



Grove - LED Strip Driver

Release date : 9/20/2015

Version : 1.0

Wiki: [http://www.seeedstudio.com/wiki/Grove - LED Strip Driver](http://www.seeedstudio.com/wiki/Grove_-_LED_Strip_Driver)

Bazaar: <http://www.seeedstudio.com/depot/Grove-LED-Strip-Driver-p-1197.html>

Document Revision History

Revision	Date	Author	Description
1.0	Sep 21, 2015	Victor.He	Create file

Contents

Document Revision History	2
1. Introduction	2
2. Specifications	3
3. Demonstration	4
3.1 Hardware installation	4
3.2 Software Programming	5
4. Resources	7

Disclaimer

For physical injuries and possessions loss caused by those reasons which are not related to product quality, such as operating without following manual guide, natural disasters or force majeure, we take no responsibility for that.

Under the supervision of Seeed Technology Inc., this manual has been compiled and published which covered the latest product description and specification. The content of this manual is subject to change without notice.

Copyright

The design of this product (including software) and its accessories is under tutelage of laws. Any action to violate relevant right of our product will be penalized through law. Please consciously observe relevant local laws in the use of this product.

1. Introduction

The LED Strip Driver with 4-pin Grove interface provides easy connectivity to your standard Arduino device or Seeed Stalker. It can help you control the luminance of a single-color LED strip, as well as the color and the luminance of an RGB LED strip through Arduino or Seeeduino.

It has 2 terminals and 2 Grove interfaces. The power for LED strip comes in through the 2-pin terminal. And the LED controlling voltages output through the 4-pin terminal. The 2 Grove interfaces are respectively screen-printed “IN” (for controlling data input) and “OUT” (for controlling data shared with the next strip driver).

It can drive an LED strip 1 to 2 meters long with 9 V, while 1 to 5 meters long with 12 V. The driver in conjunction with the colorful LED strips can add a wonderful effect to indoor or outdoor usages.

Different version comparison

- Grove - LED Strip Driver V1.1 :

1. SI5904 is used to level translation.
2. 78M05 is a Voltage Regulator, the output voltage is 5V.

- Grove - LED Strip Driver V1.2:

1. Replace SI5904 with two 2N7002.
2. The package of 100nF capacitors is 0603, not 0402.
3. 3.3K discrete resistors change to exclusion.

Note: clock/data IO requires 5V logic level.

2. Specifications

Power supply	LED Strip	LED Color	Length(m)	Max current(mA)
12V/5A	RGB LED strip	White	1	1032
			2	1822
			3	2430
			4	2800
			5	3000
9V/1A	RGB LED strip	White	1	365
			2	627

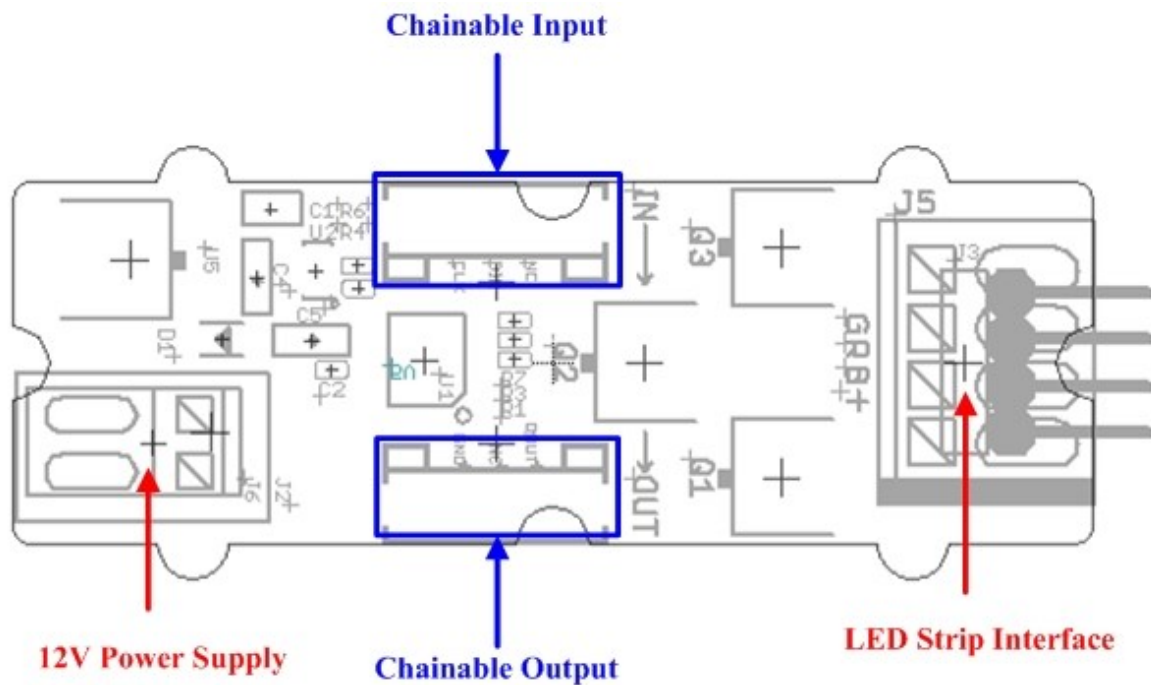

12V Power Supply – Screw terminal for 9~12v power supply.

Chainable Input – Connected to Grove - Base Shield] or the other driver's chainable output. Pin definition: **CLK DIN NC GND**.

Chainable Output – Connected to the other driver's chainable input. Pin definition: **CLK DOUT NC GND**

LED strip interface – Screw terminals for LED strip. Pin definition: **+ B R G**

Note: VCC of Arduino/Seeeduino is not connected to the Grove interface.

3. Demonstration

3.1 Hardware installation

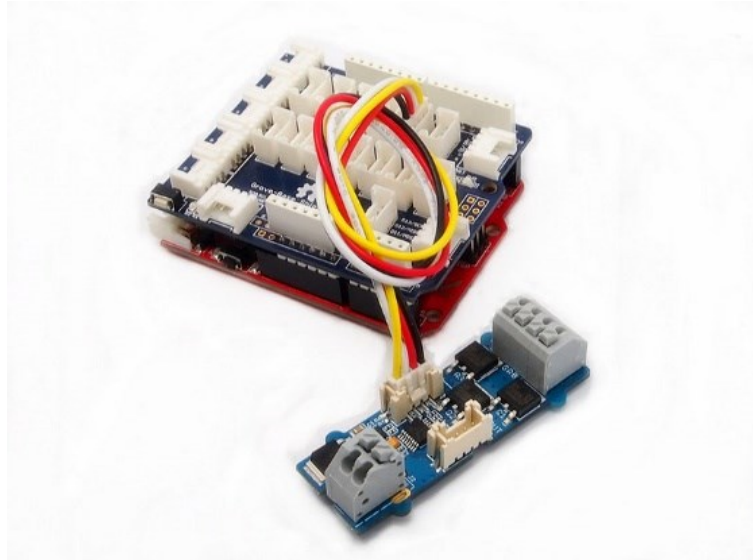

1. Connect the Grove socket marked "IN" on the LED Strip Driver and digital port 2 on the Base Shield with a Grove cable.

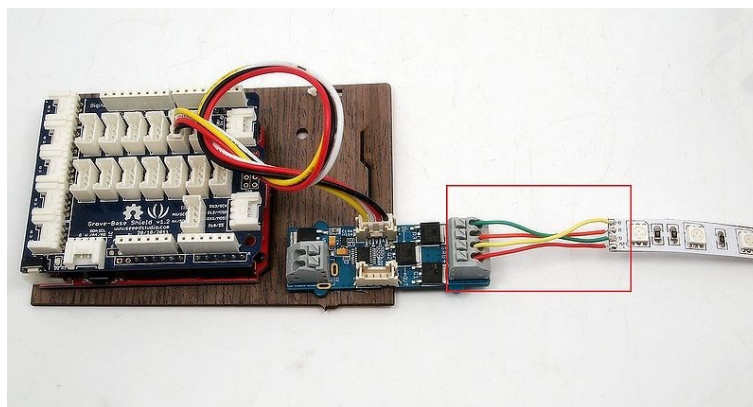

2. Connect the LED strip to the 4 pin terminal of Grove - LED Strip Driver. Make sure the wire marked "+12v" of the LED strip goes into the seat marked "+" of the terminal, and "B" into "B", "R" into "R" and "G" into "G". Most of the LED strips we are selling have 4 wires as the picture above except [White LED Flexi-Strip - 60 LED - 1m](#). If this is the kind you are going to use, the connection steps can be a little different. Still plug the wire marked "+12V" into the seat marked "+", but the other wire can go into whichever seat of "B", "R" and "G". And run the demo code named "**DemoForWhiteLEDStrip**" instead in the following software steps.

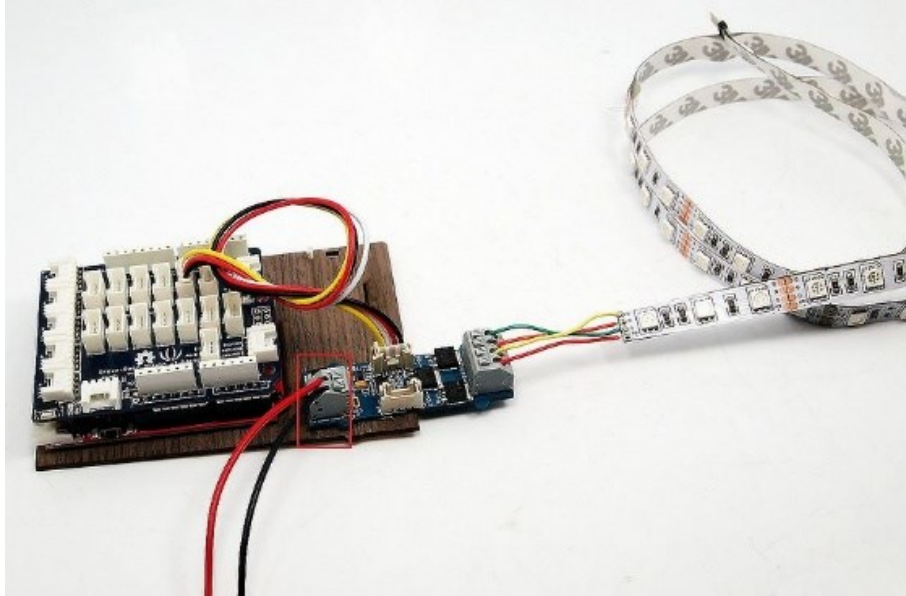

3. Connect the 12V DC or 9V DC power wires to the 2 pin terminal.

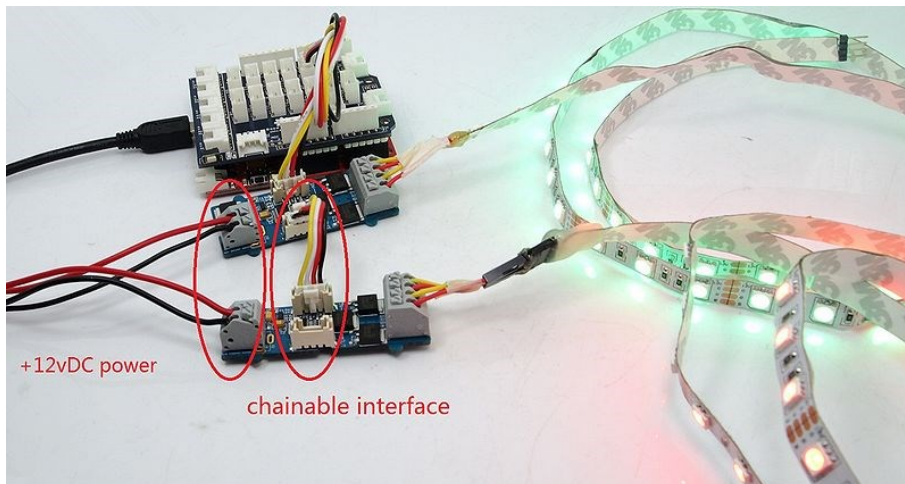

1. In cases that you want to utilize the cascade feature, prepare another driver and strip first. Then use a Grove cable to connect the Grove socket marked "out" on the first board and the Grove socket marked "IN" on the second board. Done. Two strips will shine in sync now.

3.2 Software Programming

1. Download [the LED Strip Driver Library](#). Unzip and import it into Arduino-1.0 Libraries: ..\arduino-1.0\libraries.
2. Upload the SingleLEDStrip demo code if you only use a single driver.

Single LED strip demo

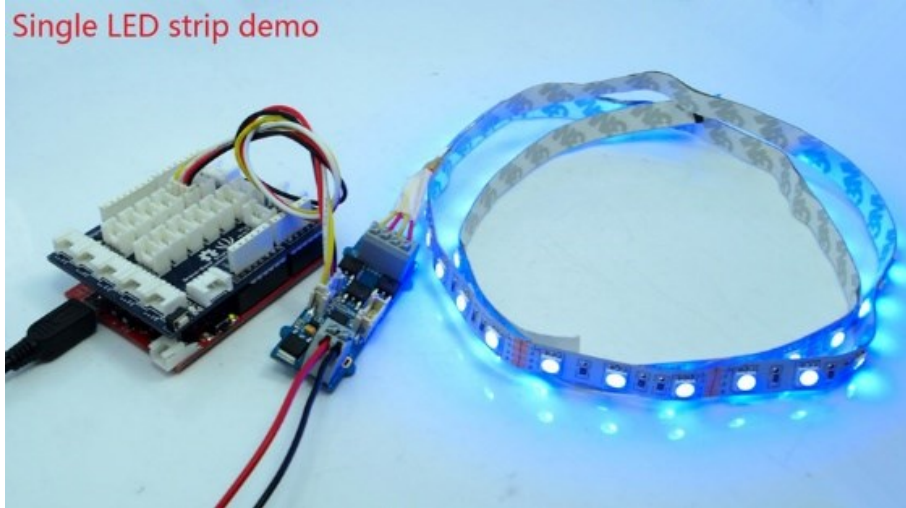

3. In case of two LED strips, upload the DualLEDStrip demo code instead.

Dual LED strip demo

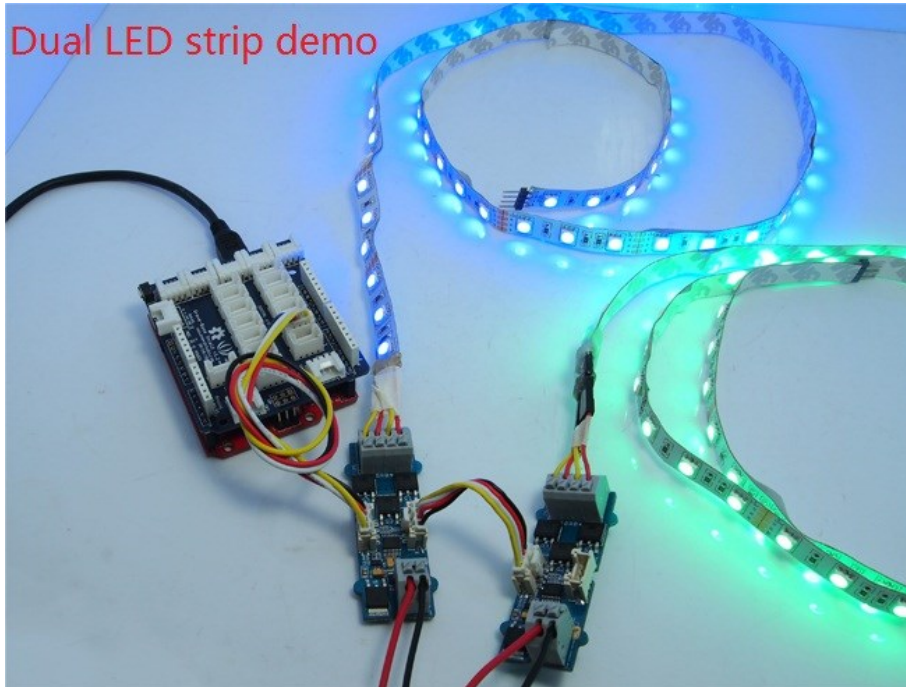

4. Resources

[LED Strip driver eagle files V1.1](#)

[LED Strip driver eagle files V1.2](#)

[Schematic V1.1 in PDF](#)

[Schematic V1.2 in PDF](#)

[P9813 Datasheet](#)

[N-MOSFET DMN3016LK3 Datasheet](#)

[LED Strip Driver library](#)

[Suli Library](#)

Mouser Electronics

Authorized Distributor

Click to View Pricing, Inventory, Delivery & Lifecycle Information:

[Seeed Studio:](#)

[105020002](#)