



International Conference on Computational Intelligence and Data Science (ICCIDS 2018)

NSE Stock Market Prediction Using Deep-Learning Models

Hiransha M^a, Gopalakrishnan E.A^b, Vijay Krishna Menon^{ab}, Soman K.P*

Centre for Computational Engineering and Networking, Amrita School of Engineering, Amrita Vishwa Vidyapeetham, Coimbatore-641112, India

Abstract

The neural network, one of the intelligent data mining technique that has been used by researchers in various areas for the past 10 years. Prediction and analysis of stock market data have got an important role in today's economy. The various algorithms used for forecasting can be categorized into linear (AR, MA, ARIMA, ARMA) and non-linear models (ARCH, GARCH, Neural Network). In this paper, we are using four types of deep learning architectures i.e Multilayer Perceptron (MLP), Recurrent Neural Networks (RNN), Long Short-Term Memory (LSTM) and Convolutional Neural Network (CNN) for predicting the stock price of a company based on the historical prices available. Here we are using day-wise closing price of two different stock markets, National Stock Exchange (NSE) of India and New York Stock Exchange (NYSE). The network was trained with the stock price of a single company from NSE and predicted for five different companies from both NSE and NYSE. It has been observed that CNN is outperforming the other models. The network was able to predict for NYSE even though it was trained with NSE data. This was possible because both the stock markets share some common inner dynamics. The results obtained were compared with ARIMA model and it has been observed that the neural networks are outperforming the existing linear model (ARIMA).

© 2018 The Authors. Published by Elsevier Ltd.

This is an open access article under the CC BY-NC-ND license (<https://creativecommons.org/licenses/by-nc-nd/3.0/>)

Peer-review under responsibility of the scientific committee of the International Conference on Computational Intelligence and Data Science (ICCIDS 2018).

Keywords: Artificial Neural Network ;Deep learning ;Mean Absolute Percentage Error ; National Stock Exchange ;New York Stock Exchange.

Nomenclature

ANN	Artificial Neural Network
AR	Auto Regression
ARMA	Auto Regressive Moving Average
ARIMA	Auto Regressive Integrated Moving Average
CNN	Convolutional Neural Network

* Hiransha M. Tel.: +91-9961933201

** Gopalakrishnan E.A

E-mail address: hiransham5600@gmail.com, ea.gopalakrishnan@cb.amrita.edu

DL	Deep learning
LSTM	Long Short Term Memory
ML	Machine Learning
MAPE	Mean Absolute Percentage Error
MLP	Multi Layer Perceptron
RNN	Recurrent Neural Network
NSE	National Stock Exchange
NYSE	New York Stock Exchange

1. Introduction

Stock market is a place where shares or stocks of a firm are traded. It can be split into two components:

- primary market
- secondary market

Primary market is where new issues are introduced to the market through Initial Public Offerings. Secondary market is where investors trade securities that they already own. Stock market is having a highly fluctuating and non-linear time series data. A time series is a set of data measured over time to acquire the status of some activity [6]. Linear models like AR, ARMA, ARIMA [9][10] have been used for stock market forecasting. The only problem with these models are, that they work only for a particular time series data, i.e the model identified for a particular company won't perform well for another. Due to the equivocal and unforeseeable nature of stock market, stock market forecasting takes higher risk compared to other sectors. It is one of the most important reason for the difficulty in stock market prediction. Here is where the application of deep-learning models in financial [4] forecasting comes in. Deep neural network got its name due to the use of neural network architecture in DL models. It is also called as ANN. ANNs are good approximators and they are capable to learn and generalize from experience. Practical application of ANN in forecasting problems is very successful due to the following characteristics:

- ANN's are good function approximators, so the input and output relationship can be examined by them even if the data set is very complex.
- ANN's can identify new test samples even if they have not been used during the training of network.

For the past few decades, ANN has been used for stock market prediction. Comparison study of different DL models of stock market prediction has already been done as we can see in [1]. Coskun Hamzacebi has experimented forecast- ing using iterative and directive methods [6]. Ajith Kumar Rout et.al made use of a low complexity recurrent neural network for stock market prediction [7]. Yunus Yetis et.al applied ANN to predict NASDAQ's (National Association of Securities Dealers Automated Quotations) stock value with given input parameter of stock market [12]. Roman et.al performed an analysis on multiple stock market return using Back propagation and RNN [13]. Neini et.al con- ducted a comparison study between Feed Forward MLP an Elman Recurrent Network for predicting stock value of company [18]. Mizuno et.al applied neural networks to technical analysis as a prediction model [15]. Guresen in 2011 had conducted a study to know about the effectiveness of ANN in stock market forecasting [19]. In [20], they explored the interdependency between stock volume and stock price on a certain number of nifty 50 listed companies. In [21], Batres-Estrada explains about different applications of DL models on time series analysis. X Ding et.al in [22] con- ducted a study on combination of Natural language processing (NLP) and financial time series analysis. In [23], they used ML algorithms like Least Square Support Vector Machine (LSSVM) and Particle Swarm Optimization (PSO) for stock market prediction. In [24], Kim et.al proposed a different approach for stock market prediction. i.e They intro- duced a Genetic Algorithm(GA) for discretization of features in ANN for stock price forecasting. In [25], deals with multi-stage fuzzy inference and wavelet transform for forecasting stock trends. Here the short-term features present in the stock trend is described using wavelet transform.

2. ARTIFICIAL NEURAL NETWORK

ANN [16] is a computational structure which performs in a similar manner to that of biological neurons [8]. It is designed to identify an underlying trend from a data and to generalize from it. ANN's are considered as non-linear statistical data tool [2]. The intricate relationship between outputs and inputs can be modeled using ANN. The main advantage of ANN is its capability to learn the underlying patterns from the data, where most of the conventional methods fail [3]. Usually, ANN consist of three layers namely input layer, hidden layer and output layer. Non-linear activation functions are used in all the nodes in hidden as-well-as output layers excluding input layer. Each node in the input layer is connected to each neuron in the succeeding hidden layer followed by output layer.

2.1. NEURONS

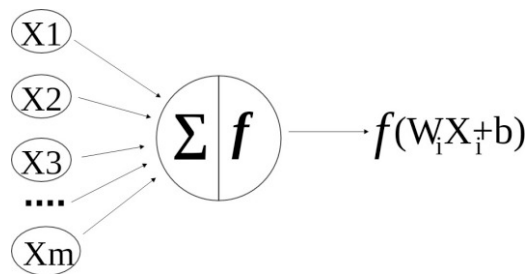

Fig. 1. Artificial Neuron

The above figure shows an artificial neuron which is a simple processing unit inspired from the biological neuron [8][10]. The neuron has 'm' inputs (x_i) and each input is connected to the neuron by weighted link (w_i). Here the neuron sums up the inputs multiplied by the weights using the below equation

$$A = \sum x_i w_i + b \quad (1)$$

Where A is the net sum and b is the threshold value. For getting the output this net sum is applied into a function called activation function $F(A)$.

$$\text{out put} = F(A) \quad (2)$$

Here the input values and weights are real numbers. In some situations the threshold value b is considered as an imaginary input $x_0 = +1$ and a connection weight w_0 for the simplicity of computation.

2.2. FEED FORWARD NETWORK

Feed forward network [11] also known as MLP is an example of a simple neural network. Each input neurons are linked to the succeeding hidden layer neurons through a weighted matrix w_{ki} . A Network has three section of layers input, hidden and output layers [8]. Artificial neurons are those which are present in the hidden and output layer [8] which is also known as [17]. Each of these neurons receive inputs from a previous layer. Neurons in the network are not connected to the neurons in the same layer but they are connected with neurons in the next layer. Equation for

activation function [14] of an i^{th} hidden neuron is given by

$$h_i = f(u_i) = f\left(\sum_{k=0}^K w_{ki} x_k\right) \tag{3}$$

h_i : i^{th} hidden neuron , $f(u_i)$: link function which provides non-linearity between input and hidden layer , w_{ki} : weight in the $(k, i)^{th}$ entry in a $(K \times N)$ weight matrix , x_k : K^{th} input value

$$y_j = f(u'_j) = f\left(\sum_{i=1}^N w'_{ij} h_i\right) \tag{4}$$

y_j : j^{th} output value

2.3. RECURRENT NEURAL NETWORK

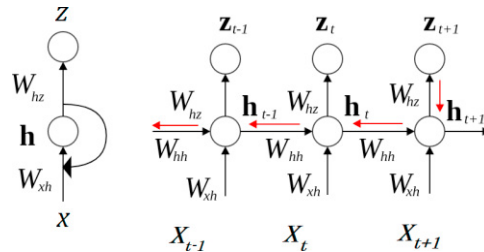

Fig. 2. Recurrent Neural Network

Unlike MLP, RNN [18] takes input from two sources, one is from the present and the other from the past. Information from these two sources are used to decide how they react to the new set of data. This is done with the help of a feedback loop where output at each instant is an input to the next moment. Here we can say that the recurrent neural network has memory. Each input sequence has plenty of information and this information are stored in the hidden state of recurrent networks. This hidden information is recursively used in the network as it sweeps forward to deal with a new example. Fig 2 shows a pictorial representation of recurrent neural networks.

Input to hidden layer equation is given as:

$$h_t = g_n(W_{xh}X_t + W_{hh}h_{t-1} + b_h) \tag{5}$$

where as h_t : hidden layer at t^{th} instant , g_n : function , W_{xh} : input to hidden layer weight matrix, X_t : input at t^{th} instant, h_{t-1} :hidden layer at $t - 1^{th}$ instant , b_h :bias or threshold value

hidden to output layer equation is given as :

$$Z_t = g_n(W_{hz}h_t + b_z) \quad (6)$$

whereas Z_t :output vector, W_{hz} :hidden to output layer weight matrix, b_z :bias or threshold

2.4. LONG SHORT TERM MEMORY

LSTM [19] is a special type of RNN. These networks are proficient in learning about long-term dependencies. It was introduced by Hochreiter and Schmidhuber in 1997. These networks are clearly designed to evade the long-term dependency problem, but remembering information for a long time period back is their normal behavior. Fig 3 shows a pictorial representation of LSTM cell. LSTM have a different structure compared to other neural networks. Conventional RNN has a very simple neural network with a feedback loop but LSTM consists of a memory block or cells instead of a single neural network layer. Each cell or block has 3 gates and a cell state tend to regulate the flow of data information through the cells. Fig 3 shows a pictorial representation of LSTM. Here C_{t-1} :old cells state, C_t

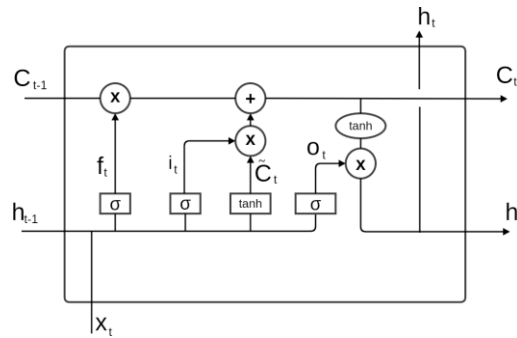

Fig. 3. LSTM CELL

:present cell state, h_{t-1} :Output of previous cell, h_t :Output of present cell, i_t : Input gate layer, f_t :forget gate layer, O_t :Output sigmoid gate layer

In the above figure horizontal line passing through the top of the diagram is known as cell state (C_{t-1}, C_t). It acts like a conveyor belt that runs over the entire network. It carries the information from the previous cell to the present and so on. The decision for storing information in cell state is taken by forget gate layer (f_t) which is also known as sigmoid layer. The output from forget gate is added to cell state using a point-wise multiplication operation. Next is input gate which comprises of a sigmoid layer (i_t) and tanh layer. Input gate combines these two into the cell state. Here \tilde{C}_t are the new values created by tanh layer. Output (h_t) is formed by a point-wise multiplication of sigmoid gate O_t and tanh.

3. Methodology

3.1. DATASET 1

Dataset is taken from highly traded stocks of three different sectors which are Automobile, Banking and IT sectors from NSE. The corresponding stocks from these sectors are Maruti, Axis bank, and Hcltech. Each contains information like stock symbol, stock series, stock date and previous closing, opening, high, low, last, closing and average prices, total traded quantity, turnover and no. of trades. From these datasets, we extract only the day-wise closing price of each stock because day wise stock price is preferred since investors make decision on buying which stock or forfeiting which stock based on the closing price of the market.

TRAINING. Training dataset used is TATAMOTORS which is from Automobile sector. The training dataset is from the period of 1 JAN 1996 TO 2015 June 30 and it contains the closing price of 4861 days. The training data ranges between 58.79 and 1365.15. The extracted data was then subjected to normalization to unify the data range within 0 and 1. Normalization of data is done to bring all stock data into a common range. Since we are using stock data from different market, we need the data to be under a common range. This process was done using the equation:

$$x_{norm} = (x - x_{min}) / (x_{max} - x_{min}) \quad (7)$$

where x_{norm} is the normalized value, x_{min} and x_{max} is the minimum and maximum value in the training dataset. This normalized data was given as the input to the network in a window size of 200 to predict 10 days in future. And the output from the network was subjected to a De-normalization process for acquiring original predicted values. The training of network was done for 1000 epochs. The window size was fixed by performing error calculation on each window size which varies from 50 to 250. Among this, the window size of 200 resulted minimum error than other window sizes.

WINDOW SIZE FIXING. The table 1 shows the MAPE (Mean Absolute Percentage Error) obtained for different window size and prediction days. The topmost row with values 50,100,150,200 and 250 represents window size and 10,20, 30, 40 in the first column represents the prediction days. From the table, it is clear that minimum MAPE is obtained with window size 200 for 10 days prediction. So here we fix our window size as 200 with 10 days prediction.

Table 1. Table elaborating window size and interval of prediction days

Pred:days	50	100	150	200	250
10	4.5	4.34	4.62	4.17	4.18
20	6.53	6.05	5.88	5.61	5.16
30	6.49	7.84	6.97	5.11	5.86
40	9.65	9.34	6.84	5.86	7.06

TESTING. For testing, we chose data from three main sectors such as Automobile, Banking, IT and the corresponding stocks from this sectors were Maruti, Axis bank, and Hcl technologies respectively. Here also we extract the day-wise closing price of each stock and they were subjected to data normalization and the predicted output was subjected to De-normalization as done in the training dataset. Test datasets were from the time period of 5th October 2007 to 30th June 2017. The window size of input stock data to the network was 200 and was found by performing error calculation for various window sizes.

Predicted output was subjected to mean absolute percentage error for calculating the error in the predicted output. Equation for calculating MAPE is given below.

$$MAPE = \frac{1}{n} \sum \left(\frac{|Actual - Forecast|}{|Actual|} \right) \quad (8)$$

Here ‘Actual’ values are the labels and ‘Forecast’ values represents the predicted values.

3.2. DATASET 2

In order to verify whether the models identify the common dynamics between different stock exchange, we tried to predict the model using NYSE stock data. Data is taken from yahoo finance. We selected top two active stock in new york stock exchange and they are Bank of America (BAC) and Chesapeake Energy (CHK). Time period for the dataset was from 3rd January 2011 to 30th December 2016 and the data is expressed in US in dollar. From dataset, we extracted only the day-wise closing price.

TESTING. We selected day-wise closing price for each company for the period of 3rd January 2011 to 30th December 2016. Then we normalized the extracted data by using the equation (1) to unify the data before giving it as input to the network.

4. RESULTS AND DISCUSSION

Here we have performed the analysis on two stock markets data and they are NSE and NYSE. For this, we had used four types of deep neural networks named MLP, RNN, LSTM, and CNN. All these networks were trained with NSE data of Tata Motors which belong to the automobile sector. And these networks subjected to test using the data from NSE and NYSE. For NSE we choose data from automobile, financial, IT sectors and for NYSE we choose financial and petroleum sectors. For the comparison between linear and non-linear models, we have used ARIMA model which is a linear model.

In this work we have considered 400 days prediction for ARIMA and neural network. The motive behind this was to compare the performance of ARIMA and neural network for a specific period of time. The results obtained are tabulated in table 2 and table 3.

Table 2. MAPE incurred during the prediction of MARUTI, HCL and AXIS BANK NSE values using ARIMA model for the duration of 400 days

COMPANY	MAPE
MARUTI	20.66
HCL	24.69
AXIS BANK	19.64

Table 2 shows the MAPE obtained for predicting closing price for 400 days using ARIMA model.

Table 3. MAPE incurred during the prediction of MARUTI, HCL and AXIS BANK NSE values using DL network for the duration of 400 days

COMPANY	RNN	LSTM	CNN	MLP
MARUTI	5.82	6.03	4.05	4.81
HCL	5.40	5.52	4.40	3.85
AXIS BANK	11.64	4.88	5.22	5.5

Table 3 shows the MAPE obtained by the neural network for 400 days prediction. Comparing table 2 and table 3 result shows that the performance of neural network architecture is better than that of ARIMA. This may be due to the reason that ARIMA fails to identify the non-linearities existing with in the data, where as neural network architectures can identify the non-linear trends existing with in the data.

Table 4. MAPE incurred during the prediction of MARUTI, HCL and AXIS BANK NSE values using DL network

COMPANY	RNN	LSTM	CNN	MLP
MARUTI	7.86	6.37	5.36	6.29
HCL	8.53	6.97	6.42	7.38
AXIS BANK	9.27	8.13	7.94	8.10

In table 4 we have the MAPE values obtained for testing MARUTI, HCL and AXIS BANK for the time period of 5th October 2007 to 30th June 2017.

In case of Maruti, fig (4a) shows the MLP network which was successful in capturing the pattern because it uses

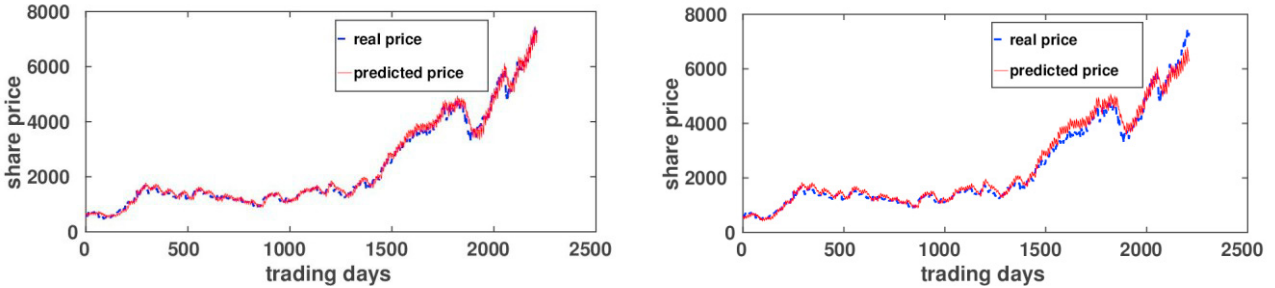

Fig. 4. (a) Real and Predicted values of MARUTI stock using MLP;(b) Real and Predicted values of MARUTI stock using RNN

the current window information for the prediction. But in case of fig(4b) and fig(5a) between the period of 1500 and 2300 days RNN and LSTM failed to identify the seasonal pattern which can be considered as change in behavior of system. In fig(5b) CNN almost captured the pattern since it accounts only the data in a particular window.

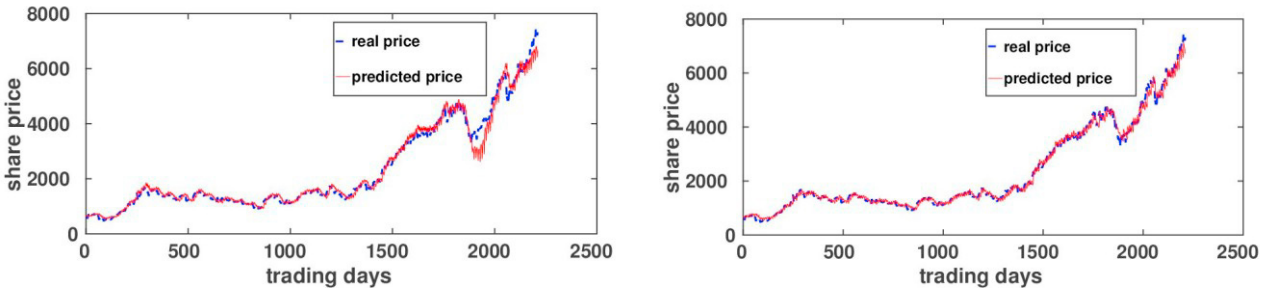

Fig. 5. (a) Real and Predicted values of MARUTI stock using LSTM ; (b) Real and Predicted values of MARUTI stock using CNN.

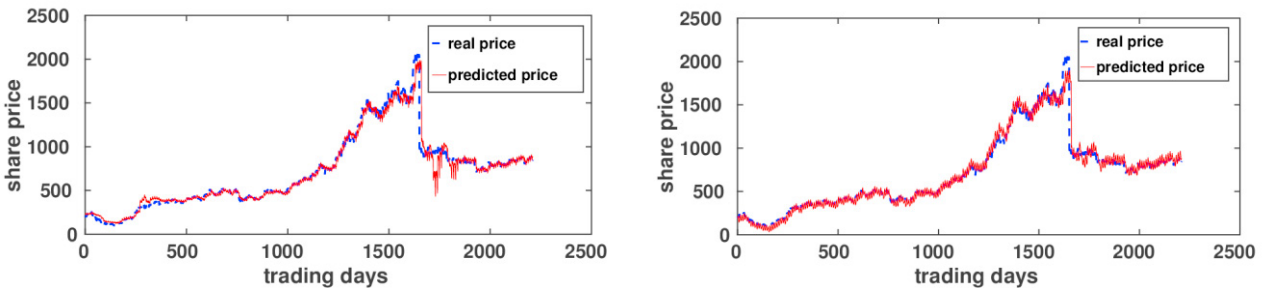

Fig. 6. (a) Real and Predicted values of HCLTECH stock using MLP;(b) Real and Predicted values of HCLTECH stock using RNN.

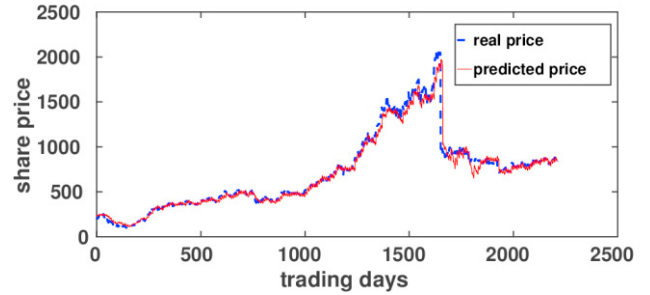
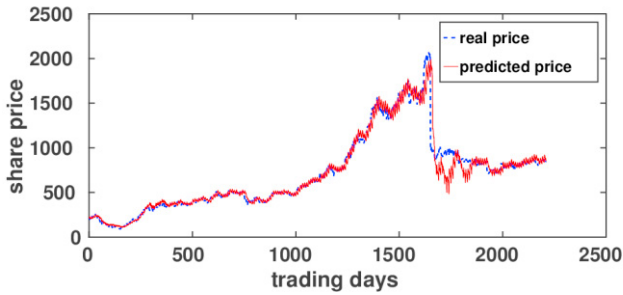

Fig. 7. (a) Real and Predicted values of HCLTECH stock using LSTM; (b) Real and Predicted values of HCLTECH stock using CNN.

In case of HCLTECH, fig (6a), MLP network is successful in capturing the seasonal pattern but between the time period 1600 and 1900 days it failed to capture the pattern. In fig(6b) RNN was almost successful in identifying the pattern where as fig(7a) and fig(7b) shows that LSTM and CNN fail to capture change in system between the period 1400 and 1800 days.

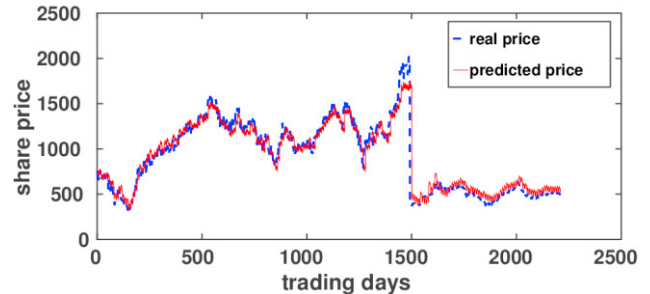
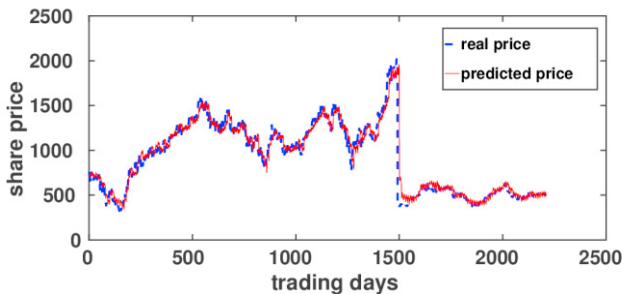

Fig. 8. (a) Real and Predicted values of AXISBANK stock using MLP; (b) Real and Predicted values of AXISBANK stock using RNN

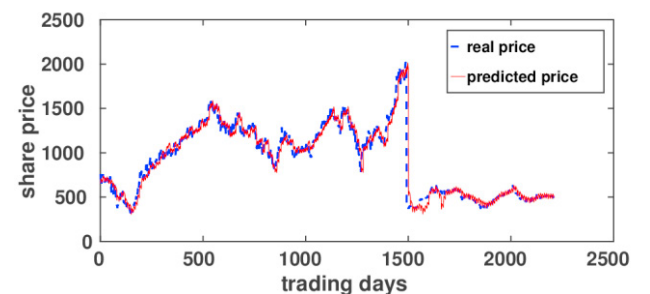
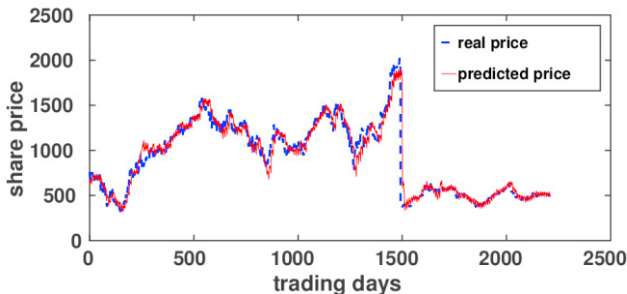

Fig. 9. (a) Real and Predicted values of AXISBANK stock using LSTM; (b) Real and Predicted values of AXISBANK stock using CNN

In case of AXIS BANK, from fig(8a), MLP network identified the pattern at the beginning but on reaching the time period between 1400 and 1700 days it failed to capture the pattern. Similar effects can be found in fig(8b) where RNN captured the pattern at the initial stage but on reaching the time period between 1300 and 1600 it fails to identify the pattern. From fig(9a) and fig(9b), LSTM and CNN, LSTM network is not identifying the pattern for time periods between 200 and 500 days where as CNN almost captured the pattern except at the period between 1600 and 1800 days.

Table 5. MAPE incurred during the prediction of BANK OF AMERICA and CHESAPEAKE ENERGY NYSE values using DL network

COMPANY	RNN	LSTM	CNN	MLP
BANK OF AMERICA	5.38	6.01	5.31	4.82
CHESAPEAKE ENERGY	8.94	8.98	9.18	7.85

Table 5 shows the mean absolute percentage error obtained for testing BANK OF AMERICA (BAC), CHESAPEAKE(CHK) energy from NYSE with four DNNs pre-trained with TATA MOTORS from NSE.

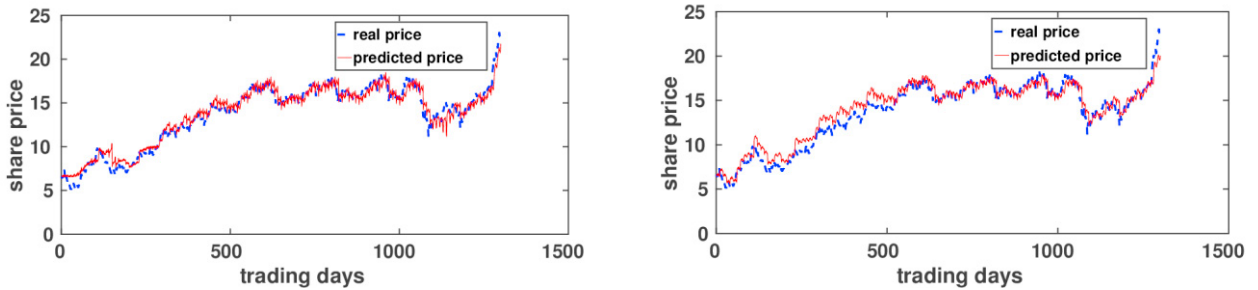

Fig. 10. (a) Real and Predicted values of BAC stock using MLP; (b) Real and Predicted values of BAC stock using RNN

In case of Bank of America, fig(10a), MLP network failed to identify the pattern in beginning but later on it almost captured the pattern. From fig(10b), RNN also exhibits similar behavior in beginning time period from 50 to 600 and later on it captured the pattern but on reaching the end prediction is little lagging compared to the actual values. From fig(11a) we can see LSTM failed to capture the pattern at the beginning and also between the period 1100 and 1250 days. In fig(11b), CNN almost captured the pattern compared to other three networks.

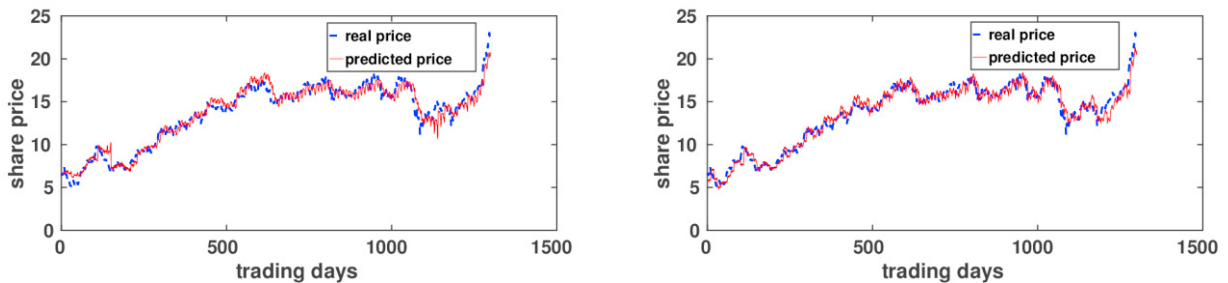

Fig. 11. (a) Real and Predicted values of BAC stock using LSTM; (b) Real and Predicted values of BAC stock using CNN

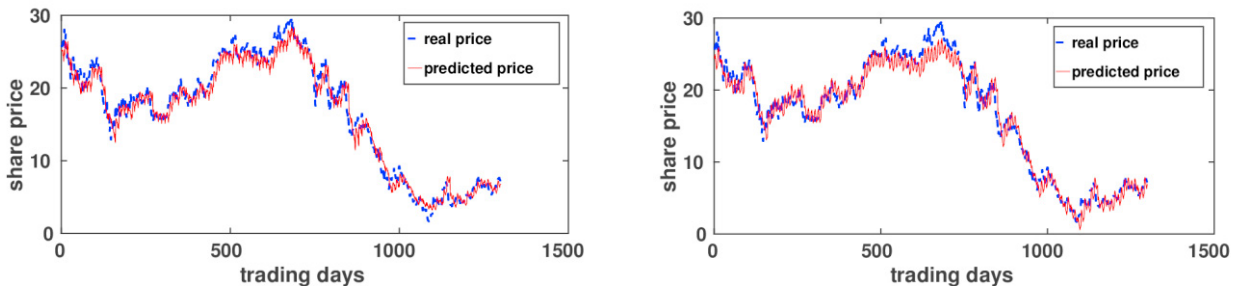

Fig. 12. (a) Real and Predicted values of CHK stock using MLP; (b) Real and Predicted values of CHK stock using RNN

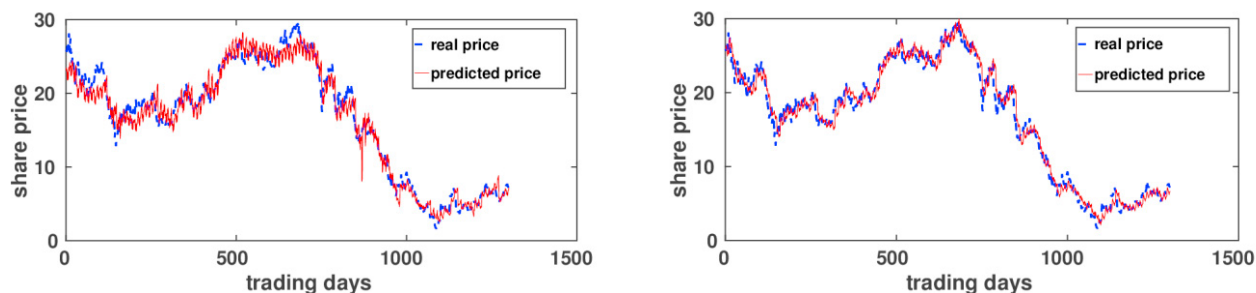

Fig. 13. (a) Real and Predicted values of CHK stock using LSTM; (b) Real and Predicted values of CHK stock using CNN

In case of Chesapeake Energy, fig(12a) and fig(12b), MLP and RNN failed to identify the pattern between a period of 500 and 900 days. In fig(13a), LSTM, failed to capture the seasonal pattern at the beginning and also for the period between 600 and 800 days. But towards the end, it almost identified the pattern. In fig(13b) we can observe that CNN performed better compared to other three networks even though there are some region which shows less accuracy for the predicted values.

5. CONCLUSION

In this work we used four DL architectures for the stock price prediction of NSE and NYSE, which are two different leading stock markets in the world. Here we trained four networks MLP, RNN, LSTM and CNN with the stock price of TATA MOTORS from NSE. The models obtained were used for predicting the stock price of MARUTI, HCL and AXIS BANK from NSE stock market and also for predicting the stock price of BANK OF AMERICA (BAC) and CHESAPEAKE ENERGY (CHK) from NYSE. From the result obtained, it is clear that the models are capable of identifying the patterns existing in both the stock markets. This shows that there exist an underlying dynamics, common to both the stock markets. Linear models like ARIMA is a univariate time series prediction and hence they are not capable of identifying underlying dynamics within various time series. From the result, we can conclude that DL models are outperforming ARIMA model. In the proposed work, CNN has performed better than other three networks as it is capable of capturing the abrupt changes in the system since a particular window is used for predicting the next instant. This work hasn't explored the advantage of using a hybrid network which combines two networks to make a model for prediction.

References

- [1] S. Selvin, R. Vinayakumar, E. A. Gopalakrishnan, V. K. Menon and K. P. Soman. (2017) "Stock price prediction using LSTM, RNN and CNN-sliding window model." *International Conference on Advances in Computing, Communications and Informatics*: 1643-1647.
- [2] Rather A. M., Agarwal A., and Sastry V. N. (2015). "Recurrent neural network and a hybrid model for prediction of stock returns." *Expert Systems with Applications* **42** (6): 3234-3241.
- [3] Zhang G., Patuwo B. E., and Hu M. Y. (1998). "Forecasting with artificial neural networks: The state of the art." *International journal of forecasting* **14** (1): 35-62.
- [4] Heaton J. B., Polson N. G., and Witte J. H. (2017). "Deep learning for finance: deep portfolios." *Applied Stochastic Models in Business and Industry* **33** (1): 3-12.
- [5] Jabin S. (2014). "Stock market prediction using feed-forward artificial neural network". *growth* **99** (9).
- [6] Hamzaebi C., Akay D. and Kutay F. (2009). "Comparison of direct and iterative artificial neural network forecast approaches in multi-periodic time series forecasting." *Expert Systems with Applications* **36** (2): 3839-3844.
- [7] Rout A. K., Dash P. K., Dash R., and Bisoi R. (2015). "Forecasting financial time series using a low complexity recurrent neural network and evolutionary learning approach." *Journal of King Saud University-Computer and Information Sciences* **29** (4): 536-552.
- [8] Moghaddam A. H., Moghaddam M. H., and Esfandyari M. (2016). "Stock market index prediction using artificial neural network." *Journal of Economics, Finance and Administrative Science* **21** (41): 89-93.
- [9] Zhang G. P. (2003). "Time series forecasting using a hybrid ARIMA and neural network model." *Neurocomputing* **50**: 159-175.
- [10] Menon V. K., Vasireddy N. C., Jami S. A., Pedamallu V. T. N., Sureshkumar V., and Soman K. P. (2016, June). "Bulk Price Forecasting Using Spark over NSE Data Set." *In International Conference on Data Mining and Big Data* : 137-146.

- [11] Budhani N., Jha C. K., and Budhani S. K. (2014). "Prediction of stock market using artificial neural network." *In Soft Computing Techniques for Engineering and Technology (ICSCCTET)* : 1-8.
- [12] Yetis Y., Kaplan H., and Jamshidi M. (2014). "Stock market prediction by using artificial neural network." *In World Automation Congress (WAC)* :718-722.
- [13] Roman J., and Jameel A. (1996). "Backpropagation and recurrent neural networks in financial analysis of multiple stock market returns." *In Twenty-Ninth Hawaii International Conference on system sciences* 2: 454-460.
- [14] Sibi P., Jones S. A. and Siddarth P. (2013). "Analysis of different activation functions using back propagation neural networks." *Journal of Theoretical and Applied Information Technology* 47 (3): 1264-1268.
- [15] Mizuno H., Kosaka M., Yajima H. and Komoda N. (1998). "Application of neural network to technical analysis of stock market prediction." *Studies in Informatic and control* 7 (3): 111-120.
- [16] Wang J. Z., Wang J. J., Zhang Z. G. and Guo S. P. (2011). "Forecasting stock indices with back propagation neural network." *Expert Systems with Applications* 38 (11): 14346-14355.
- [17] Karpathy A., Johnson J. and Fei-Fei L. (2015). "Visualizing and understanding recurrent networks." *arXiv preprint arXiv :1506.02078*
- [18] Jia H. (2016). "Investigation into the effectiveness of long short term memory networks for stock price prediction." *arXiv preprint arXiv :1603.07893*
- [19] Guresen E., Kayakutlu G., and Daim T. U. (2011). "Using artificial neural network models in stock market index prediction." *Expert Systems with Applications* 38 (8): 10389-10397.
- [20] Abinaya P., Kumar V.S., Balasubramanian P. and Menon V.K. (2016). "Measuring stock price and trading volume causality among Nifty50 stocks: The Toda Yamamoto method." *In Advances in Computing, Communications and Informatics (ICACCI)* :1886-1890
- [21] Batres-Estrada B. (2015). "Deep learning for multivariate financial time series."
- [22] Ding X., Zhang Y., Liu T. and Duan J. (2015). "Deep learning for event-driven stock prediction." *In Ijcai* :2327-2333
- [23] Hegazy O., Soliman O.S. and Salam M.A. (2014). "A Machine Learning Model for Stock Market Prediction." *arXiv preprint arXiv :1402.7351*
- [24] Kim K.J. and Han I. (2000). "Genetic algorithms approach to feature discretization in artificial neural networks for the prediction of stock price index." *Expert systems with Applications* 19 (2) :125-132
- [25] Kishikawa Y. and Tokinaga S. (2000). " Prediction of stock trends by using the wavelet transform and the multi-stage fuzzy inference system optimized by the GA." *IEICE transactions on fundamentals of electronics, communications and computer sciences* 83 (2) :357-366