

BERMAD 700 Large Size Series

Model: 700-M5, 700-M5M, 700-M5L

- Large scale pumping systems
- National and municipal water networks
- Reservoir and dam water level control
- Industrial water systems

The BERMAD 700 Series large size control valves are hydraulically operated, diaphragm actuated type. Unique hydro-dynamic globe valve design with a special open plug provides high flow capabilities. The valves are available in the standard configuration or with an Independent Flow Check code "2S". These valves are designed for large flow applications (On-off valve, pressure reducing, pressure sustaining, pump control, level control, check valve, flow control, burst control, emergency shut-off valve etc.), where precise control is needed.



Features and Options

- Hydrodynamic wide globe valve body provides:
 - Higher flow (Kv; Cv) than standard globe valves
 - Higher resistance to cavitation damage
- In-line serviceable
- Valves are suitable for working with all types of command: Hydraulic, Electric and Pneumatic.
- Self-operated valves that can work without an external source of power.
- Wide range of options and accessories:
 - One-way or two-way flow direction
 - V-Port (optional)
 - Cavitation cage (optional)
 - Visual position indicator
 - Limit switches
 - Analog opening output
 - Large selection of control accessories
 - Large inspection and service ports (700-M5M, 700-M5L)



Technical Data

Valve Pattern: Globe
 Size Range: DN 500-1200; 20"-48"
 Pressure Rating: PN10, 16 & 25
 ANSI Class #150;
 ANSI Class #300 (Consult Factory)

End Connections: Flanged
 Temperature: Water up to 60°C; 140°F for
 Cold water applications
 Coating: Fusion Bonded Epoxy, dark blue, certified
 for drinking water applications, outside UV protection

Valve Plugs Characteristics

Kv; Cv to Valve Travel Graph

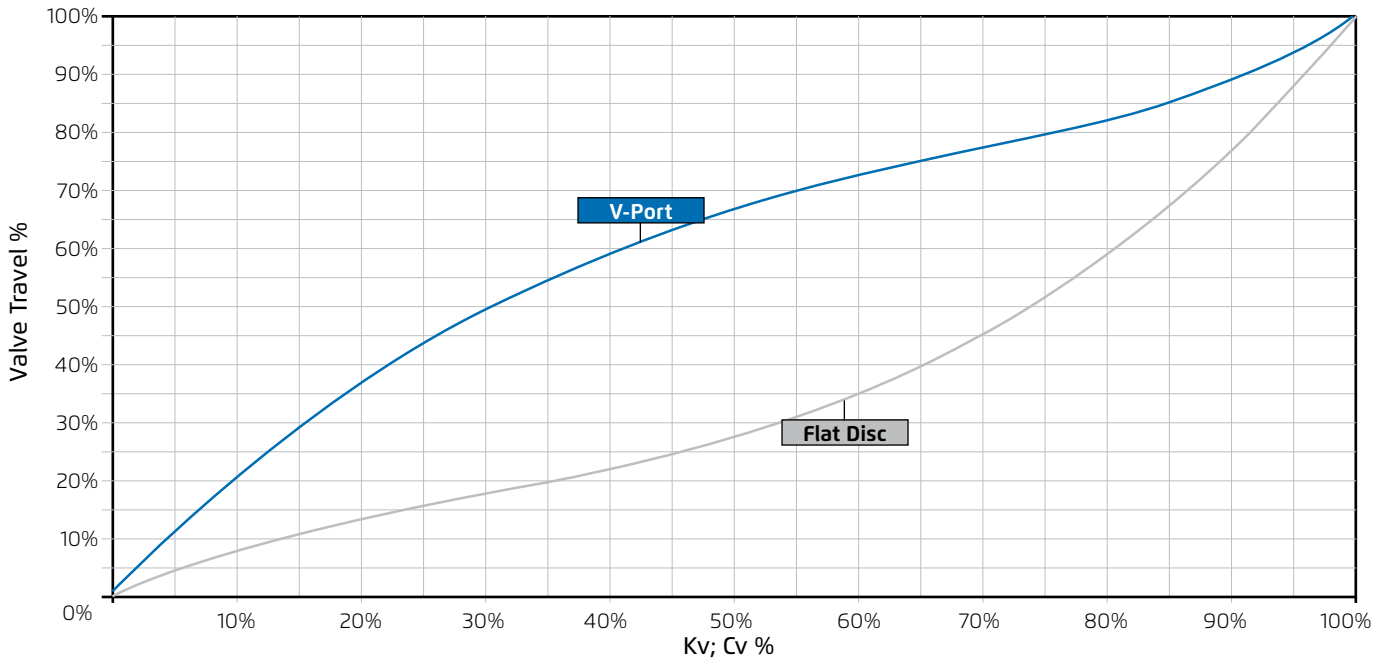

SI

Valve Travel

Type	M5	M5M	M5L
mm	167	200	250

Flow Factors

Type	M5	M5M	M5L
Kv – Flat Disc	5,020	6,850	11,150
Kv – V-Port / Cage	Consult Factory		

Differential Pressure & Flow Calculation

Valve flow coefficient, $K_v = Q \sqrt{\frac{G_f}{\Delta P}}$

Where:

K_v = Valve flow coefficient (flow in m³/h at 1bar ΔP)
 Q = Flow rate (m³/h)
 ΔP = Differential pressure (bar)
 G_f = Liquid specific gravity (Water = 1.0)

Practical formulas for water:

$$Q = K_v \sqrt{\Delta P} \quad \Delta P = \left(\frac{Q}{K_v}\right)^2$$

US

Type	M5	M5M	M5L
Inch	6.57	7.87	9.84

Type	M5	M5M	M5L
Cv – Flat Disc	5,798	7,878	12,878
Cv – V-Port / Cage	Consult Factory		

Valve flow coefficient, $C_v = Q \sqrt{\frac{G_f}{\Delta P}}$

Where:

C_v = Valve flow coefficient (flow in gpm at 1psi ΔP)
 Q = Flow rate (gpm)
 ΔP = Differential pressure (psi)
 G_f = Liquid specific gravity (Water = 1.0)

Practical formulas for water:

$$Q = C_v \sqrt{\Delta P} \quad \Delta P = \left(\frac{Q}{C_v}\right)^2$$

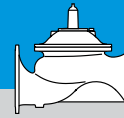

Flow Charts

SI Metric

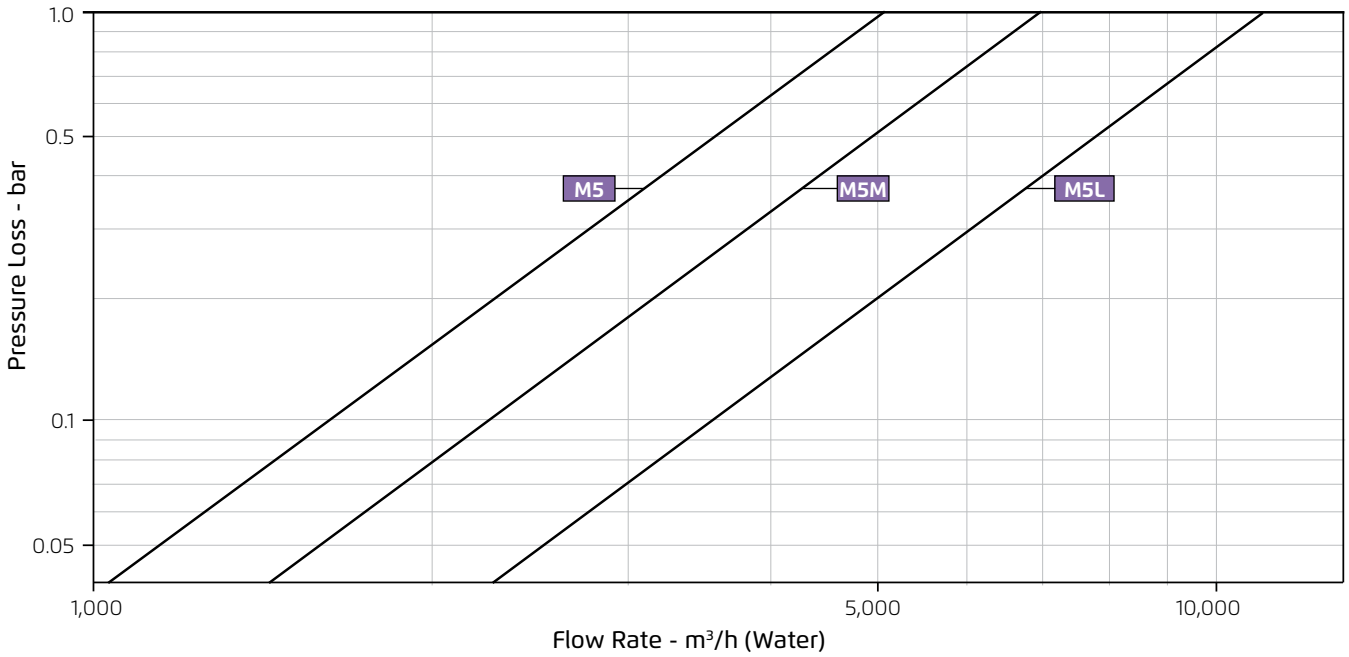

US English

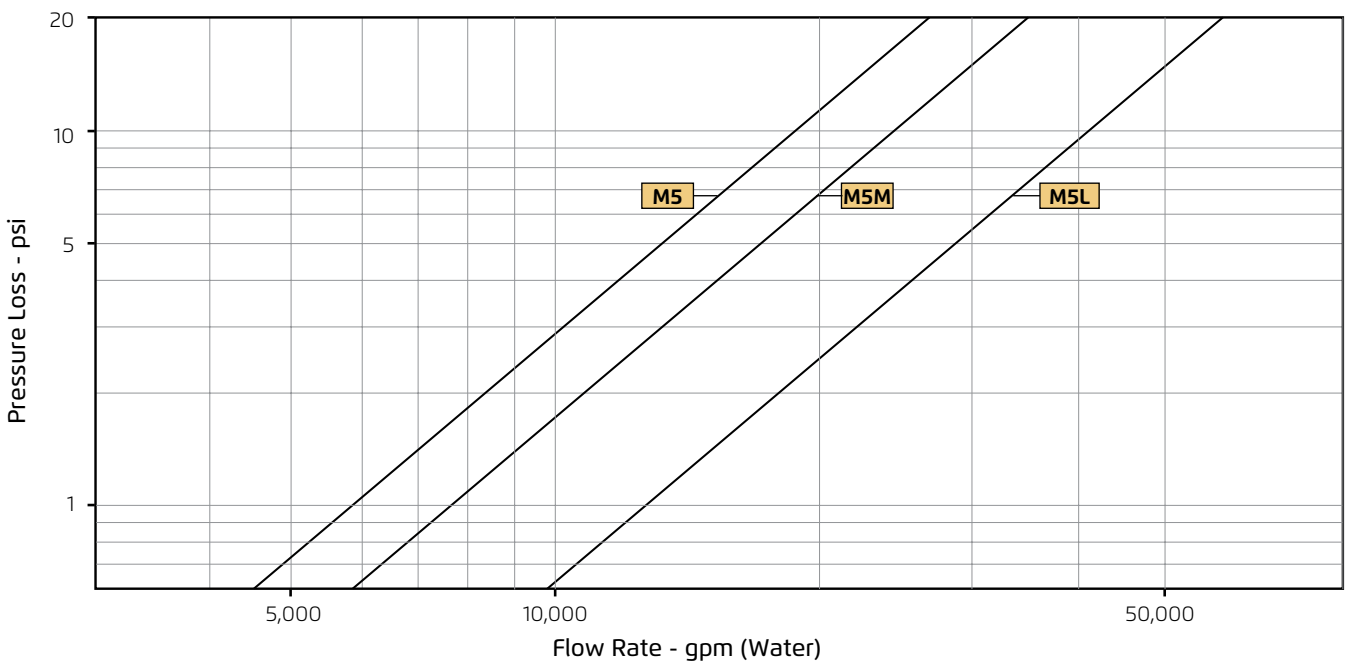

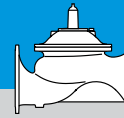

Dimensions Tables

SI Metric (mm; kg)

Type	Inch DN	20"	24"	28"	30"	32"	36"	40"	42"	48"
		500	600	700	750	800	900	1000	1050	1200
M5	L	1250	1450	1650	1750	1850	-	-	-	-
	W	965	965	965	965	965	-	-	-	-
	h	385	435	500	530	560	-	-	-	-
	H	1364	1414	1479	1509	1539	-	-	-	-
	Weight	1327	1435	1560	1759	1893	-	-	-	-
M5M	L	-	1450	1650	1750	1850	-	-	-	-
	W	-	1130	1130	1130	1130	-	-	-	-
	h	-	450	500	530	560	-	-	-	-
	H	-	1561	1611	1641	1671	-	-	-	-
	Weight	-	1791	1916	2086	2216	-	-	-	-
M5L	L	-	-	-	1750	1850	2050	2250	2250	2250
	W	-	-	-	1425	1425	1425	1425	1425	1425
	h	-	-	-	507	545	600	670	670	785
	H	-	-	-	1825	1863	1918	1988	1988	2103
	Weight	-	-	-	3463	3609	3519	4392	4362	4846

Notes: Length according to ISO 5752-1
Weight calculated for the haviest flange

Weight and height with cradel

Type	Inch DN	20"	24"	28"	30"	32"	36"	40"	42"	48"
		500	600	700	750	800	900	1000	1050	1200
M5	Height	1594	1644	1709	1739	1769	-	-	-	-
	Weight	1473	1588	1719	1971	2110	-	-	-	-
M5M	Height	-	1791	1841	1871	1901	-	-	-	-
	Weight	-	1944	2075	5598	2433	-	-	-	-
M5L	Height	-	-	-	2055	2093	2148	2218		
	Weight	-	-	-	3692	3849	3771	4657		

Control Chamber Displacement

Model	M5	M5M	M5L
Liter	60	117	230

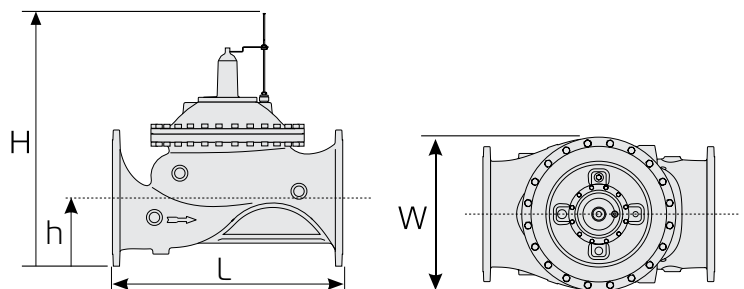



Dimensions Tables

US English (inch ; lb)

Type	Size	20"	24"	28"	30"	32"	36"	40"	42"	48"
M5	L	49.19	57.06	64.94	69	72.81	-	-	-	-
	W	38.6	38.6	38.6	38.6	38.6	-	-	-	-
	h	15.4	17.4	20	21.2	22.4	-	-	-	-
	H	54.54	56.54	59.14	60.34	61.54	-	-	-	-
	Weight	2919	3157	3432	3869	4164	-	-	-	-
M5M	L	-	57.09	64.96	68.90	72.83	-	-	-	-
	W	-	44.49	44.49	44.49	45.28	-	-	-	-
	h	-	18.70	21.18	22.24	23.23	-	-	-	-
	H	-	62.40	64.92	65.98	66.97	-	-	-	-
	Weight	-	4319	4886	5152	5507	-	-	-	-
M5L	L	-	-	-	68.88	72.81	80.69	88.56	88.56	88.56
	W	-	-	-	57	57	57	57	57	57
	h	-	-	-	20.28	21.8	26.4	26.8	26.8	31.4
	H	-	-	-	73	74.52	79.12	79.52	79.52	84.12
	Weight	-	-	-	7618.6	7939.8	9387.4	9662.4	9596.4	10661.2

Notes: weight calculated for the heaviest flange

Weight and height with cradel

US		20"	24"	28"	30"	32"	36"	40"	42"	48"
M5	Height	63.6	65.6	68.2	69.4	70.6	-	-	-	-
	Weight	3240.9	3493.9	3782.2	4336.8	4642.6	-	-	-	-
M5M	Height)	-	71.5	74.0	75.0	76.0	-	-	-	-
	Weight	-	4656.0	5236.8	5619.9	5985.1	-	-	-	-
M5L	Height	-	-	-	82.1	83.6	88.2	88.6		
	Weight	-	-	-	8123.5	8469.0	9943.1	10246.7		

Control Chamber Displacement

Model	M5	M5M	M5L
US Gal.	16	31	61

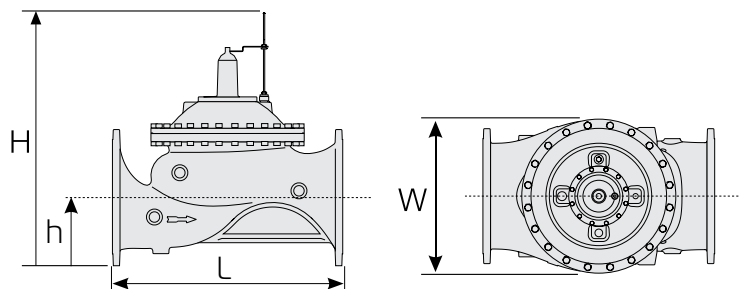

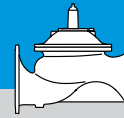

Control Ports

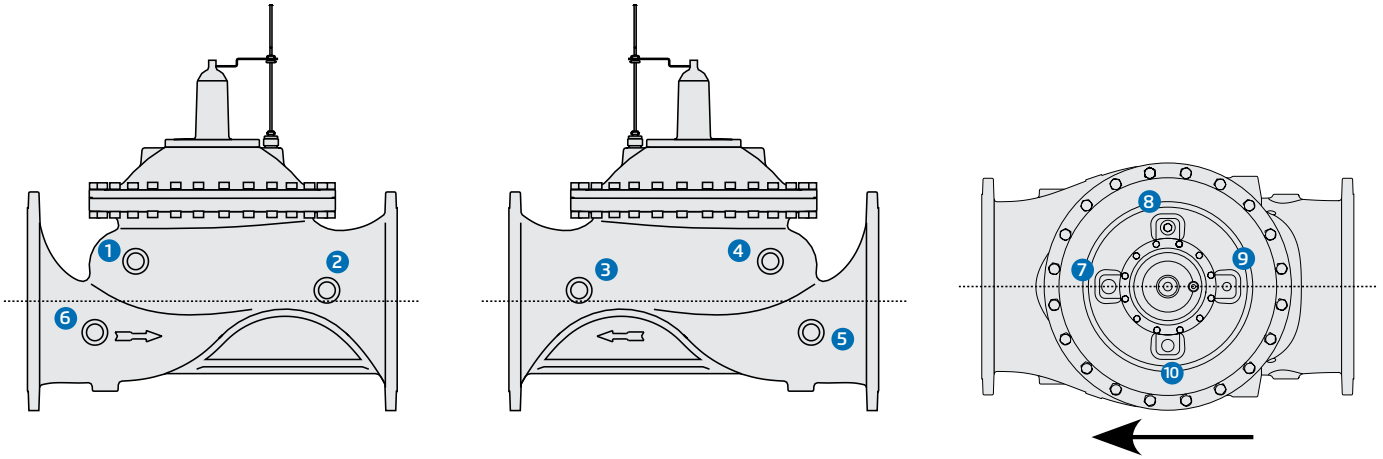

Hubs	M5	M5M	M5L
1	2" Rc	1.5" Rc	2" Rc
2	2" Rc	1.5" Rc	2" Rc
3	2" Rc	1.5" Rc	2" Rc
4	2" Rc	1.5" Rc	2" Rc
5	2" Rc	2" Rc	Service port 150 mm
6	2" Rc	Service port 120 mm	Service port 150 mm (2" Rc)
7	1" Rc	1" Rc	1" Rc
8	1.5" Rc	1.5" Rc	1.5" Rc
9	1.5" Rc	1.5" Rc	1.5" Rc
10		Service port 120 mm	Service port 120 mm

Rc = BSPT

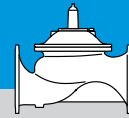

Material Specifications 700-M5 / 700-M5M / 700-M5L

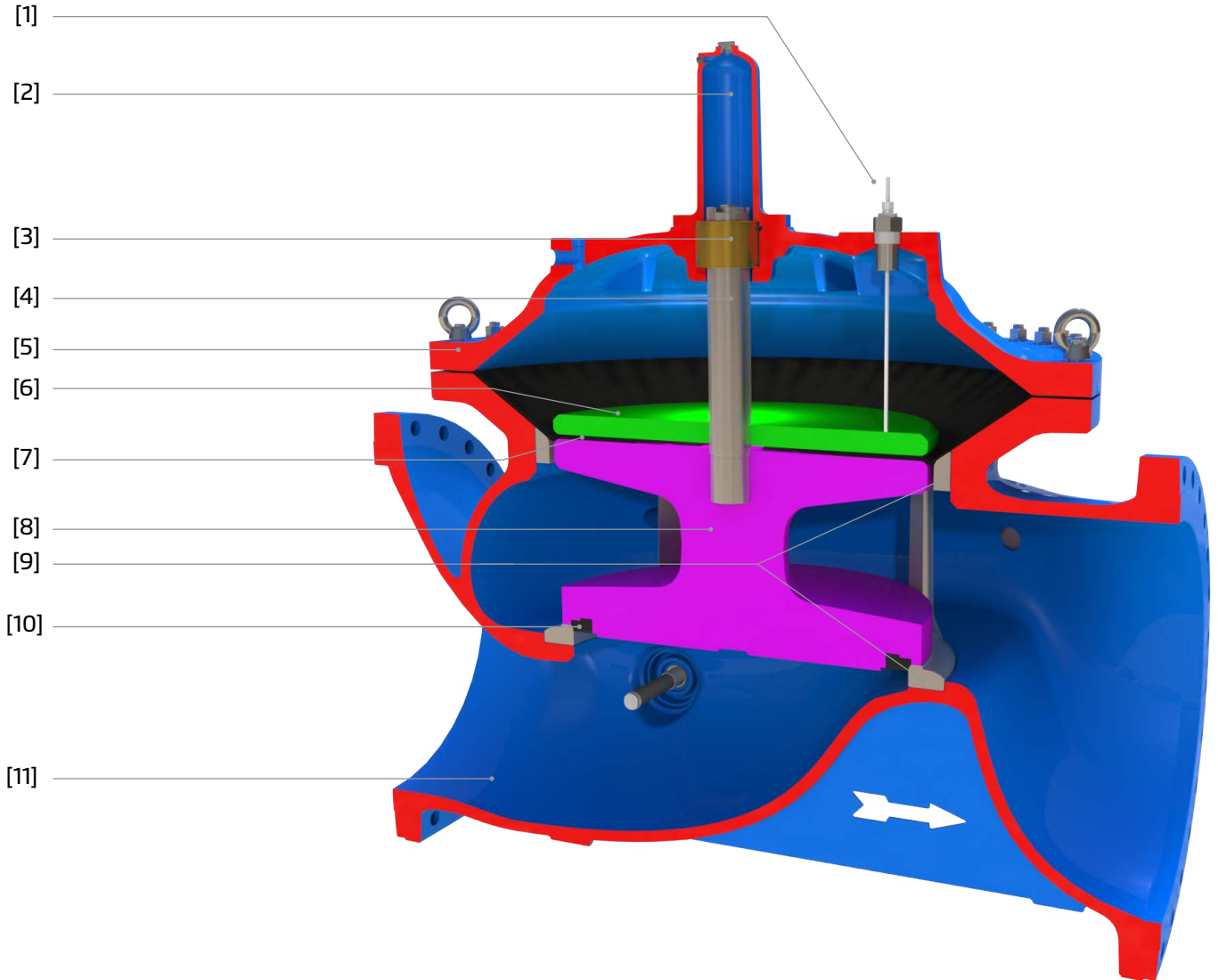

Item Number	Description	Material
1	Visual Opening Indicator	
2	Top Guide Cover	Ductile Iron
3	Top Bearing	Tin Bronze
4	Top Guide	Stainless Steel
5	Valve Cover	Ductile Iron
6	Diaphragm Top Washer	Stainless Steel
7	Diaphragm	Synthetic Rubber Nylon Fabric Reinforced
8	Valve Plug	Ductile Iron
9	Valve Seat	Stainless Steel
10	Closure Seal	NR or Synthetic Rubber
11	Valve Body	Ductile Iron



Independent Check Feature

Additional feature code 25

The Independent Check Feature is an integral, lift type, non slam check mechanism that opens to allow flow in the required direction and smoothly closes drip tight to prevent back flow.

The Independent Check Feature is used on various system applications such as:

- Pump control valves
- One-way level control valves
- One-way zone backup valves
- Pressure regulating valves

Principal of Operation

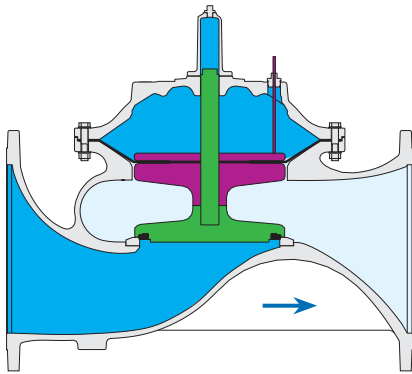

Closed Valve

Line pressure applied to the upper control chamber of the valve creates a superior force that moves the valve to the closed position and provides drip tight sealing.

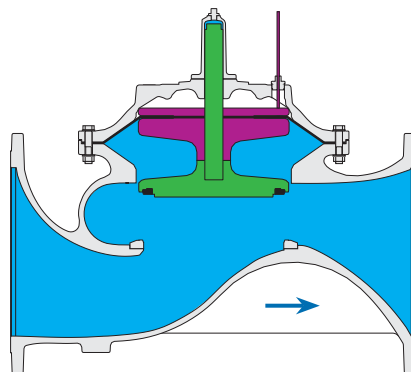

Fully Open Valve

Discharging the pressure from the upper control chamber to atmosphere or some other lower pressure zone, causes the line pressure acting on the seal disk to move the valve to the open position.

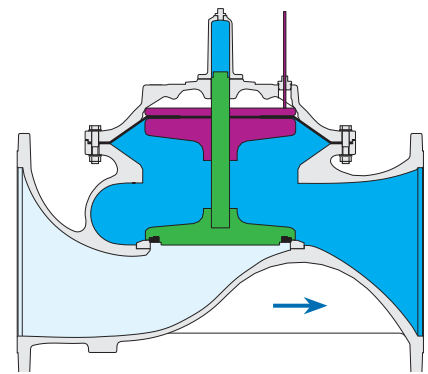

Independent Check Closed

The independent seal disc assembly closes as soon as differential pressure force across the valve is lower than the valve plug weight, preventing reverse flow through the valve regardless of control chamber pressure and the position of the diaphragm.