

GPS

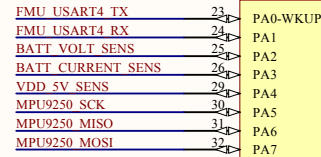

FrSky INV U1202 pin 1

PB0 is the PPM RC\_INPUT

8266 GPIO2 added here  
BRICK\_VALID is now Active HIGH

USART1 is for ESP8266

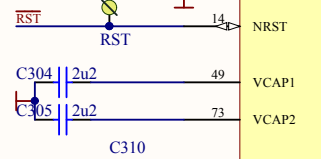
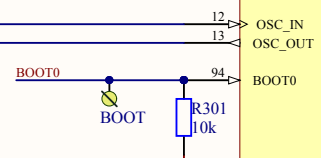
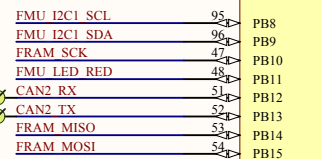
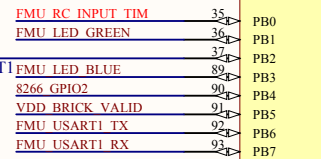
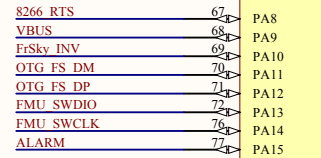
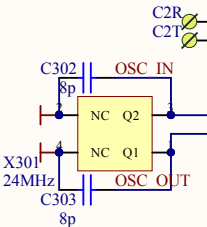
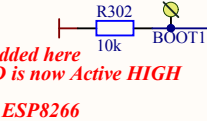
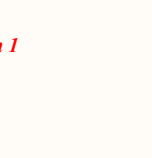

U301 STM32F427VIT6

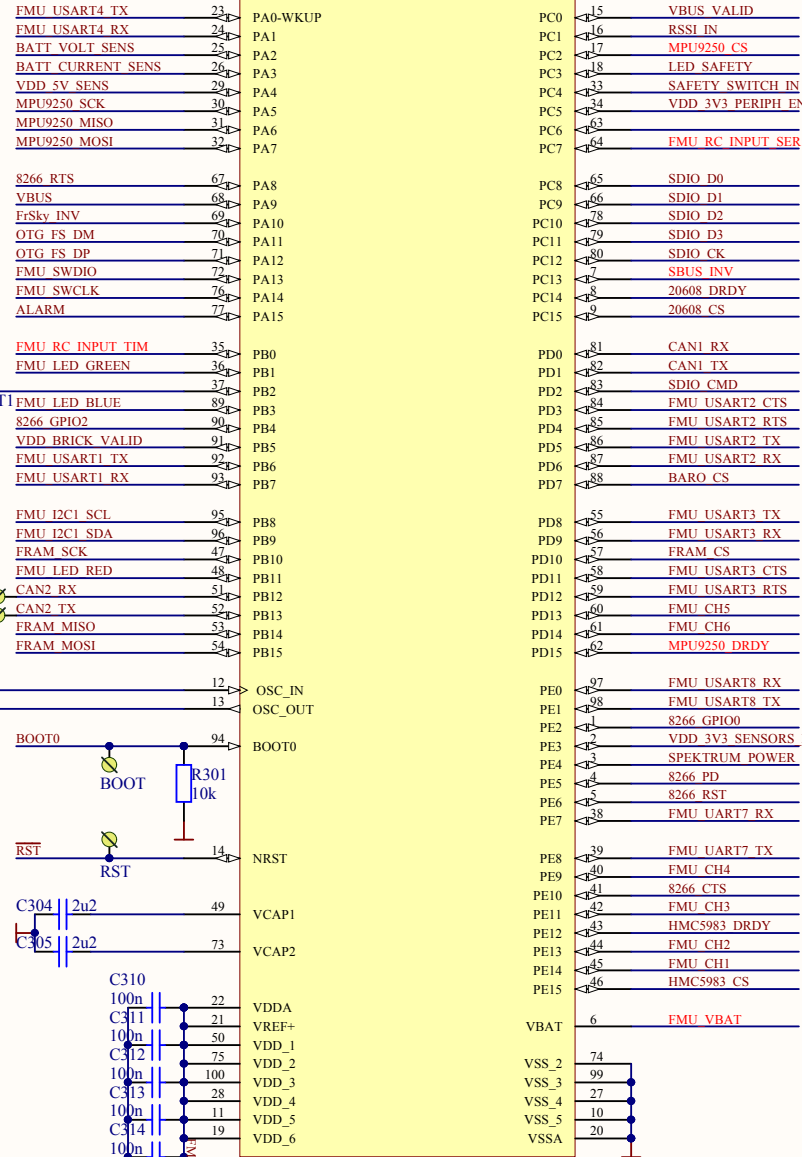

VBUS\_VALID is now Active HIGH

Enables 3V3 for 8266 and Spektrum  
FMU\_RC\_OUTPUT

PC7 is the serial RC\_INPUT

SBUS inverted with active HIGH (U1203)

TELEMETRY1

TELEMETRY2 / OSD

FrSky

Powers the Spektrum satellite

SERIAL DEBUG

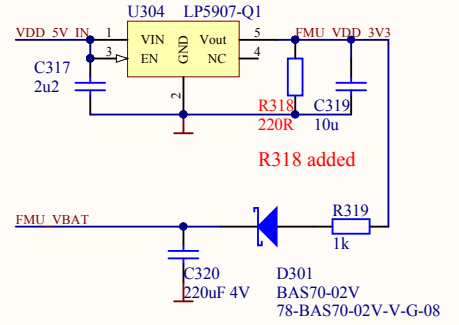
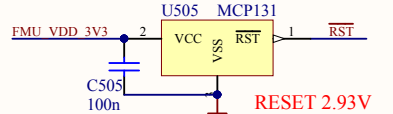
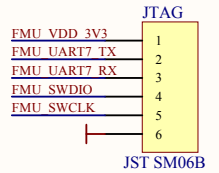
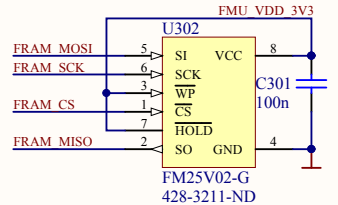

D301,R319,C320 added



Title		PIXRACER-V1-FMU	AUAV.CO
Size	Number	JAN-17-2016-0915	Revision
A4			RC13
Date:	17.01.2016	Sheet of	3 of 5
File:	F:\fwdsch\PIXRACER-FMU-R13.SchDoc	Drawn By:	Nick Arsov

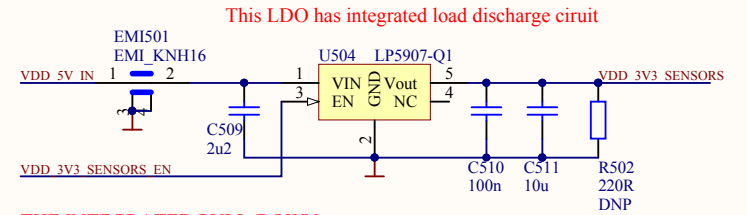
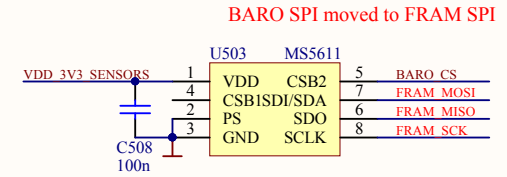
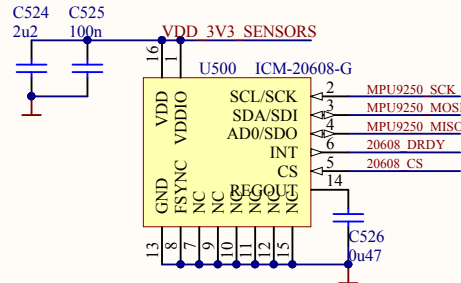
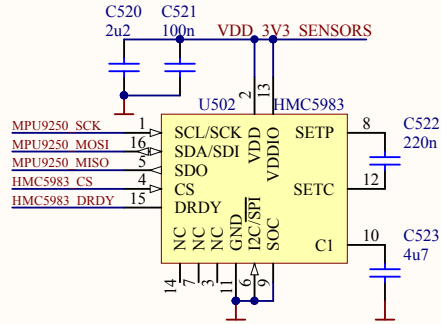
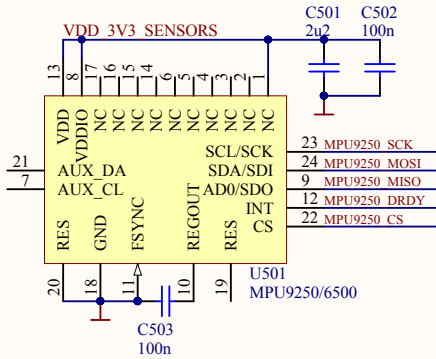

THE INTEGRATED PULL-DOWN  
DISABLES THE VDD\_3V3\_SENSORS AT POWER ON



open source  
hardware

Title		PIXRACER-V1-IMU		AUAV.CO	
Size	Number	JAN-17-2016-0915		Revision	RC13
Date:	17.01.2016	Sheet of	5 of 5		
File:	F:\fwdsch\PIXRACER-IMU-R13.SchDoc	Drawn By:	Nick Arsov		

**R104 prevents rev current of D101 when USB is disconnected**

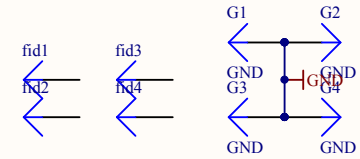
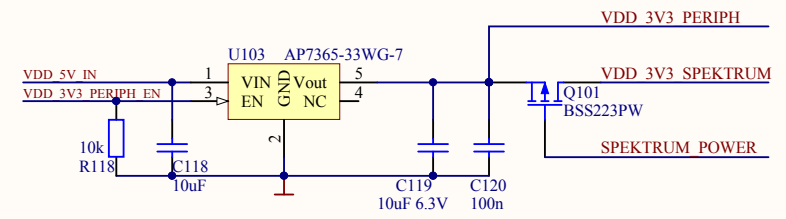
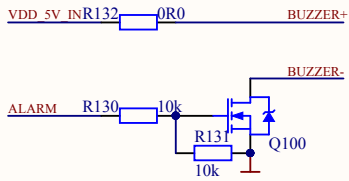
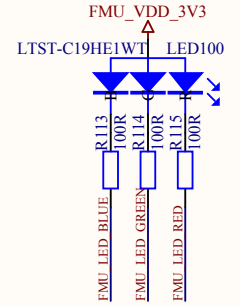
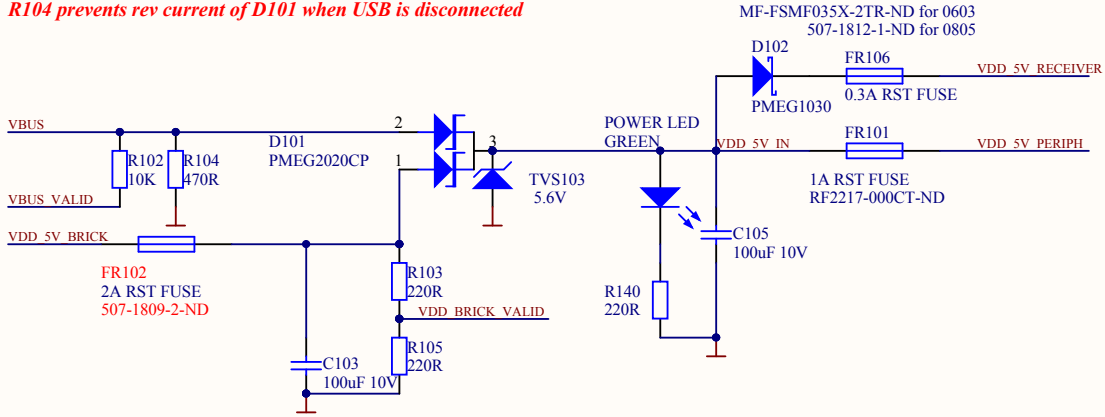

Title		PIXRACER-V1-POWER		AUAV.CO	
Size	Number	JAN-17-2016-0915		Revision	
A4				RC13	
Date:	17.01.2016	Sheet of	1 of 5		
File:	F:\fwdsch\PIXRACER-POWER-R13.SchDoc	Drawn By:	Nick Arsov		

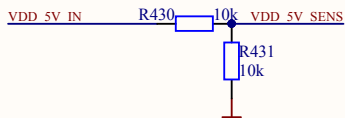
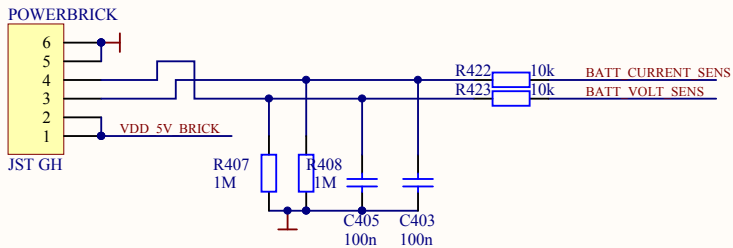
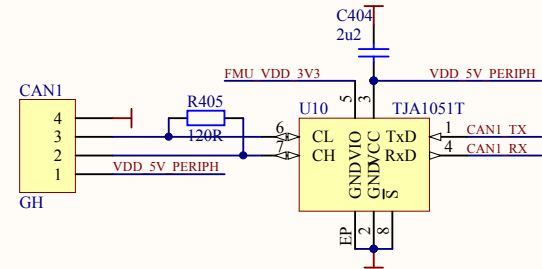
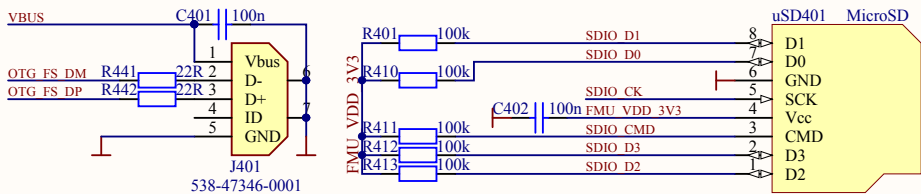

Title		PIXRACER-V1-SD-USB-CAN-I2C		AUAV.CO	
Size	Number	Date:		Revision	
A4	JAN-17-2016-0915	17.01.2016		RC13	
Date:		Sheet of		4 of 5	
File:		F:\fwdsch\PIXRACER-SD-USB-R13.Sch		Drawn By: Nick Arsov	

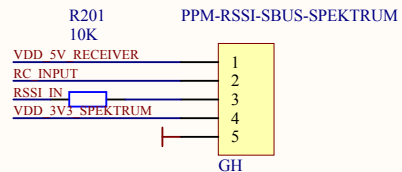

*RC\_INPUT is for any of PPM/SBUS/SPEKTRUM/BIND*

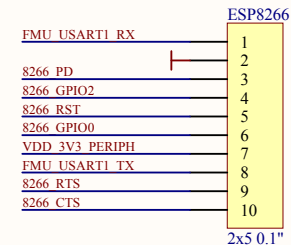
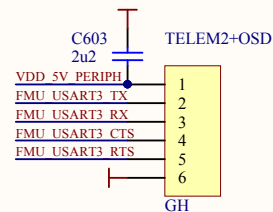
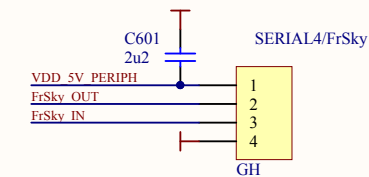
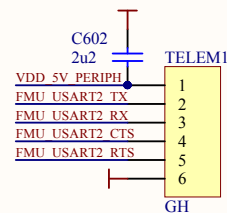
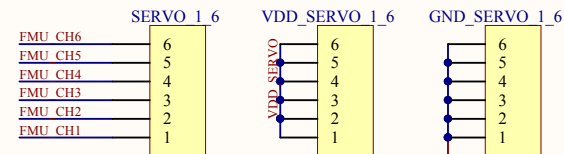
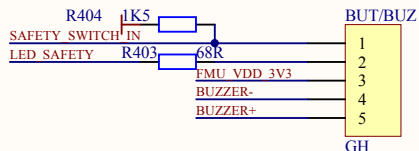
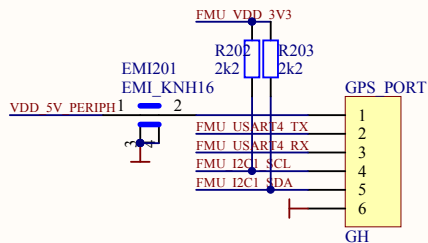
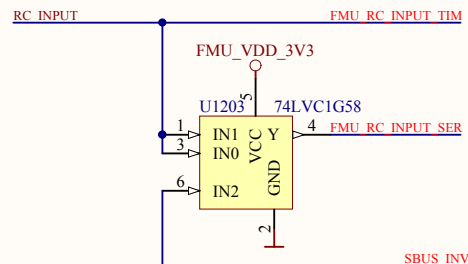

*FrSky inverter*

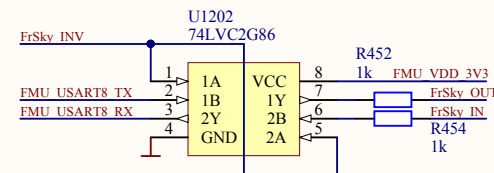

Title		PIXRACER-V1-SERIALS	AUAV.CO
Size	Number	JAN-17-2016-0915	Revision
A4			RC13
Date:	17.01.2016	Sheet of	2 of 5
File:	F:\fwdsch\PIXRACER-SERIALS-R13.Sch	Drawn By:	Nick Arsov