

Pilot's Guide

Engine Data Management

EDM-700

EDM-800

EDM-711 Primary

Copyright © 2000-2007 J.P. Instruments, Inc.

All Rights Reserved

J.P. INSTRUMENTS INC.

Information: P. O. Box 7033
Huntington Beach, CA 92646

Factory: 3185 B Airway Avenue
Costa Mesa, CA 92626

(714) 557-5434 (800) 345 4574

Fax (714) 557-9840

www.jp instruments.com

Support@jp instruments.com

Printed in the United States of America

Rev X 11/2017

Last printed 11/13/2017 3:30:00 PM

Table of Contents

Section 1 - Introduction	1
Product Features	1
Engine Data Management	2
Benefits of Proper Mixture Control	2
JPI Probes	2
Temperature and Mixture	2
Section 2 - Displays and Controls	4
Displays	4
Modes	7
Buttons	8
Parameter Scan— EDM-700 without Fuel Flow Options	9
Automatic Parameter Scan—EDM-711	10
Section 3 - Operating Procedures	11
Diagnostic Testing on Startup and During Flight	11
Modes	11
Automatic Mode	11
Manual Mode	12
LeanFind Mode—Leaning Rich of Peak	12
LeanFind Procedure—General Explanation	14
Operation for each Phase of Flight	18
Shock Cooling	19
Common Misapplications	20
Section 4 - Diagnosing Engine Problems	21
Alarms	24
Pre-Ignition and Detonation	25
Section 5 - Fuel Flow Option Operation	26
Fuel Flow Display Select Switch	26
Fuel Management	28
Parameter Scan—Systems with Fuel Flow Option	28
Section 6 - Long Term Data Memory	30
Downloading from Long Term Memory	31
Downloading Data from the EDM to a Flash Drive	31
Downloading from USB Flash Drive to a PC	33
Section 7 - Personalizing	33
Pilot Programming	33
Section 8 - Programming the EDM-800 Horsepower Constant	36
Section 9 - Programming Manifold Pressure (MAP)	36
Section 10 - Programming use of Factory Original TIT Probe	37
Section 11 - Programming the Fuel Flow Option	39
Fuel Flow Option Programming Procedure	41
Section 12 - Programming Long Term Data Memory	41
Section 13 - EDM-711 Primary Alarm Display	42
Section 14 - Alarm Limits	43
MAP, Fuel Flow Alarm Limits, Units, Fuel Capacity	45

Navigation Data Formats	47
GPS-C Fuel Flow Format for GPS Bi-directional Comm	47
Diagnostic Messages, Fuel Flow	48
Navigation Data Ports for GPS Comm	48
Section 15 - Option Connector Pin Assignments	50
Section 16 - Reference Reading	51
Section 17 - Technical Support	51
Limited Warranty	52
Index	53

How to Change Modes (page 7)

EDM-700 enters Automatic mode two minutes after power up

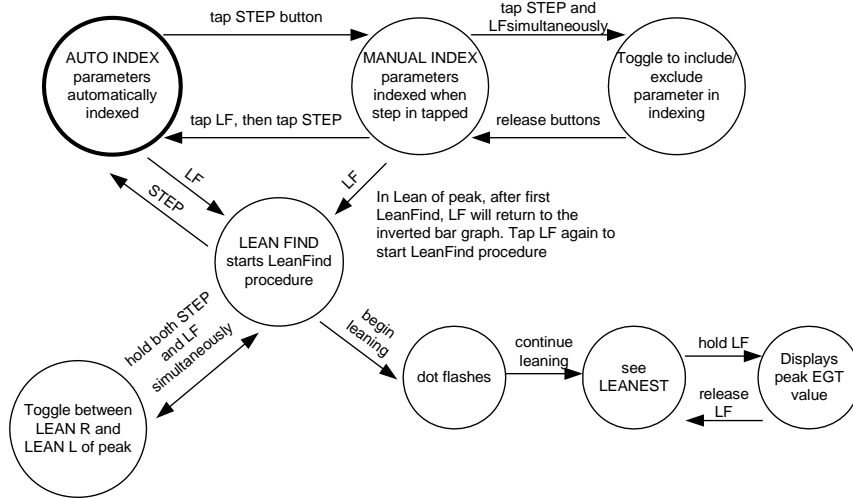

Section 1 - Introduction

Product Features

✓ indicates standard feature

	700	711	800
Hands-free, automatic scanning (711: primary only)	✓	✓	✓
All programming done from the Front Panel	✓	✓	✓
LeanFind™ finds the first and last cylinder to peak with true peak detect—eliminates a false peaks	✓	✓	✓
Displays both leaned temperature below peak and peak	✓	✓	✓
Battery voltage with alarm	✓	✓	✓
24 Programmable alarm limits	✓	✓	✓
Normalize view	✓	✓	✓
DIF low to high EGT with alarm	✓	✓	✓
EGTs to stable 1°F resolution	✓	✓	✓
Shock cooling monitored on <i>every</i> cylinder	✓	✓	✓
User selectable index rate	✓	✓	✓
Fast response probes	✓	✓	✓
Non-volatile long term memory	✓	✓	✓
Records and stores data up to 30 hours	✓	✓	✓
Post-flight data retrieval	✓	✓	✓
Data retrieval software	✓	✓	✓
FAA Approved as primary temperature instruments for CHT, OIL, TIT		✓	
Alarm and warning light panel		✓	
Oil Temperature	opt	✓	opt
Oil Pressure	opt	opt	opt
Turbine inlet temperature	opt	opt	opt
Outside air temperature	opt	opt	✓
Compressor discharge temperature	opt	opt	opt
Carburetor temperature	opt	opt	opt
Fuel Flow	FF opt	FF opt	✓
Solid-state rotor fuel flow transducer	FF opt	FF opt	✓
Fuel quantity in gallons, kilograms, liters, or pounds	FF opt	FF opt	✓
Low fuel quantity alarm	FF opt	FF opt	✓
Low fuel time alarm	FF opt	FF opt	✓
GPS interface	FF opt	FF opt	✓
Instantaneous fuel flow rate	FF opt	FF opt	✓
Total amount of fuel consumed	FF opt	FF opt	✓
Total fuel remaining	FF opt	FF opt	✓
Time to empty at the current fuel flow rate	FF opt	FF opt	✓
Displays % horsepower and RPM	RPM opt	RPM opt	✓
Automatically calculates percent horsepower			✓

Engine Data Management

The EDM Engine Data Management system is the most advanced and accurate piston engine-monitoring instrument on the market. Using the latest microprocessor technology, the EDM will monitor up to twenty-four critical parameters in your engine, four times a second, **with a linearized thermocouple accuracy of better than 0.1 percent or 2 F°.**

As your built-in flight engineer, the EDM is constantly “red line” checking: all critical parameters are automatically checked four times a second, regardless of the current display status. Leaning is accomplished quickly and automatically using the LeanFind™ procedure. With the EDM it is now possible to have substantially more diagnostic information available to you in a timely and usable manner.

The real-time serial data port—a standard feature—permits you to record scanned parameters in real-time using a user-supplied laptop PC.

Benefits of Proper Mixture Control

- Improved engine efficiency
- Greater fuel economy
- Smoother engine operation
- Longer spark plug life
- Reduced maintenance costs
- Reduced operating costs
- Proper engine temperatures
- Reduced engine vibration

JPI Probes

Temperature information processed by the EDM is captured by **fast response**, grounded **JPI** temperature probes, that accurately measure the small temperature changes—as small as 1°F—that occur during mixture adjustment.

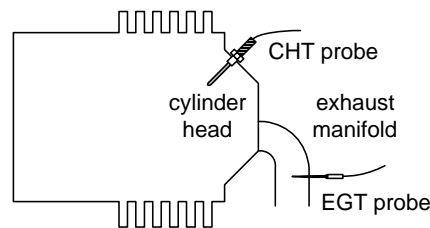

Temperature and Mixture

In a piston engine only a small portion of the energy from combustion produces movement of the piston during the power stroke. The majority of energy passes into the exhaust pipe as hot gasses. By monitoring the temperature of these exhaust gasses you will have an indication of the quality of the combustion process. Low compression, non-uniform fuel distribution, faulty ignition, and clogged injectors diminish the efficiency of the combustion process that generates power.

From the cockpit you can adjust the fuel/air ratio by a process called *leaning*. Retarding the mixture control changes the fuel/air ratio and hence the resulting Exhaust Gas Temperature (EGT).

The following figure depicts the mixture and temperature relationship.

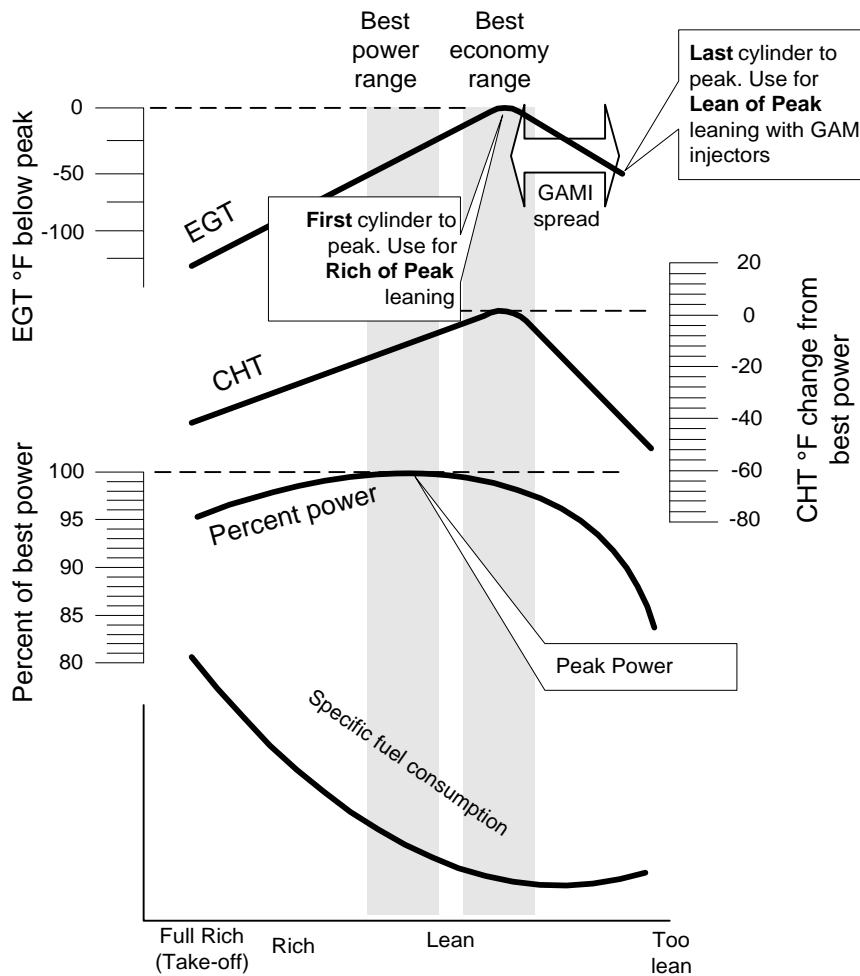

As the mixture is leaned, EGT rises to a peak temperature, and then drops as the mixture is further leaned. Peak *power* occurs at a mixture using more fuel than at peak EGT. Best *economy* occurs at peak EGT. Accurate leaning yields optimal engine temperatures. By being able to precisely adjust the mixture, your engine can produce either the best fuel economy or maximum power, whichever you choose.

A single EGT gauge merely gives you an average of each cylinder's temperature: some cylinders can be too rich, while others too lean. Variations produced by differences in fuel distribution, ignition, and compression will cause each cylinder to follow its own mixture and temperature relationship such that one cylinder will reach peak before another.

Section 2 - Displays and Controls

The EDM monitors engine temperatures and voltages, assists in adjusting the fuel/air mixture, and helps diagnose engine malfunctions. There are three components of the user interface:

- Analog display including cylinder number and index dot
- Digital display for numeric readouts and messages
- Two front panel operating buttons.

Displays

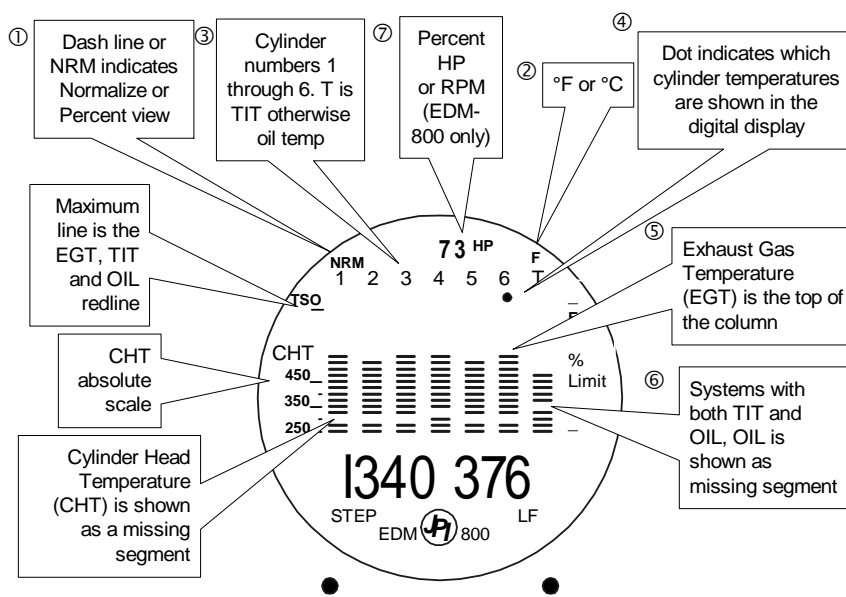

Analog Display

The upper half of the face of the EDM is the analog display with %HP.

The following is a description of the analog display, from top to bottom. Numbers in circles refer to features in the above diagram.

@Normalize and Percentage View Indicators

- Percentage view: when there is a dash — near the P at the top of the display (EDM-700) or NRM is not lighted (EDM-800), the columns indicate percent of EGT red line. Each column is composed of a stack of segments. A maximum height column depicts 100 % of red line and a one segment-high column depicts 50 % of red line. For example, if the red line is 1650°F, a maximum height column represents 1650°F and a one segment-high column represents half that value, or 825°F. The *Percentage view* permits comparison of EGTs *across all* cylinders. Hotter cylinders display higher columns than cooler cylinders.
- Normalize view: when there is a dash _ near the N at the top of the display (EDM-700) or the letters NRM are lighted on the left side (EDM-800), the EGT columns are displayed normalized. When you change to the Normalize view, all column peaks are set to the same half-height level for trend analysis. Any changes are shown as an increase or decrease in column height. **A one-segment change in column height represents a 10°F change.** The Normalize view permits rapid visualization of EGT *trends*, rather than a percentage of red line. You should use normalize in level cruise and run-up.

To toggle between Percentage and the Normalize views, hold the LF button for five seconds until the display changes. The analog display becomes half height and the display changes to the Normalize view. Selecting the Normalize view does not affect the digital display nor alter the parameter sequence. The CHT display—described later—is not affected by the Normalize or Percentage view.

You may select the Normalize view in either the Manual or Automatic mode. Normalize view is most helpful for engine trend monitoring of each cylinder's operation. For example using the Normalize view during engine run-up, a fouled spark plug will appear as a higher column.

A common misapplication is to be in the Normalize view and then change your power setting, causing all columns to go off scale, high or low. Set to the Percentage view before adding or reducing power. Always set Percentage View when beginning your descent.

@Temperature Units (°F or °C)

- °F temperatures in the digital display are in Fahrenheit degrees.
- °C temperatures in the digital display are in Celsius degrees.

To change the display of engine temperatures see “Changing the Alarm Limits” on page 43.

ⓐⓐCylinder Numbers and Dot Index

A row of numbers 1 through 6 and the letter T are the column labels for the analog display. The 1 through 6 are the cylinder numbers. If the TIT option is installed, the T denotes the last column is displaying Turbine Input Temperature (TIT) as a column. If the T is absent and the Oil temperature option is installed, the last column displays Oil temperature. If both TIT and Oil temperature options are installed, the last column displays TIT and the missing segment displays Oil temperature. The highest Oil temperature segment will flash only when the digital display shows OIL. The highest TIT segment will flash on when the digital display shows TIT. A round dot under the numbers 1 through 6 indicates that particular column is shown numerically in the EGT and CHT digital display.

ⓐⓐBar Graph EGT and CHT

Each column in the bar graph is composed of a stack of segments. The total height of each column represents the **EGT** and the missing segment in the column represents the **CHT**.

- In the Percentage view, the EGT, TIT, and Oil temperature resolutions depend on the programmed red line limits.
- CHT is displayed by a missing segment and should be interpreted as follows: a missing segment corresponds to the CHT in 25 F° increments, starting at 250°F at the bottom. In the example shown here, the CHT is 300°F. If the EGT bar is lower than the missing CHT segment, then the CHT will be indicated by a single isolated lighted segment.

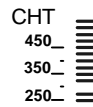

The CHT display is the not affected by mode or view.

ⓐPercent HP (EDM-800 only)

Displays percent of rated HP or RPM depending on pilot programming.

Digital Display

Beneath the bar graph is the 9-segment alphanumeric display.

EGT and CHT

When the dot index is beneath a cylinder number, 1 through 6, the digital display shows the EGT on the left (four digits) and the CHT on the right (three digits). Other parameters are displayed in the digital display as

described in the subsection “Parameter Scan— EDM-700 without Fuel Flow Option” on page 9. The EDM-711 will briefly display EGT – CHT before displaying the numerical values.

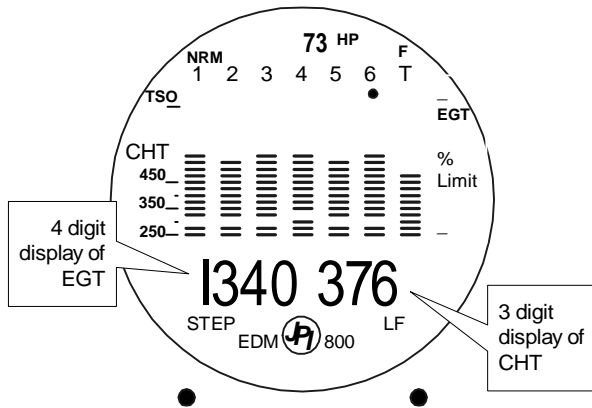

Display Dimming

The entire display panel features automatic dimming. Allow ten seconds for the display to adjust to ambient lighting conditions.

Modes

There are three standard operating modes of the EDM: *Automatic*, *Manual*, and two *LeanFind* submodes. These modes will be described in more detail beginning on page 11. Most of the time you will operate the EDM in the Automatic mode. When you first turn on the power the EDM starts in the Manual mode, but will enter the Automatic mode after two minutes. The three modes affect primarily the digital display.

Automatic Mode

Just tap the LF button, then tap the STEP button. No user intervention is required to use this mode. Each cylinder and each parameter value is automatically sequenced and shown in the digital display for a few seconds. The EDM-711 will automatically scan only the primary temperatures: highest CHT, TIT, OIL.

Manual Mode

Just tap the STEP button. Automatic stops. Each indexed parameter is frozen in the digital display until you manually index to the next parameter by tapping the STEP button. The EDM-711 will manually scan all parameters.

LeanFind Mode

Simply pre-lean, tap the LF button and begin leaning. The EDM will assist you in finding the first cylinder to peak.

Buttons



Buttons, Front Panel

Two operating buttons control all functions of the EDM.

The term *tap* will be used to denote pressing a button momentarily. The term *hold* will be used to denote pressing and holding a button for five seconds or longer.

STEP Button

Located on the lower left side near the instrument face.

- In the Automatic mode, *tapping* the STEP button will stop and change to the Manual mode. Then each *tap* of the STEP button will display the next parameter in the sequence.
- In the LeanFind mode *tapping* the STEP button will terminate the LeanFind mode and change to the Automatic mode.

Secondary functions of the STEP button include:

- In the Manual mode *holding* the STEP button will display the previous parameters in the sequence (rapidly backwards).
- In the programming procedures, *tapping* the STEP button will advance to the next item in the list.
- When an alarm is displayed, *tapping* the STEP button will temporarily delete that alarm from appearing for the next ten minutes.
- When an alarm is displayed, *holding* the STEP button until the word OFF appears will delete that alarm from appearing for the remainder of the flight.

LF Button

Located on the lower right side near the instrument face.

- In Automatic or Manual modes, *tapping* the LF button will change to the LeanFind mode.
- In Automatic or Manual modes *holding* the LF button for three seconds will toggle between Percentage and Normalize views.

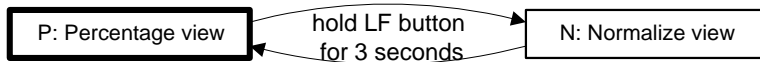

- In the LF mode *holding* the LF button after peak EGT is found will display peak EGT.

Secondary functions of the LF button include:

- In the pilot programming procedure, *holding* or *tapping* the LF button is used to increment or decrement parameter values and toggle between Yes and No answers to questions.

STEP and LF Buttons

- Holding both the **STEP** and LF buttons simultaneously for five seconds changes to the pilot programming procedure.
- Holding both the **STEP** and LF buttons simultaneously for five seconds after entering LeanFind mode but before beginning to lean will toggle between leaning “rich of peak” and “lean of peak.”
- Tapping both the **STEP** and LF buttons simultaneously in Manual mode toggles to include or exclude the displayed parameter from the Automatic mode. It has no affect on the displayed parameters in the Manual mode.
- In the LF mode *tapping* both the **STEP** and LF buttons simultaneously will **mark** a data record in long term memory and display will flash SNAP.

Parameter Scan— EDM-700 without Fuel Flow Options

The EDM steps through the engine parameters in a specific sequence. Listed below is the sequence, parameter description and example of the digital display.

<i>Parameter</i>	<i>Example</i>	<i>Comments</i>
Voltage , System Bus	I4.2 BAT	Battery voltage
Outside Air Temperature	8I OAT	°F or °C
Induction Air Temperature	I25 IAT	Out of the intercooler
Compressor Discharge Temperature	300 CDT	Into the intercooler
Carburetor Temperature	-22 CRB	Not available when CDT is installed
Difference between hottest and coolest EGT	80 DIF	Dot indicates most widely deviating cylinder
EGT, CHT	I340 376	EGT, left, CHT, right. Dot indicates cylinder
TIT , Turbine Inlet Temperature	TIT TI2	Turbine #1, left shows as column. Turbine #2, right
Oil Temperature	I78 OIL	Missing bar in TIT column or is column
Oil Pressure	90 O-P	Only available as an option or in the EDM-830
Shock Cooling	-30 CLD	Dot indicates fastest cooling cylinder

The display will pause at each parameter for four seconds in the Automatic mode. (The four second pause time can be changed.) In the Manual mode, tap the **STEP** button to advance to next parameter. Only the parameters for the options that are installed will be displayed; uninstalled parameters will not appear.

Automatic Parameter Scan—EDM-711

The EDM-711 in automatic scan mode will display only the following three primary temperatures: highest CHT, OIL and if the option is installed, TIT.

Section 3 - Operating Procedures

Diagnostic Testing on Startup and During Flight

When your EDM is first turned on, all digits light up for a few seconds, permitting you to check for non-functional segments. Then each column is self-tested in sequence while the EDM tests internal components, calibration and integrity of the probes. If a problem is found, it will be displayed as OPEN PRB or CAL ERR, followed by the name of the probe or channel.

<i>Display</i>	<i>Channel</i>	<i>Display</i>	<i>Channel</i>	<i>Display</i>	<i>Channel</i>			
EGT	I	EGT #1	CHT	I	CHT #1	OIL	Oil	
EGT	2	EGT #2	CHT	2	CHT #2	TIT	I	TIT #1
EGT	3	EGT #3	CHT	3	CHT #3	TIT2	TIT #2	
EGT	4	EGT #4	CHT	4	CHT #4	CDT	CRB	CDT carb
EGT	5	EGT #5	CHT	5	CHT #5	IND	IAT	
EGT	6	EGT #6	CHT	6	CHT #6	OAT	OAT	

During flight, probes are constantly checked for inconsistent or intermittent signals. A faulty channel or probe encountered during start-up or during flight will be deleted from the sequence, producing a missing column or blank digital data.

Modes

The EDM has three different operating modes: *Automatic*, *Manual* and *LeanFind*. When you first turn on the power the EDM starts in the Manual mode, but will enter the Automatic mode after a few minutes. The Automatic mode provides you with engine monitoring information for the majority of flight conditions. To adjust the mixture, use the LeanFind mode. And to display specific parameters, use the Manual mode. In both the Automatic and Manual modes the analog display shows a bar graph of EGT and CHT for each cylinder and the TIT and Oil temperature.

Automatic Mode

Just tap the LF button, then tap the STEP button. No user intervention is required to use this mode. In the Automatic mode the EDM displays the parameter sequence at a user-selected rate (see “Personalizing” on page 33).

Individual parameters can be excluded from the *Automatic mode* (exclusion does not apply to the EDM-711): tap **STEP** to enter the Manual mode. Tap **STEP** to index to the parameter you want to exclude. Then tap both the **STEP** and **LF** buttons simultaneously. Excluded

parameters display a decimal point before the parameter name. For example:

Included: I84 OIL Excluded: I84 .OIL

Tapping the **STEP** and **LF** buttons simultaneously will toggle back and forth between *include* and *exclude*.

- Every time you turn on the EDM, all parameters are reset to be included.
- All installed parameters are always displayed in the Manual mode. Exclusion only applies to the Automatic mode.
- All parameters are checked for alarm conditions every second regardless of their included or excluded status.

Manual Mode

Just tap the STEP button. Use the Manual mode when you want to monitor one specific parameter such as shock cooling during descent, or a particular cylinder temperature during climbs. To change to the Manual mode, tap the **STEP** button once. Subsequent taps will index the digital display through the parameter sequence (see “Parameter Scan— EDM-700 without Fuel Flow Option” on page 9). To exit the Manual mode and return to the Automatic mode, either tap the **LF** button and then tap the **STEP** button—see “How to Change Modes” in the front of this manual. You may disable the Automatic mode by setting “0” for scan rate (disabling Automatic mode does not apply to EDM-711).

LeanFind Mode—Leaning Rich of Peak

JPI’s EDM-700 and EDM-800 provide two methods of leaning: lean rich of peak (LEAN R) or lean of peak (LEAN L). The standard method is to lean about 20° rich of peak. With the advent of GAMI injectors it is now possible to set the mixture lean of peak—saving fuel and running the engine cooler. Teledyne Continental recommends lean of peak for the Malibu. This manual primarily describes the rich of peak method, and provides the procedure for the lean of peak method. The **default** method is set to **rich of peak**.

Simply pre-lean, tap the LF button and begin leaning. Upon reaching cruise configuration, you will use the LeanFind mode to identify the first cylinder to reach peak EGT.

LeanFind Procedure—Step-by-Step

Procedure	Example	Comments
-----------	---------	----------

1	Establish cruise at approx. 65 to 75% power.		
2	Pre-lean the mixture to 50°F estimated rich of peak EGT on any cylinder: _____°	I 490 370	*For your <i>first flight</i> with the EDM, use the method shown below.
3	Wait one minute		Let engine stabilize.
4	Tap the LF button	LEAN R	Start LeanFind. (Optionally to change to “lean of peak” method, hold both STEP and LF simultaneously.)
5	Lean the mixture—approx. 10°/second <i>without pausing</i> —while observing the display. When there is a 15°F rise in EGT, LeanFind mode becomes active.	I 520 LF Without FF I 520 I 3 . 8 With FF	Flashing cylinder DOT indicates hottest cylinder and that LeanFind mode is active.
6	Stop leaning when a column begins flashing. You will see LEANEST for two seconds, followed by:	I 545 SET or with Fuel Flow I 545 I 2 . 4	Flashing cylinder dot & column indicates leanest cylinder. (SET means Set the mixture.) Due to thermal inertia this will usually be about -15°F lean of peak.
7	If you hold LF, peak EGT will be displayed while the LF button is held down.	I 560 PK	Captured peak EGT value is displayed.
8	Slowly enrich the mixture. the temperature will increase, returning to peak. Stop enriching at the desired EGT. Best economy Best power	I 560 SET I 560 SET I 460 SET	<ul style="list-style-type: none"> • Peak EGT for best economy • 100° rich of peak for best power
9	If you have chosen the Lean of Peak method, at step 5 continue leaning until the last cylinder has peaked.	- I 5 SET OR - I 5 I 2 . 3	Only for GAMI injected engines. When each cylinder reaches peak, the cylinder number will begin flashing.

***Determining the pre-lean value:** while in cruise at under 65 percent power, choose any cylinder and lean that cylinder to peak EGT in the Manual mode or to engine roughness, whichever occurs first. Note the peak, subtract 50° and write the resulting number in the space provided in step 2.

LeanFind Procedure—General Explanation

Lycoming and Continental engines have established specific restrictions on leaning that must be followed, such as percentage of power, climb leaning, and TIT limits. Lycoming recommends operation at peak EGT for power settings of 75% or lower, while Continental recommends operation at peak EGT for power settings of 65% or lower. This guide is not meant to supersede any specific recommendations of the engine manufacturer or airframe manufacturer.

It is your responsibility to know your aircraft's limitations.

Pre-lean the mixture to about 50° below peak. After pre-leaning, wait for one minute for the temperatures to stabilize. Next, begin the leaning process by tapping the LF button. This tells the EDM to begin looking for a 15° rise in EGT for any cylinder. Begin leaning the mixture *without pausing*. When a 15° rise occurs, eliminating false peaks, the LeanFind mode becomes activated shown when the cylinder dot above the column of the hottest cylinder begins flashing. **The LeanFind mode is not active until a cylinder dot is blinking.**

With the Fuel Flow Option, instead of seeing the word LF in the display, you will see numerical fuel flow rate during the leaning process on the right side of the digital display, for example I2 . 4. This allows you to observe the EGT rise and at the same time watch the fuel flow rate decrease.

To show the progress of the leaning process, the EDM selects the hottest cylinder for reference in the digital display. In the example below, the I360 is the current temperature of the hottest cylinder.

When LF is activated:

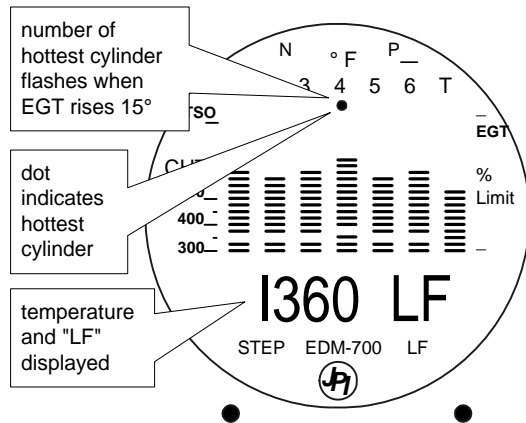

Continue leaning slowly *without pausing*. With a vernier mixture control, turn the knob about a quarter turn every second. With a non-vernier or quadrant mixture control, lean slowly and smoothly about 1/16 inch every five seconds. Eventually, one cylinder will reach peak before any of the other cylinders. The EDM will determine this automatically. *Notice that this cylinder does not necessarily have the hottest EGT.*

The EDM will indicate success in finding a peak by displaying the words LEANEST for two seconds, followed by flashing the column and displaying the value of the EGT of the cylinder that peaked first. The word SET will also be displayed. (With the Fuel Flow Option the current fuel flow rate will be displayed on the right side of the digital display instead of the word SET.) The flashing cylinder will be locked—or set—into the digital display during the remainder of the LeanFind procedure to allow you to set the final mixture. The peak EGT value is remembered by the EDM and will be displayed as long as you hold the LF button.

You may now enrichen the mixture to operate at peak or continue enriching to 100° rich of peak, or a value of your choice, consistent with the procedures defined in your aircraft engine manual.

If you lean too much, the EGT will drop and the engine will be operating lean of peak.

Leaning Rich of Peak

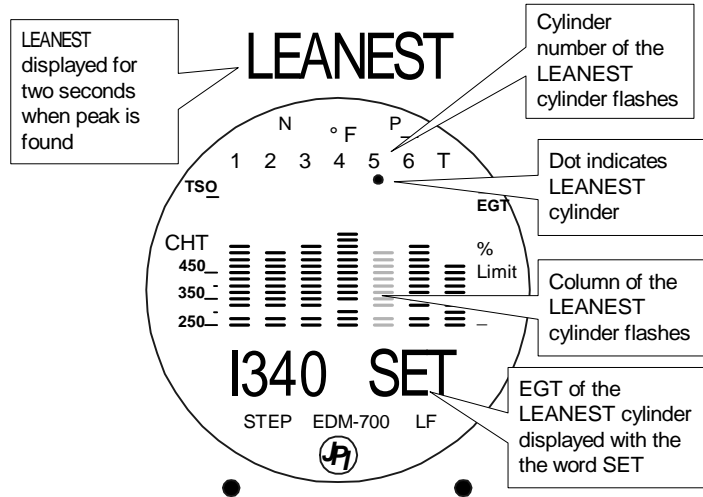

Lean of Peak Leaning with GAMI injectors

To use the “lean of peak” method, tap LF and then immediately hold both STEP and LF until you see LEAN L. Once you begin leaning (flashing dot) you cannot change leaning methods. You may toggle back to LEAN R by holding both buttons again.

Leaning Lean of Peak

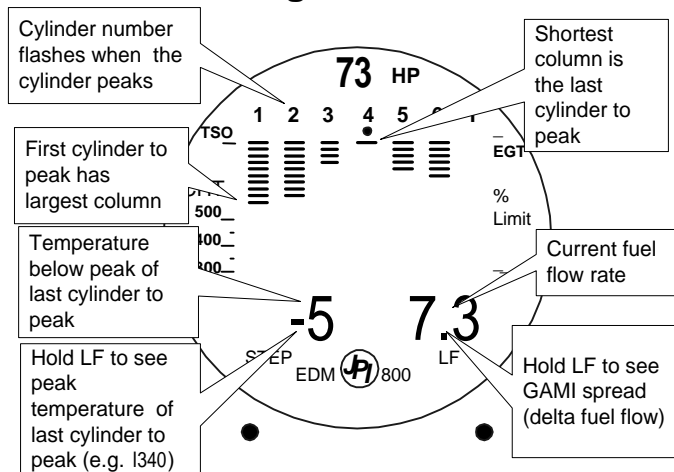

In the “lean of peak” method the columns will **invert** with the first to peak progressing down from the top of the display. The inverted column scale is **5° per segment** below peak. As you continue to lean past peak the dot of the each successive cylinder will flash as it peaks. The peaks

will be shown as an **inverted bar graph**; when the last cylinder peaks its column will flash. The analog display is an inverted bar graph showing where each cylinder peaked. When the LF button is held the display will show the delta fuel flow between the first and last to peak (GAMI Spread), as well as the richest peak EGT.

If you tap **STEP**, scanning will resume. Or instead, if you Tap LF you will return to the inverted bar graph, which can be used for fine tuning. To begin the LeanFind procedure anew, tap LF a second time.

Turbocharged Engines

The leaning process for turbocharged engines is by reference to the first cylinder or TIT to reach peak. However, the TIT *factory red line* may limit the leaning process. TIT red line is generally 1650°F, and up to 1750°F in some installations. In the LeanFind mode the T column—TIT—is included in the procedure. If during leaning the TIT exceeds red line by less than 100° for less than one minute, the LeanFind procedure will continue to operate, allowing you to complete the leaning process. Otherwise the digital display will show, for example, I650 TIT and TIT will flash. You will notice that in some cases the TIT reads **100°F hotter than the hottest EGT**. This is caused by unburned fuel in the exhaust and igniting.

The reduced size of the **JPI Hastaloy-X-tip probes produces faster response** and more accurate than the massive factory installed probe. Therefore **JPI** probes may read as much as 100°F higher than the factory installed probe. However, note that the engine was certified with the factory-installed probe and gauge, and this gauge reading is the limiting factor when adjusting your engine.

Operation for each Phase of Flight



Engine Run-Up

Suggested setup:

Runup RPM

Normalize view

Manual mode

Verify:

- uniform rise of about 50°F in all EGTs in single magneto operation
- uniform rise of EGTs with application of the mixture control.

Be alert for:

- unusually low voltage (less than nominal battery voltage)
- cold OIL
- abnormally high CHT
- a higher EGT on one cylinder in dual magneto operation—indicates fouled spark plug.

Include your EDM on your run-up checklist.

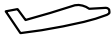

Take-Off, Climb, and Full Throttle Operations

Suggested setup:

Percentage view

Automatic mode

Verify:

- EGTs and CHTs consistent with past climbs. EGTs should be the 1100 to 1250°F range (100° to 300°F cooler than cruise) due to fuel cooling.

Be alert for:

- high EGT in one cylinder, 300°F above the others may indicate plugged injector or leaking manifold gasket.
- If all EGT bars go off scale to the top of the column, be sure you are not in *Normalize* view.

At high density altitude an overly rich mixture can significantly reduce engine power.

 **Cruise**

After the engine is warmed up, use LeanFind to lean the mixture.

Suggested setup:

Percentage view

Automatic mode

Be alert for:

- uneven EGTs or CHTs (carbureted engines). Make fine adjustments to throttle, then RPM, then mixture to level the display columns.
- abnormal patterns of EGTs and CHT. (see “Diagnosing Engine Problems” on page 21).

**Descent****Suggested setup:**

Percentage view

Manual mode

Be alert for:

- CLD: shock cooling alarm is set to -60°F . Average cool rates of $-40^{\circ}\text{F}/\text{minute}$ to $-60^{\circ}\text{F}/\text{minute}$ are normal, depending on the engine size.

Shock Cooling

Cooling the cylinders too fast can result in cracking and eventual failure. Lycoming Service Instruction 1094D (March 25, 1994) on *Fuel Mixture*

Leaning Procedures states:

“At all times, caution must be taken not to shock cool the cylinders. The maximum recommended temperature change should not exceed 50°F per minute.”

JPI checks shock cooling on all cylinders displaying the highest reading cylinder.

Common Misapplications

Some of the more common misapplications made by first-time EDM users are presented here in an attempt to help you avoid similar problems.

<i>Problem</i>	<i>Situation</i>	<i>Correction</i>
LeanFind finds a “peak” too soon.	Failure to pre-lean before performing LeanFind or stopping while leaning. Leaning too slowly.	Follow the pre-lean procedure in the section “LeanFind Mode” on page 12. Lean more quickly.
Peak not found	Lean Find not activated or stopping while leaning	Lean at the speed of approximately 10°F per second.
Off-scale EGT bars, too high or low	You forgot that you set the EDM in the Normalize view and later observe off-scale EGT bar readings.	The higher sensitivity (10° per segment) of the Normalize view can quickly go too high or low off-scale with only small changes in EGT.
First cylinder to peak is not the hottest	This is normal. The first to cylinder peak is not necessarily the hottest.	
EGTs rise during single magneto check	This is normal, due to incomplete combustion persisting longer.	
EGTs not uniform during low power operation	This is normal. Fuel and air distribution is not optimal at low power settings.	
No display of %HP	Fuel flow not reading	Fuel Flow option is required for HP

Section 4 - Diagnosing Engine Problems

Typical Normal Parameters

The follow chart lists typical *normal* parameter values that you will observe for most general aircraft engines.

<i>Parameter</i>	<i>Normal range</i>	<i>Comments</i>
EGTs in Cruise	1350°F 1550°F	<ul style="list-style-type: none">• under 200 HP• high performance• EGT should drop 200°F when full throttle is applied
EGT span (DIF)	70 to 90°F 120 to 150°F	<ul style="list-style-type: none">• fuel injected• carbureted
TIT	1600°F average	<ul style="list-style-type: none">• 100° higher than EGT
CHTs	350°F (OAT 60°F) 410°F	<ul style="list-style-type: none">• normally aspirated• Turbocharged
CHT span	50 to 70°F	100° with gasket probes
OIL	200°F	<ul style="list-style-type: none">• oil cooler thermostat opens at 180°F
O-P	60-90psi	<ul style="list-style-type: none">• generally
Shock cooling*	-40°/minute -55°/minute -200°/minute	<ul style="list-style-type: none">• tightly cowled• Bonanza• helicopter

* Maintain a cooling rate of less than -60°/minute. You will find that the cylinder with the greatest shock cooling will shift from front cylinders (during climb out) to the rear cylinders (during descent).

If one CHT is reading 20° to 50° above or below the others, this may be due to that cylinder having a spark plug gasket probe instead of a bayonet probe. This is necessary because the aircraft's factory original CHT probe is occupying the socket in the cylinder head rather than the EDM. This is normal. If the discrepancy is greater, be sure the spark plug gasket probe is mounted on the *top* spark plug. An adapter probe is available to occupy the same socket as the factory original probe. Contact your dealer.

Engine Diagnosis Chart

The following chart will help you diagnose engine problems in your aircraft. (Views are Percentage views). Notice that there will be always one CHT that is shown hotter than the others.

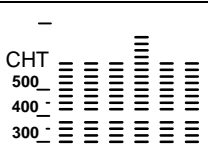
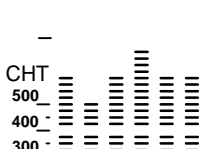
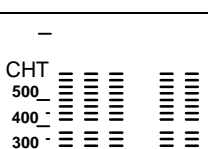
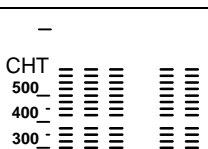
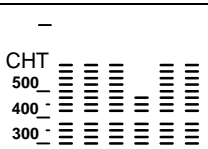
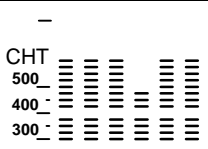
<i>Display</i>	<i>Symptom</i>	<i>Probable Cause</i>	<i>Recommended Action</i>
	75° to 100° EGT rise for one cylinder during flight	Spark plug not firing due to fouling, faulty plug, wire or distributor.	Enrich mixture to return EGT to normal. Have plugs checked.
	EGT Increase or decrease after ignition system maintenance	Improper timing: high EGT → retarded ignition; low EGT → advanced ignition.	Check EGT for each magneto to determine any uneven timing.
	Loss of EGT for one cylinder. Engine rough	Stuck valve. Other cylinders are okay.	Have valve train checked.
	Loss of EGT for one cylinder; <i>no digital EGT</i>	Failed probe or failed wire harness.	Swap probes to determine if probe or wire harness is bad.
	Decrease in EGT for one cylinder	Intake valve not opening fully; faulty valve lifter.	Have valve lifter or rocker arm checked.
	Decrease in EGT for one cylinder at low RPM	Low compression.	Check compression.

<i>Display</i>	<i>Symptom</i>	<i>Probable Cause</i>	<i>Recommended Action</i>
	EGT and CHT not uniform	Dirty fuel injectors or fouled plugs.	Check injectors and plugs. Non-uniformity is normal for carbureted engines
	Decrease in EGT for all cylinders	Decrease in airflow into the induction system. Carb or induction ice. Engine units set to Celsius	Check for change in manifold pressure. Check that the alarm limits are set to Celsius degrees
	Slow rise in EGT. Low CHT	Burned exhaust valve. CHT is low due to low power output.	Have compression checked.
	High CHT on cylinders on one side of engine	Obstruction under cowling.	Check for improper installed baffling, cowl flap misalignment or bird nests.
	Rapid rise in CHT of one cylinder	Detonation.	Reduce power.
	Sudden off scale rise for any or all cylinders	Pre-ignition or Normalize view. or failed probe	Full rich and reduce power. Change to Percentage view. Check probe

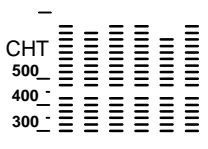
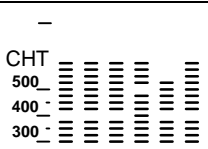
<i>Display</i>	<i>Symptom</i>	<i>Probable Cause</i>	<i>Recommended Action</i>
(no picture)	Loss of peak EGT	Poor ignition or vapor in fuel injection system.	Have magneto tested.
(no picture)	Decrease in peak or flat EGT response to leaning process	Detonation. Usually the result of 80 Octane fuel in 100 Octane engine.	Enrich mixture, reduce power and relean mixture. Repeat to find power setting where normal peak is obtained or run rich.
 <p>— CHT 500_ — 400_ — 300_ —</p>	Below 10,000 ft. full throttle causes EGTs to rise	Weak or defective mechanical fuel pump.	Apply booster pump. If EGTs drop, replace fuel pump.
 <p>— CHT 500_ — 400_ — 300_ —</p>	CHT more than 500°, EGT normal. Adjacent EGT may be low	Leaking exhaust gasket blowing on CHT probe.	Look for white powder around cylinder to determine leak area.
	Large DIF at low RPM	Blow by in cylinder rings	Check compression

Alarms

The EDM has programmable alarms. When a parameter falls outside of its normal limits, the digital display will flash with the value and abbreviation of the alarming item. If the condition triggering the alarm returns to within normal limits, the display will stop flashing the alarm. If your installation includes a separate panel mounted alarm warning enunciator light or audible warning, it too will be activated.

There are no alarms for the individual EGTs because the temperature values can assume different ranges depending on the flight configuration—run up, climb, cruise. However there *is* an alarm on the DIF parameter, the difference between the hottest and coolest EGTs. DIF—or span—is the important parameter for monitoring the EGTs. See “Factory Set Default Limits” on page 43 for a list of the alarms and their factory default settings.

When an alarm is displayed, *tapping* the **STEP** button will temporarily disable the alarm digital indication for the next ten minutes.

When an alarm is displayed, *holding* the **STEP** button until the word **OFF** appears will disable that alarm digital indication for the remainder of the flight. See “Alarm Limits” on page 42.

EDM-711 primary alarm display lamps cannot be disabled.

Alarm Priority

If multiple alarms occur simultaneously, the higher priority alarm will temporarily “mask” the lower priority alarm(s). When an alarm occurs, note the cause of the alarm and tap the **STEP** button to clear the alarm indication so that you will be notified of any other alarm that might have occurred. The alarm priorities are as follows:

Highest priority	CHT	High CHT
	OIL	High OIL temperature
	TIT	High TIT
	OIL	Low OIL temperature
	CLD	Excessive CHT cooling rate
	DIF	Excessive EGT span
	BAT	High battery voltage
	BAT	Low battery voltage
	MAP	Over boost Manifold pressure
	O-P	Oil Pressure
	LO	Low fuel quantity remaining
	FUEL	
	Lowest priority	LO
	TIME	

Pre-Ignition and Detonation

Combustion that is too rapid leads to detonation and possibly pre-ignition. *Detonation* is abnormally rapid combustion where the fuel-air mixture explodes instead of burning uniformly. It causes the EGT to decrease and the CHT to increase, and can appear during the leaning process. It occurs under high compression from fuel with too low an octane rating, or from avgas contaminated by jet fuel. Fuel additives, such as lead, boost the octane rating and slow down the combustion process, producing an even pressure to the piston.

Pre-ignition is caused by hot spots in the cylinder. Ignition occurs prior to the spark plug firing. The EDM depicts pre-ignition as a sudden red line of the EGT on the analog display. This may occur in one or more cylinders. The affected cylinder column(s) will flash while the digital display will show an EGT higher than 2000°F. **At this temperature pre-**

ignition will destroy your engine in less than a minute unless you take immediate corrective action.

Section 5 - Fuel Flow Option Operation

Fuel Flow Display Select Switch

The select switch is a three-position toggle switch mounted on your instrument panel near the display of the EDM. It affects only the display scan.

- In the **EGT (Temperature)** position only the installed temperature (and battery voltage) parameters are displayed.
- In the **ALL (All)** position, the EDM both installed temperature and fuel flow parameters are displayed.
- In the **FF (Fuel Flow)** position only fuel flow parameters are displayed.

Any alarm warning will appear regardless of the select switch setting. These parameters are displayed in the digital display in either the Automatic or Manual modes or during the pilot programming procedure. The select switch does not effect the analog display. EDM-711: the toggle switch is disabled during Automatic scan mode.

Start Up Fuel

After initial self-test, you will be asked to inform the EDM of start up fuel. The EDM will display FUEL for one second, and then flash FILL? N until any button is pressed. If your aircraft has tank fill tabs and no auxiliary tanks, you can use the auxiliary tank feature to select either filling to the tank tabs or topping the tank. See “Main Tank Capacity” beginning on page 46 to program the EDM for this feature. The EDM does not differentiate fuel flow between the main and auxiliary tanks; it considers only *total* fuel in the aircraft. **During flight you may also inform the EDM of startup fuel using the pilot program mode display if you forgot to do so at start up.**

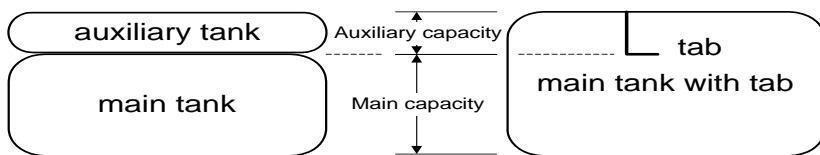

Refer to the flow chart. Then tap the **STEP** button to complete the entry and advance to the Manual mode.

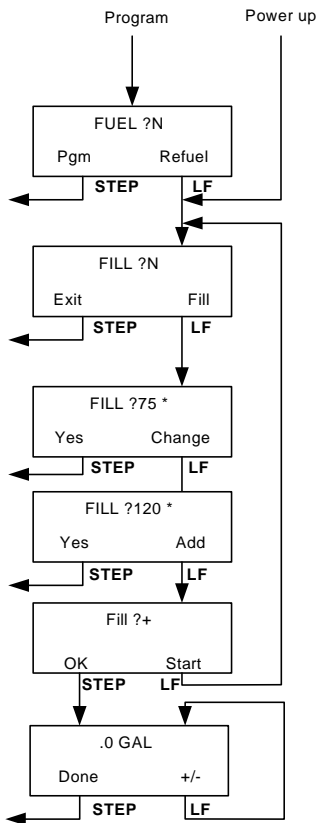

Adding Fuel and Auxiliary Tanks

If you either

- a) added less than full fuel to only the main tanks, or
- b) topped the main tanks but have some fuel remaining in the auxiliary tanks,

then select **FILL +** and the next display will ask you how much you added: **.0 GAL** (or selected units). Hold the **LF** button to count up, tap the **LF** button to count down. The count up will stop at full tanks, since you cannot add more fuel than would top the tanks.

If you added fuel to only the main tanks, then input how much you added.

If you topped the main tanks, but have some fuel remaining in the auxiliary tanks, input how much is now in the auxiliary tanks.

You can “add” a negative amount of fuel if you remove fuel from the aircraft or

wish to correct the total quantity of fuel on board.

Accumulate Total—Trip Total

You may either display total fuel *used* since the last time you informed the EDM that the aircraft was refueled, or for an extended trip with multiple fuel stops. This selection affects only the USD parameter. How to select whether to accumulate or reset is described in “Pilot Programming” beginning on page 33.

Resetting “USED”

Every time you inform the EDM that the aircraft is refueled, the amount of fuel *used* is set to zero, unless the instrument is programmed to accumulate. The display of fuel *used* pertains only to the fuel used since the last time you informed the EDM that the aircraft was refueled.

To reset to zero the amount of fuel *used* at any point in time, manually step to display USD and hold both buttons for five seconds until the display shows .0 USD.

Fuel Management

Without a means of measuring fuel flow, you must rely on the aircraft fuel gauges or total time of flight. Aircraft fuel gauges are notoriously inaccurate (they are only required by the FAA to read accurately when displaying *empty*). And measuring time of flight is only an approximation, and assumes a constant fuel flow rate for each phase of flight.

The EDM Fuel Flow Option uses a small, turbine transducer that measures the fuel flowing into the engine. Higher fuel flow causes the transducer turbine to rotate faster which generates a faster pulse rate. Because the transducer turbine generates thousands of pulses per gallon of fuel, it can measure with high resolution the amount of fuel that flows into the engine. Prior to engine start you inform the EDM Fuel Flow Option of the known quantity of fuel aboard, and it will keep track of all fuel delivered to the engine.

Parameter Scan—Systems with Fuel Flow Option

Listed below is the sequence, parameter description and example of the digital display. The first column indicates what position the select switch must be in to display that particular parameter. T is EGT, F is FF and A is ALL.

<i>Select Switch</i>	<i>Parameter Description</i>	<i>Example</i>	<i>Comments</i>
T, A	Voltage , System Bus	I 4 . 2 BAT	Battery voltage
T, A	Outside Air Temperature	8 I OAT	°F or °C
T, A	Induction Air Temperature	I 25 IAT	Out of intercooler
T, A	Compressor Discharge Temperature	300 CDT	Into intercooler
T, A	Carburetor Temperature	- 22 CRB	Not available when CDT is installed
T, A	Difference between hottest and coldest EGT	80 DIF	Dot indicates most widely deviating cylinder
T,A,F	RPM MAP for 1 sec	2450 23 . I	RPM and Manifold pressure
F, A	Fuel Remaining	37 . 2 REM	In gallons, liters or pounds or kilograms
F, A	Fuel required to next GPS WPT or Destination	25 . 9 REQ	Present with GPS interface Valid signal and way point
F, A	Fuel Reserve at next GPS WPT or Destination	I I . 3 RES	Present with GPS interface Valid signal and way point
F, A	Nautical Miles per Gal	I 3 . 0 MPG	Present with GPS interface and valid signal or MPK, MPL, MPP
F, A	Time to Empty	02 . 45 H . M .	Hours. Minutes Remaining at current fuel burn
F, A	Fuel Flow Rate	I 3 . 5 GPH	Or KPH, LPH, PPH
F, A	Total Fuel Used	38 USD	Since last refueling or trip total.
T, A	EGT, CHT	I 340 376	EGT, left, CHT, right. Dot indicates cylinder
T, A	TIT , Turbine Inlet Temperature	I 370 I 3 . 5	Turbine #1, left and fuel flow right
T, A	Oil Temperature	I 7 8 OIL	Oil Temperature
A	Oil Pressure	52 O-P	Oil Pressure
T, A	Shock Cooling	-30 CLD	Dot indicates fastest cooling cylinder

For fuel calculations to be accurate, it is imperative that you inform the EDM of the correct amount of fuel aboard the aircraft. Do not rely on fuel flow instruments to determine fuel levels in tanks. Refer to original fuel flow instrumentation for primary information

Section 6 - Long Term Data Memory

The EDM Long Term Data Memory will record and store **all** displayed parameters once every **six seconds** (or at the programmed interval of between 2 to 500 seconds). At a later time it will transfer them directly to a laptop PC.

When you retrieve recorded data to your laptop PC you can choose to retrieve *all* the data in stored in the EDM, or only the *new* data recorded since your last retrieval. In either case, no data in the EDM is erased. The data will be saved in the PC in a file in a compressed format. The PC program supplied with the Long Term Data Memory will decompress the data for display.

The amount of total data that the EDM can store will vary depending on how rapidly the measured temperatures change. The typical storage is up to 20 hours at a 6 second interval (1600 hours at 8 minute interval), but may vary depending on which options are installed. When the memory becomes full, the oldest data will be discarded to make room for the newest. In the LeanFind mode you may place a mark at the next data record by tapping both the **STEP** and **LF** buttons simultaneously. You will see the word **SNAP** within the next six seconds, indicating a data record has been marked. Tap the **STEP** button to return to the Automatic mode. Recording begins when EGTs are greater than 500°F or “snap” is requested.

All data are time-stamped. The EDM Long Term Data Memory contains a real-time clock that may be reset to local time when you initially program your instrument. You may also program an *aircraft id* that will appear in the output data file. The aircraft id can be your aircraft registration number or your name. Initially the *aircraft ID* is set to the EDM's serial number.

You may change the record interval from 2 to 500 seconds, even in flight. When you change the interval in flight, the current flight file is closed, and a new flight file is created with the new record interval.

At power on, the EDM will execute its self test and then display the date (e.g., I I . I2 . 0 I), the time (I3 . 26), the percentage of memory filled since the last save (FULL 24), and the Aircraft ID.

Downloading from Long Term Memory

To download data from the long term memory to your laptop PC, do the following steps.

1. Connect the data cable between the PC serial port and the EDM data port connector mounted on your instrument panel.
2. Run the EzPlot program on the PC.
3. On the EDM hold both **STEP** and **LF** for five seconds.
4. Tap **STEP** a number of times until you see **DUMP? N**.
5. Tap **LF** to select **NEW** data or **ALL** data.
6. Click on the Start button on the PC.
7. Wait 2 seconds and tap **STEP** on the EDM.

At the completion of the download, you can plot the data. Refer to the EzPlot program and documentation.

Downloading Data from the EDM to a Flash Drive

Using the Accessory USB Memory Box

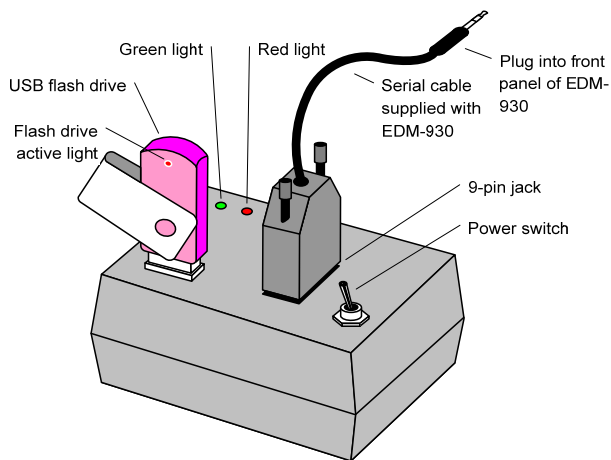

To download EDM data into a USB flash drive using the accessory USB memory box, follow these instructions.

1. Insert the serial cable plug into the front panel of the EDM. Insert the other end of the serial data cable into the 9-pin jack on the memory box. (The serial cable is supplied with the EDM, not the memory box.)
2. Turn on the power switch on the memory box; the red light on the memory box will light up.
3. Insert the USB flash drive into the USB port on the memory box. The green light on the memory box will light up. If so equipped, the active light on the USB flash drive will light up.
4. You should see DUMPNEW on the EDM display. If you want to dump only new data since the last download, tap the STEP button. If you want all the data in the EDM, first tap the LF button and see DUMPALL. Then tap STEP.
5. During the download, the EDM will display DATA DOWNLOAD MODE and the percent complete indicator will progress from 0% to 100%. The green light on the memory box should blink and the active light on the USB flash drive will blink.
6. When the download is complete the EDM display will show DONE. Wait 10 seconds.
7. Remove the USB flash drive from the memory box, turn off the memory box, and disconnect the cable from the EDM.

This completes the download. See “Downloading from USB Flash Drive to a PC,” below.

Using the Optional USB Port

To download EDM data into a USB flash drive using the optional USB port, follow these instructions.

1. With the EDM powered up, plug the USB flash drive into the USB connector on the aircraft instrument panel. The EDM display will show NEW.
2. If you want to dump only new data since the last download, tap the STEP button. If you want all the data in the EDM, first tap the LF button and see ALL. Then tap STEP.
3. You will see a count down as the data is copied to the USB flash drive. When the download is complete the display on the EDM will show DONE.
4. Remove the USB flash drive from the USB connector.

This completes the download. Continue to the next step.

Downloading from USB Flash Drive to a PC

To download your data from the USB flash drive to your PC, follow these easy steps.

1. On your PC, start the EzTrends program.
2. Plug in the USB flash drive into an available USB port.
3. In EzTrends, select the Move and Plot Data from Memory Stick option.
4. In the displayed list, find the USB flash drive and double click it.
5. Select the file you wish to plot and then select the flight in that file.

Refer to the EzTrends manual for details on how to use EzTrends.

Section 7 - Personalizing

Pilot Programming

To start the Pilot Programming Procedure, simultaneously hold the **STEP** and **LF** buttons for five seconds. You will see the word **PROGRAM** for two seconds and then the sequence shown in the chart below. Tap the **STEP** button to advance to the next item in the list. Tap the **LF** button to select alternate values of that item. The shaded areas in the chart below pertain only to the Fuel Flow Option.

Select switch	Tap STEP to advance to the next item	Tap LF to sequence through these values	Comments
T, F, A	PROGRAM		Stays on for two seconds. Hold both buttons for 5 seconds set up the factory original TIT (see page 37).
T, F, A	FUEL ? N	N ↔ Y	Y—Yes—to change fuel status (see page 26).
T, A	RATE 4	0 ... 9	Index rate (pause time) in the Automatic Mode. 0 disables the Automatic Mode (except EDM-711).
T, A	OAT F	OAT F ↔ OAT C	To calibrate the OAT $\pm 10^\circ$, hold both the STEP and LF buttons simultaneously for five seconds, which will proceed to the next step. Otherwise the next step will be skipped.

T, A	OAT+0	OAT-I 0 ... OAT+I 0	This step will be normally be skipped. Adjust the indicated temperature up or down by up to 10°. For example, OAT+3 adjust the OAT 3° higher.
T, A	EGT I?N	EGT I?N ⇔ EGT I?Y	Y—Yes—sets the digital display to one-degree resolution; N—No—sets 10°. (10° resolution is easier to interpret the EGTs.)
	HP - ? Y	N ⇔ Y	Y—Yes—displays %HP in the upper digital window. N—No—displays RPM in the upper digital window. Hold STEP and LF for 5 seconds to adjust the horsepower constant.
T, A		70 ^{HP} HPC= I 25	%HP display will change when HP constant is adjusted. See Programming the EDM-800 Horsepower Constant beginning page 36. Hold STEP and LF for 5 seconds to set the MAP calibration. Tap STEP to exit.
T, A		MAP +0	Correct the MAP to the altimeter setting at a sea level airport ±3.0 in Hg. Hold Step/OK and Change for 5 seconds until you see ADJUST to set the MAP calibration. Tap Step/OK to continue to the next step.
F, A	KF-SET	29.00=K F	KF-set, hold both STEP and LF buttons simultaneously for five seconds to begin the next sequence.
		29.00=K F	29.00 One digit will be flash and the LF button will adjust up or down. STEP to next digit. Hold both buttons to exit set mode.
F, A	ACCUM? N	ACCUM?N ⇔ ACCUM?Y	N—No—Upon informing the EDM that you refueled the aircraft, reset total fuel used to 0. Y—Yes—accumulate total fuel used rather than reset to 0 at each refueling.
F, A	GPS - C = 2	0 ... 6	GPS Com Format.
T, F, A	DUMP? N	N ⇒ NEW ⇒ ALL ⇒	Memory dump. Select to transfer ALL or only NEW data. The END Y step is skipped after a successful a Long Term Memory DUMP.

T, F, A	END Y	END Y ↔ END N	Y—Yes to exit; N—No to review list again.
------------	-------	---------------------	-------------------------------------------

Section 8 - Programming the EDM-800 Horsepower Constant

You must adjust the HP Constant **once for your aircraft**. The default display will be RPM if Fuel Flow is not operational or you can adjust the display to show RPM instead of HP. Before takeoff, put the EDM in the HP Constant mode. Enter the pilot program mode by simultaneously holding the STEP and LF buttons until the display changes, about 5 seconds.

1. Tap STEP about 4 times until you see **HP-? Y**. If you see **HP-? N**, change the N to a Y by tapping the LF button, then hold both the STEP and LF buttons display until you see **HPC= 120**. Change the number 120 by tapping or holding the LF button. Note that the %HP number in the display will change as you change the constant.
2. Referring to the Aircraft Flight Manual (AFM) set the engine to a constant power setting of 70% , Rich of peak and maintain straight and level flight at any altitude below 10,000 feet. View the reading in the %HP display and see how close it is to your current engine percent HP. If the value in the display not at your current engine percent HP setting, then change the HP reading by adjusting the HP constant in the lower display by holding or tapping the LF button.
Note: the reading is the percent of maximum HP, not total HP.
3. Keep adjusting the HP constant until the upper window displays the same power level as the current engine percent HP.
4. Tap the STEP button to exit.

Section 9 - Programming Manifold Pressure (MAP)

Do this one time and only if the MAP on your manifold pressure gauge doesn't match the MAP shown on the EDM-800.

1. Do this on the ground with the **engine turned off**.
2. Enter the pilot program mode by simultaneously holding the STEP and LF buttons for five seconds.
3. Tap STEP to index to **HP-? Y**.
4. Hold both the STEP and LF buttons and you will see **HPC= 125**.
5. Hold both the STEP and LF buttons and you will see **MAP= 0**
6. Use **one** of the following two methods to calibrate the MAP.

You may need to correct the MAP based on the **altimeter setting at a sea level airport**.

- A. Enter the pilot program mode by simultaneously holding the Step and LF buttons for five seconds.
- B. Tap Step/OK repeatedly until you see—for example— HP Constant=125. Then hold both the Step/OK and Change buttons display until you see Adjust, followed by HP Constant=125.
- C. Again, Hold both the Step/OK and Change buttons display until you see ADJUST, followed by MAP=0. The adjustment range for the MAP is ± 3.0 in Hg.
- D. Adjust the MAP based on the **altimeter setting at a sea level airport** using the Change button.
- E. Tap the Step/OK button to proceed to the next step.

OR

- F. Absolute calibration: the table below shows the MAP for a given field elevation (down the left side of the table) and altimeter setting (along top row of the table). Find the entry in the table most closely matching your field elevation and current altimeter setting. Interpolate if necessary. Use the LF button to index up or down when adjusting the MAP

Alt setting-> field elev.	29.0	29.2	29.4	29.6	29.8	29.9	30.0	30.2	30.4	30.6	30.8	31.0
0	29.0	29.2	29.4	29.6	29.8	29.9	30.0	30.2	30.4	30.6	30.8	31.0
1000	28.0	28.2	28.4	28.5	28.7	28.8	28.9	29.1	29.3	29.5	29.7	29.9
2000	27.0	27.1	27.3	27.5	27.7	27.8	27.9	28.1	28.3	28.5	28.6	28.8
3000	26.0	26.2	26.3	26.5	26.7	26.8	26.9	27.1	27.2	27.4	27.6	27.8
4000	25.0	25.2	25.4	25.6	25.7	25.8	25.9	26.1	26.3	26.4	26.6	26.8
5000	24.1	24.3	24.5	24.6	24.8	24.9	25.0	25.1	25.3	25.5	25.6	25.8
6000	23.2	23.4	23.6	23.7	23.9	24.0	24.0	24.2	24.4	24.5	24.7	24.8
7000	22.4	22.5	22.7	22.8	23.0	23.1	23.1	23.3	23.5	23.6	23.8	23.9

Do not set MAP to the local altimeter (Kollsman window) setting since that setting is the pressure at sea level, and is not the same as your field elevation pressure.

Tap or hold the LF button to change the MAP value.

- 7. Tap the STEP button to exit.

Section 10 - Programming use of Factory Original TIT Probe

If your aircraft is using the factory original TIT probe and gauge, you should calibrate the EDM for that probe. The factory original TIT probe must be a type K and the leads must be wired red-to-red and yellow-to-yellow. Both the EDM and factory original gauge may be used

concurrently. Due to the high input impedance of the EDM instrument, it will not affect the accuracy of the factory installed probe or gauge.

In normal cruise flight, record the difference between the factory installed TIT gauge and the EDM TIT reading.

TIT gauge _____ EDM _____.

If you haven't already done so, start the pilot programming procedure, by simultaneously holding the **STEP** and **LF** buttons for five seconds. You will see the word **PROGRAM** for two seconds.

Tap STEP

to advance
to the next
item

Tap the LF button to
sequence through
these values

Comments

PROGRAM		Stays on for two seconds.
RATE 4	RATE 4	hold both STEP and LF buttons simultaneously for five seconds to begin the next sequence.
ORIG TIT	ORIG T-N ⇔ ORIG T-Y	Y—Yes—selects factory original TIT probe and proceeds to the next step.
CAL TIT	- 975 ... +975	Tap the LF button to lower the correction; hold the LF button to raise the correction. For example, if the EDM reads 100 less than the aircraft's TIT gauge, set the display to read TIT + I00.
		Tap STEP button to exit the procedure.

Section 11 - Programming the Fuel Flow Option**Fuel Flow Parameters**

Three additional parameters may be set by the pilot when the Fuel Flow Option is installed:

- K Factor—the fuel flow transducer calibration constant.
- Accumulate—default is OFF: resets the fuel *used* to 0 every time you inform the EDM that the aircraft was refueled. With accumulate ON fuel *used* will not be reset to 0 when you inform the EDM that the aircraft was refueled.
- GPS Communications fuel data format.

K Factor

The K factor is shown on the fuel flow transducer as a four-digit number, which is the number of pulses generated per gallon of fuel flow. **Before installing the transducer, write down the K factor here _____.**

To enter the number, move the decimal point three places to the left. For example if the K factor on the fuel flow transducer is 29,123, enter 29.12 in the K factor parameter.

The K factor can be changed in the pilot programming procedure. *When the K factor is changed during a trip, calculations of fuel used, fuel remaining and time to empty are not retroactively recalculated.*

Fine Tuning the K Factor

The K factor shown on the fuel flow transducer does not take into account your aircraft's particular installation. Fuel hose diameters and lengths, elbows, fittings and routing can cause the true K factor to be different from that shown on the fuel flow transducer.

You must use the following procedure to fine tune the K factor.

1. Make at least three flights of about two to three hours each. Note the actual fuel used (as determined by topping the tanks) and the EDM calculation of the fuel consumed for each flight = USD.

<i>Flight</i>	<i>Fuel USED shown by EDM (total tank - REM)</i>	<i>Actual fuel used by topping tanks</i>
1		
2		
3		
Total	①	②

2. Total **①** the EDM fuel used and **②** the actual fuel used.
3. Record the current K factor here **③** _____ and in the table below.
4. Calculate the New K Factor as follows:

$$\text{New K Factor} = \frac{(\text{① EDM fuel used}) \times (\text{③ Current K factor})}{(\text{② actual fuel used})}$$

$$\text{New K Factor} = \frac{(\text{①}) \times (\text{③})}{(\text{②})}$$

Every time you fine tune the K factor, record the measurements here:

<i>Date</i>	<i>①EDM fuel used</i>	<i>②actual fuel used</i>	<i>③Current K factor</i>	<i>New K factor = ①x③/②</i>	<i>Pilot's initials</i>

Fuel Flow Option Programming Procedure

Setting the K factor

This procedure is different than for setting other parameters. Place the select switch in the FF position. If you haven't already done so, start the pilot programming procedure, simultaneously hold the STEP and LF buttons for five seconds. You will see the word PROGRAM for two seconds.

1. Tap STEP button to advance to the KF-SET screen 29.00=KF
2. Hold both the STEP and LF buttons simultaneously for five seconds. First digit flashes (shown here as a larger digit only for illustration purposes): 29.00
3. Tap or hold the LF button to change flashing digit: I 9.00
4. Tap STEP button for next digit: I 9.00
5. Tap or hold the LF button to change flashing digit: I 8.00
6. Tap STEP button for next digit: I 8.00
7. Repeat items 5 and 6 for the remaining two digits.
8. Hold STEP and LF buttons simultaneously for five seconds to exit.

Accumulate Total—Trip Total

Select “No” if you wish to display total fuel used since the last time you informed the EDM that the aircraft was refueled. Select “Yes” to display total fuel used for an extended trip with multiple fuel stops. This selection affects only the USD parameter.

GPS-C Comm settings

The GPS-C setting selects the format of the *fuel data* output of the EDM. See “

GPS-C Fuel Flow Format” on page 47.

Section 12 - Programming Long Term Data Memory

If you haven't already done so, start the pilot programming procedure, simultaneously hold the STEP and LF buttons for five seconds. You will see the word PROGRAM for two seconds. To change the date, time and user id for the Long Term Data Memory, tap the STEP button until the display shows DUMP? N. Next, simultaneously hold the STEP and LF buttons for five seconds. Then set the date and time as show below:

STEP	LF	Comments
TIME	2⇒ 500	Record time interval, in seconds
MNTH	I ⇒ I2	Month
DAY	I ⇒ 3I	Day
YEAR	80 ⇒ 79	Year (note: represents 1980 through 2079)
HOUR	00 ⇒ 23	24 hour time. We suggest you set Zulu time
MIN	00 ⇒ 59	This also zeros the seconds
N----- -	N I2345 6	Current Aircraft ID. To <i>change</i> Aircraft ID, hold both STEP and LF buttons until the first character flashes. LF selects the first character. STEP moves to the next character. To <i>Save</i> , hold both STEP and LF for 5 sec.
END Y		Tap STEP button to exit the procedure.

Section 13 - EDM-711 Primary Alarm Display

The EDM-711—There are 3 primary functions available to your EDM-700/800 CHT, OIL and TIT. When an EDM-700-800 has primary functions it is called an EDM-711. A Remote alarm lamp is supplied that will function even when the primary display fails. Each lamp is a dual lamp Red/Yellow. The lamp will light when the indicated temperature exceeds alarm limit. The limits for these alarms and warnings are preset by the factory for your type of aircraft and can only be changed at the factory. The yellow warnings are set as follows: CHT 45°F below redline, OIL 25°F below redline, and TIT 100°F below redline.

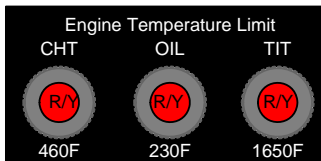

Tapping **STEP** will extinguish the flashing digital display but the remote yellow/red warning indication cannot be extinguished.

In the procedure in the next section to change the alarm limits, you will *not* be able to change the limits for CHT, OIL or TIT.

Section 14 - Alarm Limits

Factory Set Default Limits—Non-Primary

JPI conservatively sets the default alarm limits below Lycoming and Continental recommendations.

<i>Parameter</i>	<i>Default Low Limit</i>	<i>Default High Limit</i>	<i>Alarm Example</i>
CHT		450°F* 230°C	465 CHT
OIL	90°F 32°C	230°F* 110°C	280 OIL
O-P	20 psi	N/A	19 O-P
TIT		1650°F* 900°C	I 720 TIT
CLD		-60°F/min. -33°C/min.	-65 CLD
DIF		500°F 280°C	525 DIF
BAT, 24 V	24V	32V	22 .4 BAT
BAT, 12 V	12V	16V	I7.6 BAT
MAP		32 inches	46.3 MAP
LO FUEL	45 min		00.20 H.M
LO TIME	10 gal, kg, ltr, lbs		7.2 REM

The alarm limits may differ from those shown here, depending on your type of aircraft.

If you change the display between Fahrenheit and Celsius, newer instruments will automatically change the alarms to the factory limits.

When an alarm is displayed, tapping the **STEP** button will temporarily delete that parameter from the sequence for the next ten minutes. When an alarm is displayed, holding the **STEP** button until the word **OFF** appears will delete that parameter from the sequence for the remainder of the flight. On EDM-711 primary instruments the red alarm light cannot be extinguished as long as the alarm condition is present.

Changing the Alarm Limits/Tank Capacity

You may prefer to set your own alarm limits or change your usable fuel in the main tanks. Follow the procedure outlined below to change any of the factory default settings.

To start the alarm limit procedure, after power up, wait until the EDM completes its self test and is in the Automatic or Manual mode. If in doubt, tap the **STEP** button a few times. Then follow the steps depicted here:

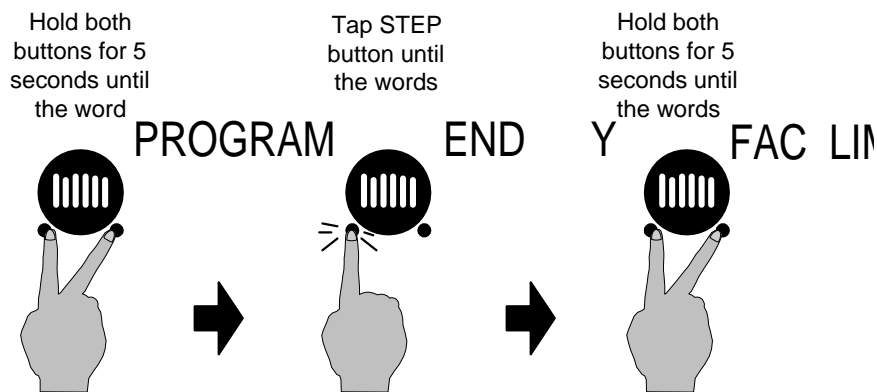

The display will then sequence as shown in the chart below. Tap the **STEP** button to advance to the next item in the list. Tap the **LF** button to select alternate values of that item. *Hold* the **LF** button to increase a numerical value; *tap* the **LF** button to decrease a numerical value. The shaded areas in the chart below pertain only to the Fuel Flow Option.

Procedure for changing the alarm limits or main tank capacity:

<i>Tap STEP to next item</i>	<i>LF sequences through these value ranges</i>	<i>Description</i>
FAC? N	FAC? N ↔ FAC? Y	Restore factory defaults?
ENG F	ENG F ↔ ENG C	Select F or C degrees for all engine temps. You must also change the alarm limits to °F or °C.
I6.0 H BAT	I0.0 H BAT ... 35.0 H BAT	Battery high voltage limit, set in 0.5 volt increments.
I2.0 L BAT	8.5 L BAT ... 30.0 L BAT	Battery low voltage limit.
500 DIF	30 DIF ... 990 DIF	EGT difference limit, set in 10° increments.
450 H CHT	90 H CHT ... 500 H CHT	CHT high limit, set in 5° increments.*
-60 CLD	-5 CLD ... -200 CLD	Cooling limit, set in 5°/min. increments.
I650 TIT	650 TIT ... 2000 TIT	Also sets the maximum scale of the EGT and TIT bar graph.*
230 H OIL	40 H OIL ... 500 H OIL	Oil temperature high limit, set in 5° increments.*
90 L OIL	I0 L OIL ... 250 L OIL	Oil temperature low limit set in 5° increments
20 O-P	0 O-P... .99 O-P	Oil Pressure low limit set in 1 pound increments.

42.0 MAP	25MAP ... 90 MAP	MAP over boost alarm (EDM-800 only)
FUEL GAL	FUEL GAL⇒ FUEL KGS⇒ FUEL LTR⇒ FUEL LBS⇒	Selects the units in all parameters where fuel quantity or fuel rate is displayed
MAIN=50	MAIN=0 ... MAIN=999	Main tank capacity, in units selected
AUX? N	AUX? N↔AUX? Y	Y—Yes—aircraft has auxiliary tanks
AUX=0	AUX=0 ... AUX=250	Auxiliary tank capacity
MIN =45	MIN =0 ... MIN =60	Alarm limit in minutes for low time in tanks
REM =I0	REM =0 ... REM =200	Alarm limit for low fuel quantity in tanks, in units selected
CARB?	CARB? N ↔ CARB? Y	Y—Yes—carbureted engine. Setting 1-3, 3 being high filter
RECRD?	RECRD? Y ↔ RECRD? N	Long Term Memory. Y—only data recording. N—only real-time data output.
CYL=6	CYL=4 ... CYL=I 2	(EDM-800 only) Set the number of cylinders. See page 46 for exceptions.
HP =I 80	HP=60 ... HP=500	(EDM-800 only) Set the HP constant
I 4.90 = EC	I 2.00= EC... I6.00= EC	(EDM-800 only) Set the Engine Constant
	END Y ↔ END N	Y—Yes to exit; N—No to review list again

MAP, Fuel Flow Alarm Limits, Units, Fuel Capacity

MAP Overboost Alarm

Enter the redline for overboost on turbocharged engines.

Fuel Flow Units (shaded area above)

Selects the units in *all* measurements where fuel quantity or fuel rate is displayed. If you change this parameter, it does *not* change the numerical value of the fuel tank capacity. You must do this manually. For example if you change from Gal. to Lbs., the tank capacity will be interpreted as 50 Lbs. rather than 50 gallons; the EDM will not convert 50 Gal to equivalent pounds.

Main Tank Capacity

Enter the total usable fuel capacity of the main tanks in the fuel flow units selected.

If you do not have auxiliary tanks or tank tabs, answer “No.” If you answer “Yes,” you will be asked to input the capacity of the auxiliary tanks in the fuel flow units selected. If you have tank tabs and sometimes fill only to the tabs, set the auxiliary tank capacity to the difference between full tank capacity and tab capacity. The EDM does not differentiate fuel flow between the main and auxiliary tanks; it tracks only *total* fuel in the aircraft.

Low Time Alarm Limit

Select the value of the time remaining, in minutes, that triggers the alarm. Time remaining is calculated at the current fuel flow rate.

Low Fuel Alarm Limit

Select the value of the fuel remaining, in the selected fuel flow units, that triggers the alarm. Fuel remaining is calculated at the current fuel flow rate.

Carburetor?

Different **response filters** are used depending on whether your engine is carbureted or fuel injected. The filter for a carbureted engine has a slower response time to reduce sudden fluctuations in readings. The higher the number the more filtering or less jumping around.

Number of Cylinders

This applies only to EDM-800. Set CYL = 4 or 6 depending on your engine. Exceptions:

- 4 cylinder engine with dual (all-in-one) magnetos set to CYL= 8.
- 4 cylinder Lasar® ignition set to CYL=8 .
- 6 cylinder Lasar® ignition set to CYL=12.

HP and EC (EDM-800 only)

These adjustments set the parameters for the HP calculations in the EDM. Set the **Rated HP** for your particular aircraft. Set the **HP Constant** to 14.9 for normally aspirated or turbo normalized engines; set it to 13.75 for turbo boost engines. To set the **EC**, hold **STEP** and **LF** for five seconds. The first digit will flash. Use **LF** to change the digit, use **STEP** to advance to the next digit. Hold **STEP** and **LF** for five seconds to exit.

Diagnostic Messages, Fuel Flow

The following displays indicate a malfunction in the Fuel Flow Option transducer or associated electrical connections:

0.0 GPH	Zero's indicate Fuel flow is too low to register
--- GPH	Dashes indicate No fuel flow transducer signals
--- H.M	Dashes indicate No fuel flow transducer signals

GPS Interface Diagnostics

Parameters REQ, RES, & MPG are all missing from the scan.	No communications from GPS receiver to EDM. Possibly no connection or aircraft GPS is off.
NO - COM message and parameters REQ, RES, & MPG are missing.	Communications are received by EDM and the Auto-Protocol setup is in process. Verify correct output format setup in GPS receiver; check GPS connections.
NO - SIG message and parameters REQ, RES, & MPG are missing.	GPS receiver has insufficient signal for valid data.
NO - WPT message and parameters REQ & RES, are missing.	No waypoints are programmed into the aircraft GPS receiver.
- - - REQ or - - - RES message	Your ground track is more than $\pm 70^\circ$ from your course to the next GPS waypoint.

Navigation Data Ports for GPS Comm

(These ports are completely independent of the EDM serial data output port.)

Navigation Data (output of GPS; input to EDM)

Compatible with RS-232, TTL, RS-423, RS-422 SDA.

Serial data format: 8 data, 1 start, no parity. Baud rates: 1,200, 4,800, or 9,600 depending on the GPS data output format. The EDM

automatically detects the GPS data output format and is independent of the GPS-C setting.

Fuel Data (input to GPS; output of EDM)

RS-232. Serial data format: 8 data, 1 start, no parity. Baud rate: 9,600.

Output format is determined by the GPS-C setting, but may be overridden by the GPS navigation format: If the EDM senses Northstar or NMEA-183 navigation data input, there will be no fuel data output.

Section 15 - Option Connector Pin Assignments

P1 (upper) 25-pin connector for 4 or 6 cylinder engines. See installation manual for 7, 8, 9 cylinder instruments			MAP-RPM 9-pin connector (EDM-800)		Fuel Flow Option 15-pin connector	
<i>Pin no.</i>	<i>Pin no.</i>	<i>Probe or function</i>	<i>Pin no.</i>	<i>Function/sensor pin</i>	<i>Pin no.</i>	<i>Function</i>
yel 1	red 2	OIL	grn 1	RPM sig /1	1	RS-232 out
yel 3	red 4	IAT	blk 2	RPM grd /2	2	RS-232 in
yel 5	red 6	CARB (or CDT)	red 3	RPM pwr /3	wht 4	FF signal
yel 14	red 15	OAT	red 4	MAP pwr /3	red 5	FF power
yel 16	red 17	TIT	blk 5	MAP grd /1	blk 6	FF return
yel 18	red 19	TIT-2 (2 nd TIT)	blk 6	Oil P. term	7	Switch com
	gry 12	Remote alarm	wht 7	Oil P. term	8	Switch EGT
	red 13	+ Power 14/28 vdc	wht 8	MAP sig+ /2	9	Switch FF
	wht 24	RS-232 data port	grn 9	MAP sig- /4	11	Remote FF alarm
	blk 25	Ground at Engine				

Interface connections to selected GPS models

EDM	Fuel flow conn Pin 1	Fuel flow conn Pin 2
Arnav 5000	Pin 4	Pin 5
Garmin 195	(nc)	Pin 4
Garmin 430 / 530	Pin 57	Pin 56
Northstar M3P	(nc)	Pin 6 (leave pin 11 open)
UPS GX50 / 60	Pin 4	Pin 5

Section 16 - Reference Reading

You may wish to know more about the effect of engine operations on EGT and CHT. The reading list below provides general overviews as well as original references on topics that may be of interest.

General Overview

These references are readily available to pilots and provide a readable source of general technical information.

- Teledyne Continental Motors, *Engine Operation for Pilots*, from the FAA Accident Prevention Program, FAA-P-8740-13.
- Editors of *Light Plane Maintenance Magazine, EGT Systems*, Belvoir Publications Inc., Greenwich, CT 06836. 1989.
- *Lycoming Flyer* Issue 53 dated January 93.

Technical Reviews and Original References

For those pilots who have engineering backgrounds, the references listed below present the original research on the combustion process and represent the source documents for those with technical interests.

- A. Hundere, "Autogas for Avgas," *AOPA Pilot*, October, 1969.
- A. Hundere and J. Bert, "Pre-ignition and Its Deleterious Effects in Aircraft Engines," *SAE Quarterly Transactions*, Vol. 2, No. 4, pages 547-562, October 1948.

Section 17 - Technical Support

JPI offers both e-mail (support@jpinstruments.com) and telephone technical support. Have your model and serial number ready when you call. Call **JPI** for a return authorization number RMA before returning any equipment.

J.P. INSTRUMENTS Inc.

3185 B Airway
Costa Mesa, CA 92626

800 345-4574
714 557 3805
Fax 714-557-9840

www.jpinstruments.com

Limited Warranty

J.P. Instruments Inc. (JPI) warrants all parts in your new EDM to be free from defects in material and workmanship under normal use. Our obligation under this warranty is limited to repair or exchange of any defective part of this unit if the part is returned, shipping prepaid, within three years for electronics and one year for probes from the date of original purchase. Installation labor is the responsibility of the aircraft owner. Homebuilt aircraft warranty starts when the aircraft is certified for flight. Replacement parts carry a warranty for the balance of the warranty period.

Under this warranty, JPI is not responsible for any service charges, including removal, installation, nor any other consequential damages. JPI incurs no obligation under this warranty unless a Warranty Registration Certificate describing the warranted product has been completed and mailed to JPI with all information requested.

This warranty is void on any product which has been subject to misuse, accident, damage caused by negligence, damage in transit, handling or modification which, in the opinion of JPI, has altered or repaired the product in any way that effects the reliability or detracts from the performance of the product, or any product whereon the serial number has been altered, defaced, effaced or destroyed.

This warranty is in lieu of all other warranties expressed or implied and other obligations of liability on JPI's part, and it neither assumes nor authorizes any other person to assume for JPI any other liability in connection with the sale of JPI products.

To initiate this warranty, the aircraft owner must submit a completed Data Logging Worksheet to JPI. Upon receiving a completed worksheet, JPI will initiate the warranty from the date of original purchase. Any replacement parts carry a warranty that extends for the balance of the period of the original warranty. For homebuilt aircraft the warranty starts when the aircraft is certificated for flight and noted on the warranty card.

Index

A

Accumulate, 34, 39
 total, 27
Adapter probe, CHT, 21
Adding fuel, 27
Adjusting
 K-factor, 37
 OAT, 34
 TIT, factory original, 36
Alarm Display Lights, 40
Alarm limits
 changing, 41
 factory defaults, 41
 fuel flow, 43
Alarms, 24
 low fuel, 44
 priority, 25
 resetting, 25
ALL, 34
 select switch, 26
Allied Signal, 45
Arnav, 45
Automatic indexing mode, 7
Automatic mode, 11
AUX, 43, 45
Auxiliary tanks, 43
Avgas, 25
Aviation data format, 45

B

Bar graph, 4
 column resolution, 6
 EGT, 6
Baud rate, 46
Blinking display, 13, 17, 24, 25
Brightness, display, 7
Buttons
 front panel, 8

C

CAL ERR, 11
Calibration
 horsepower, 35
 internal self test, 11
 K-factor, 37

For Your Safe Flight

 manifold pressure (MAP), 35
 OAT, 34
 TIT, factory original, 36
Capacity, fuel tank, 26
CARB?, 43
Carburetor, 44
 ice, 23
 temperature, 10, 29
Celsius
 display indicator, 5
 engine temperatures, 42
 OAT, 33
Changing alarm limits, 41
CHT
 missing segment, 6
 probe, 2, 21
 too high or too low, 21, 24
CLD. See Shock cooling
Climb, 18
Combustion, 2, 25, 48
Compression, 2, 23
 high, 25
 low, 22
Compressor discharge temperature,
 CDT, 10, 29
Connector
 option pins, 47
Cooling. See Shock cooling
Cowling, obstruction, 23
Cruise, 19
Custom programming, 33
 alarm limits, 41
 fuel flow option, 37
 Long Term Memory Option, 39
Cylinder numbers, 6

D

Data
 GPS formats, 45
 ports, GPS, 46
Default alarm limits, 41
Defueling, 27
Descent, 19
Detonation, 24, 25
Diagnosing engine problems, 21, 36,
 37, 41
Diagnostic
 fuel flow messages, 46
 GPS interface messages, 46

Page 53

- self test, 11
- DIF, 10, 24, 29, 42
- Dimming, display, 7
- Display, 4
 - analog, 4
 - digital, 6
 - flashing, 13, 17, 24, 25
- Dot index, 6
- Download, 31

E

- Economy, best, 3
- EDM-711, 40
- EGT
 - alarms, 24
 - loss, 22
 - probe, 2
 - resolution, display, 34
 - select switch, 26
 - too high, 20, 22
 - too low, 20, 23
- Electronics International, 45
- Engine
 - diagnosis chart, 22
 - limits, normal, 21
 - run-up, 18
- Enunciator, alarm, 24
- Exclude parameters, 11
- Exhaust leak, 18, 24
- EzPlot, 31

F

- Factory default alarm limits, 41
- Factory original TIT probe, 36
- Fahrenheit
 - display indicator, 5
 - engine temperatures, 42
 - OAT, 33
- Failure to pre-lean, 20
- FF, select switch, 26
- Fill options, 27
- FILL? N, 26
- FILL+, 27
- First cylinder to peak, 13
- Flash drive, 31
- Flashing
 - segment, 6
- Flashing display, 13, 17, 24, 25
- Flat EGT response, 24

Page 54

- Fouled spark plugs, 5
- Fuel
 - accumulate, 27
 - adding or filling, 27
 - auxiliary tank capacity, 43
 - capacity, 26, 43
 - injectors, 24
 - injectors, clogged, 2, 18, 23
 - Octane, 24
 - pump, 24
 - remaining, 29
 - required, 29
 - reserve, 29
 - resetting fuel used, 28
 - start up, 26
 - tabs, tank, 43
 - tank capacity, 26, 43
 - used, 29

- Fuel flow
 - alarm limits, 43
 - connector, 47
 - diagnostics messages, 46
 - units, 43
- Full throttle, 18

G

- Gallons per hour, 29
- GAMI, 12, 13, 15, 16
- Gasket probe, 21
- Gasket, manifold, 18, 24
- GPH, 29
- GPS
 - comm settings, 39
 - constant, 34
 - data formats, 45
 - data ports, 46
 - GPS-C, 34
 - interface diagnostics, 46

H

- H.S, 29
- Hastaloy, 17
- HBAT, 42
- HCHT, 42
- HOIL, 42
- Holding a button, 8
- Horsepower
 - constant setting, 34, 35

Engine Data Management

I

Ice, carburetor or induction, 23
Ignition, 24
 timing, 22
Include parameters, 11
Index dot, 6
Indexing
 rate, 37
 sequence, 29
Induction, 23
 air temperature, IAT, 10, 29
Informing the EDM-700
 startup fuel, 26
Initial tank capacity, 45
Injectors. See Fuel, injectors
Intake valve, 22

K

K-factor
 changing, 34, 39
 determining, 38
KPH, 29

L

LBAT, 42
Leak
 manifold, 24
Leak, manifold, 18
Lean of Peak, 15
Lean of Peak Leaning, 15
Leanest cylinder, 13
LeanFind
 button, 8
 description, 8
 mode, 12
 procedure, 13
Leaning, 3, See also, LeanFind
 by TIT, 16
 pre-leaning, 14
 too quickly, 20
LF. See LeanFind
Lights
 Alarm Display, 40
LOIL, 42
Long Term Memory Option
 mark, 30
 operation, 30
Lotus 123, 30

For Your Safe Flight

Low fuel alarm, 44
LPH, 29

M

Magneto check, 18
MAIN, 43, 45
Manifold Air Pressure (MAP)
 calibration, 35
Manual indexing mode, 7
Manual mode, 12
Mark, 30
Memory box, 31
Methods
 leaning, 12
Miles per gallon, 29
Misapplications, 20
Missing
 column, 22
 segment, 6
Mixture, 3, 13
 best economy, 3
 best power, 3
Modes, 7, 11
MPG, MPK, MPL, MPP, 29
MS Excel, 30

N

Nautical miles per gallon, 29
Navigation data formats, 45
NEW, 34
NMEA-183, 45
NO COM, 46
NO SIG, 46
NO WPT, 46
Normal engine limits, 21
Normalize view, 5
Northstar binary format, 45
NRM, 5

O

OAT
 calibration, 34
 F or C, 33
Octane, 24
OFF, 8, 25, 41
Off-scale EGT bars, 20
Oil
 flashing segment, 6

Page 55

- missing segment, 6
- OIL, 10, 29
- OIL pressure, 1, 21, 23, 25, 29, 42, 43
- Oil temperature, 10, 29
- OPEN PRB, 11
- Operation
 - fuel flow option, 26
 - temperature scanner, 4
- Option connector, 47
- Outside air temperature. See OAT

P

- Panel
 - Alarm Display, 40
- Parameter indexing, 9, 28
- Peak EGT, 13
- PEAK EGT, 13, 15
- Percentage view, 5
- Pilot programming, 33
 - alarm limits, 41
 - data recording, 39
 - fuel flow option, 37
- Pin assignments, option connector, 47
- Power, best, 3
- PPH, 29
- Pre-ignition, 23, 25
- Pre-leaning. See Leaning, pre-leaning
- Primary
 - Alarm Display, 40
- Priority, alarm, 25
- Product support, 48
- Programming, 33
 - alarm limits, 41
 - data recording, 39
 - fuel flow option, 37

R

- Range, normal temperature, 21
- Rate
 - baud, 46
 - fuel flow, 28, 29
 - indexing, 37
 - shock cooling, 19
- Real-time, 43
- Record, on, off, 43
- Recording. See Long Term Memory
 - Option
- RECRD?, 43

Page 56

- Red line, 21
- Reference reading, 48
- REM, 29
- Removing fuel, 27
- REQ, 29
- RES, 29
- Reset
 - alarm limits, 41
 - alarms, 25
 - fuel used, 28
- Resolution, EGT display, 34
- Rich of Peak, 12
- Rough engine, 22
- RS-232, 46
- Run-up, 18

S

- Scanning. See Indexing
- Segment
 - flashing, 6
- Select switch, 26
- Self-test, 11, See also Diagnostic
- Setting the K factor. See Fuel Flow
- Setup, 33
 - alarm limits, 41
 - fuel flow option, 37
 - Long Term Memory Option, 39
- Shadin Miniflow, 45
- Shock cooling, 10, 12, 19, 21
- SNAP, 30
- Spark plug
 - fouling, 5, 18, 22
- Startup
 - diagnostics, 11
 - fuel, 26
- STEP button, 8
- Stuck valve, 22
- Switch, select, 26

T

- Tabs, tank, 43
- Take-off, 18
- Tank capacity
 - entering at power up, 45
- Tanks, fuel
 - capacity, 26, 43
 - tabs, 26, 43
- Tapping a button, 8
- Technical support, 48

Engine Data Management

Test, self, 11
Time to empty, 29
Timing, ignition, 22
TIT, 10, 16
 factory original probe, 36
 missing segment, 6
Toggle, N, P, 5
Top fuel tanks. See Fill
Total fuel, 27
 used, 29
Transducer, fuel flow, 28
Turbocharged Engines, 16

U

Uniform, CHT, EGT not, 23
Units, fuel flow, 43
USB
 port, 32
USD, 29

V

Valve
 lifter, 22
 stuck, 22
Vapor, 24
View
 change diagram, 9
 normalize, percentage, 5
Voltage, 10, 29

W

Warranty, 49

Z

Zeroing fuel used, 28

Quick Reference Guide

Normalize View

- Hold LF for three seconds.

Percentage View

- Hold LF for three seconds.

Automatic Scan

1. Tap LF.
2. Tap STEP.

Exclude Parameter in Automatic Scan (except EDM-711)

1. Tap STEP to index to the parameter to exclude.
2. Tap both STEP and LF.
3. See decimal point before parameter name to exclude.

Change Indexing Rate

1. Hold both STEP and LF until the display shows PROGRAM, followed by FUEL? N.
2. Tap STEP and see RATE 4.
3. Tap LF to change the number: 1 through 9 is the pause time during automatic indexing. 0 sets to never index (except EDM-711).
4. Tap STEP until you see END Y, then tap STEP to exit

Mark Data in Memory

- Tap LF twice.

Reset Fuel Used to zero in flight

1. Tap STEP and see USD.
2. Hold both STEP and LF until the display shows .0 USD

Transfer Data in Memory

1. Connect PC Computer to the EDM serial port.
2. Hold both STEP and LF until the display shows PROGRAM, followed by FUEL? N.
3. Tap STEP a few times until you see DUMP? N.
4. Tap LF until you see DUMP NEW or DUMP ALL.
5. On the PC Computer click on the Start button
6. On the EDM tap STEP to transfer. (to abort hold STEP and LF for 5 seconds).
7. On the EDM see SAVE D?N.
8. If save was successful, tap LF to see SAVE D?Y.
9. Tap STEP to exit.

Initially Entering Tank Capacity

To initialize or change the tank capacities, hold the STEP button while turning on the power to the EDM. The following program steps will be displayed:

MAIN=50	Main tank capacity, in units selected
AUX? N	Y—Yes—aircraft has auxiliary tanks
AUX=0	Auxiliary tank capacity

Tap STEP to advance to the next item. Hold LF to increase or tap LF to change the amount.

Filled Tanks

In flight, do this first (on power up, skip to step 4):

1. Hold both **STEP** and **LF** until the display shows **PROGRAM**, followed by **FUEL? N**.
2. Tap **LF** to see **FUEL? Y**.
3. Tap **STEP**
4. See **FILL? N**. Tap **LF** to see **FILL 75***
5. With aux tanks or tabs, tap **LF** again to see **FILL I20***
6. Tap **STEP** to exit.

Added or Removed Fuel

In flight, do this first (on power up, skip to step 4):

1. Hold both **STEP** and **LF** until the display shows **PROGRAM**, followed by **FUEL? N**.
2. Tap **LF** to see **FUEL? Y**.
3. Tap **STEP**.
4. See **FILL? N**. Tap **LF** 2 or 3 times to see **FILL+**.
5. Tap **STEP** and see **.0 GAL.**
6. Hold **LF** to increase or tap **LF** to decrease the amount of fuel displayed.
7. Tap **STEP** to exit.

Reset Alarm (except EDM-711)

- **Temporary reset** (next 10 minutes): tap **STEP**.
- **Reset for remainder of flight:** hold **STEP** until the word **OFF** appears.

Leaning Rich of Peak

1. Pre-lean mixture and wait 1 minute.
2. Tap **LF** and see **LEAN R**.
3. Lean mixture until you see a column flash and the words **LEANEST** followed by **I545 SET***
4. Hold **LF** and see **I560 PK*** or **I560 I3.5***, the peak **EGT** of the first cylinder to peak and fuel flow.
5. Enrich mixture to set desired temperature.

Leaning Lean of Peak

1. Pre-lean mixture and wait 1 minute.
2. Tap **LF** and see **LEAN R**.
3. Hold both **STEP** and **LF** until you see **LEAN L**
4. Lean mixture until inverted columns.
5. Continue leaning until you see a column flash. You will see the temperature below peak of the last cylinder to peak and the fuel flow.
6. Hold **LF** to see **I560 I.0*** to see peak **EGT** of the first cylinder to peak and the delta fuel flow (**GAMI** spread).
7. Lean mixture to set desired temperature.

* Values will vary depending on your individual installation.