

Title	<Title>
Size	Document Number
B	<Doc>
Date:	Tuesday, November 12, 2019
Sheet	1 of 5

# DC/DC 4.2V

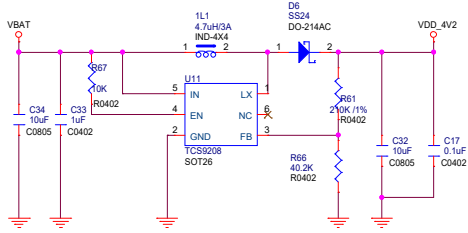

Title		<Title>
Size	Document Number	Rev
B	<Doc>	<Rev>
Date:	Tuesday, November 12, 2019	Sheet 1 of 1

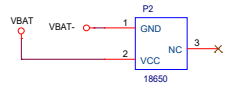
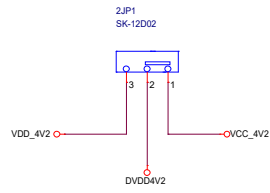
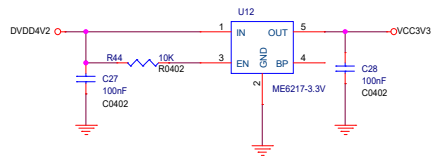
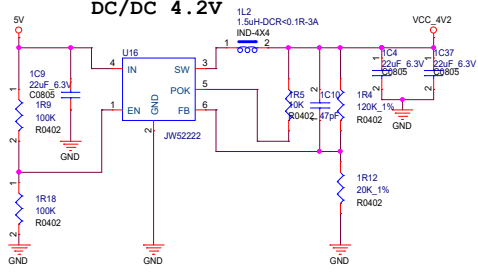
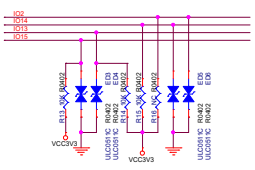
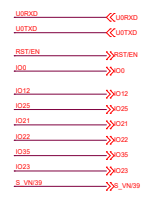
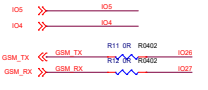
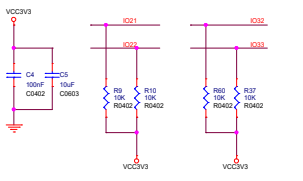
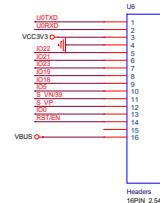
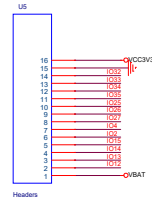
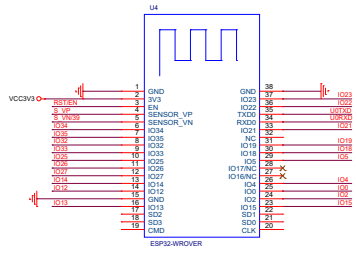

1778 模块  
 020-826-1013  
 020-826-1015  
 010-826-1014  
 020-826-1011

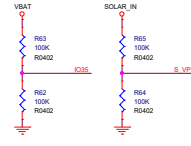
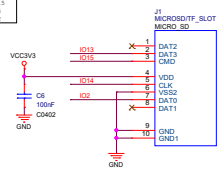



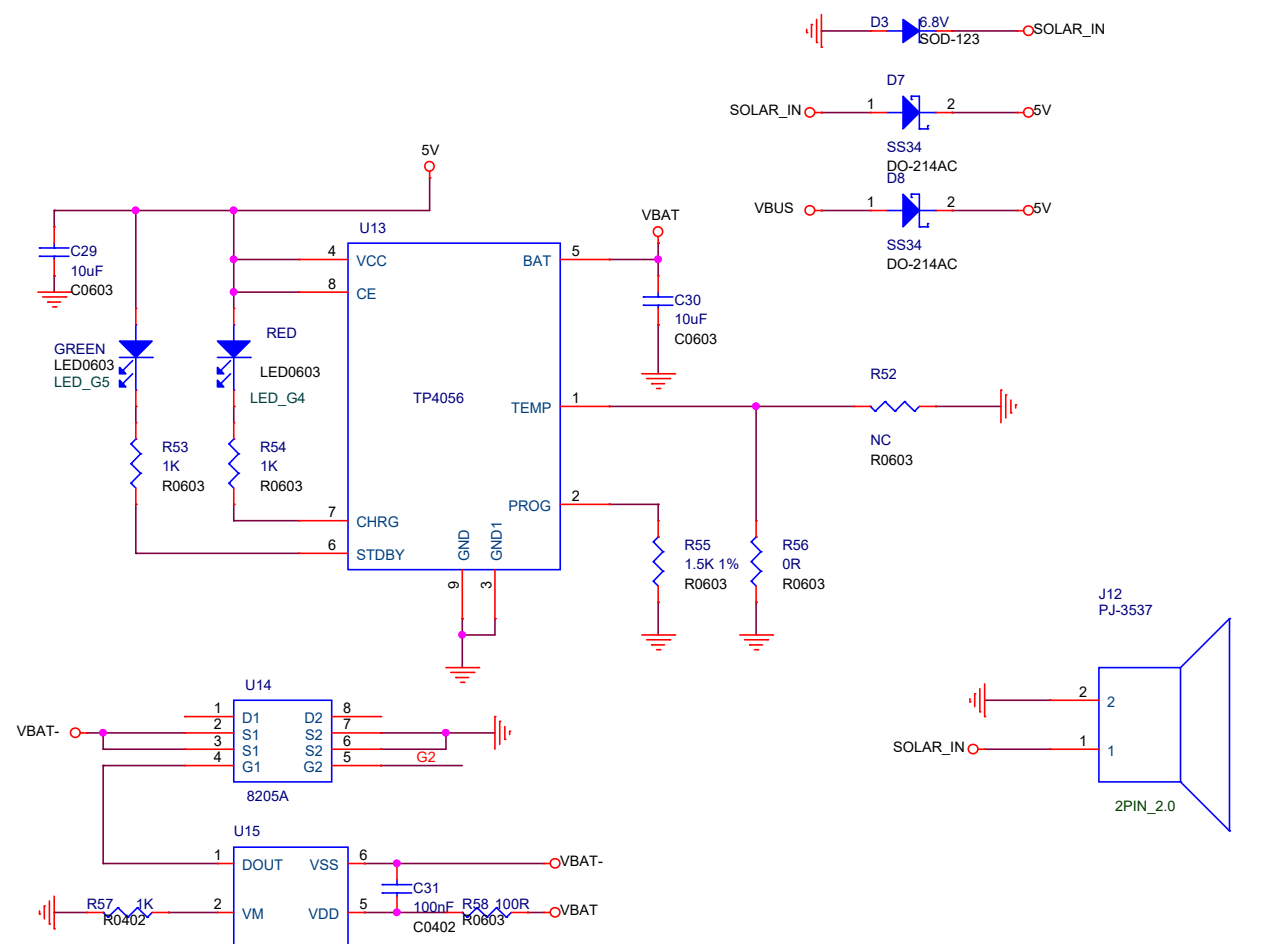

Title		
<Title>		
Size	Document Number	Rev
A	<Doc>	<RevCo
Date:	Tuesday, November 12, 2019	Sheet 5 of 5