

Title		<Title>
Size	Document Number	<Doc>
B		
Date:	Saturday, November 23, 2019	Sheet 1 of 5

DC/DC 4.2V

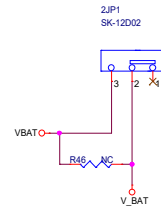

Title		<Title>
Size	Document Number	<Doc>
B		
Date:	Saturday, November 23, 2019	Sheet 1 of 1

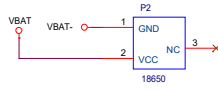
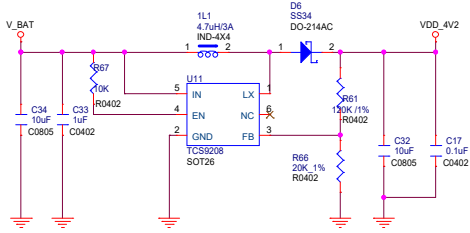
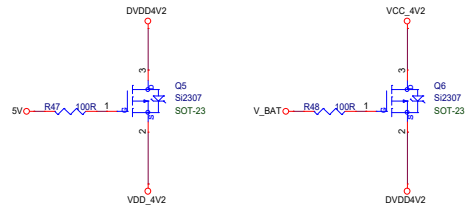
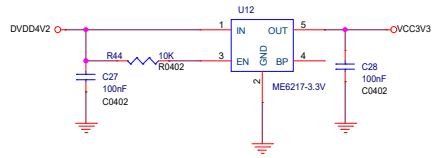
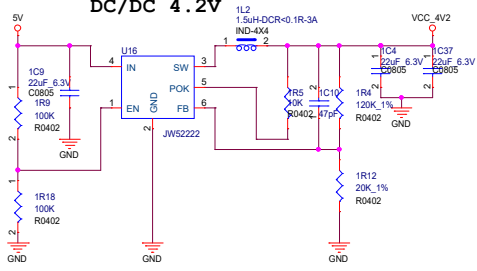
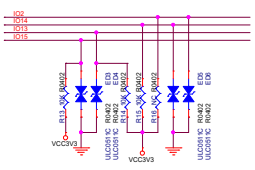
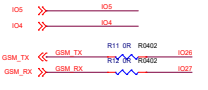
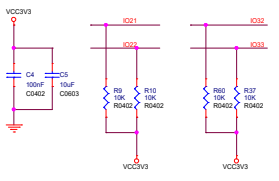
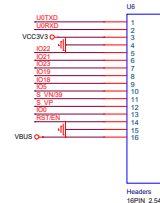
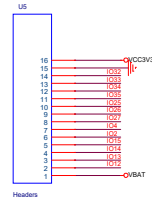
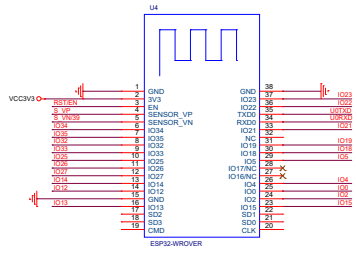

1778 模块
 020-020-0113
 020-020-0115
 010-020-0114
 020-020-0111

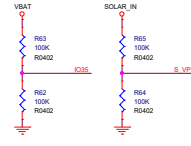
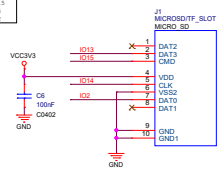

VBAT 3V-4.3V

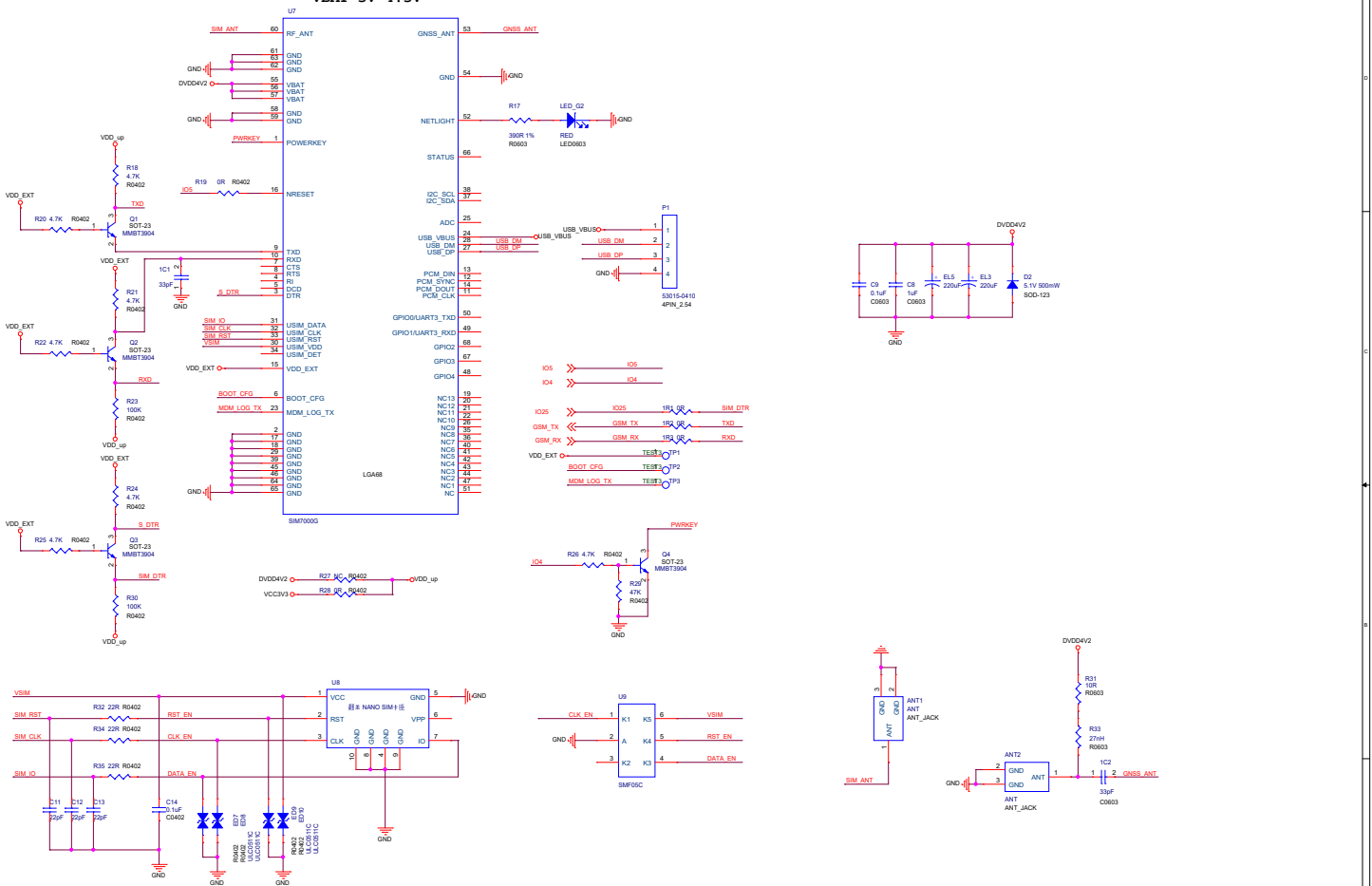

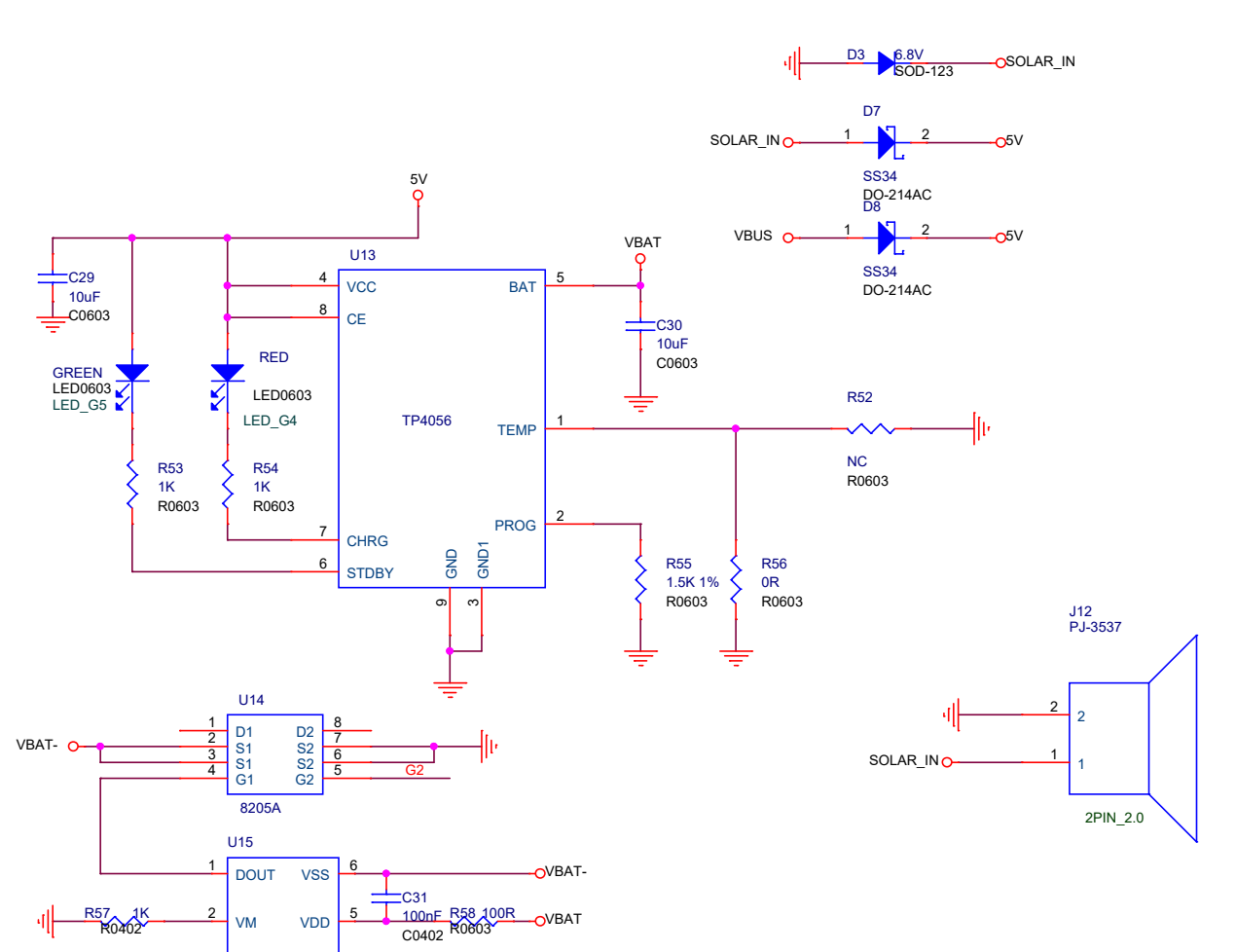

Title		<Title>
Size	Document Number	Rev
A	<Doc>	<RevCo
Date:	Saturday, November 23, 2019	Sheet 5 of 5
	2	1