

Leader

LV5300 / LV5300A / LV5350 / LV7300 WAVEFORM MONITOR / RASTERIZER

LV7300-SER01	SDI INPUT
LV7300-SER02	SDI INPUT / EYE
LV5300-SER11 / LV5350-SER11	BATTERY ADAPTER V MOUNT
LV5300-SER12 / LV5350-SER12	BATTERY ADAPTER QR GOLD
LV5300-SER20 / LV5350-SER20 / LV7300-SER20	AUDIO
LV5300-SER21 / LV5350-SER21 / LV7300-SER21	CLOSED CAPTION
LV5300-SER22 / LV5350-SER22 / LV7300-SER22	CIE
LV5300-SER23 / LV5350-SER23 / LV7300-SER23	HDR
LV5300-SER24 / LV5350-SER24 / LV7300-SER24	TSG
LV5300-SER25 / LV5350-SER25 / LV7300-SER25	FOCUS ASSIST
LV5300-SER26 / LV5350-SER26 / LV7300-SER26	LAYOUT
LV5300-SER27 / LV5350-SER27 / LV7300-SER27	TALLY
LV5300-SER28 / LV5350-SER28 / LV7300-SER28	4K
LV5300-SER40 / LV5350-SER40 / LV7300-SER40	EXTENDED VEC

Instruction Manual

Thank you for purchasing.

Please carefully read this instruction manual and the included "GENERAL SAFETY SUMMARY".
Please use the product safely.

TABLE OF CONTENTS

GENERAL SAFETY SUMMARY	I
1. INTRODUCTION.....	1
1.1 Scope of Warranty.....	1
1.2 Operating Precautions.....	1
1.2.1 Maximum Allowable Input Voltage.....	1
1.2.2 Mechanical Shock.....	2
1.2.3 Electrostatic Damage.....	2
1.2.4 Warming Up.....	2
1.2.5 About Standby Mode	2
1.2.6 Backup.....	2
1.2.7 About the LCD Panel (LV5300/LV5300A/LV5350)	2
1.3 About Trademarks and Licenses	3
1.4 Terminology Used in This Manual.....	3
2. PRODUCT CONFIGURATION.....	5
2.1 Lineup.....	5
2.2 Hardware Options	5
2.3 Software Options	6
2.4 Items Sold Separately.....	6
3. SPECIFICATIONS.....	7
3.1 General.....	7
3.2 Features	8
3.3 Specifications	11
3.3.1 SDI Video Formats and Standards (SER01/SER02/SER28)	11
3.3.2 SDI Audio Formats and Standards (SER01/SER02/SER20)	16
3.3.3 SDI Input Connector (SER01/SER02/ SER28).....	16
3.3.4 SDI Output Connector (SER01/SER02/SER24/SER28)	17
3.3.5 External Reference Input.....	18
3.3.6 Monitor Output Connector (LV7300)	18
3.3.7 Headphone Output.....	19
3.3.8 Control Connectors.....	19
3.3.9 Front Panel	20
3.3.10 Capturing	21
3.3.11 TSG (SER24/SER28).....	22
3.3.12 Presets.....	25
3.3.13 Display	25
3.3.14 Video Signal Waveform Display	26
3.3.15 Vector Display	28
3.3.16 Picture Screen	29
3.3.17 Superimpose Display (SER21).....	30

3.3.18	CINELITE Display	31
3.3.19	CINELITE Advanced Display.....	33
3.3.20	CINEZONE Display	34
3.3.21	Focus Assist (SER25).....	35
3.3.22	CIE Chromaticity Diagram Display (SER22).....	35
3.3.23	HDR Display (SER23)	36
3.3.24	Audio Display	36
3.3.25	Status Display	39
3.3.26	Eye Pattern (LV5300/LV5300A/LV7300-SER02).....	46
3.3.27	Jitter Display (LV5300/LV5300A/LV7300-SER02).....	47
3.3.28	Tally Display	48
3.3.29	Camera ID Display	48
3.3.30	General Specifications.....	49
4.	PANEL DESCRIPTION.....	50
4.1	Front Panel.....	50
4.2	Rear Panel.....	55
5.	BEFORE YOU BEGIN MEASURING	58
5.1	Precautions When Installing the ZEN series.....	58
5.2	Turning the Instrument On and Off	60
5.3	Connecting USB Devices.....	61
5.4	Signal I/O	62
5.4.1	SDI Signal I/O	62
5.4.2	External Sync Signal Input	64
5.4.3	Monitor Signal Output (LV7300).....	68
5.5	Operation Basics	69
5.5.1	Displaying the Function Menu	69
5.5.2	Function Menu Operations.....	69
5.5.3	Mouse and Touch Panel Control.....	70
5.5.4	Tab Menu Operations.....	72
5.5.5	Setting the Key Lock.....	73
5.6	Measurement Screen Description.....	74
6.	BASIC OPERATION	76
6.1	Setting the Input Signals	76
6.1.1	Selecting the Input Mode	76
6.1.2	Selecting the Simul Mode	77
6.1.3	Selecting the Displayed Channel.....	78
6.1.4	Input Format Error Indication	78
6.2	Setting the Signals to Measure	79
6.2.1	SD, HD, 3G-A, and 3G-B-DL Measurement	79
6.2.2	Measuring 6G Signals (SER28).....	82
6.2.3	Measuring 12G Signals (SER28)	84
6.2.4	Measuring 3G(DL)-4K Signals (SER28).....	86
6.3	Selecting the Measurement Mode	89

6.3.1	Video Signal Waveform Display	89
6.3.2	Vector Display	89
6.3.3	Picture Screen	90
6.3.4	Audio Display	90
6.3.5	Status Display	91
6.3.6	Eye Pattern Display (LV5300/LV5300A/LV7300-SER02)	91
6.3.7	Multi Display	92
6.4	Operation Key Actions	96
6.5	Customized Layout (SER26)	97
6.5.1	Notes	97
6.5.2	Layout Procedure	98
6.5.3	Layout Screen Description	101
6.6	Enhanced Layout (SER26)	113
6.6.1	Enhanced Layout Procedure	114
6.6.2	Enhanced Layout Screen Description	118
7.	SYSTEM SETTINGS	124
7.1	Configuring the I/O Connectors	124
7.1.1	Configuring the Input System	124
7.1.2	Setting the Input Format	127
7.1.3	Setting the Payload ID	128
7.1.4	Setting the Format Alarm	130
7.1.5	Configuring the SDI Output Connectors	132
7.1.6	Configuring the TSG Settings (SER24)	133
7.1.7	Configuring the Monitor Output Connectors	137
7.1.8	Configuring the HDR Settings (SER23)	138
7.2	Configuring the Instrument	142
7.2.1	General Settings	142
7.2.2	Configuring the Function Menu	143
7.2.3	Configuring the On-screen Menu	144
7.2.4	Configuring the Capture Feature	145
7.2.5	Configuring the Information Display	146
7.2.6	Setting the Network IP	147
7.2.7	Configuring SNTP	148
7.2.8	Configuring the Server	149
7.2.9	Configuring SNMP	150
7.2.10	Configuring the Remote Control Settings	152
7.2.11	Setting the Camera ID (SER27)	153
7.2.12	Configuring the Tally Display (SER27)	155
7.2.13	Setting the Operation keys	157
7.2.14	Date and time settings	159
7.2.15	Configuring the LV7290	160
7.3	Displaying System Information	162
7.4	Installing Software Options	164
7.5	Adjusting the Backlight (LV5300/LV5300A/LV5350)	165
7.6	Turning Off the LCD Panel (LV5300/LV5300A/LV5350)	165
7.7	Initialization	166

7.7.1	Initializing Settings.....	166
7.7.2	Initializing the Layout	167
7.7.3	Initializing the Operation keys.....	167
7.7.4	Initializing the Settings and Layout	167
8.	CAPTURE FEATURE.....	168
8.1	Capturing the Displayed Screen.....	168
8.2	Displaying Screen Capture Data	168
8.3	Saving to a USB Memory Device.....	169
8.4	Displaying Screen Capture Data from a USB Memory Device	171
8.5	Deleting Screen Capture Data from a USB Memory Device	171
9.	PRESET FEATURE	173
9.1	Registering Presets.....	173
9.2	Loading Presets	175
9.3	Deleting Presets.....	176
9.4	Copying All Presets from the instrument to a USB Memory Device.....	177
9.5	Copying All Presets from a USB Memory Device to the instrument.....	178
10.	VIDEO SIGNAL WAVEFORM DISPLAY	179
10.1	Operation Key Description	179
10.2	Setting the Waveform Display Position.....	180
10.3	Configuring the Display Settings.....	181
10.3.1	Selecting the Display Mode.....	181
10.3.2	Turning the Channels On and Off.....	182
10.3.3	Adjusting the Waveform Intensity	182
10.3.4	Selecting the Waveform Color	183
10.3.5	Adjusting the Scale Intensity	183
10.3.6	Selecting the Scale Color.....	183
10.3.7	Selecting the Scale Unit	184
10.3.8	Displaying a Scale for 75% Color Bars.....	186
10.3.9	Displaying the Scale	186
10.4	Configuring the Gain and Filter Settings.....	187
10.4.1	Setting the Variable Gain.....	187
10.4.2	Selecting the Fixed Gain.....	188
10.4.3	Selecting the Filter	188
10.4.4	Setting the Scale Jump	191
10.5	Configuring the Sweep Settings.....	193
10.5.1	Selecting the Sweep Method.....	193
10.5.2	Selecting the Line Display Format.....	194
10.5.3	Selecting the Field Display Format	195
10.5.4	Selecting the Horizontal Magnification	196
10.5.5	Displaying the Blanking Interval	199
10.6	Configuring the Cursor Settings.....	200
10.6.1	Turning Cursors On and Off	200
10.6.2	Selecting the Cursor	200

10.6.3	Selecting the Y-Axis Measurement Unit	201
10.6.4	Selecting the X-Axis Measurement Unit	202
10.6.5	Moving the Cursors	202
10.6.6	Turning the Cursor Value Display On and Off	202
10.7	Configuring the Line Selection Settings	203
10.7.1	Turning Line Selection On and Off	203
10.7.2	Setting the Line Selection Range	204
10.8	Configuring the Color System Settings	205
10.8.1	Selecting the Color Matrix	205
10.8.2	Turning the Luminance Signal On and Off	207
10.8.3	Selecting the Composite Display Format	207
10.8.4	Selecting the Setup Level	208
11.	VECTOR DISPLAY	209
11.1	Operation Key Description	210
11.2	Setting the Display and Waveform Intensity	211
11.2.1	Switching the Display Mode	211
11.2.2	Selecting the Vector Mode (SER40)	212
11.2.3	Adjusting the Waveform Intensity	213
11.2.4	Selecting the Waveform Color	213
11.3	Setting the Vector Scale	214
11.3.1	Adjusting the Scale Intensity	214
11.3.2	Selecting the Scale Color	214
11.3.3	Turning the Color Wheel On and Off	214
11.3.4	ARIB Check Marker	215
11.3.5	Turning the I and Q Axes On and Off	216
11.3.6	Selecting the Scale	217
11.3.7	Turning the Variable Scale On and Off	217
11.4	Setting the RGB Vector Scale (SER40)	218
11.4.1	Adjusting the Scale Intensity	218
11.4.2	Selecting the Scale Color	218
11.4.3	Selecting the Adjust Target	218
11.4.4	Adjusting the G-B H / G-R H	218
11.4.5	Adjusting the G-B V / G-R V	218
11.5	Setting the YCbCr Vector Scale (SER40)	219
11.5.1	Adjusting the Scale Intensity	219
11.5.2	Selecting the Scale Color	219
11.5.3	Selecting the Timing Marker	219
11.5.4	Selecting the YCbCr Vector Scale	219
11.6	Setting the Vector Gain	220
11.6.1	Setting the Variable Gain	220
11.6.2	Selecting the Fixed Gain	221
11.6.3	Turning the Guide Display On and Off	221
11.7	Setting the RGB Vector Gain	222
11.7.1	Adjusting the Gain H	222
11.7.2	Adjusting the Gain V	222
11.8	Setting the YCbCr Vector Gain	223

11.8.1	Setting the Variable Gain.....	223
11.8.2	Selecting the Fixed Gain.....	223
11.8.3	Selecting the Observation Point.....	223
11.9	Configuring the Marker Settings	224
11.9.1	Displaying the Vector Marker	224
11.9.2	Configuring the Variable Marker	225
11.10	Configuring the Line Selection Settings.....	226
11.10.1	Turning Line Selection On and Off.....	226
11.10.2	Setting the Line Selection Range	227
11.11	Configuring the Color System Settings.....	228
11.11.1	Selecting the Color Matrix	228
11.11.2	Displaying a Scale for 75% Color Bars.....	229
11.11.3	Selecting the Composite Display Format.....	230
11.11.4	Selecting the Setup Level	231
11.12	5-Bar Display.....	232
11.12.1	Selecting the Scale Unit	233
11.12.2	Selecting the Display Order	235
11.13	Histogram Display	236
11.13.1	Selecting the Display Format	236
11.13.2	Selecting the Measurement Signal	238
12.	CIE CHROMATICITY DIAGRAM DISPLAY (SER22)	239
12.1	Setting the Scale.....	239
12.1.1	Selecting the Color Scale.....	240
12.1.2	Selecting the Triangle	241
12.1.3	Setting the User-defined Triangle	242
12.1.4	Turning the Sub Scale On and Off.....	243
12.2	Setting the Chromaticity Diagram Mode.....	245
12.2.1	Selecting the Display Mode.....	245
12.2.2	Selecting the Display Standard.....	245
12.2.3	Turning Clipping On and Off.....	246
12.2.4	Turning the Filter On and Off	246
12.2.5	Setting the Gamma Value.....	246
12.3	Displaying Cursors.....	247
12.4	Configuring the Line Selection Settings.....	247
13.	PICTURE SCREEN.....	248
13.1	Selecting the Display Mode	249
13.2	Adjusting the Picture	250
13.2.1	Switching between the Color and Monochrome Displays	250
13.2.2	Setting the Chroma Gain.....	250
13.2.3	Adjusting the Brightness	250
13.2.4	Adjusting the Contrast.....	250
13.2.5	Adjusting the Gain	251
13.2.6	Adjusting the Bias	251
13.3	Configuring the Display Settings.....	252

13.3.1	Displaying Gamut Errors	252
13.3.2	Turning the Information On and Off	253
13.3.3	Configuring the SCTE-104 Detection Display settings	254
13.3.4	Displaying the SCTE-104 Detection screen.....	255
13.4	Configuring the Marker Settings	257
13.4.1	Turning the Frame Marker On and Off	258
13.4.2	Turning the Center Marker On and Off.....	258
13.4.3	Setting the Aspect Marker	258
13.4.4	Setting the Aspect Shadow.....	260
13.4.5	Setting the Safe Action Marker.....	261
13.4.6	Setting the Safe Title Marker	261
13.4.7	Setting User Markers	262
13.5	Setting the Superimpose Feature (SER21)	263
13.5.1	Selecting the Closed Caption Display.....	263
13.5.2	Selecting the Format of English Closed Captions	263
13.5.3	Selecting the Display Details of English Closed Captions.....	264
13.5.4	Selecting the Format of Japanese Closed Captions	264
13.5.5	Selecting the Japanese Closed Caption Data	264
13.5.6	Displaying the Clear Screen Log	265
13.5.7	Clearing Japanese Closed Caption Data	270
13.5.8	Selecting the Multiplex System for European Closed Captions	271
13.5.9	Selecting the Magazine Number and Page Number for European Closed Captions.....	271
13.6	Configuring CINELITE Settings	272
13.6.1	f Stop Display Description	273
13.6.2	Procedure for Displaying the f Stop Display	274
13.6.3	%DISPLAY Screen Description	275
13.6.4	Selecting the Points to Display	277
13.6.5	Setting Measurement Points	277
13.6.6	Setting the Measurement Size.....	277
13.6.7	Configuring User-Defined Correction Tables	278
13.6.8	Displaying Link Markers	283
13.7	Configuring CINEZONE Settings.....	284
13.7.1	Gradation Display Mode	284
13.7.2	Step Display Mode	285
13.7.3	Search Display Mode	287
13.8	Configuring %DISPLAY & CINEZONE Settings.....	288
13.9	Focus Assist Display (SER25)	289
13.9.1	Selecting the Display Mode.....	289
13.9.2	Turning Focus Assist On and Off	289
13.9.3	Selecting the Detection Sensitivity	290
13.9.4	Selecting the Luminance Level	290
13.9.5	Selecting the Highlight Color.....	290
13.10	Configuring the Line Selection Settings.....	291
13.10.1	Turning Line Selection On and Off.....	291
13.10.2	Setting the Line Selection Range	292
13.10.3	Setting the Lip Sync Measurement Range (SER20).....	292

14. HDR DISPLAY (SER23).....	293
14.1 Video Signal Waveform Display	295
14.1.1 Scale Display	295
14.1.2 Selecting the Scale Display	301
14.1.3 Setting the Reference Level	302
14.1.4 Cursor Display	303
14.2 Vector Display.....	304
14.2.1 HDR Mode Display.....	304
14.2.2 Histogram Display	305
14.3 Picture Screen	306
14.3.1 CINELITE and CINEZONE Displays.....	306
14.3.2 %DISPLAY	309
14.3.3 CINEZONE Display	310
14.3.4 Link Marker Display	311
14.4 MAX FALL and MAX CLL Displays	312
14.4.1 Turning the Display On and Off	312
14.4.2 Starting and Stopping Measurements.....	313
14.4.3 Clearing Measurements.....	313
14.4.4 Setting the MAX FALL/CLL Error	313
15. AUDIO DISPLAY	315
15.1 Setting the Signals to Measure	316
15.1.1 Selecting the Measurement Signal	316
15.1.2 Channel Assignment for the Lissajous Display (SER20).....	317
15.1.3 Channel Assignment for the Surround Display	317
15.2 Selecting the Display Mode (SER20).....	318
15.3 Configuring Error Detection Settings	320
15.4 Adjusting the Volume.....	321
15.5 Meter Display	322
15.5.1 Selecting the Scale	322
15.5.2 Selecting the Response Model	323
15.5.3 Setting the Peak Hold	323
15.5.4 Setting the Reference Level	324
15.5.5 Configuring the Numeric Display	324
15.5.6 Resetting the Peak Hold	325
15.6 Lissajous Display (SER20)	326
15.6.1 Adjusting the Lissajous Curve Intensity	326
15.6.2 Adjusting the Scale Intensity	326
15.6.3 Selecting the Lissajous Curve Display Format.....	327
15.6.4 Selecting the Scale Display Format	328
15.6.5 Setting the Lissajous Curve Gain	329
15.7 Surround Display (SER20)	330
15.7.1 Adjusting the Surround Waveform Intensity.....	330
15.7.2 Adjusting the Scale Intensity	330
15.7.3 Selecting the Surround Display Format.....	331
15.7.4 Setting the Surround Waveform Gain	331

15.8	Status Display (SER20)	332
15.8.1	Status Screen Description	332
15.8.2	Event Log Display	333
15.8.3	Channel Status Display	334
15.8.4	Displaying User Bits.....	335
15.8.5	Resetting Errors.....	335
16.	STATUS DISPLAY.....	336
16.1	Status Screen Description.....	336
16.2	Configuring Error Detection Settings	341
16.2.1	Error Setup 1	341
16.2.2	Error Setup 2	343
16.2.3	Error Setup 3	345
16.2.4	Error Setup 4	347
16.3	Clearing Error Counts.....	350
16.4	Configuring Event Log Settings.....	350
16.4.1	Event Log Screen Description	350
16.4.2	Starting the Event Log	354
16.4.3	Clearing the Event Log.....	354
16.4.4	Selecting the Overwrite Mode	354
16.4.5	Saving to a USB Memory Device	355
16.5	Configuring the Data Dump Settings	357
16.5.1	Data Dump Display Description	358
16.5.2	Moving the Display Position	359
16.5.3	Selecting the Adjustment Step Resolution.....	360
16.5.4	Selecting What the Function Dial Controls.....	360
16.5.5	Selecting the Display Mode.....	360
16.5.6	Selecting the Display Format	361
16.5.7	Selecting the Content to Display.....	363
16.5.8	Saving to a USB Memory Device	363
16.6	Configuring Phase Difference Measurement Settings	364
16.6.1	Phase Difference Measurement Screen Description	365
16.7	Setting the Lip Sync Measurement (SER20)	369
16.7.1	Selecting the Measurement Range.....	370
16.7.2	Updating the Measurement Screen	370
16.7.3	Setting the Measurement Range	371
16.8	Displaying a List of Ancillary Data	374
16.8.1	Ancillary Data Display Description.....	374
16.8.2	Displaying a Dump of Ancillary Data	375
16.8.3	Updating the Dump Display	375
16.8.4	Selecting the Dump Mode	376
16.9	Detecting Ancillary Packets	377
16.9.1	Ancillary Packet Screen Description.....	377
16.9.2	Displaying EDH Packets.....	379
16.9.3	Displaying Payload IDs.....	379
16.9.4	Displaying Audio Control Packets	380
16.9.5	V-ANC ARIB Display	381

16.9.6	Displaying Closed Caption Packets	381
16.9.7	Displaying the Inter-Stationary Control Signal	382
16.9.8	Displaying the Data Broadcast Trigger Signal	385
16.9.9	Displaying User Data	386
16.9.10	V-ANC SMPTE Display	386
16.9.11	Displaying EIA-708 Data	387
16.9.12	Displaying EIA-608 Data	388
16.9.13	Displaying Program Data	389
16.9.14	Displaying VBI Data	390
16.9.15	Displaying AFD Packets	391
16.9.16	Configuring the SCTE-104 Detection Display settings	392
16.9.17	Displaying the SCTE-104 Detection screen.....	394
16.9.18	Displaying SR Live Packets	396
16.9.19	Performing Custom Searches	397
17.	EYE PATTERN DISPLAY (LV5300/LV5300A/LV7300-SER02)	399
17.1	Eye Pattern Display Description	401
17.2	Jitter Display Description	403
17.3	Setting the Waveform Display Position.....	404
17.4	Switching between Eye Pattern and Jitter	405
17.5	Turning the Histogram Display On and Off	405
17.6	Setting the Intensity	406
17.6.1	Adjusting the Waveform Intensity	406
17.6.2	Adjusting the Histogram Intensity	406
17.6.3	Adjusting the Scale Intensity	406
17.7	Selecting the Display Colors	407
17.7.1	Selecting the Waveform Color	407
17.7.2	Selecting the Histogram Color	407
17.7.3	Selecting the Scale Color	407
17.8	Configuring Error Detection Settings	408
17.8.1	Configuring 12G Error Settings.....	408
17.8.2	Configuring 6G Error Settings	410
17.8.3	Configuring 3G Error Settings	412
17.8.4	Configuring HD Error Settings.....	414
17.8.5	Configuring SD Error Settings	416
17.9	Configuring Eye Pattern Display Settings.....	418
17.9.1	Adjusting the Gain	418
17.9.2	Selecting the Filter	418
17.9.3	Selecting the Sweep Time	419
17.9.4	Turning the Peak Hold On and Off.....	420
17.9.5	Clearing the Peak Hold.....	420
17.9.6	Turning Cursors On and Off	421
17.9.7	Selecting the Cursor	422
17.9.8	Selecting the X-Axis Measurement Unit	424
17.9.9	Selecting the Y-Axis Measurement Unit	424
17.9.10	Moving the Cursors	424
17.9.11	Resetting Cursors.....	425

17.9.12	Selecting the Display Mode.....	425
17.9.13	Selecting the 2-Screen Display Mode	425
17.10	Configuring the Jitter Display Settings	425
17.10.1	Selecting the Magnification	426
17.10.2	Selecting the Filter	426
17.10.3	Selecting the Sweep Time	426
17.10.4	Turning the Peak Hold On and Off.....	427
17.10.5	Clearing the Peak Hold.....	427
17.10.6	Turning Cursors On and Off	428
17.10.7	Selecting the Cursor	428
17.10.8	Selecting the X-Axis Measurement Unit	429
17.10.9	Selecting the Y-Axis Measurement Unit	429
17.10.10	Moving the Cursors	429
17.10.11	Resetting Cursors.....	430
17.10.12	Selecting the Display Mode.....	430
17.10.13	Selecting the 2-Screen Display Mode	430
18.	REMOTE CONTROL	431
18.1	Bit Mode	432
18.2	Binary Mode	435
18.3	Command Mode.....	437
18.4	Tally Mode (SER27)	439
19.	NETWORK CONTROL	441
19.1	SNTP Client Function	441
19.1.1	How to Use	441
19.1.2	Time Adjustment Value.....	442
19.2	TELNET	443
19.2.1	How to Use	443
19.2.2	How to Enter Commands	444
19.2.3	TELNET Commands.....	445
19.3	FTP	463
19.3.1	How to Use	463
19.3.2	How to Enter Commands	464
19.3.3	FTP Commands	464
19.4	HTTP.....	465
19.4.1	Operating Environment.....	465
19.4.2	Notes	465
19.4.3	How to Use	466
19.4.4	MEASUREMENT WITH DISPLAY	468
19.4.5	REMOTE CONTROL.....	469
19.4.6	EVENT LOG VIEWER.....	470
19.5	SNMP	471
19.5.1	SMI Definitions	471
19.5.2	How to Use	471
19.5.3	Standard MIBs.....	474

19.5.4	Enterprise MIB.....	478
19.5.5	Extended TRAP (Variable Binding List)	504
20.	MENU TREE.....	515
20.1	INPUT Menu	515
20.2	SYS Menu	516
20.3	CAP Menu	520
20.4	MEM Menu	522
20.5	RECALL Menu	523
20.6	WFM Menu	524
20.7	VECT Menu	527
20.8	PIC Menu	534
20.9	AUDIO Menu	540
20.10	STATUS Menu	543
20.11	EYE Menu (LV5300/LV5300A/LV7300-SER02)	550
20.12	MULTI Menu	552
21.	FIRMWARE UPDATE HISTORY	553

GENERAL SAFETY SUMMARY

■ Read This before Using the Instrument

This instrument should only be used by persons with sufficient knowledge of electronics who thoroughly understand the contents of this manual.



This instrument is not designed or manufactured for households or ordinary consumers. If unqualified personnel are to use the instrument, be sure the instrument is handled under the supervision of qualified personnel (those who have electrical knowledge). This is to prevent the possibility of personal injury or damage to the instrument.

■ Note about Reading This Manual

The contents of this manual contain specialized terminology and may be difficult to understand. If you have any questions about the contents of this manual, please contact your local LEADER agent.

■ Symbols and Terms

The following symbols and terms are used in this instruction manual and on the instrument to indicate important warnings and notes.

<p><Symbol></p> 	<p>This symbol appears in this instruction manual and on the instrument to indicate an area where improper handling could result in personal injury, damage to the instrument, or malfunction of the instrument or devices connected to it.</p> <p>When you encounter this symbol on the instrument, be sure to refer to the information in this instruction manual that corresponds to the area that the symbol marks.</p>
<p><Term></p> 	<p>Ignoring the precautions that this term indicates could lead to death or serious injury.</p>
<p><Term></p> 	<p>Ignoring the precautions that this term indicates could lead to personal injury or damage to the instrument.</p>

GENERAL SAFETY SUMMARY

Read the warnings and information below thoroughly to avoid death, personal injury, and damage and deterioration of the instrument.



■ Warnings Concerning the Case and Panels

Do not remove the instrument's case or panels for any reason. Touching the internal components of the instrument could lead to fire or electric shock.

Also, do not allow foreign materials, such as liquids, combustible matter, and metal, to enter the instrument. Turning the instrument on when such materials are inside it could lead to fire, electric shock, damage to the instrument, or some other accident.

■ Installation Environment

• Operating Temperature Range

Use this instrument in a 0 to 40 °C environment. Using the instrument with its vents blocked or in a high temperature environment could lead to fire.

Drastic changes in temperature, such as might be caused by moving the instrument between two rooms with different temperatures, can damage the instrument by causing condensation to form within it. If there is a possibility that the instrument has condensation within it, wait for approximately 30 minutes before turning on the power.

• Operating Humidity Range

Use this instrument in an environment whose relative humidity is 85 % or less where there is no threat of condensation forming.

Also, do not operate this instrument with wet hands. Doing so could lead to electric shock or fire.

• Do Not Operate in an Explosive Atmosphere

Using this instrument in an environment where flammable gases, explosive gases, or steam is emitted or stored could lead to an explosion or fire. Do not use the instrument in such an environment.

• Do Not Insert Foreign Materials

Do not insert foreign materials, such as metal and flammable objects, through the vents or allow liquid to enter the instrument. Such acts can lead to fire, electric shock, damage to the instrument, or some other accident.

■ If You Notice Something Wrong during Operation

If you notice smoke, fire, a strange smell, or something else that is wrong with the instrument while you are operating it, stop operation immediately. Failing to do so could lead to fire. Turn OFF the power switch, and remove the power cord from the outlet. After making sure that fire has not spread anywhere, contact your local LEADER agent.

GENERAL SAFETY SUMMARY



■ Warnings Concerning the Power Source

Do not use a power source with a voltage other than the rated power source voltage for the instrument. Doing so could lead to fire.

Confirm the voltage of the power source before you connect the power cord to it.

Only use a power source whose frequency is 50/60 Hz.

Use a power cord that is appropriate for the voltage of the power source. Also, use a power cord that meets the safety standards of the country that you are using it in.

Using a power cord that does not meet the standards could lead to fire. If the power cord is damaged, stop using it, and contact your local LEADER agent. Using a damaged power cord could lead to electrical shock or fire.

When removing the power cord from the power outlet, do not pull on the cord. Pull from the plug.

■ Warnings Concerning Grounding

The instrument has a ground terminal to protect the user and the instrument from electric shock. Ensure that the product is properly grounded for safe operation.

■ Warnings Concerning the Panel

Sections of the panel are made out of glass. If the glass breaks, the broken glass may lead to injury. Do not apply a strong shock to the panel, cut it with sharp metal, or damage it in any similar manner.



■ Cautions Concerning the Input and Output Connectors

To avoid damaging the instrument, only apply signals to the input connectors that conform to the specifications in this instruction manual. Do not short or apply external voltage to the output connectors. Doing so could damage the instrument.

■ Cautions Concerning the Ethernet Port

When you are connecting the instrument to the communication provider's equipment, connect to the Ethernet port through a hub that is authorized for use in the country that you are using the instrument in.

GENERAL SAFETY SUMMARY

■ Calibration and Repairs

This instrument has been carefully examined at the factory to ensure that its performance is in accordance with the standards. However, because of factors such as parts wearing out over time, the performance of the instrument may degrade. To ensure stable performance, we recommend that you have the instrument calibrated regularly. Also, if the instrument malfunctions, repairs are necessary. For repairs and calibration, contact your local LEADER agent.

■ Routine Maintenance

When you clean the instrument, remove the power plug from the outlet.

Do not use thinner or benzene when you clean the instrument's case, panels, or knobs. Doing so could lead to paint chipping and the corrosion of plastic components. To clean the case, panels, and knobs, use a soft cloth with mild detergent, and wipe gently. While cleaning, make sure that foreign materials, such as water and detergent, do not enter the product. If liquid or a metal object enters into the instrument, fire or electric shock may result.

■ About the European WEEE Directive

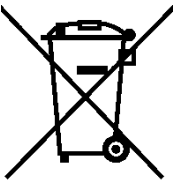

This instrument and its accessories are subject to the European WEEE Directive. Follow the applicable regulations of your country or region when discarding this instrument or its accessories. Follow the EU Battery Directive when discarding the batteries that you removed from this instrument.



(WEEE stands for Waste Electrical and Electronic Equipment.)

Follow the warnings and precautions that have been listed in this section to use the instrument correctly and safely. Precautions are also contained in various other sections of this instruction manual. To use the instrument correctly, be sure to follow those precautions as well.

If you have any questions or comments about this instruction manual, please contact your local LEADER agent.

1. INTRODUCTION

Thank you for purchasing this LEADER instrument. To use this instrument safely, read this instruction manual thoroughly, and make sure that you know how to use the instrument properly.

If some point about the operation of this instrument is still unclear after you have read this instruction manual, refer to the contact information on the back cover of the manual to contact LEADER, or contact your local LEADER agent.

After you have finished reading this manual, keep it in a convenient place so that you can refer to it when necessary.

1.1 Scope of Warranty

This LEADER instrument has been manufactured under the strictest quality control guidelines.

LEADER shall not be obligated to furnish the following free services during the warranty period.

1. Repair of malfunction or damages resulting from fire, natural calamity, or improper voltage applied by the user.
2. Repair of a product that has been improperly repaired, adjusted, or modified by personnel other than a factory-trained LEADER representative.
3. Repair of malfunctions or damages resulting from improper use.
4. Repair of malfunctions caused by devices other than this instrument.
5. Repair of malfunctions or damages without the presentation of a proof of purchase or receipt bill for the instrument.

This Warranty is valid only in Japan.

1.2 Operating Precautions

1.2.1 Maximum Allowable Input Voltage



The maximum signal voltage that can be applied to the input connectors is indicated below. Do not apply excessive voltage to the connectors. Doing so may damage the device or lead to injury.

Table 1-1 Maximum allowable input voltage

Input Connector		Maximum Allowable Voltage
Main unit	EXT REF	± 5 V (DC + peak AC)
Main unit	REMOTE	0 to 5 VDC
SER01	SDI INPUT	± 1 V (DC + peak AC)
SER02	SDI INPUT	± 1 V (DC + peak AC)

1. INTRODUCTION

1.2.2 Mechanical Shock

This instrument contains sensitive components, so it may be damaged if it is dropped or otherwise exposed to a strong shock.

1.2.3 Electrostatic Damage

Electronic components can be damaged by static discharge. Static electricity can build up in the core wire of a coaxial cable. Before connecting a coaxial cable to an I/O connector of the instrument, short the core wire of the cable with the external conductor.

1.2.4 Warming Up

To ensure more accurate measurements, turn ON the instrument approximately 30 minutes before you intend to use it to allow its internal temperature to stabilize.

1.2.5 About Standby Mode

Even if you press the power switch to turn off this instrument, the instrument remains in standby mode as long as the power cord is connected to the outlet. In standby mode, some of the internal circuits operate and may generate heat. Unless necessary, keep the power cord disconnected from the outlet.

1.2.6 Backup

This instrument has a last-memory feature. When you turn the power on, the instrument starts with the panel settings that were in use the last time that it was turned off. If the backup battery is out of power, the message "The last memory feature is disabled." will appear, and this last-memory feature will no longer work.

To continually use the last-memory feature, we recommend that you replace the backup battery with a new one every five years after you purchase the instrument. You cannot replace the backup battery yourself. For details, contact your nearest LEADER agent.

1.2.7 About the LCD Panel (LV5300/LV5300A/LV5350)

There may be a small number of pixels in the LCD panel that do not light or are always on. Note that this is not a malfunction.

The LCD panel supports a large number of video signals. SDI input signals are displayed asynchronously on the LCD. Therefore, images may appear to flicker on the waveform and picture displays.

In addition, the input SDI signal is temporarily stored in frame memory and is loaded by using the LCD display synchronization signal—which is not synchronized with the input SDI signal. Therefore, because frame skip—which skips over frames in the memory—and frame repeat—which reads the same frames of the memory twice—occur, the image may appear to flicker.

(An external sync signal can be used to synchronize the LCD to the input signal.)

1. INTRODUCTION

1.3 About Trademarks and Licenses

The company and product names in this document are trademarks or registered trademarks of their respective holders.

DynaFont is a registered trademark of DynaComware Taiwan Inc.

This product uses open source software under the GNU General Public License (<http://www.gnu.org/copyleft/gpl.html>).

If you need the source code covered by the GNU General Public License, CONTACT YOUR LOCAL LEADER AGENT.

[Notes]

1. Leader does not provide warranty or support for the software covered by the GNU General Public License.
2. Alteration and distribution of this program shall be performed under your responsibility.
3. The expense of Leader distributing the software to you shall be borne by you.

1.4 Terminology Used in This Manual

- ZEN series

The following products are referred to as ZEN series.

Table 1-2 ZEN series lineup (including options)

Model	Model Name
LV5300/LV5300A	WAVEFORM MONITOR
LV5350	WAVEFORM MONITOR
LV5600	WAVEFORM MONITOR
LV7300	RASTERIZER
LV7600	RASTERIZER

- SER**

LV5300-SER**, LV5350-SER** and LV7300-SER** are referred to as SER**.

- Single Input Mode

This refers to the mode in which on the INPUT menu, **F•7** DISPLAY is set to SINGLE. It is a mode for measuring a single input signal.

- Simul Mode

This refers to the mode in which on the INPUT menu, **F•7** DISPLAY is set to SIMUL. It is a mode for measuring multiple input signals simultaneously.

- Multi-screen Display

This refers to the mode in which the MULTI key is on.

- Underlining (_)

Underlined options indicate the default values.

1. INTRODUCTION

- Input Formats and Link Systems

The following names are used for the input formats and link systems.

Multi link may be used as a collective term to refer to dual link and quad link.

Table 1-3 Input formats and link systems

Name	Description	Link System
SD	SD-SDI	Single link
HD	HD-SDI	Single link
3G-A	3G-SDI level A	Single link
3G-B-DL	3G-SDI level B dual link mapping	Single link
6G	6G-SDI	Single link
12G	12G-SDI	Single link
3G(DL)-4K	3G-B DS dual link Resolution 3840 (4096)×2160	Dual link
3G	Collective name for 3G links	-
3G-B	Collective name for 3G-B-DL and 3G-B DS	-
3G(DL)	Collective name for 3G(DL)-2K, 3G(DL)-4K	-
2K	Collective name for SD, HD, 3G-A, 3G-B-DL	-
4K	Collective name for 6G, 12G	-

2. PRODUCT CONFIGURATION

2.1 Lineup

LV5300/LV5300A WAVEFORM MONITOR (*1)	Built-in LCD
LV5350 WAVEFORM MONITOR	Built-in LCD
LV7300 RASTERIZER	External monitor type

*1 The features of LV5300 and LV5300A are the same.

2.2 Hardware Options

This instrument operates as a measuring instrument by installing hardware options.

To replace or add hardware options, contact your local LEADER agent. You cannot install or uninstall units.

Table 2-1 Hardware options

Model Name	Lineup			Function
	LV5300 /LV5300A	LV5350	LV7300	
SDI INPUT	-	Standard support	LV7300-SER01	SD, HD, 3G SDI input (*1) (6G, 12G SDI input is enabled when SER28 is installed)
SDI INPUT/EYE	Standard support	-	LV7300-SER02	SD, HD, 3G SDI input and eye pattern display (*1) (6G, 12G SDI input is enabled when SER28 is installed)
BATTERY ADAPTER V MOUNT	LV5300-SER11	LV5350-SER11	-	V mount type battery adapter (*2)
BATTERY ADAPTER QR GOLD	LV5300-SER12	LV5350-SER12	-	QR gold mount type battery adapter (*2)

*1 The LV7300 requires the LV7300-SER01, or LV7300-SER02 to be installed.

The LV7300-SER01 and LV7300-SER02 cannot be installed in the instrument at the same time.

*2 The LV5300-SER11 and LV5300-SER12 cannot be installed in the instrument at the same time.

The LV5350-SER11 and LV5350-SER12 cannot be installed in the instrument at the same time

2. PRODUCT CONFIGURATION

2.3 Software Options

The following software options (sold separately) can be installed in the instrument.

If you want to obtain a software option, provide your local LEADER agent with the instrument's MAC address (see the LICENSE tab) and serial number (see the rear panel). We will issue a license key.

When you receive the license key, install the option by referring to section 7.4, "Installing Software Options." Each instrument requires a unique license key. You cannot use the same key for multiple instruments.

Table 2-2 Software options

Model Name	Lineup			Function
	LV5300/ LV5300A	LV5350	LV7300	
AUDIO	LV5300-SER20	LV5350-SER20	LV7300-SER20	Audio display function
CLOSED CAPTION	LV5300-SER21	LV5350-SER21	LV7300-SER21	Japanese, EIA-608, 708, and TELETEXT closed caption display function
CIE	LV5300-SER22	LV5350-SER22	LV7300-SER22	CIE chromaticity diagram display function
HDR	LV5300-SER23	LV5350-SER23	LV7300-SER23	HDR measurement function
TSG	LV5300-SER24	LV5350-SER24	LV7300-SER24	SDI signal generation function (*1)
FOCUS ASSIST	LV5300-SER25	LV5350-SER25	LV7300-SER25	Focus assist display function
LAYOUT	LV5300-SER26	LV5350-SER26	LV7300-SER26	Customized layout function
TALLY	LV5300-SER27	LV5350-SER27	LV7300-SER27	ID, iris, tally display function
4K	LV5300-SER28	LV5350-SER28	LV7300-SER28	4K video signal support function
EXTENDED VEC	LV5300-SER40	LV5350-SER40	LV7300-SER40	Extended vector display function

*1 You need the LV5300-SER28 to output 4K patterns on the LV5300-SER24.

You need the LV5350-SER28 to output 4K patterns on the LV5350-SER24.

You need the LV7300-SER28 to output 4K patterns on the LV7300-SER24.

2.4 Items Sold Separately

LV7290	Ethernet connection remote controller
LR2530	Dual rack mount adapter for the LV5350
LR2535	Blank panel for the LR2530
LR2731	Single rack mount adapter for the LV7300
LR2732	Dual rack mount adapter for the LV7300
AC adapter for the LV5300/LV5300A, LV5350, and LV7300	GST90A-12
	Included as a standard accessory for the LV7300

3. SPECIFICATIONS

3.1 General

The LV5300/LV5300A WAVEFORM MONITOR, LV5350 WAVEFORM MONITOR, and LV7300 RASTERIZER are compact waveform display devices supporting 12G-SDI to SD-SDI standards. The LV5300/LV5300A and LV5350 are 3U half-rack size waveform monitors with a built-in LCD while the LV7300 is a 1U half-rack size rasterizer that can be connected to an external LCD.

The LV5300/LV5300A and LV7300, while being compact, support the eye pattern display of a variety of SDI signals up to 12G-SDI. The video signal waveform display, vector display, and picture display enable quality control of various video signals. The status display allows you to view various error statuses and analyze system stability and problems using the event log. Audio signals embedded in SDI signals can be shown on the level display, Lissajous display, and status display.

The LV5300/LV5300A, LV5350, and LV7300 employ DC power supplies, which enables them to be used in locations where AC power supplies are not available. Moreover, the LV5300/LV5300A and LV5350 can be operated off of batteries by installing a battery mount option.

For operating these instruments, in addition to the keys and knobs, which are available on conventional instruments, USB mouse, touch panel (*1), and remote control through a Web browser can be used according to your application.

Furthermore, a rich lineup of options is available in addition to these powerful functions, operability, and portability. Through the combination of options, these instruments can be used in the measurement and monitoring of video and audio signals in a wide variety of applications including (1) quality control applications of video and audio signals at filming locations, (2) video-engineer station applications in outside broadcast vans, (3) maintenance applications to isolate fault areas when problems occur, (4) post production applications for controlling the video signal levels, and (5) broadcast equipment compliance applications for determining whether video and audio signals comply with appropriate standards.

*1 The LV7300 requires a touch-panel type external monitor to be connected to the main unit. The touch panel interface on the external monitor is connected to the LV7300's USB port. The video interface on the external monitor is connected to the LV7300's monitor output connector. LEADER does not guarantee that all touch panel type monitors will work with the LV7300.

3. SPECIFICATIONS

3.2 Features

- Support for a Variety of SDI Signal Inputs

12G-SDI, 6G-SDI, 3G-SDI, HD-SDI, and SD-SDI single link, and 4K 3G dual link standards are supported, allowing SDTV, HDTV, 2K, and 4K video signals to be monitored from a single unit. Up to two HDTV and SDTV video signals can be displayed simultaneously.

- Superb Operability

Operability was prioritized in the design of these instruments. You can use the best control interface according to your liking or situation. In addition to the conventional keys and knobs on the front panel, you can control the instrument remotely using a USB mouse. Further, the LV5300/LV5300A and LV5350 have a 7-inch full-HD touch panel. The LV7300 can be connected to a USB touch panel interface of a touch-panel monitor. These interfaces allow intuitive control and configuration through touch operation.

The LV7300 has dedicated keys for controlling the function menus that can be controlled from a remote screen.

These instruments can also be controlled remotely by connecting a dedicated remote controller (sold separately), controlled remotely from a Web browser on a PC over an Ethernet connection, and used to perform automatic measurements using TELNET or FTP.

- Compact

While providing high flexibility through various options and high functionality for various situations, the LV5300/LV5300A is 3U half-rack size with 300 mm depth, the LV5350 is 3U half-rack size with 85 mm depth, and the LV7300 is 1U half-rack size with 300 mm depth.

- 4K Video Format (SER28)

In addition to SD-SDI, HD-SDI, 3G-SDI single link, 6G-SDI single link, 12G-SDI single link, and 4K 3G dual link are supported. These cover SDI signals from SD video format to HD video format and even 4K video format.

- Transmission Quality Analysis Function

Signal analysis functions have been enhanced based on the SDI signal measurement technology that Leader has cultivated over the years. Other enhancements have been made to various transmission error monitoring, external sync phase difference display, lip sync measurement (SER20), SDI signal frequency deviation measurement function, equivalent cable length meter function, and the ancillary data analysis function, which has become more important with the introduction of 4K video signals.

- Video Analysis Functions

Numerous types of displays are available for the various video signals such as the video signal waveform display, vector display, picture display, 5-bar display, and CIE chromaticity diagram display (SER22). In addition, quality control (QoE) functions for video signals are available including freeze error, black error, and gamut error detection functions. Detected errors can be recorded in event logs.

3. SPECIFICATIONS

- Audio Analysis Functions (SER20)

For audio signals, level meter display is possible on audio signals embedded in SDI.

The SER20 AUDIO option allows Lissajous display, surround display and detection of mute and clip errors. Detected errors can be recorded in event logs.

- Eye Pattern Display (LV5300/LV5300A/LV7300-SER02/SER28) (*1)

Eye pattern display and jitter display, which are physical layer measurements of SDI signals from SD-SDI to 12G-SDI, are possible. These physical layer measurements can be performed using cursors or performed automatically. Measurements can be exported via a network.

A histogram can be superimposed on the eye pattern display.

- Closed Caption Decode Display Function (SER21)

Japanese closed captions embedded in SDI signals, CEA-608 and CEA-708 closed captions, teletext, and OP47 subtitles can be decoded and displayed.

- External Sync Signal Input

The phase difference and synchronization states of SDI or IP video signals can be shown graphically based on an external reference sync signal (black burst, tri-level sync).

- Customizable Layout (SER26)

Video signal waveforms, vector waveforms, picture, and other items of input video signals can be laid out freely in the sizes of your choice. Up to 2 input signals can be displayed simultaneously.

- SDI Reclock Output and SDI Signal Generation Function (SER24/SER28)

Two SDI signal reclock output connectors are available. SDI OUTPUT 1 can reclock and output a signal from SDI INPUT 1 or SDI INPUT 2 by switching.

The function of SDI OUTPUT 2 on the LV5300/LV5300A and LV5350 can be switched between the reclocked output of the SDI signal of SDI INPUT 2, the SD output of the screen display, and the SDI signal generation function.

The function of SDI OUTPUT 2 on the LV7300 can be switched between the reclocked output of the SDI signal of SDI INPUT 2 and the SDI signal generation function.

The SDI signal generation function supports HD-SDI to 12G-SDI. For the pattern, you can select the HD multiformat color bar, the 4K multiformat color bar, or the color raster pattern, which allows you to select any level. You can also overlay a moving box or insert embedded audio. When SER23 is installed, the HDR color bar can be output.

- External Monitor Output

The SDI output of the measurement screen is transmitted from SDI OUTPUT 2 on the LV5300/LV5300A and LV5350 by switching the function and from the SDI monitor output connector on the LV7300. The signal can be displayed on an external SDI monitor in full high definition resolution.

Further, because the LV7300 can also output the measurement screen in TMDS format from the monitor output connector, the output signal can be displayed on an HDMI monitor (*2) in full high definition resolution.

3. SPECIFICATIONS

- CINELITE Feature

The CINELITE feature makes it easy to manage the levels of specific points on the picture display. This is useful for adjusting the gain of multiple cameras to the same reference point. Furthermore, the CINELITE Advanced feature makes it possible to synchronize measurements with the video signal waveform display and vector display.

The CINEZONE feature makes it possible to check the luminance distribution of the whole picture display at a glance.

- Screen Capture Feature

A screen capture feature, which captures the entire display as still-image data, is available. Not only can captured data be displayed on the instrument, but it can also be compared with an input signal or saved to a USB memory device as bitmap data for viewing on a PC.

- Time Code Display

The timecodes embedded in SDI signals can be displayed. The timecode can also be used as the timestamp in the event log.

- External Remote Connector

A contact terminal can be used to load presets, switch the input signal, and transmit alarms.

- Ethernet Port

The following features become available when you connect the instrument to a PC: remote control through TELNET, file transfer through FTP, remote control and alarm generation through SNMP, remote control from a Web browser through HTTP, and internal clock synchronization through SNTP. Using the LV7290 REMOTE CONTROLLER (sold separately) allows up to eight LV5300/LV5300As, LV5350s, or LV7300s to be remote controlled.

- HDR (SER23)

Level monitoring is possible on HLG and PQ defined in ITU-R BT.2100 as well as S-Log3, C-LOG, and Log-C compatible HDR signals. Level control is possible based on the estimated brightness (Nits) of a display taking the OOTF into consideration. Video signal waveform display supports IRE scale as well as HDR scale. On CINEZONE display, the SDR area is displayed in monochrome, while the HDR area is displayed using colors corresponding to the brightness. This makes it easy to view the brightness distribution in the HDR area. Furthermore, you can display the MAX FALL and MAX CLL compliant with CEA-861.

- Focus Assist (SER25)

A new focusing algorithm based on nonlinear super-resolution technology has been developed, allowing highly sensitive focusing even on low-contrast images that were difficult to be focused in on in the past. You can select the sensitivity according to the image scene.

*1 Only SDI INPUT 1 supports the eye pattern display.

*2 LEADER does not guarantee the operation on all HDMI monitors.

3. SPECIFICATIONS

3.3 Specifications

3.3.1 SDI Video Formats and Standards (SER01/SER02/SER28)

Table 3-1 SD video signal formats and standards

Color System	Quantization	Image	Field Frequency/Scanning	Supported Standard
YCbCr 4:2:2	10 bit	720×487	59.94 /I	SMPTE ST 259
		720×576	50 /I	

Table 3-2 HD video signal formats and standards

Color System	Quantization	Image	Frame (Field) Frequency/Scanning	Supported Standard
YCbCr 4:2:2	10 bit	1280×720	60/59.94/50/30/29.97/25/24/23.98 /P	SMPTE ST 292-1 SMPTE ST 296
			60/59.94/50 /I	SMPTE ST 274
		1920×1080	30/29.97/25/24/23.98 /P 30/29.97/25/24/23.98 /PsF	SMPTE ST 292-1

3. SPECIFICATIONS

Table 3-3 3G-A video signal formats and standards

Color System	Quantization	Image	Frame (Field) Frequency/Scanning	Supported Standard		
Y _{C_BC_R} 4:2:2	10 bit	1920×1080	60/59.94/50 /P	SMPTE ST 274 SMPTE ST 425-1		
			48/47.95 /P	-		
		2048×1080	60/59.94/50/48/47.95 /P	SMPTE ST 425-1 SMPTE ST 2048-2		
	12 bit	1920×1080	60/59.94/50 /I	SMPTE ST 274		
			30/29.97/25/24/23.98 /P	SMPTE ST 425-1		
			30/29.97/25/24/23.98 /PsF			
		2048×1080	30/29.97/25/24/23.98 /P	SMPTE ST 425-1		
			30/29.97/25/24/23.98 /PsF	SMPTE ST 2048-2		
Y _{C_BC_R} 4:4:4	10 bit	1280×720	60/59.94/50/30/29.97/25/24/23.98 /P	SMPTE ST 296 SMPTE ST 425-1		
		1920×1080	60/59.94/50 /I	SMPTE ST 274		
			30/29.97/25/24/23.98 /P	SMPTE ST 425-1		
			30/29.97/25/24/23.98 /PsF			
		2048×1080	30/29.97/25/24/23.98 /P	SMPTE ST 425-1		
			30/29.97/25/24/23.98 /PsF	SMPTE ST 2048-2		
	12 bit	1920×1080	60/59.94/50 /I	SMPTE ST 274		
			30/29.97/25/24/23.98 /P	SMPTE ST 425-1		
		2048×1080	30/29.97/25/24/23.98 /P	SMPTE ST 425-1		
			30/29.97/25/24/23.98 /PsF	SMPTE ST 2048-2		
		RGB 4:4:4	10 bit	1280×720	60/59.94/50/30/29.97/25/24/23.98 /P	SMPTE ST 296 SMPTE ST 425-1
				1920×1080	60/59.94/50 /I	SMPTE ST 274
30/29.97/25/24/23.98 /P	SMPTE ST 425-1					
30/29.97/25/24/23.98 /PsF						
2048×1080	30/29.97/25/24/23.98 /P			SMPTE ST 425-1		
	30/29.97/25/24/23.98 /PsF			SMPTE ST 2048-2		
12 bit	1920×1080		60/59.94/50 /I	SMPTE ST 274		
			30/29.97/25/24/23.98 /P	SMPTE ST 425-1		
	2048×1080		30/29.97/25/24/23.98 /P	SMPTE ST 425-1		
			30/29.97/25/24/23.98 /PsF	SMPTE ST 2048-2		
	30/25/24 /PsF					
XYZ 4:4:4	12bit	2048×1080	30/25/24 /P	SMPTE ST 425-1		
			30/25/24 /PsF	SMPTE ST 428		

3. SPECIFICATIONS

Table 3-4 3G-B-DL Video Signal Formats and Standards

Color System	Quantization	Image	Frame (Field) Frequency/Scanning	Supported Standard	
Y _{C_B} C _R 4:2:2	10 bit	1920×1080	60/59.94/50 /P	SMPTE ST 274 SMPTE ST 372 SMPTE ST 425-1	
			48/47.95 /P	-	
		2048×1080	60/59.94/50/48/47.95 /P	SMPTE ST 372 SMPTE ST 425-1 SMPTE ST 2048-2	
			12 bit	1920×1080	60/59.94/50 /I
	30/29.97/25/24/23.98 /P	SMPTE ST 372			
	30/29.97/25/24/23.98 /PsF	SMPTE ST 425-1			
	2048×1080	30/29.97/25/24/23.98 /P		SMPTE ST 372	
		30/29.97/25/24/23.98 /PsF	SMPTE ST 425-1 SMPTE ST 2048-2		
Y _{C_B} C _R 4:4:4	10 bit	1920×1080	60/59.94/50 /I	SMPTE ST 274	
			30/29.97/25/24/23.98 /P	SMPTE ST 372	
			30/29.97/25/24/23.98 /PsF	SMPTE ST 425-1	
		2048×1080	30/29.97/25/24/23.98 /P	SMPTE ST 372	
			30/29.97/25/24/23.98 /PsF	SMPTE ST 425-1 SMPTE ST 2048-2	
			12 bit	1920×1080	60/59.94/50 /I
	30/29.97/25/24/23.98 /P	SMPTE ST 372			
	30/29.97/25/24/23.98 /PsF	SMPTE ST 425-1			
	2048×1080	30/29.97/25/24/23.98 /P		SMPTE ST 372	
		30/29.97/25/24/23.98 /PsF		SMPTE ST 425-1 SMPTE ST 2048-2	
		RGB 4:4:4		10 bit	1920×1080
	30/29.97/25/24/23.98 /P		SMPTE ST 372		
30/29.97/25/24/23.98 /PsF	SMPTE ST 425-1				
2048×1080	30/29.97/25/24/23.98 /P		SMPTE ST 372		
	30/29.97/25/24/23.98 /PsF		SMPTE ST 425-1 SMPTE ST 2048-2		
	12 bit		1920×1080		60/59.94/50 /I
30/29.97/25/24/23.98 /P		SMPTE ST 372			
30/29.97/25/24/23.98 /PsF		SMPTE ST 425-1			
2048×1080		30/29.97/25/24/23.98 /P	SMPTE ST 372		
		30/29.97/25/24/23.98 /PsF	SMPTE ST 425-1 SMPTE ST 2048-2		
		XYZ 4:4:4	12bit	2048×1080	30/25/24 /P
30/25/24 /PsF	SMPTE ST 425-1 SMPTE ST 428				

3. SPECIFICATIONS

Table 3-5 3G(DL)-4K Video Signal Formats and Standards

Division Transmission System	Color System	Quantization	Image	Frame Frequency/Scanning	Supported Standard
Square	YCbCr 4:2:2	10bit	3840×2160	30/29.97/25/24/23.98 /P	SMPTE ST 425-3 SMPTE ST 2036-1
				30/29.97/25/24/23.98 /PsF	-
			4096×2160	30/29.97/25/24/23.98 /P	SMPTE ST 425-3 SMPTE ST 2048-1
				30/29.97/25/24/23.98 /PsF	-
2 sample interleave	YCbCr 4:2:2	10bit	3840×2160	30/29.97/25/24/23.98 /P	SMPTE ST 425-3 SMPTE ST 2036-1
			4096×2160	30/29.97/25/24/23.98 /P	SMPTE ST 425-3 SMPTE ST 2048-1

- * You also need the SER28.
- * When these signals are displayed, phase differences of up to 100 clocks (approx. 0.67 μs) between links are automatically corrected.
- * 3G-B DS links are supported.

Table 3-6 6G video signal formats and standards

Division Transmission System	Color System	Quantization	Image	Frame Frequency/Scanning	Supported Standard
2 sample interleave	YCbCr 4:2:2	10bit	3840×2160	30/29.97/25/24/23.98 /P	SMPTE ST 2036-1 SMPTE ST 2081-10
			4096×2160	30/29.97/25/24/23.98 /P	SMPTE ST 2048-1 SMPTE ST 2081-10

- * You also need the SER28.

3. SPECIFICATIONS

Table 3-7 12G video signal formats and standards

Division Transmission System	Color System	Quantization	Image	Frame Frequency/Scanning	Supported Standard
2 sample interleave	YCbCr 4:2:2	10 bit	3840×2160	60/59.94/50 /P	SMPTE ST 2036-1 SMPTE ST 2082-10
				48/47.95/P	-
		4096×2160	60/59.94/50/48/47.95 /P	SMPTE ST 2048-1 SMPTE ST 2082-10	
			30/29.97/25/24/23.98 /P	SMPTE ST 2036-1 SMPTE ST 2082-10	
		12 bit	3840×2160	30/29.97/25/24/23.98 /P	SMPTE ST 2036-1 SMPTE ST 2082-10
			4096×2160	30/29.97/25/24/23.98 /P	SMPTE ST 2048-1 SMPTE ST 2082-10
	YCbCr 4:4:4	10 bit	3840×2160	30/29.97/25/24/23.98 /P	SMPTE ST 2036-1 SMPTE ST 2082-10
			4096×2160	30/29.97/25/24/23.98 /P	SMPTE ST 2048-1 SMPTE ST 2082-10
		12 bit	3840×2160	30/29.97/25/24/23.98 /P	SMPTE ST 2036-1 SMPTE ST 2082-10
			4096×2160	30/29.97/25/24/23.98 /P	SMPTE ST 2048-1 SMPTE ST 2082-10
	RGB 4:4:4	10 bit	3840×2160	30/29.97/25/24/23.98 /P	SMPTE ST 2036-1 SMPTE ST 2082-10
			4096×2160	30/29.97/25/24/23.98 /P	SMPTE ST 2048-1 SMPTE ST 2082-10
		12 bit	3840×2160	30/29.97/25/24/23.98 /P	SMPTE ST 2036-1 SMPTE ST 2082-10
			4096×2160	30/29.97/25/24/23.98 /P	SMPTE ST 2048-1 SMPTE ST 2082-10

* 12G-SDI TYPE 1 is supported.

* You also need the SER28.

3. SPECIFICATIONS

3.3.2 SDI Audio Formats and Standards (SER01/SER02/SER20)

Supported Standard	
12G, 6G, 3G, HD	SMPTE ST 299
SD	SMPTE ST 272
Sampling Frequency	48 kHz
Quantization	24 bit
Format	L-PCM
Clock Generation	Generated from the video clock
Synchronization	Synchronized to the video signal
	All SDI signals must be synchronized during Simul Display.
SDI Audio Channel Separation	
	Separates up to four groups (16 channels) from any SDI input.

3.3.3 SDI Input Connector (SER01/SER02/ SER28)

Connector Type	BNC
Number of Input Connectors	2 (SDI INPUT 1, 2)
Input Impedance	75Ω
Input Return Loss	
5 MHz to 1.485 GHz	-15 dB or more
1.485 to 2.970 GHz	-10 dB or more
2.970 to 5.940 GHz	-7 dB or more (SDI INPUT 1)
5.940 to 11.880 GHz	-4 dB or more (SDI INPUT 1)
Maximum Input Voltage	±1 V (DC + peak AC)
12G-SDI Input	SDI INPUT 1
Eye Pattern, Jitter Display	Eye pattern, jitter display is possible only on SDI INPUT 1.

3. SPECIFICATIONS

3.3.4 SDI Output Connector (SER01/SER02/SER24/SER28)

Connector Type	BNC
Number of Output Connectors	2 (SDI INPUT 1, 2)
Output Impedance	75Ω
Output Return Loss	
5 MHz to 1.485 GHz	-15 dB or more
1.485 to 2.970 GHz	-10 dB or more
2.970 to 5.940 GHz	-7 dB or more (SDI OUTPUT 1)
5.940 to 11.880 GHz	-4 dB or more (SDI OUTPUT 1)
Output Voltage	800 mVp-p ± 10 % (into 75 Ω)
Output Signal (LV5300/LV5300A/LV5350)	Reclocked signal of SDI input (*1), TSG output, SDI monitor output
SDI OUTPUT 1	Reclock output of SDI INPUT 1 or selected reclock output of SDI INPUT 1/2
SDI OUTPUT 2	Reclock output of SDI INPUT 2 (*1), SDI monitor output, or TSG output
SDI Monitor Output Signal	Outputs the LCD screen in HD, 3G-A, or 3G-B-DL.
SDI Monitor Output Format	

Color System	Quantization	Image	Frame (Field) Frequency/Scanning	Supported Standard
YCbCr 4:2:2	10bit	1920×1080	60/59.94/50 /I	SMPTE ST 274
			24/23.98 /PsF (*2)	
			60/59.94/50/48/47.95 /P	

SDI Monitor Output Synchronization

Output Signal (LV7300)	Synchronizes to the refresh rate of the LCD (free run)
SDI OUTPUT 1	Reclocked signal of SDI input (*1), TSG output
SDI OUTPUT 2	Reclock output of SDI INPUT 1 or selected reclock output of SDI INPUT 1/2
SDI OUTPUT 2	Reclock output of SDI INPUT 2 (*3) or TSG output

*1 When SDI system setting is 2K SD/HD/3G-B-DL/3G-A and input signal is 6G-SDI, reclock output is not possible.

*2 Equivalent to 48I when the SDI input is 48P.

*3 This is not output when the input is 6G-SDI, 12G-SDI.

3. SPECIFICATIONS

3.3.5 External Reference Input

Connector Type	BNC
Number of Input Connectors	1 pair
Input Impedance	15 k Ω passive loop-through
Input Return Loss	\geq 30 dB for 50 kHz to 30 MHz into 75 Ω
Maximum Input Voltage	\pm 5 V (DC + peak AC)
Input Signal	Tri-level sync or NTSC/PAL black burst signal
Function	Video signal waveform display and phase difference display based on the phase of an external sync signal

- * The display position of the video signal waveform display and the measured phase of the phase difference display based on the phase of the external sync signal may vary by \pm 1 clock depending on the timing when the external sync signal or SDI signal is connected or disconnected or when the device is restarted.
- * Video signal waveform display based on the phase of an external sync signal is not possible for the following formats.
 - 3G's 720/30P, 720/29.97P, 720/25P, 720/24P, 720/23.98P
 - 3G(DL), 6G, 12G
 - Frame frequency 48P, 47.95P
- * Phase difference display based on the phase of an external sync signal is not possible for the following formats.
 - 3G's 720/30P, 720/29.97P, 720/25P, 720/24P, 720/23.98P
 - Frame frequency 48P, 47.95P

3.3.6 Monitor Output Connector (LV7300)

SDI Output Connector

Function	Output the displayed screen to an SDI monitor
Output Connector	BNC
Number of Output Connectors	1
Output Impedance	75 Ω
Output Return Loss	
5 MHz to 1.485 GHz	15 dB or more
1.485 to 2.97 GHz	10 dB or more
Output Voltage	800 mVp-p \pm 10 % (into 75 Ω)
Output Signal	Outputs the LCD screen in HD, 3G-A, or 3G-B-DL.
Output Format	

Color System	Quantization	Image	Frame (Field) Frequency/Scanning	Supported Standard
YCbCr 4:2:2	10 bit	1920 \times 1080	60/59.94/50 /I	SMPTE ST 274
			24/23.98 /PsF (*1)	
			60/59.94/50/48/47.95 /P	

Synchronization

Synchronized with the LCD refresh rate (free run)

3. SPECIFICATIONS

TMDS Output Connector

Function	Output the displayed screen to an HDMI monitor (*2)
Output Connector	HDMI
Number of Output Connectors	1
Signal Format	Single Link T.M.D.S
DDC	Not supported
HOT PLUG Detection	Not supported
Output Signal	Outputs the LCD screen
Image	1920×1080
Frame Frequency	60P, 59.94P, 50P, 48P, 47.95P
Synchronization	Synchronized with the LCD refresh rate (free run)
Touch Control	Touch control possible by connecting the USB touch panel interface of a touch panel monitor to the LV5300/LV5300A, LV5350 or LV7300 (*3)

*1 Equivalent to 48I when the SDI input is 48P.

*2 LEADER does not guarantee the operation on all HDMI monitors.

*3 LEADER does not guarantee that all touch panel type monitors will work with the LV7300.

3.3.7 Headphone Output

Output Connector

LV5300/LV5300A, LV5350	One 3.5 mm mini jack (stereo)
LV7300	One stereo jack
Output Signal	2 channels from the audio signals that are being displayed on the screen (downmixed Lt and Rt are also possible)
Sampling Frequency	48 kHz
Volume Adjustment	Using the menu
Power Output	100 mW maximum (into 8 Ω load)

3.3.8 Control Connectors

USB Port

Port Type	Standard A
Number of Ports	2
Specifications	USB 2.0
Compatible Devices	USB memory, USB mouse, touch panel monitor
USB Memory Feature	Saves capture data, preset data, event log data, and data dumps
Supported USB Memory Format	FAT32 (*1)
USB Mouse Feature	Used to control on the screen
Touch panel monitor	Touch control of the displayed screen (*2, *3)

3. SPECIFICATIONS

Ethernet Port

Supported Standard	IEEE802.3
Supported Protocol	
TELNET (*4)	Command control, status query
FTP	File transfer
SNMP	Command control, alarm query
HTTP	Remote monitoring and control from a Web browser
SNTP	Internal clock synchronization
Connector Type	RJ-45
Function	Remote control from an external PC or remote controller (*4), file transfer, status information query
Type	10Base-T, 100Base-TX, 1000Base-T

Remote Connector

Port Type	15-pin D-sub (female)
Locking Screws	Inch screws (No.4-40UNC)
Number of Ports	1
Control Signal	LV-TTL level (low active)
Input Voltage Range	0 to 5 V DC All inputs are pulled up to +3.3 V (control is also possible using +5 V)
Function	Load preset settings, switch input signals, transmit alarm signals, and activate tally
Alarm Output	Outputs alarms signals when a format alarm occurs, when various errors occur, when the fan malfunctions, or when the internal temperature is abnormal

*1 We do not guarantee the operation of all USB-HDDs and USB memory. The this instrument may not operate normally depending on the connected USB device.

*2 Pinch out and swipe operations are not supported.

*3 LEADER does not guarantee that all touch panel type monitors will work with the LV7300.

*4 You cannot use TELNET and the LV7290 at the same time.

3.3.9 Front Panel

Display (LV5300/LV5300A/LV5350)

LCD Type	7-inch color TFT
Resolution	1920×1080
Refresh Rate	60 Hz, 59.94 Hz, 50 Hz (free run)
Touch Panel	Electrostatic touch panel Tapping the display shows touch keys
Key LEDs	All the keys are dimly back-lit. The selected key is lit more brightly.
Power Switch	Electronic switch (which remembers whether the instrument is on or off)
Last Memory	Backs up the panel settings to memory
Key Lock	Lock by holding down the SYS key. Prevents unintentional operations on the instrument.

3. SPECIFICATIONS

3.3.10 Capturing

Screen Capture

Function

Captures the screen

Display

Displays only the captured image or overlays the captured image over the input signal

Media

Internal memory (RAM) and USB memory

You can only save one screen capture to the internal memory.

Data Output

Saved to bitmap format to a USB memory device or to a file format that the instrument can load (BSG).

Data Input

Data saved to a USB memory device can be loaded and displayed on the instrument.

3. SPECIFICATIONS

3.3.11 TSG (SER24/SER28)

Table 3-8 HD video signal formats and standards

Color System	Quantization	Image	Frame (Field) Frequency/Scanning	Supported Standard
Y _C B _C R _C 4:2:2	10 bit	1280×720	60/59.94/50 /P	SMPTE ST 292-1
			30/29.97/25/24/23.98 /P	SMPTE ST 296
		1920×1080	60/59.94/50 /I	SMPTE ST 274
			30/29.97/25/24/23.98 /P	SMPTE ST 292-1
			30/29.97/25/24/23.98 /PsF	

Table 3-9 3G-A, 3G-B-DL video signal formats and standards

Color System	Quantization	Image	Frame (Field) Frequency/Scanning	Supported Standard
Y _C B _C R _C 4:2:2	10 bit	1920×1080	60/59.94/50/48/47.95 /P	SMPTE ST 274 SMPTE ST 425-1
			48/47.95 /P	-
		2048×1080	60/59.94/50/48/47.95 /P	SMPTE ST 425-1 SMPTE ST 2048-2
Y _C B _C R _C 4:4:4	10 bit	1920×1080	60/59.94/50 /I	SMPTE ST 274
			30/29.97/25/24/23.98 /P	SMPTE ST 425-1
			30/29.97/25/24/23.98 /PsF	
		2048×1080	30/29.97/25/24/23.98 /P	SMPTE ST 425-1
			30/29.97/25/24/23.98 /PsF	SMPTE ST 2048-2
RGB 4:4:4	10 bit	1920×1080	60/59.94/50 /I	SMPTE ST 274
			30/29.97/25/24/23.98 /P	SMPTE ST 425-1
			30/29.97/25/24/23.98 /PsF	
		2048×1080	30/29.97/25/24/23.98 /P	SMPTE ST 425-1
			30/29.97/25/24/23.98 /PsF	SMPTE ST 2048-2

Table 3-10 6G video signal formats and standards

Division Transmission System	Color System	Quantization	Image	Frame Frequency/Scanning	Supported Standard
2 sample interleave	Y _C B _C R _C 4:2:2	10bit	3840×2160	30/29.97/25/24/23.98 /P	SMPTE ST 2036-1 SMPTE ST 2081-10
			4096×2160	30/29.97/25/24/23.98 /P	SMPTE ST 2048-1 SMPTE ST 2081-10

* You also need the SER28.

3. SPECIFICATIONS

Table 3-11 12G video signal formats and standards

Division Transmission System	Color System	Quantization	Image	Frame Frequency/Scanning	Supported Standard
2 sample interleave	YCbCr 4:2:2	10 bit	3840×2160	60/59.94/50 /P	SMPTE ST 2036-1 SMPTE ST 2082-10
				48/47.95/P	-
			4096×2160	60/59.94/50/48/47.95 /P	SMPTE ST 2048-1 SMPTE ST 2082-10
	YCbCr 4:4:4	10 bit	3840×2160	30/29.97/25/24/23.98 /P	SMPTE ST 2036-1 SMPTE ST 2082-10
				4096×2160	30/29.97/25/24/23.98 /P
	RGB 4:4:4	10 bit	3840×2160	30/29.97/25/24/23.98 /P	SMPTE ST 2036-1 SMPTE ST 2082-10
				4096×2160	30/29.97/25/24/23.98 /P

* You also need the SER28.

3. SPECIFICATIONS

Output Pattern 100% color bar, 75% color bar, HD multiformat color bar (*1), 4K multiformat color bar (*1), color raster, gamma, cross hatch, 10 step, limit lamp, check field, lip sync pattern (SER20), HDR color bar (SER23) (*1)

YCbCr/RGB on/off, Level Adjustment

When the following patterns are selected, you can turn on and off YCbCr or RGB separately.

When COLOR RASTER pattern is selected, you can set the YCbCr or RGB levels separately. Moreover, if Structure is set to RGB, You can set R, G, and B level in interlocking.

Pattern	YCbCr/RGB on/off separately	YCbCr/RGB level adjustment separately	RGB level adjustment interlocking
100% color bar	Yes		
75% color bar	Yes		
HD multiformat color bar	Yes		
4K multiformat color bar	Yes		
Color raster	Yes	Yes	Yes
Gamma	Yes		
Cross hatch	Yes		
10 step	Yes		
Limit lamp	Yes		
Check field			
Lip sync pattern			
HDR color bar	Yes		

Scrolling (*2)

ON, OFF

Direction

Eight directions (up, down, left, right, and their combinations)

Speed Range and Unit

Per frame (field)

4 to 124 dots, in 4 dot steps

Moving Box (*2)

ON, OFF

Colors

WHITE, YELLOW, CYAN, GREEN, MAGENTA, RED, BLUE, BLACK

Speed

1 to 3

Embedded Audio

Number of Embedded Channels

16 channels max. (*3)

Embedding On/Off

On/off at the audio group level

Audio Level

-20d BFS, -18 dBFS, 0 dBFS, mute

Audio Frequency

1 kHz

CRC Error Addition

An incorrect CRC is inserted into the Y component of the first line.

*1 It cannot be set in horizontal 1280, 4096, and 2048 pixel format.

*2 Either scrolling, or moving box can be turned on.

*3 For 4096×2160 6G and 2048×1080 3G-B-DL, only 8 channels are embedded.

3. SPECIFICATIONS

3.3.12 Presets

Preset	Saves panel settings (with a few exceptions)
Number of Presets	60
Preset Loading Method	Front panel or remote connector (*1)
Copying	All preset data can be copied from the instrument to a USB memory device or from a USB memory device to the instrument.

*1 The number of presets loaded from the remote connector can be 8 or 60.

3.3.13 Display

Number of simultaneously displayed SDI input signals

SD, HD, 3G-A, 3G-B-DL	2
3G(DL)-4K (SER28)	1
6G (SER28)	1
12G (SER28)	1

Display Mode

Single display	Displays a single input signal
Simul Display	Displays two input signals simultaneously

Alarm Indications

System Alarm Indication	Displays an alarm when the fan malfunctions or when the internal temperature is abnormal
Error Indication	Displays an error when an receive signal error occurs

Display Layout

Multi Display	Control the WFM/PIC and other display functions in multiple areas from a single screen
---------------	--

Customized Layout (SER26)

Function	Freely arrange the windows shown with the WFM, VECT, PIC, AUDIO, STATUS, and EYE (LV5300/LV5300A/LV7300-SER02) keys (one of each), and a window consisting of six displays shown with MULTI
Display Format	Displays up to two single link input signals in tiled, mixed, V aligned, or H aligned mode.
Normal Mode	Each display area is divided evenly.
Tiled Display	The windows are divided into two quadrants.
Mixed Display	The windows are cascaded.
V Aligned Display	The windows are arranged top to bottom.
H Aligned Display	The windows are arranged side by side.
Tile Mode	The display contents arranged in the display are shown in two quadrants per screen.
V Aligned Mode	The display contents arranged in the display are shown in two vertical divided windows per screen.
H Aligned Mode	The display contents arranged in the display are shown in two horizontally divided windows per screen.

3. SPECIFICATIONS

Enhanced Layout (SER26)	
Function	When multiple channels of single link are displayed, the selected channel is automatically shown in a specific area. You can make the specific area larger than the other areas to show the selected channel enlarged.
Time Display	
Displayed Contents	Current time, time code
Current Time Display	The time based on the internal clock
Time Code Display	LTC, VITC, D-VITC (SD only)
Supported Standard	
LTC, VITC	SMPTE ST 12-2
D-VITC	SMPTE ST 266
Tally Display	
Remote Connector	Turn on and off the tally display by controlling through the remote connector
Camera ID Display	
Instrument Setting	Shows the camera ID set with the instrument's menu
Iris Display	Shows the Iris set with the instrument's menu

3.3.14 Video Signal Waveform Display

Waveform Control	
Display Mode	
Overlay	Overlays component signals
Parade	Displays component signals side by side
Blanking Interval	H and V blanking periods can be masked.
RGB Conversion	
Channel Assignment	Converts a YC _B C _R signal into an RGB signal and displays the result
Pseudo-Composite Display	GBR or RGB order
Artificially converts component signals into composite signals and displays the result	
Line Select	Displays the selected line
Sweep Modes	H, V
Color	7 colors to choose from
Vertical Axis	
Gain	×1, ×5, ×10
Variable Gain	
Gain x1	×0.2 to ×2.0
Gain x5	×1.0 to ×10.0
Gain x10	×2.0 to ×10.0
Amplitude Accuracy ±0.5% (single default display)	
3G (1080/60P, 1080/59.94P, 1080/50P)	
Y Signal	±0.5 % (1 to 60 MHz)
C _B C _R Signal	±0.5 % (0.5 to 30 MHz)
Low-Pass Attenuation	≥ 20 dB (at 40 MHz)

3. SPECIFICATIONS

3G, HD (1080/60P, 1080/59.94P, 1080/50P)

Y Signal	±0.5 % (1 to 30 MHz)
C _B C _R Signal	±0.5 % (0.5 to 15 MHz)
Low-Pass Attenuation	≥ 20 dB (at 20 MHz)

SD

Y Signal	±0.5 % (1 to 5.75 MHz)
C _B C _R Signal	±0.5 % (0.5 to 2.75 MHz)
Low-Pass Attenuation	≥ 20 dB (at 3.8 MHz)

Horizontal Axis

Line Display

Display Format	Overlay (1H, 2H) Parade (1H, 2H, 3H)
Magnification	×1, ×10, ×20, ACTIVE, BLANK

Field Display

Display Format	Overlay (1V, 2V) (*1) Parade (1V, 2V, 3V)
Magnification	×1, ×20, ×40
Time Accuracy	±0.5% (single default display)

Cursor Measurement

Composition

Horizontal Cursors	2 (REF and DELTA)
Vertical Cursors	2 (REF and DELTA)
Simultaneous Display	Displays the horizontal cursors and vertical cursors simultaneously
Amplitude Measurement	mV, %, R%, DEC, HEX
Time Measurement	Second display
Frequency Display	Computes and displays the frequency with the length of one period set to the time between two cursors
Cursor Value Display	Displays measured values at the cursors

Scale

Type	%, V, decimal, hexadecimal
Display Colors	7 colors to choose from

HDR Scale (SER23) Adds an HDR scale to each scale for HDR

*1 2V display is not possible when the input signal is progressive.

3. SPECIFICATIONS

3.3.15 Vector Display

Vector Mode	Vector, RGB vector (SER40), YCbCr vector (SER40)
Display Colors	7 colors to choose from
Blanking Interval	H and V blanking periods can be masked (according to the video signal waveform display settings).
Pseudo-Composite Display	Artificially converts component signals into composite signals and displays the result
Line Select	Displays the selected line
Gain	×1, ×5, IQ-MAG
Variable Gain	
Gain x1	×0.2 to ×2.0
Gain x5	×1.0 to ×10.0
Gain IQ-MAG	
Not SD, component display	0.620 to 6.240
SD, component display	0.580 to 5.840
Not SD, pseudo-composite display	0.570 to 5.700
SD, pseudo-composite display	0.520 to 5.260
Amplitude Accuracy	±0.5 %
Scale	
Type	AUTO, ITU-R BT.601, ITU-R BT.709, DCI, ITU-R BT.2020
Color Bar Saturation	75%, 100%
IQ Axis	Show or hide
ARIB Check Marker	OFF, STD-B66, STD-B72
Display Colors	7 colors to choose from
Variable Scale	ON, OFF
Color Wheel	ON, OFF
Vector Marker Display	Displays a marker and numeric value at the specified location on the vector display
Number of Markers	1
Numeric Display	Displays the marker position numerically
Cb	Displays the C_B position as a percentage
Cr	Displays the C_R position as a percentage
deg	Displays the hue in degrees.
d	Displays the distance from the center as a percentage
Variable Marker	Marker and frame resizing
Histogram Display	Displays the Y, R, G, and B histograms
5-Bar Display	
Function	Converts an SDI signal into Y, R, G, B, and composite values, and then displays the five peak levels.
Channel Assignment	RGB, GBR
Scale	%, mV, HEX, DEC
Error Level	Based on the gamut error, composite gamut error, and luminance error thresholds

3. SPECIFICATIONS

Line Select	Displays the selected line
Low-Pass Filter	The same as for gamut errors

3.3.16 Picture Screen

Quantization	8 bit (internal signal processing is performed with signed 12 bit or higher)
Level Mapping	Maps the black level to 0 (8bit), SDI code value (when receiving 10 bit RGB) 1024 to 255 (8 bit)
Display Sizes	Reduced, actual size, ×2 (4K not supported), full frame (4K not supported)
Quality Adjustment and Color Selection	Brightness, contrast, RGB gain, RGB bias, chroma gain, monochrome display (RGB gain, RGB bias, chroma gain not valid)
Frame Rate	Converts the frame rate based on the LCD frame rate (60P, 59.94P, 50P)
SCTE-104 Display	
Function	SCTE-104 message monitoring
Supported Standard	SMPTE 2010, ANSI/SCTE 104
Supported Format	For Dual / Quad Link, Link1 only (Link cannot be changed)
Supported Input Channel	SDI INPUT 1 / 2 / 3 / 4 (DS1 only)
Display	Superimpose when SCTE-104 message is detected
Display Location	OFF / Top left / Top right / Bottom left / Bottom right
Display Time	1 to 10 seconds (1 second step)
SPLICE Display	When a splice_request_data message is detected, the details of the message are displayed
Aspect Marker Display	
3G (17:9 aspect ratio)	16:9, 14:9, 13:9, 4:3, 2.39:1
3G (16:9 aspect ratio), HD	17:9, 14:9, 13:9, 4:3, 2.39:1, AFD (*1)
SD	16:9, 14:9, 13:9, AFD (*1)
Aspect Marker Format	Line, shadow (99 levels), or black
Safety Marker Size	ARIB TR-B4, SMPTE RP-218, or user-defined
AFD Display (*1)	Displays abbreviations for SMPTE ST 2016-1-2007 standard AFD codes
Line Select	Marks the selected line
Error Indication	Displays markers in the gamut error and level error areas

*1 AFD Supports only SD or HD.

3. SPECIFICATIONS

3.3.17 Superimpose Display (SER21)

Displays English closed captions, European closed captions, and Japanese closed captions over the picture

English Closed Caption

Supported Standards (Mapping Standards)

EIA-708 SMPTE ST 334

EIA/CEA-608-B (EIA-708-B)

SMPTE ST 334

EIA/CEA-608-B (EIA/CEA-608-B)

SMPTE ST 334

VBI (EIA/CEA-608-B Line21)

CIA/EIA-608-B

Supported Video Formats

SD, HD, 3G-A, 3G-B-DL,
3G(DL)-4K (close caption decoding only for link 1),
6G (close caption decoding only for sub 1),
12G (close caption decoding only for sub 1)

European Closed Caption

Supported Standards

Teletext

VBI (ITU-R BT. 653-3 System B) (SD only), OP47

Simple Japanese Closed Caption Display

Displays a simple Japanese closed caption on the picture display. (Select HD, SD, analog, or portable closed caption to display. Select language 1 or 2.)

Supported Standard

ARIB STD-B37 short form data

Supported Video Formats

SD, HD, 3G-A,
3G(DL)-4K (close caption decoding only for link 1),
12G (close caption decoding only for sub 1)

525i/59.94 (SMPTE 259M)

Display

Display position control is supported only for HD and SD closed captions.

Characters

Only Kanji, roman numerals, katakana, hiragana, additional characters (ARIB STD-B24), additional kanji (ARIB STD-B24), and 1-byte DRCS are displayed.

Character Sizes

Supports only standard, medium, small, and specified size codes

Logging

Logged Events

Clear screen command, text closed caption display event, time code, TV commercial material check result

Data Format

Text

3. SPECIFICATIONS

TV Commercial Material Checking

Function	Checks whether closed caption displays are present during the closed caption prohibited time
Check Period	The material start time and end time can be specified using timecodes.
Log Display Color	
Closed Caption during Prohibited Time	Red
Closed Caption Not during Prohibited Time	Green
Check Result Display	Displays OK or NG when measurements are complete

3.3.18 CINELITE Display

Function	Video levels are displayed numerically.
f Stop Display (not supported on the SER23)	Displays f Stop values relative to a reference point Set in reference to an object with an 18% reflectance f Stop gamma correction
Fundamental Gamma	ITU-R BT.709, hybrid log gamma (HLG)(SER23), PQ (SER23), S-Log3 (SER23)
User Correction Table	3 types (data acquired with a real device)
% Display (SDR)	Displays the luminance level or RGB level as a percentage with the SDI code value 64 assumed to be 0% and the SDI code value 940 assumed to be 100%
Gradation Display	Displays the luminance or RGB value with the SDI code value 64 assumed to be 0 and the SDI code value 940 assumed to be 255
CV Display	Decimal, hexadecimal Displays the SDI signal code value as YCBCR or RGB according to the input signal (only for measurement size 1×1)

3. SPECIFICATIONS

HDR Display (SER23)

HLG

System Gamma OFF

Narrow Range

Displays the relative HLG luminance with the SDI code value 64 assumed to 0% and 940 assumed to be 1200% or 100%

Full Range

Displays the relative HLG luminance with the SDI code value 0 assumed to 0% and 1023 assumed to be 1200% or 100%

System Gamma ON

Assuming a Display with a peak brightness of 1000 Nits

Narrow Range

Displays the relative HLG luminance with the SDI code value 64 assumed to 0Nits and 940 assumed to be 1000Nits

Full Range

Displays the relative HLG luminance with the SDI code value 0 assumed to 0Nits and 1023 assumed to be 1000Nits

PQ

Converts the luminance level to the display's Nits and displays the result

Narrow Range

SDI code value 64 to 940 are assumed to be 0Nits to 10000Nits

Full Range

SDI code value 0 to 1023 are assumed to be 0Nits to 10000Nits

S-Log3

Converts the reflectance to IRE with SDI code value 95 assumed to be 0% and 589 assumed to be 100% and displays it as a percentage

C-Log

Displays the percentage with the SDI code value 128 assumed to 0% and 614 assumed to be 100%

Log-C

EI200

Displays the percentage with the SDI code value 95 assumed to 0.39% and 853 assumed to be 83%

EI400

Displays the percentage with the SDI code value 95 assumed to 0.39% and 917 assumed to be 90%

EI800

Displays the percentage with the SDI code value 95 assumed to 0.39% and 976 assumed to be 95%

EI1600

Displays the percentage with the SDI code value 95 assumed to 0.39% and 1022 assumed to be 94%

Measured Points

3

Measurement Sizes

1 × 1 pixel, 3 × 3 pixels, and 9 × 9 pixels

3. SPECIFICATIONS

3.3.19 CINELITE Advanced Display

Function	Synchronizes the markers on the waveform display, vector display, and chromaticity diagram display to the points selected with CINELITE
Waveform Display Link Markers	Synchronizes the markers on the waveform display to the points selected with CINELITE
Number of Link Markers	Up to 16 (for YRGB, YGBR display) (including the 4 reference points)
Vector Link Markers	Synchronizes the markers on the vector display to the points selected with CINELITE
Number of Link Markers	Up to 4 (including the 1 reference point)
Vector Numeric Display	Displays numerically the active marker position
Cb	Displays the C_B position as a percentage
Cr	Displays the C_R position as a percentage
deg	Displays the hue as an angle ($^{\circ}$).
d	Displays the distance from the center as a percentage
CIE Chromaticity Diagram Display Link Markers (SER22)	Synchronizes the markers on the CIE chromaticity diagram display to the points selected with CINELITE
Number of Link Markers	Up to 4 (including the 1 reference point)

3. SPECIFICATIONS

3.3.20 CINEZONE Display

SDR Display

Gradation and Step

Function	Adds colors to the display in accordance with luminance levels
Display Colors	Linear (1024 colors), step (12 colors)
Upper Limit	-6.3 to 109.4 % (values equal to or greater than the upper limit are displayed in white)
Lower Limit	-7.3 to 108.4 % (values less than the lower limit are displayed in black)

Search

Function	Monochrome display of the set luminance level range Color display within $\pm 0.5\%$ of the set luminance level
Display Colors	Green
Level Setting	-7.3 to 109.4%
Upper Limit	-6.3 to 109.4% (values equal to or greater than the upper limit are displayed in red)
Lower Limit	-7.3 to 108.4% (values less than the lower limit are displayed in blue)

HDR display (SER23)

Function	Adds colors to the display in accordance with luminance levels
HDR Area Setting	Displays color according to the brightness
SDR Area Setting	Monochrome display
Upper Limit	Displays magenta for values exceeding the limit Ref.LEVEL to 100% (code values 64 to 940 or 0 to 1023 assumed to be 100%)
Lower Limit	Displays black for values less than the limit 0% to Ref.LEVEL% (code values 64 to 940 or 0 to 1023 assumed to be 100%)

3. SPECIFICATIONS

3.3.21 Focus Assist (SER25)

Detection Sensitivity	LOW, MIDDLE, HIGH
Highlight Display Color	WHITE, GREEN, BLUE, RED
Picture Luminance Level	OFF, EMBOSS, 25%, 50%, 75%, 100%

3.3.22 CIE Chromaticity Diagram Display (SER22)

Display Standard	CIE1931 (xy display), CIE1976 (u'v' display)
Display Type	Chromaticity diagram display, color temperature display
Display Mode	Chromaticity Diagram Display
	Luminance display, color display
Color Temperature Display	Luminance display
Colorimetry	ITU-R BT.601(525), ITU-R BT.601(625), BT.709, DCI, ITU-R BT.2020
Clipping	
ON	Clips negative values of the input signal to zero
OFF	Displays negative values of the input signal according to ITU-R BT.1361
Smoothing	Displays by averaging data every two pixels
Accuracy	± 0.005 (relative to the measurement coordinate value)
Chromaticity Diagram Display Scale	
Triangle	Select two from ITU-R BT.601 (525), ITU-R BT.601 (625), ITU-R BT.709, DCI, and ITU-R BT.2020
User-defined Triangle	Set a single user-defined triangle
Background	Color sample, white background, black background
Sub scale	Color temperature curve, grid (0.1 steps), white point (D65), triangle name (each can be turned on or off)
Cursor	Displays the cursor position in coordinates
Gamma	ITU-R BT.709, user (1.5 to 3.0), HLG (SER23), PQ (SER23), S-Log3 (SER23), C-Log (SER23), Log-C (SER23)

3. SPECIFICATIONS

3.3.23 HDR Display (SER23)

Supported Standard	ITU-R BT.2100 (HLG: Hybrid Log Gamma, Full range / Narrow range), ITU-R BT.2100 (PQ: Perceptual Quantization, Full range / Narrow range), S-Log3, C-Log, Log-C
Supported Formats	All formats except SD-SDI
Function	
Video Waveform Display	Scale, cursor
Vector Display	Histogram
Picture Screen	
HDR CINEZONE	
HDR CINELITE	
MAX CLL, MAX FALL (CEA-861 Supported)	Supports HLG and PQ
START	MAX CLL, MAX FALL computation start
STOP	MAX CLL, MAX FALL computation stop
MAX CLL, MAX FALL Error	When the measurement result is equal to or greater than the specified threshold, it is displayed turns red and recorded as the event log.

3.3.24 Audio Display

Input Signal	SDI embedded audio
Format	L-PCM
Sampling Frequency	48 kHz
Quantization	24 bit
Supported Standard	
3G, HD	SMPTE ST 299
SD	SMPTE ST 272
Clock Generation	Generated from the video clock
Synchronization	Must be synchronized to the video clock. All SDI signals must be synchronized.
Channel Separation	Separates up to two groups (8 channels) from an SDI input.
Maximum Number of Display Channels	8 (from any SDI input, displayed in groups)
Display Types	Level meter, Lissajous (SER20), correlation meter (SER20), surround (SER20), status (SER20)

3. SPECIFICATIONS

Level meter	
Displayed Channels	8ch
Dynamic Range	SDI-60 dBFS, -90 dBFS, reference level±3 dB
Level Accuracy	±0.3 dB (-50 to 0 dBFS, 1 kHz, signal source impedance 40 Ω or less)
Frequency Response	30 Hz to 20 kHz ± 0.4 dB (4 dBu, 1 kHz reference, TRUE PEAK response) 20 Hz to 20 kHz + 0.4 dB, -0.6 dB (4 dBu, 1 kHz reference, TRUE PEAK response)
Meter Response Model	TRUE PEAK, PPM type I , PPM type II , VU
Peak Hold Time	0.0 to 5.0 s (in 0.5 s steps), HOLD
Level Setting	-40.0 to 0.0 dBFS (standard level, warning level, over level)
Level Numeric Display	Displays the levels numerically Numeric display in red when level-over is detected Displays a blue "M" when mute is detected (ON/OFF selectable. The displays changes to a blue ■ when the layout size is small.) Displays "U.L" when audio is not detected
Lissajous Display (SER20)	
Displayed Channels	2 channels × 1 2 channels × 4
Display Mode	X-Y, MATRIX
Correlation Meter	Displays the correlation between two channels as a value from -1 to 1
Channel Assignment	
SINGLE LISSAJOU	L, R
MULTI LISSAJOU	L1, R1 to L4, R4
Surround Display (SER20)	
Function	Displays a graphical representation of a sound field
Surround Format	5.1 channels
Channel Mapping	L, R, C, LFE, Ls, Rs, Lt, Rt
Center Channel Format	NORMAL, PHANTOM CENTER
Gain	×1, AUTO

3. SPECIFICATIONS

Status Display (SER20)

Level	Audio levels are displayed using numbers (dBFS).
Error Detection	Counts the number of errors that occur for each channel
Level Over	Counts the number of times that the level of the input signal exceeds the set value
Detection Setting	-40.0 to 0.0 dBFS
Clipping	Counts the number of times that a received signal exceeds the maximum signal value for the specified number of consecutive samples
Detection Setting	1 to 100 sample
Mute	Counts the number of times that the length of a received mute signal exceeds the specified period
Detection Setting	1 to 5000 ms
Parity Error	Counts the number of times that the input signal's parity bit and the parity bit recalculated by the instrument differ
Validity Error	Counts the number of times that the input signal's validity bit is 1
CRC Error	Counts the number of times that the CRC of the channel status bits and the calculated CRC are different
Code Violation	Counts the number of times that the state of the input signal's biphase modulation is abnormal
Elapsed Time	Displays the amount of time that has elapsed since the instrument was reset
Channel Status Bits	Dump display, text display
User Data Bits	Dump Display

3. SPECIFICATIONS

3.3.25 Status Display

Signal Detection	Detects the presence of an SDI signal
Format Display	Displays the video signal format
Frequency Deviation Display	
Function	Displays the sampling frequency deviation Displays an error if ± 10 ppm is exceeded
Measurement Range	± 100 ppm
Precision	± 2 ppm

Equivalent Cable Length Display

Function	Displays SDI signal attenuation in terms of cable length Displays an error if the specified cable length is exceeded
Supported Cables	
12G	L-5.5CUHD
3G, HD	LS-5CFB, 1694A
SD	L-5C2V, 8281
Display Range	
12G	< 10 m, 10 to 80 m, > 80 m
3G	< 10 m, 10 to 100 m, > 100 m
HD	< 10 m, 10 to 130 m, > 130 m
SD	< 50 m, 50 to 200 m, > 200 m
Precision	
12G, 3G, HD	± 20 m
SD	± 30 m
Resolution	10 m
Error Count Display	Up to 999999 errors for each error type
Count Period	1 second, 1 field (frame)

Embedded Audio Channel Display

Displays the embedded audio channel numbers

* If the input signal is 3G-B-DL, only stream 1 is supported.

SDI Signal Error Detection

CRC Error	Detects 3G and HD signal transmission errors
EDH Error	Detects SD signal transmission errors
TRS Position Error	Detects TRS embedding position errors
TRS Code Error	Detects TRS protection bit errors
Line Number Error	Detects errors with the line numbers embedded in 3G and HD signals
Illegal Code Error	Detects data within the range of 000 to 003h and 3FC to 3FFh in locations other than TRS and ADF

3. SPECIFICATIONS

Ancillary Data Packet Error Detection

Checksum error	Detects ancillary data transmission errors
Parity Error	Detects ancillary data header parity errors
Embedded Audio Packet Error Detection (*1)	
BCH Error	Detects audio packet transmission errors
DBN Error	Detects audio packet continuity errors
Parity Error	Detects audio packet parity errors
Embedded Position Error	Detects the presence of audio in lines where it should not be embedded
Sample Counter Error	Detects asynchronous audio by measuring the number of audio samples

*1 If the input signal is 3G-B-DL, only stream 1 is supported.

Video Error Detection

Freeze Error	Detects freezing of video within the specified time range
Detection Method	Video interval checksum
Time Specification	2 to 300 frames
Black Error	Detects video blackouts
Black Level Specification	0 to 100%
Area Specification	1 to 100%
Time Specification	1 to 300 frames
Level Error	Detects luminance level errors and chrominance level errors
Luminance Level Detection Range	
Upper limit	-51 to 766 mV
Lower Limit	-51 to 766 mV
Chrominance Level Detection Range	
Upper limit	-400 to 399 mV
Lower Limit	-400 to 399 mV

3. SPECIFICATIONS

Gamut Error Detects gamut errors
 Detection Range
 Upper limit 90.8 to 109.4%
 Lower Limit -7.2 to 6.1%

Low-Pass Filter

Format	Low-Pass Filter	
	HD/SD: 1 MHz	HD: 2.8 MHz SD: 1 MHz
SD 720×487	Approx. 1 MHz (EBU R103-2000)	Approx. 1 MHz
SD 720×576	Approx. 1 MHz (EBU R103-2000)	Approx. 1 MHz
HD 1280×720	Approx. 1 MHz	Approx. 2.8 MHz
HD 1920×1080 (frame rate ≤ 30 Hz)	Approx. 1 MHz (IEEE STD 205)	Approx. 2.8 MHz
HD 1920×1080 (frame rate > 30 Hz)	Approx. 2 MHz	Approx. 5.5 MHz
HD 2048×1080 (frame rate ≤ 30 Hz)	Approx. 1 MHz (IEEE STD 205)	Approx. 2.8 MHz
HD 2048×1080 (frame rate > 30 Hz)	Approx. 2 MHz	Approx. 5.5 MHz
4K 3840×2160 (frame rate ≤ 30 Hz)	Approx. 4 MHz	Approx. 11 MHz
4K 3840×2160 (frame rate > 30 Hz)	Approx. 8 MHz	Approx. 22 MHz
4K 4096×2160 (frame rate ≤ 30 Hz)	Approx. 4 MHz	Approx. 11 MHz
4K 4096×2160 (frame rate > 30 Hz)	Approx. 8 MHz	Approx. 22 MHz

Area Specification 0.0 to 5.0%

Time Specification 1 to 60 frames

Composite Gamut Error Detects level errors that occur when component signals are converted to composite signals

Detection Range

Upper limit 90.0 to 135.0%

Lower Limit -40.0 to 20.0%

Low-Pass Filter The same as the gamut error

Area Specification 0.0 to 5.0%

Time Specification 1 to 60 frames

SDI Analysis Features

Event Log Display

Function Records detected errors, events—such as the instrument switching between input signals, and timestamps.

Log Capacity Up to 1000 events

Operation Logs all events from start to finish

Data Output Overwrite mode, Stop after 1,000 events

3. SPECIFICATIONS

Data Dump Display

Display Format	Displays serial data sequence or displays each color component separately
SD, HD, 3G-A	PICTURE, stream 1, stream 2
3G-B-DL	PICTURE, link A, link B
3G(DL)-4K (SER28)	PICTURE, link 1, link 2
6G (SER28), 12G (SER28)	PICTURE, sub 1, sub 2, sub 3, sub 4
Display Format Details	
PICTURE	Links or streams 1 and 2 are combined and displayed in a picture structure.
Stream 1/2	Displays each stream in a transmission structure
Link A, B, 1, 2, 3, 4	Displays the selected link
Line Select	Displays the selected line
Sample Select	Displays from the selected sample
Jump Feature	Jumps to an EAV or SAV
Data Output	Text output to USB memory

Phase Difference Display

Function	Displays the phase difference between a reference signal and an SDI signal numerically and graphically
Reference Signal	
SD, HD, 3G-A, 3G-B-DL	external sync signal, Ach
3G(DL)-4K (SER28)	External sync signal, Ach
6G (SER28), 12G (SER28)	External sync signal
Display Range	
Vertical	1 frame For 3G-B-DL 47.95P to 60P, ± 1 frame measurement possible
Horizontal	± 1 line

- * If the reference signal is set to an external sync signal, the measured phase may vary by ± 1 clock depending on the timing when the external sync signal or SDI signal is connected or disconnected or when the power is turned on and off.

SDI Ancillary Data List Display

List Display Details	Presence or absence of each ancillary data type, embedded line number, and number of packets per frame
Dump Display	The selected ancillary data is displayed in hexadecimal or binary.

EDH Display (Only for SD)

Supported Standard	SMPTE RP 165
Displayed Contents	Analyzes and displays EDH packets and displays received CRC errors
Display Format	Text, hexadecimal, binary

3. SPECIFICATIONS

Payload ID Display

Supported Standard	SMPTE ST 352
Displayed Contents	Analyzes and displays payload information
Display Format	Text and binary

Displaying Audio Control Packets

Supported Standard	SMPTE ST 299-1, SMPTE ST 272
Displayed Contents	Displays audio control packet analysis
Display Format	Text, hexadecimal, binary
Display Format	1, 2, 3, 4

Japanese Closed Caption Display (*1)

Supported Standard	ARIB STD-B37
Displayed Contents	Analysis display of closed caption signals
Display Format	Text, hexadecimal, binary

English Closed Caption Display

Supported Video Formats	SD, HD, 3G-A, 3G-B-DL, 3G(DL)-4K (close caption decoding only for link 1), 6G (close caption decoding only for sub 1), 12G (close caption decoding only for sub 1)
-------------------------	---

CDP Packet Display Details

CDP packet header information

Presence or absence of timecode packet,
Presence or absence of closed caption packet and validity of
this packet,
Presence or absence of closed caption service packet and
validity of this packet,
Presence or absence of the FUTURE data packet

Time Code

When time code packets are present

Closed Caption Data

When valid closed caption packets are present

Presence or absence of CC1 to 4, TEXT1 to 4, XDS packets

XDS Packet Display Details

Contents adviser information

Copy management information

Display content of ProgramDescription packet

Stuffing Descriptor

AC3 Audio Descriptor

Caption Service Descriptor

Content Advisory Descriptor

Extended Channel Name Descriptor

Service Location Descriptor

Time-Shifted Service Descriptor

Component Name Descriptor

DCC Arriving Request Descriptor

DCC Arriving Request Descriptor

Redistribution Control Descriptor

3. SPECIFICATIONS

Inter-Stationary Control Signal (NET-Q) Display (*1)

ARIB STD-B39

Analysis display of inter-stationary control signals

Text, hexadecimal, binary

Q signal logging

Analysis display of the format ID

Outputs Q signal logs in CSV format through a USB memory device

Data Broadcast Trigger Signal Display (*1)

ARIB STD-B35

Text, hexadecimal, binary

V-ANC User Data Display (*1)

ARIB TR-B23

Hexadecimal, binary

AFD Packet Display

SMPTE ST 2016-3

Text, hexadecimal, binary

SCTE-104 Display

Function

SCTE-104 message monitoring

Supported Standard

SMPTE 2010, ANSI/SCTE 104

Supported Format

For Dual / Quad Link, Link1 only (Link cannot be changed)

Supported Input Channel

SDI INPUT 1 / 2 / 3 / 4 (DS1 only)

Display

Superimpose when SCTE-104 message is detected

Display Time

1 to 10 seconds (1 second step)

Log

Records when SCTE-104 message is detected

DUMP Display

Displays DUMP data when SCTE-104 message is detected

SPLICE Display

When a splice_request_data message is detected, the details of the message are displayed

SPLICE Log

Records when a splice_request_data message is detected

SR Live Packet Display

Text, hexadecimal, binary

User-Defined ANC Packet Display

DID, SDID

Y, C

Hexadecimal, binary

- *1 Supported video formats are as follows:SD, HD, 3G-A, 3G(DL)-4K (close caption decoding only for link 1), 12G (close caption decoding only for sub 1)

3. SPECIFICATIONS

Lip Sync Display (SER20)

Displays the phase difference between the video and audio

Lip Sync Measurement Function

Measures the time difference between the SDI signal and digital audio signal and displays the results numerically and graphically

Reference Signal

A Leader TSG that supports lip syncing (*1)

Measurement Method

Measures the time difference when the luminance level of the video signal exceeds the specified value and when the audio level signal exceeds the specified value

Luminance Level Setting 25 to 100%

Audio Signal Level Setting

-30 to 0 dBFS

Supported Audio Signals Embedded audio signal

Measurement Range (Bar Display)

±50 ms, ±100 ms, ±500 ms, ±1.0 s, ±2.5 s

Measurement Range (Numeric Display)

±3999 ms

Measurement Resolution 1 ms

*1 TSG patterns not made by Leader may be supportable by specifying the video signal setting and audio signal setting.

3. SPECIFICATIONS

3.3.26 Eye Pattern (LV5300/LV5300A/LV7300-SER02)

SDI Input Connector	SDI INPUT 1
Display	Displays the input SDI waveform before equalizing
Number of Displays	
1-Screen Display	Displays the eye pattern of the selected filter in a single screen
2-Screen Display	Displays the timing filter and eye pattern of the selected filter in two screens
Waveform Display Color	7 colors to choose from
Scale Display Color	7 colors to choose from
Method	Equivalent time sampling
Amplitude Accuracy	800 mV \pm 5 % (for 800 mV input)
Time Axis	
2 UI Display	
12G (SER28)	12.5 ps/div
6G (SER28)	25 ps/div
3G	50 ps/div
HD	100 ps/div
SD	550 ps/div
4 UI Display	
12G (SER28)	25 ps/div
6G (SER28)	50 ps/div
3G	100 ps/div
HD	200 ps/div
SD	1100 ps/div
16 UI Display	
12G (SER28)	100 ps/div
6G (SER28)	200 ps/div
3G	400 ps/div
HD	800 ps/div
SD	4400 ps/div
Time Axis Accuracy	\pm 3 %
Jitter Filter	
10Hz	HPF 10Hz
100Hz	HPF 100Hz
1 kHz	HPF 1 kHz
100 kHz	HPF 100 kHz
TIMING	HPF 10Hz
ALIGNMENT	
12G (SER28), 6G (SER28)	HPF 100 kHz
3G, HD	HPF 100 kHz
SD	HPF 1 kHz
Cursor Measurement	Amplitude measurement using Y cursors Time measurement using X cursors Rise time and fall time measurement using the TrTf cursor

3. SPECIFICATIONS

Automatic Measurement Items

	Eye pattern's amplitude
	Rise time (the time for the signal to rise from 20 to 80 % of its amplitude)
	Fall time (the time for the signal to fall from 80 to 20 % of its amplitude)
	Timing jitter
	Jitter
	Rising edge overshoot
	Falling edge overshoot
Histogram Display	Displays the frequency distribution of the eye pattern waveform amplitudes

3.3.27 Jitter Display (LV5300/LV5300A/LV7300-SER02)

SDI Input Connector	SDI INPUT 1
Display	Displays the jitter component of an SDI signal
Number of Displays	
1-Screen Display	Displays the jitter waveform of the selected filter in a single screen
2-Screen Display	Displays the timing jitter and the jitter waveform of the selected filter in two screens
Waveform Display Color	7 colors to choose from
Scale Display Color	7 colors to choose from
Method	Phase detection method
Gain	×16, ×8, ×4, ×2, ×1
Measurement Range	
12G (SER28)	
×16	0.00 to 1.20 UI
×4	1.20 to 4.80 UI
×2	4.80 to 9.60 UI
×1	9.60 to 19.20 UI
3G, HD, SD, 6G (SER28)	
×8	0.00 to 1.20 UI
×2	1.20 to 4.80 UI
×1	4.80 to 9.60 UI
Time Axis	1H, 2H, 1V, 2V (*1)
Time Axis Accuracy	±3 %

3. SPECIFICATIONS

Jitter Filter

10Hz	HPF 10Hz
100Hz	HPF 100Hz
1 kHz	HPF 1 kHz
100 kHz	HPF 100 kHz
TIMING	HPF 10Hz

ALIGNMENT

12G (SER28), 6G (SER28)

	HPF 100 kHz
3G, HD	HPF 100 kHz
SD	HPF 1 kHz

Cursor Measurement Jitter value measurement through the use of cursors

Automatic Measurement Display Feature

Displays the jitter value in seconds (sec) and unit intervals (UI)

Automatic Measurement Items

Timing jitter, alignment jitter, jitter

Accuracy Input jitter frequency: 1 kHz. Filter setting: 10 Hz, within measurement range

0 UI < automatic measured value \leq 1 UI
 $\pm 10\% + 0.07$ UI

1 UI < automatic measured value \leq 7 UI
 $\pm 10\%$

*1 2V display is not possible when the input signal is progressive.

3.3.28 Tally Display

Number of Displays	3 (TALLY-1, TALLY-2, TALLY-EXT) (*1)
Display Colors	7 colors to choose from
Control Method	Remote connector, RS-422/485 connector (SER27)

*1 The number of displays per channel. Arranged using the customized layout feature or the enhanced layout feature.

3.3.29 Camera ID Display

Number of Displays	2 (LABEL-1, LABEL-2) (*1)
Iris Display	1 (IRIS) (*1)
Control Method	Instrument

*1 The number of displays per channel. Arranged using the customized layout feature or the enhanced layout feature.

3. SPECIFICATIONS

3.3.30 General Specifications

Environmental Conditions

Operating Temperature	0 to 40 °C
Operating Humidity Range	85 %RH or less (no condensation)
Optimal Temperature	10 to 30 °C
Operating Environment	Indoors
Elevation	Up to 2,000 m
Overvoltage Category	I
Pollution Degree	2

Power Requirements

Voltage	DC 10 to 18 V
Power Consumption	
LV5300/LV5300A	80 W max.
LV5350	60 W max.
LV7300	80 W max.

Dimensions

LV5300/LV5300A	215 (W) × 132 (H) × 132 (D) mm (excluding protrusions)
LV5350	215 (W) × 132 (H) × 85 (D) mm (excluding protrusions)
LV7300	213 (W) × 44 (H) × 300 (D) mm (excluding protrusions)

Weight

LV5300/LV5300A	2.95 kg max. (excluding accessories and battery option)
LV5350	2.5 kg max. (excluding accessories and battery option)
LV7300	2.25 kg max. (including options, excluding accessories)

Accessories

AC adaptor (GST90A-12)(LV7300)	1
Instruction manual (CD-ROM)	1

4. PANEL DESCRIPTION

4.1 Front Panel

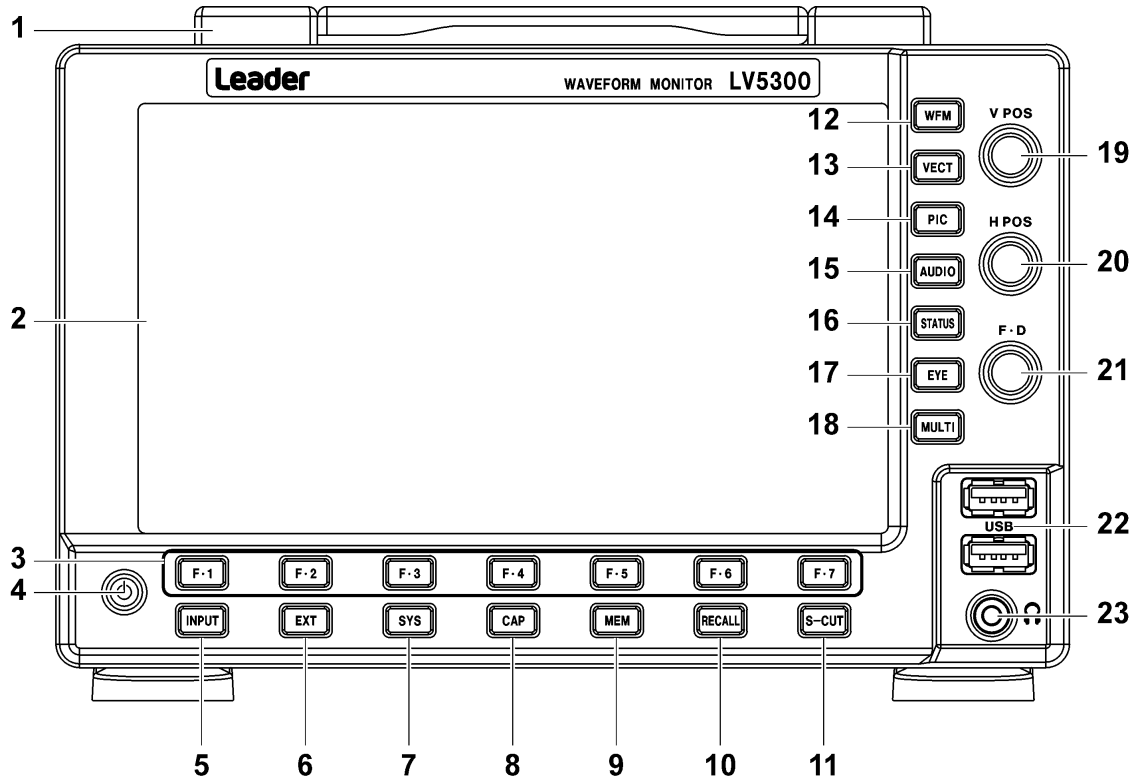

Figure 4-1 LV5300/LV5300A front panel

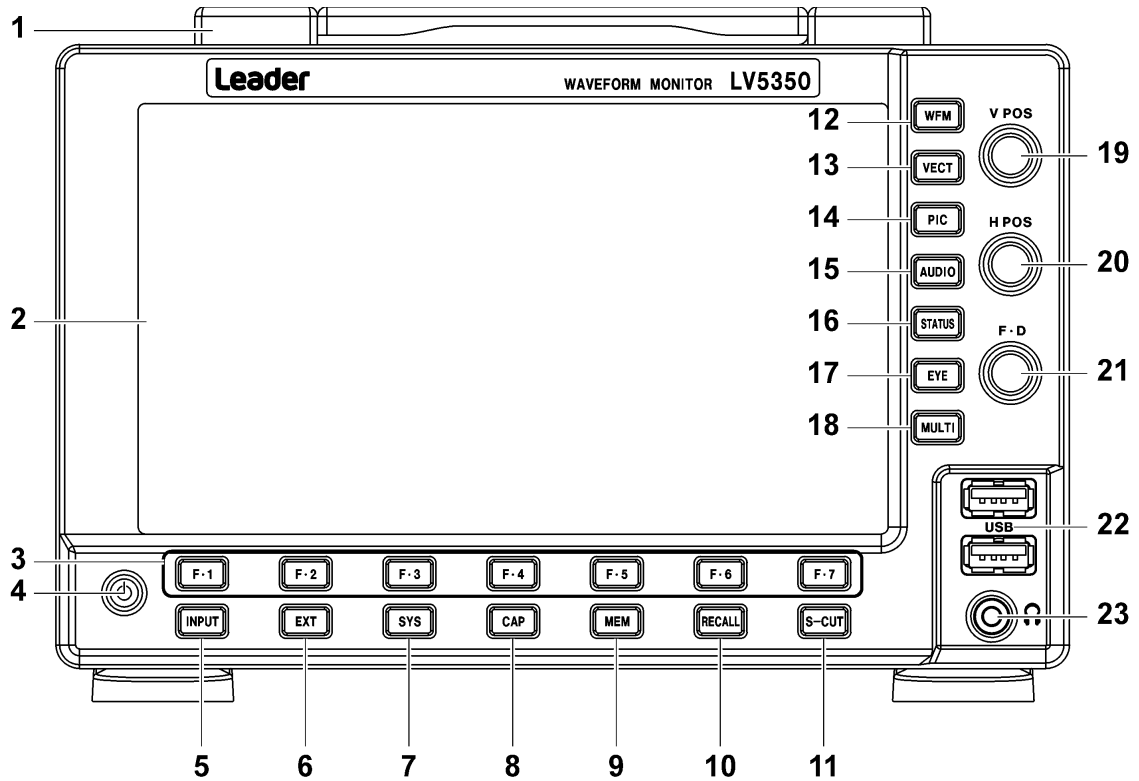

Figure 4-2 LV5350 front panel

4. PANEL DESCRIPTION

Table 4-1 LV5300/LV5300A/LV5350 front panel description

No.	Name	Description
1	Handle	Use this to carry the instrument.
2	LCD	Displays measurement and setup screens. Control the instrument with the touch panel.
3	F•1 to F•7	Carries out the corresponding function menu operation. [See also] 5.5.2, "Function Menu Operations"
4	Power Switch	Press to turn the instrument on. Hold down to turn the instrument off. [See also] 5.1, "Turning the Instrument On and Off"
5	INPUT	Sets the display channel. [See also] 6.1, "Setting the Input Signals"
6	EXT	Switches the sync signal. When the internal sync signal is being used, this key's LED turns off. When the external sync signal is being used, this key's LED lights. [See also] 5.4.2, "External Sync Signal Input"
7	SYS	Configures the settings [See also] 7, "SYSTEM SETTINGS."
8	CAP	Captures the screen [See also] 8, "CAPTURE FEATURE"
9	MEM	Press this key to register or delete a single preset setting, or copy all preset settings. [See also] 9, "PRESET FEATURE"
10	RECALL	Press this key to recall a preset setting configuration. [See also] 9, "PRESET FEATURE"
11	S-CUT	Loads panel settings, saves a screen capture to the USB memory device, adjusts the intensity, performs cursor measurement, or adjusts the headphone volume. [See also] 6.4, "Operation Key Actions"
12	WFM	Shows the video signal waveform display. You can change the layout as you like. [See also] 10, "VIDEO SIGNAL WAVEFORM DISPLAY"
13	VECT	Shows vectors. You can change the layout as you like. [See also] 11, "VECTOR DISPLAY"
14	PIC	Shows the picture display. You can change the layout as you like. [See also] 13, "PICTURE DISPLAY"
15	AUDIO	Shows the audio display. You can change the layout as you like. [See also] 14.4.4, "AUDIO DISPLAY"
16	STATUS	Shows the status. You can change the layout as you like. [See also] 16, "STATUS DISPLAY"
17	EYE (LV5300/LV5300A)	The eye pattern is displayed. You can change the layout as you like. [See also] 17, "EYE PATTERN DISPLAY (SER02)"
18	MULTI	Shows a combination of measurement screens. You can change the layout as you like. [See also] 6.3.7, "MULTI-SCREEN DISPLAY"
19	V POS	Turn to adjust the vertical position of the video signal waveform or other item. Press to return to the reference position.
20	H POS	Turn to adjust the horizontal position of the video signal waveform or other item. Press to return to the reference position.
21	F•D	Turn to specify a numeric value or to move cursors. In most cases, press to reset the value to its default value.

4. PANEL DESCRIPTION

No.	Name	Description
22	USB	Connect a USB memory device, USB mouse, or touch panel monitor. [See also] 5.3, "Connecting USB Devices."
23	Headphone jack	This is a mini-plug headphone jack. When a pair of headphones are connected to this jack, the instrument transmits the audio signal embedded in the SDI signal.

4. PANEL DESCRIPTION

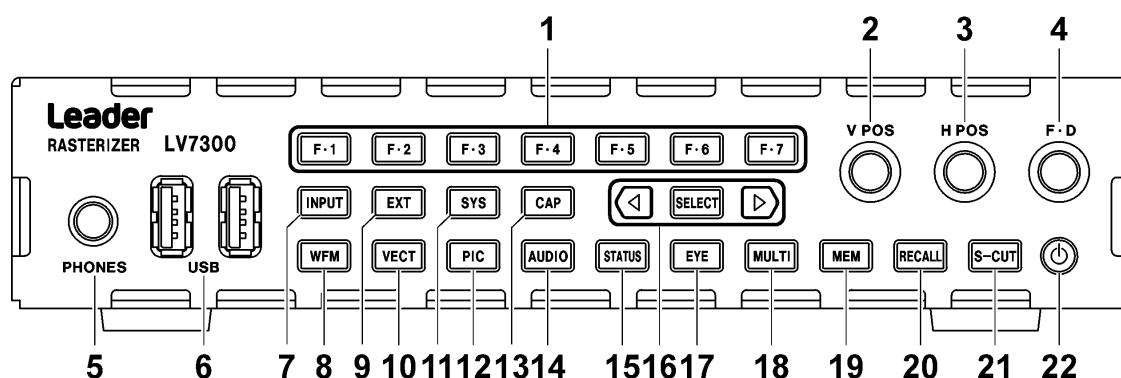

Figure 4-3 LV7300 front panel

Table 4-2 LV7300 front panel description

No.	Name	Description
1	F•1 to F•7	Carries out the corresponding function menu operation. [See also] 5.5.2, "Function Menu Operations"
2	V POS	Turn to adjust the vertical position of the video signal waveform or other item. Press to return to the reference position.
3	H POS	Turn to adjust the horizontal position of the video signal waveform or other item. Press to return to the reference position.
4	F•D	Turn to specify a numeric value or to move cursors. In most cases, press to reset the value to its default value.
5	PHONES	This is a mini-plug headphone jack. When a pair of headphones are connected to this jack, the instrument transmits the audio signal embedded in the SDI signal.
6	USB	Connect a USB memory device, USB mouse, or touch panel monitor. [See also] 5.3, "Connecting USB Devices."
7	INPUT	Sets the display channel. [See also] 6.1, "Setting the Input Signals"
8	WFM	Shows the video signal waveform display. You can change the layout as you like. [See also] 10, "VIDEO SIGNAL WAVEFORM DISPLAY"
9	EXT	Switches the sync signal. When the internal sync signal is being used, this key's LED turns off. When the external sync signal is being used, this key's LED lights. [See also] 5.4.2, "External Sync Signal Input"
10	VECT	Shows vectors. You can change the layout as you like. [See also] 11, "VECTOR DISPLAY"
11	SYS	Configures the settings [See also] 7, "SYSTEM SETTINGS."
12	PIC	Shows the picture display. You can change the layout as you like. [See also] 13, "PICTURE DISPLAY"
13	CAP	Captures the screen [See also] 8, "CAPTURE FEATURE"
14	AUDIO	Shows the audio display. You can change the layout as you like. [See also] 14.4.4, "AUDIO DISPLAY"
15	STATUS	Shows the status. You can change the layout as you like.

4. PANEL DESCRIPTION

No.	Name	Description
		[See also] 16, "STATUS DISPLAY"
16	◀ SELECT ▶	Carries out the corresponding function menu operation. [See also] 5.5.2, "Function Menu Operations"
17	EYE (SER02)	The eye pattern is displayed. You can change the layout as you like. [See also] 17, "EYE PATTERN DISPLAY (SER02)"
18	MULTI	Shows a combination of measurement screens. You can change the layout as you like. [See also] 6.3.7, "MULTI-SCREEN DISPLAY"
19	MEM	Press this key to register or delete a single preset setting, or copy all preset settings. [See also] 9, "PRESET FEATURE"
20	RECALL	Press this key to recall a preset setting configuration. [See also] 9, "PRESET FEATURE"
21	S-CUT	Loads panel settings, saves a screen capture to the USB memory device, adjusts the intensity, performs cursor measurement, or adjusts the headphone volume. [See also] 6.4, "Operation Key Actions"
22	Power Switch	Press to turn the instrument on. Hold down to turn the instrument off. [See also] 5.1, "Turning the Instrument On and Off"

4. PANEL DESCRIPTION

4.2 Rear Panel

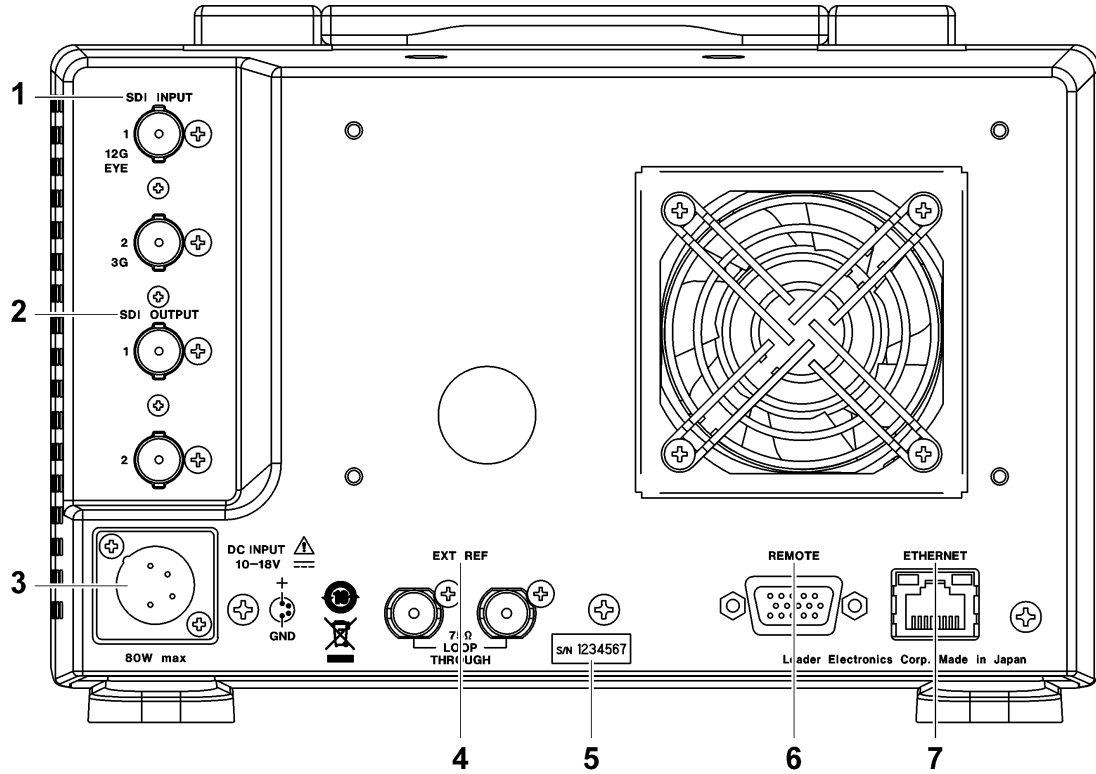

Figure 4-4 LV5300/LV5300A rear panel

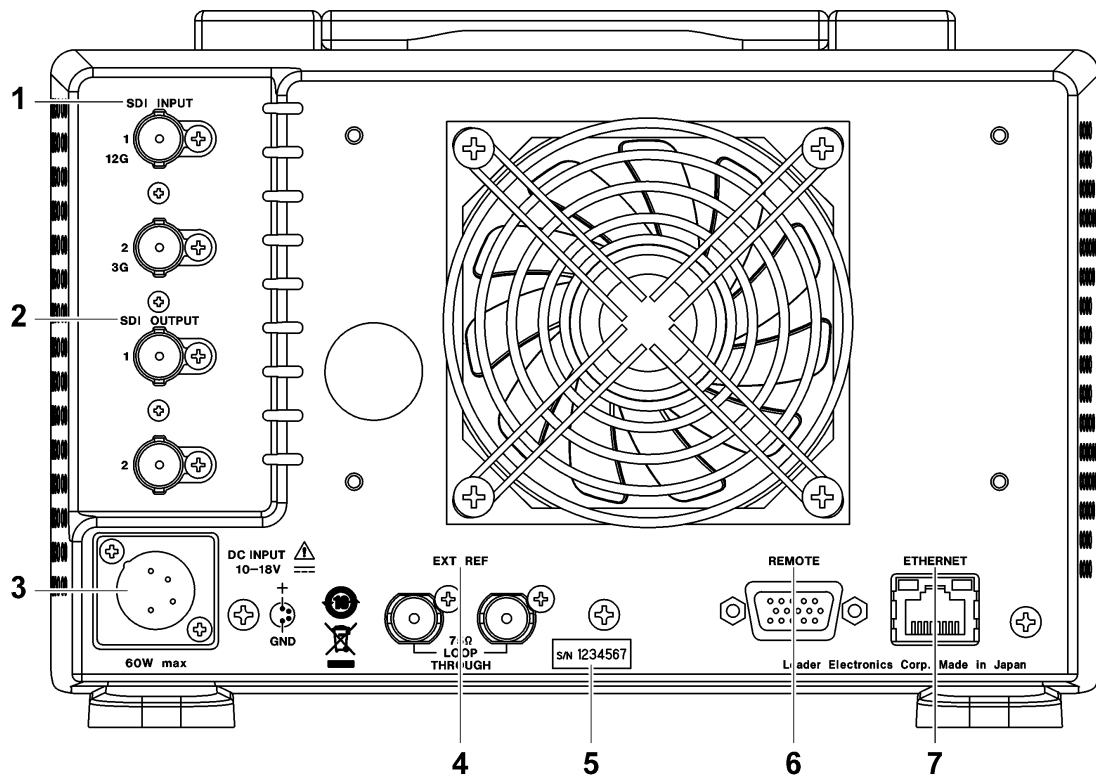

Figure 4-5 LV5350 rear panel

4. PANEL DESCRIPTION

Table 4-3 LV5300/LV5300A/LV5350 rear panel description

No.	Name	Description
1	SDI OUTPUT	SDI signal output connectors [See also] 5.4.1, "SDI Signal I/O."
2	SDI INPUT	SDI signal input connectors. [See also] 5.4.1, "SDI Signal I/O."
3	DC INPUT	DC inlet. [See also] 5.1, "Turning the Instrument On and Off"
4	EXT REF	External reference input connector. This is a loop-through connector. [See also] 5.4.2, "External Sync Signal Input"
5	Serial number label	The serial number is printed on this label.
6	REMOTE	15-pin D-sub remote connector. This can be used to execute actions such as recalling preset settings.
7	ETHERNET	Ethernet port. Supports TELNET, FTP, SNMP, HTTP, and SNTP.

4. PANEL DESCRIPTION

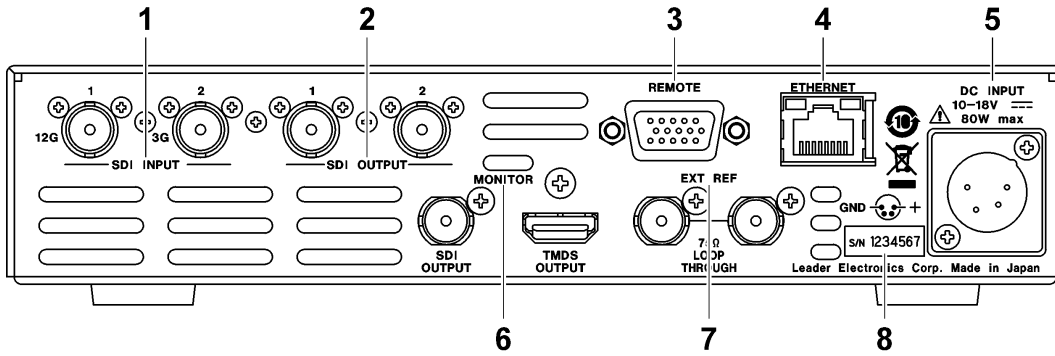

Figure 4-6 LV7300 rear panel (SER01/SER02)

Table 4-4 LV7300 rear panel description

No.	Name	Description
1	SDI INPUT (SER01/SER02)	SDI signal input connectors. [See also] 5.4.1, "SDI Signal I/O."
2	SDI OUTPUT (SER01/SER02)	SDI signal output connectors [See also] 5.4.1, "SDI Signal I/O."
3	REMOTE	15-pin D-sub remote connector. This can be used to execute actions such as recalling preset settings.
4	ETHERNET	Ethernet port. Supports TELNET, FTP, SNMP, HTTP, and SNTP.
3	DC INPUT	DC inlet. [See also] 5.1, "Turning the Instrument On and Off"
6	MONITOR	Transmits the screen image. [See also] 5.4.3, "Transmitting Monitor Signals"
7	EXT REF	External reference input connector. This is a loop-through connector. [See also] 5.4.2, "External Sync Signal Input"
8	Serial number label	The serial number is printed on this label.

5. BEFORE YOU BEGIN MEASURING

5.1 Precautions When Installing the ZEN series

The ZEN series WAVEFORM MONITORS have intake and exhaust ports for ventilation. The intake ports and exhaust ports of each model are shown below.

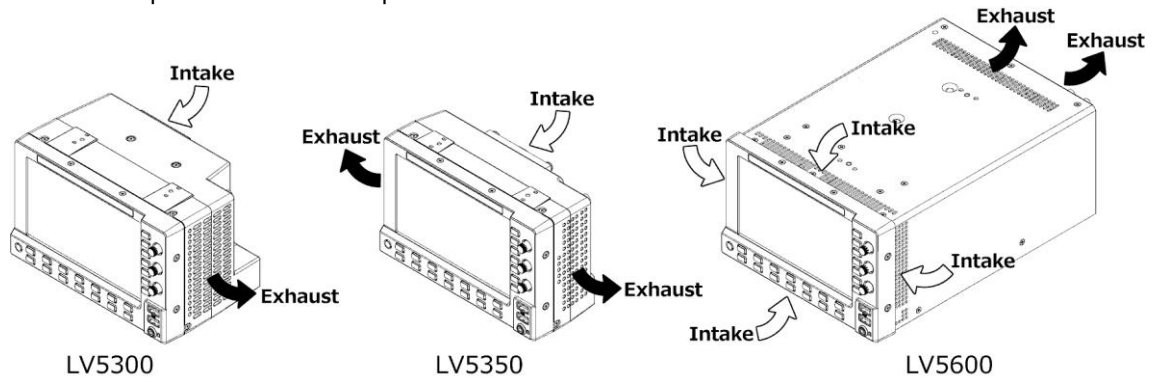

Taking precautions the following when installing the ZEN series.

- When installing, don't block the ventilation ports.
- If there is a wall near the ventilation port, make a ventilation hole on the wall.

5. BEFORE YOU BEGIN MEASURING

- When installing the ZEN series instruments side by side, make sure that the intake and exhaust ports are not next to each other.
- When installing the LV5300/LV5300A and the LV5350 or LV5600 side by side, place the LV5300/LV5300A on the right side when viewed from the front panel side.

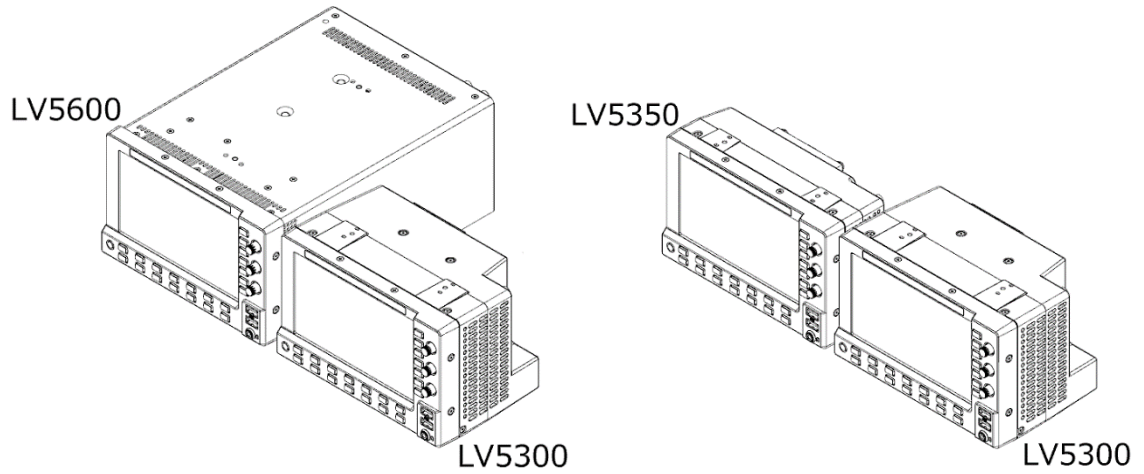

- When installing the LV5350 and LV5600 side by side, place the LV5350 on the right side when viewed from the front panel side, and separate the LV5350 and LV5600 by a partition.

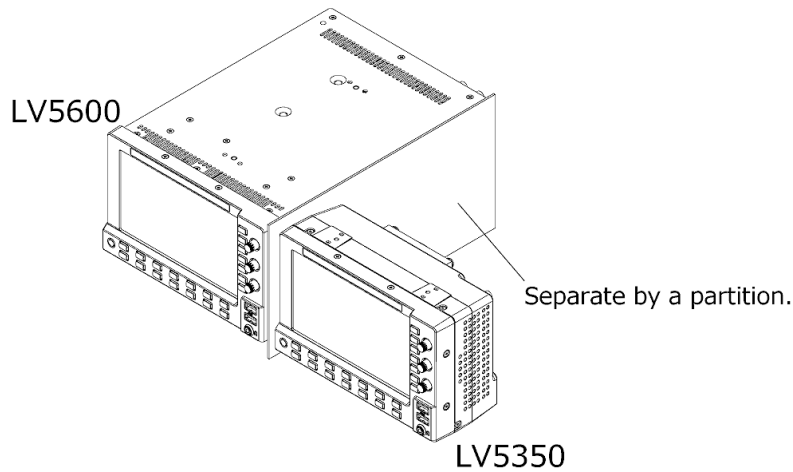

- When installing two ZEN series instruments side by side, install them at the following intervals.

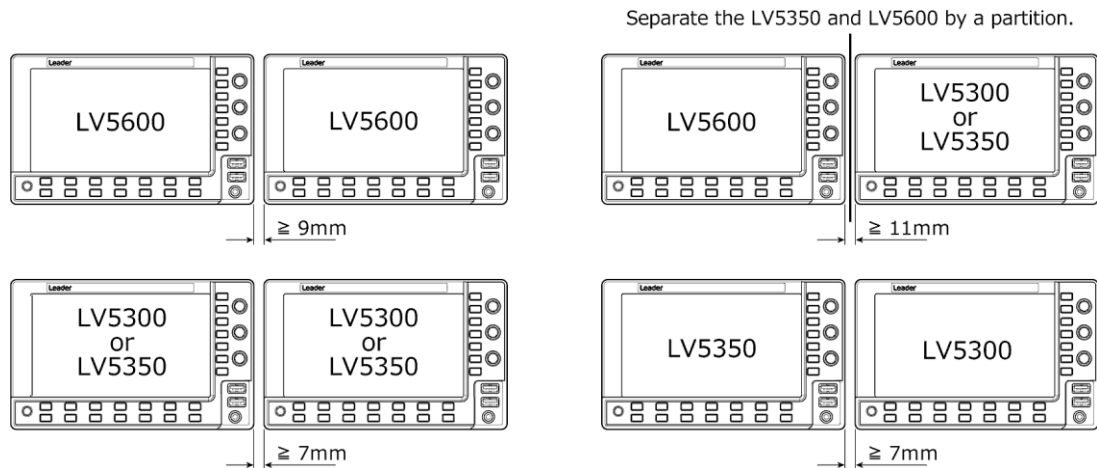

5.2 Turning the Instrument On and Off

- Applying DC Power

The DC input and its pinout are shown below. Apply +12 V to pin 4.

When power is applied, the internal microcomputer is in standby mode, and some power is consumed even if the power switch is turned off. If you do not intend to use the instrument for an extended period of time, disconnect the power supply.

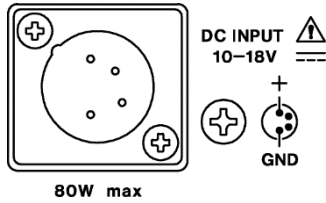

* 60W max. on the LV5350

Figure 5-1 LV5300/LV5300A/LV5350 DC INPUT connector

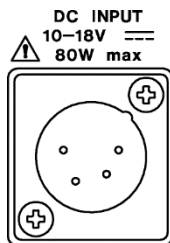

Figure 5-2 LV7300 DC INPUT connector

Table 5-1 DC INPUT pinout

Pin No.	Pin Name
1	GND
2	NC (*)
3	NC (*)
4	+12V

* Do not connect anything.

- Turning the Power On

To turn on the power, press the power switch. The LED next to the power switch and the instrument will turn on. When you turn on the power, the instrument starts up with the same panel settings that were set when it was last turned off.

- Turning the Power Off

To turn off the power, hold down the power switch for at least 2 seconds. The power switch LED and the instrument turn OFF.

5.3 Connecting USB Devices

The front panel has two USB ports. You can connect a USB memory device, USB mouse, or touch panel monitor to these ports. You can connect the devices to either USB port, but you cannot connect the same type of devices to the instrument simultaneously.

USB devices can be connected or removed with the power turned on.

- USB Memory Device

When a USB memory device is connected, a USB memory icon  appears in the upper right of the screen.

You can save various types of data in a USB memory device.

This icon is normally green, but it changes to red when the USB memory device is being accessed. Do not turn the power OFF or remove the USB memory device when the icon is red.

- USB Mouse

When a USB mouse is connected, a mouse icon  appears in the upper right of the screen. Basic operations can be performed without a mouse, but arranging the measurement screen layout requires a mouse or touch panel control.

[See also] 6.5, "Customized Layout (SER26)," 6.6, "Enhanced Layout (SER26)"

- Touch Panel Monitor

When the USB touch panel interface of a touch panel monitor is connected, a mouse icon  appears in the upper right of the screen. The video interface of the touch panel monitor is connected to the monitor output connector.

Basic operations can be performed without a touch panel, but arranging the measurement screen layout requires a mouse or touch panel control.

[See also] 6.5, "Customized Layout (SER26)," 6.6, "Enhanced Layout (SER26)"

5.4 Signal I/O

5.4.1 SDI Signal I/O

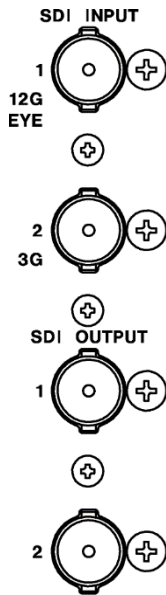
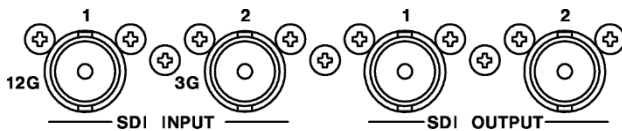

Figure 5-3 LV5300/LV5300A/LV5350 SDI I/O connectors



* When an SER01 or SER02 is installed

Figure 5-4 LV7300 SDI I/O connectors

- SDI Signal Input SDI INPUT 1/2

Apply signals that are specified in section 3.3.1, “SDI Video Formats and Standards,” and section 3.3.2, “SDI Audio Formats and Standards.”

Select the SDI System on the SDI IN SETUP1 tab of the SYS menu, and then apply signals to SDI INPUT 1/2.

[See also] SDI IN SETUP1 tab → 7.1.1, “Configuring the SDI Input Connectors.”

- SDI Signal Output SDI OUTPUT 1/2

There are two SDI signal output settings: Through Out (SDI1) and Mode (SDI2). You can set it on the SDI OUT tab of the SYS menu.

- Through Out (SDI1)

SDI OUTPUT 1 transmits reclocked signal of the signal received through SDI INPUT 1/2. Use the signals for monitoring.

You can select whether to assign SDI OUTPUT 1 to SDI INPUT 1 or a channel that you select, SDI INPUT 1 or 2, on the SDI OUT tab. If you select to use a channel that you select, set the output channel using the INPUT menu or **F•6** INPUT SELECT in the appropriate measurement screen.

5. BEFORE YOU BEGIN MEASURING

- Mode (SDI2)

Select the signal that is generated from SDI OUTPUT 2.

If you select Input Through, SDI OUTPUT 2 transmits a reclocked signal of the signal received through SDI INPUT 2. However, this is not output when the input is 6G-SDI or 12G-SDI.

If you select Test Signal, SDI OUTPUT 2 outputs various patterns. You can superimpose a moving box, vary the phase, and so on. You can use the instrument as a signal generator. Further, on the LV5300/LV5300A and LV5350, you can select Monitor Out. If you select Monitor Out, SDI OUTPUT 2 transmits the instrument's screen for monitoring purposes. Connect to an full high definition (1920×1080) display. On the MONITOR OUT tab of the SYS menu, select the output format.

[See also] MONITOR OUT tab → 7.1.7, "Configuring the Monitor Output Connectors"

- Terminators

The SDI input connectors are terminated internally at 75 Ω , so there is no need to connect terminators to them. Connect cables with a characteristic impedance of 75 Ω .

- Setting the Display Channels

Configure the display channels using the SDI IN SETUP1 tab of the SYS menu and the INPUT menu.

[See also] 6.2, "Setting the Signals to Measure"

- Cables

It has been confirmed that errors do not occur when the instrument receives an 800 mVp-p stress pattern through the following cables.

Input Signal	Cable Type	Input Connector (SDI INPUT 1/2)	Video Pattern
12G	L5.5CUHD cable	70 m	Color bar
3G	LS-5CFB cable	70 m	Check field
HD	LS-5CFB cable	110 m	Check field
SD	L-5C2V cable	200 m	Check field

5.4.2 External Sync Signal Input

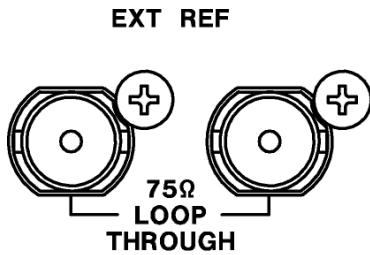

Figure 5-5 LV5300/LV5300A/LV5350 External sync signal input connectors

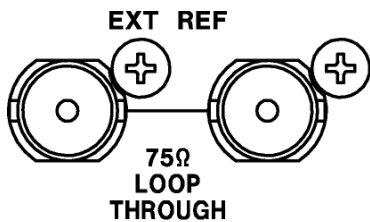

Figure 5-6 LV7300 External sync signal input connectors

On the video-signal-waveform and vector displays, you can apply an external sync signal to display waveforms. (*1) Apply an external sync signal to an external sync signal input connector, and then press EXT. The instrument determines the sync signal format automatically.

As shown in the figure below, the external sync signal input connectors are loop-through. Apply the input signal to one of the two connectors, and terminate the other connector at 75 Ω, or connect it to another 75 Ω device. If you connect to another device, be sure to terminate the device at the end of the chain at 75 Ω. Connect cables with a characteristic impedance of 75 Ω.

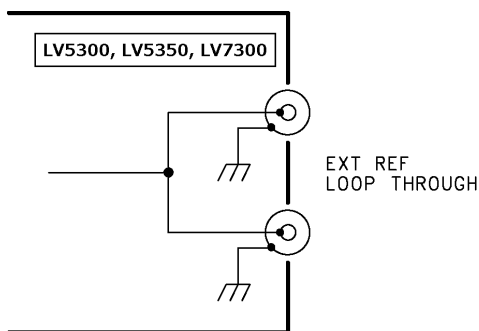

Figure 5-7 Loop-through

*1 Waveform display using an external sync signal is not possible for the following formats.

- 3G's 720/30P, 720/29.97P, 720/25P, 720/24P, 720/23.98P
- 3G(DL), 6G, 12G
- Frame frequency 48P, 47.95P

5. BEFORE YOU BEGIN MEASURING

External sync signals that are compatible with each input signal are indicated with a check mark in the following table.

Proper measurement is possible only for combinations that are indicated with check marks.

Table 5-2 External sync signal formats (SD, HD)

		SDI (SD, HD) Input Signal Format																									
		525/59.94I	625/50I	1080/60I	1080/59.94I	1080/50I	1080/30PsF	1080/29.97PsF	1080/25PsF	1080/24PsF	1080/23.98PsF	1080/30P	1080/29.97P	1080/25P	1080/24P	1080/23.98P	720/60P	720/59.94P	720/50P	720/30P	720/29.97P	720/25P	720/24P	720/23.98P			
External Sync Signal Format	NTSC (59.94Hz)	✓			✓			✓					✓					✓			✓						
	PAL (50Hz)		✓			✓		✓					✓						✓			✓					
	1080/60I			✓			✓					✓															
	1080/59.94I				✓		✓					✓															
	1080/50I					✓		✓				✓															
	1080/24PsF									✓					✓												
	1080/23.98PsF										✓					✓											
	1080/30P			✓			✓					✓															
	1080/29.97P				✓		✓					✓															
	1080/25P					✓		✓					✓														
	1080/24P									✓				✓													
	1080/23.98P										✓				✓												
	720/60P																✓										
	720/59.94P																	✓									
	720/50P																		✓								
	720/30P																				✓						
	720/29.97P																					✓					
	720/25P																						✓				
	720/24P																							✓			
	720/23.98P																								✓		

5. BEFORE YOU BEGIN MEASURING

Table 5-3 External sync signal formats (3G)

		SDI (3G) Input Signal Format																			
		1080/60P	1080/59.94P	1080/50P	1080/60I	1080/59.94I	1080/50I	1080/30PsF	1080/29.97PsF	1080/25PsF	1080/24PsF	1080/23.98PsF	1080/30P	1080/29.97P	1080/25P	1080/24P	1080/23.98P	720/60P	720/59.94P	720/50P	
External Sync Signal Format	NTSC (59.94Hz)		<			<			<						<					<	
	PAL (50Hz)			✓			✓		✓						✓						✓
	1080/60I	✓			✓		✓														
	1080/59.94I		✓			✓		✓													
	1080/50I			✓			✓		✓												
	1080/24PsF										✓					✓					
	1080/23.98PsF											✓					✓				
	1080/30P	✓			✓		✓						✓								
	1080/29.97P		✓			✓		✓						✓							
	1080/25P			✓			✓		✓						✓						
	1080/24P										✓					✓					
	1080/23.98P											✓					✓				
	720/60P																	✓			
	720/59.94P																		✓		
	720/50P																				✓

5. BEFORE YOU BEGIN MEASURING

Table 5-4 External sync signal formats (6G)

		SDI (6G) Sub Image Input Signal Format (*1)				
		1080/30P	1080/29.97P	1080/25P	1080/24P	1080/23.98P
External Sync Signal Format	NTSC (59.94Hz)		✓			
	PAL (50Hz)			✓		
	1080/30P	✓				
	1080/29.97P		✓			
	1080/25P			✓		
	1080/24P				✓	
	1080/23.98P					✓

*1 If the input signal is 6G, the phase difference is measured for the 4k sub image format.

Table 5-5 External sync signal formats (12G)

		SDI (12G) Sub Image Input Signal Format (*1)							
		1080/60P	1080/59.94P	1080/50P	1080/30P	1080/29.97P	1080/25P	1080/24P	1080/23.98P
External Sync Signal Format	NTSC (59.94Hz)		✓			✓			
	PAL (50Hz)			✓			✓		
	1080/60I	✓							
	1080/59.94I		✓			✓			
	1080/50I			✓			✓		
	1080/30P	✓			✓				
	1080/29.97P		✓			✓			
	1080/25P			✓			✓		
	1080/24P							✓	
	1080/23.98P								✓

*1 If the input signal is 12G, the phase difference is measured for the 4k sub image format.

5.4.3 Monitor Signal Output (LV7300)

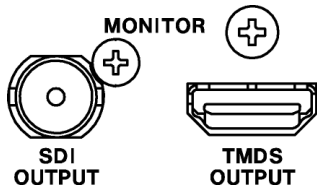

Figure 5-8 LV7300 Monitor output connectors

The SDI OUTPUT connector and TMDS OUTPUT connector transmit the instrument's screen for monitoring purposes. Connect to an full high definition (1920×1080) display.

- Selecting the output format

On the MONITOR OUT tab of the SYS menu, select the output format.

[See also] MONITOR OUT tab →7.1.7 "Configuring the Monitor Output Connectors"

5.5 Operation Basics

5.5.1 Displaying the Function Menu

Use the function menu to change the various settings.

Normally the function menu is displayed, but it can be cleared by pressing the mode key that is currently selected. You can also set it to disappear automatically on the GENERAL tab of the SYS menu.

[See also] GENERAL tab → 7.2.1, “General Settings”

If the measurement menu disappears, carry out one of the following operations to display it again. When you perform this operation, the menu is displayed at the level that was displayed before it disappeared.

- Displaying the Menu by Pressing the Mode Key

Press the currently selected mode key (WFM, VECT, PIC, AUDIO, STATUS, or EYE) to display the menu again.

In multi-screen display, you can select whether to switch the measurement screen with the mode keys (WFM, VECT, PIC, AUDIO, STATUS, and EYE) on the GENERAL tab of the SYS menu.

[See also] GENERAL tab → 7.2.1, “General Settings”

- Pressing a Function Key to Display a Menu

Press one of the function keys to display the menu again.

5.5.2 Function Menu Operations

This section explains how to operate the function menu, using the **WFM** → **F•1** WFM INTEN/CONFIG menu as an example.

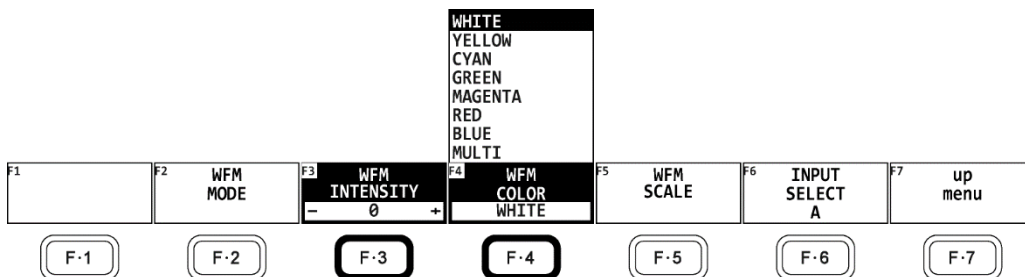

Figure 5-9 Function menu operations

- Specifying Values

To set the value of a setting like **F•3** WFM INTENSITY, which is shown in the figure above, press **F•3**, and then turn the function dial (F•D). You can reset most settings to their default values by pressing the function dial (F•D).

5. BEFORE YOU BEGIN MEASURING

- Selecting Settings

To select a setting from a list like the one shown in the figure above for **F•4** WFM COLOR, press **F•4** several times to select the setting you want. The setting changes each time you press **F•4**. After you stop pressing **F•4**, the setting is confirmed and the pop-up menu disappears.

When the options are on and off or start and stop, the setting toggles each time you press the key.

- Selecting Settings Using the ◀ SELECT ▶ Key (LV7300)

On the LV7300, you can use the ◀ SELECT ▶ key to operate the function menu. Press the ◀ ▶ key to move horizontally, and press SELECT to select.

The menu level changes. If there is no applicable menu item, the selection moves to the left menu item.

5.5.3 Mouse and Touch Panel Control

You can use the mouse or touch panel to control the keys on the screen to specify settings in the same manner as using the front panel keys. To display the keys, connect a mouse, and click in the screen or tap the screen.

Mouse and touch panel can be used at the same time.

To use touch panel control on the LV7300, connect the USB touch panel interface of a touch panel monitor using a USB cable. Connect the video interface of the touch panel monitor to the monitor output connector.

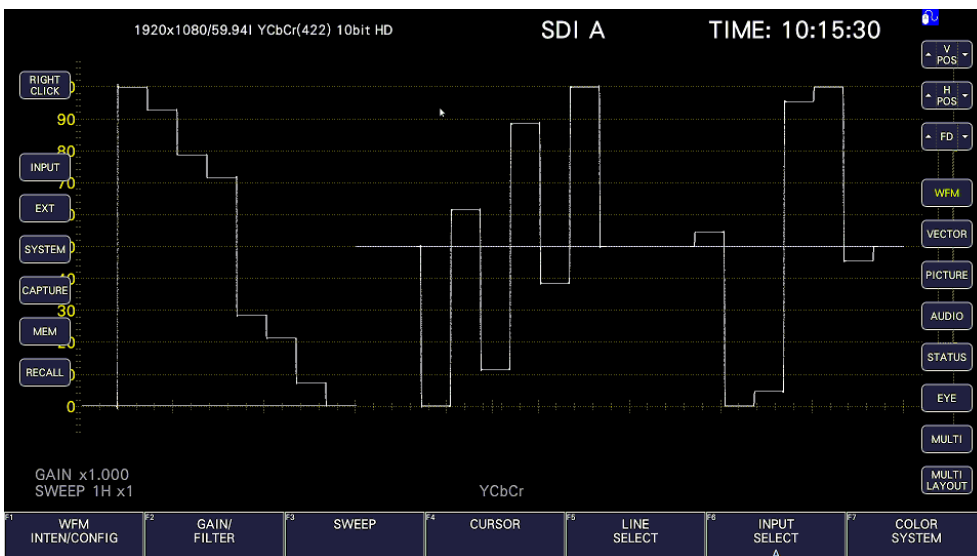

Figure 5-10 Mouse and touch panel control

- Measurement Screen Settings

Click or tap the keys on the screen and the function menu.

You can change a value in the function menu by using the ▲▼ key to the left and right of FD, the ▲▼ key to the left and right of the value, or the mouse wheel.

5. BEFORE YOU BEGIN MEASURING

- Tab Screen Settings

Click or tap the setting on the screen and the function menu.

You can change a value on a tab screen by using the ▲▼ key to the left and right of FD or the mouse wheel.

- Moving Cursors

Cursors on video signal waveforms can be moved easily with a mouse or touch panel.

When using a mouse, click a cursor to select it, and then click a position to move the cursor. To unselect, right-click. A portion of the cursors can be moved with a mouse wheel. If you use a mouse wheel, right-click to set the position.

When using the touch panel, tap a cursor to select it, and then tap a position to move the cursor.

- Right-Click Menu

Right-click the mouse or click or tap RIGHT CLICK at the upper left of the screen to display the following menu.

LAYOUT and ENHANCED LAYOUT are an item that can only be set using the mouse or touch panel.

Table 5-6 Right-click menu

Menu	Description
ALL CLEAR	Hides the keys and function menu from the screen. Click in the screen to redisplay them.
KEY CLEAR	Hides the keys from the screen. Click in the screen to redisplay them.
MENU CLEAR	Hides the function menu. Click in the screen to redisplay it.
LAYOUT	Creates a measurement screen layout. [See also] 6.5, "Customized Layout (SER26)"
ENHANCED LAYOUT	Creates a measurement screen layout. This option can be selected in simul mode. [See also] 6.6, "Enhanced Layout (SER26)"

5. BEFORE YOU BEGIN MEASURING

5.5.4 Tab Menu Operations

Normally, the function menus are used to configure the various settings. However, tab menus—such as that shown below—are displayed in some situations.

This section explains how to operate the tab menu, using the GENERAL tab menu as an example.

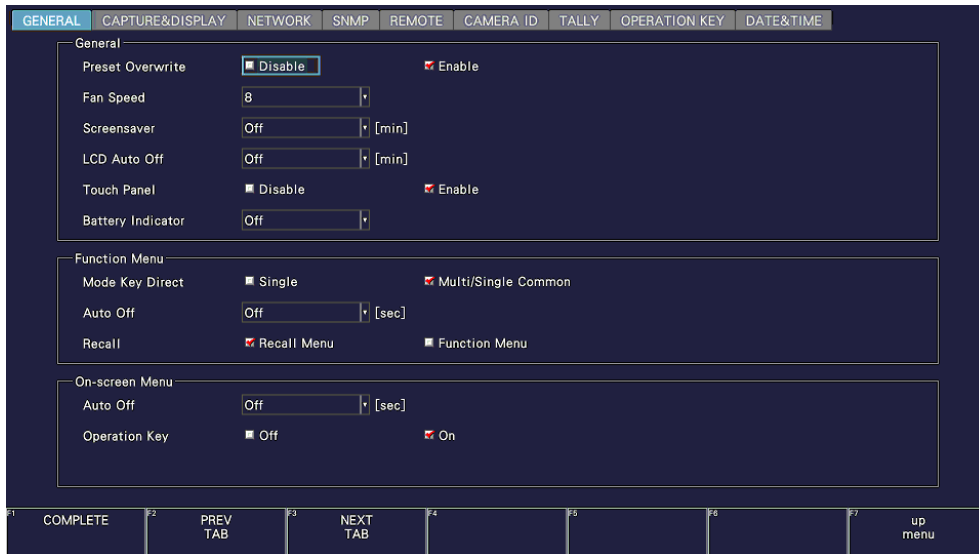

Figure 5-11 Tab menu operations

- Moving Cursors

To move the cursor, turn the function dial (F•D). Depending on what you are setting, there are some items in which you cannot move the cursor.

- Switching Tabs

When there are multiple tabs, such as in the figure above, **F•2** PREV TAB and **F•3** NEXT TAB to change between tabs. If you switch to another tab, the settings are retained, but they are not confirmed until you press **F•1** COMPLETE.

- Selecting a Check Box

Move the cursor to the check box that you want to select, and press the function dial (F•D).

- Entering Values

Move the cursor to the item that you want to enter the value for, and press the function dial (F•D). Turn the function dial (F•D) to set the value. To confirm the value that you have set, press the function dial (F•D) again.

- Confirming Settings

Press **F•1** COMPLETE to apply the settings from all the tabs and return to the screen that is one level up.

- Canceling Settings

Press **F•7** up menu to cancel the settings from all the tabs and return to the screen that is one level up.

5.5.5 Setting the Key Lock

You can prevent unintentional operations on the instrument by enabling the key lock. The key lock disables all the keys except for the power switch. Mouse and touch panel control are also disabled.

- Enabling the Key Lock

Hold down SYS until the following message is displayed on the screen. While the key lock is enabled, the key lock icon  appears in the upper right of the screen.

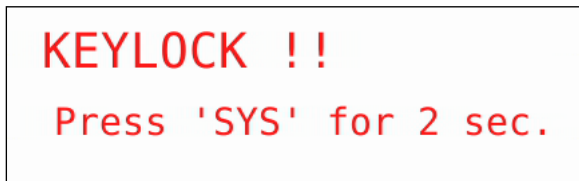

Figure 5-12 Enabling the key lock

- Releasing the Key Lock

Hold down SYS until the following message is displayed on the screen.

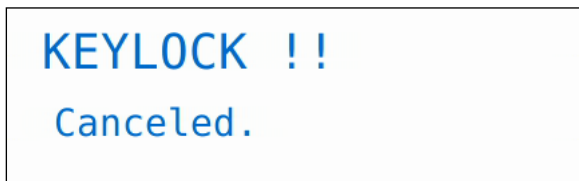

Figure 5-13 Releasing the key lock

5. BEFORE YOU BEGIN MEASURING

5.6 Measurement Screen Description

The measurement screen layout can be arranged as you like. This section explains items that are common to all displays.

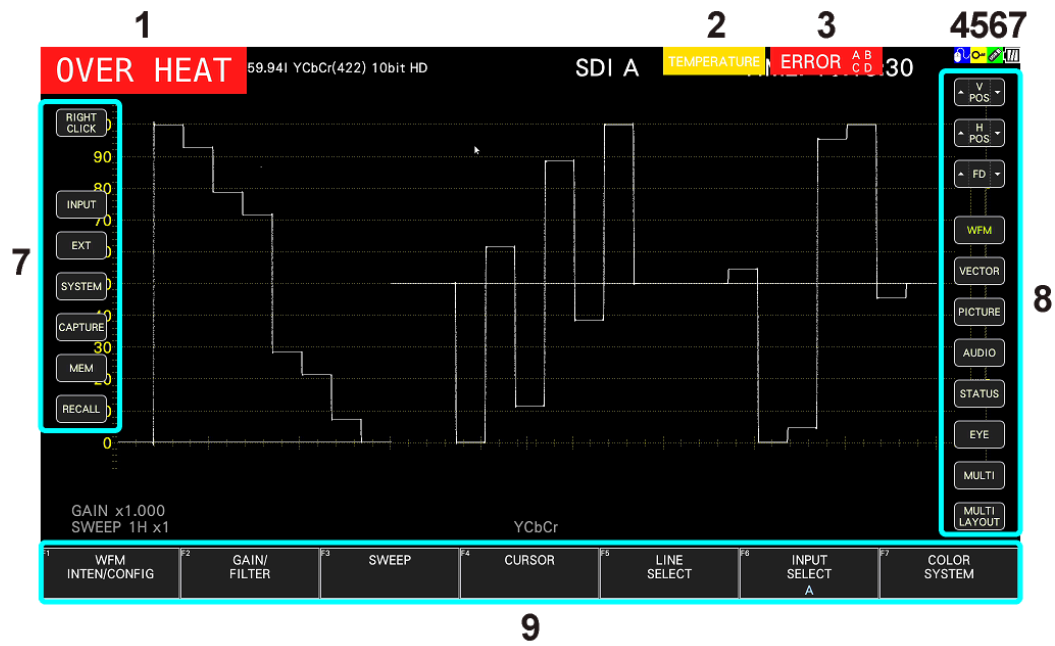

Figure 5-14 Measurement screen description

5. BEFORE YOU BEGIN MEASURING

Table 5-7 Measurement screen description

No.	Name	Description
1	OVER HEAT FAN ALARM	<p>“OVER HEAT” appears when the internal temperature increases. “FAN ALARM” appears when a fan error occurs.</p> <p>If “OVER HEAT” is displayed, increase the fan speed. If “OVER HEAT” is displayed and increasing the fan speed does not decrease the internal temperature, the power is automatically turned off.</p> <p>After the power is turned off, if you turn the power back on but “OVER HEAT” is displayed repetitively even when the fan speed is at maximum or if “FAN ALARM” is displayed, immediately turn off the power, and check the operating environment. If this alarm appears even though there are no problems with the operating environment, contact your local LEADER agent.</p> <p>[See also] 7.2.15, “Displaying System Information.” and 7.2.1, “General Settings.”</p>
2	TEMPERATURE	<p>Appears when the internal temperature increases. You can also choose to hide this information.</p> <p>If “TEMPERATURE” is displayed, increase the fan speed until the display disappears.</p> <p>[See also] 7.2.15, “Displaying System Information” and 7.2.1, “General Settings.”</p>
3	ERROR	<p>Appears when an input signal error occurs. (*1) You can also choose to hide this information.</p> <p>To configure error detection settings, use F•5 STATUS SETUP on the STATUS menu or F•4 ERROR SETUP on the EYE menu.</p> <p>[See also] 7.2.15, “Displaying System Information” and 7.2.1, “General Settings.”</p>
4	Mouse icon	<p>Appears when a USB mouse is connected or the USB interface of a touch panel monitor is connected. You can also choose to hide this information.</p> <p>[See also] 5.3, “Connecting USB Devices,” and 7.2.1, “General Settings”</p>
5	Key lock icon	<p>Appears when key lock is enabled. You can also choose to hide this information.</p> <p>[See also] 5.5.5, “Setting the Key Lock,” and 7.2.1, “General Settings”</p>
6	USB memory icon	<p>This appears when a USB memory device is connected. You can also choose to hide this information.</p> <p>[See also] 5.3, “Connecting USB Devices,” and 7.2.1, “General Settings”</p>
7	Battery indicator	<p>The battery level is indicated when the SER11 or SER12 is installed.</p>
8	Screen keys	<p>Keys on the screen that you operate with a mouse or the touch panel.</p> <p>[See also] 5.5.3, “Mouse and Touch Panel Control”</p>
9	Function menu	<p>A menu for configuring settings.</p> <p>[See also] 5.5.1, “Displaying the Function Menu.”</p>

*1 All channels are applicable. However, when measuring 3G(DL)-4K, 6G or 12G, only on the currently displayed channels are applicable.

6. BASIC OPERATION

6.1 Setting the Input Signals

This section explains the INPUT menu settings and input format display.

6.1.1 Selecting the Input Mode

When SDI System on the SDI IN SETUP1 tab is set to 2K SD/HD/3G-A/3G-B-DL, to select the input mode, follow the procedure below.

Procedure

INPUT	→	F•7	DISPLAY: SINGLE / SIMUL
-------	---	-----	-------------------------

Settings

- SINGLE:** The instrument operates in single input mode.
It is a mode for measuring a single signal that has been turned on using **F•1** to **F•2**.
- SIMUL:** The instrument operates in simul mode.
It is a mode for measuring multiple signals that have been turned on using **F•1** to **F•2**.

DISPLAY = SINGLE

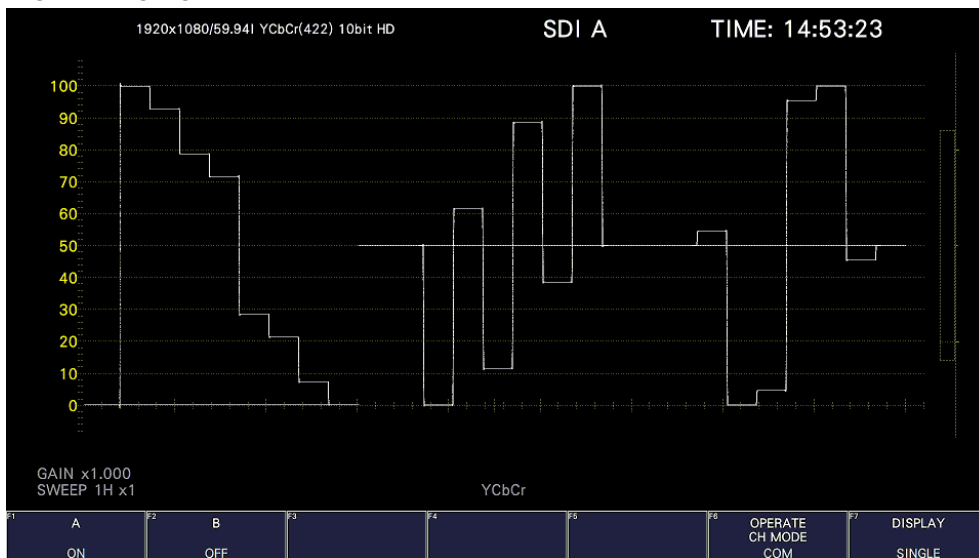

6. BASIC OPERATION

DISPLAY = SIMUL

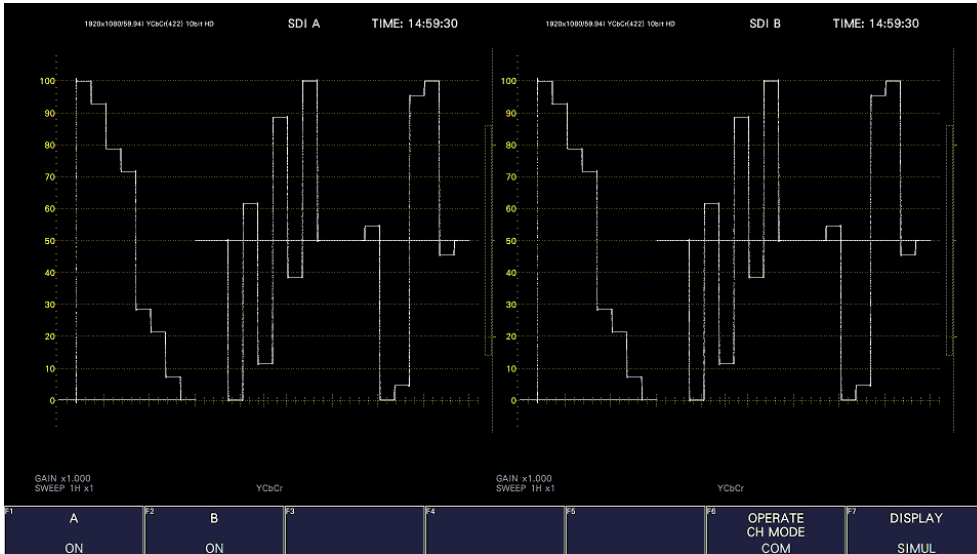

Figure 6-1 Selecting the input mode

6.1.2 Selecting the Simul Mode

When in simul mode, to select how to set each channel, follow the procedure below. If you change INDIVIDUAL to COM, all the settings are changed to those of the channel selected with **F•6** INPUT SELECT on each measurement screen.

Procedure

INPUT → **F•6** OPERATE CH MODE: COM / INDIVIDUAL

Settings

COM:	Measurement settings are made for all channels. A portion of the settings, such as the line selection when signals of different formats are applied, are not shared by all channels.
INDIVIDUAL:	Measurement settings are made for each channel. To select the channel you want to set, use F•6 INPUT SELECT on each measurement screen. A portion of the settings, such as ERROR CLEAR on the STATUS menu are shared by all channels.

6. BASIC OPERATION

6.1.3 Selecting the Displayed Channel

To select the channels to display, follow the procedure below.

Procedure

INPUT
→ F•1 A: ON / OFF
→ F•2 B: ON / OFF

You can also use **F•6** INPUT SELECT on each measurement screen to select the display channels.

F•6 INPUT SELECT works as follows:

- Select the display channel.
- When Through Out(SDI1) on the SDI OUT tab is Selection(1/2), select the signal to output from SDI OUTPUT 1.
- Selects that channel to be configured when **F•6** OPERATE CH MODE of the INPUT menu is set to INDIVIDUAL.

6.1.4 Input Format Error Indication

If the format of the received signal is not appropriate for the setting specified on the SDI IN SETUP1 tab of the SYS menu, the instrument displays the format in red or an INPUT FORMAT window in the center of the screen. If this occurs, check the settings on the SDI IN SETUP1 tab, the input signal, and payload ID.

The format is displayed in red in the following situations.

- If the format is 2 sample interleave of 3G(DL)-4K, and the order of the link is not correct
- When the SDI SYSTEM setting and the payload ID of the input signal are different
- When the payload ID is not appropriate

[See also] SDI IN SETUP1 tab → 7.1.1, "Configuring the SDI Input Connectors."

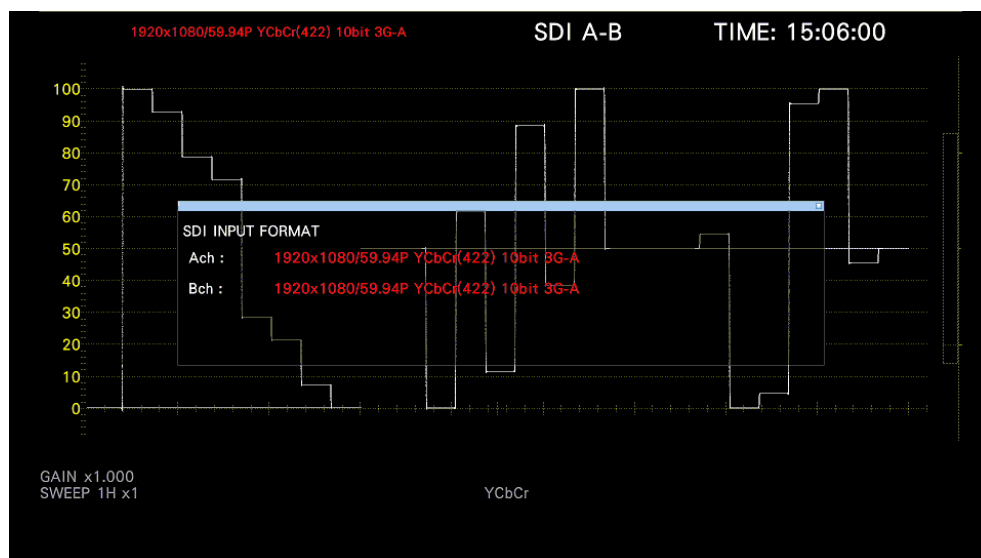

Figure 6-2 SDI IN SETUP1 tab

6.2 Setting the Signals to Measure

This section explains the procedure from applying an input to displaying the measurement screen for each of the different input signal formats.

6.2.1 SD, HD, 3G-A, and 3G-B-DL Measurement

1. On the SDI IN SETUP1 tab of the SYS menu, set SDI System to 2K SD/HD/3G-A/3G-B-DL.

[See also] 7.1.1, "Configuring the SDI Input Connectors"

SYS → F•1 SIGNAL IN OUT → F•2 PREV TAB or F•3 NEXT TAB →

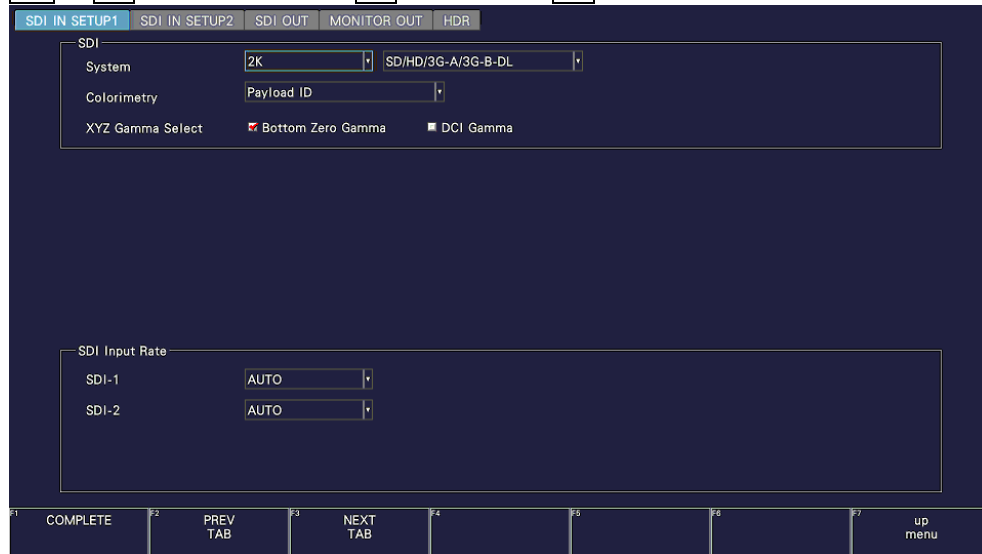

Figure 6-3 SDI IN SETUP1 tab

6. BASIC OPERATION

- If the input signal is HD or 3G, press **F•2** PREV TAB or **F•3** NEXT TAB, and under SETTING on the SDI IN SETUP2 tab, set the payload ID.

Select Use or Not Use. If you select Not Use, specify the following settings.

- HD: Set i/PsF Select.
- 3G-A, 3G-B-DL: Set i/PsF Select, Color System, and Pixel Depth.

[See also] 7.1.3, "Setting the Payload ID"

SYS → **F•1** SIGNAL IN OUT → **F•2** PREV TAB or **F•3** NEXT TAB →



Figure 6-4 SDI IN SETUP2 tab

- Press COMPLETE.

6. BASIC OPERATION

- Apply SDI signals to the SDI INPUT connectors on the rear panel.

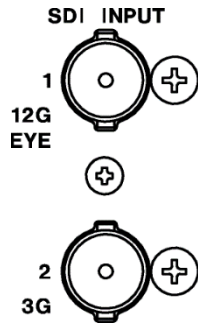

Figure 6-5 LV5300/LV5300A SDI input connectors

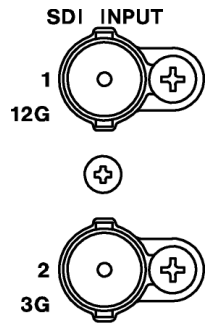

Figure 6-6 LV5350 SDI input connectors

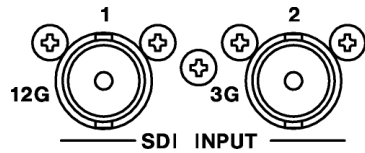

Figure 6-7 LV7300 SDI input connectors

- Press INPUT to select the channels you want to measure.
Press **F•7** DISPLAY to select whether to measure a single channel (SINGLE) or multiple channels (SIMUL).

Press **F•1** to **F•2** to turn on the channels you want to measure.

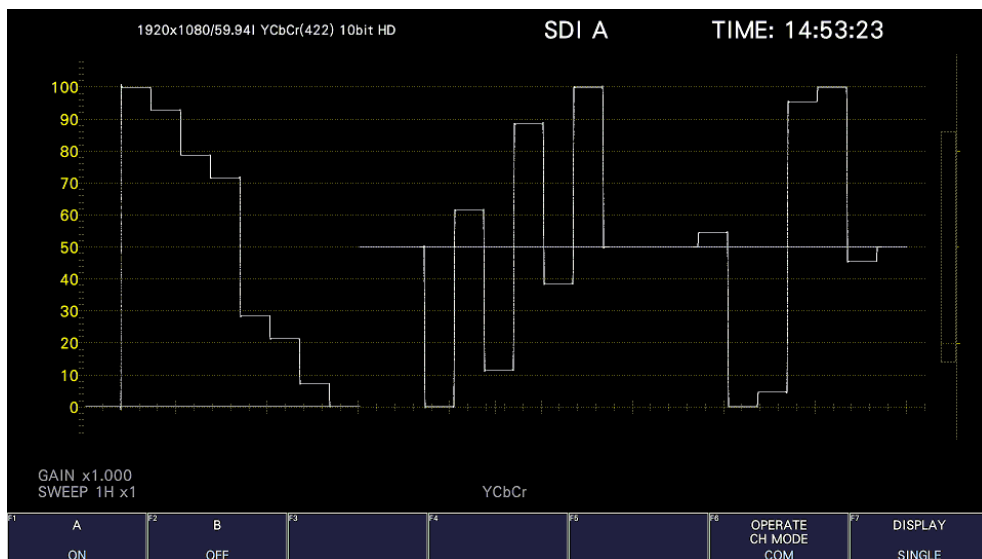

Figure 6-8 Measurement screen

6. BASIC OPERATION

6.2.2 Measuring 6G Signals (SER28)

1. On the SDI IN SETUP1 tab of the SYS menu, set SDI System to 4K 6G.

[See also] 7.1.1, "Configuring the SDI Input Connectors"

SYS → F•1 SIGNAL IN OUT → F•2 PREV TAB or F•3 NEXT TAB →

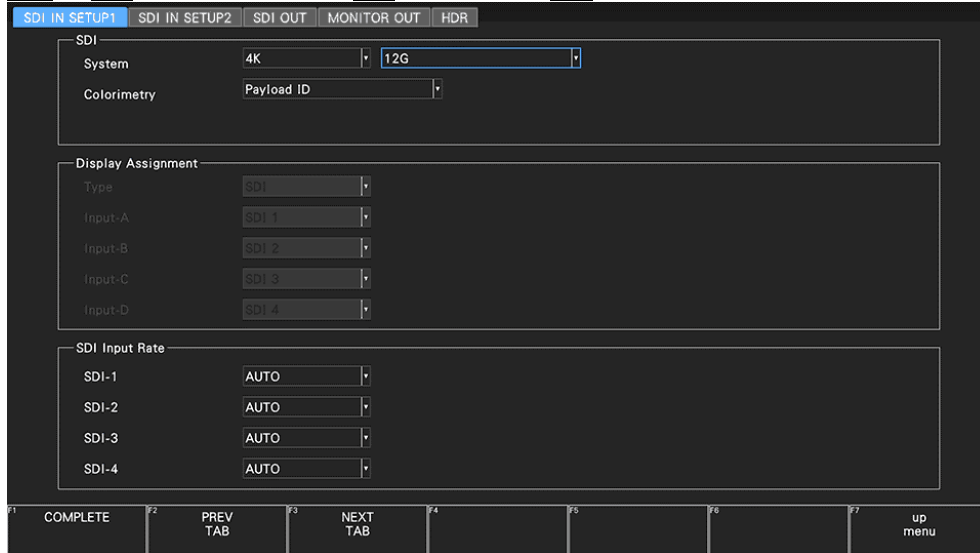

Figure 6-9 SDI IN SETUP1 tab

2. Press F•2 PREV TAB or F•3 NEXT TAB, and under SETTING on the SDI IN SETUP2 tab, set the payload ID.

Select Use or Not Use.

[See also] 7.1.3, "Setting the Payload ID"

Only 2 sample interleave is supported for the division transmission system.

SYS → F•1 SIGNAL IN OUT → F•2 PREV TAB or F•3 NEXT TAB →



Figure 6-10 SDI IN SETUP2 tab

3. Press COMPLETE.
4. Apply 4K 6G signals to the SDI INPUT connectors on the rear panel.

6. BASIC OPERATION

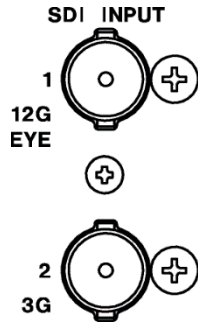

Figure 6-11 LV5300/LV5300A SDI input connectors

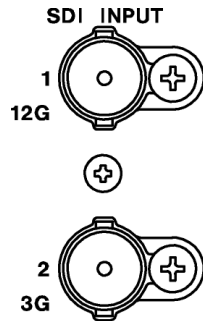

Figure 6-12 LV5350 SDI input connectors

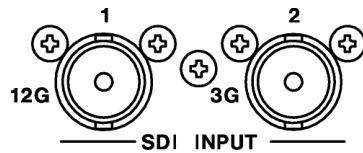

Figure 6-13 LV7300 SDI input connectors

- When you press INPUT, F•1 A is fixed to ON.
Simul mode cannot be used.

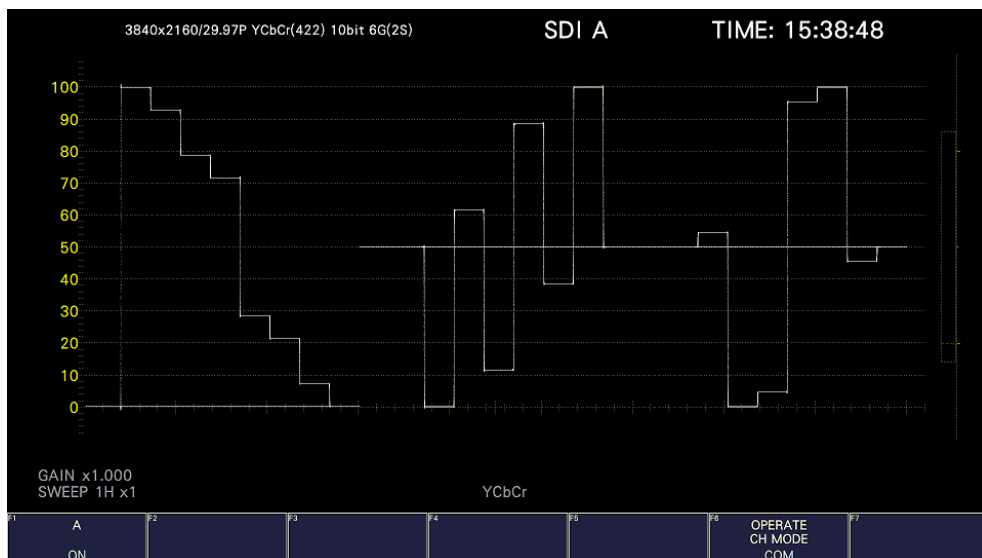

Figure 6-14 Measurement screen

- * To measure 6G-SDI signals, use cables and connectors that are appropriate for transmitting 6G-SDI signals. Using incompatible or degraded cables or connectors may cause the transmission characteristics to degrade drastically.

6. BASIC OPERATION

6.2.3 Measuring 12G Signals (SER28)

1. On the SDI IN SETUP1 tab of the SYS menu, set SDI System to 4K 12G.
[See also] 7.1.1, "Configuring the SDI Input Connectors"

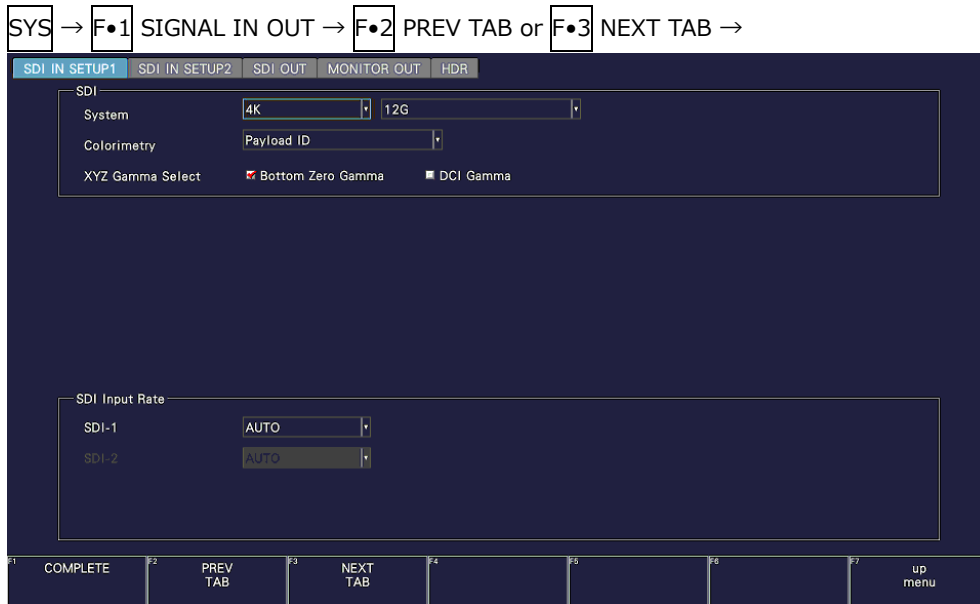

Figure 6-15 SDI IN SETUP1 tab

2. Press **F•2** PREV TAB or **F•3** NEXT TAB, and under SETTING on the SDI IN SETUP2 tab, set the payload ID.

Select Use or Not Use. If you select Not Use, set Color System, and Pixel Depth.
[See also] 7.1.3, "Setting the Payload ID"

Only 2 sample interleave is supported for the division transmission system.

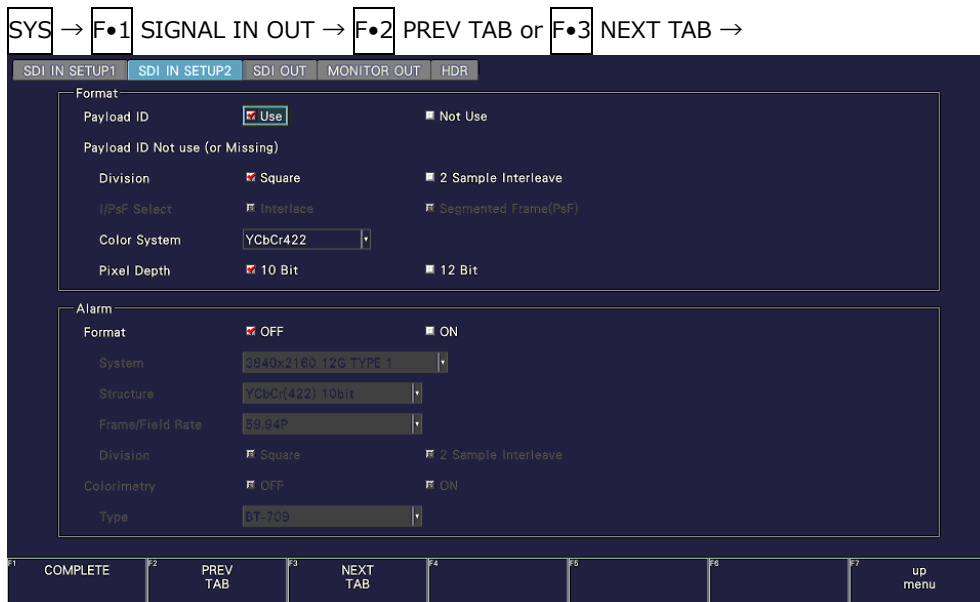

Figure 6-16 SDI IN SETUP2 tab

3. Press COMPLETE.
4. Apply 12G signals to the SDI INPUT 1 connectors on the rear panel.

6. BASIC OPERATION

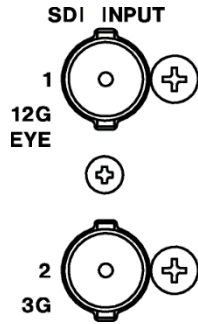

Figure 6-17 LV5300/LV5300A SDI input connectors

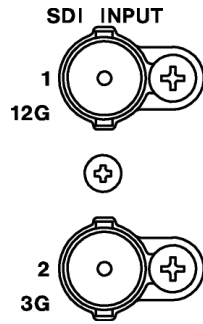

Figure 6-18 LV5350 SDI input connectors

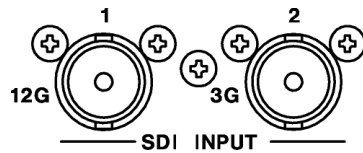

Figure 6-19 LV7300 SDI input connectors

- When you press INPUT, F•1 A is fixed to ON.
Simul mode cannot be used.



Figure 6-20 Measurement screen

- * To measure 12G-SDI signals, use cables and connectors that are appropriate for transmitting 12G-SDI signals. Using incompatible or degraded cables or connectors may cause the transmission characteristics to degrade drastically.

6. BASIC OPERATION

6.2.4 Measuring 3G(DL)-4K Signals (SER28)

1. On the SDI IN SETUP1 tab of the SYS menu, set SDI System to 4K 3G Dual Link.
[See also] 7.1.1, "Configuring the SDI Input Connectors"

SYS → **F•1** SIGNAL IN OUT → **F•2** PREV TAB or **F•3** NEXT TAB →



Figure 6-21 SDI IN SETUP1 tab

2. Press **F•2** PREV TAB or **F•3** NEXT TAB, and under SETTING on the SDI IN SETUP2 tab, set the payload ID.

Select Use or Not Use. If you select Not Use, set Division.

The Psf format does not support 2 sample interleave.

Even if Use is selected, if a 3G-B-DL signal is applied, it will be detected as a 3G-B DS signal.

[See also] 7.1.3, "Setting the Payload ID"

SYS → **F•1** SIGNAL IN OUT → **F•2** PREV TAB or **F•3** NEXT TAB →



Figure 6-22 SDI IN SETUP2 tab

6. BASIC OPERATION

3. Press COMPLETE.
4. Apply 3G-B DS signals to the SDI INPUT connectors on the rear panel.
Connectors 1 and 2 is pair.

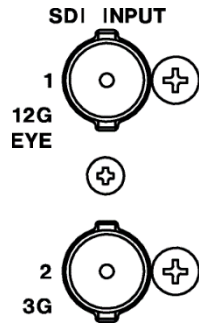

Figure 6-23 LV5300/LV5300A SDI input connectors

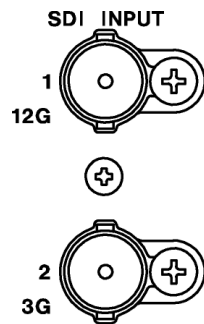

Figure 6-24 LV5350 SDI input connectors

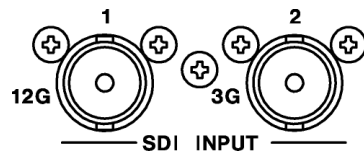

Figure 6-25 LV7300 SDI input connectors

6. BASIC OPERATION

5. When you press INPUT, **F•1** A-B is fixed to ON.

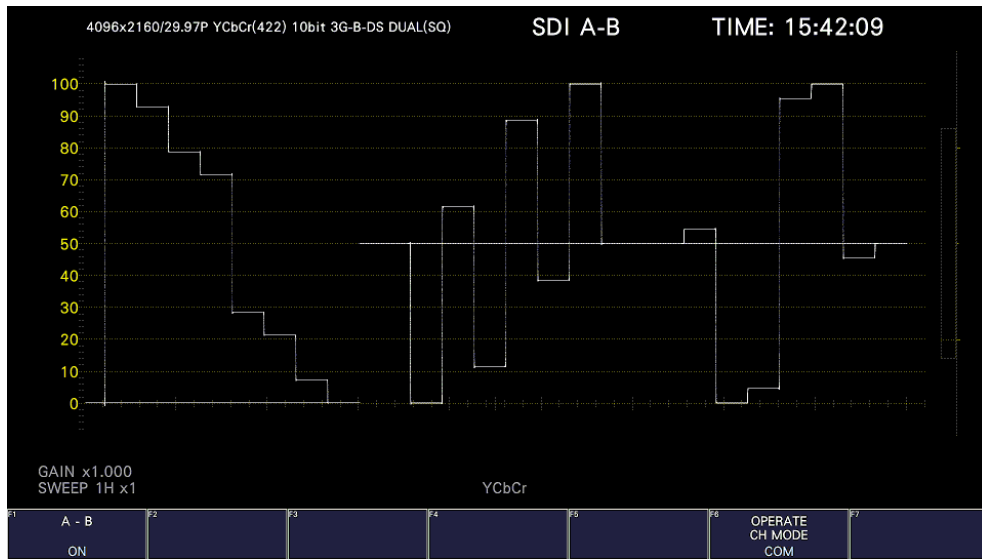

Figure 6-26 Measurement screen

6. BASIC OPERATION

6.3 Selecting the Measurement Mode

The types of measurement screens available are WFM, VECT, PIC, AUDIO, STATUS, and EYE. There is also another type, MULTI, that combines these six types. Press a mode key on the front panel to select the type.

6.3.1 Video Signal Waveform Display

To display video signal waveforms, press WFM.

The available features include line select display, which displays the waveform of the selected line, RGB display, and pseudo-composite display.

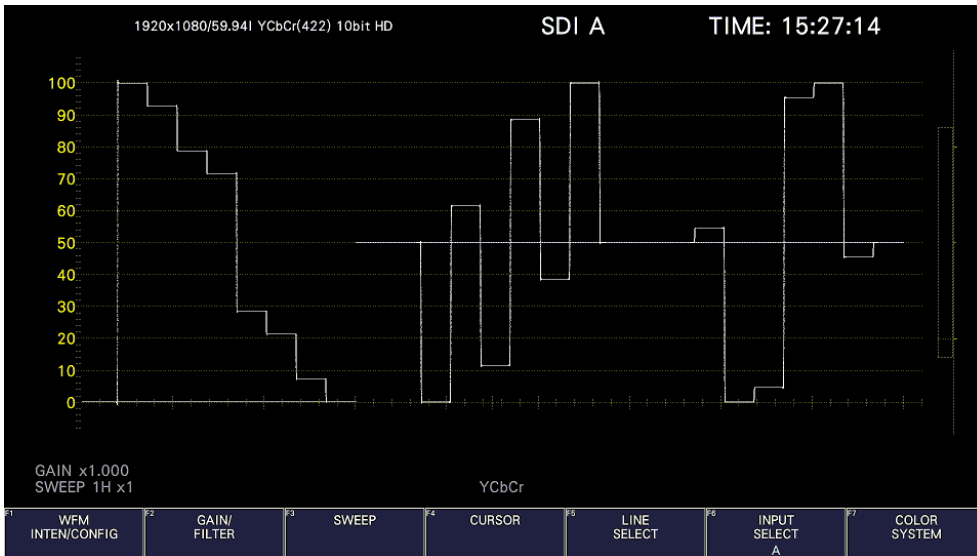

Figure 6-27 Video signal waveform display

6.3.2 Vector Display

To display vectors, press VECT.

The available features include line select display, marker display, pseudo-composite display, 5-bar display, and CIE chromaticity diagram display (SER22).

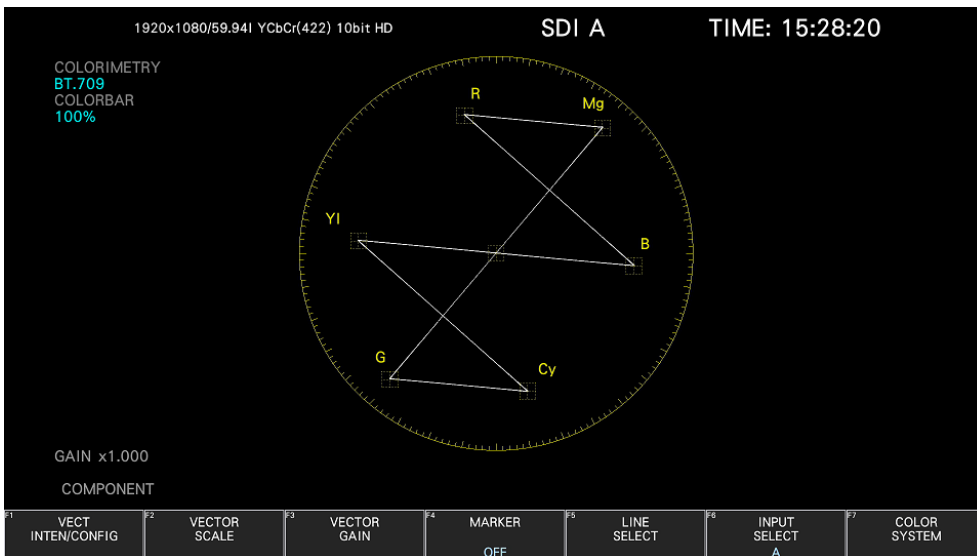

Figure 6-28 Vector display

6. BASIC OPERATION

6.3.3 Picture Screen

To show the picture display, press PIC.

The available features include monochrome display, marker display, line select display, and focus assist display (SER25).

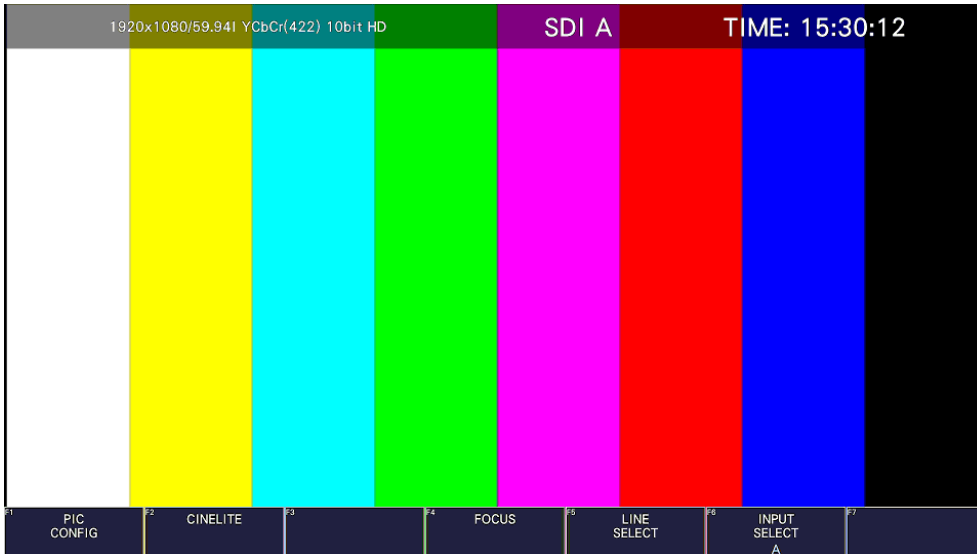

Figure 6-29 Picture display

6.3.4 Audio Display

To show the audio display, press AUDIO.

The available features include meter display, Lissajous display (SER20), surround display (SER20), and status display (SER20) of the signal selected with **F•7** MAPPING.

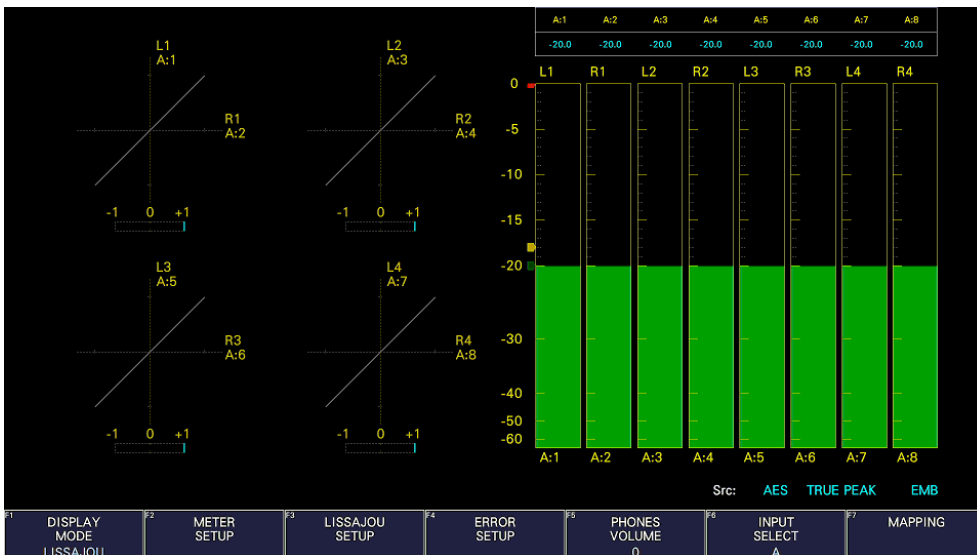

Figure 6-30 Audio display

6. BASIC OPERATION

6.3.5 Status Display

To show the status display, press STATUS.

Event log display and data dump display are available.



Figure 6-31 Status display

6.3.6 Eye Pattern Display (LV5300/LV5300A/LV7300-SER02)

To show eye patterns, press EYE. (If LV5350 or LV7300-SER02 is not installed, the EYE key is disabled.)

You can also show jitter by switching **F•1** EYE/JITTER MODE.

Simul mode is not supported.

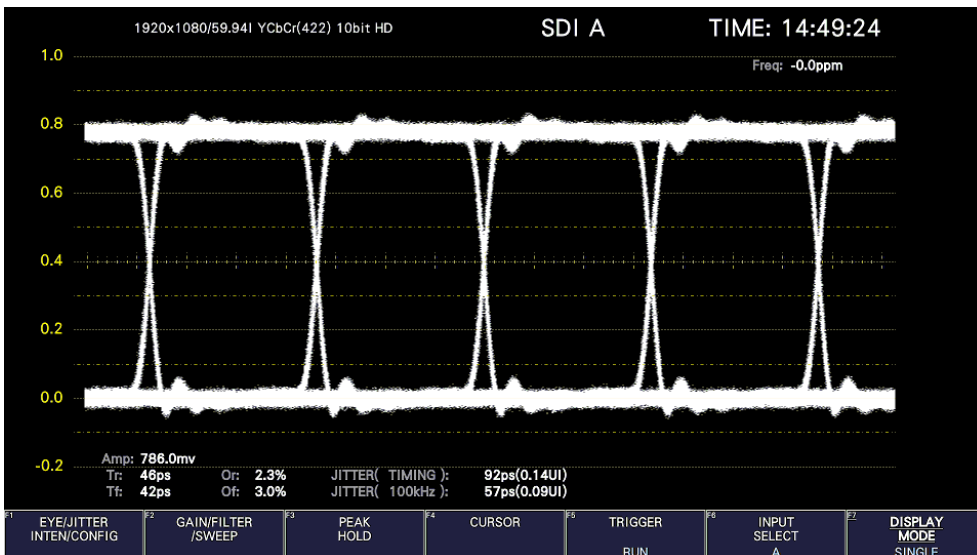

Figure 6-32 Eye pattern display

6. BASIC OPERATION

6.3.7 Multi Display

To show a multi screen, which is a combination of measurement screens, press MULTI.

If Mode Key Direct on the GENERAL tab is set to Single, you can select between six types of layouts by using **[F•1]** LAYOUT SELECT.

To set each measurement screen, use **[F•2]** MULTI WFM MENU to **[F•7]** MULTI EYE MENU.

If Mode Key Direct on the GENERAL tab is set to Multi/Single Common, you can switch between measurement screens by pressing MULTI. To select the layout, hold MULTI down for 2 seconds to display the function menu. Then select using **[F•1]** LAYOUT USER 1 to **[F•6]** LAYOUT USER 6.

[See also] GENERAL tab → 7.2.1, "General Settings"

• USER 1

The vector, video signal waveform, status, and picture are displayed in four divided screens.

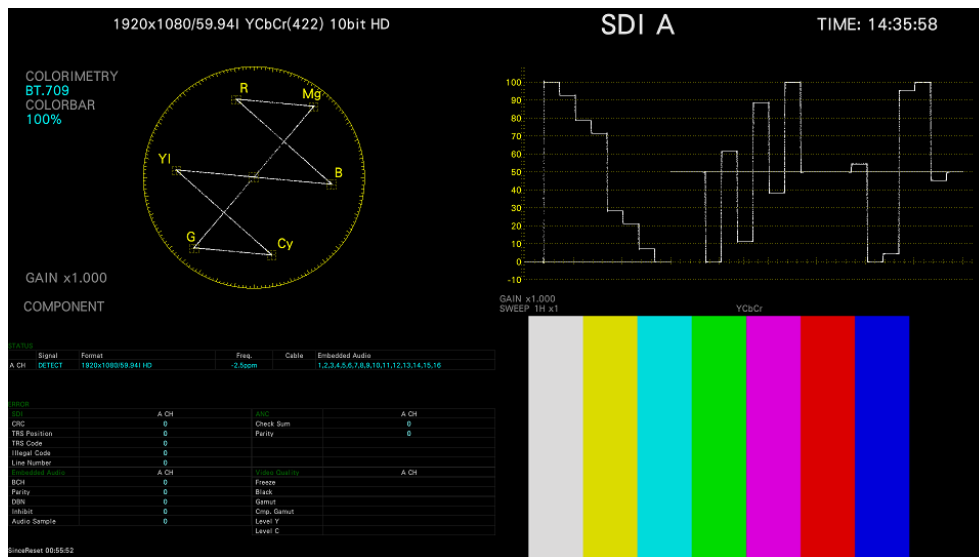

Figure 6-33 Multi display (USER 1, Single Mode)

6. BASIC OPERATION

- USER 2

The picture is displayed in the main screen, and the video signal waveform and vector are displayed as thumbnails.

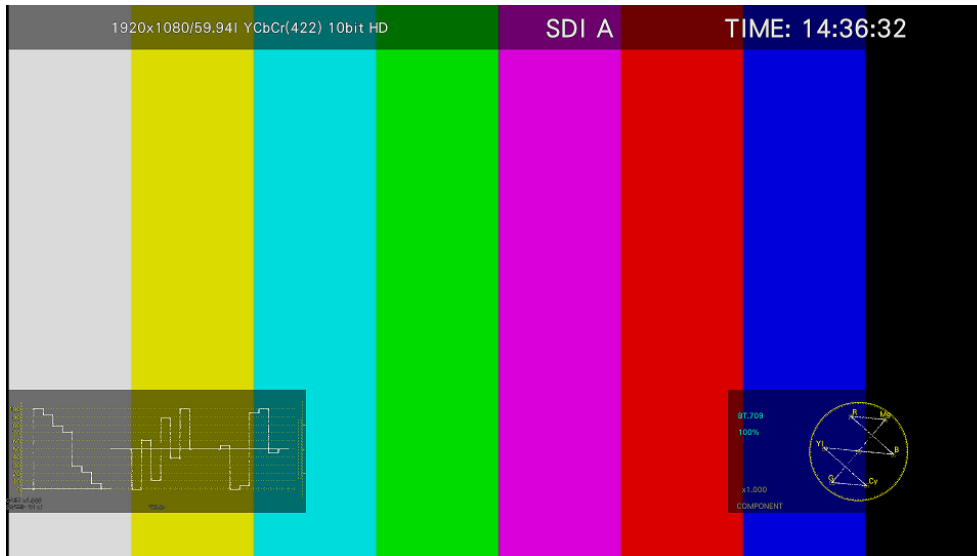

Figure 6-34 Multi display (USER 2, Single Mode)

- USER 3

The vector is displayed in the main screen, and the video signal waveform and picture are displayed as thumbnails.

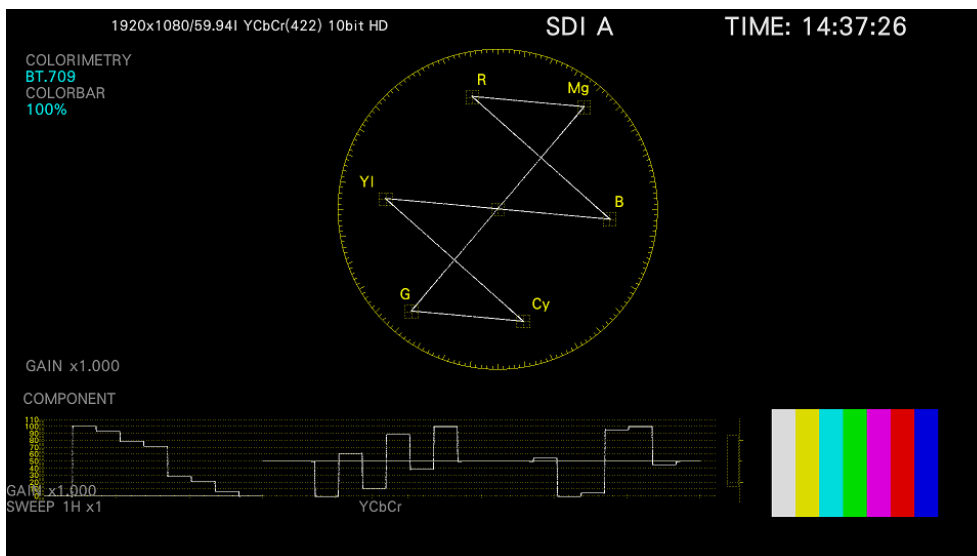

Figure 6-35 Multi display (USER 3, Single Mode)

6. BASIC OPERATION

- USER 4

The picture, video-signal-waveform, and vector are displayed top to bottom. This is suitable for simul mode.

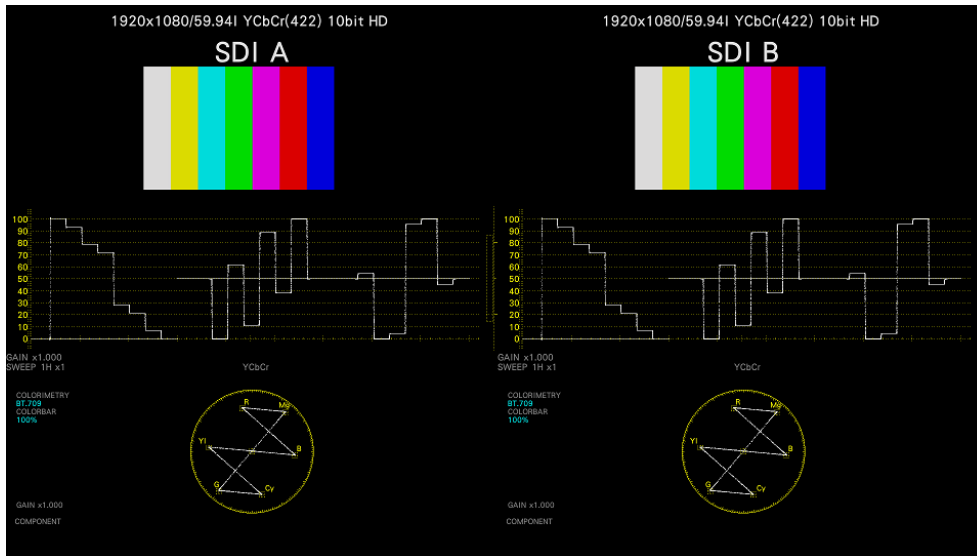

Figure 6-36 Multi display (USER 4, Simul Mode)

- USER 5

The picture and video signal waveform are displayed in the top and bottom screens. This is suitable for simul mode.

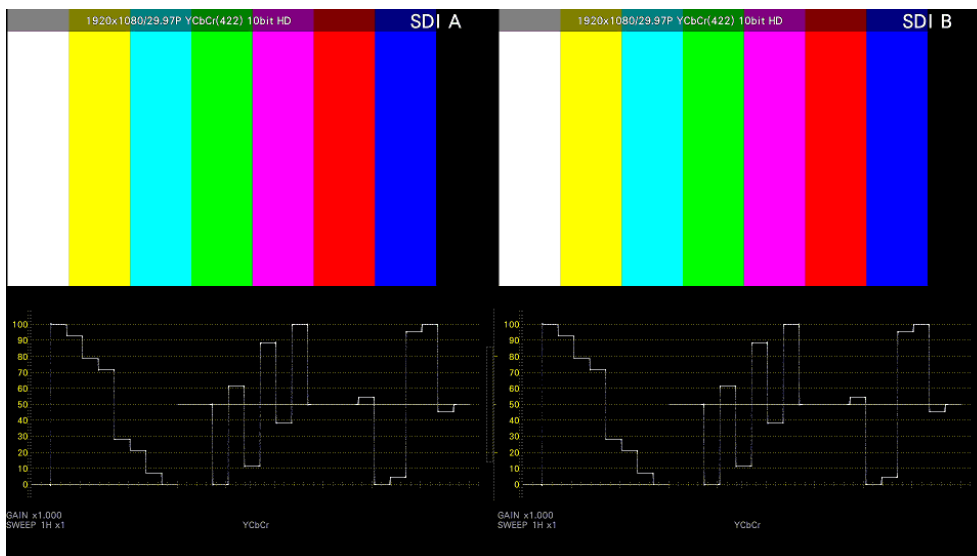

Figure 6-37 Multi display (USER 5, Simul Mode)

6. BASIC OPERATION

- USER 6

The tally, picture, and video signal waveform are displayed in tiles.
This is suitable for simul mode.

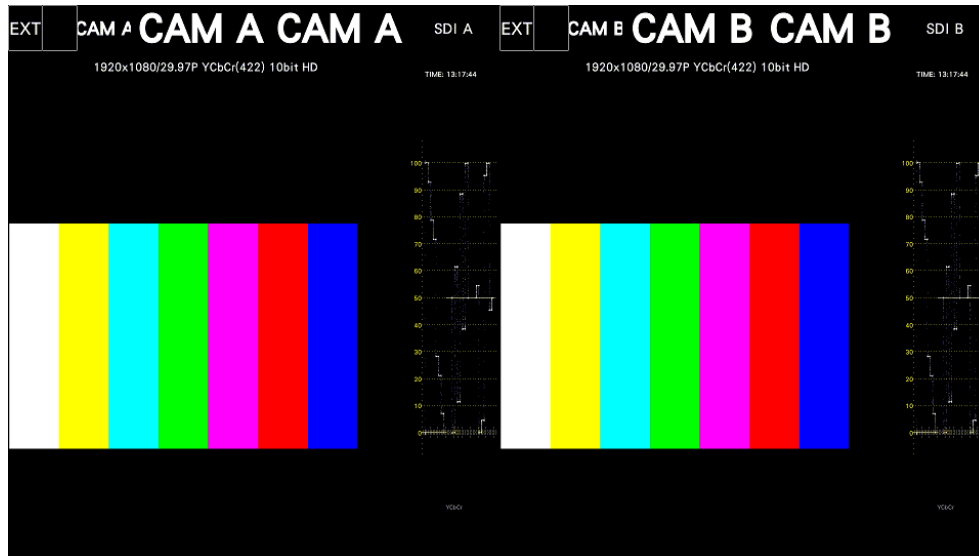

Figure 6-38 Multi display (USER 6, Simul Mode)

6.4 Operation Key Actions

Operation keys are shortcut keys for functions that are frequently used in video content production. Key assignments can be changed freely on the OPERATION KEY tab.

[See also] OPERATION KEY tab → 7.2.13, "Setting the Operation keys"

The S-CUT key can be controlled from the panel, mouse, and touch panel. Others can be controlled from the mouse and touch panel.



Figure 6-39 Operation keys

- S-CUT Key

Performs the action selected with SHORT CUT on the OPERATION KEY tab.

Table 6-1 SHORTCUT key action

DIRECT	The previously registered panel settings will be loaded. To register the panel settings, configure the instrument to the settings that you want to register, press MEM, and then press SHORTCUT.
CAP&WAIT	A screen capture will be taken and saved to a USB memory device. Connect a USB memory device in advance.
INTEN	Use the function menu shown in the lower right of the screen to adjust the waveform intensity. This is valid on the video signal waveform display, vector display, and audio display . When a mouse is connected, clicking the function menu resets the value to the default. When using the touch panel, tapping the function menu resets the value to the default.
CURSOR	Performs cursor measurement. This is valid on the video signal waveform display and vector display.
VOLUME	Use the function menu shown in the lower right of the screen to adjust the headphone volume. When a mouse is connected, clicking the function menu resets the value to the default. When using the touch panel, tapping the function menu resets the value to the default.

6. BASIC OPERATION

- Operation keys Other Than S-CUT

Other operation keys can be controlled from the mouse and touch panel.

This is valid on the video signal waveform display and vector display. Each time you press the key, the settings assigned to the key switch.

[See also] Video signal waveform display → 10.1, "Operation Key Description"

Vector display → 11.1, "Operation Key Description"

6.5 Customized Layout (SER26)

The layout of the measurement screen that appears when the WFM, VECT, PIC, AUDIO, STATUS, or EYE key is pressed (one type each) and the screen that appears when the MULTI key is pressed (six types) can be arranged freely. To do so, connect a mouse to the front panel USB port or use the touch panel.

The layout that you specify will not be initialized even if you initialize the instrument. To initialize, perform any of the procedures below.

[See also] 7.7, "Initialization"

LAYOUT INITIALIZE YES on the SYS menu:	The entire layout is initialized.
ALL INITIALIZE YES on the SYS menu:	The entire layout is initialized.
Factory default settings:	The entire layout is initialized.
DEFAULT LAYOUT in the layout window	The layout of the selected measurement display is initialized.

6.5.1 Notes

The maximum number of items that can be arranged is determined by $128 \div$ the number of display channels (1 to 4).

Item, here, includes the items on the Main and Sub tabs as well as Format, Input, and Time on the Option tab.

6. BASIC OPERATION

6.5.2 Layout Procedure

As an example, this section explains how to change the layout of a multi display (User 1) in the following manner.

- Display the layout screen
- Change TIME in the upper right of the screen to DATE
- Superimpose the vector on the picture
- Add audio
- Add TIME to the status
- Apply the changes

Before change

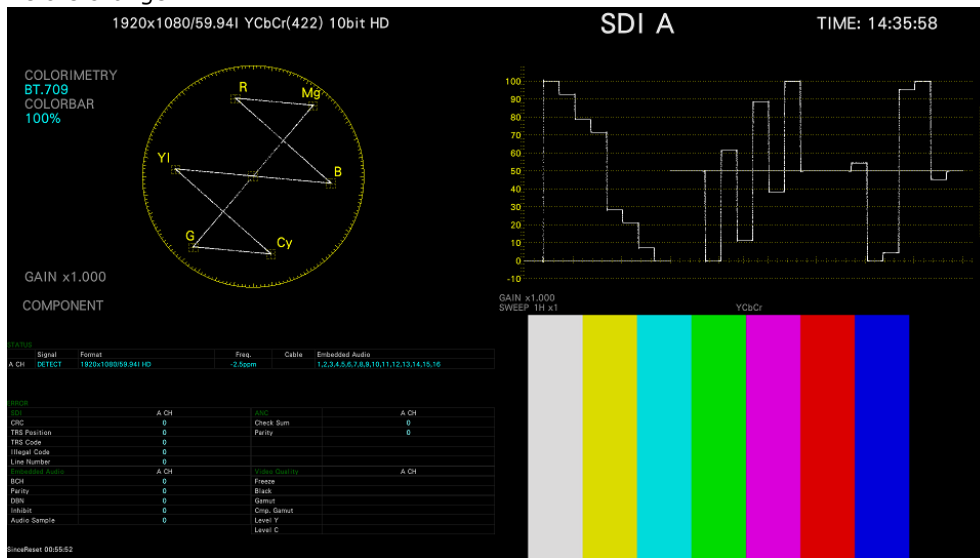

After change

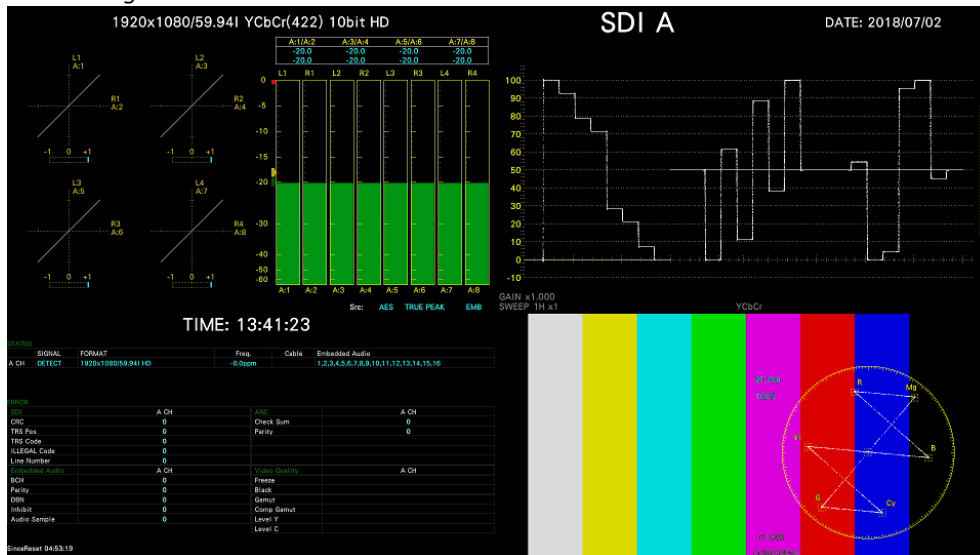

Figure 6-40 Arranging the multi display layout

6. BASIC OPERATION

a) Display the layout screen

1. Press MULTI, and set **F•1** LAYOUT SELECT to USER 1.

If Mode Key Direct on the GENERAL tab is set to Multi/Single Common, hold MULTI down for about 2 seconds to display the function menu.

There are six layouts for the multi screen. You can use USER 1 to USER 6 to switch between the layouts.

2. Right-click on the measurement screen or click or tap RIGHT CLICK at the upper left of the screen to select LAYOUT.

The layout screen appears.

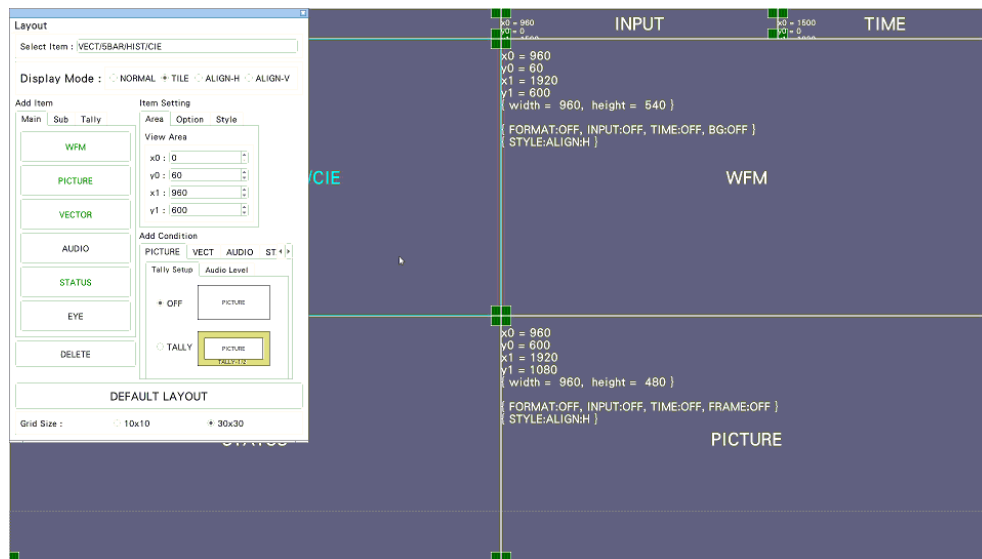

Figure 6-41 Layout screen

b) Change TIME in the upper right of the screen to DATE

3. Click or tap the TIME item in the upper right of the screen.

The color of the frame and text changes to light blue, and Select Item in the layout window displays TIME. This indicates that the TIME item is selected.

4. Click or tap DELETE.

The TIME item is deleted.

5. On the Sub tab, click or tap DATE.

The DATE item appears.

6. BASIC OPERATION

6. Place the DATE item in the area where the TIME item was displayed.

To move an item, drag it.

To resize an item, drag the green handles at the four corners of the item.

The position and size of an item snap to the grid selected by Grid Size in the layout window.

You can also use the Area tab to move and resize an item.

The coordinates at the upper left corner of the screen are (0, 0). Those at the lower right corner are (1920, 1080). Using these references, set the coordinates of the upper left corner of the item (x0, y0) and the lower right corner (x1, y1).

The minimum size is 90×60.

If the layout window gets in the way, move it or close it. When using a mouse, to display a window that you closed, double-click in the layout screen.

If multiple items are on top of each other, items in the back may not be selectable. If you need to select such item, click or tap the item on the Main or Sub tab. The selected item will move to the front.

c) Superimpose the vector on the picture

7. Select the VECTOR item, and click Background Transparent on the Option tab.

Background Transparent is for making the background transparent when an item is superimposed on a picture.

8. Place the VECTOR item on top of the picture.

Resize as necessary.

d) Add audio

9. On the Main tab, click or tap AUDIO.

The AUDIO item appears.

10. Place the AUDIO item in the area where the VECTOR item was originally displayed.

e) Add TIME to the status

11. Click or tap the STATUS item.

12. On the Option tab, click or tap Time.

The TIME item on the Sub tab can be placed anywhere. Time on the Option tab is displayed at the top of the selected item. You cannot change the display position or size.

f) Apply the changes

13. Right-click or tap in the layout screen, and click or tap SAVE.

The measurement screen returns.

If you click or tap EXIT, all the changes that you made up to that point will be canceled.

6. BASIC OPERATION

6.5.3 Layout Screen Description

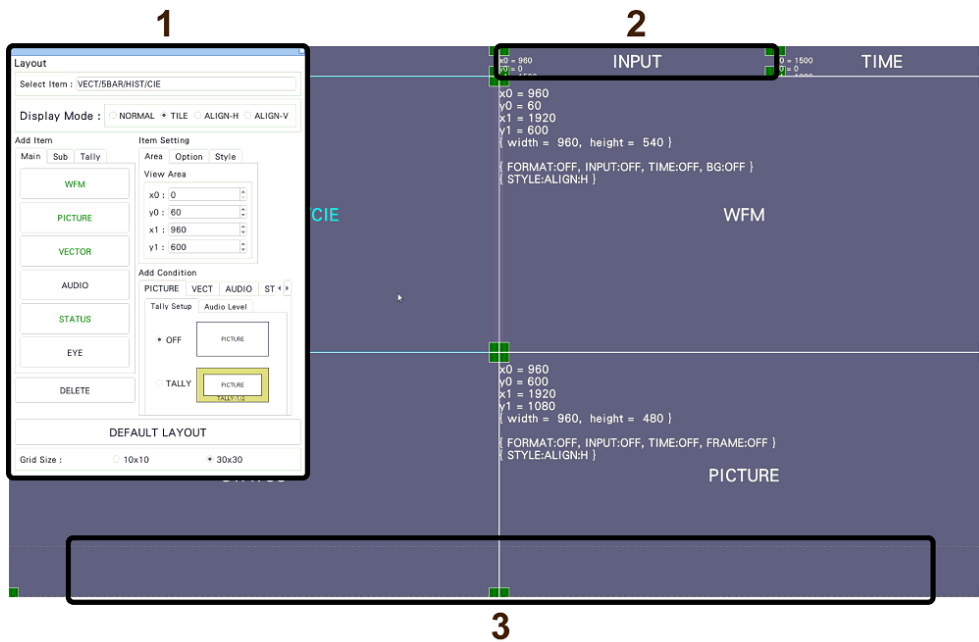



Figure 6-42 Layout screen

1 Layout Window

The Layout window is used to create layouts.

Mode in the title bar displays the current measurement mode (WFM, USER 1 to USER 5, etc.).

You can move the window by dragging and close it by clicking or tapping  in the upper right of the window. When using a mouse, to display a window that you closed, double-click in the layout screen.

2 Item

Displays the item selected on the Main or Sub tab.

The settings specified with Item Setting are displayed in the frame.

If you select it, the frame color changes from white to light blue.

3 Menu Guide

A function menu appears in this area.

Use these as guides when placing items.

6. BASIC OPERATION

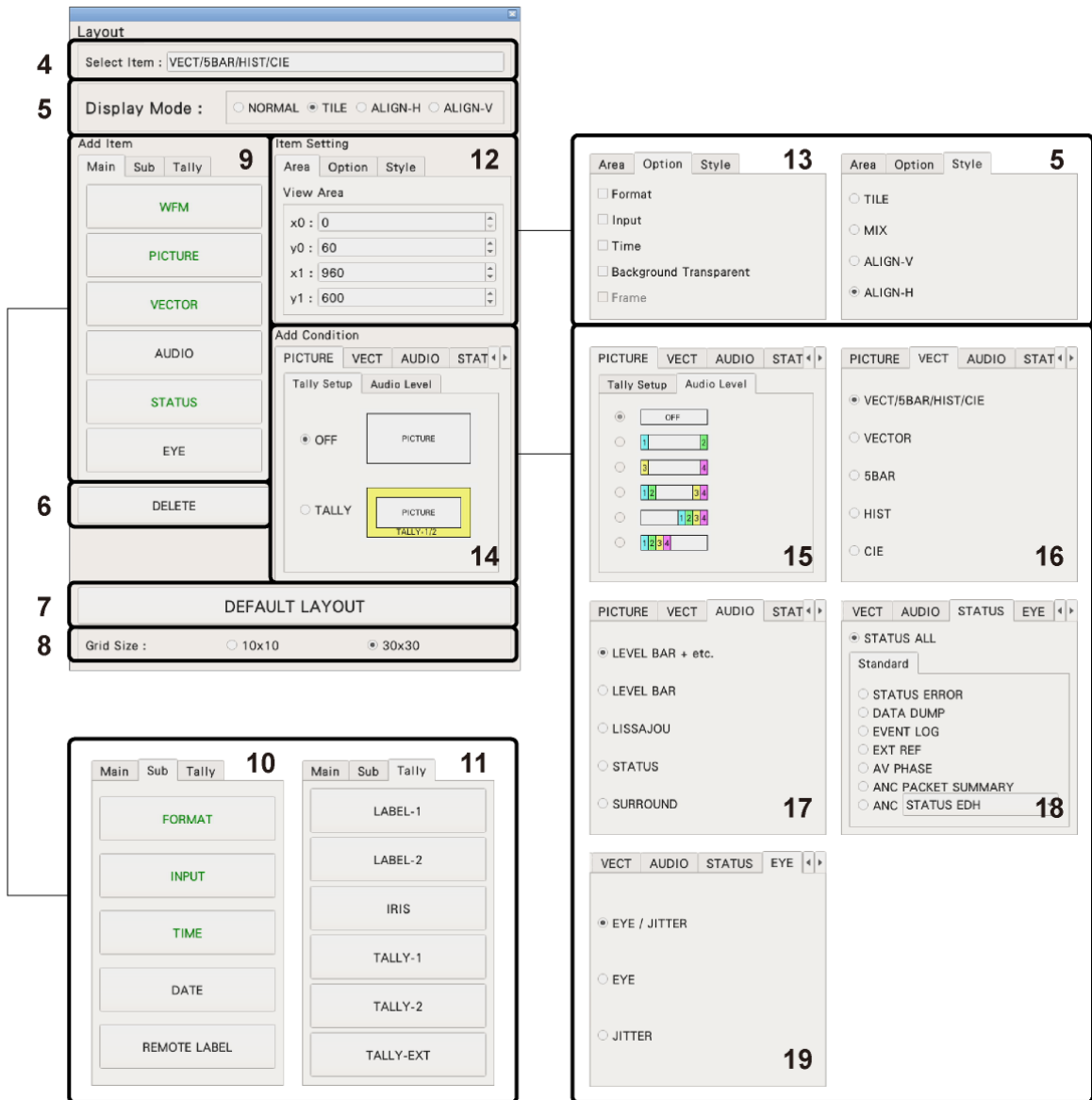

Figure 6-43 Layout window

6. BASIC OPERATION

4 Select Item

Displays the selected item.

5 Display Mode / Style

Select the display format for simul mode.

Display Mode applies to the entire screen, Style applies to the selected item.

If Display Mode is not set to NORMAL or if the selected item is AUDIO or EYE, Style cannot be selected.

If the selected item is VECTOR (5BAR), VECTOR (HIST), VECTOR (CIE), STATUS, or an item on the Sub tab, you cannot set Style to MIX.

If Display Mode is not set to NORMAL and multiple channels are displayed in simul mode, even if you place AUDIO or EYE items in the layout, "Not supported" will appear and will not work.

For example, if the following screens are displayed in single input mode and you change to simul mode, the display changes depending on Display Mode as follows.

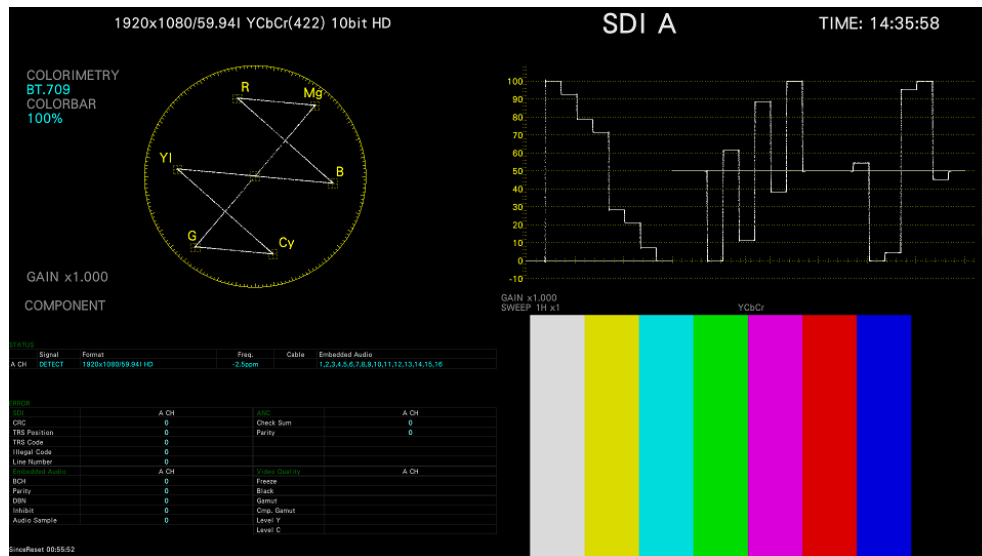

Figure 6-44 Single input mode

6. BASIC OPERATION

- When Display Mode Is NORMAL

The screen is divided by channel within each item. Select the division format with Style.

TILE (tile the screens)

MIX (cascade the screens)



ALIGN-V (arrange vertically)

ALIGN-H (arrange horizontally)

Figure 6-45 Normal display

- When Display Mode Is TILE

The screen is divided by channel.

Ach

Bch



Figure 6-46 Tiled display

6. BASIC OPERATION

- When Display Mode Is ALIGN-H

The screen is divided by channel and arranged side by side.

Ach

Bch



Figure 6-47 ALIGN-H display

- When Display Mode Is ALIGN-V

The screen is divided by channel and arranged top to bottom.



Figure 6-48 ALIGN-V display

6. BASIC OPERATION

6 DELETE

Deletes the selected item.

7 DEFAULT LAYOUT

Resets the layout to the initial settings defined for each measurement mode. Grid Size is not reset.

8 Grid Size: 10x10 / 30x30

Select the grid size.

The position and size of items snap to the grid specified here.

9 Main

Measurement items.

- WFM

Shows the video signal waveform display.

- PIC

Shows the picture display.

- VECTOR

Click or tap this after selecting the display mode on the VECTOR tab to show the vector waveform. A CIE chromaticity diagram will not be displayed properly if the VECT item is overlapping other items.

- AUDIO

Click or tap this after selecting the display mode on the AUDIO tab to show audio.

- STATUS

Click or tap this after selecting the display mode on the STATUS tab to show the status.

- EYE

Click or tap this after selecting the display mode on the EYE tab to show the eye pattern or jitter.

If LV5350 or LV7300-SER02 is not installed, the message "Not installed" is displayed.

6. BASIC OPERATION

10 Sub

Items for displaying information.

- **FORMAT**

Shows the format (e.g., 1920x1080/59.94I YCbCr(422) 10bit HD).

If you place this item, you can show and hide it using the GENERAL SETUP tab of the SYS menu.

It is normally displayed in white, but if the input format is not appropriate, it turns red.

- **INPUT**

Shows the input signal (e.g., SDI A).

If you place this item, you can show and hide it using the GENERAL SETUP tab of the SYS menu.

- **TIME**

Shows the time (e.g., TIME: 00:00:00).

If you place this item, you can select the display format using the GENERAL SETUP tab of the SYS menu.

- **DATE**

Shows the date (e.g., DATE: 2000/01/01).

If you place this item, you can select the display format using the GENERAL SETUP tab of the SYS menu.

Only one item is displayed even if you switch to simul mode.

11 Tally

Items for tally display and camera ID display.

Unarranged items are displayed with black characters. Clicking an item places the item.

Arranged items are displayed with green characters. Clicking an item selects the item.

- **LABEL-1, LABEL-2**

Shows the camera ID set on the CAMERA ID tab.

The default values are CAM A to CAM D and vary depending on the channel.

[See also] CAMERA ID tab → 7.2.11, "Setting the Camera ID (SER27)"

- **IRIS**

Shows the iris set on the CAMERA ID tab.

The default values are CAM A to CAM D and vary depending on the channel.

[See also] CAMERA ID tab → 7.2.11, "Setting the Camera ID (SER27)"

- **TALLY-1, TALLY-2, TALLY-EXT**

Shows the tally set on the TALLY tab or through the remote connector.

TALLY-EXT (EXTENDED) is a tally display with a comment of up to eight characters. You can edit the comment on the REMOTE tab.

[See also] TALLY tab → 7.2.12, "Configuring the Tally Display (SER27)"

REMOTE tab → 7.2.8, "Setting the Remote Connector"

6. BASIC OPERATION

12 Area

Set the position and size of the selected item.

The coordinates at the upper left corner of the screen are (0, 0). Those at the lower right corner are (1920, 1080). Based on these references, the coordinates of the upper left corner of the item is (x0, y0), and those of the lower right corner is (x1, y1).

You can change the values using the ▲▼ key or the wheel on the mouse.

13 Option

Set the options for the selected item.

- Format

Turns on and off the format display (e.g., 1920x1080/59.94I YCbCr(422) 10bit HD).

This option cannot be displayed for an AUDIO item, EYE item, or an item on the Sub tab.

If this is set to on, you can show and hide it using the GENERAL SETUP tab of the SYS menu.

It is normally displayed in white, but if the input format is not appropriate, it turns red.

- Input

Turns on and off the input signal display (e.g., SDI A).

This option cannot be displayed for an AUDIO item, EYE item, or an item on the Sub tab.

If this is set to on, you can show and hide it using the GENERAL SETUP tab of the SYS menu.

- Time

Turns on and off the time display (e.g., TIME: 00:00:00).

This option cannot be displayed for an AUDIO item, EYE item, or an item on the Sub tab.

If this is set to on, you can select the display format using the GENERAL SETUP tab of the SYS menu.

- Background Transparent

Selects the transmittance of the background when the sub item is superimposed on a picture.

When enabled, the transmittance is set to 100 %; when disabled, the transmittance is set to 50 %.

You cannot set this option for a PIC item.

- Frame

Turns on and off the frame display of PICTURE items.

6. BASIC OPERATION

14 PICTURE - Tally Setup

Select whether to display tallies on the outer frame of the PICTURE item.
This setting applies to all PICTURE items and enhanced layout.

If this is set to on, TALLY-1 set on the TALLY tab or through the remote connector is shown on the outside and TALLY-2 on the inside.

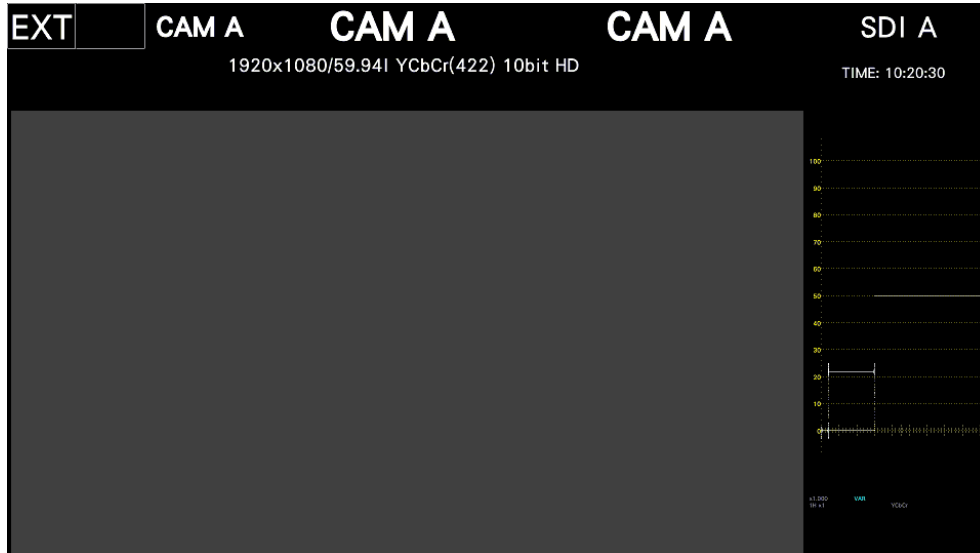

Figure 6-49 Tally display

15 PICTURE - Audio Level

Select whether to display audio meters on both sides of the PICTURE item.
This setting applies to all PICTURE items.

If the AUDIO item is also displayed simultaneously, audio meters are not displayed.

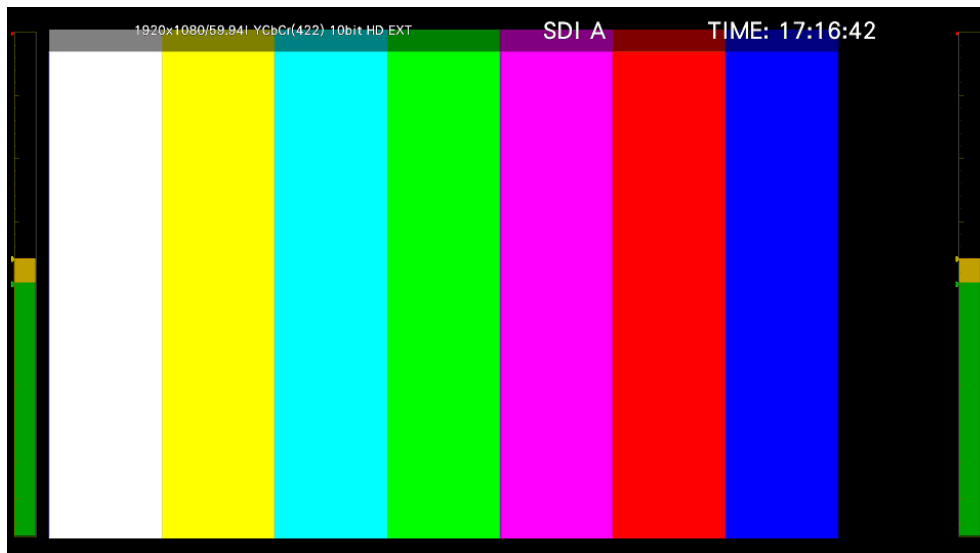

Figure 6-50 Audio meter display

6. BASIC OPERATION

16 VECT

Select the display mode of the VECTOR item. Select the mode before clicking or tapping the VECTOR item.

VECT / 5BAR /HIST / CIE (*1)	Shows the normal vector display. You can switch the display between vector waveform, 5bar, histogram and CIE chromaticity diagram. It cannot be arranged with the items below at the same time. If you want to arrange the items below, delete this item first.
VECTOR	Shows vectors.
5BAR	Switches to the 5-bar display.
HIST	A histogram is displayed.
CIE	The CIE chromaticity diagram display is shown.

17 AUDIO

Select the display mode of the AUDIO item. Select the mode before clicking or tapping the AUDIO item.

LEVEL BAR + etc. (*1)	This is the normal audio display. The display switches between Lissajous, surround, meter, and status. It cannot be arranged with the items below at the same time. If you want to arrange the items below, delete this item first.
LEVEL BAR	Meters are displayed.
LISSAJOU	Lissajous curves are displayed.
STATUS	Shows the status.
SURROUND	Surround waveforms are displayed. This item will not be displayed correctly when embedded audio is being measured in simul mode.

6. BASIC OPERATION

18 STATUS - Standard

Selects the display mode of the STATUS item. Select the mode before clicking or tapping the STATUS item.

STATUS ALL (*1)	This is the normal status display. The display switches between error count, data dump, etc. It cannot be arranged with the items below at the same time. If you want to arrange the items below, delete this item first.
STATUS ERROR	Error counts are displayed.
DATA DUMP	Data dump is displayed.
EVENT LOG	The event log is displayed.
EXT REF	Phase differences are displayed.
AV PHASE	Lip sync is displayed.
ANC PACKET SUMMARY	A summary of ancillary pockets is displayed.
ANC	One of the following is displayed. <ul style="list-style-type: none"> • STATUS EDH: EDH Display • STATUS PAYLOAD: Payload ID Display • STATUS CONTROL: Audio control packet display • STATUS ARIB CC: Closed Caption Display • STATUS ARIB NETQ: NET-Q display • STATUS ARIB TRIG: Data trigger display • STATUS ARIB USER1: User data 1 display • STATUS ARIB USER2: User data 2 display • STATUS SMPTE SR Live: SR Live display • STATUS SMPTE 608: EIA-608 data display • STATUS SMPTE 708: EIA-708 data display • STATUS SMPTE AFD: AFD Display • STATUS SMPTE PROG: Program data display • STATUS SMPTE VBI: VBI data display • STATUS SMPTE SCTE104: SCTE-104 display • STATUS SEARCH: Ancillary packet search display

6. BASIC OPERATION

19 EYE

Select the display mode of the EYE item. Select the mode before clicking or tapping the EYE item.

EYE / JITTER (*1)	This is the normal eye pattern display. The display switches between eye pattern and jitter. It cannot be arranged with the items below at the same time. If you want to arrange the items below, delete this item first.
EYE	The eye pattern is displayed.
JITTER	The jitter waveform is displayed.

*1 For the VECTOR, AUDIO, STATUS, or EYE conditions, to arrange items other than normal displays, delete the normal displays first.

For example, for the EYE condition, delete the normal display "EYE / JITTER" first and then arrange "EYE" and "JITTER" to display these items simultaneously.

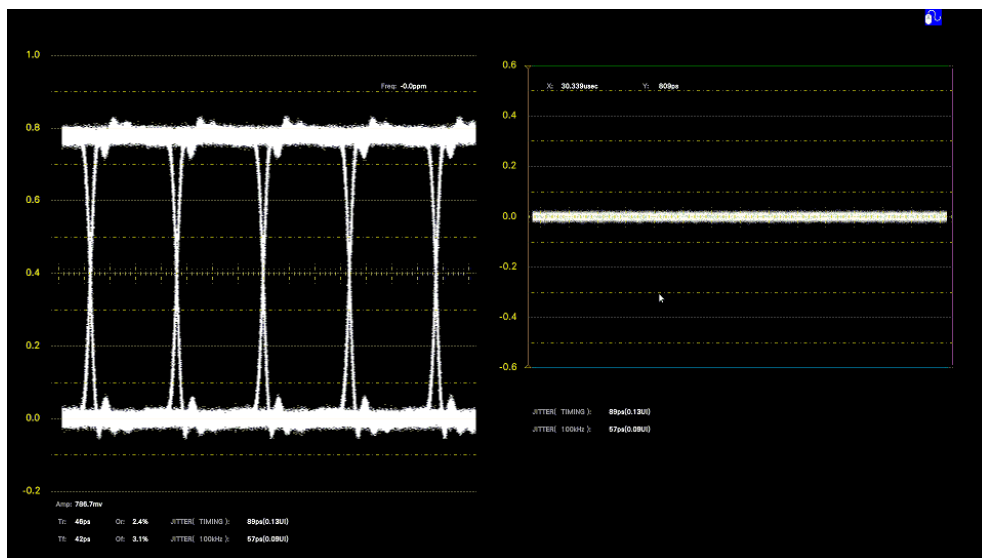

Figure 6-51 Eye pattern and jitter display

6. BASIC OPERATION

6.6 Enhanced Layout (SER26)

Enhanced layout is an extended function that enables the measurement screens of up to two channels to be laid out on a single screen simultaneously in simul mode. To use this function, connect a mouse to the front panel USB port.

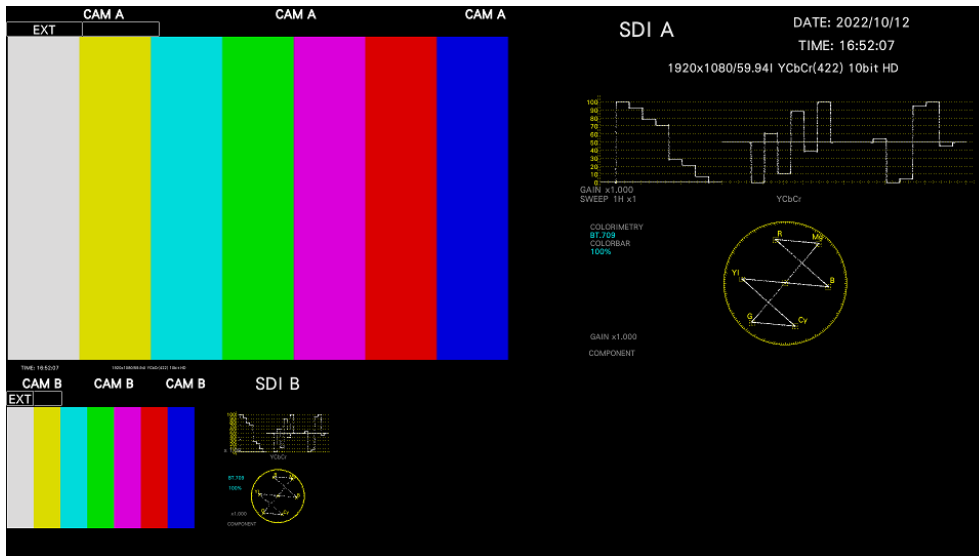

Figure 6-52 Enhanced layout

Enhanced layout will not be initialized even if PARAM INIT YES is executed from the SYS menu. To initialize it, execute LAYOUT INIT YES or ALL INIT YES from the SYS menu, factory default initialization, or DEFAULT LAYOUT from the enhanced layout window.

[See also] 7.7, "Initialization"

As shown below, the number of layout channels differs between the enhanced layout and customized layout.

[See also] 6.5, "Customized Layout"

Table 6-2 Layout comparison

	Enhanced layout	Customized layout
Number of layout channels	1 to 2	1

6. BASIC OPERATION

6.6.1 Enhanced Layout Procedure

As an example, this section will explain the procedure to display the enhanced layout of channels A and B.

Enhanced layout can be shown in simul mode when multi-screen display is in use.

1. On the SDI IN SETUP1 tab of the SYS menu, set SDI System to 2K SD/HD/3G-A/3G-B-DL.

SYS → F•1 SIGNAL IN OUT → F•2 PREV TAB or F•3 NEXT TAB →

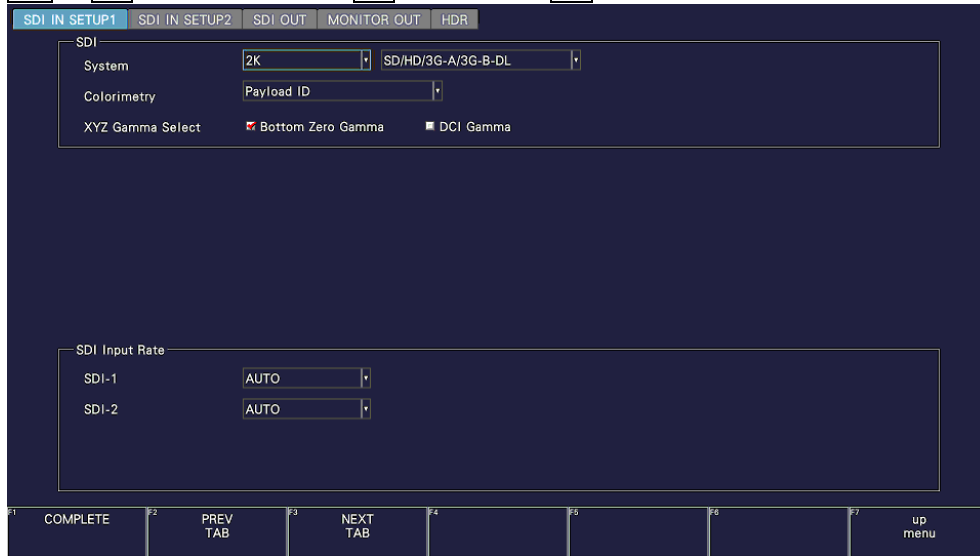

Figure 6-53 SDI IN SETUP1 tab

2. Set F•7 DISPLAY of the INPUT menu to SIMUL, and set F•1 A to F•2 B to ON.

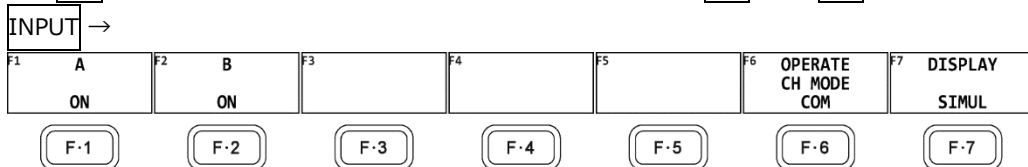

Figure 6-54 INPUT menu

3. Press MULTI.

6. BASIC OPERATION

- Right-click in the measurement screen, and click ENHANCED LAYOUT.

The enhanced layout screen appears.

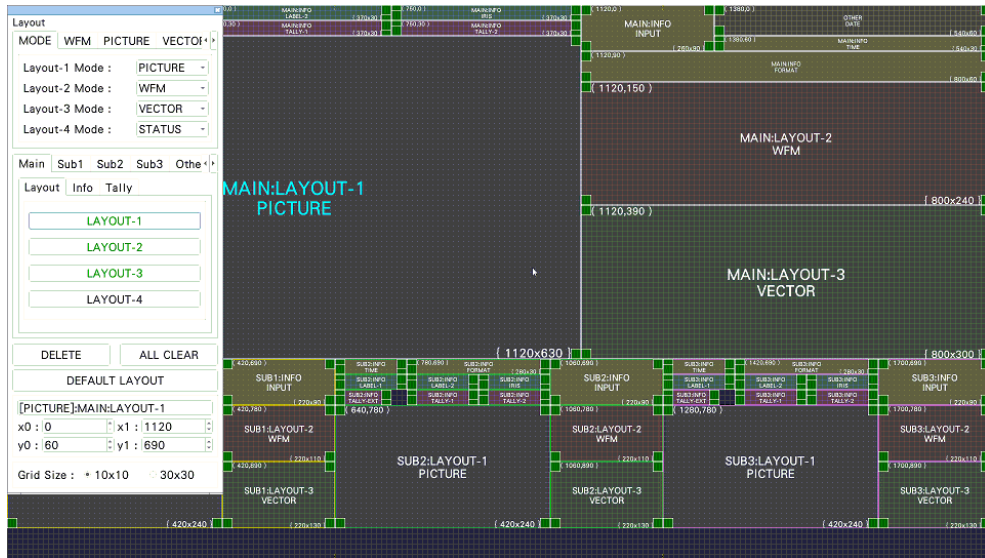

Figure 6-55 Enhanced layout screen

- Change the layout as necessary.

A default layout is initially stored in the main unit. Even after you change the layout, you can return to the default layout by clicking DEFAULT LAYOUT.

To create a new layout after clearing the default layout, click ALL CLEAR.

The basic operation is the same as with the customized layout. See section 6.5.2, "Layout Procedure."

For details on the enhanced layout screen, see section 6.6.2, "Enhanced Layout Screen Description."

- Selecting the Measurement Mode

You can select up to four measurement modes. Assign measurement modes to Layout-1 to Layout-4.

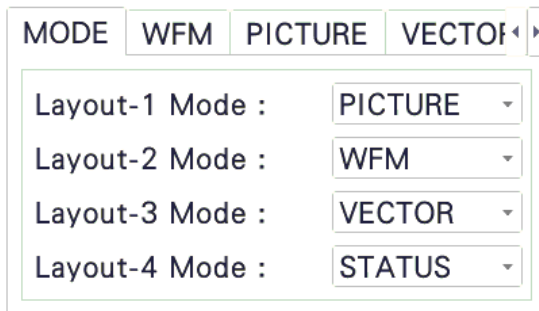

6. BASIC OPERATION

- Arranging Items

Arrange items on the Main, Sub1, Sub2, Sub3, and Other tabs.

Main, Sub1, Sub2, and Sub3 represent four channels. The channel selected with **F•6** INPUT SELECT on each measurement screen is displayed in Main.

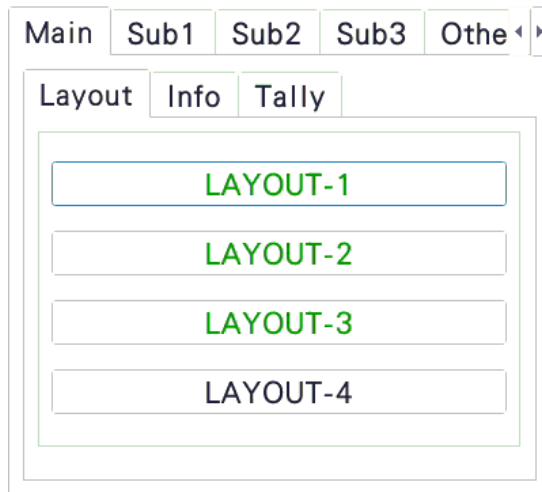

- Notes

- Arrange PICTURE items so they do not overlap.
- Arrange waveform display items (WFM, VECTOR) so they do not overlap.
- Arrange Main, Sub1, Sub2, and Sub3 according to the number of channels to be used with the following combinations. Arrangements other than these combinations are possible, but they will not be displayed correctly.

Number of channels	Main	Sub1	Sub2	Sub3
1	✓	-	-	-
2	✓	✓	-	-
3	✓	✓	✓	-
4	✓	✓	✓	✓

6. BASIC OPERATION

- Right-click or tap in the enhanced layout screen, and click or tap SAVE.

The measurement screen returns.

If you click or tap EXIT, all the changes that you made up to that point will be canceled.

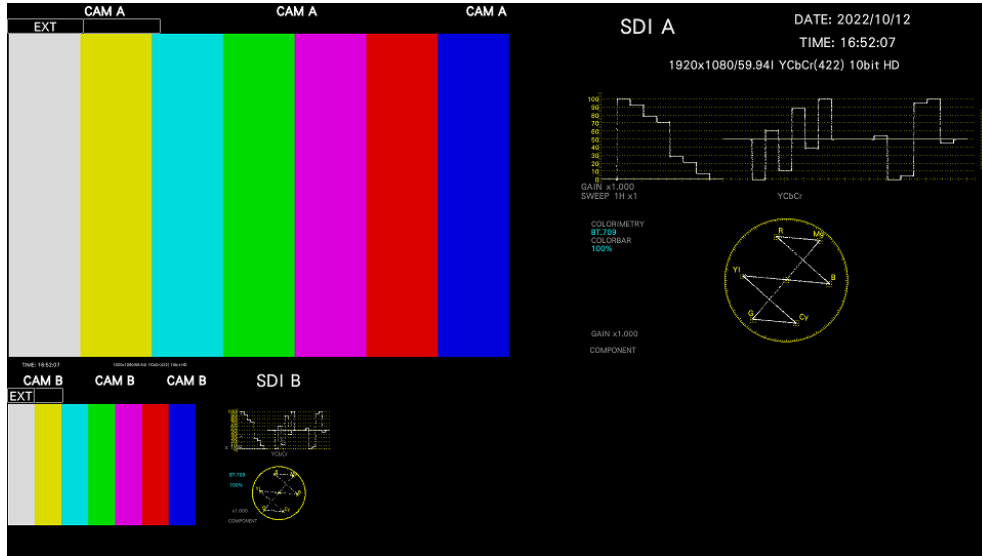

Figure 6-56 Enhanced layout (INPUT SELECT = A)

Items arranged on Main show the channels selected with **F•6** INPUT SELECT on each measurement screen. However, if you click a picture of Sub1, Sub2, or Sub3, the channel that you click appears on Main.

For example, in the above figure, if you click the picture of Sub1 (Bch), Bch appears on Main. (Sub1 shows channels other than the channel shown on Main.)

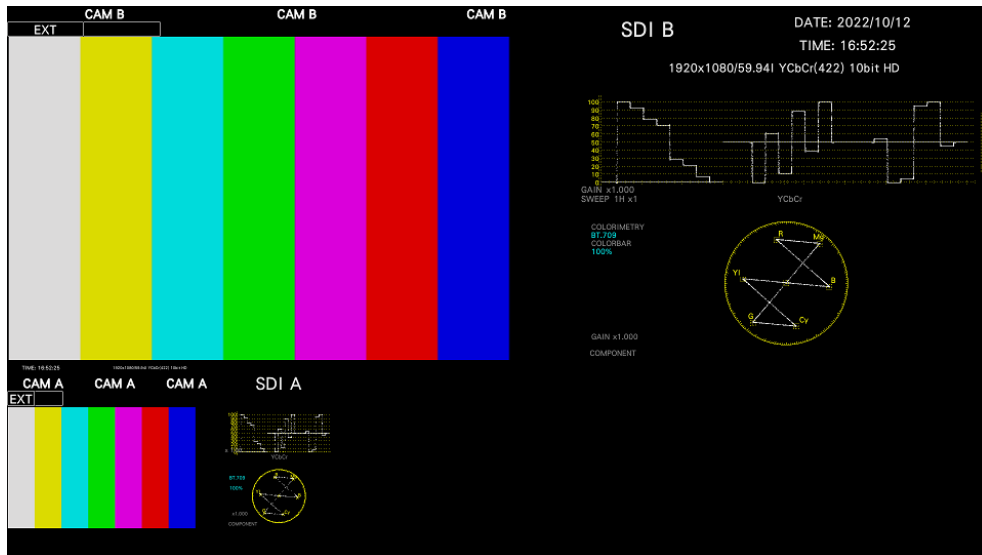

Figure 6-57 Enhanced layout (INPUT SELECT = B)

6. BASIC OPERATION

6.6.2 Enhanced Layout Screen Description

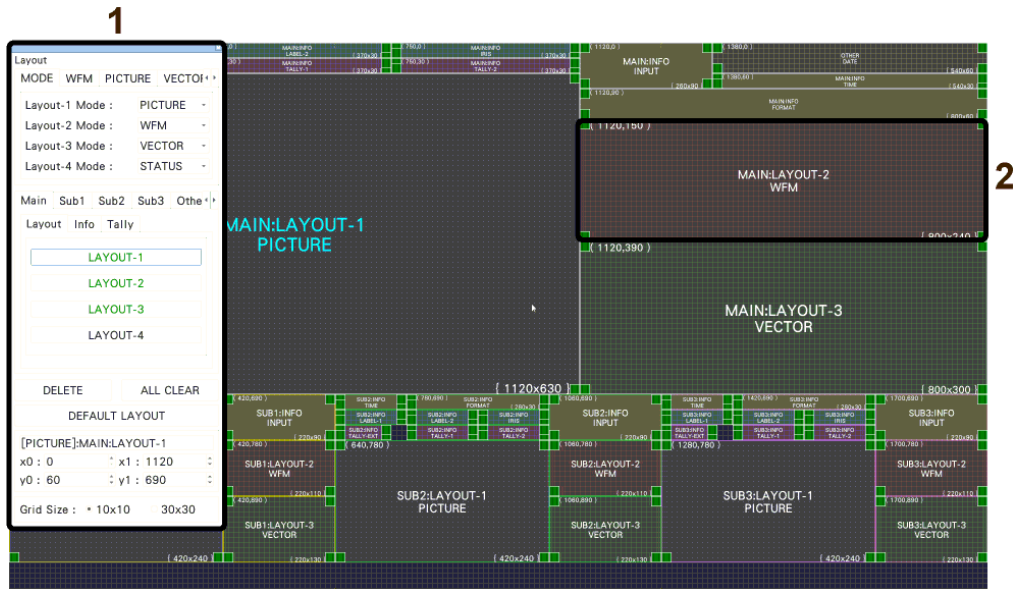

Figure 6-58 Enhanced layout screen description

1 Enhanced layout window

The Layout window is used to create layouts.

You can move the window by dragging and close it by clicking in the upper right of the window. If you close it, you can redisplay it by double-clicking in the enhanced layout screen.

6. BASIC OPERATION

2 Item

Items arranged on the Main, Sub1 to Sub3, and other tabs are displayed. The upper-left coordinate, item name, and size are displayed in the frame. If you select it, the item name color changes from white to light blue.

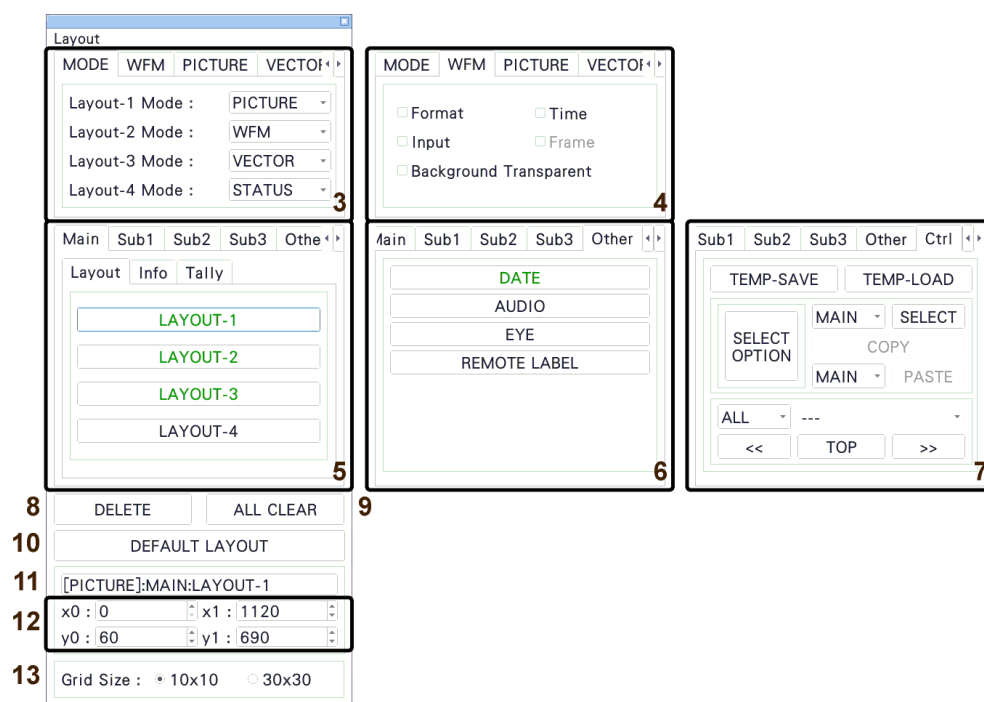

Figure 6-59 Enhanced layout window

3 MODE

Assign measurement modes to Layout-1 to Layout-4. You can select from the following measurement modes.

WFM / VECTOR / PICTURE / STATUS

4 WFM / PICTURE / VECTOR / AUDIO / STATUS / EYE

Set the options for each measurement mode.

You can set these items when you arrange an item.

- Format

Turns on and off the format display (e.g., 1920x1080/59.94I YCbCr(422) 10bit HD). If you set this to ON, you can show and hide it using the GENERAL SETUP tab of the SYS menu.

It is normally displayed in white, but if the input format is not appropriate, it turns red. If the specified format is not received, it turns yellow.

- Time

Turns on and off the time display (e.g., TIME: 00:00:00).

If you set this option to ON, you can select the display format using the GENERAL SETUP tab of the SYS menu.

6. BASIC OPERATION

- **Input**
Turns on and off the input signal display (e.g., SDI A).
If you set this to ON, you can show and hide it using the GENERAL SETUP tab of the SYS menu.
 - **Frame**
Turns on and off the frame display of PICTURE items.
 - **Background Transparent**
Selects the transmittance of the background when the sub item is superimposed on a picture.
When enabled, the transmittance is set to 100 %; when disabled, the transmittance is set to 50 %.
You cannot set this option for a PICTURE item.
 - **Tally Setup**
Select whether to display tallies on the outer frame of the PICTURE item.
See "14 PICTURE - Tally Setup" in section 6.5.3, "Layout Screen."
 - **Audio Level**
Select whether to display audio meters on both sides of the PICTURE item.
See "15 PICTURE - Audio Level" in section 6.5.3, "Layout Screen."
- 5 **Main / Sub1 / Sub2 / Sub3**
- Main, Sub1, Sub2, and Sub3 represent four channels. For each channel, you arrange items. (To arrange items for three channels, use the Main, Sub1, Sub2 combination. For two channels, use the Main, Sub1 combination. For one channel, use Main.)
- Main displays the channel selected with **F•6** INPUT SELECT on each measurement screen.
- Sub1 to Sub3 show channels other than the channel shown on Main in the A, B, C, D order.
- Items are categorized into Layout, Info, and Tally.
Unarranged items are displayed with black characters. Clicking an item places the item.
Arranged items are displayed with green characters. Clicking an item selects the item.

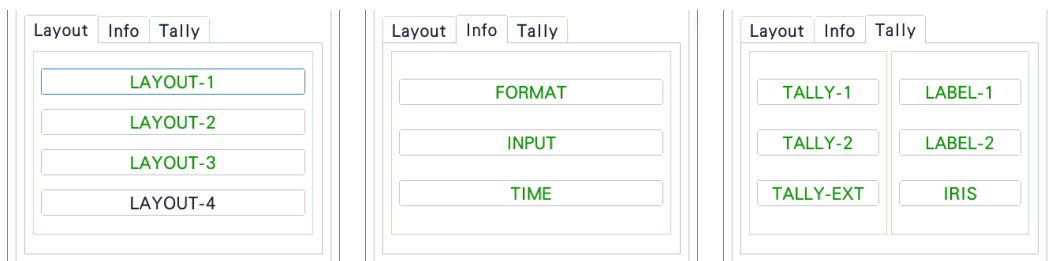

- **LAYOUT-1 to LAYOUT-4**
Shows the measurement mode assigned on the MODE tab.

6. BASIC OPERATION

- **FORMAT**

Shows the format (e.g., 1920x1080/59.94I YCbCr(422) 10bit HD).
If you place this item, you can show and hide it using the GENERAL SETUP tab of the SYS menu.
It is normally displayed in white, but if the input format is not appropriate, it turns red.
If the specified format is not received, it turns yellow.
 - **INPUT**

Shows the input signal (e.g., SDI A).
If you place this item, you can show and hide it using the GENERAL tab of the SYS menu.
 - **TIME**

Shows the time (e.g., TIME: 00:00:00).
If you place this item, you can select the display format using the GENERAL tab of the SYS menu.
 - **TALLY-1, TALLY-2, TALLY-EXT**

Shows the tally set on the TALLY tab or through the remote connector.
TALLY-EXT (EXTENDED) is a tally display with a comment of up to eight characters. You can edit the comment on the REMOTE tab.
[See also] TALLY tab → 7.2.12, "Configuring the Tally Display (SER27)"
REMOTE tab → 7.2.8, "Setting the Remote Connector"
 - **LABEL-1, LABEL-2**

Shows the camera ID set on the CAMERA ID tab.
The default values are CAM A to CAM D and vary depending on the channel.
[See also] CAMERA ID tab →7.2.11, "Setting the Camera ID (SER27)"
 - **IRIS**

Shows the iris set on the CAMERA ID tab.
The default values are CAM A to CAM D and vary depending on the channel.
[See also] CAMERA ID tab →7.2.11, "Setting the Camera ID (SER27)"
- 6 Other
- **DATE**

Place the DATE item.
The DATE item shows the date (e.g., DATE: 2000/01/01).
If you place this item, you can select the display format using the GENERAL SETUP tab of the SYS menu.
 - **AUDIO**

Place the AUDIO item.
 - **EYE**

Place the EYE item.

6. BASIC OPERATION

7 Ctrl

Manipulates items such as select, copy, and paste.

- TEMP-SAVE

Temporarily saves the current layout.

Note that the layout that is present when you enter the enhanced layout screen is automatically saved even if you don't click TEMP-SAVE.

The saved layout is deleted when you exit from the enhanced layout screen.

- TEMP-LOAD

Loads the layout saved with TEMP-SAVE or the layout that was present when you entered the enhanced layout screen.

- SELECT OPTION

Selects the target items when you group items with the SELECT function.

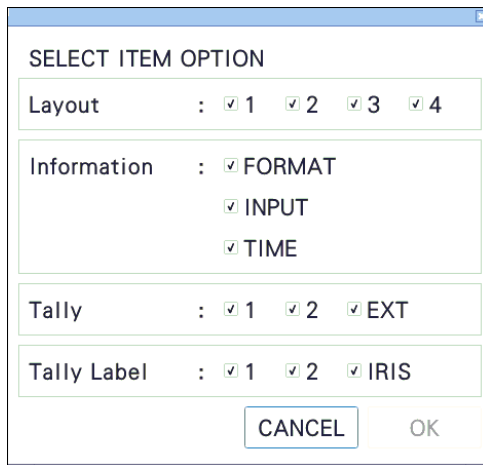

- MAIN/SUB1/SUB2/SUB3 - SELECT

Selects the items of the selected channels as a group.

If items are not grouped, SELECT is displayed with black characters.

If items are grouped, SELECT is displayed with green characters, and the selected item range is displayed in white. Moving by dragging, COPY, and DELETE can be used on grouped items.

- COPY

Temporarily saves the layout of items grouped with SELECT.

The saved layout is deleted when you exit from the enhanced layout screen or change the SELECT OPTION.

- MAIN/SUB1/SUB2/SUB3 - PASTE

Pastes the layout saved with COPY to the selected channel.

This is useful such as when you want to make Sub1 to Sub3 the same layout.

If there is a same item as the copied item at the paste destination channel, the position and size are overwritten.

6. BASIC OPERATION

- ALL - ---
CH - MAIN/SUB1/SUB2/SUB3
ITEM - LAYOUT-1/LAYOUT-2 and the like
Selects the target items when you select items with << and >>.
If you select ALL, all items of all channels are selected in order.
If you select CH, all items of the selected channel are selected in order.
If you select ITEM, the selected items of all channels are selected in order.
 - <<, >>
Selects the items specified by ALL/CH/ITEM in order. You can select an item by clicking it directly, but this is useful when items are overlapped and you want to select items in the back.
Moving by dragging, COPY, DELETE, and TOP can be used on selected items.
 - TOP
Moves the selected items to the front.
- 8 DELETE
Deletes individually selected or grouped items.
If the Ctrl tab is displayed, individually selected items can only be deleted if they are part of the ALL/CH/ITEM target.
- 9 ALL CLEAR
Deletes all items.
- 10 DEFAULT LAYOUT
Resets the layout to factory default.
- 11 Item name
Displays the selected item name.
- 12 x0, y0, x1, y1
Set the position and size of the selected item.
The coordinates at the upper left corner of the screen are (0, 0). Those at the lower right corner are (1920, 1080). Based on these references, the coordinates of the upper left corner of the item is (x0, y0), and those of the lower right corner is (x1, y1).
You can change the values using the ▲▼ key or the wheel on the mouse.
- 13 Grid Size: 10x10 / 30x30
Select the grid size.
The position and size of items snap to the grid specified here.

7. SYSTEM SETTINGS

The SYS menu can be used to configure the instrument and options. Press SYS, and use the SYS menu.

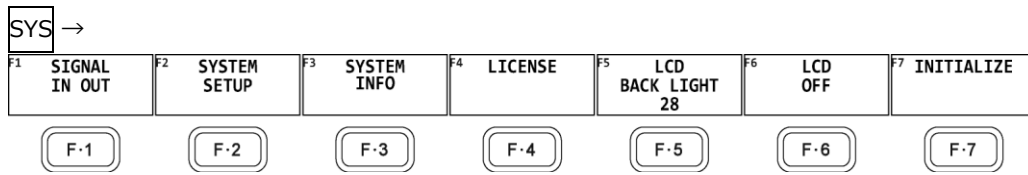

Figure 7-1 SYS menu

7.1 Configuring the I/O Connectors

To configure the I/O connector settings, use **F•1** SIGNAL IN OUT on the SYS menu.

7.1.1 Configuring the Input System

Use SDI on the SDI IN SETUP1 tab to configure the input system of SDI INPUT on the rear panel.

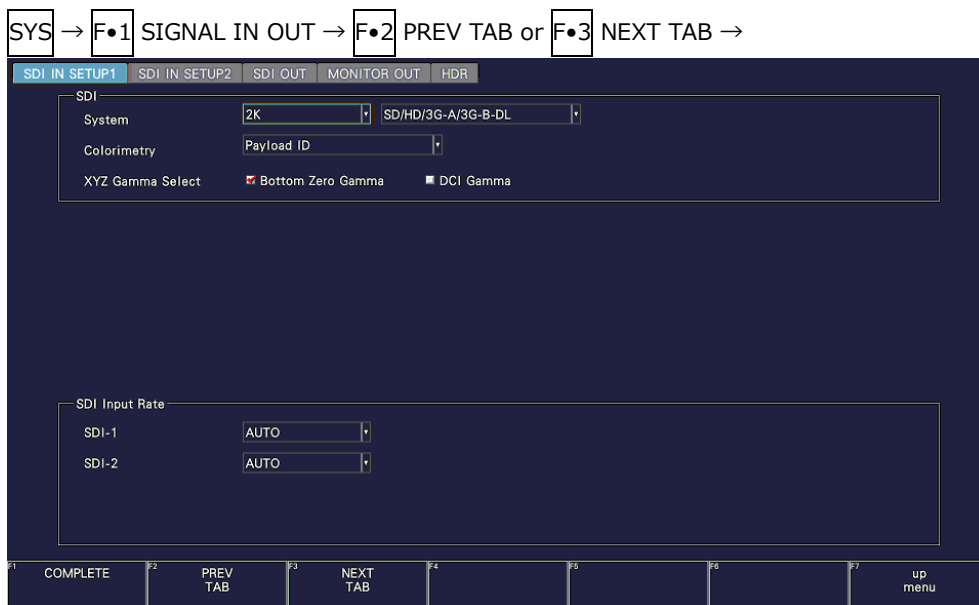

Figure 7-2 SDI IN SETUP1 tab

- System

Select the input format.

4K 12G / 4K 6G / 4K 3G Dual Link / 2K SD/HD/3G-A/3G-B-DL

7. SYSTEM SETTINGS

- Colorimetry

Select the colorimetry to use on the video-signal-waveform, vector, picture, and CIE-chromaticity-diagram displays.

The currently applied colorimetry is displayed in cyan in the vector display and CIE chromaticity diagram display.

For 3G(DL)-4K, if you select a payload ID, the current applied colorimetry is displayed in yellow if the colorimetries of all links are not matched.

For SD input, the colorimetry is fixed to BT.601, regardless of the colorimetry selection.

The picture display on the instrument LCD is not capable of expressing the color gamut of the applied colorimetry.

<u>Payload ID:</u>	The instrument automatically detects the colorimetry from the payload ID and operates. In addition, when the payload ID is an XYZ signal, the instrument operates in DCI mode.
BT-709:	Runs in BT.709 mode.
BT-2020:	Runs in BT.2020 mode.
DCI:	Runs in DCI mode.

- XYZ Gamma Select

Select the gamma correction method for XYZ signal input.

XYZ signals can be converted to RGB signals and displayed as video signal waveforms or vector waveforms, but with 12-bit quantized value (when DCI Gamma is selected) specified in standards, conversion errors will be large near 0% of the input. Therefore, when displaying such as RGB or vector waveforms with SMPTE RP 431 color bar (color patch) code, there are areas where the waveform deviates greatly from the scale.

To reduce this error, the default is set to "Bottom Zero Gamma". This setting is fixed at 0% when the input is from 0% to 0.05%. Select this setting if you want to adjust devices.

<u>Bottom Zero Gamma:</u>	when the input is from 0% to 0.05% gamma is fixed at 0% for DCI gamma.
DCI Gamma:	1/2.6 power of input

7. SYSTEM SETTINGS

Gamma curve (0 to 100% of input)

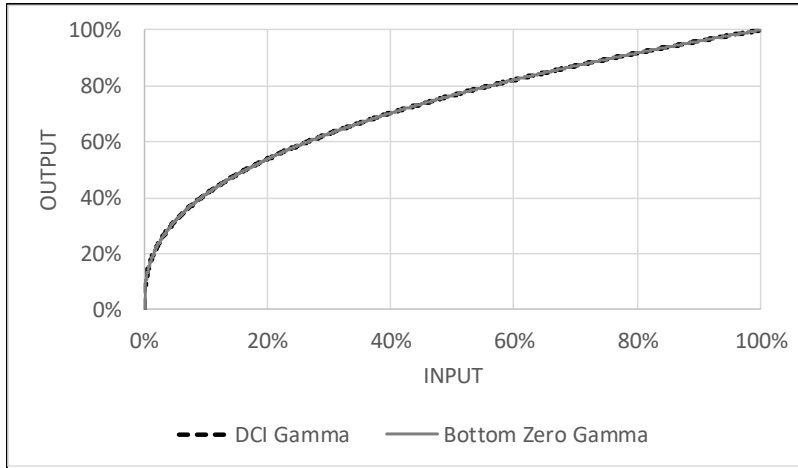

Gamma curve (Expand 0 to 0.2% of input)

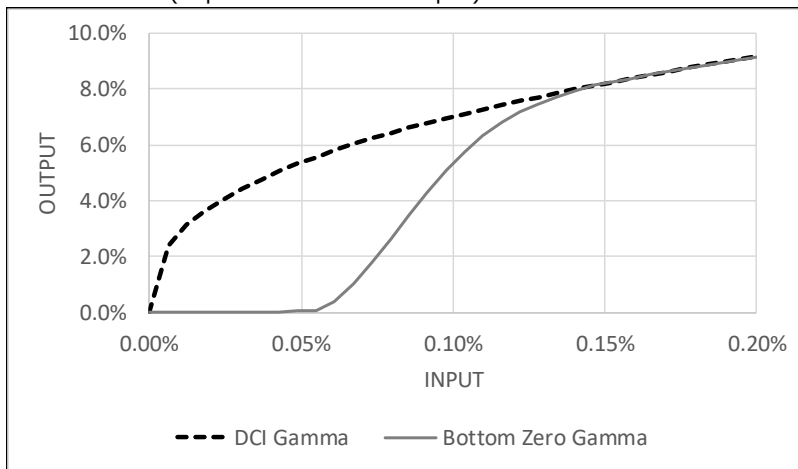

Example of vector waveform display

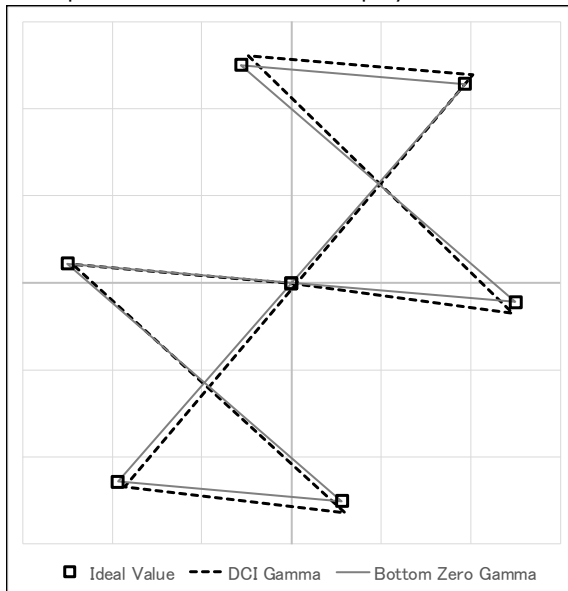

7. SYSTEM SETTINGS

7.1.2 Setting the Input Format

Use SDI Input Rate on the SDI IN SETUP1 tab to set the SDI input signal format.

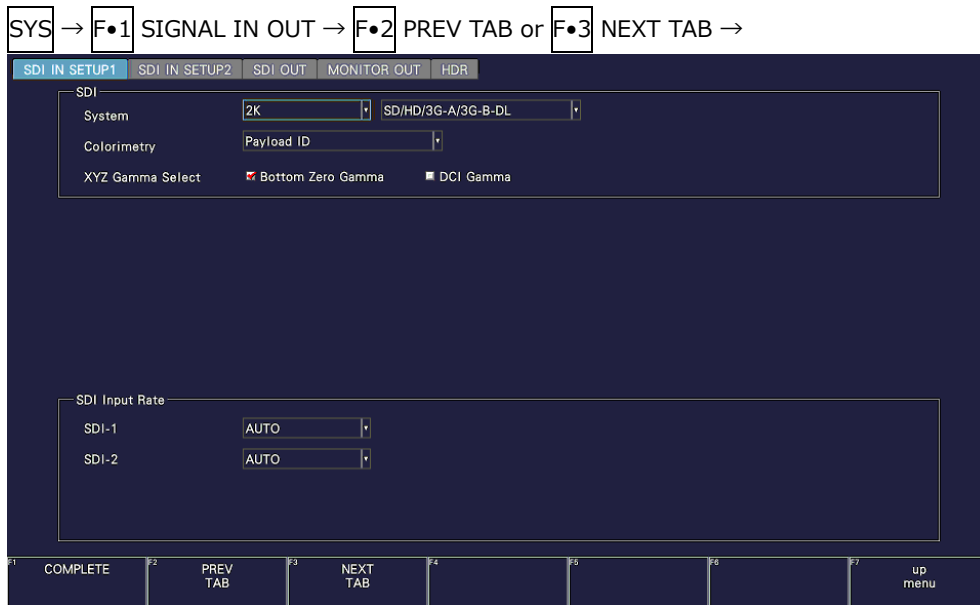

Figure 7-3 SDI IN SETUP1 tab

- SDI Input Rate

If SDI System is set to SD/HD/3G-A/3G-B-DL, select the format of the signal to receive from SDI INPUT 1 and 2. If SDI System is set to 6G or 12G, select the format of the signal to receive from SDI INPUT 1.

In normal cases, use AUTO. If you select a setting other than AUTO and apply a signal different from the selected format, the signal will not be received correctly.

SDI System = SD/HD/3G-A/3G-B-DL

AUTO / 3G / HD / SD

SDI System = 12G

AUTO / 12G

SDI System = 6G

AUTO / 6G

7. SYSTEM SETTINGS

7.1.3 Setting the Payload ID

User Format on the SDI IN SETUP2 tab to set the payload ID parameters.

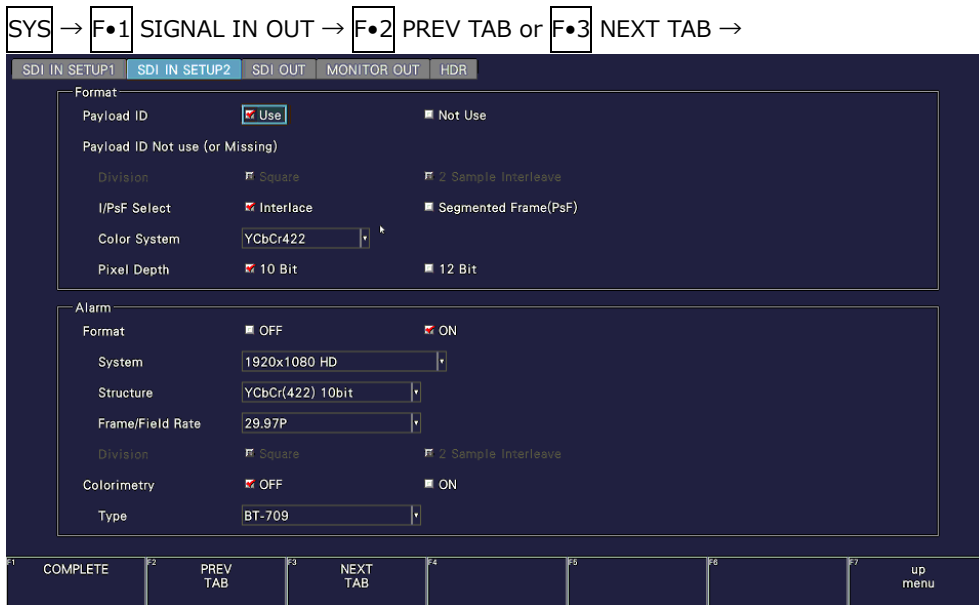

Figure 7-4 SDI IN SETUP2 tab

- Payload ID

Select whether to use the payload ID for input format identification.

Use / Not Use

If you select Not Use, set the items marked with a Y in Table 7-1. The instrument will operate using the specified settings.

If you select Use, the items marked with a Y will be detected from the payload ID. There is no need to set these items, but if you set them and a payload ID is not embedded in the input signal, the instrument will operate using the specified settings.

Regardless of whether you select Use or Not Use, items such as scanning and frame frequency will be detected from the TRS.

Table 7-1 Payload ID settings.

Input Signal	Division	i/PsF Select	Color System	Pixel Depth
HD	Cannot be set	Y	No need to set (fixed to YCbCr 422)	No need to set (fixed to 10 bits)
SD	Cannot be set	No need to set (fixed to interlace)	No need to set (fixed to YCbCr 422)	No need to set (fixed to 10 bits)
3G-A, 3G-B-DL	Cannot be set	Y	Y	Y
6G	Cannot be set	Cannot be set	Cannot be set	Cannot be set
12G	Cannot be set	Cannot be set	Y	Y
3G(DL)-4K	Y	Cannot be set	Cannot be set	Cannot be set

7. SYSTEM SETTINGS

- Division

Selects the division transmission system when SDI System is 4K 3G Dual Link.
If you select 2 Sample Interleaved when Psf format is in use, the instrument will not operate properly.

Square / 2 Sample Interleave

- i/PsF Select

The instrument cannot detect the following formats if the payload ID is not in use or is not embedded. In such a case, select whether to use interlace or segmented frame for displaying.

This cannot be selected when SDI System is 4K.

- 1080/60I and 1080/30PsF
- 1080/59.94I and 1080/29.97PsF
- 1080/50I and 1080/25PsF

Interlace / Segmented Frame(PsF)

- Color System

Select the color system of the input signal.

YCbCr 422 / YCbCr 444 / RGB 444 / XYZ 444

- Pixel Depth

Select the quantization of the input signal.

10bit / 12bit

7. SYSTEM SETTINGS

7.1.4 Setting the Format Alarm

User Alarm on the SDI IN SETUP2 tab to set the format alarm parameters.

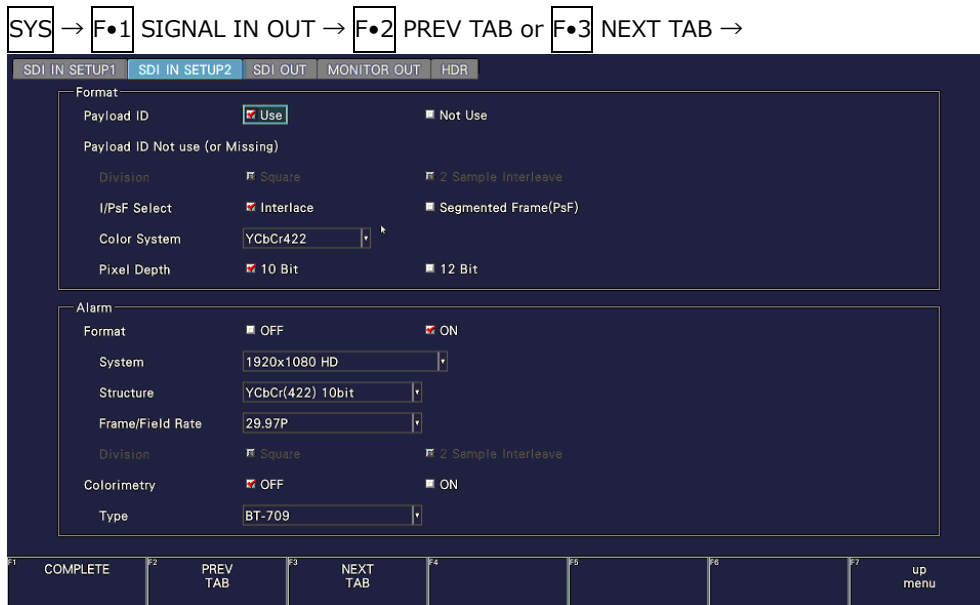

Figure 7-5 SDI IN SETUP2 tab

- Format

Turn on and off the format alarm detection.

If alarm detection is set to ON and a format other than the format specified with Format is received, the instrument operates in the following manner.

- Displays the format in yellow
- Displays errors in the event log of the status display
- Displays "ERROR" in the upper right of the display.
- Transmits a signal from the alarm output remote terminal

OFF / ON

7. SYSTEM SETTINGS

- System
- Structure
- Frame/Field Rate

When format alarm detection is on, specify the expected format. For information on the format combinations that are available, see section 3.3.1, "SDI Video Formats and Standards."

Table 7-2 Format selection

Video System	System	Structure	Frame/Field Rate	Division
4K 12G	3840x2160 12G 4096x2160 12G	YCbCr(422) 10bit YCbCr(422) 12bit YCbCr(444) 10bit YCbCr(444) 12bit RGB(444) 10bit RGB(444) 12bit	60/59.94/50/48/47.95/ 30/29.97/25/24/23.98/P	-
4K 6G	3840x2160 6G 4096x2160 6G	YCbCr(422) 10bit	30/29.97/25/24/23.98/P	-
4K 3G Dual Link	3840x2160 3G-B DS Dual 4096x2160 3G-B DS Dual	YCbCr(422) 10bit	30/29.97/25/24/23.98/P 30/29.97/25/24/23.98/PsF	Square/ 2 Sample Interleave
SD/HD/3G-A/3G-B-DL	1920x1080 3G-B-DL 2048x1080 3G-B-DL 1280x720 3G-A 1920x1080 3G-A 2048x1080 3G-A 1280x720 HD 1920x1080 HD 720x487 SD 720x576 SD	YCbCr(422) 10bit YCbCr(422) 12bit YCbCr(444) 10bit YCbCr(444) 12bit RGB(444) 10bit RGB(444) 12bit XYZ(444) 12bit	60/59.94/50/I 60/59.94/50/48/47.95/ 30/29.97/25/24/23.98/P 30/29.97/25/24/23.98/PsF	-

- Colorimetry

Turn on and off the colorimetry alarm detection.

Normally, colorimetry is displayed in cyan on the vector waveform display and CIE chromaticity diagram display. But for 3G(DL)-4K, if any of the colorimetries does not match, it is displayed in yellow.

If alarm detection is set to on and a colorimetry other than that specified with Type is received, the colorimetry is displayed in red. It is also displayed in red on the video signal waveform display.

Note that this is invalid when the input signal is SD.

OFF / ON

- Type

When colorimetry alarm detection is on, specify the expected colorimetry.

BT-709 / BT-2020 / DCI

7. SYSTEM SETTINGS

7.1.5 Configuring the SDI Output Connectors

Use Output on the SDI OUT tab to configure the SDI OUTPUT connectors on the rear panel.

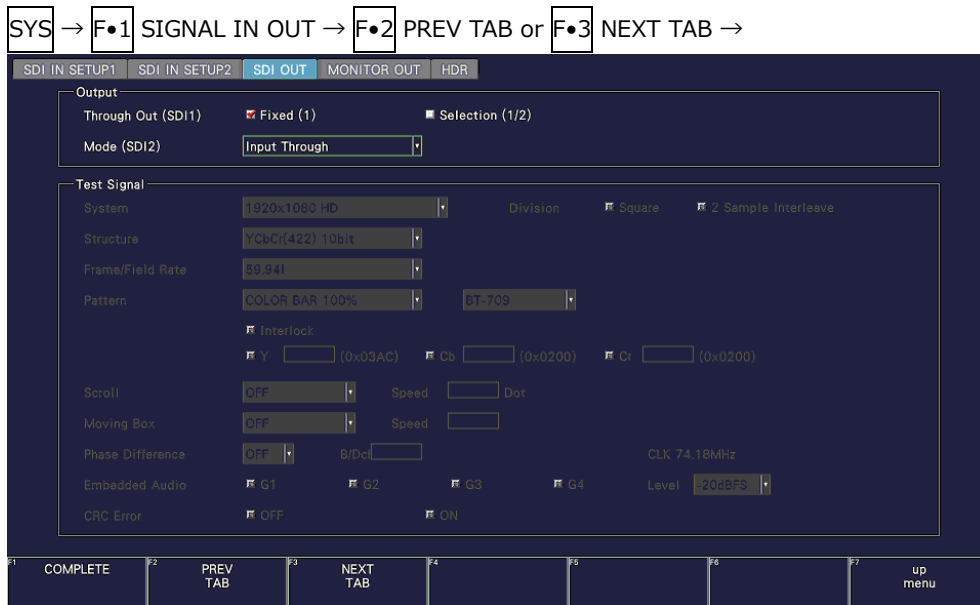

Figure 7-6 SDI OUT tab

- Through Out (SDI1)

Select the signal to output from SDI OUTPUT 1.

When SDI system setting is 2K SD/HD/3G-B-DL/3G-A and input signal is 6G-SDI, reclock output is not possible.

<u>Fixed (1):</u>	Transmits the reclocked version of the signal that has been received by the SDI INPUT 1 connector.
<u>Selection (1/2):</u>	Transmits the reclocked version of the signal that has been received by the SDI INPUT 1 and 2 connectors. To select the output channel, use the INPUT menu or F•6 INPUT SELECT on each measurement screen.

- Mode (SDI2)

Select the signal output from SDI OUTPUT 2.

If SER24 TSG is not installed, Test Signal cannot be selected.

On the LV5300/LV5300A and LV5350, you can select Monitor Out. If you select Monitor Out, SDI OUTPUT 2 transmits the instrument's screen for monitoring purposes. On the MONITOR OUT tab, select the output format.

[See also] MONITOR OUT tab → 7.1.7, "Configuring the Monitor Output Connectors."

<u>Input Through:</u>	Transmits the reclocked version of the signal that has been received by the SDI INPUT 2 connector. This is not output when the input is 6G-SDI or 12G-SDI.
<u>Test Signal:</u>	Transmits the pattern specified by Test Signal.
<u>Monitor Out</u>	Outputs the instrument's screen. (LV5300/LV5300A/LV5350)

7. SYSTEM SETTINGS

7.1.6 Configuring the TSG Settings (SER24)

When Mode (SDI2) on the SDI OUT tab is set to Test Signal, use the parameters under Test Signal to set the TSG to output from SDI OUTPUT 2 on the rear panel.

SYS → **F•1** SIGNAL IN OUT → **F•2** PREV TAB or **F•3** NEXT TAB →

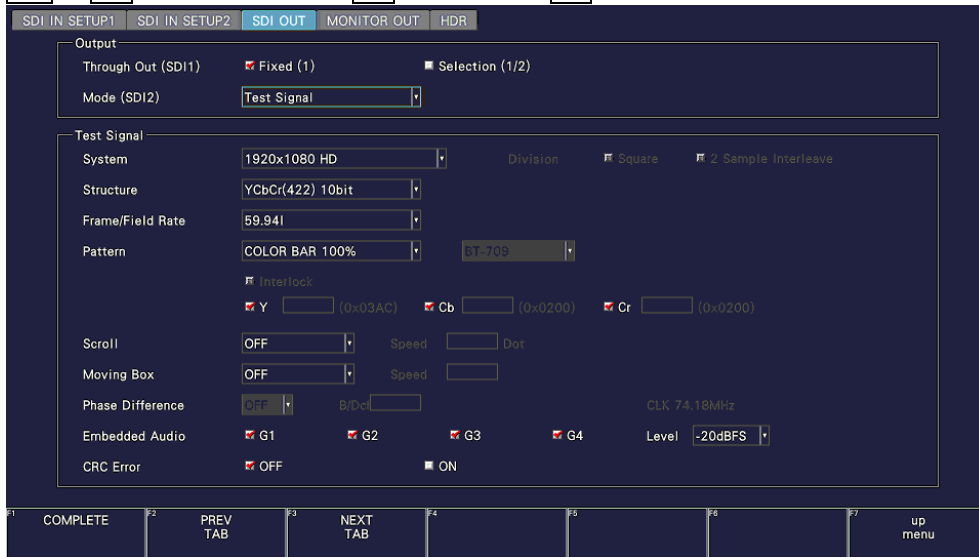

Figure 7-7 SDI OUT tab

- System
- Structure
- Frame/Field Rate

Set the output format. The possible format combinations are shown below. The default values are 1920x1080 HD, YCbCr(422) 10 bit, 59.94I.

Table 7-3 Output format selection

System	Structure	Frame/Field Rate
3840x2160 12G	YCbCr(422) 10 bit	60/59.94/50/48/47.95/P
4096x2160 12G	YCbCr(444) 10 bit RGB(444) 10 bit	30/29.97/25/24/23.98/P
3840x2160 6G 4096x2160 6G	YCbCr(422) 10bit	30/29.97/25/24/23.98/P
2048x1080 3G-B-DL 2048x1080 3G-A	YCbCr(422) 10 bit YCbCr(444) 10 bit RGB(444) 10 bit	60/59.94/50/48/47.95/P 30/29.97/25/24/23.98/P 30/29.97/25/24/23.98/PsF
1920x1080 3G-B-DL 1920x1080 3G-A	YCbCr(422) 10 bit YCbCr(444) 10 bit RGB(444) 10 bit	60/59.94/50/48/47.95/P 60/59.94/50/I 30/29.97/25/24/23.98/P 30/29.97/25/24/23.98/PsF
1920x1080 HD	YCbCr(422) 10 bit	60/59.94/50/I 30/29.97/25/24/23.98/P 30/29.97/25/24/23.98/PsF
1280x720 HD	YCbCr(422) 10 bit	60/59.94/50/P 30/29.97/25/24/23.98/P

7. SYSTEM SETTINGS

- Pattern
- Interlock

Select the output pattern. The selectable patterns are shown below. The selectable patterns vary depending on the System setting.

Depending on the pattern, you can turn on and off YCbCr or RGB separately.

For COLOR RASTER, you can set the YCbCr or RGB levels separately. Moreover, if Structure is set to RGB, you can select the Interlock check box to synchronize the RGB levels.

Table 7-4 Output pattern selection

Pattern	YCbCr/RGB on/off	Level adjustment
COLOR BAR 100%	Yes	No
COLOR BAR 75%	Yes	No
ARIB2020 COLOR BAR (*1)	Yes	No
MULTI COLOR BAR 100% (*1)	Yes	No
MULTI COLOR BAR 75% (*1)	Yes	No
MULTI COLOR BAR (+I) (*1)	Yes	No
COLOR RASTER	Yes	Yes
OETF	Yes	No
CROSS HATCH	Yes	No
10_STEP	Yes	No
LIMIT RAMP	Yes	No
CHECK FIELD	No	No
LIP SYNC (SER20)	No	No
HDR COLOR BAR (SER23) (*1)	Yes	No

* The signal will be interrupted when the pattern is changed.

*1 It cannot be set in horizontal 1280, 2048, and 4096 pixel format.

When OETF is selected, select the gamma characteristics.

BT-709 / HLG / PQ

Note that bandwidth limit is not applied to patterns other than COLOR BAR 100% and COLOR BAR 75%.

7. SYSTEM SETTINGS

- Scroll

Select the scroll direction for when a pattern is scrolled.

If a setting other than OFF is selected, Moving Box and Phase Difference are turned off.

You cannot select this when Pattern is set to CROSS HATCH.

OFF

RIGHT: Scrolls from left to right.

LEFT: Scrolls from right to left.

UP: Scrolls from bottom to top.

DOWN: Scrolls from top to bottom.

RIGHT & UP: Scrolls from lower left to upper right.

RIGHT & DOWN: Scrolls from upper left to lower right.

LEFT & UP: Scrolls from lower right to upper left.

LEFT & DOWN: Scrolls from upper right to lower left.

- Speed

When Scroll is not set to off, set the scroll speed.

4 - 124 dots (4 dot steps)

- Moving Box

If you select the color of the moving box, a square that moves randomly is superimposed.

If a setting other than OFF is selected, Scroll and Phase Difference are turned off.

OFF / WHITE / YELLOW / CYAN / GREEN / BLUE / RED / MAGENTA / BLACK

- Speed

When Moving Box is not set to off, set the moving box speed.

Greater the value, higher the speed.

1 - 3

7. SYSTEM SETTINGS

- Embedded Audio

When the pattern is not LIP SYNC, select the audio channels to embed in the SDI signal. 1 to 4ch is referred to as G1, 5 to 8ch as G2, 9 to 12ch as G3, and 13 to 16ch as G4.

The channels that can be embedded are 8 channels or 16 channels depending on the system and frame/field rate as shown below.

Table 7-5 Embedded audio settings

System	Frame/Field Rate	G1	G2	G3	G4
3840x2160 12G 4096x2160 12G 3840x2160 6G 1920x1080 3G-B-DL 1920x1080 3G-A 2048x1080 3G-A 1920x1080 HD 1280x720 HD	-	Yes	Yes	Yes	Yes
4096x2160 6G	-	Yes	Yes	No	No
2048x1080 3G-B-DL	60/59.94/30/29.97/P 30/29.97/PsF	Yes	Yes	No	No
	50/48/47.95/25/24/23.98/P 25/24/23.98/PsF	Yes	Yes	Yes	Yes

- Level

Select the embedded audio level.

-20dBFS / -18dBFS / 0dBFS / Mute

- CRC Error

When set to on, an incorrect CRC is inserted into the Y component of the first line.

OFF / ON

7. SYSTEM SETTINGS

7.1.7 Configuring the Monitor Output Connectors

On the LV5300/LV5300A and LV5350, use LCD/SDI on the MONITOR OUT tab to specify the SDI signal (Monitor Out) transmitted from SDI OUTPUT 2 on the rear panel when Mode (SDI2) is set to Monitor Out on the SDI OUT tab and configure the instrument's LCD settings.

On the LV7300, use LCD, TMDS, and SDI on the MONITOR OUT tab to configure the MONITOR OUTPUT connectors on the rear panel.

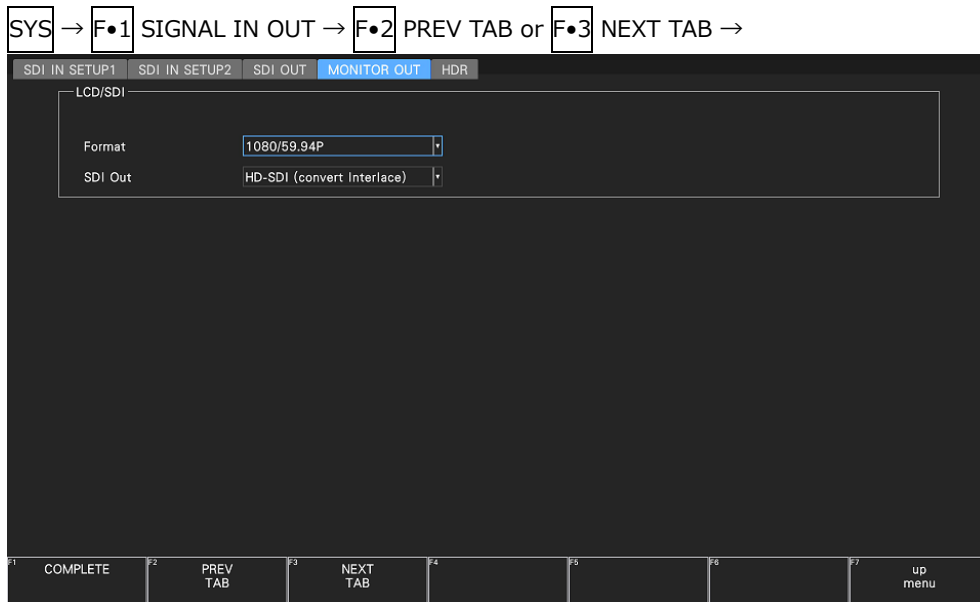

Figure 7-8 MONITOR OUT tab

- Format

Select the frame frequency of the output signal.

1080/60P / 1080/59.94P / 1080/50P / 1080/48P / 1080/47.95P

- SDI Out

Select the output format of the SDI signal.

If HD-SDI (convert Interlace) is selected, the frame frequency selected with Format is switched and output in the following manner.

1080/60P → 1080/60I

1080/59.94P → 1080/59.94I

1080/50P → 1080/50I

1080/48P → 1080/24PsF (*1)

1080/47.95P → 1080/23.98PsF (*1)

*1 Equivalent to 48I when the SDI input is 48P.

HD-SDI (convert Interlace) / 3G-SDI Level-A / 3G-SDI Level-B

7. SYSTEM SETTINGS

7.1.8 Configuring the HDR Settings (SER23)

On the HDR tab, configure the settings of HDR measurement for each display channel (Input A/B).

SYS → F•1 SIGNAL IN OUT → F•2 PREV TAB or F•3 NEXT TAB →

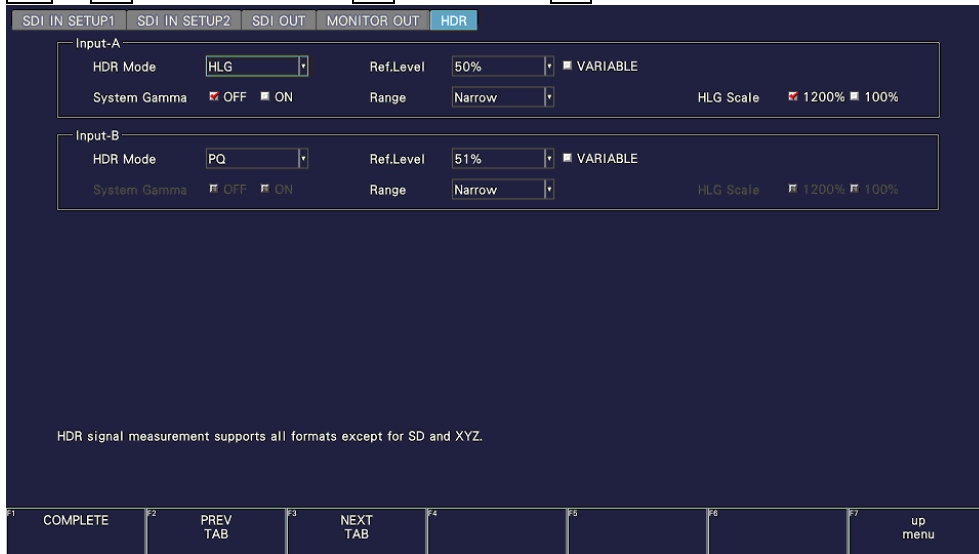

Figure 7-9 HDR tab

7. SYSTEM SETTINGS

- HDR Mode

Turn of the HDR measurement, or select the HDR signal standard. If you select an HDR signal standard, HDR signals can be measured on the video-signal-waveform, vector, and picture displays.

HLG and PQ refer to ITU-R BT.2100, and S-Log3, C-Log and Log-C refer to the log curve output from cameras of other manufacturers.

OFF:	An HDR scale is not displayed.
HLG:	When HLG Scale is 1200% (default value), 0 to 100% is displayed as 0 to 1200%. When HLG Scale is 100% (default value), 0 to 100% is displayed as 0 to 100%.
PQ:	0 to 100 % is displayed as 0 to 10000 Nits.
S-Log3:	If 0 to 100% is set to 64 to 940, 95 to 940 is displayed as 0 to 2055%.
C-Log:	Displays the percentage with the SDI code value 128 assumed to 0% and 614 assumed to be 100%
Log-C:	EI = 200 Displays the percentage with the SDI code value 95 assumed to 0.39% and 853 assumed to be 83% EI = 400 Displays the percentage with the SDI code value 95 assumed to 0.39% and 917 assumed to be 90% EI = 800 Displays the percentage with the SDI code value 95 assumed to 0.39% and 976 assumed to be 95% EI = 1600 Displays the percentage with the SDI code value 95 assumed to 0.39% and 1022 assumed to be 94%
PayloadID UnSpec:S-Log3:	Operates in OFF (SDR-TV), HLG, or PQ mode according to the payload ID information. When the payload ID information is Unspecified, the instrument operates in S-Log3 mode.
PayloadID UnSpec:C-Log:	Operates in OFF (SDR-TV), HLG, or PQ mode according to the payload ID information. When the payload ID information is Unspecified, the instrument operates in C-Log mode.
PayloadID UnSpec:Log-C:	Operates in OFF (SDR-TV), HLG, or PQ mode according to the payload ID information. When the payload ID information is Unspecified, the instrument operates in Log-C mode.

7. SYSTEM SETTINGS

- Ref. Level

When HDR Mode is set to HLG or PQ, select the reference level for the program production. When HDR Mode is set to S-Log3, C-Log, or Log-C, it is set to default value and cannot be selected.

When the HDR mode is set to PayloadID UnSpec:S-Log3, PayloadID UnSpec:C-Log, or PayloadID UnSpec:Log-C, select the level by combining the HLG and PQ levels. The HLG or PQ reference level selected with Ref. Level is applied according to the payload ID information. When the payload ID information is Unspecified, the S-Log3, C-Log, or Log-C reference level is applied. When the payload ID information is OFF (SDR-TV), the reference level is not applied.

On the video signal waveform display, the selected reference level is shown using broken lines on the scale.

On the picture display, the selected reference level is set to the REF default value on the HDR signal CINEZONE display. The REF default value is applied when you press the function dial (F•D).

HDR Mode = HLG

50% / 75%

HDR Mode = PQ

51% / 58%

HDR Mode = S-Log3

61%

HDR Mode = C-Log

63%

HDR Mode = Log-C

58%

HDR Mode = PayloadID UnSpec:S-Log3

HLG:50%,PQ:51% / HLG:50%,PQ:58% / HLG:75%,PQ:51% / HLG:75%,PQ:58%

HDR Mode = PayloadID UnSpec:C-Log

HLG:50%,PQ:51% / HLG:50%,PQ:58% / HLG:75%,PQ:51% / HLG:75%,PQ:58%

HDR Mode = PayloadID UnSpec:Log-C

HLG:50%,PQ:51% / HLG:50%,PQ:58% / HLG:75%,PQ:51% / HLG:75%,PQ:58%

- Variable

Select whether to enable the reference level setting.

The default reference level is set to the Ref.Level value.

OFF / ON

7. SYSTEM SETTINGS

- EI

When HDR mode is set to Log-C, select the EI value.

200 / 400 / 800 / 1600

- System Gamma

When HDR Mode is set to HLG or S-Log3, turn system gamma on or off.

If system gamma is set to on, the scale corresponding to the HDR signal of the video signal waveform display and picture display is shown in Nits, which is a unit of display intensity for HLG displays.

When HDR Mode is set to HLG, gamma 1.2 is used to calculate the intensity with the full scale ranging up to 1000Nits.

When HDR Mode is set to S-Log3, the intensity is displayed with the full scale ranging up to 3000Nits.

OFF / ON

- Range

When HDR Mode is set to HLG or PQ, select the range.

Narrow / Full

- HLG Scale

When HDR Mode is set to HLG, select the HDR scale display.

<u>1200%:</u>	0 to 100 % is displayed as 0 to 1200%.
<u>100%</u>	0 to 100 % is displayed as 0 to 100%.

7. SYSTEM SETTINGS

7.2 Configuring the Instrument

To configure the instrument, press **F•2** SYSTEM SETUP on the SYS menu.

7.2.1 General Settings

Use General on the GENERAL tab to configure general settings of the instrument. They are not reset even if you initialize the settings. In addition, they are not recorded to presets.

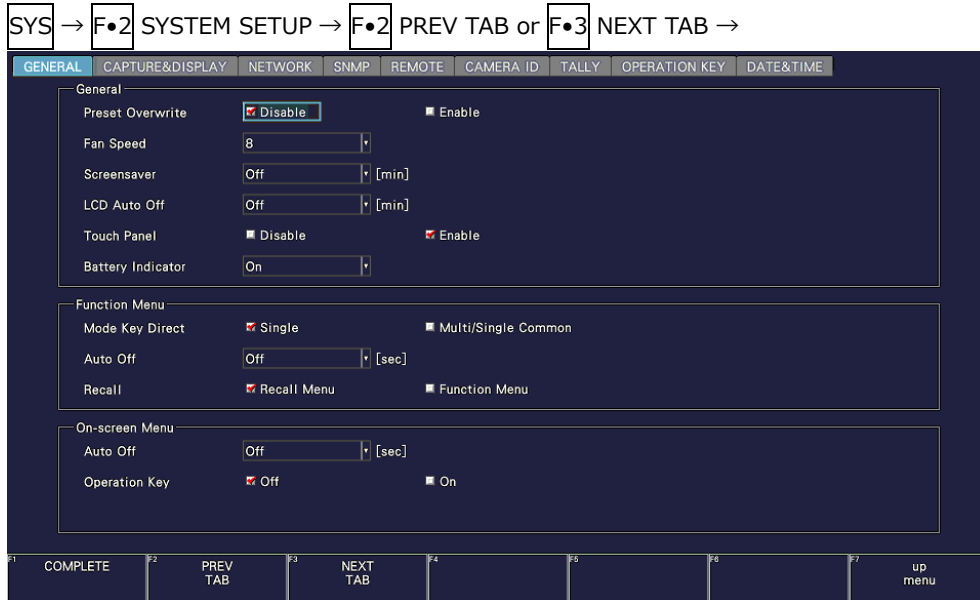

Figure 7-10 GENERAL tab

- Preset Overwrite

Select whether to enable overwriting when registering presets.
Disable this to prevent overwriting presets.

Disable / Enable

- Fan Speed

Select the fan speed.

The larger the value, the higher the speed and the higher the cooling capability. In contrast, the smaller the value, the quieter the fan noise.

The settings that you specify here will not be initialized even if you initialize the instrument. In addition, they are not recorded to presets.

LV5300/LV5300A / LV7300-SER02

4 / 5 / 6 / 7 / 8

LV5350 / LV7300-SER01

1 / 2 / 3 / 4 / 5 / 6 / 7 / 8

7. SYSTEM SETTINGS

- Screensaver

Select the length of time that must elapse without any key operations for the screen saver to start.

To clear the screen saver, press any key excluding the power switch, double-click, or operate the touch panel.

Off / 1 / 5 / 10 / 20 / 30 / 60 [min]

- LCD Auto Off (LV5300/LV5300A/LV5350)

Select the length of time that must elapse after the last key operation before the backlight is automatically turned off.

To turn it on again, press any key excluding the power switch, double-click, or operate the touch panel.

Off / 5 / 30 / 60 [min]

- Touch Panel (LV5300/LV5300A/LV5350)

Select whether to enable the touch panel function.

Disable / Enable

- Battery Indicator (SER11/SER12)

When SER11 or SER12 is installed, select whether to show the battery level in the upper right of the measurement screen.

Off / On

7.2.2 Configuring the Function Menu

Use Function Menu on the GENERAL tab to configure the function menu.

SYS → **F•2** SYSTEM SETUP → **F•2** PREV TAB or **F•3** NEXT TAB →

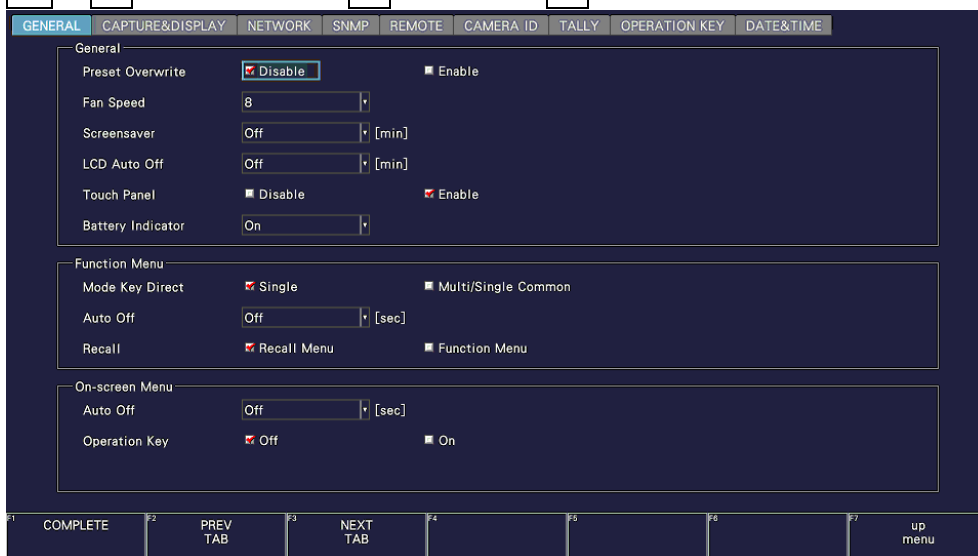

Figure 7-11 GENERAL tab

7. SYSTEM SETTINGS

- Mode Key Direct

In multi-screen display, you can select whether to switch the measurement screen with the mode keys (WFM, VECT, PIC, AUDIO, STATUS, and EYE).

Single:	Using the mode key switches the function menu and measurement screen.
<u>Multi/Single Common</u> :	Using the mode key switches only the function menu. The measurement screen does not change from the multi-screen display. To display the function menu on the multi-screen display, hold down MULTI for about 2 seconds.

- Auto Off

Set the length of time that must elapse without any key operations for the function menu to disappear automatically.

If set to off, the menu will not disappear automatically, but for example, the measurement menu can be temporarily hidden by pressing the MODE key again.

Even if set to a value other than off, some menus, such as the SYS menu, never automatically disappear.

Off / 1 / 2 / 3 / 4 / 5 / 10 / 20 / 30 / 60 [sec]

- Recall

Select the menu to be displayed when recalling presets.

<u>Recall Menu</u> :	The Recall menu is displayed.
<u>Function Menu</u> :	The measurement menu is displayed.

7.2.3 Configuring the On-screen Menu

Use On-screen Menu on the GENERAL tab to configure the on-screen menu.

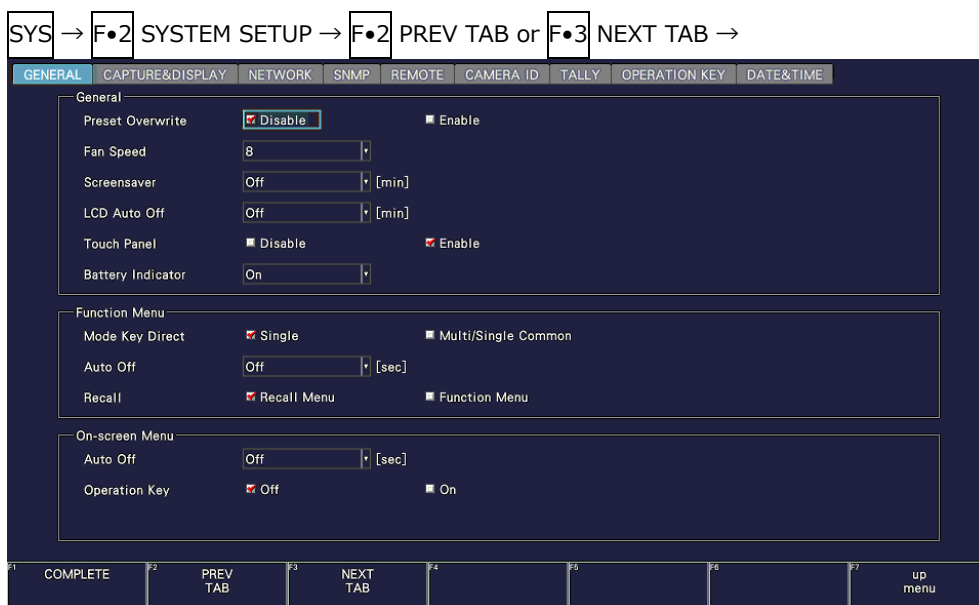

Figure 7-12 GENERAL tab

7. SYSTEM SETTINGS

- Auto Off

For keys on the screen controlled with the mouse or touch panel, select the length of time that must elapse without any key operations for the keys to disappear automatically.

Off / 1 / 2 / 3 / 4 / 5 / 10 / 20 / 30 / 60 [sec]

- Operation Key

Set whether to include the operation key in the keys on the screen controlled with the mouse or touch panel.

Off / On

7.2.4 Configuring the Capture Feature

Use Capture on the CAPTURE & DISPLAY tab to configure the capture feature.

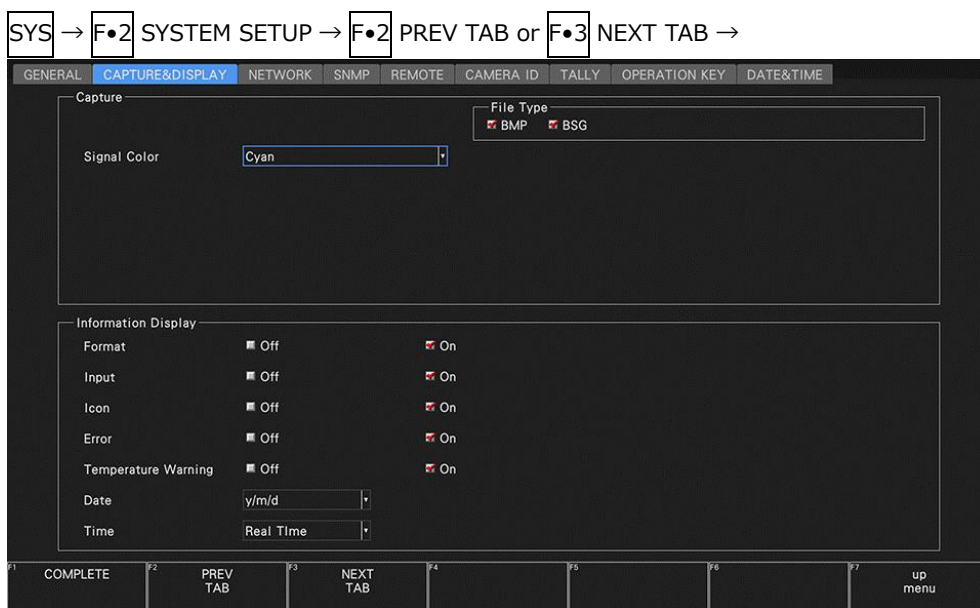

Figure 7-13 CAPTURE & DISPLAY tab

- Signal Color

Select the capture waveform color.

White / Yellow / Cyan / Green / Magenta / Red / Blue

- File Type

Turns on the file format for saving the captured screen data to a USB memory device. [See also] 8, "CAPTURE FEATURE"

BMP: Files are saved to a USB memory device in BMP format. You can view the saved files on a PC.

BSG: Files are saved to a USB memory device in BSG format. You can view the saved files on the instrument.

* By default, BMP and BSG are both on. You cannot set both of these settings to OFF.

7.2.5 Configuring the Information Display

Use Information Display on the CAPTURE & DISPLAY tab to configure the information display.

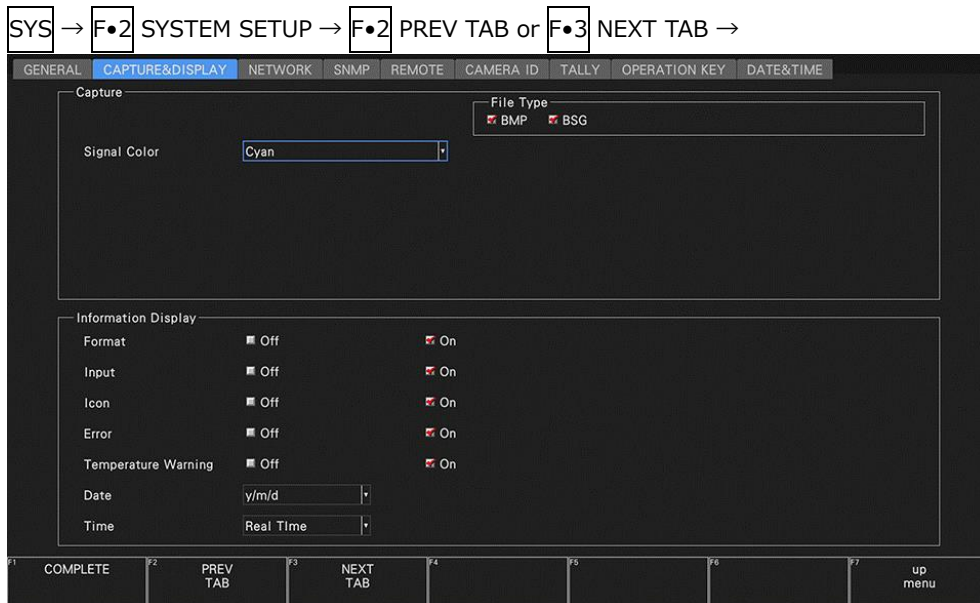

Figure 7-14 CAPTURE & DISPLAY tab

- Format

Turns on and off the format display (e.g., 1920x1080/59.94I YCbCr(422) 10bit HD). This setting is valid when a FORMAT item or Format option is placed in the layout.



Off / On

- Input

Turns on and off the input signal display (e.g., SDI A). This setting is valid when a INPUT item or Input option is placed in the layout.

Off / On

- Icon

Turns on and off the mouse icon , key lock icon , and USB memory icon . If you turn this off, you will not be able to tell from the screen whether a mouse, the US interface of a touch panel monitor, or a USB memory device is connected. [See also] 5.6, "Measurement Screen Description"

Off / On

- Temperature Warning

Turns on and off the alarm display (TEMPERATURE) that appears when the internal temperature increases.

"OVER HEAT" will still be displayed even if this is set to off.

[See also] 7.2.15, "Displaying System Information"

Off / On

7. SYSTEM SETTINGS

- Error

Turn on or off the error display in the upper right of the measurement screen.
[See also] 5.6, "Measurement Screen Description"

Off / On

- Date

Select the display format of the date. y is the Gregorian year, m is the month, and d is the day.

This setting is valid when a DATE item is placed in the layout.

Off / y/m/d / m/d/y / d/m/y

- Time

Select the display format of the time.

This setting is valid when a TIME item or Time option is placed in the layout, in the clear screen log of the picture display, and in the event log of the status display.

Off / Real Time / LTC / VITC / D-VITC

7.2.6 Setting the Network IP

Use IP on the NETWORK tab to configure network IP settings and view the MAC address. The settings that you specify here will not be initialized even if you initialize the instrument. In addition, they are not recorded to presets.

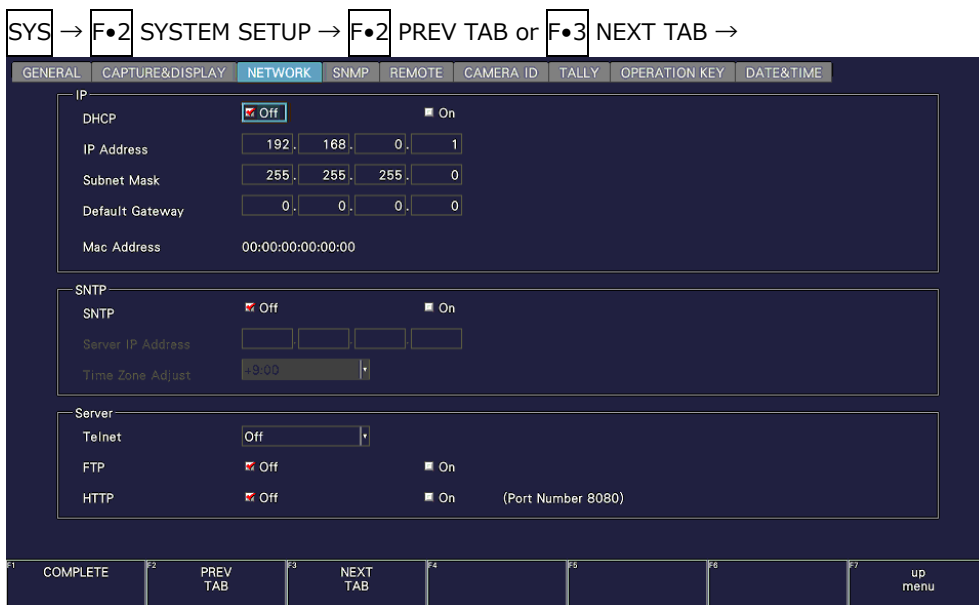

Figure 7-15 NETWORK tab

7. SYSTEM SETTINGS

- DHCP

Select how to set the IP address.

Off: Enter the IP address, subnet mask, and default gateway manually.

On: The IP address, subnet mask, and default gateway are set automatically.

- IP Address

- Subnet Mask

- Default Gateway

Set the IP address, subnet mask, and default gateway.

- MAC Address

Displays the MAC address.

7.2.7 Configuring SNTP

Use SNTP on the NETWORK tab to configure the SNTP parameters.

The settings that you specify here will not be initialized even if you initialize the instrument.

In addition, they are not recorded to presets.

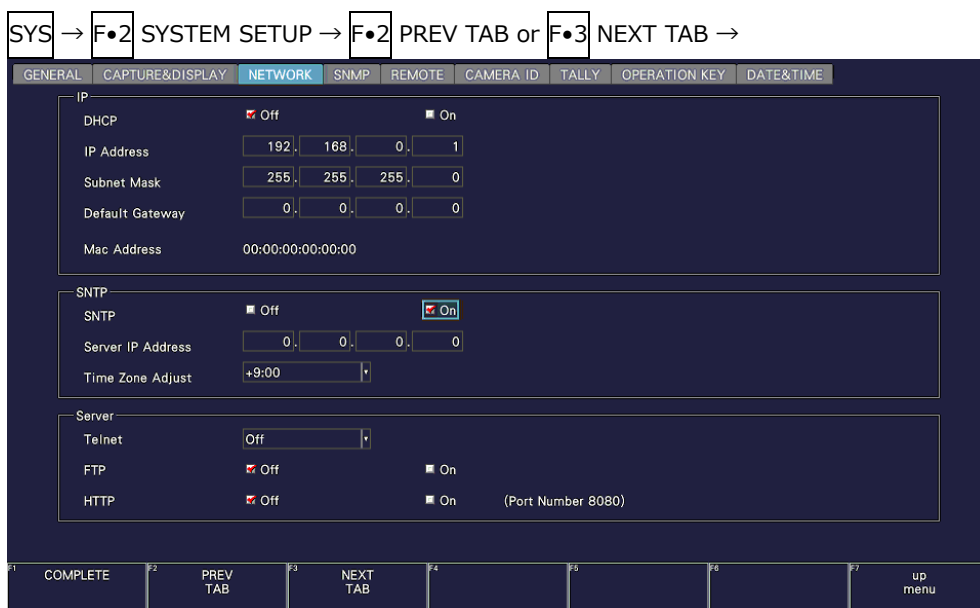

Figure 7-16 NETWORK tab

- SNTP

Select whether to enable the SNTP client function.

When set to On, enter the NTP server IP address in Server IP Address and the time adjustment value in Time Zone Adjust.

Off / On

7. SYSTEM SETTINGS

- Server IP Address
- Time Zone Adjust

When the SNTP client function is set to ON, enter the NTP server IP address in Server IP Address and the time adjustment value in Time Zone Adjust.

7.2.8 Configuring the Server

Use Server on the NETWORK tab to configure the TELNE, FTP, and HTTP. The settings that you specify here will not be initialized even if you initialize the instrument. In addition, they are not recorded to presets.

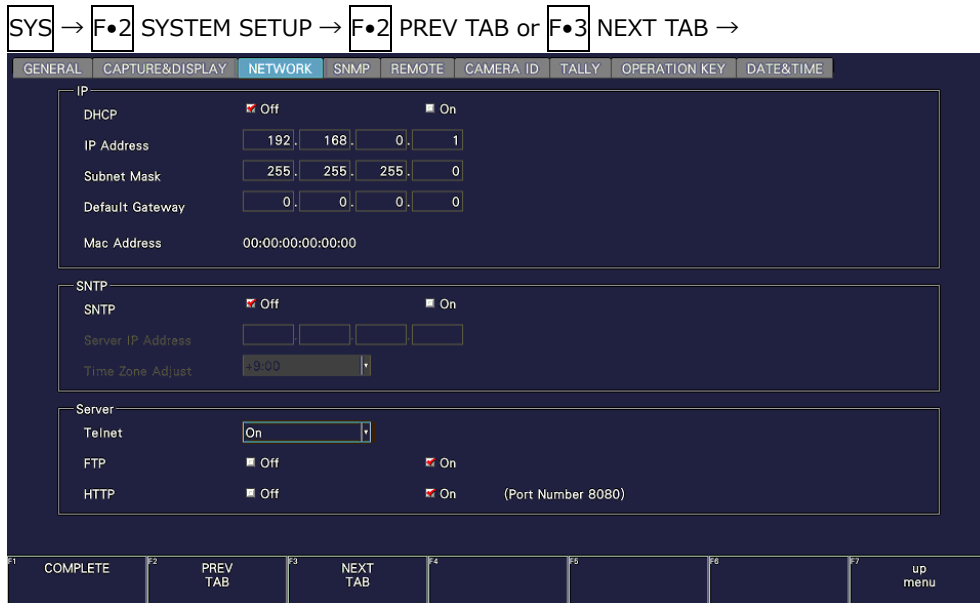

Figure 7-17 NETWORK tab

- Telnet

Select whether to enable the TELNET server feature and the LV7290 REMOTE CONTROLLER.

You cannot use TELNET and the LV7290 at the same time.

Off / On / LV7290

- FTP Server

Select whether to enable the FTP server function.

Off / On

- HTTP Server

Select whether to enable the HTTP server feature.

Off / On

7. SYSTEM SETTINGS

7.2.9 Configuring SNMP

Use SNTP tab to configure the SNTP parameters.

The settings that you specify here will not be initialized even if you initialize the instrument. Nor are they recorded to presets.

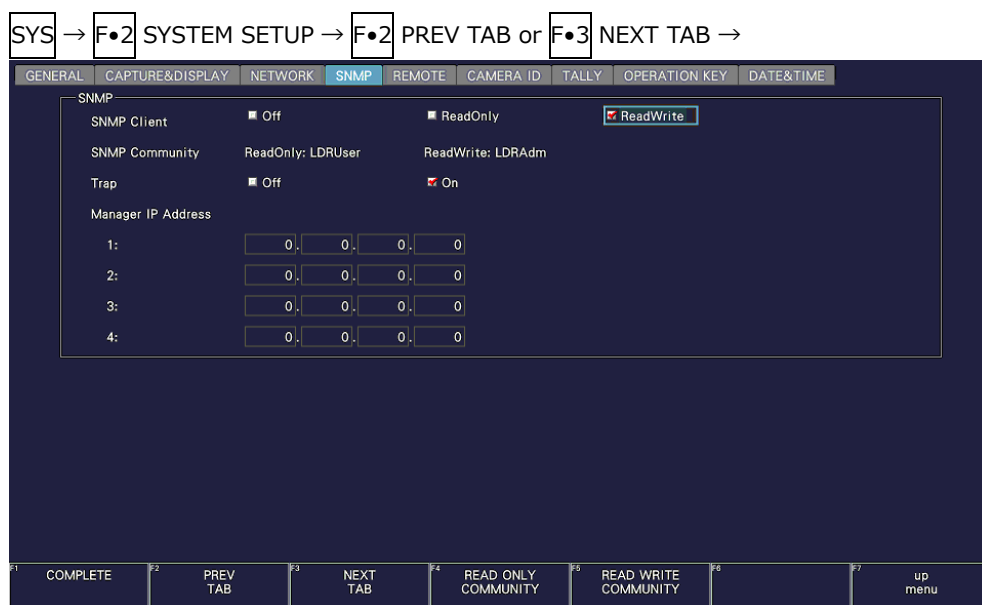

Figure 7-18 SNMP tab

- SNMP Client

Select the SNMP access mode.

<u>Off</u> :	SNMP cannot be used.
ReadOnly:	Settings can be read.
ReadWrite:	Settings can be read and written.

- SNMP Community

Shows the SNMP community name.

The default values are shown below. You can change them using F•4 READ ONLY COMMUNITY and F•5 READ WRITE COMMUNITY. You cannot change the community name of TRAP.

Enter a comment using up to 15 characters.

Default

ReadOnly:	LDRUser
ReadWrite:	LDRAdm
TRAP:	LDRUser

7. SYSTEM SETTINGS

You can use the following keys on the SNMP community name input screen.

F•1	CLEAR ALL	Deletes all characters
F•2	DELETE	Deletes the character at the cursor
F•3	INSERT	Inserts the selected character at the cursor position
F•4	<=	Moves the cursor to the left
F•5	=>	Moves the cursor to the right
F•6	CHAR SET	Enters the character
Function dial (F•D)		Turn to select a character, and press to enter the character.

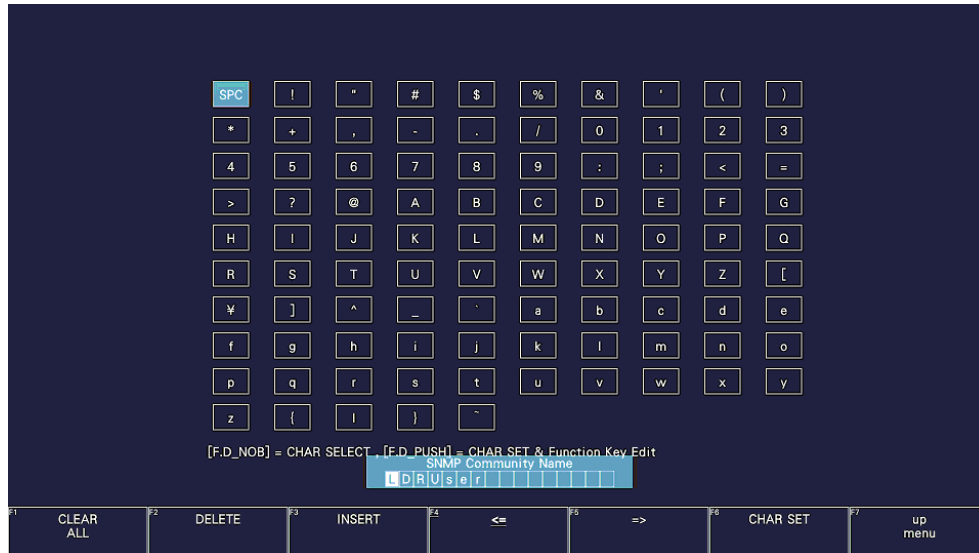

Figure 7-19 Community name input screen

- Trap

Select whether to enable SNMP trap output.

Off / On

- Manager IP Address

Shows up to four SNMP manager IP addresses.

- Saving the enterprise MIB file to USB memory device

To save the enterprise MIB file to USB memory device, follow the procedure shown below.

1. Connect a USB memory device to the instrument.

2. Press **F•6** USB MEMORY.

7. SYSTEM SETTINGS

3. Press **F•1** MIB FILE COPY.

The enterprise MIB file is saved to USB memory device.

Enterprise MIB file is saved to the following locations.

- 📁 USB memory device
 - 📁 LV5300_USER, LV5350_USER or LV7300_USER
 - 📁 MIB
 - 📄 lv5300.my, lv5350.my or lv7300.my

When the enterprise MIB file exists in the USB memory device, **F•1** OVER WRITE YES and **F•3** OVER WRITE NO appear.

To overwrite, press **F•1** OVER WRITE YES. To not overwrite, press **F•3** OVER WRITE NO.

7.2.10 Configuring the Remote Control Settings

Use the REMOTE tab to configure remote control settings.

The settings that you specify here will not be initialized even if you initialize the instrument.

In addition, they are not recorded to presets.

[See also] 10, "REMOTE CONTROL"

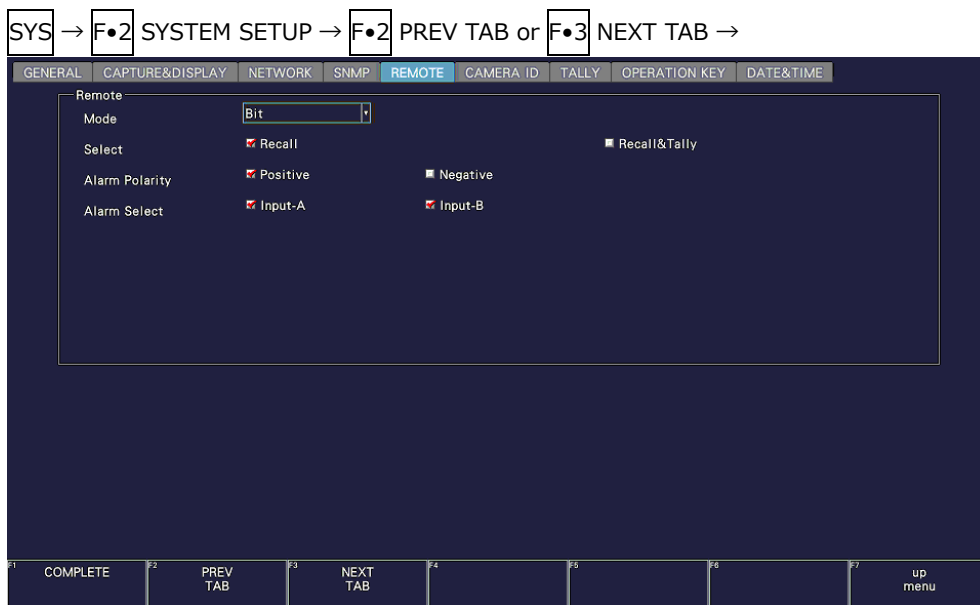

- Mode

Select the method for loading presets.

<u>Bit</u> :	Use pin 2 (/P1) to pin 9 (/P8) to load presets 1 to 8.
<u>Binary</u> :	Set pin 2 (/P1) as the least significant bit and pin 7 (/P6) as the most significant bit, and use binary code to load presets 1 to 60.
<u>Command</u> :	Recalls presets (1 to 60), selects channels, outputs alarms, and displays tallies (1/2).
<u>Tally</u> :	Outputs alarms and displays tallies (1/2/EXT). (SER27)

7. SYSTEM SETTINGS

- Select (SER27)

When Mode is Bit or Binary, select the function to assign to pin 10 (/ACH), pin 11 (/BCH), pin 12 (/CCH), and pin 13 (/DCH) of the remote connector. When Mode is Command or Tally, select Recall.

This does not appear when SER27 is not installed.

<u>Recall:</u>	Assign preset recalling.
<u>Recall&Tally:</u>	Assigned tally control.

- Alarm Polarity

Select the alarm output polarity.

<u>Positive:</u>	A high signal is transmitted when an error is detected.
<u>Negative:</u>	A low signal is transmitted when an error is detected.

- Alarm Select

Select the display channel that errors are detected on for transmitting alarms. By default, all the check boxes are selected.

Input-A / Input-B

7.2.11 Setting the Camera ID (SER27)

Use the CAMERA ID tab to select the placement of the camera ID and set the label.

The procedures for Camera ID Label-1, Camera ID Label-2, and Camera ID Label-IRIS are the same.

The settings that you specify here (except the placement selection and label setting) will not be initialized even if you initialize the instrument. In addition, they are not recorded to presets.



Figure 7-21 CAMERA ID tab

7. SYSTEM SETTINGS

- Control Select

Set the camera ID from the instrument.

To camera ID is displayed for the LABEL-1, LABEL-2, and IRIS items on the layout.

Local

- Selecting the placement

Select the placement of the camera ID.

LEFT / CENTER / RIGHT

- Setting the label

The default camera ID labels are CAM A to CAM D, but you can change them by selecting their check boxes and pressing **F•5** LOCAL LABEL INPUT. Enter up to 16 characters.

You can use the following keys on the camera ID input screen.

F•1	CLEAR ALL	Deletes all characters
F•2	DELETE	Deletes the character at the cursor
F•3	INSERT	Inserts the selected character at the cursor position
F•4	<=	Moves the cursor to the left
F•5	=>	Moves the cursor to the right
F•6	CHAR SET	Enters the character
Function dial (F•D)		Turn to select a character, and press to enter the character.

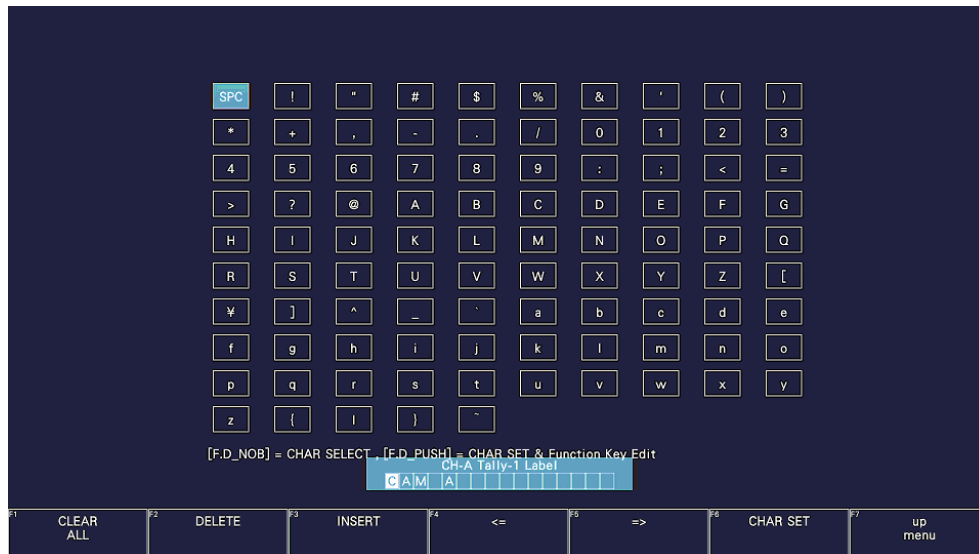

Figure 7-22 Camera ID label input screen

7. SYSTEM SETTINGS

7.2.12 Configuring the Tally Display (SER27)

Use the TALLY tab to configure the settings of the TALLY item placed in the layout.

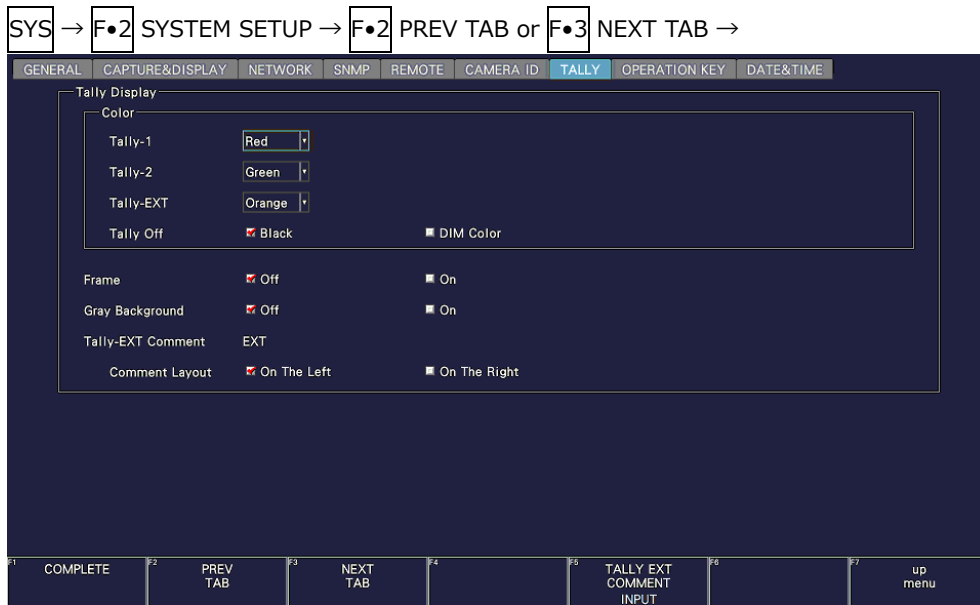

Figure 7-23 TALLY tab

- Tally-1, Tally-2, Tally-EXT

Select the color of the TALLY item placed in the layout. The default values are red for Tally-1, green for Tally-2, and orange for Tally-EXT.

Red / Green / Blue / Cyan / Magenta / Yellow / Orange

- Tally Off

Select the color of the TALLY item placed in the layout and that of the tally frame for when the tally is off.

Black: No color is displayed.
DIM COLOR: The selected color is displayed dimly.

- Frame

Turns on and off the frame of the LABEL-1, LABEL-2, IRIS, TALLY-1, and TALLY-2 items placed in the layout.

(The frame of the TALLY-EXT item is always shown.)

Off / On

- Gray Background

Select whether to display the background of the LABEL-1, LABEL-2, IRIS, and TALLY-EXT items placed in the layout in gray.

Off / On

7. SYSTEM SETTINGS

- Tally-EXT Comment

Displays the comment of the TALLY-EXT item placed in the layout.

The default value is EXT, but you can change it using **F•5** TALLY EXT COMMENT INPUT.

Enter a comment using up to eight characters.

You can use the following keys on the comment input screen.

F•1	CLEAR ALL	Deletes all characters
F•2	DELETE	Deletes the character at the cursor
F•3	INSERT	Inserts the selected character at the cursor position
F•4	<=	Moves the cursor to the left
F•5	=>	Moves the cursor to the right
F•6	CHAR SET	Enters the character
Function dial (F•D)		Turn to select a character, and press to enter the character.

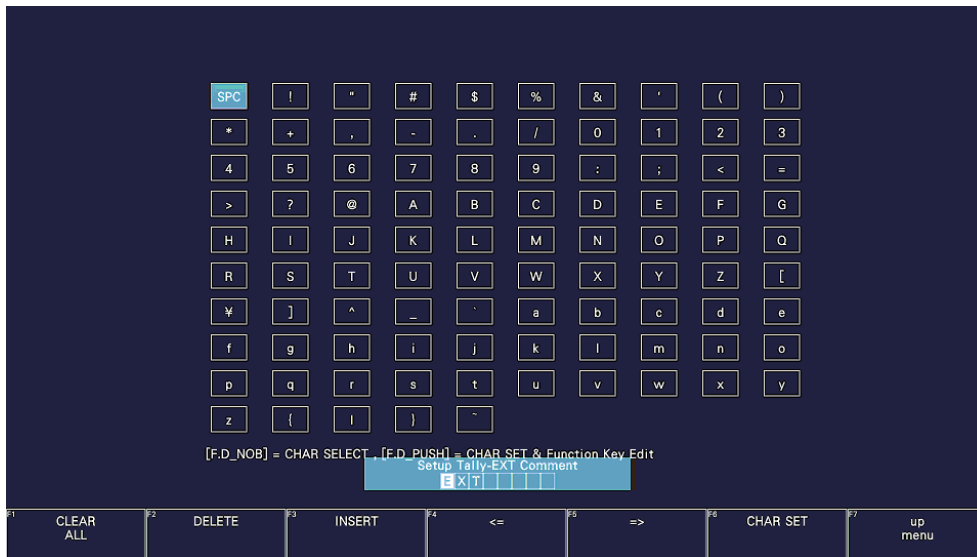

Figure 7-24 Comment input screen

- Comment Layout

Select the comment position of the TALLY-EXT item placed in the layout.

on the left: Places the comment on the left.

on the right: Places the comment on the right.

7. SYSTEM SETTINGS

7.2.13 Setting the Operation keys

Use the OPERATION KEY tab to set the operation keys.



Figure 7-25 OPERATION KEY tab

- FORM

Set the display format and display order to apply when the FORM key is pressed on the video signal waveform display or vector display. Select SKIP to skip an item.

WFM: Y / YCbCr / YGBR / GBR / YRGB / RGB / COMPOSITE / SKIP
 VECTOR: COMPONENT / COMPOSITE / SKIP

- SHORT CUT

Select the action to perform when the S-CUT key is pressed.

DIRECT: The previously registered panel settings will be loaded. To register the panel settings, configure the instrument to the settings that you want to register, press MEM, and then press SHORTCUT.

CAP&WAIT: A screen capture will be taken and saved to a USB memory device. Connect a USB memory device in advance.

INTENSITY: Use the function menu shown in the lower right of the screen to adjust the waveform intensity. This is valid on the video signal waveform display, vector display, and audio display. When a mouse is connected, clicking the function menu resets the value to the default. When using the touch panel, tapping the function menu resets the value to the default.

CURSOR: Performs cursor measurement. This is valid on the video signal waveform display and vector display.

VOLUME: Use the function menu shown in the lower right of the screen to adjust the headphone volume. When a mouse is connected, clicking the function menu resets the value to the default. When using the touch panel, tapping the function menu resets the value to the default.

7. SYSTEM SETTINGS

- FILTER

Set the filter and display order to apply when the FILTER key is pressed in the pseudo-composite display of the video signal waveform display. Select SKIP to skip an item. Note that for component display, the FILTER key is used to switch between FLAT and LOWPASS.

FLAT / LUM / FLAT+LUM / LUM+CRMA / SKIP

- MAG(GAIN)

Set the magnification and display order to apply when the MAG (GAIN) key is pressed on the video signal waveform display or vector display. Select SKIP to skip an item.

WFM: X1 / X5 0% / X5 10% / X5 20% / X5 30% / X5 40% / X5 50% / X5 60% / X5 70% / X5 80% / X5 90% / X5 100% / X10 0% / X10 10% / X10 20% / X10 30% / X10 40% / X10 50% / X10 60% / X10 70% / X10 80% / X10 90% / X10 100% / SKIP

VECTOR: X1 / X5 / IQ-MAG / SKIP

- SWEEP

Set the sweep method and display order to apply when the SWEEP key is pressed on the video signal waveform display. Select SKIP to skip an item.

1H / 2H / 1V / 2V / SKIP

- MAG(SWEEP)

Set the horizontal magnification and display order to apply when the MAG (SWEEP) key is pressed on the video signal waveform display. Select SKIP to skip an item.

X1 / X10 / X20 / X40 / ACTIVE / BLANK / SKIP

7. SYSTEM SETTINGS

7.2.14 Date and time settings

Use the DATE&TIME tab to set the date and time.

You cannot set these settings when the SNTP client function is set to on.

The settings that you specify here will not be initialized even if you initialize the instrument.

In addition, they are not recorded to presets.

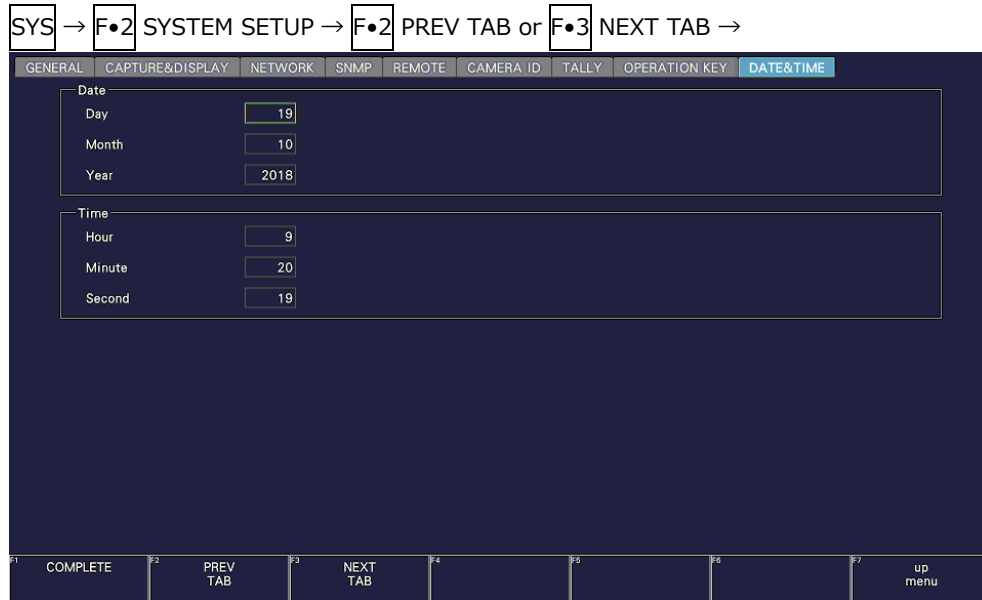

Figure 7-26 DATE & TIME tab

7. SYSTEM SETTINGS

7.2.15 Configuring the LV7290

You can configure the LV 7290 REMOTE CONTROLLER (sold separately) on the LV7290 SETUP tab.

If LV7290 is not selected under Telnet on the NETWORK tab, the LV7290 will not be displayed.

[See also] Telnet → 7.2.8, "Configuring the Server"

The connection to the LV7290 will be disconnected as soon as you change the LV7290 settings.

The settings that you specify here will not be initialized even if you initialize the instrument. Nor are they recorded to presets.



Figure 7-27 LV7290 tab

- Remote Controller

Select whether to send the IP address, subnet mask, and default gateway settings to the LV7290.

Off / On

- IP Address / Subnet Mask / Default Gateway

Set the LV7290's IP address, subnet mask, and default gateway.

- Remote Label

Displays the label of the REMOTE LABEL item placed in the layout.

There is no label in the default settings, but, you can press F•5 REMOTE LABEL INPUT to enter a label.

Enter up to 16 characters.

7. SYSTEM SETTINGS

You can use the following keys on the label input screen.

F•1	CLEAR ALL	Deletes all characters
F•2	DELETE	Deletes the character at the cursor
F•3	INSERT	Inserts the selected character at the cursor position
F•4	<=	Moves the cursor to the left
F•5	=>	Moves the cursor to the right
F•6	CHAR SET	Enters the character
Function dial (F•D)		Turn to select a character, and press to enter the character.

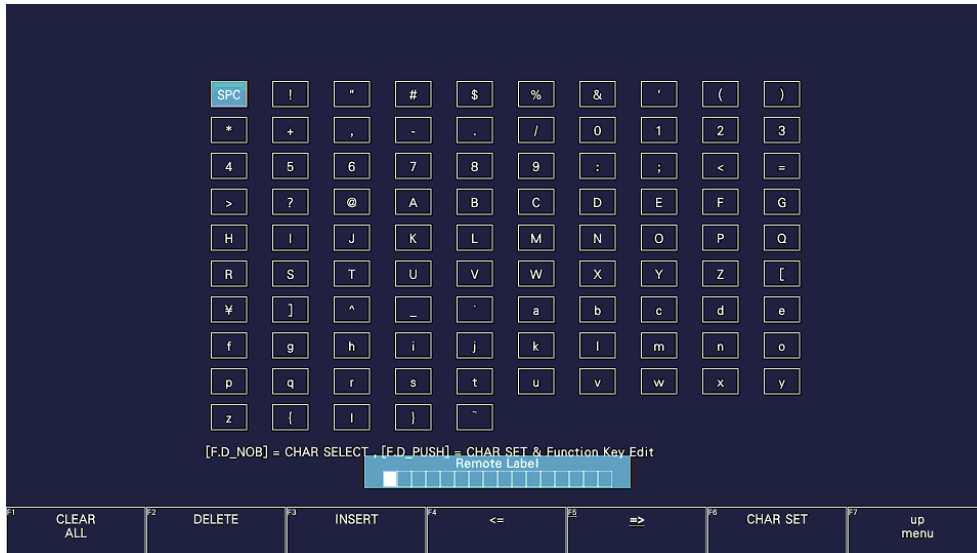

Figure 7-28 Label input screen

- Frame

Turns on and off the frame of the REMOTE LABEL item placed in the layout.

Off / On

- Gray Background

Select whether to display the background of the REMOTE LABEL item placed in the layout in gray.

Off / On

- Connect Destination

Select whether to send the LV5300/LV5300A's, LV5350's and LV7300's IP address to the LV7290.

Off / On

- UNIT-1 to 8 IP Address

Set the connection destination LV5300/LV5300A, LV5350 and LV7300 IP addresses.

7. SYSTEM SETTINGS

- Temperature

The internal temperature is displayed in a bar graph.

The internal temperature is displayed using 6 levels. Green levels indicate normal temperature. If the temperature increases and reaches the yellow area, a "TEMPERATURE" alarm appears at the top of the measurement screen.

If the internal temperature increases still further and reaches the red area, the alarm "OVER HEAT" appears in the upper left area of the measurement screen. When a specific temperature is reached, the power will be shut down.

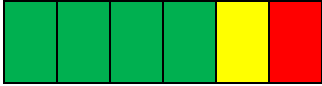

If either of these alarm appears, immediately turn the power off, and then check for problems with the operating environment. If this alarm appears even though there are no problems with the operating environment, contact your local LEADER agent.

7.4 Installing Software Options

To install options, use **F•4** LICENSE on the SYS menu.

You can use this screen to view the MAC address and install options.

[See also] 2.3, "Software Options"



Figure 7-30 LICENSE tab

- Installing an Option

Have your license key ready, and follow the procedure below.

1. Use the function dial (F•D) to enter the license key number.

Press **F•2** CLEAR to clear the license key to 0000000000.

2. Press **F•3** REGISTER.

"Accepted" appears if the license key has been entered correctly, and the corresponding option becomes usable. The name of the option that has been installed appears in the License List.

"Failed" appears if the license key is not correct. Reenter the license key correctly.

- Disabling an Option

Have your license key ready, and follow the procedure below.

1. Use the function dial (F•D) to enter the license key number.

Press **F•2** CLEAR to clear the license key to 0000000000.

2. Press **F•4** REMOVE.

"Accepted" appears if the license key has been entered correctly, and the corresponding option is disabled. The name of the option is deleted from the License list.

"Failed" appears if the license key is not correct. Reenter the license key correctly.

3. Restart the instrument.

7.5 Adjusting the Backlight (LV5300/LV5300A/LV5350)

To adjust the backlight, use **F•5** LCD BACK LIGHT on the SYS menu.

The larger the value, the brighter the backlight. Press the function dial (F•D) to return the setting to its default value (28).

1 - 28 - 32

7.6 Turning Off the LCD Panel (LV5300/LV5300A/LV5350)

To turn off the LCD, press **F•6** LCD OFF on the SYS menu.

To turn it on again, press any key excluding the power switch, double-click, or operate the touch panel.

7. SYSTEM SETTINGS

7.7 Initialization

To initialize the settings and layout, use **F•7** INITIALIZE on the SYS menu.

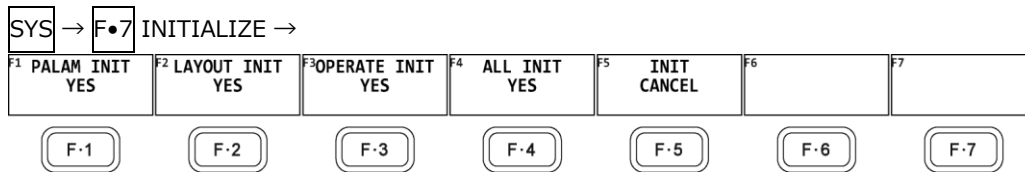

Figure 7-31 INITIALIZE menu

7.7.1 Initializing Settings

To initialize the settings, press **F•1** PARAM INIT YES.

To cancel, press **F•5** INIT CANCEL.

When you initialize the settings, all the settings—excluding those listed below—are initialized. For information about the default values, see chapter 20, “MENU TREES.”

- Network settings (NETWORK tab)
- Remote control settings (REMOTE tab)
- Camera ID settings (CAMERA ID tab)
- Date and time settings (DATE&TIME tab)
- Preset contents
- Measurement screen layout
- Factory Default Settings

If you also want to initialize the above settings (excluding the date and time settings), turn on the power while holding down the V POS and H POS knobs. Release them when about 3 seconds elapse after the power is turned on, and then press **F•3** SRAM/FLASH INIT YES.

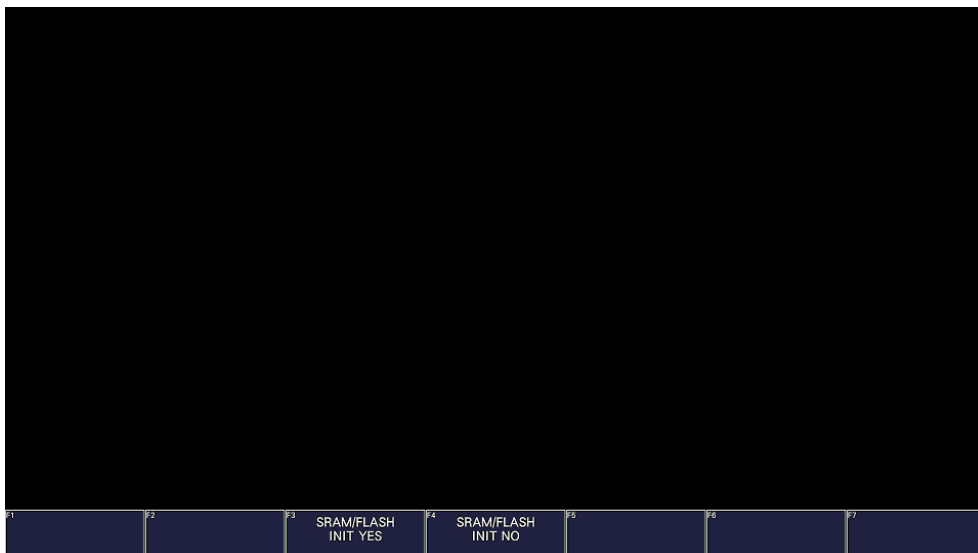

Figure 7-32 Factory default settings

7. SYSTEM SETTINGS

7.7.2 Initializing the Layout

To initialize the layout, press **F•2** LAYOUT INIT YES.

To cancel, press **F•5** INIT CANCEL.

When you initialize the layout, the layouts configured in all measurement displays (11 total) will be initialized. To initialize the layout in each measurement display, click or tap DEFAULT LAYOUT in the appropriate layout window.

[See also] DEFAULT LAYOUT → 6.5.3, "Layout Screen Description"

7.7.3 Initializing the Operation keys

To initialize the operation keys, press **F•3** OPERATE INIT YES.

To cancel, press **F•5** INIT CANCEL.

7.7.4 Initializing the Settings and Layout

To initialize the settings and layout, press **F•4** ALL INIT YES.

To cancel, press **F•5** INIT CANCEL.

8. CAPTURE FEATURE

You can use the screen capture feature to capture still-image data of the screen. You can save the captured data to a USB memory device or overlay it on the input signal on the instrument's display.

8.1 Capturing the Displayed Screen

To take a screen capture, follow the procedure below.

1. Display the screen you want to capture.
2. Press CAP.

The screen is captured to the internal memory. You can also take screen captures by pressing **F•2** REFRESH while the CAP menu is displayed.

Note that if you perform one of the following operations after taking a screen capture, the captured data will be deleted.

- Change the measurement screen
- Press INPUT, MULTI, SYS, MEM, or RECALL
- Turn off the power

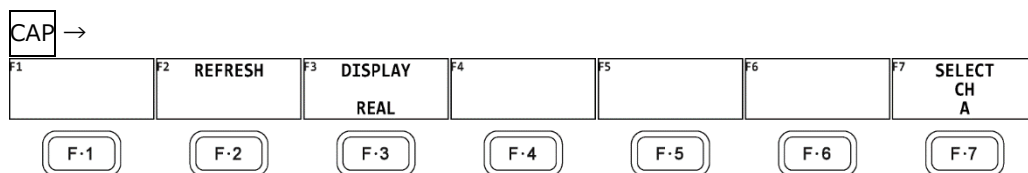

Figure 8-1 CAP menu

8.2 Displaying Screen Capture Data

Press CAP to display the acquired screen capture data on the instrument or overlay it on the current input signal.

You can display captured video signal waveform, vector, picture, audio waveform, and eye pattern waveform display data on the instrument. Other kinds of data (such as status and scale data) cannot be displayed. However, these other kinds of data can be saved to a USB memory device as BMP files.

To display screen capture data, press **F•3** DISPLAY on the CAP menu.

<u>REAL</u> :	The current input signal is displayed.
<u>HOLD</u> :	The screen capture data is displayed.
<u>BOTH</u> :	The current input signal and the screen capture data are overlaid with their intensities halved.

8.3 Saving to a USB Memory Device

Captured data acquired by pressing CAP is deleted when you perform an operation such as changing the measurement screen. However, by saving the screen capture data to a USB memory device in BSG format, you will be able to display the screen capture data on the instrument even after it is restarted.

Also, if you save the screen capture data in BMP format, you can view the captured data on a PC.

Use the CAPTURE & DISPLAY tab on the SYS menu to set the file format.

[See also] CAPTURE & DISPLAY tab → 7.2.4, “Configuring the Capture Feature”

1. Connect a USB memory device to the instrument.
2. Press **F•6** USB MEMORY.

A file list screen and a USB MEMORY menu appear.

3. Select how to name the file.

If **F•1** AUTO FILENAME is set to on, the file is automatically assigned a name that consists of the year, month, day, hour, minute, and second (in that order) that are set on the SYS menu. (Example: 20090501100859.bmp)

Screen capture data is saved to the following locations.

- ┆ USB memory device
 - ┆ LV5300_USER, LV5350_USER or LV7300_USER
 - ┆ BMP
 - ┆ yyyyymmddhhmmss.bmp
 - ┆ yyyyymmddhhmmss.bsg

8. CAPTURE FEATURE

If **F•1** AUTO FILENAME is set to off, press **F•2** NAME INPUT to enter the file name. Enter up to 17 characters.

The key operations that you can perform in the file name input display are as follows:

F•1 CLEAR ALL	Deletes all characters
F•2 DELETE	Deletes the character at the cursor
F•4 <=	Moves the cursor to the left
F•5 =>	Moves the cursor to the right
F•6 CHAR SET	Enters the character
Function dial (F•D)	Turn to select a character, and press to enter the character.

After entering the file name, **F•7** up menu. The CAP menu appears.

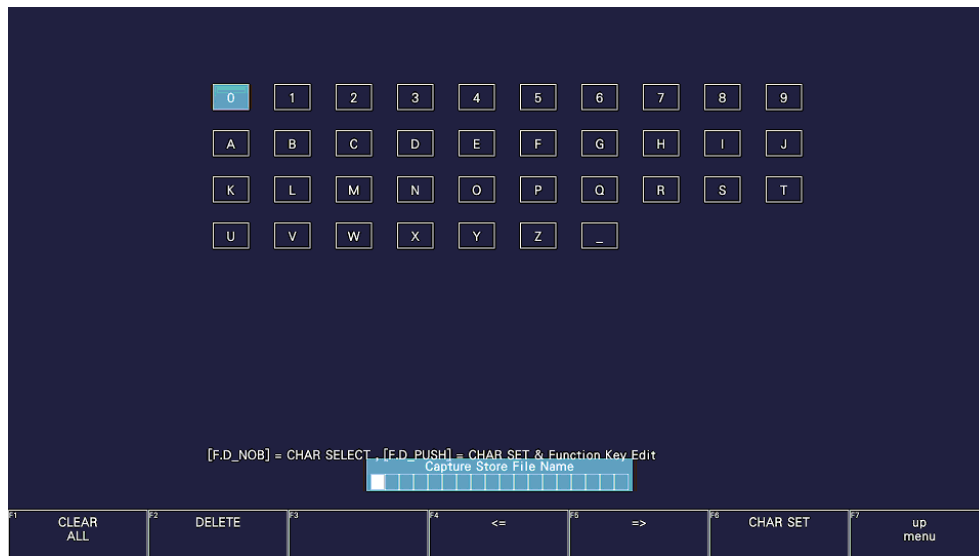

Figure 8-2 File name input screen

4. Press **F•3** STORE.

When AUTO FILENAME is set to on or if the specified file name does not exist in the USB memory device when AUTO FILENAME is set to off, the message "Please wait. Saving file" is displayed on the screen, and the screen capture data is saved to USB memory.

When AUTO FILENAME is set to off and the specified file name exists in the USB memory device, the STORE menu appears.

To overwrite, press **F•1** OVER WRITE DONE. The message "Please wait. Saving file" is displayed on the screen, and the screen capture data is saved to USB memory.

To not overwrite, press **F•3** OVER WRITE CANCEL.

CAP → **F•6** USB MEMORY → **F•3** STORE

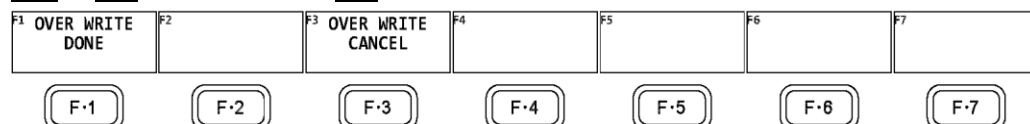

Figure 8-3 STORE menu

8.4 Displaying Screen Capture Data from a USB Memory Device

To display or overlay on the current input signal the BSG screen capture data that has been saved to a USB memory device, follow the procedure below.

(Screen capture data that has been saved in BMP format and screen capture data that has been saved in BSG format on a different model cannot be displayed on the instrument.)

1. Connect a USB memory device to the instrument.
2. Press CAP.
The CAP menu appears.
3. Press **F•6** USB MEMORY.
A file list screen and a USB MEMORY menu appear.
4. Press **F•5** RECALL.
The BSG format file list screen appears.
5. Turn the function dial (F•D) to select the file that you want to display.
6. Press **F•1** RECALL.
The capture data and CAP menu appear.
7. Press **F•3** DISPLAY to select the display format.
After you press **F•1** RECALL, the display format is BOTH.

8.5 Deleting Screen Capture Data from a USB Memory Device

To delete screen capture data from a USB memory device, follow the procedure below. (You can also delete the data on the PC.)

1. Connect a USB memory device to the instrument.
2. Press CAP.
The CAP menu appears.
3. Press **F•6** USB MEMORY.
A file list screen and a USB MEMORY menu appear.
You can also press **F•5** RECALL here to display a BSG format file list screen.
4. Turn the function dial (F•D) to select the file that you want to delete.

8. CAPTURE FEATURE

5. Press **F•5** DELETE FILE.

The DELETE FILE menu appears.

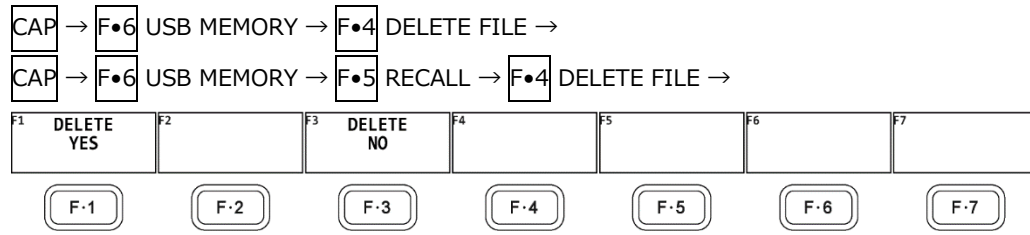

Figure 8-4 DELETE FILE menu

6. Press **F•1** DELETE YES.

To cancel the operation, press **F•3** DELETE NO.

9. PRESET FEATURE

The preset feature stores up to 60 sets of panel settings. It can be used to easily recall fixed settings.

Also, you can use the same settings on multiple instruments by copying presets to USB memory. However, the preset data is not compatible between the LV5300/LV5300A, LV5350, and LV7300.

All items except the items below are stored in a preset. Stored items are not deleted even if you initialize the settings.

- Network settings (NETWORK tab)
- Remote control settings (REMOTE tab)
- Camera ID settings (CAMERA ID tab)
- Date and time settings (DATE&TIME tab)

9.1 Registering Presets

To register a selected preset, follow the procedure below.

1. Display the screen you want to register.

You can prevent overwriting presets by setting Preset Overwrite to disable on the GENERAL tab of the SYS menu. To overwrite presets, set Preset Overwrite to Enable. Note that even when set to Disable, registering to an empty preset is possible.

You can set the menu that appears when a preset is recalled by setting Recall on the GENERAL SETUP tab of the SYS menu in advance.

[See also] GENERAL SETUP tab → 7.2.1, "General Settings"

2. Press MEM.

The preset registration screen appears.

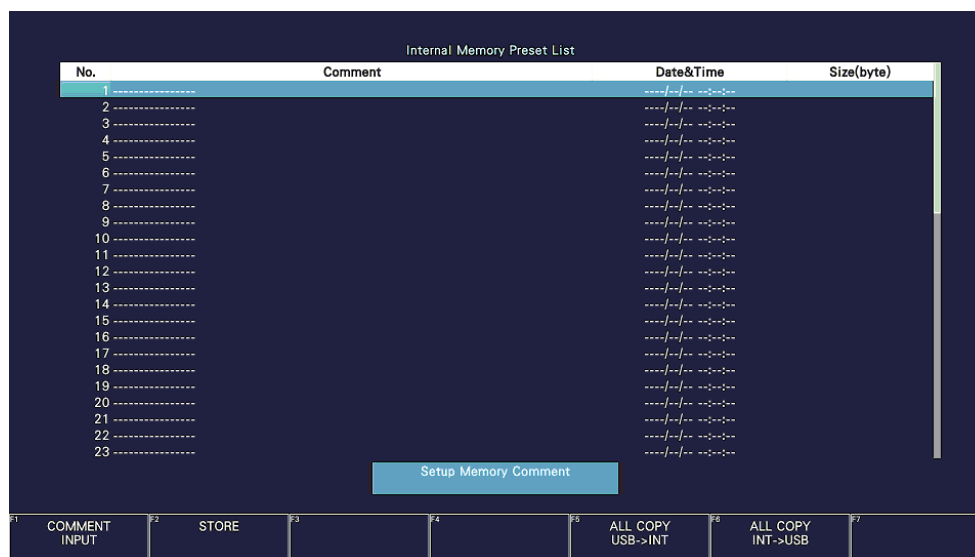

Figure 9-1 Preset registration screen

9. PRESET FEATURE

- Press **F•1** COMMENT INPUT.

The comment input screen appears.

You can also copy a comment from a preset that already has a comment saved to it. To copy a comment, on the preset registration display, move the cursor to the preset that has the comment that you want to copy, and press the function dial (F•D).

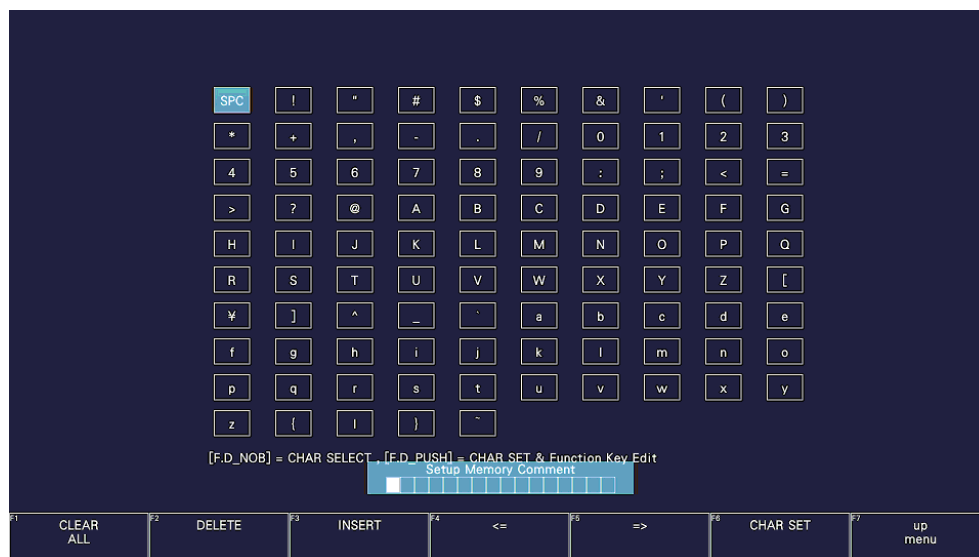

Figure 9-2 Comment input screen

- Enter a comment of up to 16 characters.

You can use the following keys on the comment input screen.

F•1 CLEAR ALL	Deletes all characters
F•2 DELETE	Deletes the character at the cursor
F•3 INSERT	Inserts the selected character at the cursor position
F•4 <=	Moves the cursor to the left
F•5 =>	Moves the cursor to the right
F•6 CHAR SET	Enters the character
Function dial (F•D)	Turn to select a character, and press to enter the character.

- Press **F•7** up menu.
- Turn the function dial (F•D) to select the number of the preset you want to register.
- Press **F•2** STORE.

If a preset has already been stored with the number that you selected, the STORE menu appears. To overwrite the existing preset, press **F•1** OVER WRITE YES. Otherwise, press **F•4** OVER WRITE NO.

F•2 STORE does not appear if Preset Overwrite is set to Disable on the GENERAL tab of the SYS menu.

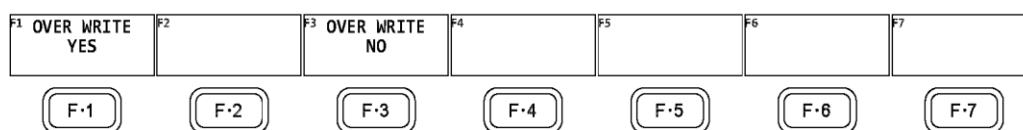

Figure 9-3 STORE menu

9. PRESET FEATURE

9.2 Loading Presets

To recall a preset, follow the procedure below.

1. Press RECALL.

The RECALL menu appears.

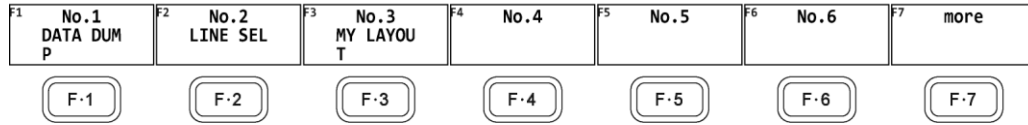

Figure 9-4 RECALL menu

2. Press a key from **F·1** No.1 to **F·6** No.6.

If the preset that you want to load is number 7 or greater, press **F·7** more or turn the function dial (F•D).

The menu that appears immediately after loading the preset is either the RECALL menu or measurement menu depending on the setting that was specified on the GENERAL SETUP tab when the preset was registered.

[See also] GENERAL SETUP tab → 7.2.1, "General Settings"

9. PRESET FEATURE

9.3 Deleting Presets

To delete a preset, follow the procedure below.

1. Press MEM.

The preset registration screen appears.

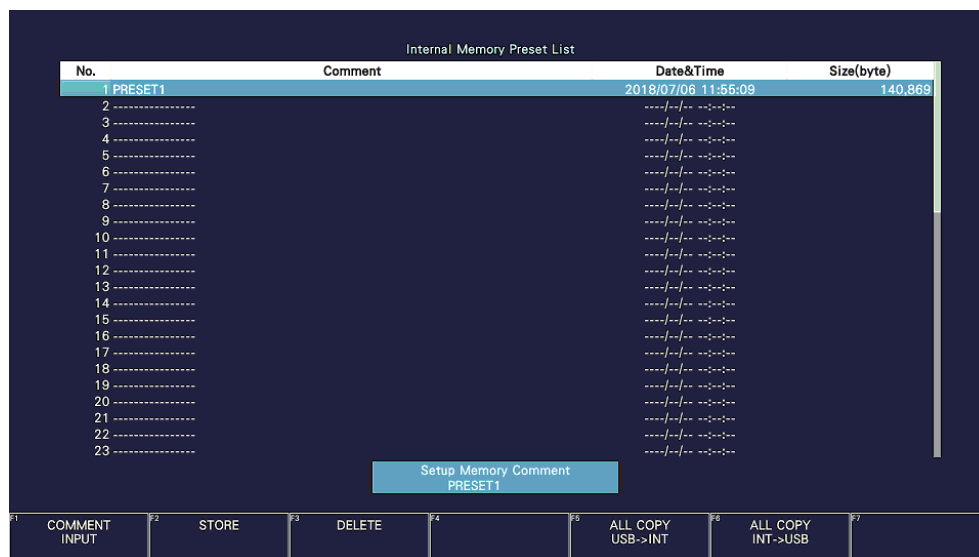

Figure 9-5 Preset registration screen

2. Turn the function dial (F•D) to select the file that you want to delete.

3. Press **F•3** DELETE.

The DELETE menu appears.

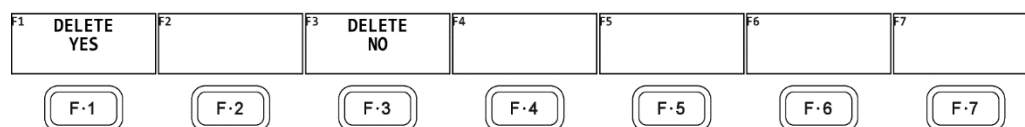

Figure 9-6 DELETE menu

4. Press **F•1** DELETE YES.

To cancel the operation, press **F•3** DELETE NO.

9. PRESET FEATURE

9.4 Copying All Presets from the instrument to a USB Memory Device

To copy all the presets from the instrument to a USB memory device, follow the procedure below.

1. Connect a USB memory device to the instrument.
2. Press MEM.

The preset registration screen appears.

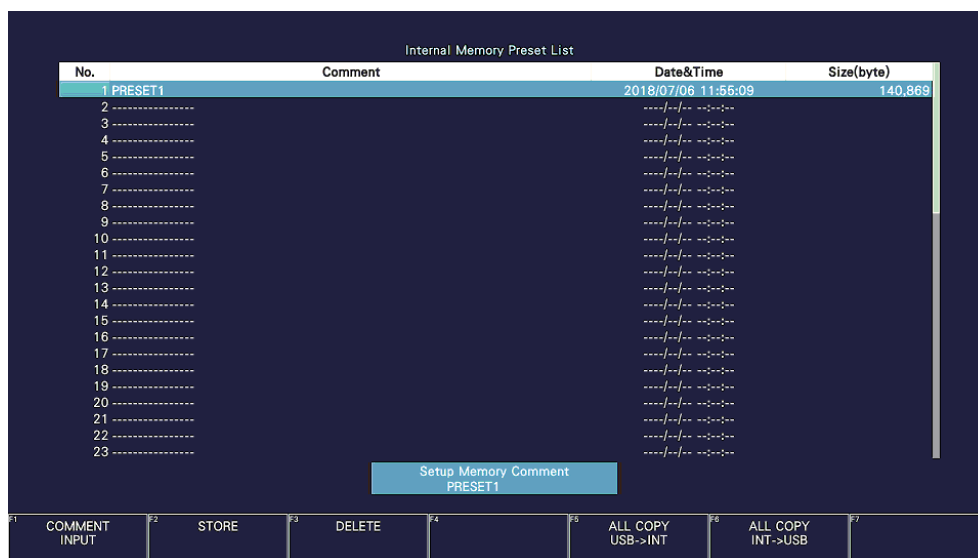

Figure 9-7 Preset registration screen

3. Press **F•6** ALL COPY INT->USB.

The ALL COPY INT->USB menu appears.

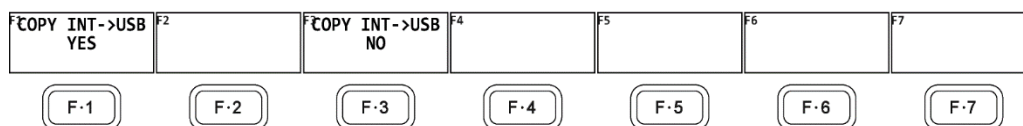

Figure 9-8 ALL COPY INT->USB menu

4. Press **F•1** COPY INT->USB YES.

To cancel the copy operation, press **F•3** COPY INT->USB NO. If the USB memory device already contains presets, they will be overwritten.

Presets are saved to the following location.

Note that if you use a PC to change the names of the files stored in the USB memory device, you will no longer be able to copy the altered presets from the USB memory device to an instrument.

- 📁 USB memory device
 - ↳ 📁 LV5300_USER, LV5350_USER or LV7300_USER
 - ↳ 📁 MEM
 - ↳ 📁 PRESET_01.PRE (to PRESET_60.PRE)

9. PRESET FEATURE

9.5 Copying All Presets from a USB Memory Device to the instrument

To copy all the presets from a USB memory device to the instrument, follow the procedure below.

1. Connect a USB memory device to the instrument.
2. Press MEM.

The preset registration screen appears.

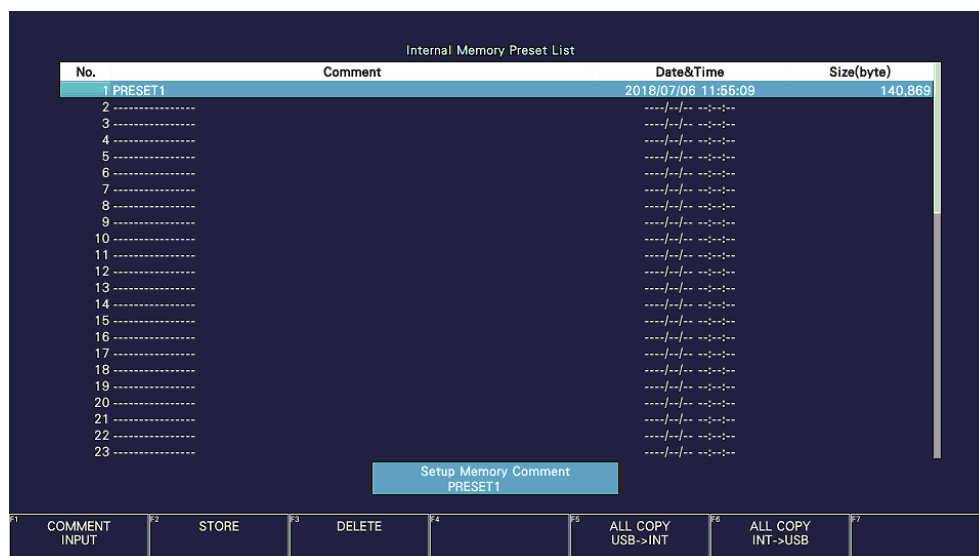

Figure 9-9 Preset registration screen

3. Press **F•5** ALL COPY USB->INT.

The ALL COPY USB->INT menu appears.

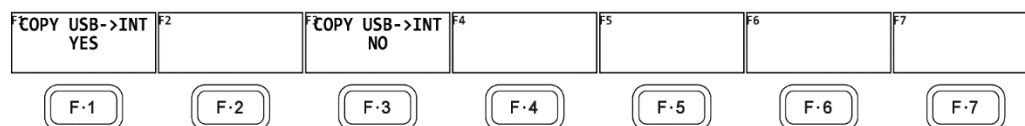

Figure 9-10 ALL COPY USB->INT menu

4. Press **F•1** COPY USB->INT YES.

To cancel the copy operation, press **F•3** COPY USB->INT NO. If the instrument already has presets, the operation will be according to the Preset Overwrite setting on the GENERAL tab.

10. VIDEO SIGNAL WAVEFORM DISPLAY

To display the video signal waveform, press WFM.

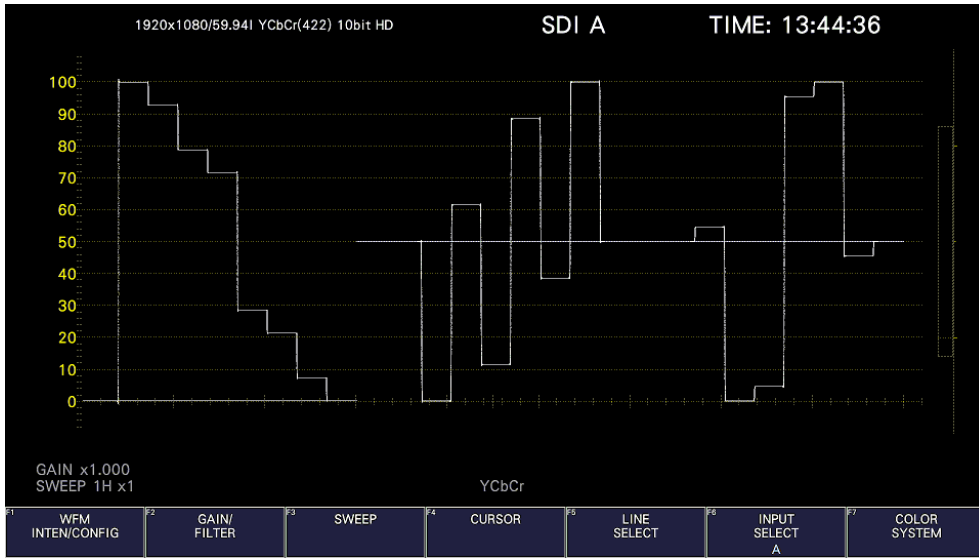

Figure 10-1 Video signal waveform display

- Colorimetry

Normally, colorimetry is not displayed, but when the colorimetry alarm on the SYS menu is set to on and a colorimetry different from the one specified is received, the alarm is indicated in red in the upper left of the screen.

10.1 Operation Key Description

Operation keys other than S-CUT key can be controlled from the mouse and touch panel. On the video signal waveform display, you can press the operation keys to change the following settings. (Some settings may not be changed.)

Key assignments can be changed freely on the OPERATION KEY tab.

[See also] OPERATION KEY tab → 7.2.13, "Setting the Operation keys"

Table 10-1 Operation Key Actions

	Setting	Notes
FORM	<u>Y</u> / <u>YCbCr</u> / <u>YGBR</u> / <u>GBR</u> / <u>YRGB</u> / <u>RGB</u> / COMPOSITE	
OVLAY	OVERLAY / PARADE	
FILTER	FLAT / LOWPASS	During component display
	FLAT / LUM / FLAT+LUM / LUM+CRMA	During pseudo-composite display
GAIN	CAL / VARIABLE	
MAG (GAIN)	X1 / X5 0% / X5 +90%	X5 + 10% to X5 + 80%
SWEEP	1H / 2H / 1V / 2V	
MAG (SWEEP)	X1 / <u>X10</u> / <u>X20</u> / <u>X40</u>	ACTIVE and BLANK are also selectable.

10.2 Setting the Waveform Display Position

Use the V POS and H POS knobs to adjust the display position of video signal waveforms. On the multi display, these are valid when you press **F•2** MULTI WFM on the MULTI menu.

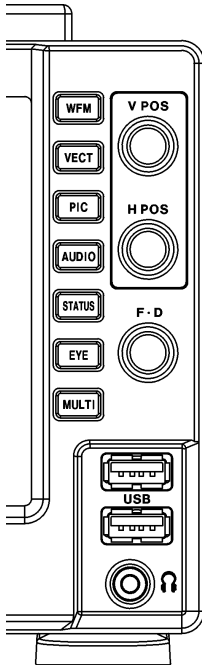

Figure 10-2 LV5300/LV5300A, LV5350 V POS and H POS knobs

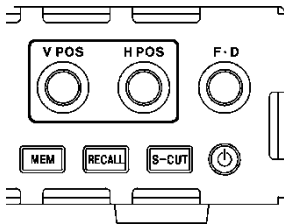

Figure 10-3 LV7300 V POS and H POS knobs

- V POS Knob

This knob adjusts the vertical position of the video signal waveform.
Pressing the knob returns the waveform to its default position.
- H POS Knob

This knob adjusts the horizontal position of the video signal waveform.
Pressing the knob returns the waveform to its default position.

10.3 Configuring the Display Settings

To configure the display settings, press **F•1** WFM INTEN/CONFIG on the WFM menu.

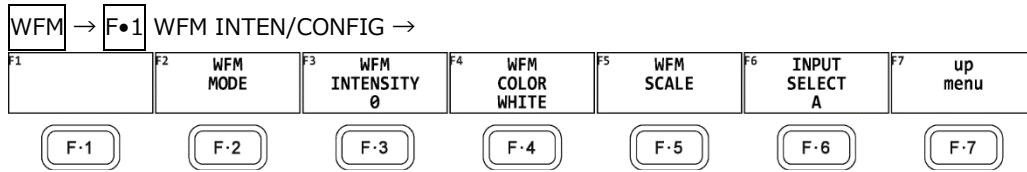

Figure 10-4 WFM INTEN/CONFIG menu

10.3.1 Selecting the Display Mode

To configure the display mode settings, press **F•2** WFM MODE on the WFM INTEN/CONFIG menu.

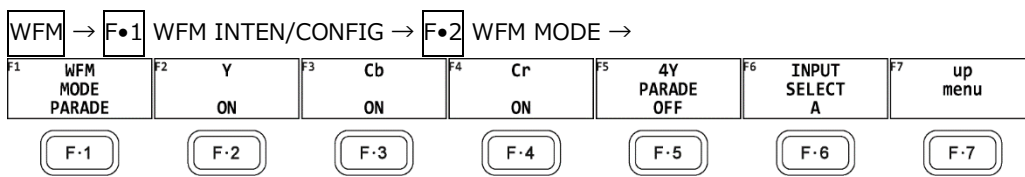

Figure 10-5 WFM MODE menu

To select the video signal waveform display mode, follow the procedure below.

This setting is invalid when COLOR MATRIX is set to COMPOSITE.

[See also] COLOR MATRIX → section 10.8.1, "Selecting the Color Matrix."

Procedure



Settings

- OVERLAY: The input signals are displayed overlaid.
- PARADE: The input signals are displayed side by side.

WFM MODE = OVERLAY

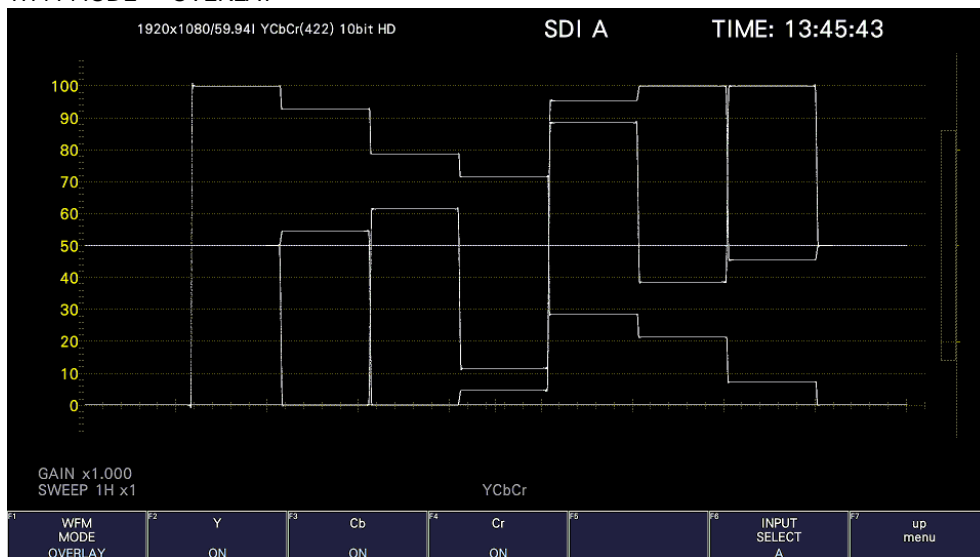

10. VIDEO SIGNAL WAVEFORM DISPLAY

WFM MODE = PARADE

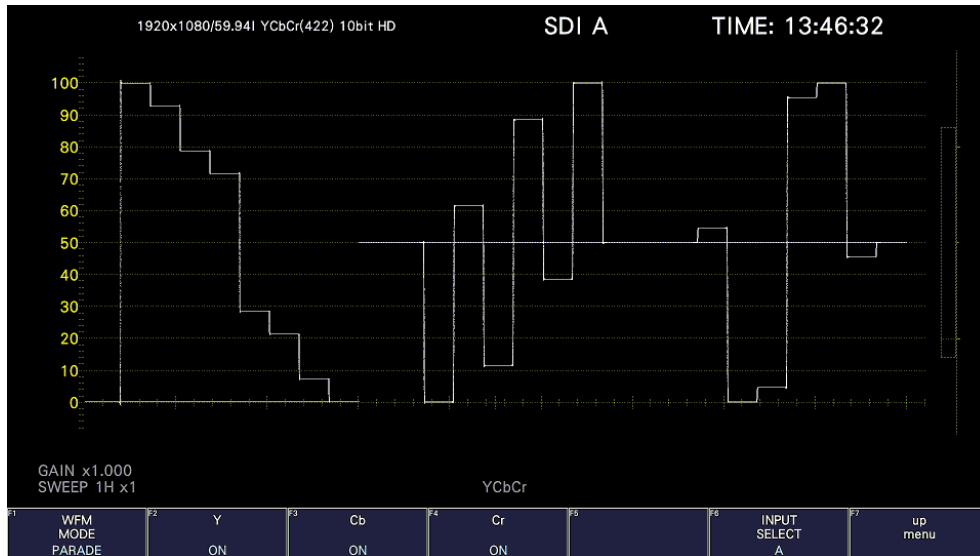

Figure 10-6 Selecting the display mode

10.3.2 Turning the Channels On and Off

To turn the waveforms on and off, follow the procedure below.

You cannot turn all the waveforms off.

This menu item is not displayed when COLOR MATRIX is set to COMPOSITE or when YGBR or YRGB is set to ON.

[See also] COLOR MATRIX → section 10.8.1, "Selecting the Color Matrix."

YGBR, YRGB → section 10.8.20, "Turning Luminance Signals On and Off."

Procedure

WFM	→	F•1	WFM INTEN/CONFIG	→	F•2	WFM MODE
		F•2	Y / G / R / X:			ON / OFF
		F•3	Cb / B / G / Y:			ON / OFF
		F•4	Cr / R / B / Z:			ON / OFF

10.3.3 Adjusting the Waveform Intensity

To adjust the video signal waveform intensity, follow the procedure below.

Press the function dial (F•D) to return the setting to its default value (0).

Procedure

WFM	→	F•1	WFM INTEN/CONFIG	→	F•3	WFM INTENSITY: -128 - <u>0</u> - 127
-----	---	-----	------------------	---	-----	--------------------------------------

10. VIDEO SIGNAL WAVEFORM DISPLAY

10.3.4 Selecting the Waveform Color

To select the video signal waveform color, follow the procedure below.

On the multi display, the following colors are assigned to the video signal waveforms.

Y: White Cb: Cyan Cr: Magenta

G: Green B: Blue R: Red

X: White Y: Cyan Z: Magenta

COMPOSITE: White

Procedure

WFM → F•1 WFM INTEN/CONFIG → F•4 WFM COLOR: WHITE / YELLOW / CYAN / GREEN / MAGENTA / RED / BLUE / MULTI

10.3.5 Adjusting the Scale Intensity

To configure the scale, press F•5 WFM SCALE on the WFM INTEN/CONFIG menu.

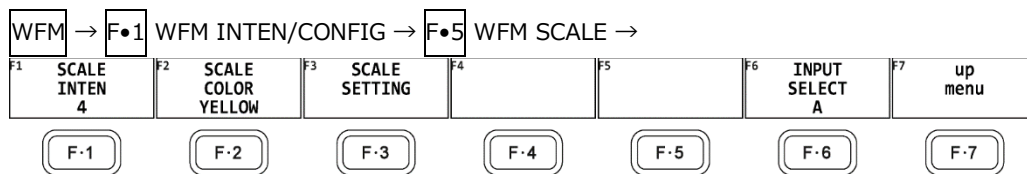

Figure 10-7 WFM SCALE menu

To adjust the scale intensity, follow the procedure below.

Press the function dial (F•D) to return the setting to its default value (4).

Procedure

WFM → F•1 WFM INTEN/CONFIG → F•5 WFM SCALE → F•1 SCALE INTEN: -8 - 4 - 7

10.3.6 Selecting the Scale Color

To select the scale color, follow the procedure below.

Procedure

WFM → F•1 WFM INTEN/CONFIG → F•5 WFM SCALE → F•2 SCALE COLOR: WHITE / YELLOW / CYAN / GREEN / MAGENTA / RED / BLUE

10. VIDEO SIGNAL WAVEFORM DISPLAY

10.3.7 Selecting the Scale Unit

To select the scale unit, follow the procedure below.

When COLOR MATRIX is set to COMPOSITE and the composite display format is NTSC, the scale unit setting is fixed at %. When the composite display format is PAL, this is fixed to V.

Video signal white (100 %) becomes 0.7 V or 100 % on the scale.

Video signal black (0 %) becomes 0 V or 0 % on the scale.

[See also] COLOR MATRIX → section 10.8.1, "Selecting the Color Matrix."

Procedure

WFM → F•1 WFM INTEN/CONFIG → F•5 WFM SCALE → F•3 SCALE SETTING → F•1 SCALE UNIT: HDV,SD% / HDV,SDV / HD%,SD% / CV DEC / CV HEX / V / %

Settings

HDV,SD%:	The scale shows voltages when the input signal is not SD and percentages when the input signal is SD.
HDV,SDV:	The scale shows voltages.
HD%,SD%:	The scale shows percentages.
CV DEC:	0 to 100 % is displayed as 64 to 940 (YGBR) or 64 to 960 (CbCr). For XYZ, 0 to 100% is displayed as 0 to 4095.
CV HEX:	0 to 100 % is displayed as 040 to 3AC (YGBR) or 040 to 3C0 (CbCr). For XYZ, 0 to 100% is displayed as 000 to FFF.
V	The scale shows voltages.
%	The scale shows percentages.

SCALE UNIT = HDV,SDV

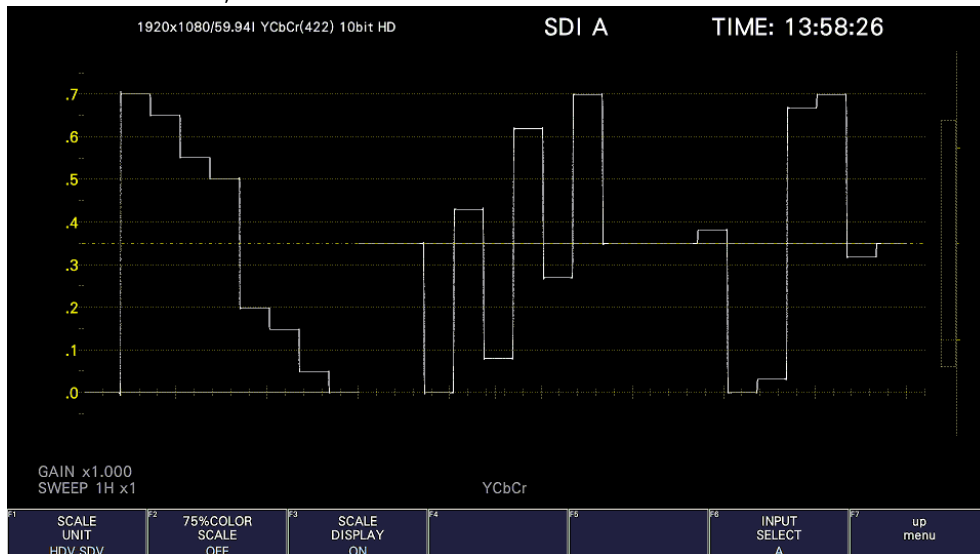

10. VIDEO SIGNAL WAVEFORM DISPLAY

SCALE UNIT = HD%,SD%

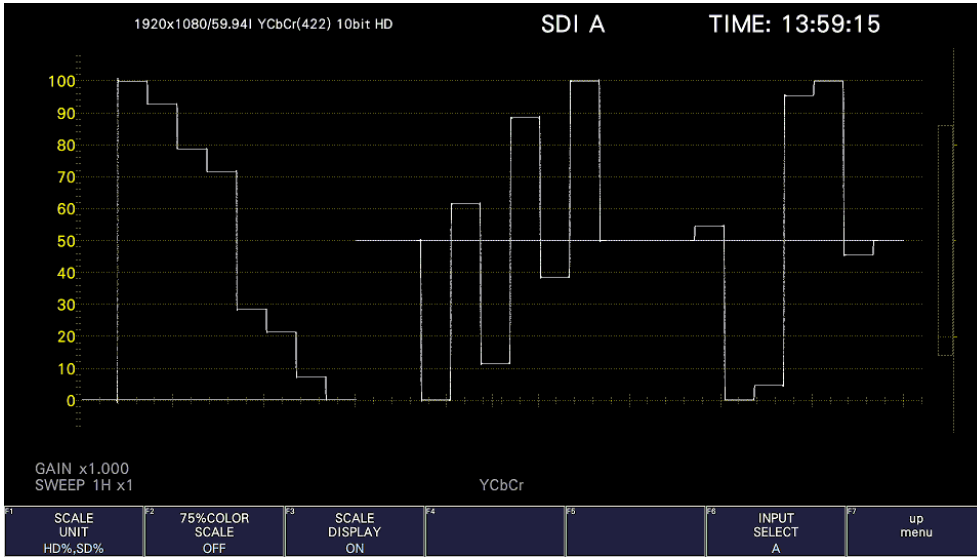

SCALE UNIT = CV DEC

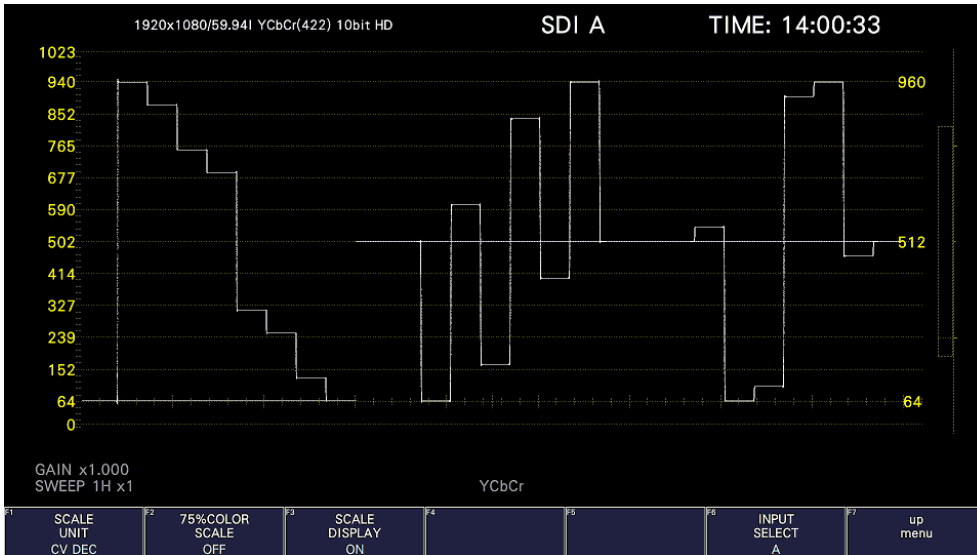

SCALE UNIT = CV HEX

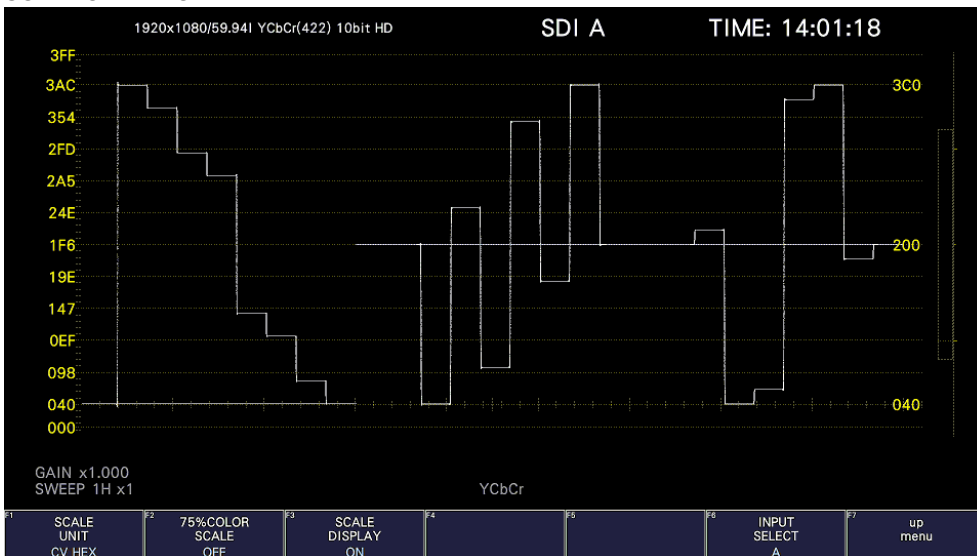

Figure 10-8 Selecting the scale unit

10. VIDEO SIGNAL WAVEFORM DISPLAY

10.3.8 Displaying a Scale for 75% Color Bars

When COLOR MATRIX is set to YCbCr, to display a scale on which a 75% color bar signal input is mapped to the peak level of the chrominance, follow the procedure below.

[See also] COLOR MATRIX → section 10.8.1, "Selecting the Color Matrix."

Procedure

WFM → F•1 WFM INTEN/CONFIG → F•5 WFM SCALE → F•3 SCALE SETTING → F•2 75%
COLOR SCALE: ON / OFF

75%COLOR SCALE = ON

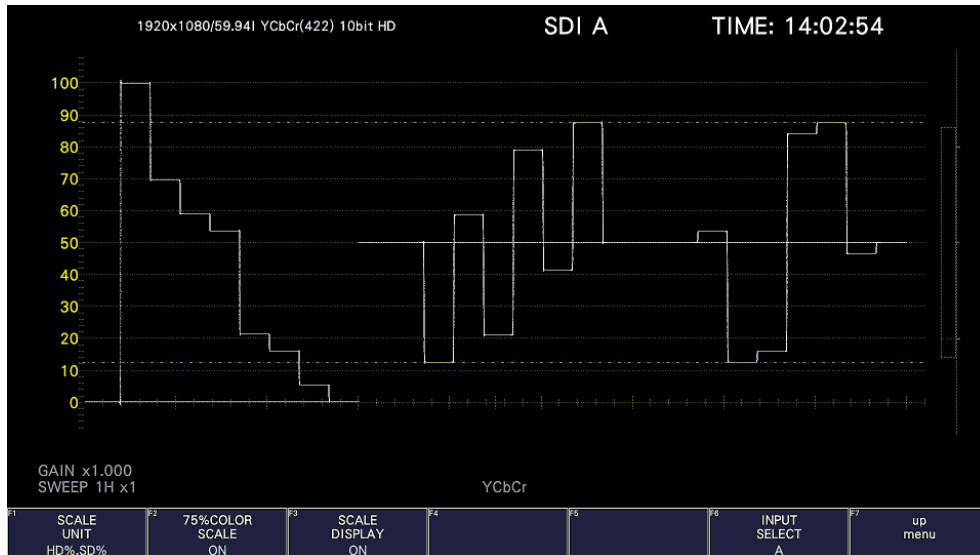

Figure 10-9 Displaying a scale for 75 % color bars

10.3.9 Displaying the Scale

To turn the scale display on and off, follow the procedure shown below.

Procedure

WFM → F•1 WFM INTEN/CONFIG → F•5 WFM SCALE → F•3 SCALE SETTING → F•3 SCALE
DISPLAY: ON / OFF

10. VIDEO SIGNAL WAVEFORM DISPLAY

SCALE DISPLAY = OFF

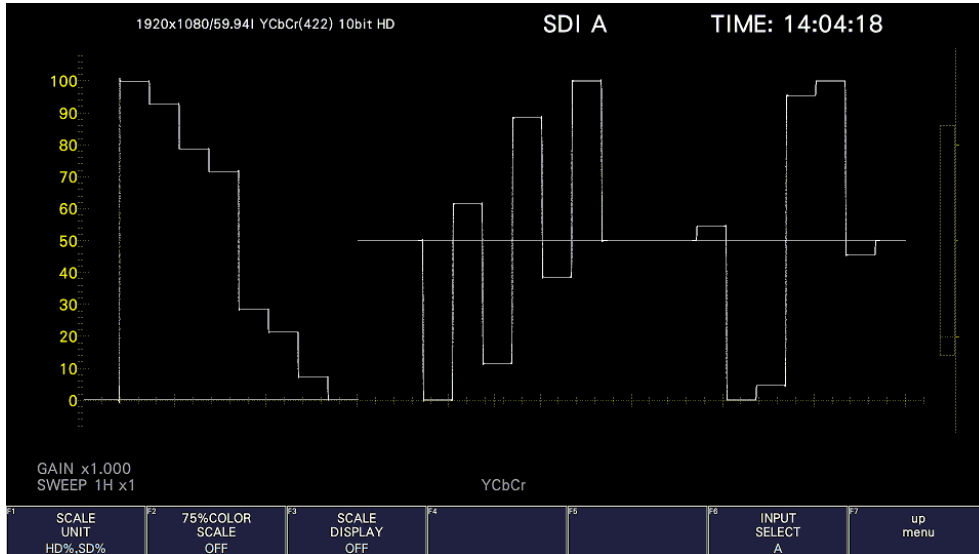

Figure 10-10 Displaying the scale

10.4 Configuring the Gain and Filter Settings

To configure the gain and filter settings, press **F•2** GAIN/FILTER on the WFM menu.

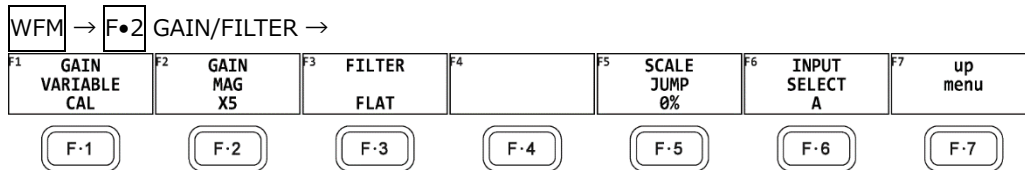

Figure 10-11 GAIN/FILTER menu

10.4.1 Setting the Variable Gain

To set the variable video signal waveform gain, follow the procedure below.

Procedure

WFM → **F•2** GAIN/FILTER → **F•1** GAIN VARIABLE: CAL / VARIABLE

Settings

CAL: The waveform gain is fixed.

VARIABLE: You can adjust the waveform gain by turning the function dial (F•D). Press the function dial (F•D) to return the setting to its default value (1.000 or 5.000).

The adjusted gain value (the combination of **F•1** GAIN VARIABLE and **F•2** GAIN MAG) appears at the bottom of the screen.

0.200 - 1.000 - 2.000 (for X1)

1.000 - 5.000 - 10.000 (for X5)

2.000 - 10.000 (for X10)

10. VIDEO SIGNAL WAVEFORM DISPLAY

10.4.2 Selecting the Fixed Gain

To select the fixed video signal waveform gain, follow the procedure below.

Procedure

WFM	→	F•2	GAIN/FILTER	→	F•2	GAIN MAG: <u>X1</u> / X5 / X10
-----	---	-----	-------------	---	-----	--------------------------------

10.4.3 Selecting the Filter

To select the filter to apply to video signal waveforms, follow the procedure below.

The filters that you can select vary depending on the COLOR MATRIX setting.

[See also] COLOR MATRIX → section 10.8.1, "Selecting the Color Matrix."

Procedure (When COLOR MATRIX is set to YCbCr, GBR, or RGB)

WFM	→	F•2	GAIN/FILTER	→	F•3	FILTER: <u>FLAT</u> / LOWPASS
-----	---	-----	-------------	---	-----	-------------------------------

Settings

FLAT: A filter with a flat frequency response over the entire bandwidth of the input signal is applied.

LOWPASS: A low-pass filter with the following characteristics is applied.
At 40 MHz, 20 dB attenuation or more (when the input signal is 1080/60P, 59.94P, or 50P)
At 20 MHz, 20 dB attenuation or more (when the input signal is 3G, or HD excluding 1080/60P, 59.94P, or 50P)
At 3.8 MHz, 20 dB attenuation or more (when the input signal is SD)

FILTER = FLAT

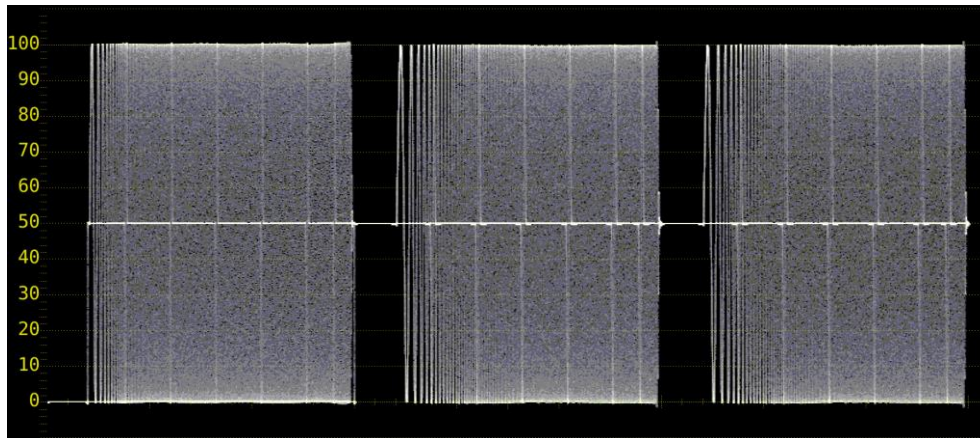

10. VIDEO SIGNAL WAVEFORM DISPLAY

FILTER = LOWPASS

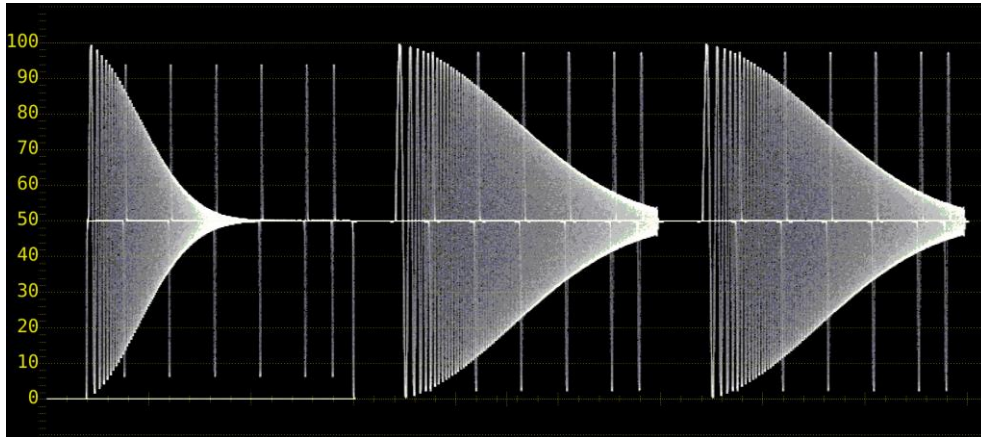

Figure 10-12 Selecting the filter (component)

Procedure (When COLOR MATRIX is set to COMPOSITE)

WFM	→	F•2	GAIN/FILTER	→	F•3	FILTER: <u>FLAT</u> / LUM / FLAT+LUM / LUM+CRMA
-----	---	-----	-------------	---	-----	---

Settings

- | | |
|-----------|--|
| FLAT: | Only the pseudo-composite signal is displayed. |
| LUM: | Only the luminance signal is displayed. |
| FLAT+LUM: | The pseudo-composite and luminance signals are displayed side by side. A filter with an attenuation of 20 dB or more at 40 MHz is applied to the luminance signal. |
| LUM+CRMA: | The luminance and chrominance signals are displayed side by side. A filter with an attenuation of 20 dB or more at 40 MHz is applied to the luminance signal. |

FILTER = FLAT

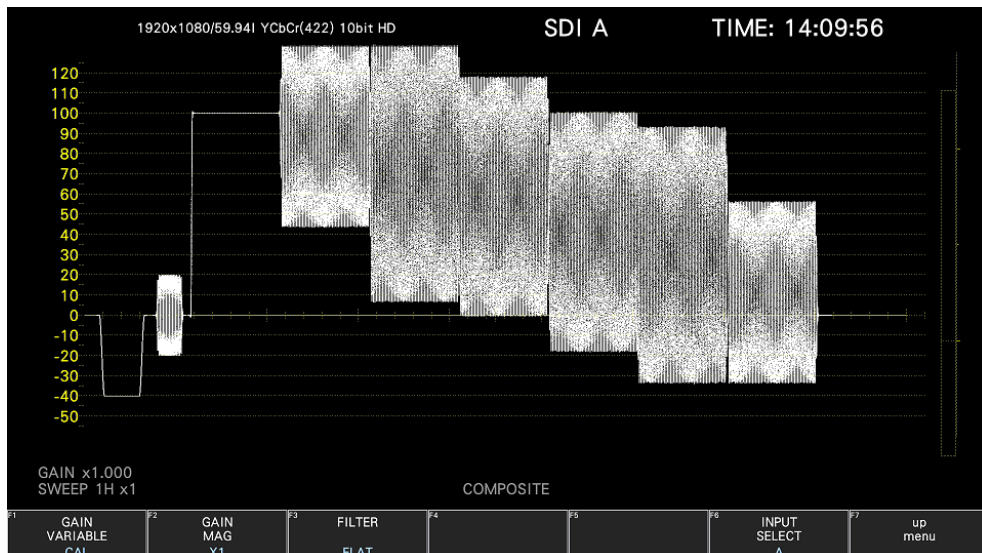

10. VIDEO SIGNAL WAVEFORM DISPLAY

FILTER = LUM

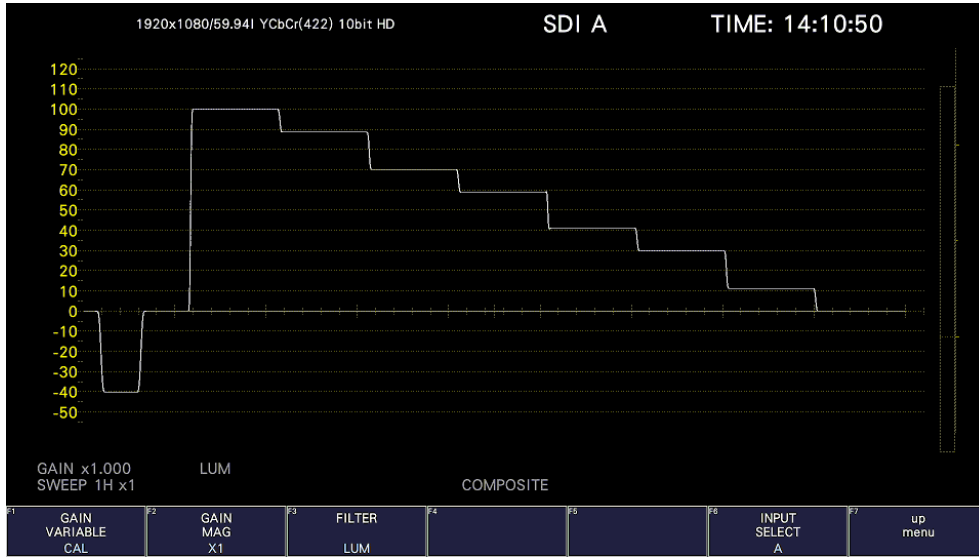

FILTER = FLAT+LUM

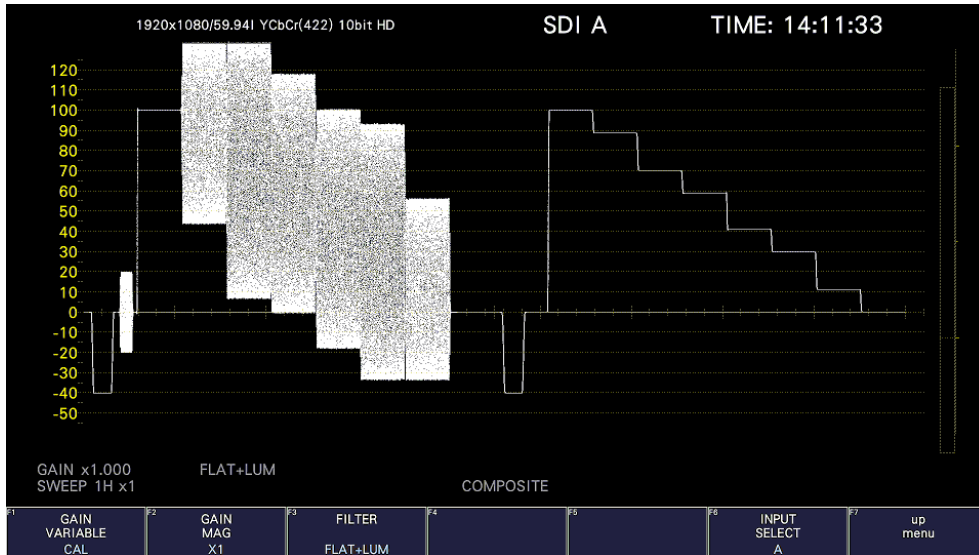

FILTER = LUM+CRMA

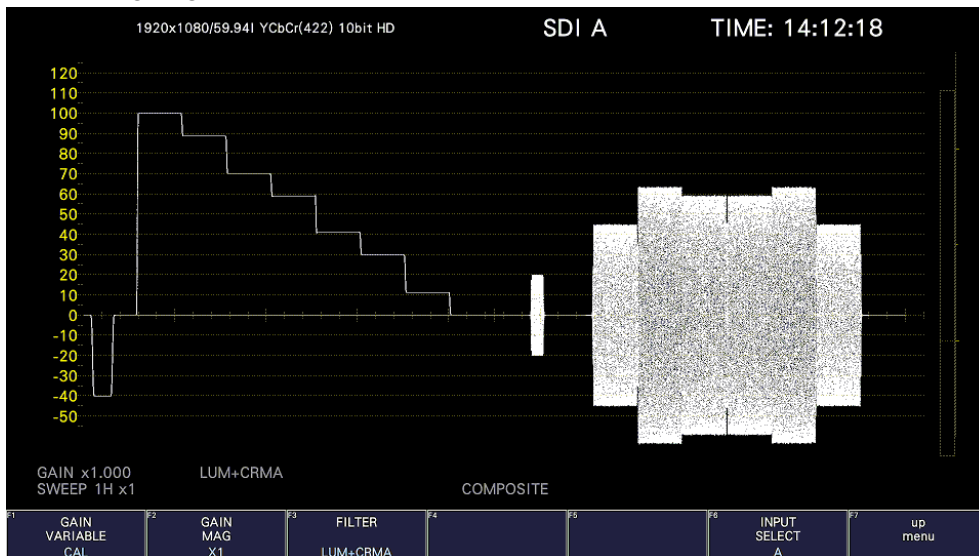

Figure 10-13 Selecting the filter (composite)

10. VIDEO SIGNAL WAVEFORM DISPLAY

10.4.4 Setting the Scale Jump

If **F•2** GAIN MAG is set to X5, the waveform is expanded five times in the Y-axis direction. To select the area you want to see expanded, follow the procedure below. You can view the area that is currently displayed with respect to the entire waveform on the scale shown on the right side of the screen.

This menu item appears when GAIN MAG is set to X5 or X10.

Procedure

WFM → **F•2** GAIN/FILTER → **F•5** SCALE JUMP: 0% / 10% / 20% / 30% / 40% / 50% / 60% / 70% / 80% / 90% / 100% / CURSOR

- 0 to 100%

The instrument has 11 types of screens in the Y-axis direction, these screens are switched in the range of 0 to 100%.

For example, if the scale unit is % and YCbCr is displayed, selecting 0% displays the 0 to 20% range, selecting 10% displays the 10 to 30% range, selecting 90% displays the 90 to 110% range, and selecting 100% displays the 100 to 120% range.

10. VIDEO SIGNAL WAVEFORM DISPLAY

• Cursors

The scale jump function operates based on the Y-axis cursor, and the area near the currently selected cursor (▼ mark) is expanded. An operation example is shown below.

[Preparation]

1. On the CURSOR menu, set **F•1** CURSOR to ON and **F•2** XY SEL to Y.
2. On the GAIN/FILTER menu, set **F•2** GAIN MAG to X5 or X10.
3. Set **F•4** SCALE JUMP to CURSOR.

[Operation]

4. Set **F•2** GAIN MAG to X1.
5. Move the Y-axis cursor to the area you want magnified. (You can move the cursor on the GAIN/FILTER menu. You can switch between REF, DELTA, and TRACK by pressing the function dial (F•D).)
6. Set **F•2** GAIN MAG to X5 or X10 to expand the area near the Y-axis cursor.

SCALE JUMP = CURSOR

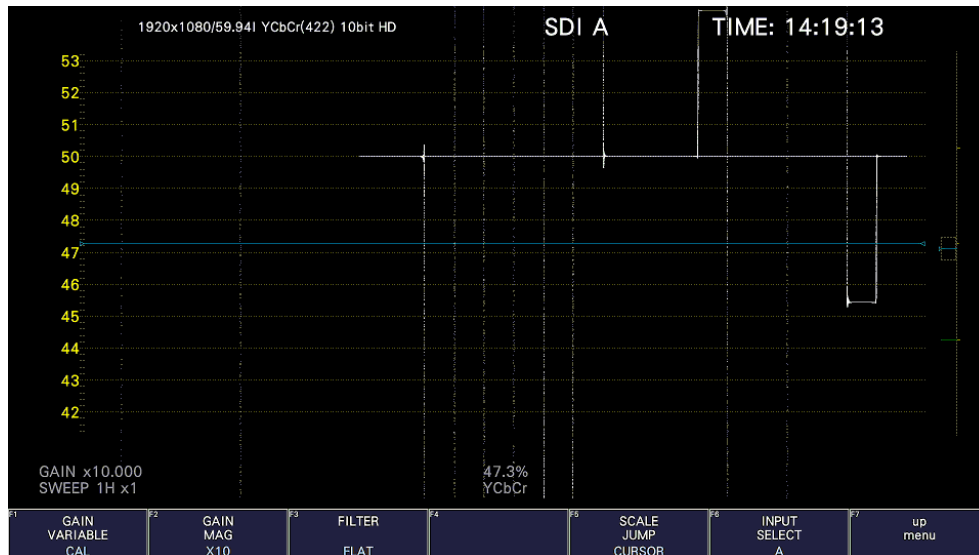

Figure 10-14 Setting the scale jump

10.5 Configuring the Sweep Settings

To configure the sweep settings, press **F•3** SWEEP on the WFM menu.

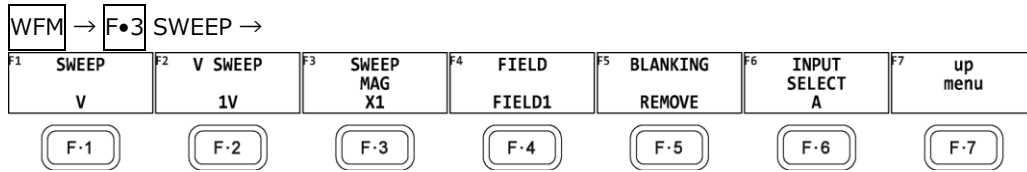

Figure 10-15 SWEEP menu

10.5.1 Selecting the Sweep Method

To select the video signal waveform sweep method, follow the procedure below.

Procedure



Settings

- H: Lines are displayed.
- V: Fields or frames are displayed. Because the sampled data is downsampled, aliasing distortion occurs.

SWEEP = H

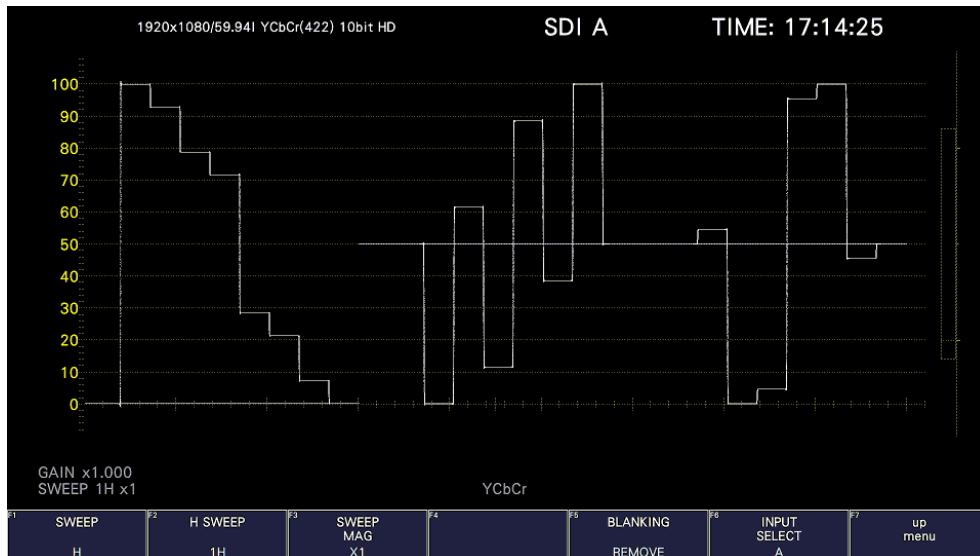

10. VIDEO SIGNAL WAVEFORM DISPLAY

SWEEP = V

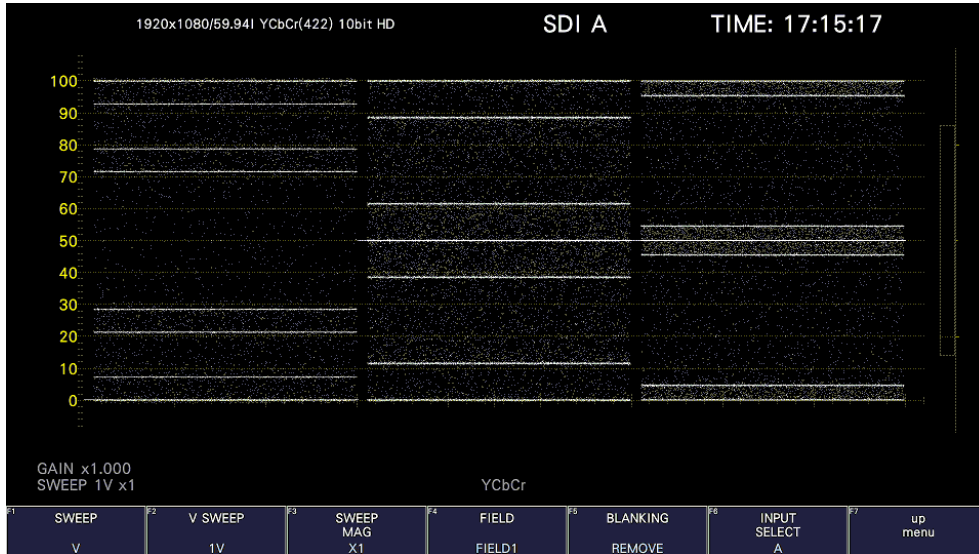

Figure 10-16 Selecting the sweep method

10.5.2 Selecting the Line Display Format

When **F•1** SWEEP is set to H, to select the sweep time, follow the procedure below.

Procedure

WFM → **F•3** SWEEP → **F•2** H SWEEP: 1H / 2H

Settings

1H: One line is displayed.

2H: Two lines are displayed. This cannot be selected in the following situations.

- For 4K
- When **WFM** → **F•1** WFM INTEN/CONFIG → **F•2** WFM MODE → **F•1** MODE is set to PARADE
- When **F•7** COLOR SYSTEM → **F•1** COLOR MATRIX is set to COMPOSITE

H SWEEP = 1H

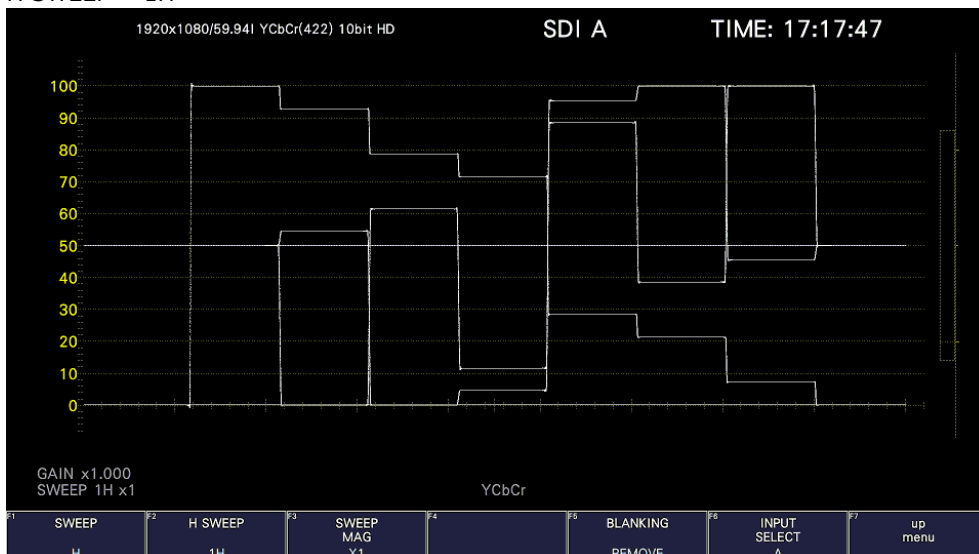

10. VIDEO SIGNAL WAVEFORM DISPLAY

H SWEEP = 2H

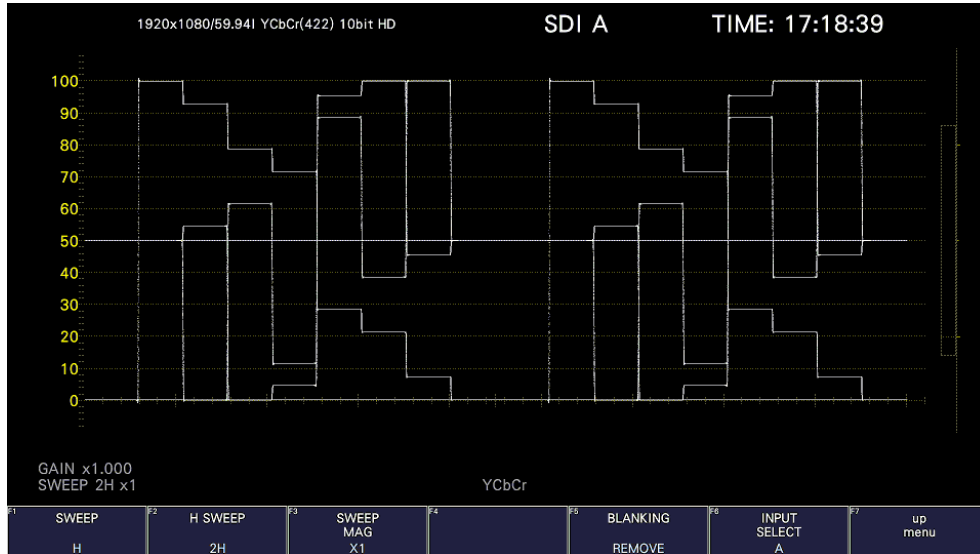

Figure 10-17 Selecting the line display format

10.5.3 Selecting the Field Display Format

When **F•1** SWEEP is set to V, to select the sweep time, follow the procedure below.

Procedure

WFM → **F•3** SWEEP → **F•2** V SWEEP: 1V / 2V

Settings

1V: One field is displayed.
 2V: One frame is displayed. This option cannot be selected when the input signal is progressive.

V SWEEP = 1V

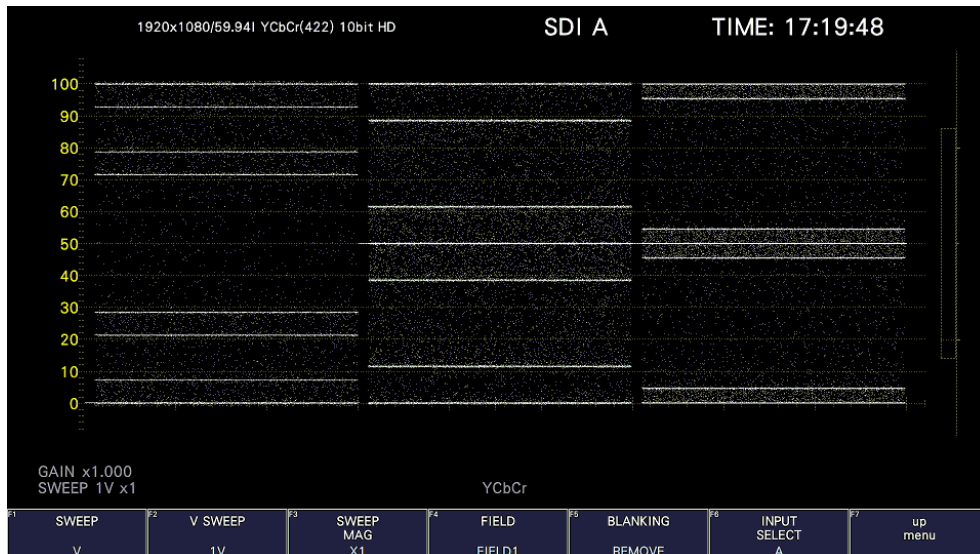

10. VIDEO SIGNAL WAVEFORM DISPLAY

V SWEEP = 2V

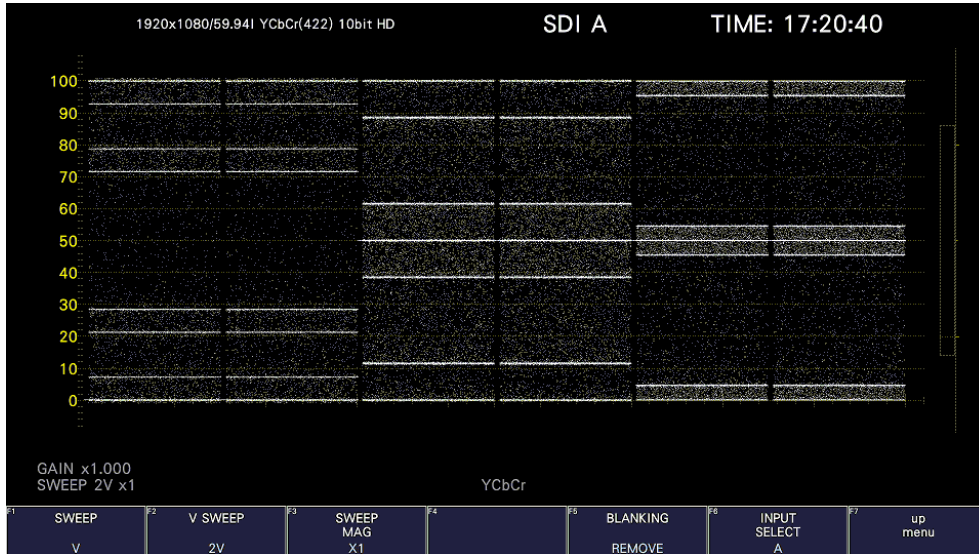

Figure 10-18 Selecting the field display format

Furthermore, when the input signal is interlace or segmented frame and **F•2** V SWEEP is set to 1V, to select which field is displayed, follow the procedure below.

Procedure

WFM → **F•3** SWEEP → **F•4** FIELD: FIELD1 / FIELD2

10.5.4 Selecting the Horizontal Magnification

To select the horizontal magnification, follow the procedure below. The magnifications that you can select vary as shown below depending on settings such as COLOR MATRIX.

[See also] COLOR MATRIX → section 10.8.1, "Selecting the Color Matrix."

Table 10-2 Horizontal magnifications

F•1 SWEEP	COLOR MATRIX	F•2 H SWEEP	X1	X10	X20	X40	ACTIVE	BLANK
H	YCbCr, GBR, RGB	1H	Yes	Yes	Yes	No	Yes	Yes
		2H	Yes	Yes	Yes	No	No	Yes
	COMPOSITE	-	Yes	Yes	Yes	No	Yes	No
V	-	-	Yes	No	Yes	Yes	No	No

(Yes: Settable. No: Not settable.)

Procedure

WFM → **F•3** SWEEP → **F•3** SWEEP MAG: X1 / X10 / X20 / X40 / ACTIVE / BLANK

10. VIDEO SIGNAL WAVEFORM DISPLAY

Settings

X1:	The video signal waveforms are displayed so that they fit on the screen.
X10:	The video signal waveforms are magnified from the center of the display to 10 times the size of X1.
X20:	The video signal waveforms are magnified from the center of the display to 20 times the size of X1.
X40:	The video signal waveforms are magnified from the center of the display to 40 times the size of X1.
ACTIVE:	Everything but the video signal waveform blanking interval is magnified.
BLANK:	The video signal waveform blanking interval is magnified. The vertical blanking interval is also displayed on the vector display.

SWEEP MAG = X1

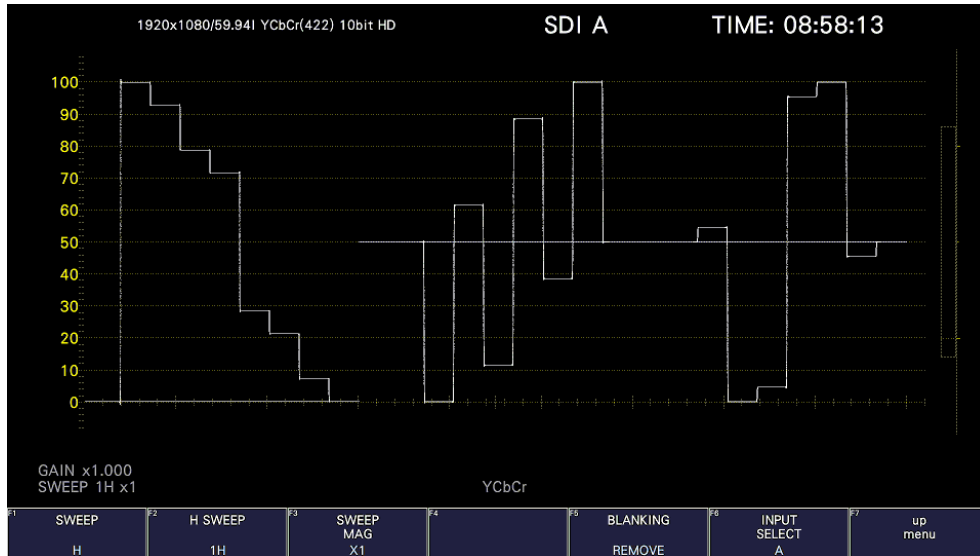

SWEEP MAG = X10

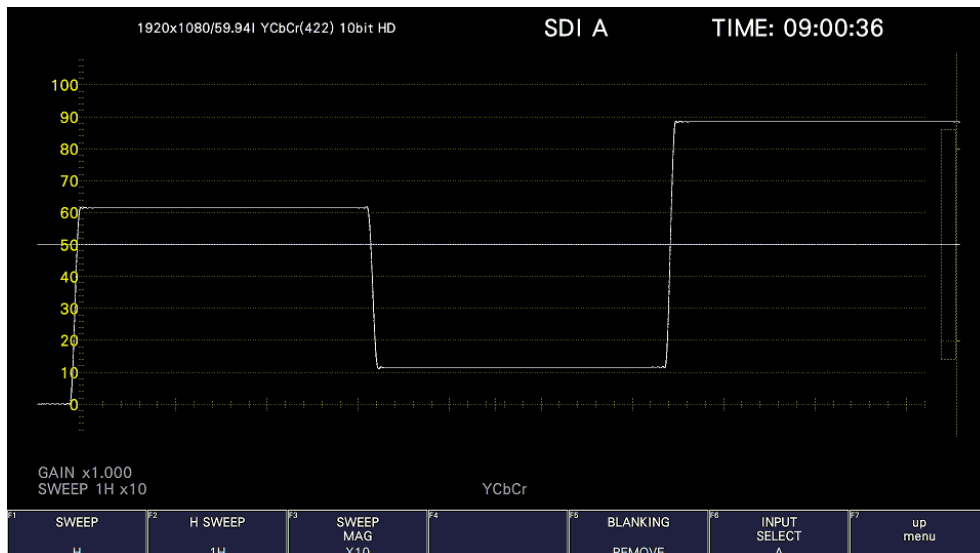

10. VIDEO SIGNAL WAVEFORM DISPLAY

SWEEP MAG = ACTIVE

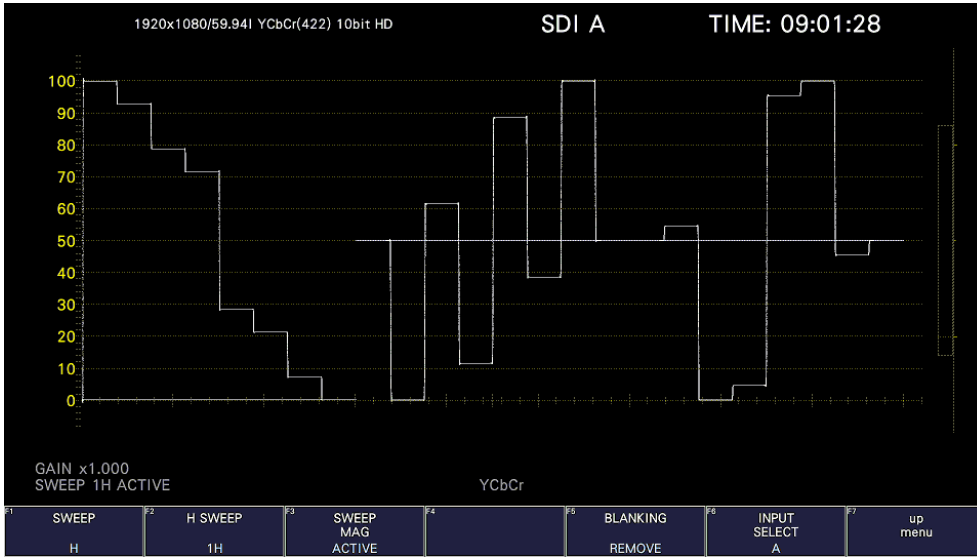

SWEEP MAG = BLANK

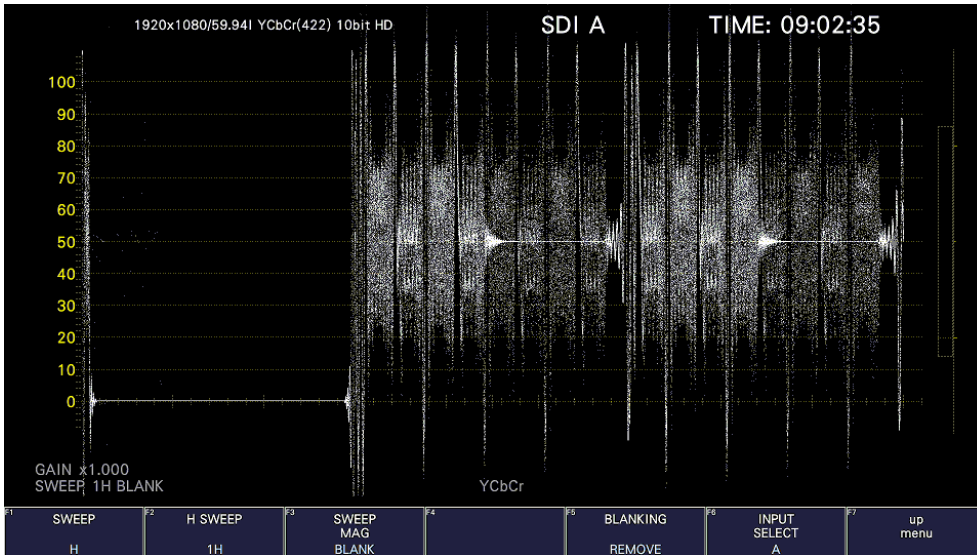

Figure 10-19 Horizontal magnifications

10. VIDEO SIGNAL WAVEFORM DISPLAY

10.5.5 Displaying the Blanking Interval

To set how the waveforms in the blanking interval are displayed, follow the procedure below.

If a setting other than REMOVE is selected, the vertical blanking interval is also displayed on the vector display.

[See also] COLOR MATRIX → section 10.8.1, "Selecting the Color Matrix."

Procedure

WFM	→	F•3	SWEEP	→	F•5	BLANKING: <u>REMOVE</u> / V VIEW / H VIEW / ALL VIEW
-----	---	-----	-------	---	-----	--

Settings

- REMOVE: Only the active interval is displayed.
- V VIEW: The active interval and the vertical blanking interval are displayed.
- H VIEW: The active interval and the horizontal blanking interval are displayed.
This option cannot be selected when COLOR MATRIX is set to COMPOSITE.
- ALL VIEW: The entire input signal is displayed.
This option cannot be selected when COLOR MATRIX is set to COMPOSITE.

BLANKING = ALL VIEW

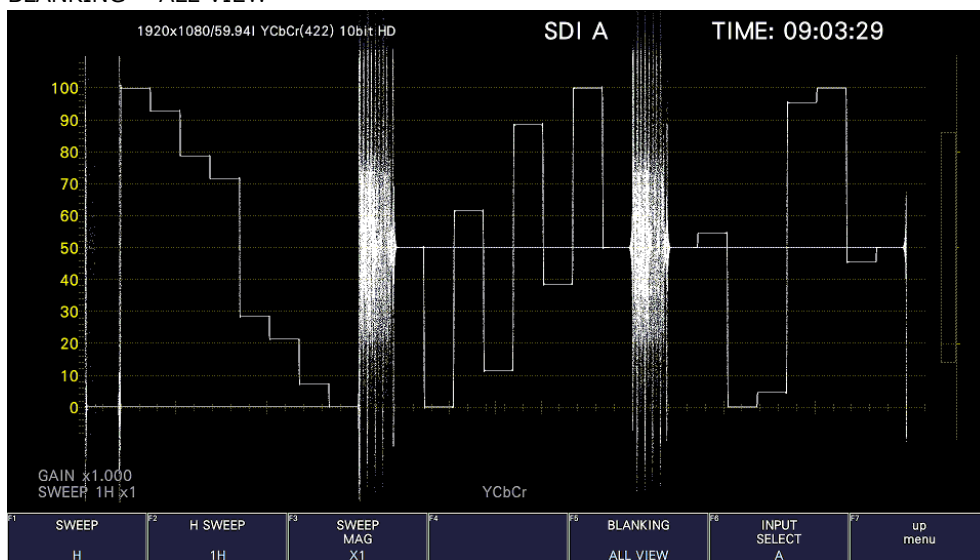

Figure 10-20 Displaying blanking intervals

10.6 Configuring the Cursor Settings

To configure the cursor settings, press **F•4** CURSOR on the WFM menu.

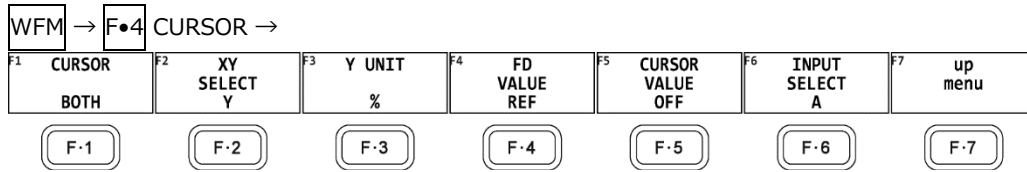

Figure 10-21 CURSOR menu

10.6.1 Turning Cursors On and Off

To turn cursors on and off, follow the procedure shown below.

The REF cursor is displayed in blue, and the DELTA cursor is displayed in green. The value of DELTA - REF appears as a measured value in the lower right of the screen. (When **F•3** Y UNIT is set to DEC or HEX, absolute values are displayed.)

0If BOTH is selected, the X-axis cursors and Y-axis cursors are displayed simultaneously.

Procedure



10.6.2 Selecting the Cursor

To select the X (time measurement) or Y (amplitude measurement) cursor, follow the procedure below.

If **F•1** CURSOR is set to BOTH, select the cursor to move here.

Procedure



XY SELECT = X

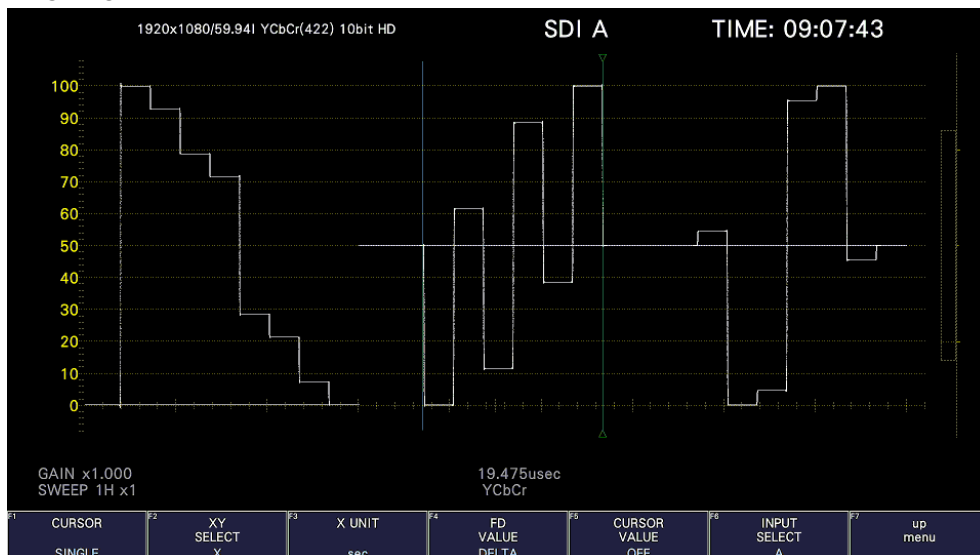

10. VIDEO SIGNAL WAVEFORM DISPLAY

XY SELECT = Y

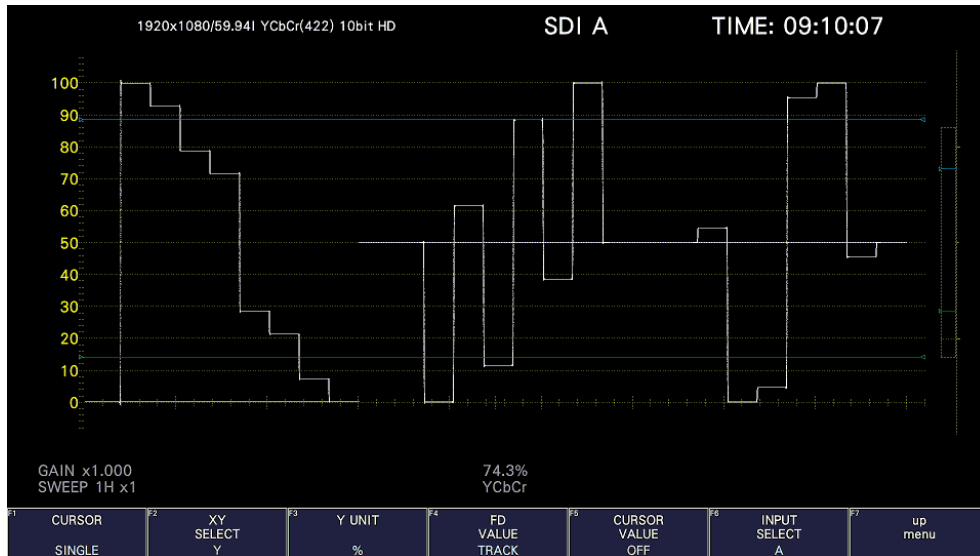

Figure 10-22 Selecting the cursor

10.6.3 Selecting the Y-Axis Measurement Unit

When **F•2** XY SELECT is set to Y, to select the Y-axis cursor measurement unit, follow the procedure below.

When COLOR MATRIX is set to YCbCr, GBR, or RGB, the default value is %.

[See also] COLOR MATRIX → section 10.8.1, “Selecting the Color Matrix.”

Procedure

WFM → **F•4** CURSOR → **F•3** Y UNIT: mV / % / R% / DEC / HEX / HDR

Settings

- mV: The measurement unit is volts.
 - %: The measurement unit is percentage.
When the composite display format is NTSC, 714.3 mV is 100 %. When the composite display format is PAL, 700 mV is 100 %.
 - R%: The amplitude will be measured as a percentage of the amplitude at the time when you pressed **F•5** REF SET.
 - DEC: Values are displayed in decimal with 0 to 100 % expressed as 64 to 940. This option cannot be selected when COLOR MATRIX is set to COMPOSITE.
C_BC_R signal measurement is not supported.
 - HEX: Values are displayed in hexadecimal with 0 to 100 % expressed as 040 to 3AC. This option cannot be selected when COLOR MATRIX is set to COMPOSITE.
C_BC_R signal measurement is not supported.
 - HDR: Values are displayed as a percentage or Nits. You can select this option when SER23 is installed and when HDR signals are being measured. For details, see section 14.1.4, “Cursor Display.”
-

10. VIDEO SIGNAL WAVEFORM DISPLAY

10.6.4 Selecting the X-Axis Measurement Unit

When **F•2** XY SELECT is set to X, to select the X-axis cursor measurement unit, follow the procedure below.

Procedure

WFM	→	F•4	CURSOR	→	F•3	X UNIT: <u>sec</u> / Hz
-----	---	-----	--------	---	-----	-------------------------

Settings

sec:	The measurement unit is seconds.
Hz:	The measurement unit is frequency, with the length of one period set to the distance between the two cursors.

10.6.5 Moving the Cursors

To move a cursor, follow the procedure shown below to select a cursor. Then, move the cursor by turning the function dial (F•D). Triangles appear on both ends of the selected cursor.

You can also select a cursor by pressing the function dial (F•D). Each time you press the function dial (F•D), the selected cursor switches from REF, to DELTA, to TRACK, and then back to REF.

Procedure

WFM	→	F•4	CURSOR	→	F•4	FD VALUE: <u>REF</u> / DELTA / TRACK
-----	---	-----	--------	---	-----	--------------------------------------

10.6.6 Turning the Cursor Value Display On and Off

To display cursor values, follow the procedure shown below (except when **F•3** Y UNIT is set to R%).

The display unit is the unit specified with **F•3** Y UNIT or **F•3** X UNIT.

If **F•1** CURSOR is set to BOTH, the value is displayed on the cursor selected with **F•2** XY SELECT.

Procedure

WFM	→	F•4	CURSOR	→	F•5	CURSOR VALUE: ON / <u>OFF</u>
-----	---	-----	--------	---	-----	-------------------------------

10. VIDEO SIGNAL WAVEFORM DISPLAY

CURSOR VALUE = ON

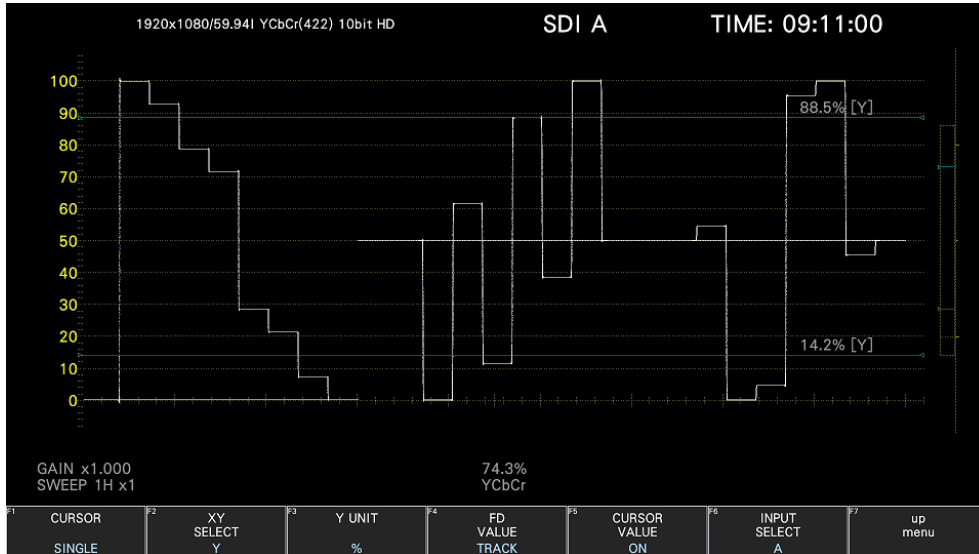

Figure 10-23 Turning the cursor value display on and off

10.7 Configuring the Line Selection Settings

To configure the line selection settings, press **F•5** LINE SELECT on the WFM menu.

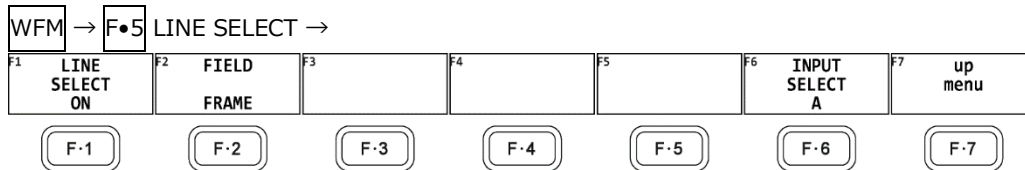

Figure 10-24 LINE SELECT menu

10.7.1 Turning Line Selection On and Off

To display the vector of the selected line, follow the procedure below. You can use the function dial (F•D) to select a line. The number of the selected line appears in the lower left of the screen.

Changing this setting will also change the vector-display and picture-display line selection settings.

When SWEEP is set to V, this is fixed at OFF.

When CINELITE ADVANCE is set to on, CINELITE appears.

[See also] SWEEP → 10.5.1, "Selecting the Sweep Method,"

CINELITE ADVANCE → 13.6.8, "Displaying Link Markers"

Procedure

WFM	→	F•5	LINE SELECT	→	F•1	LINE SELECT: ON / OFF / CINELITE
-----	---	-----	-------------	---	-----	----------------------------------

10. VIDEO SIGNAL WAVEFORM DISPLAY

LINE SELECT = ON

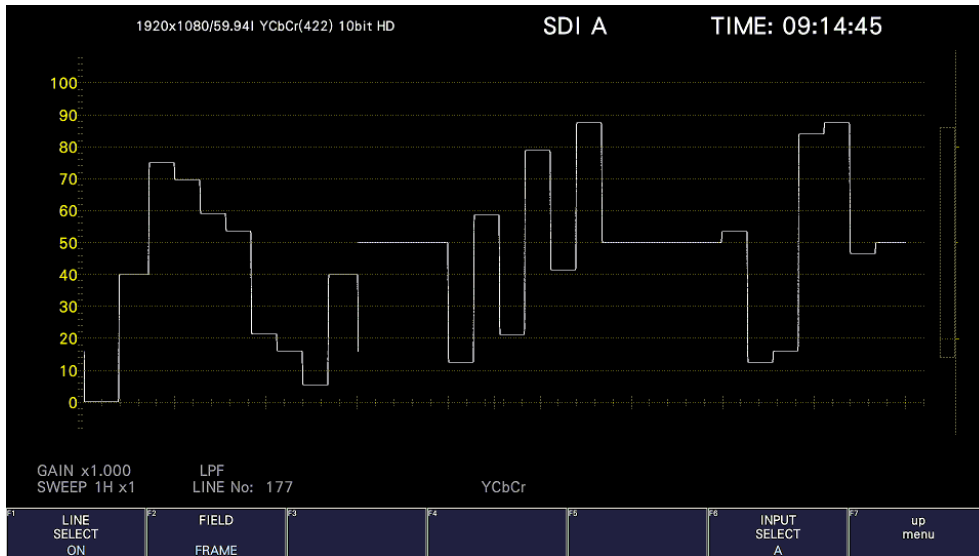

LINE SELECT = OFF

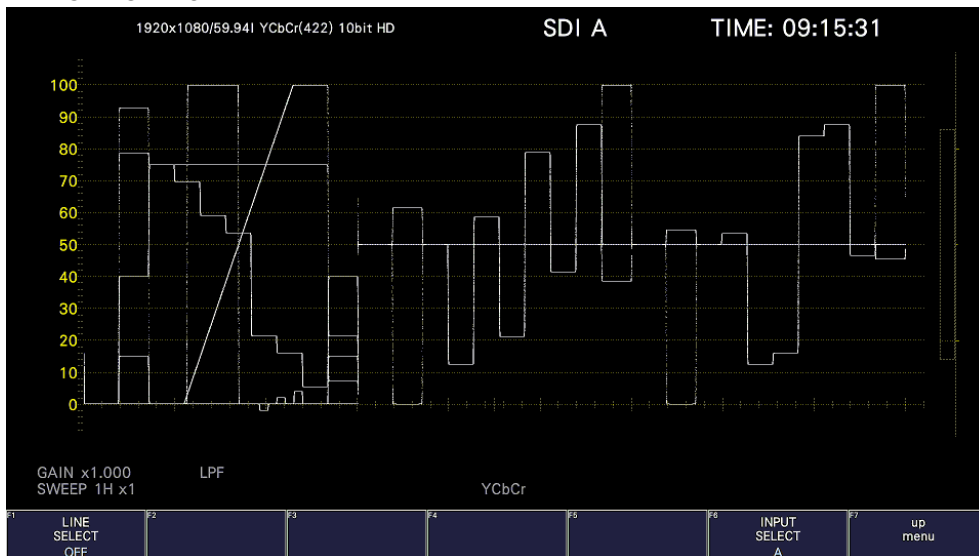

Figure 10-25 Turning line selection on and off

10.7.2 Setting the Line Selection Range

When **F•1** LINE SELECT is set to ON and the input signal format is interlaced or segmented frame, to set the line selection range, follow the procedure below. Changing this setting will also change the selected line on the video-signal-waveform, picture, and status (data dump) displays.

Procedure

VECT → **F•3** LINE SEL → **F•2** FIELD: FIELD1 / FIELD2 / FRAME

Settings

FIELD1:	A line from field 1 can be selected. (Example: 1 to 563)
FIELD2:	A line from field 2 can be selected. (Example: 564 to 1125)
FRAME:	All lines can be selected. (Example: 1 to 1125)

10.8 Configuring the Color System Settings

To configure the color system settings, press **F•7** COLOR SYSTEM on the WFM menu.

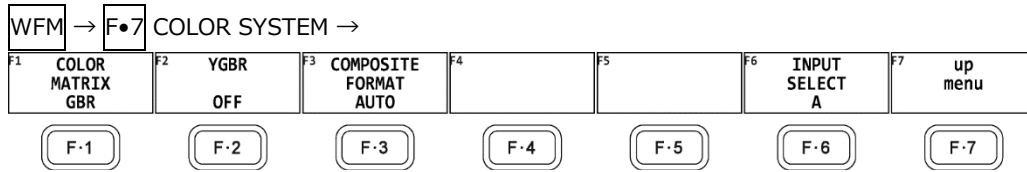
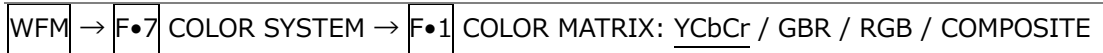

Figure 10-26 COLOR SYSTEM menu

10.8.1 Selecting the Color Matrix

The instrument performs a matrix conversion on an input signal to convert it into a GBR, RGB or pseudo-composite signal. To select the waveform display format, follow the procedure below. The selected display format is indicated in the lower right of the display.

Procedure



Settings

- YCbCr:** The $Y C_B C_R$ signal is displayed.
This setting cannot be selected when the input signal is RGB.
- GBR:** The input signal is converted into a GBR signal and displayed.
- RGB:** The input signal is converted into a RGB signal and displayed.
- COMPOSITE:**
The input signal is converted into a pseudo NTSC or PAL composite signal and displayed.
- Color burst frequencies do not match those of PAL and NTSC.
 - Color burst and sync signal widths and locations are different from those of PAL and NTSC.
 - The signal bandwidth is that of the original signal.

COLOR MATRIX = YCbCr

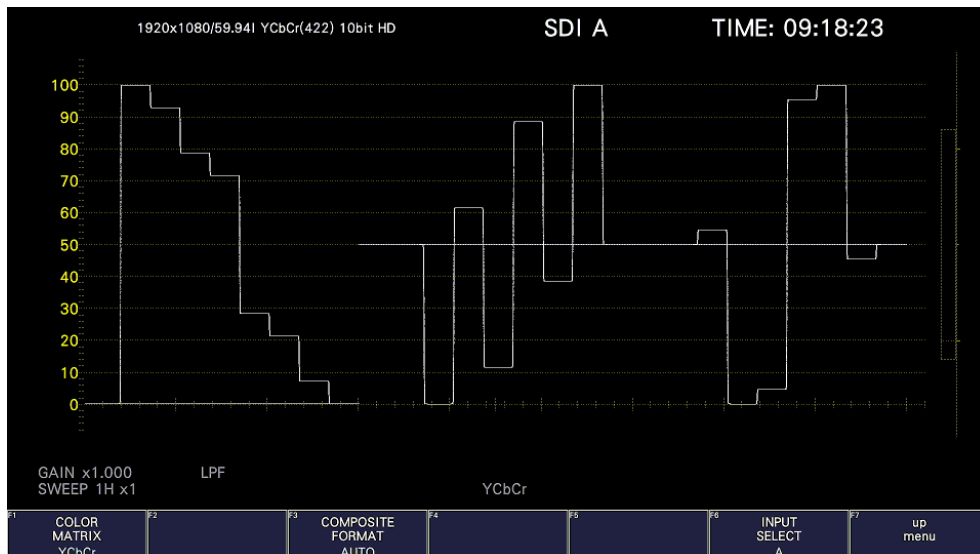

10. VIDEO SIGNAL WAVEFORM DISPLAY

COLOR MATRIX = GBR

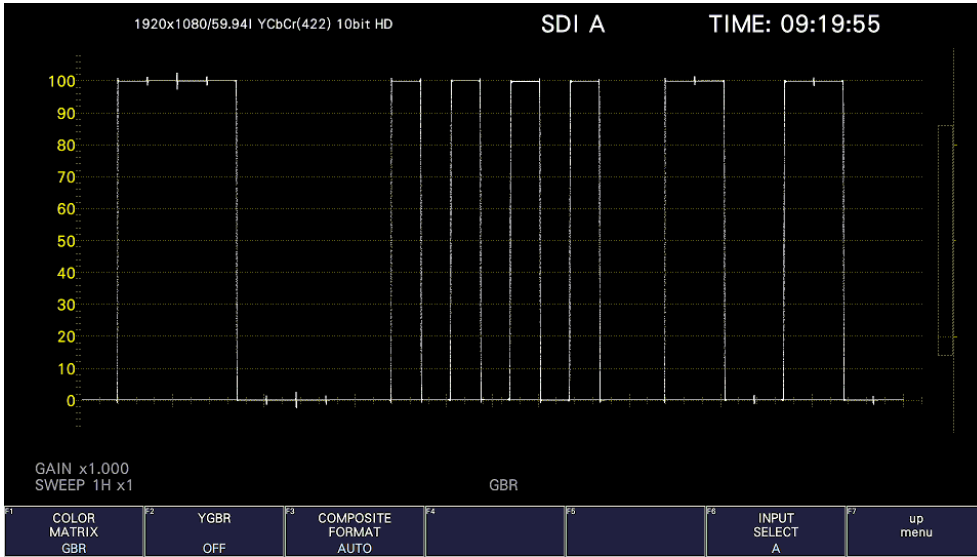

COLOR MATRIX = RGB

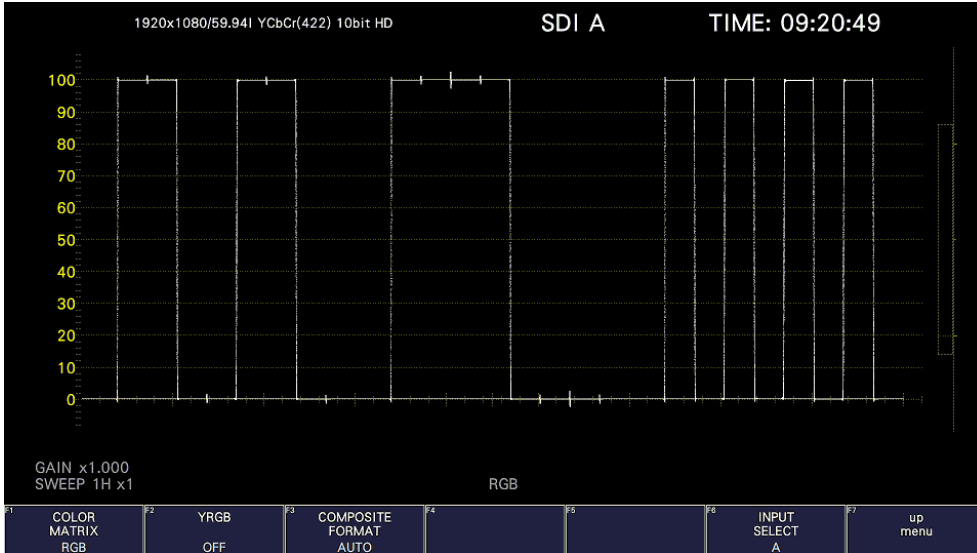

COLOR MATRIX = COMPOSITE

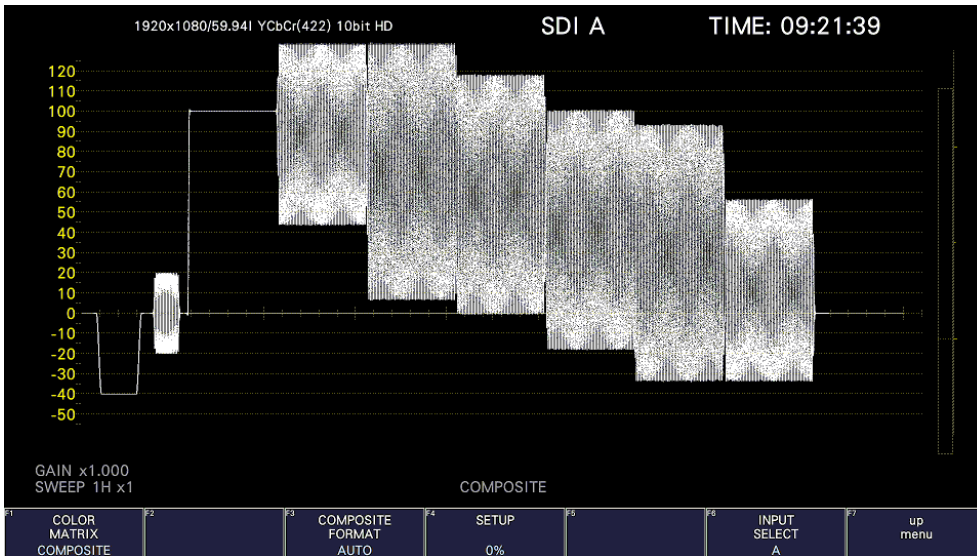

Figure 10-27 Selecting the color matrix

10.8.2 Turning the Luminance Signal On and Off

When **F•1** COLOR MATRIX is set to GBR or RGB, to turn the luminance signal (Y) on and off, follow the procedure below.

Procedure

WFM → **F•7** COLOR SYSTEM
 → **F•2** YGBR: ON / OFF
 → **F•2** YRGB: ON / OFF

YGBR = ON

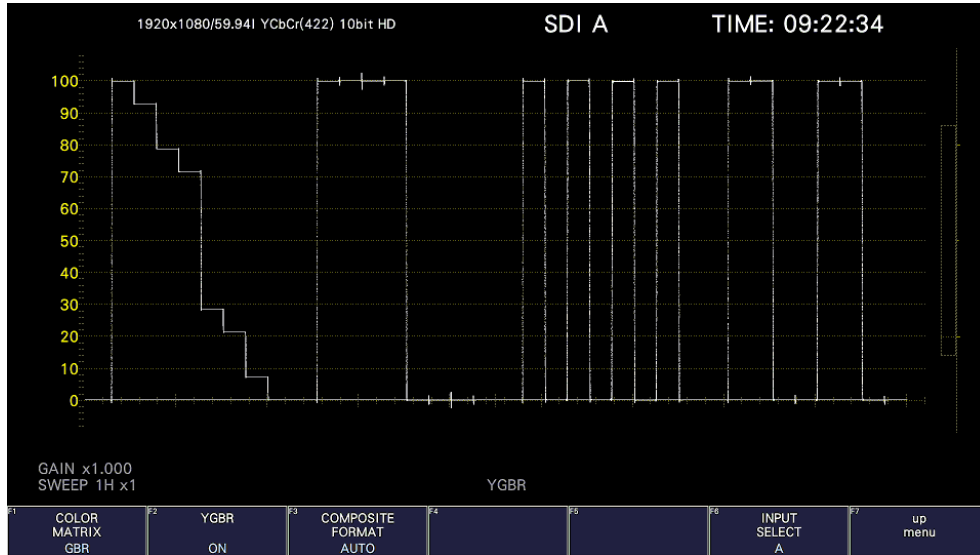

Figure 10-28 Turning the luminance signal on and off

10.8.3 Selecting the Composite Display Format

To select the composite display format, follow the procedure below.

Procedure

WFM → **F•7** COLOR SYSTEM → **F•4** COMPOSITE FORMAT: AUTO / NTSC / PAL

Settings

-
- AUTO: When the input signal frame rate is 25 Hz or 50 Hz, the format is PAL. Otherwise, the format is NTSC.
 - NTSC: The format is NTSC. The scale is fixed to percentage.
 - PAL: The format is PAL. The scale is fixed to V.
-

10. VIDEO SIGNAL WAVEFORM DISPLAY

10.8.4 Selecting the Setup Level

When **F•1** COLOR MATRIX is set to COMPOSITE, to select the setup level, follow the procedure below.

This menu does not appear if the composite display format is PAL.

Procedure

WFM → **F•7** COLOR SYSTEM → **F•5** SETUP: 0% / 7.5%

SETUP = 7.5%

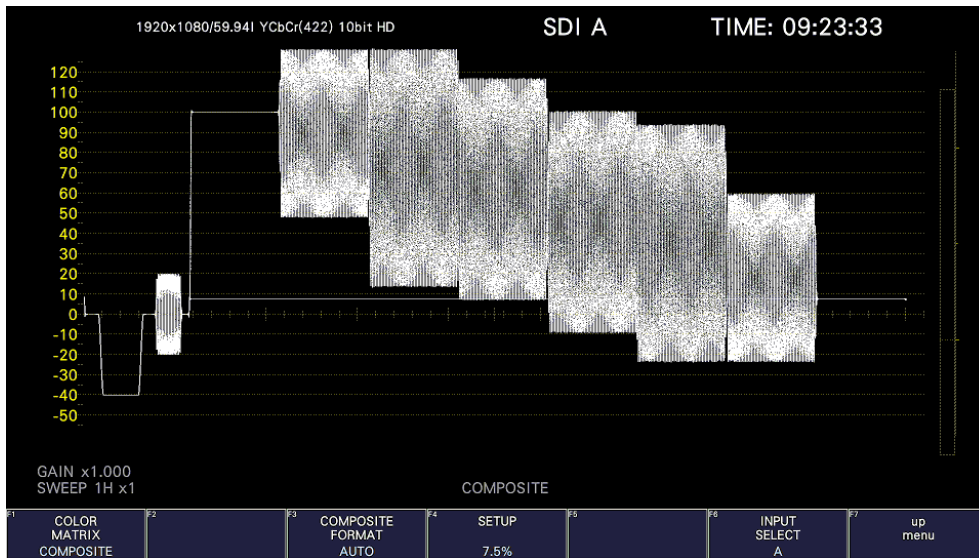

Figure 10-29 Selecting the setup level

11. VECTOR DISPLAY

To display vectors, press VECT, **F•1** VECT INTEN/CONFIG, and then **F•1** VECTOR DISPLAY to select VECTOR.

When VECTOR DISPLAY is set to 5BAR, see 11.12, "5-Bar Display," for the explanation. When set to HISTOGRAM, see 11.13, "Histogram Display," for the explanation. When VECTOR DISPLAY is set to CIE, see 12, "CIE Chromaticity Diagram Display (SER22)," for the explanation.

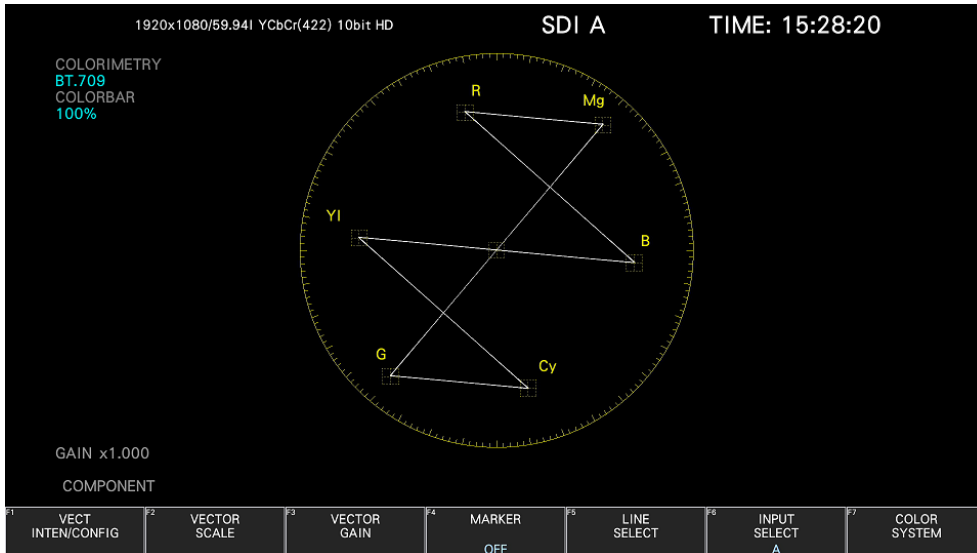

Figure 11-1 Vector display

- Vectors

Component signal vector displays are X-Y displays based on C_B (horizontal) and C_R (vertical). The vector display scale has the following qualities.

- Frame: $\pm 5\%$ of the full scale value 0.7 V (during component display) (*1)
 $\pm 3\%$ of the full scale value 0.7 V (For the pseudo-composite display when VARIABLE SCALE is set to off)
- Circle: +20 % with respect to green (For the pseudo-composite display when VARIABLE SCALE is set to off)

*1 The variable scale is set to on, it can be varied from 5% ($\pm 2.5\%$) to 10% ($\pm 5\%$).

- Blanking interval

Normally, blanking interval is not displayed with vectors, but if SWEEP MAG is set to BLANK on the WFM menu or BLANKING is set to REMOVE, it is displayed.

- Colorimetry

The colorimetry selected on the SYS menu is displayed in cyan in the upper left of the screen. However, for 3G(DL)-4K, the current applied colorimetry is displayed in yellow if the colorimetry information of all links specified by the payload ID are not matched. When the colorimetry alarm on the SYS menu is set to on and a colorimetry different from the one specified is received, the alarm is indicated in red.

[See also] Colorimetry alarm → 7.1.3, "Setting the Input Format and Format Alarm"

11. VECTOR DISPLAY

- Scale

The scale selected with COLOR BAR on the COLOR SYSTEM menu is displayed in cyan in the COLORBAR on the upper left of the screen.

[See also] COLOR BAR → 11.11.2, "Displaying a Scale for 75% Color Bars"

11.1 Operation Key Description

Operation keys other than S-CUT key can be controlled from the mouse and touch panel. On the vector display, you can press the operation keys to change the following settings. (Some settings may not be changed.)

Key assignments can be changed freely on the OPERATION KEY tab.

[See also] OPERATION KEY tab → 7.2.13, "Setting the Operation keys"

Table 11-1 Operation Key Actions

	Setting
FORM	COMPONENT / COMPOSITE
OVLAY	Disabled
FILTER	Disabled
GAIN	CAL / VARIABLE
MAG (GAIN)	X1 / X5 / IQ-MAG
SWEEP	Disabled
MAG (SWEEP)	Disabled

11.2 Setting the Display and Waveform Intensity

To configure the display and waveform intensity settings, press **F•1** VECT INTEN/CONFIG on the VECT menu.

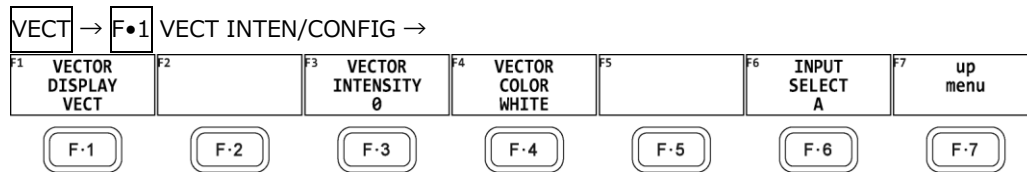

Figure 11-2 VECT INTEN/CONFIG menu

11.2.1 Switching the Display Mode

To select the display mode, follow the procedure below.

Procedure

VECT → F•1 VECT INTEN/CONFIG → F•1 VECTOR DISPLAY: VECTOR / 5BAR / HISTOGRAM / CIE DIAGRAM

Settings

VECTOR: Shows vectors s, RGB vectors (SER40), or YCbCr vectors (SER40).

5BAR: Switches to the 5-bar display.
For details, see section 11.12, "5-Bar Display."

HISTOGRAM: A histogram is displayed.
For details, see section 11.13, "Histogram Display."

CIE DIAGRAM: The CIE chromaticity diagram display is shown.
For details, see section 12, "CIE Chromaticity Diagram Display (SER22)."

11. VECTOR DISPLAY

11.2.2 Selecting the Vector Mode (SER40)

When the SER40 is installed, you can select the vector mode, follow the procedure below.

The RGB VECTOR display consists of two factors. One is displayed the G and B components of 100% color bar signal as unit vector on in the upper half of the measurement screen, and the other is displayed the G and R components of the 100% color bar signal as the unit vector in the lower half of the measurement screen. Each vertical axis shows the G + B and -(G + R) of the 100% color bar signal, which is useful for monitoring the color conditions, including the gamut errors.

The YCbCr VECTOR display shows the Cb signal as the horizontal axis and the Y signal as the vertical axis in the upper half of the measurement screen, and the Cr signal as the horizontal axis and the inverted Y signal as the vertical axis in the lower half of the measurement screen. The luminance (Y signal) amplitude can be checked by the deviation in the vertical axis direction from the center of each marker. The chrominance (Cb / Cr signal) amplitude can be checked by the deviation in the horizontal axis direction from the center of each marker.

Procedure

VECT → F.1 VECT INTEN/CONFIG → F.2 VECTOR MODE: VECTOR / RGB VECTOR / YCbCr VECTOR

Settings

VECTOR: Shows vectors.
RGB VECTOR: Shows RGB vectors.
YCbCr VECTOR: Shows YCbCr vectors.

VECTOR MODE = VECTOR

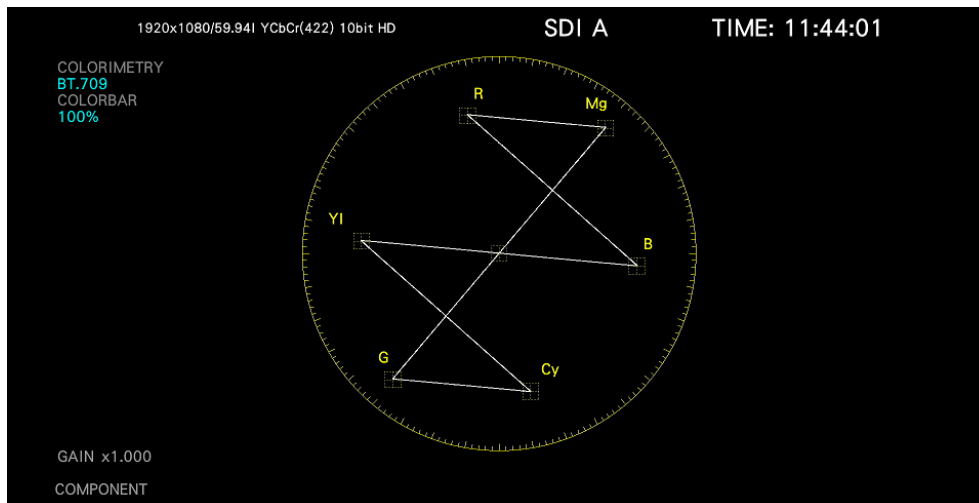

11. VECTOR DISPLAY

VECTOR MODE = RGB VECTOR

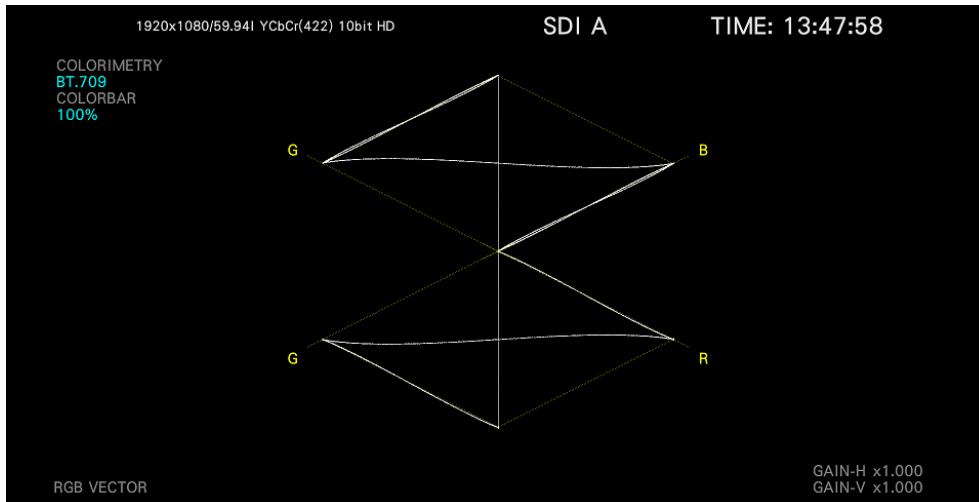

VECTOR MODE = YCbCr VECTOR

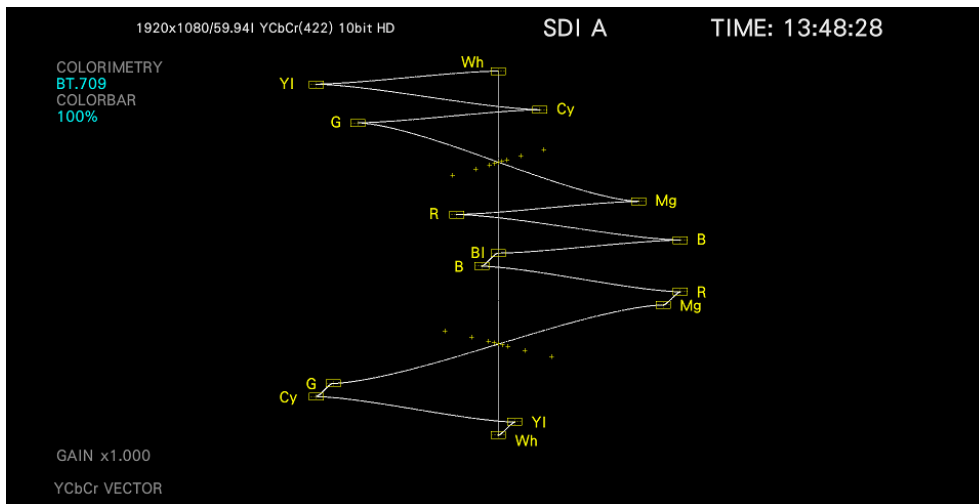

Figure 11-3 Vector mode

11.2.3 Adjusting the Waveform Intensity

To adjust the vector intensity, follow the procedure below.

Press the function dial (F•D) to return the setting to its default value (0).

Procedure

VECT → F•1 VECT INTEN/CONFIG → F•3 VECTOR INTENSITY: -128 - 0 - 127

11.2.4 Selecting the Waveform Color

To select the vector color, follow the procedure below.

Procedure

VECT → F•1 VECT INTEN/CONFIG → F•2 VECTOR COLOR: WHITE / YELLOW / CYAN / GREEN / MAGENTA / RED / BLUE

11.3 Setting the Vector Scale

To configure the scale, use **F•2** VECTOR SCALE on the VECT menu.

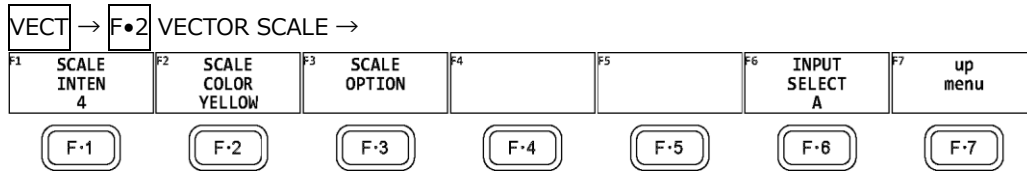

Figure 11-4 VECTOR SCALE menu

11.3.1 Adjusting the Scale Intensity

To adjust the scale intensity, follow the procedure below.

Press the function dial (F•D) to return the setting to its default value (4).

Procedure



11.3.2 Selecting the Scale Color

To select the scale color, follow the procedure below.

Procedure



11.3.3 Turning the Color Wheel On and Off

To configure the scale option, use **F•3** SCALE OPTION on the VECTOR SCALE menu.

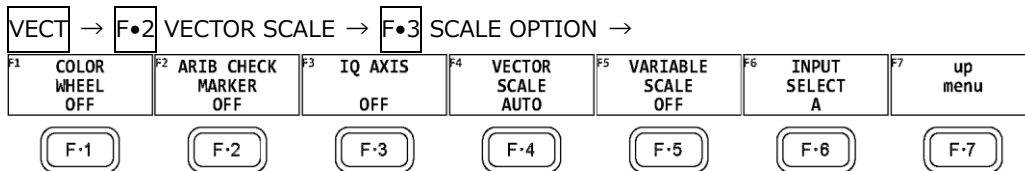

Figure 11-5 SCALE OPTION menu

When VARIABLE SCALE is set to off, COLOR WHEEL (Hue circle) display can be turn on or off, follow the procedure below.

Procedure



11. VECTOR DISPLAY

COLOR WHEEL = ON

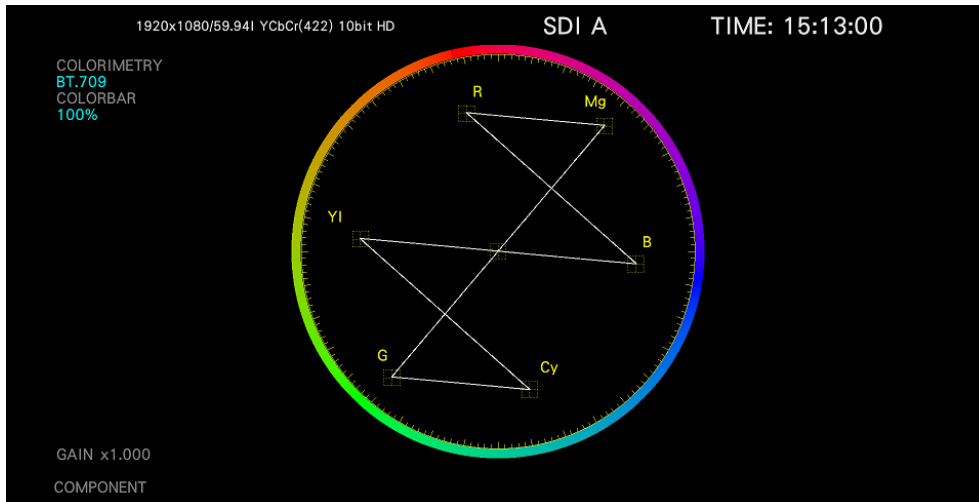

Figure 11-6 Turning the color wheel on and off

11.3.4 ARIB Check Marker

When VARIABLE SCALE is set to on and VECTOR SCALE is set to BT.2020, the ARIB check marker can be displayed on the vector waveform follow the procedure below.

[See also] VARIABLE SCALE → 11.3.7, "Turning the Variable Scale On and Off."

Procedure

VECT → F•2 VECTOR SCALE → F•3 SCALE OPTION → F•2 ARIB CHECK MARKER: OFF /
STD-B66 / STD-B72

ARIB CHECK MARKER = STD-B72

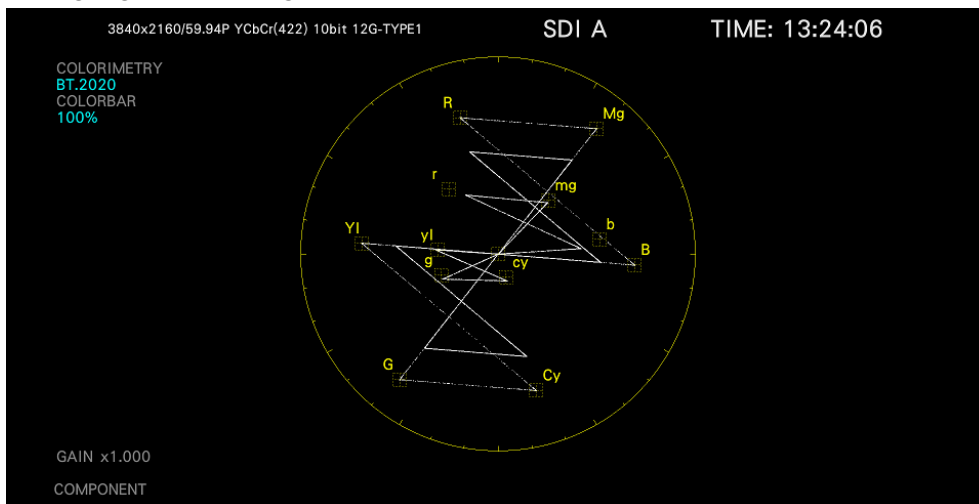

Figure 11-7 ARIB check marker

11. VECTOR DISPLAY

11.3.5 Turning the I and Q Axes On and Off

To turn the I and Q axes on and off, follow the procedure below.

This menu item does not appear when VECTOR SCALE is set to DCI or BT.2020.

When the full scale value of 0.7 V is 100 %, the I and Q axes are displayed at the following values.

Table 11-2 Displaying the I and Q axes

	I Axis	Q Axis
G	44.559 %	37.056 %
B	27.865 %	84.085 %
R	69.120 %	62.417 %

Procedure

VECT	→	F•2	VECTOR SCALE	→	F•3	SCALE OPTION	→	F•3	IQ AXIS: ON / <u>OFF</u>
------	---	-----	--------------	---	-----	--------------	---	-----	--------------------------

IQ AXIS = ON

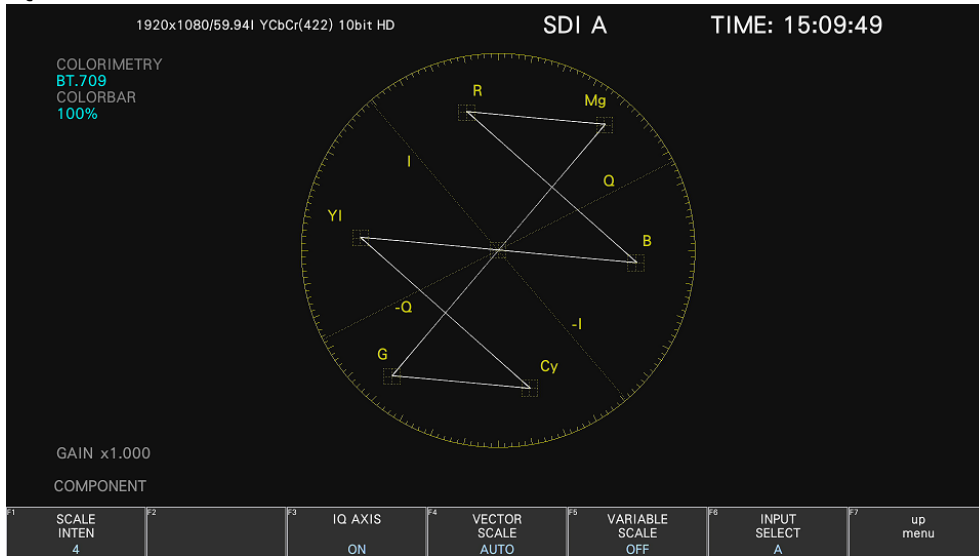

Figure 11-8 Turning the I and Q axes on and off

11. VECTOR DISPLAY

11.3.6 Selecting the Scale

When COLOR MATRIX is set to COMPONENT, follow the procedure below to select the scale type.

[See also] COLOR MATRIX → section 11.11.1, "Selecting the Color Matrix."

Procedure

VECT	→	F•2	VECTOR SCALE	→	F•3	SCALE OPTION	→	F•4	VECTOR SCALE: <u>AUTO</u> / BT.601 / BT.709 / DCI / BT.2020
------	---	-----	--------------	---	-----	--------------	---	-----	---

Settings

AUTO:	A scale for the colorimetry selected on the SYS menu is displayed.
BT.601:	A scale defined in ITU-R BT.601 is displayed. When the input signal is SD and a 100 % color bar signal is being applied, the peak levels match the ends of the scale.
BT.709:	A scale defined in ITU-R BT.709 is displayed. When the input signal is HD and a 100 % color bar signal is being applied, the peak levels match the ends of the scale.
DCI:	A scale defined in DCI is displayed.
BT.2020:	A scale defined in ITU-R BT.2020 is displayed. When the input signal is 4K, the division transmission system is 2 sample interleave, and a 100% color bar signal is being applied, the peak levels match the ends of the scale.

11.3.7 Turning the Variable Scale On and Off

To turn the variable scale on and off, follow the procedure below. When set to on, the variable marker display is valid.

When set to on, IQ-MAG cannot be selected for GAIN MAG.

Procedure

VECT	→	F•2	VECTOR SCALE	→	F•3	SCALE OPTION	→	F•5	VARIABLE SCALE: ON / <u>OFF</u>
------	---	-----	--------------	---	-----	--------------	---	-----	---------------------------------

11.4 Setting the RGB Vector Scale (SER40)

When the SER40 is installed and the vector mode is set to RGB VECTOR, you can configure the scale, use **F•2** RGB VECTOR SCALE on the VECT menu.

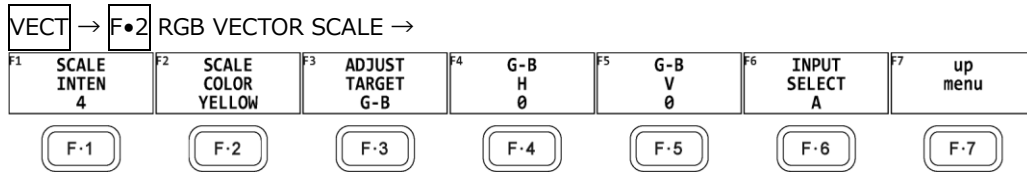

Figure 11-9 RGB VECTOR SCALE menu

11.4.1 Adjusting the Scale Intensity

To adjust the scale intensity, see section 11.3.1, "Adjusting the Scale Intensity."

11.4.2 Selecting the Scale Color

To select the scale color, see section 11.3.2, "Selecting the Scale Color."

11.4.3 Selecting the Adjust Target

To select the adjust target, follow the procedure below.

Procedure

VECT	→	F•2	RGB VECTOR SCALE	→	F•3	ADJUST TARGET: <u>G-B</u> / G-R
------	---	------------	------------------	---	------------	---------------------------------

11.4.4 Adjusting the G-B H / G-R H

To adjust the G-B H / G-R H, follow the procedure below.

Procedure (When the adjust target is set to G-B)

VECT	→	F•2	RGB VECTOR SCALE	→	F•4	G-B H: -500 - <u>0</u> - 500
------	---	------------	------------------	---	------------	------------------------------

Procedure (When the adjust target is set to G-R)

VECT	→	F•2	RGB VECTOR SCALE	→	F•4	G-R H: -500 - <u>0</u> - 500
------	---	------------	------------------	---	------------	------------------------------

11.4.5 Adjusting the G-B V / G-R V

To adjust the G-B V / G-R V, follow the procedure below.

Procedure (When the adjust target is set to G-B)

VECT	→	F•2	RGB VECTOR SCALE	→	F•5	G-B V: -500 - <u>0</u> - 500
------	---	------------	------------------	---	------------	------------------------------

Procedure (When the adjust target is set to G-R)

VECT	→	F•2	RGB VECTOR SCALE	→	F•5	G-R V: -500 - <u>0</u> - 500
------	---	------------	------------------	---	------------	------------------------------

11.5 Setting the YCbCr Vector Scale (SER40)

When the SER40 is installed and the vector mode is set to YCbCr VECTOR, you can configure the scale, use **F•2** YCbCr VECTOR SCALE on the VECT menu.

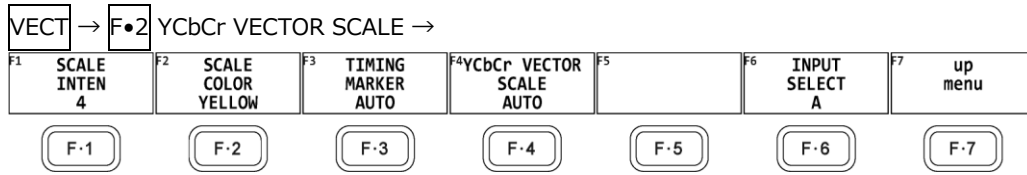

Figure 11-10 YCbCr VECTOR SCALE menu

11.5.1 Adjusting the Scale Intensity

To adjust the scale intensity, see section 11.3.1, "Adjusting the Scale Intensity."

11.5.2 Selecting the Scale Color

To select the scale color, see section 11.3.2, "Selecting the Scale Color."

11.5.3 Selecting the Timing Marker

To select the timing marker, follow the procedure below.

Procedure

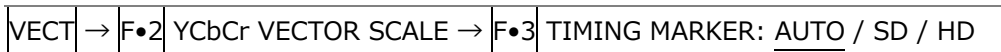

11.5.4 Selecting the YCbCr Vector Scale

To select the scale, see section 11.3.6, "Selecting the Scale."

11.6 Setting the Vector Gain

To set the gain, press **F•3** VECTOR GAIN on the VECT menu.

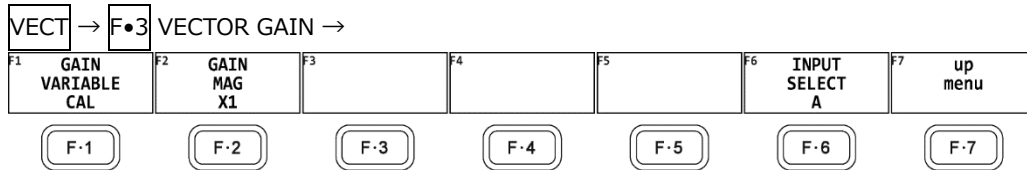

Figure 11-11 VECTOR GAIN menu

11.6.1 Setting the Variable Gain

To set the variable vector gain, follow the procedure below.

Procedure



Settings

CAL:	The waveform gain is fixed.
VARIABLE:	<p>You can adjust the waveform gain by turning the function dial (F•D). Press the function dial (F•D) to return the setting to its default value. The adjusted gain value (the combination of F•1 GAIN VARIABLE and F•2 GAIN MAG) appears in the lower right of the screen.</p> <p>0.200 - <u>1.000</u> - 2.000 (for X1)</p> <p>1.000 - <u>5.000</u> - 10.000 (for X5)</p> <p>0.620 - <u>3.120</u> - 6.240 (not IQ-MAG or SD, component display)</p> <p>0.580 - <u>2.920</u> - 5.840 (IQ-MAG or SD, composite display)</p> <p>0.570 - <u>2.850</u> - 5.700 (not IQ-MAG or SD, for pseudo-composite display)</p> <p>0.520 - <u>2.630</u> - 5.260 (IQ-MAG or SD, for pseudo-composite display)</p>

11. VECTOR DISPLAY

11.6.2 Selecting the Fixed Gain

To select the fixed vector gain, follow the procedure below.

Procedure

VECT	→	F•3	VECTOR GAIN	→	F•2	GAIN MAG: <u>X1</u> / X5 / IQ-MAG
------	---	-----	-------------	---	-----	-----------------------------------

Settings

X1: Vectors are displayed at ×1 magnification.

X5: Vectors are displayed at ×5 magnification.

IQ-MAG: Vectors are displayed using the following magnifications.

×3.12 (for signals other than SD during component display; magnification that causes the I signal of the multiformat colorbar to lie on the circumference of the scale)

×2.85 (for signals other than SD during pseudo-composite display; magnification that causes the I signal of the multiformat colorbar, which has gone through pseudo-composite conversion, to lie on the circumference of the scale)

×2.92 (for SD signals during component display; magnification that causes the amplitude to lie on the circumference of the scale when the burst signal of the composite vector display is converted into component signals)

×2.63 (for SD signals during pseudo-composite display; magnification that causes the -I and Q signals of the SMPTE colorbar, which has gone through pseudo-composite conversion, to lie on the circumference of the scale)

When the variable scale is set to on, you cannot select this setting.

11.6.3 Turning the Guide Display On and Off

When the variable scale is set to on and the fixed vector gain is set to X5, to turn the guide display on and off. When set to on, the current display position is displayed in the upper right of the screen.

Procedure

VECT	→	F•3	VECTOR GAIN	→	F•3	GUIDE DISPLAY: ON / <u>OFF</u>
------	---	-----	-------------	---	-----	--------------------------------

11. VECTOR DISPLAY

11.7 Setting the RGB Vector Gain

When the SER40 is installed and the vector mode is set to RGB VECTOR, you can set the gain, use **F•3** RGB VECTOR GAIN on the VECT menu.

To set the gain, press **F•3** RGB VECTOR GAIN on the VECT menu.

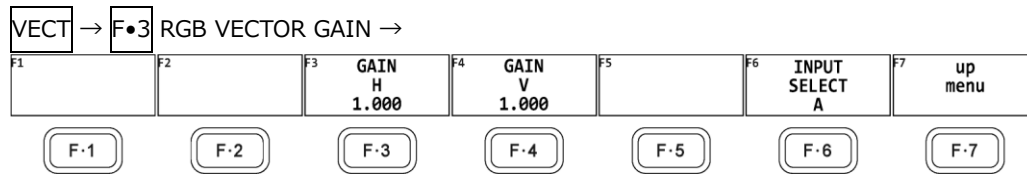

Figure 11-12 RGB VECTOR GAIN menu

11.7.1 Adjusting the Gain H

To adjust the gain H, follow the procedure below.

Procedure

VECT	→	F•3	RGB VECTOR GAIN	→	F•3	GAIN H: 0.200 - <u>1.000</u> - 2.000
------	---	------------	-----------------	---	------------	--------------------------------------

11.7.2 Adjusting the Gain V

To adjust the gain V, follow the procedure below.

Procedure

VECT	→	F•3	RGB VECTOR GAIN	→	F•4	GAIN V: 0.200 - <u>1.000</u> - 2.000
------	---	------------	-----------------	---	------------	--------------------------------------

11.8 Setting the YCbCr Vector Gain

When the SER40 is installed and the vector mode is set to YCbCr VECTOR, you can set the gain, use **F•3** YCbCr VECTOR GAIN on the VECT menu.

To set the gain, press **F•3** VECTOR GAIN on the VECT menu.

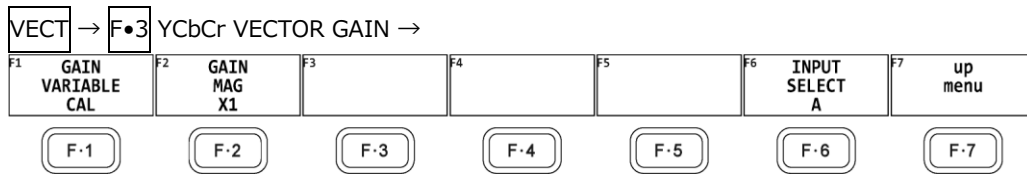

Figure 11-13 YCbCr VECTOR GAIN menu

11.8.1 Setting the Variable Gain

To set the variable vector gain, see section 11.6.1, "Setting the Variable Gain."

11.8.2 Selecting the Fixed Gain

To select the fixed vector gain, see section 11.6.2, "Selecting the Fixed Gain." However, IQ-MAG cannot be selected.

11.8.3 Selecting the Observation Point

When the fixed vector gain is set to X5, to select the observation point, follow the procedure below.

Procedure

VECT → **F•3** YCbCr VECTOR GAIN → **F•3** OBSERVATION POINT: B-Y:Wh / B-Y:Yl / B-Y:Cy / B-Y:G / B-Y:TIMING / B-Y:Mg / B-Y:R / B-Y:B / Bl / R-Y:B / R-YR / R-Y:Mg / R-Y:TIMING / R-Y:G / R-Y:Cy / R-Y:Yl / R-Y:Wh

11.9 Configuring the Marker Settings

To configure the marker settings, press **F•4** MARKER or **F•4** VARIABLE MARKER.

When the VARIABLE SCALE is set to off, you can use **F•4** MARKER to turn the marker display on and off.

When the VARIABLE SCALE is set to on, you can use **F•4** VARIABLE MARKER to display the VARIABLE MARKER menu.

[See also] VARIABLE SCALE → Section 11.3.7, "Turning the Variable Scale On and Off"

11.9.1 Displaying the Vector Marker

When the VARIABLE SCALE is set to off, to display a marker on the vector display, follow the procedure below.

[See also] VARIABLE SCALE → Section 11.3.7, "Turning the Variable Scale On and Off"

You can move the marker horizontally using the H POS knob and vertically using the V POS knob. The measured values are displayed in the lower left of the display. Press the H POS knob to move the marker to the Cb = 0.0% position. Press the V POS knob to move the marker to the Cr = 0.0% position.

Measured values are displayed using the following references: Cb at position B = 100.0% and Cr at position R = 100.0%. The distance from the center is expressed as "d," and hue is expressed as "deg."

Normally, the marker is displayed in green. When it falls outside the display area, it blinks in red. If this occurs, "OVER" appears above the measured values.

Procedure

VECT	→	F•4	MARKER: ON / OFF
------	---	------------	------------------

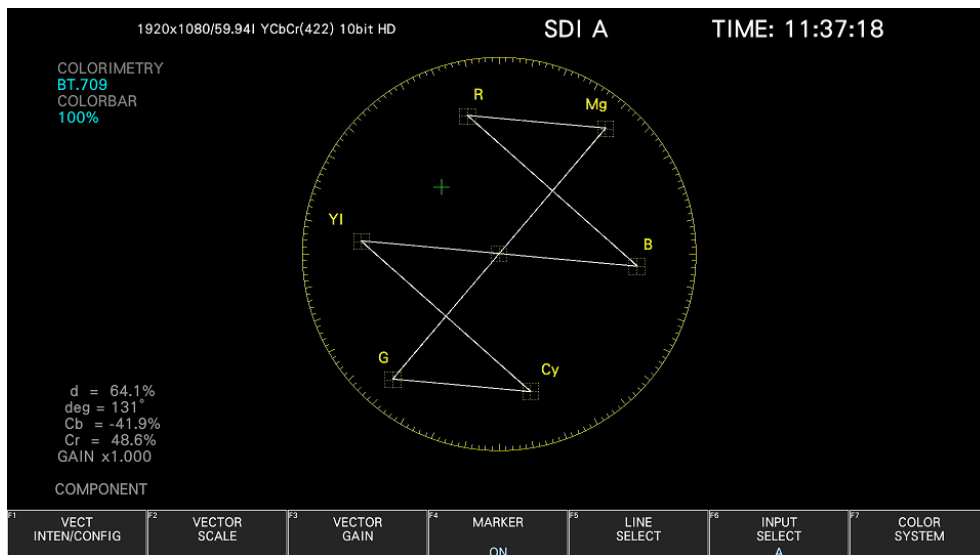

Figure 11-14 Displaying the vector marker

11. VECTOR DISPLAY

11.9.2 Configuring the Variable Marker

When the VARIABLE SCALE is set to on, you can use **F•4** VARIABLE MARKER to configure the variable marker.

[See also] VARIABLE SCALE → Section 11.3.7, "Turning the Variable Scale On and Off"

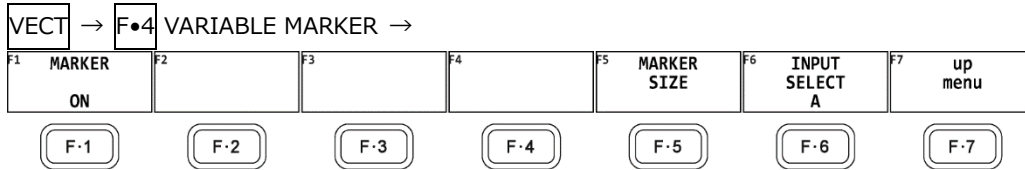

Figure 11-15 VARIABLE MARKER menu

- Turning the Display On and Off

To display the variable marker on the vector display, follow the procedure below.

[See also] VARIABLE SCALE → Section 11.3.7, "Turning the Variable Scale On and Off"

You can move the marker horizontally using the H POS knob and vertically using the V POS knob. The measured values are displayed in the lower right of the display. Press the H POS knob to move the marker to the Cb = 0.0% position. Press the V POS knob to move the marker to the Cr = 0.0% position.

Measured values are displayed using the following references: Cb at position B = 100.0% and Cr at position R = 100.0%. The distance from the center is expressed as "d," and hue is expressed as "deg."

Procedure

VECT → **F•4** VARIABLE MARKER → **F•1** MARKER: ON / OFF

- Configuring the Marker Size

To configure the size of the marker and frame, follow the procedure below. It can be configured even if the variable marker is set to off.

Procedure

VECT → **F•4** VARIABLE MARKER → **F•5** MARKER SIZE: 5 % - 10 %

11.10 Configuring the Line Selection Settings

To configure the line selection settings, press **F•5** LINE SELECT on the VECT menu.

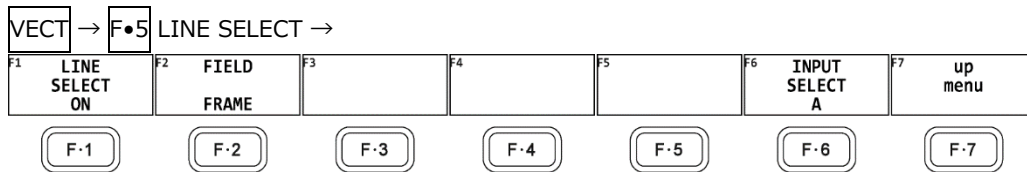

Figure 11-16 LINE SELECT menu

11.10.1 Turning Line Selection On and Off

To display the vector of the selected line, follow the procedure below. You can use the function dial (F•D) to select a line. The number of the selected line appears in the lower left of the screen.

Changing this setting will also change the video-signal-waveform-display and picture-display line selection settings.

This menu item does not appear when SWEEP on the WFM menu is set to V.

[See also] SWEEP → Section 10.5.1, “Selecting the Sweep Method”

Procedure



LINE SELECT = ON

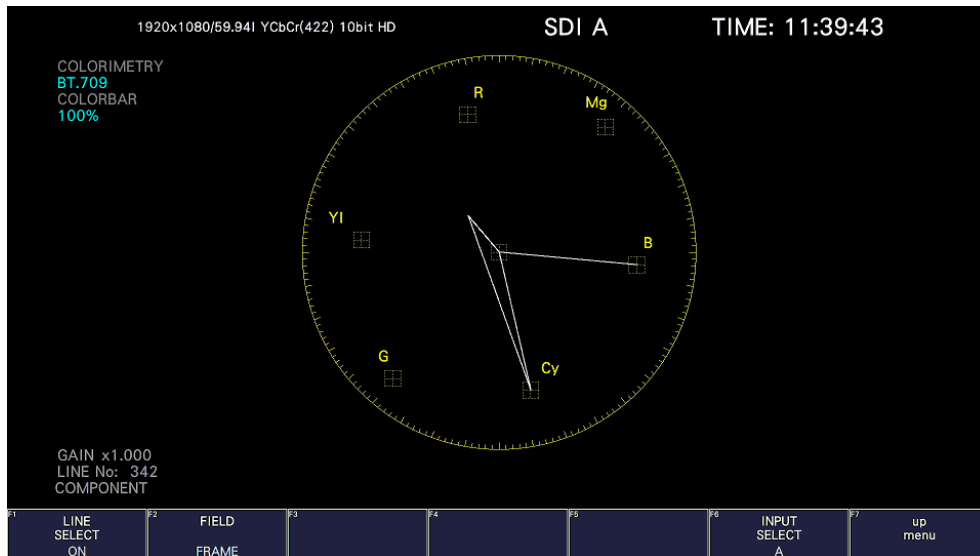

11. VECTOR DISPLAY

LINE SELECT = OFF

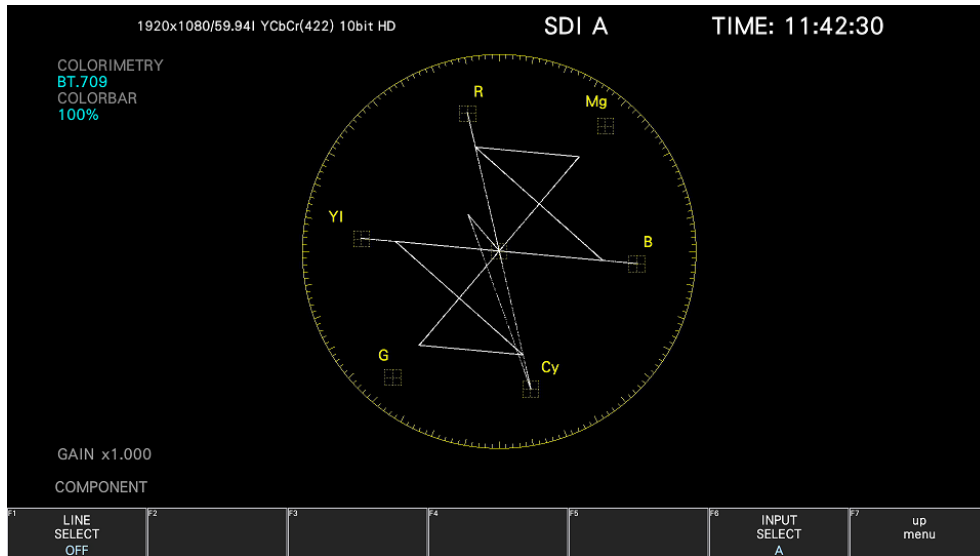

Figure 11-17 Turning line selection on and off

11.10.2 Setting the Line Selection Range

When **F•1** LINE SELECT is set to ON and the input signal format is interlaced or segmented frame, to set the line selection range, follow the procedure below. Changing this setting will also change the selected line on the video-signal-waveform, picture, and status (data dump) displays.

Procedure

VECT	→	F•5	LINE SELECT	→	F•2	FIELD: FIELD1 / FIELD2 / <u>FRAME</u>
------	---	-----	-------------	---	-----	---------------------------------------

Settings

FIELD1:	A line from field 1 can be selected. (Example: 1 to 563)
FIELD2:	A line from field 2 can be selected. (Example: 564 to 1125)
FRAME:	All lines can be selected. (Example: 1 to 1125)

11.11 Configuring the Color System Settings

To configure the color system settings, press **F•7** COLOR SYSTEM on the VECT menu.

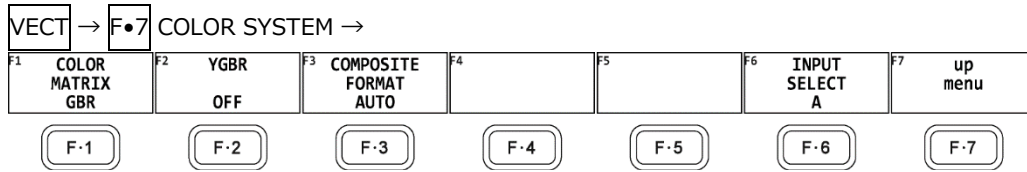
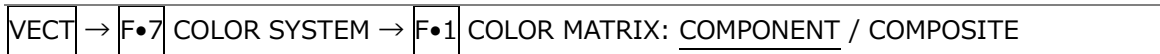

Figure 11-18 COLOR SYSTEM menu

11.11.1 Selecting the Color Matrix

To select the vector display format, follow the procedure below. The selected display format is indicated in the lower right of the display.

Procedure



Settings

- COMPONENT: The component chrominance signal is displayed on the X and Y axes.
- COMPOSITE: The component signal is converted into a pseudo-composite signal, and the pseudo-composite signal's chrominance signal is displayed on the X and Y axes.

COLOR MATRIX = COMPONENT

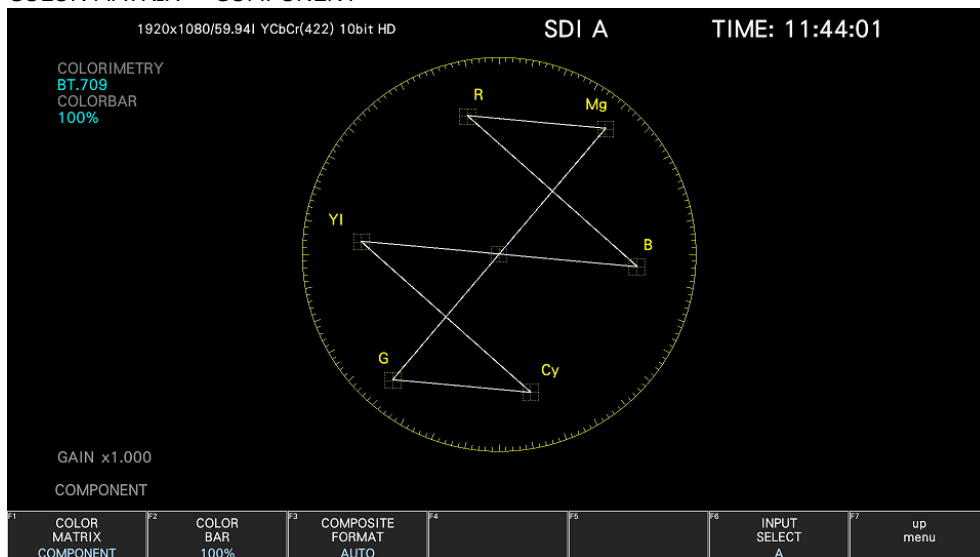

11. VECTOR DISPLAY

COLOR MATRIX = COMPOSITE

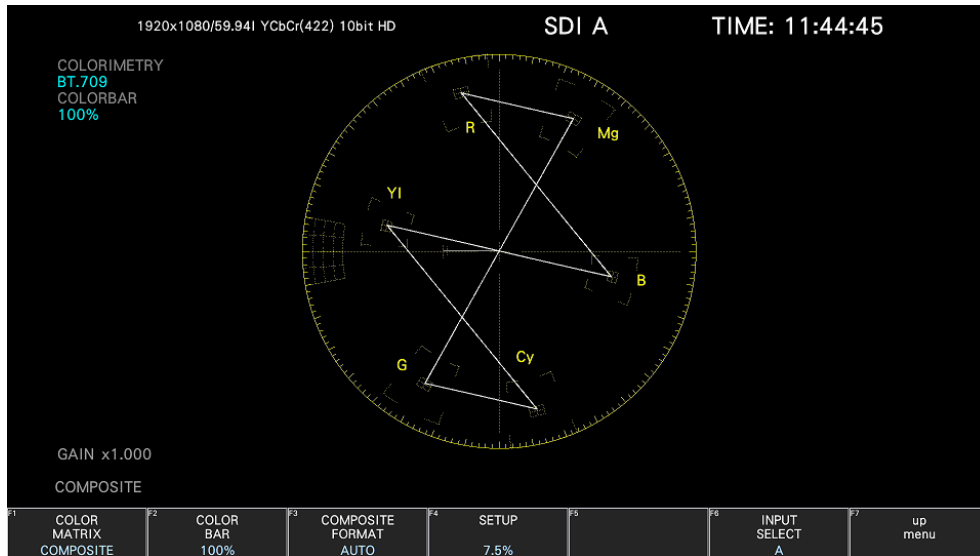

Figure 11-19 Selecting the color matrix

11.11.2 Displaying a Scale for 75% Color Bars

To display a scale for 75 % color bars, follow the procedure below.

The scale selected here is displayed in the COLORBAR on the upper left of the screen.

Procedure

VECT	→	F•7	COLOR SYSTEM	→	F•2	COLOR BAR: <u>100%</u> / 75%
------	---	-----	--------------	---	-----	------------------------------

Settings

100%: A scale on which a 100% color bar signal input is mapped to the peak level is displayed.

75%: A scale on which a 75% color bar signal input is mapped to the peak level is displayed.

COLOR BAR = 75%

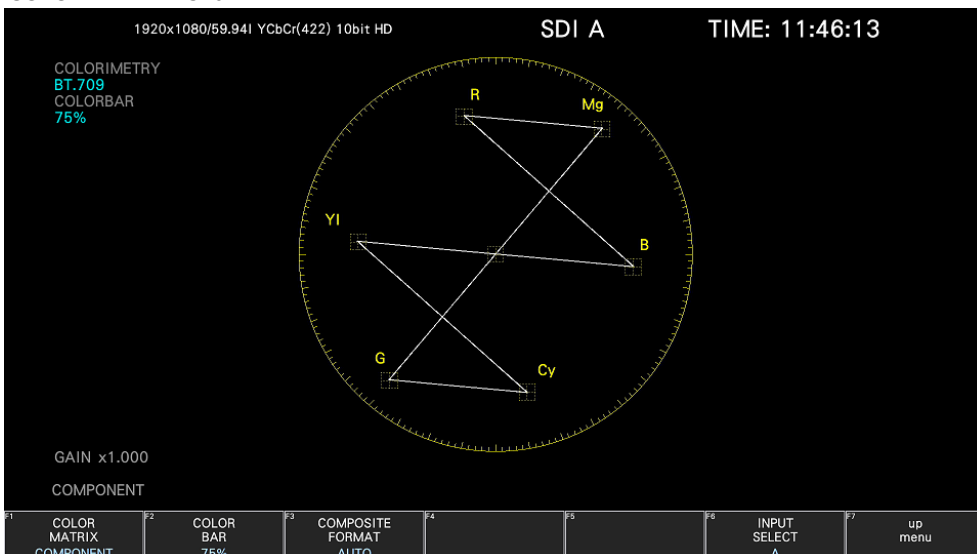

Figure 11-20 Displaying a scale for 75 % color bars (when receiving a 75 % intensity color bar signal)

11. VECTOR DISPLAY

11.11.3 Selecting the Composite Display Format

To select the composite display format, follow the procedure below.

Procedure

VECT	→	F•7	COLOR SYSTEM →	F•3	COMPOSITE FORMAT: <u>AUTO</u> / NTSC / PAL
------	---	-----	----------------	-----	--

Settings

AUTO:	When the input signal frame rate is 25 Hz or 50 Hz, the format is PAL. Otherwise, the format is NTSC.
NTSC:	The format is NTSC.
PAL:	The format is PAL.

COMPOSITE FORMAT = NTSC

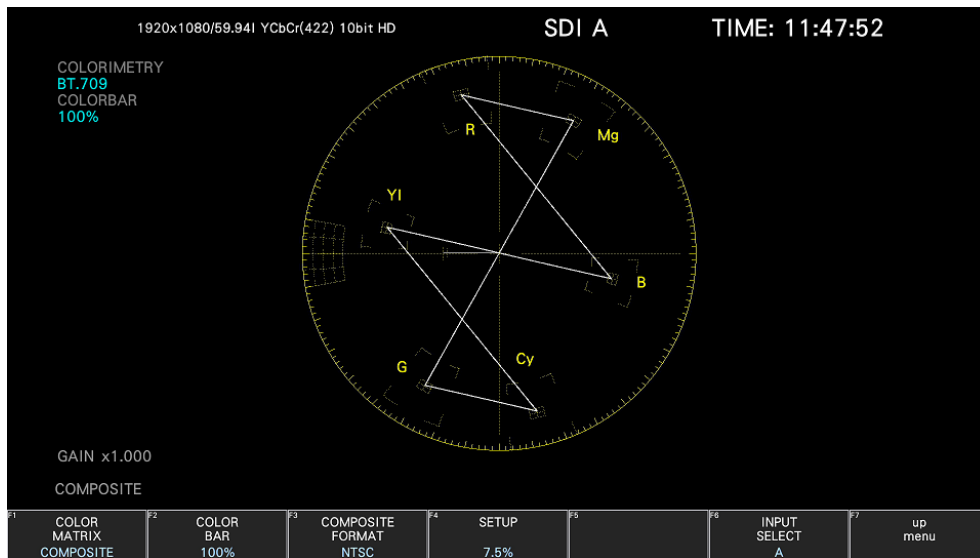

COMPOSITE FORMAT = PAL

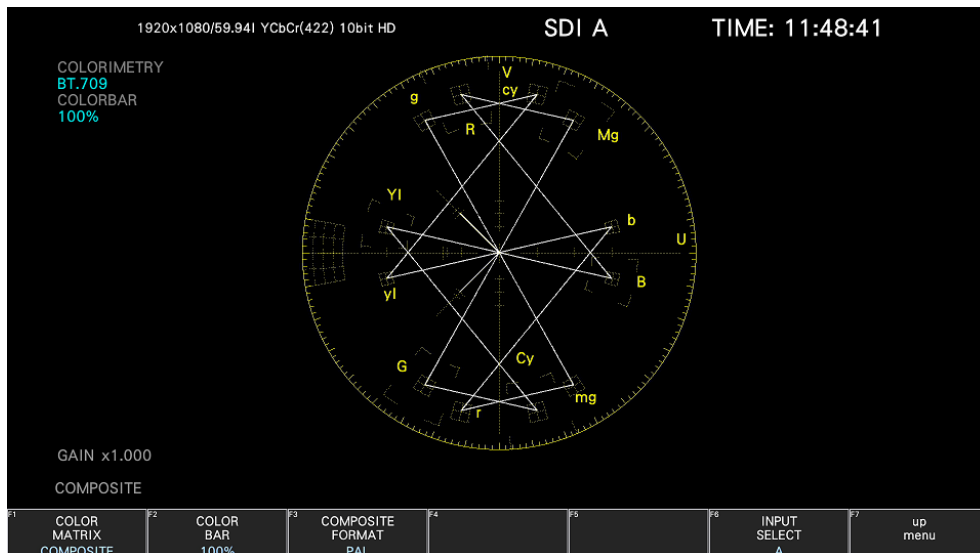

Figure 11-21 Selecting the composite display format

11. VECTOR DISPLAY

11.11.4 Selecting the Setup Level

When **F•1** COLOR MATRIX is set to COMPOSITE, to select the setup level, follow the procedure below.

This menu does not appear if the composite display format is PAL.

Procedure

VECT	→	F•7	COLOR SYSTEM	→	F•4	SETUP: <u>0%</u> / 7.5%
------	---	-----	--------------	---	-----	-------------------------

11. VECTOR DISPLAY

11.12 5-Bar Display

To display the 5 bar screen, press VECT, **F•1** VECT INTEN/CONFIG, and then **F•1** VECTOR DISPLAY to select 5BAR.

In the 5-bar display, the $YCbCr$ signal is converted into a GBR or pseudo-composite signal, and the peak levels of the converted signal's Y, G, B, R, and CMP (composite) components are displayed simultaneously using five bars.

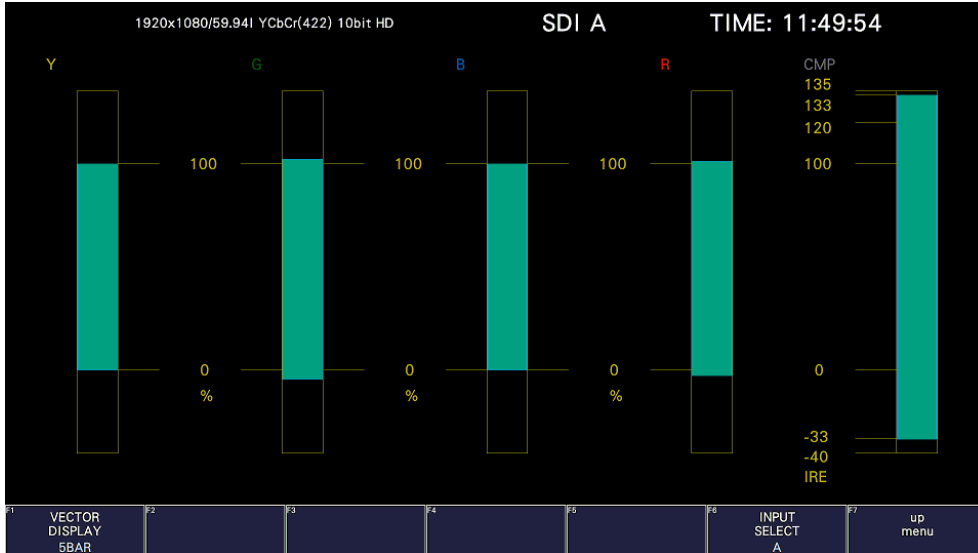

Figure 11-22 5-bar display

- Y

Levels that fall outside of the range that you set using Luminance Upper and Luminance Lower on the status menu are displayed in red.

[See also] Luminance Upper and Luminance Lower → 4, "Error Setup 4"

- GBR

Levels that fall outside of the range that you set using Gamut Upper and Gamut Lower on the status menu are displayed in red.

[See also] Gamut Upper/Lower → 16.2.3, "Error Setup 3"

- CMP

Levels that fall outside of the range that you set using Composite Upper and Composite Lower on the status menu are displayed in red.

[See also] Composite Upper/Lower → 16.2.3, "Error Setup 3"

- Menu

Use the VECT menu to configure the 5-bar display settings.

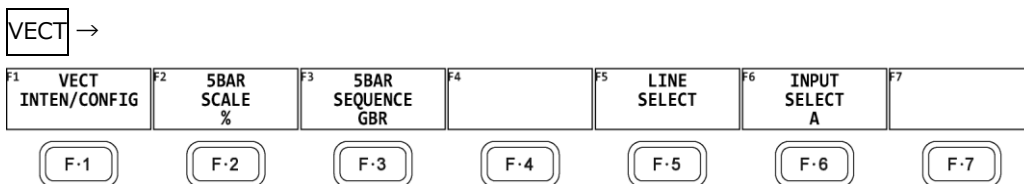

Figure 11-23 Vector menu

11. VECTOR DISPLAY

11.12.1 Selecting the Scale Unit

When VECTOR DISPLAY is set to 5BAR, to select the scale unit, follow the procedure below.
 [See also] VECTOR DISPLAY → 11.2.1, "Switching the Display Mode" and 11.11.3, "Selecting the Composite Display Format"

Procedure

VECT	→	F•2	5BAR SCALE: % / mV / HEX / DEC
------	---	-----	--------------------------------

Settings

%:	The display unit for YGBR is percentage, and the display unit for CMP is IRE.
mV:	The display unit is mV. Depending on the composite display format, the scale differs as follows: NTSC: 100 % = 700 mV (YGBR), 100IRE = 714.3 mV (CMP) PAL: 100%(IRE) = 700mV
HEX:	YGBR is displayed as a percentage with 0 to 100% expressed as 040 to 3AC. CMP is displayed using IRE.
DEC:	YGBR is displayed as a percentage with 0 to 100% expressed as 64 to 940. CMP is displayed using IRE.

5BAR SCALE = %

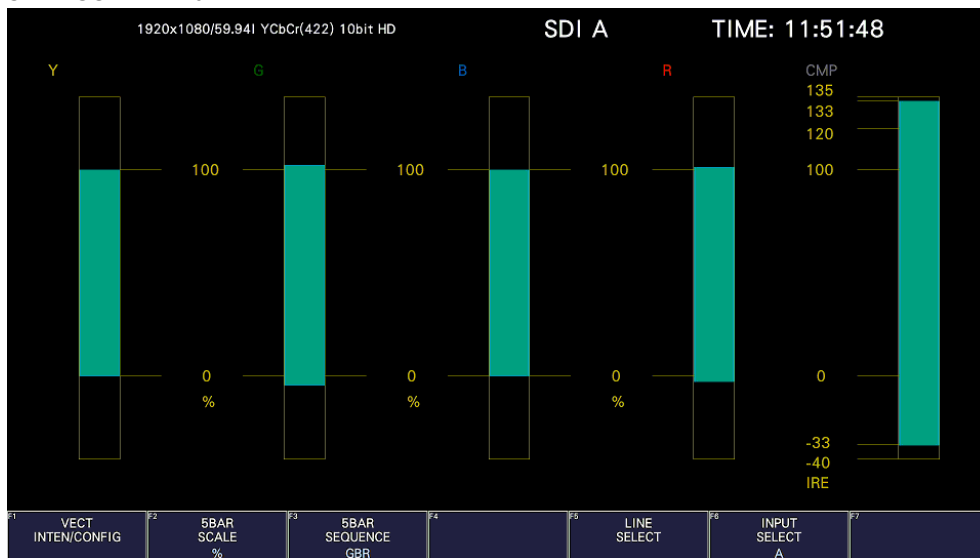

11. VECTOR DISPLAY

5BAR SCALE = mV

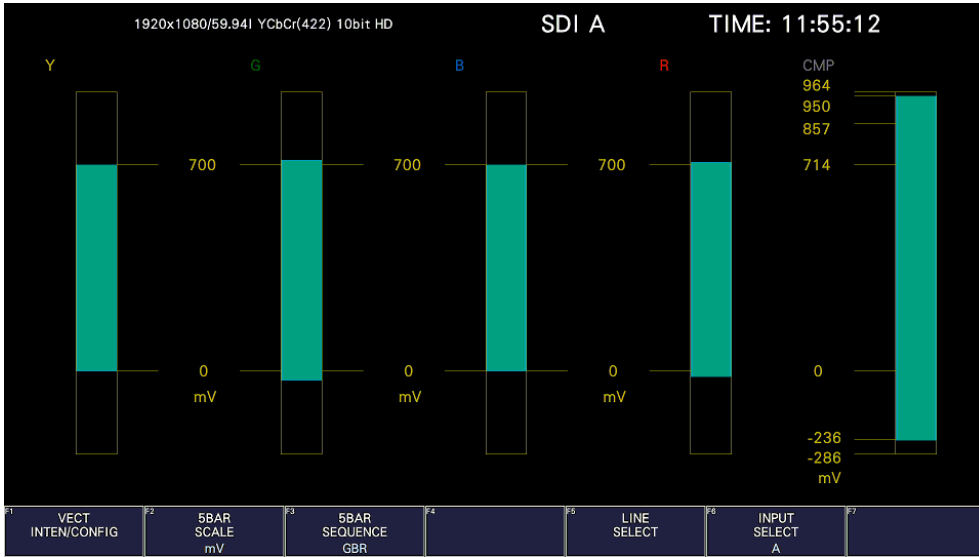

5BAR SCALE = HEX

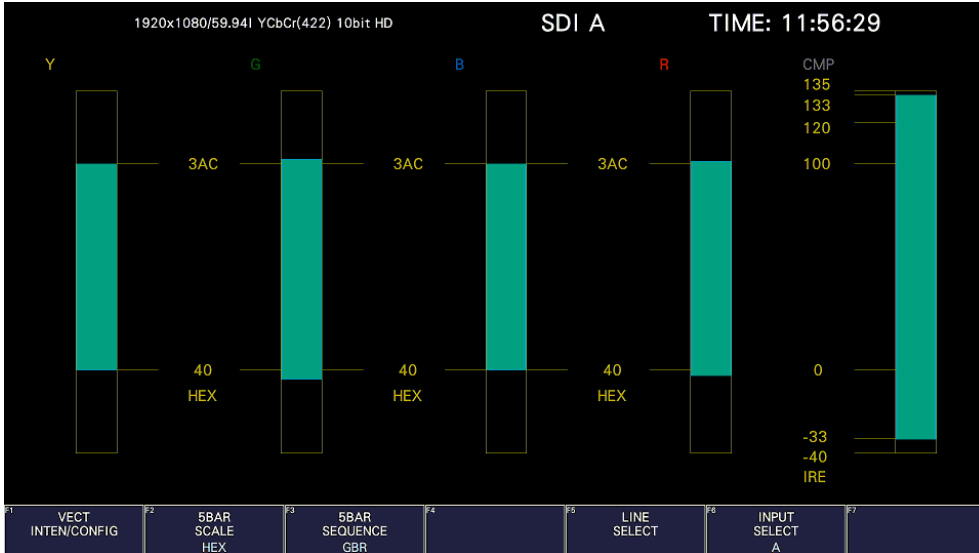

5BAR SCALE = DEC

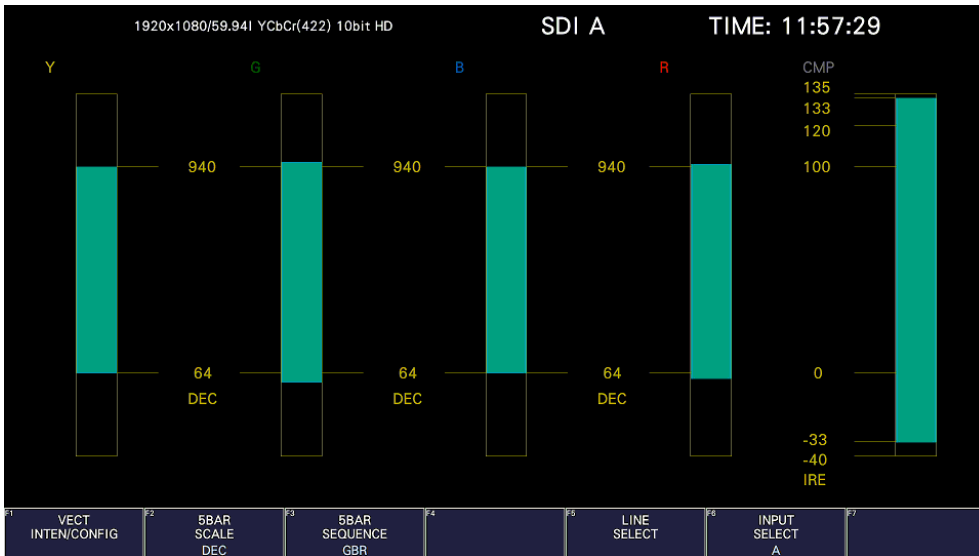

Figure 11-24 Selecting the scale unit

11. VECTOR DISPLAY

11.12.2 Selecting the Display Order

To select the 5-bar display order, follow the procedure shown below.

Procedure

VECT	→	F•3	5BAR SEQUENCE: <u>GBR</u> / RGB
------	---	-----	---------------------------------

Settings

GBR: From the left, the signals are displayed in this order: Y, G, B, R, CMP.

RGB: From the left, the signals are displayed in this order: Y, R, G, B, CMP.

5BAR SEQUENCE = GBR

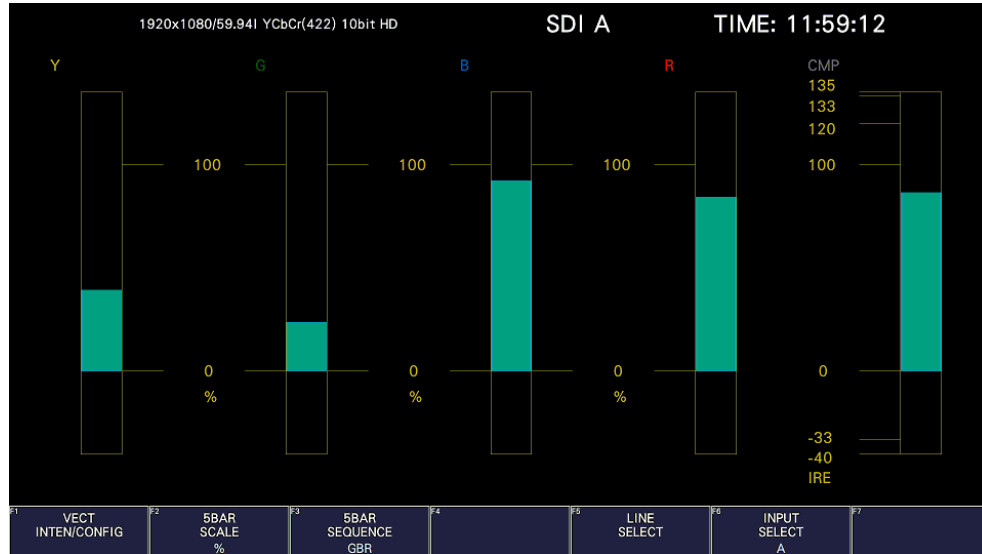

5BAR SEQUENCE = RGB

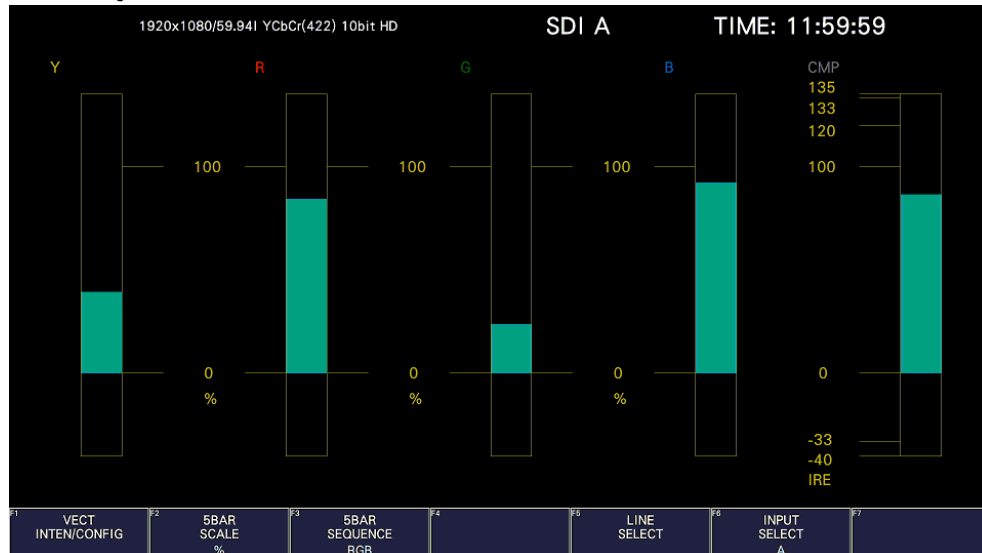

Figure 11-25 Selecting the display order

11.13 Histogram Display

To display histograms, press VECT, **F•1** VECT INTEN/CONFIG, and then **F•1** VECTOR DISPLAY to select HISTOGRAM.

The histogram display shows the image data distribution by plotting the luminance level and R, G, B levels on the horizontal axis and the number of pixels at each luminance level and R, G, B level on the vertical axis.

If SER23 is installed, you can change the horizontal scale. See section 14.2.2, "Histogram Display."

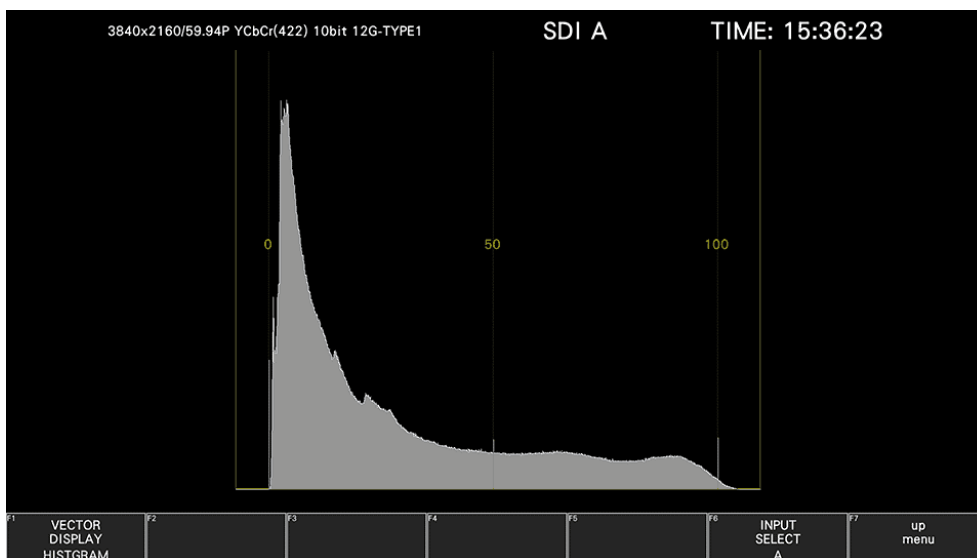

Figure 11-26 Histogram Display

- Menu

Use the VECT menu to configure the histogram display settings.

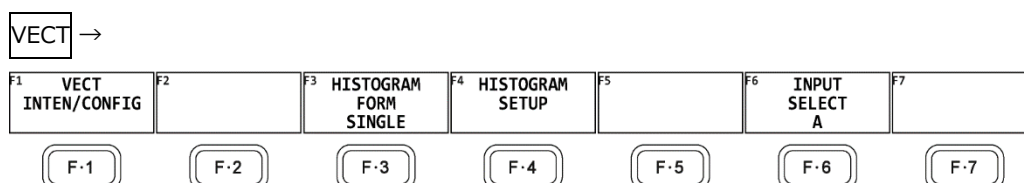

Figure 11-27 Vector menu

11.13.1 Selecting the Display Format

To select the display format, follow the procedure below.

Procedure

VECT → **F•3** HISTOGRAM FORM: SINGLE / TILE / ALIGN_H / ALIGN_V

Settings

- SINGLE: Luminance, R, G, or B is displayed.
- TILE: Luminance, R, G, and B are displayed in tiles.
- ALIGN_H: Luminance, R, G, and B are displayed side by side.
- ALIGN_V: Luminance, R, G, and B are displayed top to bottom.

11. VECTOR DISPLAY

- When HISTOGRAM FORM is TILE

Luminance, R, G, and B are displayed in tiles.

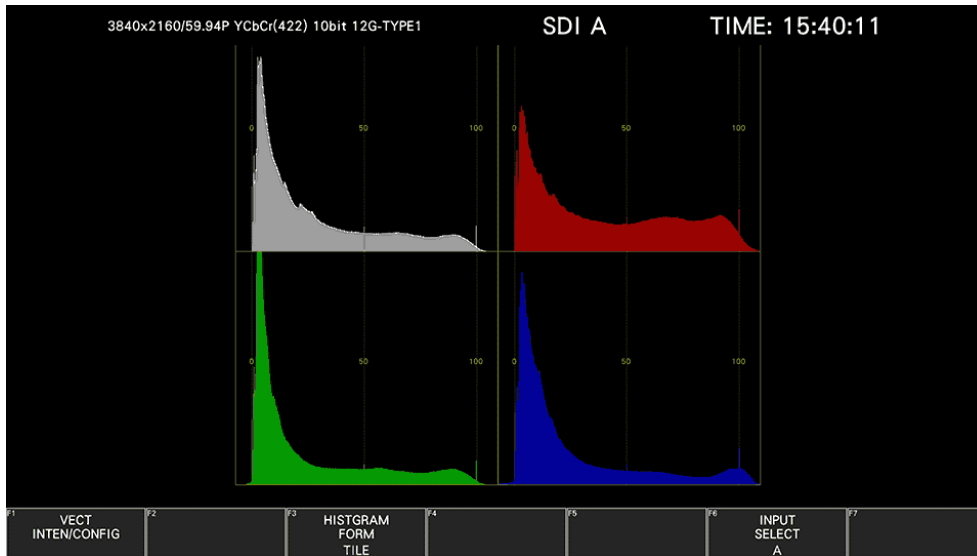

Figure 11-28 Tiled display

- When HISTOGRAM FORM is ALIGN-H

Luminance, R, G, and B are displayed side by side.

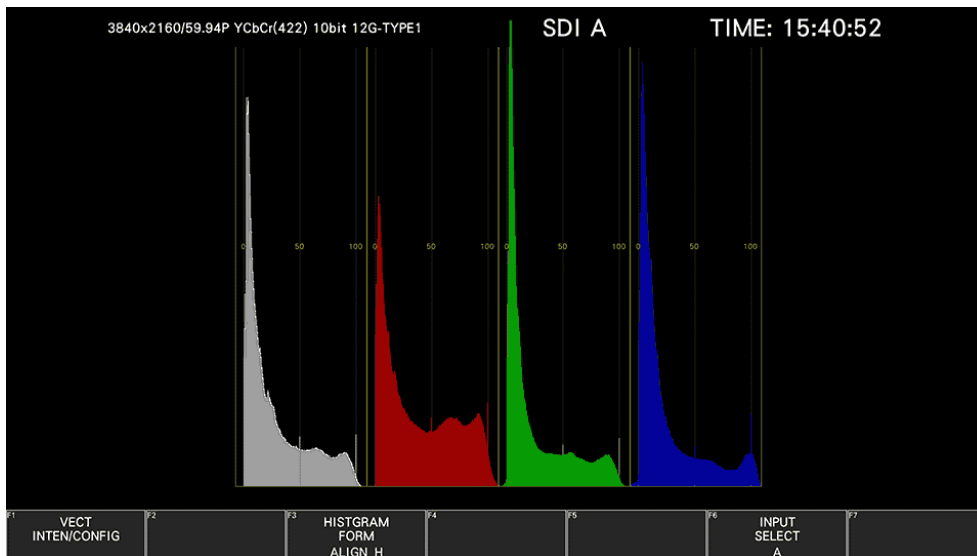

Figure 11-29 ALIGN_H display

11. VECTOR DISPLAY

- When HISTOGRAM FORM is ALIGN-V

Luminance, R, G, and B are displayed top to bottom.

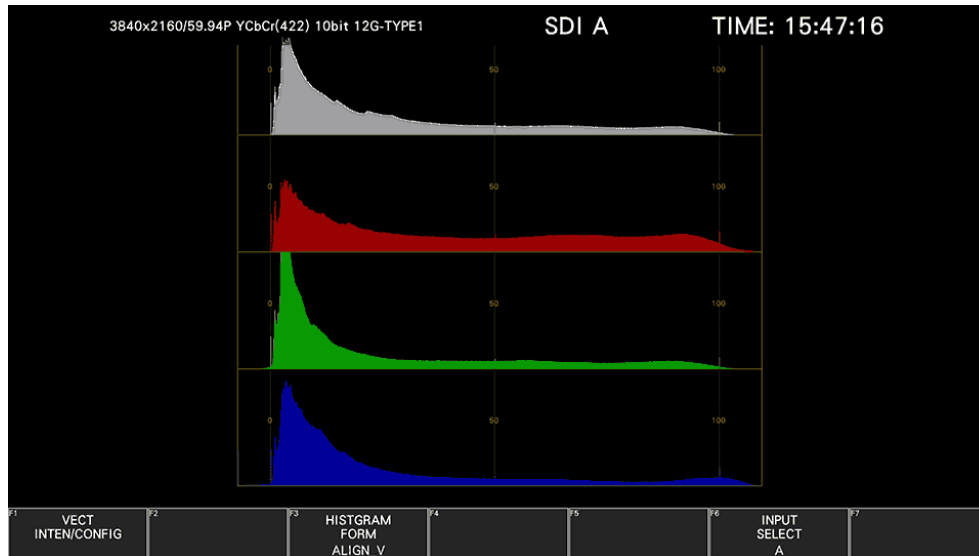

Figure 11-30 ALIGN_V display

11.13.2 Selecting the Measurement Signal

When HISTOGRAM FORM is SINGLE, to select the measurement signal, follow the procedure below. A single signal from luminance, R, G, and B can be turned on.

Procedure

VECT	→	F•4	HISTOGRAM SETUP
→	F•1	Y: ON / OFF	
→	F•2	R: ON / OFF	
→	F•3	G: ON / OFF	
→	F•4	B: ON / OFF	

12. CIE CHROMATICITY DIAGRAM DISPLAY (SER22)

To display the CIE chromaticity diagram, press VECT, **F•1** VECT INTEN/CONFIG, and then **F•1** VECTOR DISPLAY to select CIE DIAGRAM.

When VECTOR DISPLAY is set to VECT, 5BAR or HISTOGRAM, see 11, "CIE Chromaticity Diagram Display," for the explanation.

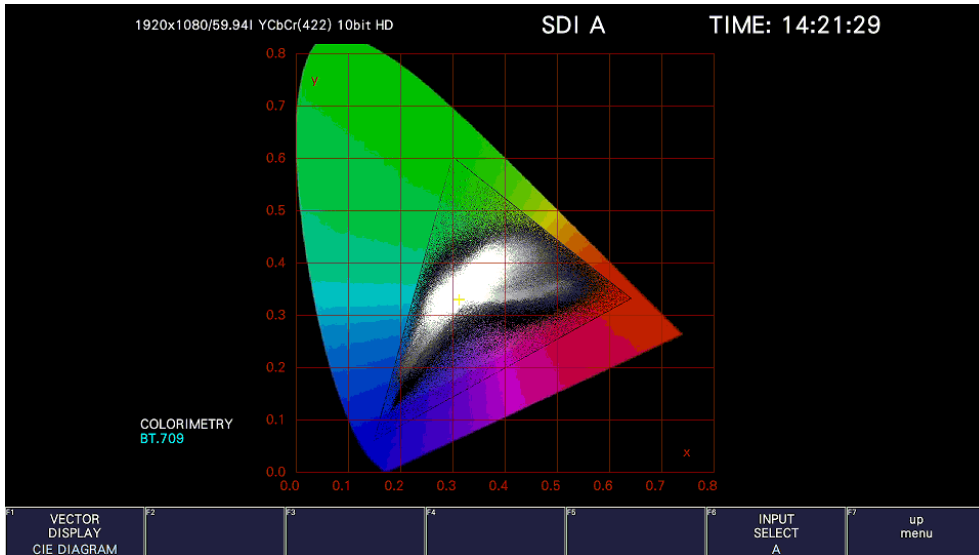

Figure 12-1 CIE chromaticity diagram display

- Colorimetry

The colorimetry selected on the SYS menu is displayed in cyan in the lower left of the screen. However, for 3G(DL)-4K, the current applied colorimetry is displayed in yellow if the colorimetry information of all links specified by the payload ID are not matched.

12.1 Setting the Scale

To configure the scale, use **F•2** CIE DIAGRAM SCALE on the VECT menu.

This menu item does not appear when DISPLAY MODE is set to TEMP.

[See also] DISPLAY MODE → 12.2.1, "Selecting the Display Mode"

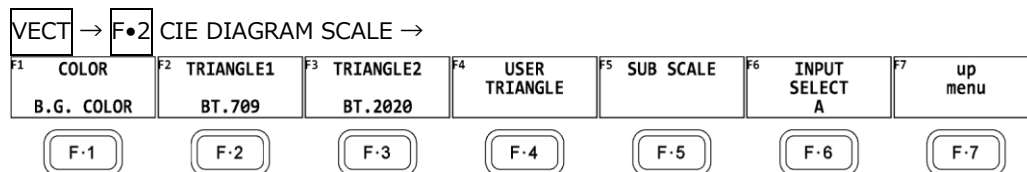

Figure 12-2 CIE DIAGRAM SCALE menu

12. CIE CHROMATICITY DIAGRAM DISPLAY (SER22)

12.1.1 Selecting the Color Scale

To select the horseshoe-shaped color scale, follow the procedure below.

Procedure

VECT	→	F•2	CIE DIAGRAM SCALE	→	F•1	COLOR: <u>B.G. COLOR</u> / B.G. WHITE / B.G. BLACK
------	---	-----	-------------------	---	-----	--

Settings

B.G. COLOR: The color scale is displayed. The background is black, and the waveform is displayed according to the luminance level.

B.G. WHITE: The color scale is not displayed. The background is white, and the waveform is displayed according to the picture color.

B.G. BLACK: The color scale is not displayed. The background is black, and the waveform is displayed according to the picture color.

COLOR = B.G. WHITE

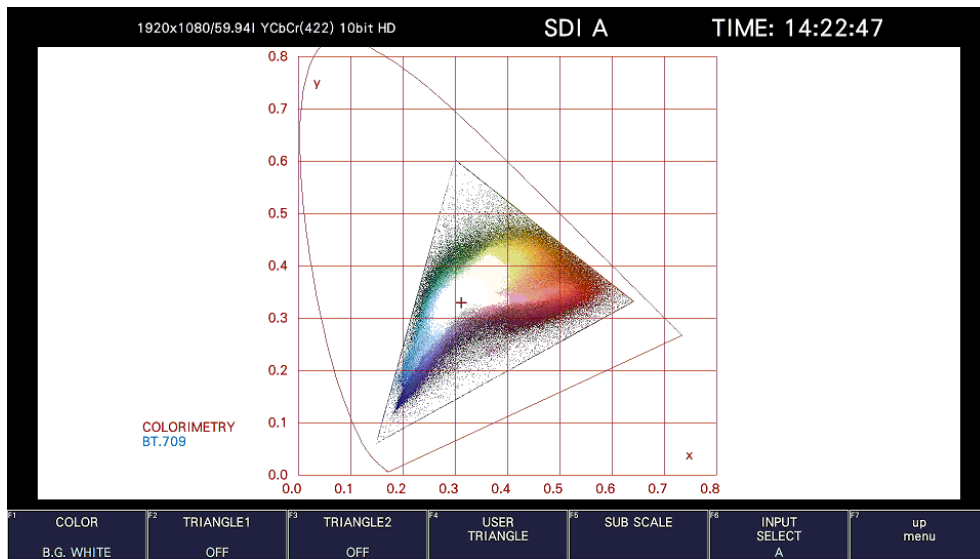

COLOR = B.G. BLACK

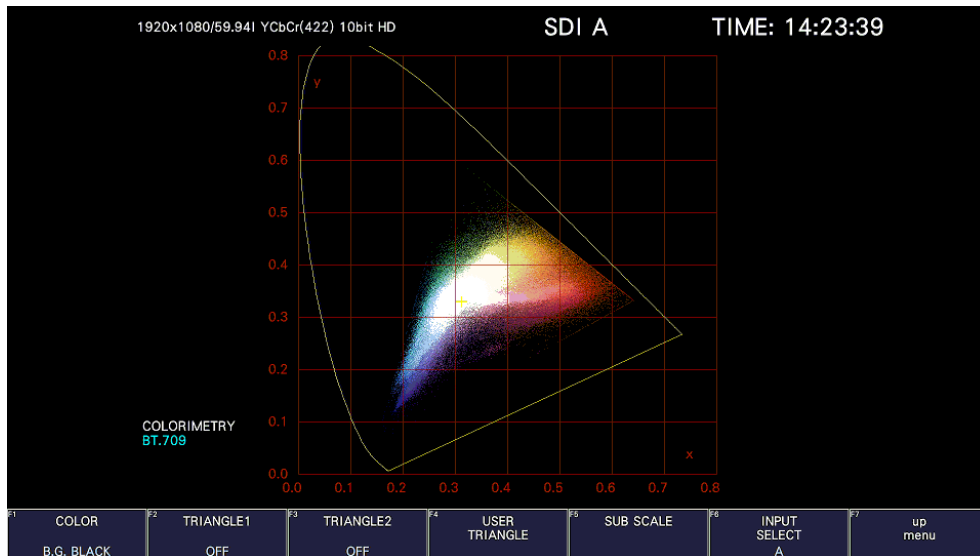

Figure 12-3 Selecting the color scale

12. CIE CHROMATICITY DIAGRAM DISPLAY (SER22)

12.1.2 Selecting the Triangle

To display up to three color triangles, follow the procedure below.

Procedure

VECT → F•2 CIE DIAGRAM SCALE
 → F•2 TRIANGLE1: BT.601(525) / BT.601(625) / BT.709 / DCI / BT.2020 / OFF
 → F•3 TRIANGLE2: BT.601(525) / BT.601(625) / BT.709 / DCI / BT.2020 / OFF
 → F•4 USER TRIANGLE → F•1 TRIANGLE: 1 / 2 / OFF

The color triangle vertex coordinates are shown below.
 u'v' coordinates are calculated from the xy coordinates.

Table 12-1 Color triangle vertex coordinates

F•1 TRIANGLE1 F•2 TRIANGLE2		CIE1931		CIE1976	
		x	y	u'	v'
BT.601(525)	R	0.630	0.340	0.433	0.526
	G	0.310	0.595	0.130	0.563
	B	0.155	0.070	0.176	0.178
BT.601(625)	R	0.640	0.330	0.451	0.523
	G	0.290	0.600	0.121	0.561
	B	0.150	0.060	0.175	0.158
BT.709	R	0.640	0.330	0.451	0.523
	G	0.300	0.600	0.125	0.563
	B	0.150	0.060	0.175	0.158
DCI	R	0.680	0.320	0.496	0.526
	G	0.265	0.690	0.099	0.578
	B	0.150	0.060	0.175	0.158
BT.2020	R	0.708	0.292	0.557	0.517
	G	0.170	0.797	0.056	0.587
	B	0.131	0.046	0.159	0.126

12. CIE CHROMATICITY DIAGRAM DISPLAY (SER22)

12.1.3 Setting the User-defined Triangle

To set the user-defined triangle, press **F•4** USER TRIANGLE on the CIE DIAGRAM SCALE menu.

Up to two user-defined triangles can be specified. Press **F•1** TRIANGLE to select 1 or 2.

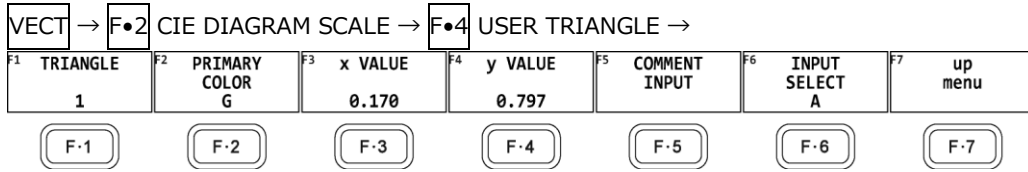
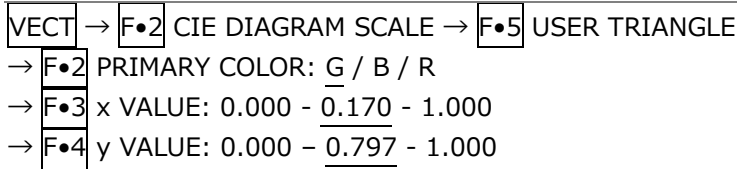

Figure 12-4 USER TRIANGLE menu

To change the vertex coordinates of the color triangle, follow the procedure below. Press **F•2** PRIMARY COLOR to select the vertex you want to change, and then press **F•3** x VALUE and **F•4** y VALUE to set the coordinates. The default setting is equivalent to the BT.2020 coordinates.

Procedure



Press **F•5** COMMENT INPUT to assign names of your choice to user-defined triangles. Enter up to 8 characters.

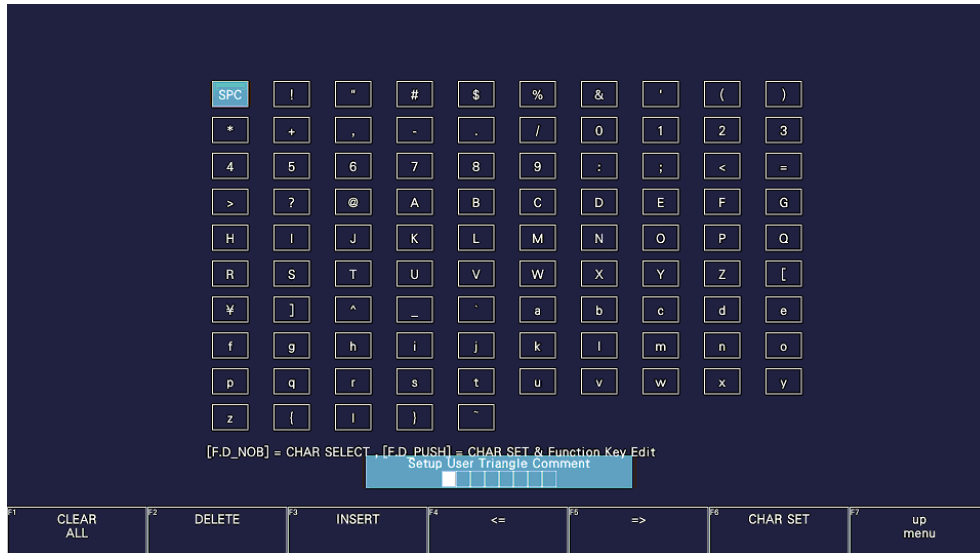

Figure 12-5 Triangle name input screen

12. CIE CHROMATICITY DIAGRAM DISPLAY (SER22)

The key operations that you can perform in the triangle name input display are as follows:

F•1	CLEAR ALL	Deletes all characters
F•2	DELETE	Deletes the character at the cursor
F•3	INSERT	Inserts a character at the cursor
F•4	<=	Moves the cursor to the left
F•5	=>	Moves the cursor to the right
F•6	CHAR SET	Enters the character
Function dial (F•D)		Turn to select a character, and press to enter the character.

12.1.4 Turning the Sub Scale On and Off

To set the sub scale, press **F•5** SUB SCALE on the CIE DIAGRAM SCALE menu.

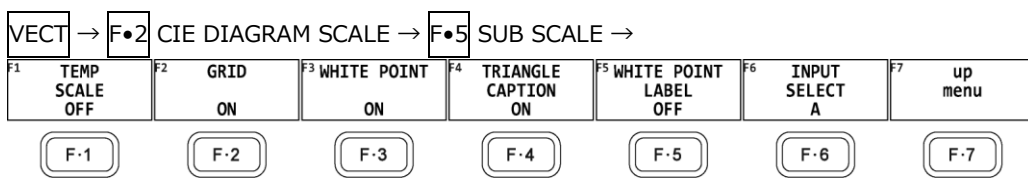

Figure 12-6 SUB SCALE menu

To turn on and off the color temperature curve, grid, white point, triangle name, or white point label, follow the procedure below.

When **F•3** WHITE POINT is on, **F•5** WHITE POINT LABEL is displayed. The white point label is set to DCI W when the colorimetry is set to DCI. Otherwise, it is set to D65.

Procedure

VECT → F•2 CIE DIAGRAM SCALE → F•5 SUB SCALE
→ F•1 TEMP SCALE: ON / OFF
→ F•2 GRID: ON / OFF
→ F•3 WHITE POINT: ON / OFF
→ F•4 TRIANGLE CAPTION: ON / OFF
→ F•5 WHITE POINT LABEL: ON / OFF

12. CIE CHROMATICITY DIAGRAM DISPLAY (SER22)

TEMP SCALE = ON / GRID = ON / WHITE POINT = ON / TRIANGLE CAPTION = ON / WHITE POINT LABEL = OFF

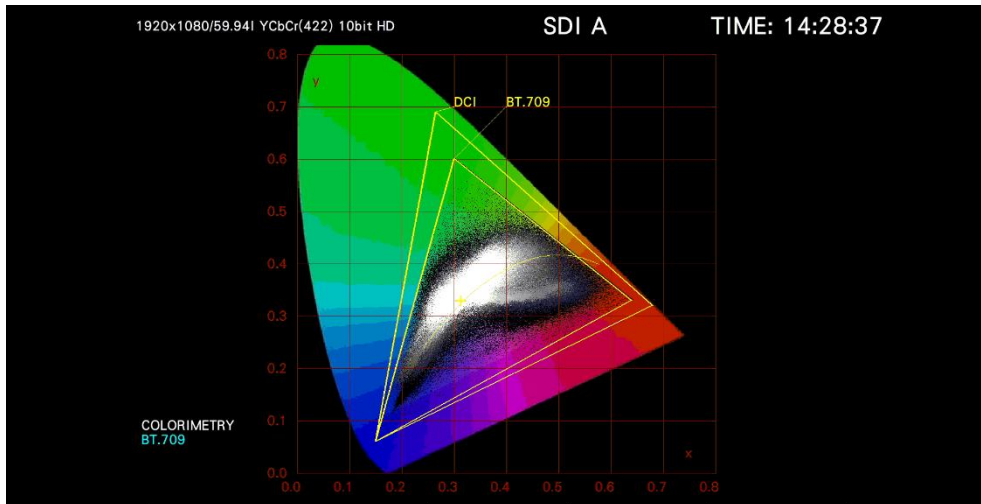

Figure 12-7 The sub scale display

12. CIE CHROMATICITY DIAGRAM DISPLAY (SER22)

12.2 Setting the Chromaticity Diagram Mode

To set the chromaticity diagram mode, press **F•3** CIE DIAGRAM SETTING on the VECT menu.

VECT → **F•3** CIE DIAGRAM SETTING →

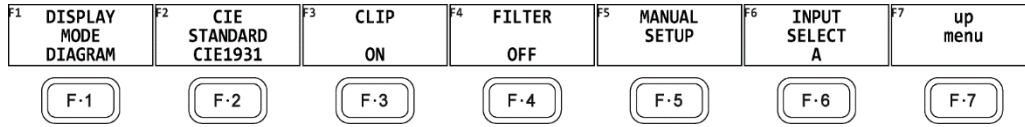

Figure 12-8 CIE DIAGRAM SETTING menu

12.2.1 Selecting the Display Mode

To select the display mode, follow the procedure below.

Procedure

VECT → **F•3** CIE DIAGRAM SETTING → **F•1** DISPLAY MODE: DIAGRAM / TEMP

Settings

DIAGRAM: The chromaticity diagram is displayed.
TEMP: The color temperature is displayed.

DISPLAY MODE = TEMP

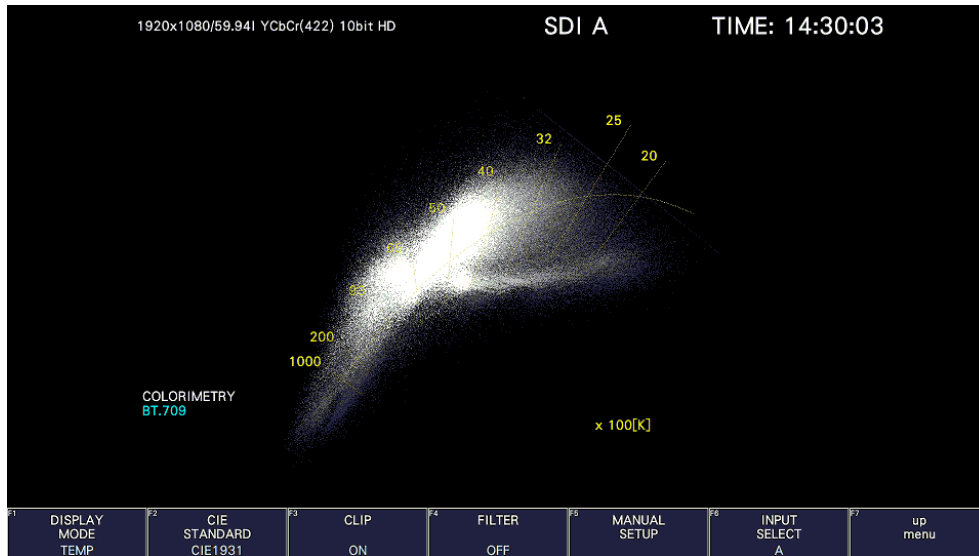

Figure 12-9 Selecting the display mode

12.2.2 Selecting the Display Standard

To select the display standard, follow the procedure below.

Procedure

VECT → **F•3** CIE DIAGRAM SETTING → **F•2** CIE STANDARD: CIE1931 / CIE1976

Settings

CIE1931: Chromaticity diagram based on CIE 1931 is displayed.
CIE1976: Chromaticity diagram based on CIE 1976 is displayed.

12. CIE CHROMATICITY DIAGRAM DISPLAY (SER22)

12.2.3 Turning Clipping On and Off

To turn clipping on and off, follow the procedure below.

Procedure

VECT	→	F•3	CIE DIAGRAM SETTING	→	F•3	CLIP: <u>ON</u> / OFF
------	---	-----	---------------------	---	-----	-----------------------

Settings

ON: Negative values of the input signal are clipped to zero.

OFF: Negative values of the input signal are displayed according to BT.1361.

12.2.4 Turning the Filter On and Off

To turn the filter on and off, follow the procedure below.

When set to ON, data is averaged every two pixels and displayed.

Procedure

VECT	→	F•3	CIE DIAGRAM SETTING	→	F•4	FILTER: ON / <u>OFF</u>
------	---	-----	---------------------	---	-----	-------------------------

12.2.5 Setting the Gamma Value

To set the gamma value, follow the procedure below.

Procedure

VECT	→	F•3	CIE DIAGRAM SETTING	→	F•5	MANUAL SETUP
	→	F•1	MANUAL SETUP: ON / <u>OFF</u>			
	→	F•2	COLORIMETRY: BT.601(525) / BT.601(625) / <u>BT.709</u> / DCI / BT.2020			
	→	F•5	GAMMA SETUP: 1.50 - <u>2.20</u> - 3.00			

Settings

ON: The colorimetry set using **F•2** COLORIMETRY and the gamma value set with **F•5** GAMMA SETUP are used. However, this is not applied to the video-signal-waveform, vector, or picture display.

The gamma calculation expression is (input signal level)^(gamma value).

Negative input signal values are clipped to zero, regardless of whether

F•3 CLIP is set to on or off.

OFF: The colorimetry standard selected on the SYS menu is used.

12. CIE CHROMATICITY DIAGRAM DISPLAY (SER22)

12.3 Displaying Cursors

To display a cursor on the chromaticity diagram, follow the procedure shown below. You can move the cursor horizontally using the H POS knob and vertically using the V POS knob. The measured values are shown in the upper right of the display. Press the H POS and V POS knobs to move the cursor to the following position.

Chromaticity diagram display: $(x, y) = (u', v') = (0, 0)$

Color temperature display: Lower left of the display

Procedure

VECT → F•4 CURSOR: ON / OFF

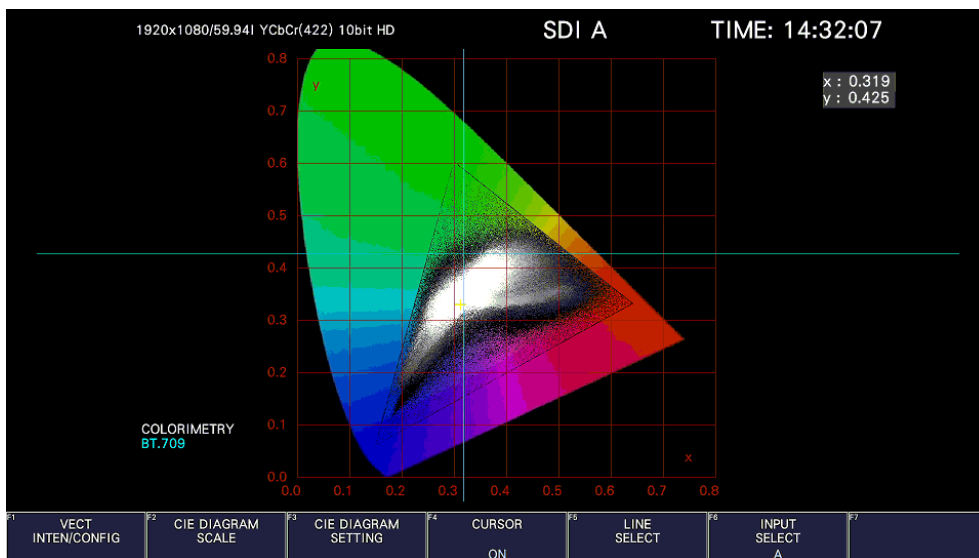

Figure 12-10 Displaying the chromaticity diagram cursor

12.4 Configuring the Line Selection Settings

To configure the line selection settings, press **F•5** LINE SELECT on the VECT menu. See section 11.9.2, "Configuring Line Selection Settings."

13. PICTURE SCREEN

To display the picture, press PIC.

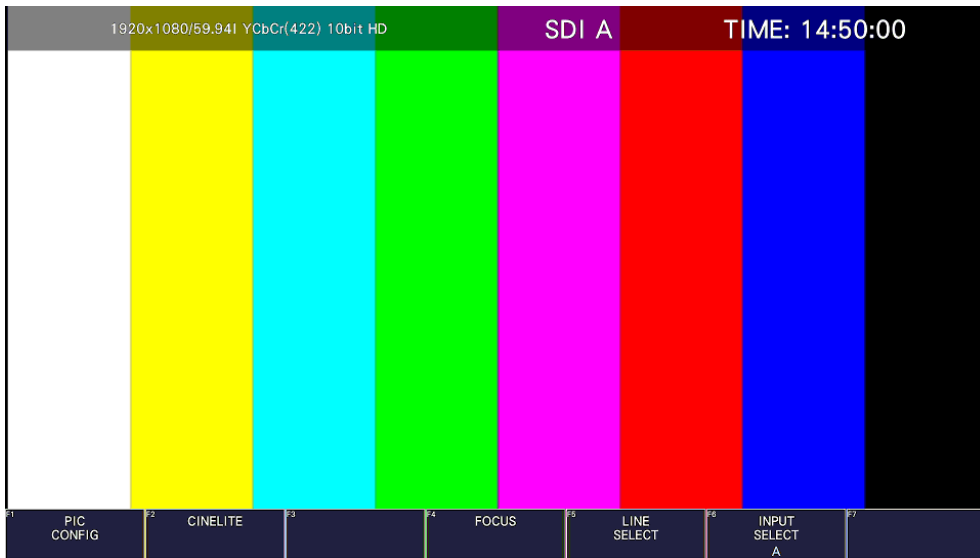

Figure 13-1 Picture display

13. PICTURE SCREEN

13.1 Selecting the Display Mode

To select the picture display mode, follow the procedure below.

Procedure

PIC	→	F•1	PIC CONFIG	→	F•1	PICTURE MODE: <u>FIT</u> / REAL / X2 / FULL FRM
-----	---	-----	------------	---	-----	---

Settings

- FIT:** The picture is displayed at the optimal size for the display area. Because the picture is enlarged or reduced, the display may become coarse or pixels may drop out. The instrument uses simple filtering to enlarge and reduce the picture.
- REAL:** A single sample of the video signal is displayed with a single pixel on the screen. If the picture is larger than the display area, use the V•POS and H•POS knobs to adjust the picture display position. Press a knob to return the picture to the corresponding default location.
- X2:** A single sample of the video signal is displayed with 4 pixels (2 horizontal and 2 vertical pixels) on the screen. If the picture is larger than the display area, use the V•POS and H•POS knobs to adjust the picture display position. Press a knob to return the picture to the corresponding default location. This is not displayed for 4K.
- FULL FRM:** A single frame, including the blanking interval, is displayed. This is not displayed for 4K.

SIZE = FIT

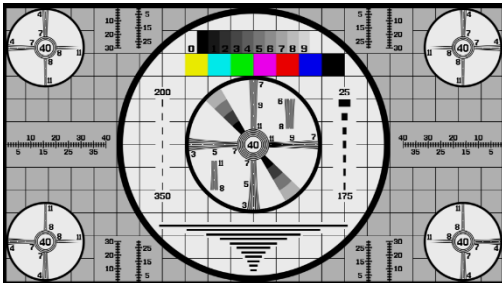

SIZE = REAL

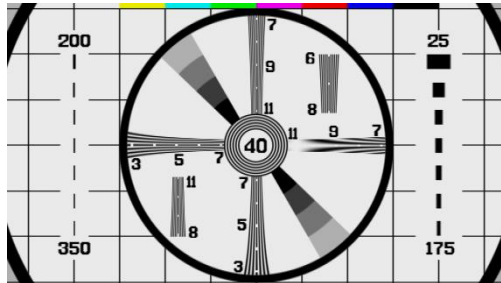

SIZE = X2

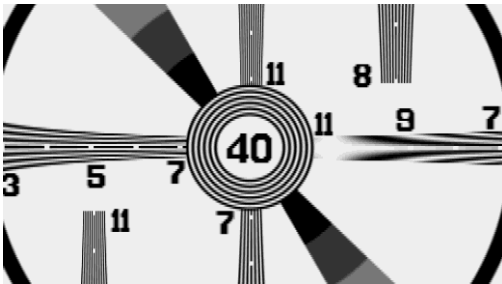

SIZE = FULL FRM

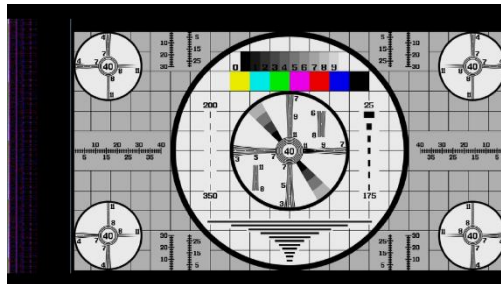

Figure 13-2 Selecting the display mode

13.2 Adjusting the Picture

To adjust the picture, press **F•2** ADJUST in the PIC CONFIG menu.

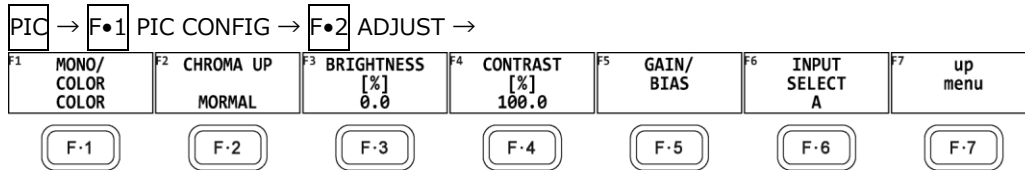
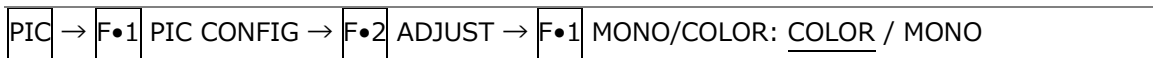

Figure 13-3 ADJUST menu

13.2.1 Switching between the Color and Monochrome Displays

To switch between the color and monochrome displays, follow the procedure below.

Procedure



13.2.2 Setting the Chroma Gain

To switch the chroma gain, follow the procedure below.

Procedure

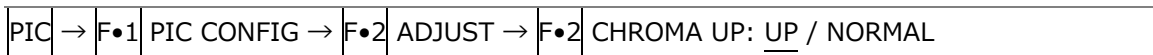

Settings

UP:	The chroma gain is set to 2 (200.0 %).
NORMAL:	The chroma gain is set to the value that you have set using F•5 GAIN/BIAS → F•1 GAIN.

13.2.3 Adjusting the Brightness

To adjust the brightness, follow the procedure below.

Press the function dial (F•D) to return the setting to its default value (0.0).

Procedure

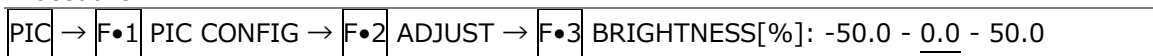

13.2.4 Adjusting the Contrast

To adjust the contrast, follow the procedure below.

Press the function dial (F•D) to return the setting to its default value (100.0).

Procedure

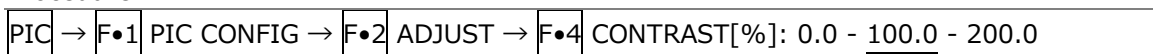

13. PICTURE SCREEN

13.2.5 Adjusting the Gain

To adjust the gain, press **F•1** GAIN on the GAIN/BIAS menu.

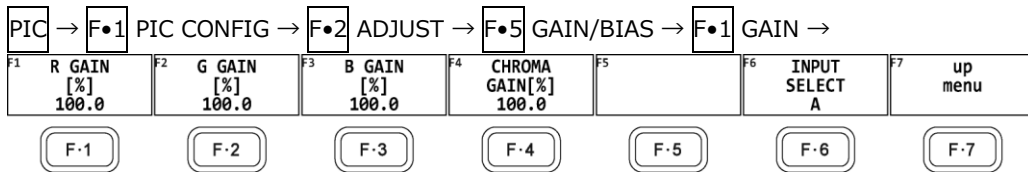

Figure 13-4 GAIN menu

To adjust the gain separately for the R, G, B, and chroma signals, follow the procedure below.

Press the function dial (F•D) to return the setting to its default value (100.0).

When **F•2** CHROMA UP is set to UP, **F•4** CHROMA GAIN does not appear. If is fixed at 200.0.

Procedure

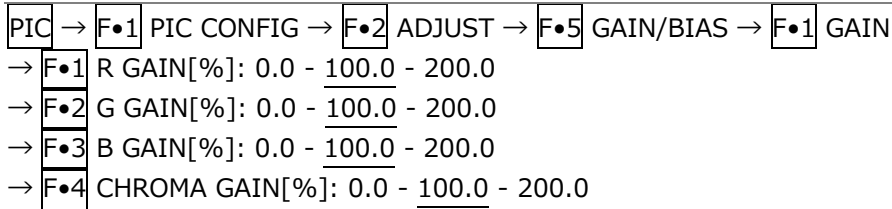

13.2.6 Adjusting the Bias

To adjust the bias, press **F•2** BIAS on the GAIN/BIAS menu.

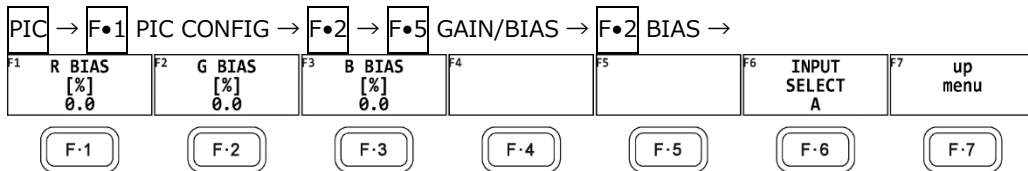
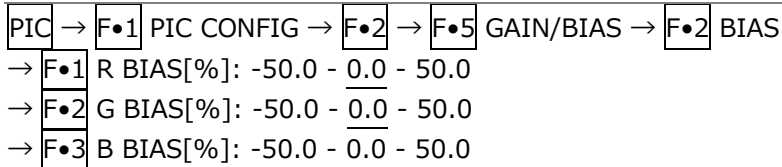

Figure 13-5 BIAS menu

To set the RGB signal bias separately for each color, follow the procedure below.

Press the function dial (F•D) to return the setting to its default value (0.0).

Procedure



13.3 Configuring the Display Settings

To configure the display settings, press **F•3** INDICATION SETTING on the PIC CONFIG menu.

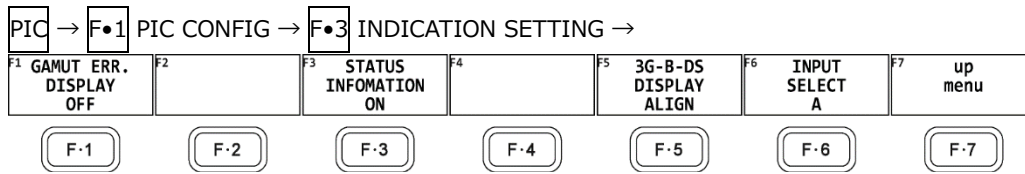

Figure 13-6 INDICATION SETTING menu

13.3.1 Displaying Gamut Errors

To display the locations of gamut errors and luminance errors on the picture, follow the procedure below.

These errors are defined by the ranges that you specify by setting Gamut Upper and Gamut Lower, Composite Upper and Composite Lower, and Luminance Upper and Luminance Lower in the status menu. If Gamut Error, Composite Gamut Error, or Level Error is set to OFF, the corresponding errors are not displayed.

[See also] Gamut Upper/Lower, Composite Upper/Lower → 16.2.3, "Error Setup 3"
 Luminance Upper/Lower → 16.2.4, "Error Setup 4"

Procedure

PIC → **F•1** PIC CONFIG → **F•3** INDICATION SETTING → **F•1** GAMUT ERR. DISPLAY: OFF / WHITE / RED / MESH

Settings

- OFF: Gamut errors are not displayed.
- WHITE: The picture intensity is halved, and gamut error are marked in white.
- RED: The picture intensity is halved, and gamut error are marked in red.
- MESH: Gamut errors are marked with a mesh pattern.

13. PICTURE SCREEN

13.3.2 Turning the Information On and Off

To turn on and off the display of the following information that you arranged in the layout, follow the procedure below.

This setting is valid on the display that appears when PIC is pressed. For multi display and other displays, it is fixed to ON.

- Sub tab items (FORMAT, INPUT, TIME, DATE)
- Option tab options (Format, Input, Time)

Procedure

PIC → F•1 PIC CONFIG → F•3 INDICATION SETTING → F•3 STATUS INFORMATION: ON / OFF

STATUS INFO = ON

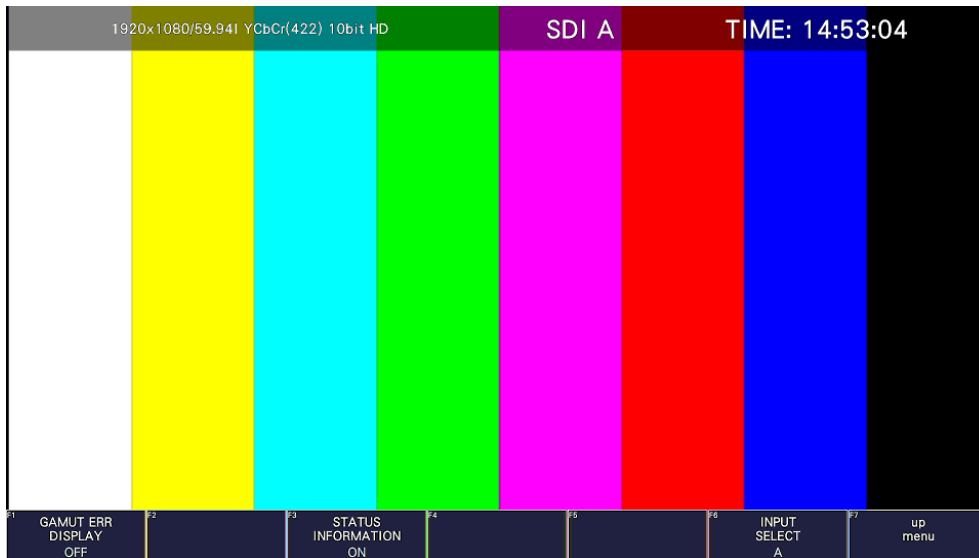

Figure 13-7 Turning the information on and off

13. PICTURE SCREEN

13.3.3 Configuring the SCTE-104 Detection Display settings

To superimpose the SCTE-104 detection packets up to 3 types on the picture. On the SCTE-104 SETUP tab, you can set the SCTE-104 detection display.

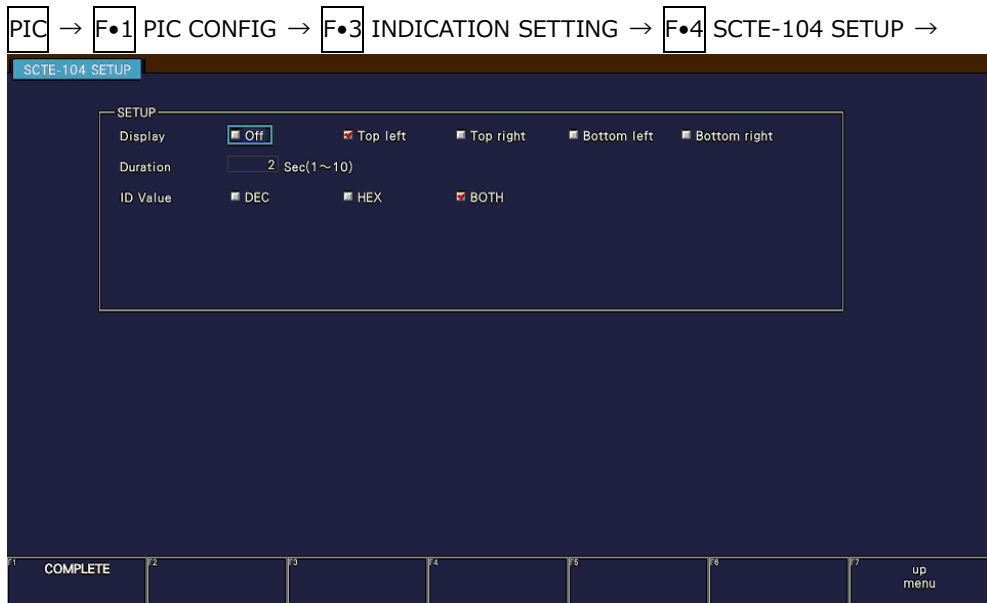

Figure 13-8 SCTE-104 SETUP tab

- Display

Select the display location of SCTE-104 detection from the upper left, upper right, lower left, or lower right of the screen.

If you select off, the SCTE-104 detection is not displayed.

OFF / Top left / Top right / Bottom left / Bottom right

- Duration

Select the display time of the SCTE-104 detection message from 1 to 10 seconds.

It doesn't work in conjunction with the SCTE-104 packet display time of the status display.

1 / 2 / 3 / 4 / 5 / 6 / 7 / 8 / 9 / 10

- ID Value

Select the message display format from HEX (hexadecimal display), DEC (decimal display), or BOTH for the SCTE-104 detection.

It works in conjunction with F•3 ID VALUE on the SPLICE display screen of the status display.

When ID Value is set to BOTH, splice_event_id and unique_program_id are displayed simultaneously in hexadecimal and decimal numbers as shown below.

Splice ID	Hexadecimal (decimal)
Program ID	Hexadecimal (decimal)

DEC / HEX / BOTH

13. PICTURE SCREEN

13.3.4 Displaying the SCTE-104 Detection screen

When a SCTE-104 message is detected, the message is displayed on the picture screen. Up to 3 messages are displayed, and the top of the messages is the latest detected message. The message is displayed for the time set in Duration, and if no message is detected during the set time, it returns to the hidden state.

- (Time Code) xx:xx:xx:xx SCTE104: (Message 1) Latest detected message
- (Time Code) xx:xx:xx:xx SCTE104: (Message 2) Once ago detected message
- (Time Code) xx:xx:xx:xx SCTE104: (Message 3) Twice ago detected message

When a splice_request_data message is detected, the details of the message are displayed.

Display = Top left / ID Value = BOTH



Figure 13-9 SCTE-104 Detection screen

13. PICTURE SCREEN

- Displaying abbreviated message

The detected message is abbreviated as shown below.

SCTE-104 message	Abbreviated message
init_request_data	init
alive_request_data	alive
config_request_data	config
fault_request_data	fault
inject_section_data_request	inject_section
splice_request_data	splice
splice_null_request_data	splice_null
start_schedule_download_request_data	start_schedule_down
time_signal_request_data	time_signal
transmit_schedule_request_data	transmit_schedule
component_mode_DPI_request_data	comp_mode_DPI
encrypted_DPI_request_data	encrypted_DPI
insert_descriptor_request_data	insert_desc
insert_DTMF_descriptor_request_data	insert_DTMF_desc
insert_avail_descriptor_request_data	insert_avail_desc
insert_segmentation_descriptor_request_data	insert_seg_desc
proprietary_command_request_data	proprietary_command
schedule_component_mode_request_data	schedule_comp_mode
schedule_definition_data	schedule_definition
insert_tier_data	insert_tier
insert_time_descriptor	insert_time_desc
insert_audio_descriptor	insert_audio_desc
delete_ControlWord_data	delete_ControlWord
update_ControlWord_data	update_ControlWord

splice_request_data message	Abbreviated message
splice_insert_type	SpliceType
splice_event_id	SpliceID
unique_program_id	ProgramID
pre_roll_time	PreRoll
break_duration	Break
avail_num	AvailNum
avails_expected	AvailsExp
auto_return_flag	AutoReturn

13. PICTURE SCREEN

13.4 Configuring the Marker Settings

To configure the marker settings, press **F•4** MARKER on the PIC CONFIG menu. This menu item does not appear when PICTURE MODE is set to a value other than FIT. [See also] PICTURE MODE → 13.1, "Selecting the Display Mode"

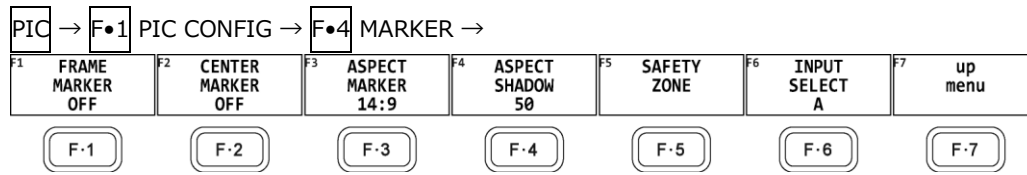

Figure 13-10 MARKER menu

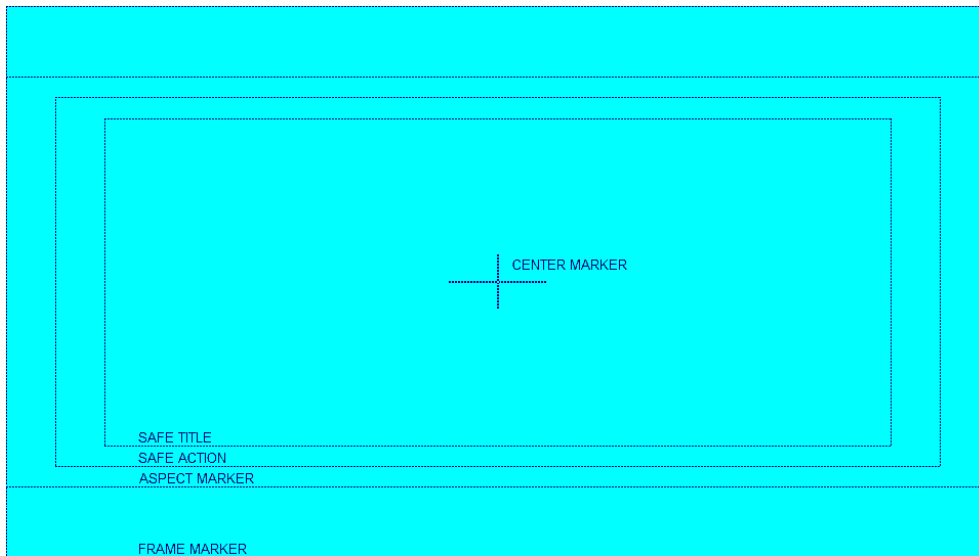

Figure 13-11 Horizontal marker display

13. PICTURE SCREEN

13.4.1 Turning the Frame Marker On and Off

To turn the frame marker on and off, follow the procedure below.

Procedure

PIC	→	F•1	PIC CONFIG	→	F•4	MARKER	→	F•1	FRAME MARKER: ON / <u>OFF</u>
-----	---	-----	------------	---	-----	--------	---	-----	-------------------------------

13.4.2 Turning the Center Marker On and Off

To turn the center marker on and off, follow the procedure below.

Procedure

PIC	→	F•1	PIC CONFIG	→	F•4	MARKER	→	F•2	CENTER MARKER: ON / <u>OFF</u>
-----	---	-----	------------	---	-----	--------	---	-----	--------------------------------

13.4.3 Setting the Aspect Marker

To display the aspect marker, follow the procedure below.

Procedure

PIC	→	F•1	PIC CONFIG	→	F•4	MARKER	→	F•3	ASPECT MARKER: <u>OFF</u> / 17:9 / 16:9 / 14:9 / 13:9 / 4:3 / 2.39:1 / AFD
-----	---	-----	------------	---	-----	--------	---	-----	--

Settings

OFF:	The aspect marker is not displayed.
17:9	A 17:9 aspect marker is displayed. This option cannot be selected when the input signal is a 17:9 frame signal or an SD signal.
16:9:	A 16:9 aspect marker is displayed. This option cannot be selected when the input signal is a 16:9 frame signal.
14:9:	A 14:9 aspect marker is displayed.
13:9:	A 13:9 aspect marker is displayed.
4:3:	A 4:3 aspect marker is displayed. This option cannot be selected when the input signal is SD.
2.39:1:	A 2.39:1 aspect marker is displayed. This option cannot be selected when the input signal is SD.
AFD:	The aspect marker included in the AFD (Active Format Description) packets is displayed. Also, abbreviations for SMPTE ST 2016-1-2007 standard AFD codes are displayed in the upper left of the screen. This option can be selected when the input signal is SD or HD.

13. PICTURE SCREEN

The AFD codes that are displayed in the upper left of the screen are displayed as shown below according to the coded frame and the AFD code. If there are no AFD packets embedded in the input signal, "-----" is displayed.

Table 13-1 AFD display

Displayed Abbreviation	Coded Frame	AFD Code	Description
0000- UNDEFINED	0 (4:3)	0000	Undefined
0001- RESERVED	0 (4:3)	0001	Reserved
0010- 16:9LBTOP	0 (4:3)	0010	Letterbox 16:9 image, at top of the coded frame
0011- 14:9LBTOP	0 (4:3)	0011	Letterbox 14:9 image, at top of the coded frame
0100- >16:9LBox	0 (4:3)	0100	Letterbox image with an aspect ratio greater than 16:9, vertically centered in the coded frame
0101- RESERVED	0 (4:3)	0101	Reserved
0110- RESERVED	0 (4:3)	0110	Reserved
0111- RESERVED	0 (4:3)	0111	Reserved
1000- FullFrame	0 (4:3)	1000	Full frame 4:3 image, the same as the coded frame
1001- Full Frame	0 (4:3)	1001	Full frame 4:3 image, the same as the coded frame
1010- 16:9LBox	0 (4:3)	1010	Letterbox 16:9 image, vertically centered in the coded frame with all image areas protected
1011- 14:9LBox	0 (4:3)	1011	Letterbox 14:9 image, vertically centered in the coded frame
1100- RESERVED	0 (4:3)	1100	Reserved
1101-4:3Full14:9	0 (4:3)	1101	Full frame 4:3 image, with alternative 14:9 center
1110-16:9LB14:9	0 (4:3)	1110	Letterbox 16:9 image, with alternative 14:9 center
1111-16:9LB4:3	0 (4:3)	1111	Letterbox 16:9 image, with alternative 4:3 center
0000w UNDEFINED	1 (16:9)	0000	Undefined
0001w RESERVED	1 (16:9)	0001	Reserved
0010w Full Frame	1 (16:9)	0010	Full frame 16:9 image, the same as the coded frame
0011w 14:9Pillbox	1 (16:9)	0011	Pillarbox 14:9 image, horizontally centered in the coded frame
0100w >16:9LBox	1 (16:9)	0100	Letterbox image with an aspect ratio greater than 16:9, vertically centered in the coded frame
0101w RESERVED	1 (16:9)	0101	Reserved
0110w RESERVED	1 (16:9)	0110	Reserved
0111w RESERVED	1 (16:9)	0111	Reserved
1000w FullFrame	1 (16:9)	1000	Full frame 16:9 image, the same as the coded frame
1001w 4:3Pillbox	1 (16:9)	1001	Pillarbox 4:3 image, horizontally centered in the coded frame
1010w FullNoCrop	1 (16:9)	1010	Full frame 16:9 image, with all image areas protected
1011w14:9Pillbox	1 (16:9)	1011	Pillarbox 14:9 image, horizontally centered in the coded frame
1100w RESERVED	1 (16:9)	1100	Reserved
1101w4:3PB14:9	1 (16:9)	1101	Pillarbox 4:3 image, with alternative 14:9 center
1110wFul14:9Safe	1 (16:9)	1110	Full frame 16:9 image, with alternative 14:9 center
1111wFull4:3Safe	1 (16:9)	1111	Full frame 16:9 image, with alternative 4:3 center

13. PICTURE SCREEN

13.4.4 Setting the Aspect Shadow

When **F•3** ASPECT MARKER is set to a value other than OFF, to adjust the darkness of the aspect marker shadow, follow the procedure below. The larger the number, the darker the shadow. If you specify 0, the aspect marker will be indicated with a line.

Press the function dial (F•D) to return the setting to its default value (50).

Procedure

PIC → F•1 PIC CONFIG → F•4 MARKER → F•4 ASPECT SHADOW[%]: 0 - 50 - 100

ASPECT SHADOW = 50

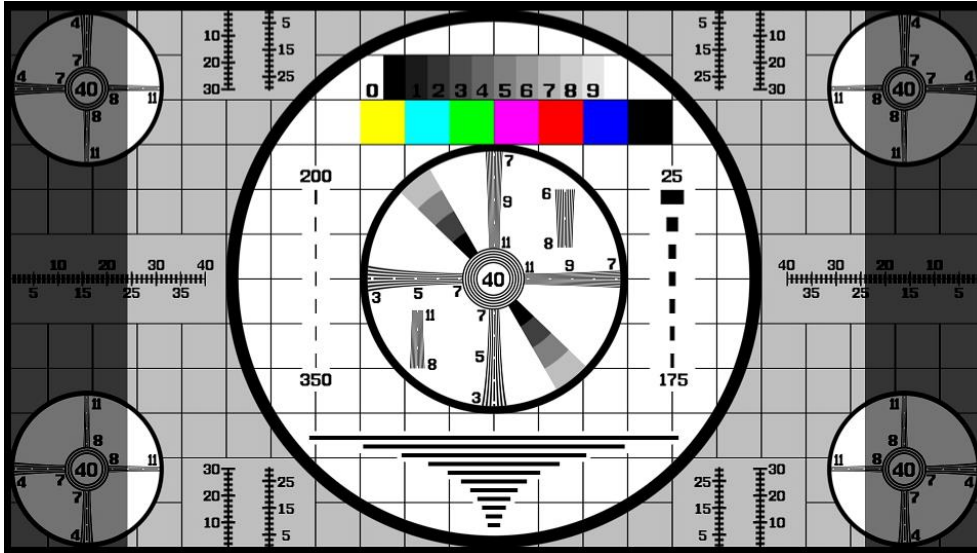

Figure 13-12 Setting the aspect shadow

13. PICTURE SCREEN

13.4.5 Setting the Safe Action Marker

To configure safety marker settings, press **F•5** SAFETY ZONE on the MARKER menu. When **F•3** ASPECT MARKER is set to AFD, this menu item is not available.

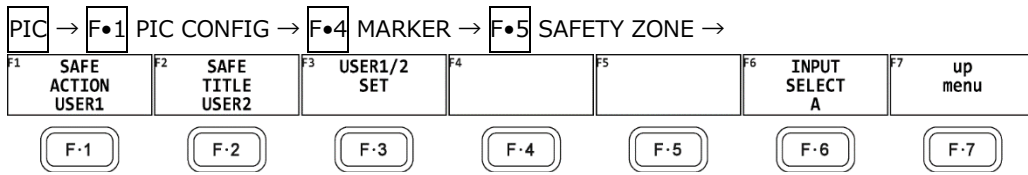

Figure 13-13 SAFETY ZONE menu

To display the safe action marker, follow the procedure below.

When an aspect marker is displayed, the safe action marker is displayed relative to the aspect marker.

Procedure

PIC → **F•1** PIC CONFIG → **F•4** MARKER → **F•5** SAFETY ZONE → **F•1** SAFE ACTION: ARIB / SMPTE / USER1 / OFF

Settings

ARIB:	An ARIB TR-B4 safe action marker is displayed. This setting cannot be selected when the input signal is 4K.
SMPTE:	An SMPTE RP-218 safe action marker is displayed. This setting cannot be selected when the input signal is 4K.
USER1:	A marker that has been set with F•1 USER1 WIDTH[%] and F•2 USER1 HEIGHT[%] for F•3 USER1/2 SET is displayed.
OFF:	A safe action marker is not displayed.

13.4.6 Setting the Safe Title Marker

To display the safe title marker, follow the procedure below.

When an aspect marker is displayed, the safe action marker is displayed relative to the aspect marker.

Procedure

PIC → **F•1** PIC CONFIG → **F•4** MARKER → **F•5** SAFETY ZONE → **F•2** SAFE TITLE: ARIB / SMPTE / USER2 / OFF

Settings

ARIB:	An ARIB TR-B4 safe title marker is displayed. This setting cannot be selected when the input signal is 4K.
SMPTE:	An SMPTE RP-218 safe title marker is displayed. This setting cannot be selected when the input signal is 4K.
USER2:	A marker that has been set with F•3 USER2 WIDTH[%] and F•4 USER2 HEIGHT[%] for F•3 USER1/2 SET is displayed.
OFF:	A safe title marker is not displayed.

13. PICTURE SCREEN

13.4.7 Setting User Markers

By setting **F•1** SAFE ACTION to USER1 and **F•2** SAFE TITLE to USER2, you can display up to two user-defined markers.

To configure user-defined marker settings, press **F•3** USER1/2 SET on the SAFETY ZONE menu.

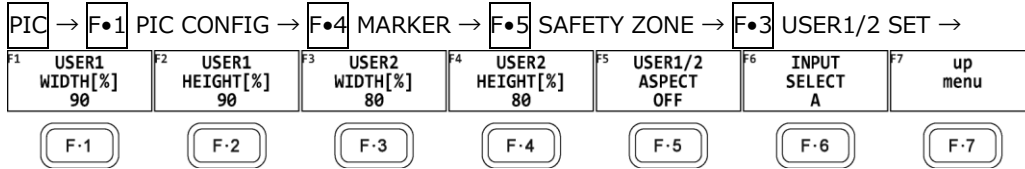

Figure 13-14 USER1/2 SET menu

To set the width and height of a user marker and turn the aspect ratio display on and off, follow one of the procedures below.

Press the function dial (**F•D**) to return the width and height settings to their default value.

The aspect ratio display on/off setting applies both to USER1 and USER2.

Procedure

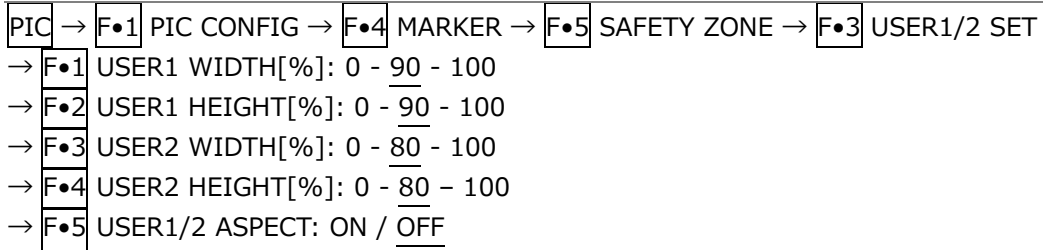

13.5 Setting the Superimpose Feature (SER21)

The superimpose feature displays closed caption information on top of pictures.

To display the closed caption information, press **F•5** SUPER IMPOSE on the PIC CONFIG menu. This menu item is not displayed when the input signal is 3G-B.

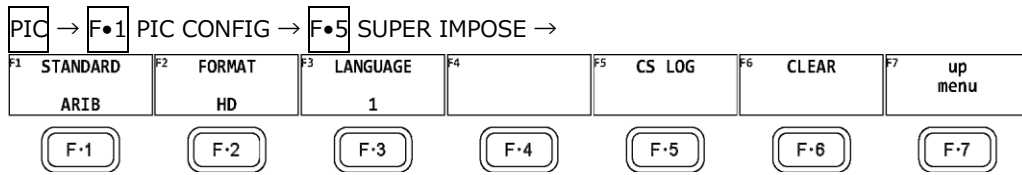

Figure 13-15 SUPER IMPOSE menu

13.5.1 Selecting the Closed Caption Display

To select the closed caption to display over the picture, follow the procedure below. If you select OFF, no closed captions will be displayed.

Procedure

PIC → **F•1** PIC CONFIG → **F•5** SUPER IMPOSE → **F•1** STANDARD: OFF / SMPTE / ARIB / TELETEXT

Settings

- OFF: Closed captions are not displayed.
- SMPTE: English closed captions are displayed. This cannot be selected in 6G.
- ARIB: Simple Japanese closed captions are displayed. This cannot be selected in 6G.
- TELETEXT: European closed captions are displayed. This can be selected in SD or HD.

On the Japanese closed caption display, if a clear screen command is received, "CS" is displayed in cyan for approximately 0.5 seconds in the upper right of the screen.

13.5.2 Selecting the Format of English Closed Captions

To select the English closed caption format from the four types below, follow the procedure below.

Procedure

PIC → **F•1** PIC CONFIG → **F•5** SUPER IMPOSE → **F•2** FORMAT: 608(708) / 608(608) / VBI / 708

Settings

- 608(708): CEA/EIA-608-B English closed caption information that is embedded in EIA-708-B CDP packets is displayed.
- 608(608): CEA/EIA-608-B English closed caption information is displayed.
- VBI: CEA/EIA-608-B English closed caption information that is embedded in vertical blanking intervals is displayed. This can be selected in SD.
- 708: EIA-708 English closed caption information that is embedded in EIA-708-B CDP packets is displayed.

13. PICTURE SCREEN

13.5.3 Selecting the Display Details of English Closed Captions

When **F•2** FORMAT is set to a value other than 708, to select the English closed caption content to display, follow the procedure below.

Procedure

PIC → **F•1** PIC CONFIG → **F•5** SUPER IMPOSE → **F•3** LANGUAGE: CC1 / CC2 / CC3 / CC4 / TEXT1 / TEXT2 / TEXT3 / TEXT4

When **F•2** FORMAT is set to 708, to select the English closed caption content to display, follow the procedure below.

Press the function dial (**F•D**) to return the setting to its default value (1).

Procedure

PIC → **F•1** PIC CONFIG → **F•5** SUPER IMPOSE → **F•4** SERVICE DATA: 1 - 63

13.5.4 Selecting the Format of Japanese Closed Captions

To select the ARIB Japanese closed caption information format from the four types below, follow the procedure below. A border is displayed around the name of the selected format of Japanese closed captions in the upper right of the screen.

The closed caption format names are displayed in green when packets of the corresponding closed caption format are being received and in white otherwise.

Procedure

PIC → **F•1** PIC CONFIG → **F•5** SUPER IMPOSE → **F•2** FORMAT: HD / SD / ANALOG / CELLULAR

Settings

HD:	Displays HD closed caption data
SD:	Displays SD closed caption data
ANALOG:	Displays analog closed caption data
CELLULAR:	Displays porta closed caption data

13.5.5 Selecting the Japanese Closed Caption Data

To select the closed caption data type, follow the procedure below.

Procedure

PIC → **F•1** PIC CONFIG → **F•5** SUPER IMPOSE → **F•3** LANGUAGE: 1 / 2

13. PICTURE SCREEN

Settings

1: Language 1
2: Language 2

13.5.6 Displaying the Clear Screen Log

You can detect the clear screen commands that are embedded in the broadcasts of programs with closed captions and display a log of these commands. In addition, using specified timecodes, you can check whether closed captions in TV commercial materials are displayed during the closed caption prohibited time.

Carry out the procedure below to display the clear screen command log.
Use the CS LOG menu to set the clear screen log.

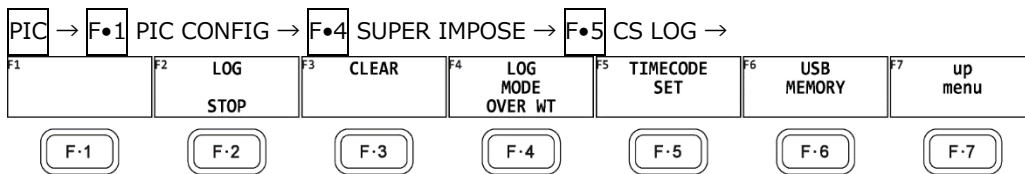

Figure 13-16 CS LOG menu

Log screen

CS LOG LIST		SAMPLE No.10		<< NOW LOGGING >>	
4:	LTC TC20:32:56:01	A	HD	1080i/59.94	T_DSP
3:	LTC TC20:32:56:01	A	HD	1080i/59.94	CS
2:	LTC TC20:32:54:01	A	HD	1080i/59.94	T_DSP
1:	LTC TC20:32:54:01	A	HD	1080i/59.94	CS
1	2	3	4	5	6

1. Generation Number
2. Time Code
3. Input channel
4. Closed caption format
5. Input format
6. Log Entry Contents

- * Even if there are several of these units installed in the instrument, there is only one log file.
- * The clear screen log can be recorded when the Japanese closed caption screen or the clear screen log screen is displayed. Use the multi screen display or other means to keep these screens from closing during measurement.
- * If you rewind a VCR, reset the log buffer before starting the clear screen log. Use START/STOP of **F.2** LOG or **F.6** CLEAR (Japanese closed caption screen) on the **F.3** CLEAR, SUPER IMPOSE menu to reset.
- * The clear screen log recording period is approximately 83 minutes when the closed caption changes every 2 seconds.
- * Closed caption codes and decoded closed captions cannot be logged.

13. PICTURE SCREEN

- General Display Description

- Generation Number

The clear screen log entries are listed in order with the most recent events listed first. By turning the function dial (F•D) to the right, you can scroll the screen to view older entries in the log. Press the function dial (F•D) to display the latest entries in the log.

- Time Code

In the clear screen log, entries are recorded using the time code specified on the CAPTURE & DISPLAY tab of the SYS menu. Set the time code to LTC or VITC. D-VITC is not supported.

[See also] 7.2.5, "Configuring the Information Display"

- Log Entry Contents

The meanings of the displayed log contents are shown below.

CS: Detection of a clear screen command

T_DSP: Detection of closed caption display

- Starting or Stopping the Log

To start or stop the clear screen log, follow the procedure below.

Procedure

PIC	→	F•1	PIC CONFIG	→	F•5	SUPER IMPOSE	→	F•5	CS LOG	→	F•2	LOG: START / <u>STOP</u>
-----	---	-----	------------	---	-----	--------------	---	-----	--------	---	-----	--------------------------

- Clearing the Log

To clear the clear screen log, follow the procedure below.

Procedure

PIC	→	F•1	PIC CONFIG	→	F•5	SUPER IMPOSE	→	F•5	CS LOG	→	F•3	CLEAR
-----	---	-----	------------	---	-----	--------------	---	-----	--------	---	-----	-------

- Log Operation Mode

The clear screen log can record up to 5,000 entries.

To select the action to perform when more than 5,000 events occur, follow the procedure below.

Procedure

PIC	→	F•1	PIC CONFIG	→	F•5	SUPER IMPOSE	→	F•5	CS LOG	→	F•4	LOG MODE: <u>OVER</u> <u>WT / STOP</u>
-----	---	-----	------------	---	-----	--------------	---	-----	--------	---	-----	---

Settings

OVER WT: Old logs are discarded and overwritten.

STOP: Logs after the 5,000 events are not recorded.

13. PICTURE SCREEN

- Configuring the Closed Caption Checking Function

Carry out the procedure below to check whether a closed caption is displayed during the closed caption prohibited time.

Procedure

PIC	→	F•1	PIC CONFIG	→	F•5	SUPER IMPOSE	→	F•5	CS LOG	→	F•5	TIMECODE SET
-----	---	-----	------------	---	-----	--------------	---	-----	--------	---	-----	--------------

Settings

OFF:	Closed caption checking is disabled (log will be recorded).
Timecode:	Closed caption checking is enabled.

- Start Time and End Time

If you select Timecode, set the check period to 4 s or longer using Start Time and End Time. If Time Code on the SYS menu is set to Real Time, you cannot set the trigger.

- Non Caption Time

Under Non Caption Time, set the closed caption prohibited time. If closed captions are displayed between Start Time and Front seconds after Start Time or between Rear seconds before End Time to End Time, the check result will be NG.



13. PICTURE SCREEN

- Saving Data to a USB Memory Device

You can save the clear screen log to a USB memory device as a text file. To save a file with a name that you specify, follow the procedure below.

1. Used to connect USB memory.
2. Press **F•6** USB MEMORY.

The file list screen appears.

This setting appears when a USB memory device is connected.

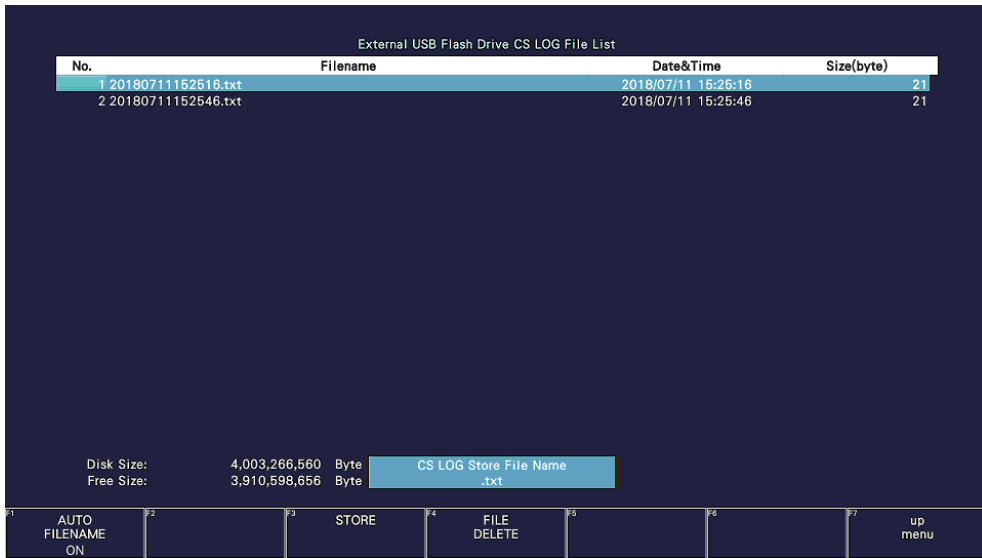

Figure 13-17 File list screen

3. Set **F•1** AUTO FILENAME to OFF.
4. Press **F•2** NAME INPUT.

The file name input display appears.



Figure 13-18 File name input screen

13. PICTURE SCREEN

5. Enter a file name using up to 14 characters.

The key operations that you can perform in the file name input display are as follows:

F•1	CLEAR ALL	Deletes all characters
F•2	DELETE	Deletes the character at the cursor
F•4	<=	Moves the cursor to the left
F•5	=>	Moves the cursor to the right
F•6	CHAR SET	Enters the character
Function dial (F•D)		Turn to select a character, and press to enter the character.

You can also copy the file name of an already saved file. To copy a file name, move the cursor to the file in the file list whose name you want to copy, and then press the function dial (F•D).

6. Press **F•7** up menu.
7. Press **F•3** STORE.

If a file with the same name that you have specified already exists on the USB memory device, an overwrite confirmation menu appears. To overwrite the existing preset, **F•1** OVER WR YES. Otherwise, press **F•3** OVER WR NO.

- Deleting the Clear Screen Log

To delete a clear screen log that has been saved to the USB memory device, select the log file on the file list display, and then press **F•4** FILE DELETE. To delete the file, press **F•1** DELETE YES. To cancel the delete operation, press **F•3** DELETE NO.

- Automatic File Name Generation

If you set **F•1** AUTO FILENAME to ON, the file name will be generated automatically in the format "YYYYMMDDhhmmss" when you save the file. In this situation, **F•2** NAME INPUT is not displayed.

- USB Memory Device Folder Structure

Clear screen logs are saved in the LOG folder.

- 📁 USB memory device
 - ↳ 📁 LV5300_USER, LV5350_USER or LV7300_USER
 - ↳ 📁 LOG
 - ↳ 📄 YYYYMMDDhhmmss.txt Clear screen log file (with check result)

13. PICTURE SCREEN

• Measurement Example

As an example, this section describes how to perform closed caption checking on TV commercial material.

1. On the CAPTURE & DISPLAY tab of the SYS menu, set Time Code to LTC or VITC.
After setting them, press **F•1** COMPLETE.
2. Set **PIC** → **F•1** PIC CONFIG → **F•5** SUPER IMPOSE → **F•1** STANDARD to ARIB.
3. Set **F•2** FORMAT and **F•3** LANGUAGE.
4. Press **F•5** CS LOG.
5. Press **F•5** TIMECODE SET to set the time code.
Set Trigger to Timecode first, and then set the timecode and closed caption prohibited time. After setting them, press **F•1** COMPLETE.
6. Press **F•2** LOG to start the log.
From this point until the end of measurement, do not exit the clear screen log screen or Japanese closed caption screen.
7. Start the TV commercial material.
Closed caption checking will start at the specified time.
On the clear screen log screen, log entries are displayed in red when closed captions are displayed during the closed caption prohibited time and in green otherwise.
8. When the check result is displayed, press any key.
The caption check result is displayed as OK or NG.
9. If necessary, press **F•6** USB MEMORY to save the measurement results to USB memory.

13.5.7 Clearing Japanese Closed Caption Data

To clear the displayed Japanese closed caption, follow the procedure below to press CLEAR.

Procedure

PIC	→	F•1	PIC CONFIG	→	F•5	SUPER IMPOSE	→	F•6	CLEAR
-----	---	-----	------------	---	-----	--------------	---	-----	-------

13. PICTURE SCREEN

13.5.8 Selecting the Multiplex System for European Closed Captions

To select the multiplex system for European closed captions from the two types below, follow the procedure below.

Procedure

PIC	→	F•1	PIC CONFIG	→	F•5	SUPER IMPOSE	→	F•2	WST TRANSPORT: <u>VBI</u> / OP47
-----	---	-----	------------	---	-----	--------------	---	-----	----------------------------------

Settings

VBI: European closed caption information that is embedded in vertical blanking intervals is displayed.

This can be selected in SD.

OP47: Closed captions in SMPTE RDD-08 SDP format are displayed.

13.5.9 Selecting the Magazine Number and Page Number for European Closed Captions

To select a magazine number for European closed captions, follow the procedure below.

Procedure

PIC	→	F•1	PIC CONFIG	→	F•5	SUPER IMPOSE	→	F•3	MAGAZINE:1 - <u>7</u> - 8
-----	---	-----	------------	---	-----	--------------	---	-----	---------------------------

To select a page number for European closed captions, follow the procedure below.

Procedure

PIC	→	F•1	PIC CONFIG	→	F•5	SUPER IMPOSE	→	F•4	PAGE:00 - <u>77</u> - FF
-----	---	-----	------------	---	-----	--------------	---	-----	--------------------------

13.6 Configuring CINELITE Settings

CINELITE is a feature that displays luminance levels of video signals on the picture. To show the CINELITE display, press **F•2** CINELITE on the PIC menu.

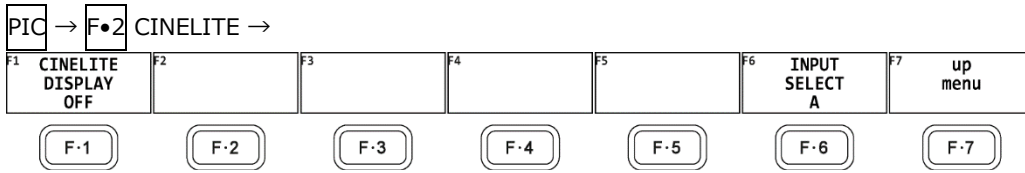

Figure 13-19 CINELITE menu

To switch to the CINELITE display, follow the procedure below.

Procedure

PIC → **F•2** CINELITE → **F•1** CINELITE DISPLAY: OFF / f Stop / %DISPLAY / CINEZONE / %DISP & CINEZONE

Settings

- OFF: CINELITE is not displayed.
 - f Stop: The f Stop screen is displayed.
This option cannot be selected when PICTURE MODE is set to a value other than FIT.
 - %DISPLAY: The %DISPLAY screen is displayed.
This option cannot be selected when PICTURE MODE is set to a value other than FIT.
 - CINEZONE: The CINEZONE screen is displayed.
 - %DISP & CINEZONE: The %DISPLAY screen and the CINEZONE screen are displayed at the same time.
When PICTURE MODE is set to a value other than FIT, the %DISPLAY screen will not be displayed even if you select %DISP & CINEZONE.
-

13. PICTURE SCREEN

13.6.1 f Stop Display Description

To set f Stop, press **F•1** CINELITE DISPLAY to select f Stop and then press **F•2** f STOP SETUP.

On the f Stop display, luminance levels are displayed using f-stop (exposure) values. The measured f Stop value for a group of measured points is typically displayed using white, but it will be displayed using yellow when it corresponds to a luminance level of 80 % or more. Additionally, f Stop values that correspond to luminance levels equal to or less than 0 % cannot be measured. They are displayed in yellow as "*****."

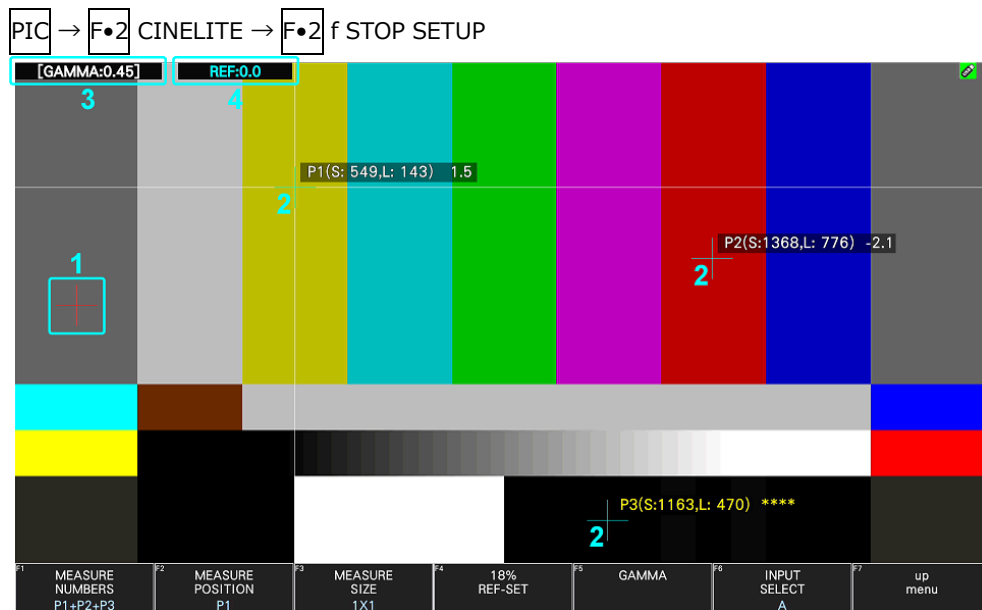

Figure 13-20 f Stop display

1 Reference Position

The position where the cursors intersected when **F•4** 18% REF SET was pressed is displayed in red. This is the reference position for f-stop measurement.

2 Cursor

Up to three cursors can be set. The cursor coordinates are indicated using sample numbers and line numbers. The f Stop value relative to the reference point is displayed at each point.

3 Gamma Correction Value

The gamma correction value that you selected using **F•5** GAMMA → **F•1** GAMMA SELECT is displayed.

4 Reference display

The f Stop value at the reference position is displayed. The value immediately after you have pressed **F•4** 18% REF-SET is zero, but it will change when the picture changes.

13.6.2 Procedure for Displaying the f Stop Display

The following example shows how to display luminance levels as f Stop numbers relative to the luminance level of 18 % gray chart. Include an 18 % gray chart with the objects that you are filming.

1. Press PIC.
2. Press **F•2** CINELITE.
3. Press **F•1** CINELITE DISPLAY to select f Stop.
4. Press **F•2** f STOP SETUP.
5. Press **F•5** GAMMA and then **F•1** GAMMA SELECT to select the gamma correction table type.

The default gamma correction value is 0.45, but you can also use a user-defined gamma correction table that matches the gamma characteristics of the camera that you are using. For details, see section 13.6.7, "Configuring User-Defined Correction Tables." The selected gamma correction value is indicated in the upper left of the display.

6. Press **F•7** up menu.
7. Make sure that the cursors are over the 18 % gray chart, and press **F•4** 18% REF SET. The f Stop value for 18 % gray chart becomes 0.0 and is displayed in the upper part of the screen next to "REF:." The reference position is displayed with a red cursor.
8. Use the cursors to set the measurement points. The f Stop value relative to 18 % gray chart appears next to each cursor. You can set up to three measurement points.

13. PICTURE SCREEN

13.6.3 %DISPLAY Screen Description

To set %DISPLAY, press **F•1** CINELITE DISPLAY to select %DISPLAY and then press **F•2** %DISP SETUP.

On the %DISPLAY screen, you can display luminance levels using Y%, RGB%, RGB255, CODE VALUE, or CODE VALUE DEC. Use **F•4** UNIT SELECT to select the display format. The measured values are typically displayed in white, but they are displayed in yellow when the luminance level at a measurement point is 80 % or more or 0 % or less. (Except CV)

- Y% Display

Luminance levels are indicated as percentages.

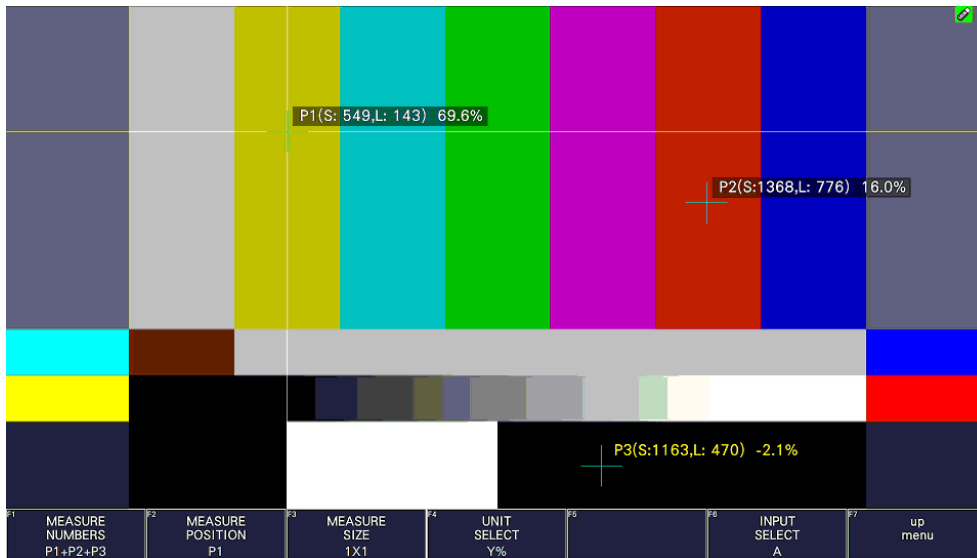

Figure 13-21 Y% display

- RGB% Display

Each of the R, G, and B levels is indicated using a percentage. The levels are also indicated using bars on the left side of the display (the order is R, G, and then B).

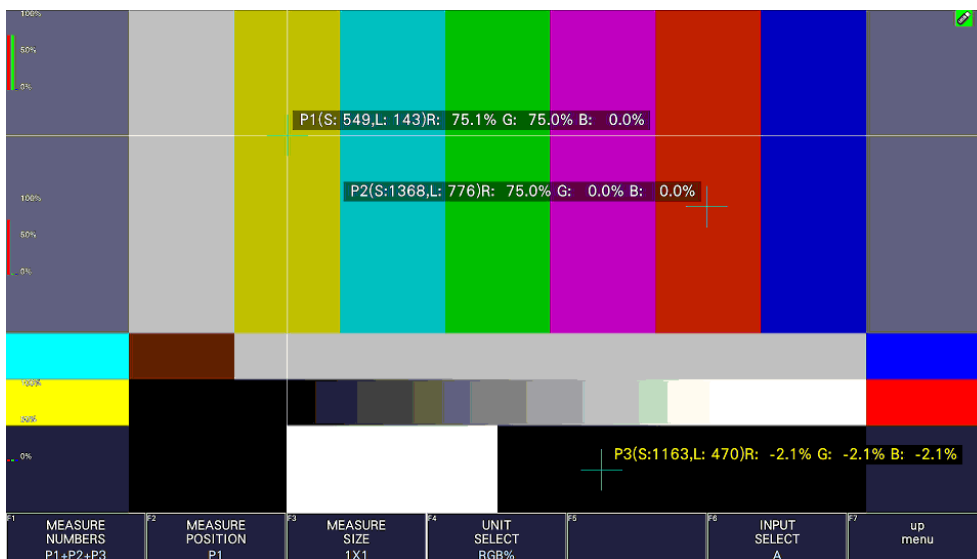

Figure 13-22 RGB% display

13. PICTURE SCREEN

- RGB255 Display

Each of the R, G, and B levels is indicated using 256 steps from 0 to 255. The levels are also indicated using bars on the left side of the display (the order is R, G, and then B). The value of an RGB level that is 100 % or greater is 255.

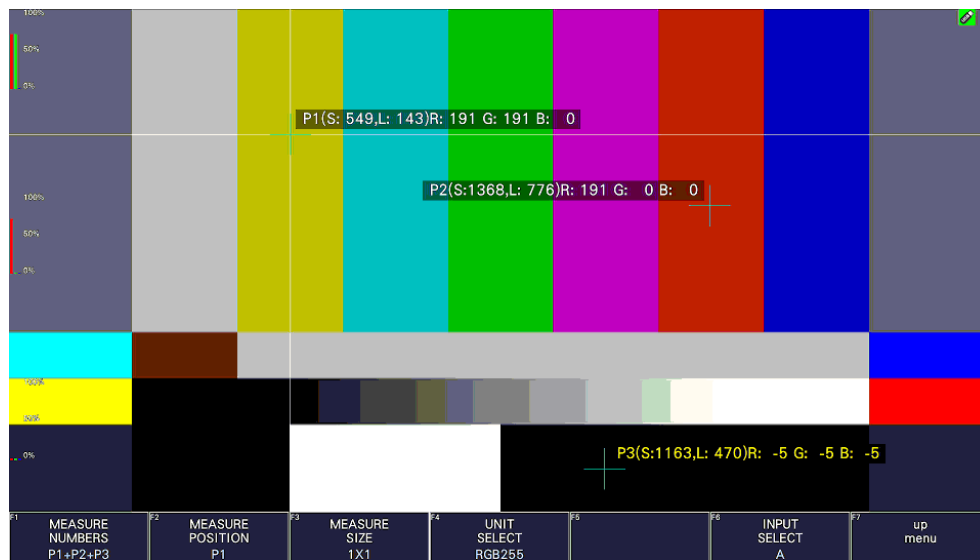

Figure 13-23 RGB255 display

- CV (CODE VALUE) Display, CV (CODE VALUE) (DEC) Display

When CV is selected, the SDI signal video data is displayed in hexadecimal.

When CA(DEC) is selected, the SDI signal video data is displayed in decimal.

When the input signal is YCbCr, the video is displayed in YCbCr, and when the input signal is RGB, the video is displayed in RGB.

You can select CV or CV(DEC) when MEAS SIZE is 1x1.

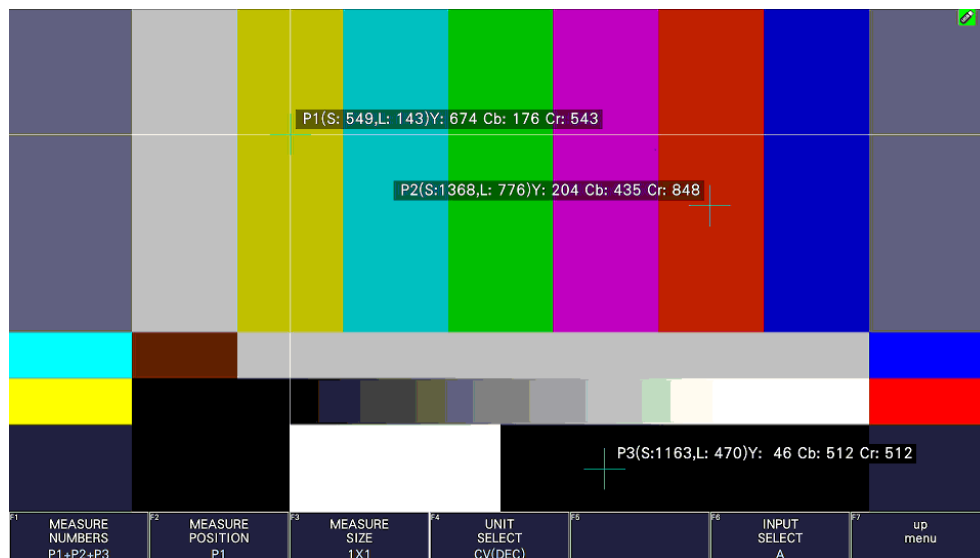

Figure 13-24 CODE VALUE DEC display

13. PICTURE SCREEN

13.6.4 Selecting the Points to Display

You can set three points to measure: P1 to P3. To select the measured points that you want to display, follow the procedure below.

Procedure

PIC	→	F•2	CINELITE		
→	F•2	f STOP SETUP	→	F•1	MEASURE NUMBERS: <u>P1</u> / P1+P2 / P1+P2+P3
→	F•2	%DISP SETUP	→	F•1	MEASURE NUMBERS: <u>P1</u> / P1+P2 / P1+P2+P3

Settings

P1:	P1 is displayed.
P1+P2:	P1 and P2 are displayed.
P1+P2+P3:	P1 to P3 are displayed.

13.6.5 Setting Measurement Points

Follow the procedure below to select which measurement point to set with the cursors, and then move the X cursor by using the H POS knob and the Y cursor by using the V POS knob. Press the H POS and V POS knobs at the same time to move the cursors to the center of the picture.

The cursors are not displayed if they are within the blanking interval. To display cursors that do not appear, move them within the screen.

The measurement point specified for f Stop and that specified for %DISPLAY are linked.

Procedure

PIC	→	F•2	CINELITE		
→	F•2	f STOP SETUP	→	F•2	MEASURE POSITION: <u>P1</u> / P2 / P3
→	F•2	%DISP SETUP	→	F•2	MEASURE POSITION: <u>P1</u> / P2 / P3

13.6.6 Setting the Measurement Size

To select the measurement size, follow the procedure below. This setting is applied to P1 to P3 and REF.

The measurement size specified for f Stop and that specified for %DISPLAY are linked.

Procedure

PIC	→	F•2	CINELITE		
→	F•2	f STOP SETUP	→	F•3	MEASURE SIZE: <u>1X1</u> / 3X3 / 9X9
→	F•2	%DISP SETUP	→	F•3	MEASURE SIZE: <u>1X1</u> / 3X3 / 9X9

Settings

1X1:	The single pixel at the intersection of the cursors is measured.
3X3:	The 3×3 area of pixels with its center at the intersection of the cursors is averaged and measured.
9X9:	The luminance of the 9×9 area of pixels centered on the pixel at the intersection of the cursors is averaged and measured.

13.6.7 Configuring User-Defined Correction Tables

The default gamma correction value when measuring f Stop levels is 0.45, but you can also use a user-defined gamma correction table that matches the gamma characteristics of the camera that you are using.

There are two types of user-defined correction tables. The first type consists of tables that are created using the instrument and is made up of the USER1 to USER3 tables. The second type consists of tables that have been created externally using a device such as a PC and is made up of the USER_A to USER_E tables. These tables are not deleted even if you initialize the instrument.

- Creating User-Defined Correction Tables Using the instrument

You can create and store up to three user-defined correction tables.

As an example, the following procedure shows how to create a user-defined correction table that matches a camera's gamma characteristics.

Set the camera's f Stop value to F5.6 beforehand, and put an 18 % gray chart in the area that you will film.

1. Adjust the lighting so that the displayed luminance level of the 18 % gray chart is 45.0 % (for example) on a camera whose f Stop value is set to F5.6.

For details, see section 13.6.3, "%DISPLAY Screen Description."

2. Press **F•7** up menu.
3. Press **F•1** CINELITE DISPLAY to select f Stop.
4. Press **F•2** f STOP SETUP.
5. Press **F•5** GAMMA and then **F•1** GAMMA SELECT to select USER1.

In this example, explanation will be given for USER1, but USER2 and USER3 can also be created in the same way.

6. Press **F•2** GAMMA CAL.

A user-defined correction table appears in the lower left of the screen, and the luminance level appears as a 10-bit value (0% is displayed as 64, and 100% is displayed as 940) close to the cursor.

This setting is available when **F•1** GAMMA SELECT is set to an option from USER1 to USER3.

13. PICTURE SCREEN



Figure 13-25 User-defined correction table creation screen

7. Press **F•1** TABLE CLEAR.

All the values in the user-defined correction table that is currently being edited are initialized. Be sure to initialize the values first when you create a new user-defined correction table.

8. Press **F•1** CLEAR YES.

To cancel the initialization of the user-defined correction table, **F•3** CLEAR NO.

9. Place the cursors over the 18 % gray chart.

10. Press **F•5** CAL F, and select 5.6.

11. Press **F•4** CAL SET.

The luminance level when the camera f Stop value is F5.6 is input into Lev in the user-defined correction table. To delete a line of data, press **F•3** 1 DATA CLEAR.

12. Change **F•5** CAL F and the camera f Stop value together in the following order: 4.0, 2.8, 2.0, 8.0, 11.0, 16.0, 22.0. **F•4** CAL SET each time you change the value to input the luminance level for each value.

Do not change the lighting or the position of the 18 % gray chart.

Also, make sure that the Lev value for f Stop values 22.0 to 2.0 increases linearly.

13. PICTURE SCREEN

The REF value in the user-defined correction table is entered when you press **F•4** 18% REF-SET on the f Stop display.

For example, if you use the left-hand table shown below and press **F•4** 18% REF-SET when the luminance value at the intersection of the cursors is 416 (10-bit value), the f Stop value at that point (3.0) is displayed as the REF value.

[USER1] REF=0.0				[USER1] REF=3.0		
CAL_F	F	Lev		CAL_F	F	Lev
[22.0]	0.0,	152	→	[22.0]	0.0,	152
[16.0]	1.0,	240		[16.0]	1.0,	240
[11.0]	2.0,	328		[11.0]	2.0,	328
[8.0]	3.0,	416		[8.0]	3.0,	416
[5.6]	4.0,	504		[5.6]	4.0,	504
[4.0]	5.0,	592		[4.0]	5.0,	592
[2.8]	6.0,	680		[2.8]	6.0,	680
[2.0]	7.0,	768		[2.0]	7.0,	768

Figure 13-26 User-defined correction tables

When the above user-defined correction tables are used, f Stop values are indicated as shown below. The values between specified values are interpolated linearly.

When Lv = 152	f Stop = -3.0
When Lv = 240	f Stop = -2.0
When Lv = 328	f Stop = -1.0
When Lv = 416	f Stop = 0.0
When Lv = 504	f Stop = 1.0
When Lv = 592	f Stop = 2.0
When Lv = 680	f Stop = 3.0
When Lv = 768	f Stop = 4.0

13. PICTURE SCREEN

- Loading a User-Defined Correction Table into the instrument

You can load up to five user-defined correction tables into the instrument.

To load a user-defined correction table into the instrument, follow the procedure below.

1. Create a user-defined correction table.

Example (TEST.CLT):

#####	Comment
NAME:SAMPLE_1	Keyword
TYPE:0	Keyword
#Input -7% 0	Comment
# 109% 4095	Comment
#Output 0% 0	Comment
# 1000% 65535	Comment
#Input Output	Comment
#####	Comment
0 0	Data
1 16	Data
2 32	Data
(Omitted)	
4093 65488	Data
4094 65504	Data
4095 65520	Data
# EOF	Comment

When you create a correction table, make sure that it conforms to the specifications listed below.

Overall File Specifications

Description:	ASCII text file
Extension:	.CLT
End-of-line character:	CR+LF
Number of lines:	5000 or less
Number of characters per line:	255 or less (including CR+LF)
File name length:	20 characters or less (excluding the extension)
Permitted file name characters:	Letters of the alphabet (A to Z; uppercase and lowercase), numerals (0 to 9), and underscores (_).

Comment

If you start a line with the number sign (#), the line is treated as a comment and does not affect operations.

You can put comments anywhere.

13. PICTURE SCREEN

Keyword

Be sure to put the keyword lines before the data lines and to enter a keyword without anything preceding it at the beginning of each keyword line.

- NAME:** The instrument displays the eight characters that follow the separator (colon) as the name of the correction table. After the separator, enter the correction table name using letters of the alphabet (A to Z; uppercase and lowercase), numbers (0 to 9), and underscores (_). You can enter up to 10 characters.
- TYPE:** This is a code for identifying the file type. Enter a zero after the separator (colon).

Data

From the start of a line, enter the input value, a separator, and then the output value, in that order.

- Input value:** Enter values from 0 to 4095 (12 bits), increasing the value by one for each line.
A luminance level of 100 % is defined as $940 \text{ (10 bits)} \times 4 = 3760 \text{ (12 bits)}$.
A luminance level of 0 % is defined as $64 \text{ (10 bits)} \times 4 = 256 \text{ (12 bits)}$.
- Separator:** Enter a single tab code.
- Output value:** Enter a value from 0 to 65535 (16 bits).

2. Save the user-defined correction table to USB memory, and connect the USB memory to the instrument.

Save the correction table in the following directory.

```
├─ USB memory device
├─ LV5300_USER, LV5350_USER or LV7300_USER
├─ CLT
├─ TEST.CLT (example)
```

3. Press PIC.
4. Press **F•2** CINELITE.
5. Press **F•1** CINELITE DISPLAY to select f Stop.
6. Press **F•2** f STOP SETUP.
7. Press **F•5** GAMMA and then **F•1** GAMMA SELECT to select USER_A.

In this example, a user-defined correction table is copied to USER_A, but user-defined correction tables can be copied to USER_B through USER_E in the same way.

8. Press **F•2** GAMMA FILE.
This setting is available when **F•1** GAMMA SELECT is set to an option from USER_A to USER_E.

9. Press **F•1** FILE LIST.

The file list screen appears. This setting appears when a USB memory device is connected.

To clear the table that has been copied to USER_A, press **F•2** TABLE CLEAR.

13. PICTURE SCREEN

10. Turn the function dial (F•D) to select the copy source file from the USB memory device.

11. Press **F•3** FILE LOAD.

The user-defined correction table that you selected is copied from the USB memory to USER_A. The copy operation is complete when the file list screen disappears and the display returns to the measurement screen.

If a file has already been stored to USER_A, an overwrite confirmation prompt appears.

If you want to overwrite the current file, press **F•1** OVER WRITE YES. Otherwise, press **F•3** OVER WRITE NO.

After you have copied a user-defined correction table, you can select it by pressing **F•1** GAMMA SELECT in the CINELITE menu. A loaded correction table is displayed using the name determined by its NAME keyword.

13.6.8 Displaying Link Markers

To synchronize the markers on the vector screen and video signal waveform screen to measurement points P1 to P3 and REF that you specify on the CINELITE screen, follow the procedure below.

Synchronized markers can be displayed only when an f Stop screen, %DISPLAY screen, or %DISP & CINEZONE screen is shown in the same multi-screen display.

Markers cannot be displayed on the video signal waveform in the following situations.

- When SWEEP is set to V or H SWEEP is set to 2H in the video signal waveform menu
- When COLOR MATRIX in the video signal waveform menu is COMPOSIT

Marker display will not work properly when waveforms are being displayed using an external sync signal.

Procedure

PIC → **F•2** CINELITE → **F•4** CINELITE ADVANCE: ON / OFF

CINELITE ADVANCE = ON

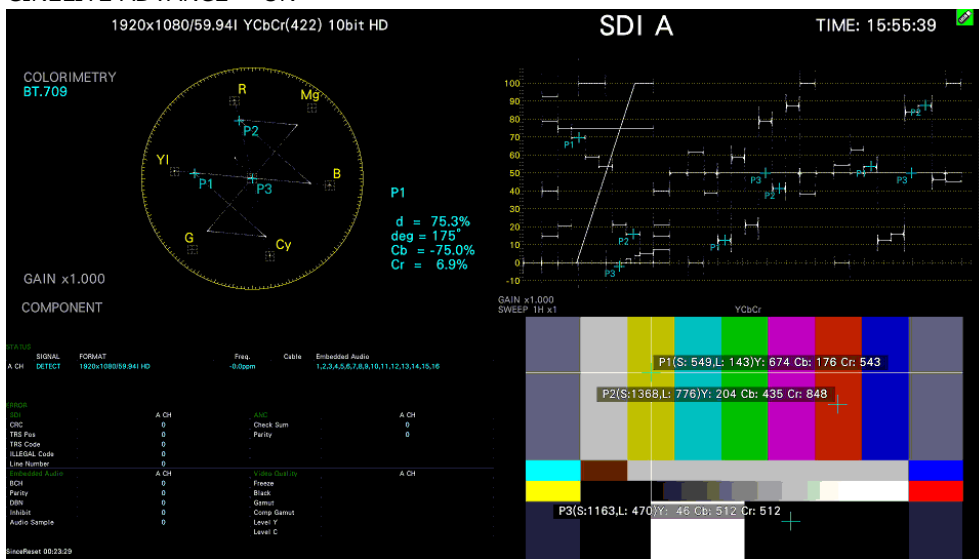

Figure 13-27 Displaying link markers

13.7 Configuring CINEZONE Settings

The CINEZONE display has a gradation (step) display mode, in which the picture luminance levels are converted into RGB colors and displayed and a search display mode, in which the specified luminance level is displayed using green.

To set either of these modes, on the picture menu, press **F•2** CINELITE → **F•1** CINELITE DISPLAY to select CINEZONE and then **F•2** CINEZONE SETUP.

[See also] CINEZONE SETUP → 13.5, “Configuring CINELITE Settings”

13.7.1 Gradation Display Mode

To display picture luminance levels through color gradation, follow the procedure below. In the gradation display mode, luminance levels are displayed using 1024 colors.

The picture is displayed such that luminance levels above **F•2** UPPER are displayed using white, and levels below **F•3** LOWER are displayed using black.

You can see what colors correspond to what luminance levels by looking at the scale on the right of the display.

F•2 UPPER can be changed with the V POS knob as well as the function dial (F•D).

F•3 LOWER can be changed with the H POS knob as well as the function dial (F•D).

If the difference between **F•2** UPPER and **F•3** LOWER is 1%, reducing **F•2** UPPER will also reduce **F•3** LOWER automatically to maintain the 1% difference. Likewise, increasing **F•3** LOWER will also increase **F•2** UPPER automatically to maintain the 1% difference.

Procedure

PIC → **F•2** CINELITE → **F•2** CINEZONE SETUP → **F•1** CINEZONE FORM and select GRADATE
 → **F•2** UPPER: -6.3 - 100.0 - 109.4
 → **F•3** LOWER: -7.3 - 0.0 - 108.4

Picture Screen

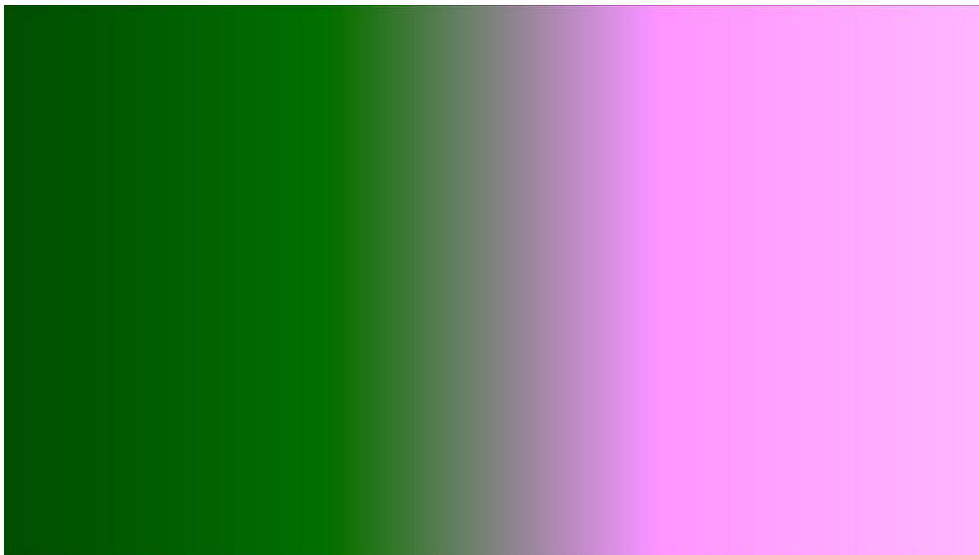

13. PICTURE SCREEN

Gradation Display (0% = B, 50% = G, 100% = R)

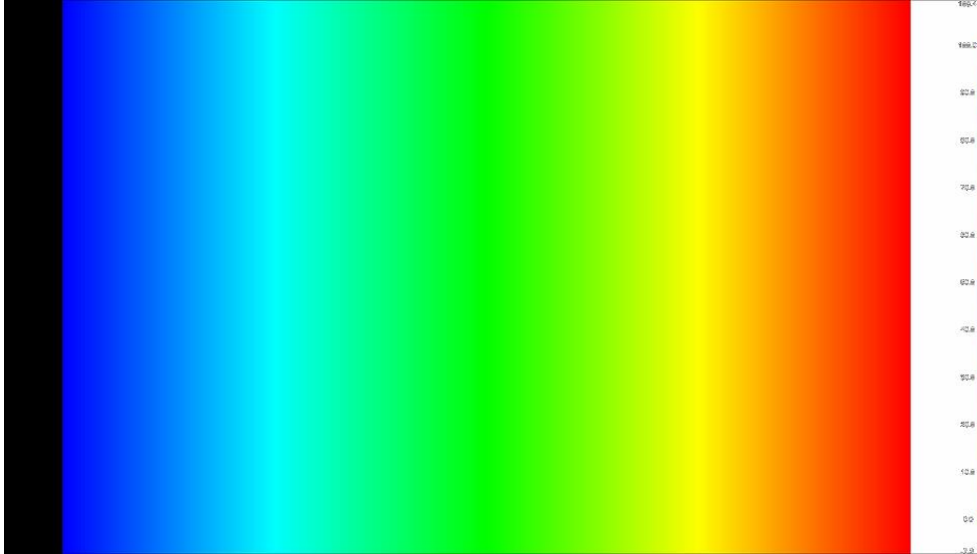

Figure 13-28 Gradation display

13.7.2 Step Display Mode

To display picture luminance levels in steps, follow the procedure below.

In the step display mode, luminance levels are divided into 10 % steps and assigned to 12 different colors. For information about **F•2** UPPER and **F•3** LOWER, see section 13.7.1, "Gradation Display Mode."

Procedure

PIC → **F•2** CINELITE → **F•2** CINEZONE SETUP → **F•1** CINEZONE FORM and select STEP
→ **F•2** UPPER
→ **F•3** LOWER

CINEZONE FORM = GRADATE

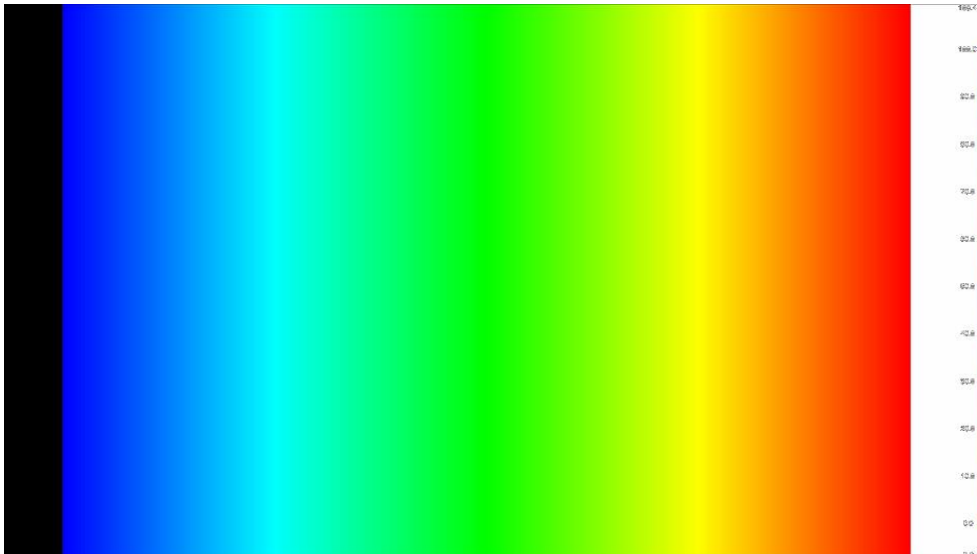

13. PICTURE SCREEN

CINEZONE FORM = STEP

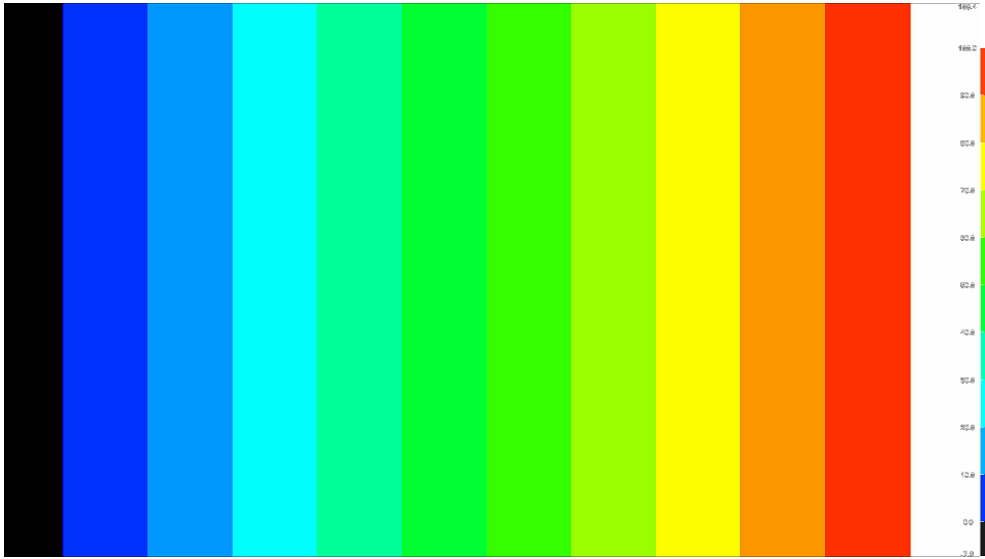

Figure 13-29 Step display

13. PICTURE SCREEN

13.7.3 Search Display Mode

In the search display mode, the specified luminance level $\pm 0.5\%$ is displayed using green on an otherwise monochrome picture display.

The picture is displayed such that luminance levels above **F•2** UPPER are displayed using red, and levels below **F•3** LOWER are displayed using blue.

To set the level that is displayed using green, follow the procedure below.

F•4 LEVEL appears when **F•1** CINEZONE FORM is set to SEARCH.

For information about **F•2** UPPER and **F•3** LOWER, see section 13.7.1, "Gradation Display Mode."

Procedure

PIC → **F•2** CINELITE → **F•2** CINEZONE SETUP → **F•1** CINEZONE FORM and select SEARCH
→ **F•4** LEVEL: -7.3 - 50.0 - 109.4

CINEZONE FORM = SEARCH

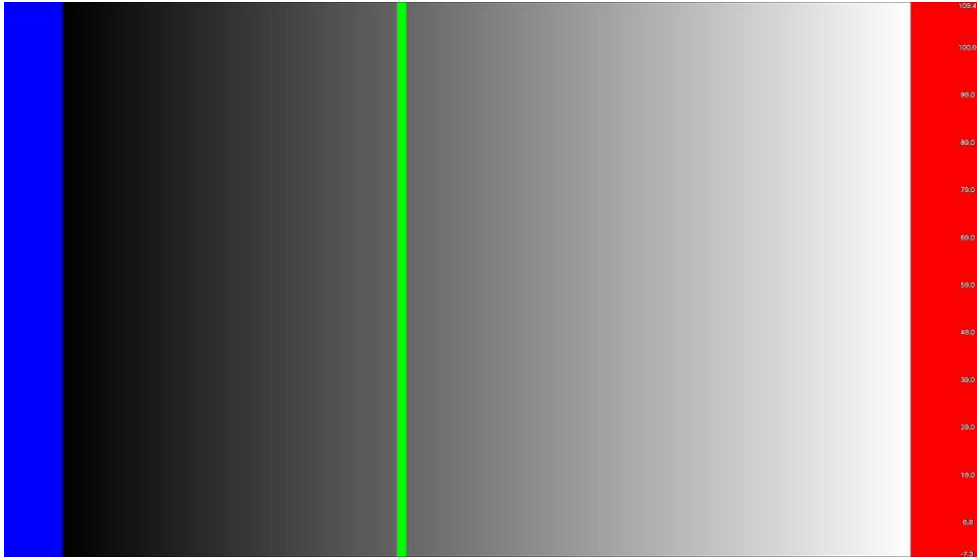

Figure 13-30 Search display

13.8 Configuring %DISPLAY & CINEZONE Settings

To display the %DISPLAY screen and the CINEZONE screen at the same time, follow the procedure below.

To configure the %DISPLAY screen settings, press **F•1** %DISP SETUP on the %DISP CINEZONE SETUP menu. See section 13.6.3, “%DISPLAY Screen Description,” 13.6.4, “Selecting the Points to Display,” 13.6.5, “Setting Measurement Points,” and 13.6.6, “Setting the Measurement Size.”

To configure the CINEZONE screen settings, press **F•2** CINEZONE SETUP on the %DISP CINEZONE SETUP menu. See section 13.7, “Configuring CINEZONE Settings.”

Procedure

PIC → **F•2** CINELITE → **F•1** CINELITE DISPLAY and select %DISP & CINEZONE → **F•2** %DISP CINEZONE SETUP
 → **F•1** %DISP SETUP
 → **F•2** CINEZONE SETUP

PIC → **F•2** CINELITE → **F•2** %DISP CINEZONE SETUP →

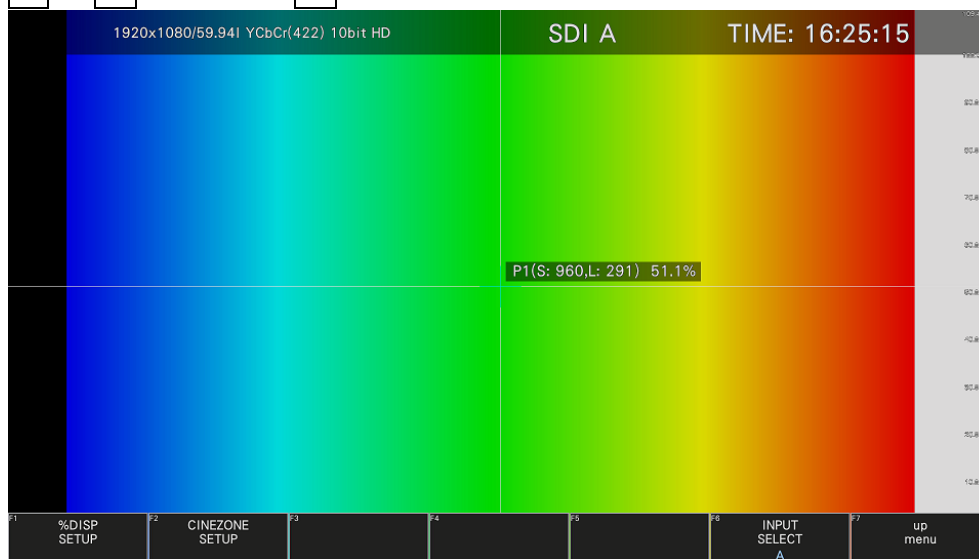

Figure 13-31 %DISPLAY & CINEZONE display

13.9 Focus Assist Display (SER25)

The focus assist display makes it easy to verify the focus by highlighting the image according to the amount of detected edges.

To configure the focus assist settings, press **F•4** FOCUS on the PIC menu. This menu item does not appear when PICTURE MODE is set to FULL FRM. [See also] SIZE → 13.1, "Selecting the Display Mode"

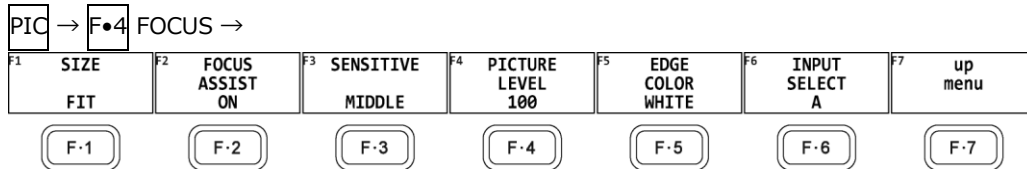

Figure 13-32 FOCUS menu



Figure 13-33 Focus assist display

13.9.1 Selecting the Display Mode

To select the picture display mode, follow the procedure below. For details, see section 13.1, "Selecting the Display Mode."

Procedure

PIC	→	F•4	FOCUS	→	F•1	PICTURE MODE: <u>FIT</u> / REAL / X2
-----	---	------------	-------	---	------------	--------------------------------------

13.9.2 Turning Focus Assist On and Off

To turn the focus assist display on and off, follow the procedure below.

Procedure

PIC	→	F•4	FOCUS	→	F•2	FOCUS ASSIST: ON / <u>OFF</u>
-----	---	------------	-------	---	------------	-------------------------------

13. PICTURE SCREEN

13.9.3 Selecting the Detection Sensitivity

When **F•2** FOCUS ASSIST is set to ON, to select the edge detection sensitivity, follow the procedure below.

Procedure

PIC	→	F•4	FOCUS	→	F•3	SENSITIVE: LOW / <u>MIDDLE</u> / HIGH / V-HIGH / U-HIGH
-----	---	-----	-------	---	-----	---

13.9.4 Selecting the Luminance Level

When **F•2** FOCUS ASSIST is set to ON, to select the picture luminance level as a percentage, follow the procedure below.

Select OFF to hide the picture. Select EMBOSS to emboss the edges.

Procedure

PIC	→	F•4	FOCUS	→	F•4	PICTURE LEVEL: OFF / EMBOSS / 25 / 50 / 75 / <u>100</u>
-----	---	-----	-------	---	-----	---

PIC LEVEL = OFF

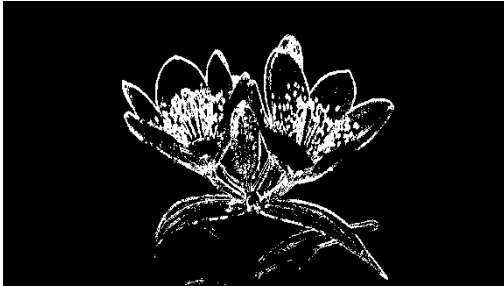

PIC LEVEL = EMBOSS



Figure 13-34 Selecting the luminance level

13.9.5 Selecting the Highlight Color

When **F•4** PIC LEVEL is 25, 50, 75, or 100, to select the edge display color, follow the procedure below.

Procedure

PIC	→	F•4	FOCUS	→	F•5	EDGE COLOR: <u>WHITE</u> / RED / GREEN / BLUE
-----	---	-----	-------	---	-----	---

13.10 Configuring the Line Selection Settings

To configure the line selection settings, press **F•5** LINE SELECT on the PIC menu. This menu item does not appear when PICTURE MODE is set to a value other than FIT. [See also] PICTURE MODE → 13.1, "Selecting the Display Mode"

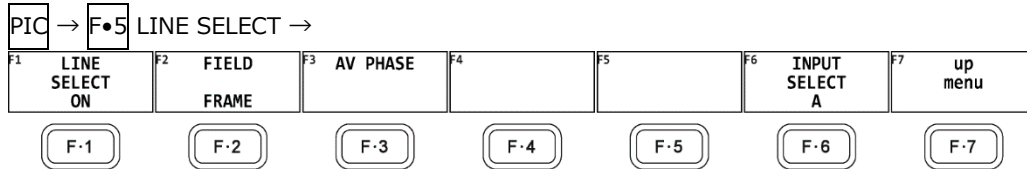

Figure 13-35 LINE SELECT menu

13.10.1 Turning Line Selection On and Off

To display a marker at the selected line, follow the procedure below. You can use the function dial (F•D) to select a line. The number of the selected line appears in the upper left of the screen.

Changing this setting will also change the video-signal-waveform-display and vector-display line selection settings.

Procedure

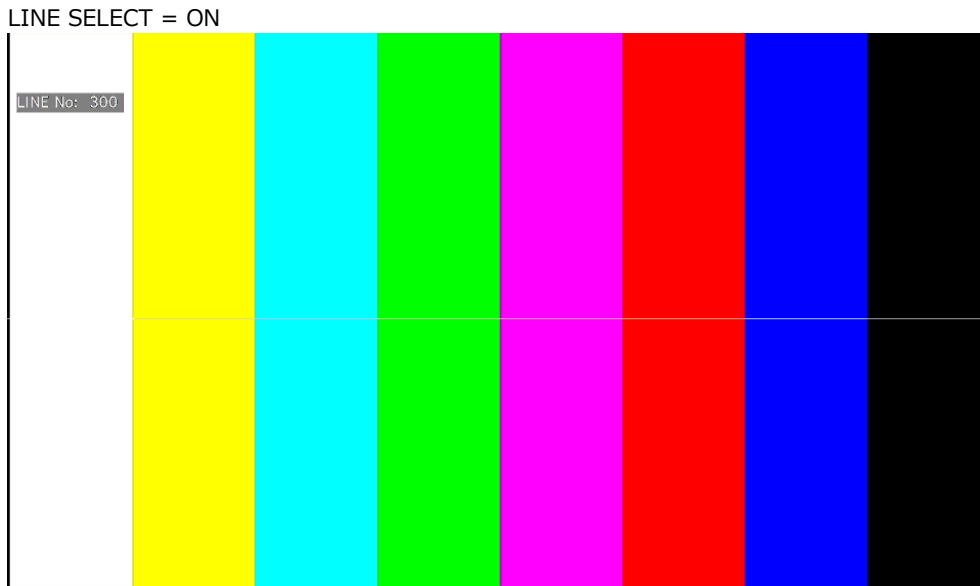
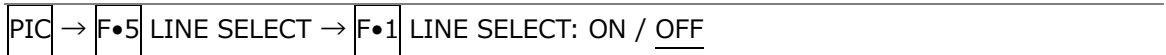

Figure 13-36 Turning line selection on and off

13. PICTURE SCREEN

13.10.2 Setting the Line Selection Range

When **F•1** LINE SELECT is set to ON and the input signal format is interlaced or segmented frame, to set the line selection range, follow the procedure below.

Changing this setting will also change the selected line on the video-signal-waveform, vector, and status (data dump) displays.

Procedure

PIC → **F•5** LINE SELECT → **F•2** FIELD: FIELD1 / FIELD2 / FRAME

Settings

FIELD1: A line from field 1 can be selected. (Example: 1 to 563)
 FIELD2: A line from field 2 can be selected. (Example: 564 to 1125)
 FRAME: All lines can be selected. (Example: 1 to 1125)

13.10.3 Setting the Lip Sync Measurement Range (SER20)

To set the lip sync measurement range, press **F•3** AV PHASE on the LINE SELCT menu.

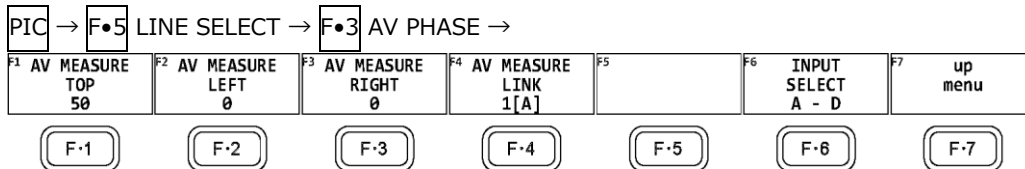

Figure 13-37 AV PHASE menu

To set the lip sync measurement range, follow the procedure below. Markers are displayed at the specified lines.

You can also set these using AV PHASE SETUP of the STATUS menu, but here you can set them while viewing the picture. For details on the settings, section 16.7.3, "Setting the Measurement Range."

Procedure

PIC → **F•5** LINE SEL → **F•3** AV PHASE
 → **F•1** AV MEASURE TOP: 0 - 50 - 100
 → **F•2** AV MEASURE LEFT: 0 - 99
 → **F•3** AV MEASURE RIGHT: 0 - 99
 → **F•4** AV MEASURE LINK: 1[A] / 2[B] / 3[C] / 4[D]

14. HDR DISPLAY (SER23)

HDR signals can be measured by installing SER23. HDR signal measurement supports all formats except for SD and XYZ.

To measure HDR signals, use **[SYS]** → **[F•1]** SIGNAL IN OUT → HDR tab to select the HDR signal standard for each display channel. Also set SYSTEM GAMMA on or off and other settings. [See also] HDR tab → 7.1.8, “Configuring the HDR Settings (SER23)”

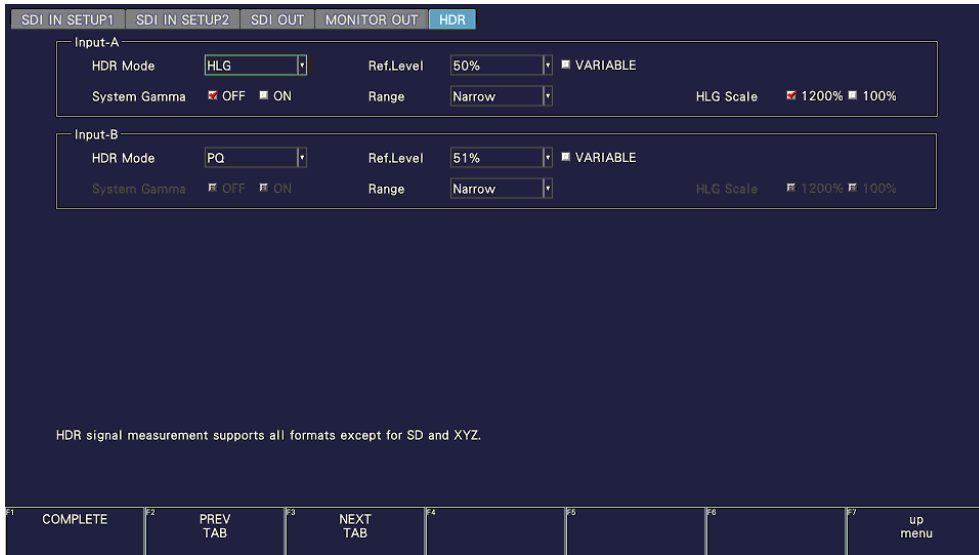

Figure 14-1 HDR tab

14. HDR DISPLAY (SER23)

- Scale Unit and Range

The scale unit and range used on HDR signal measurements are as follows depending on the settings on the HDR tab.

HDR Mode	EI	System Gamma	Range	HLG Scale	Scale
OFF	-	-	-	-	None
HLG	-	OFF	Narrow	1200%	SDI code value: 64 to 940 is displayed as 0 to 1200%.
				100%	SDI code value: 64 to 940 is displayed as 0 to 100%.
			Full	1200%	SDI code value: 0 to 1023 is displayed as 0 to 1200%. (*1)
				100%	SDI code value: 0 to 1023 is displayed as 0 to 100%. (*1)
		ON	Narrow	1200%	SDI code value: 64 to 940 is displayed as 0 to 1000Nits.
				100%	SDI code value: 64 to 940 is displayed as 0 to 1000Nits.
			Full	1200%	SDI code value: 0 to 1023 is displayed as 0 to 1000Nits. (*1)
				100%	SDI code value: 0 to 1023 is displayed as 0 to 1000Nits. (*1)
PQ	-	-	Narrow	-	SDI code value: 64 to 940 is displayed as 0 to 10000Nits.
			Full	-	SDI code value: 0 to 1023 is displayed as 0 to 10000Nits. (*1)
S-Log3	-	OFF	-	-	SDI code value: 95 to 940 is displayed as 0 to 2055%.
		ON	-	-	SDI code value: 95 to 940 is displayed as 0 to 3000Nits.
C-Log	-	-	-	-	Displays the percentage with the SDI code value 128 assumed to 0% and 614 assumed to be 100%
Log-C	200	-	-	-	Displays the percentage with the SDI code value 95 assumed to 0.39% and 853 assumed to be 83%
	400	-	-	-	Displays the percentage with the SDI code value 95 assumed to 0.39% and 917 assumed to be 90%
	800	-	-	-	Displays the percentage with the SDI code value 95 assumed to 0.39% and 976 assumed to be 95%
	1600	-	-	-	Displays the percentage with the SDI code value 95 assumed to 0.39% and 1022 assumed to be 94%
PayloadID UnSpec:S-Log3	Operates in OFF (SDR-TV), HLG, or PQ mode according to the payload ID information. When the payload ID information is Unspecified, the instrument operates in S-Log3 mode.				
PayloadID UnSpec:C-Log	Operates in OFF (SDR-TV), HLG, or PQ mode according to the payload ID information. When the payload ID information is Unspecified, the instrument operates in C-Log mode.				
PayloadID UnSpec:Log-C	Operates in OFF (SDR-TV), HLG, or PQ mode according to the payload ID information. When the payload ID information is Unspecified, the instrument operates in Log-C mode.				

*1 SDI code values: 0 to 1023 take on values from 4 to 1019.

14. HDR DISPLAY (SER23)

14.1 Video Signal Waveform Display

On the video signal waveform display, scales and cursors for HDR signals can be displayed.

14.1.1 Scale Display

During HDR measurement, a scale corresponding to the HDR signal is displayed on the right side of the video signal waveform.

Note that the scale on the right side is not displayed when COLOR MATRIX is set to COMPOSITE.

The scale on the right side varies as follows depending on the settings on the HDR tab.

HDR Mode	EI	System Gamma	HLG Scale	Scale
HLG	-	OFF	1200%	0 to 1200 [%]
			100%	0 to 100 [%]
		ON	1200%	0 to 1000 [Nits]
			100%	0 to 1000 [Nits]
PQ	-	-	-	0 to 10000 [Nits]
S-Log3	-	OFF	-	0 to 2055 [%]
		ON	-	0 to 3000 [Nits]
C-Log	-	-	-	-2.7 to 546 [%]
Log-C	200	-	-	0.2 to 100 [%]
		-	-	0.3 to 100 [%]
		-	-	0.3 to 100 [%]
		-	-	0.4 to 100 [%]
PayloadID UnSpec:S-Log3	Operates in OFF (SDR-TV), HLG, or PQ mode according to the payload ID information. When the payload ID information is Unspecified, the instrument operates in S-Log3 mode.			
PayloadID UnSpec:C-Log	Operates in OFF (SDR-TV), HLG, or PQ mode according to the payload ID information. When the payload ID information is Unspecified, the instrument operates in C-Log mode.			
PayloadID UnSpec:Log-C	Operates in OFF (SDR-TV), HLG, or PQ mode according to the payload ID information. When the payload ID information is Unspecified, the instrument operates in Log-C mode.			

HDR Mode = HLG, SYSTEM GAMMA = OFF, Range = Narrow, HLG Scale = 1200%

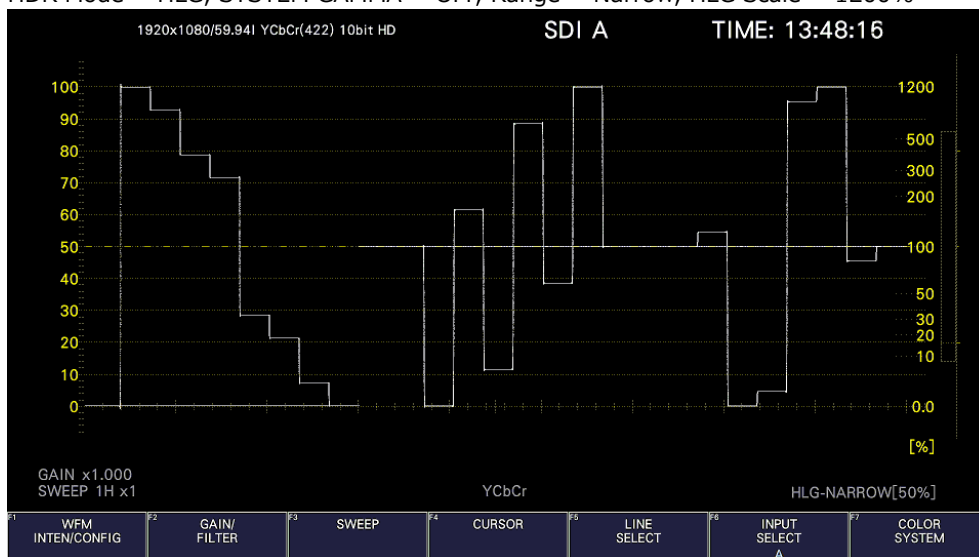

14. HDR DISPLAY (SER23)

HDR Mode = HLG, SYSTEM GAMMA = OFF, Range = Narrow, HLG Scale = 100%

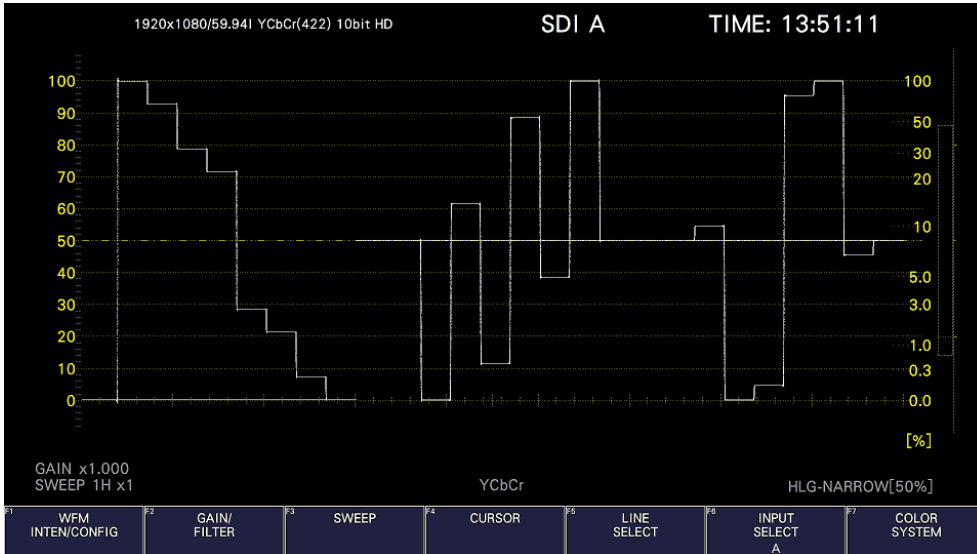

HDR Mode = HLG, SYSTEM GAMMA = OFF, Range = Full, HLG Scale = 1200%

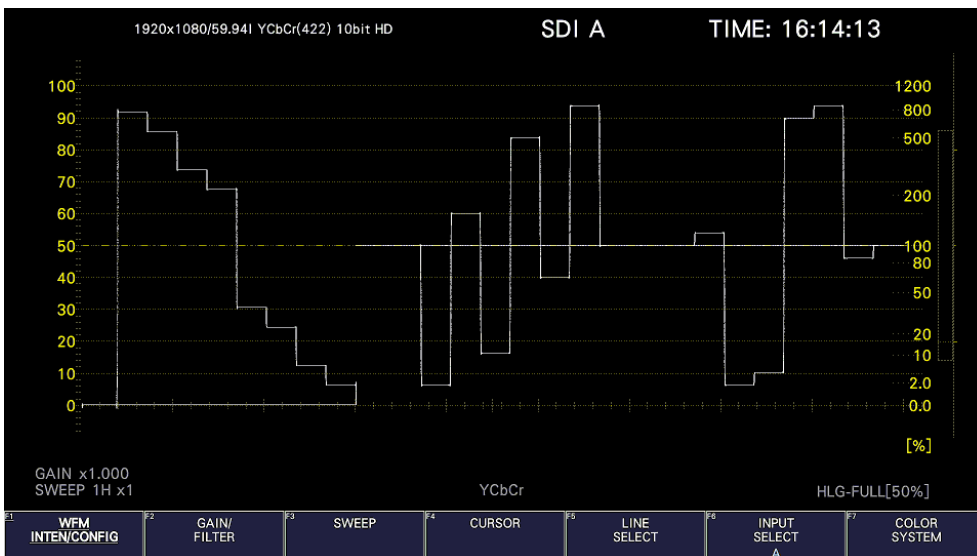

HDR Mode = HLG, SYSTEM GAMMA = OFF, Range = Full, HLG Scale = 100%

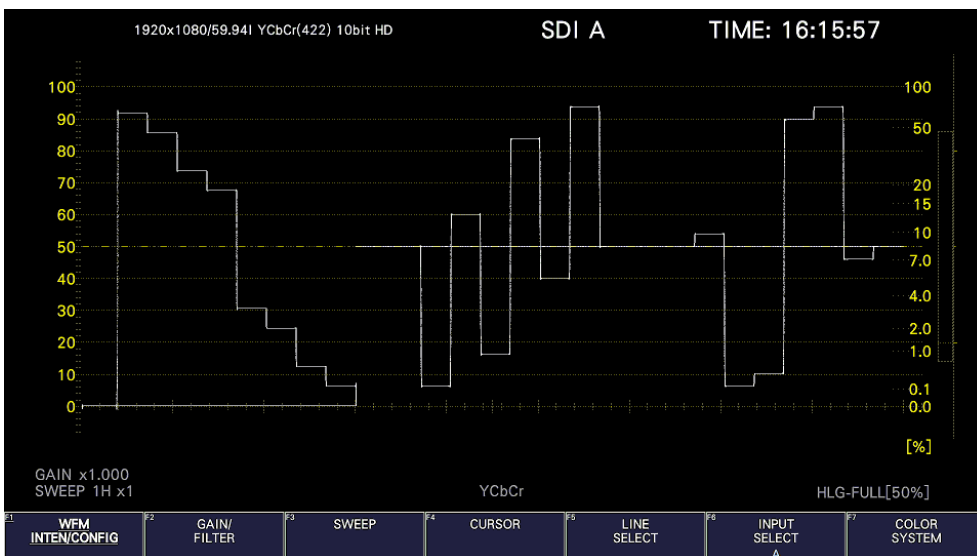

14. HDR DISPLAY (SER23)

HDR Mode = HLG、SYSTEM GAMMA = ON、Range = Narrow、HLG Scale = 1200%または 100%

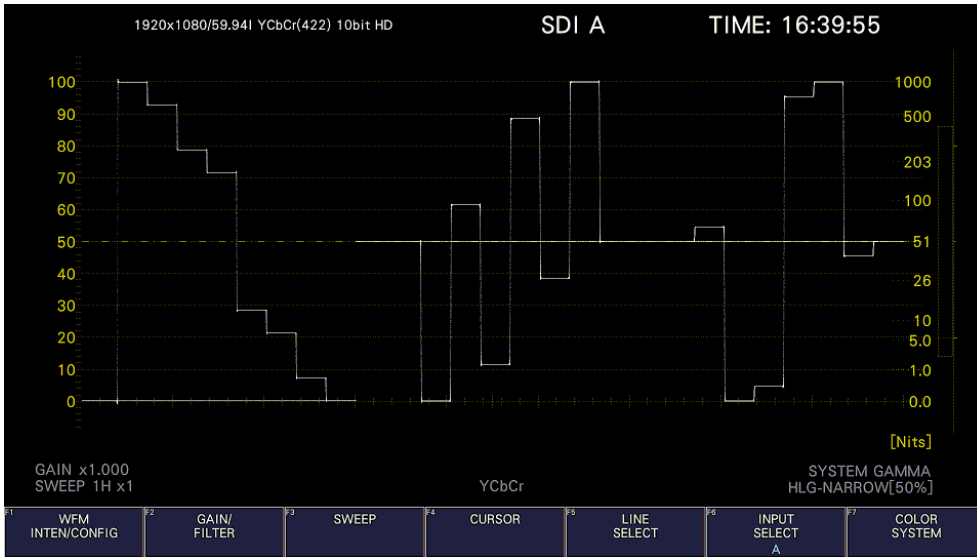

HDR Mode = HLG、SYSTEM GAMMA = ON、Range = Full、HLG Scale = 1200%または 100%

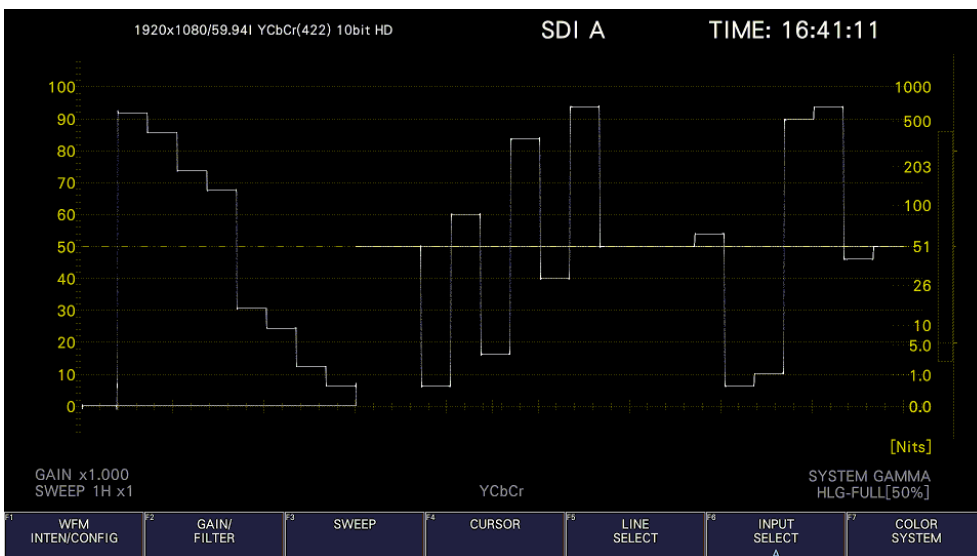

HDR Mode = PQ、Range = Narrow

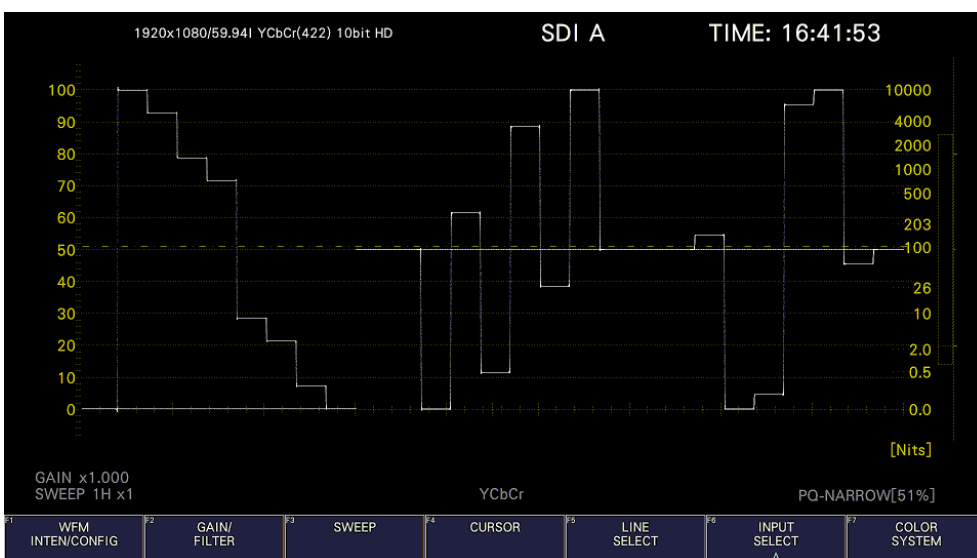

14. HDR DISPLAY (SER23)

HDR Mode = PQ, Range = Full

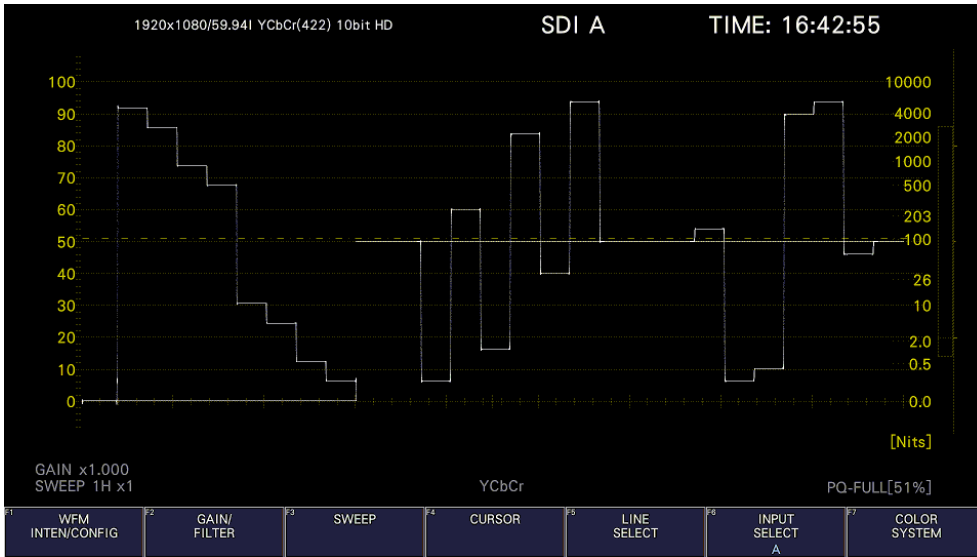

HDR Mode = S-Log3, SYSTEM GAMMA = OFF

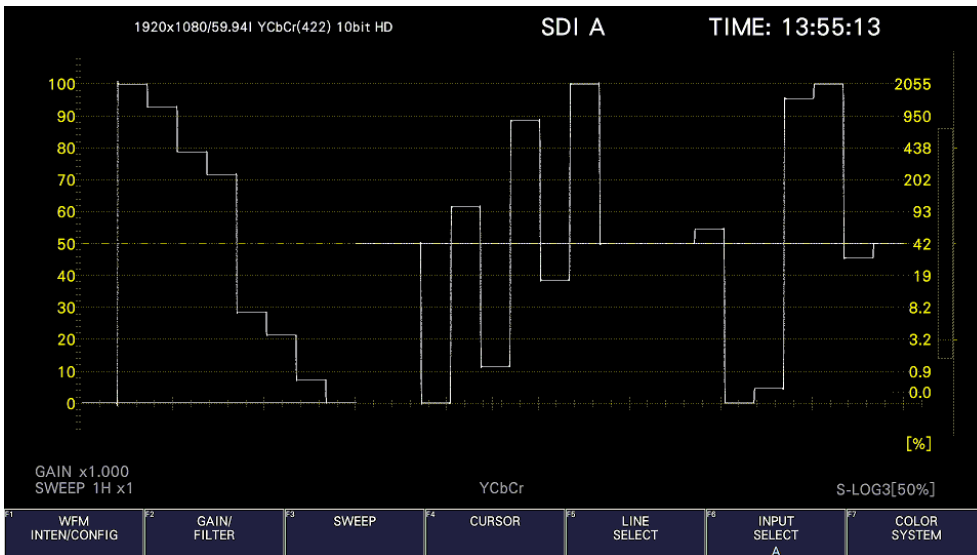

HDR Mode = S-Log3, SYSTEM GAMMA = ON

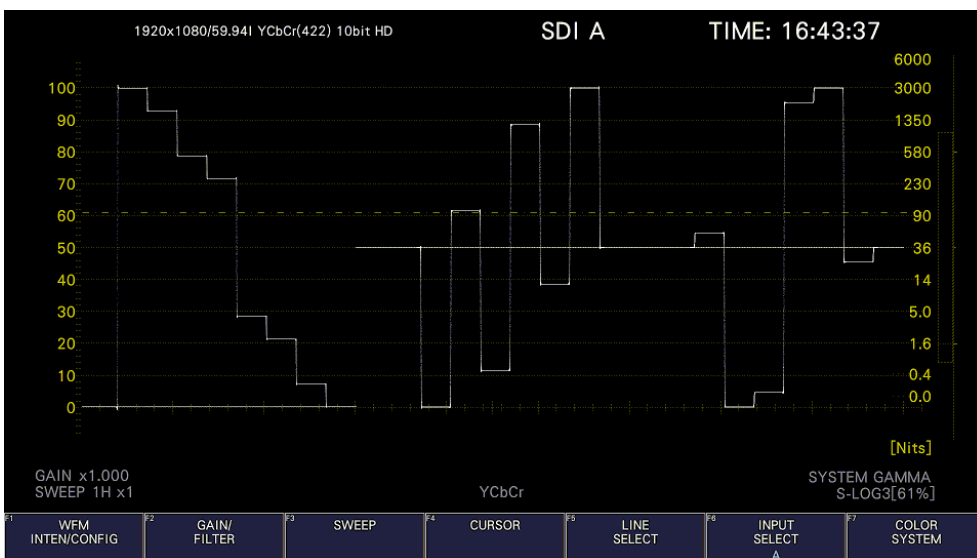

14. HDR DISPLAY (SER23)

HDR Mode = C-Log

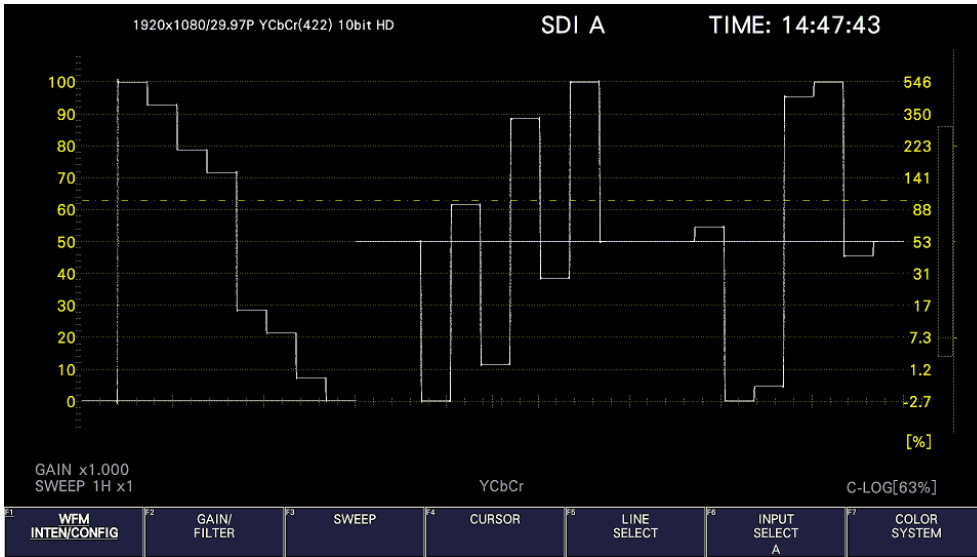

HDR Mode = Log-C, EI = 200

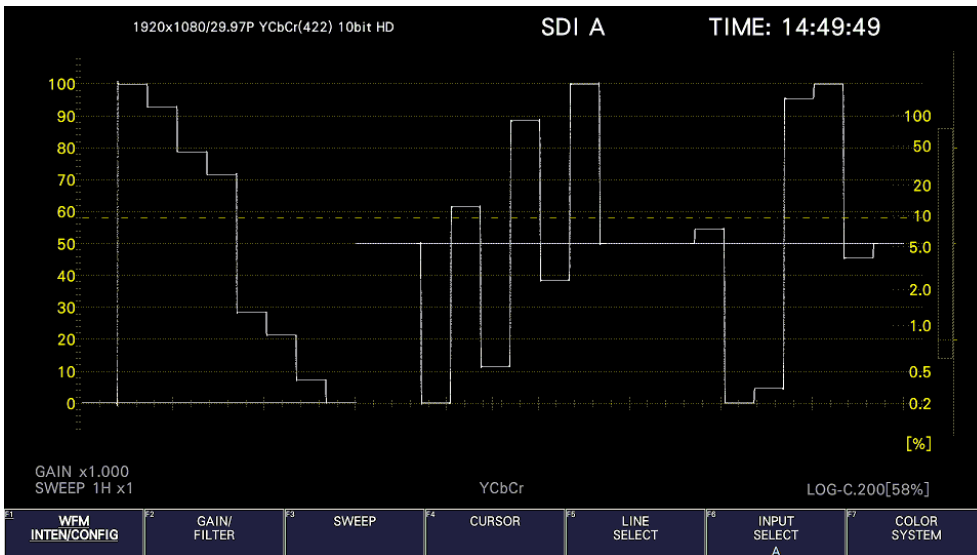

HDR Mode = Log-C, EI = 400

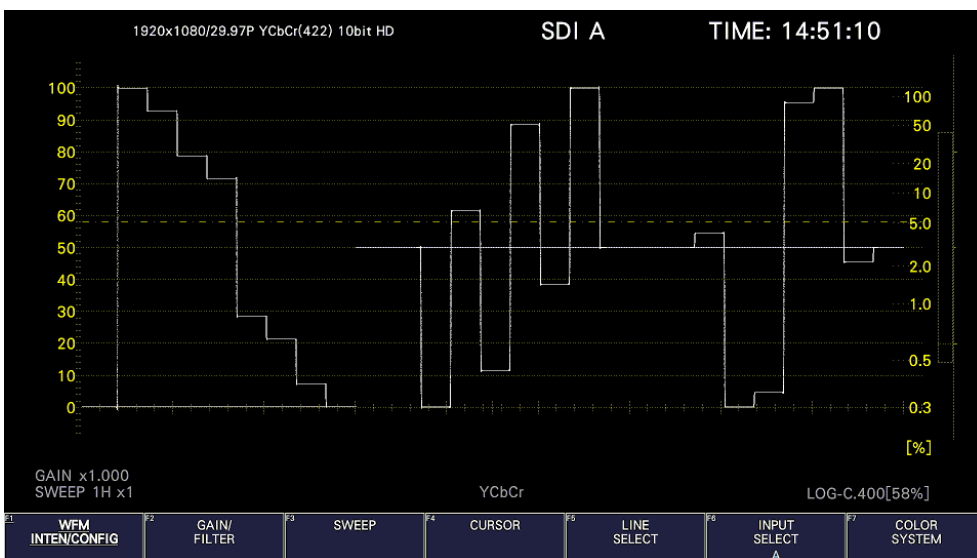

14. HDR DISPLAY (SER23)

HDR Mode = Log-C, EI = 800

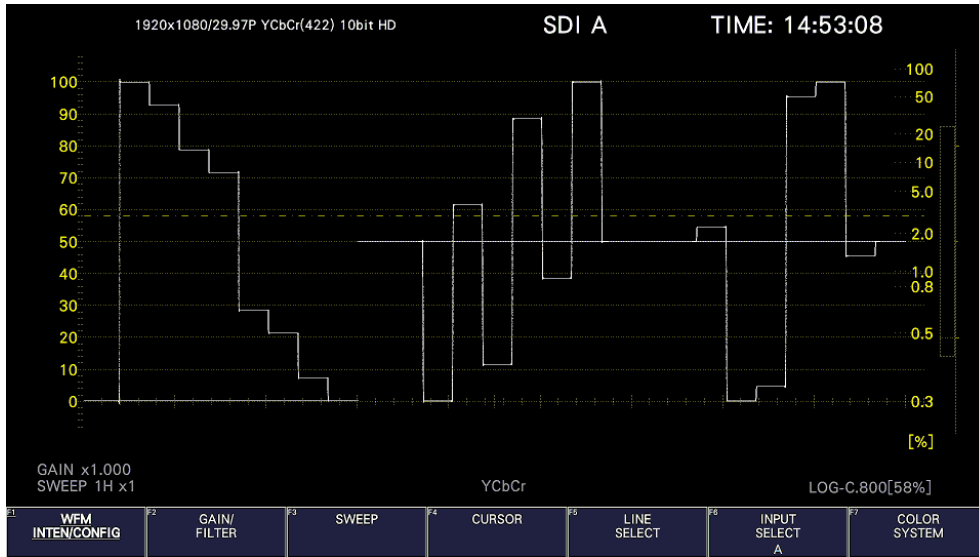

HDR Mode = Log-C, EI = 1600

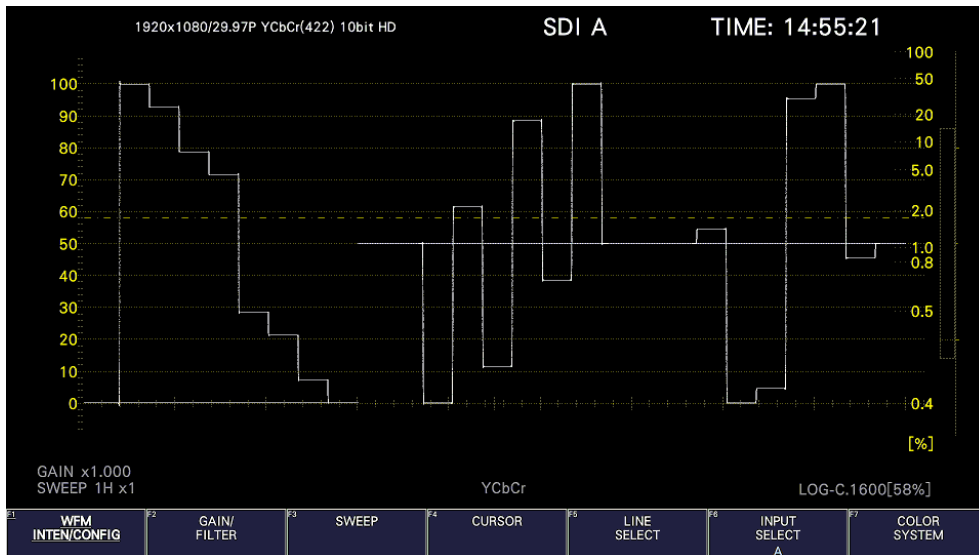

Figure 14-2 Scale display

14. HDR DISPLAY (SER23)

14.1.2 Selecting the Scale Display

During HDR measurement, to select the scale display, follow the procedure below.

Procedure

WFM → F•1 WFM INTEN/CONFIG → F•5 WFM SCALE → F•3 SCALE SETTING → F•3 SCALE
DISPLAY: OFF / MAIN / HDR / BOTH

Settings

OFF:	The scale display is turned off.
MAIN:	The normal scale is displayed.
HDR:	An HDR scale for HDR signals is displayed.
BOTH:	The normal scale and an HDR scale for HDR signals are displayed.

SCALE DISPLAY = OFF

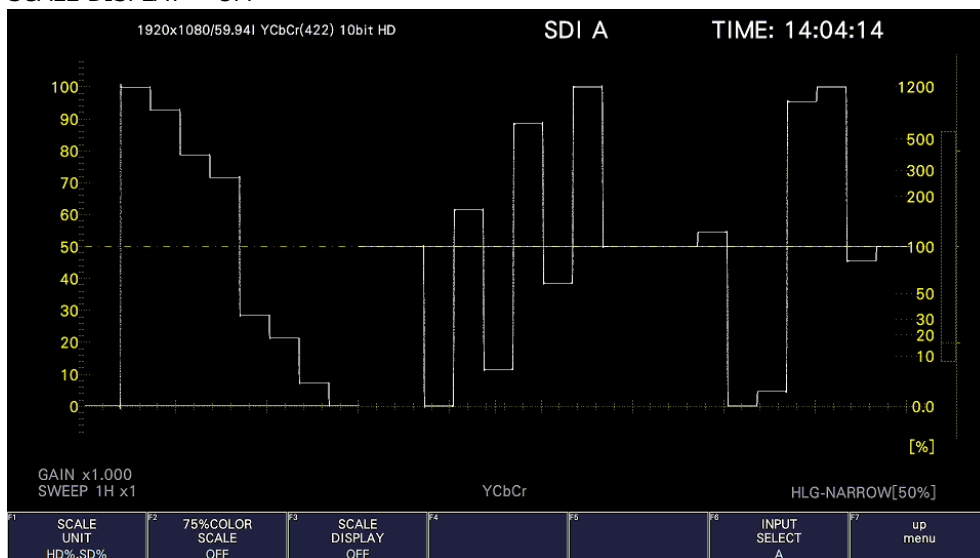

SCALE DISPLAY = MAIN

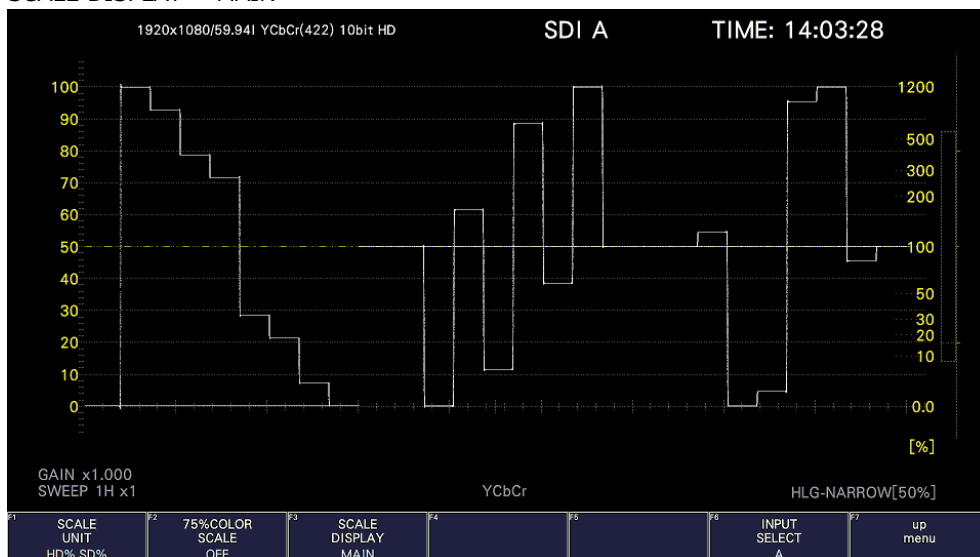

14. HDR DISPLAY (SER23)

SCALE DISPLAY = HDR

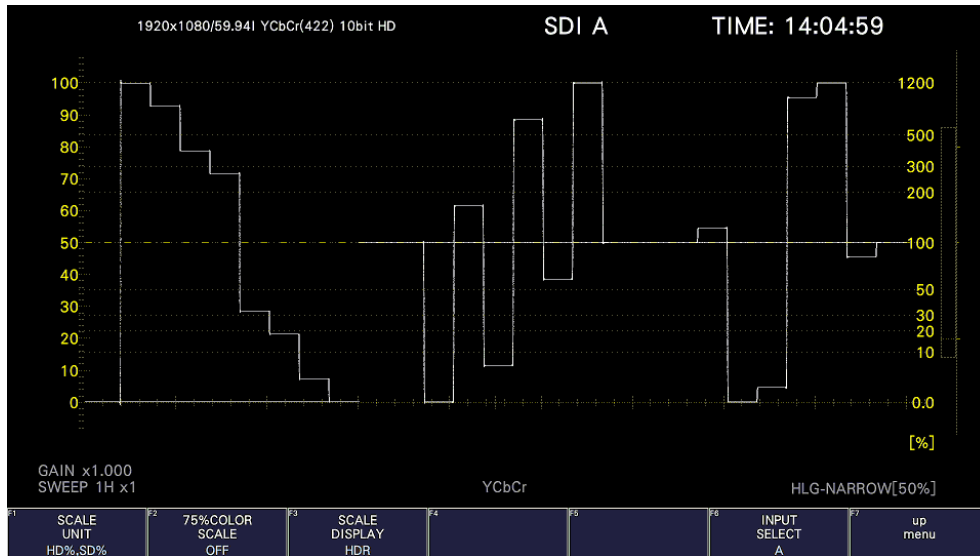

SCALE DISPLAY = BOTH

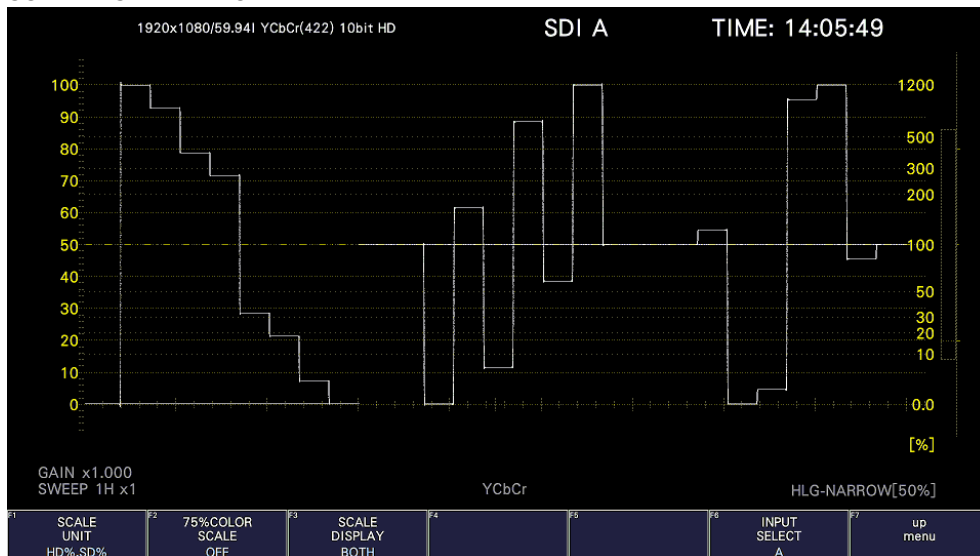

Figure 14-3 Selecting the scale display

14.1.3 Setting the Reference Level

When VARIABLE is selected on the HDR tab for HDR measurement, to set the reference level, follow the procedure below.

This setting is shared with REF [%] of the CINEZONE display.

The Ref.Level on the HDR tab is the default value.

[See also] VARIABLE → 7.1.8, “Configuring the HDR Settings (SER23)”

Procedure

WFM → F•1 WFM INTEN/CONFIG → F•5 WFM SCALE → F•3 SCALE SETTING
 → F•4 REF. LEVEL [%]: 0.0 – Ref.Level - 100

14. HDR DISPLAY (SER23)

14.1.4 Cursor Display

During cursor measurement, to display measured values for HDR signals, follow the procedure below.

The unit of measurement is % when on the HDR tab, HDR Mode is HLG or S-Log3 and SYSTEM GAMMA is OFF and Nits when HDR Mode is HLG or S-Log3 and SYSTEM GAMMA is ON or when HDR Mode is PQ.

Procedure

WFM	→	F•4	CURSOR	→	F•3	Y UNIT: HDR
-----	---	-----	--------	---	-----	-------------

Y UNIT = HDR

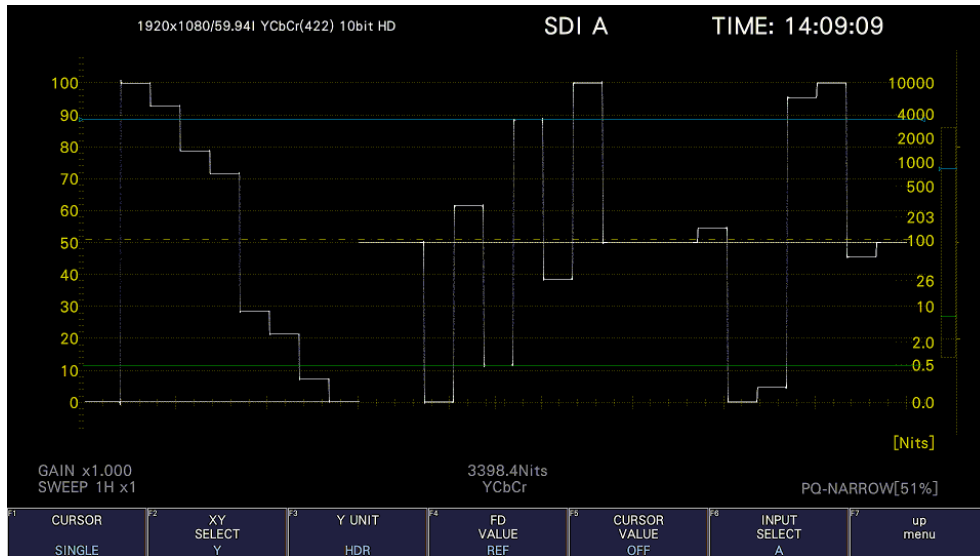

Figure 14-4 Cursor display (HDR Mode = PQ)

14. HDR DISPLAY (SER23)

14.2 Vector Display

On the vector display, HDR mode and a histogram for HDR signals can be displayed.

14.2.1 HDR Mode Display

When VECTOR DISPLAY is set to VECTOR, the HDR mode selected in HDR Mode in the system settings is displayed in cyan in HDR at the top left of the screen.

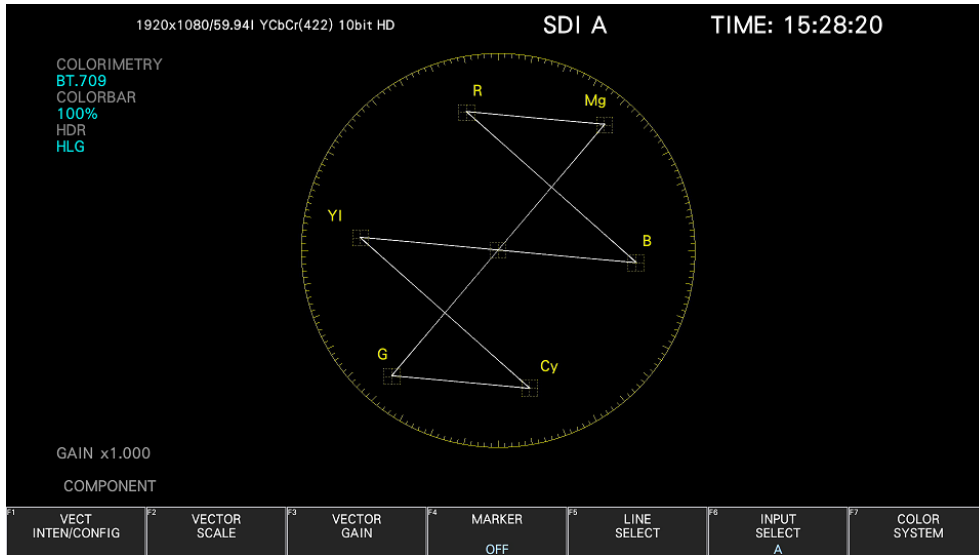

Figure 14-5 HDR mode display

14. HDR DISPLAY (SER23)

14.2.2 Histogram Display

During histogram display, to select the horizontal scale, follow the procedure below.

Procedure

VECT	→	F•2	HISTOGRAM SCALE: % / HDR
------	---	-----	--------------------------

The scale for HDR varies as follows depending on the settings on the HDR tab.

HDR Mode	EI	System Gamma	HLG Scale	Scale
HLG	-	OFF	1200%	0 to 1200 [%]
			100%	0 to 100 [%]
		ON	1200%	0 to 1000 [Nits]
			100%	0 to 1000 [Nits]
PQ	-	-	-	0 to 10000 [Nits]
S-Log3	-	OFF	-	0 to 2055 [%]
		ON	-	0 to 3000 [Nits]
C-Log	-	-	-	-2.7 to 546 [%]
Log-C	200	-	-	0.33 to 83 [%]
		-	-	0.36 to 90 [%]
		-	-	0.38 to 72 [%]
		-	-	0.38 to 43 [%]
PayloadID UnSpec:S-Log3	Operates in OFF (SDR-TV), HLG, or PQ mode according to the payload ID information. When the payload ID information is Unspecified, the instrument operates in S-Log3 mode.			
PayloadID UnSpec:C-Log	Operates in OFF (SDR-TV), HLG, or PQ mode according to the payload ID information. When the payload ID information is Unspecified, the instrument operates in C-Log mode.			
PayloadID UnSpec:Log-C	Operates in OFF (SDR-TV), HLG, or PQ mode according to the payload ID information. When the payload ID information is Unspecified, the instrument operates in Log-C mode.			

HISTOGRAM SCALE = HDR

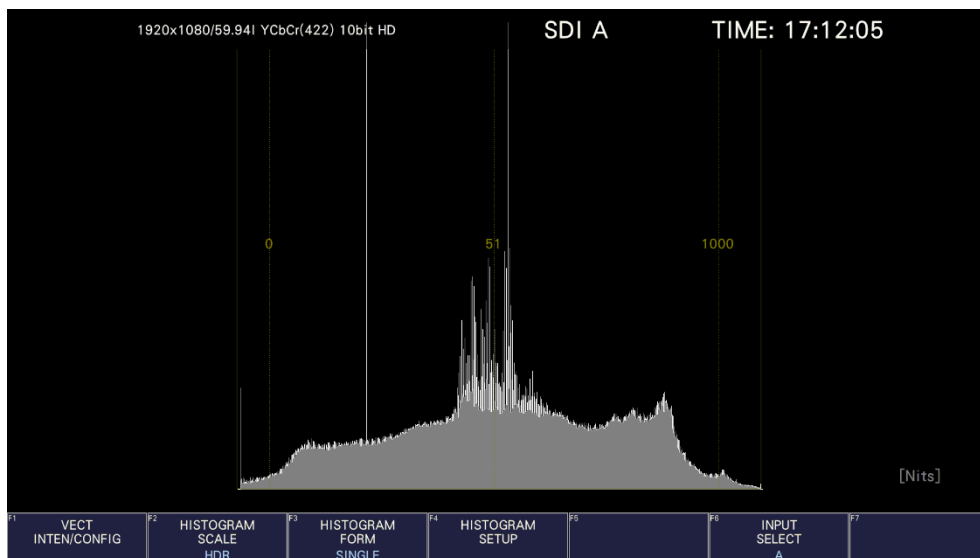

Figure 14-6 Histogram display (HDR Mode = PQ)

14.3 Picture Screen

The picture display can show CINELITE, CINEZONE, MAX FALL, and MAX CLL for HDR signals. During HDR measurement **F•2** CINELITE of the PIC menu changes to **F•2** CINELITE/HDR. You can use this to show CINELITE, CINEZONE, MAX FALL, and MAX CLL.

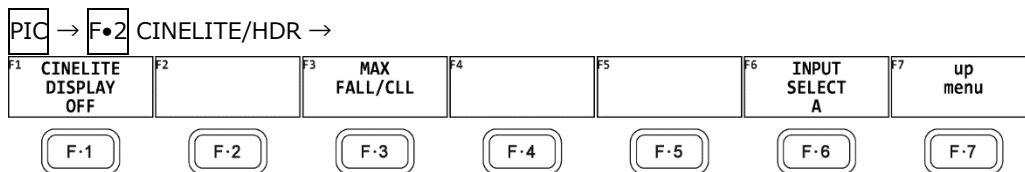

Figure 14-7 CINELITE/HDR menu

14.3.1 CINELITE and CINEZONE Displays

To switch to the CINELITE or CINEZONE display, follow the procedure below.

Procedure

PIC → **F•2** CINELITE/HDR → **F•1** CINELITE DISPLAY: OFF / %DISPLAY / CINEZONE / %DISP & CINEZONE

Settings

OFF:	CINELITE and CINEZONE is not displayed.
%DISPLAY:	The %DISPLAY screen is displayed. This option cannot be selected when PICTURE MODE is set to a value other than FIT.
CINEZONE:	The CINEZONE screen is displayed.
%DISP & CINEZONE:	The %DISPLAY screen and the CINEZONE screen are displayed at the same time. When PICTURE MODE is set to a value other than FIT, the %DISPLAY screen will not be displayed even if you select %DISP & CINEZONE.

- * For black-and-white images, the brightness indicated by %DISPLAY and the brightness indicated by CINEZONE are the same, but for color images there is a slight difference depending on the size of the color component. This difference is especially large for test signals with large color components such as color bars.

14. HDR DISPLAY (SER23)

CINELITE DISPLAY = OFF



CINELITE DISPLAY = %DISPLAY

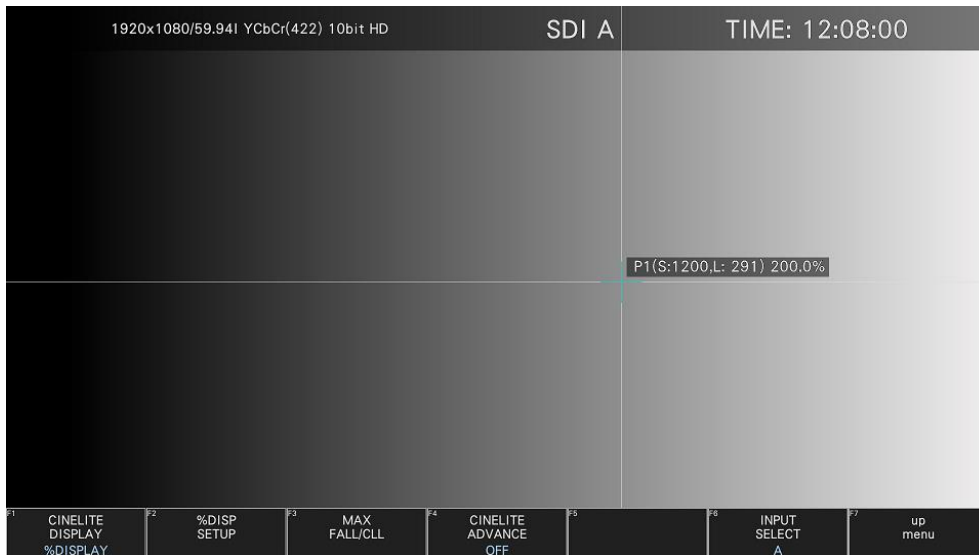

14. HDR DISPLAY (SER23)

CINELITE DISPLAY = CINEZONE

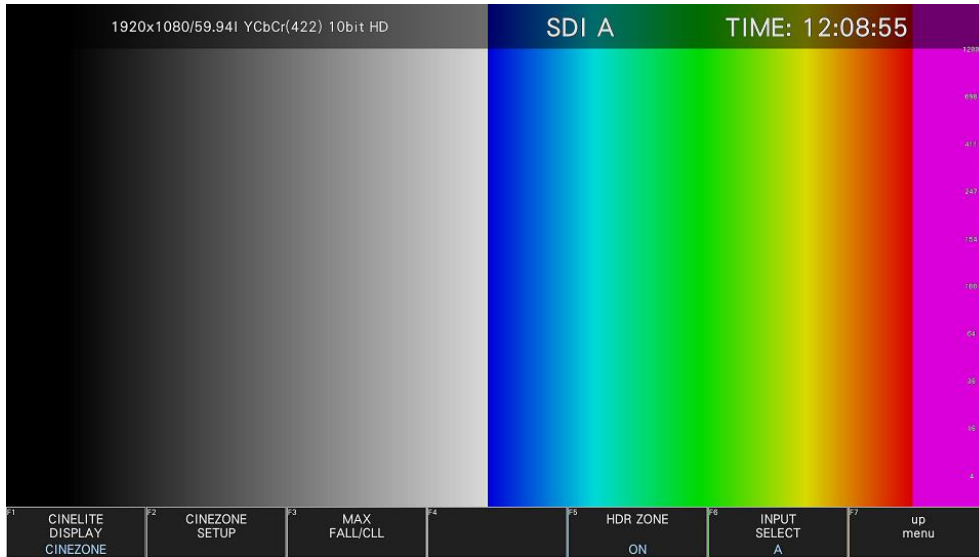

CINELITE DISPLAY = %DISP & CINEZONE

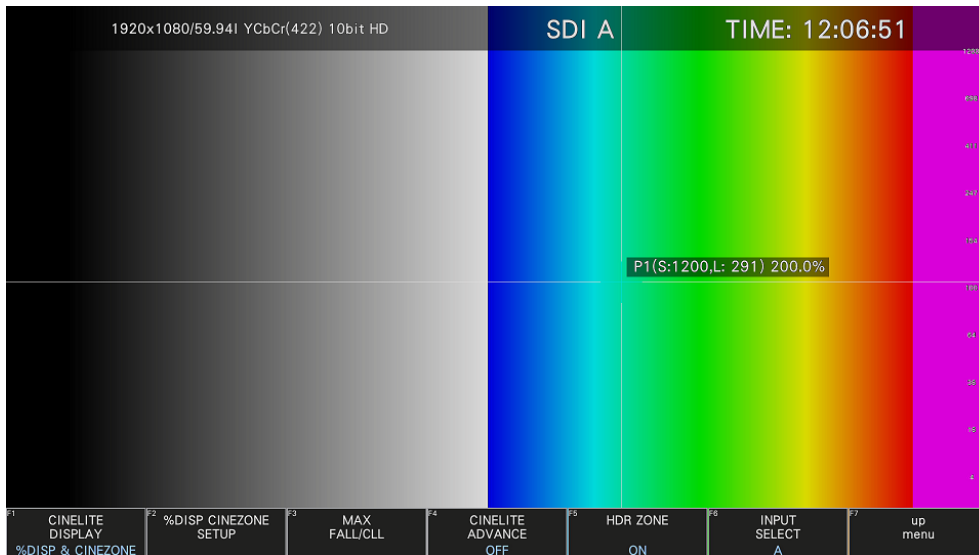

Figure 14-8 CINELITE and CINEZONE displays

14. HDR DISPLAY (SER23)

14.3.2 %DISPLAY

On the %DISPLAY of HDR signals, to shows measured values for HDR signals, follow the procedure below to set **F•4** UNIT SELECT to HDR. In addition, even if the brightness level is 80% or higher or 0% or lower, measured values are displayed in white, not yellow.

Use the %DISP SETUP menu to configure the %DISPLAY settings.

[See also] %DISP SETUP → 13.5.8, "Configuring CINELITE Settings"

PIC → **F•2** CINELITE/HDR → **F•2** %DISP SETUP → **F•4** UNIT SELECT: Y% / RGB% / RGB255 / CV / CV(DEC) / HDR

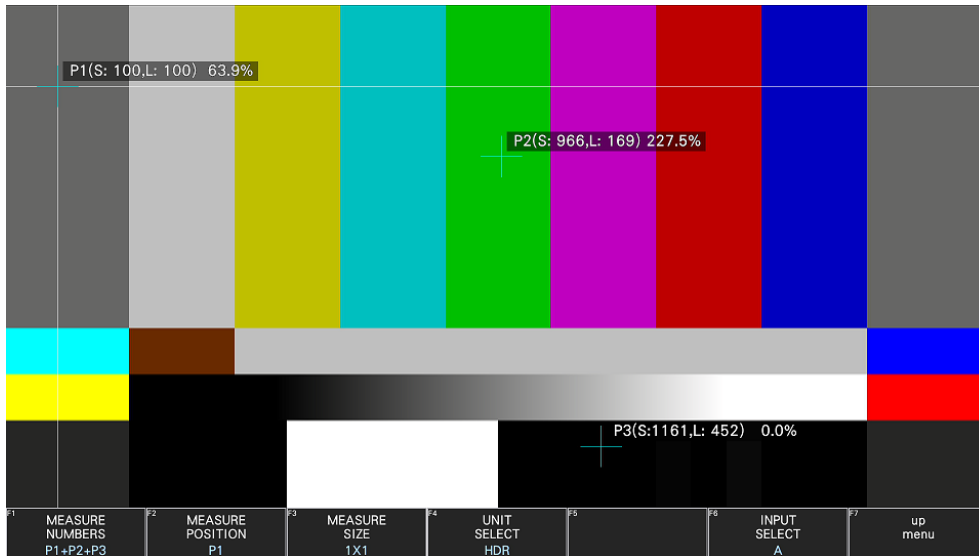

Figure 14-9 %DISPLAY

14. HDR DISPLAY (SER23)

14.3.3 CINEZONE Display

On the CINEZONE display of HDR signals, to display the SDR area in monochrome and HDR area in color, follow the procedure below to set **F•5** HDR ZONE to ON.

If **F•5** HDR ZONE is set to ON, STEP and SEARCH cannot be selected for **F•1** CINEZONE FORM.

Procedure

PIC	→	F•2	CINELITE/HDR	→	F•5	HDR ZONE: OFF / ON
-----	---	-----	--------------	---	-----	--------------------

HDR ZONE = OFF

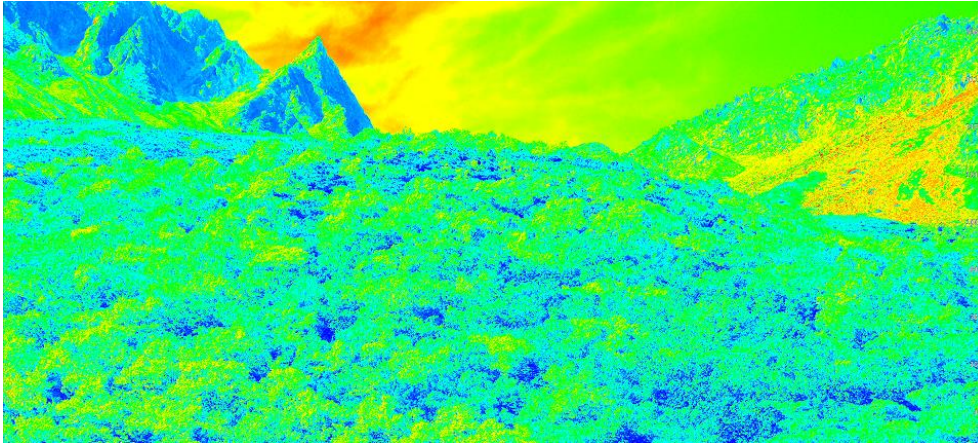

HDR ZONE = ON

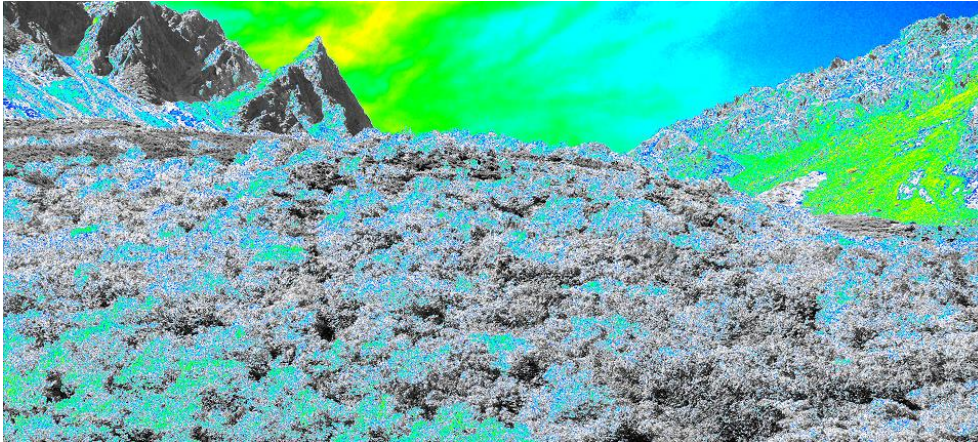

Figure 14-10 CINEZONE display

14. HDR DISPLAY (SER23)

To set the display colors, follow the procedure below. If you set REF at boundary of the SDR area and HDR area, the SDR area can be displayed in monochrome and HDR area in color. When Variable is set to on the HDR tab, you can set the REF value. If set to off, the default value is used.

This setting is shared with REF.LEVEL [%] of the video signal waveform display.

UPPER or higher:	Magenta
REF or higher, less than UPPER:	Gradation from blue to red
LOWER or higher, less than REF:	Monochrome
Less than LOWER:	Black

Procedure

PIC	→	F•2	CINELITE/HDR	→	F•2	CINEZONE SETUP
		→	F•2			UPPER [%]
		→	F•3			LOWER [%]
		→	F•4			REF [%]

The values vary depending on the HDR tab settings as follows.

Set the values as percentages (0.0 to 100.0%) of the input video level.

HDR equivalent values are displayed in the upper left corner of the screen.

Figure 14-1 Display color values

HDR Mode	EI	Range	Setting range	Default UPPER value	Default LOWER value	Default REF value
HLG	-	Narrow	0.0 to 109.4	100.0	0.0	Ref. Level
		Full	0.0 to 100.0	100.0	0.0	Ref. Level
PQ	-	Narrow	0.0 to 109.4	100.0	0.0	Ref. Level
		Full	0.0 to 100.0	100.0	0.0	Ref. Level
S-Log3	-	-	3.5 to 109.4	100.0	3.5	61.0
C-Log	-	-	7.3 to 108.7	100.0	7.3	63.0
Log-C	200	-	3.5 to 90.1	90.0	3.5	58
	400	-	3.5 to 97.4	90.0	3.5	58
	800	-	3.5 to 104.1	90.0	3.5	58
	1600	-	3.5 to 109.4	90.0	3.5	58
PayloadID UnSpec:S-Log3	Operates in OFF (SDR-TV), HLG, or PQ mode according to the payload ID information. When the payload ID information is Unspecified, the instrument operates in S-Log3 mode.					
PayloadID UnSpec:C-Log	Operates in OFF (SDR-TV), HLG, or PQ mode according to the payload ID information. When the payload ID information is Unspecified, the instrument operates in C-Log mode.					
PayloadID UnSpec:Log-C	Operates in OFF (SDR-TV), HLG, or PQ mode according to the payload ID information. When the payload ID information is Unspecified, the instrument operates in Log-C mode.					

14.3.4 Link Marker Display

Use **F•4** CINELITE ADVANCE to configure the link marker display settings.

[See also] CINELITE ADVANCE → 13.6.8, "Displaying Link Markers"

PIC	→	F•2	CINELITE/HDR	→	F•4	CINELITE ADVANCE: ON / OFF
-----	---	-----	--------------	---	-----	----------------------------

14.4 MAX FALL and MAX CLL Displays

MAX FALL (Maximum Frame Average Light Level) is a function that calculates the maximum value among the R, G, and B values in each pixel and sums the maximums of all pixels. The sum is divided by the number of pixels per frame to derive the average in the frame. The average of each frame is compared among all frames from the start of measurement, and the maximum value is displayed.

The R, G, and B values are converted linearly from the start of the calculation through OETF or InverseOETF.

MAX CLL (Maximum Content Light Level) is a function that displays the maximum value among the R, G, and B values from the start of measurement. The R, G, and B values are converted linearly.

The R, G, and B values are converted linearly from the start of the calculation through OETF or InverseOETF.

14.4.1 Turning the Display On and Off

To display MAX FALL and MAX CLL at the top of the screen, follow the procedure below to turn the function on.

Procedure

PIC	→	F•2	CINELITE/HDR	→	F•3	MAX FALL/CLL	→	F•1	MAX FALL/CLL DISPLAY: OFF / ON
-----	---	-----	--------------	---	-----	--------------	---	-----	--------------------------------

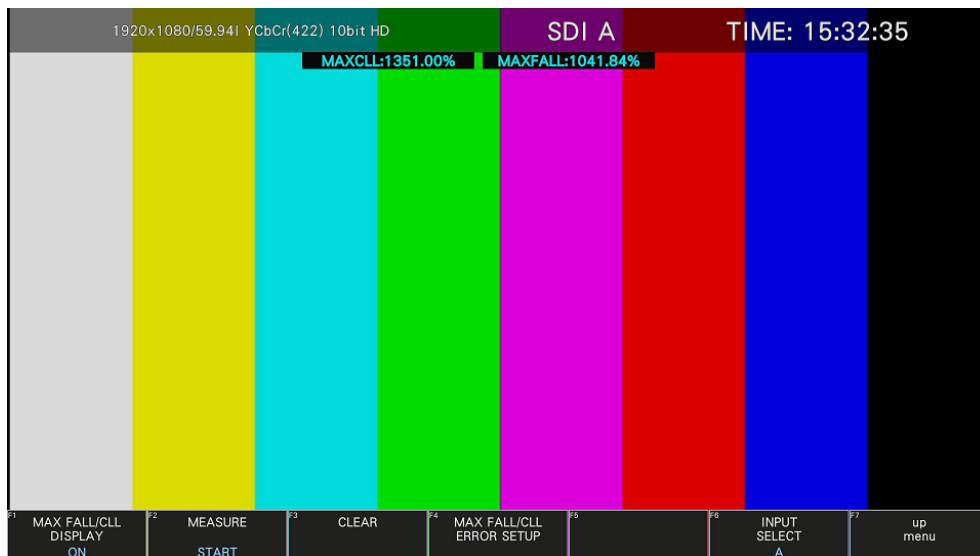

Figure 14-11 MAX FALL and MAX CLL displays

14. HDR DISPLAY (SER23)

14.4.2 Starting and Stopping Measurements

To start or stop MAX FALL and MAX CLL measurements, follow the procedure below.

Procedure

PIC	→	F•2	CINELITE/HDR	→	F•3	MAX FALL/CLL	→	F•2	MEASURE: <u>STOP</u> / START
-----	---	-----	--------------	---	-----	--------------	---	-----	------------------------------

14.4.3 Clearing Measurements

To clear MAX FALL and MAX CLL measurements, follow the procedure below.

Procedure

PIC	→	F•2	CINELITE/HDR	→	F•3	MAX FALL/CLL	→	F•3	CLEAR
-----	---	-----	--------------	---	-----	--------------	---	-----	-------

14.4.4 Setting the MAX FALL/CLL Error

To display the MAX FALL/CLL error setting screen, follow the procedure below.

Procedure

PIC	→	F•2	CINELITE/HDR	→	F•3	MAX FALL/CLL	→	F•4	MAX FALL/CLL ERROR SETUP
-----	---	-----	--------------	---	-----	--------------	---	-----	--------------------------



Figure 14-12 MAX FALL/CLL error setting screen

- MAX FALL/CLL ERROR

To turn the MAX FALL/CLL error on and off.

When set to on, when the measurement result is equal to or greater than the specified threshold, it is displayed turns red and recorded as the event log.

[See also] 16.4, "Configuring Event Log Settings."

OFF / ON

- PQ Upper

Set the threshold for PQ.

MAX FALL: 0.000 Nits to 10.000 Nits

MAX CLL: 0.000 Nits to 10.000 Nits

14. HDR DISPLAY (SER23)

- HLG Upper Scale 1200% / 100%

Set the threshold for HLG.

When the function dial (F•D) is turned, the threshold values of HLG Scale 1200% and 100% change at the same ratio.

HLG Scale = 1200%

MAX FALL:	0,000 % (0.0 Nits) to <u>1,200</u> % (1000.0 Nits) to 2,000 % (1845.9 Nits)
MAX CLL:	0,000 % (0.0 Nits) to <u>1,200</u> % (1000.0 Nits) to 2,000 % (1845.9 Nits)

HLG Scale = 100%

MAX FALL:	0 % to <u>60</u> % to 100 %
MAX CLL:	0 % to <u>60</u> % to 100 %

15. AUDIO DISPLAY

To display the audio screen, press AUDIO.

On the audio display, the embedded audio signal applied to SDI INPUT can be displayed on a meter.

If SER20 is installed, Lissajous display, surround display, or status display can be shown with the meter display.

Switching to simul mode enables SDI inputs A/B to be displayed in combination with the audio. (They can be displayed even if **F•1** A, **F•2** B on the INPUT menu are set to OFF.)

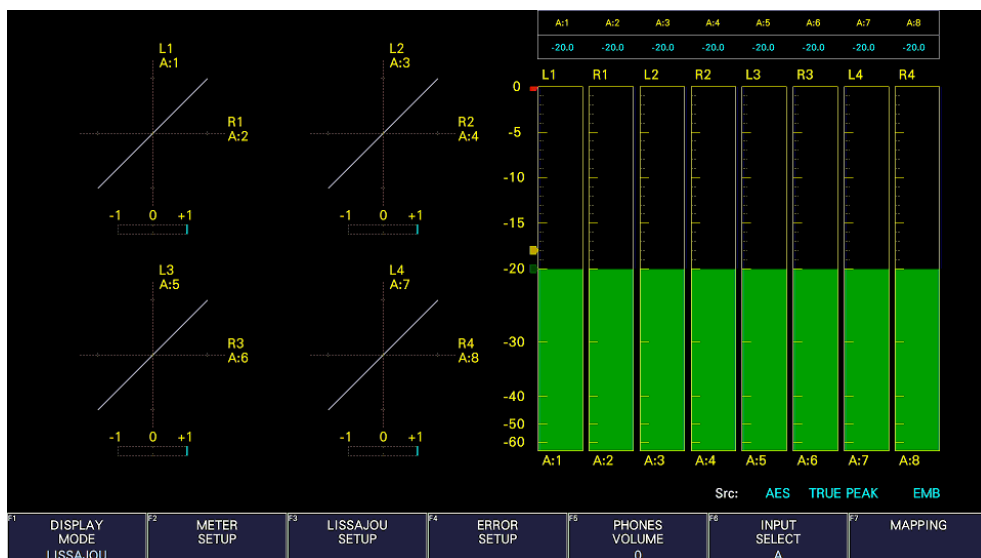

Figure 15-1 Audio display

- Src

The Src line in the lower right of the display shows the following information in order from the left.

	Display	Description	Reference
1. Input signal display	AES	-	15.1
2. Meter response model display	TRUE PEAK / PPM(I) / PPM(II) / VU+TRUE / VU+PPM(I) / VU+PPM(II)	-	15.5.2
3. Measurement signal display	EMB	Embedded audio	15.1

15.1 Setting the Signals to Measure

To configure the measurement signal settings, press **F•7** MAPPING on the AUDIO menu.

Procedure

AUDIO → **F•7** MAPPING

15.1.1 Selecting the Measurement Signal

On the TARGET tab, select the audio group, and assign the headphone output.

AUDIO → **F•7** MAPPING → **F•2** PREV TAB or **F•3** NEXT TAB →

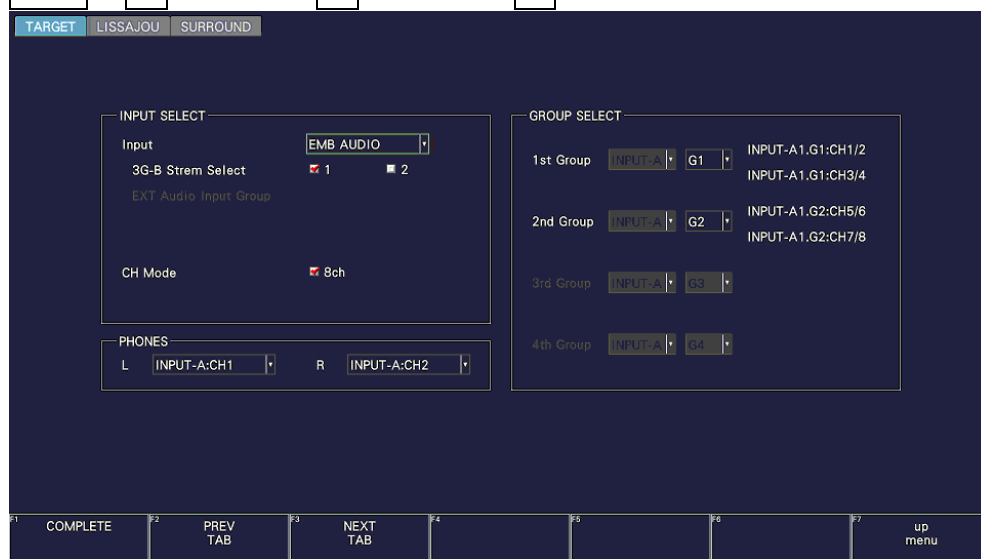

Figure 15-2 TARGET tab

- Input

The input signal is fixed to EMB AUDIO.

EMB AUDIO: The embedded audio signal applied to SDI INPUT is measured.

- 3G-B Stream Select

Select the 3G-B stream.

This is invalid when the input signal is not 3G-B.

1 / 2

- CH Mode

This is fixed to 8 channels. Select the number of measurement channels.

8ch

- PHONES

Select the headphone output channel.

15. AUDIO DISPLAY

- GROUP SELECT

Select the audio group.

Also select the input channel in simul mode.

G1: 1 to 4ch, G2: 5 to 8ch, G3: 9 to 12ch, G4: 13 to 16ch

15.1.2 Channel Assignment for the Lissajous Display (SER20)

On the LISSAJOU tab, assign channels from the audio group selected with GROUP SELECT and Lt and Rt (excluding some channels).

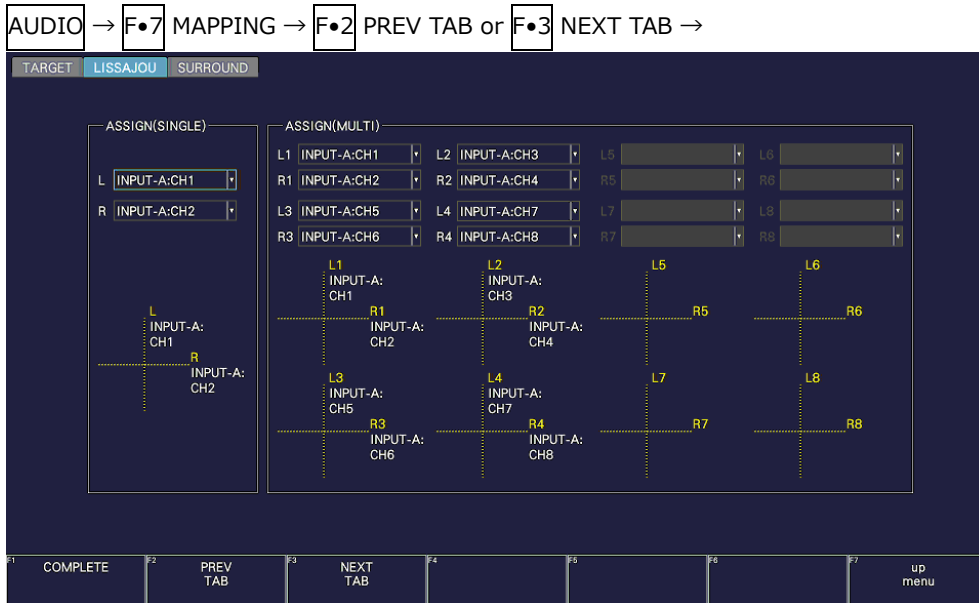

Figure 15-3 LISSAJOU tab

15.1.3 Channel Assignment for the Surround Display

On the SURROUND tab, assign channels from the audio group selected with GROUP SELECT.

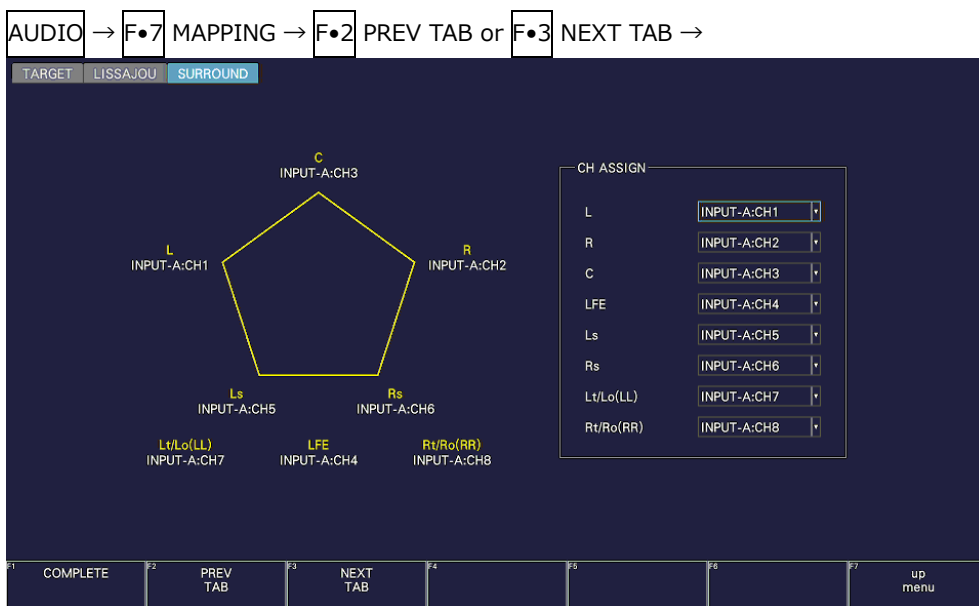

Figure 15-4 SURROUND tab

15. AUDIO DISPLAY

15.2 Selecting the Display Mode (SER20)

To select the display mode, follow the procedure below.

Procedure

AUDIO → F•1 DISPLAY MODE: LISSAJOU / SURROUND / STATUS

Settings

- LISSAJOU:** The Lissajous display is shown on the left side of the screen, and the audio meter is displayed on the right side of the screen.
- SURROUND:** The surround display is shown on the left side of the screen, and the audio meter is displayed on the right side of the screen.
This option cannot be selected in simul mode.
- STATUS:** The status display is shown on the left side of the screen, and the audio meter is displayed on the right side of the screen.

DISPLAY MODE = LISSAJOU

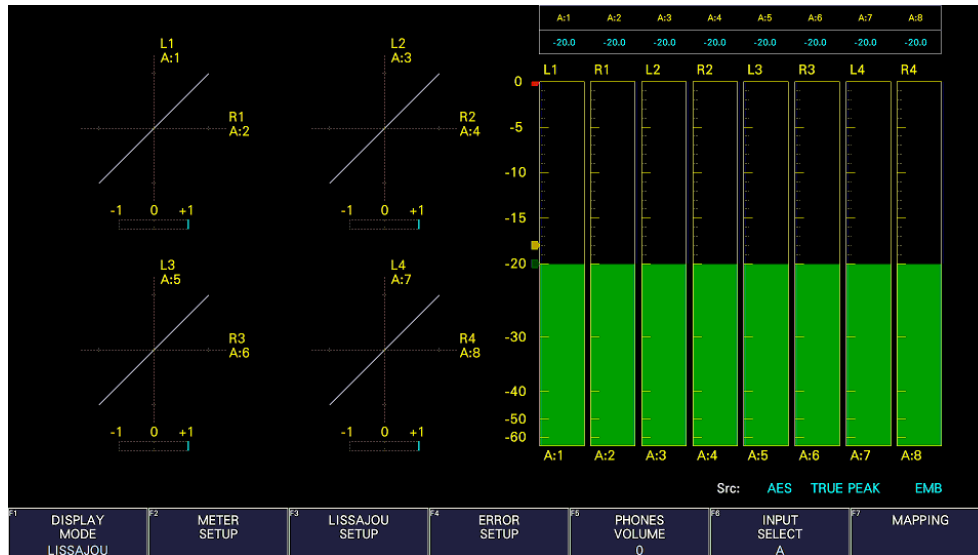

DISPLAY MODE = SURROUND

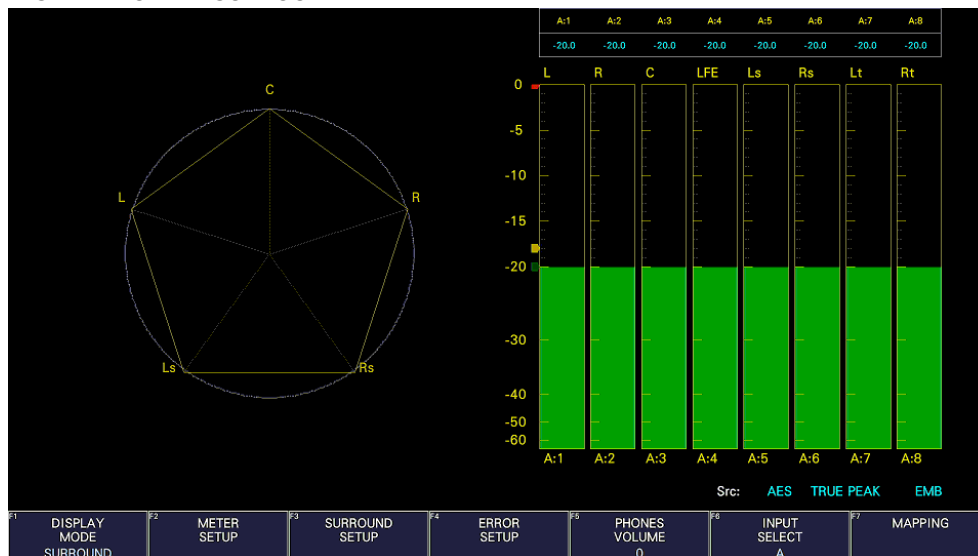

15. AUDIO DISPLAY

DISPLAY MODE = STATUS

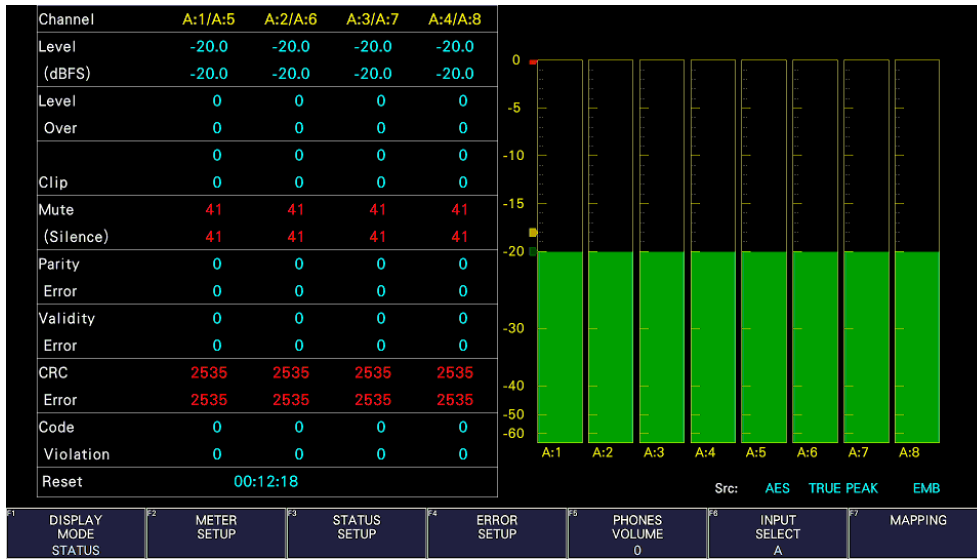

Figure 15-5 Selecting the display mode

15.3 Configuring Error Detection Settings

To configure the error detection and meter display settings, follow the procedure below.

Procedure

AUDIO → F•4 ERROR SETUP

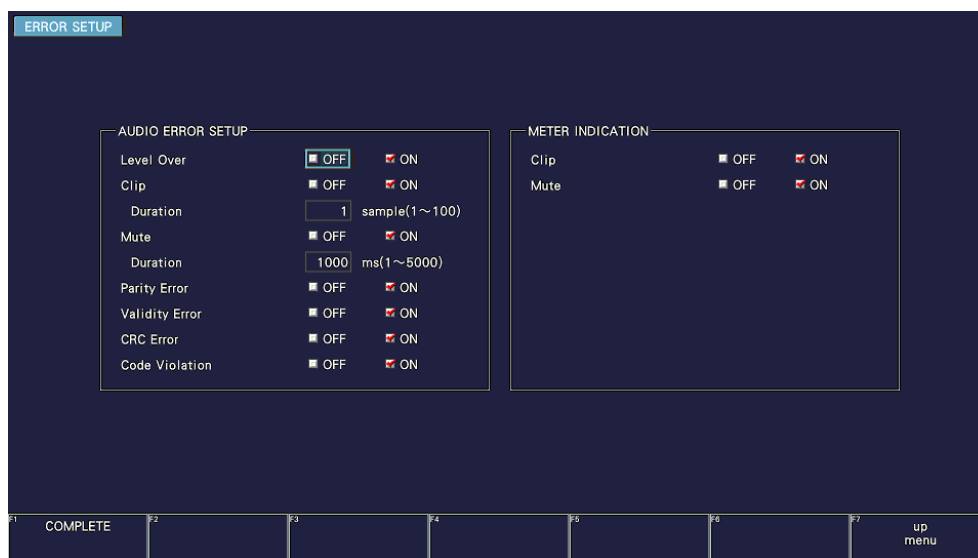

Figure 15-6 ERROR SETUP tab

- Level Over

Turn the level error detection on or off.

An error is detected when the level set with OVER dBFS is exceeded.

[See also] OVER dBFS → 15.5.4, "Setting the Reference Level"

OFF / ON

- Clip

Turn the clip error detection on or off.

OFF / ON

If set to ON, you can set the duration. An error is detected when the maximum signal extends beyond the number of samples set here.

1 - 100

- Mute

Turn the mute error detection on or off.

OFF / ON

If set to ON, you can set the duration. An error is detected when a mute signal lasts longer than the duration set here.

1 - 1000 - 5000

15. AUDIO DISPLAY

- Parity Error

Turn the parity error detection on or off.

OFF / ON

- Validity Error

Turn the validity error detection on or off.

OFF / ON

- CRC Error

Turn the CRC error detection on or off.

OFF / ON

- Code Violation

Turn the code violation error detection on or off.

OFF / ON

- Clip (METER INDICATION)

If Clip is set to ON, turn on or off the "CLIP" indication that appears when errors occur.

OFF / ON

- Mute (METER INDICATION)

If Mute is set to ON, turn on or off the "M" indication that appears when errors occur.

OFF / ON

15.4 Adjusting the Volume

To adjust the headphone volume, follow the procedure below.

Press the function dial (F•D) to return the setting to its default value (0).

Procedure

AUDIO	→	F•5	PHONES VOLUME: <u>0</u> - 63
-------	---	-----	------------------------------

15. AUDIO DISPLAY

15.5 Meter Display

Meters are always displayed.

To configure meter display settings, press **F•2** METER SETUP on the AUDIO menu.

AUDIO → **F•2** METER SETUP →

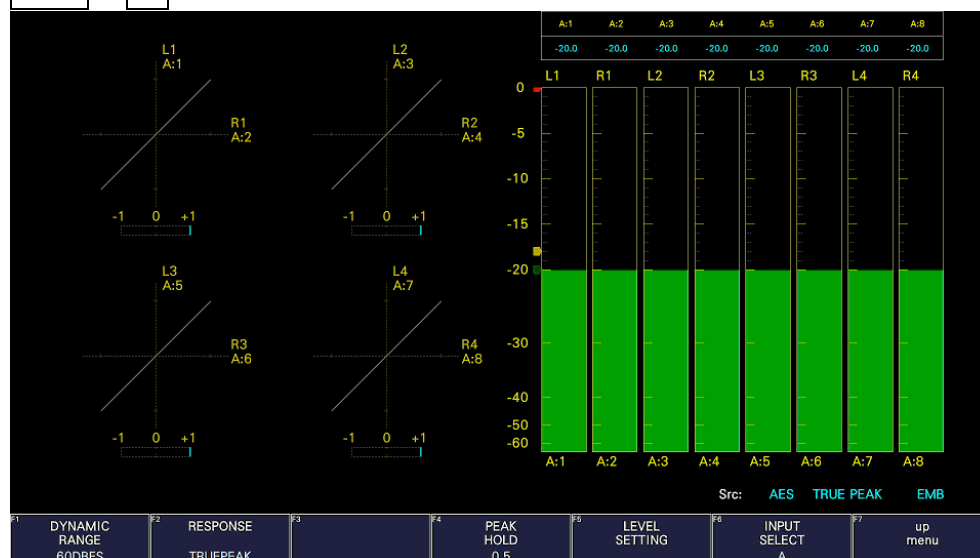

Figure 15-7 Meter display (right side)

15.5.1 Selecting the Scale

To select the meter's scale, follow the procedure below.

Procedure

AUDIO → **F•2** METER SETUP → **F•1** DYNAMIC RANGE: 60DBFS / 90DBFS / MAG

Settings

60DBFS: The meter's scale is set to -60 to 0 (dBFS).

90DBFS: The meter's scale is set to -90 to 0 (dBFS).

MAG: The meter's scale is set to the level specified by **F•5** LEVEL SETTING → **F•3** REF dBFS ±3 dB.

15. AUDIO DISPLAY

15.5.2 Selecting the Response Model

To select the meter's response model, follow the procedure below. The selected response model is indicated in the lower right of the screen.

Procedure

AUDIO → F•2 METER SETUP
 → F•2 RESPONSE: TRUEPEAK / PPM / VU
 → F•3 PPM MODE: PPM(I) / PPM(II) (for PPM)
 → F•3 PEAK METER: TRUE / PPM(I) / PPM(II) (for VU)

The response model settings (typical) are detailed below.

F•2 RESPONSE	F•3 PPM MODE / F•3 PEAK METER	Display	Delay time (*1)	Return time (*2)	Average time
TRUEPEAK	-	TRUE PEAK	0 msec	1.7 sec	-
PPM	PPM(I)	PPM(I)	10 msec	1.7 sec	-
	PPM(II)	PPM(II)	10 msec	2.8 sec	-
VU	TRUE	VU+TRUE	-	-	300 msec
	PPM(I)	VU+PPM(I)	-	-	300 msec
	PPM(II)	VU+PPM(II)	-	-	300 msec

*1 The amount of time it takes for the meter to show -20 dBFS when a -20 dBFS/1 kHz sine-wave signal is applied with no input preceding it.

*2 The amount of time it takes for the meter to show -40 dBFS when a -20 dBFS/1 kHz sine-wave signal is removed from the input.

15.5.3 Setting the Peak Hold

To set the peak hold time, follow the procedure below. The unit is seconds. You can set the value in 0.5-second steps.

Press the function dial (F•D) to return the setting to its default value (0.5).

Procedure

AUDIO → F•2 METER SETUP (→ F•5 LEVEL SETTING) → F•4 PEAK HOLD: 0.0 - 0.5 - 5.0 / HOLD

15. AUDIO DISPLAY

15.5.4 Setting the Reference Level

To set the reference level, press **F•5** LEVEL SETTING on the METER SETUP menu.

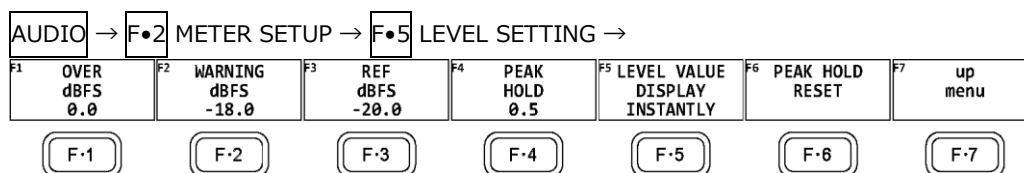
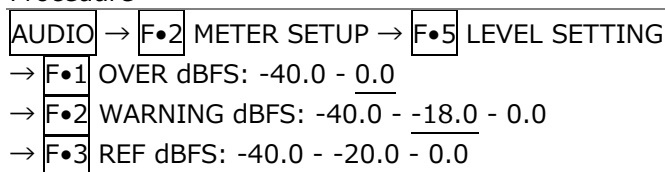

Figure 15-8 LEVEL SETTING menu

To set the meter reference level, follow the procedure below.

Procedure



Settings

OVER dBFS: Set the threshold level for audio level errors.

WARNING dBFS: The portion of the meter that exceeds the level specified here is displayed in red. The portion of the meter below this level is displayed in yellow.

REF dBFS: The portion of the meter that exceeds the level specified here is displayed in yellow. The portion of the meter below this level is displayed in green.

15.5.5 Configuring the Numeric Display

On the meter display, measured values are displayed using a meter and numeric values. You can select the content of the numeric display by following the procedure below. Note that for Level in the status display, the current measured value (INSTANTLY) is displayed regardless of the selection made here.

Procedure



Settings

INSTANTLY: The current measured value is displayed. Normally, the value is displayed in light blue. When Level Over detection is enabled and the measured value exceeds the value specified using **F•1** OVER dBFS, the values displayed in red.

PEAK HOLD: The peak value set using **F•4** PEAK HOLD is displayed. The value is always displayed in green.

15. AUDIO DISPLAY

15.5.6 Resetting the Peak Hold

To reset the peak hold on the meter display and measured value, follow the procedure below.

Procedure

AUDIO	→	F•2	METER SETUP	→	F•5	LEVEL SETTING	→	F•6	PEAK HOLD RESET
-------	---	-----	-------------	---	-----	---------------	---	-----	-----------------

15. AUDIO DISPLAY

15.6 Lissajous Display (SER20)

To display Lissajous curves, set **F•1** DISPLAY MODE on the AUDIO menu to LISSAJOU. To configure the Lissajous display settings, press **F•3** LISSAJOU SETUP. This setting is available when **F•1** DISPLAY MODE is set to LISSAJOU.

AUDIO → **F•1** DISPLAY MODE and select LISSAJOU → **F•3** LISSAJOU SETUP →

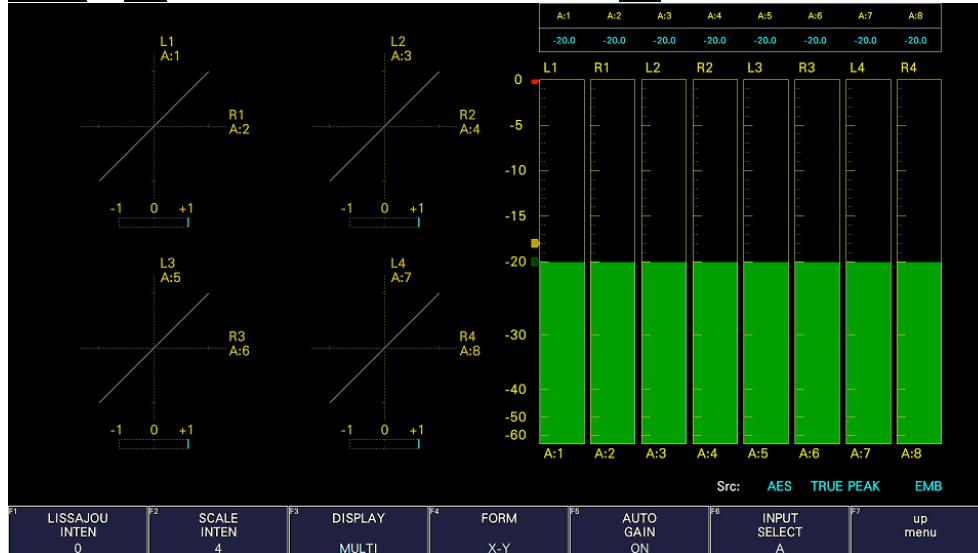

Figure 15-9 Lissajous display

- Correlation Meter

The correlation meter indicates the phase difference between the two signals. A reading of +1 indicates that the signals are in-phase, a reading of -1 indicates that the signals are 180 ° out of phase, and a reading of 0 indicates that the signals are not correlated.

15.6.1 Adjusting the Lissajous Curve Intensity

To set the Lissajous curve intensity, follow the procedure below. Press the function dial (**F•D**) to return the setting to its default value (0).

Procedure

AUDIO → **F•3** LISSAJOU SETUP → **F•1** LISSAJOU INTEN: -8 - 0 - 7

15.6.2 Adjusting the Scale Intensity

To adjust the intensity of the Lissajous and meter scales, follow the procedure below. Press the function dial (**F•D**) to return the setting to its default value (4).

Procedure

AUDIO → **F•3** LISSAJOU SETUP → **F•2** SCALE INTEN: -8 - 4 - 7

15. AUDIO DISPLAY

15.6.3 Selecting the Lissajous Curve Display Format

To select the Lissajous curve display format, follow the procedure below.

Procedure

AUDIO	→	F•3	LISSAJOU SETUP	→	F•3	DISPLAY: <u>MULTI</u> / SINGLE
-------	---	-----	----------------	---	-----	--------------------------------

Settings

MULTI: Eight channels of Lissajous waveforms and eight channels of audio meters are displayed.

SINGLE: Two channels of Lissajous waveforms and eight channels of audio meters are displayed.

This option cannot be selected in simul mode.

DISPLAY = MULTI

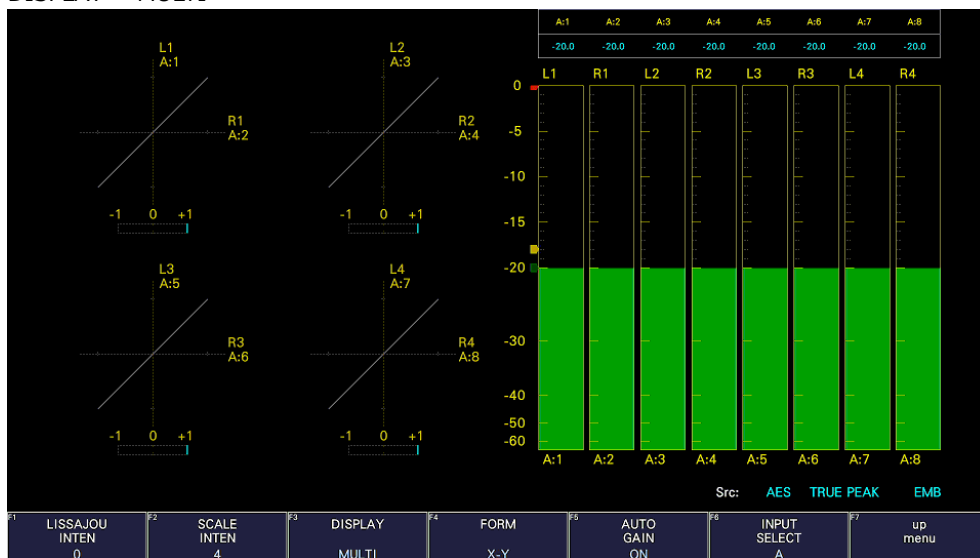

DISPLAY = SINGLE

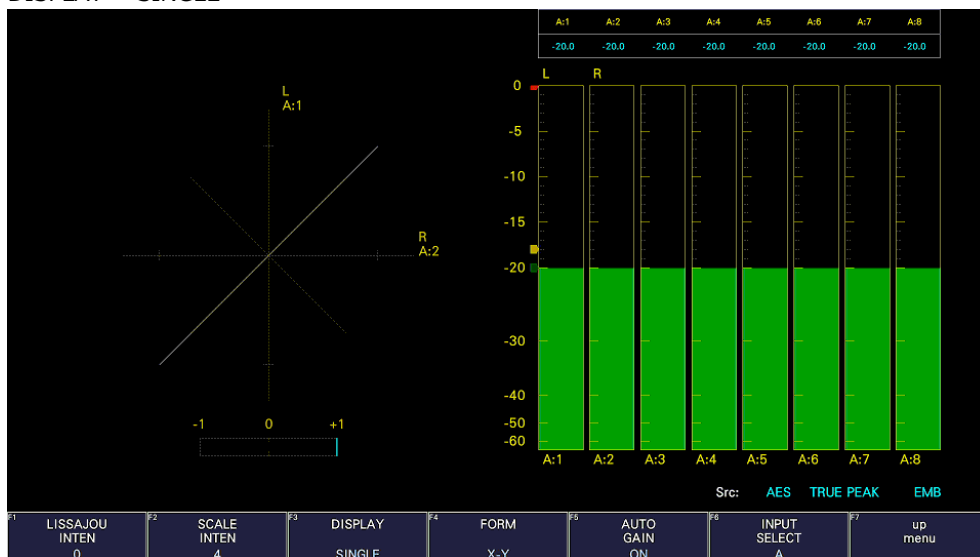

Figure 15-10 Selecting the Lissajous curve display format

15. AUDIO DISPLAY

15.6.4 Selecting the Scale Display Format

To select the scale display format, follow the procedure below.

Procedure

AUDIO	→	F•3	LISSAJOU SETUP	→	F•4	FORM: <u>X-Y</u> / MATRIX
-------	---	-----	----------------	---	-----	---------------------------

Settings

X-Y: R is assigned to the X-axis (horizontal), and L is assigned to the Y-axis (vertical).

MATRIX: The R and L axes are positioned at 45 ° angles to the X and Y axes.

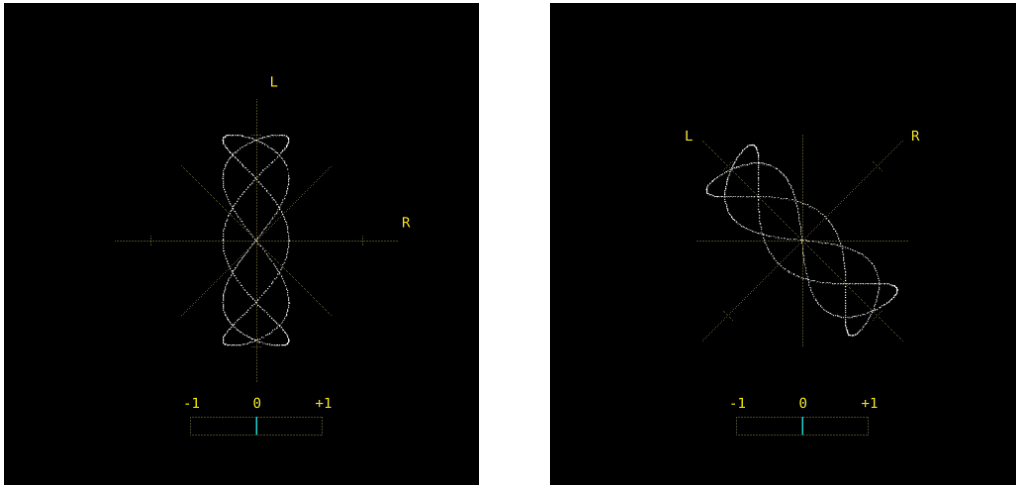

Figure 15-11 Selecting the scale display format

15. AUDIO DISPLAY

15.6.5 Setting the Lissajous Curve Gain

To select the Lissajous curve gain, follow the procedure below.

Procedure

AUDIO	→	F•3	LISSAJOU SETUP	→	F•5	AUTO GAIN: <u>ON</u> / OFF
-------	---	-----	----------------	---	-----	----------------------------

Settings

ON: The gain is automatically adjusted so that the waveform fits the scale.

OFF: The waveform is displayed with a fixed gain.

AUTO GAIN = ON

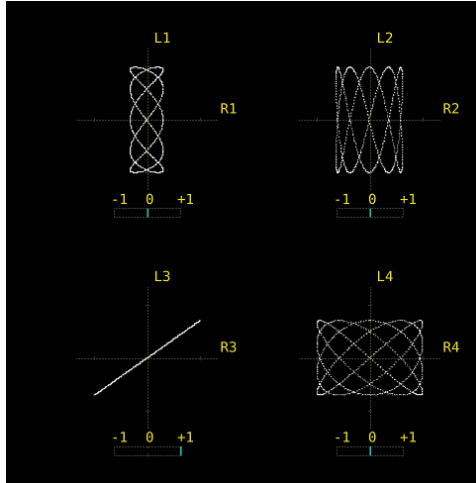

AUTO GAIN = OFF

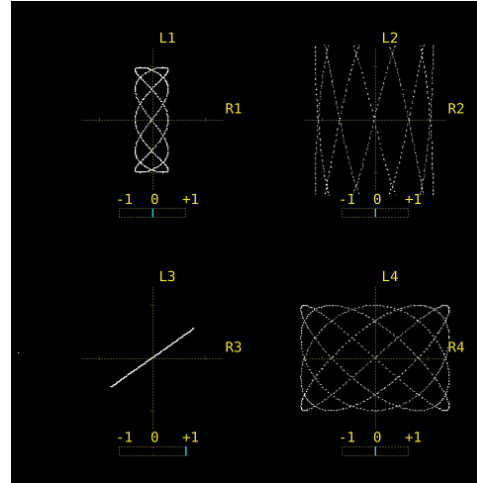

Figure 15-12 Setting the Lissajous curve gain

15. AUDIO DISPLAY

15.7 Surround Display (SER20)

To show the surround display, set **F•1** DISPLAY MODE on the AUDIO menu to SURROUND.
To configure the surround display settings, press **F•3** SURROUND SETUP. This setting is available when **F•1** DISPLAY MODE is set to SURROUND.

AUDIO → **F•1** DISPLAY MODE and select SURROUND → **F•3** SURROUND SETUP →

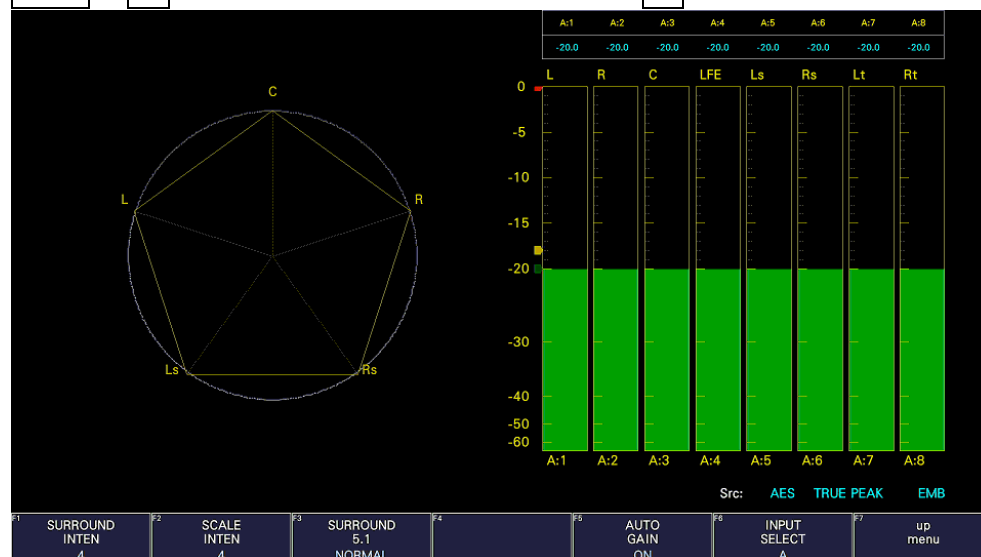

Figure 15-13 Surround display

15.7.1 Adjusting the Surround Waveform Intensity

To adjust the surround waveform intensity, follow the procedure below.
Press the function dial (F•D) to return the setting to its default value (4).

Procedure

AUDIO → **F•3** SURROUND SETUP → **F•1** SURROUND INTEN: -8 - 4 - 7

15.7.2 Adjusting the Scale Intensity

To adjust the intensity of the surround and meter scales, follow the procedure below.
Press the function dial (F•D) to return the setting to its default value (4).

Procedure

AUDIO → **F•3** SURROUND SETUP → **F•2** SCALE INTEN: -8 - 4 - 7

15. AUDIO DISPLAY

15.7.3 Selecting the Surround Display Format

To select the surround display format, follow the procedure below.

If adjacent channels (including Lch and Rch for PHANTOM) are of opposite phases, the scale between the channels is displayed in red.

Procedure

AUDIO	→	F•3	SURROUND SETUP	→	F•3	SURROUND 5.1: <u>NORMAL</u> / PHANTOM
-------	---	-----	----------------	---	-----	---------------------------------------

Settings

NORMAL: A waveform that combines Lch, Rch, Lsch, Rsch, and Cch (hard center) is displayed.

PHANTOM: A waveform that combines Lch, Rch, Lsch, Rsch, and phantom center and a Cch (hard center) waveform are displayed separately.

SURROUND 5.1 = NORMAL

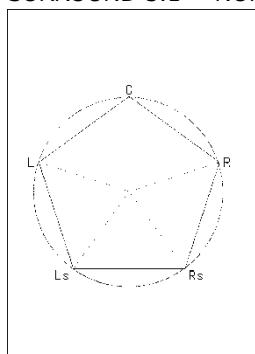

SURROUND 5.1 = PHANTOM

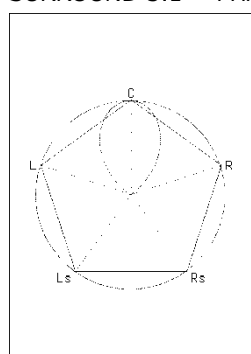

Figure 15-14 Selecting the surround display format

15.7.4 Setting the Surround Waveform Gain

To select the surround waveform gain, follow the procedure below.

Procedure

AUDIO	→	F•3	SURROUND SETUP	→	F•5	AUTO GAIN: <u>ON</u> / OFF
-------	---	-----	----------------	---	-----	----------------------------

Settings

ON: The gain is automatically adjusted so that the waveform fits the scale.

OFF: The waveform is displayed with a fixed gain.

15. AUDIO DISPLAY

15.8 Status Display (SER20)

To display the status, set **F•1** DISPLAY MODE on the AUDIO menu to STATUS.

To configure the status display settings, press **F•3** STATUS SETUP. This setting is available when **F•1** DISPLAY MODE is set to STATUS.

AUDIO → **F•1** DISPLAY MODE and select STATUS → **F•3** STATUS SETUP →

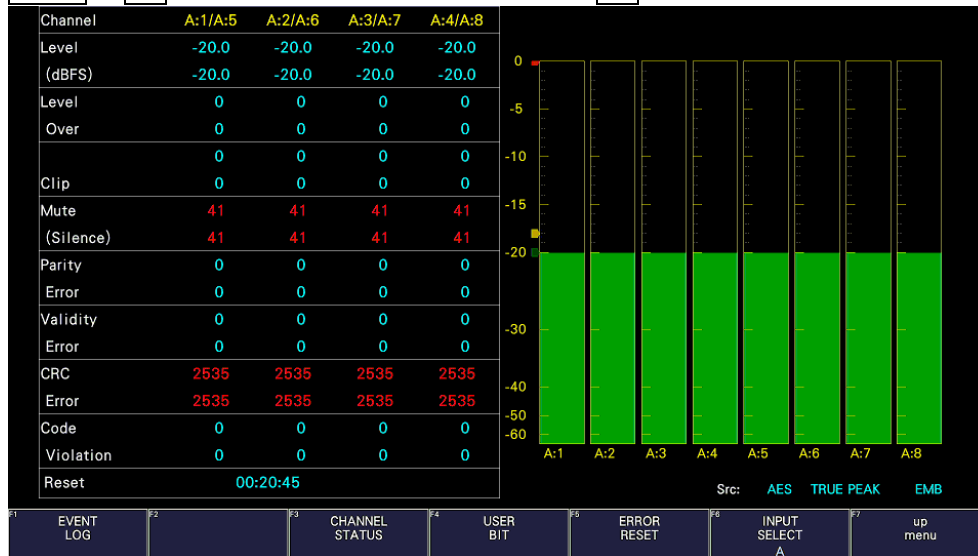

Figure 15-15 Status display

15.8.1 Status Screen Description

On the status display, the levels and the number of detected errors are displayed for the selected channels (up to 9999). Errors are only detected for the items that have been set to ON in section 15.3, “Configuring Error Detection Settings.”

- Channel

Displays the channel. Each item below this item is displayed in two lines. The top line corresponds to the channel to the left of the slash, and the bottom line corresponds to the channel to the right of the slash.

- Level (dBFS)

Displays the level numerically.

- Level Over

Displays the number of times the level is greater than equal to the OVER dBFS value set in section 15.5.4, “Setting the Reference Level.”

- Clip

Displays the number of times that a received signal exceeds the maximum signal value for the number of consecutive samples specified in section 15.3, “Configuring Error Detection Settings.”

15. AUDIO DISPLAY

- Mute (Silence)

Displays the number of times that a mute signal exceeding the duration specified in section 15.3, "Configuring Error Detection Settings" is received.

- Parity Error

Counts the number of times that the input signal's parity bit and the recalculated parity bit differ.

- Validity Error

Counts the number of times that the input signal's validity bit is 1.

- CRC Error

Counts the number of times that the CRC of the channel status bits and the calculated CRC are different.

- Code Violation

Counts the number of times that the state of the input signal's biphase modulation is abnormal.

- Reset

Displays the time that has elapsed since **AUDIO** → **F•3** STATUS SETUP → **F•5** ERROR RESET were pressed.

15.8.2 Event Log Display

To view the event log, follow the procedure below.

This screen is the same as the event log screen of the status display. For details, see section 16.4, "Configuring Event Log Settings."

Procedure

AUDIO → **F•3** STATUS SETUP → **F•1** EVENT LOG

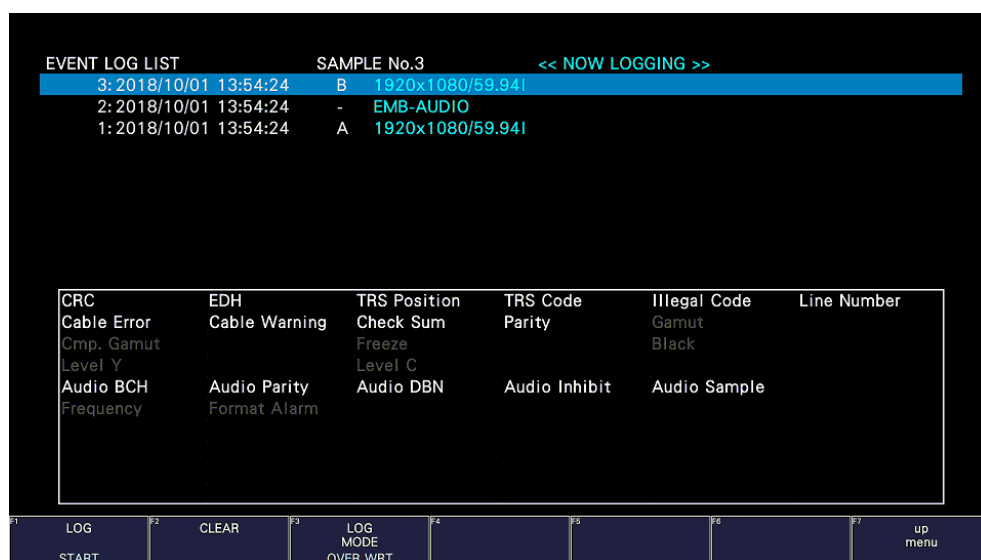

Figure 15-16 Event log display

15. AUDIO DISPLAY

15.8.3 Channel Status Display

To display the status of the selected channel, follow the procedure below.

Use **F•1** DISPLAY CHANNEL to select the channel. You can also use **F•2** ALIGN to select the bit order.

Procedure

AUDIO → **F•3** STATUS SETUP → **F•3** CHANNEL STATUS

AES/EBU CHANNEL STATUS DISPLAY AES-3		Src: AES EMB	
DISPLAY CHANNEL : 1			
FORMAT	: Professional	Byte : 01234567	01234567
AUDIO DATA	: PCM	00 :	10100001 12 : 00000000
EMPHASIS	: No emphasis	01 :	00010001 13 : 00000000
SIGNAL LOCK	: Locked	02 :	00110100 14 : 00000000
SAMPLING FREQ:	48kHz	03 :	00000000 15 : 00000000
REFERENCE	: Not reference	04 :	00000000 16 : 00000000
CH MODE	: Two-channel	05 :	00000000 17 : 00000000
		06 :	00000000 18 : 00000000
RESOLUTION	: 24bits	07 :	00000000 19 : 00000000
ALIGNMENT	: Not indicated	08 :	00000000 20 : 00000000
ORIGIN	:	09 :	00000000 21 : 00000000
DESTINATION	:	10 :	00000000 22 : 00000000
TIME-OF-DAY	: 00:00:00	11 :	00000000 23 : 10100001
CRC	: NORMAL		
F1 DISPLAY CHANNEL 1	F2 ALIGN LSB 1st	F3	F4
		F5	F6 INPUT SELECT A
			F7 up menu

Figure 15-17 Channel status display

15. AUDIO DISPLAY

15.8.4 Displaying User Bits

To display the user bits of the selected channel, follow the procedure below.

Use **F•1** DISPLAY CHANNEL to select the channel. You can also use **F•2** ALIGN to select the bit order.

Procedure

AUDIO → **F•3** STATUS SETUP → **F•4** USER BIT

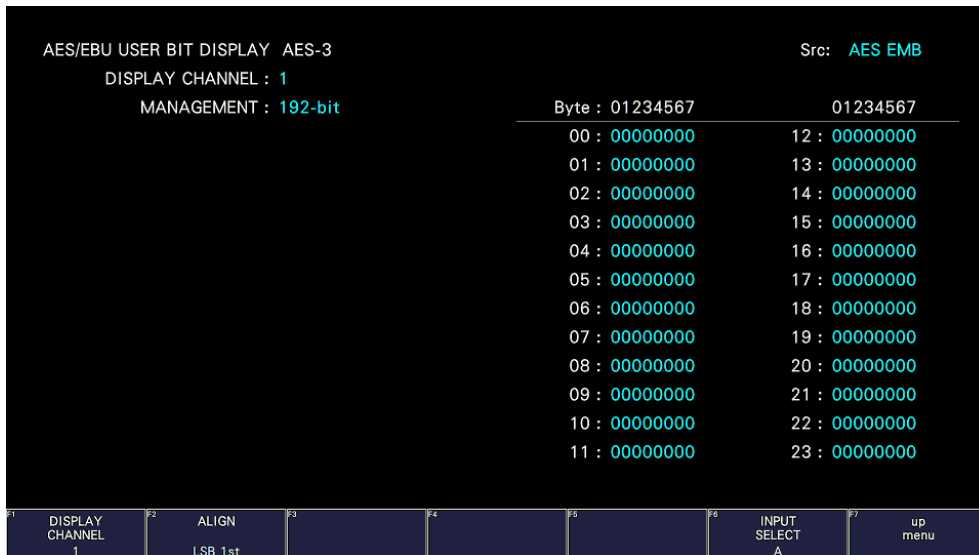

Figure 15-18 Displaying user bits

15.8.5 Resetting Errors

To reset the error counts that appear on the status display to 0, follow the procedure below. Also, the Reset indication at the lower left of the screen will be reset to 00:00:00.

Procedure

AUDIO → **F•3** STATUS SETUP → **F•5** ERROR RESET

16. STATUS DISPLAY

To display the status, press STATUS.



Figure 16-1 Status display

16.1 Status Screen Description

- SIGNAL

If the instrument is receiving an SDI signal, "DETECT" is displayed. Otherwise, "NO SIGNAL" is displayed.

If "NO SIGNAL" is displayed, the following items are not displayed.

- FORMAT/SUB IMAGE FORMAT

The input signal format is indicated. It is normally displayed in light blue, but if the input is not appropriate, it turns red.

For 4K, the sub image format 1920(2048) × 1080 is displayed.

- Freq

The sampling frequency deviation is displayed.

Normally, this is displayed in light blue. If Frequency Error on the ERROR SETUP1 tab is set to ON, the color changes to red when ± 10 ppm is exceeded.

The display range is "<-100 ppm, -100 to +100 ppm, >+100 ppm," and the accuracy is ± 2 ppm.

[See also] ERROR SETUP1 tab → section 16.2.1, "Error Setup 1"

16. STATUS DISPLAY

- Cable

The input signal attenuation is converted into a cable length that you selected and displayed.

Normally the value is displayed in light blue, but by setting Cable Error on the ERROR SETUP1 tab to ON, if the value exceeds the specified Warning value, it will change to yellow. If the value exceeds the Error value, it will change to red.

The display range, accuracy, and resolution are shown below.

[See also] ERROR SETUP1 tab → section 16.2.1, "Error Setup 1"

- Display Range

12G	< 10 m, 10 to 80 m, > 80 m	(10 m steps)
3G	< 10 m, 10 to 100 m, > 100 m	(10 m steps)
HD	< 10 m, 10 to 130 m, > 130 m	(10 m steps)
SD	< 50 m, 50 to 200 m, > 200 m	(10 m steps)

- Accuracy

12G, 3G, HD	±20 m
SD	±30 m

- Resolution 10 m

- Embedded Audio

The channels of the audio packets embedded in the input signal are displayed.

If the input signal is 3G-B-DL, only stream 1 is displayed.

- ERROR

The counts of the errors for the items whose detection setting was set to ON with F•5 STATUS SETUP are displayed. Errors are counted once per second or once per field. The maximum number of errors that can be counted is 999999.

Switching video formats or input channels may cause disturbances in the signal that will cause errors to be detected.

- CRC (other than SD)

An error is counted when the CRC embedded in the input signal is different from the CRC that the instrument calculates.

- EDH (SD only)

An error is counted when the EDH packet contains an ancillary data error flag, an active picture error flag, or a full-field error flag and when the CRC in the EDH packet is different from the CRC that the instrument calculates from the video data.

- TRS Pos

Input signal TRS (Timing Reference Signal) errors are displayed.

An error is counted when the position of the header word (3FFh, 000h, 000h) of EAV (End of Active Video) and SAV (Start of Active Video) is not correct or when the F, V, or H TRS protection bit is outside the video specifications (such as when the blanking period is different).

16. STATUS DISPLAY

- TRS Code

Input signal TRS (Timing Reference Signal) protection bit errors are displayed.

An error is counted when the correspondence between F, V, and H in the protection bits (XYZ) of EAV (End of Active Video) and SAV (Start of Active Video) and error correction flags P3, P2, P1, and P0 is outside the video specifications.

- ILLEGAL Code

An error is counted when the input signal data is outside the timing reference signal (TRS) range or the range specified for the ancillary data flag (ADF) and "000h to 003h" or "3FCh to 3FFh" is detected.

In SDI signals, 000h to 003h and 3FCh to 3FFh (expressed as 10 bit data) are designed to be used as timing reference signals and ancillary data flags, they cannot be used as video signal data or ancillary data. An error is counted when data other than timing reference signal or ancillary data flag is present in this area.

- Line Number (other than SD)

An error is counted when the line number that is embedded in the input signal does not match the line number that has been counted by the instrument.

- Check Sum

The instrument uses the checksum in the input signal's ancillary data header to count errors.

- Parity

The instrument uses the parity bit in the input signal's ancillary data header to count errors.

- BCH (other than SD)

The instrument counts the errors in the BCH code in the input signal's embedded audio.

- Parity (other than SD)

The instrument counts the parity errors in the input signal's embedded audio.

- DBN

The instrument counts the continuity errors in the input signal's embedded audio.

Embedded audio packets contain data block number words (DBN), which indicate packet continuity. A serial number between 1 and 255 is assigned to each packet. An error is counted when this DBN is not continuous between packets.

If DBN does not repeat the values from 1 and 255 and is fixed to 0, it is not detected as an error.

16. STATUS DISPLAY

- Inhibit

An error is counted when embedded audio packets are found in lines where they should not be embedded. The embedding inhibit lines are as follows.

However, for 3G-B-DL 60p, 59.94p, 50p, 48p, and 47.95p, the transmission scanning mode is interlace. For 12G and 6G, the line numbers are those of the sub images divided into the HD and 3G data structure.

Table 16-1 Embedding inhibit lines

Format		Transmission Scanning Mode	
		Progressive	Interlace
12G/6G	3840(4096)×2160	Line 8	-
HD/3G	1280×720	Line 8	-
	1920×1080	Line 8	Lines 8, 570
SD	720×487	-	Lines 11, 274
	720×576	-	Lines 7, 320

- Audio Sample

An error is counted when audio that is asynchronous to the video is embedded. For the video and audio to be synchronized, there is a specific number of audio data samples that need to be embedded in a given number of video frames. If this rule is not met, it is considered an error.

- Freeze

An error is counted when the video data is the same between video frames. Specify an area of the video to use for detection and the number of continuous frames that is required for the condition to be detected as an error.

Video data is compared using checksums.

- Black

An error is counted when the video luminance level is less than the specified value.

Set the luminance level for detecting error pixels, the ratio of error pixels in a frame, and the number of continuous frames that is required for the condition to be detected as an error.

- Gamut

Gamut errors are counted.

Set the upper and lower limits for detecting errors, the ratio of error pixels in a frame, and the number of continuous frames that is required for the condition to be detected as an error.

- Comp Gamut

Composite gamut errors are counted.

Set the upper and lower limits for detecting errors, the ratio of error pixels in a frame, and the number of continuous frames that is required for the condition to be detected as an error.

- Level Y

An error is counted when the luminance level is outside the specified range.

Set the upper and lower limits for detecting errors.

16. STATUS DISPLAY

- Level C

An error is counted when the chrominance level is outside the specified range.
Set the upper and lower limits for detecting errors.

- SinceReset

The time that has elapsed since F•7 ERROR CLEAR was pressed, the instrument was initialized, or the instrument was restarted is displayed.

16.2 Configuring Error Detection Settings

To configure the error detection settings, use **F•5** STATUS SETUP.

When error detection is set to ON, the following actions are performed when an error occurs.

- Counts errors on the status display.
- Displays errors in the event log of the status display
- Displays "ERROR" in the upper right of the display.
- Transmits a signal from the alarm output remote terminal

16.2.1 Error Setup 1

Use the ERROR SETUP1 tab to configure error detection settings for SDI signals.



Figure 16-2 ERROR SETUP1 tab

• Error Counter

Sec: Errors are counted in units of seconds. Even if multiple errors occur within the same second, only a single error is counted.

Field: Errors are counted in units of fields (frames). Even if multiple errors occur within the same field (frame), only a single error is counted.

• TRS Error

Select whether to detect TRS Pos and TRS Code errors.

OFF / ON

• Line Number Error(Except SD)

Select whether to detect line number errors. This setting is valid when the input signal is not SD.

OFF / ON

16. STATUS DISPLAY

- CRC Error(Except SD)

Select whether to detect CRC errors. This setting is valid when the input signal is not SD.

OFF / ON

- EDH Error(SD)

Select whether to detect EDH errors. This setting is valid when the input signal is SD.

OFF / ON

- Illegal Code Error

Select whether to detect illegal code errors.

OFF / ON

- Frequency Error

Select whether to detect frequency deviation errors.

Even when this is set to OFF, the frequency deviation is still shown in the status display.

OFF / ON

- Cable Error

Select whether to detect cable errors.

Even when this is set to OFF, the cable length is still shown in the status display.

OFF / ON

- 12G Cable Error / Warning

Set the upper cable error limit and the upper cable warning limit for 12G input signals. If the value on the left side is exceeded, an error will occur, and the measured value on the status display will be displayed in red.

If the value on the right side is exceeded, a warning will occur, and the measured value on the status display will be displayed in yellow.

The cable used in cable length measurement is L-5.5CUHD.

10 – 80 m

- 3G Cable

Select the cable to use for cable length measurements when the input signal is 3G.

LS-5CFB / 1694A

- 3G Cable Error / Warning

Set the upper cable error limit and the upper cable warning limit for 3G input signals. If the value on the left side is exceeded, an error will occur, and the measured value on the status display will be displayed in red.

If the value on the right side is exceeded, a warning will occur, and the measured value on the status display will be displayed in yellow.

10 – 100 m

16. STATUS DISPLAY

- HD Cable

Select the cable to use for cable length measurements when the input signal is HD.

LS-5CFB / 1694A

- HD Cable Error / Warning

Set the upper cable error limit and the upper cable warning limit for HD input signals. If the value on the left side is exceeded, an error will occur, and the measured value on the status display will be displayed in red.

If the value on the right side is exceeded, a warning will occur, and the measured value on the status display will be displayed in yellow.

10 - 130 m

- SD Cable

Select the cable to use for cable length measurements when the input signal is SD.

L-5C2V / 8281

- SD Cable Error / Warning

Set the upper cable error limit and the upper cable warning limit for SD input signals. If the value on the left side is exceeded, an error will occur, and the measured value on the status display will be displayed in red.

If the value on the right side is exceeded, a warning will occur, and the measured value on the status display will be displayed in yellow.

50 - 200 m

16.2.2 Error Setup 2

Use the ERROR SETUP2 tab to configure ancillary data and embedded audio error detection settings.



Figure 16-3 ERROR SETUP2 tab

16. STATUS DISPLAY

- Parity Error

Select whether to detect parity errors in the ancillary data.

OFF / ON

- Checksum Error

Select whether to detect checksum errors in the ancillary data.

OFF / ON

- BCH Error(Except SD)

Select whether to detect BCH errors in the embedded audio. This setting is valid when the input signal is not SD.

OFF / ON

- DBN Error

Select whether to detect DBN errors in the embedded audio.

OFF / ON

- Parity Error(Except SD)

Select whether to detect parity errors in the embedded audio. This setting is valid when the input signal is not SD.

OFF / ON

- Inhibit Line Error

Select whether to detect embedding errors in the embedded audio.

OFF / ON

- Sample Count Error

Select whether to detect sample number errors in the embedded audio.

An error is counted when audio that is asynchronous to the video is embedded. If a certain number of audio data samples are not embedded in a certain number of video frames, it will be considered an error (as defined in SMPTE ST 299 and SMPTE ST 272).

OFF / ON

16. STATUS DISPLAY

16.2.3 Error Setup 3

In the ERROR SETUP3 tab, configure gamut error settings.



Figure 16-4 ERROR SETUP3 tab

- LowPass Filter

Select the frequency response of the low-pass filter used for gamut error and composite gamut error detection. Set this to remove transient errors caused by overshoot and other anomalies.

HD/SD: 1MHz / HD: 2.8MHz SD: 1MHz / OFF

- Gamut Error

Select whether to detect gamut errors.

ON / OFF

- Gamut Upper

Set the gamut error upper limit. An error occurs when the input signal level exceeds the specified value.

In the 5-bar GBR display, levels that are greater than or equal to the specified value are displayed in red.

90.8 - 109.4%

- Gamut Lower

Set the gamut error lower limit. An error occurs when the input signal level goes below the specified value.

In the 5-bar GBR display, levels that are less than or equal to the specified value are displayed in red.

-7.2 - 6.1%

16. STATUS DISPLAY

- Area

Specify the percentage of the active picture area over which errors must occur to be recognized as an error. You cannot configure this setting when Gamut Error is set to OFF.

0.0 - 1.0 - 5.0%

- Duration

Set the number of consecutive video frames over which errors must occur to be recognized as an error. You cannot configure this setting when Gamut Error is set to OFF.

1 - 60 Frames

- Composite Gamut Error

Select whether to detect composite gamut errors.

ON / OFF

- Setup

Select the setup level to add when converting component signals to composite signals.

<u>0%</u> :	No setup level is added.
7.5%:	A setup level of 7.5 % is added.

- Composite Upper

Set the composite gamut error upper limit. An error occurs when the input signal level exceeds the specified value.

In the 5-bar CMP display, levels that are greater than or equal to the specified value are displayed in red.

90.0 - 135.0%

- Composite Lower

Set the composite gamut error lower limit. An error occurs when the input signal level goes below the specified value.

In the 5-bar CMP display, levels that are less than or equal to the specified value are displayed in red.

-40.0 - 20.0%

- Area

Specify the percentage of the active picture area over which errors must occur to be recognized as an error. You cannot configure this setting when Composite Gamut Error is set to OFF.

0.0 - 1.0 - 5.0%

16. STATUS DISPLAY

- Duration

Set the number of consecutive video frames over which errors must occur to be recognized as an error. You cannot configure this setting when Composite Gamut Error is set to OFF.

1 - 60 Frames

- Gamut Details

Turns on and off the extended display of gamut error.

ON / OFF

16.2.4 Error Setup 4

On the ERROR SETUP4 tab, configure freeze error, black error, and level error settings.

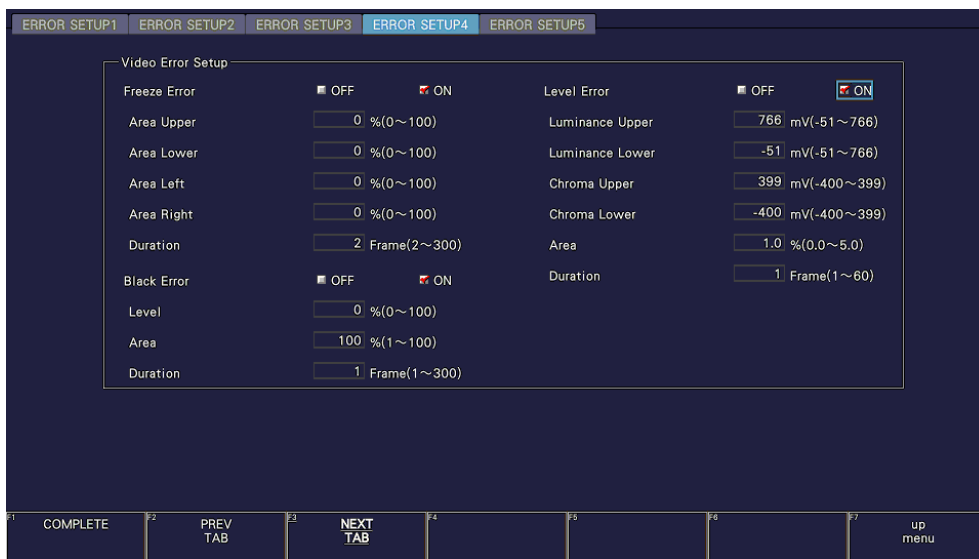

Figure 16-5 ERROR SETUP4 tab

- Freeze Error

Select whether to detect freeze errors. If you set this to OFF, you cannot configure the following settings.

ON / OFF

16. STATUS DISPLAY

- Area Upper / Area Lower / Area Left / Area Right

Set what percent of each active picture area (the upper, lower, left, and right areas) will not be subject to error detection.

0 - 100%

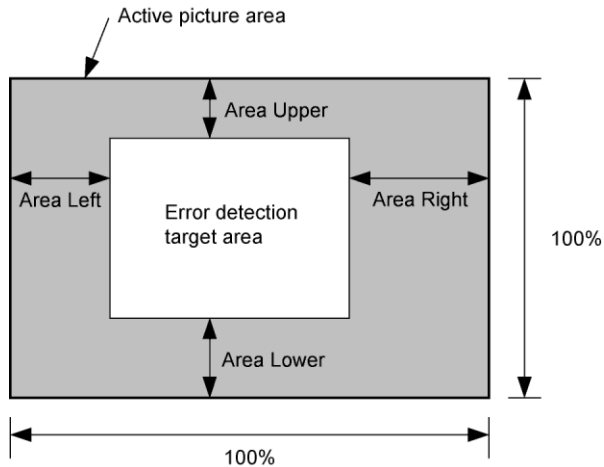

- Duration

Set the number of consecutive video frames over which errors must occur to be recognized as an error.

2 - 300 Frames

- Black Error

Select whether to detect black errors. If you set this to OFF, you cannot configure the following settings.

ON / OFF

- Level

Set the black error level. Any signals that are less than or equal to the specified value will be detected as errors.

0 - 100%

- Area

Specify the percentage of the active picture area over which errors must occur to be recognized as an error.

1 - 100%

- Duration

Set the number of consecutive video frames over which errors must occur to be recognized as an error.

1 - 300 Frames

16. STATUS DISPLAY

- Level Error

Select whether to detect level errors. If you set this to OFF, you cannot configure the following settings.

ON / OFF

- Luminance Upper

Set the luminance level error upper limit. An error occurs when the input signal level exceeds the specified value.

In the 5-bar Y display, levels that are greater than or equal to the specified value are displayed in red.

-51 - 766mV

- Luminance Lower

Set the luminance level error lower limit. An error occurs when the input signal level goes below the specified value.

In the 5-bar Y display, levels that are less than or equal to the specified value are displayed in red.

-51 - 766mV

- Chroma Upper

Set the chroma level error upper limit. An error occurs when the input signal level exceeds the specified value.

-400 - 399mV

- Chroma Lower

Set the chroma level error lower limit. An error occurs when the input signal level goes below the specified value.

-400 - 399mV

- Area

Specify the percentage of the active picture area over which errors must occur to be recognized as an error.

0.0 - 1.0 - 5.0%

- Duration

Set the number of consecutive video frames over which errors must occur to be recognized as an error.

1 - 60 Frames

16.3 Clearing Error Counts

To clear the error counts and SinceReset, follow the procedure below.

Procedure

STATUS	→	F•7	ERROR CLEAR
--------	---	-----	-------------

16.4 Configuring Event Log Settings

To display the event log, follow the procedure below.

The event log displays a list of the events that have occurred.

The applicable event-detection channels are all A/B channels. However, when measuring 3G(DL)-4K, 6G or 12G, events are detected only for displayed channels.

Procedure

STATUS	→	F•1	EVENT LOG
--------	---	-----	-----------

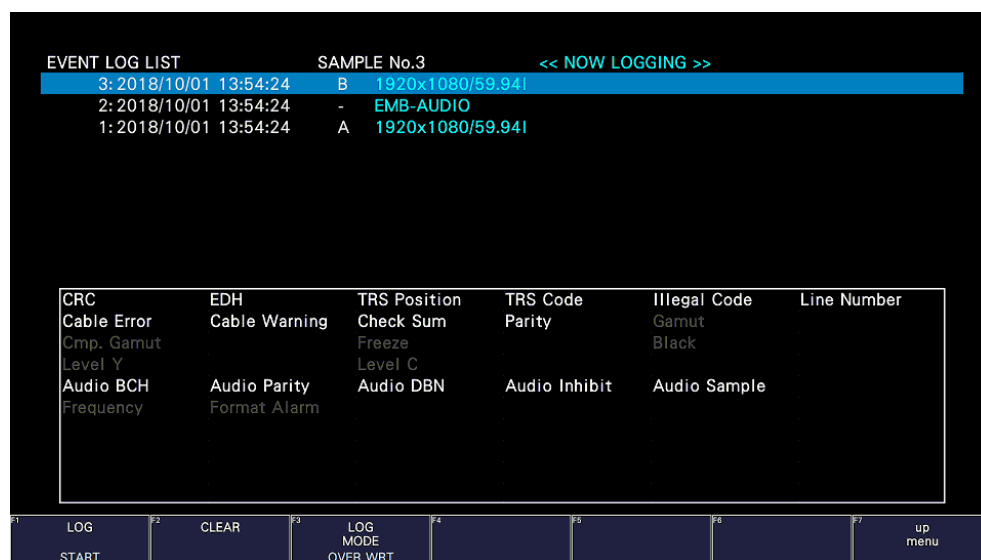

Figure 16-6 Event log display

16.4.1 Event Log Screen Description

Events are listed on the event log screen by the time of their occurrence.

Turn the function dial (F•D) to the right to scroll the screen and view older events in the log. Press the function dial (F•D) to display the latest events.

• Notes

- When the same event occurs successively and when multiple events occur at the same time, they are treated as a single event.
- When multiple events occur at the same time, you may not be able to check all the events on the screen. When this happens, you can view all the events by saving them to a USB memory device.
- The event display is cleared when you turn the power off.
- Switching video formats or input channels may cause disturbances in the signal that will cause errors to be displayed.

16. STATUS DISPLAY

- Time Display

The time is displayed in the format specified by Time that you select by pressing **SYS** → **F•2** SYSTEM SETUP.

- Channel display

The input channel is displayed.

A “-” is displayed for audio events detected by SER20.

- Format Display

The input format is displayed.

If there is no input signal, “NO SIGNAL” is displayed.

- Event Display

Events are displayed one line at a time in rectangular frames. In the frame, the event occurrence state is shown for the number that you selected with the function dial (F•D). Further, for audio events detected by SER20, the corresponding channels are shown. The colors are used in frames to indicate different states. Gray indicates not applicable for counting. White indicates no event. Red indicates that an event is occurring. Green indicates that an event occurred in the past (not occurring currently).

The events that are displayed in the event log are listed below.

Of the items listed below, only those whose detection settings have been set to ON on the SDI IN SETUP2 tab of the SYS menu, GAMUT COLOR LOG and MAX FALL/CLL ERROR of the PIC menu, STATUS SETUP of the STATUS menu, ERROR SETUP of the EYE menu, and ERROR SETUP of the AUDIO menu are displayed.

Table 16-2 Events

Model/Option	Event Name (in frame)	Event Name (one line display)	Description
LV5300/LV5300A/LV5350/ LV7300-SER01/LV7300-SER02/ SE23/SER28	CRC	CRC	CRC Error(Except SD)
	EDH	EDH	EDH Error(SD)
	TRS Position	TRS Position	TRS Position Error
	TRS_Code	TRS_Code	TRS Code Error
	Illegal Code	Illegal Code	Illegal Code Error
	Line Number	Line Number	Line Number Error(Except SD)
	Cable Error	Cable Error	Cable Error
	Cable Warning	Cable Warning	Cable Warning
	Check Sum	Check Sum	Ancillary Data Checksum Error
	Parity	Parity	Ancillary Data Parity Error
	Gamut	Gamut	Gamut Error(Gamut Details = OFF)
	Gmt R	Gamut R	Gamut Error R UPPER(Gamut Details = ON)
	Gmt G	Gamut G	Gamut Error G UPPER(Gamut Details = ON)
	Gmt B	Gamut B	Gamut Error B UPPER(Gamut Details = ON)
	Gmt r	Gamut r	Gamut Error R LOWER(Gamut Details = ON)
	Gmt g	Gamut g	Gamut Error G LOWER(Gamut Details = ON)
Gmt b	Gamut b	Gamut Error B LOWER(Gamut Details = ON)	

16. STATUS DISPLAY

Model/Option	Event Name (in frame)	Event Name (one line display)	Description
	Gamut ST1	Gamut ST1	Gamut Error Stream 1(Gamut Details = OFF)
	Gmt R ST1	Gamut R ST1	Gamut Error Stream 1 R UPPER(Gamut Details = ON)
	Gmt G ST1	Gamut G ST1	Gamut Error Stream 1 G UPPER(Gamut Details = ON)
	Gmt B ST1	Gamut B ST1	Gamut Error Stream 1 B UPPER(Gamut Details = ON)
	Gmt r ST1	Gamut r ST1	Gamut Error Stream 1 R LOWER(Gamut Details = ON)
	Gmt g ST1	Gamut g ST1	Gamut Error Stream 1 G LOWER (Gamut Details = ON)
	Gmt b ST1	Gamut b ST1	Gamut Error Stream 1 B LOWER (Gamut Details = ON)
	Gamut ST2	Gamut ST2	Gamut Error Stream 2(Gamut Details = OFF)
	Gmt R ST2	Gamut R ST2	Gamut Error Stream 2 R UPPER(Gamut Details = OFF)
	Gmt G ST2	Gamut G ST2	Gamut Error Stream 2 G UPPER(Gamut Details = OFF)
	Gmt B ST2	Gamut B ST2	Gamut Error Stream 2 B UPPER(Gamut Details = OFF)
	Gmt r ST2	Gamut r ST2	Gamut Error Stream 2 r LOWER(Gamut Details = OFF)
	Gmt g ST2	Gamut g ST2	Gamut Error Stream 2 g LOWER(Gamut Details = OFF)
	Gmt b ST2	Gamut b ST2	Gamut Error Stream 2 b LOWER(Gamut Details = OFF)
	Cmp. Gamut	Cmp. Gamut	Composite Gamut Error
	Cmp. Gamut ST1	Cmp. Gamut ST1	Composite Gamut Error Stream 1
	Cmp. Gamut ST2	Cmp. Gamut ST2	Composite Gamut Error Stream 2
	Freeze	Freeze	Freeze Error
	Freeze ST1	Freeze ST1	Freeze Error Stream 1
	Freeze ST2	Freeze ST2	Freeze Error Stream 2
	Black	Black	Black Error
	Black ST1	Black ST1	Black Error Stream 1
	Black ST2	Black ST2	Black Error Stream 2
	Level Y	Level Y	Luminance Error(Gamut Details = OFF)
	Level Y	Level Y	Luminance Error Y UPPER(Gamut Details = ON)
	Level y	Level y	Luminance Error Y LOWER(Gamut Details = ON)
	Level Y ST1	Level Y ST1	Luminance Error Stream 1(Gamut Details = OFF)
	Level Y ST1	Level Y ST1	Luminance Error Stream 1 Y UPPER(Gamut Details = ON)
	Level y ST1	Level y ST1	Luminance Error Stream 1 Y LOWER(Gamut Details = ON)
	Level Y ST2	Level Y ST2	Luminance Error Stream 2(Gamut Details = OFF)
	Level Y ST2	Level Y ST2	Luminance Error Stream 2 Y UPPER(Gamut Details = ON)
	Level y ST2	Level y ST2	Luminance Error Stream 2 Y LOWER(Gamut Details = ON)

16. STATUS DISPLAY

Model/Option	Event Name (in frame)	Event Name (one line display)	Description
	Level C	Level C	Chroma Error
	Level C ST1	Level C ST1	Chroma Error Stream 1
	Level C ST2	Level C ST2	Chroma Error Stream 2
	Audio BCH	Audio BCH	Embedded Audio BCH Error(Except SD)
	Audio Parity	Audio Parity	Embedded Audio Parity Error(Except SD)
	Audio DBN	Audio DBN	Embedded Audio DBN Error
	Audio Inhibit	Audio Inhibit	Embedded Audio Inhibit Line Error
	Audio Sample	Audio Sample	Embedded Audio Sample Count Error
	Frequency	Frequency	Frequency Error
	Format Alarm	Format Alarm	Format Alarm
	Max Fall	MAX FALL	MAX FALL Error
	Max Fall ST1	MAX FALL ST1	MAX FALL Error Stream 1
	Max Fall ST2	MAX FALL ST2	MAX FALL Error Stream 2
	Max Cll	MAX CLL	MAX CLL Error
	Max Cll ST1	MAX CLL ST1	MAX CLL Error Stream 1
Max Cll ST2	MAX CLL ST2	MAX CLL Error Stream 2	
LV5300/LV5300A/LV7300-SER02 (other than 12G) LV5300/LV5300A+SER28/ LV7300-SER02+SER28 (12G)	EYE Jitter	EYE 12G Jitter	12G Jitter Error
		EYE 6G Jitter	6G Jitter Error
		EYE 3G Jitter	3G Jitter Error
		EYE HD Jitter	HD Jitter Error
		EYE SD Jitter	SD Jitter Error
	EYE T Jitter	EYE 12G T Jitter	12G Timing Jitter Error
		EYE 6G T Jitter	6G Timing Jitter Error
		EYE 3G T Jitter	3G Timing Jitter Error
		EYE HD T Jitter	HD Timing Jitter Error
		EYE SD T Jitter	SD Timing Jitter Error
	EYE Tr_Tf	EYE 12G Tr_Tf	12G Deltatime Error(Tr-Tf)
		EYE 6G Tr_Tf	6G Deltatime Error(Tr-Tf)
		EYE 3G Tr_Tf	3G Deltatime Error(Tr-Tf)
		EYE HD Tr_Tf	HD Deltatime Error(Tr-Tf)
		EYE SD Tr_Tf	SD Deltatime Error(Tr-Tf)
	EYE Tf	EYE 12G Tf	12G Falltime Error
		EYE 6G Tf	6G Falltime Error
		EYE 3G Tf	3G Falltime Error
		EYE HD Tf	HD Falltime Error
		EYE SD Tf	SD Falltime Error
	EYE Tr	EYE 12G Tr	12G Risetime Error
		EYE 6G Tr	6G Risetime Error
		EYE 3G Tr	3G Risetime Error
		EYE HD Tr	HD Risetime Error
		EYE SD Tr	SD Risetime Error
	EYE Amp.	EYE 12G Amp.	12G Amplitude Error
		EYE 6G Amp.	6G Amplitude Error
		EYE 3G Amp.	3G Amplitude Error
		EYE HD Amp.	HD Amplitude Error
		EYE SD Amp.	SD Amplitude Error
EYE Or	EYE 12G Or	12G OverShoot Rising Error	
	EYE 6G Or	6G OverShoot Rising Error	
	EYE 3G Or	3G OverShoot Rising Error	
	EYE HD Or	HD OverShoot Rising Error	
	EYE SD Or	SD OverShoot Rising Error	
EYE Of	EYE 12G Of	12G OverShoot Falling Error	
	EYE 6G Of	6G OverShoot Falling Error	
	EYE 3G Of	3G OverShoot Falling Error	

16. STATUS DISPLAY

Model/Option	Event Name (in frame)	Event Name (one line display)	Description
		EYE HD Of	HD OverShoot Falling Error
		EYE SD Of	SD OverShoot Falling Error
SER20	Validity	Validity	Validity Error
	CRC	CRC	CRC Error
	Clip	Clip	Clip
	Mute	Mute	Mute
	Level Ov.	Level Ov.	Level Over
	Parity	Parity	Parity Error
	Code Vil.	Code Vil.	Code Violation

16.4.2 Starting the Event Log

To start the event log, follow the procedure below.

Procedure

STATUS	→	F•1	EVENT LOG	→	F•1	LOG: <u>START</u> / <u>STOP</u>
--------	---	-----	-----------	---	-----	---------------------------------

Settings

START: The event log is started. "NOW LOGGING" appears in the upper right of the event log.

STOP: The event log is stopped. "LOGGING STOPPED" appears in the upper right of the event log.

16.4.3 Clearing the Event Log

To delete the event log, follow the procedure below.

Procedure

STATUS	→	F•1	EVENT LOG	→	F•2	CLEAR
--------	---	-----	-----------	---	-----	-------

16.4.4 Selecting the Overwrite Mode

Up to 1000 events can be displayed. To select the action to perform when more than 1000 events occur, follow the procedure below.

Procedure

STATUS	→	F•1	EVENT LOG	→	F•3	LOG MODE: <u>OVER WRT</u> / STOP
--------	---	-----	-----------	---	-----	----------------------------------

Settings

OVER WRT: Oldest events are overwritten.

STOP: Additional events are not recorded.

16. STATUS DISPLAY

16.4.5 Saving to a USB Memory Device

You can save the event log to a USB memory device as a text file.
To save a file with a name that you specify, follow the procedure below.

1. Used to connect USB memory.
2. Press **F•6** USB MEMORY.

The file list screen appears.

This setting appears when a USB memory device is connected.

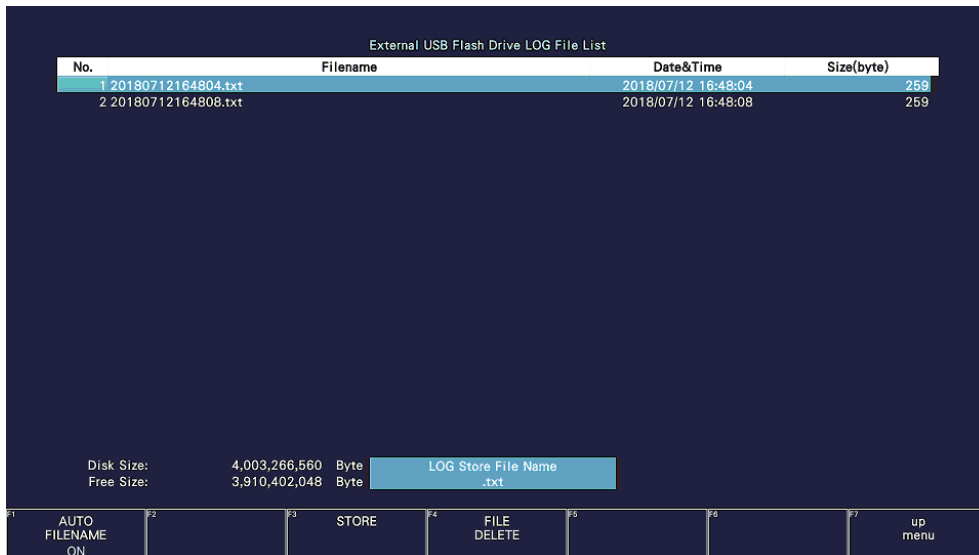

Figure 16-7 File list screen

3. Set **F•1** AUTO FILENAME to OFF.
4. Press **F•2** NAME INPUT.

The file name input display appears.

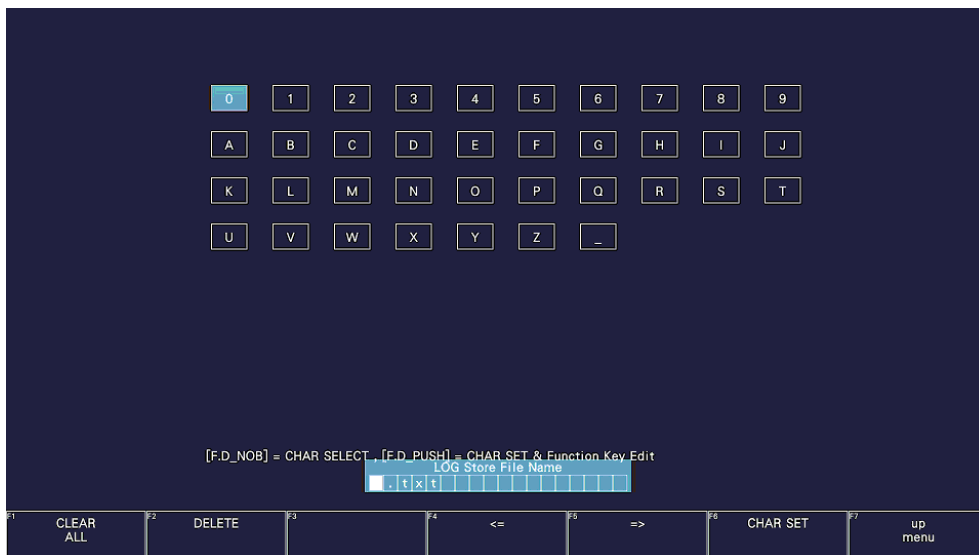

Figure 16-8 File name input screen

16. STATUS DISPLAY

5. Enter a file name using up to 14 characters.

The key operations that you can perform in the file name input display are as follows:

F•1	CLEAR ALL	Deletes all characters
F•2	DELETE	Deletes the character at the cursor
F•4	<=	Moves the cursor to the left
F•5	=>	Moves the cursor to the right
F•6	CHAR SET	Enters the character
Function dial (F•D)		Turn to select a character, and press to enter the character.

You can also copy the file name of an already saved file. To copy a file name, move the cursor to the file in the file list whose name you want to copy, and then press the function dial (F•D).

6. Press **F•7** up menu.
7. Press **F•3** STORE.

If a file with the same name that you have specified already exists on the USB memory device, an overwrite confirmation menu appears. To overwrite the existing preset, **F•1** OVER WR YES. Otherwise, press **F•3** OVER WR NO.

- Deleting an Event Log

To delete an event log that has been saved to the USB memory device, select the log file on the file list display, and then press **F•4** FILE DELETE. To delete the file, press **F•1** DELETE YES. To cancel the delete operation, press **F•3** DELETE NO.

- Automatic File Name Generation

If you set **F•1** AUTO FILENAME to ON, the file name will be generated automatically in the format "YYYYMMDDhhmmss" when you save the file. In this situation, **F•2** NAME INPUT is not displayed.

- USB Memory Device Folder Structure

Event logs are saved in the LOG folder.

- 📁 USB memory device
 - ↳ 📁 LV5300_USER, LV5350_USER or LV7300_USER
 - ↳ 📁 LOG
 - ↳ 📄 YYYYMMDDhhmmss.txt

16.5 Configuring the Data Dump Settings

To view the data dump, follow the procedure below.

In the data dump, the data of the selected line is listed. You can change the line number using the V POS knob and the sample number using the H POS knob. (You can also use the function dial (F•D).

Changing this setting will also change the selected line on the video-signal-waveform, vector, and picture displays.

Procedure

STATUS	→	F•2	SDI ANALYSIS	→	F•1	DATA DUMP
--------	---	-----	--------------	---	-----	-----------



Figure 16-9 Data dump display

16. STATUS DISPLAY

16.5.1 Data Dump Display Description

- Detection Code Display

The input signal's embedded ancillary data is detected, and the following detection codes are displayed.

Table 16-3 Detection code display

Detection Code	Display Colors	Description
ADF	Cyan	Ancillary data flags (000h, 3FFh, and 3FFh)
DID	Cyan	Data identification (the data after ADF)
SDID	Cyan	SECONDARY DATA IDENTIFICATION (the secondary format data when the DID is smaller than 80h)
DBN	Cyan	DATA BLOCK NUMBERS (the primary data format when the DID is larger than 80h)
DC	Cyan	Data count (the data after the SDID/DBN)
UDW	Cyan	User data words (the user data words of the data count length after ADF)
CS	Magenta	Checksum (the data immediately after UDW)
AP	Yellow	ACTIVE PICTURE (From after the SAV to just before the EAV when the selected line is within the active video area)

- Line Number Display

Pictures sent in SDI signals are assigned line numbers as part of the transmission format. The line number is displayed in one of the following formats at the top of the screen.

Figure 16-4 Line number display

Line number display	Description
LINE No.	The picture scan line numbers and the line numbers during transmission are matched.
I/F LINE No.	The picture scan line numbers and the line numbers during transmission are not matched. Line numbers during transmission are displayed.
PIC LINE No.	The picture scan line numbers and the line numbers during transmission are not matched. Picture scan line numbers are displayed.

Normally, the picture scan line numbers and the line numbers for storing those line numbers during transmission are matched. However, they do not match when the following format is received.

If this is the case, you can switch between the picture scan line number (PICTURE) and line numbers during transmission.

Table 16-5 Format

Format	Frame Rate	Switching operation
3G-B-DL	60/59.94/50/48/47.95/P	F•4 DISPLAY (PICTURE/STREAM1/STREAM2)

16. STATUS DISPLAY

As an example, the switching procedure for setting the picture scan line number to 42 when 3G-B-DL (1920×1080/59.94P) is applied is shown below.

1. Data dump is displayed.
2. Set **F•4** DISPLAY to PICTURE.
3. Use the V POS knob to set PIC LINE No. to 42.
4. Set **F•4** DISPLAY to STREAM1.

The line number display changes to I/F LINE No.21.

This indicates that the line number in which the picture scan line number 42 is stored for transmission is 21.

The relationship of other 3G-B-DL line numbers is shown below.

Table 16-6 3G-B-DL line number relationship

Picture scan line number (PIC LINE No.)	Line number during transmission (I/F LINE No.)	
	STREAM1	STREAM2
1	563	1125
2	1	563
n (odd number)	$(n+1)/2+562$	$(n-1)/2$
m (even number)	$m/2$	$m/2+562$

16.5.2 Moving the Display Position

To configure data dump operation settings, press **F•1** DUMP OPERATION on the DATA DUMP menu.

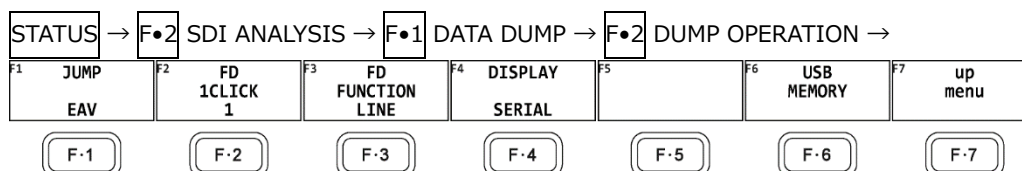

Figure 16-10 DUMP OPERATION menu

To move the data dump sample number to a specific location, follow the procedure below.

Procedure

STATUS → **F•2** SDI ANALYSIS → **F•1** DATA DUMP → **F•2** DUMP OPERATION → **F•1** JUMP
 : EAV / SAV
 : END / START (when the input signal is 4K and **F•5** LINK or **F•5** SUB is set to PICTURE)

Settings

EAV: The display starts with the EAV sample number.
 SAV: The display starts with the SAV sample number.
 END: The last sample number is displayed.
 START: The display starts with sample number 0.

16. STATUS DISPLAY

16.5.3 Selecting the Adjustment Step Resolution

To select the line or sample number adjustment step resolution for when the function dial (F•D) is turned, follow the procedure below.

Procedure

STATUS	→	F•2	SDI ANALYSIS	→	F•1	DATA DUMP	→	F•2	DUMP OPERATION	→	F•2	FD
--------	---	-----	--------------	---	-----	-----------	---	-----	----------------	---	-----	----

1CLICK: 1 / 10 / 50

16.5.4 Selecting What the Function Dial Controls

To select whether the line number or sample number is controlled with the function dial (F•D), follow the procedure below. You can also change the line number using the V POS knob and the sample number using the H POS knob.

Procedure

STATUS	→	F•2	SDI ANALYSIS	→	F•1	DATA DUMP	→	F•2	DUMP OPERATION	→	F•3	FD
--------	---	-----	--------------	---	-----	-----------	---	-----	----------------	---	-----	----

FUNCTION: LINE / SAMPLE

Settings

LINE: Turning the function dial (F•D) changes the line number. If you press the function dial (F•D), the data of line number 0 or 1 is displayed.

SAMPLE: Turning the function dial (F•D) changes the sample number. If you press the function dial (F•D), EAV is displayed.

16.5.5 Selecting the Display Mode

To select the data dump display mode, follow the procedure below.

Procedure

STATUS	→	F•2	SDI ANALYSIS	→	F•1	DATA DUMP	→	F•1	MODE: <u>RUN</u> / HOLD
--------	---	-----	--------------	---	-----	-----------	---	-----	-------------------------

Settings

RUN: The input signal data is automatically updated and displayed.

HOLD: The input signal data is displayed statically.

16. STATUS DISPLAY

DISPLAY = COMPO

DATA DUMP		LINE No.1	Y	Cb	Cr
[EAV]		<1920>	3FF	3FF	
[EAV]		<1921>	000		000
[EAV]		<1922>	000	000	
[EAV]		<1923>	2D8		2D8
LN	LN	<1924>	204	204	
LN	LN	<1925>	200		200
CRC	CRC	<1926>	2BB	2F7	
CRC	CRC	<1927>	23C		1E8
	ADF	<1928>	040	000	
	ADF	<1929>	040		3FF
	ADF	<1930>	040	3FF	
	DID	<1931>	040		2E7
	DBN	<1932>	040	2BE	
	DC	<1933>	040		218
	UDW	<1934>	040	1C4	
	UDW	<1935>	040		203
	UDW	<1936>	040	260	
	UDW	<1937>	040		2A0
	UDW	<1938>	040	2B1	
	UDW	<1939>	040		20F

F1	JUMP	F2	FD 1CLICK	F3	FD FUNCTION	F4	DISPLAY	F5		F6	USB MEMORY	F7	up menu
	EAV		1		LINE		COMPO						

DISPLAY = BINARY

DATA DUMP		LINE No.1	Y	Cb/Cr
[EAV]		<1920>	1111111111	1111111111
[EAV]		<1921>	0000000000	0000000000
[EAV]		<1922>	0000000000	0000000000
[EAV]		<1923>	1011011000	1011011000
LN	LN	<1924>	1000000100	1000000100
LN	LN	<1925>	1000000000	1000000000
CRC	CRC	<1926>	1010111011	1011110111
CRC	CRC	<1927>	1000111100	0111101000
	ADF	<1928>	0001000000	0000000000
	ADF	<1929>	0001000000	1111111111
	ADF	<1930>	0001000000	1111111111
	DID	<1931>	0001000000	1011100111
	DBN	<1932>	0001000000	1000111100
	DC	<1933>	0001000000	1000011000
	UDW	<1934>	0001000000	1000100100
	UDW	<1935>	0001000000	1000000000
	UDW	<1936>	0001000000	1010100000
	UDW	<1937>	0001000000	1010011001
	UDW	<1938>	0001000000	1010011001
	UDW	<1939>	0001000000	1000001111

F1	JUMP	F2	FD 1CLICK	F3	FD FUNCTION	F4	DISPLAY	F5		F6	USB MEMORY	F7	up menu
	EAV		1		LINE		BINARY						

Figure 16-11 Selecting the display format

16. STATUS DISPLAY

16.5.7 Selecting the Content to Display

When the format is set to multi, 6G or 12G, to select which content to display the data dump of, follow the procedure below.

If you select PICTURE, the links and sub images are combined and displayed in a picture structure.

If you select LINK or SUB, the link or sub before combination is displayed in a transmission structure.

This menu appears both in the DATA DUMP menu and DUMP OPERATION menu.

Procedure (for multi link)

STATUS → [F•2] SDI ANALYSIS → [F•1] DATA DUMP → ([F•2] DUMP OPERATION →) [F•5]
LINK
: PICTURE / 1[A] / 2[B]

Procedure (for 6G or 12G)

STATUS → [F•2] SDI ANALYSIS → [F•1] DATA DUMP → ([F•2] DUMP OPERATION →) [F•5] SUB:
PICTURE / 1[A] / 2[B] / 3[C] / 4[D]

16.5.8 Saving to a USB Memory Device

You can save the data dump to a USB memory device as a text file. The procedure to follow to save data is the same as the procedure that was given for the event log. See section 16.4.5, "Saving to a USB Memory Device."

Data dumps are saved in the DUMP folder.

- 📁 USB memory device
 - └ 📁 LV5300_USER, LV5350_USER or LV7300_USER
 - └ 📁 DUMP
 - └ 📄 YYYYMMDDhhmmss.txt

16.6 Configuring Phase Difference Measurement Settings

To show the phase difference measurement display, follow the procedure below.

You can use the phase difference measurement display to measure the phase difference between an SDI signal and an external sync signal or the phase difference between a pair of SDI signals.

Procedure

STATUS → F•2 SDI ANALYSIS → F•2 EXT REF PHASE

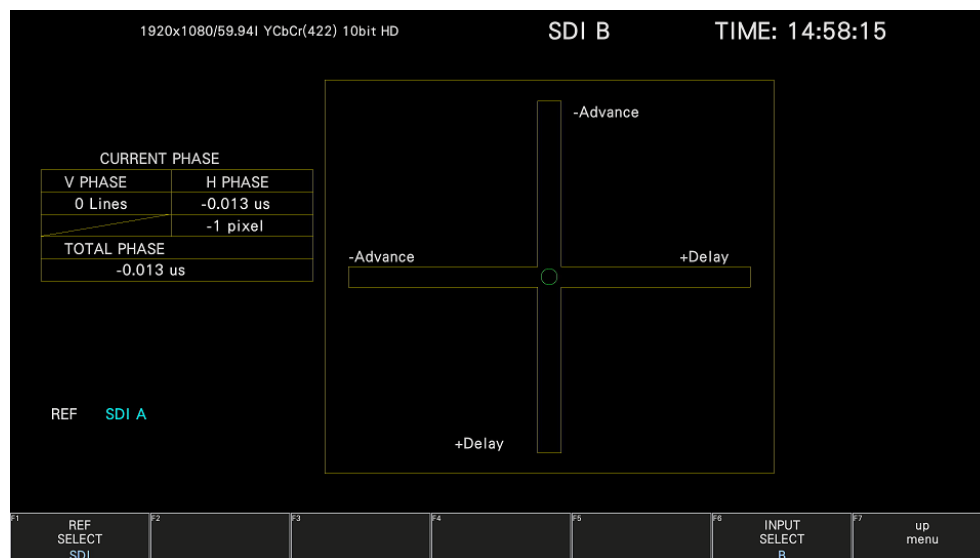

Figure 16-12 Phase difference measurement screen

- Measuring the Phase Difference between an SDI Signal and an External Sync Signal

You can measure the phase difference between an SDI signal and an external sync signal by setting **F•1** REF SELECT to EXT. Apply the external sync signal.

Note that the following input formats are not supported.

- 3G 720/30P, 720/29.97P, 720/25P, 720/24P, 720/23.98P
- Frame frequency 48P, 47.95P

- Measuring the Phase Difference between SDI Signals

You can measure the phase difference between SDI signals by setting **F•1** REF SELECT to SDI. This measurement is not possible when SDI System is set to 4K 12G, or 4K 6G on the SYS > **F•1** SIGNAL IN OUT > SDI IN SETUP1 tab.

The reference signal varies depending on the input signal as shown below.

Figure 16-7 Reference signal

Input Signal	Reference Signal
SD, HD, 3G	Ach
3G(DL)-4K	Link 1

16. STATUS DISPLAY

16.6.1 Phase Difference Measurement Screen Description

- CURRENT PHASE

V PHASE: The phase difference is displayed in units of lines.

H PHASE: The phase difference is displayed in units of time and in units of pixels or clocks. (*1)

TOTAL PHASE: The total of the V PHASE and H PHASE differences is displayed in units of time.

*1 When the input signal is SD, the unit is clocks. Pixels are in units of the video's sampling frequency. Clocks are in units of the parallel video's transmission clock frequency.

- REF

This displays the reference signal as shown below.

Table 16-8 REF indications

F•1 REF SELECT	Display	Description
EXT	EXT BB : DEFAULT	When the reference signal is BB and the phase difference is at the default value
	EXT BB : USER REF	When the reference signal is BB and the phase difference is at the user reference value
	EXT HD : DEFAULT	When the reference signal is HD3 and the phase difference is at the default value
	EXT HD : USER REF	When the reference signal is HD3 and the phase difference is at the user reference value
	NO SIGNAL	When no external sync signal is being applied
SDI	SDI A	When the input signal is SD, HD, or 3G and the reference signal is A
	LINK 1	When the input signal is 3G(DL)-4K and the reference signal is link 1
	SDI A NO SIGNAL	Indicates that the reference SDI signal is not being received.

- Setting the User-Defined Phase Difference Reference

When F•1 REF SELECT is set to EXT, you can set the current phase difference to zero by pressing F•2 REF SET USER. You can change the reference to match the system that you are using.

To reset the phase difference to its default value (see below), press F•3 REF SET DEFAULT.

16. STATUS DISPLAY

- Default Phase Difference Setting

If the input signal is HD or SD and **F•1** REF SELECT is set to EXT, you can use **F•4** 0H TIMING to select the reference where the phase difference is assumed to be zero.

When using a LEADER signal generator that allows you to select LEGACY or SERIAL, this setting must be matched to the setting selected on the instrument. In addition, depending on the output accuracy of the signal generator and measurement accuracy of the instrument, there may be an offset of around 0 ± 4 clocks in the display.

LEGACY: The phase difference is assumed to be zero when an external sync signal without a timing offset transmitted from a LEADER signal generator and an SDI signal are received.

SERIAL: The phase difference is zero when the external sync signal and the SDI signal are received at the times defined in the signal standard.

- Graphical Display

The vertical axis represents the V phase difference in lines. The horizontal axis represents the H phase time difference. When the circles that represent V and H overlap with each other in the center, there is no phase difference.

The circles are normally displayed in white, but they will be displayed in green under the following circumstances.

Horizontal: When the circle is within ± 3 clocks of the center.

Vertical: When the circle is within ± 0 clocks of the center.

When the signal is behind the reference signal, the circle is displayed on the Delay (+) side. When the signal is ahead of the reference signal, the circle is displayed on the Advance (-) side. For both the V and H axes, differences of up to approximately $+1/2$ frames from the center are displayed on the Delay axis and differences of up to approximately $-1/2$ frames from the center are displayed on the Advance axis. See the following table for details.

When the phase difference between an SDI signal and an external sync signal is being measured, the H axis phase difference may vary within a range of ± 1 clock in cases such as when the signal is switched. When the phase difference between SDI signals is being measured, the H difference may vary within a range of ± 2 clock in cases such as when the signal is switched.

16. STATUS DISPLAY

Table 16-9 Delay and Advance axis display ranges (3G-A, 3G-B, HD, SD)

3G-A, 3G-B, HD, SD Format		Displayed on the Advance Axis					Displayed on the Delay Axis			
		V PHASE	H PHASE		V PHASE	H PHASE		V PHASE	H PHASE	
		[Lines]	[us]		[Lines]	[us]		[Lines]	[us]	
3G-A	1080/59.94P	-562	-14.822	to	0	0	to	562	0	
	1080/60P	-562	-14.808	to	0	0	to	562	0	
	1080/50P	-532	-17.771	to	0	0	to	562	0	
3G-B	1080/59.94P	-1124	-14.822	to	0	0	to	1125	0	
	1080/60P	-1124	-14.808	to	0	0	to	1125	0	
	1080/50P	-1124	-17.771	to	0	0	to	1125	0	
3G-A 3G-B HD	1080/59.94I, 1080/29.97P, 1080/29.97PsF	-562	-29.645	to	0	0	to	562	0	
	1080/60I, 1080/30P, 1080/30PsF	-562	-29.616	to	0	0	to	562	0	
	1080/50I, 1080/25P, 1080/25PsF	-562	-35.542	to	0	0	to	562	0	
	1080/23.98P, 1080/23.98PsF	-562	-37.060	to	0	0	to	562	0	
	1080/24P, 1080/24PsF	-562	-37.023	to	0	0	to	562	0	
	720/59.94P	-375	0	to	0	0	to	374	22.230	
	720/60P	-375	0	to	0	0	to	374	22.208	
	720/50P	-375	0	to	0	0	to	374	26.653	
	720/29.97P	-375	0	to	0	0	to	374	44.475	
	720/30P	-375	0	to	0	0	to	374	44.430	
	720/25P	-375	0	to	0	0	to	374	53.319	
	720/23.98P	-375	0	to	0	0	to	374	55.597	
	720/24P	-375	0	to	0	0	to	374	55.542	
	SD	525/59.94I	-262	-63.518	to	0	0	to	262	0
		625/50I	-312	-63.962	to	0	0	to	312	0

16. STATUS DISPLAY

Table 16-10 Delay and Advance axis display ranges (6G)

6G Sub Image Format		Displayed on the Advance Axis								
					Displayed on the Delay Axis					
		V PHASE [Lines]	H PHASE [us]		V PHASE [Lines]	H PHASE [us]		V PHASE [Lines]	H PHASE [us]	
6G	1080/29.97P	-562	-29.645	to	0	0	to	562	0	
	1080/30P	-562	-29.616	to	0	0	to	562	0	
	1080/25P	-562	-35.542	to	0	0	to	562	0	
	1080/23.98P	-562	-37.060	to	0	0	to	562	0	
	1080/24P	-562	-37.023	to	0	0	to	562	0	

Table 16-11 Delay and Advance axis display ranges (12G)

12G Sub Image Format		Displayed on the Advance Axis								
					Displayed on the Delay Axis					
		V PHASE [Lines]	H PHASE [us]		V PHASE [Lines]	H PHASE [us]		V PHASE [Lines]	H PHASE [us]	
12G	1080/59.94P	-562	-14.822	to	0	0	to	562	0	
	1080/60P	-562	-14.808	to	0	0	to	562	0	
	1080/50P	-532	-17.771	to	0	0	to	562	0	
	1080/29.97P	-562	-29.645	to	0	0	to	562	0	
	1080/30P	-562	-29.616	to	0	0	to	562	0	
	1080/25P	-562	-35.542	to	0	0	to	562	0	
	1080/23.98P	-562	-37.060	to	0	0	to	562	0	
	1080/24P	-562	-37.023	to	0	0	to	562	0	

16.7 Setting the Lip Sync Measurement (SER20)

To show the lip sync measurement screen, follow the procedure below.

By combining a Leader signal generator that supports lip syncing with this instrument, you can use the lip sync measurement screen to measure the offset between the video signal and the audio signal that occurs in the transfer route.

Procedure

STATUS → F•2 SDI ANALYSIS → F•3 AV PHASE

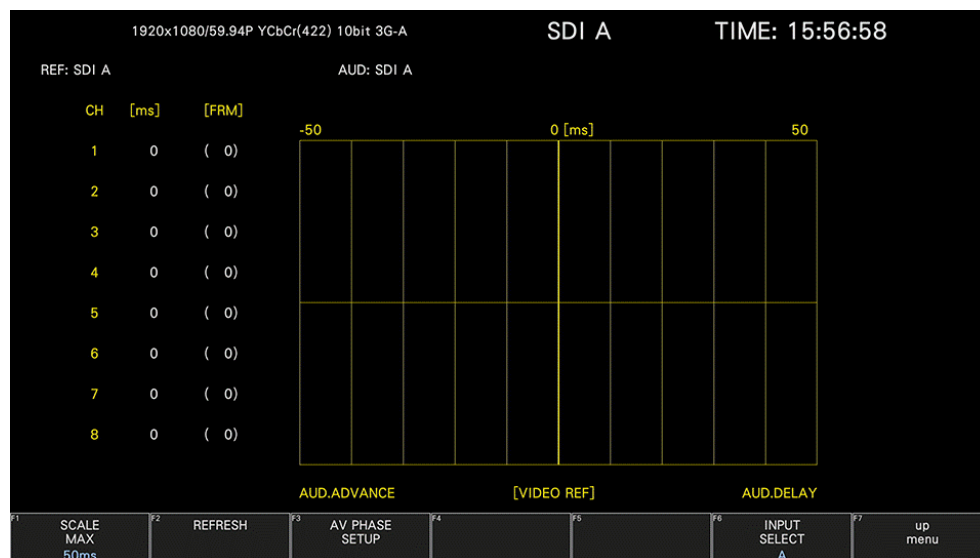

Figure 16-13 Lip sync measurement screen

As an example, below is the procedure for when the LT4600A, LT4610 (with LT4610-SER02 and LT4610-SER24 installed according to the format), or LT4611 (with LT4610-SER22 installed and LT4610-SER02 and LT4611-SER24 installed according to the format) is used for the signal generator with a lip sync feature when the audio output is set to SDI embedded audio.

- Turn the signal generator that supports lip syncing lip sync feature on.
 - On the LT4600A

Select SDI SETTING→SDI→LIPSYNC to turn lip sync on. Select AES/EBU SETTING→AES/EBU 1→LIPSYNC ENABLE to set the audio. For details, see the LT4600A instruction manual.
 - On the LT4610 or LT4611

Depending on the format, select ETC→LIPSYNC→SDI1+AES / SDI2 or 12G OPTION→SDI 1 / 2 / 3 / 4→VIDEO→LIPSYNC to turn lip sync on. Then, select SDI→SDI1 / 2→AUDIO or 12G OPTION→SDI 1 / 2 / 3 / 4→AUDIO to set the audio. For details, see the LT4610 or LT4611 instruction manual.
- Send the signal generated from the signal generator that supports lip syncing SDI output connector to the transfer route. Apply the signal received from the transfer route to the SDI connector of this instrument.
- The lip sync measurement screen is displayed.

Press STATUS → F•2 SDI ANALYSIS → F•3 AV PHASE.

16. STATUS DISPLAY

The time difference when the luminance level of the video signal (the G signal level when the input signal is RGB) exceeds the specified value or when the audio level signal exceeds the specified value is measured, and the results are displayed numerically and graphically for each channel.

The measured value is displayed in units of time and frames. If the audio signal cannot be detected, "UNLOCK" is displayed. If the audio signal cannot be measured correctly, "MISSING" is displayed. Further, when the measured value is updated, an asterisk is displayed next to the channel.

You can set the video signal measurement range, video signal luminance level, and audio signal level using **F•3** AV PHASE SETUP.

16.7.1 Selecting the Measurement Range

To select the graph measurement range, follow the procedure below.

Procedure

STATUS	→	F•2	SDI ANALYSIS	→	F•3	AV PHASE	→	F•1	SCALE MAX: 50ms / 100ms / 500ms / 1.0s / 2.5s
--------	---	-----	--------------	---	-----	----------	---	-----	---

16.7.2 Updating the Measurement Screen

To update the measurement screen, follow the procedure below.

Procedure

STATUS	→	F•2	SDI ANALYSIS	→	F•3	AV PHASE	→	F•2	REFRESH
--------	---	-----	--------------	---	-----	----------	---	-----	---------

16. STATUS DISPLAY

16.7.3 Setting the Measurement Range

To set the measurement range, follow the procedure below. Use the AV PHASE SETUP tab to configure these settings.

Procedure

STATUS → F•2 SDI ANALYSIS → F•3 AV PHASE → F•3 AV PHASE SETUP

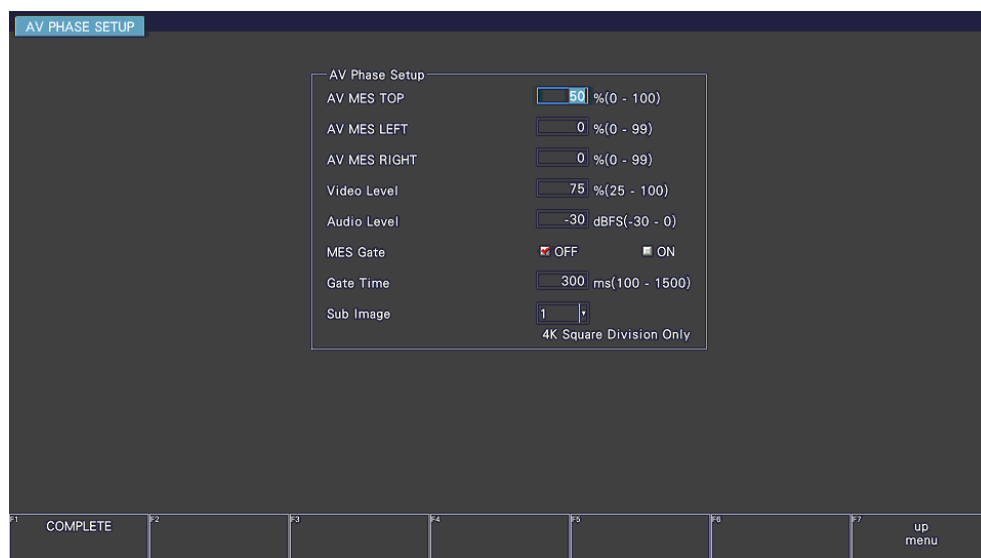

Figure 16-14 AV PHASE SETUP tab

- AV MES TOP

Set the video signal measurement line with the top edge of the picture taken to be 0 % and the bottom edge to be 100 %.

You can also set this using LINE SELECT on the PIC menu while viewing the picture.

[See also] 13.10.3, "Setting the Lip Sync Measurement Range (SER20)"

0 - 50 - 100%

- AV MES LEFT

Set the video signal measurement range (left side) with the left edge of the picture taken to be 0 % and the right edge to be 100 %. You cannot set this to the right of the line set with AV MES RIGHT.

You can also set this using LINE SELECT on the PIC menu while viewing the picture.

[See also] 13.10.3, "Setting the Lip Sync Measurement Range (SER20)"

0 - 99%

- AV MES RIGHT

Set the video signal measurement range (right side) with the right edge of the picture taken to be 0 % and the left edge to be 100 %. You cannot set this to the left of the line set with AV MES LEFT.

You can also set this using LINE SELECT on the PIC menu while viewing the picture.

[See also] 13.10.3, "Setting the Lip Sync Measurement Range (SER20)"

0 - 99%

16. STATUS DISPLAY

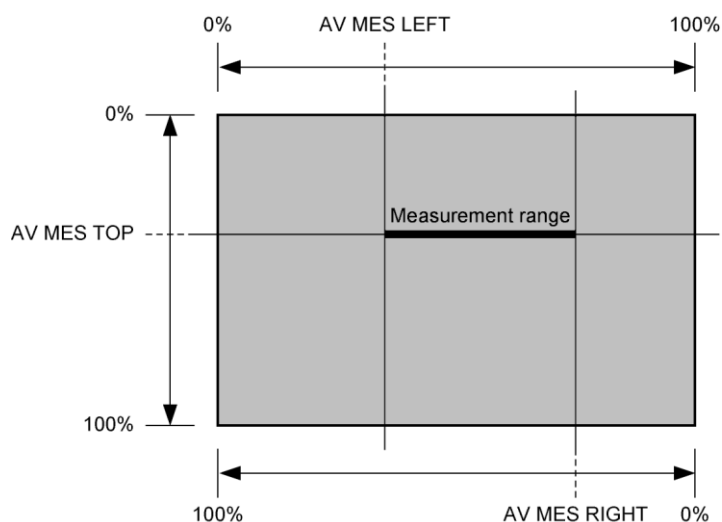

Figure 16-15 Setting the measurement range (video signal)

- Video Level

Set the video signal luminance level. The time difference from the audio signal is measured when the luminance level of the measurement range specified with AV MES exceeds the level specified here.

25 - 75 - 100%

- Audio Level

Set the audio signal level. The time difference from the video signal is measured when the audio signal level exceeds the level specified here.

-30 - 0dBFS

- MES Gate

Select whether to specify the measurement range of the audio signal. Set this to ON such as when using a pattern containing multiple audio signals for a single video signal.

OFF / ON

- Gate Time

When MES Gate is set to ON, set the measurement range of the audio signal. The measurement range is "the rise time of the video signal \pm the time set with Gate Time."

100 - 300 - 1500

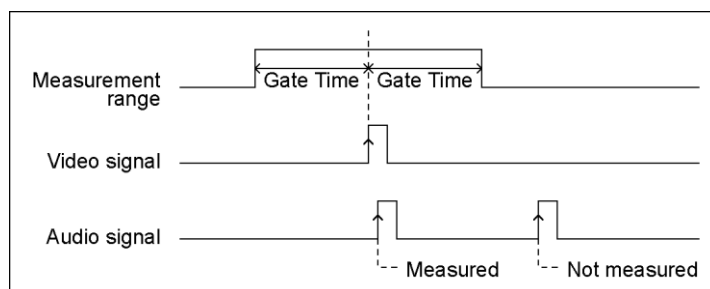

Figure 16-16 Setting the measurement range (audio signal)

16. STATUS DISPLAY

- Sub Image

If the input signal is 12G and Division is set to Square on the SDI IN SETUP2 tab of the SYS menu, select the link for setting the measurement range.

1 / 2 / 3 / 4

16.8 Displaying a List of Ancillary Data

To display a list of ancillary data, follow the procedure below.
Ancillary data not embedded in every frame may not be displayed.

Procedure

STATUS → F•3 ANC DATA VIEWER

STANDARD	DID/SDID	STATUS	LINE No.	PACKET
S291M MARK DEL	80/--	MISSING		
S291M END PKT	84/--	MISSING		
S291M START PKT	88/--	MISSING		
ARIB B.27 CC	CF/--	MISSING		
S299M ctrl G4	E0/--	DETECT	571/F2	2/FRAME
S299M ctrl G3	E1/--	DETECT	571/F2	2/FRAME
S299M ctrl G2	E2/--	DETECT	571/F2	2/FRAME
S299M ctrl G1	E3/--	DETECT	571/F2	2/FRAME
S299M aud G4	E4/--	DETECT	1125/F2	1601/FRAME
S299M aud G3	E5/--	DETECT	1125/F2	1601/FRAME
S299M aud G2	E6/--	DETECT	1125/F2	1601/FRAME
S299M aud G1	E7/--	DETECT	1125/F2	1601/FRAME
S272M ctrl G4	EC/--	MISSING		
S272M ctrl G3	ED/--	MISSING		
S272M ctrl G2	EE/--	MISSING		
S272M ctrl G1	EF/--	MISSING		
RP165 EDH	F4/--	MISSING		
S272M ext G4	F8/--	MISSING		
S272M aud G4	F9/--	MISSING		
S272M ext G3	FA/--	MISSING		
S272M aud G3	FB/--	MISSING		
S272M ext G2	FC/--	MISSING		

Figure 16-17 Ancillary data screen

16.8.1 Ancillary Data Display Description

On the ancillary data screen, data is displayed as a list for each standard. If data is detected, "DETECT" is displayed in the STATUS column. If data is not detected, "MISSING" is displayed in the STATUS column.

- Data Viewing

By turning the function dial (F•D) to the right, you can scroll the screen to view all the data. You can also press **F•2** PAGE UP and **F•3** PAGE DOWN to move between pages. In the upper right of the screen, the "page number/total number of pages" is displayed. If you press the function dial (F•D), the cursor returns to the first data entry.

- Selecting the Displayed Stream

When the input signal is 3G-B, to set the display stream to STREAM1 or STREAM2, press **F•4** STREAM SELECT.

- Selecting the Content to Display

You can select the displayed content using **F•5** LINK when the input signal is multi link and **F•5** SUB when the input signal is 6G and 12G.

16. STATUS DISPLAY

16.8.2 Displaying a Dump of Ancillary Data

To display a dump of the data that you have selected on the ancillary data display, follow the procedure below.

By turning the function dial (F•D) to the right, you can scroll the screen to view all the data. If you press the function dial (F•D), the cursor returns to the first data entry.

Procedure

STATUS	→	F•3	ANC DATA VIEWER	→	F•1	ANC DUMP
--------	---	-----	-----------------	---	-----	----------

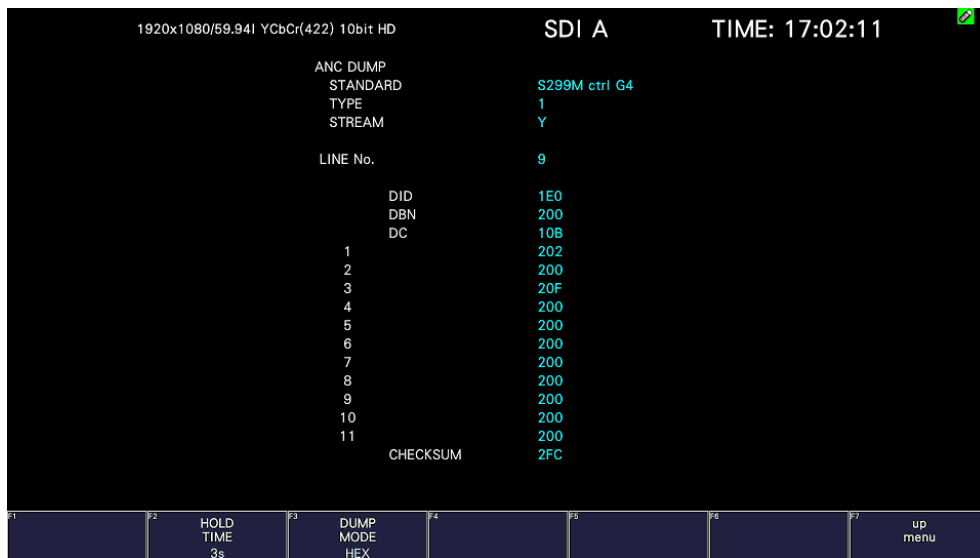

Figure 16-18 Ancillary dump screen

16.8.3 Updating the Dump Display

When the selected data is embedded in multiple lines, the line number that is displayed on the ANC dump screen is switched at a regular interval. (However, the order in which the line numbers are switched is irregular.)

To select the dump display update time, follow the procedure below.

Procedure

STATUS	→	F•3	ANC DATA VIEWER	→	F•1	ANC DUMP	→	F•2	HOLD TIME: HOLD / 1s / <u>3s</u>
--------	---	-----	-----------------	---	-----	----------	---	-----	----------------------------------

Settings

HOLD:	The screen is not updated.
1s:	The screen is updated once per second.
3s:	The screen is updated once every 3 seconds.

16. STATUS DISPLAY

16.8.4 Selecting the Dump Mode

To select the dump mode, follow the procedure below.

Procedure

STATUS	→	F•3	ANC DATA VIEWER	→	F•1	ANC DUMP	→	F•3	DUMP MODE: <u>HEX</u> / BINARY
--------	---	-----	-----------------	---	-----	----------	---	-----	--------------------------------

Settings

HEX:	Data is displayed in hexadecimal format.
BINARY:	Data is displayed in binary format.

DUMP MODE = HEX

1920x1080/59.94i YCbCr(422) 10bit HD		SDI A	TIME: 17:02:11
ANC DUMP		S299M ctrl G4	
STANDARD		1	
TYPE		Y	
STREAM		Y	
LINE No.		9	
	DID	1E0	
	DBN	200	
	DC	10B	
1		202	
2		200	
3		20F	
4		200	
5		200	
6		200	
7		200	
8		200	
9		200	
10		200	
11		200	
	CHECKSUM	2FC	
F1	F2	F3	F4
	HOLD TIME 3s	DUMP MODE HEX	up menu

DUMP MODE = BINARY

1920x1080/59.94i YCbCr(422) 10bit HD		SDI A	TIME: 17:02:59
ANC DUMP		S299M ctrl G4	
STANDARD		1	
TYPE		Y	
STREAM		Y	
LINE No.		571	
	DID	0111100000	
	DBN	1000000000	
	DC	0100001011	
1		1000000010	
2		1000000000	
3		1000001111	
4		1000000000	
5		1000000000	
6		1000000000	
7		1000000000	
8		1000000000	
9		1000000000	
10		1000000000	
11		1000000000	
	CHECKSUM	1011111100	
F1	F2	F3	F4
	HOLD TIME 3s	DUMP MODE BINARY	up menu

Figure 16-19 Selecting the dump mode

16.9 Detecting Ancillary Packets

To display the ancillary packet display, follow the procedure below.

If an ancillary packet is detected, "DETECT" appears. If not, "MISSING" appears. If a dummy packet is detected, "DUMMY" appears.

Procedure

STATUS → F•4 ANC PACKET



Figure 16-20 Ancillary packet screen

- Selecting the Content to Display

You can select the displayed content using **F•5** LINK when the input signal is multi link and **F•5** SUB when the input signal is 6G and 12G.

16.9.1 Ancillary Packet Screen Description

- AUDIO CONTROL PACKET

The embedded audio consists of 4 groups that each contain 4 channels. This makes for a total of 16 channels. A single audio control packet is embedded in each group.

[See also] 16.9.4, "Displaying Audio Control Packets"

- EDH (Error detection and handling; when the input signal is SD)

This packet is used for detecting transmission errors. When multiple devices are connected, this packet can be used to determine which device caused an error. Both full-field and active picture errors are detected.

[See also] 16.9.2, "Displaying EDH Packets"

- LTC (Linear/Longitudinal Time Code)

This is a type of timecode. One packet is embedded per frame.

- VITC (Vertical Interval Time Code)

This is a type of timecode. One packet is embedded per field.

16. STATUS DISPLAY

- PAYLOAD ID

This is a packet that is used to identify the video format. It conforms to SMPTE ST 352.
[See also] 16.9.3, "Displaying Payload IDs"

- EIA-708

This is one of the closed caption specifications. This packet is embedded in the V-ANC area.

This is used for digital video closed caption data. It only supports alphanumeric characters.

[See also] 16.9.11, "Displaying EIA-708 Data"

- EIA-608

This is one of the closed caption specifications. This packet is embedded in the V-ANC area.

This was previously used for analog composite (embedded in line number 21) closed caption data. It only supports alphanumeric characters.

[See also] 16.9.12, "Displaying EIA-608 Data"

- PROGRAM

It is embedded in the V-ANC area.

[See also] 16.9.13, "Displaying Program Data"

- DATA BROADCAST

It is embedded in the V-ANC area.

- VBI (when the input signal is SD)

It is embedded in the V-ANC area.

[See also] 16.9.14, "Displaying VBI Data"

- AFD

It is embedded in the V-ANC area.

[See also] 16.9.11, "Displaying AFD Packets"

- CLOSED CAPTION 1 to 3 (3G-B is not supported)

This is a closed caption information packet that is embedded in the V-ANC area. Up to three closed caption data entries can be embedded.

[See also] 16.9.6, "Displaying Closed Caption Packets"

- NET-Q (3G-B is not supported)

This is an inter-stationary control signal.

[See also] 16.9.7, "Displaying the Inter-Stationary Control Signal"

- TRIGGER PACKET (3G-B is not supported)

This is the data transmission trigger signal.

[See also] 16.9.8, "Displaying the Data Broadcast Trigger Signal"

- USER DATA 1 and 2 (3G-B is not supported)

Up to two packets of user-defined data.

[See also] 16.9.9, "Displaying User Data"

16. STATUS DISPLAY

16.9.2 Displaying EDH Packets

When the input signal is SD, to display the EDH packet screen, follow the procedure below.

Procedure

STATUS	→	F•4	ANC PACKET	→	F•1	PACKET ANALYSIS	→	F•1	EDH
--------	---	-----	------------	---	-----	-----------------	---	-----	-----

- Selecting the Display Format

You can use **F•1** DISPLAY to set the display format to TEXT (text display) or DUMP (dump display).

If you select DUMP, the dump display appears, and you can use the function dial (F•D) to view the entire data. If you press the function dial (F•D), the first data entry is displayed.

- Selecting the Dump Mode

When **F•1** DISPLAY is set to DUMP, you can use **F•2** DUMP MODE to set the dump mode to HEX (hexadecimal display) or BINARY (binary display).

16.9.3 Displaying Payload IDs

To show the payload ID display, follow the procedure below.

Procedure

STATUS	→	F•4	ANC PACKET	→	F•1	PACKET ANALYSIS	→	F•2	PAYLOAD ID
--------	---	-----	------------	---	-----	-----------------	---	-----	------------



Figure 16-21 Payload ID display

- Selecting the Displayed Stream

When the input signal is 3G, to set the display stream to STREAM1 or STREAM2, press **F•4** STREAM SELECT.

- Selecting the Content to Display

You can select the displayed content using **F•5** LINK when the input signal is multi link and **F•5** SUB when the input signal is 6G and 12G.

16. STATUS DISPLAY

16.9.4 Displaying Audio Control Packets

To display audio control packets, follow the procedure below.

Procedure

STATUS	→	F•4	ANC PACKET	→	F•1	PACKET ANALYSIS	→	F•3	CONTROL PACKET
--------	---	-----	------------	---	-----	-----------------	---	-----	----------------

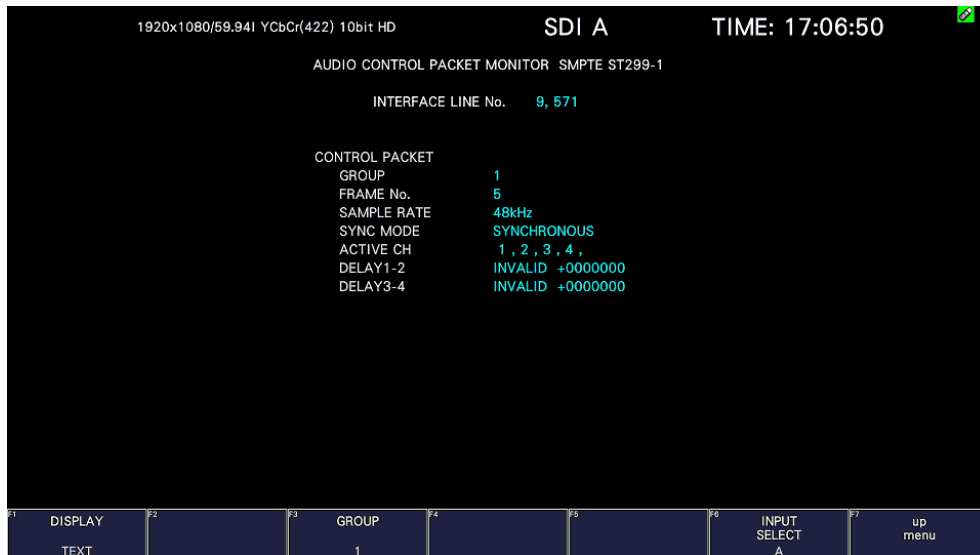

Figure 16-22 Audio control packet screen

- Selecting the Display Format

You can use **F•1** DISPLAY to set the display format to TEXT (text display) or DUMP (dump display).

If you select DUMP, the dump display appears, and you can use the function dial (F•D) to view the entire data. If you press the function dial (F•D), the first data entry is displayed.

- Selecting the Dump Mode

When **F•1** DISPLAY is set to DUMP, you can use **F•2** DUMP MODE to set the dump mode to HEX (hexadecimal display) or BINARY (binary display).

- Selecting the Group to Display

You can use **F•3** GROUP to set the group to display to a group from groups 1 to 4. A single group in the audio signal consists of four channels.

- Selecting the Displayed Stream

When the input signal is 3G-B, to set the display stream to STREAM1 or STREAM2, press **F•4** STREAM SELECT.

- Selecting the Content to Display

You can select the displayed content using **F•5** LINK when the input signal is multi link and **F•5** SUB when the input signal is 6G and 12G.

16. STATUS DISPLAY

16.9.5 V-ANC ARIB Display

To display the V blanking ancillary packets defined in the ARIB standard, use the ARIB menu.

This menu item is not displayed when the input signal is 3G-B.

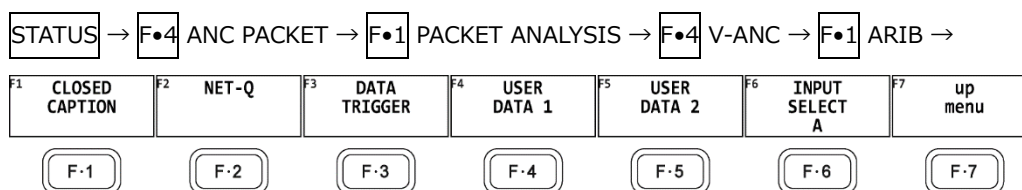

Figure 16-23 V-ANC ARIB menu

16.9.6 Displaying Closed Caption Packets

To display closed caption packets, follow the procedure below.

Procedure

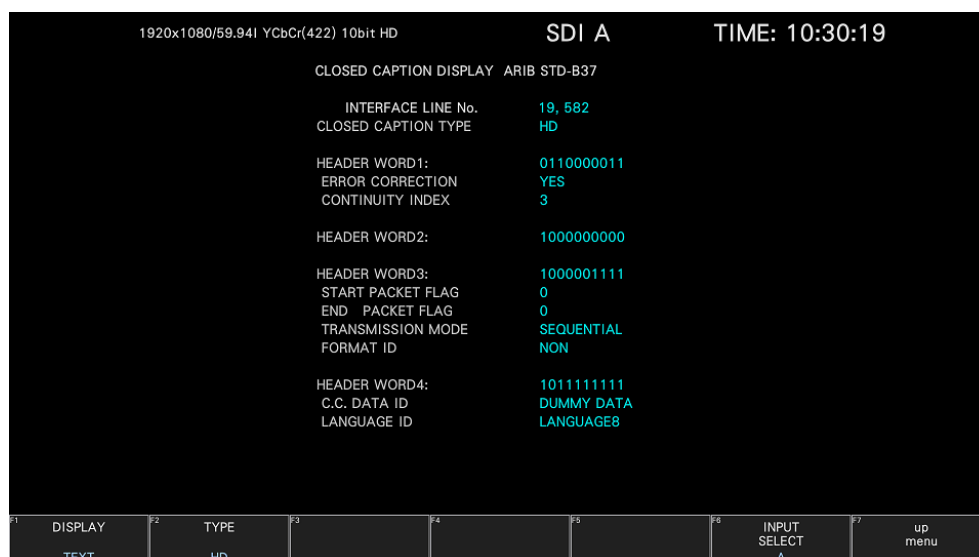

Figure 16-24 Closed caption packet screen

- Selecting the Closed Caption Type

You can use F•2 TYPE to set the closed caption type to HD, SD, ANALOG, or CELLULAR.

- Selecting the Display Format

You can use F•1 DISPLAY to set the display format to TEXT (text display) or DUMP (dump display).

If you select DUMP, the dump display appears, and you can use the function dial (F•D) to view the entire data. If you press the function dial (F•D), the first data entry is displayed.

- Selecting the Dump Mode

When F•1 DISPLAY is set to DUMP, you can use F•3 DUMP MODE to set the dump mode to HEX (hexadecimal display) or BINARY (binary display).

16. STATUS DISPLAY

- Selecting the Content to Display

You can select the displayed content using **F•5** LINK when the input signal is multi link and **F•5** SUB when the input signal is 6G or 12G.

16.9.7 Displaying the Inter-Stationary Control Signal

To display the inter-stationary control signal, follow the procedure below.

Procedure

STATUS → **F•4** ANC PACKET → **F•1** PACKET ANALYSIS → **F•4** V-ANC → **F•1** ARIB
→ **F•2** NET-Q

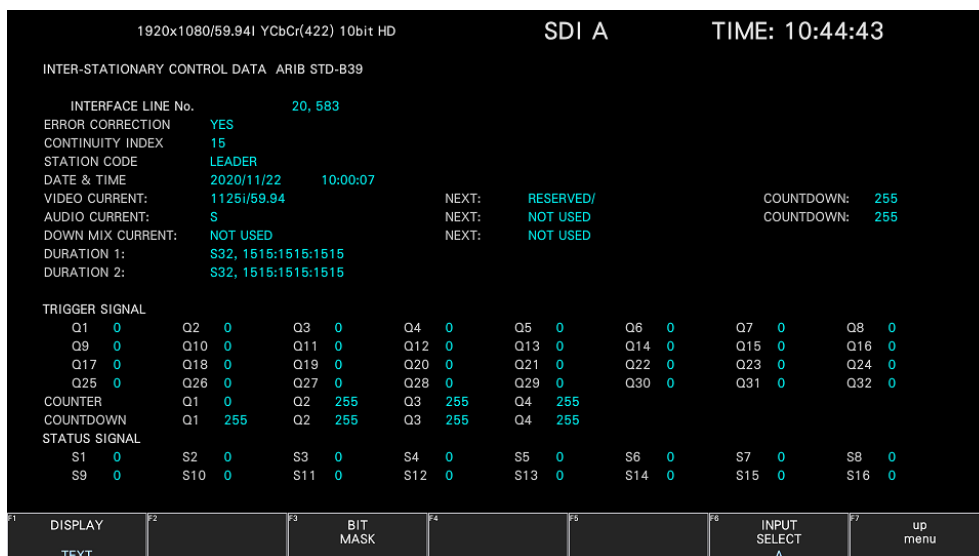

Figure 16-25 Inter-stationary control signal screen (TEXT)

- Selecting the Display Format

You can use **F•1** DISPLAY to set the display format to TEXT (text display), DUMP (dump display), Q LOG (Q-signal log display), or FORMAT (format ID display).

If you select DUMP, the dump display appears. If you select Q LOG, the log display appears. In either case, you can use the function dial (**F•D**) to view the entire data. If you press the function dial (**F•D**), the first data entry is displayed.

16. STATUS DISPLAY

- Selecting the Dump Mode

When **F•1** DISPLAY is set to DUMP, you can use **F•2** DUMP MODE to set the dump mode to HEX (hexadecimal display) or BINARY (binary display).

- Clearing the Q-Signal Log

When **F•1** DISPLAY is set to Q LOG, press **F•2** Q LOG CLEAR to clear the Q-signal log.

- Setting the Bit Mask

When **F•1** DISPLAY is set to TEXT, you can use **F•3** BIT MASK to mask the Q and status signals independently.

Press **F•4** ALL ON to select all the check boxes. Press **F•5** ALL OFF to clear all the check boxes.

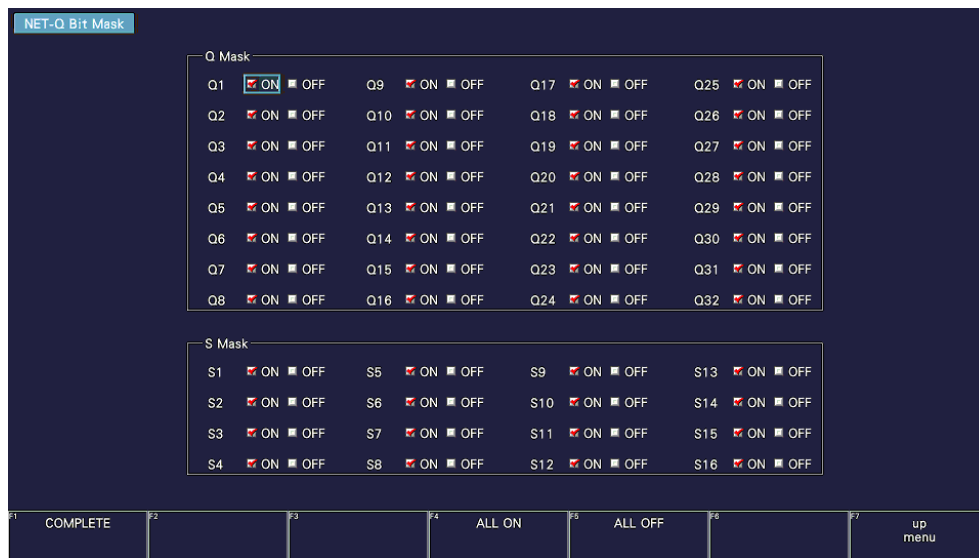

Figure 16-27 NET-Q Bit Mask tab

- Selecting the Content to Display

You can select the displayed content using **F•5** LINK when the input signal is multi link and **F•5** SUB when the input signal is 6G or 12G.

- Saving data to a USB memory device

If **F•1** DISPLAY is set to Q LOG, you can press **F•6** USB MEMORY to save the Q signal log to a USB memory device in CSV format. The procedure to follow to save data is the same as the procedure that was given for the event log. See section 16.4.5, "Saving to a USB Memory Device."

Q signal logs are saved in the NETQ folder.

📁 USB memory device

└─ 📁 LV5300_USER, LV5350_USER or LV7300_USER

└─ 📁 NETQ

└─ 📄 YYYYMMDDhhmmss.csv

16. STATUS DISPLAY

16.9.8 Displaying the Data Broadcast Trigger Signal

To display the data broadcast trigger signal, follow the procedure below.

Procedure

STATUS → F•4 ANC PACKET → F•1 PACKET ANALYSIS → F•4 V-ANC → F•1 ARIB
→ F•3 DATA TRIGGER

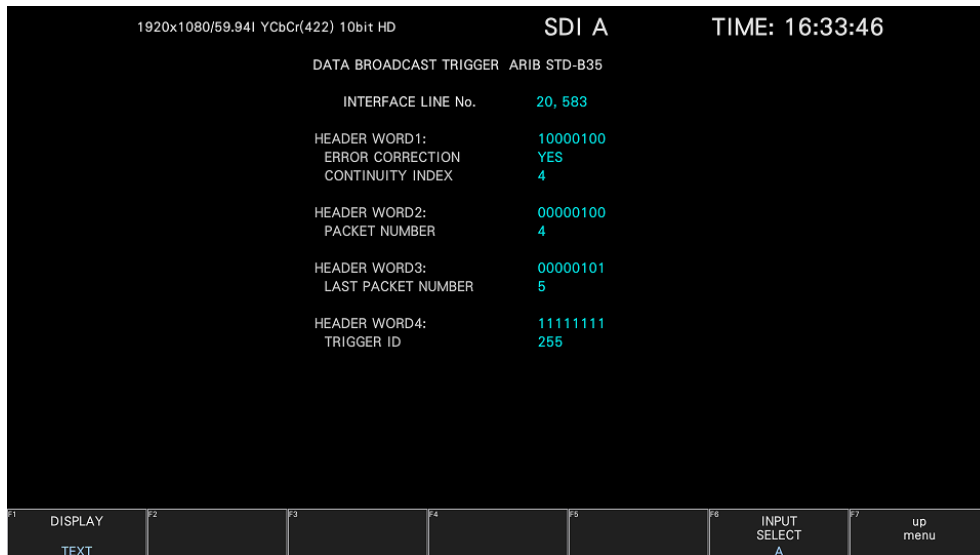

Figure 16-28 Data broadcast trigger signal screen

- Selecting the Display Format

You can use F•1 DISPLAY to set the display format to TEXT (text display) or DUMP (dump display).

If you select DUMP, the dump display appears, and you can use the function dial (F•D) to view the entire data. If you press the function dial (F•D), the first data entry is displayed.

- Selecting the Dump Mode

When F•1 DISPLAY is set to DUMP, you can use F•2 DUMP MODE to set the dump mode to HEX (hexadecimal display) or BINARY (binary display).

- Selecting the Content to Display

You can select the displayed content using F•5 LINK when the input signal is multi link and F•5 SUB when the input signal is 6G or 12G.

16. STATUS DISPLAY

16.9.9 Displaying User Data

To display user data 1 or 2, follow the procedure below.

You can use the function dial (F•D) to view all the data. If you press the function dial (F•D), the first data entry is displayed.

Procedure

STATUS → F•4 ANC PACKET → F•1 PACKET ANALYSIS → F•4 V-ANC → F•1 ARIB
 → F•4 USER DATA 1
 → F•5 USER DATA 2

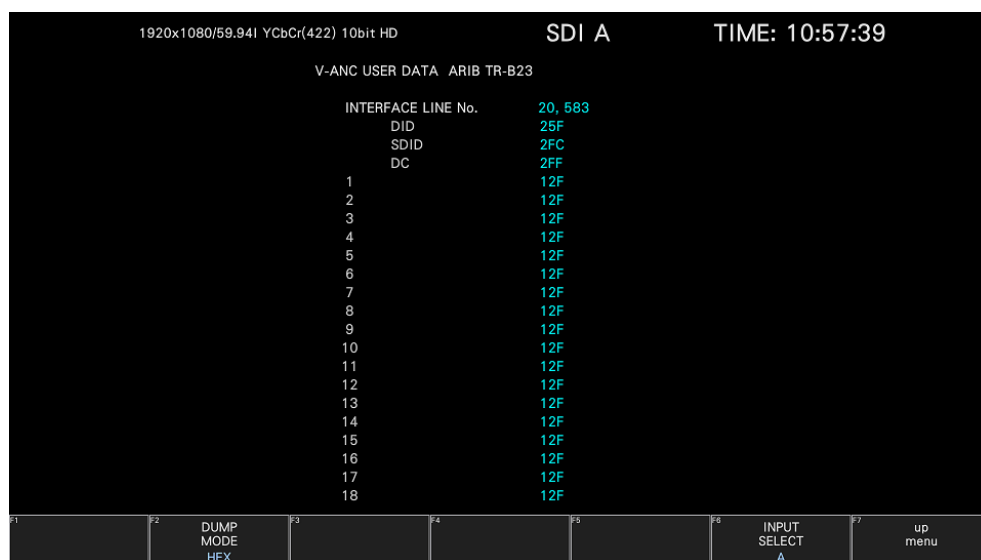

Figure 16-29 User data display

- Selecting the Dump Mode

You can use F•2 DUMP MODE to set the dump mode to HEX (hexadecimal display) or BINARY (binary display).

- Selecting the Content to Display

You can select the displayed content using F•5 SUB when the input signal is 6G or 12G.

16.9.10 V-ANC SMPTE Display

To display the V blanking ancillary packets defined in the SMPTE standard, use the SMPTE menu.

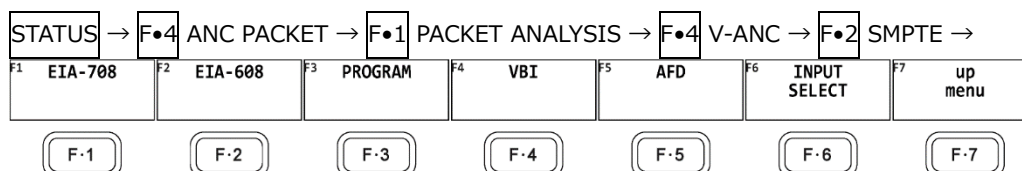

Figure 16-30 SMPTE menu

16. STATUS DISPLAY

16.9.11 Displaying EIA-708 Data

To display data that is specified by the EIA-708 standard, follow the procedure below.

Procedure

STATUS → F•4 ANC PACKET → F•1 PACKET ANALYSIS → F•4 V-ANC → F•2 SMPTE
→ F•1 EIA-708

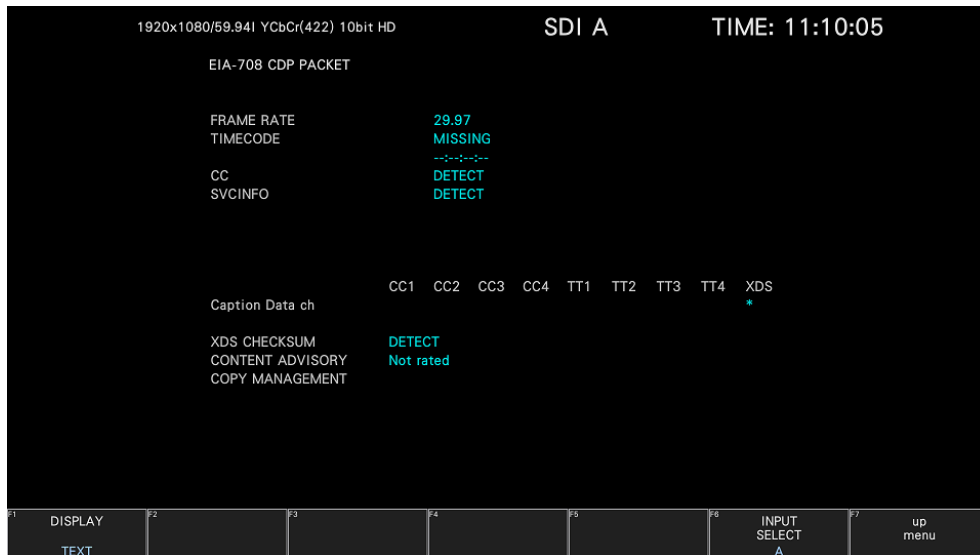

Figure 16-31 EIA-708 data display

- Selecting the Display Format

You can use F•1 DISPLAY to set the display format to TEXT (text display) or DUMP (dump display).

If you select DUMP, the dump display appears, and you can use the function dial (F•D) to view the entire data. If you press the function dial (F•D), the first data entry is displayed.

- Selecting the Dump Mode

When F•1 DISPLAY is set to DUMP, you can use F•2 DUMP MODE to set the dump mode to HEX (hexadecimal display) or BINARY (binary display).

- Selecting the Content to Display

You can select the displayed content using F•5 LINK when the input signal is multi link and F•5 SUB when the input signal is 6G or 12G.

16. STATUS DISPLAY

16.9.12 Displaying EIA-608 Data

To display data that is specified by the EIA-608 standard, follow the procedure below.

Procedure

STATUS → F•4 ANC PACKET → F•1 PACKET ANALYSIS → F•4 V-ANC → F•2 SMPTE
→ F•2 EIA-608



Figure 16-32 EIA-608 data display

- Selecting the Display Format

You can use F•1 DISPLAY to set the display format to TEXT (text display) or DUMP (dump display).

If you select DUMP, the dump display appears, and you can use the function dial (F•D) to view the entire data. If you press the function dial (F•D), the first data entry is displayed.

- Selecting the Dump Mode

When F•1 DISPLAY is set to DUMP, you can use F•2 DUMP MODE to set the dump mode to HEX (hexadecimal display) or BINARY (binary display).

- Selecting the Content to Display

You can select the displayed content using F•5 LINK when the input signal is multi link and F•5 SUB when the input signal is 6G or 12G.

16. STATUS DISPLAY

16.9.13 Displaying Program Data

To display whether program description packets that are specified by the ATSC A/65 standard are present, follow the procedure below. For each descriptor, if its ID is present, "DETECT" is displayed; if its ID is not present, "MISSING" is displayed.

Procedure

STATUS → F•4 ANC PACKET → F•1 PACKET ANALYSIS → F•4 V-ANC → F•2 SMPTE
→ F•3 PROGRAM

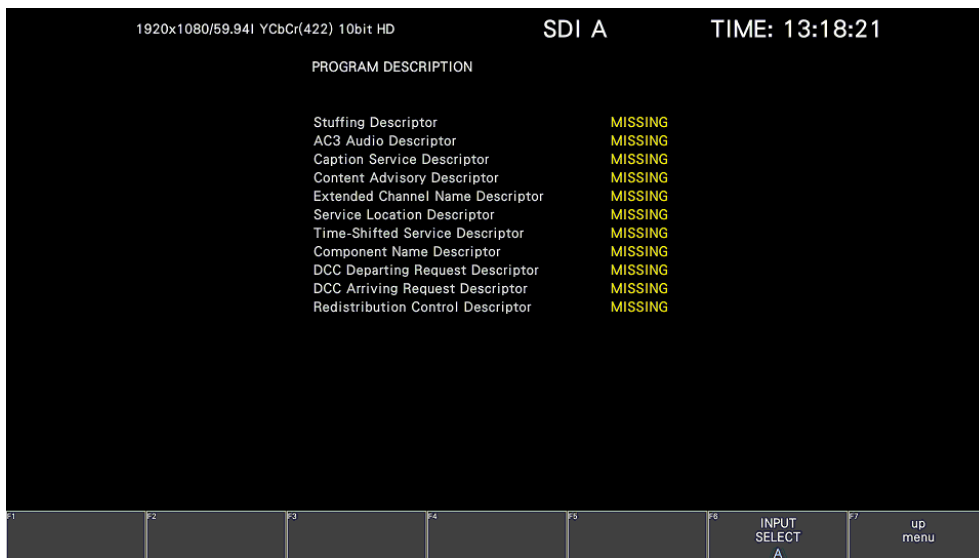

Figure 16-33 Program data display

- Selecting the Content to Display

You can select the displayed content using F•5 LINK when the input signal is multi link and F•5 SUB when the input signal is 6G or 12G.

16. STATUS DISPLAY

16.9.14 Displaying VBI Data

When the input signal is SD, to display VBI data, follow the procedure below.

Procedure

STATUS → F•4 ANC PACKET → F•1 PACKET ANALYSIS → F•4 V-ANC → F•2 SMPTE
→ F•4 VBI



Figure 16-34 VBI data display

- Selecting the Content to Display

You can select the displayed content using F•5 LINK when the input signal is multi link and F•5 SUB when the input signal is 6G or 12G.

16. STATUS DISPLAY

16.9.15 Displaying AFD Packets

To display AFD packets, follow the procedure below.

Procedure

STATUS → F•4 ANC PACKET → F•1 PACKET ANALYSIS → F•4 V-ANC → F•2 SMPTE
→ F•5 AFD

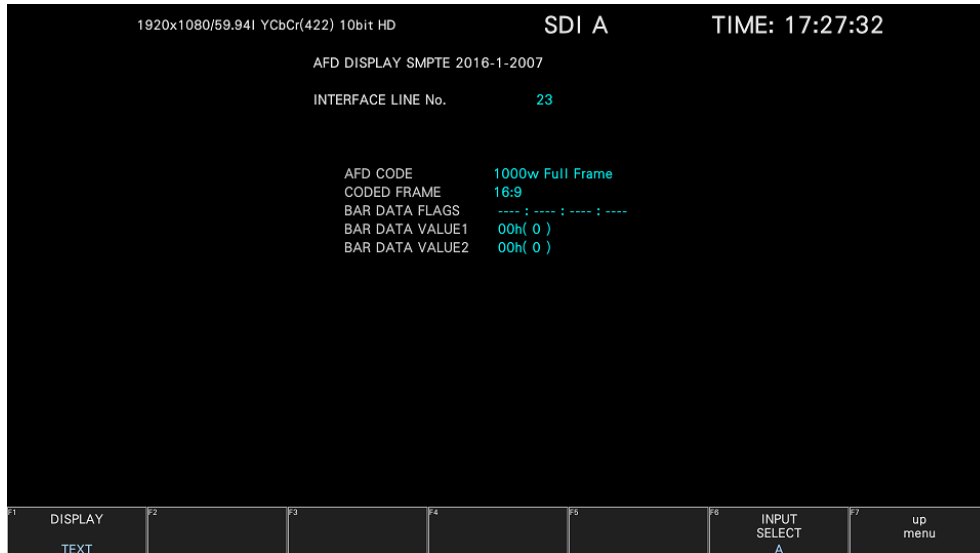

Figure 16-35 AFD packet display

- Selecting the Display Format

You can use F•1 DISPLAY to set the display format to TEXT (text display) or DUMP (dump display).

If you select DUMP, the dump display appears, and you can use the function dial (F•D) to view the entire data. If you press the function dial (F•D), the first data entry is displayed.

- Selecting the Dump Mode

When F•1 DISPLAY is set to DUMP, you can use F•2 DUMP MODE to set the dump mode to HEX (hexadecimal display) or BINARY (binary display).

- Selecting the Displayed Stream

When the input signal is 3G-B, to set the display stream to STREAM1 or STREAM2, press F•4 STREAM SELECT.

- Selecting the Content to Display

You can select the displayed content using F•5 LINK when the input signal is multi link and F•5 SUB when the input signal is 6G and 12G.

16. STATUS DISPLAY

16.9.16 Configuring the SCTE-104 Detection Display settings

To display SCTE-104 packets, follow the procedure below.

Procedure

STATUS → F•4 ANC PACKET → F•1 PACKET ANALYSIS → F•4 V-ANC → F•3 SCTE /
CAMERA META → F•1 SCTE-104

- Selecting the Display Format

You can use F•1 DISPLAY to set the display format to TEXT (text display), DUMP (dump display), or SPLICE (splice display).

If you select TEXT, the text display appears, the currently received packets are displayed in blue, and they are also recorded as the event log.

If you select DUMP, the dump display appears, and you can turn the function dial (F•D) to view the entire data. If you press the function dial (F•D), the first entry data is displayed.

If you select SPLICE, the splice display appears, and when a splice_request_data message is detected, the message appears.

TEXT / DUMP / SPLICE

- Selecting the Text Mode

When F•1 DISPLAY is set to TEXT, you can use F•2 DURATION to select the display time from 1 to 10 seconds for SCTE-104 packets.

Changing this setting will not change the display time on the SCTE-104 SETUP tab in the picture display in conjunction.

1 / 2 / 3 / 4 / 5 / 6 / 7 / 8 / 9 / 10

- Updating the dump display

When F•1 DISPLAY is set to DUMP, you can select the update time of the dump display, follow the procedure below.

Procedure

STATUS → F•4 ANC PACKET → F•1 PACKET ANALYSIS → F•4 V-ANC → F•3 SCTE /
CAMERA META → F•1 SCTE-104 → F•2 HOLD TIME: HOLD / 1s / 3s

Settings

HOLD:	Does not update the screen.
1s:	Updates the screen every second.
3s:	Updates the screen every 3 seconds.

16. STATUS DISPLAY

- Starting the Event Log

When **F•1** DISPLAY is set to TEXT or SPLICE, you can start the event log, follow the procedure below.

Procedure

STATUS → **F•4** ANC PACKET → **F•1** PACKET ANALYSIS → **F•4** V-ANC → **F•3** SCTE /
CAMERA META → **F•1** SCTE-104 → **F•3** LOG: START / STOP

Settings

START: The event log is started. "NOW LOGGING" appears in the upper right of the event log.

STOP: The event log is stopped. "LOGGING STOPPED" appears in the upper right of the event log.

- Clearing the Event Log

When **F•1** DISPLAY is set to TEXT or SPLICE, you can clear the event log, follow the procedure below.

Procedure

STATUS → **F•4** ANC PACKET → **F•1** PACKET ANALYSIS → **F•4** V-ANC → **F•3** SCTE /
CAMERA META → **F•1** SCTE-104 → **F•4** CLEAR

- Selecting the Dump Mode

When **F•1** DISPLAY is set to DUMP, you can use **F•2** DUMP MODE to set the dump mode to HEX (hexadecimal display) or BINARY (binary display).

16. STATUS DISPLAY

16.9.17 Displaying the SCTE-104 Detection screen

- TEXT Display

When a SCTE-104 message is detected, the message is displayed in blue. The message display time is displayed only for the time set in Duration, and if no message is detected during the set time, all detected messages are grayed out.

You can also log up to 1000 detected messages. Set **F•3** LOG to START to start logging.

To stop logging, set **F•3** LOG to STOP, and to clear the log, press **F•4** CLEAR. **F•3** LOG

START / STOP is linked to the SPLICE display. You can output the log as a file by inserting the USB memory device.

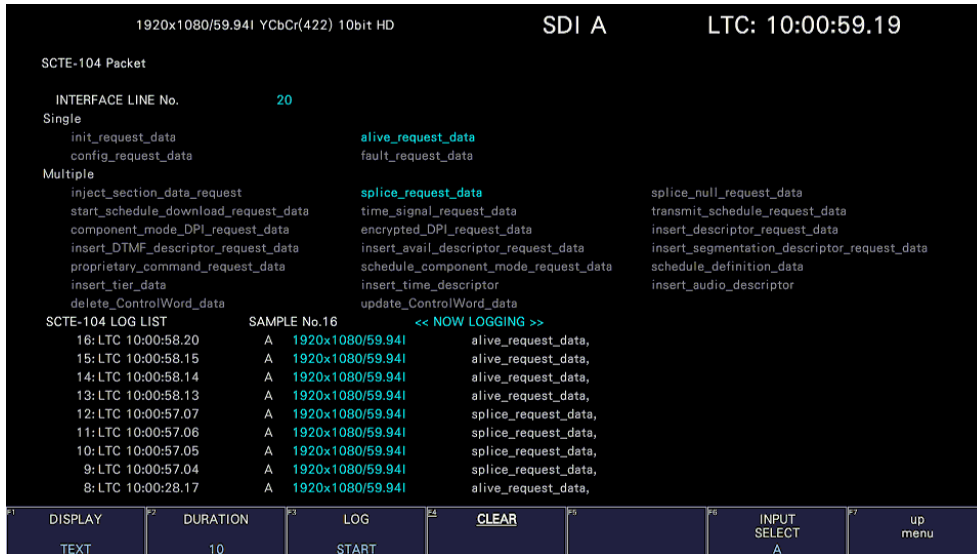

Figure 16-36 SCTE-104 detection screen (TEXT display)

- DUMP Display

When a SCTE-104 message is detected, the dump data of the message is displayed.

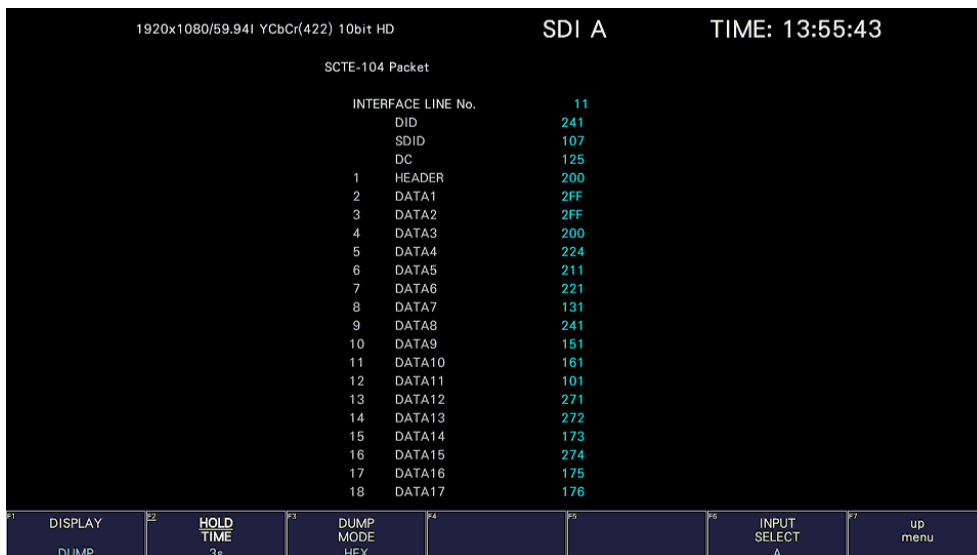

Figure 16-37 SCTE-104 detection screen (DUMP display)

16. STATUS DISPLAY

- SPLICE Display

When a splice_request_data message is detected, the message is displayed.

You can log up to 1000 detected the splice_request_data messages. To display the details of the message, turn the function dial (F•D) to select the target message. Set **F•3** LOG to START to start logging. To stop logging, set **F•3** LOG to STOP, and to clear the log, press **F•4** CLEAR. **F•3** LOG START / STOP is linked to the TEXT display. You can output the log as a file by inserting the USB memory device.

You can change the ID display setting with **F•2** ID Value. It is linked with the ID Value on the SCTE-104 SETUP tab of the picture screen. When ID Value is set to BOTH, splice_event_id and unique_program_id are displayed simultaneously in hexadecimal and decimal numbers as shown below.

```
splice_event_id      Hexadecimal (decimal)
unique_program_id    Hexadecimal (decimal)
```

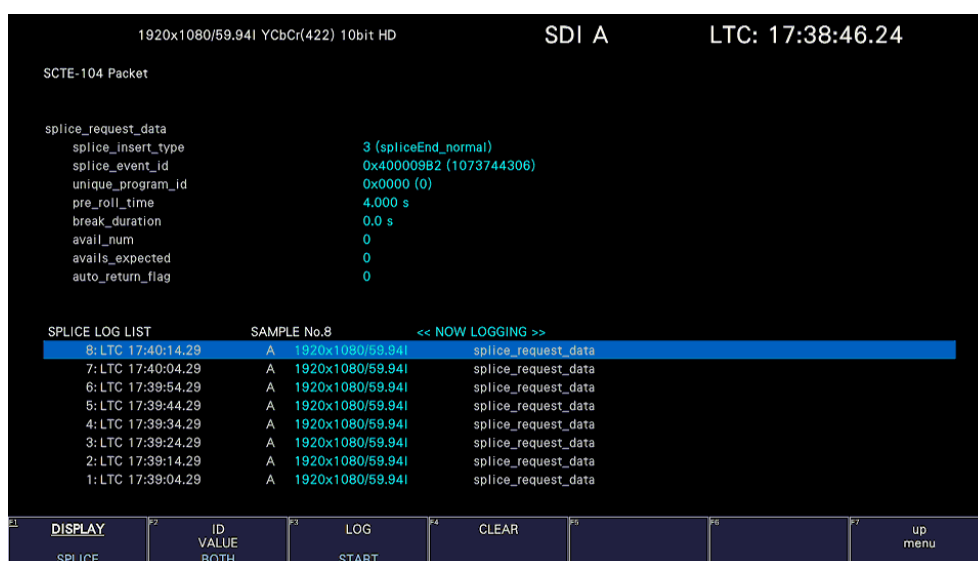

Figure 16-38 SCTE-104 detection screen (SPLICE display)

16. STATUS DISPLAY

16.9.18 Displaying SR Live Packets

To display SR Live packets, follow the procedure below.

Procedure

STATUS → F•4 ANC PACKET → F•1 PACKET ANALYSIS → F•4 V-ANC → F•3 SCTE /
CAMERA META → F•2 SR Live

1920x1080/59.94P YCbCr(422) 10bit 3G-B-DL			SDI A			TIME: 15:04:07		
SR Live Packet								
INTERFACE LINE No. 14								
No.	ITEM	VALUE	CTRL[Abs]	No.	ITEM	VALUE	CTRL[Abs]	
1	Table Version	V 1.00	--	14	Knee	OFF	OFF	
2	OETF	HLG	--	15	Knee Point	96%	[-15]	
3	Transfer Matrix	BT.2020	--	16	Knee Slope	0.19	[+37]	
4	Color Gamut	WIDE-BC	--	17	Knee Saturation	OFF	OFF	
5	Conversion Mode	SR AIR ON	--	18	Knee Saturation Level	0.50	[+0]	
6	HDR Look	Live	Live	19	Soft Knee	--	--	
7	HDR Black Compression	ON	ON	20	Knee Radius	--	--	
8	SDR Gain	-5.2dB	[-5.2dB]	21	SDR White Clip	ON	ON	
9	Master Black	1.03%	[+4.7]	22	SDR White Clip Level	109%	[-94]	
10	HDR Black Offset	Δ-0.99%	[-4.5]	23	HDR Knee	OFF	OFF	
11	Gamma Table	STD 5	STD 5	24	HDR Knee Point	349%	[+0]	
12	Gamma Step	0.45	0.45	25	HDR Knee Slope	0.65	[+0]	
13	Gamma Level	0.95	[-12]	26	HDR Target White	203nit	--	

Figure 16-39 SR Live packet display(TEXT display)

- Selecting the Display Format

You can use F•1 DISPLAY to set the display format to TEXT (text display) or DUMP (dump display).

If you select DUMP, the dump display appears, and you can turn the function dial (F•D) to view the entire data. If you press the function dial (F•D), the first entry data is displayed.

- Selecting the Dump Mode

When F•1 DISPLAY is set to DUMP, you can use F•2 DUMP MODE to set the dump mode to HEX (hexadecimal display) or BINARY (binary display).

- Selecting the Displayed Stream

When the input signal is 3G-B, to set the display stream to STREAM1 or STREAM2 by pressing F•4 STREAM SELECT.

- Selecting the Content to Display

You can select the displayed content using F•5 LINK when the input signal is multi link and F•5 SUB when the input signal is 6G or 12G.

16. STATUS DISPLAY

16.9.19 Performing Custom Searches

To show the custom search screen, follow the procedure below.

You can use the function dial (F•D) to view all the data. If you press the function dial (F•D), the first data entry is displayed.

Procedure

STATUS → F•4 ANC PACKET → F•1 PACKET ANALYSIS → F•5 CUSTOM SEARCH

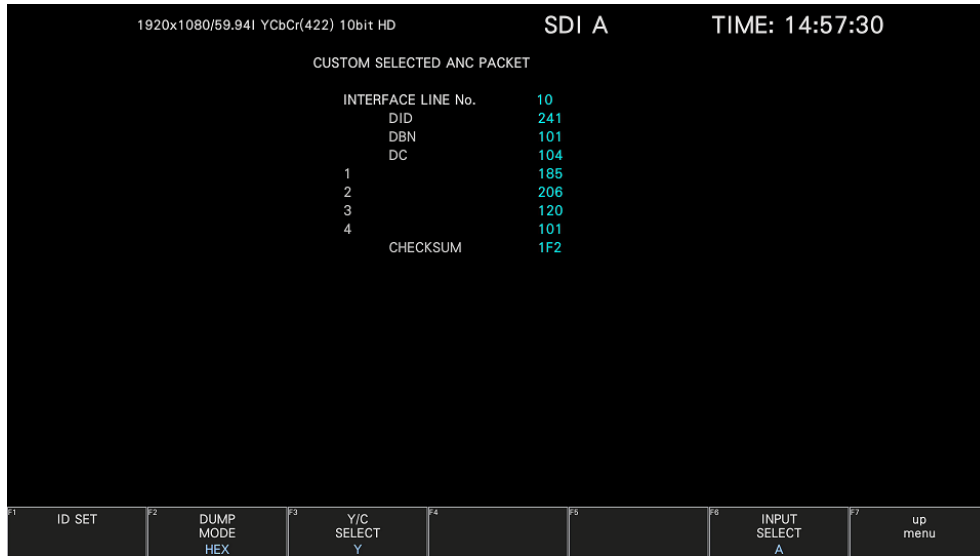

Figure 16-40 Custom search screen

- Detecting Ancillary Packets

You can search ancillary packets by using F•1 ID SET in the CUSTOM SEARCH menu.

STATUS → F•4 ANC PACKET → F•1 PACKET ANALYSIS → F•5 CUSTOM SEARCH → F•1 ID SET →

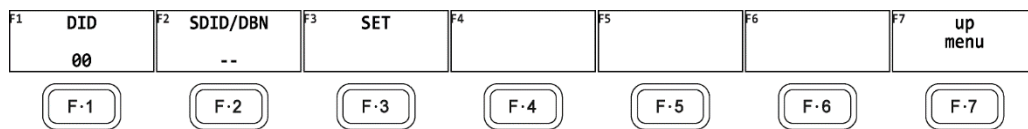

Figure 16-41 ID SET menu

16. STATUS DISPLAY

Set **F•1** DID and **F•2** SDID/DBN to display ancillary packets on the basis of the combination of the DID and SDID/DBN.

You can set **F•1** DID in the range of 00 to FF. Press the function dial (F•D) to return the setting to its default value (00).

You can set **F•2** SDID/DBN in the range of 00 to FF or select "--" to not specify a value. Press the function dial (F•D) to return the setting to its default value (--).

Press **F•3** SET to clear the blue cursor assigned to **F•1** DID or **F•2** SDID/DBN. Use this key when you want to view all the data using the function dial (F•D).

- Selecting the Dump Mode

You can use **F•2** DUMP MODE to set the dump mode to HEX (hexadecimal display) or BINARY (binary display).

- Selecting Which Signal to Display

When the input signal is not SD, you can use **F•3** Y/C SELECT to set the signal to display to Y signal or C signal.

- Selecting the Displayed Stream

When the input signal is 3G-B, to set the display stream to STREAM1 or STREAM2, press **F•4** STREAM SELECT.

- Selecting the Content to Display

You can select the displayed content using **F•5** LINK when the input signal is multi link and **F•5** SUB when the input signal is 6G and 12G.

17. EYE PATTERN DISPLAY (LV5300/LV5300A/LV7300-SER02)

To display the eye pattern, press EYE.

On the eye pattern display you can use **F•1** EYE/JITTER INTEN/CONFIG → **F•1** EYE/JITTER MODE to display the eye pattern or jitter.

The SDI signal applied to SDI INPUT 1 is displayed.

If **F•6** INPUT SELECT is set to a signal other than what is applied to SDI INPUT 1, the message “Not Supported” appears, and the eye pattern nor jitter is displayed. Simul mode is not supported.

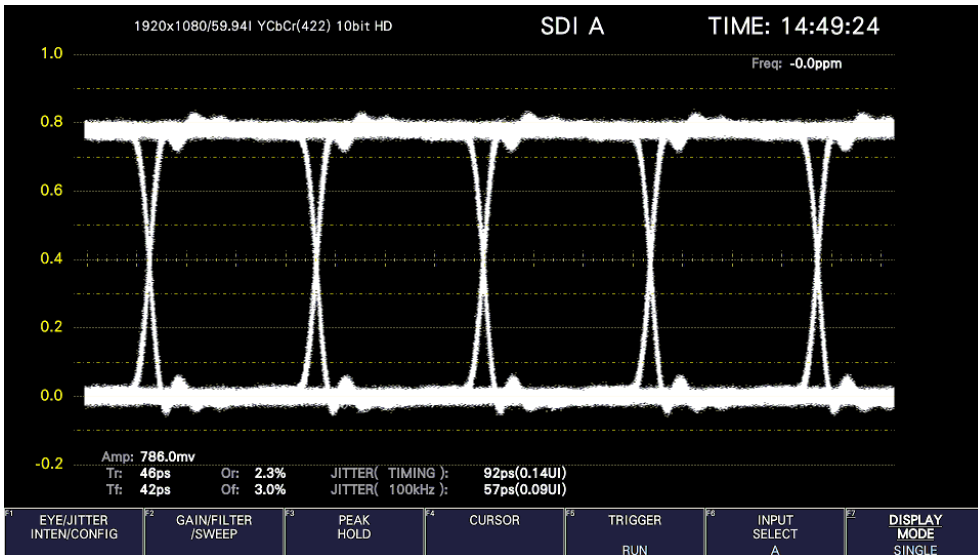

Figure 17-1 Eye pattern display

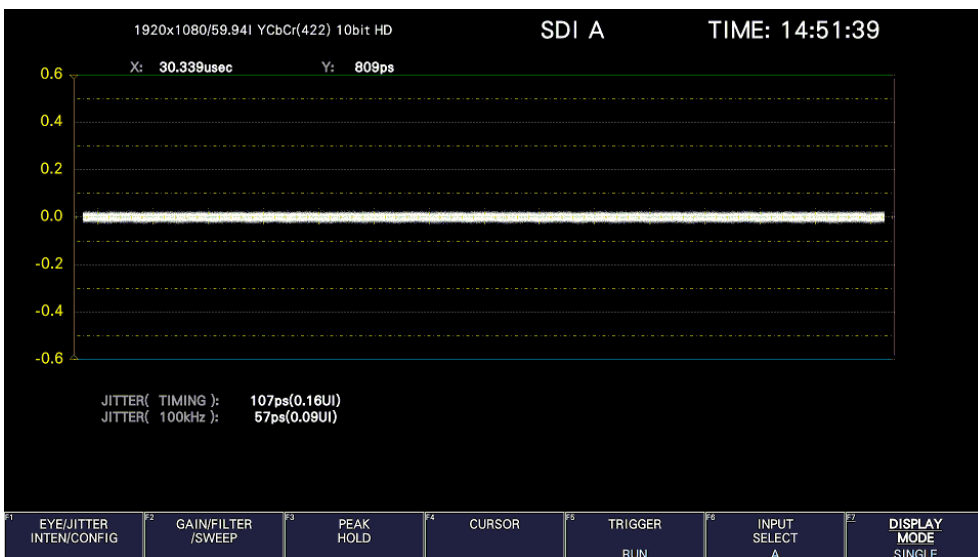

Figure 17-2 Jitter display

17. EYE PATTERN DISPLAY (LV5300/LV5300A/LV7300-SER02)

- Displaying the Eye Pattern and Jitter Simultaneously

By using the customized layout feature (SER26), you can display the eye pattern and jitter simultaneously.

[See also] 6.5, "Customized Layout (SER26)"

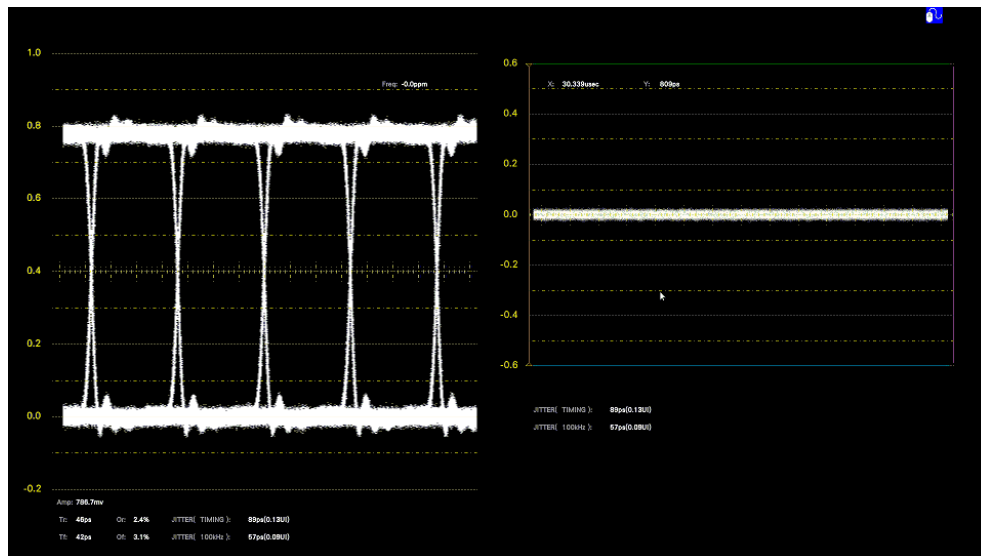

Figure 17-3 Eye pattern and jitter display

17.1 Eye Pattern Display Description

- Automatic Measurement

On the eye pattern display, values such as the amplitude of the eye pattern and the jitter are measured automatically and displayed. Measured values are normally displayed in white, but they are displayed in yellow until they stabilize and in red if they exceed the values that you have specified in the error setup. If automatic measurements cannot be performed due to noise in the waveform or other reason, measured values are displayed as "----." If this occurs, use cursors to measure manually.

[See also] Reference 17.8, "Configuring Error Detection Settings"

The timing jitter and jitter measurement items show the values that were measured in jitter display mode. The instrument uses the phase demodulator method.

Other measurement items show the measured values calculated from the eye pattern waveform. Therefore, if the waveform degrades significantly, the difference between the automatically measured values and the cursor-measured values may become large.

- Measurement items

The items that can be automatically measured are shown below.

Table 17-1 Measurement items

Symbol	Display	Description
a	Amp	Eye-pattern amplitude
b	Tr	Rise time (time from 20% to 80% of amplitude)
c	Tf	Fall time (time from 80% to 20% of amplitude, figure omitted)
d	T.J	Timing Jitter
e	JIT	Jitter (jitter value when the currently selected filter is applied)
f	Or	Overshoot of the rising edge
g	Of	Overshoot of the falling edge

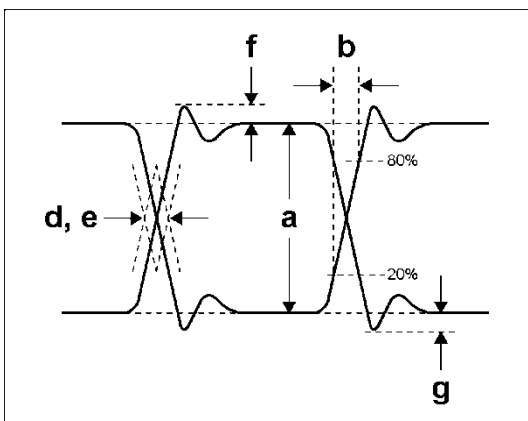

Figure 17-4 Explanation of measurement items

17. EYE PATTERN DISPLAY (LV5300/LV5300A/LV7300-SER02)

- Unit interval

This unit uses unit intervals (UI) as jitter measurement units.

One cycle of the eye pattern is 1 UI. The time that corresponds to 1 UI varies depending on the input signal, as shown below.

Table 17-2 Time that corresponds to 1 UI

Input Signal	Bit Rate	Time That Corresponds to 1 UI
3G	2.970/1.001 Gbps	337.0 ps
	2.970 Gbps	336.7 ps
HD	1.485/1.001 Gbps	674.1 ps
	1.485 Gbps	673.4 ps
SD	270 Mbps	3.7 ns

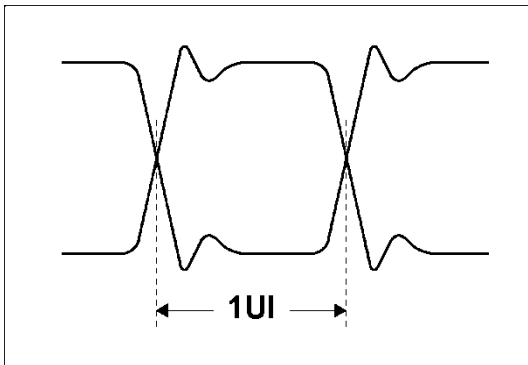

Figure 17-5 Unit interval

- Histogram display

The histogram is superimposed on the eye pattern display and shows amplitude information of the eye pattern waveform, such as the amount of eye opening, amplitude position, superimposed noise, rising edge overshoot (Or), and falling edge overshoot (Of).

17.2 Jitter Display Description

- Measurement

In the jitter display mode, the jitter component is extracted from the input signal and plotted on a time graph. The time (horizontal) axis can be displayed in different ways depending on the data interval of the lines, fields, or frames, which are being transmitted in the SDI signal.

- Automatic Measurement

Timing jitter (T.J) and jitter (JIT) are automatically measured and displayed on the jitter display screen. The measurement range is 0.00 to 9.60 UI.

SMPTE defines two methods of measuring jitter. One method uses an eye pattern, and the other method uses a phase demodulator.

The eye pattern method has disadvantages not only that measurements are difficult when the eye is not open but that measurements are prone to errors because the distinction between waveform distortion (such as noise and sags) and jitter is difficult.

In contrast, the phase demodulator method makes jitter measurements with small errors possible even when the eye pattern is closed and even when the amount of jitter is 1 UI or more.

The unit use the phase demodulator method.

17. EYE PATTERN DISPLAY (LV5300/LV5300A/LV7300-SER02)

Measured values are normally displayed in white, but they are displayed in red if they exceed the values that you have specified in the error setup. If 10.00 UI is exceeded, "OVER" is displayed.

[See also] Reference 17.8, "Configuring Error Detection Settings"

17.3 Setting the Waveform Display Position

Use the V POS and H POS knobs to adjust the display position of the waveform.

On the multi display, these are valid when you press **F•7** MULTI EYE on the MULTI menu.

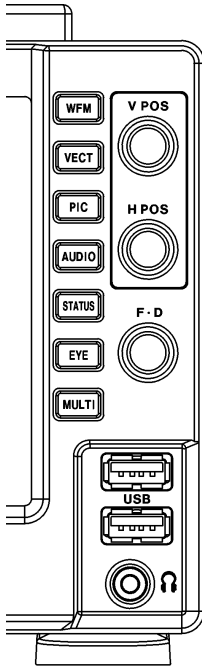

Figure 17-6 LV5300/LV5300A, LV5350 V POS and H POS knobs

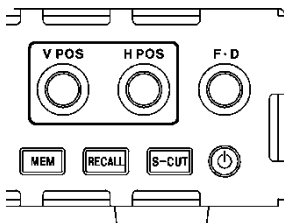

Figure 17-7 LV7300 V POS and H POS knobs

- V POS Knob

Adjusts the vertical position of the waveform.

Pressing the knob returns the waveform to its default position.

- H POS Knob

Adjusts the horizontal position of the waveform.

Pressing the knob returns the waveform to its default position.

17.4 Switching between Eye Pattern and Jitter

To switch between eye pattern and jitter, follow the procedure below.

Procedure

EYE	→	F•1	EYE/JITTER INTEN/CONFIG	→	F•1	EYE/JITTER: <u>E</u> YE / JITTER
-----	---	-----	-------------------------	---	-----	----------------------------------

17.5 Turning the Histogram Display On and Off

When an eye pattern is displayed, to superimpose the histogram on the eye pattern, follow the procedure below.

Procedure

EYE	→	F•1	EYE/JITTER INTEN/CONFIG	→	F•2	HISTOGRAM: <u>O</u> FF / ON
-----	---	-----	-------------------------	---	-----	-----------------------------

HISTOGRAM = ON

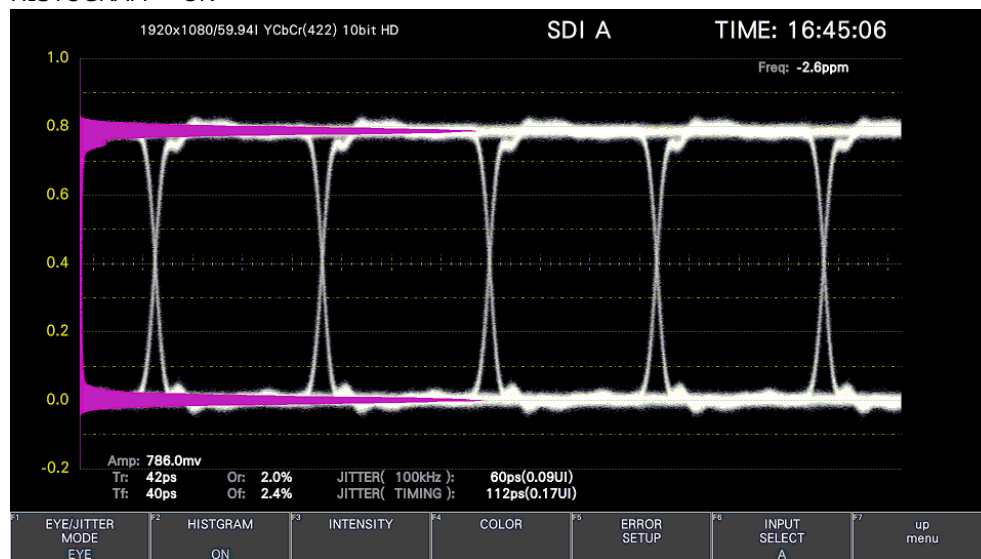

Figure 17-8 Histogram display

17.6 Setting the Intensity

Use **F•1** EYE/JITTER INTEN/CONFIG → **F•3** INTENSITY on the EYE menu to set the intensity. You can configure these settings separately for the eye pattern, histogram and jitter.

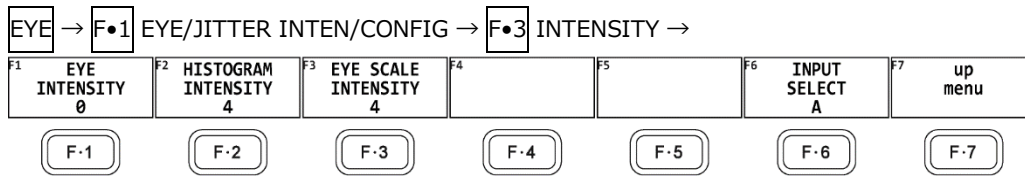

Figure 17-9 INTENSITY menu

17.6.1 Adjusting the Waveform Intensity

To adjust the intensity of the eye pattern and jitter, follow the procedure below. Press the function dial (F•D) to return the setting to its default value (0).

Procedure

EYE → **F•1** EYE/JITTER INTEN/CONFIG → **F•3** INTENSITY
 → **F•1** EYE INTENSITY: -128 - 0 - 127
 → **F•1** JITTER INTENSITY: -128 - 0 - 127

17.6.2 Adjusting the Histogram Intensity

To adjust the intensity of the histogram superimposed on the eye pattern, follow the procedure below. Press the function dial (F•D) to return the setting to its default value (4).

Procedure

EYE → **F•1** EYE/JITTER INTEN/CONFIG → **F•3** INTENSITY
 → **F•2** HISTOGRAM INTENSITY: -8 - 4 - 7

17.6.3 Adjusting the Scale Intensity

To adjust the scale intensity, follow the procedure below. Press the function dial (F•D) to return the setting to its default value (4).

Procedure

EYE → **F•1** INTEN/SCALE → **F•3** SCALE INTEN: -8 - 4 - 7

17.7 Selecting the Display Colors

Use **F•1** EYE/JITTER INTEN/CONFIG → **F•4** COLOR on the EYE menu to set the display colors. You can configure these settings separately for the eye pattern, histogram and jitter.

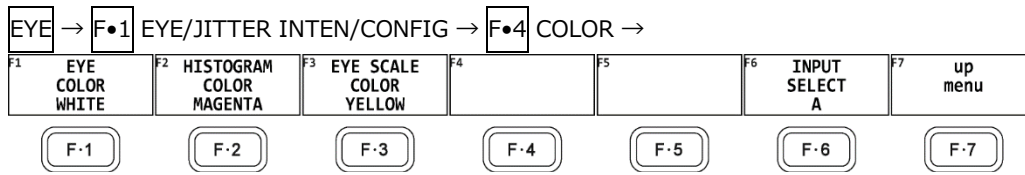

Figure 17-10 COLOR menu

17.7.1 Selecting the Waveform Color

To select the color of the eye-pattern and jitter, follow the procedure below.

Procedure

EYE → **F•1** EYE/JITTER INTEN/CONFIG → **F•4** COLOR
 → **F•1** EYE COLOR: WHITE / YELLOW / CYAN / GREEN / MAGENTA / RED / BLUE
 → **F•1** JITTER COLOR: WHITE / YELLOW / CYAN / GREEN / MAGENTA / RED / BLUE

17.7.2 Selecting the Histogram Color

To select the color of the histogram superimposed on the eye pattern, follow the procedure below.

Procedure

EYE → **F•1** EYE/JITTER INTEN/CONFIG → **F•4** COLOR
 → **F•2** HISTOGRAM COLOR: WHITE / YELLOW / CYAN / GREEN / MAGENTA / RED / BLUE

17.7.3 Selecting the Scale Color

To select the scale color, follow the procedure below.

Procedure

EYE → **F•1** EYE/JITTER INTEN/CONFIG → **F•4** COLOR
 → **F•3** EYE SCALE COLOR: WHITE / YELLOW / CYAN / GREEN / MAGENTA / RED / BLUE
 → **F•3** JITTER SCALE COLOR: WHITE / YELLOW / CYAN / GREEN / MAGENTA / RED / BLUE

17.8 Configuring Error Detection Settings

Use **F•1** EYE/JITTER INTEN/CONFIG → **F•5** ERROR SETUP on the EYE menu to set error detection.

When error detection is set to ON, the following actions are performed when an error occurs.

- Displays measured values on the eye pattern display and jitter display in red
- Displays errors in the event log of the status display
- Displays “ERROR” in the upper right of the display.
- Transmits a signal from the alarm output remote terminal

[See also] Section 16.4.1, “Event Log Screen Description”

17.8.1 Configuring 12G Error Settings

Use the 12G-SDI ERROR SETUP tab to configure error detection settings for 12G signals. You can set the threshold values when you set the error detection to ON. Measured values given in SMPTE ST 2082-1 are used as 100 %.

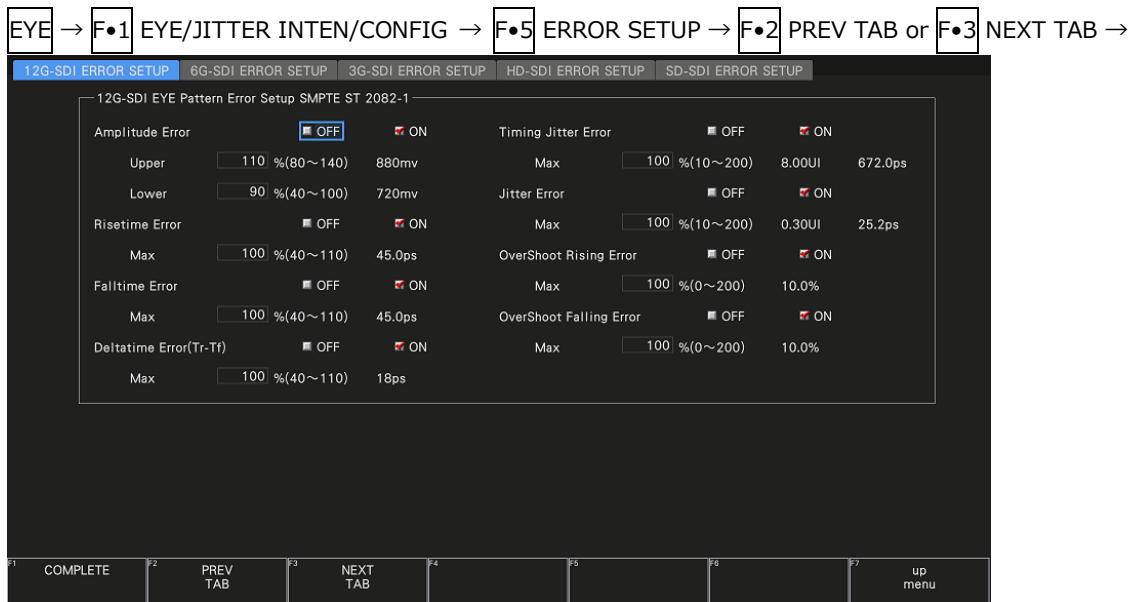

Figure 17-11 12G-SDI ERROR SETUP tab

A configuration example showing threshold values that correspond to SMPTE ST 2082-1 is given below.

Table 17-3 12G-SDI ERROR SETUP configuration example

Parameter	Setting Example	Corresponding Value
Amplitude Error	Upper	110%
	Lower	90%
Risetime Error	Max	100%
Falltime Error	Max	100%
Deltatime Error(Tr-Tf)	Max	100%
Timing Jitter Error	Max	100%
Jitter Error	Max	100%
Overshoot Rising Error	Max	100%
Overshoot Falling Error	Max	100%

17. EYE PATTERN DISPLAY (LV5300/LV5300A/LV7300-SER02)

- Amplitude Error

Turns the eye pattern's amplitude error detection on and off.

You cannot set Lower to a value that is greater than Upper, even if the value is within the selectable range.

Upper:	80 - <u>110</u> - 140% (640 - 1120 mV)
Lower:	40 - <u>90</u> - 100% (320 - 800 mV)

- Risetime Error

Turns the eye pattern's rise time (the time for the signal to rise from 20 to 80 % of its amplitude) error detection on and off.

Max:	40 - <u>100</u> - 110% (18.0 - 49.5 ps)
------	---

- Falltime Error

Turns the eye pattern's fall time (the time for the signal to fall from 80 to 20 % of its amplitude) error detection on and off.

Max:	40 - <u>100</u> - 110% (18.0 - 49.5 ps)
------	---

- Deltatime Error(Tr-Tf)

Turns the eye pattern's time difference (between the rise and fall times) error detection on and off. When the measured values exceed the specified value, Tr and Tf are displayed in red.

Max:	40 - <u>100</u> - 110% (7 - 20 ps)
------	------------------------------------

- Timing Jitter Error

Turns the eye pattern and jitter's timing jitter error detection on and off.

Max:	10 - <u>100</u> - 200% (0.80 - 16.00 UI, 67.2 - 1344.0 ps)
------	--

- Jitter Error

Turns jitter error detection for eye pattern and jitter.

Max:	10 - <u>100</u> - 200% (0.03 - 0.60 UI, 2.5 - 50.4 ps)
------	--

- Overshoot Rising Error

Turns the rising edge overshoot error detection on and off.

Max:	0 - <u>100</u> - 200% (0.0 - 20.0%)
------	-------------------------------------

- Overshoot Falling Error

Turns the falling edge overshoot error detection on and off.

Max:	0 - <u>100</u> - 200% (0.0 - 20.0%)
------	-------------------------------------

17. EYE PATTERN DISPLAY (LV5300/LV5300A/LV7300-SER02)

17.8.2 Configuring 6G Error Settings

Use the 6G-SDI ERROR SETUP tab to configure error detection settings for 6G signals. You can set the threshold values when you set the error detection to ON. Measured values given in SMPTE ST 2082-1 are used as 100 %.

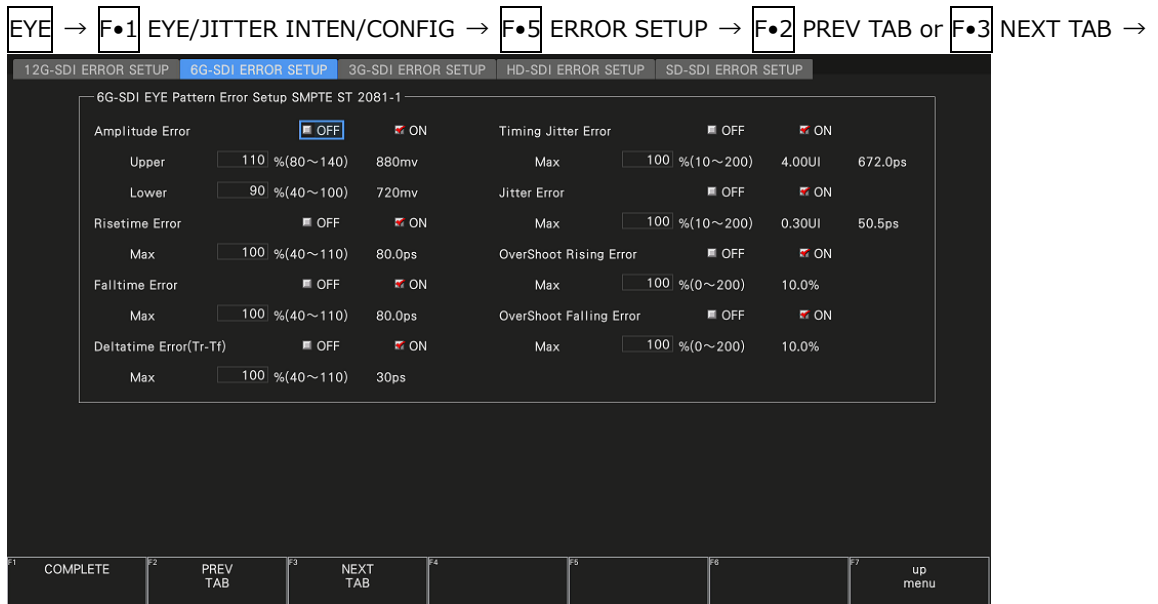

Figure 17-12 6G-SDI ERROR SETUP tab

A configuration example showing threshold values that correspond to SMPTE ST 2082-1 is given below.

Table 17-4 6G-SDI ERROR SETUP configuration example

Item		Setting Example	Corresponding Value
Amplitude Error	Upper	110%	880 mV
	Lower	90%	720 mV
Risetime Error	Max	100%	80.0 ps
Falltime Error	Max	100%	80.0 ps
Deltatime Error(Tr-Tf)	Max	100%	30 ps
Timing Jitter Error	Max	100%	4.00 UI (672.0ps)
Jitter Error	Max	100%	0.30 UI (50.5ps)
Overshoot Rising Error	Max	100%	10.0%
Overshoot Falling Error	Max	100%	10.0%

17. EYE PATTERN DISPLAY (LV5300/LV5300A/LV7300-SER02)

- Amplitude Error

Turns the eye pattern's amplitude error detection on and off.

You cannot set Lower to a value that is greater than Upper, even if the value is within the selectable range.

Upper:	80 - <u>110</u> - 140% (640 - 1120 mV)
Lower:	40 - <u>90</u> - 100% (320 - 800 mV)

- Risetime Error

Turns the eye pattern's rise time (the time for the signal to rise from 20 to 80 % of its amplitude) error detection on and off.

Max:	40 - <u>100</u> - 110% (32.0 - 88.0 ps)
------	---

- Falltime Error

Turns the eye pattern's fall time (the time for the signal to fall from 80 to 20 % of its amplitude) error detection on and off.

Max:	40 - <u>100</u> - 110% (32.0 - 88.0 ps)
------	---

- Deltatime Error(Tr-Tf)

Turns the eye pattern's time difference (between the rise and fall times) error detection on and off. When the measured values exceed the specified value, Tr and Tf are displayed in red.

Max:	40 - <u>100</u> - 110% (12 - 33 ps)
------	-------------------------------------

- Timing Jitter Error

Turns the eye pattern and jitter's timing jitter error detection on and off.

Max:	10 - <u>100</u> - 200% (0.40 - 8.00 UI, 67.2 - 1344.0 ps)
------	---

- Jitter Error

Turns jitter error detection for eye pattern and jitter.

Max:	10 - <u>100</u> - 200% (0.03 - 0.60 UI, 5.0 - 100.9 ps)
------	---

- Overshoot Rising Error

Turns the rising edge overshoot error detection on and off.

Max:	0 - <u>100</u> - 200% (0.0 - 20.0%)
------	-------------------------------------

- Overshoot Falling Error

Turns the falling edge overshoot error detection on and off.

Max:	0 - <u>100</u> - 200% (0.0 - 20.0%)
------	-------------------------------------

17. EYE PATTERN DISPLAY (LV5300/LV5300A/LV7300-SER02)

17.8.3 Configuring 3G Error Settings

Use the 3G-SDI ERROR SETUP tab to configure error detection settings for 3G signals. You can set the threshold values when you set the error detection to ON. Measured values given in SMPTE ST 424 are used as 100 %.

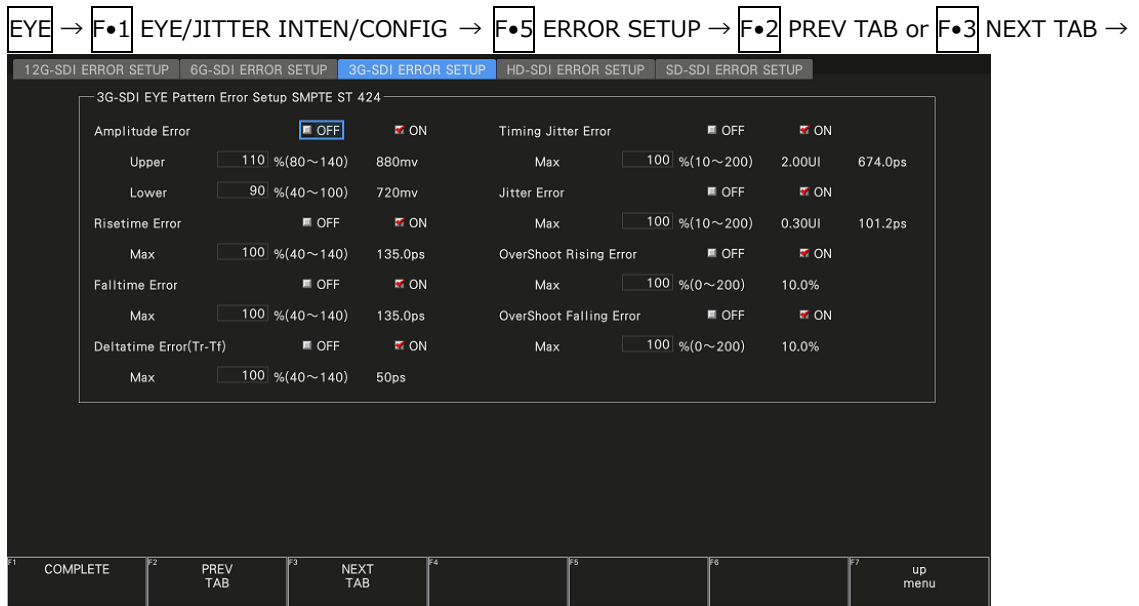

Figure 17-13 3G-SDI ERROR SETUP tab

A configuration example showing threshold values that correspond to SMPTE ST 424 is given below.

Table 17-5 3G-SDI ERROR SETUP configuration example

Parameter		Setting Example	Corresponding Value
Amplitude Error	Upper	110%	880 mV
	Lower	90%	720 mV
Risetime Error	Max	100%	135.0 ps
Falltime Error	Max	100%	135.0 ps
Deltatime Error(Tr-Tf)	Max	100%	50 ps
Timing Jitter Error	Max	100%	2.00 UI (674.0 ps)
Jitter Error	Max	100%	0.30 UI (101.2 ps)
Overshoot Rising Error	Max	100%	10.0%
Overshoot Falling Error	Max	100%	10.0%

17. EYE PATTERN DISPLAY (LV5300/LV5300A/LV7300-SER02)

- Amplitude Error

Turns the eye pattern's amplitude error detection on and off.

You cannot set Lower to a value that is greater than Upper, even if the value is within the selectable range.

Upper:	80 - <u>110</u> - 140% (640 - 1120 mV)
Lower:	40 - <u>90</u> - 100% (320 - 800 mV)

- Risetime Error

Turns the eye pattern's rise time (the time for the signal to rise from 20 to 80 % of its amplitude) error detection on and off.

Max:	40 - <u>100</u> - 140% (54.0 - 189.0 ps)
------	--

- Falltime Error

Turns the eye pattern's fall time (the time for the signal to fall from 80 to 20 % of its amplitude) error detection on and off.

Max:	40 - <u>100</u> - 140% (54.0 - 189.0 ps)
------	--

- Deltatime Error(Tr-Tf)

Turns the eye pattern's time difference (between the rise and fall times) error detection on and off. When the measured values exceed the specified value, Tr and Tf are displayed in red.

Max:	40 - <u>100</u> - 140% (20 - 70 ps)
------	-------------------------------------

- Timing Jitter Error

Turns the eye pattern and jitter's timing jitter error detection on and off.

Max:	10 - <u>100</u> - 200% (0.20 - 4.00 UI, 67.4 - 1348.0 ps)
------	---

- Jitter Error

Turns jitter error detection for eye pattern and jitter.

Max:	10 - <u>100</u> - 200% (0.03 - 0.60 UI, 10.1 - 202.5 ps)
------	--

- Overshoot Rising Error

Turns the rising edge overshoot error detection on and off.

Max:	0 - <u>100</u> - 200% (0.0 - 20.0%)
------	-------------------------------------

- Overshoot Falling Error

Turns the falling edge overshoot error detection on and off.

Max:	0 - <u>100</u> - 200% (0.0 - 20.0%)
------	-------------------------------------

17. EYE PATTERN DISPLAY (LV5300/LV5300A/LV7300-SER02)

17.8.4 Configuring HD Error Settings

Use the HD-SDI ERROR SETUP tab to configure error detection settings for HD signals. You can set the threshold values when you set the error detection to ON. Measured values given in SMPTE ST 292 are used as 100 %.

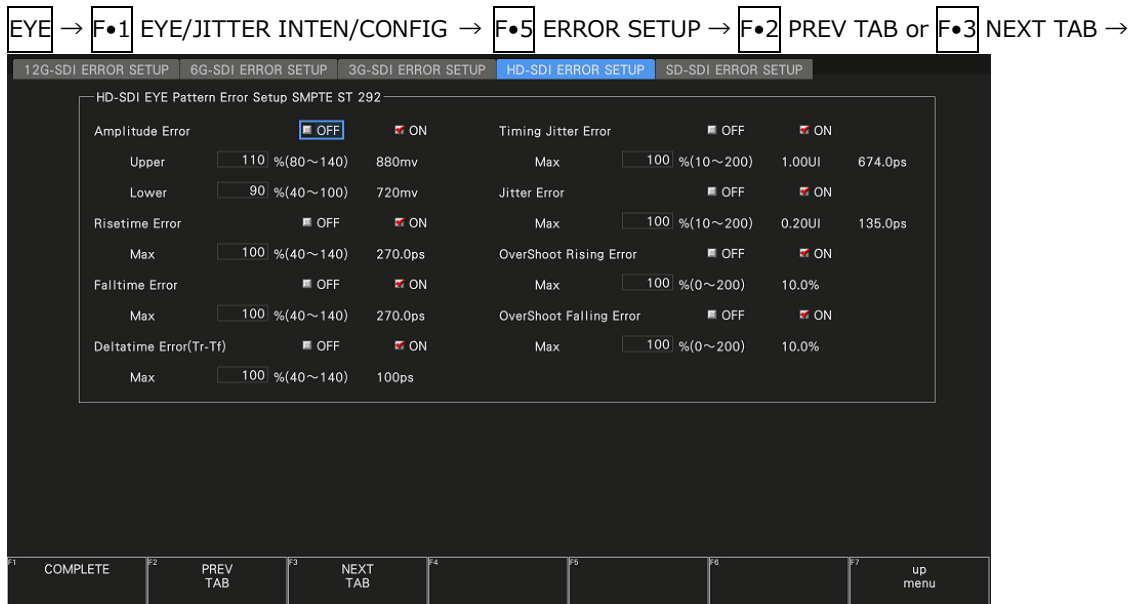

Figure 17-14 HD-SDI ERROR SETUP tab

A configuration example showing threshold values that correspond to SMPTE ST 292 is given below.

Table 17-6 HD-SDI ERROR SETUP configuration example

Parameter		Setting Example	Corresponding Value
Amplitude Error	Upper	110%	880 mV
	Lower	90%	720 mV
Risetime Error	Max	100%	270.0 ps
Falltime Error	Max	100%	270.0 ps
Deltatime Error(Tr-Tf)	Max	100%	100 ps
Timing Jitter Error	Max	100%	1.00 UI (674.0 ps)
Jitter Error	Max	100%	0.20 UI (135.0 ps)
Overshoot Rising Error	Max	100%	10.0%
Overshoot Falling Error	Max	100%	10.0%

17. EYE PATTERN DISPLAY (LV5300/LV5300A/LV7300-SER02)

- Amplitude Error

Turns the eye pattern's amplitude error detection on and off.

You cannot set Lower to a value that is greater than Upper, even if the value is within the selectable range.

Upper:	80 - <u>110</u> - 140% (640 - 1120 mV)
Lower:	40 - <u>90</u> - 100% (320 - 800 mV)

- Risetime Error

Turns the eye pattern's rise time (the time for the signal to rise from 20 to 80 % of its amplitude) error detection on and off.

Max:	40 - <u>100</u> - 140% (108.0 - 378.0 ps)
------	---

- Falltime Error

Turns the eye pattern's fall time (the time for the signal to fall from 80 to 20 % of its amplitude) error detection on and off.

Max:	40 - <u>100</u> - 140% (108.0 - 378.0 ps)
------	---

- Deltatime Error(Tr-Tf)

Turns the eye pattern's time difference (between the rise and fall times) error detection on and off. When the measured values exceed the specified value, Tr and Tf are displayed in red.

Max:	40 - <u>100</u> - 140% (40 - 140 ps)
------	--------------------------------------

- Timing Jitter Error

Turns the eye pattern and jitter's timing jitter error detection on and off.

Max:	10 - <u>100</u> - 200% (0.10 - 2.00 UI, 67.4 - 1348.0 ps)
------	---

- Jitter Error

Turns jitter error detection for eye pattern and jitter.

Max:	10 - <u>100</u> - 200% (0.02 - 0.40 UI, 13.5 - 270.0 ps)
------	--

- Overshoot Rising Error

Turns the rising edge overshoot error detection on and off.

Max:	0 - <u>100</u> - 200% (0.0 - 20.0%)
------	-------------------------------------

- Overshoot Falling Error

Turns the falling edge overshoot error detection on and off.

Max:	0 - <u>100</u> - 200% (0.0 - 20.0%)
------	-------------------------------------

17. EYE PATTERN DISPLAY (LV5300/LV5300A/LV7300-SER02)

17.8.5 Configuring SD Error Settings

Use the SD-SDI ERROR SETUP tab to configure error detection settings for SD signals. You can set the threshold values when you set the error detection to ON. Measured values given in SMPTE ST 259 are used as 100 %.

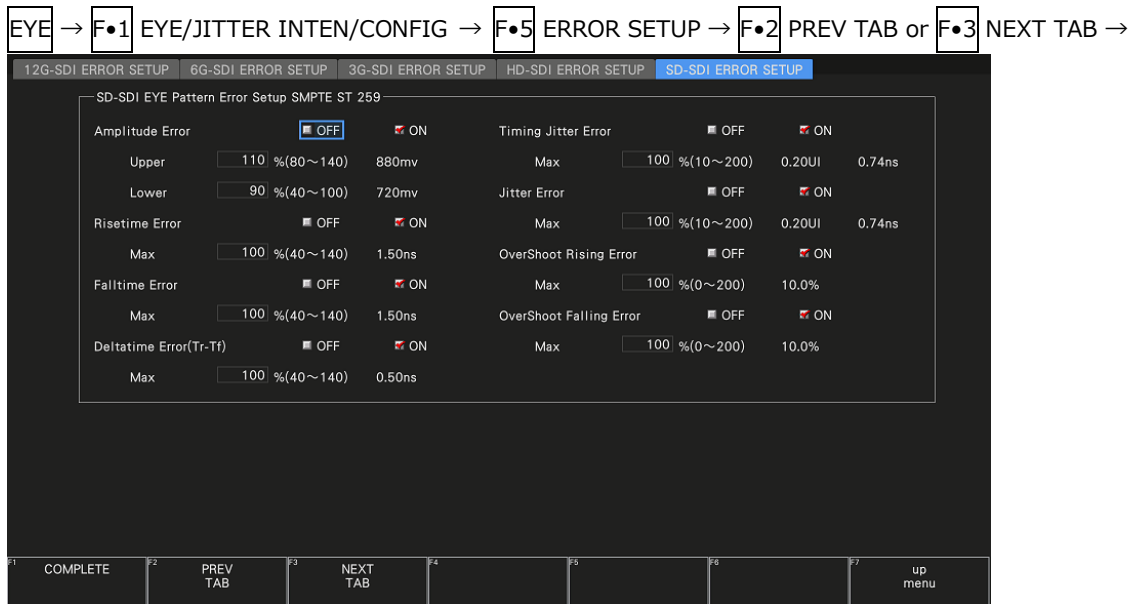

Figure 17-15 SD-SDI ERROR SETUP tab

A configuration example showing threshold values that correspond to SMPTE ST 259 is given below.

Table 17-7 SD-SDI ERROR SETUP configuration example

Parameter		Setting Example	Corresponding Value
Amplitude Error	Upper	110%	880 mV
	Lower	90%	720 mV
Risetime Error	Max	100%	1.50 ns
Falltime Error	Max	100%	1.50 ns
Deltatime Error(Tr-Tf)	Max	100%	0.50 ns
Timing Jitter Error	Max	100%	0.20 UI (0.74 ns)
Jitter Error	Max	100%	0.20 UI (0.74 ns)
Overshoot Rising Error	Max	100%	10.0%
Overshoot Falling Error	Max	100%	10.0%

17. EYE PATTERN DISPLAY (LV5300/LV5300A/LV7300-SER02)

- Amplitude Error

Turns the eye pattern's amplitude error detection on and off.

You cannot set Lower to a value that is greater than Upper, even if the value is within the selectable range.

Upper:	80 - <u>110</u> - 140% (640 - 1120 mV)
Lower:	40 - <u>90</u> - 100% (320 - 800 mV)

- Risetime Error

Turns the eye pattern's rise time (the time for the signal to rise from 20 to 80 % of its amplitude) error detection on and off.

Max:	40 - <u>100</u> - 140% (0.60 - 2.10 ns)
------	---

- Falltime Error

Turns the eye pattern's fall time (the time for the signal to fall from 80 to 20 % of its amplitude) error detection on and off.

Max:	40 - <u>100</u> - 140% (0.60 - 2.10 ns)
------	---

- Deltatime Error(Tr-Tf)

Turns the eye pattern's time difference (between the rise and fall times) error detection on and off. When the measured values exceed the specified value, Tr and Tf are displayed in red.

Max:	40 - <u>100</u> - 140% (0.20 - 0.70 ns)
------	---

- Timing Jitter Error

Turns the eye pattern and jitter's timing jitter error detection on and off.

Max:	10 - <u>100</u> - 200% (0.02 - 0.40 UI, 0.07 - 1.48 ns)
------	---

- Jitter Error

Turns jitter error detection for eye pattern and jitter.

Max:	10 - <u>100</u> - 200% (0.02 - 0.40 UI, 0.07 - 1.48 ns)
------	---

- Overshoot Rising Error

Turns the rising edge overshoot error detection on and off.

Max:	0 - <u>100</u> - 200% (0.0 - 20.0%)
------	-------------------------------------

- Overshoot Falling Error

Turns the falling edge overshoot error detection on and off.

Max:	0 - <u>100</u> - 200% (0.0 - 20.0%)
------	-------------------------------------

17.9 Configuring Eye Pattern Display Settings

To configure eye pattern display settings, press **F•2** GAIN/FILTER/SWEEP on the EYE menu. This menu appears when **F•1** EYE/JITTER INTEN/CONFIG → **F•1** EYE/JITTER MODE is set to EYE.

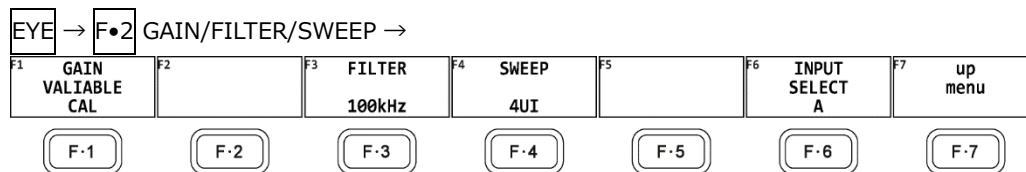

Figure 17-16 GAIN/FILTER/SWEEP menu

17.9.1 Adjusting the Gain

To adjust the eye-pattern gain, follow the procedure below.

Procedure

EYE → **F•2** GAIN/FILTER/SWEEP → **F•1** GAIN VARIABLE: CAL / VARIABLE

Settings

CAL: The eye pattern is shown without gain.
VARIABLE: The eye pattern is shown with the specified gain (×0.50 to ×2.00). The gain value appears in the upper right of the screen.
 Turn the function dial (F•D) to adjust the gain. Press the function dial (F•D) to return the setting to its default value (1.00).

17.9.2 Selecting the Filter

To select the filter that is used during jitter measurement, follow the procedure below. The selected filter is indicated at the bottom of the display.

If you change this setting, the filter that you selected for jitter display also changes.

[See also] 17.10.2, "Selecting the Filter"

Procedure

EYE → **F•2** GAIN/FILTER/SWEEP → **F•3** FILTER: 100kHz / 1kHz / 100Hz / 10Hz / TIMING / ALIGNMENT

Settings

100kHz: Jitter at 100 kHz or higher is measured.
1kHz: Jitter at 1 kHz or higher is measured.
100Hz: Jitter at 100 Hz or higher is measured.
10Hz: Jitter at 10 Hz or higher is measured.
TIMING: Timing jitter is measured. Jitter at 10 Hz or higher is measured.
ALIGNMENT: Alignment jitter is measured. When the input signal is not SD, jitter at 100 kHz and higher is measured. When the input signal is SD, jitter at 1 kHz and higher is measured.

17. EYE PATTERN DISPLAY (LV5300/LV5300A/LV7300-SER02)

17.9.3 Selecting the Sweep Time

To select the eye pattern sweep time, follow the procedure below.

Procedure

EYE	→	F•2	GAIN/FILTER/SWEEP	→	F•4	SWEEP: 2UI / <u>4UI</u> / 16UI
-----	---	-----	-------------------	---	-----	--------------------------------

Settings

2UI:	Two cycles of the eye pattern are shown.
4UI:	Four cycles of the eye pattern are shown.
16UI:	Sixteen cycles of the eye pattern are shown.

SWEEP = 2UI

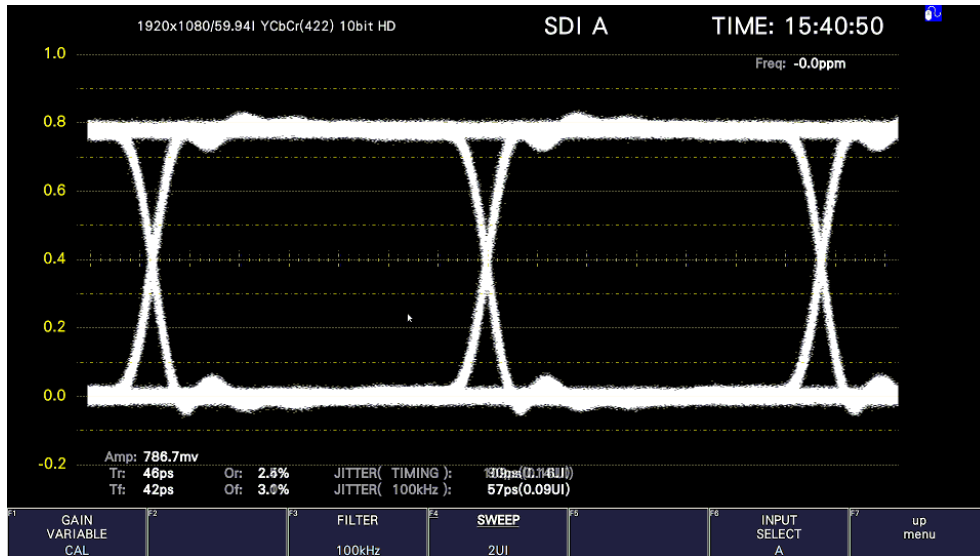

SWEEP = 16UI

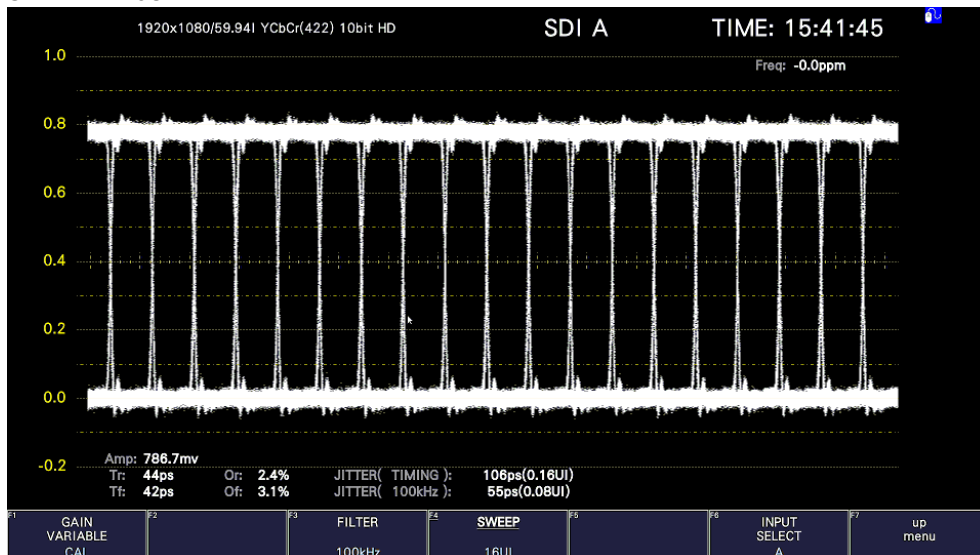

Figure 17-17 Selecting the sweep time

17. EYE PATTERN DISPLAY (LV5300/LV5300A/LV7300-SER02)

17.9.4 Turning the Peak Hold On and Off

To configure the peak hold settings, press **F•3** PEAK HOLD on the EYE menu. Measurement is possible regardless of whether **F•1** EYE/JITTER INTEN/CONFIG → **F•2** EYE/JITTER is set to EYE or JITTER.

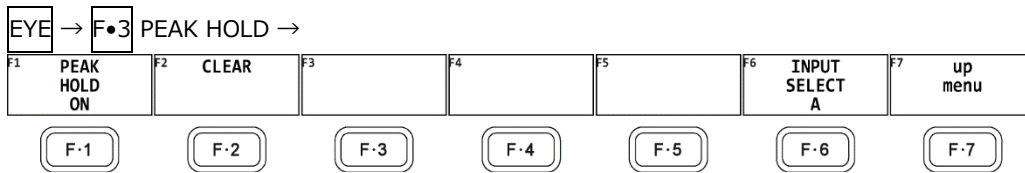

Figure 17-18 PEAK HOLD menu

To measure the peak values of the timing jitter (T.J) and the jitter (JIT), follow the procedure below.

When you set **F•1** PEAK HOLD to ON, the peak values T.J.PEAK and J.PEAK are displayed in the lower part of the screen next to "PEAK." The peak values are retained until you press **F•2** CLEAR. If a peak value exceeds 10.00UI, "OVER" is displayed.

Procedure

EYE → **F•3** PEAK HOLD → **F•1** PEAK HOLD: ON / OFF

PEAK HOLD = ON

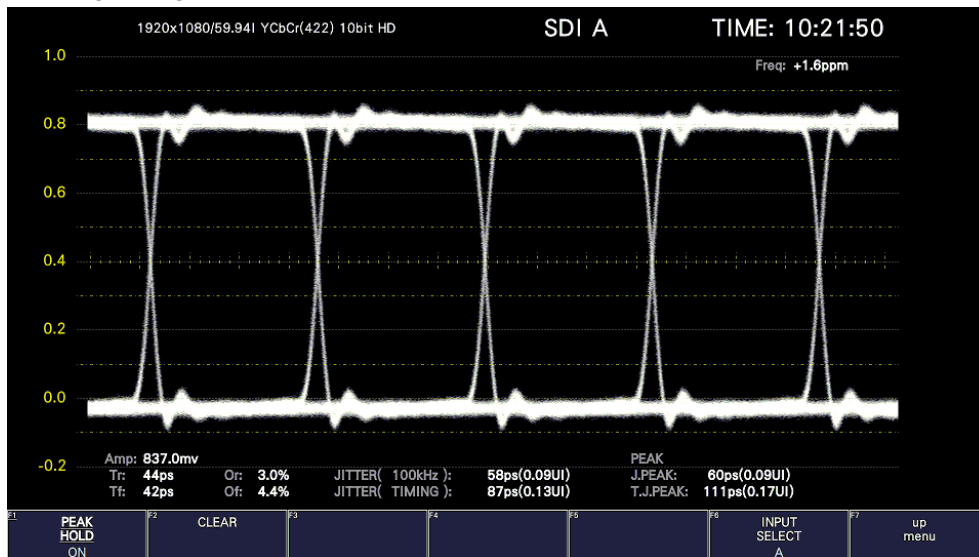

Figure 17-19 Peak hold display

17.9.5 Clearing the Peak Hold

When **F•1** PEAK HOLD is set to ON, to clear the peak hold, follow the procedure below.

Procedure

EYE → **F•3** PEAK HOLD → **F•2** CLEAR

17. EYE PATTERN DISPLAY (LV5300/LV5300A/LV7300-SER02)

17.9.6 Turning Cursors On and Off

To configure the cursor settings, press **F•4** CURSOR on the EYE menu.

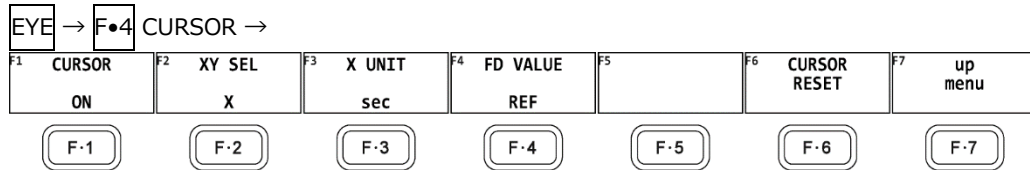

Figure 17-20 CURSOR menu

To turn cursors on and off, follow the procedure shown below.

When the cursors are turned on, the REF cursors are displayed in yellow (X) and light blue (Y), and the DELTA cursors are displayed in purple (X) and green (Y). The values of DELTA-REF appear as measured values in the upper part of the screen.

Procedure

EYE → **F•4** CURSOR → **F•1** CURSOR: ON / OFF

CURSOR = ON

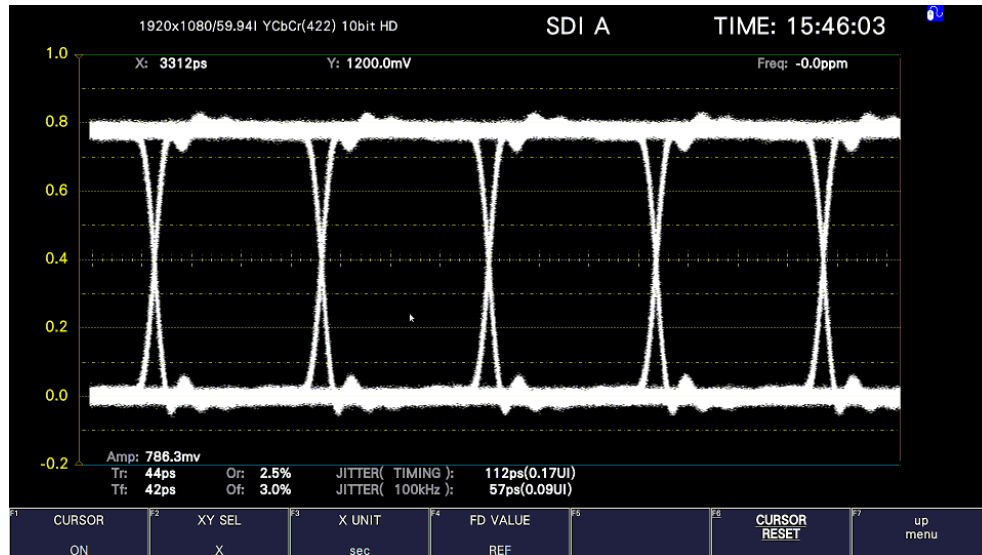

Figure 17-21 Cursor display

17.9.7 Selecting the Cursor

The X-axis and Y-axis cursors are displayed at the same time, but you can only use the function dial (F•D) to move one set of cursors at a time. To select which cursors you want to move, follow the procedure below.

Procedure

EYE	→	F•4	CURSOR	→	F•2	XY SEL: X / Y / Tr,Tf
-----	---	-----	--------	---	-----	-----------------------

If you select Tr,Tf, you can measure the rise time (Tr) and fall time (Tf). Follow the procedure below.

1. Set **F•2** XY SEL to Tr,Tf.
This selects the Y-axis cursors.
2. Use the function dial (F•D) to align the cursors with the amplitude of the eye pattern.
This is the 100% amplitude position.

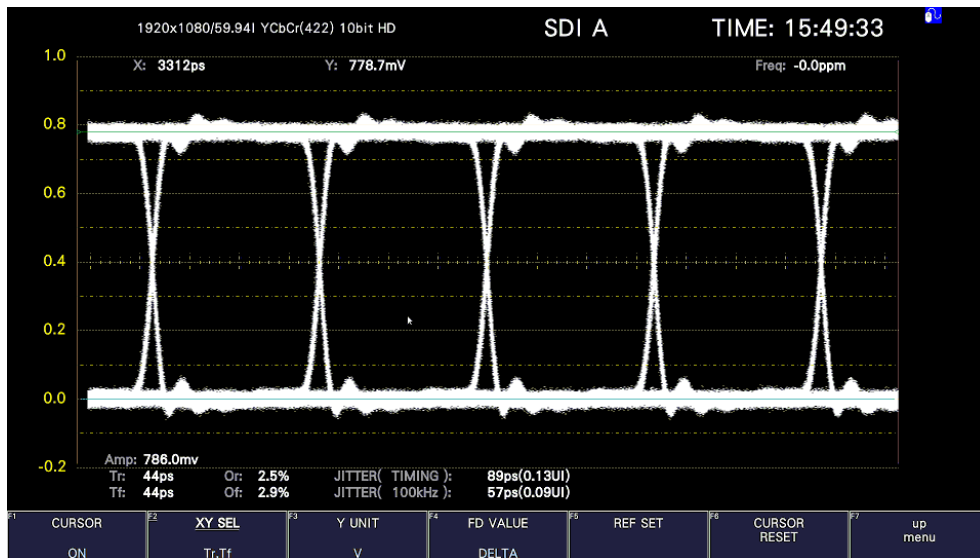

Figure 17-22 Tr,Tf measurement (1)

17. EYE PATTERN DISPLAY (LV5300/LV5300A/LV7300-SER02)

- Press **F•5** REF SET.

The Y-axis cursors move to the 20 % and 80 % positions of the amplitude, and then **F•2** XY SEL is automatically set to X.

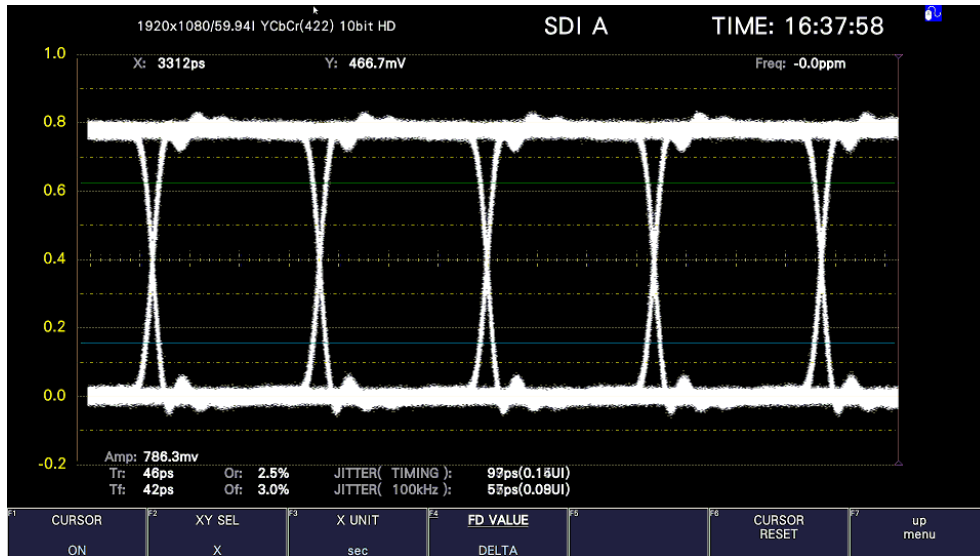

Figure 17-23 Tr,Tf measurement (2)

- Align the X-axis cursors with the intersections of the Y-axis cursors and the eye pattern. Align with the rising edge of the pattern to measure Tr and the falling edge to measure Tf.

The measured value is displayed next to X in the upper part of the screen.

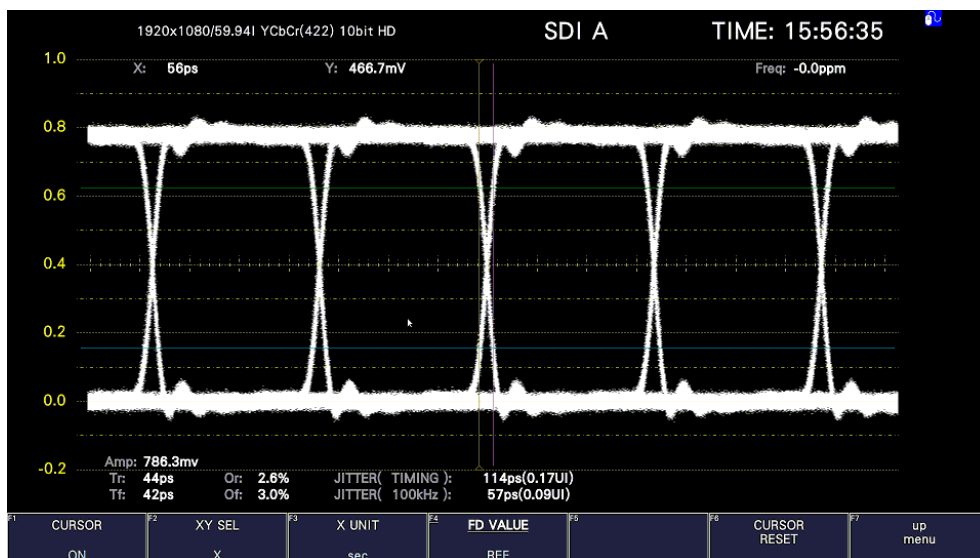

Figure 17-24 Tr, Tf measurement 3 (example of Tr)

17.9.8 Selecting the X-Axis Measurement Unit

When **F•2** XY SEL is set to X, to select the X-axis cursor measurement unit, follow the procedure below.

Procedure

EYE	→	F•4	CURSOR	→	F•3	X UNIT: <u>sec</u> / Hz / UIp-p
-----	---	-----	--------	---	-----	---------------------------------

Settings

sec:	The measurement unit is seconds.
Hz:	The measurement unit is frequency, with the length of one period set to the distance between the two cursors.
UIp-p:	The measurement unit is UIp-p, with one UIp-p set to one cycle of the eye pattern.

17.9.9 Selecting the Y-Axis Measurement Unit

When **F•2** XY SEL is set to Y, to select the Y-axis cursor measurement unit, follow the procedure below.

Procedure

EYE	→	F•4	CURSOR	→	F•3	Y UNIT: <u>V</u> / %
-----	---	-----	--------	---	-----	----------------------

Settings

V:	The measurement unit is volts.
%:	The amplitude will be measured as a percentage of the amplitude at the time when you pressed F•5 REF SET.

17.9.10 Moving the Cursors

To move a cursor, follow the procedure shown below to select a cursor. Then, move the cursor by turning the function dial (F•D). Triangles appear on both ends of the selected cursor.

You can also select a cursor by pressing the function dial (F•D). Each time you press the function dial (F•D), the selected cursor switches from REF, to DELTA, to TRACK, and then back to REF.

Procedure

EYE	→	F•4	CURSOR	→	F•4	FD VALUE: <u>REF</u> / DELTA / TRACK
-----	---	-----	--------	---	-----	--------------------------------------

Settings

REF:	The REF cursor (yellow or light blue) is selected.
DELTA:	The DELTA cursor (purple or green) is selected.
TRACK:	The REF cursor and DELTA cursor are both selected.

17. EYE PATTERN DISPLAY (LV5300/LV5300A/LV7300-SER02)

17.9.11 Resetting Cursors

To reset the cursor positions, follow the procedure below.

Procedure

EYE	→	F•4	CURSOR	→	F•6	CURSOR RESET
-----	---	-----	--------	---	-----	--------------

17.9.12 Selecting the Display Mode

To select the eye pattern display mode, follow the procedure below.

If the eye pattern and jitter are displayed simultaneously, the setting specified here also applies to the jitter.

Procedure

EYE	→	F•5	TRIGGER: <u>RUN</u> / STOP
-----	---	-----	----------------------------

Settings

RUN: The input signal is automatically updated and displayed.

STOP: The input signal is displayed statically. This is convenient for cursor measurement.

Even if STOP is selected, if you change the measurement conditions, such as switching to jitter, the mode switches to RUN.

17.9.13 Selecting the 2-Screen Display Mode

To select the eye pattern's 2-screen display mode, follow the procedure below.

Procedure

EYE	→	F•7	DISPLAY MODE: <u>SINGLE</u> / DUAL
-----	---	-----	------------------------------------

Settings

SINGLE: Displays the eye pattern of the selected filter in a single screen

DUAL: Displays the timing filter and eye pattern of the selected filter in two screens

17.10 Configuring the Jitter Display Settings

To configure the jitter display settings, press **F•1** EYE/JITTER INTEN/CONFIG on the EYE menu.

This menu appears when **F•1** EYE/JITTER INTEN/CONFIG → **F•1** EYE/JITTER MODE is set to JITTER.

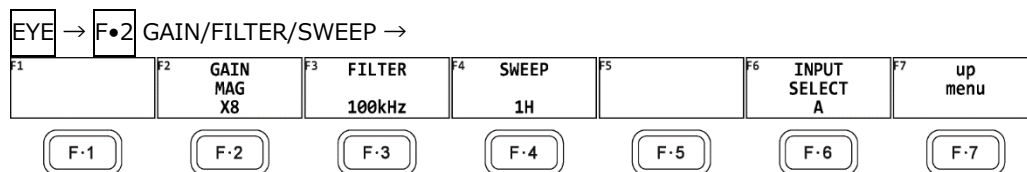

Figure 17-25 GAIN/FILTER/SWEEP menu

17.10.1 Selecting the Magnification

To select the jitter display magnification, follow the procedure below.

Procedure

EYE	→	F•2	GAIN/FILTER/SWEEP	→	F•2	GAIN MAG
: X1 / X2 / <u>X8</u> (for formats other than 12G)						
: X1 / X2 / X4 / <u>X16</u> (for 12G)						

17.10.2 Selecting the Filter

To select the filter that is used during jitter measurement, follow the procedure below. The selected filter is indicated at the bottom of the display.

If you change this setting, the filter that you selected for the eye pattern display also changes.

[See also] 17.9.2, "Selecting the Filter"

Procedure

EYE	→	F•2	GAIN/FILTER/SWEEP	→	F•3	FILTER: <u>100kHz</u> / 1kHz / 100Hz / 10Hz / TIMING / ALIGNMENT
-----	---	-----	-------------------	---	-----	--

17.10.3 Selecting the Sweep Time

To select the sweep time, follow the procedure below.

Procedure

EYE	→	F•2	GAIN/FILTER/SWEEP	→	F•4	SWEEP: 1H / <u>2H</u> / 1V / 2V
-----	---	-----	-------------------	---	-----	---------------------------------

Settings

1H:	The jitter from a period of one line is shown.
2H:	The jitter from a period of two lines is shown.
1V:	When the input signal is interlace or segmented frame, the jitter from a period of one field is shown. When the input signal is progressive, the jitter from a period of one frame is shown.
2V:	When the input signal is interlace or segmented frame, the jitter from a period of one frame is shown. When the input signal is progressive, the jitter from a period of two frames is shown. This option cannot be selected when the input signal is progressive.

17.10.4 Turning the Peak Hold On and Off

To configure the peak hold settings, press **F•3** PEAK HOLD on the EYE menu.

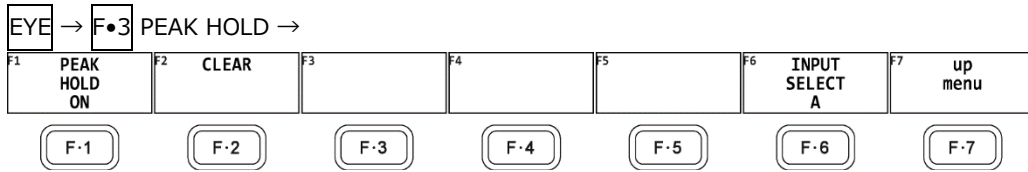

Figure 17-26 PEAK HOLD menu

To measure the peak values of the timing jitter (T.J) and the jitter (JIT), follow the procedure below.

When you set **F•1** PEAK HOLD to ON, the peak values T.J.PEAK and J.PEAK are displayed in the lower part of the screen next to "PEAK." The peak values are retained until you press **F•2** CLEAR. If a peak value exceeds 10.00UI, "OVER" is displayed.

Procedure



PEAK HOLD = ON

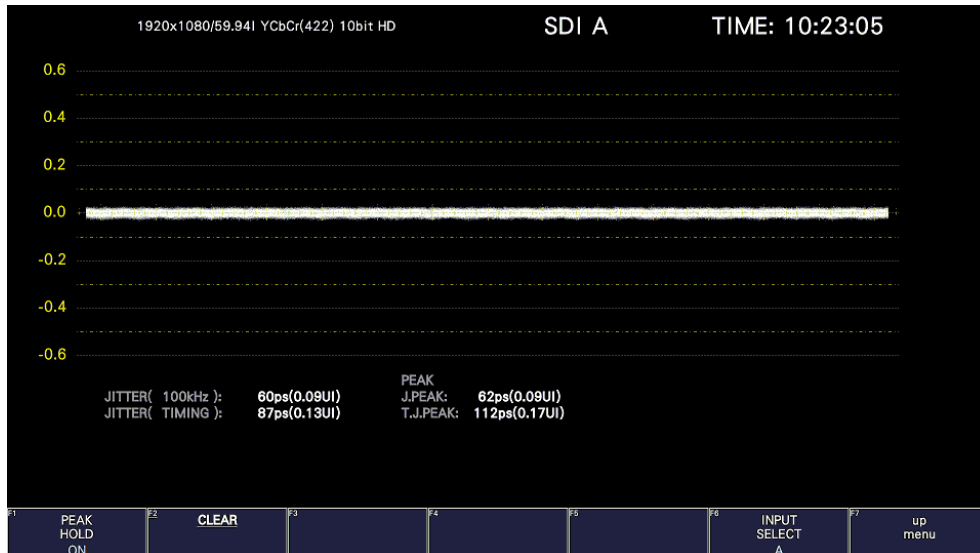

Figure 17-27 Peak hold display

17.10.5 Clearing the Peak Hold

When **F•1** PEAK HOLD is set to ON, to clear the peak hold, follow the procedure below.

Procedure



17.10.6 Turning Cursors On and Off

To configure the cursor settings, press **F•4** CURSOR on the EYE menu.

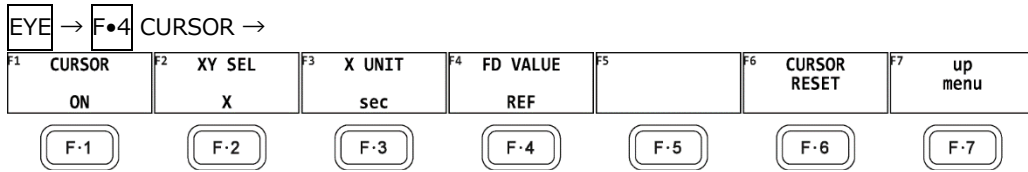
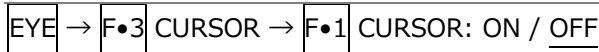

Figure 17-28 CURSOR menu

To turn cursors on and off, follow the procedure shown below.

When the cursors are turned on, the REF cursors are displayed in yellow (X) and light blue (Y), and the DELTA cursors are displayed in purple (X) and green (Y). The values of DELTA-REF appear as measured values in the upper part of the screen.

Procedure



CURSOR = ON

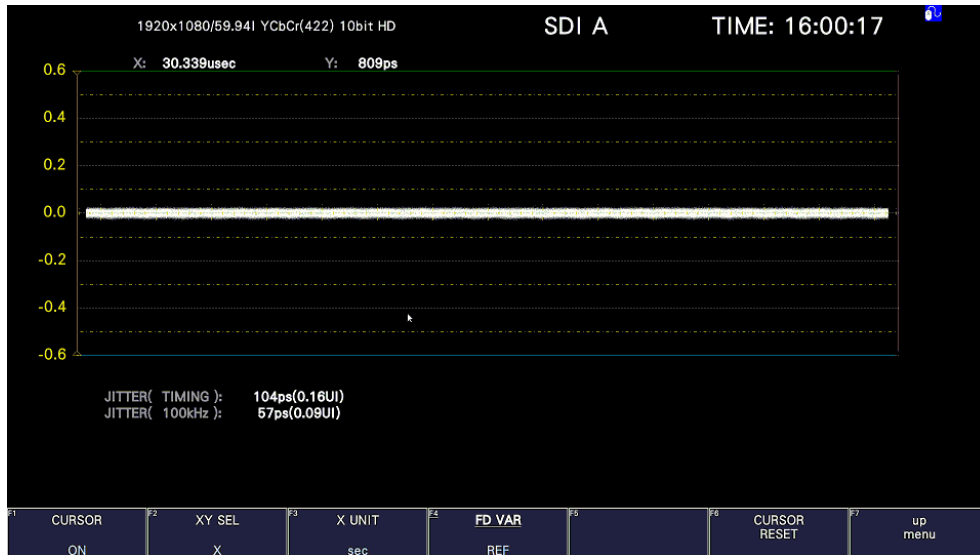
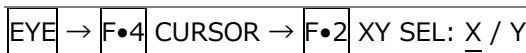

Figure 17-29 Cursor display

17.10.7 Selecting the Cursor

The X-axis and Y-axis cursors are displayed at the same time, but you can only use the function dial (F•D) to move one set of cursors at a time. To select which cursors you want to move, follow the procedure below.

Procedure



17.10.8 Selecting the X-Axis Measurement Unit

When **F•2** XY SEL is set to X, to select the X-axis cursor measurement unit, follow the procedure below.

Procedure

EYE	→	F•4	CURSOR	→	F•3	X UNIT: <u>sec</u> / Hz
-----	---	-----	--------	---	-----	-------------------------

Settings

sec:	The measurement unit is seconds.
Hz:	The measurement unit is frequency, with the length of one period set to the distance between the two cursors.

17.10.9 Selecting the Y-Axis Measurement Unit

When **F•2** XY SEL is set to Y, to select the Y-axis cursor measurement unit, follow the procedure below.

Procedure

EYE	→	F•4	CURSOR	→	F•3	Y UNIT: <u>sec</u> / UIp-p
-----	---	-----	--------	---	-----	----------------------------

Settings

sec:	The measurement unit is seconds.
UIp-p:	The measurement unit is UIp-p, with one UIp-p set to one cycle of the eye pattern.

17.10.10 Moving the Cursors

To move a cursor, follow the procedure shown below to select a cursor. Then, move the cursor by turning the function dial (F•D). Triangles appear on both ends of the selected cursor.

You can also select a cursor by pressing the function dial (F•D). Each time you press the function dial (F•D), the selected cursor switches from REF, to DELTA, to TRACK, and then back to REF.

Procedure

EYE	→	F•4	CURSOR	→	F•4	FD VAR: <u>REF</u> / DELTA / TRACK
-----	---	-----	--------	---	-----	------------------------------------

Settings

REF:	The REF cursor (yellow or light blue) is selected.
DELTA:	The DELTA cursor (purple or green) is selected.
TRACK:	The REF cursor and DELTA cursor are both selected.

17.10.11 Resetting Cursors

To reset the cursor positions, follow the procedure below.

Procedure

EYE	→	F•4	CURSOR	→	F•6	CURSOR RESET
-----	---	-----	--------	---	-----	--------------

17.10.12 Selecting the Display Mode

To select the jitter display mode, follow the procedure below.

If the eye pattern and jitter are displayed simultaneously, the setting specified here also applies to the eye pattern.

Procedure

EYE	→	F•5	TRIGGER: <u>RUN</u> / STOP
-----	---	-----	----------------------------

Settings

RUN: The input signal is automatically updated and displayed.

STOP: The input signal is displayed statically. This is convenient for cursor measurement.

Even if STOP is selected, if you change the measurement conditions, such as switching to eye pattern, the mode switches to RUN.

17.10.13 Selecting the 2-Screen Display Mode

To select the jitter's 2-screen display mode, follow the procedure below.

Procedure

EYE	→	F•7	DISPLAY MODE: <u>SINGLE</u> / DUAL
-----	---	-----	------------------------------------

Settings

SINGLE: Displays the jitter waveform of the selected filter in a single screen

DUAL: Displays the timing jitter and the jitter waveform of the selected filter in two screens

18. REMOTE CONTROL

You can use the remote connector on the rear panel to load presets, transmit alarm signals, and perform other operations. Use your 15-pin D-sub connector to control the instrument.

- Remote Connector Diagram

The remote connector diagram as viewed from the rear panel is shown below.

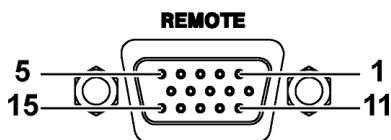

Figure 18-1 Remote connector (female, inch screws)

- Configuring the instrument

To configure the remote control connector, use the SYS menu. See section 7.2.8, “Setting the Remote Connector.”

To display tallies through the remote connector, an SER27 must be installed and Tally Control Select must be set to Remote.

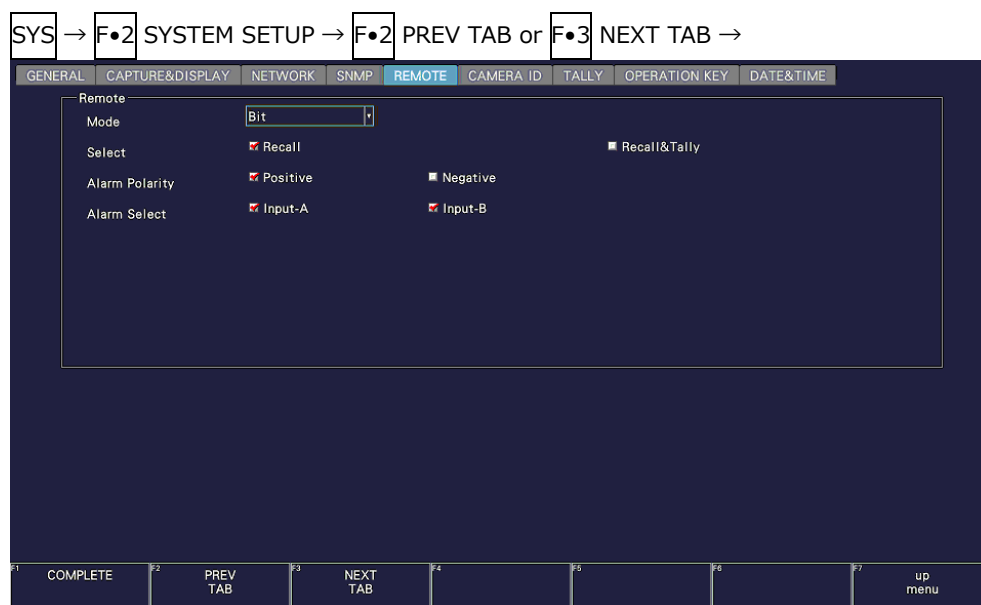

Figure 18-2 REMOTE tab

Each mode on the REMOTE tab is described below. Depending on the selected mode, the items that can be controlled vary as follows.

Table 18-1 Mode

	Bit	Binary	Command	Tally
Load presets	P	Y	Y	N
Switch the display channel	Y	Y	Y	N
Alarm output	Y	Y	Y	Y
Tally display (SER27)	P	N	P	Y

(Y: supported; P: partially supported N: not supported)

18. REMOTE CONTROL

18.1 Bit Mode

This section describes the control method when Mode on the SYS menu is set to Bit.

- Pinout

Table 18-2 Pinout

Pin No.	Name	I/O (*1)	Description
1	OPEN	-	Open (*2)
2	/P1	I	Loads preset 1
3	/P2	I	Loads preset 2
4	/P3	I	Loads preset 3
5	/P4	I	Loads preset 4
6	/P5	I	Loads preset 5
7	/P6	I	Loads preset 6
8	/P7	I	Loads preset 7
9	/P8	I	Loads preset 8
10	/ACH	I	Selects Ach / Tally1 (*3)
11	/BCH	I	Selects Bch / Tally2 (*3)
12	-	I	-
13	-	I	-
14	ALARM	O	Alarm output
15	GND	-	Ground

*1 Is (inputs) are all pulled up to +3.3 V but can also receive +5 V.

*2 Do not connect anything.

*3 On the REMOTE tab of the SYS menu, when Select is set to Recall, the pins are for Input Select A and Bch. When Select is set to Recall&Tally, the pins are for Tally 1 and 2.

18. REMOTE CONTROL

- Control

The input connectors respond to active-low signals. Do not apply negative voltages or voltages that exceed +5 V. The active-low signal must be stable for at least 350 ms. After that, wait at least 1 second before applying the next signal.

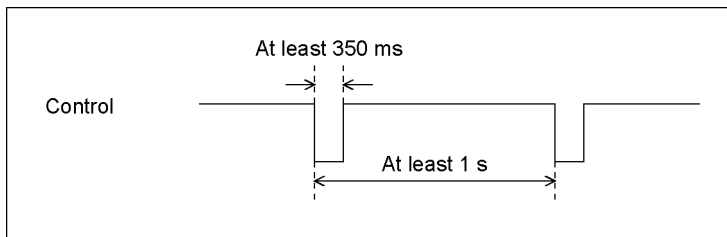

Figure 18-3 Control timing 1

After a setting is made, it may take about 3 seconds for the operation to finish. If you configure subsequent settings before the initial operation finishes, only the last setting will take effect. All settings in between will be discarded. (In the following example, control 2 will be discarded.)

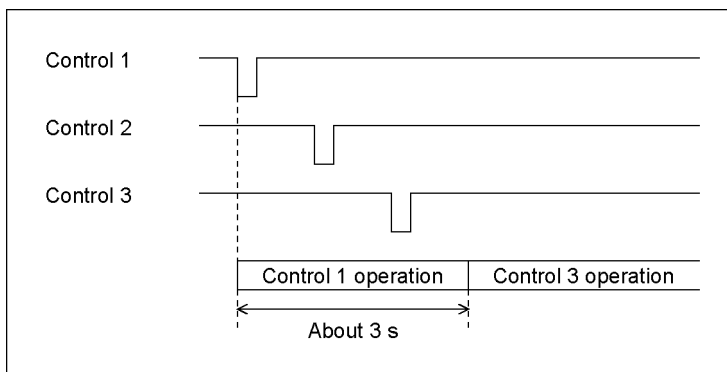

Figure 18-4 Control timing 2

- Recalling a Preset

You can use pins 2 to 9 of the remote connector to load presets.

In Bit mode, presets 1 to 8 can be recalled out of presets 1 to 60. Set the number to recall to low level.

- Switching Display Channels

You can use pins 10 to 13 of the remote connector to switch the display channel.

Channels that you set to low will be turned on, and channels that you set to high will be turned off. However, in single input mode, you cannot turn multiple channels on.

- Alarm output

An alarm is transmitted from pin 14 of the remote connector in the following situations.

The alarm output applies to A/B channels. However, when measuring 3G(DL)-4K, alarms are output only for the currently displayed channels.

18. REMOTE CONTROL

- When a format other than that specified on the SDI IN SETUP2 tab of the SYS menu is received
- When an error occurs in the item that you have set to ON using **F•5** STATUS SETUP on the STATUS menu
- When a fan error occurs
- When the internal temperature rises to an abnormal level
(When Temperature of **F•3** SYSTEM INFO on the SYS menu turns yellow)

18.2 Binary Mode

This section describes the control method when Mode on the SYS menu is set to Binary.

- Pinout
- Control
- Switching Display Channels
- Alarm output

These are the same as Bit mode. See section 18.1, "Bit Mode."

- Recalling a Preset

You can use pins 2 to 7 of the remote connector to load presets.

Table 18-3 Loading presets

Preset No.	7p	6p	5p	4p	3p	2p
	/P6	/P5	/P4	/P3	/P2	/P1
1	H	H	H	H	H	L
2	H	H	H	H	L	H
3	H	H	H	H	L	L
4	H	H	H	L	H	H
5	H	H	H	L	H	L
6	H	H	H	L	L	H
7	H	H	H	L	L	L
8	H	H	L	H	H	H
9	H	H	L	H	H	L
10	H	H	L	H	L	H
11	H	H	L	H	L	L
12	H	H	L	L	H	H
13	H	H	L	L	H	L
14	H	H	L	L	L	H
15	H	H	L	L	L	L
16	H	L	H	H	H	H
17	H	L	H	H	H	L
18	H	L	H	H	L	H
19	H	L	H	H	L	L
20	H	L	H	L	H	H
21	H	L	H	L	H	L
22	H	L	H	L	L	H
23	H	L	H	L	L	L
24	H	L	L	H	H	H
25	H	L	L	H	H	L
26	H	L	L	H	L	H
27	H	L	L	H	L	L
28	H	L	L	L	H	H
29	H	L	L	L	H	L
30	H	L	L	L	L	H
31	H	L	L	L	L	L

18. REMOTE CONTROL

Preset No.	7p	6p	5p	4p	3p	2p
	/P6	/P5	/P4	/P3	/P2	/P1
32	L	H	H	H	H	H
33	L	H	H	H	H	L
34	L	H	H	H	L	H
35	L	H	H	H	L	L
36	L	H	H	L	H	H
37	L	H	H	L	H	L
38	L	H	H	L	L	H
39	L	H	H	L	L	L
40	L	H	L	H	H	H
41	L	H	L	H	H	L
42	L	H	L	H	L	H
43	L	H	L	H	L	L
44	L	H	L	L	H	H
45	L	H	L	L	H	L
46	L	H	L	L	L	H
47	L	H	L	L	L	L
48	L	L	H	H	H	H
49	L	L	H	H	H	L
50	L	L	H	H	L	H
51	L	L	H	H	L	L
52	L	L	H	L	H	H
53	L	L	H	L	H	L
54	L	L	H	L	L	H
55	L	L	H	L	L	L
56	L	L	L	H	H	H
57	L	L	L	H	H	L
58	L	L	L	H	L	H
59	L	L	L	H	L	L
60	L	L	L	L	H	H

18.3 Command Mode

This section describes the control method when Mode on the SYS menu is set to Command.

- Pinout

Table 18-4 Pinout

Pin No.	Name	I/O (*1)	Description
1	OPEN	-	Open (*2)
2	/F1	I	Function 1
3	/F2	I	Function 2
4	/F3	I	Function 3
5	/F4	I	Function 4
6	/F5	I	Function 5
7	/F6	I	Function 6
8	/F7	I	Function 7
9	/F8	I	Function 8
10	CMD1	I	Command 1
11	CMD2	I	Command 2
12	CMD3	I	Command 3
13	/STR	I	Strobe
14	ALARM	O	Alarm output
15	GND	-	Ground

*1 Is (inputs) are all pulled up to +3.3 V but can also receive +5 V.

*2 Do not connect anything.

The functions that can be assigned to pins 2 to 9 of the remote connector vary depending on the setting specified by pins 10 to 12 as follows.

Table 18-5 Command mode functions

Pin No.	Name	Function			
		Preset recall (Bit)	Preset recall (Binary)	Switch the display channel	Tally display (SER27)
10	CMD1	H	L	L	H
11	CMD2	H	H	L	H
12	CMD3	H	H	H	L
2	/F1	Recall 1	Recall 1 (LSB)	Selects channel A	Channel A tally 1 display
3	/F2	Recall 2	Recall 2	Selects channel B	Channel A tally 2 display
4	/F3	Recall 3	Recall 3	-	Channel B tally 1 display
5	/F4	Recall 4	Recall 4	-	Channel B tally 2 display
6	/F5	Recall 5	Recall 5	-	-
7	/F6	Recall 6	Recall 6 (MSB)	-	-
8	/F7	Recall 7	-	-	-
9	/F8	Recall 8	-	-	-

18. REMOTE CONTROL

- Control

Strobe signals are used for Command mode control. Data is retrieved when the strobe signal is at low level. Strobe signals should maintain a stable low level state for at least 350 ms. Before the next command, the strobe signal should maintain a stable high level state for at least 650ms and then set it to a low level.

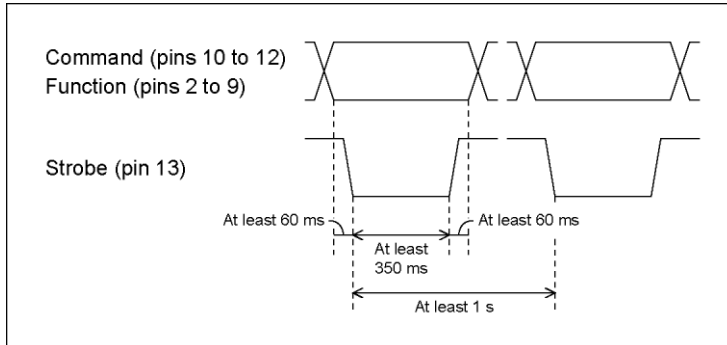

Figure 18-5 Control timing

- Loading presets (Bit)
- Switching Display Channels
- Alarm output

These are the same as Bit mode. See section 18.1, "Bit Mode."

- Loading presets (Binary)

This is the same as Binary mode. See section 18.2, "Binary Mode."

- Tally display (SER27)

You can use pins 2 to 9 of the remote connector to display tallies.

Tallies that you set to low will be turned on, and those that you set to high will be turned off. To display tallies, you must place TALLY items in the layout or turn Tally Frame on.

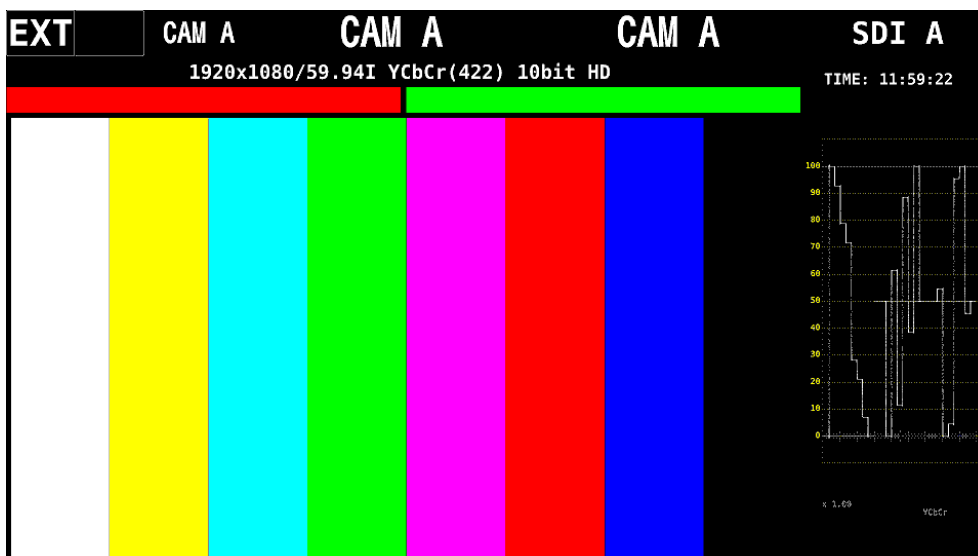

Figure 18-6 Tally display

18.4 Tally Mode (SER27)

This section describes the control method when Mode on the SYS menu is set to Tally.

- Pinout

Table 18-6 Pinout

Pin No.	Name	I/O (*1)	Description
1	OPEN	-	Open (*2)
2	/AT1	I	Channel A tally 1 display
3	/AT2	I	Channel A tally 2 display
4	/ATE	I	Channel A tally EX display
5	/BT1	I	Channel B tally 1 display
6	/BT2	I	Channel B tally 2 display
7	/BTE	I	Channel B tally EX display
8	-	I	-
9	-	I	-
10	-	I	-
11	-	I	-
12	-	I	-
13	-	I	-
14	ALARM	O	Alarm output
15	GND	-	Ground

*1 Is (inputs) are all pulled up to +3.3 V but can also receive +5 V.

*2 Do not connect anything.

- Control

The input connectors respond to active-low signals. Tallies light at low level and turns off at high level.

Set the low level period to at least 32 ms.

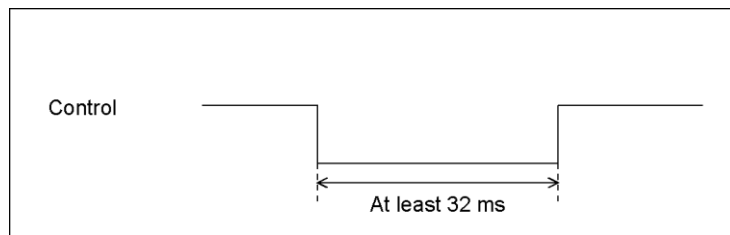

Figure 18-7 Control timing

- Alarm output

These are the same as Bit mode. See section 18.1, "Bit Mode."

18. REMOTE CONTROL

- Tally Display

You can use pins 2 to 13 of the remote connector to display tallies.

Tallies that you set to low will be turned on, and those that you set to high will be turned off.

To display tallies, you must place TALLY items in the layout or turn Tally Frame on.

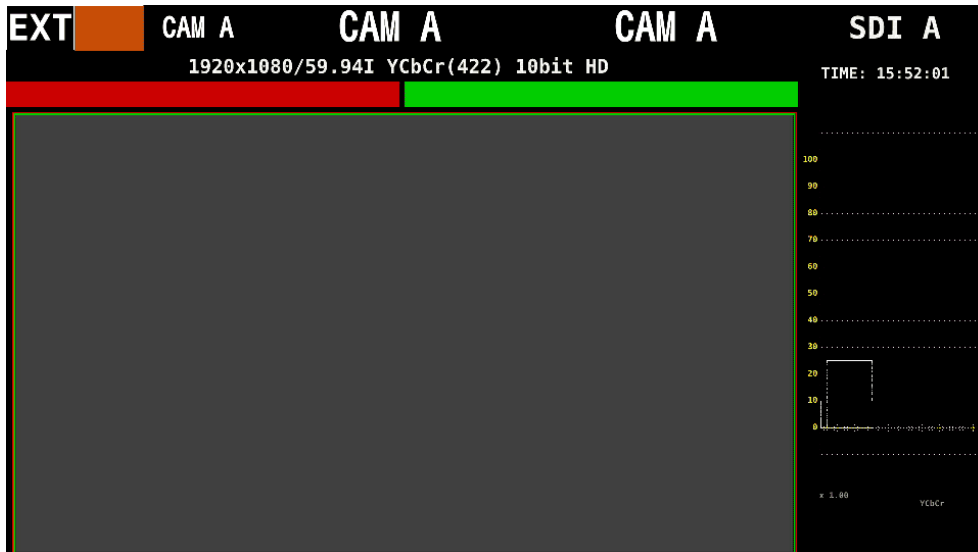

Figure 18-8 Tally display

19. NETWORK CONTROL

The instrument can be remotely controlled through its Ethernet port on the rear panel. Controlling the instrument remotely through its Ethernet interface has only been confirmed to work in a local network environment. LEADER does not guarantee that this feature will work in any network environment.

19.1 SNTP Client Function

The instrument can display time that is synchronized to an NTP server on the network.

19.1.1 How to Use

1. Configure the Ethernet settings on the NETWORK tab of the SYS menu.

Set SNTP Client Select to On, and set the IP address, server IP address, and time zone adjustment. For details on time zone adjustment, see the next section.

[See also] 7.2.6, "Setting the Network IP"

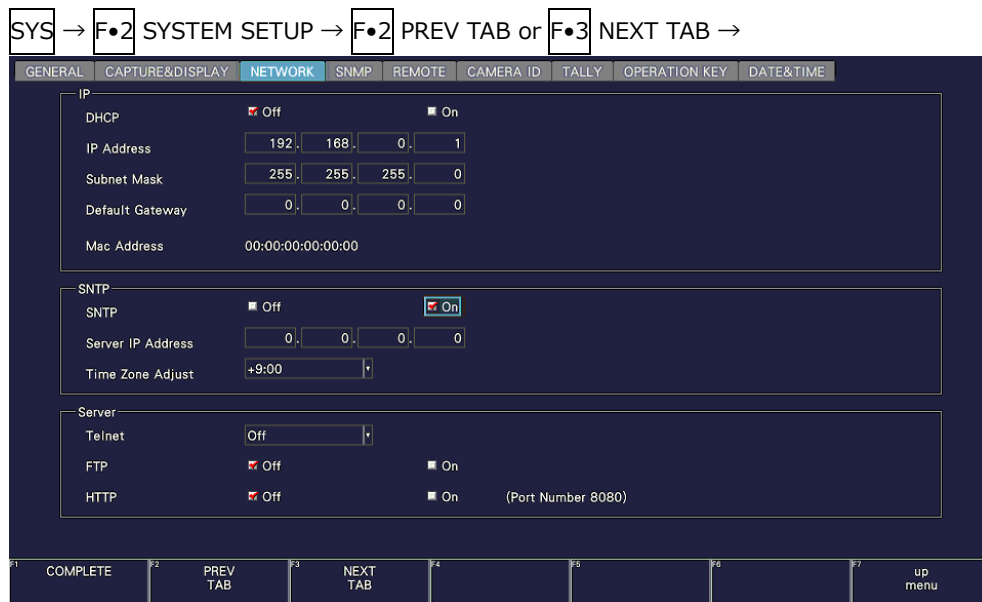

Figure 19-1 NETWORK tab

2. Press F•1 COMPLETE.
3. Connect the instrument's Ethernet port to the external network device.

The instrument connects to the NTP server at the following times.

- When you press F•1 COMPLETE in SYSTEM SETUP
- Once every approximately 10 minutes

When the instrument connects normally to an NTP server, the time is displayed at the upper right of the screen.

If a connection cannot be established, "NTP ERROR" is displayed in red in the TIME box.

19. NETWORK CONTROL

19.1.2 Time Adjustment Value

The date and time exchanged with an NTP (SNTP) are basically Coordinated Universal Time (UTC). Therefore, the time must be adjusted in accordance with the country or region where the device is used in. On the NETWORK tab, set Time Zone Adjust to one of the following values.

Table 19-1 Time adjustment values

Country or region	Time Zone Adjust
Eniwetok, Kwajalein	-12:00
Midway Island, Samoa	-11:00
Hawaii	-10:00
Alaska	-9:00
Pacific Time (US & Canada), Tijuana	-8:00
Mountain Time (US & Canada), Arizona	-7:00
Central Time (US & Canada), Central America, Saskatchewan, Mexico City	-6:00
Eastern Time (US & Canada), Indiana (East), Bogota, Lima, Quito	-5:00
Atlantic Time (Canada), La Paz, Santiago	-4:00
Greenland, Buenos Aires, Georgetown, Brasilia	-3:00
Mid-Atlantic	-2:00
Azores, Cape Verde Is.	-1:00
Greenwich Mean Time (Dublin, Edinburgh, Lisbon, London), Casablanca, Monrovia	0:00
Amsterdam, Berlin, Bern, Rome, Stockholm, Sarajevo, Skopje, Sofija, Vilnius, Warsaw, Zagreb, Brussels, Madrid, Copenhagen, Paris, Belgrade, Bratislava, Budapest, Ljubljana, Prague, West Central Africa	+1:00
Athens, Istanbul, Minsk, Jerusalem, Cairo, Harare, Pretoria, Bucharest, Isinki, Riga, Tallinn	+2:00
Kuwait, Riyadh, Nairobi, Baghdad, Moscow, Volgograd, St. Petersburg	+3:00
Abu Dhabi, Muscat, Baku, Tbilisi, Yerevan	+4:00
Islamabad, Karachi, Tashkent, Ekaterinburg	+5:00
Astana, Dhaka, Almaty, Novosibirsk	+6:00
Krasnoyarsk, Bangkok, Hanoi, Jakarta	+7:00
Irkutsk, Ulaan Bataar, Kuala Lumpur, Singapore, Perth, Taipei, Beijing, Chongqing, Hong Kong SAR, Urumqi	+8:00
Seoul, Yakutsk, Osaka, Sapporo, Tokyo	+9:00
Vladivostok, Canberra, Melbourne, Sydney, Guam, Port Moresby, Brisbane, Hobart	+10:00
Magadan, Solomon Is., New Caledonia	+11:00
Auckland, Wellington, Fiji Islands, Kamchatka, Marshall Is.	+12:00
French Polynesia	-9:30
Newfoundland Standard Time	-3:30
Iran	+3:30
Afghanistan	+4:30
Indian Standard Time, Sri Lanka	+5:30
Nepal	+5:45
Cocos Islands, Myanmar	+6:30

19. NETWORK CONTROL

Country or region	Time Zone Adjust
Western Australia	+8:45
Australian Central Standard Time	+9:30
New South Wales (Lord Howe Island)	+10:30
Phoenix Islands, Tonga, Tokelau	+13:00
Line Islands	+14:00

19.2 TELNET

From a PC connected to the same network as the instrument, you can remotely control most of the operations that can be controlled from the panel.

If you are using the LV5350 or LV7300, read LV5300 and lv5300 as LV5350 and lv5350 or LV7300 and lv7300.

19.2.1 How to Use

1. Configure the Ethernet settings on the NETWORK tab of the SYS menu.

Set the IP address, and set Telnet to On.

You cannot use the LV7290 REMOTE CONTROLLER while using TELNET. Conversely, if you set LV7290 to On, you cannot use TELNET.

[See also] 7.2.8, "Configuring the Server"

SYS → F•2 SYSTEM SETUP → F•2 PREV TAB or F•3 NEXT TAB →

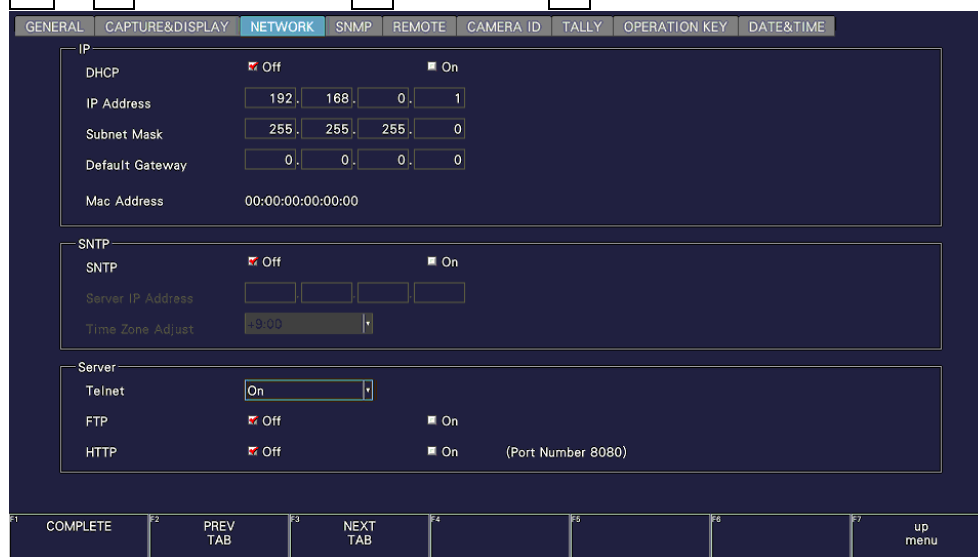

Figure 19-2 NETWORK tab

2. Press F•1 COMPLETE.
3. Connect the instrument's Ethernet port to the external network device.
4. On the PC, start a TELNET client.

On Windows 7, on the taskbar, click Start, and then click Run. Type "TELNET" and the IP address that you set in step 1. Then, click OK.

(To use TELNET, open Control Panel, click Turn Windows features on or off under Program and Features, and select the Telnet Client check box.)

19. NETWORK CONTROL

5. Type the login name and password.

The login name and password are "LV5300". Use uppercase for all characters. When the login name and password are entered correctly, "LV5300@LV5300:~\$" appears.

```
LV5300 login: LV5300
Password: *****
LV5300@LV5300:~$
```

6. Enter TELNET commands.

Enter commands by referring to sections 19.2.2, "How to Enter Commands," and 19.2.3, "TELNET Commands."

To end a TELNET session, type "exit" in lowercase letters.

```
LV5300@LV5300:~$ exit
```

19.2.2 How to Enter Commands

The command syntax is explained below. (Some commands do not have parameters.) To query a current setting, use a question mark as the parameter.

```
LV5300@LV5300:~$ [Command] + [Space] + [Parameter]
```

Examples of how to enter commands are shown below.

- Showing the Status Display

```
LV5300@LV5300:~$ STATUS
```

- Displaying the Center Marker in the Picture Display

```
LV5300@LV5300:~$ PIC:MARKER:CENTER ON
```

- Querying the Vector Intensity

```
LV5300@LV5300:~$ VECTOR:INTEN ?
```

- * You can enter commands using uppercase or lowercase letters.
- * Because the display channel selection command is different depending on the display mode (single or simul) and SDI signal input settings, check the INPUT KEY command.
- * To query the measured value or detected value, you must use the INPUT KEY command to show the measurement screen of the appropriate channel.
Further, for 4K 3G Dual Link settings, you must also select the link according to the link selection command of each measurement item.

19. NETWORK CONTROL

19.2.3 TELNET Commands

TELNET commands follow the instrument or the option menu structure. Some of the descriptions do not apply depending on the installed options or the current settings.

- INPUT KEY

r/w Limitation	Command	Parameter	
-	INPUT	SINGLE / SIMUL / ?	
-	INPUT:SINGLE_A	ON / ? (Return value:ON(Channel A selected) / OFF(not selected))	SD/HD/3G-A/3G-B-DL setting, Select the display channel in single input mode.
-	INPUT:SINGLE_B	ON / ? (Return value:ON(Channel B selected) / OFF(not selected))	
-	INPUT:SIMUL_A	OFF / ON / ? (Return value:Channel A display on/off)	SD/HD/3G-A/3G-B-DL setting, Select the display channel in simul mode.
-	INPUT:SIMUL_B	OFF / ON / ? (Return value:Channel B display on/off)	
-	INPUT:12G_A	ON / ? (Return value:ON(Channel A selected) / OFF(not selected))	4K 12G setting, Select the display channel.
-	INPUT:SINGLE_DUAL_AB	ON / ? (Return value: Channel A-B pair display on/off(not selected))	4K 3G Dual Link setting, Select the display channel in single input mode.
-	INPUT:OPERATE	COM / INDIVIDUAL / ?	
-	INPUT:6G_A	ON / ? (Return value:ON(Channel A selected) / OFF(not selected))	4K 6G setting, Select the display channel.

- EXT KEY

r/w Limitation	Command	Parameter
-	EXT	INT / EXT / ?

- CAP KEY

r/w Limitation	Command	Parameter
WO	CAP:REFRESH	None
-	CAP:DISPLAY	REAL / HOLD / BOTH / ?
-	CAP:FILE:BMP	OFF / ON / ?
-	CAP:FILE:BSG	OFF / ON / ?
WO	CAP:STORE	None
WO	MAKE	CAP_BMP / CAP_BSG / LOG / DUMP (*1) / SCTE104_TEXT / SCTE104_SPLICE * File make command. Use FTP to retrieve created files. *1 If you want to create an event log, or data dump file, the corresponding measurement screen must be displayed on the screen.

- PRESET KEY

r/w Limitation	Command	Parameter
WO	RCLL	1 to 60

- MULTI KEY

r/w Limitation	Command	Parameter
-	MULTI	OFF / ON / ?
WO	USER:LYT	USER1/ USER2 / USER3 / USER4 / USER5 / USER6

19. NETWORK CONTROL

• SYS KEY

r/w Limitation	Command	Parameter
-	SYS:LCD:BACKLIGHT	1 to 32 / ?
WO	SYS:LCD:ON	None
WO	SYS:LCD:OFF	None
WO	SYS:INITIALIZE:PARAM	None
WO	SYS:INITIALIZE:LAYOUT	None
WO	SYS:INITIALIZE:OPERATE	None
WO	SYS:INITIALIZE:ALL	None
-	SYS:SDI:SYSTEM	4K_12G / 4K_6G / 4K_3G_DLINK / SINGLE_LINK / ? * Correspondence between parameters and settings 4K_12G : 4K 12G 4K_6G : 4K 6G 4K_3G_DLINK : 4K 3G Dual Link SINGLE_LINK : SD/HD/3G-A/3G-B-DL
-	SYS:SDI:COLORIMETRY	PAYLOAD_ID / BT709 / BT2020 / DCI / ?
-	SYS:XYZ_GAMMA	BOTTOM_ZERO / DCI / ?
-	SYS:HDR:MODE_A	OFF / HLG / PQ / SLOG3 / CLOG / LOGC / ?
-	SYS:HDR:MODE_B	OFF / HLG / PQ / SLOG3 / CLOG / LOGC / ?
-	SYS:HDR:GAMMA_A	OFF / ON / ?
-	SYS:HDR:GAMMA_B	OFF / ON / ?
-	SYS:HDR:HLG_SCALE_A	1200P / 100P / ?
-	SYS:HDR:HLG_SCALE_B	1200P / 100P / ?
-	SYS:HDR:RANGE_A	NARROW / FULL / ?
-	SYS:HDR:RANGE_B	NARROW / FULL / ?
-	SYS:HDR:EI_A	EI200 / EI400 / EI800 / EI1600 / ?
-	SYS:HDR:EI_B	EI200 / EI400 / EI800 / EI1600 / ?
-	SYS:HDR:DETECT_PAYLOAD_A	OFF / ON / ?
-	SYS:HDR:DETECT_PAYLOAD_B	OFF / ON / ?
-	SYS:HDR:REF_LV_HLG_A	50P / 75P / ?
-	SYS:HDR:REF_LV_HLG_B	50P / 75P / ?
-	SYS:HDR:REF_LV_PQ_A	51P / 58P / ?
-	SYS:HDR:REF_LV_PQ_B	51P / 58P / ?

• WFM KEY

r/w Limitation	Command	Parameter
WO	WFM	None
-	WFM:MODE	OVERLAY / PARADE / ?
-	WFM:MODE:YCBCR:Y	ON / OFF / ?
-	WFM:MODE:YCBCR:CB	ON / OFF / ?
-	WFM:MODE:YCBCR:CR	ON / OFF / ?
-	WFM:MODE:GBR:G	ON / OFF / ?
-	WFM:MODE:GBR:B	ON / OFF / ?
-	WFM:MODE:GBR:R	ON / OFF / ?
-	WFM:MODE:RGB:R	ON / OFF / ?
-	WFM:MODE:RGB:G	ON / OFF / ?
-	WFM:MODE:RGB:B	ON / OFF / ?
-	WFM:MODE:XYZ:X	ON / OFF / ?
-	WFM:MODE:XYZ:Y	ON / OFF / ?
-	WFM:MODE:XYZ:Z	ON / OFF / ?
-	WFM:INTEN	-128 to 127 / ?

19. NETWORK CONTROL

-	WFM:COLOR	WHITE / YELLOW / CYAN / GREEN / MAGENTA / RED / BLUE / MULTI / ?
-	WFM:SCALE:INTEN	-8 to 7 / ?
-	WFM:SCALE:COLOR	WHITE / YELLOW / CYAN / GREEN / MAGENTA / RED / BLUE / ?
-	WFM:SCALE:UNIT	HDTV_SDP / HDV_SDV / HDP_SDP / CV_DEC / CV_HEX / ?
-	WFM:SCALE:UNIT:NTSC	P / ?
-	WFM:SCALE:UNIT:PAL	V / ?
-	WFM:SCALE:UNIT:FULL	HDP_SDP / CV_DEC / CV_HEX / ?
-	WFM:SCALE:75_COLOR	ON / OFF / ?
-	WFM:SCALE:DISPLAY	ON / OFF / BOTH / MAIN / HDR / ?
-	WFM:GAIN:VARIABLE	CAL / VAR / ?
-	WFM:GAIN:MAG	X1 / X5 / X10 / ?
-	WFM:GAIN:VALUE	20 to 200 / ? * MAG value × 0.200 (20) - 2.000 (200)
-	WFM:GAIN:SCALE_JUMP	0P / 10P / 20P / 30P / 40P / 50P / 60P / 70P / 80P / 90P / 100P / CURSOR / ?
-	WFM:FILTER:NORMAL	FLAT / LOWPASS / ?
-	WFM:FILTER:COMPOSITE	FLAT / LUM / FLAT_LUM / LUM_CRMA / ?
-	WFM:SWEEP	H / V / ?
-	WFM:SWEEP:H_SWEEP	1H / 2H / ?
-	WFM:SWEEP:V_SWEEP	1V / 2V / ?
-	WFM:SWEEP:H_MAG	X1 / X10 / X20 / ACTIVE / BLANK / ?
-	WFM:SWEEP:V_MAG	X1 / X20 / X40 / ?
-	WFM:SWEEP:FIELD	FIELD1 / FIELD2 / ?
-	WFM:BLANKING:NORMAL	REMOVE / H_VIEW / V_VIEW / ALL_VIEW / ?
-	WFM:BLANKING:COMPOSITE	REMOVE / V_VIEW / ?
-	WFM:CORSOR	SINGLE / BOTH / OFF / ?
-	WFM:CORSOR:SELECT	X / Y / ?
-	WFM:CORSOR:UNIT:X	SEC / HZ / ?
-	WFM:CORSOR:UNIT:Y	MV / P / RP / DEC / HEX / HDR / ?
-	WFM:CORSOR:UNIT:Y:COMPOSITE	MV / P / RP / ?
-	WFM:CORSOR:FD	REF / DELTA / TRACK / ?
-	WFM:CORSOR:REF	0 to 927 (when X is selected) -5000 to 15000 (when Y is selected)
-	WFM:CORSOR:DELTA	0 to 927 (when X is selected) -5000 to 15000 (when Y is selected)
-	WFM:CORSOR:TRACK	0 to 927 (when X is selected) -5000 to 15000 (when Y is selected)
WO	WFM:CORSOR:REFSET	None
-	WFM:CORSOR:VAL	ON / OFF / ?
-	WFM:LINE_SELECT	ON / OFF / CINELITE / ?
-	WFM:LINE_NUMBER	0 to 32767 / ?
-	WFM:LINE_FIELD	FIELD1 / FIELD2 / FRAME / ?
-	WFM:MATRIX:YCBCR	YCBCR / GBR / RGB / COMPOSITE / ?
-	WFM:MATRIX:RGB	GBR / RGB / COMPOSITE / ?
-	WFM:MATRIX:YGBR	ON / OFF / ?
-	WFM:MATRIX:YRGB	ON / OFF / ?
-	WFM:MATRIX:COMPOSITE:FORMAT	AUTO / NTSC / PAL / ?
-	WFM:MATRIX:COMPOSITE:SETUP	0P / 7.5P / ?
-	WFM:MATRIX:XYZ	XYZ / GBR / RGB / COMPOSITE / ?

• VECTOR KEY

r/w Limitation	Command	Parameter
WO	VECTOR	None

19. NETWORK CONTROL

-	VECTOR:DISPLAY	VECT / 5BAR / HIST / CIE / ?
-	VECTOR:LINE_SELECT	ON / OFF / CINELITE / ?
-	VECTOR:LINE_NUMBER	0 to 32767 / ?
-	VECTOR:LINE_FIELD	FIELD1 / FIELD2 / FRAME / ?
-	VECTOR:MATRIX:CB	100P / 75P / ?
-	VECTOR:MATRIX:COLOR_MATRIX	COMPONENT / COMPOSITE / ?
-	VECTOR:MATRIX:COMPOSITE:FORMAT	AUTO / NTSC / PAL / ?
-	VECTOR:MATRIX:COMPOSITE:SETUP	0P / 7_5P / ?
-	VECTOR:VECTOR:MODE	VECTOR / RGBVECTOR / YCBCRVECTOR / ?
-	VECTOR:VECTOR:INTEN	-128 to 127 / ?
-	VECTOR:VECTOR:COLOR	WHITE / YELLOW / CYAN / GREEN / MAGENTA / RED / BLUE / ?
-	VECTOR:VECTOR:SCALE:INTEN	-8 to 7 / ?
-	VECTOR:VECTOR:SCALE:COLOR	WHITE / YELLOW / CYAN / GREEN / MAGENTA / RED / BLUE / ?
-	VECTOR:VECTOR:SCALE:IQ_AXIS	ON / OFF / ?
-	VECTOR:VECTOR:SCALE:VEC_SCALE	AUTO / BT601 / BT709 / BT2020 / DCI / ?
-	VECTOR:VECTOR:SCALE:VAR_SCALE	ON / OFF / ?
-	VECTOR:VECTOR:GAIN:VARIABLE	CAL / VAR / ?
-	VECTOR:VECTOR:GAIN:MAG	X1 / X5 / IQ / ?
-	VECTOR:VECTOR:GAIN:VALUE	200 to 2000 / ? * X1 1000 to 10000 / ? * X5 580 to 5840 / ? * IQ-MAG or SD, composite display 620 to 6240 / ? * not IQ-MAG or SD, component display 520 to 5260 / ? * IQ-MAG or SD, for pseudo-composite display 570 to 5700 / ? * not IQ-MAG or SD, for pseudo-composite display
-	VECTOR:GAIN:GUIDE_DISP	ON / OFF / ?
-	VECTOR:VECTOR:MARKER	ON / OFF / ?
-	VECTOR:VECTOR:VAR_MKR:MKR_SIZE	5 to 10 / ?
-	VECTOR:RGBVECTOR:SCALE:ADJ_TARGET	GB / GR / ?
-	VECTOR:RGBVECTOR:SCALE:H	-500 to 500 / ?
-	VECTOR:RGBVECTOR:SCALE:V	-500 to 500 / ?
-	VECTOR:RGBVECTOR:GAIN:H	200 to 2000 / ? * 0.200 (200) - 2.000 (2000)
-	VECTOR:RGBVECTOR:GAIN:V	200 to 2000 / ? * 0.200 (200) - 2.000 (2000)
-	VECTOR:YCBCRVECTOR:SCALE:TIM_MKR	AUTO / HD / SD / ?
-	VECTOR:YCBCRVECTOR:SCALE:VEC_SCALE	AUTO / BT601 / BT709 / BT2020 / DCI / ?
-	VECTOR:YCBCRVECTOR:GAIN:VARIABLE	CAL / VAR / ?
-	VECTOR:YCBCRVECTOR:GAIN:MAG	X1 / X5 / ?
-	VECTOR:YCBCRVECTOR:GAIN:VALUE	200 to 2000 / ? * MAG value × 0.200 (200) - 2.000 (2000)
-	VECTOR:YCBCRVECTOR:GAIN:OBS_POINT	BY_WH / BY_YL / BY_CY / BY_G / BY_TM / BY_MG / BY_R / BY_B / BL / RY_B / RY_R / RY_MG / RY_TM / RY_G / RY_CY / RY_YL / RY_WH / ?
RO	VECTOR:5BAR:Y:DATA	?
RO	VECTOR:5BAR:G:DATA	?
RO	VECTOR:5BAR:B:DATA	?
RO	VECTOR:5BAR:R:DATA	?
RO	VECTOR:5BAR:CMP:DATA	?
-	VECTOR:5BAR:SCALE	P / MV / HEX / DEC / ?
-	VECTOR:5BAR:SEQUENCE	GBR / RGB / ?

19. NETWORK CONTROL

-	VECTOR:HIST:SCALE	P / HDR / ?
-	VECTOR:HIST:FORM	SINGLE / TILE / ALIGN_H / ALIGN_V / ?
-	VECTOR:HIST:Y	ON / OFF / ?
-	VECTOR:HIST:R	ON / OFF / ?
-	VECTOR:HIST:G	ON / OFF / ?
-	VECTOR:HIST:B	ON / OFF / ?
-	VECTOR:CIE:SCALE:COLOR	BG_COLOR / BG_WHITE / BG_BLACK / ?
-	VECTOR:CIE:SCALE:TRIANGLE1	OFF / BT601_525 / BT601_625 / BT709 / DCI / BT2020 / ?
-	VECTOR:CIE:SCALE:TRIANGLE2	OFF / BT601_525 / BT601_625 / BT709 / DCI / BT2020 / ?
-	VECTOR:CIE:SCALE:USER_TRIANGLE	1 / 2 / OFF / ?
-	VECTOR:CIE:SCALE:USER_TRIANGLE:COLOR	G / B / R / ?
-	VECTOR:CIE:SCALE:USER_TRIANGLE1:X	0 to 1000 / ? * 0(0.000) - 1000(1.000)
-	VECTOR:CIE:SCALE:USER_TRIANGLE1:Y	0 to 1000 / ? * 0(0.000) - 1000(1.000)
-	VECTOR:CIE:SCALE:USER_TRIANGLE2:X	0 to 1000 / ? * 0(0.000) - 1000(1.000)
-	VECTOR:CIE:SCALE:USER_TRIANGLE2:Y	0 to 1000 / ? * 0(0.000) - 1000(1.000)
-	VECTOR:CIE:SCALE:SUB:TEMP_SCALE	ON / OFF / ?
-	VECTOR:CIE:SCALE:SUB:GRID	ON / OFF / ?
-	VECTOR:CIE:SCALE:SUB:D65	ON / OFF / ?
-	VECTOR:CIE:SCALE:SUB:CAP	ON / OFF / ?
-	VECTOR:CIE:SCALE:SUB:WP_LABEL	ON / OFF / ?
-	VECTOR:CIE:MODE	DIAGRAM / TEMP / ?
-	VECTOR:CIE:STANDARD	CIE1931 / CIE1976 / ?
-	VECTOR:CIE:CLIP	ON / OFF / ?
-	VECTOR:CIE:FILTER	ON / OFF / ?
-	VECTOR:CIE:MANUAL	ON / OFF / ?
-	VECTOR:CIE:MANUAL:COLORIMETRY	BT601_525 / BT610_625 / BT709 / DCI / BT2020 / ?
-	VECTOR:CIE:MANUAL:GAMMA	150 to 300 / ? * 150(1.50) - 300(3.00)
-	VECTOR:CIE:CURSOR	ON / OFF / ?

• PICTURE KEY

r/w Limitation	Command	Parameter
WO	PICTURE	None
-	PIC:MODE	FIT / REAL / X2 / FULL_FRAME / ?
-	PIC:COLOR	MONO / COLOR / ?
-	PIC:CHROMA	UP / NORMAL / ?
-	PIC:BRIGHTNESS	-500 to 500 / ? * -500(-50.0%) - 500(50.0%)
-	PIC:CONTRAST	0 to 2000 / ? * 0(0%) - 2000(200.0%)
-	PIC:GAIN:R	0 to 2000 / ? * 0(0%) - 2000(200.0%)
-	PIC:GAIN:G	0 to 2000 / ? * 0(0%) - 2000(200.0%)
-	PIC:GAIN:B	0 to 2000 / ? * 0(0%) - 2000(200.0%)
-	PIC:GAIN:CHROMA	0 to 2000 / ? * 0(0%) - 2000(200.0%)

19. NETWORK CONTROL

-	PIC:BIAS:R	-500 to 500 / ? * -500(-50.0%) - 500(50.0%)
-	PIC:BIAS:G	-500 to 500 / ? * -500(-50.0%) - 500(50.0%)
-	PIC:BIAS:B	-500 to 500 / ? * -500(-50.0%) - 500(50.0%)
-	PIC:DISP:GAMUT	OFF / WHITE / RED / MESH / ?
-	PIC:DISP:STATUS_INFO	ON / OFF / ?
-	PIC:MARKER:FRAME	ON / OFF / ?
-	PIC:MARKER:CENTER	ON / OFF / ?
-	PIC:MARKER:ASPECT	OFF / 17_9 / 16_9 / 14_9 / 13_9 / 4_3 / 2.93_1 / AFD / ?
-	PIC:MARKER:ASPECT:SHADOW	0 to 100 / ?
-	PIC:MARKER:SAFE:ACTION	ARIB / SMPTE / USER1 / OFF / ?
-	PIC:MARKER:SAFE:TITLE	ARIB / SMPTE / USER2 / OFF / ?
-	PIC:MARKER:SAFE:USER1:WIDTH	0 to 100 / ?
-	PIC:MARKER:SAFE:USER1:HEIGHT	0 to 100 / ?
-	PIC:MARKER:SAFE:USER2:WIDTH	0 to 100 / ?
-	PIC:MARKER:SAFE:USER2:HEIGHT	0 to 100 / ?
-	PIC:MARKER:SAFE:USER1_2:ASPECT	ON / OFF / ?
-	PIC:SUPER_IMPOSE	OFF / SMPTE / ARIB / TELETEXT / ?
-	PIC:SUPER_IMPOSE:FORMAT	FMT_608_708 / FMT_608_608 / FMT_VBI / FMT_708 / ? * CC_SMPTE SD / HD / ANALOG / CELLUAR / ? * CC_ARIB
-	PIC:SUPER_IMPOSE:WST_TRANSPORT	VBI / OP47 / ?
-	PIC:SUPER_IMPOSE:LANGUAGE	CC1 / CC2 / CC3 / CC4 / TEXT1 / TEXT2 / TEXT3 / TEXT4 / ? * CC_SMPTE 1 / 2 / ? * CC_ARIB
-	PIC:SUPER_IMPOSE:MAGAZINE	1 to 8 / ?
-	PIC:SUPER_IMPOSE:PAGE	0 to 255 / ?
-	PIC:SUPER_IMPOSE:SERVICE_DATA	1 to 63 / ?
-	PIC:SUPER_IMPOSE:CS_LOG	START / STOP / ?
WO	PIC:SUPER_IMPOSE:CS_LOG:CLEAR	None
-	PIC:SUPER_IMPOSE:CS_LOG:MODE	OVER_WRITE / STOP / ?
WO	PIC:SUPER_IMPOSE:CLEAR	None
-	PIC:SUPER_IMPOSE:CONTENT	ON / OFF / ?
-	PIC:CINELITE:DISPLAY	OFF / FSTOP / _DISPLAY / CINEZONE / PER_CINE / ?
-	PIC:CINELITE:ADVANCE	ON / OFF / ?
-	PIC:CINELITE:MEASURE_NUMBERS	P1 / P1+P2 / P1+P2+P3 / ?
-	PIC:CINELITE:MEASURE_POSITION	P1 / P2 / P3 / ?
-	PIC:CINELITE:MEASURE_SIZE	1X1 / 3X3 / 9X9 / ?
RO	PIC:CINELITE:P1_DATA	?
RO	PIC:CINELITE:P2_DATA	?
RO	PIC:CINELITE:P3_DATA	?
-	PIC:CINELITE:MAX_FALL_CLL	ON / OFF / ?
-	PIC:CINELITE:MAX_FALL_CLL:MEASURE	STOP / START / ?
WO	PIC:CINELITE:MAX_FALL_CLL:CLEAR	None
WO	PIC:CINELITE:FSTOP:18P_REF_SET	None
-	PIC:CINELITE:FSTOP:GAMMA_SELECT	0.45 / USER1 / USER2 / USER3 / USER_A / USER_B / USER_C / USER_D / USER_E / ?
WO	PIC:CINELITE:FSTOP:GAMMA:CAL:TABLE_CLEAR	None

19. NETWORK CONTROL

WO	PIC:CINELITE:FSTOP:GAMMA:CAL:1_DATA_CLEAR	None
WO	PIC:CINELITE:FSTOP:GAMMA:CAL:SET	None
-	PIC:CINELITE:FSTOP:GAMMA:CAL:F	22.0 / 16.0 / 11.0 / 8.0 / 5.6 / 4.0 / 2.8 / 2.0 / ?
WO	PIC:CINELITE:FSTOP:GAMMA:FILE:TABLE_CLEAR	None
-	PIC:CINELITE:_DISPLAY:UNIT_SELECT	Y_P / RGB_P / RGB255 / ? * MEASURE SIZE : not 1x1 Y_P / RGB_P / RGB255 / CV_HEX / CV_DEC / ? * MEASURE SIZE : 1x1, input signal: not XYZ Y_P / RGB_P / RGB255 / CV_XYZ_HEX / CV_XYZ_DEC / CV_RGB_HEX / CV_RGB_DEC / ? * MEASURE SIZE : 1x1, input signal : XYZ
-	PIC:CINELITE:CINEZONE:FORM	GRADATE / STEP / SEARCH / ?
-	PIC:CINELITE:CINEZONE:UPPER	-63 to 1094 / ? * -63(-6.3%) - 1094(109.4%)
-	PIC:CINELITE:CINEZONE:LOWER	-73 to 1084 / ? * -73(-7.3%) - 1084(108.4%)
-	PIC:CINELITE:CINEZONE:LEVEL	-73 to 1094 / ? * -73(-7.3%) - 1094(109.4%)
-	PIC:FOCUS:PICTURE_MODE	FIT / REAL / X2 / ?
-	PIC:FOCUS:ASSIST	ON / OFF / ?
-	PIC:FOCUS:SENSITIVE	LOW / MIDDLE / HIGH / V_HIGH / U_HIGH / ?
-	PIC:FOCUS:PICTURE_LEVEL	OFF / EMBOSS / 25 / 50 / 75 / 100 / ?
-	PIC:FOCUS:EDGE_COLOR	WHITE / RED / GREEN / BLUE / ?
-	PIC:LINE_SELECT	ON / OFF / CINELITE / ?
-	PIC:LINE_NUMBER	-32768 to 32767 / ?
-	PIC:LINE_FIELD	FIELD1 / FIELD2 / FRAME / ?

• AUDIO KEY

r/w Limitation	Command	Parameter
WO	AUDIO	None
-	AUDIO:MODE	LISSAJOU / SURROUND / STATUS / ?
-	AUDIO:METER:RANGE	60DBFS / 90DBFS / MAG / ?
-	AUDIO:METER:RESPONSE	TRUEPEAK / PPM / VU / ?
-	AUDIO:METER:RESPONSE:PPM	PPM_I / PPM_II / ?
-	AUDIO:METER:RESPONSE:VU	TRUE / PPM_I / PPM_II / ?
-	AUDIO:METER:PEAK_HOLD	0.0 / 0.5 / 1.0 / 1.5 / 2.0 / 2.5 / 3.0 / 3.5 / 4.0 / 4.5 / 5.0 / HOLD / ?
-	AUDIO:METER:LEVEL_SET:OVER_LEVEL	-400 to 0 / ? * -40.0 (-400) - 0.0 (0)
-	AUDIO:METER:LEVEL_SET:WARNING_LEVEL	-400 to 0 / ? * -40.0 (-400) - 0.0 (0)
-	AUDIO:METER:LEVEL_SET:REF_LEVEL	-400 to 0 / ? * -40.0 (-400) - 0.0 (0)
-	AUDIO:METER:LEVEL_SET:LVL_VAL_DISP	INSTANTLY / PEAKHOLD / ?
WO	AUDIO:METER:LEVEL_SET:PEAK_HOLD_RESET	None
-	AUDIO:LISSAJOU:LISSAJOU:INTEN	-8 to 7 / ?
-	AUDIO:LISSAJOU:SCALE:INTEN	-8 to 7 / ?
-	AUDIO:LISSAJOU:DISPLAY	MULTI / SINGLE / ?
-	AUDIO:LISSAJOU:FORM	X_Y / MATRIX / ?
-	AUDIO:SURROUND:SURROUND:INTEN	-8 to 7 / ?
-	AUDIO:SURROUND:SCALE:INTEN	-8 to 7 / ?
-	AUDIO:SURROUND:5.1	NORMAL / PHANTOM / ?
-	AUDIO:SURROUND:AUTO_GAIN	ON / OFF / ?

19. NETWORK CONTROL

WO	AUDIO:DISP:LOG	None
-	AUDIO:STATUS:EVENT_LOG	START / STOP / ?
WO	AUDIO:STATUS:EVENT_LOG:CLEAR	None
-	AUDIO:STATUS:EVENT_LOG:MODE	OVER_WRT / STOP / ?
WO	AUDIO:DISP:CH_STATUS	None
-	AUDIO:STATUS:CH_STATUS:CH	CH1 / CH2 / CH3 / CH4 / CH5 / CH6 / CH7 / CH8 / CH9 / CH10 / CH11 / CH12 / CH13 / CH14 / CH15 / CH16 / A1 / A2 / A3 / A4 / A5 / A6 / A7 / A8 / A9 / A10 / A11 / A12 / A13 / A14 / A15 / A16 / B1 / B2 / B3 / B4 / B5 / B6 / B7 / B8 / B9 / B10 / B11 / B12 / B13 / B14 / B15 / B16 / C1 / C2 / C3 / C4 / C5 / C6 / C7 / C8 / C9 / C10 / C11 / C12 / C13 / C14 / C15 / C16 / D1 / D2 / D3 / D4 / D5 / D6 / D7 / D8 / D9 / D10 / D11 / D12 / D13 / D14 / D15 / D16 / ?
-	AUDIO:STATUS:CH_STATUS:ALIGN	LSB / MSB / ?
WO	AUDIO:DISP:USER_BIT	None
-	AUDIO:STATUS:USER_BIT:CH	CH1 / CH2 / CH3 / CH4 / CH5 / CH6 / CH7 / CH8 / CH9 / CH10 / CH11 / CH12 / CH13 / CH14 / CH15 / CH16 / A1 / A2 / A3 / A4 / A5 / A6 / A7 / A8 / A9 / A10 / A11 / A12 / A13 / A14 / A15 / A16 / B1 / B2 / B3 / B4 / B5 / B6 / B7 / B8 / B9 / B10 / B11 / B12 / B13 / B14 / B15 / B16 / C1 / C2 / C3 / C4 / C5 / C6 / C7 / C8 / C9 / C10 / C11 / C12 / C13 / C14 / C15 / C16 / D1 / D2 / D3 / D4 / D5 / D6 / D7 / D8 / D9 / D10 / D11 / D12 / D13 / D14 / D15 / D16 / ?
-	AUDIO:STATUS:USER_BIT:ALIGN	LSB / MSB / ?
WO	AUDIO:STATUS:ERROR_RESET	None
RO	AUDIO:DATA:STATUS:LEVEL:CH1	?
RO	AUDIO:DATA:STATUS:LEVEL:CH2	?
RO	AUDIO:DATA:STATUS:LEVEL:CH3	?
RO	AUDIO:DATA:STATUS:LEVEL:CH4	?
RO	AUDIO:DATA:STATUS:LEVEL:CH5	?
RO	AUDIO:DATA:STATUS:LEVEL:CH6	?
RO	AUDIO:DATA:STATUS:LEVEL:CH7	?
RO	AUDIO:DATA:STATUS:LEVEL:CH8	?

• STATUS KEY

r/w Limitation	Command	Parameter
WO	STATUS	None
WO	STS:DUMP	None
WO	STS:EXT_REF	None
WO	STS:AVPHASE	None
WO	STS:ANCVIEW	None
WO	STS:ANCVIEW:DUMP	None
WO	STS:LOG	None
WO	STS:ANCPKT	None
WO	STS:ANCPKT:PKT_ANALYS:EDH	None
WO	STS:ANCPKT:PKT_ANALYS:PAYLOAD	None
WO	STS:ANCPKT:PKT_ANALYS:CTRL_PKT	None
WO	STS:ANCPKT:PKT_ANALYS:V Anc:ARIB:CC	None
WO	STS:ANCPKT:PKT_ANALYS:V Anc:ARIB:NETQ	None
WO	STS:ANCPKT:PKT_ANALYS:V Anc:ARIB:TRIG	None

19. NETWORK CONTROL

WO	STS:ANCPKT:PKT_ANALYS:V_ANC:ARIB:USER 1	None
WO	STS:ANCPKT:PKT_ANALYS:V_ANC:ARIB:USER 2	None
WO	STS:ANCPKT:PKT_ANALYS:V_ANC:SMPTE:60 8	None
WO	STS:ANCPKT:PKT_ANALYS:V_ANC:SMPTE:70 8	None
WO	STS:ANCPKT:PKT_ANALYS:V_ANC:SMPTE:AF D	None
WO	STS:ANCPKT:PKT_ANALYS:V_ANC:SMPTE:PR OG	None
WO	STS:ANCPKT:PKT_ANALYS:V_ANC:SMPTE:VBI	None
WO	STS:ANCPKT:PKT_ANALYS:V_ANC:SMPTE:SR LIVE	None
WO	STS:ANCPKT:PKT_ANALYS:V_ANC:SMPTE:SC TE104	None
WO	STS:ANCPKT:PKT_ANALYS:SEARCH	None
WO	STS:ERROR:CLEAR	None
-	STS:LOG:LOG	START / STOP / ?
-	STS:LOG:MODE	OVER_WRT / STOP / ?
WO	STS:LOG:CLEAR	None
-	STS:SDI_ANALYS:DUMP:MODE	RUN / HOLD / ?
-	STS:SDI_ANALYS:DUMP:OPE:JUMP	EAV / SAV / ?
-	STS:SDI_ANALYS:DUMP:DISPLAY	SERIAL / COMPO / BINARY / PICTURE / STREAM12 / STREAM1 / STREAM2 / S1_SERIAL / S1_COMPO / S1_BINARY / S2_SERIAL / S2_COMPO / S2_BINARY / ?
-	STS:SDI_ANALYS:DUMP:LINK_SELECT	PICTURE / LINK_A / LINK_B / LINK_C / LINK_D / LINK_1 / LINK_2 / ?
WO	STS:SDI_ANALYS:EXT_REF:USER_REF	None
WO	STS:SDI_ANALYS:EXT_REF:DEFAULT	None
WO	STS:SDI_ANALYS:EXT_REF:SELECT	EXT / SDI / ?
-	STS:SDI_ANALYS:EXT_REF:TIMING	LEGACY / SERIAL / ?
-	STS:AV_PHASE:SCALE	50MS / 100MS / 500MS / 1000MS / 2500MS / ?
WO	STS:AVPHASE:REFRESH	None
-	STS:ANCVIEW:DUMP:HOLD	HOLD / 1S / 3S / ?
-	STS:ANCVIEW:DUMP:MODE	HEX / BINARY / ?
-	STS:ANCVIEW:DUMP:SAMPLE	0 to 258 / ?
-	STS:ANCPKT:PKT_ANALYS:EDH:DISP	TEXT / DUMP / ?
-	STS:ANCPKT:PKT_ANALYS:EDH:MODE	HEX / BINARY / ?
-	STS:ANCVIEW:STREAM	STREAM1 / STREAM2 / ?
-	STS:ANCPKT:PKT_ANALYS:PAYLOAD_ID:STRE AM	STREAM1 / STREAM2 / ?
-	STS:ANCPKT:PKT_ANALYS:CTRL_PKT:DISPLA Y	TEXT / DUMP / ?
-	STS:ANCPKT:PKT_ANALYS:CTRL_PKT:MODE	HEX / BINARY / ?
-	STS:ANCPKT:PKT_ANALYS:CTRL_PKT:GROUP	GROUP1 / GROUP2 / GROUP3 / GROUP4 / ?
-	STS:ANCPKT:PKT_ANALYS:CTRL_PKT:STREA M	STREAM1 / STREAM2 / ?
-	STS:ANCPKT:PKT_ANALYS:V_ANC:ARIB:CC:D ISP	TEXT / DUMP / ?
-	STS:ANCPKT:PKT_ANALYS:V_ANC:ARIB:CC:T YPE	HD / SD / ANALOG / CELLULAR / ?
-	STS:ANCPKT:PKT_ANALYS:V_ANC:ARIB:CC:M ODE	HEX / BINARY / ?
-	STS:ANCPKT:PKT_ANALYS:V_ANC:ARIB:CC:S MPL	0 to 258 / ?

19. NETWORK CONTROL

-	STS:ANCPKT:PKT_ANALYS:V_ANC:ARIB:CC:STREAM	STREAM1 / STREAM2 / ?
-	STS:ANCPKT:PKT_ANALYS:V_ANC:ARIB:NETQ:DISP	TEXT / DUMP / Q_LOG / FORMAT / ?
-	STS:ANCPKT:PKT_ANALYS:V_ANC:ARIB:NETQ:MODE	HEX / BINARY / ?
-	STS:ANCPKT:PKT_ANALYS:V_ANC:ARIB:NETQ:SMPL	0 to 258 / ?
-	STS:ANCPKT:PKT_ANALYS:V_ANC:ARIB:NETQ:LOG	-50 to 50 / ?
-	STS:ANCPKT:PKT_ANALYS:V_ANC:ARIB:NETQ:STREAM	STREAM1 / STREAM2 / ?
WO	STS:ANCPKT:PKT_ANALYS:V_ANC:ARIB:NETQ:CLEAR	None
-	STS:ANCPKT:PKT_ANALYS:V_ANC:ARIB:TRIG:DISP	TEXT / DUMP / ?
-	STS:ANCPKT:PKT_ANALYS:V_ANC:ARIB:TRIG:MODE	HEX / BINARY / ?
-	STS:ANCPKT:PKT_ANALYS:V_ANC:ARIB:TRIG:SMPL	0 to 258 / ?
-	STS:ANCPKT:PKT_ANALYS:V_ANC:ARIB:TRIG:STREAM	STREAM1 / STREAM2 / ?
-	STS:ANCPKT:PKT_ANALYS:V_ANC:ARIB:USER1:MODE	HEX / BINARY / ?
-	STS:ANCPKT:PKT_ANALYS:V_ANC:ARIB:USER1:SMPL	0 to 258 / ?
-	STS:ANCPKT:PKT_ANALYS:V_ANC:ARIB:USER1:STREAM	STREAM1 / STREAM2 / ?
-	STS:ANCPKT:PKT_ANALYS:V_ANC:ARIB:USER2:MODE	HEX / BINARY / ?
-	STS:ANCPKT:PKT_ANALYS:V_ANC:ARIB:USER2:SMPL	0 to 258 / ?
-	STS:ANCPKT:PKT_ANALYS:V_ANC:ARIB:USER2:STREAM	STREAM1 / STREAM2 / ?
-	STS:ANCPKT:PKT_ANALYS:V_ANC:SMPTE:708:DISP	TEXT / DUMP / ?
-	STS:ANCPKT:PKT_ANALYS:V_ANC:SMPTE:708:MODE	HEX / BINARY / ?
-	STS:ANCPKT:PKT_ANALYS:V_ANC:SMPTE:708:SMPL	0 to 258 / ?
-	STS:ANCPKT:PKT_ANALYS:V_ANC:SMPTE:708:STREAM	STREAM1 / STREAM2 / ?
-	STS:ANCPKT:PKT_ANALYS:V_ANC:SMPTE:608:DISP	TEXT / DUMP / ?
-	STS:ANCPKT:PKT_ANALYS:V_ANC:SMPTE:608:MODE	HEX / BINARY / ?
-	STS:ANCPKT:PKT_ANALYS:V_ANC:SMPTE:608:SMPL	0 to 258 / ?
-	STS:ANCPKT:PKT_ANALYS:V_ANC:SMPTE:608:STREAM	STREAM1 / STREAM2 / ?
-	STS:ANCPKT:PKT_ANALYS:V_ANC:SMPTE:PROG:STREAM	STREAM1 / STREAM2 / ?
-	STS:ANCPKT:PKT_ANALYS:V_ANC:SMPTE:VBI:STREAM	STREAM1 / STREAM2 / ?
-	STS:ANCPKT:PKT_ANALYS:V_ANC:SMPTE:AFD:DISP	TEXT / DUMP / ?
-	STS:ANCPKT:PKT_ANALYS:V_ANC:SMPTE:AFD:MODE	HEX / BINARY / ?

19. NETWORK CONTROL

-	STS:ANCPKT:PKT_ANALYS:V_ANC:SMPTE:AF D:STREAM	STREAM1 / STREAM2 / ?
-	STS:ANCPKT:PKT_ANALYS:CSTM:ID_SET:DID	0 to 255 / ?
-	STS:ANCPKT:PKT_ANALYS:CSTM:ID_SET:SDI D	-1 to 255 / ?
-	STS:ANCPKT:PKT_ANALYS:CSTM:MODE	HEX / BINARY / ?
-	STS:ANCPKT:PKT_ANALYS:CSTM:YC	Y / C / ?
-	STS:ANCPKT:PKT_ANALYS:CSTM:STREAM	STREAM1 / STREAM2 / ?
WO	STS:ANCPKT:PKT_ANALYS:CSTM:ID_SET:SET	None
-	STS:ANCPKT:PKT_ANALYS:CSTM:SMPL	0 to 258 / ?
-	STS:ANCPKT:PKT_ANALYS:V_ANC:SMPTE:SR LIVE:DISP	TEXT / DUMP / ?
-	STS:ANCPKT:PKT_ANALYS:V_ANC:SMPTE:SR LIVE:MODE	HEX / BINARY / ?
-	STS:ANCPKT:PKT_ANALYS:V_ANC:SMPTE:SR LIVE:SMPL	0 - 258 / ?
-	STS:ANCPKT:PKT_ANALYS:V_ANC:SMPTE:SR LIVE:STREAM	STREAM1 / STREAM2 / ?
-	STS:ANCPKT:PKT_ANALYS:V_ANC:SMPTE:SC TE104:LOG:POS	-50 - 50 / ?
WO	STS:ANCPKT:PKT_ANALYS:V_ANC:SMPTE:SC TE104:LOG:CLEA	None
-	STS:ANCPKT:PKT_ANALYS:V_ANC:SMPTE:SC TE104:DISP	TEXT / DUMP / SPLICE / ?
-	STS:ANCPKT:PKT_ANALYS:V_ANC:SMPTE:SC TE104:MODE	HEX / BINARY / ?
-	STS:ANCPKT:PKT_ANALYS:V_ANC:SMPTE:SC TE104:LOG:LOGGING	START / STOP / ?
-	STS:ANCPKT:PKT_ANALYS:V_ANC:SMPTE:SC TE104:SMPL	0 - 258 / ?
-	STS:ANCPKT:PKT_ANALYS:V_ANC:SMPTE:SC TE104:TEXT:DURATION	1 - 10 / ?
-	STS:ANCPKT:PKT_ANALYS:V_ANC:SMPTE:SC TE104:DUMP:DURATION	HOLD / 1S / 3S / ?
-	STS:ANCPKT:PKT_ANALYS:V_ANC:SMPTE:SC TE104:ID_VALUE	DEC / HEX / BOTH / ?
-	STS:ANCPKT:PKT_ANALYS:V_ANC:LINK_SELE CT	LINK_A / LINK_B / LINK_C / LINK_D / LINK_1 / LINK_2 / ?
-	STS:ERROR:SDI:COUNTER	SEC / FIELD / ?
-	STS:ERROR:SDI:TRS	ON / OFF / ?
-	STS:ERROR:SDI:HD_LINE	ON / OFF / ?
-	STS:ERROR:SDI:HD_CRC	ON / OFF / ?
-	STS:ERROR:SDI:SD_EDH	ON / OFF / ?
-	STS:ERROR:SDI:ILLEGAL_CODE	ON / OFF / ?
-	STS:ERROR:SDI:FREQ	ON / OFF / ?
-	STS:ERROR:SDI:CABLE	ON / OFF / ?
-	STS:ERROR:SDI:CABLE_12G	L_55UCHD / ?
-	STS:ERROR:SDI:CABLE_3G	LS_5CFB / 1694A / ?
-	STS:ERROR:SDI:CABLE_HD	LS_5CFB / 1694A / L_7CDH / ?
-	STS:ERROR:SDI:CABLE_SD	L_5C2V / 8281SD / 1505A / ?
-	STS:ERROR:SDI:CABLE_ERR_12G	10 to 80 / ?
-	STS:ERROR:SDI:CABLE_WAR_12G	10 to 80 / ?
-	STS:ERROR:SDI:CABLE_ERR_3G	10 to 100 / ?
-	STS:ERROR:SDI:CABLE_WAR_3G	10 to 100 / ?
-	STS:ERROR:SDI:CABLE_ERR_HD	10 to 130 / ?
-	STS:ERROR:SDI:CABLE_WAR_HD	10 to 130 / ?
-	STS:ERROR:SDI:CABLE_ERR_SD	50 to 200 / ?

19. NETWORK CONTROL

-	STS:ERROR:SDI:CABLE_WAR_SD	50 to 200 / ?
-	STS:ERROR:ANC:PARITY	ON / OFF / ?
-	STS:ERROR:ANC:CHECKSUM	ON / OFF / ?
-	STS:ERROR:AUDIO:BCH	ON / OFF / ?
-	STS:ERROR:AUDIO:DBN	ON / OFF / ?
-	STS:ERROR:AUDIO:PARITY	ON / OFF / ?
-	STS:ERROR:AUDIO:INHIBIT	ON / OFF / ?
-	STS:ERROR:AUDIO:SAMPLE	ON / OFF / ?
-	STS:ERROR:GAMUT:LPF	OFF / HD1M_SD1M / HD28M_SD1M / ?
-	STS:ERROR:GAMUT	ON / OFF / ?
-	STS:ERROR:GAMUT:UPPER	908 to 1094 / ?
-	STS:ERROR:GAMUT:LOWER	-72 to 61 / ?
-	STS:ERROR:GAMUT:UPPER_MV	6356 to 7658 / ?
-	STS:ERROR:GAMUT:LOWER_MV	-504 to 427 / ?
-	STS:ERROR:GAMUT:AREA	0 to 50 / ?
-	STS:ERROR:GAMUT:DURATION	1 to 60 / ?
-	STS:ERROR:C_GAMUT	ON / OFF / ?
-	STS:ERROR:C_GAMUT:SETUP	0% / 7.5% / ?
-	STS:ERROR:C_GAMUT:UPPER	900 to 1350 / ?
-	STS:ERROR:C_GAMUT:LOWER	-400 to 200 / ?
-	STS:ERROR:C_GAMUT:UPPER_MV	6300 to 9640 / ?
-	STS:ERROR:C_GAMUT:LOWER_MV	-2860 to 1430 / ?
-	STS:ERROR:C_GAMUT:AREA	0 to 50 / ?
-	STS:ERROR:C_GAMUT:DURATION	1 to 60 / ?
-	STS:ERROR:FREEZE	ON / OFF / ?
-	STS:ERROR:FREEZE:UPPER	0 to 100 / ?
-	STS:ERROR:FREEZE:LOWER	0 to 100 / ?
-	STS:ERROR:FREEZE:LEFT	0 to 100 / ?
-	STS:ERROR:FREEZE:RIGHT	0 to 100 / ?
-	STS:ERROR:FREEZE:DURATION	2 to 300 / ?
-	STS:ERROR:BLACK	ON / OFF / ?
-	STS:ERROR:BLACK:LEVEL	0 to 100 / ?
-	STS:ERROR:BLACK:AREA	1 to 100 / ?
-	STS:ERROR:BLACK:DURATION	1 to 300 / ?
-	STS:ERROR:LEVEL	ON / OFF / ?
-	STS:ERROR:LEVEL:LUMA:UPPER	-51 to 766 / ?
-	STS:ERROR:LEVEL:LUMA:LOWER	-51 to 766 / ?
-	STS:ERROR:LEVEL:CHROMA:UPPER	-400 to 399 / ?
-	STS:ERROR:LEVEL:CHROMA:LOWER	-400 to 399 / ?
-	STS:ERROR:GAMUT:UPPER	908 to 1094 / ?
-	STS:AVPHASE:4K_SQD	1A / 2B / 3C / 4D / ?
-	STS:AVPHASE:TOP	0 to 100 / ?
-	STS:AVPHASE:LEFT	0 to 99 / ?
-	STS:AVPHASE:RIGHT	0 to 99 / ?
-	STS:AVPHASE:VIDEO	25 to 100 / ?
-	STS:AVPHASE:AUDIO	-30 to 0 / ?
-	STS:AVPHASE:MESGATE	ON / OFF / ?
-	STS:AVPHASE:GATETIME	100 to 1500 / ?
-	STS:ANCPKT:PKT_ANALYS:V Anc:ARIB:NETQ :BIT:Q1	ON / OFF / ?
-	STS:ANCPKT:PKT_ANALYS:V Anc:ARIB:NETQ :BIT:Q2	ON / OFF / ?
-	STS:ANCPKT:PKT_ANALYS:V Anc:ARIB:NETQ :BIT:Q3	ON / OFF / ?
-	STS:ANCPKT:PKT_ANALYS:V Anc:ARIB:NETQ :BIT:Q4	ON / OFF / ?

19. NETWORK CONTROL

-	STS:ANCPKT:PKT_ANALYS:V_ANC:ARIB:NETQ :BIT:Q5	ON / OFF / ?
-	STS:ANCPKT:PKT_ANALYS:V_ANC:ARIB:NETQ :BIT:Q6	ON / OFF / ?
-	STS:ANCPKT:PKT_ANALYS:V_ANC:ARIB:NETQ :BIT:Q7	ON / OFF / ?
-	STS:ANCPKT:PKT_ANALYS:V_ANC:ARIB:NETQ :BIT:Q8	ON / OFF / ?
-	STS:ANCPKT:PKT_ANALYS:V_ANC:ARIB:NETQ :BIT:Q9	ON / OFF / ?
-	STS:ANCPKT:PKT_ANALYS:V_ANC:ARIB:NETQ :BIT:Q10	ON / OFF / ?
-	STS:ANCPKT:PKT_ANALYS:V_ANC:ARIB:NETQ :BIT:Q11	ON / OFF / ?
-	STS:ANCPKT:PKT_ANALYS:V_ANC:ARIB:NETQ :BIT:Q12	ON / OFF / ?
-	STS:ANCPKT:PKT_ANALYS:V_ANC:ARIB:NETQ :BIT:Q13	ON / OFF / ?
-	STS:ANCPKT:PKT_ANALYS:V_ANC:ARIB:NETQ :BIT:Q14	ON / OFF / ?
-	STS:ANCPKT:PKT_ANALYS:V_ANC:ARIB:NETQ :BIT:Q15	ON / OFF / ?
-	STS:ANCPKT:PKT_ANALYS:V_ANC:ARIB:NETQ :BIT:Q16	ON / OFF / ?
-	STS:ANCPKT:PKT_ANALYS:V_ANC:ARIB:NETQ :BIT:Q17	ON / OFF / ?
-	STS:ANCPKT:PKT_ANALYS:V_ANC:ARIB:NETQ :BIT:Q18	ON / OFF / ?
-	STS:ANCPKT:PKT_ANALYS:V_ANC:ARIB:NETQ :BIT:Q19	ON / OFF / ?
-	STS:ANCPKT:PKT_ANALYS:V_ANC:ARIB:NETQ :BIT:Q20	ON / OFF / ?
-	STS:ANCPKT:PKT_ANALYS:V_ANC:ARIB:NETQ :BIT:Q21	ON / OFF / ?
-	STS:ANCPKT:PKT_ANALYS:V_ANC:ARIB:NETQ :BIT:Q22	ON / OFF / ?
-	STS:ANCPKT:PKT_ANALYS:V_ANC:ARIB:NETQ :BIT:Q23	ON / OFF / ?
-	STS:ANCPKT:PKT_ANALYS:V_ANC:ARIB:NETQ :BIT:Q24	ON / OFF / ?
-	STS:ANCPKT:PKT_ANALYS:V_ANC:ARIB:NETQ :BIT:Q25	ON / OFF / ?
-	STS:ANCPKT:PKT_ANALYS:V_ANC:ARIB:NETQ :BIT:Q26	ON / OFF / ?
-	STS:ANCPKT:PKT_ANALYS:V_ANC:ARIB:NETQ :BIT:Q27	ON / OFF / ?
-	STS:ANCPKT:PKT_ANALYS:V_ANC:ARIB:NETQ :BIT:Q28	ON / OFF / ?
-	STS:ANCPKT:PKT_ANALYS:V_ANC:ARIB:NETQ :BIT:Q29	ON / OFF / ?
-	STS:ANCPKT:PKT_ANALYS:V_ANC:ARIB:NETQ :BIT:Q30	ON / OFF / ?
-	STS:ANCPKT:PKT_ANALYS:V_ANC:ARIB:NETQ :BIT:Q31	ON / OFF / ?
-	STS:ANCPKT:PKT_ANALYS:V_ANC:ARIB:NETQ :BIT:Q32	ON / OFF / ?
-	STS:ANCPKT:PKT_ANALYS:V_ANC:ARIB:NETQ :BIT:S1	ON / OFF / ?

19. NETWORK CONTROL

-	STS:ANCPKT:PKT_ANALYS:V_ANC:ARIB:NETQ :BIT:S2	ON / OFF / ?
-	STS:ANCPKT:PKT_ANALYS:V_ANC:ARIB:NETQ :BIT:S3	ON / OFF / ?
-	STS:ANCPKT:PKT_ANALYS:V_ANC:ARIB:NETQ :BIT:S4	ON / OFF / ?
-	STS:ANCPKT:PKT_ANALYS:V_ANC:ARIB:NETQ :BIT:S5	ON / OFF / ?
-	STS:ANCPKT:PKT_ANALYS:V_ANC:ARIB:NETQ :BIT:S6	ON / OFF / ?
-	STS:ANCPKT:PKT_ANALYS:V_ANC:ARIB:NETQ :BIT:S7	ON / OFF / ?
-	STS:ANCPKT:PKT_ANALYS:V_ANC:ARIB:NETQ :BIT:S8	ON / OFF / ?
-	STS:ANCPKT:PKT_ANALYS:V_ANC:ARIB:NETQ :BIT:S9	ON / OFF / ?
-	STS:ANCPKT:PKT_ANALYS:V_ANC:ARIB:NETQ :BIT:S10	ON / OFF / ?
-	STS:ANCPKT:PKT_ANALYS:V_ANC:ARIB:NETQ :BIT:S11	ON / OFF / ?
-	STS:ANCPKT:PKT_ANALYS:V_ANC:ARIB:NETQ :BIT:S12	ON / OFF / ?
-	STS:ANCPKT:PKT_ANALYS:V_ANC:ARIB:NETQ :BIT:S13	ON / OFF / ?
-	STS:ANCPKT:PKT_ANALYS:V_ANC:ARIB:NETQ :BIT:S14	ON / OFF / ?
-	STS:ANCPKT:PKT_ANALYS:V_ANC:ARIB:NETQ :BIT:S15	ON / OFF / ?
-	STS:ANCPKT:PKT_ANALYS:V_ANC:ARIB:NETQ :BIT:S16	ON / OFF / ?
RO	STS:DATA:SIGNAL_A	?
RO	STS:DATA:SIGNAL_B	?
RO	STS:DATA:SIGNAL_C	?
RO	STS:DATA:SIGNAL_D	?
RO	STS:DATA:LINK_A	?
RO	STS:DATA:LINK_B	?
RO	STS:DATA:LINK_C	?
RO	STS:DATA:LINK_D	?
RO	STS:DATA:FORMAT_A	?
RO	STS:DATA:FORMAT_B	?
RO	STS:DATA:FORMAT_C	?
RO	STS:DATA:FORMAT_D	?
RO	STS:DATA:AUDIO_A	?
RO	STS:DATA:AUDIO_B	?
RO	STS:DATA:AUDIO_C	?
RO	STS:DATA:AUDIO_D	?
RO	STS:DATA:EXTREF_A	?
RO	STS:DATA:EXTREF_STAT_A	?
RO	STS:DATA:EXTREF_HTIME_A	?
RO	STS:DATA:EXTREF_HPIX_A	?
RO	STS:DATA:EXTREF_VLINE_A	?
RO	STS:DATA:EXTREF_TOTAL_A	?
RO	STS:DATA:EXTREF_B	?
RO	STS:DATA:EXTREF_STAT_B	?
RO	STS:DATA:EXTREF_HTIME_B	?
RO	STS:DATA:EXTREF_HPIX_B	?
RO	STS:DATA:EXTREF_VLINE_B	?

19. NETWORK CONTROL

RO	STS:DATA:EXTREF_TOTAL_B	?
RO	STS:DATA:EXTREF_C	?
RO	STS:DATA:EXTREF_STAT_C	?
RO	STS:DATA:EXTREF_HTIME_C	?
RO	STS:DATA:EXTREF_HPIX_C	?
RO	STS:DATA:EXTREF_VLINE_C	?
RO	STS:DATA:EXTREF_TOTAL_C	?
RO	STS:DATA:EXTREF_D	?
RO	STS:DATA:EXTREF_STAT_D	?
RO	STS:DATA:EXTREF_HTIME_D	?
RO	STS:DATA:EXTREF_HPIX_D	?
RO	STS:DATA:EXTREF_VLINE_D	?
RO	STS:DATA:EXTREF_TOTAL_D	?
RO	STS:DATA:ANC:AUDIO_CTRL1	?
RO	STS:DATA:ANC:AUDIO_CTRL2	?
RO	STS:DATA:ANC:EDH	?
RO	STS:DATA:ANC:LTC1	?
RO	STS:DATA:ANC:LTC2	?
RO	STS:DATA:ANC:VLTC1	?
RO	STS:DATA:ANC:VLTC2	?
RO	STS:DATA:ANC:PAYLOAD1	?
RO	STS:DATA:ANC:PAYLOAD2	?
RO	STS:DATA:ANC:EIA:708_708	?
RO	STS:DATA:ANC:EIA:708_608	?
RO	STS:DATA:ANC:EIA:608	?
RO	STS:DATA:ANC:PROGRAM	?
RO	STS:DATA:ANC:BROADCAST	?
RO	STS:DATA:ANC:VBI	?
RO	STS:DATA:ANC:AFD1	?
RO	STS:DATA:ANC:AFD2	?
RO	STS:DATA:ANC:JPN_CC1	?
RO	STS:DATA:ANC:JPN_CC2	?
RO	STS:DATA:ANC:JPN_CC3	?
RO	STS:DATA:ANC:NETQ1	?
RO	STS:DATA:ANC:NETQ2	?
RO	STS:DATA:ANC:TRIGGER	?
RO	STS:DATA:ANC:USER1	?
RO	STS:DATA:ANC:USER2	?
RO	STS:DATA:ANC:PKT:PAYLOAD	?
RO	STS:DATA:ANC:PKT:ARIB:NETQ:STATION	?
RO	STS:DATA:ANC:PKT:ARIB:NETQ:VCURR	?
RO	STS:DATA:ANC:PKT:ARIB:NETQ:VNEXT	?
RO	STS:DATA:ANC:PKT:ARIB:NETQ:ACURR	?
RO	STS:DATA:ANC:PKT:ARIB:NETQ:ANEXT	?
RO	STS:DATA:ANC:PKT:ARIB:NETQ:DCURR	?
RO	STS:DATA:ANC:PKT:ARIB:NETQ:DNEXT	?
RO	STS:DATA:ANC:PKT:SMPTE:AFD:CODE	?
RO	STS:DATA:ANC:PKT:SMPTE:AFD:FRAME	?
RO	STS:DATA:ANC:PKT:SMPTE:AFD:BAR:FLG	?
RO	STS:DATA:ANC:PKT:SMPTE:AFD:BAR:VAL1	?
RO	STS:DATA:ANC:PKT:SMPTE:AFD:BAR:VAL2	?
RO	STS:DATA:ANC:FREQ	?

• EYE KEY

r/w Limitation	Command	Parameter
-------------------	---------	-----------

19. NETWORK CONTROL

WO	EYE	None
-	EYE:MODE	EYE / JITTER / ?
-	EYE:EYE:INTEN	-128 to 127 / ?
-	EYE:EYE:COLOR	WHITE / YELLOW / CYAN / GREEN / MAGENTA / RED / BLUE / ?
-	EYE:EYE:SCALE:INTEN	-8 to 7 / ?
-	EYE:EYE:SCALE:COLOR	WHITE / YELLOW / CYAN / GREEN / MAGENTA / RED / BLUE / ?
-	EYE:EYE:SETUP:GAIN:VAR	CAL / VAR / ?
-	EYE:EYE:SETUP:GAIN:VAL	50 to 200 / ?
-	EYE:EYE:SETUP:SWEEP	2UI / 4UI / 16UI / ?
-	EYE:EYE:SETUP:FILTER	100KHZ / 10KHZ / 1KHZ / 100HZ / 10HZ / TIMING / ALIGNMENT / ?
-	EYE:EYE:SETUP:TILE	SINGLE / DUAL / ?
-	EYE:EYE:SETUP:CURSOR	ON / OFF / ?
WO	EYE:EYE:SETUP:CURSOR:RESET	None
-	EYE:EYE:SETUP:CURSOR:XY_SEL	X / Y / TR_TF / ?
-	EYE:JIT:INTEN	-128 to 127 / ?
-	EYE:JIT:COLOR	WHITE / YELLOW / CYAN / GREEN / MAGENTA / RED / BLUE / ?
-	EYE:JIT:SCALE:INTEN	-8 to 7 / ?
-	EYE:JIT:SCALE:COLOR	WHITE / YELLOW / CYAN / GREEN / MAGENTA / RED / BLUE / ?
-	EYE:JIT:SETUP:GAIN_SWEEP:MAG	X1 / X2 / X8 / ?
-	EYE:JIT:SETUP:GAIN_SWEEP:12G:MAG	X1 / X2 / X4 / X16 / ?
-	EYE:JIT:SETUP:GAIN_SWEEP:SWEEP	1H / 2H / 1V / 2V / ?
-	EYE:JIT:SETUP:FILTER	100KHZ / 10KHZ / 1KHZ / 100HZ / 10HZ / TIMING / ALIGNMENT / ?
-	EYE:JIT:SETUP:PEAK_HOLD	ON / OFF / ?
WO	EYE:JIT:SETUP:PEAK_CLEAR	None
-	EYE:JIT:SETUP:TILE	SINGLE / DUAL / ?
-	EYE:JIT:SETUP:CURSOR	ON / OFF / ?
WO	EYE:JIT:SETUP:CURSOR:RESET	None
-	EYE:JIT:SETUP:CURSOR:XY_SEL	X / Y / ?
WO	EYE:ERROR:SETUP:COMPLETE	None
-	EYE:ERROR:12G:AMP	ON / OFF / ?
-	EYE:ERROR:12G:AMP:UPPER	80 to 140 / ?
-	EYE:ERROR:12G:AMP:LOWER	40 to 100 / ?
-	EYE:ERROR:12G:RISE	ON / OFF / ?
-	EYE:ERROR:12G:RISE:MAX	40 to 110 / ?
-	EYE:ERROR:12G:FALL	ON / OFF / ?
-	EYE:ERROR:12G:FALL:MAX	40 to 110 / ?
-	EYE:ERROR:12G:DELTA	ON / OFF / ?
-	EYE:ERROR:12G:DELTA:MAX	40 to 110 / ?
-	EYE:ERROR:12G:TIMING_JIT	ON / OFF / ?
-	EYE:ERROR:12G:TIMING_JIT:MAX	10 to 200 / ?
-	EYE:ERROR:12G:CURRENT_JIT	ON / OFF / ?
-	EYE:ERROR:12G:CURRENT_JIT:MAX	10 to 200 / ?
-	EYE:ERROR:12G:OVERSHOOT_RISE	ON / OFF / ?
-	EYE:ERROR:12G:OVERSHOOT_RISE:MAX	0 to 200 / ?
-	EYE:ERROR:12G:OVERSHOOT_FALL	ON / OFF / ?
-	EYE:ERROR:12G:OVERSHOOT_FALL:MAX	0 to 200 / ?
-	EYE:ERROR:6G:AMP	ON / OFF / ?
-	EYE:ERROR:6G:AMP:UPPER	80 to 140 / ?
-	EYE:ERROR:6G:AMP:LOWER	40 to 100 / ?
-	EYE:ERROR:6G:RISE	ON / OFF / ?
-	EYE:ERROR:6G:RISE:MAX	40 to 110 / ?

19. NETWORK CONTROL

-	EYE:ERROR:6G:FALL	ON / OFF / ?
-	EYE:ERROR:6G:FALL:MAX	40 to 110 / ?
-	EYE:ERROR:6G:DELTA	ON / OFF / ?
-	EYE:ERROR:6G:DELTA:MAX	40 to 110 / ?
-	EYE:ERROR:6G:TIMING_JIT	ON / OFF / ?
-	EYE:ERROR:6G:TIMING_JIT:MAX	10 to 200 / ?
-	EYE:ERROR:6G:CURRENT_JIT	ON / OFF / ?
-	EYE:ERROR:6G:CURRENT_JIT:MAX	10 to 200 / ?
-	EYE:ERROR:6G:OVERSHOOT_RISE	ON / OFF / ?
-	EYE:ERROR:6G:OVERSHOOT_RISE:MAX	0 to 200 / ?
-	EYE:ERROR:6G:OVERSHOOT_FALL	ON / OFF / ?
-	EYE:ERROR:6G:OVERSHOOT_FALL:MAX	0 to 200 / ?
-	EYE:ERROR:3G:AMP	ON / OFF / ?
-	EYE:ERROR:3G:AMP:UPPER	80 to 140 / ?
-	EYE:ERROR:3G:AMP:LOWER	40 to 100 / ?
-	EYE:ERROR:3G:RISE	ON / OFF / ?
-	EYE:ERROR:3G:RISE:MAX	40 to 140 / ?
-	EYE:ERROR:3G:FALL	ON / OFF / ?
-	EYE:ERROR:3G:FALL:MAX	40 to 140 / ?
-	EYE:ERROR:3G:DELTA	ON / OFF / ?
-	EYE:ERROR:3G:DELTA:MAX	40 to 140 / ?
-	EYE:ERROR:3G:TIMING_JIT	ON / OFF / ?
-	EYE:ERROR:3G:TIMING_JIT:MAX	10 to 200 / ?
-	EYE:ERROR:3G:CURRENT_JIT	ON / OFF / ?
-	EYE:ERROR:3G:CURRENT_JIT:MAX	10 to 200 / ?
-	EYE:ERROR:3G:OVERSHOOT_RISE	ON / OFF / ?
-	EYE:ERROR:3G:OVERSHOOT_RISE:MAX	0 to 200 / ?
-	EYE:ERROR:3G:OVERSHOOT_FALL	ON / OFF / ?
-	EYE:ERROR:3G:OVERSHOOT_FALL:MAX	0 to 200 / ?
-	EYE:ERROR:HD:AMP	ON / OFF / ?
-	EYE:ERROR:HD:AMP:UPPER	80 to 140 / ?
-	EYE:ERROR:HD:AMP:LOWER	40 to 100 / ?
-	EYE:ERROR:HD:RISE	ON / OFF / ?
-	EYE:ERROR:HD:RISE:MAX	40 to 140 / ?
-	EYE:ERROR:HD:FALL	ON / OFF / ?
-	EYE:ERROR:HD:FALL:MAX	40 to 140 / ?
-	EYE:ERROR:HD:DELTA	ON / OFF / ?
-	EYE:ERROR:HD:DELTA:MAX	40 to 140 / ?
-	EYE:ERROR:HD:TIMING_JIT	ON / OFF / ?
-	EYE:ERROR:HD:TIMING_JIT:MAX	10 to 200 / ?
-	EYE:ERROR:HD:CURRENT_JIT	ON / OFF / ?
-	EYE:ERROR:HD:CURRENT_JIT:MAX	10 to 200 / ?
-	EYE:ERROR:HD:OVERSHOOT_RISE	ON / OFF / ?
-	EYE:ERROR:HD:OVERSHOOT_RISE:MAX	0 to 200 / ?
-	EYE:ERROR:HD:OVERSHOOT_FALL	ON / OFF / ?
-	EYE:ERROR:HD:OVERSHOOT_FALL:MAX	0 to 200 / ?
-	EYE:ERROR:SD:AMP	ON / OFF / ?
-	EYE:ERROR:SD:AMP:UPPER	80 to 140 / ?
-	EYE:ERROR:SD:AMP:LOWER	40 to 100 / ?
-	EYE:ERROR:SD:RISE	ON / OFF / ?
-	EYE:ERROR:SD:RISE:MAX	40 to 140 / ?
-	EYE:ERROR:SD:FALL	ON / OFF / ?
-	EYE:ERROR:SD:FALL:MAX	40 to 140 / ?
-	EYE:ERROR:SD:DELTA	ON / OFF / ?
-	EYE:ERROR:SD:DELTA:MAX	40 to 140 / ?
-	EYE:ERROR:SD:TIMING_JIT	ON / OFF / ?
-	EYE:ERROR:SD:TIMING_JIT:MAX	10 to 200 / ?

19. NETWORK CONTROL

-	EYE:ERROR:SD:CURRENT_JIT	ON / OFF / ?
-	EYE:ERROR:SD:CURRENT_JIT:MAX	10 to 200 / ?
-	EYE:ERROR:SD:OVERSHOOT_RISE	ON / OFF / ?
-	EYE:ERROR:SD:OVERSHOOT_RISE:MAX	0 to 200 / ?
-	EYE:ERROR:SD:OVERSHOOT_FALL	ON / OFF / ?
-	EYE:ERROR:SD:OVERSHOOT_FALL:MAX	0 to 200 / ?
RO	EYE:TRIGGER	RUN / STOP / ?
RO	EYE:DATA:AMP	?
RO	EYE:DATA:TR	?
RO	EYE:DATA:TF	?
RO	EYE:DATA:TJ	?
RO	EYE:DATA:CJ	?
RO	EYE:DATA:OR	?
RO	EYE:DATA:OF	?
RO	EYE:DATA:PEAK:TJ	?
RO	EYE:DATA:PEAK:JIT	?
-	EYE:HISTOGRAM	ON / OFF / ?
-	EYE:HISTOGRAM:INTEN	-8 to 7 / ?
-	EYE:HISTOGRAM:COLOR	WHITE / YELLOW / CYAN / GREEN / MAGENTA / RED / BLUE / ?

19.3 FTP

The files that are generated by the instrument can be transferred to a PC connected to the same network.

If you are using the LV5350 or LV7300, read LV5300 and lv5300 as LV5350 and lv5350 or LV7300 and lv7300.

19.3.1 How to Use

1. Configure the Ethernet settings on the NETWORK tab of the SYS menu.

Set the IP address, and set FTP to ON.

[See also] 7.2.8, "Configuring the Server"



Figure 19-3 NETWORK tab

2. Press F•1 COMPLETE.
3. Connect the instrument's Ethernet port to the external network device.
4. On the PC, start an FTP client.

On Windows 7, on the taskbar, click Start, and then click Run. Type "FTP" and the IP address that you set in step 1. Then, click OK.

5. Type the login name and password.

The login name and password are "LV5300". Use uppercase for all characters.

When the login name and password are entered correctly, "ftp>" appears.

```

Connected to *.*.*.*.*.*.
220 Walcome to LV5300 FTP service.
User (*.*.*.*.*.*:(none)): LV5300 ..... User name
331 Please specify the password.
Password: LV5300 ..... Password (The password is not actually
displayed.)
230 Login successful
ftp>
    
```

19. NETWORK CONTROL

6. Enter FTP commands.

Enter commands while referring to sections 19.3.2, "How to Enter Commands," and 19.3.3, "FTP Commands." You must generate files using the TELNET "MAKE" command before you use FTP commands.

To end an FTP session, type "bye" in lowercase letters.

```
ftp> bye
```

19.3.2 How to Enter Commands

The command syntax is explained below.

```
ftp> [Command] + [Space] + [Parameter 1] + [Space] + [Parameter 2]
```

Examples of how to enter commands are shown below.

```
ftp> get log.txt D:¥log.txt .....Transfer the event log file to the PC.  
200 PORT Command successful.....Return value  
:  
ftp>
```

19.3.3 FTP Commands

Table 19-2 FTP commands

Command	Parameter 1	Parameter 2
get	log.txt	Storage location on the PC and file name (example: D:¥log.txt)
	dump.txt	Storage location on the PC and file name (example: D:¥dump.txt)
	cap_bmp.bmp	Storage location on the PC and file name (example: D:¥capture.bmp)
	cap_bsg.bsg	Storage location on the PC and file name (example: D:¥capture.bsg)
	lv5300.my	Storage location on the PC and file name (example: D:¥lv5300.my)

19.4 HTTP

You can use this feature to control the instrument from a web browser on a PC in the same manner as you would control the instrument from the panel.

19.4.1 Operating Environment

The following web browsers have been confirmed to work.

- Internet Explorer Ver.11
- Google Chrome Ver.46

19.4.2 Notes

- Enable JavaScript and pop-up on the WEB browser in advance.
- After you press a key in the web browser interface, wait for the screen to update before you perform the next operation. The screen cannot redraw fast enough to keep up with consecutive key presses. In this situation, a completely gray screen may be displayed temporarily. (After a few seconds the screen will return to normal.)
- When you are using the HTTP server feature, perform as few panel operations on the instrument as possible. The instrument's internal processing load increases when it is redrawing the web browser screen, so there is a lag of 1 to 2 seconds from the time that you perform panel operations on the instrument to the time that the operations are actually carried out.
- The number of simultaneous PC connections to the HTTP server feature is 1. Multiple connections are not supported.
- User layout and enhanced layout features (SER26) cannot be used.

19. NETWORK CONTROL

19.4.3 How to Use

1. Configure the Ethernet settings on the NETWORK tab of the SYS menu.
Set the IP address, and set HTTP to ON.

[See also] 7.2.8, "Configuring the Server"

SYS → F•2 SYSTEM SETUP → F•2 PREV TAB or F•3 NEXT TAB →



Figure 19-4 NETWORK tab

2. Press F•1 COMPLETE.
3. Connect the instrument's Ethernet port to the external network device.
4. Start the web browser on your PC.
5. In the address box, enter "http://(the IP address that you set in step 1):8080."

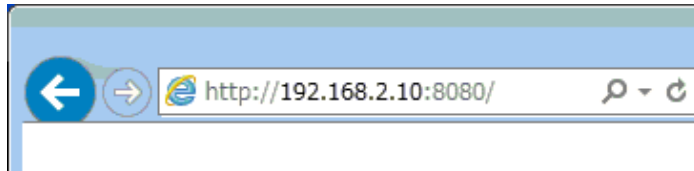

Figure 19-5 Entering the IP address

6. From the HTTP server menu, select the display mode.

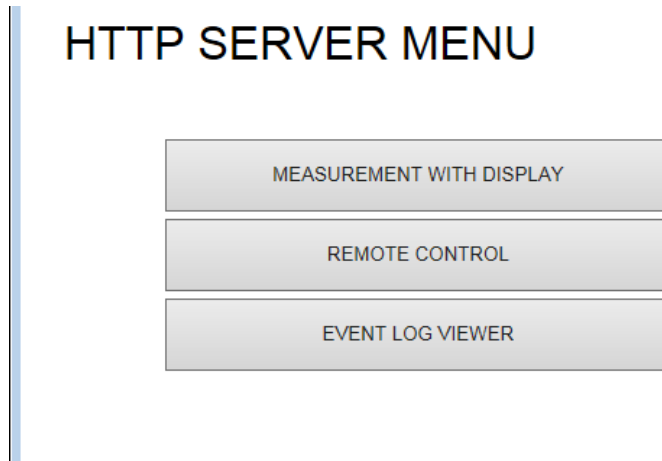

Figure 19-6 HTTP server menu

Table 19-3 HTTP server menu description

Name	Description
MEASUREMENT WITH DISPLAY	A measurement screen and control buttons are displayed.
REMOTE CONTROL	Only control buttons are displayed. Select this mode when you want to control the instrument while looking at its screen.
EVENT LOG VIEWER	The event log is displayed. The log can also be saved in text format.

If you select MEASUREMENT WITH DISPLAY, the measurement screen appears, but responses to operations can take 4 to 10 seconds, and auto display updating is every 10 seconds.

If you select REMOTE CONTROL, a screen is not displayed, but the response time is reduced to 2 to 3 seconds.

Select the mode that meets your needs.

19. NETWORK CONTROL

19.4.4 MEASUREMENT WITH DISPLAY

On the MEASUREMENT WITH DISPLAY tab, the instrument is controlled by clicking the control buttons.

The measurement screen is updated automatically at a given interval. It may take some time for the screen to be updated after you click a control button depending on the operating environment.



Figure 19-7 MEASUREMENT WITH DISPLAY

19. NETWORK CONTROL

Table 19-4 MEASUREMENT WITH DISPLAY description

No.	Name	Description
1	Tabs	Switches the display mode.
2	Measurement screen	This is the measurement screen. You cannot click this area. Set the tab menu using the F•D button.
3	Function key menu	Click to control the menu. Double-click slowly to change to the next item. Use the F•D button to change values.
4	SELECT	This button corresponds to holding down the MULTI key (layout selection).
5	MEM	This button corresponds to holding down the PRESET key (preset registration).
6	V POS H POS F•D	">" and "<" correspond to turning the knob to the right and left respectively. The number of "<" or ">" corresponds to the amount of change. The V•POS, H•POS, and F•D buttons correspond to the behavior performed when the corresponding button is pressed.
7	CAPTURE	Click this button after selecting the file format (BMP or JPG) to display a measurement screen in a separate window. Right-click the screen and click "Save picture as" to save the image in the specified file format. If this method does not work, use "DOWNLOAD" in the upper left of the screen to save it.
8	MENU CLEAR	Hides the menu. To show it again, click the function menu area.
9	SCREEN REFRESH	Set the screen's auto update interval to FAST, NORMAL, or SLOW.

19.4.5 REMOTE CONTROL

On the REMOTE CONTROL tab, the instrument is controlled by clicking the control buttons. As this mode does not display a measurement screen, select this mode when you want to control the instrument while looking at its screen.

The descriptions of the control buttons are the same as in section 19.4.4, "MEASUREMENT WITH DISPLAY."

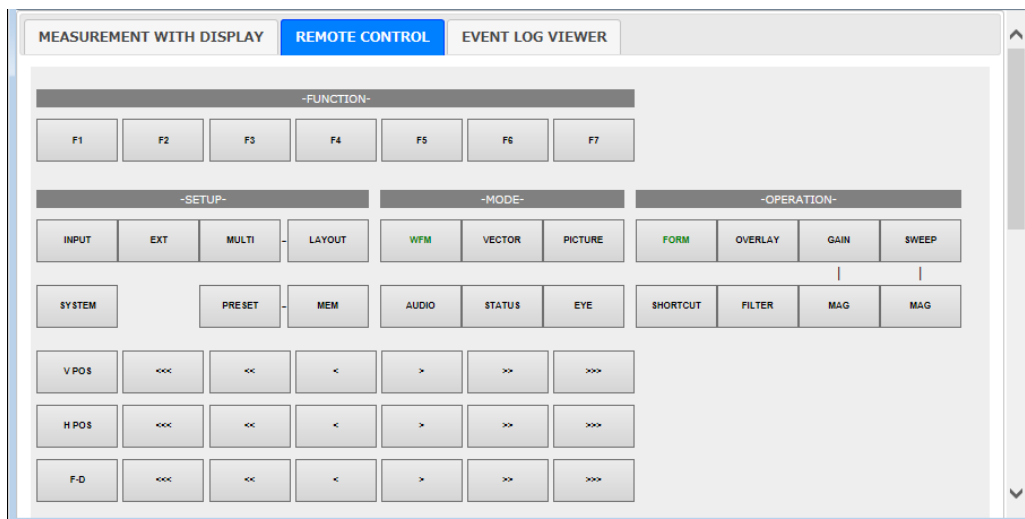

Figure 19-8 REMOTE CONTROL

19. NETWORK CONTROL

19.4.6 EVENT LOG VIEWER

The EVENT LOG VIEWER tab displays the event log of the status display. Nothing is displayed at first. You can display the log entries by setting LOG VIEWER to UPDATE. The screen is updated automatically at a given interval. Set LOG to START on the EVENT LOG menu in advance. [See also] 16.4, "Configuring Event Log Settings"

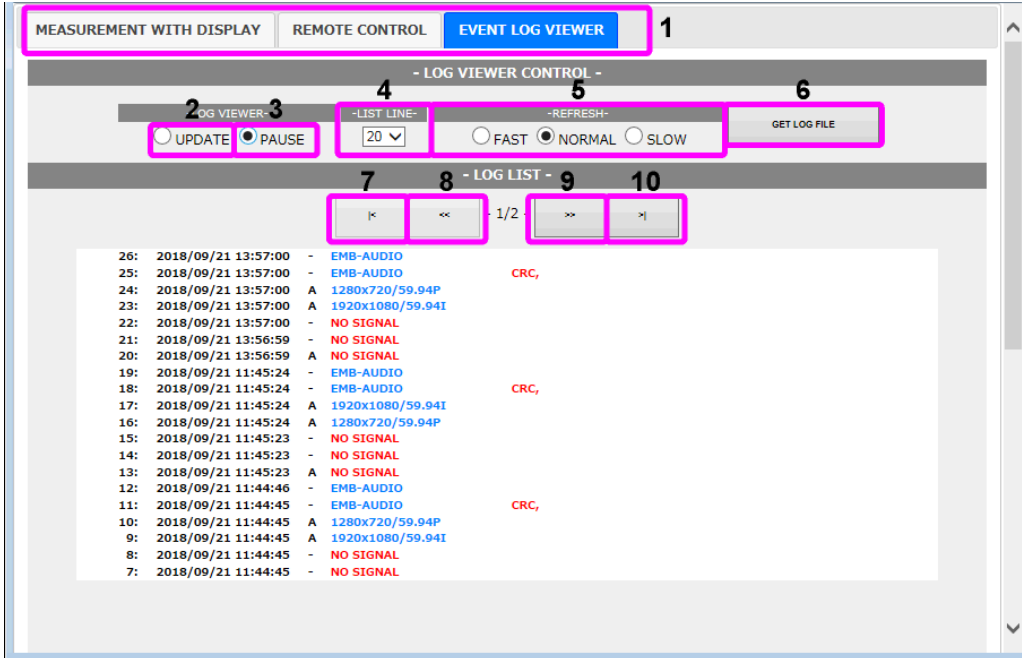

Figure 19-9 EVENT LOG VIEWER

Table 19-5 EVENT LOG VIEWER description

No.	Name	Description
1	Tabs	Switches the display mode.
2	UPDATE	The screen is updated automatically. LOG LIST shows the latest log.
3	PAUSE	The screen is not automatically updated. Past log entries can be displayed in LOG LIST.
4	LIST LINE	Select the number of entries to display on a screen from 10 to 50 (in 5 steps).
5	REFRESH	Set the screen's auto update interval to FAST, NORMAL, or SLOW.
6	GET LOG FILE	The event log is displayed in a separate window. From the File menu, choose Save As to save the log in text format.
7	<	The latest log entries are displayed when LOG VIEWER is set to PAUSE.
8	<<	The next newer log page appears when LOG VIEWER is set to PAUSE.
9	>>	The next older log page appears when LOG VIEWER is set to PAUSE.
10	>	The oldest log entries are displayed when LOG VIEWER is set to PAUSE.

19.5 SNMP

By using SNMP (Simple Network Management Protocol), you can control the instrument from SNMP managers. Additionally, you can notify the SNMP managers of errors that the instrument generates.

This product supports SNMPv2.

If you are using the LV5350 or LV7300, read LV5300 and lv5300 as LV5350 and lv5350 or LV7300 and lv7300.

The descriptions in this section follow the instrument or the option menu structure. Some of the descriptions do not apply depending on the installed options or the current settings.

19.5.1 SMI Definitions

INPORTS

MODULE-IDENTITY, OBJECT-TYPE, NOTIFICATION-TYPE, enterprises

FROM SNMPv2-SMI

DisplayString

FROM SNMPv2-TC

OBJECT-GROUP, MODULE-COMPLIANCE

FROM SNMPv2-CONF;

19.5.2 How to Use

1. Configure the SNMP settings on the SNMP tab of the SYS menu.

Set the IP Address, and set SNMP Client to ReadWrite and SNMP Trap to ON.

[See also] 7.2.9, "Configuring SNMP"

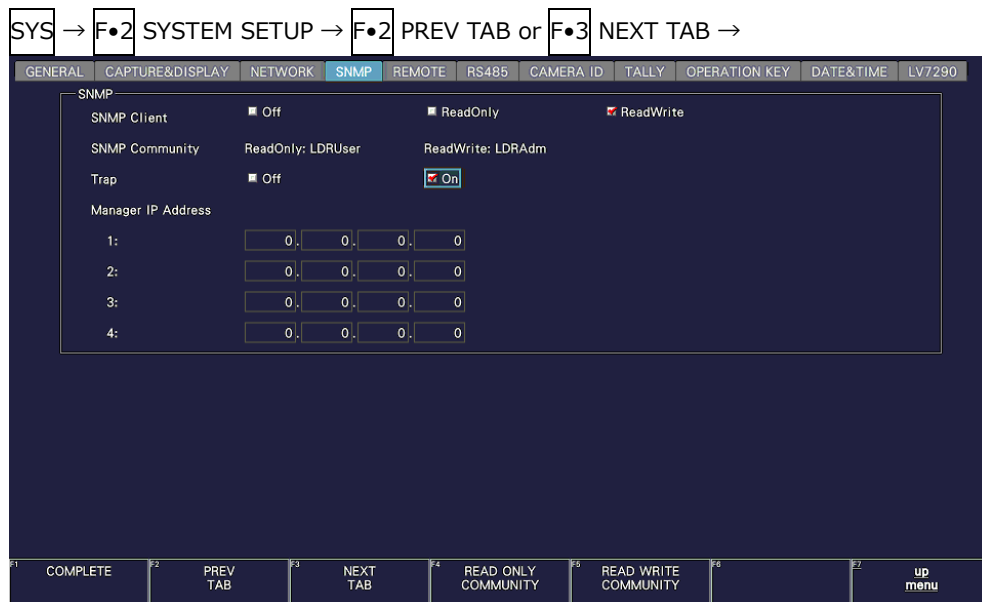

Figure 19-10 SNMP tab

2. Press F•1 COMPLETE.
3. Connect the instrument's Ethernet port to the external network device.

19. NETWORK CONTROL

4. On the PC, start an SNMP manager.

You must provide the SNMP manager yourself.

The default community names are shown below.

ReadOnly and ReadWrite can be changed with the SNMP Community parameter.

[See also] SNMP Community → 7.2.9, "Configuring SNMP"

ReadOnly: LDRUser

ReadWrite: LDRAdm

TRAP: LDRUser

5. Check that the SNMP managers can perform GET and SET operations.
6. From the SNMP manager, set the following MIB items to the SNMP managers' IP addresses.

Up to four locations can be set.

[IP address of TRAP transmission destination 1]

1.3.6.1.4.1.leader(20111).lv5300(40).lv5300ST1(1).l40trapTBL(9).l40trapIpTBL(1).l40trapIp1TBL(1).l40trapManagerIp1(1).0

[IP address of TRAP transmission destination 2]

1.3.6.1.4.1.leader(20111).lv5300(40).lv5300ST1(1).l40trapTBL(9).l40trapIpTBL(1).l40trapIp2TBL(2).l40trapManagerIp1(1).0

[IP address of TRAP transmission destination 3]

1.3.6.1.4.1.leader(20111).lv5300(40).lv5300ST1(1).l40trapTBL(9).l40trapIpTBL(1).l40trapIp3TBL(3).l40trapManagerIp1(1).0

[IP address of TRAP transmission destination 4]

1.3.6.1.4.1.leader(20111).lv5300(40).lv5300ST1(1).l40trapTBL(9).l40trapIpTBL(1).l40trapIp4TBL(4).l40trapManagerIp1(1).0

7. Enable the TRAP transmission destinations.

To alleviate communication load, disable the transmission destinations that you are not using. This setting is disabled by factory default.

[Enable (1) or disable (2) TRAP transmission destination 1]

1.3.6.1.4.1.leader(20111).lv5300(40).lv5300ST1(1).l40trapTBL(9).l40trapIpTBL(1).l40trapIp1TBL(1).l40trapManagerIp1Act(2).0

[Enable (1) or disable (2) TRAP transmission destination 2]

1.3.6.1.4.1.leader(20111).lv5300(40).lv5300ST1(1).l40trapTBL(9).l40trapIpTBL(1).l40trapIp2TBL(2).l40trapManagerIp1Act(2).0

[Enable (1) or disable (2) TRAP transmission destination 3]

1.3.6.1.4.1.leader(20111).lv5300(40).lv5300ST1(1).l40trapTBL(9).l40trapIpTBL(1).l40trapIp3TBL(3).l40trapManagerIp1Act(2).0

[Enable (1) or disable (2) TRAP transmission destination 4]

1.3.6.1.4.1.leader(20111).lv5300(40).lv5300ST1(1).l40trapTBL(9).l40trapIpTBL(1).l40trapIp4TBL(4).l40trapManagerIp1Act(2).0

19. NETWORK CONTROL

8. Restart the LV5300.
9. When the LV5300 starts, it transmits the standard TRAP "coldStart(0)." Check that this is received by the SNMP managers.

19. NETWORK CONTROL

19.5.3 Standard MIBs

The instrument uses the following standard MIBs:

- RFC1213 (MIB- II)
- RFC1354 (IP Forwarding Table MIB)

In the tables, "ACCESS" and "SUPPORT" indicate the following:

Indication	Description	
ACCESS	R/O	Information that can be read from the SNMP managers.
	R/W	Information that can be read and written from the SNMP managers
SUPPORT	Y	Supports the MIB object as defined by the standard.
	R/O	Reading and writing are possible according to the standard, but the instrument only supports reading.
	N	Not supported.

- system group

MIB	OID	SYNTAX	ACCESS	SUPPORT
sysDescr	system.1	DisplayString	R/O	Y
sysObjectID	system.2	ObjectID	R/O	Y
sysUpTime	system.3	TimeTicks	R/O	Y
sysContact	system.4	DisplayString	R/W	Y
sysName	system.5	DisplayString	R/O	R/O
sysLocation	system.6	DisplayString	R/W	Y
sysServices	system.7	INTEGER	R/O	Y

- interface group

MIB	OID	SYNTAX	ACCESS	SUPPORT
ifNumber	interfaces.1	INTEGER	R/O	Y
ifTable	interfaces.2	Aggregate	-	-
ifEntry	ifTable.1	Aggregate	-	-
ifIndex	ifEntry.1	INTEGER	R/O	Y
ifDescr	ifEntry.2	DisplayString	R/O	Y
ifType	ifEntry.3	INTEGER	R/O	Y
ifMtu	ifEntry.4	INTEGER	R/O	Y
ifSpeed	ifEntry.5	Gauge	R/O	Y
ifPhysAddress	ifEntry.6	OctetString	R/O	Y
ifAdminStatus	ifEntry.7	INTEGER	R/O	R/O
ifOperStatus	ifEntry.8	INTEGER	R/O	Y
ifLastChange	ifEntry.9	TimeTicks	R/O	Y
ifInOctets	ifEntry.10	Counter	R/O	Y
ifInUcastPkts	ifEntry.11	Counter	R/O	Y
ifInNUcastPkts	ifEntry.12	Counter	R/O	Y
ifInDiscards	ifEntry.13	Counter	R/O	Y
ifInErrors	ifEntry.14	Counter	R/O	Y
ifInUnknownProtos	ifEntry.15	Counter	R/O	Y
ifOutOctets	ifEntry.16	Counter	R/O	Y
ifOutUcastPkts	ifEntry.17	Counter	R/O	Y
ifOutNUcastPkts	ifEntry.18	Counter	R/O	Y
ifOutDiscards	ifEntry.19	Counter	R/O	Y
ifOutErrors	ifEntry.20	Counter	R/O	Y
ifOutQLen	ifEntry.21	Gauge	R/O	Y
ifSpecific	ifEntry.22	ObjectID	R/O	Y

19. NETWORK CONTROL

- ip group

MIB	OID	SYNTAX	ACCESS	SUPPORT
ipForwarding	ip.1	INTEGER	R/O	Y
ipDefaultTTL	ip.2	INTEGER	R/O	R/O
ipInReceives	ip.3	Counter	R/O	Y
ipInHdrErrors	ip.4	Counter	R/O	Y
ipInAddrErrors	ip.5	Counter	R/O	Y
ipForwDatagrams	ip.6	Counter	R/O	Y
ipInUnknownProtos	ip.7	Counter	R/O	Y
ipInDiscards	ip.8	Counter	R/O	Y
ipInDelivers	ip.9	Counter	R/O	Y
ipOutRequests	ip.10	Counter	R/O	Y
ipOutDiscards	ip.11	Counter	R/O	Y
ipOutNoRoutes	ip.12	Counter	R/O	Y
ipReasmTimeout	ip.13	INTEGER	R/O	Y
ipReasmReqds	ip.14	Counter	R/O	Y
ipReasmOKs	ip.15	Counter	R/O	Y
ipReasmFails	ip.16	Counter	R/O	Y
ipFragOKs	ip.17	Counter	R/O	Y
ipFragFails	ip.18	Counter	R/O	Y
ipFragCreates	ip.19	Counter	R/O	Y
ipAddrTable	ip.20	Aggregate	-	-
ipAddrEntry	ipAddrTable.1		R/O	Y
ipAdEntAddr	ipAddrEntry.1	IpAddress	R/O	Y
ipAdEntIfIndex	ipAddrEntry.2	INTEGER	R/O	Y
ipAdEntNetMask	ipAddrEntry.3	IpAddress	R/O	Y
ipAdEntBcastAddr	ipAddrEntry.4	INTEGER	R/O	Y
ipAdEntReasmMaxSize	ipAddrEntry.5	INTEGER	R/O	Y
ipRouteTable	ip.21	Aggregate	-	-
ipRouteEntry	ipRouteTable.1	Aggregate	-	-
ipRouteDest	ipRouteEntry.1	IpAddress	R/O	R/O
ipRouteIfIndex	ipRouteEntry.2	INTEGER	R/O	R/O
ipRouteMetric1	ipRouteEntry.3	INTEGER	R/O	R/O
ipRouteMetric2	ipRouteEntry.4	INTEGER	R/O	R/O
ipRouteMetric3	ipRouteEntry.5	INTEGER	R/O	R/O
ipRouteMetric4	ipRouteEntry.6	INTEGER	R/O	R/O
ipRouteNextHop	ipRouteEntry.7	IpAddress	R/O	R/O
ipRouteType	ipRouteEntry.8	INTEGER	R/O	R/O
ipRouteProto	ipRouteEntry.9	INTEGER	R/O	Y
ipRouteAge	ipRouteEntry.10	INTEGER	-	N
ipRouteMask	ipRouteEntry.11	IpAddress	R/O	R/O
ipRouteMetric5	ipRouteEntry.12	INTEGER	-	N
ipRouteInfo	ipRouteEntry.13	ObjectID	R/O	Y
ipNetToMediaTable	ip.22	Aggregate	-	-
ipNetToMediaEntry	ipNetToMediaTable.1	Aggregate	-	-
ipNetToMediaIfIndex	ipNetToMediaEntry.1	INTEGER	R/O	R/O
ipNetToMediaPhysAddress	ipNetToMediaEntry.2	OctetString	R/O	R/O
ipNetToMediaNetAddress	ipNetToMediaEntry.3	IpAddress	R/O	R/O
ipNetToMediaType	ipNetToMediaEntry.4	INTEGER	R/O	R/O
ipRoutingDiscards	ip.23	Counter	R/O	Y

19. NETWORK CONTROL

- icmp group

MIB	OID	SYNTAX	ACCESS	SUPPORT
icmpInMsgs	icmp.1	Counter	R/O	Y
icmpInErrors	icmp.2	Counter	R/O	Y
icmpInDestUnreachs	icmp.3	Counter	R/O	Y
icmpInTimeExcds	icmp.4	Counter	R/O	Y
icmpInParmProbs	icmp.5	Counter	R/O	Y
icmpInSrcQuenchs	icmp.6	Counter	R/O	Y
icmpInRedirects	icmp.7	Counter	R/O	Y
icmpInEchos	icmp.8	Counter	R/O	Y
icmpInEchoReps	icmp.9	Counter	R/O	Y
icmpInTimestamps	icmp.10	Counter	R/O	Y
icmpInTimestampReps	icmp.11	Counter	R/O	Y
icmpInAddrMasks	icmp.12	Counter	R/O	Y
icmpInAddrMaskReps	icmp.13	Counter	R/O	Y
icmpOutMsgs	icmp.14	Counter	R/O	Y
icmpOutErrors	icmp.15	Counter	R/O	Y
icmpOutDestUnreachs	icmp.16	Counter	R/O	Y
icmpOutTimeExcds	icmp.17	Counter	R/O	Y
icmpOutParmProbs	icmp.18	Counter	R/O	Y
icmpOutSrcQuenchs	icmp.19	Counter	R/O	Y
icmpOutRedirects	icmp.20	Counter	R/O	Y
icmpOutEchos	icmp.21	Counter	R/O	Y
icmpOutEchoReps	icmp.22	Counter	R/O	Y
icmpOutTimestamps	icmp.23	Counter	R/O	Y
icmpOutTimestampReps	icmp.24	Counter	R/O	Y
icmpOutAddrMasks	icmp.25	Counter	R/O	Y
icmpOutAddrMaskReps	icmp.26	Counter	R/O	Y

- tcp group

MIB	OID	SYNTAX	ACCESS	SUPPORT
tcpRtoAlgorithm	tcp.1	INTEGER	R/O	Y
tcpRtoMin	tcp.2	INTEGER	R/O	Y
tcpRtoMax	tcp.3	INTEGER	R/O	Y
tcpMaxConn	tcp.4	INTEGER	R/O	Y
tcpActiveOpens	tcp.5	Counter	R/O	Y
tcpPassiveOpens	tcp.6	Counter	R/O	Y
tcpAttemptFails	tcp.7	Counter	R/O	Y
tcpEstabResets	tcp.8	Counter	R/O	Y
tcpCurrEstab	tcp.9	Gauge	R/O	Y
tcpInSegs	tcp.10	Counter	R/O	Y
tcpOutSegs	tcp.11	Counter	R/O	Y
tcpRetransSegs	tcp.12	Counter	R/O	Y
tcpConnTable	tcp.13	Aggregate	-	-
tcpConnEntry	tcpConnTable.1	Aggregate	-	-
tcpConnState	tcpConnEntry.1	INTEGER	R/O	R/O
tcpConnLocalAddress	tcpConnEntry.2	IpAddress	R/O	Y
tcpConnLocalPort	tcpConnEntry.3	INTEGER	R/O	Y
tcpConnRemAddress	tcpConnEntry.4	IpAddress	R/O	Y
tcpConnRemPort	tcpConnEntry.5	INTEGER	R/O	Y
tcpInErrs	tcp.14	Counter	R/O	Y
tcpOutRsts	tcp.15	Counter	R/O	Y

19. NETWORK CONTROL

- udp group

MIB	OID	SYNTAX	ACCESS	SUPPORT
udpInDatagrams	udp.1	Counter	R/O	Y
udpNoPorts	udp.2	Counter	R/O	Y
udpInErrors	udp.3	Counter	R/O	Y
udpOutDatagrams	udp.4	Counter	R/O	Y
udpTable	udp.5	Aggregate	-	-
udpEntry	udpTable.1	Aggregate	-	-
udpLocalAddress	udpEntry.1	IpAddress	R/O	Y
udpLocalPort	udpEntry.2	INTEGER	R/O	Y

- snmp group

MIB	OID	SYNTAX	ACCESS	SUPPORT
snmpInPkts	snmp.1	Counter	R/O	Y
snmpOutPkts	snmp.2	Counter	R/O	Y
snmpInBadVersions	snmp.3	Counter	R/O	Y
snmpInBadCommunityNames	snmp.4	Counter	R/O	Y
snmpInBadCommunityUses	snmp.5	Counter	R/O	Y
snmpInASNParseErrs	snmp.6	Counter	R/O	Y
snmpInTooBigs	snmp.7	Counter	R/O	Y
snmpInNoSuchNames	snmp.8	Counter	R/O	Y
snmpInBadValues	snmp.9	Counter	R/O	Y
snmpInReadOnlyls	snmp.10	Counter	R/O	Y
snmpInGenErrs	snmp.11	Counter	R/O	Y
snmpInTotalReqVars	snmp.12	Counter	R/O	Y
snmpInTotalSetVars	snmp.13	Counter	R/O	Y
snmpInGetRequests	snmp.14	Counter	R/O	Y
snmpInGetNexts	snmp.15	Counter	R/O	Y
snmpInSetRequests	snmp.16	Counter	R/O	Y
snmpInGetResponses	snmp.17	Counter	R/O	Y
snmpInTraps	snmp.18	Counter	R/O	Y
snmpOutTooBigs	snmp.19	Counter	R/O	Y
snmpOutNoSuchNames	snmp.20	Counter	R/O	Y
snmpOutBadValues	snmp.21	Counter	R/O	Y
snmpOutGenErrs	snmp.22	Counter	R/O	Y
snmpOutGetRequests	snmp.23	Counter	R/O	Y
snmpOutGetNexts	snmp.24	Counter	R/O	Y
snmpOutSetRequests	snmp.25	Counter	R/O	Y
snmpOutGetResponses	snmp.26	Counter	R/O	Y
snmpOutTraps	snmp.27	Counter	R/O	Y
snmpEnableAuthenTraps	snmp.28	IpAddress	R/W	Y

19.5.4 Enterprise MIB

- Enterprise Number

The Enterprise Number of LEADER ELECTRONICS CORP. is 20111.
iso(1).org(3).dod(6).internet(1).private(4).enterprises(1).leader(20111)

- Enterprise MIB File

Save the file from instrument to a USB memory device or use FTP to obtain it from the instrument.

The file name is "lv5300.my."

[See also] 7.2.9, "Configuring SNMP", 7.2.8, "Configuring the Server"

- Enterprise MIB Structure

The enterprise MIB structure is shown below. On products that do not have units installed, the MIBs for the units cannot be controlled.

```

leader                OBJECT IDENTIFIER ::= { enterprises 20111 }
lv5300                OBJECT IDENTIFIER ::= { leader 40 }
lv5300ST1             OBJECT IDENTIFIER ::= { lv5300 1 }
l40notificationTBL   OBJECT IDENTIFIER ::= { lv5300ST1 0 }
l40basicTBL           OBJECT IDENTIFIER ::= { lv5300ST1 1 }
l40systemTBL          OBJECT IDENTIFIER ::= { lv5300ST1 2 }
l40wfmTBL             OBJECT IDENTIFIER ::= { lv5300ST1 3 }
l40vectorTBL          OBJECT IDENTIFIER ::= { lv5300ST1 4 }
l40pictureTBL         OBJECT IDENTIFIER ::= { lv5300ST1 5 }
l40statusTBL          OBJECT IDENTIFIER ::= { lv5300ST1 6 }
l40eyeTBL             OBJECT IDENTIFIER ::= { lv5300ST1 7 }
l40audioTBL           OBJECT IDENTIFIER ::= { lv5300ST1 8 }
l40trapTBL            OBJECT IDENTIFIER ::= { lv5300ST1 9 }

```

- ACCESS

In the tables, "ACCESS" indicates the following:

	Indication	Description
ACCESS	R/O	Information that can be read from the SNMP managers.
	R/W	Information that can be read and written from the SNMP managers
	R/WO	Information that can be read and written from the SNMP managers (However, the retrieved data consists of meaningless fixed values.)

19. NETWORK CONTROL

- I40basicTBL(1) group

MIB	OID	SYNTAX	ACCESS	VALUE/RANGE
I40basInputTBL	I40basicTBL.1	Aggregate	-	-
I40basInputCh	I40basInputTBL.1	INTEGER	R/W	1 = a 2 = b
I40basInputSimul	I40basInputTBL.2	INTEGER	R/W	1 = off 2 = on
I40basInputOperate	I40basInputTBL.3	INTEGER	R/W	1 = com 2 = individual
I40basInputExtref	I40basInputTBL.4	INTEGER	R/W	1 = int 2 = ext
I40basDispTBL	I40basicTBL.3	Aggregate	-	-
I40basDispMulti	I40basDispTBL.1	INTEGER	R/WO	1 (fixed)
I40basDispAssignWfm	I40basDispTBL.2	INTEGER	R/WO	1 (fixed)
I40basDispAssignVec	I40basDispTBL.3	INTEGER	R/WO	1 (fixed)
I40basDispAssignPic	I40basDispTBL.4	INTEGER	R/WO	1 (fixed)
I40basDispAssignSts	I40basDispTBL.5	INTEGER	R/WO	1 (fixed)
I40basDispAssignEye	I40basDispTBL.6	INTEGER	R/WO	1 (fixed)
I40basDispAssignAud	I40basDispTBL.7	INTEGER	R/WO	1 (fixed)
I40basPresetTBL	I40basicTBL.4	Aggregate	-	-
I40basPresetStore	I40basPresetTBL.1	INTEGER	R/W	1 to 60
I40basPresetDelete	I40basPresetTBL.2	INTEGER	R/W	1 to 60
I40basPresetCopyUsbInt	I40basPresetTBL.3	INTEGER	R/WO	1 (fixed)
I40basPresetCopyIntUsb	I40basPresetTBL.4	INTEGER	R/WO	1 (fixed)
I40basPresetRecall	I40basPresetTBL.5	INTEGER	R/W	1 to 60
I40basCaptureTBL	I40basicTBL.5	Aggregate	-	-
I40basCaptureMode	I40basCaptureTBL.1	INTEGER	R/W	1 = screen
I40basCaptureRefresh	I40basCaptureTBL.3	INTEGER	R/WO	1 (fixed)
I40basCaptureDisplay	I40basCaptureTBL.4	INTEGER	R/W	1 = real 3 = both 4 = hold
I40basCaptureFileBmp	I40basCaptureTBL.5	INTEGER	R/W	1 = off 2 = on
I40basCaptureFileBsg	I40basCaptureTBL.6	INTEGER	R/W	1 = off 2 = on
I40basCaptureFileStore	I40basCaptureTBL.10	INTEGER	R/WO	1 (fixed)
I40basMakeTBL	I40basicTBL.6	Aggregate	-	-
I40basMakeFile	I40basMakeTBL.1	INTEGER	R/WO	1 = cap-bmp 2 = cap-bsg 15 = log (*1) 16 = dump (*1)

*1 If you want to create an event log, data dump, or loudness file, the corresponding measurement screen must be displayed on the screen.

- I40systemTBL(2) group

MIB	OID	SYNTAX	ACCESS	VALUE/RANGE
I40sysInputTBL	I40systemTBL.1	Aggregate	-	-
I40sysSdiIn	I40sysInputTBL.1	INTEGER	R/W	2 = sys-4k-3g-dlink 4 = sys-single-link 8 = sys-4k-12g 9 = sys-4k-6g
I40sysSdiColorimetry	I40sysInputTBL.2	INTEGER	R/W	1 = pid 2 = bt709 3 = bt2020 4 = dci
I40sysHdrTBL	I40systemTBL.4	Aggregate	-	-

19. NETWORK CONTROL

MIB	OID	SYNTAX	ACCESS	VALUE/RANGE
I40sysHdrInputAMode	I40sysHdrTBL.1	INTEGER	R/W	1 = off 2 = hlg 3 = pq 4 = slog3 5 = c-log 6 = log-c
I40sysHdrInputBMode	I40sysHdrTBL.2	INTEGER	R/W	1 = off 2 = hlg 3 = pq 4 = slog3 5 = c-log 6 = log-c
I40sysHdrInputCMode	I40sysHdrTBL.3	INTEGER	R/W	1 = off 2 = hlg 3 = pq 4 = slog3 5 = c-log 6 = log-c
I40sysHdrInputDMode	I40sysHdrTBL.4	INTEGER	R/W	1 = off 2 = hlg 3 = pq 4 = slog3 5 = c-log 6 = log-c
I40sysHdrInputASysGamma	I40sysHdrTBL.5	INTEGER	R/W	1 = off 2 = on
I40sysHdrInputBSysGamma	I40sysHdrTBL.6	INTEGER	R/W	1 = off 2 = on
I40sysHdrInputCSysGamma	I40sysHdrTBL.7	INTEGER	R/W	1 = off 2 = on
I40sysHdrInputDSysGamma	I40sysHdrTBL.8	INTEGER	R/W	1 = off 2 = on
I40sysHdrInputAHlgScale	I40sysHdrTBL.9	INTEGER	R/W	1 = off 2 = on
I40sysHdrInputBHlgScale	I40sysHdrTBL.10	INTEGER	R/W	1 = off 2 = on
I40sysHdrInputCHlgScale	I40sysHdrTBL.11	INTEGER	R/W	1 = off 2 = on
I40sysHdrInputDHlgScale	I40sysHdrTBL.12	INTEGER	R/W	1 = off 2 = on
I40sysHdrInputARange	I40sysHdrTBL.13	INTEGER	R/W	1 = narrow 2 = full
I40sysHdrInputBRange	I40sysHdrTBL.14	INTEGER	R/W	1 = narrow 2 = full
I40sysHdrInputCRange	I40sysHdrTBL.15	INTEGER	R/W	1 = narrow 2 = full
I40sysHdrInputDRange	I40sysHdrTBL.16	INTEGER	R/W	1 = narrow 2 = full
I40sysHdrInputAEi	I40sysHdrTBL.17	INTEGER	R/W	1 = ei-200 2 = ei-400 3 = ei-800 4 = ei-1600
I40sysHdrInputBEi	I40sysHdrTBL.18	INTEGER	R/W	1 = ei-200 2 = ei-400 3 = ei-800 4 = ei-1600
I40sysHdrInputCEi	I40sysHdrTBL.19	INTEGER	R/W	1 = ei-200

19. NETWORK CONTROL

MIB	OID	SYNTAX	ACCESS	VALUE/RANGE
				2 = ei-400 3 = ei-800 4 = ei-1600
I40sysHdrInputDEi	I40sysHdrTBL.20	INTEGER	R/W	1 = ei-200 2 = ei-400 3 = ei-800 4 = ei-1600
I40sysHdrInputADetectPayloadId	I40sysHdrTBL.21	INTEGER	R/W	1 = off 2 = on
I40sysHdrInputBDetectPayloadId	I40sysHdrTBL.22	INTEGER	R/W	1 = off 2 = on
I40sysHdrInputARefLvHlg	I40sysHdrTBL.25	INTEGER	R/W	1 = reflv-50-per 2 = reflv-75-per
I40sysHdrInputBRefLvHlg	I40sysHdrTBL.26	INTEGER	R/W	1 = reflv-50-per 2 = reflv-75-per
I40sysHdrInputARefLvPq	I40sysHdrTBL.29	INTEGER	R/W	1 = reflv-51-per 2 = reflv-58-per
I40sysHdrInputBRefLvPq	I40sysHdrTBL.30	INTEGER	R/W	1 = reflv-51-per 2 = reflv-58-per
I40sysSetupTBL	I40systemTBL.5	Aggregate	-	-
I40sysDateTime	I40sysSetupTBL.1	DisplayString	R/O	Date and Time
I40sysInfoTBL	I40systemTBL.6	Aggregate	-	-
I40sysInfoFirmware	I40sysInfoTBL.1	DisplayString	R/O	Firmware Version
I40sysInfoSer01	I40sysInfoTBL.2	INTEGER	R/O	1 = notavailable 2 = available
I40sysInfoSer02	I40sysInfoTBL.3	INTEGER	R/O	1 = notavailable 2 = available

• I40wfmTBL(3) group

MIB	OID	SYNTAX	ACCESS	VALUE/RANGE
I40wfmIntenConfigTBL	I40wfmTBL.1	Aggregate	-	-
I40wfmModeTBL	I40wfmIntenConfigTBL.1	Aggregate	-	-
I40wfmModeMode	I40wfmModeTBL.1	INTEGER	R/W	1 = parade 2 = overlay
I40wfmModeCh1Y	I40wfmModeTBL.2	INTEGER	R/W	1 = off 2 = on
I40wfmModeCh2Cb	I40wfmModeTBL.3	INTEGER	R/W	1 = off 2 = on
I40wfmModeCh3Cr	I40wfmModeTBL.4	INTEGER	R/W	1 = off 2 = on
I40wfmModeCh1G	I40wfmModeTBL.5	INTEGER	R/W	1 = off 2 = on
I40wfmModeCh2B	I40wfmModeTBL.6	INTEGER	R/W	1 = off 2 = on
I40wfmModeCh3R	I40wfmModeTBL.7	INTEGER	R/W	1 = off 2 = on
I40wfmModeCh1R	I40wfmModeTBL.8	INTEGER	R/W	1 = off 2 = on
I40wfmModeCh2G	I40wfmModeTBL.9	INTEGER	R/W	1 = off 2 = on
I40wfmModeCh3B	I40wfmModeTBL.10	INTEGER	R/W	1 = off 2 = on
I40wfmModeCh1X	I40wfmModeTBL.13	INTEGER	R/W	1 = off 2 = on
I40wfmModeCh2Y	I40wfmModeTBL.14	INTEGER	R/W	1 = off 2 = on

19. NETWORK CONTROL

MIB	OID	SYNTAX	ACCESS	VALUE/RANGE
I40wfmModeCh3Z	I40wfmModeTBL.15	INTEGER	R/W	1 = off 2 = on
I40wfmIntenTBL	I40wfmIntenConfigTBL.2	Aggregate	-	-
I40wfmInten	I40wfmIntenTBL.1	INTEGER	R/W	-128 to 127
I40wfmColor	I40wfmIntenTBL.2	INTEGER	R/W	1 = white 2 = yellow 3 = cyan 4 = green 5 = magenta 6 = red 7 = blue 8 = multi
I40wfmScaleTBL	I40wfmIntenConfigTBL.3	Aggregate	-	-
I40wfmScaleInten	I40wfmScaleTBL.1	INTEGER	R/W	-8 to 7
I40wfmScaleColor	I40wfmScaleTBL.2	INTEGER	R/W	1 = white 2 = yellow 3 = cyan 4 = green 5 = magenta 6 = red 7 = blue
I40wfmScaleUnit	I40wfmScaleTBL.3	INTEGER	R/W	1 = unit-hdv-sdp 2 = unit-hdv-sdv 3 = unit-hdp-sdp 4 = unit-cv-dec 5 = unit-cv-hex
I40wfmScaleUnitNtsc	I40wfmScaleTBL.4	INTEGER	R/W	3 = unit-hdp-sdp
I40wfmScaleUnitPal	I40wfmScaleTBL.5	INTEGER	R/W	2 = unit-hdv-sdv
I40wfmScaleUnitFullRange	I40wfmScaleTBL.6	INTEGER	R/W	3 = unit-hdp-sdp 4 = unit-cv-dec 5 = unit-cv-hex
I40wfmScale75perCol	I40wfmScaleTBL.7	INTEGER	R/W	1 = off 2 = on
I40wfmScaleDisplay	I40wfmScaleTBL.8	INTEGER	R/W	1 = off 2 = on (*1) 2 = main (SER23) (*2) 3 = hdr (SER23) (*2) 4 = both (SER23) (*2) *1 HDR OFF *2 HDR ON
I40wfmGainTBL	I40wfmTBL.2	Aggregate	-	-
I40wfmGainVar	I40wfmGainTBL.1	INTEGER	R/W	1 = cal 2 = variable
I40wfmGainMag	I40wfmGainTBL.2	INTEGER	R/W	1 = x1 2 = x5 3 = x10
I40wfmGainValue	I40wfmGainTBL.3	DisplayString	R/W	0.2 to 2.000
I40wfmGainFilter	I40wfmGainTBL.4	INTEGER	R/W	1 = lowpass 2 = flat
I40wfmGainFilterCmp	I40wfmGainTBL.5	INTEGER	R/W	2 = flat 3 = lum 4 = flatlum 5 = lumchroma
I40wfmGainScaleJump	I40wfmGainTBL.6	INTEGER	R/W	1 = pos-0 2 = pos-10 3 = pos-20

19. NETWORK CONTROL

MIB	OID	SYNTAX	ACCESS	VALUE/RANGE
				4 = pos-30 5 = pos-40 6 = pos-50 7 = pos-60 8 = pos-70 9 = pos-80 10 = pos-90 11 = pos-100 12 = cursor
I40wfmSweepTBL	I40wfmTBL.3	Aggregate	-	-
I40wfmSweep	I40wfmSweepTBL.1	INTEGER	R/W	1 = h 2 = v
I40wfmSweepMagH	I40wfmSweepTBL.2	INTEGER	R/W	1 = x1 2 = x10 3 = x20 4 = blank 5 = active
I40wfmSweepMagV	I40wfmSweepTBL.3	INTEGER	R/W	1 = x1 2 = x20 3 = x40
I40wfmSweepH	I40wfmSweepTBL.4	INTEGER	R/W	1 = sweep-1h 2 = sweep-2h
I40wfmSweepV	I40wfmSweepTBL.5	INTEGER	R/W	1 = sweep-1v 2 = sweep-2v
I40wfmSweepField	I40wfmSweepTBL.6	INTEGER	R/W	1 = field1 2 = field2
I40wfmBlanking	I40wfmSweepTBL.7	INTEGER	R/W	1 = remove 2 = v 3 = h 4 = all
I40wfmBlankingCmp	I40wfmSweepTBL.8	INTEGER	R/W	1 = remove 2 = v
I40wfmMatrixTBL	I40wfmTBL.4	Aggregate	-	-
I40wfmMatrix	I40wfmMatrixTBL.1	INTEGER	R/W	1 = ycbr 2 = gbr 3 = rgb 4 = composite
I40wfmMatrixRgb	I40wfmMatrixTBL.2	INTEGER	R/W	2 = gbr 3 = rgb 4 = composite
I40wfmMatrixYgbr	I40wfmMatrixTBL.3	INTEGER	R/W	1 = off 2 = on
I40wfmMatrixYrgb	I40wfmMatrixTBL.4	INTEGER	R/W	1 = off 2 = on
I40wfmCmpFormat	I40wfmMatrixTBL.5	INTEGER	R/W	1 = auto 2 = ntsc 3 = pal
I40wfmCmpSetup	I40wfmMatrixTBL.6	INTEGER	R/W	1 = setup-0p 2 = setup-75p
I40wfmMatrixXyz	I40wfmMatrixTBL.7	INTEGER	R/W	2 = gbr 3 = rgb 4 = composite 5 = xyz
I40wfmMatrixTBL	I40wfmTBL.4	Aggregate	-	-
I40wfmCursorMode	I40wfmCursorTBL.1	INTEGER	R/W	1 = off 2 = single 3 = both

19. NETWORK CONTROL

MIB	OID	SYNTAX	ACCESS	VALUE/RANGE
I40wfmCursorSel	I40wfmCursorTBL.2	INTEGER	R/W	1 = x 2 = y
I40wfmCursorUnitX	I40wfmCursorTBL.3	INTEGER	R/W	1 = sec 2 = hz
I40wfmCursorUnitY	I40wfmCursorTBL.4	INTEGER	R/W	1 = mv 2 = per 3 = r-per 4 = dec 5 = hex 6 = hdr
I40wfmCursorUnitYCmp	I40wfmCursorTBL.5	INTEGER	R/W	1 = mv 2 = per 3 = r-per
I40wfmCursorRefset	I40wfmCursorTBL.6	INTEGER	R/W	1 (fixed)
I40wfmCursorRefX	I40wfmCursorTBL.7	INTEGER	R/W	0 to 927
I40wfmCursorDeltaX	I40wfmCursorTBL.8	INTEGER	R/W	0 to 927
I40wfmCursorTrackX	I40wfmCursorTBL.9	INTEGER	R/W	-927 to 927
I40wfmCursorRefY	I40wfmCursorTBL.10	INTEGER	R/W	-5000 to 15000
I40wfmCursorDeltaY	I40wfmCursorTBL.11	INTEGER	R/W	-5000 to 15000
I40wfmCursorTrackY	I40wfmCursorTBL.12	INTEGER	R/W	-15000 to 15000
I40wfmLineselTBL	I40wfmTBL.6	Aggregate	-	-
I40wfmLinesel	I40wfmLineselTBL.1	INTEGER	R/W	1 = off 2 = on 3 = cinelite
I40wfmLineselNo	I40wfmLineselTBL.2	INTEGER	R/W	0 to 32767
I40wfmLineselField	I40wfmLineselTBL.3	INTEGER	R/W	1 = frame 2 = field1 3 = field2

• I40vectorTBL(4) group

MIB	OID	SYNTAX	ACCESS	VALUE/RANGE
I40vectorIntenConfigTBL	I40vectorTBL.1	Aggregate	-	-
I40vectorDispMode	I40vectorIntenConfigTBL .1	INTEGER	R/W	1 = vector 2 = fivebar 3 = histogram 4 = cie-diagram
I40vectorInten	I40vectorIntenConfigTBL .2	INTEGER	R/W	-128 to 127
I40vectorColor	I40vectorIntenConfigTBL .3	INTEGER	R/W	1 = white 2 = yellow 3 = cyan 4 = green 5 = magenta 6 = red 7 = blue
I40vectorVectorMode	I40vectorIntenConfigTBL .7	INTEGER	R/W	1 = vector 2 = rgb-vector 3 = ybcr-vector
I40vectorDispVecTBL	I40vectorTBL.2	Aggregate	-	-
I40vectorDispVecScaleTBL	I40vectorDispVecTBL.1	Aggregate	-	-
I40vectorDispVecScaleInten	I40vectorDispVecScaleTB L.1	INTEGER	R/W	-8 to 7
I40vectorDispVecScaleColor	I40vectorDispVecScaleTB L.2	INTEGER	R/W	1 = white 2 = yellow 3 = cyan 4 = green

19. NETWORK CONTROL

MIB	OID	SYNTAX	ACCESS	VALUE/RANGE
				5 = magenta 6 = red 7 = blue
I40vectorDispVecScaleIq	I40vectorDispVecScaleTB L.3	INTEGER	R/W	1 = off 2 = on
I40vectorDispVecVectorScale	I40vectorDispVecScaleTB L.4	INTEGER	R/W	1 = auto 2 = bt601 3 = bt709 4 = dci 5 = bt2020
I40vectorDispRGBVecAdjustTarget	I40vectorDispVecScaleTB L.5	INTEGER	R/W	1 = gb 2 = gr
I40vectorDispRGBVecAdjustPosH	I40vectorDispVecScaleTB L.6	INTEGER	R/W	-500 to 500
I40vectorDispRGBVecAdjustPosV	I40vectorDispVecScaleTB L.7	INTEGER	R/W	-500 to 500
I40vectorDispYCbCrVecTimingMarker	I40vectorDispVecScaleTB L.8	INTEGER	R/W	1 = auto 2 = hd 3 = sd
I40vectorDispYCbCrVecVectorScale	I40vectorDispVecScaleTB L.9	INTEGER	R/W	1 = auto 2 = bt601 3 = bt709 4 = dci 5 = bt2020
I40vectorDispVecVariableScale	I40vectorDispVecScaleTB L.10	INTEGER	R/W	1 = off 2 = on
I40vectorDispVecGainTBL	I40vectorDispVecTBL.2	Aggregate	-	-
I40vectorDispVecGainVar	I40vectorDispVecGainTB L.1	INTEGER	R/W	1 = cal 2 = variable
I40vectorDispVecGainMag	I40vectorDispVecGainTB L.2	INTEGER	R/W	1 = x1 2 = x5 3 = iq
I40vectorDispVecGainValue	I40vectorDispVecGainTB L.3	DisplayString	R/W	0.2 to 2.000
I40vectorDispRGBVecGainH	I40vectorDispVecGainTB L.4	DisplayString	R/W	0.2 to 2.000
I40vectorDispRGBVecGainV	I40vectorDispVecGainTB L.5	DisplayString	R/W	0.2 to 2.000
I40vectorDispYCbCrVecGainVar	I40vectorDispVecGainTB L.6	INTEGER	R/W	1 = cal 2 = variable
I40vectorDispYCbCrVecGainMag	I40vectorDispVecGainTB L.7	INTEGER	R/W	1 = x1 2 = x5
I40vectorDispYCbCrVecObsPoint	I40vectorDispVecGainTB L.8	INTEGER	R/W	1 = by-wh 2 = by-yl 3 = by-cy 4 = by-g 5 = by-timing 6 = by-mg 7 = by-r 8 = by-b 9 = bl 10 = ry-b 11 = ry-r 12 = ry-mg 13 = ry-timing 14 = ry-g 15 = ry-cy

19. NETWORK CONTROL

MIB	OID	SYNTAX	ACCESS	VALUE/RANGE
				16 = ry-yl 17 = ry-wh
I40vectorDispGuideDisplay	I40vectorDispVecGainTBL.9	INTEGER	R/W	1 = off 2 = on
I40vectorDispVecMarker	I40vectorDispVecTBL.3	INTEGER	R/W	1 = off 2 = on
I40vectorColorSystemTBL	I40vectorDispVecTBL.4	Aggregate	-	-
I40vectorColorSysMatrix	I40vectorColorSystemTBL.1	INTEGER	R/W	1 = component 2 = composite
I40vectorColorSysColorBar	I40vectorColorSystemTBL.2	INTEGER	R/W	1 = cb-100p 2 = cb75p
I40vectorColorSysCmpFormat	I40vectorColorSystemTBL.3	INTEGER	R/W	1 = auto 2 = ntsc
I40vectorColorSysSetup	I40vectorColorSystemTBL.4	INTEGER	R/W	1 = setup-0p 2 = setup-75p
I40vectorVariableMarkerTBL	I40vectorDispVecTBL.5	Aggregate	-	-
I40vectorVarMkrMarkerSize	I40vectorVariableMarkerTBL.4	INTEGER	R/W	5 to 10
I40vectorDisp5barTBL	I40vectorTBL.3	Aggregate	-	-
I40vectorDisp5barScale	I40vectorDisp5barTBL.1	INTEGER	R/W	1 = p 2 = mv 3 = hex 4 = dec
I40vectorDisp5barSeq	I40vectorDisp5barTBL.2	INTEGER	R/W	1 = gbr 2 = rgb
I40vectorDispHistTBL	I40vectorTBL.4	Aggregate	-	-
I40vectorDispHistScale	I40vectorDispHistTBL.1	INTEGER	R/W	1 = per 2 = hdr
I40vectorDispHistForm	I40vectorDispHistTBL.2	INTEGER	R/W	1 = single 2 = tile 3 = align_h 4 = align_v
I40vectorDispHistSetupTBL	I40vectorDispHistTBL.3	Aggregate	-	-
I40vectorDispHistSetupY	I40vectorDispHistSetupTBL.1	INTEGER	R/W	1 = off 2 = on
I40vectorDispHistSetupR	I40vectorDispHistSetupTBL.2	INTEGER	R/W	1 = off 2 = on
I40vectorDispHistSetupG	I40vectorDispHistSetupTBL.3	INTEGER	R/W	1 = off 2 = on
I40vectorDispHistSetupB	I40vectorDispHistSetupTBL.4	INTEGER	R/W	1 = off 2 = on
I40vectorDispCieTBL	I40vectorTBL.5	Aggregate	-	-
I40vectorDispCieScaleTBL	I40vectorDispCieTBL.1	Aggregate	-	-
I40vectorDispCieColor	I40vectorDispCieScaleTBL.1	INTEGER	R/W	1 = bg-white 2 = bg-color 3 = bg-black
I40vectorDispCieTriangle1	I40vectorDispCieScaleTBL.2	INTEGER	R/W	1 = off 2 = bt601-525 3 = bt601-625 4 = bt709 5 = dci 6 = bt2020
I40vectorDispCieTriangle2	I40vectorDispCieScaleTBL.3	INTEGER	R/W	1 = off 2 = bt601-525 3 = bt601-625 4 = bt709 5 = dci

19. NETWORK CONTROL

MIB	OID	SYNTAX	ACCESS	VALUE/RANGE
				6 = bt2020
I40vectorDispCieUserTriangle	I40vectorDispCieScaleTBL.4	INTEGER	R/W	1 = off 2 = one 3 = two
I40vectorDispCieUserPrimaryColor	I40vectorDispCieScaleTBL.5	INTEGER	R/W	1 = g 2 = b 3 = r
I40vectorDispCieUserTriangleX	I40vectorDispCieScaleTBL.6	DisplayString	R/W	0 to 1.000
I40vectorDispCieUserTriangleY	I40vectorDispCieScaleTBL.7	DisplayString	R/W	0 to 1.000
I40vectorDispCieTempScale	I40vectorDispCieScaleTBL.8	INTEGER	R/W	1 = off 2 = on
I40vectorDispCieGrid	I40vectorDispCieScaleTBL.9	INTEGER	R/W	1 = off 2 = on
I40vectorDispCieD65	I40vectorDispCieScaleTBL.10	INTEGER	R/W	1 = off 2 = on
I40vectorDispCieTriangleCaption	I40vectorDispCieScaleTBL.11	INTEGER	R/W	1 = off 2 = on
I40vectorDispCieWhitePointLabel	I40vectorDispCieScaleTBL.12	INTEGER	R/W	1 = off 2 = on
I40vectorDispCieSettingTBL	I40vectorDispCieTBL.2	Aggregate	-	-
I40vectorDispCieMode	I40vectorDispCieSettingTBL.1	INTEGER	R/W	1 = diagram 2 = temp
I40vectorDispCieStandard	I40vectorDispCieSettingTBL.2	INTEGER	R/W	5 = cie1391 6 = cie1976
I40vectorDispCieClip	I40vectorDispCieSettingTBL.3	INTEGER	R/W	1 = off 2 = on
I40vectorDispCieFilter	I40vectorDispCieSettingTBL.4	INTEGER	R/W	1 = off 2 = on
I40vectorDispCieManualSetup	I40vectorDispCieSettingTBL.5	INTEGER	R/W	1 = off 2 = on
I40vectorDispCieColorimetrySetup	I40vectorDispCieSettingTBL.6	INTEGER	R/W	1 = off 4 = bt601-525 5 = bt601-625 6 = bt709 7 = dci 8 = bt2020
I40vectorDispCieGammaSetup	I40vectorDispCieSettingTBL.7	DisplayString	R/W	1.50 to 3.00
I40vectorDispCieCursor	I40vectorDispCieTBL.3	INTEGER	R/W	1 = off 2 = on
I40vectorLineselTBL	I40vectorTBL.6	Aggregate	-	-
I40vectorLinesel	I40vectorLineselTBL.1	INTEGER	R/W	1 = off 2 = on 3 = cinelite
I40vectorLineselNo	I40vectorLineselTBL.2	INTEGER	R/W	0 to 32767
I40vectorLineselField	I40vectorLineselTBL.3	INTEGER	R/W	1 = frame 2 = field1 3 = field2
I40vector5BarDataTBL	I40vectorTBL.7	Aggregate	-	-
I40vector5BarYData	I40vector5BarDataTBL.1	DisplayString	R/O	5Bar Max/Min
I40vector5BarGData	I40vector5BarDataTBL.2	DisplayString	R/O	5Bar Max/Min
I40vector5BarBData	I40vector5BarDataTBL.3	DisplayString	R/O	5Bar Max/Min
I40vector5BarRData	I40vector5BarDataTBL.4	DisplayString	R/O	5Bar Max/Min
I40vector5BarCmpData	I40vector5BarDataTBL.5	DisplayString	R/O	5Bar Max/Min

19. NETWORK CONTROL

• I40pictureTBL(5) group

MIB	OID	SYNTAX	ACCESS	VALUE/RANGE
I40pictureConfigTBL	I40pictureTBL.1	Aggregate	-	-
I40pictureMode	I40pictureConfigTBL.1	INTEGER	R/W	1 = fit 2 = real 3 = x2 4 = full
I40pictureAdjustTBL	I40pictureConfigTBL.2	Aggregate	-	-
I40pictureAdjustColor	I40pictureAdjustTBL.1	INTEGER	R/W	1 = color 2 = mono
I40pictureChroma	I40pictureAdjustTBL.2	INTEGER	R/W	1 = normal 2 = up
I40pictureBrightness	I40pictureAdjustTBL.3	DisplayString	R/W	-50.0 to 50.0
I40pictureContrast	I40pictureAdjustTBL.4	DisplayString	R/W	0 to 200.0
I40pictureGainR	I40pictureAdjustTBL.5	DisplayString	R/W	0 to 200.0
I40pictureGainG	I40pictureAdjustTBL.6	DisplayString	R/W	0 to 200.0
I40pictureGainB	I40pictureAdjustTBL.7	DisplayString	R/W	0 to 200.0
I40pictureGainChroma	I40pictureAdjustTBL.8	DisplayString	R/W	0 to 200.0
I40pictureBiasR	I40pictureAdjustTBL.9	DisplayString	R/W	-50.0 to 50.0
I40pictureBiasG	I40pictureAdjustTBL.10	DisplayString	R/W	-50.0 to 50.0
I40pictureBiasB	I40pictureAdjustTBL.11	DisplayString	R/W	-50.0 to 50.0
I40pictureDispGamut	I40pictureConfigTBL.3	INTEGER	R/W	1 = off 2 = white 3 = red 4 = mesh
I40pictureDispStatusInfo	I40pictureConfigTBL.4	INTEGER	R/W	1 = off 2 = on
I40pictureDispPosH	I40pictureConfigTBL.6	INTEGER	R/W	-32768 to 32767
I40pictureDispPosV	I40pictureConfigTBL.7	INTEGER	R/W	-32768 to 32767
I40pictureMarkerTBL	I40pictureConfigTBL.8	Aggregate	-	-
I40pictureMarkerFrame	I40pictureMarkerTBL.1	INTEGER	R/W	1 = off 2 = on
I40pictureMarkerCenter	I40pictureMarkerTBL.2	INTEGER	R/W	1 = off 2 = on
I40pictureMarkerAspect	I40pictureMarkerTBL.3	INTEGER	R/W	1 = off 2 = asp-17x9 3 = asp-16x9 4 = asp-14x9 5 = asp-13x9 6 = asp-4x3 7 = asp-239x1 8 = asp-afd
I40pictureAspectShadow	I40pictureMarkerTBL.4	INTEGER	R/W	0 to 100
I40pictureSafeAction	I40pictureMarkerTBL.5	INTEGER	R/W	1 = off 2 = arib 3 = smpte 4 = user
I40pictureSafeTitle	I40pictureMarkerTBL.6	INTEGER	R/W	1 = off 2 = arib 3 = smpte 4 = user
I40pictureSafeUser1Width	I40pictureMarkerTBL.7	INTEGER	R/W	0 to 100
I40pictureSafeUser1Height	I40pictureMarkerTBL.8	INTEGER	R/W	0 to 100
I40pictureSafeUser2Width	I40pictureMarkerTBL.9	INTEGER	R/W	0 to 100
I40pictureSafeUser2Height	I40pictureMarkerTBL.10	INTEGER	R/W	0 to 100
I40pictureSafeUserAspect	I40pictureMarkerTBL.11	INTEGER	R/W	1 = off 2 = on

19. NETWORK CONTROL

MIB	OID	SYNTAX	ACCESS	VALUE/RANGE
I40pictureSuperImposeTBL	I40pictureConfigTBL.9	Aggregate	-	-
I40pictureStandard	I40pictureSuperImposeTBL.1	INTEGER	R/W	1 = off 2 = smpte 3 = arib 4 = teletext
I40pictureSmpteFormat	I40pictureSuperImposeTBL.2	INTEGER	R/W	1 = fmt-608-708 2 = fmt-608-608 3 = fmt-vbi 4 = fmt-708
I40pictureSmpteLanguage	I40pictureSuperImposeTBL.3	INTEGER	R/W	1 = cc1 2 = cc2 3 = cc3 4 = cc4 5 = text1 6 = text2 7 = text3 8 = text4
I40pictureSmpte708Service	I40pictureSuperImposeTBL.4	INTEGER	R/W	1 to 63
I40pictureAribFormat	I40pictureSuperImposeTBL.5	INTEGER	R/W	1 = hd 2 = sd 3 = analog 4 = cellular
I40pictureAribLanguage	I40pictureSuperImposeTBL.6	INTEGER	R/W	1 = one 2 = two
I40pictureTeletextWst	I40pictureSuperImposeTBL.7	INTEGER	R/W	1 = vbi 2 = op47
I40pictureTeletextMagazin	I40pictureSuperImposeTBL.8	INTEGER	R/W	1 to 8
I40pictureTeletextPage	I40pictureSuperImposeTBL.9	INTEGER	R/W	0 to 255
I40pictureSmpteContent	I40pictureSuperImposeTBL.10	INTEGER	R/W	1 = off 2 = on
I40pictureCITBL	I40pictureTBL. 2	Aggregate	-	-
I40pictureCIDisplay	I40pictureCITBL.1	INTEGER	R/W	1 = off 2 = fstop 3 = perdisplay 4 = cinezone 5 = perdiscpinezone
I40pictureCIAdvance	I40pictureCITBL.2	INTEGER	R/W	1 = off 2 = on
I40pictureCIMeasureNums	I40pictureCITBL.3	INTEGER	R/W	1 = p1 2 = p1p2 3 = p1p2p3
I40pictureCIMeasurePos	I40pictureCITBL.4	INTEGER	R/W	1 = p1 2 = p2 3 = p3
I40pictureCIMeasureSize	I40pictureCITBL.5	INTEGER	R/W	1 = size-1x1 2 = size-3x3 3 = size-9x9
I40pictureCIRgbUnit	I40pictureCITBL.6	INTEGER	R/W	1 = yper 2 = rgbper 3 = rgb255 4 = codevalue 5 = codevaluedec 6 = hdr
I40pictureCIFstopRefSet	I40pictureCITBL.7	INTEGER	R/WO	1 (fixed)

19. NETWORK CONTROL

MIB	OID	SYNTAX	ACCESS	VALUE/RANGE
I40pictureClFstopGammaSel	I40pictureCITBL.8	INTEGER	R/W	1 = gamma-045 2 = user1 3 = user2 4 = user3 5 = usera 6 = userb 7 = userc 8 = userd 9 = usere
I40pictureClSample	I40pictureCITBL.9	INTEGER	R/W	0 to 32767
I40pictureClLine	I40pictureCITBL.10	INTEGER	R/W	0 to 32767
I40pictureClCzTBL	I40pictureCLTBL.11	Aggregate	-	-
I40pictureClCzHdrZone	I40pictureCICzTBL.1	INTEGER	R/W	1 = off 2 = on
I40pictureCICzForm	I40pictureCICzTBL.2	INTEGER	R/W	1 = gradate 2 = step 3 = search
I40pictureCICzUpper	I40pictureCICzTBL.3	DisplayString	R/W	-6.3 to 109.4
I40pictureCICzLower	I40pictureCICzTBL.4	DisplayString	R/W	-7.3 to 108.4
I40pictureCICzRef	I40pictureCICzTBL.5	DisplayString	R/W	-7.3 to 109.4
I40pictureCICzLevel	I40pictureCICzTBL.6	DisplayString	R/W	-7.3 to 109.4
I40pictureMaxFallCIITBL	I40pictureTBL.3	Aggregate	-	-
I40pictureMaxFallCIIDisplay	I40pictureMaxFallCIITBL .1	INTEGER	R/W	1 = off 2 = on
I40pictureMaxFallCIIMeasure	I40pictureMaxFallCIITBL .2	INTEGER	R/W	1 = stop 2 = start
I40pictureMaxFallCIIClear	I40pictureMaxFallCIITBL .3	INTEGER	R/WO	1 (fixed)
I40pictureEdgeTBL	I40pictureTBL.4	Aggregate	-	-
I40pictureEdgeDetect	I40pictureEdgeTBL.1	INTEGER	R/W	1 = off 2 = on
I40pictureEdgeSensitive	I40pictureEdgeTBL.2	INTEGER	R/W	1 = low 2 = middle 3 = high 4 = v-high 5 = u-high
I40pictureEdgeLevel	I40pictureEdgeTBL.3	INTEGER	R/W	1 = lvl-off 2 = lvl-25 3 = lvl-50 4 = lvl-75 5 = lvl-100 6 = lvl-emboss
I40pictureEdgeColor	I40pictureEdgeTBL.4	INTEGER	R/W	1 = white 4 = green 6 = red 7 = blue
I40pictureLineselTBL	I40pictureTBL.5	Aggregate	-	-
I40pictureLinesel	I40pictureLineselTBL.1	INTEGER	R/W	1 = off 2 = on 3 = cinelite
I40pictureLineselNo	I40pictureLineselTBL.2	INTEGER	R/W	0 to 32767
I40pictureLineselField	I40pictureLineselTBL.3	INTEGER	R/W	1 = frame 2 = field1 3 = field2
I40pictureDataTBL	I40pictureTBL.6	Aggregate	-	-
I40pictureDataCineliteP1	I40pictureDataTBL.1	DisplayString	R/O	Cinelite Data
I40pictureDataCineliteP2	I40pictureDataTBL.2	DisplayString	R/O	Cinelite Data

19. NETWORK CONTROL

MIB	OID	SYNTAX	ACCESS	VALUE/RANGE
I40pictureDataCineliteP3	I40pictureDataTBL.3	DisplayString	R/O	Cinelite Data

• I40statusTBL(6) group

MIB	OID	SYNTAX	ACCESS	VALUE/RANGE
I40statusModeTBL	I40statusTBL.1	Aggregate	-	-
I40statusModeTop	I40statusModeTBL.1	INTEGER	R/WO	1 (fixed)
I40statusModeDump	I40statusModeTBL.2	INTEGER	R/WO	1 (fixed)
I40statusModeExtref	I40statusModeTBL.3	INTEGER	R/WO	1 (fixed)
I40statusModeAvPhase	I40statusModeTBL.4	INTEGER	R/WO	1 (fixed)
I40statusModeAncView	I40statusModeTBL.5	INTEGER	R/WO	1 (fixed)
I40statusModeAncViewDump	I40statusModeTBL.6	INTEGER	R/WO	1 (fixed)
I40statusModeLog	I40statusModeTBL.7	INTEGER	R/WO	1 (fixed)
I40statusModeAncPkt	I40statusModeTBL.8	INTEGER	R/WO	1 (fixed)
I40statusModeEdh	I40statusModeTBL.9	INTEGER	R/WO	1 (fixed)
I40statusModePayload	I40statusModeTBL.10	INTEGER	R/WO	1 (fixed)
I40statusModeCtrlPkt	I40statusModeTBL.11	INTEGER	R/WO	1 (fixed)
I40statusModeAribCc	I40statusModeTBL.12	INTEGER	R/WO	1 (fixed)
I40statusAribNetq	I40statusModeTBL.13	INTEGER	R/WO	1 (fixed)
I40statusModeAribTrig	I40statusModeTBL.14	INTEGER	R/WO	1 (fixed)
I40statusModeAribUser1	I40statusModeTBL.15	INTEGER	R/WO	1 (fixed)
I40statusModeAribUser2	I40statusModeTBL.16	INTEGER	R/WO	1 (fixed)
I40statusModeSmpte608	I40statusModeTBL.17	INTEGER	R/WO	1 (fixed)
I40statusModeSmpte708	I40statusModeTBL.18	INTEGER	R/WO	1 (fixed)
I40statusModeSmpteAfd	I40statusModeTBL.19	INTEGER	R/WO	1 (fixed)
I40statusModeSmpteProg	I40statusModeTBL.20	INTEGER	R/WO	1 (fixed)
I40statusModeSmpteVbi	I40statusModeTBL.21	INTEGER	R/WO	1 (fixed)
I40statusModeSearch	I40statusModeTBL.22	INTEGER	R/WO	1 (fixed)
I40statusModeErrClear	I40statusModeTBL.23	INTEGER	R/WO	1 (fixed)
I40statusModeSmpteSrlive	I40statusModeTBL.33	INTEGER	R/WO	1 (fixed)
I40statusModeSmpteScte104	I40statusModeTBL.34	INTEGER	R/WO	1 (fixed)
I40statusLogTBL	I40statusTBL.2	Aggregate	-	-
I40statusLogging	I40statusLogTBL.1	INTEGER	R/W	1 = stop 2 = start
I40statusLogMode	I40statusLogTBL.2	INTEGER	R/W	1 = overwrt 2 = stop
I40statusLogClear	I40statusLogTBL.3	INTEGER	R/WO	1 (fixed)
I40statusDumpTBL	I40statusTBL.3	Aggregate	-	-
I40statusDumpMode	I40statusDumpTBL.1	INTEGER	R/W	1 = run 2 = hold
I40statusDumpDisp	I40statusDumpTBL.3	INTEGER	R/W	1 = serial 2 = compo 3 = binary 7 = stream1 8 = stream2 9 = stream12-pic 10 = s1serial 11 = s1compo 12 = s1binary 13 = s2serial 14 = s2compo 15 = s2binary
I40statusDumpJump	I40statusDumpTBL.4	INTEGER	R/W	1 = eav 2 = sav
I40statusDumpSample	I40statusDumpTBL.5	INTEGER	R/W	0 to 32767
I40statusDumpLine	I40statusDumpTBL.6	INTEGER	R/W	0 to 32767
I40statusDumpLinkSelect	I40statusDumpTBL.7	INTEGER	R/W	1 = picture

19. NETWORK CONTROL

MIB	OID	SYNTAX	ACCESS	VALUE/RANGE
				2 = a 3 = b 4 = c 5 = d
I40statusExtrefTBL	I40statusTBL.4	Aggregate	-	-
I40statusExtrefSel	I40statusExtrefTBL.3	INTEGER	R/W	1 = ext 2 = sdi
I40statusExtrefUserRef	I40statusExtrefTBL.1	INTEGER	R/WO	1 (fixed)
I40statusExtrefDefaultRef	I40statusExtrefTBL.2	INTEGER	R/WO	1 (fixed)
I40statusExtrefTiming	I40statusExtrefTBL.4	INTEGER	R/W	1 = legacy 2 = serial
I40statusAvPhaseTBL	I40statusTBL.5	Aggregate	-	-
I40statusAvPhaseScaleMax	I40statusAvphaseTBL.1	INTEGER	R/W	1 = scale-50ms 2 = scale-100ms 3 = scale-500ms 4 = scale-1000ms 5 = scale-2500ms
I40statusAvPhaseRefresh	I40statusAvphaseTBL.2	INTEGER	R/WO	1 (fixed)
I40statusAncTBL	I40statusTBL.6	Aggregate	-	-
I40statusAncDumpHold	I40statusAncTBL.1	INTEGER	R/W	1 = hold-hold 2 = hold-1s 3 = hold-3s
I40statusAncDumpMode	I40statusAncTBL.2	INTEGER	R/W	1 = hex 2 = binary
I40statusAncDumpSample	I40statusAncTBL.3	INTEGER	R/W	0 to 258
I40statusAncEdhDisp	I40statusAncTBL.4	INTEGER	R/W	1 = text 2 = dump
I40statusAncEdhMode	I40statusAncTBL.5	INTEGER	R/W	1 = hex 2 = binary
I40statusAncEdhSample	I40statusAncTBL.6	INTEGER	R/W	0 to 19
I40statusAncViewStream	I40statusAncTBL.7	INTEGER	R/W	1 = stream1 2 = stream2
I40statusAncPayloadStream	I40statusAncTBL.8	INTEGER	R/W	1 = stream1 2 = stream2
I40statusAncCtrlDisp	I40statusAncTBL.9	INTEGER	R/W	1 = text 2 = dump
I40statusAncCtrlMode	I40statusAncTBL.10	INTEGER	R/W	1 = hex 2 = binary
I40statusAncCtrlGroup	I40statusAncTBL.11	INTEGER	R/W	1 = group1 2 = group2 3 = group3 4 = group4
I40statusAncCtrlStream	I40statusAncTBL.12	INTEGER	R/W	1 = stream1 2 = stream2
I40statusAncLinkSelect	I40statusAncTBL.13	INTEGER	R/W	1 = a 2 = b 3 = c 4 = d
I40statusAribTBL	I40statusTBL.7	Aggregate	-	-
I40statusAribCcDisp	I40statusAribTBL.1	INTEGER	R/W	1 = text 2 = dump
I40statusAribCcType	I40statusAribTBL.2	INTEGER	R/W	1 = hd 2 = sd 3 = analog 4 = cellular
I40statusAribCcMode	I40statusAribTBL.3	INTEGER	R/W	1 = hex 2 = binary

19. NETWORK CONTROL

MIB	OID	SYNTAX	ACCESS	VALUE/RANGE
I40statusAribCcSample	I40statusAribTBL.4	INTEGER	R/W	0 to 258
I40statusAribCcStream	I40statusAribTBL.5	INTEGER	R/W	1 = stream1 2 = stream2
I40statusAribNetqDisp	I40statusAribTBL.6	INTEGER	R/W	1 = text 2 = dump 3 = qlog 4 = format
I40statusAribNetqMode	I40statusAribTBL.7	INTEGER	R/W	1 = hex 2 = binary
I40statusAribNetqSample	I40statusAribTBL.8	INTEGER	R/W	0 to 258
I40statusAribNetqLogPos	I40statusAribTBL.9	INTEGER	R/W	-50 to 50
I40statusAribNetqStream	I40statusAribTBL.10	INTEGER	R/W	1 = stream1 2 = stream2
I40statusAribNetqClear	I40statusAribTBL.11	INTEGER	R/WO	1 (fixed)
I40statusAribTriggerDisp	I40statusAribTBL.12	INTEGER	R/W	1 = text 2 = dump
I40statusAribTriggerMode	I40statusAribTBL.13	INTEGER	R/W	1 = hex 2 = binary
I40statusAribTriggerSample	I40statusAribTBL.14	INTEGER	R/W	0 to 258
I40statusAribTriggerStream	I40statusAribTBL.15	INTEGER	R/W	1 = stream1 2 = stream2
I40statusAribTriggerUser1Mode	I40statusAribTBL.16	INTEGER	R/W	1 = hex 2 = binary
I40statusAribTriggerUser1Sample	I40statusAribTBL.17	INTEGER	R/W	0 to 258
I40statusAribTriggerUser1Stream	I40statusAribTBL.18	INTEGER	R/W	1 = stream1 2 = stream2
I40statusAribTriggerUser2Mode	I40statusAribTBL.19	INTEGER	R/W	1 = hex 2 = binary
I40statusAribTriggerUser2Sample	I40statusAribTBL.20	INTEGER	R/W	0 to 258
I40statusAribTriggerUser2Stream	I40statusAribTBL.21	INTEGER	R/W	1 = stream1 2 = stream2
I40statusSmpteTBL	I40statusTBL.8	Aggregate	-	-
I40statusSmpte608Disp	I40statusSmpteTBL.1	INTEGER	R/W	1 = text 2 = dump
I40statusSmpte608Mode	I40statusSmpteTBL.2	INTEGER	R/W	1 = hex 2 = binary
I40statusSmpte608Sample	I40statusSmpteTBL.3	INTEGER	R/W	0 to 258
I40statusSmpte608Stream	I40statusSmpteTBL.4	INTEGER	R/W	1 = stream1 2 = stream2
I40statusSmpte708Disp	I40statusSmpteTBL.5	INTEGER	R/W	1 = text 2 = dump
I40statusSmpte708Mode	I40statusSmpteTBL.6	INTEGER	R/W	1 = hex 2 = binary
I40statusSmpte708Sample	I40statusSmpteTBL.7	INTEGER	R/W	0 to 258
I40statusSmpte708Stream	I40statusSmpteTBL.8	INTEGER	R/W	1 = stream1 2 = stream2
I40statusSmpteProgStream	I40statusSmpteTBL.9	INTEGER	R/W	1 = stream1 2 = stream2
I40statusSmpteVbiStream	I40statusSmpteTBL.10	INTEGER	R/W	1 = stream1 2 = stream2
I40statusSmpteAfdDisp	I40statusSmpteTBL.11	INTEGER	R/W	1 = text 2 = dump
I40statusSmpteAfdMode	I40statusSmpteTBL.12	INTEGER	R/W	1 = hex 2 = binary
I40statusSmpteAfdStream	I40statusSmpteTBL.13	INTEGER	R/W	1 = stream1

19. NETWORK CONTROL

MIB	OID	SYNTAX	ACCESS	VALUE/RANGE
				2 = stream2
I40statusSmpteSrLiveDisp	I40statusSmpteTBL.14	INTEGER	R/W	1 = text 2 = dump
I40statusSmpteSrLiveMode	I40statusSmpteTBL.15	INTEGER	R/W	1 = hex 2 = binary
I40statusSmpteSrLiveSample	I40statusSmpteTBL.16	INTEGER	R/W	0 - 258
I40statusSmpteSrLiveStream	I40statusSmpteTBL.17	INTEGER	R/W	1 = stream1 2 = stream2
I40statusSmpteScte104LogClear	I40statusSmpteTBL.18	INTEGER	R/WO	1 (fixed)
I40statusSmpteScte104LogPos	I40statusSmpteTBL.19	INTEGER	R/W	-50 - 50
I40statusSmpteScte104Disp	I40statusSmpteTBL.20	INTEGER	R/W	1 = text 2 = dump 3 = splice
I40statusSmpteScte104Mode	I40statusSmpteTBL.21	INTEGER	R/W	1 = hex 2 = binary
I40statusSmpteScte104Logging	I40statusSmpteTBL.22	INTEGER	R/W	1 = stop 2 = start
I40statusSmpteScte104Sample	I40statusSmpteTBL.23	INTEGER	R/W	0 - 258
I40statusSmpteScte104TextDuration	I40statusSmpteTBL.24	INTEGER	R/W	1 - 10
I40statusSmpteScte104DumpDuration	I40statusSmpteTBL.25	INTEGER	R/W	1 = duration-hold 2 = duration-1s 3 = duration-3s
I40statusSmpteScte104IdValue	I40statusSmpteTBL.26	INTEGER	R/W	1 = dec 2 = hex 3 = both
I40statusCustomTBL	I40statusTBL.9	Aggregate	-	-
I40statusCustomSearchDid	I40statusCustomTBL.1	DisplayString	R/W	0 to FF
I40statusCustomSearchSdid	I40statusCustomTBL.2	DisplayString	R/W	-1 to FF
I40statusCustomSearchMode	I40statusCustomTBL.3	INTEGER	R/W	1 = hex 2 = binary
I40statusCustomSearchYc	I40statusCustomTBL.4	INTEGER	R/W	1 = y 2 = c
I40statusCustomSearchStream	I40statusCustomTBL.5	INTEGER	R/W	1 = stream1 2 = stream2
I40statusCustomSearchSet	I40statusCustomTBL.6	INTEGER	R/WO	1 (fixed)
I40statusCustomSearchSample	I40statusCustomTBL.7	INTEGER	R/W	0 to 258
I40statusDataTBL	I40statusTBL.10	Aggregate	-	-
I40statusDataSignalA	I40statusDataTBL.1	DisplayString	R/O	Signal Data
I40statusDataSignalB	I40statusDataTBL.2	DisplayString	R/O	Signal Data
I40statusDataSignalC	I40statusDataTBL.3	DisplayString	R/O	Signal Data
I40statusDataSignalD	I40statusDataTBL.4	DisplayString	R/O	Signal Data
I40statusDataLinkA	I40statusDataTBL.5	DisplayString	R/O	Link Data
I40statusDataLinkB	I40statusDataTBL.6	DisplayString	R/O	Link Data
I40statusDataLinkC	I40statusDataTBL.7	DisplayString	R/O	Link Data
I40statusDataLinkD	I40statusDataTBL.8	DisplayString	R/O	Link Data
I40statusDataFormatA	I40statusDataTBL.9	DisplayString	R/O	Format Data
I40statusDataFormatB	I40statusDataTBL.10	DisplayString	R/O	Format Data
I40statusDataFormatC	I40statusDataTBL.11	DisplayString	R/O	Format Data
I40statusDataFormatD	I40statusDataTBL.12	DisplayString	R/O	Format Data
I40statusDataAudioA	I40statusDataTBL.13	DisplayString	R/O	Audio Data
I40statusDataAudioB	I40statusDataTBL.14	DisplayString	R/O	Audio Data
I40statusDataAudioC	I40statusDataTBL.15	DisplayString	R/O	Audio Data
I40statusDataAudioD	I40statusDataTBL.16	DisplayString	R/O	Audio Data
I40statusDataExtrefA	I40statusDataTBL.17	INTEGER	R/O	1 = userref 2 = default

19. NETWORK CONTROL

MIB	OID	SYNTAX	ACCESS	VALUE/RANGE
I40statusDataExtrefStatA	I40statusDataTBL.18	INTEGER	R/O	1 = int 2 = sdi1a 3 = sdi2a 4 = sdi1c 5 = sdi2c 6 = linkA 7 = link1 8 = exthd 9 = extbb 10 = normal
I40statusDataExtrefHtimeA	I40statusDataTBL.19	DisplayString	R/O	H Phase [us]
I40statusDataExtrefHpixA	I40statusDataTBL.20	DisplayString	R/O	H Phase [pix/dot]
I40statusDataExtrefVlineA	I40statusDataTBL.21	DisplayString	R/O	V Phase
I40statusDataExtrefTotalA	I40statusDataTBL.22	DisplayString	R/O	Total Phase
I40statusDataExtrefB	I40statusDataTBL.23	INTEGER	R/O	1 = userref 2 = default
I40statusDataExtrefStatB	I40statusDataTBL.24	INTEGER	R/O	1 = int 2 = sdi1a 3 = sdi2a 4 = sdi1c 5 = sdi2c 6 = linkA 7 = link1 8 = exthd 9 = extbb 10 = nosignal
I40statusDataExtrefHtimeB	I40statusDataTBL.25	DisplayString	R/O	H Phase [us]
I40statusDataExtrefHpixB	I40statusDataTBL.26	DisplayString	R/O	H Phase [pix/dot]
I40statusDataExtrefVlineB	I40statusDataTBL.27	DisplayString	R/O	V Phase
I40statusDataExtrefTotalB	I40statusDataTBL.28	DisplayString	R/O	Total Phase
I40statusDataExtrefC	I40statusDataTBL.29	INTEGER	R/O	1 = userref 2 = default
I40statusDataExtrefStatC	I40statusDataTBL40	INTEGER	R/O	1 = int 2 = sdi1a 3 = sdi2a 4 = sdi1c 5 = sdi2c 6 = linkA 7 = link1 8 = exthd 9 = extbb 10 = normal
I40statusDataExtrefHtimeC	I40statusDataTBL.31	DisplayString	R/O	H Phase [us]
I40statusDataExtrefHpixC	I40statusDataTBL.32	DisplayString	R/O	H Phase [pix/dot]
I40statusDataExtrefVlineC	I40statusDataTBL.33	DisplayString	R/O	V Phase
I40statusDataExtrefTotalC	I40statusDataTBL.34	DisplayString	R/O	Total Phase
I40statusDataExtrefD	I40statusDataTBL.35	INTEGER	R/O	1 = userref 2 = default
I40statusDataExtrefStatD	I40statusDataTBL.36	INTEGER	R/O	1 = int 2 = sdi1a 3 = sdi2a 4 = sdi1c 5 = sdi2c 6 = linkA 7 = link1 8 = exthd 9 = extbb

19. NETWORK CONTROL

MIB	OID	SYNTAX	ACCESS	VALUE/RANGE
				10 = normal
I40statusDataExtrefHtimeD	I40statusDataTBL.37	DisplayString	R/O	H Phase [us]
I40statusDataExtrefHpixD	I40statusDataTBL.38	DisplayString	R/O	H Phase [pix/dot]
I40statusDataExtrefVlineD	I40statusDataTBL.39	DisplayString	R/O	V Phase
I40statusDataExtrefTotalD	I40statusDataTBL.40	DisplayString	R/O	Total Phase
I40statusDataAncAudioCtrl1	I40statusDataTBL.41	INTEGER	R/O	1 = detect 2 = missing
I40statusDataAncAudioCtrl2	I40statusDataTBL.42	INTEGER	R/O	1 = detect 2 = missing
I40statusDataAncEdh	I40statusDataTBL.43	INTEGER	R/O	1 = detect 2 = missing
I40statusDataAncLtc1	I40statusDataTBL.44	INTEGER	R/O	1 = detect 2 = missing
I40statusDataAncLtc2	I40statusDataTBL.45	INTEGER	R/O	1 = detect 2 = missing
I40statusDataAncVtc1	I40statusDataTBL.46	INTEGER	R/O	1 = detect 2 = missing
I40statusDataAncVtc2	I40statusDataTBL.47	INTEGER	R/O	1 = detect 2 = missing
I40statusDataAncPayload1	I40statusDataTBL.48	INTEGER	R/O	1 = detect 2 = missing
I40statusDataAncPayload2	I40statusDataTBL.49	INTEGER	R/O	1 = detect 2 = missing
I40statusDataAncEia708708	I40statusDataTBL.50	INTEGER	R/O	1 = detect 2 = missing
I40statusDataAncEia708608	I40statusDataTBL.51	INTEGER	R/O	1 = detect 2 = missing
I40statusDataAncEia608	I40statusDataTBL.52	INTEGER	R/O	1 = detect 2 = missing
I40statusDataAncProgram	I40statusDataTBL.53	INTEGER	R/O	1 = detect 2 = missing
I40statusDataAncBroadcast	I40statusDataTBL.54	INTEGER	R/O	1 = detect 2 = missing
I40statusDataAncVbi	I40statusDataTBL.55	INTEGER	R/O	1 = detect 2 = missing
I40statusDataAncAfd1	I40statusDataTBL.56	INTEGER	R/O	1 = detect 2 = missing
I40statusDataAncAfd2	I40statusDataTBL.57	INTEGER	R/O	1 = detect 2 = missing
I40statusDataAncJpnCc1	I40statusDataTBL.58	INTEGER	R/O	1 = detect 2 = missing
I40statusDataAncJpnCc2	I40statusDataTBL.59	INTEGER	R/O	1 = detect 2 = missing
I40statusDataAncJpnCc3	I40statusDataTBL.60	INTEGER	R/O	1 = detect 2 = missing
I40statusDataAncNetq1	I40statusDataTBL.61	INTEGER	R/O	1 = detect 2 = missing
I40statusDataAncNetq2	I40statusDataTBL.62	INTEGER	R/O	1 = detect 2 = missing
I40statusDataAncTrigger	I40statusDataTBL.63	INTEGER	R/O	1 = detect 2 = missing
I40statusDataAncUser1	I40statusDataTBL.64	INTEGER	R/O	1 = detect 2 = missing
I40statusDataAncUser2	I40statusDataTBL.65	INTEGER	R/O	1 = detect 2 = missing
I40statusDataAncPktPayload	I40statusDataTBL.66	DisplayString	R/O	Payload ID
I40statusDataAncPktAribNetqS	I40statusDataTBL.67	DisplayString	R/O	Station Code

19. NETWORK CONTROL

MIB	OID	SYNTAX	ACCESS	VALUE/RANGE
tation				
I40statusDataAncPktAribNetqVcurr	I40statusDataTBL.68	DisplayString	R/O	Video Current
I40statusDataAncPktAribNetqVNext	I40statusDataTBL.69	DisplayString	R/O	Video Next
I40statusDataAncPktAribNetqACurr	I40statusDataTBL.70	DisplayString	R/O	Audio Current
I40statusDataAncPktAribNetqANext	I40statusDataTBL.71	DisplayString	R/O	Audio Next
I40statusDataAncPktAribNetqDCurr	I40statusDataTBL.72	DisplayString	R/O	Downmix Current
I40statusDataAncPktAribNetqDNext	I40statusDataTBL.73	DisplayString	R/O	Downmix Next
I40statusDataAncPktSmpteAfdCode	I40statusDataTBL.74	DisplayString	R/O	AFD Code
I40statusDataAncPktSmpteAfdFrame	I40statusDataTBL.75	DisplayString	R/O	Coded Frame
I40statusDataAncPktSmpteAfdBarFlg	I40statusDataTBL.76	DisplayString	R/O	Bar Data Flags
I40statusDataAncPktSmpteAfdBarVal1	I40statusDataTBL.77	DisplayString	R/O	Bar Data Value1
I40statusDataAncPktSmpteAfdBarVal2	I40statusDataTBL.78	DisplayString	R/O	Bar Data Value2
I40statusDataFreqDev	I40statusDataTBL.79	DisplayString	R/O	<-100ppm, -100 to +100ppm, >+100ppm

• I40eyeTBL(7) group (LV5300/LV5300A/LV7300-SER02)

MIB	OID	SYNTAX	ACCESS	VALUE/RANGE
I40eyeConfigTBL	I40eyeTBL.1	Aggregate	-	-
I40eyeMode	I40eyeConfigTBL.1	INTEGER	R/W	1 = eye 2 = jit
I40eyeInten	I40eyeConfigTBL.2	INTEGER	R/W	-128 to 127
I40eyeScaleInten	I40eyeConfigTBL.3	INTEGER	R/W	-8 to 7
I40eyeColor	I40eyeConfigTBL.4	INTEGER	R/W	1 = white 2 = yellow 3 = cyan 4 = green 5 = magenta 6 = red 7 = blue
I40eyeScaleColor	I40eyeConfigTBL.5	INTEGER	R/W	1 = white 2 = yellow 3 = cyan 4 = green 5 = magenta 6 = red 7 = blue
I40eyeJitInten	I40eyeConfigTBL.6	INTEGER	R/W	-128 to 127
I40eyeJitScaleInten	I40eyeConfigTBL.7	INTEGER	R/W	-8 to 7
I40eyeJitColor	I40eyeConfigTBL.8	INTEGER	R/W	1 = white 2 = yellow 3 = cyan 4 = green 5 = magenta 6 = red 7 = blue
I40eyeJitScaleColor	I40eyeConfigTBL.9	INTEGER	R/W	1 = white

19. NETWORK CONTROL

MIB	OID	SYNTAX	ACCESS	VALUE/RANGE
				2 = yellow 3 = cyan 4 = green 5 = magenta 6 = red 7 = blue
I40eyeGainTBL	I40eyeTBL.2	Aggregate	-	-
I40eyeGainMode	I40eyeGainTBL.1	INTEGER	R/W	1 = cal 2 = variable
I40eyeGainVar	I40eyeGainTBL.2	DisplayString	R/W	0.50 to 2.00
I40eyeFilter	I40eyeGainTBL.3	INTEGER	R/W	1 = filter-100khz 2 = filter-10khz 3 = filter-1khz 4 = filter-100hz 5 = filter-10hz 6 = filter-timing 7 = filter-alignment
I40eyeSweep	I40eyeGainTBL.4	INTEGER	R/W	1 = sweep-2ui 2 = sweep-4ui 3 = sweep-16ui
I40eyeJitGainMag	I40eyeGainTBL.5	INTEGER	R/W	1 = x1 2 = x2 3 = x8
I40eyeJitGainMag12g	I40eyeGainTBL.6	INTEGER	R/W	1 = x1 2 = x2 3 = x4 4 = x16
I40eyeJitFilter	I40eyeGainTBL.7	INTEGER	R/W	1 = filter-100khz 2 = filter-10khz 3 = filter-1khz 4 = filter-100hz 5 = filter-10hz 6 = filter-timing 7 = filter-alignment
I40eyeJitSweep	I40eyeGainTBL.8	INTEGER	R/W	1 = sweep-1h 2 = sweep-2h 3 = sweep-1v 4 = sweep-2v
I40eyePeakHoldTBL	I40eyeTBL.3	Aggregate	-	-
I40eyePeakHoldMode	I40eyePeakHoldTBL.1	INTEGER	R/W	1 = off 2 = on
I40eyePeakHoldClear	I40eyePeakHoldTBL.2	INTEGER	R/WO	1 (fixed)
I40eyeTrigger	I40eyePeakHoldTBL.3	INTEGER	R/W	1 = run 2 = stop
I40eyeDisplayMode	I40eyePeakHoldTBL.4	INTEGER	R/W	1 = single 2 = dual
I40eyeJitDisplayMode	I40eyePeakHoldTBL.5	INTEGER	R/W	1 = single 2 = dual
I40eyeDataTBL	I40eyeTBL.4	Aggregate	-	-
I40eyeDataAmp	I40eyeDataTBL.1	DisplayString	R/O	Amp
I40eyeDataTr	I40eyeDataTBL.2	DisplayString	R/O	Tr
I40eyeDataTf	I40eyeDataTBL.3	DisplayString	R/O	Tf
I40eyeDataTj	I40eyeDataTBL.4	DisplayString	R/O	Tj
I40eyeDataJ	I40eyeDataTBL.5	DisplayString	R/O	Jitter
I40eyeDataOr	I40eyeDataTBL.6	DisplayString	R/O	Or
I40eyeDataOf	I40eyeDataTBL.7	DisplayString	R/O	Of
I40eyeDataPeakTj	I40eyeDataTBL.8	DisplayString	R/O	Peak Tj

19. NETWORK CONTROL

MIB	OID	SYNTAX	ACCESS	VALUE/RANGE
I40eyeDataPeakJit	I40eyeDataTBL.9	DisplayString	R/O	Peak Jitter
I40eyeHistogramTBL	I40eyeTBL.5	Aggregate	-	-
I40eyeHistogramMode	I40eyeHistogramTBL.1	INTEGER	R/W	1 = off 2 = on
I40eyeHistogramInten	I40eyeHistogramTBL.2	INTEGER	R/W	-8 to 7
I40eyeHistogramColor	I40eyeHistogramTBL.3	INTEGER	R/W	1 = white 2 = yellow 3 = cyan 4 = green 5 = magenta 6 = red 7 = blue

• I40audioTBL(8) group

MIB	OID	SYNTAX	ACCESS	VALUE/RANGE
I40audioDispMode	I40audioTBL.1	INTEGER	R/W	1 = lissajou 2 = surround 3 = meter 4 = status
I40audioMeterTBL	I40audioTBL.2	Aggregate	-	-
I40audioMeterRange	I40audioMeterTBL.1	INTEGER	R/W	1 = range-60dBFS 2 = range-90dBFS 3 = mag
I40audioMeterResponse	I40audioMeterTBL.2	INTEGER	R/W	1 = truepeak 2 = ppm 3 = vu
I40audioMeterPpmMode	I40audioMeterTBL.3	INTEGER	R/W	1 = mode1 2 = mode2
I40audioMeterPeakMeter	I40audioMeterTBL.4	INTEGER	R/W	1 = true 2 = ppm1 3 = ppm2
I40audioMeterPeakHold	I40audioMeterTBL.5	INTEGER	R/W	0 = hold-0 5 = hold-500ms 10 = hold-1000ms 15 = hold-1500ms 20 = hold-2000ms 25 = hold-2500ms 30 = hold-3000ms 35 = hold-3500ms 40 = hold-4000ms 45 = hold-4500ms 50 = hold-5000ms 55 = hold
I40audioMeterOverLevel	I40audioMeterTBL.6	DisplayString	R/W	-40.0 to 0
I40audioMeterWarningLevel	I40audioMeterTBL.7	DisplayString	R/W	-40.0 to 0
I40audioMeterRefLevel	I40audioMeterTBL.8	DisplayString	R/W	-40.0 to 0
I40audioMeterLevelValueDisplay	I40audioMeterTBL.9	INTEGER	R/W	1 = instantly 2 = peakhold
I40audioMeterPeakHoldReset	I40audioMeterTBL.10	INTEGER	R/WO	1 (fixed)
I40audioLissajouTBL	I40audioTBL.3	Aggregate	-	-
I40audioLissajouInten	I40audioLissajouTBL.1	INTEGER	R/W	-8 to 7
I40audioLissajouScaleInten	I40audioLissajouTBL.2	INTEGER	R/W	-8 to 7
I40audioLissajouDisplay	I40audioLissajouTBL.3	INTEGER	R/W	1 = multi 2 = single
I40audioLissajouForm	I40audioLissajouTBL.4	INTEGER	R/W	1 = xy 2 = matrix
I40audioLissajouAutoGain	I40audioLissajouTBL.5	INTEGER	R/W	1 = off

19. NETWORK CONTROL

MIB	OID	SYNTAX	ACCESS	VALUE/RANGE
				2 = on
I40audioSurroundTBL	I40audioTBL.4	Aggregate	-	-
I40audioSurroundInten	I40audioSurroundTBL.1	INTEGER	R/W	-8 to 7
I40audioSurroundScaleInten	I40audioSurroundTBL.2	INTEGER	R/W	-8 to 7
I40audioSurroundMode	I40audioSurroundTBL.3	INTEGER	R/W	1 = normal 2 = phantom
I40audioSurroundAutoGain	I40audioSurroundTBL.4	INTEGER	R/W	1 = off 2 = on
I40audioStatusTBL	I40audioTBL.5	Aggregate	-	-
I40audioStatusLog	I40audioStatusTBL.1	INTEGER	R/WO	1 (fixed)
I40audioStatusLogging	I40audioStatusTBL.2	INTEGER	R/W	1 = stop 2 = start
I40audioStatusLogClear	I40audioStatusTBL.3	INTEGER	R/WO	1 (fixed)
I40audioStatusLogMode	I40audioStatusTBL.4	INTEGER	R/W	1 = overwrt 2 = stop
I40audioStatusDisplayChStatus	I40audioStatusTBL.5	INTEGER	R/WO	1 (fixed)
I40audioStatusChStatus	I40audioStatusTBL.6	INTEGER	R/W	1 = ch1 2 = ch2 3 = ch3 4 = ch4 5 = ch5 6 = ch6 7 = ch7 8 = ch8 9 = ch9 10 = ch10 11 = ch11 12 = ch12 13 = ch13 14 = ch14 15 = ch15 16 = ch16 101 = A1 (A:CH1) 102 = A2 (A:CH2) 103 = A3 (A:CH3) 104 = A4 (A:CH4) 105 = A5 (A:CH5) 106 = A6 (A:CH6) 107 = A7 (A:CH7) 108 = A8 (A:CH8) 109 = A9 110 = A10 111 = A11 112 = A12 113 = A13 114 = A14 115 = A15 116 = A16 201 = B1 (B:CH1) 202 = B2 (B:CH2) 203 = B3 (B:CH3) 204 = B4 (B:CH4) 205 = B5 (B:CH5) 206 = B6 (B:CH6) 207 = B7 (B:CH7) 208 = B8 (B:CH8) 209 = B9 210 = B10

19. NETWORK CONTROL

MIB	OID	SYNTAX	ACCESS	VALUE/RANGE
				211 = B11 212 = B12 213 = B13 214 = B14 215 = B15 216 = B16 301 = C1 302 = C2 303 = C3 304 = C4 305 = C5 306 = C6 307 = C7 308 = C8 309 = C9 310 = C10 311 = C11 312 = C12 313 = C13 314 = C14 315 = C15 316 = C16 401 = D1 402 = D2 403 = D3 404 = D4 405 = D5 406 = D6 407 = D7 408 = D8 409 = D9 410 = D10 411 = D11 412 = D12 413 = D13 414 = D14 415 = D15 416 = D16
I40audioStatusChStatusAlign	I40audioStatusTBL.7	INTEGER	R/W	1 = lsb 2 = msb
I40audioStatusDisplayUserBit	I40audioStatusTBL.8	INTEGER	R/WO	1 (fixed)
I40audioStatusUserBit	I40audioConfigTBL.9	INTEGER	R/W	1 = ch1 2 = ch2 3 = ch3 4 = ch4 5 = ch5 6 = ch6 7 = ch7 8 = ch8 9 = ch9 10 = ch10 11 = ch11 12 = ch12 13 = ch13 14 = ch14 15 = ch15 16 = ch16 101 = A1 (A:CH1)

19. NETWORK CONTROL

MIB	OID	SYNTAX	ACCESS	VALUE/RANGE
				102 = A2 (A:CH2)
				103 = A3 (A:CH3)
				104 = A4 (A:CH4)
				105 = A5 (A:CH5)
				106 = A6 (A:CH6)
				107 = A7 (A:CH7)
				108 = A8 (A:CH8)
				109 = A9
				110 = A10
				111 = A11
				112 = A12
				113 = A13
				114 = A14
				115 = A15
				116 = A16
				201 = B1 (B:CH1)
				202 = B2 (B:CH2)
				203 = B3 (B:CH3)
				204 = B4 (B:CH4)
				205 = B5 (B:CH5)
				206 = B6 (B:CH6)
				207 = B7 (B:CH7)
				208 = B8 (B:CH8)
				209 = B9
				210 = B10
				211 = B11
				212 = B12
				213 = B13
				214 = B14
				215 = B15
				216 = B16
				301 = C1
				302 = C2
				303 = C3
				304 = C4
				305 = C5
				306 = C6
				307 = C7
				308 = C8
				309 = C9
				310 = C10
				311 = C11
				312 = C12
				313 = C13
				314 = C14
				315 = C15
				316 = C16
				401 = D1
				402 = D2
				403 = D3
				404 = D4
				405 = D5
				406 = D6
				407 = D7
				408 = D8
				409 = D9
				410 = D10
				411 = D11

19. NETWORK CONTROL

MIB	OID	SYNTAX	ACCESS	VALUE/RANGE
				412 = D12 413 = D13 414 = D14 415 = D15 416 = D16
I40audioStatusUserBitAlign	I40audioStatusTBL.10	INTEGER	R/W	1 = lsb 2 = msb
I40audioStatusErrorReset	I40audioStatusTBL.11	INTEGER	R/WO	1 (fixed)
I40audioPhonesVolume	I40audioTBL.6	INTEGER	R/W	0 to 63
I40audioDataTBL	I40audioTBL.7	Aggregate	-	-
I40audioDataStatusLevelCh1	I40audioDataTBL.1	DisplayString	R/O	Ch1 Level
I40audioDataStatusLevelCh2	I40audioDataTBL.2	DisplayString	R/O	Ch2 Level
I40audioDataStatusLevelCh3	I40audioDataTBL.3	DisplayString	R/O	Ch3 Level
I40audioDataStatusLevelCh4	I40audioDataTBL.4	DisplayString	R/O	Ch4 Level
I40audioDataStatusLevelCh5	I40audioDataTBL.5	DisplayString	R/O	Ch5 Level
I40audioDataStatusLevelCh6	I40audioDataTBL.6	DisplayString	R/O	Ch6 Level
I40audioDataStatusLevelCh7	I40audioDataTBL.7	DisplayString	R/O	Ch7 Level
I40audioDataStatusLevelCh8	I40audioDataTBL.8	DisplayString	R/O	Ch8 Level

• I40trapTBL(9) group

MIB	OID	SYNTAX	ACCESS	VALUE/RANGE
I40trapIpTBL	I40trapTBL.1	Aggregate	-	-
I40trapIp1TBL	I40trapIpTBL.1	Aggregate	-	-
I40trapManagerIp1	I40trapIp1TBL.1	IpAddress	R/W	IP Address
I40trapManagerIp1Act	I40trapIp1TBL.2	INTEGER	R/W	1 = enable 2 = disable
I40trapIp2TBL	I40trapIpTBL.2	Aggregate	-	-
I40trapManagerIp2	I40trapIp2TBL.1	IpAddress	R/W	IP Address
I40trapManagerIp2Act	I40trapIp2TBL.2	INTEGER	R/W	1 = enable 2 = disable
I40trapIp3TBL	I40trapIpTBL.3	Aggregate	-	-
I40trapManagerIp3	I40trapIp3TBL.1	IpAddress	R/W	IP Address
I40trapManagerIp3Act	I40trapIp3TBL.2	INTEGER	R/W	1 = enable 2 = disable
I40trapIp4TBL	I40trapIpTBL.4	Aggregate	-	-
I40trapManagerIp4	I40trapIp4TBL.1	IpAddress	R/W	IP Address
I40trapManagerIp4Act	I40trapIp4TBL.2	INTEGER	R/W	1 = enable 2 = disable

19.5.5 Extended TRAP (Variable Binding List)

- index 1
 - OID: iso(1).org(3).dod(6).internet(1).mgmt(2).mib-2(1).system(1).sysUpTime(3).0
 - Syntax: TimeTicks
 - Range: 1 to 4294967295 (overflow occurs if this range is exceeded)
 - Description: Elapsed time after starting the agent
- index 2
 - OID: iso(1).org(3).dod(6).internet(1).snmpV2(6).snmpModules(3).snmpMIB(1).snmpMIBObjects(1).snmpTrap(4).snmpTrapOID(1).0
 - Syntax: OBJECT IDENTIFIER
 - Range: ---
 - Description: Trap OID
- index 3
 - OID: leader(20111).lv5300(40).lv5300ST1(1).l40notificationTBL(0).l40trapStrTBL(2).l40trapCounter(1)
 - Syntax: Counter32
 - Range: 1 to 4294967295
 - Description: The total number of enterprise traps sent after starting up
- index 4
 - OID: leader(20111).lv5300(40).lv5300ST1(1).l40notificationTBL(0).l40trapStrTBL(2).l40trapInternalTimestamp(2)
 - Syntax: DisplayString
 - Range: Up to 20 characters
 - Description: Date and time of error occurrence
- index 5
 - OID: leader(20111).lv5300(40).lv5300ST1(1).l40notificationTBL(0).l40trapStrTBL(2).l40trapInputCh(3)
 - Syntax: INTEGER
 - Range: a(1), b(2), c(3), d(4)
 - Description: Input channel where the error occurred (A/B/C/D)
- index 6
 - OID: leader(20111).lv5300(40).lv5300ST1(1).l40notificationTBL(0).l40trapStrTBL(2).l40trapInputSignal(4)
 - Syntax: DisplayString
 - Range: Up to 20 characters
 - Description: Format information

19. NETWORK CONTROL

- index 7

OID: leader(20111).lv5300(40).lv5300ST1(1).l40notificationTBL(0).
l40trapContentTBL(1).l40trapErrorTBL(1).X

or

leader(20111).lv5300(40).lv5300ST1(1).l40notificationTBL(0).
l40trapContentTBL(1).l40trapNormalTBL(2).X

Syntax: DisplayString

Range: Up to 16 characters

Description: OID indicating the error and error information character string (see the table below)

When an error occurs, OID and error information character string of l40notificationTBL(0).l40trapContentTBL(1).l40trapErrorTBL(1).X (see the table below)

When an error recovers, OID and error information character string of l40notificationTBL(0).l40trapContentTBL(1). l40trapNormalTBL(2).X (see the table below)

- index 8

OID: leader(20111).lv5300(40).lv5300ST1(1).l40notificationTBL(0).
l40trapStrTBL(2).l40trapCableLen(5)

Syntax: INTEGER

Range: 1 to 32767

Description: Cable length

Output only when index7 is l40trapContentTBL(1).l40TrapErrorTBL(1).
l40trapErrorCableWarn(5).

19. NETWORK CONTROL

• I40notificationTBL(0) group

MIB	OID	SYNTAX	ACCESS	VALUE/RANGE
I40trapContentTBL	I40notificationTBL.1		-	-
I40trapErrorTBL	I40trapContentTBL.1	Aggregate	-	-
I40trapErrorFan	I40TrapErrorTBL.1	-	-	FAN_STOP
I40trapErrorNoSignal	I40TrapErrorTBL.2	-	-	NO_SIGNAL
I40trapErrorUnknown	I40TrapErrorTBL.3	-	-	FORMAT_UNKNOWN
I40trapErrorNTP	I40TrapErrorTBL.5	-	-	NTP_ERROR
I40trapErrorSdiCrc	I40TrapErrorTBL.20	-	-	CRC
I40trapErrorSdiEdh	I40TrapErrorTBL.21	-	-	EDH
I40trapErrorSdiTrsPosition	I40TrapErrorTBL.22	-	-	TRS_POSITION
I40trapErrorSdiTrsCode	I40TrapErrorTBL.23	-	-	TRS_CODE
I40trapErrorSdiIllegalCode	I40TrapErrorTBL.24	-	-	ILLEGAL_CODE
I40trapErrorSdiLineNumber	I40TrapErrorTBL.25	-	-	LINE_NUMBER
I40trapErrorCableError	I40TrapErrorTBL.26	-	-	CABLE_ERROR
I40trapErrorCableWarning	I40TrapErrorTBL.27	-	-	CABLE_WARNING
I40trapErrorSdiAncChecksum	I40TrapErrorTBL.28	-	-	CHECK_SUM
I40trapErrorSdiAncParity	I40TrapErrorTBL.29	-	-	PARITY
I40trapErrorSdiGamut	I40TrapErrorTBL.30	-	-	GAMUT
I40trapErrorSdiGamutSt2	I40TrapErrorTBL.31	-	-	GAMUT_ST2
I40trapErrorSdiCompGamut	I40TrapErrorTBL.32	-	-	CMP_GAMUT
I40trapErrorSdiCompGamutSt2	I40TrapErrorTBL.33	-	-	CMP_GAMUT_ST2
I40trapErrorSdiFreeze	I40TrapErrorTBL.34	-	-	FREEZE
I40trapErrorSdiFreezeSt2	I40TrapErrorTBL.35	-	-	FREEZE_ST2
I40trapErrorSdiBlack	I40TrapErrorTBL.36	-	-	BLACK
I40trapErrorSdiBlackSt2	I40TrapErrorTBL.37	-	-	BLACK_ST2
I40trapErrorSdiLevelY	I40TrapErrorTBL.38	-	-	LEVEL_Y
I40trapErrorSdiLevelYSt2	I40TrapErrorTBL.39	-	-	LEVEL_Y_ST2
I40trapErrorSdiLevelC	I40TrapErrorTBL.40	-	-	LEVEL_C
I40trapErrorSdiLevelCSt2	I40TrapErrorTBL.41	-	-	LEVEL_C_ST2
I40trapErrorSdiAudioBch	I40TrapErrorTBL.42	-	-	AUDIO_BCH
I40trapErrorSdiAudioParity	I40TrapErrorTBL.43	-	-	AUDIO_PARITY
I40trapErrorSdiAudioDbn	I40TrapErrorTBL.44	-	-	AUDIO_DBN
I40trapErrorSdiAudioInhibit	I40TrapErrorTBL.45	-	-	AUDIO_INHIBIT
I40trapErrorSdiAudioSample	I40TrapErrorTBL.46	-	-	AUDIO_SAMPLE
I40trapErrorSdiFrequency	I40TrapErrorTBL.47	-	-	FREQUENCY
I40trapErrorSdiFormatAlarm	I40TrapErrorTBL.48	-	-	FORMAT_ALARM
I40trapErrorEye12GCurrentJitter	I40TrapErrorTBL.60	-	-	EYE_12G_JITTER
I40trapErrorEye6GCurrentJitter	I40TrapErrorTBL.61	-	-	EYE_6G_JITTER
I40trapErrorEye3GCurrentJitter	I40TrapErrorTBL.62	-	-	EYE_3G_JITTER
I40trapErrorEyeHdCurrentJitter	I40TrapErrorTBL.63	-	-	EYE_HD_JITTER
I40trapErrorEyeSdCurrentJitter	I40TrapErrorTBL.64	-	-	EYE_SD_JITTER
I40trapErrorEye12GTimingJitter	I40TrapErrorTBL.65	-	-	EYE_12G_T_JITTER
I40trapErrorEye6GTimingJitter	I40TrapErrorTBL.66	-	-	EYE_6G_T_JITTER
I40trapErrorEye3GTimingJitter	I40TrapErrorTBL.67	-	-	EYE_3G_T_JITTER
I40trapErrorEyeHdTimingJitter	I40TrapErrorTBL.68	-	-	EYE_HD_T_JITTER
I40trapErrorEyeSdTimingJitter	I40TrapErrorTBL.69	-	-	EYE_SD_T_JITTER
I40trapErrorEye12GDeltaTimeTrTf	I40TrapErrorTBL.70	-	-	EYE_12G_TR_TF
I40trapErrorEye6GDeltaTimeTrTf	I40TrapErrorTBL.71	-	-	EYE_6G_TR_TF
I40trapErrorEye3GDeltaTimeTrTf	I40TrapErrorTBL.72	-	-	EYE_3G_TR_TF
I40trapErrorEyeHdDeltaTimeTrTf	I40TrapErrorTBL.73	-	-	EYE_HD_TR_TF

19. NETWORK CONTROL

MIB	OID	SYNTAX	ACCESS	VALUE/RANGE
I40trapErrorEyeSdDeltaTimeTr Tf	I40TrapErrorTBL.74	-	-	EYE_SD_TR_TF
I40trapErrorEye12GFalltime	I40TrapErrorTBL.75	-	-	EYE_12G_TF
I40trapErrorEye6GFalltime	I40TrapErrorTBL.76	-	-	EYE_6G_TF
I40trapErrorEye3GFalltime	I40TrapErrorTBL.77	-	-	EYE_3G_TF
I40trapErrorEyeHdFalltime	I40TrapErrorTBL.78	-	-	EYE_HD_TF
I40trapErrorEyeSdFalltime	I40TrapErrorTBL.79	-	-	EYE_SD_TF
I40trapErrorEye12GRisetime	I40TrapErrorTBL.80	-	-	EYE_12G_TR
I40trapErrorEye6GRisetime	I40TrapErrorTBL.81	-	-	EYE_6G_TR
I40trapErrorEye3GRisetime	I40TrapErrorTBL.82	-	-	EYE_3G_TR
I40trapErrorEyeHdRisetime	I40TrapErrorTBL.83	-	-	EYE_HD_TR
I40trapErrorEyeSdRisetime	I40TrapErrorTBL.84	-	-	EYE_SD_TR
I40trapErrorEye12GAmp	I40TrapErrorTBL.85	-	-	EYE_12G_AMP
I40trapErrorEye6GAmp	I40TrapErrorTBL.86	-	-	EYE_6G_AMP
I40trapErrorEye3GAmp	I40TrapErrorTBL.87	-	-	EYE_3G_AMP
I40trapErrorEyeHdAmp	I40TrapErrorTBL.88	-	-	EYE_HD_AMP
I40trapErrorEyeSdAmp	I40TrapErrorTBL.89	-	-	EYE_SD_AMP
I40trapErrorEye12GOverShoot Rising	I40TrapErrorTBL.90	-	-	EYE_12G_OR
I40trapErrorEye6GOverShootRising	I40TrapErrorTBL.91	-	-	EYE_6G_OR
I40trapErrorEye3GOverShootRising	I40TrapErrorTBL.92	-	-	EYE_3G_OR
I40trapErrorEyeHdOverShootRising	I40TrapErrorTBL.93	-	-	EYE_HD_OR
I40trapErrorEyeSdOverShootRising	I40TrapErrorTBL.94	-	-	EYE_SD_OR
I40trapErrorEye12GOverShoot Falling	I40TrapErrorTBL.95	-	-	EYE_12G_OF
I40trapErrorEye6GOverShootFalling	I40TrapErrorTBL.96	-	-	EYE_6G_OF
I40trapErrorEye3GOverShootFalling	I40TrapErrorTBL.97	-	-	EYE_3G_OF
I40trapErrorEyeHdOverShootFalling	I40TrapErrorTBL.98	-	-	EYE_HD_OF
I40trapErrorEyeSdOverShootFalling	I40TrapErrorTBL.99	-	-	EYE_SD_OF
I40trapErrorSdiLevelYUp	I40TrapErrorTBL.100	-	-	LEVEL_Y_UP
I40trapErrorSdiLevelYLo	I40TrapErrorTBL.101	-	-	LEVEL_Y_LO
I40trapErrorSdiGamutRUp	I40TrapErrorTBL.102	-	-	GAMUT_R_UP
I40trapErrorSdiGamutRLo	I40TrapErrorTBL.103	-	-	GAMUT_R_LO
I40trapErrorSdiGamutGUp	I40TrapErrorTBL.104	-	-	GAMUT_G_UP
I40trapErrorSdiGamutGLo	I40TrapErrorTBL.105	-	-	GAMUT_G_LO
I40trapErrorSdiGamutBUp	I40TrapErrorTBL.106	-	-	GAMUT_B_UP
I40trapErrorSdiGamutBLo	I40TrapErrorTBL.107	-	-	GAMUT_B_LO
I40trapErrorSdiLevelYUpSt2	I40TrapErrorTBL.108	-	-	LEVEL_Y_UP_ST2
I40trapErrorSdiLevelYLoSt2	I40TrapErrorTBL.109	-	-	LEVEL_Y_LO_ST2
I40trapErrorSdiGamutRUpSt2	I40TrapErrorTBL.110	-	-	GAMUT_R_UP_ST2
I40trapErrorSdiGamutRLoSt2	I40TrapErrorTBL.111	-	-	GAMUT_R_LO_ST2
I40trapErrorSdiGamutGUpSt2	I40TrapErrorTBL.112	-	-	GAMUT_G_UP_ST2
I40trapErrorSdiGamutGLoSt2	I40TrapErrorTBL.113	-	-	GAMUT_G_LO_ST2
I40trapErrorSdiGamutBUpSt2	I40TrapErrorTBL.114	-	-	GAMUT_B_UP_ST2

19. NETWORK CONTROL

MIB	OID	SYNTAX	ACCESS	VALUE/RANGE
I40trapErrorSdiGamutBLoSt2	I40TrapErrorTBL.115	-	-	GAMUT_B_LO_ST2
I40trapErrorLogAudioValidity	I40TrapErrorTBL.120	-	-	VALIDITY:XX (where XX is the channel on which the error is occurring in hexadecimal notation)
I40trapErrorLogAudioCrc	I40TrapErrorTBL.121	-	-	CRC:XX (where XX is the channel on which the error is occurring in hexadecimal notation)
I40trapErrorLogAudioClip	I40TrapErrorTBL.122	-	-	CLIP:XX (where XX is the channel on which the error is occurring in hexadecimal notation)
I40trapErrorLogAudioMute	I40TrapErrorTBL.123	-	-	MUTE:XX (where XX is the channel on which the error is occurring in hexadecimal notation)
I40trapErrorLogAudioLevelOver	I40TrapErrorTBL.124	-	-	LEVEL_OV:XX (where XX is the channel on which the error is occurring in hexadecimal notation)
I40trapErrorLogAudioParity	I40TrapErrorTBL.125	-	-	PARITY:XX (where XX is the channel on which the error is occurring in hexadecimal notation)
I40trapErrorLogAudioCodeViolation	I40TrapErrorTBL.126	-	-	CODE_VIL:XX (where XX is the channel on which the error is occurring in hexadecimal notation)
I40trapNormalTBL	I40trapContentTBL.2	Aggregate	-	-
I40trapNormalDetect	I40TrapNormalTBL.4	-	-	FORMAT_DETECT
I40trapNormalSdiCrc	I40TrapNormalTBL.20	-	-	CRC
I40trapNormalSdiEdh	I40TrapNormalTBL.21	-	-	EDH
I40trapNormalSdiTrsPosition	I40TrapNormalTBL.22	-	-	TRS_POSITION
I40trapNormalSdiTrsCode	I40TrapNormalTBL.23	-	-	TRS_CODE
I40trapNormalSdiIllegalCode	I40TrapNormalTBL.24	-	-	ILLEGAL_CODE
I40trapNormalSdiLineNumber	I40TrapNormalTBL.25	-	-	LINE_NUMBER
I40trapNormalCableError	I40TrapNormalTBL.26	-	-	CABLE_ERROR
I40trapNormalCableWarning	I40TrapNormalTBL.27	-	-	CABLE_WARNING
I40trapNormalSdiAncChecksum	I40TrapNormalTBL.28	-	-	CHECK_SUM
I40trapNormalSdiAncParity	I40TrapNormalTBL.29	-	-	PARITY
I40trapNormalSdiGamut	I40TrapNormalTBL.30	-	-	GAMUT
I40trapNormalSdiGamutSt2	I40TrapNormalTBL.31	-	-	GAMUT_ST2
I40trapNormalSdiCompGamut	I40TrapNormalTBL.32	-	-	CMP_GAMUT
I40trapNormalSdiCompGamutSt2	I40TrapNormalTBL.33	-	-	CMP_GAMUT_ST2
I40trapNormalSdiFreeze	I40TrapNormalTBL.34	-	-	FREEZE
I40trapNormalSdiFreezeSt2	I40TrapNormalTBL.35	-	-	FREEZE_ST2
I40trapNormalSdiBlack	I40TrapNormalTBL.36	-	-	BLACK
I40trapNormalSdiBlackSt2	I40TrapNormalTBL.37	-	-	BLACK_ST2
I40trapNormalSdiLevelY	I40TrapNormalTBL.38	-	-	LEVEL_Y
I40trapNormalSdiLevelYSt2	I40TrapNormalTBL.39	-	-	LEVEL_Y_ST2
I40trapNormalSdiLevelC	I40TrapNormalTBL.40	-	-	LEVEL_C
I40trapNormalSdiLevelCSt2	I40TrapNormalTBL.41	-	-	LEVEL_C_ST2
I40trapNormalSdiAudioBch	I40TrapNormalTBL.42	-	-	AUDIO_BCH
I40trapNormalSdiAudioParity	I40TrapNormalTBL.43	-	-	AUDIO_PARITY

19. NETWORK CONTROL

MIB	OID	SYNTAX	ACCESS	VALUE/RANGE
I40trapNormalSdiAudioDbn	I40TrapNormalTBL.44	-	-	AUDIO_DBN
I40trapNormalSdiAudioInhibit	I40TrapNormalTBL.45	-	-	AUDIO_INHIBIT
I40trapNormalSdiAudioSample	I40TrapNormalTBL.46	-	-	AUDIO_SAMPLE
I40trapNormalSdiFrequency	I40TrapNormalTBL.47	-	-	FREQUENCY
I40trapNormalSdiFormatAlarm	I40TrapNormalTBL.48	-	-	FORMAT_ALARM
I40trapNormalEye12GCurrentJitter	I40trapNormalTBL.60	-	-	EYE_12G_JITTER
I40trapNormalEye6GCurrentJitter	I40trapNormalTBL.61	-	-	EYE_6G_JITTER
I40trapNormalEye3GCurrentJitter	I40trapNormalTBL.62	-	-	EYE_3G_JITTER
I40trapNormalEyeHdCurrentJitter	I40trapNormalTBL.63	-	-	EYE_HD_JITTER
I40trapNormalEyeSdCurrentJitter	I40trapNormalTBL.64	-	-	EYE_SD_JITTER
I40trapNormalEye12GTimingJitter	I40trapNormalTBL.65	-	-	EYE_12G_T_JITTER
I40trapNormalEye6GTimingJitter	I40trapNormalTBL.66	-	-	EYE_6G_T_JITTER
I40trapNormalEye3GTimingJitter	I40trapNormalTBL.67	-	-	EYE_3G_T_JITTER
I40trapNormalEyeHdTimingJitter	I40trapNormalTBL.68	-	-	EYE_HD_T_JITTER
I40trapNormalEyeSdTimingJitter	I40trapNormalTBL.69	-	-	EYE_SD_T_JITTER
I40trapNormalEye12GDeltaTimeTrTf	I40trapNormalTBL.70	-	-	EYE_12G_TR_TF
I40trapNormalEye6GDeltaTimeTrTf	I40trapNormalTBL.71	-	-	EYE_6G_TR_TF
I40trapNormalEye3GDeltaTimeTrTf	I40trapNormalTBL.72	-	-	EYE_3G_TR_TF
I40trapNormalEyeHdDeltaTimeTrTf	I40trapNormalTBL.73	-	-	EYE_HD_TR_TF
I40trapNormalEyeSdDeltaTimeTrTf	I40trapNormalTBL.74	-	-	EYE_SD_TR_TF
I40trapNormalEye12GFalltime	I40trapNormalTBL.75	-	-	EYE_12G_TF
I40trapNormalEye6GFalltime	I40trapNormalTBL.76	-	-	EYE_6G_TF
I40trapNormalEye3GFalltime	I40trapNormalTBL.77	-	-	EYE_3G_TF
I40trapNormalEyeHdFalltime	I40trapNormalTBL.78	-	-	EYE_HD_TF
I40trapNormalEyeSdFalltime	I40trapNormalTBL.79	-	-	EYE_SD_TF
I40trapNormalEye12GRisetime	I40trapNormalTBL.80	-	-	EYE_12G_TR
I40trapNormalEye6GRisetime	I40trapNormalTBL.81	-	-	EYE_6G_TR
I40trapNormalEye3GRisetime	I40trapNormalTBL.82	-	-	EYE_3G_TR
I40trapNormalEyeHdRisetime	I40trapNormalTBL.83	-	-	EYE_HD_TR
I40trapNormalEyeSdRisetime	I40trapNormalTBL.84	-	-	EYE_SD_TR
I40trapNormalEye12GAmp	I40trapNormalTBL.85	-	-	EYE_12G_AMP
I40trapNormalEye6GAmp	I40trapNormalTBL.86	-	-	EYE_6G_AMP
I40trapNormalEye3GAmp	I40trapNormalTBL.87	-	-	EYE_3G_AMP
I40trapNormalEyeHdAmp	I40trapNormalTBL.88	-	-	EYE_HD_AMP
I40trapNormalEyeSdAmp	I40trapNormalTBL.89	-	-	EYE_SD_AMP
I40trapNormalEye12GOverShootRising	I40trapNormalTBL.90	-	-	EYE_12G_OR
I40trapNormalEye6GOverShootRising	I40trapNormalTBL.91	-	-	EYE_6G_OR
I40trapNormalEye3GOverShootRising	I40trapNormalTBL.92	-	-	EYE_3G_OR
I40trapNormalEyeHdOverShootRising	I40trapNormalTBL.93	-	-	EYE_HD_OR

19. NETWORK CONTROL

MIB	OID	SYNTAX	ACCESS	VALUE/RANGE
Rising				
I40trapNormalEyeSdOverShoot Rising	I40trapNormalTBL.94	-	-	EYE_SD_OR
I40trapNormalEye12GOverSho otFalling	I40trapNormalTBL.95	-	-	EYE_12G_OF
I40trapNormalEye6GOverShoot Falling	I40trapNormalTBL.96	-	-	EYE_6G_OF
I40trapNormalEye3GOverShoot Falling	I40trapNormalTBL.97	-	-	EYE_3G_OF
I40trapNormalEyeHdOverShoot Falling	I40trapNormalTBL.98	-	-	EYE_HD_OF
I40trapNormalEyeSdOverShoot Falling	I40trapNormalTBL.99	-	-	EYE_SD_OF
I40trapNormalSdiLevelYUp	I40TrapNormalTBL.100	-	-	LEVEL_Y_UP
I40trapNormalSdiLevelYLo	I40TrapNormalTBL.101	-	-	LEVEL_Y_LO
I40trapNormalSdiGamutRUp	I40TrapNormalTBL.102	-	-	GAMUT_R_UP
I40trapNormalSdiGamutRLo	I40TrapNormalTBL.103	-	-	GAMUT_R_LO
I40trapNormalSdiGamutGUp	I40TrapNormalTBL.104	-	-	GAMUT_G_UP
I40trapNormalSdiGamutGLo	I40TrapNormalTBL.105	-	-	GAMUT_G_LO
I40trapNormalSdiGamutBUp	I40TrapNormalTBL.106	-	-	GAMUT_B_UP
I40trapNormalSdiGamutBLo	I40TrapNormalTBL.107	-	-	GAMUT_B_LO
I40trapNormalSdiLevelYUpSt2	I40TrapNormalTBL.108	-	-	LEVEL_Y_UP_ST2
I40trapNormalSdiLevelYLoSt2	I40TrapNormalTBL.109	-	-	LEVEL_Y_LO_ST2
I40trapNormalSdiGamutRUpSt 2	I40TrapNormalTBL.110	-	-	GAMUT_R_UP_ST2
I40trapNormalSdiGamutRLoSt2	I40TrapNormalTBL.111	-	-	GAMUT_R_LO_ST2
I40trapNormalSdiGamutGUpSt 2	I40TrapNormalTBL.112	-	-	GAMUT_G_UP_ST2
I40trapNormalSdiGamutGLoSt 2	I40TrapNormalTBL.113	-	-	GAMUT_G_LO_ST2
I40trapNormalSdiGamutBUpSt 2	I40TrapNormalTBL.114	-	-	GAMUT_B_UP_ST2
I40trapNormalSdiGamutBLoSt2	I40TrapNormalTBL.115	-	-	GAMUT_B_LO_ST2
I40trapNormalLogAudioValidity	I40trapNormalTBL.120	-	-	VALIDITY
I40trapNormalLogAudioCrc	I40trapNormalTBL.121	-	-	CRC
I40trapNormalLogAudioClip	I40trapNormalTBL.122	-	-	CLIP
I40trapNormalLogAudioMute	I40trapNormalTBL.123	-	-	MUTE
I40trapNormalLogAudioLevelO ver	I40trapNormalTBL.124	-	-	LEVEL_OV
I40trapNormalLogAudioParity	I40trapNormalTBL.125	-	-	PARITY
I40trapNormalLogAudioCodeVi olation	I40trapNormalTBL.126	-	-	CODE_VIL
I40trapStrTBL	I40notificationTBL.2	Aggregate	-	-
I40trapCounter	I40trapStrTBL.1	INTEGER	R/O	1 to 4294967295
I40trapInternalTimestamp	I40trapStrTBL.2	DisplayString	R/O	Date and time
I40trapInputCh	I40trapStrTBL.3	INTEGER	R/O	1 = a 2 = b 3 = c 4 = d 5:no-assignment
I40trapInputSignal	I40trapStrTBL.4	DisplayString	R/O	Signal format
I40trapCableLen	I40trapStrTBL.5	INTEGER	R/O	0 to 32767

19. NETWORK CONTROL

• Trap Information Table

Trap No. (*1)	Trap Information Character String	Description	trapControl		Type	"NO_ERROR" Judgment
			Error	Normal		
1	FAN_STOP	Fan stop status detection	Y	N	Notification	N
2	NO_SIGNAL	No input signal detection	Y	N	Notification	N
3	FORMAT_UNKNOWN	Unknown signal format detection	Y	N	Notification	N
4	FORMAT_DETECT	Unprocessable signal format detection	N	Y	Notification	N
5	NTP_ERROR	NTP connection status detection	Y	N	Notification	N
20	CRC	CRC error detection	Y	Y	Status monitoring	Y
21	EDH	EDH error detection	Y	Y	Status monitoring	Y
22	TRS_POSITION	TRS Pos error detection	Y	Y	Status monitoring	Y
23	TRS_CODE	TRS Code error detection	Y	Y	Status monitoring	Y
24	ILLEGAL_CODE	Illegal command error detection	Y	Y	Status monitoring	Y
25	LINE_NUMBER	Line number error detection	Y	Y	Status monitoring	Y
26	CABLE_ERROR	Cable length measurement error detection	Y	Y	Status monitoring	Y
27	CABLE_WARNING	Cable length measurement warning detection	Y	Y	Status monitoring	Y
28	CHECK_SUM	Checksum error detection	Y	Y	Status monitoring	Y
29	PARITY	Parity error detection	Y	Y	Status monitoring	Y
30	GAMUT	Gamut error detection	Y	Y	Status monitoring	Y
31	GAMUT_ST2	Gamut error detection (stream2)	Y	Y	Status monitoring	Y
32	CMP_GAMUT	Composite gamut error detection	Y	Y	Status monitoring	Y
33	CMP_GAMUT_ST2	Composite gamut error detection (stream2)	Y	Y	Status monitoring	Y
34	FREEZE	Freeze error detection	Y	Y	Status monitoring	Y
35	FREEZE_ST2	Freeze error detection (stream2)	Y	Y	Status monitoring	Y
36	BLACK	Black error detection	Y	Y	Status monitoring	Y
37	BLACK_ST2	Black error detection (stream2)	Y	Y	Status monitoring	Y
38	LEVEL_Y	Luminance level error detection	Y	Y	Status monitoring	Y
39	LEVEL_Y_ST2	Luminance level error detection (stream2)	Y	Y	Status monitoring	Y
40	LEVEL_C	Chrominance level error detection	Y	Y	Status monitoring	Y
41	LEVEL_C_ST2	Chrominance level error detection (stream2)	Y	Y	Status monitoring	Y
42	AUDIO_BCH	(EMB AUDIO) BCH error detection	Y	Y	Status monitoring	Y
43	AUDIO_PARITY	(EMB AUDIO) PARITY error detection	Y	Y	Status monitoring	Y

19. NETWORK CONTROL

Trap No. (*1)	Trap Information Character String	Description	trapControl		Type	"NO_ERROR" Judgment
			Error	Normal		
44	AUDIO_DBN	(EMB AUDIO) DBN error detection	Y	Y	Status monitoring	Y
45	AUDIO_INHIBIT	(EMB AUDIO) INH error detection	Y	Y	Status monitoring	Y
46	AUDIO_SAMPLE	(EMB AUDIO) SAMPLE error detection	Y	Y	Status monitoring	Y
47	FREQUENCY	FREQUENCY error detection	Y	Y	Status monitoring	Y
48	FORMAT_ALARM	Format alarm detection	Y	Y	Status monitoring	Y
60	EYE_12G_JITTER	(EYE) Current jitter error detection 12G	Y	Y	Status monitoring	Y
61	EYE_6G_JITTER	(EYE) Current jitter error detection 6G	Y	Y	Status monitoring	Y
62	EYE_3G_JITTER	(EYE) Current jitter error detection 3G	Y	Y	Status monitoring	Y
63	EYE_HD_JITTER	(EYE) Current jitter error detection HD	Y	Y	Status monitoring	Y
64	EYE_SD_JITTER	(EYE) Current jitter error detection SD	Y	Y	Status monitoring	Y
65	EYE_12G_T_JITTER	(EYE) Timing jitter error detection 12G	Y	Y	Status monitoring	Y
66	EYE_6G_T_JITTER	(EYE) Timing jitter error detection 6G	Y	Y	Status monitoring	Y
67	EYE_3G_T_JITTER	(EYE) Timing jitter error detection 3G	Y	Y	Status monitoring	Y
68	EYE_HD_T_JITTER	(EYE) Timing jitter error detection HD	Y	Y	Status monitoring	Y
69	EYE_SD_T_JITTER	(EYE) Timing jitter error detection SD	Y	Y	Status monitoring	Y
70	EYE_12G_TR_TF	(EYE) Delta Time error detection 12G	Y	Y	Status monitoring	Y
71	EYE_6G_TR_TF	(EYE) Delta Time error detection 6G	Y	Y	Status monitoring	Y
72	EYE_3G_TR_TF	(EYE) Delta Time error detection 3G	Y	Y	Status monitoring	Y
73	EYE_HD_TR_TF	(EYE) Delta Time error detection HD	Y	Y	Status monitoring	Y
74	EYE_SD_TR_TF	(EYE) Delta Time error detection SD	Y	Y	Status monitoring	Y
75	EYE_12G_TF	(EYE) Fall Time error detection 12G	Y	Y	Status monitoring	Y
76	EYE_6G_TF	(EYE) Fall Time error detection 6G	Y	Y	Status monitoring	Y
77	EYE_3G_TF	(EYE) Fall Time error detection 3G	Y	Y	Status monitoring	Y
78	EYE_HD_TF	(EYE) Fall Time error detection HD	Y	Y	Status monitoring	Y
79	EYE_SD_TF	(EYE) Fall Time error detection SD	Y	Y	Status monitoring	Y
80	EYE_12G_TR	(EYE) Rise Time error detection 12G	Y	Y	Status monitoring	Y
81	EYE_6G_TR	(EYE) Rise Time error detection 6G	Y	Y	Status monitoring	Y
82	EYE_3G_TR	(EYE) Rise Time error detection 3G	Y	Y	Status monitoring	Y

19. NETWORK CONTROL

Trap No. (*1)	Trap Information Character String	Description	trapControl		Type	"NO_ERROR" Judgment
			Error	Normal		
83	EYE_HD_TR	(EYE) Rise Time error detection HD	Y	Y	Status monitoring	Y
84	EYE_SD_TR	(EYE) Rise Time error detection SD	Y	Y	Status monitoring	Y
85	EYE_12G_AMP	(EYE) Amplitude error detection 12G	Y	Y	Status monitoring	Y
86	EYE_6G_AMP	(EYE) Amplitude error detection 6G	Y	Y	Status monitoring	Y
87	EYE_3G_AMP	(EYE) Amplitude error detection 3G	Y	Y	Status monitoring	Y
88	EYE_HD_AMP	(EYE) Amplitude error detection HD	Y	Y	Status monitoring	Y
89	EYE_SD_AMP	(EYE) Amplitude error detection SD	Y	Y	Status monitoring	Y
90	EYE_12G_OR	(EYE) Overshoot Rising error detection 12G	Y	Y	Status monitoring	Y
91	EYE_6G_OR	(EYE) Overshoot Rising error detection 6G	Y	Y	Status monitoring	Y
92	EYE_3G_OR	(EYE) Overshoot Rising error detection 3G	Y	Y	Status monitoring	Y
93	EYE_HD_OR	(EYE) Overshoot Rising error detection HD	Y	Y	Status monitoring	Y
94	EYE_SD_OR	(EYE) Overshoot Rising error detection SD	Y	Y	Status monitoring	Y
95	EYE_12G_OF	(EYE) Overshoot Falling error detection 12G	Y	Y	Status monitoring	Y
96	EYE_6G_OF	(EYE) Overshoot Falling error detection 6G	Y	Y	Status monitoring	Y
97	EYE_3G_OF	(EYE) Overshoot Falling error detection 3G	Y	Y	Status monitoring	Y
98	EYE_HD_OF	(EYE) Overshoot Falling error detection HD	Y	Y	Status monitoring	Y
99	EYE_SD_OF	(EYE) Overshoot Falling error detection SD	Y	Y	Status monitoring	Y
100	LEVEL_Y_UP	Luminance level error detection	Y	Y	Status monitoring	Y
101	LEVEL_Y_LO	Luminance level error detection	Y	Y	Status monitoring	Y
102	GAMUT_R_UP	Gamut error R UPPER detection	Y	Y	Status monitoring	Y
103	GAMUT_R_LO	Gamut error R LOWER detection	Y	Y	Status monitoring	Y
104	GAMUT_G_UP	Gamut error G UPPER detection	Y	Y	Status monitoring	Y
105	GAMUT_G_LO	Gamut error G LOWER detection	Y	Y	Status monitoring	Y
106	GAMUT_B_UP	Gamut error B UPPER detection	Y	Y	Status monitoring	Y
107	GAMUT_B_LO	Gamut error B LOWER detection	Y	Y	Status monitoring	Y
108	LEVEL_Y_UP_ST2	Luminance level error detection (stream2)	Y	Y	Status monitoring	Y
109	LEVEL_Y_LO_ST2	Luminance level error detection (stream2)	Y	Y	Status monitoring	Y
110	GAMUT_R_UP_ST2	Gamut error R UPPER detection (stream2)	Y	Y	Status monitoring	Y

19. NETWORK CONTROL

Trap No. (*1)	Trap Information Character String	Description	trapControl		Type	"NO_ERROR" Judgment
			Error	Normal		
111	GAMUT_R_LO_ST2	Gamut error R LOWER detection (stream2)	Y	Y	Status monitoring	Y
112	GAMUT_G_UP_ST2	Gamut error G UPPER detection (stream2)	Y	Y	Status monitoring	Y
113	GAMUT_G_LO_ST2	Gamut error G LOWER detection (stream2)	Y	Y	Status monitoring	Y
114	GAMUT_B_UP_ST2	Gamut error B UPPER detection (stream2)	Y	Y	Status monitoring	Y
115	GAMUT_B_LO_ST2	Gamut error B LOWER detection (stream2)	Y	Y	Status monitoring	Y
120	VALIDITY	(AUDIO) VALIDITY error detection	Y	Y	Status monitoring	N
121	CRC	(AUDIO) CRC error detection	Y	Y	Status monitoring	N
122	CLIP	(AUDIO) CLIP error detection	Y	Y	Status monitoring	N
123	MUTE	(AUDIO) MUTE error detection	Y	Y	Status monitoring	N
124	LEVEL_OV	(AUDIO) LEVEL error detection	Y	Y	Status monitoring	N
125	PARITY	(AUDIO) PARITY error detection	Y	Y	Status monitoring	N
126	CODE_VIL	(AUDIO) CODE VIOLATION error detection	Y	Y	Status monitoring	N
1000 (*2)	NO_ERROR	No error	N	Y	-	-

*1 Each OID number of I40TrapErrorTBL(1) and I40TrapNormalTBL(2) of I40trapContentTBL(1)

*2 I40trapNormalNoError(60) is only defined for I40trapNormalTBL(2) and is not available for I40trapErrorTBL(1).

20. MENU TREE

This chapter shows the menu trees that correspond to each key.
The default settings are underlined.

The menus and default values that are displayed vary depending on the instrument's settings,
the configuration of options, and whether a USB memory device is connected to the instrument.

20.1 INPUT Menu

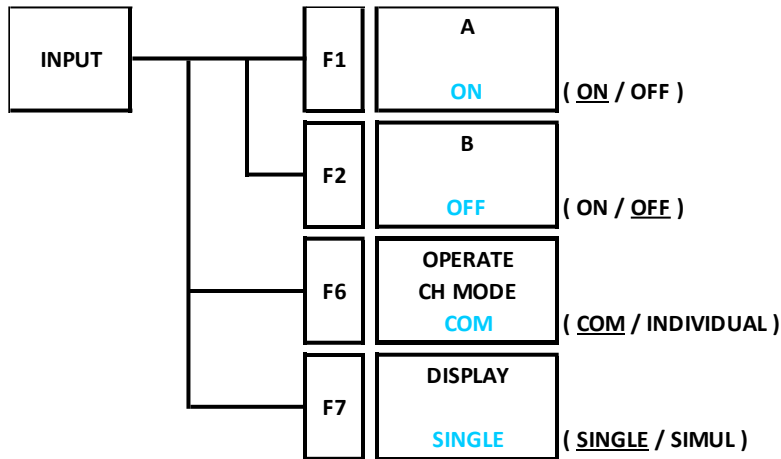

20. MENU TREE

20.2 SYS Menu

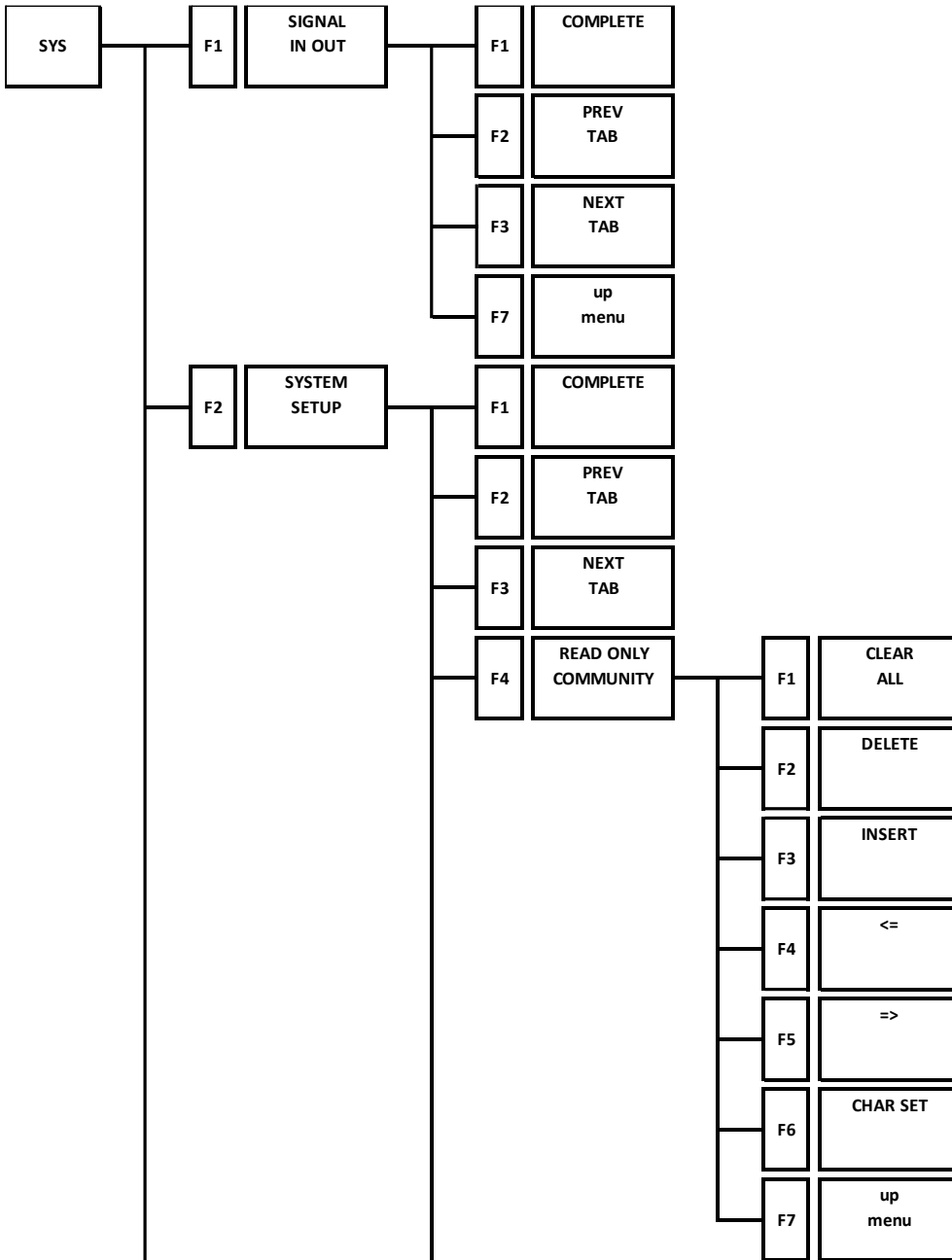

20. MENU TREE

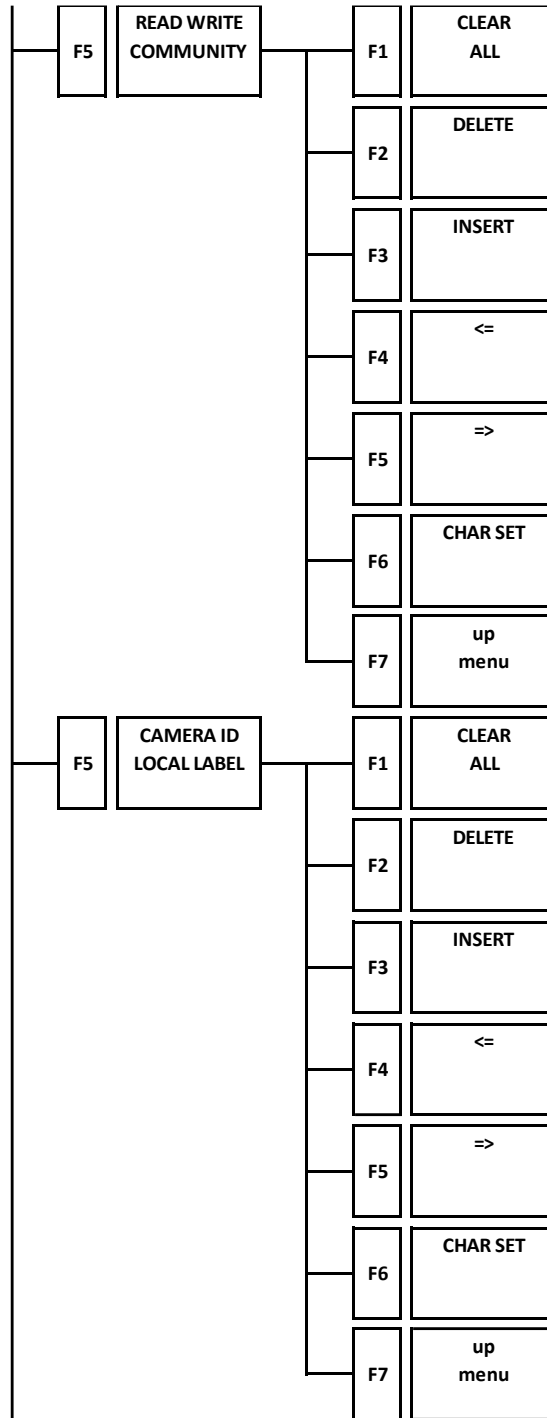

20. MENU TREE

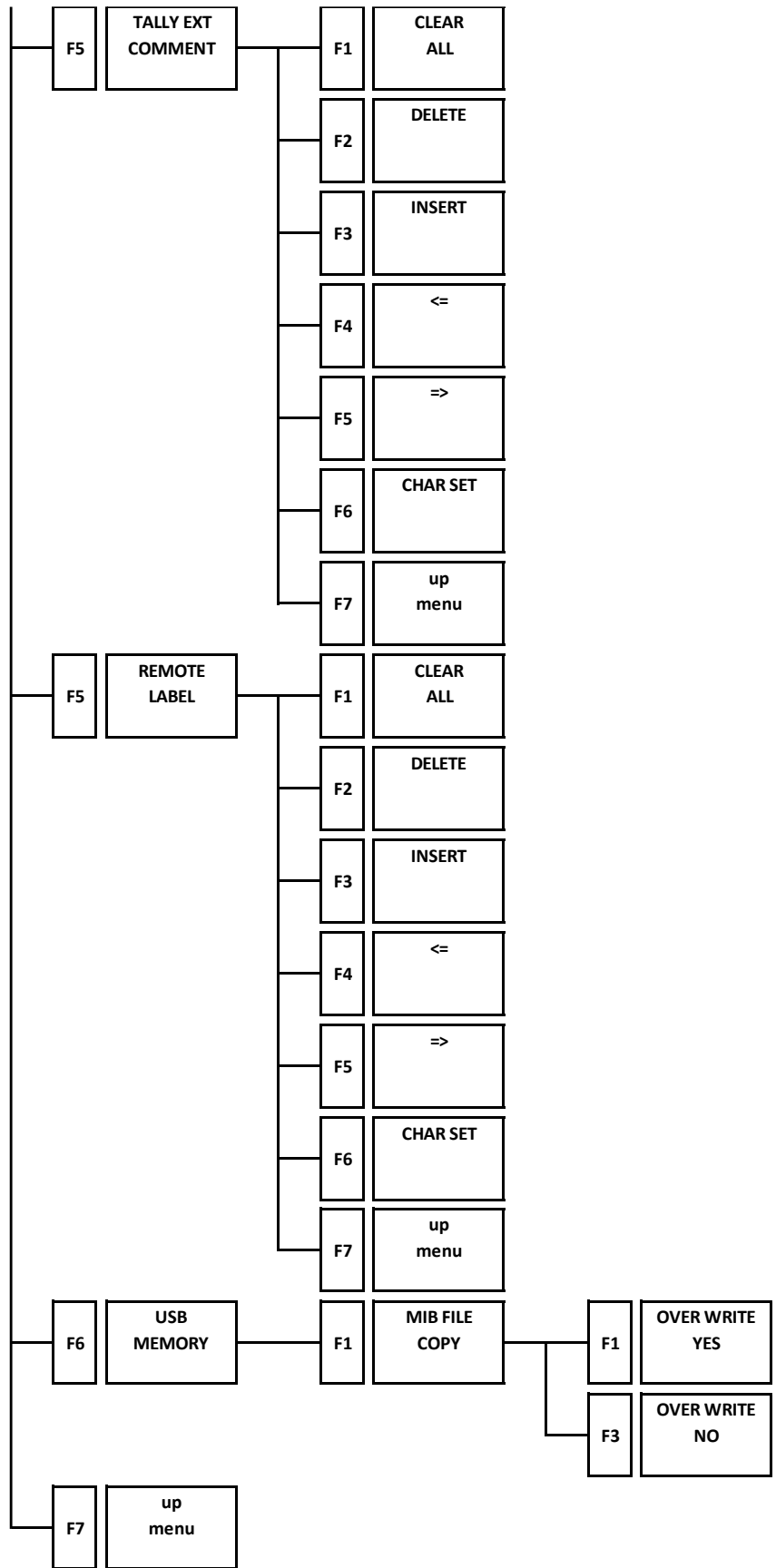

20. MENU TREE

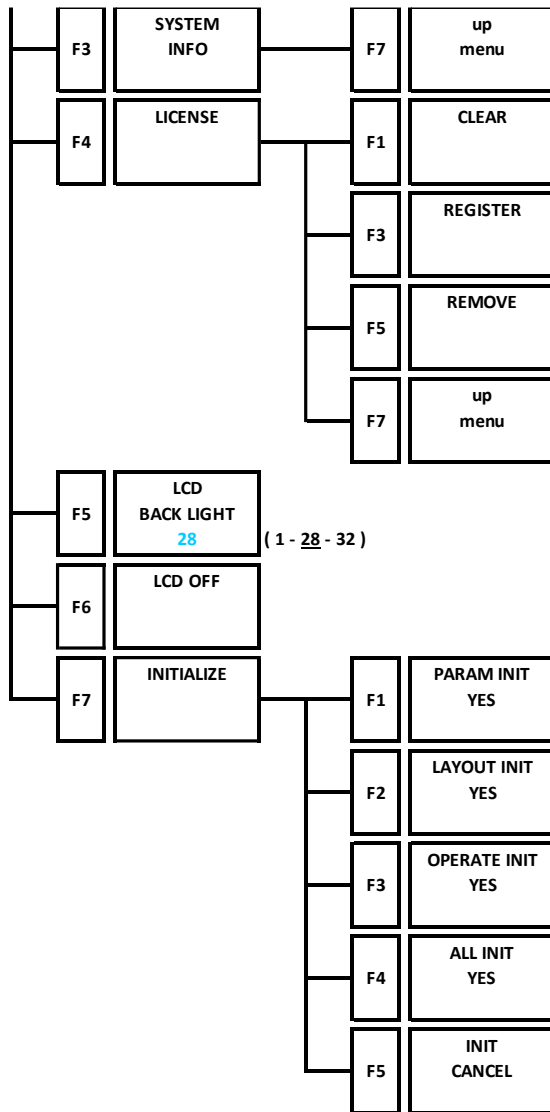

20.3 CAP Menu

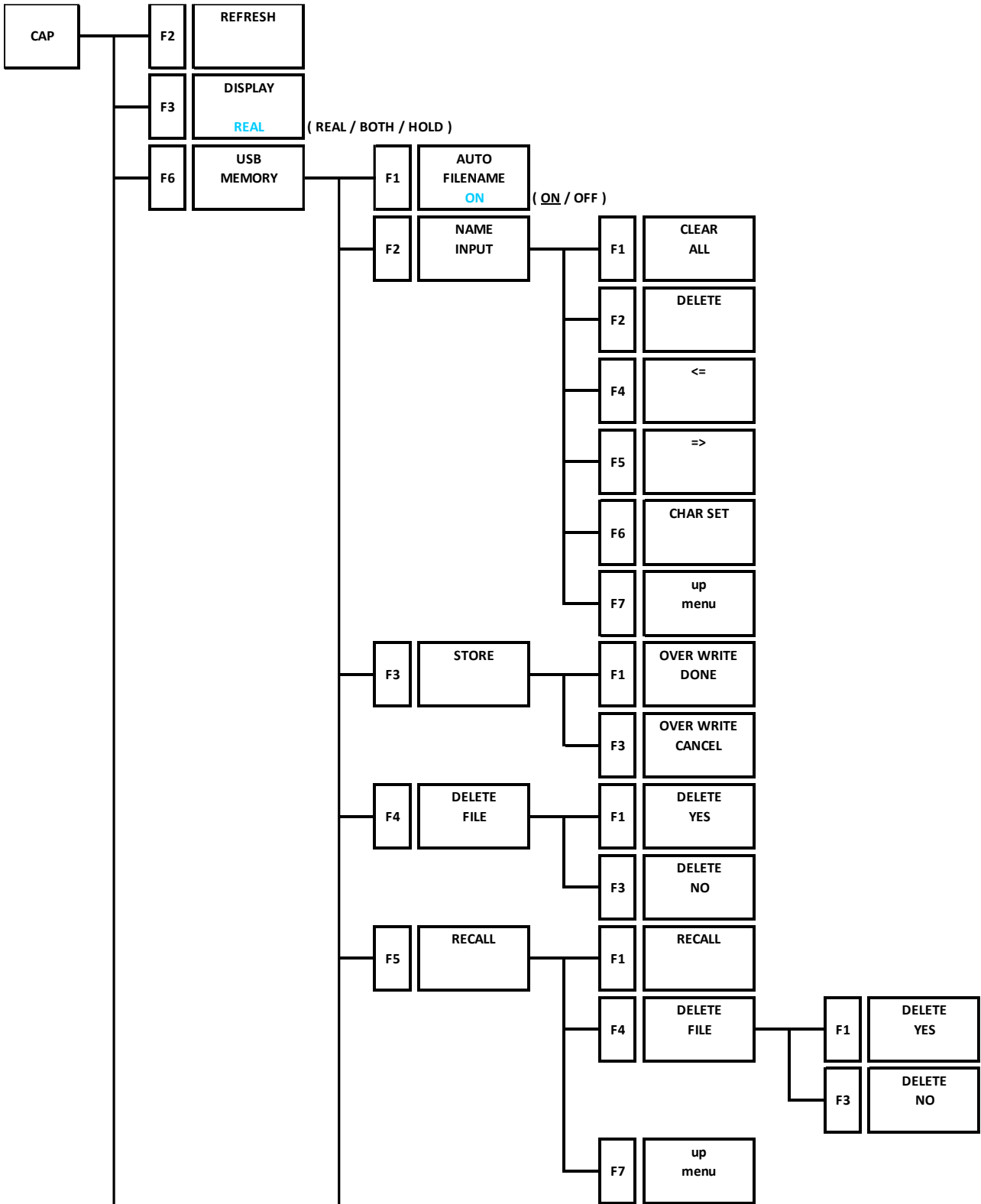

20. MENU TREE

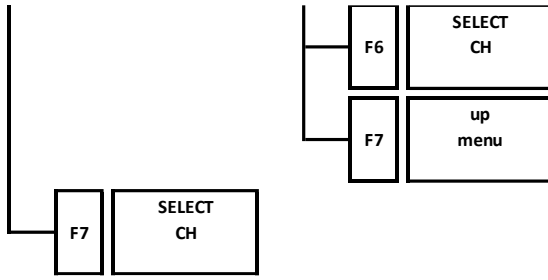

20.4 MEM Menu

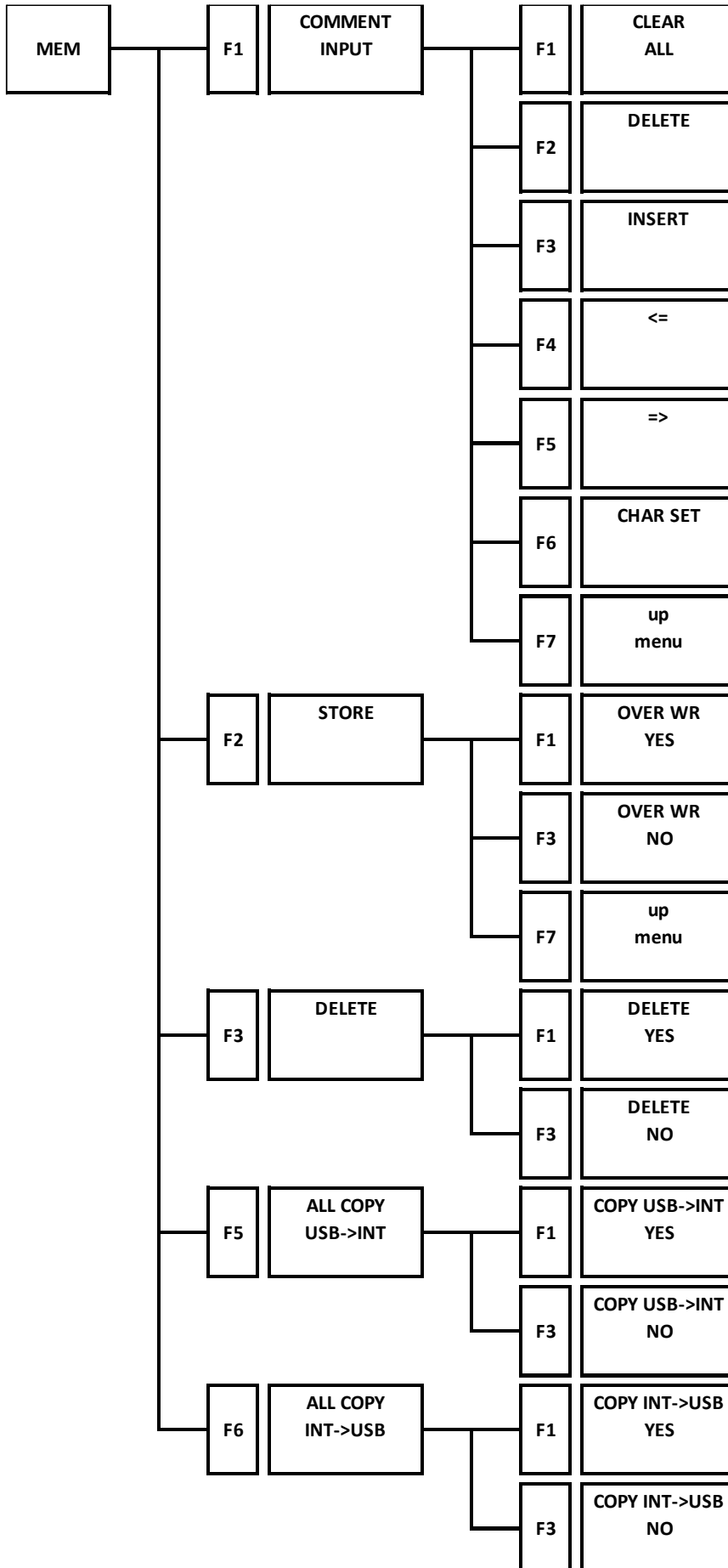

20.5 RECALL Menu

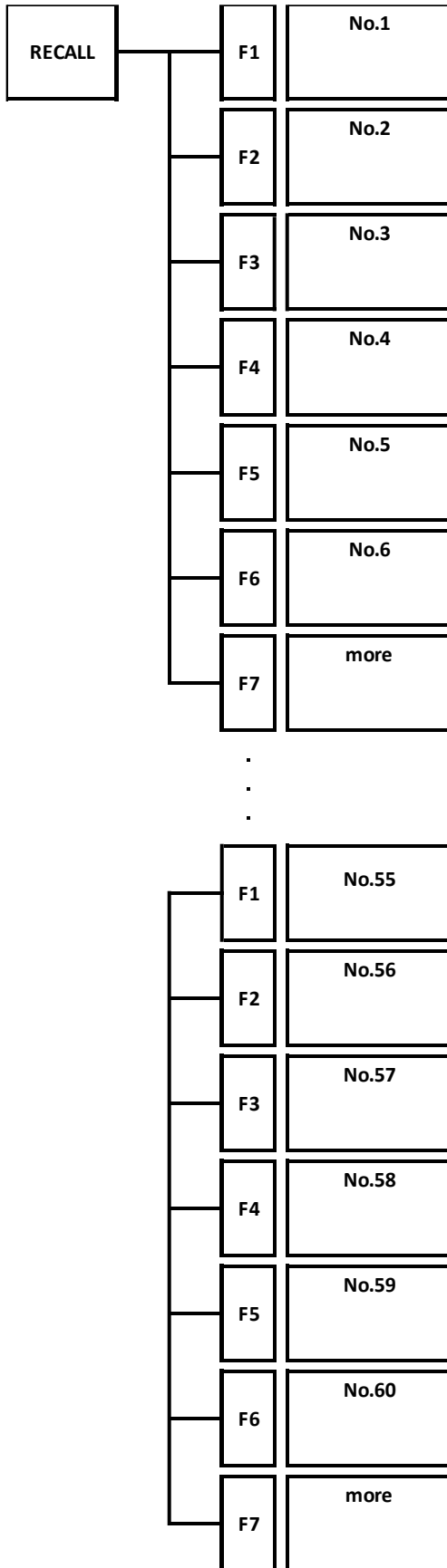

20. MENU TREE

20.6 WFM Menu

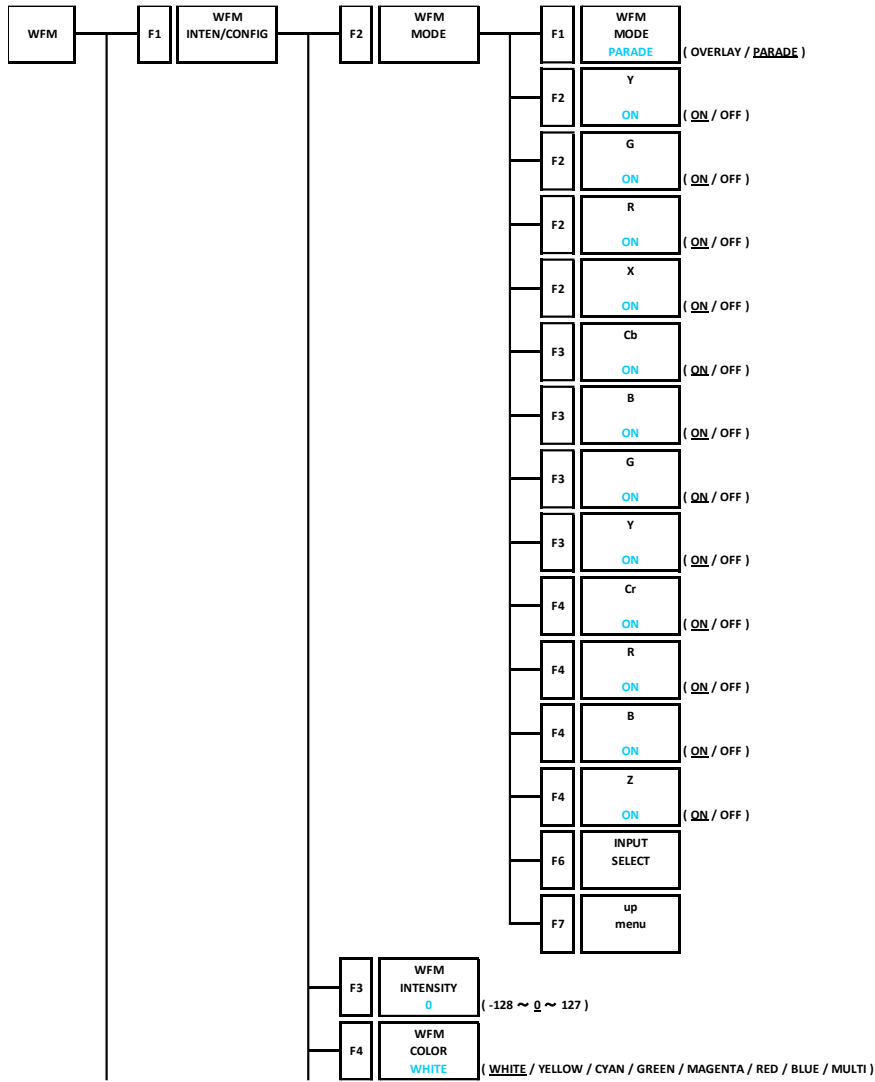

20. MENU TREE

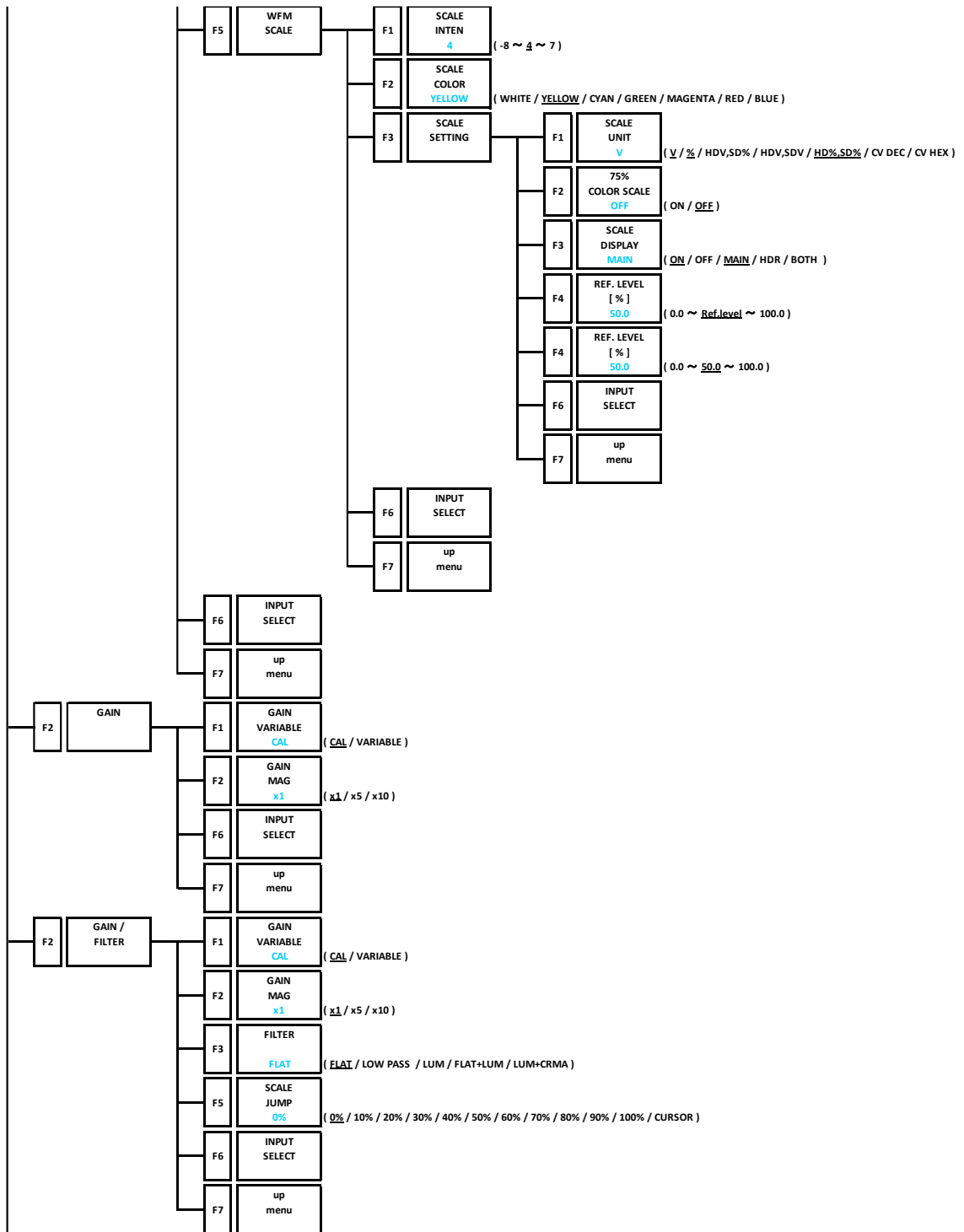

20. MENU TREE

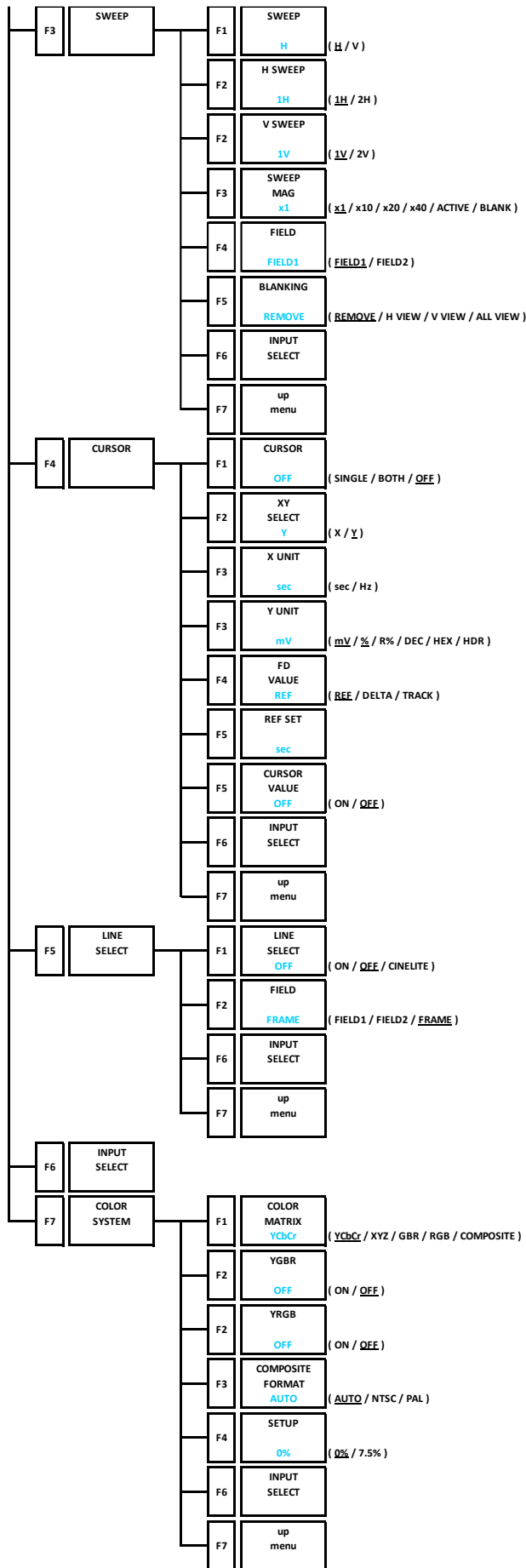

20. MENU TREE

20.7 VECT Menu

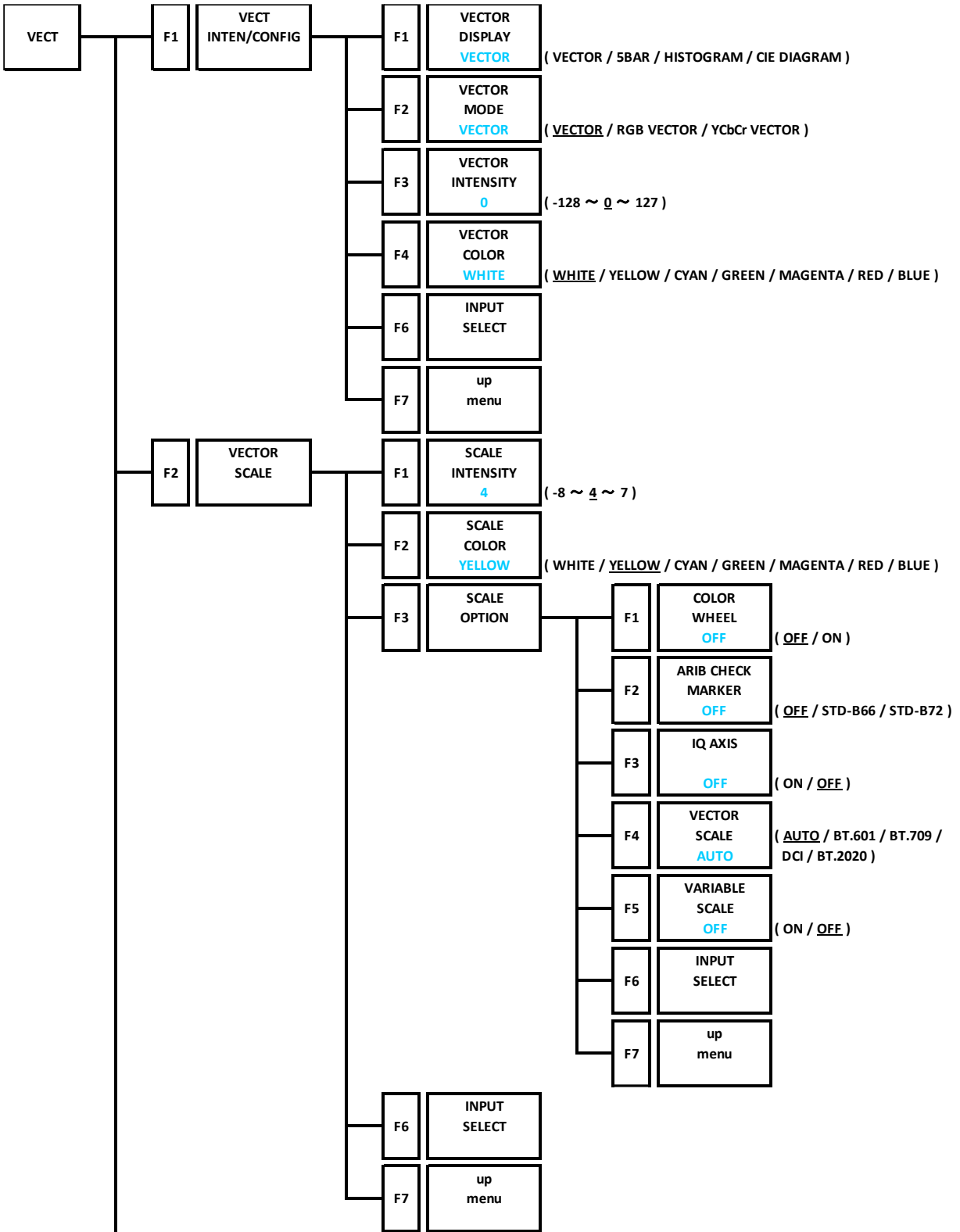

20. MENU TREE

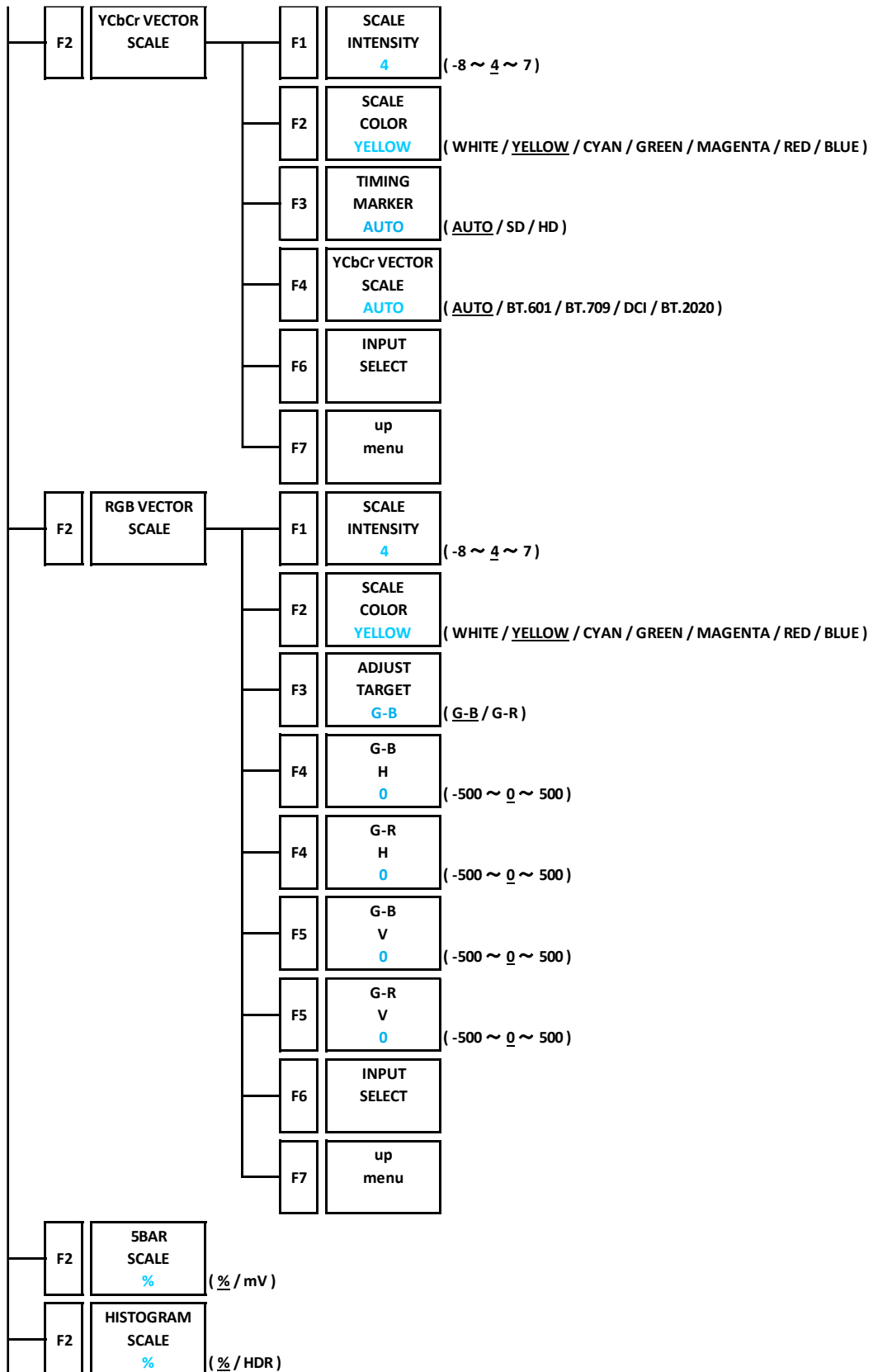

20. MENU TREE

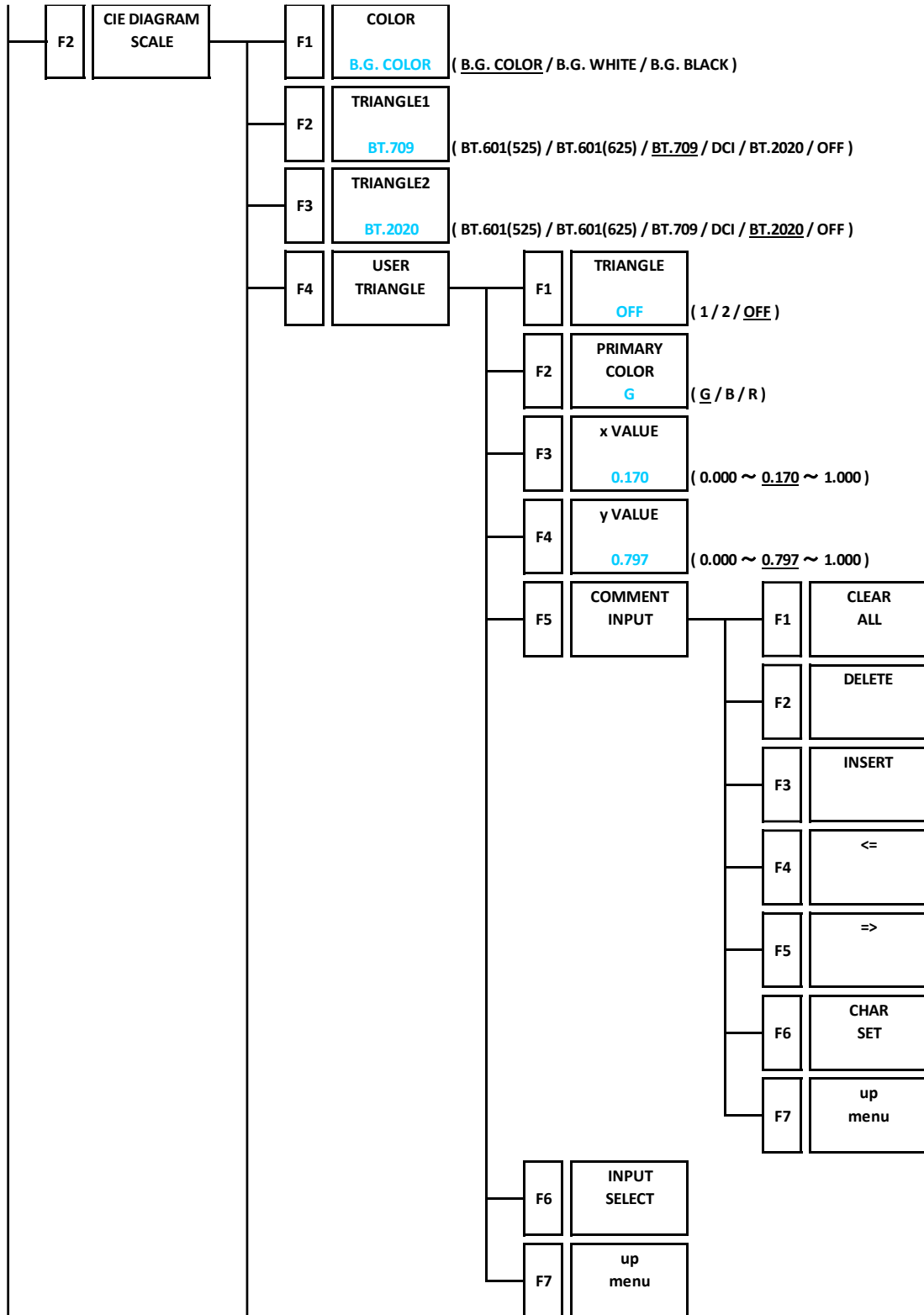

20. MENU TREE

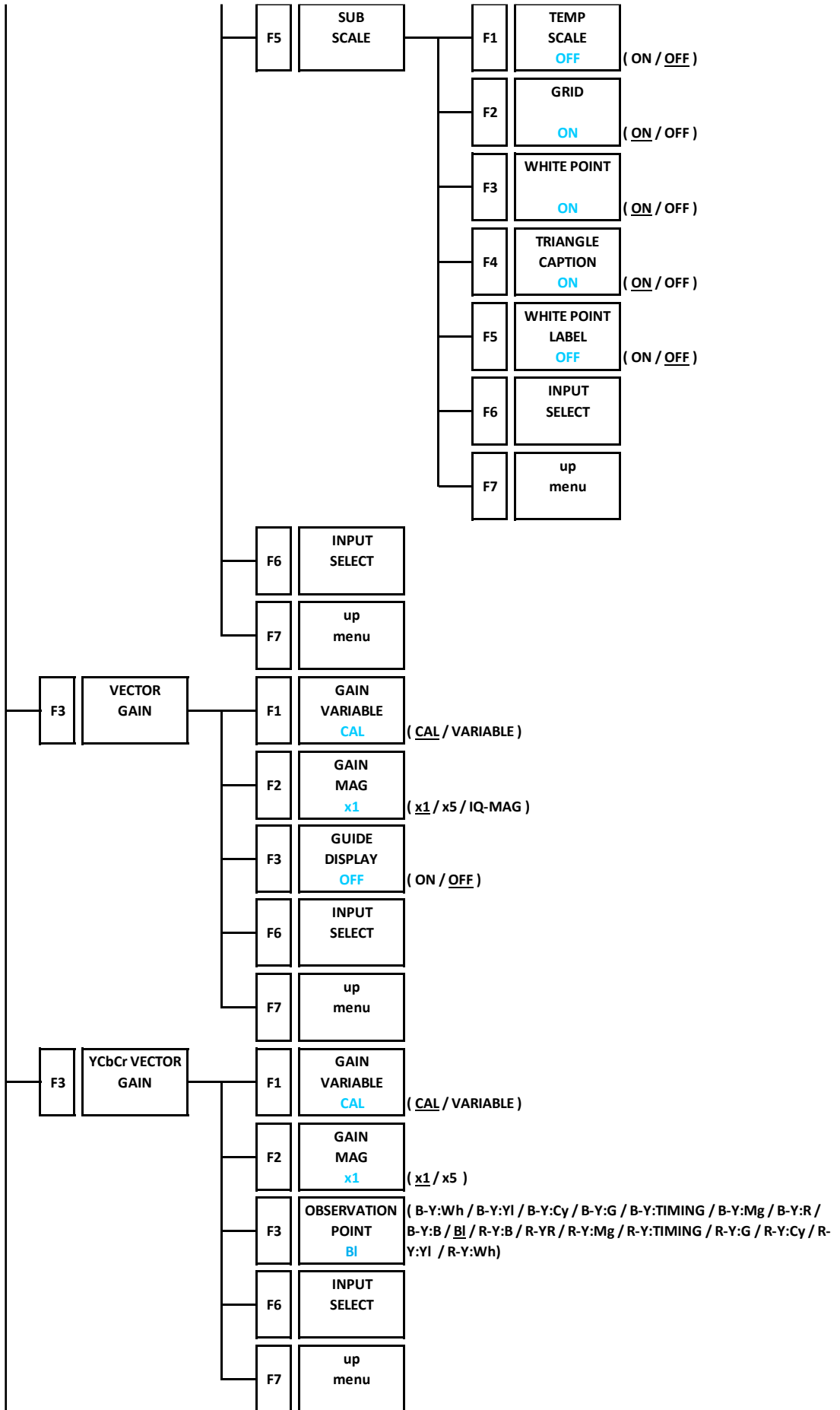

20. MENU TREE

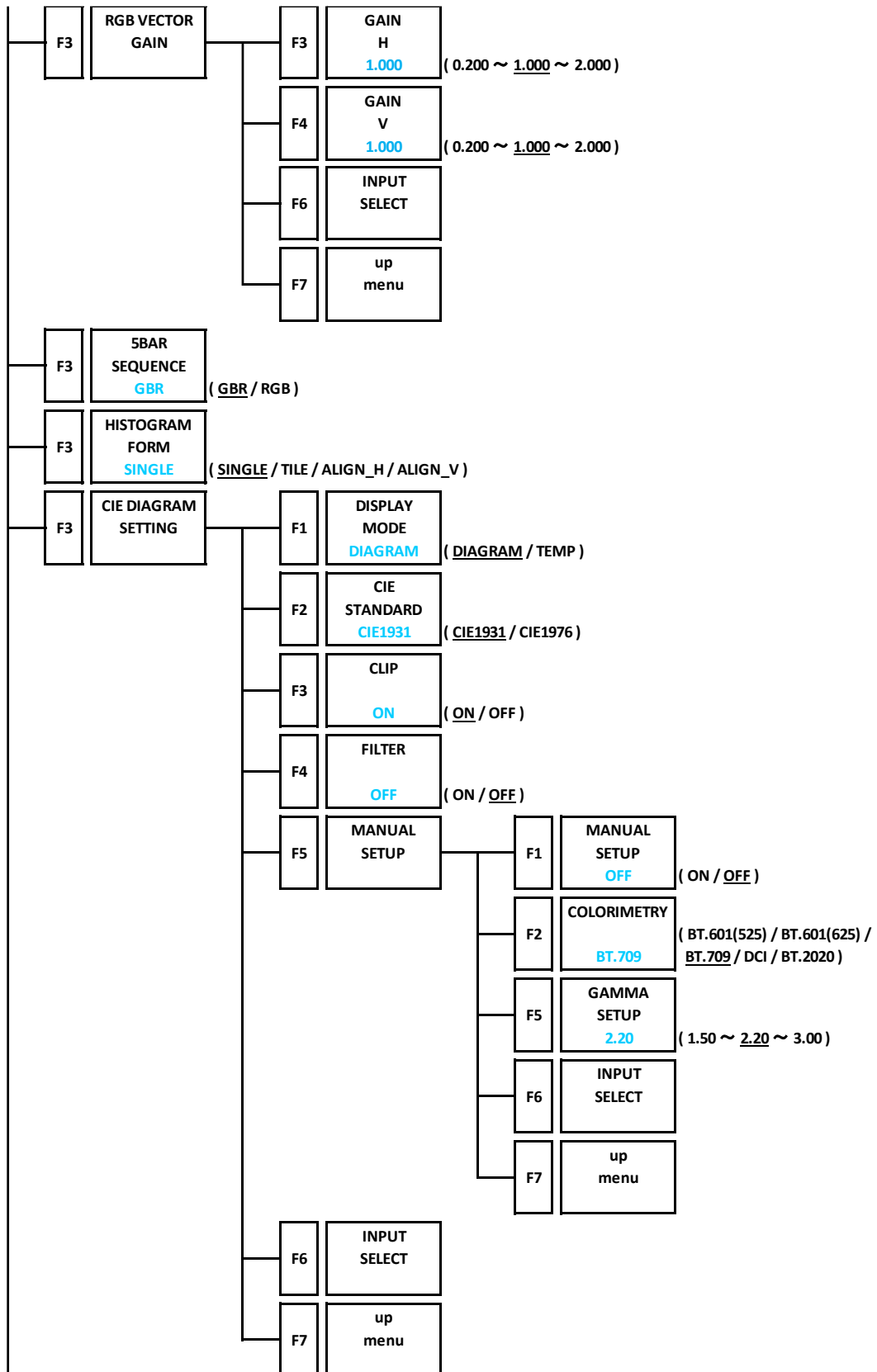

20. MENU TREE

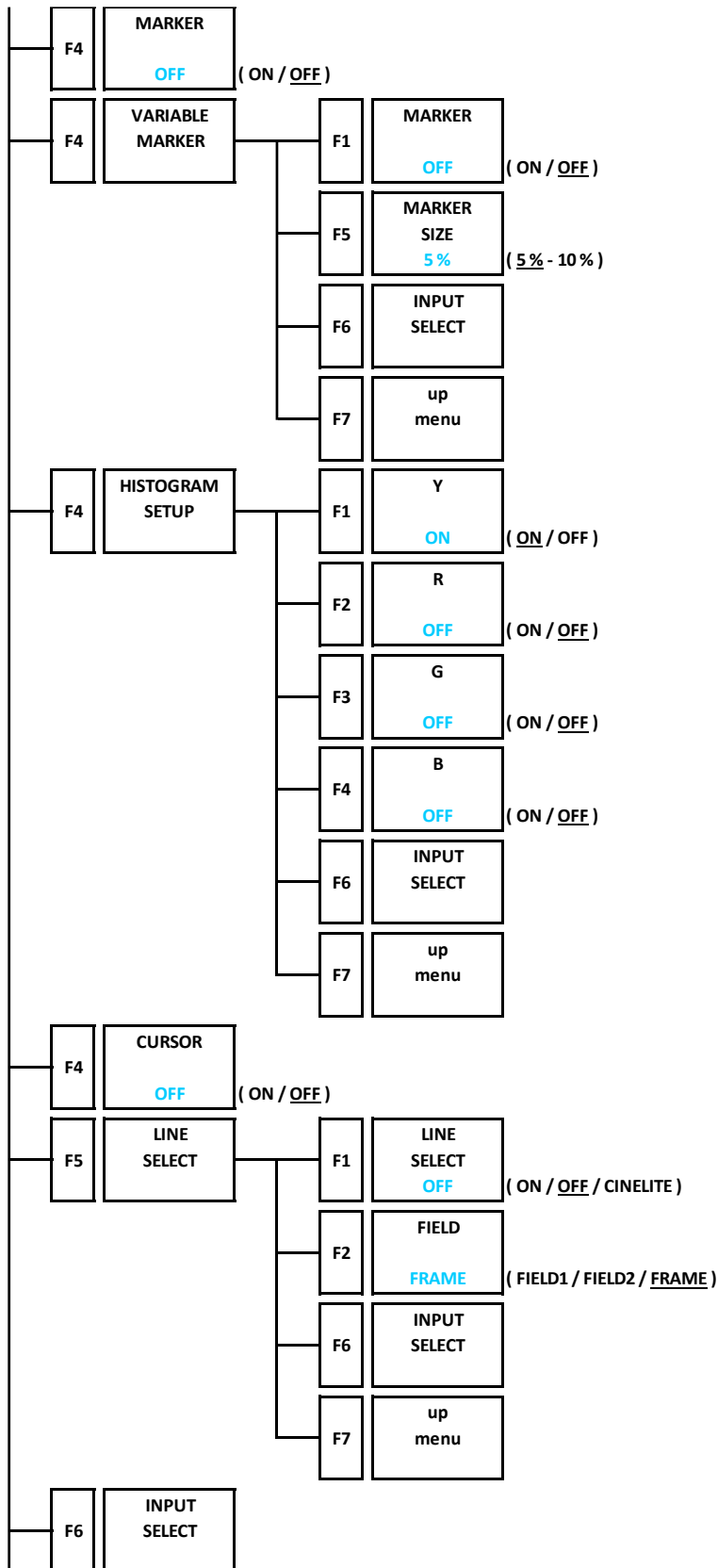

20. MENU TREE

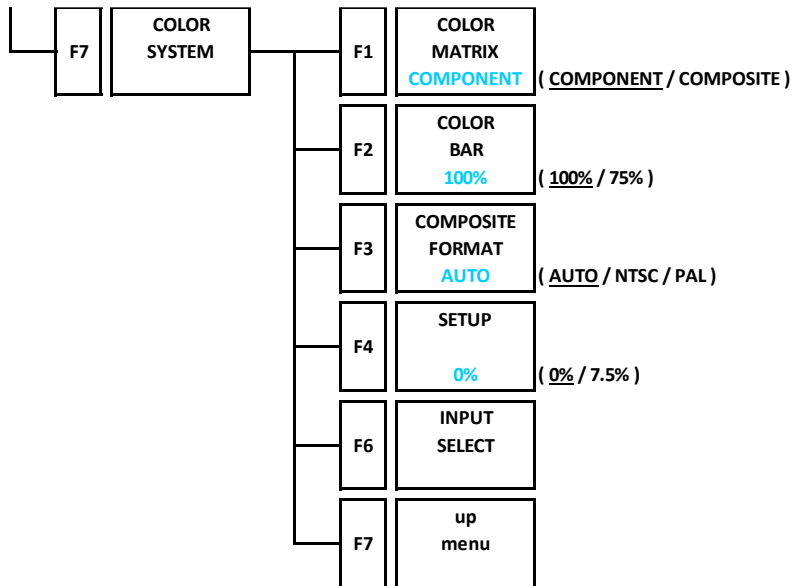

20. MENU TREE

20.8 PIC Menu

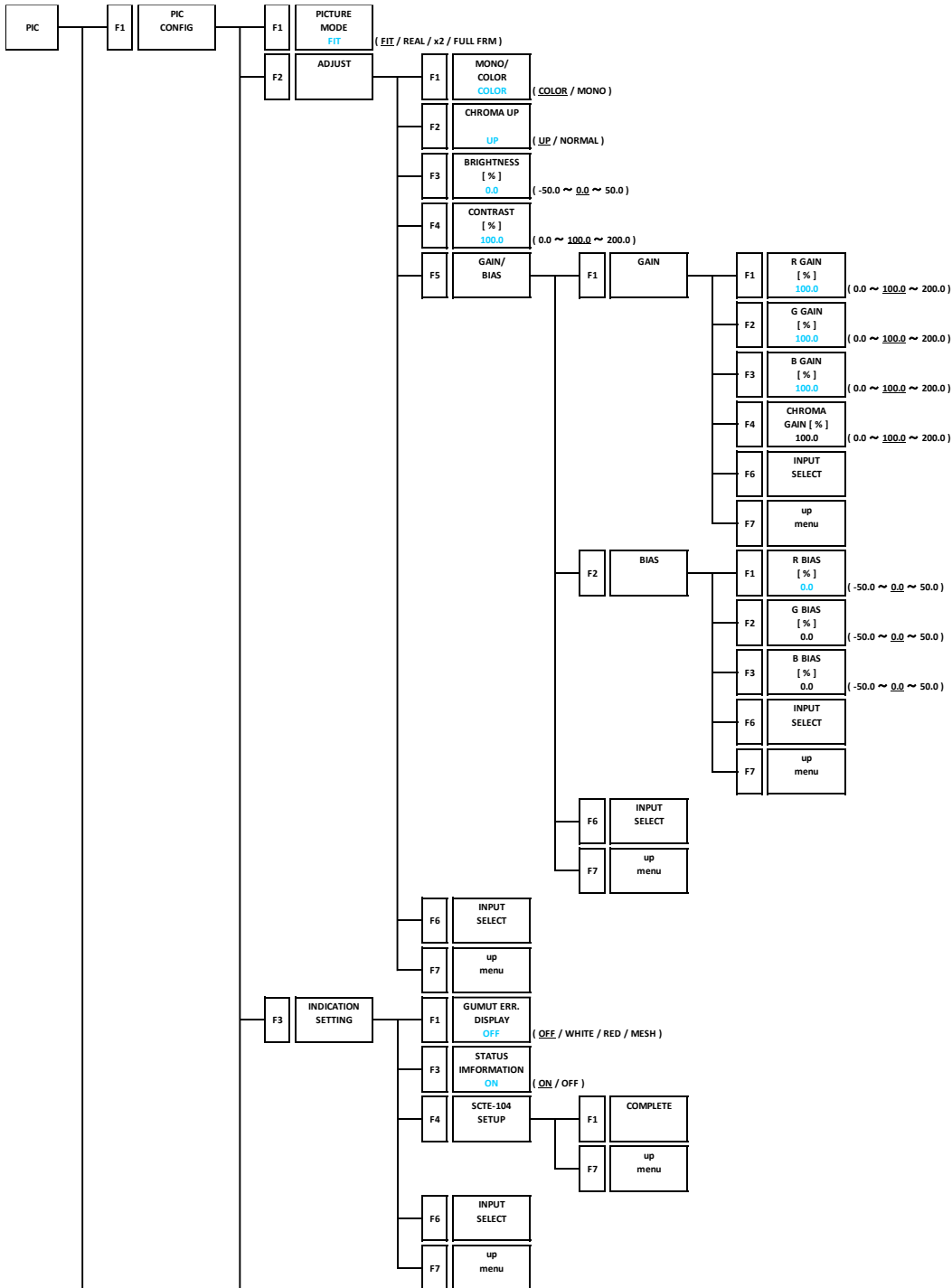

20. MENU TREE

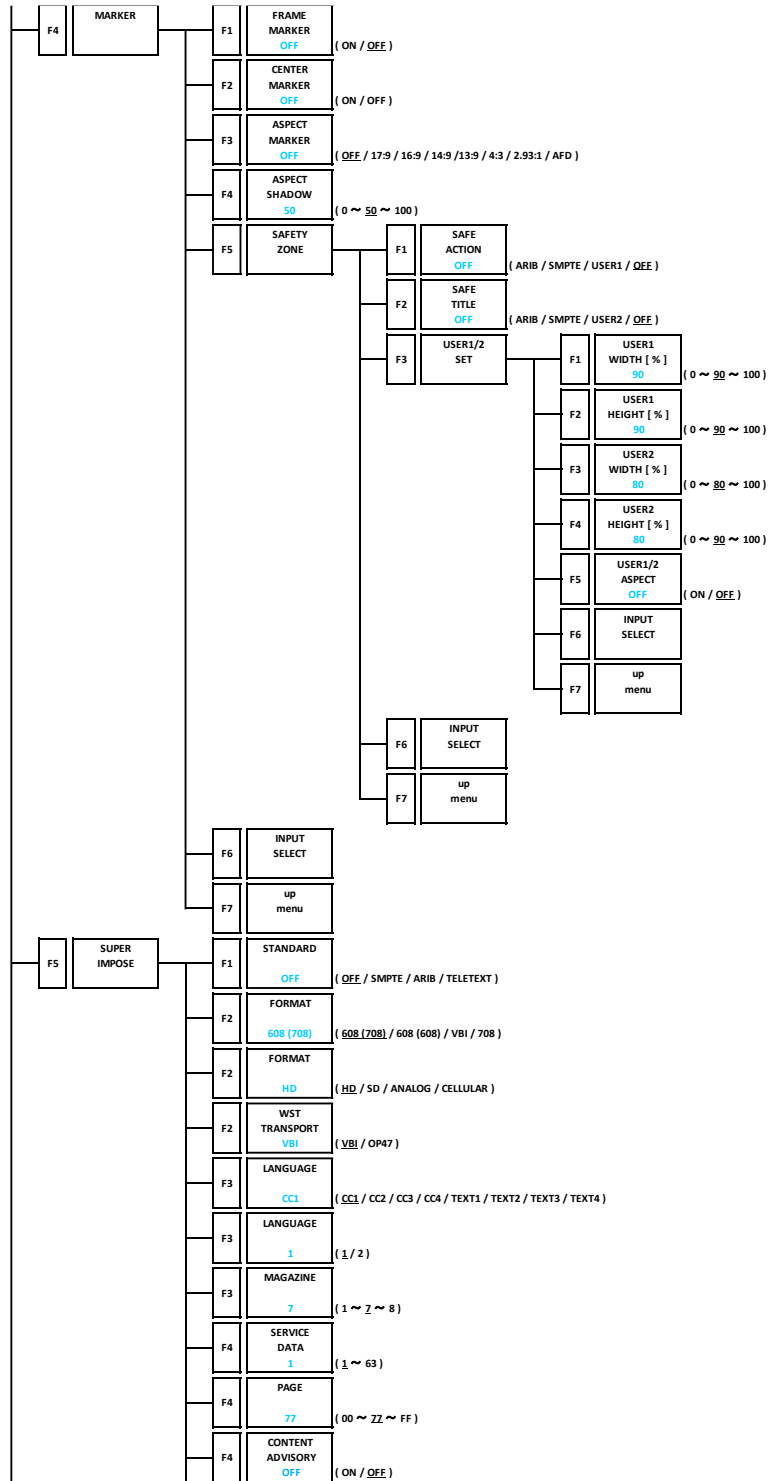

20. MENU TREE

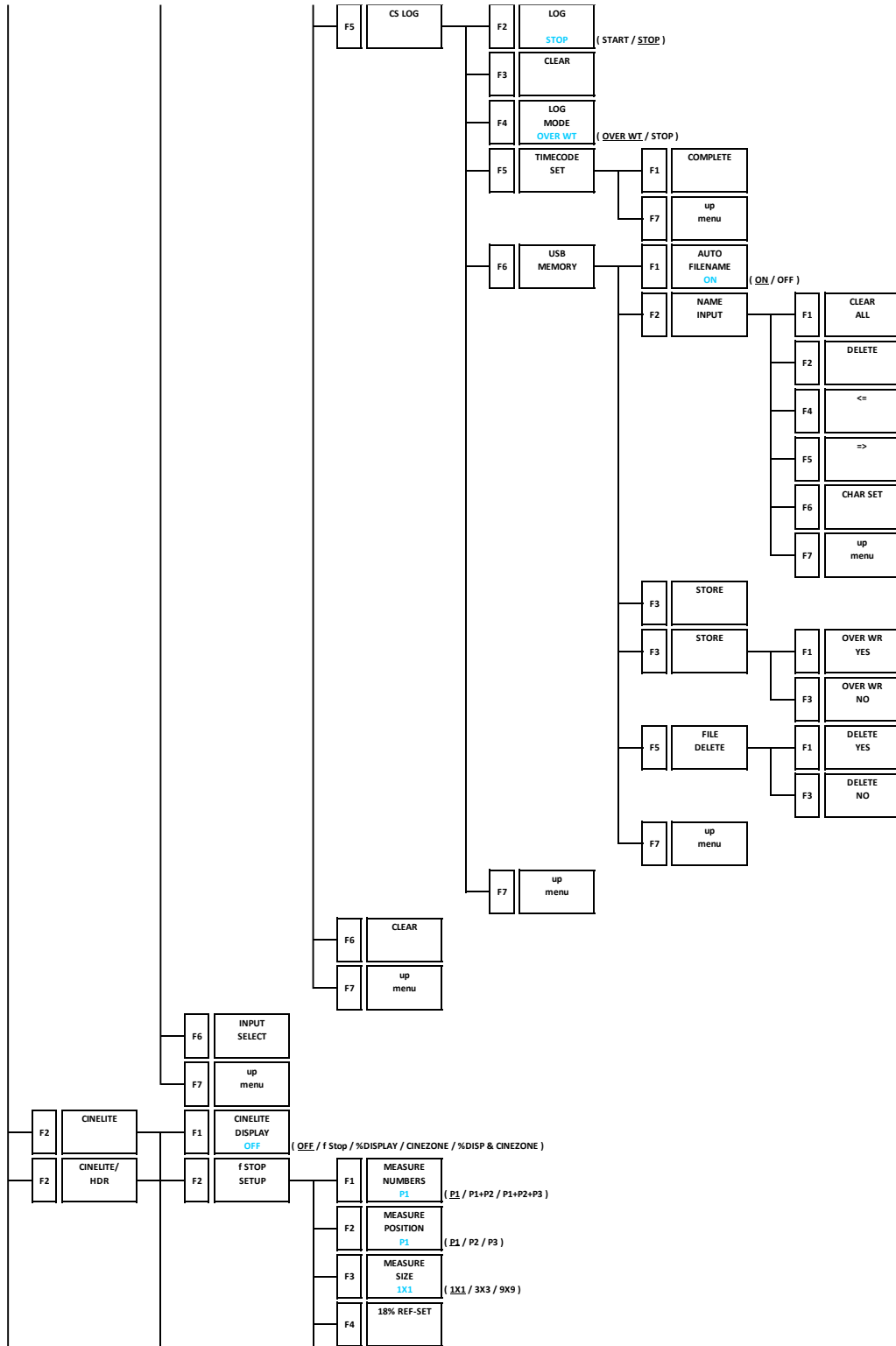

20. MENU TREE

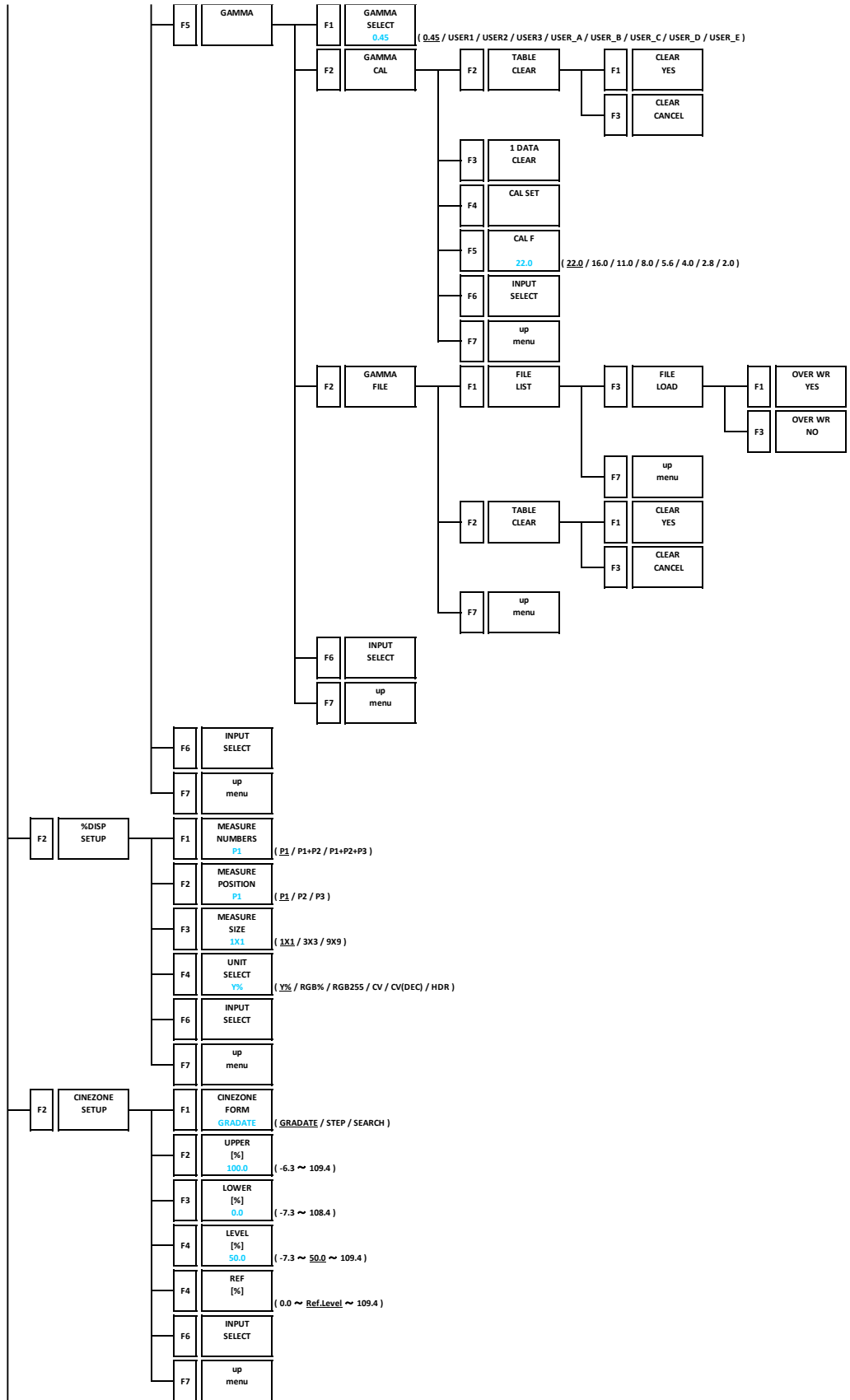

20. MENU TREE

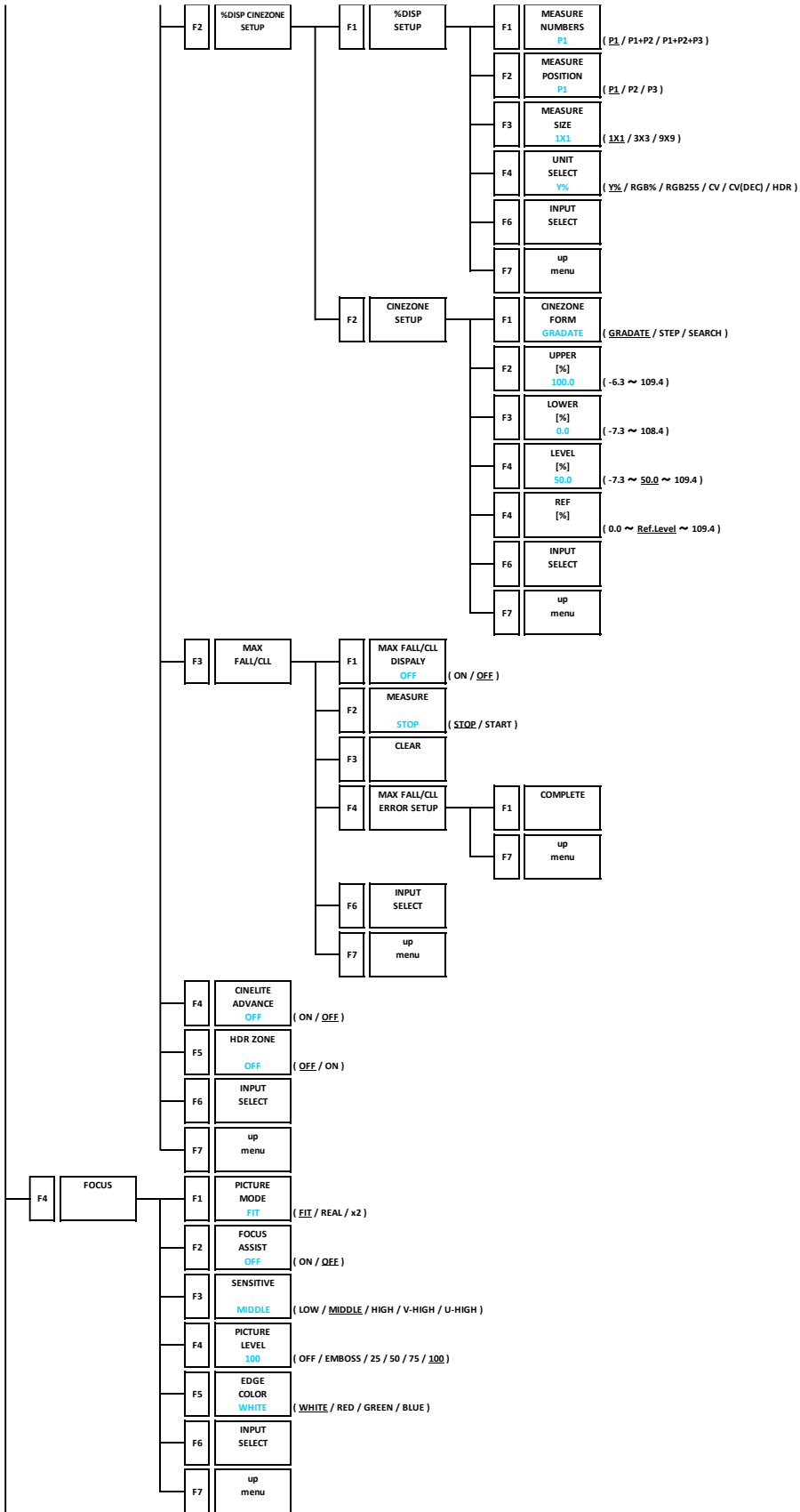

20. MENU TREE

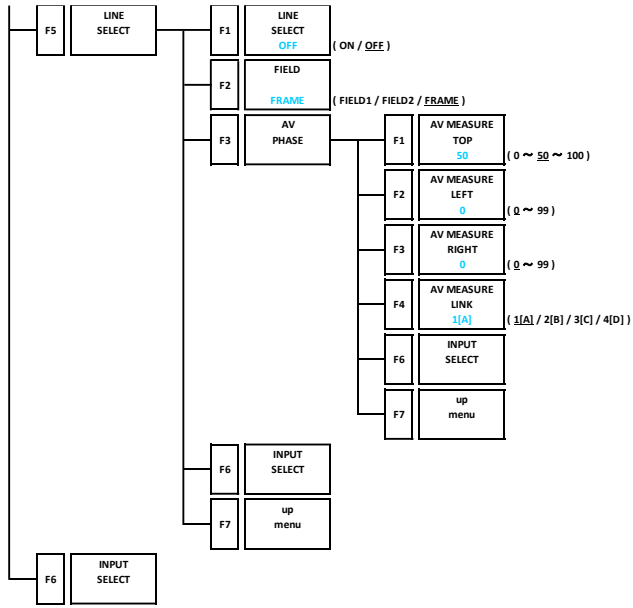

20.9 AUDIO Menu

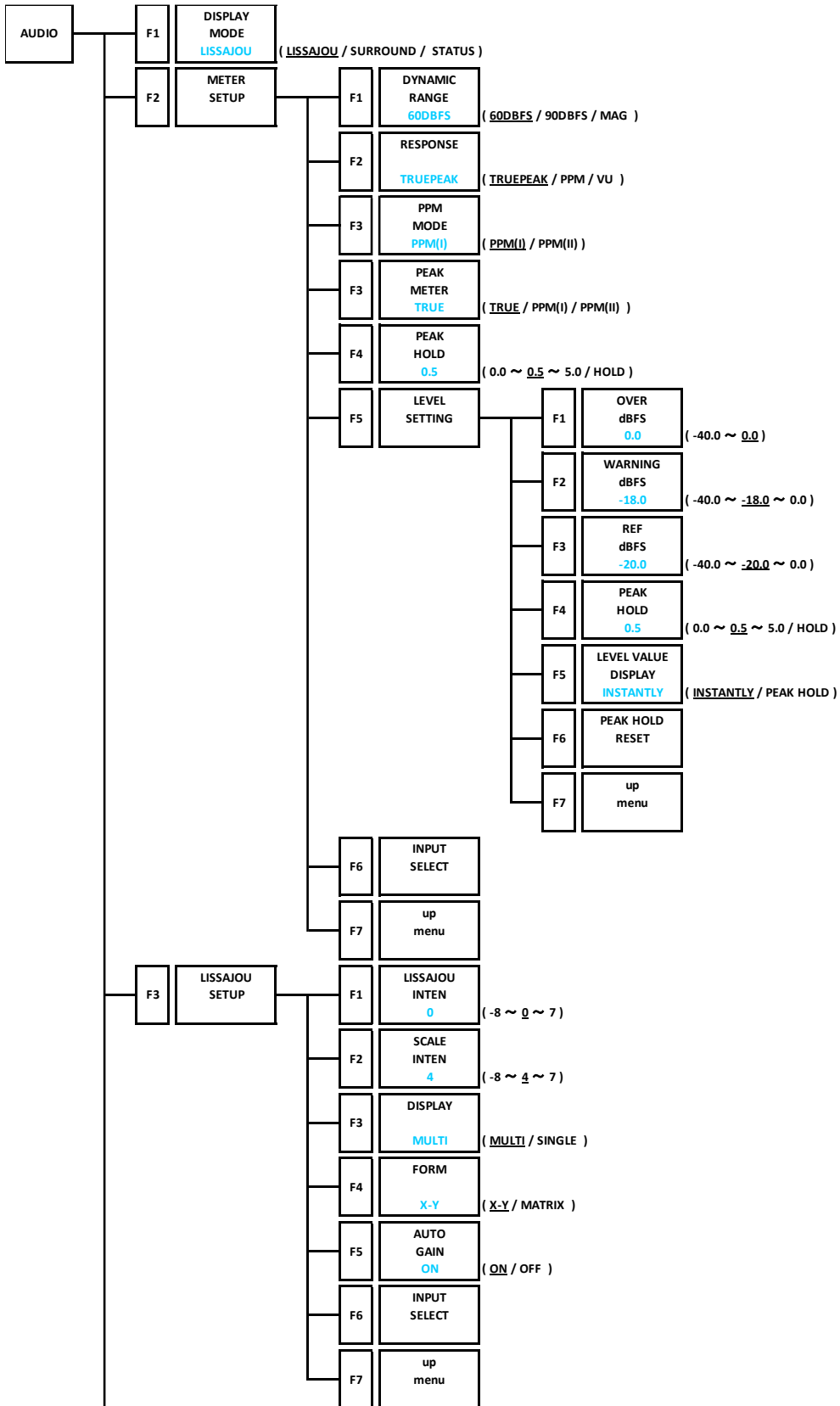

20. MENU TREE

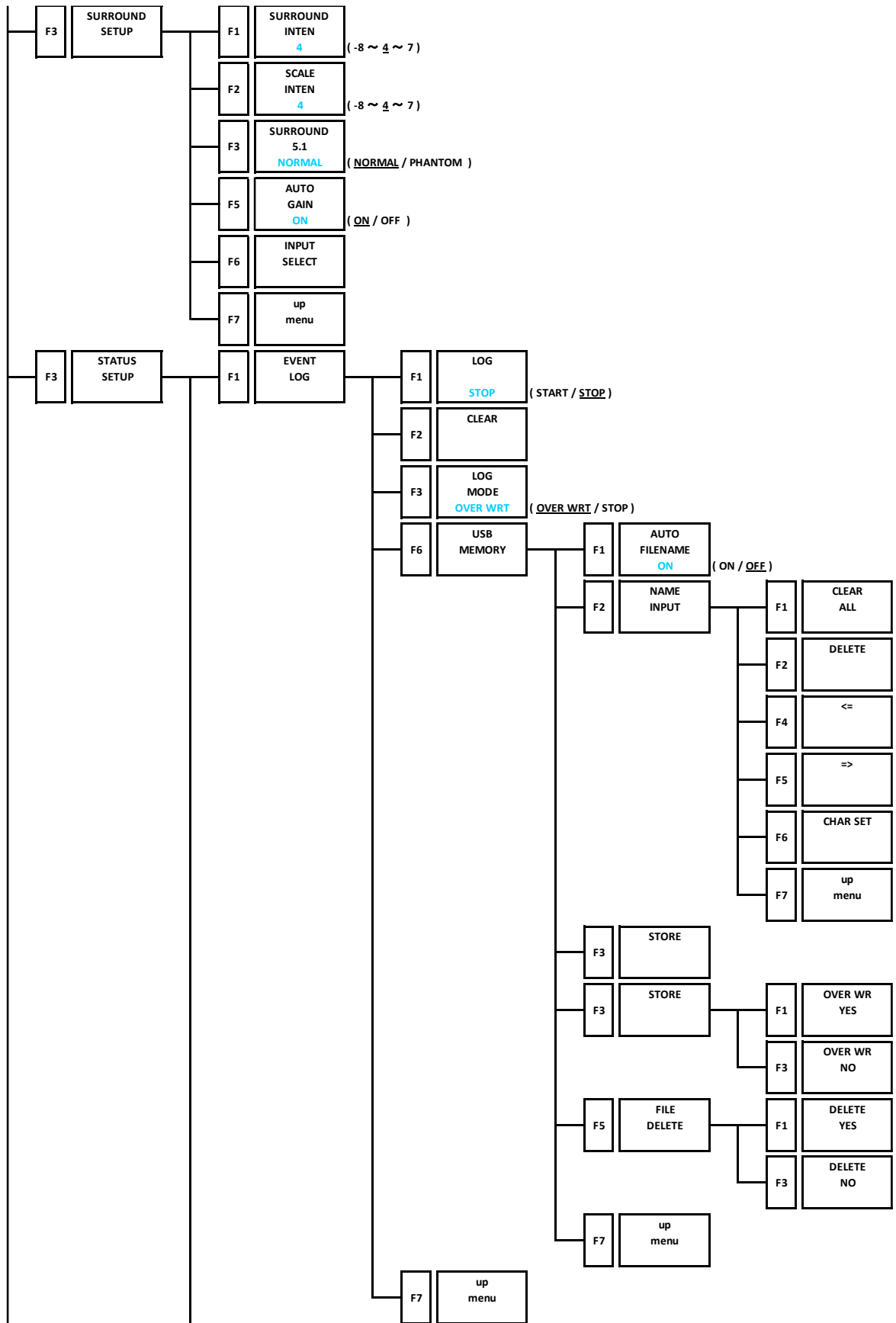

20. MENU TREE

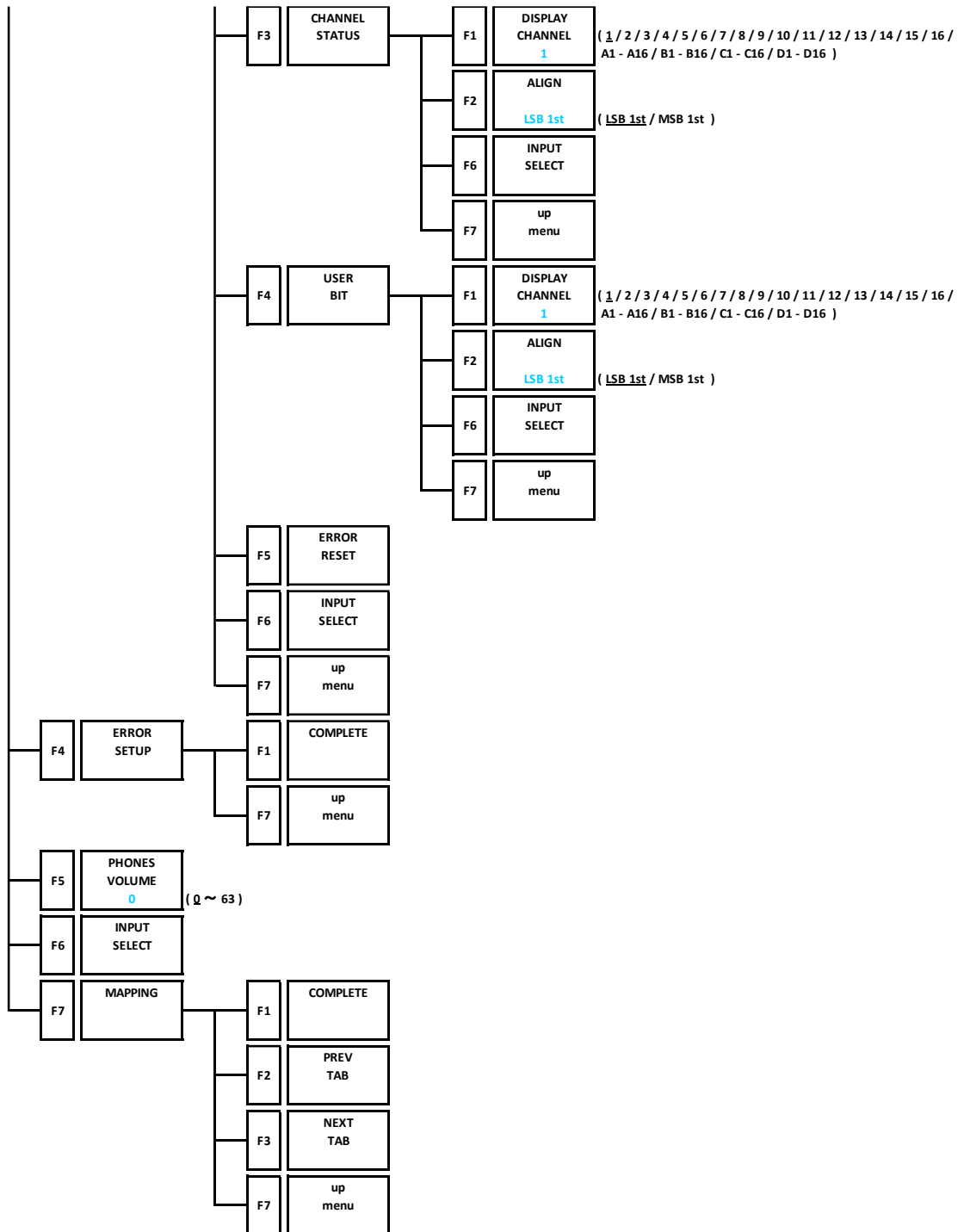

20. MENU TREE

20.10 STATUS Menu

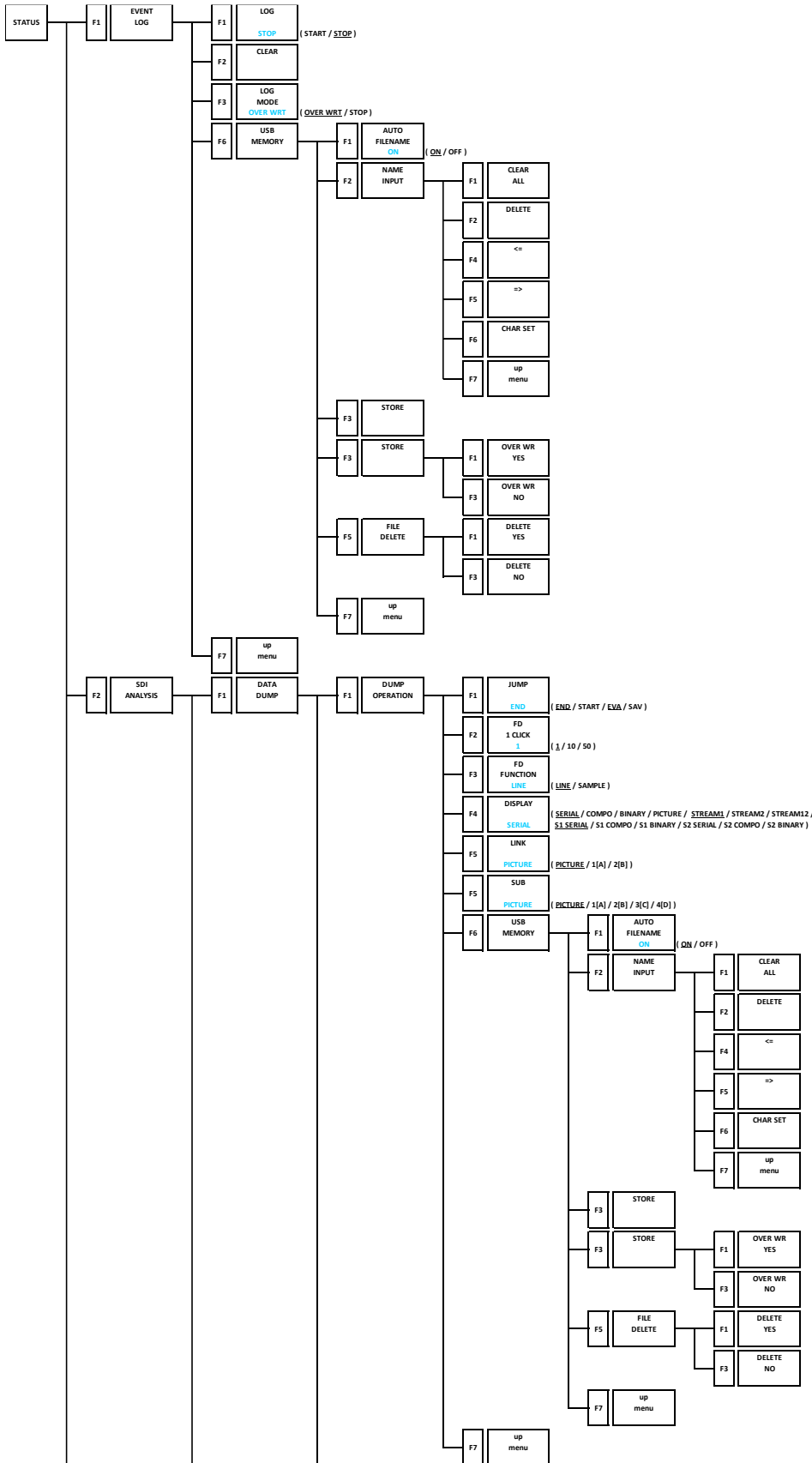

20. MENU TREE

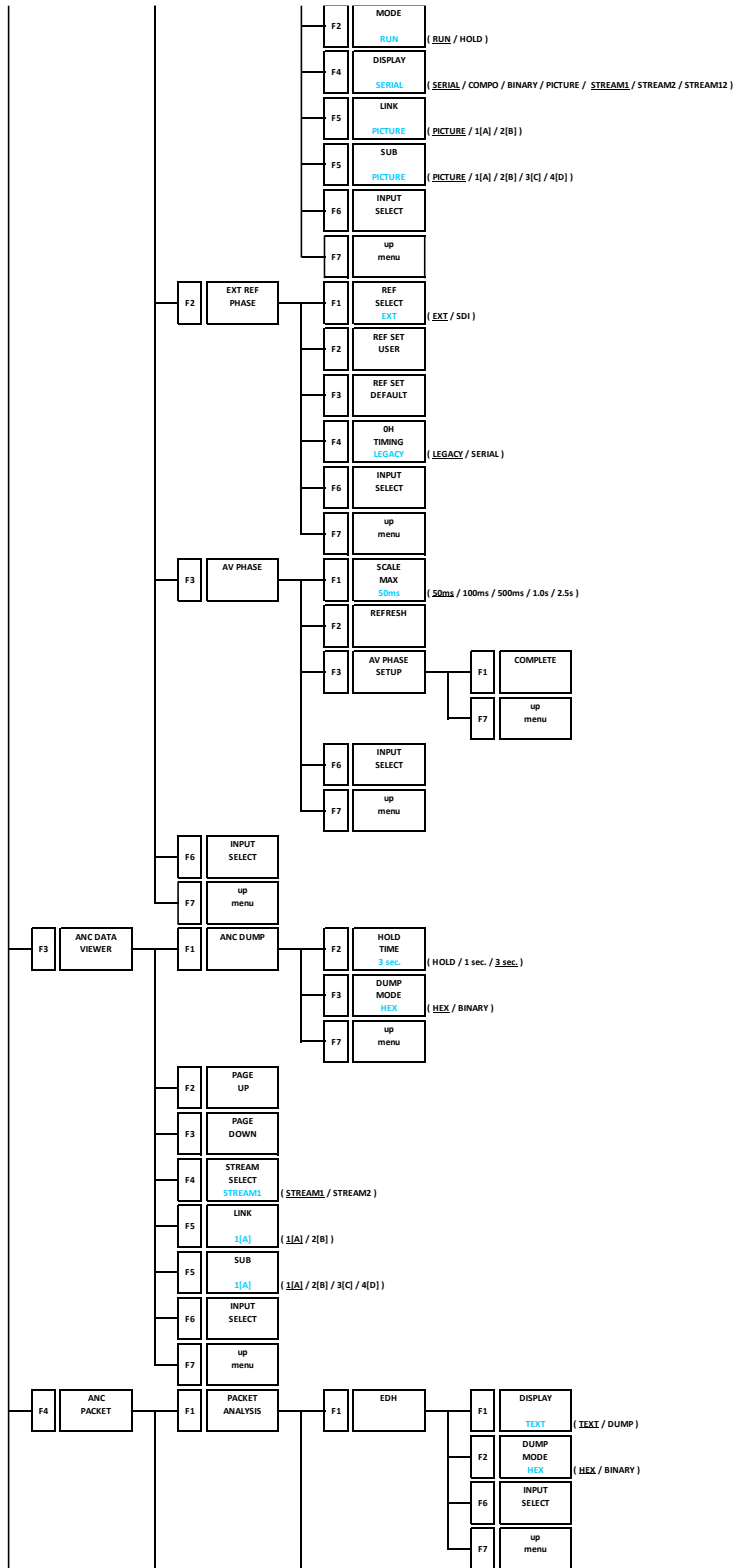

20. MENU TREE

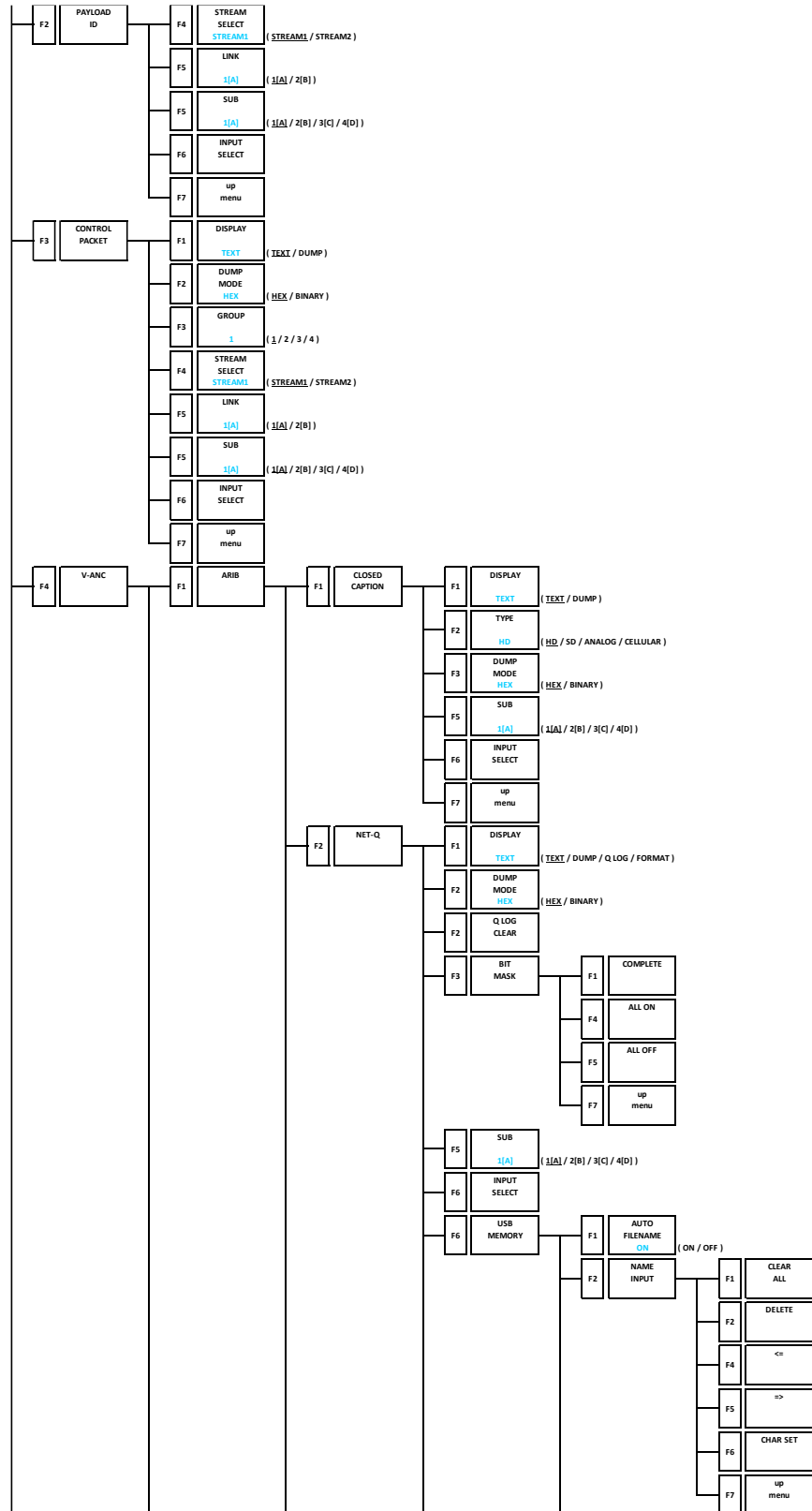

20. MENU TREE

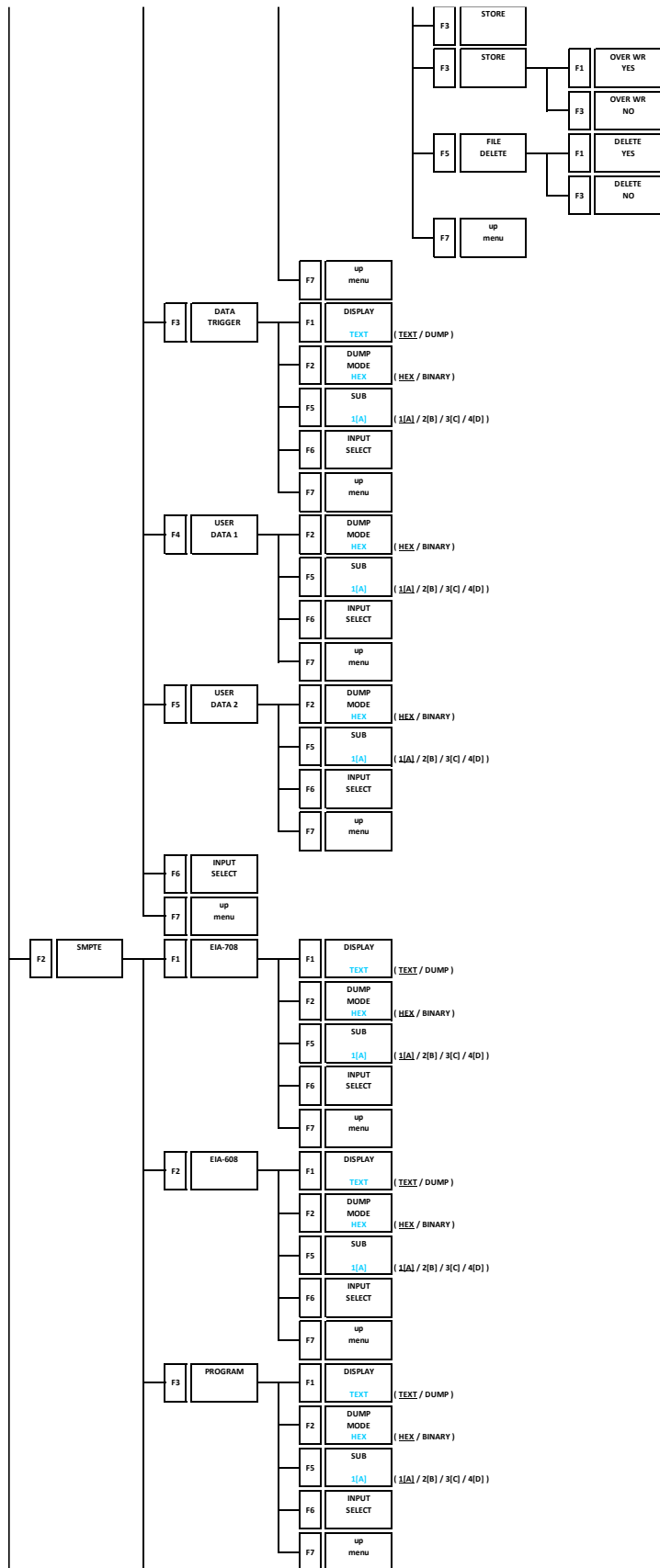

20. MENU TREE

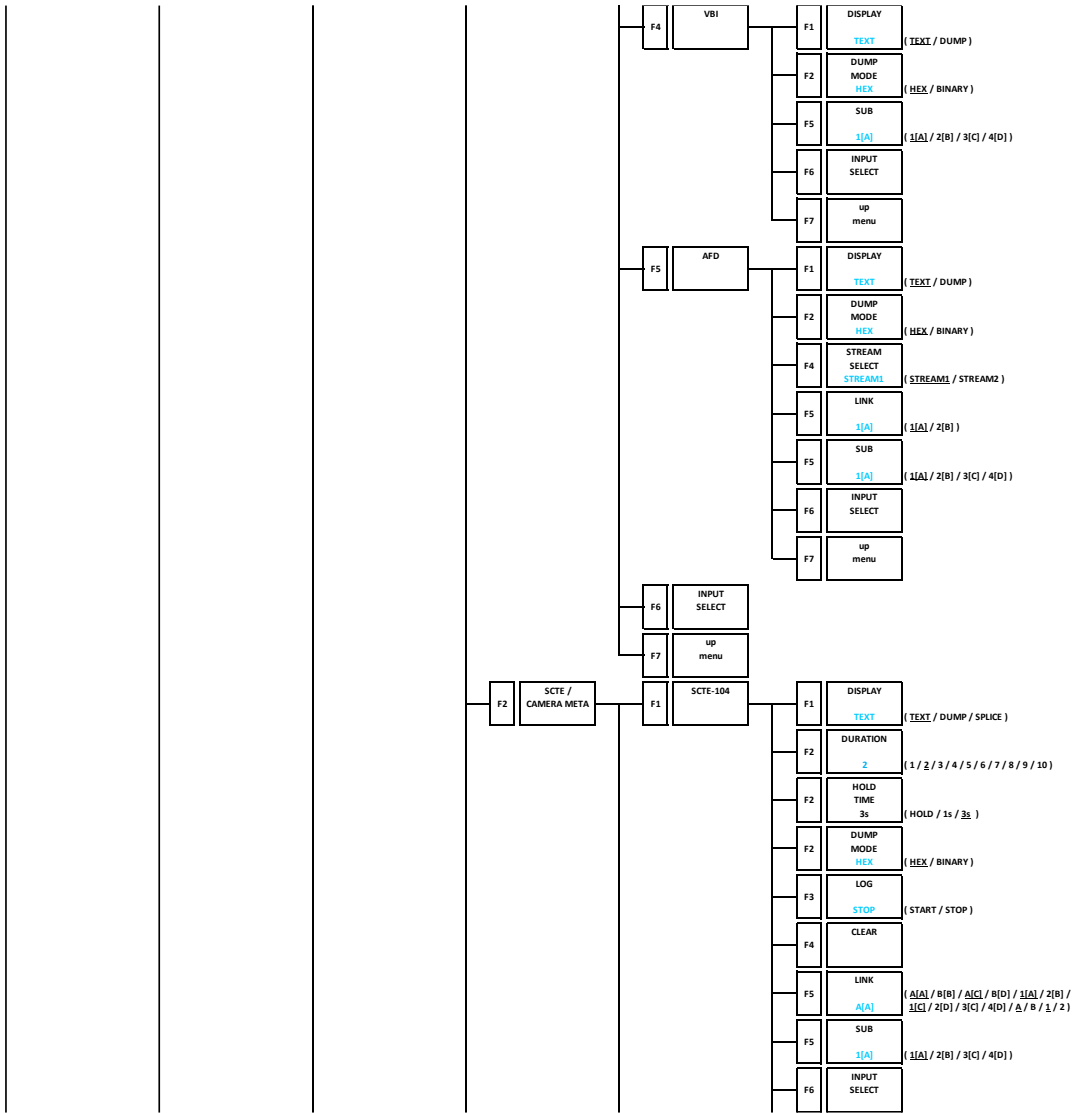

20. MENU TREE

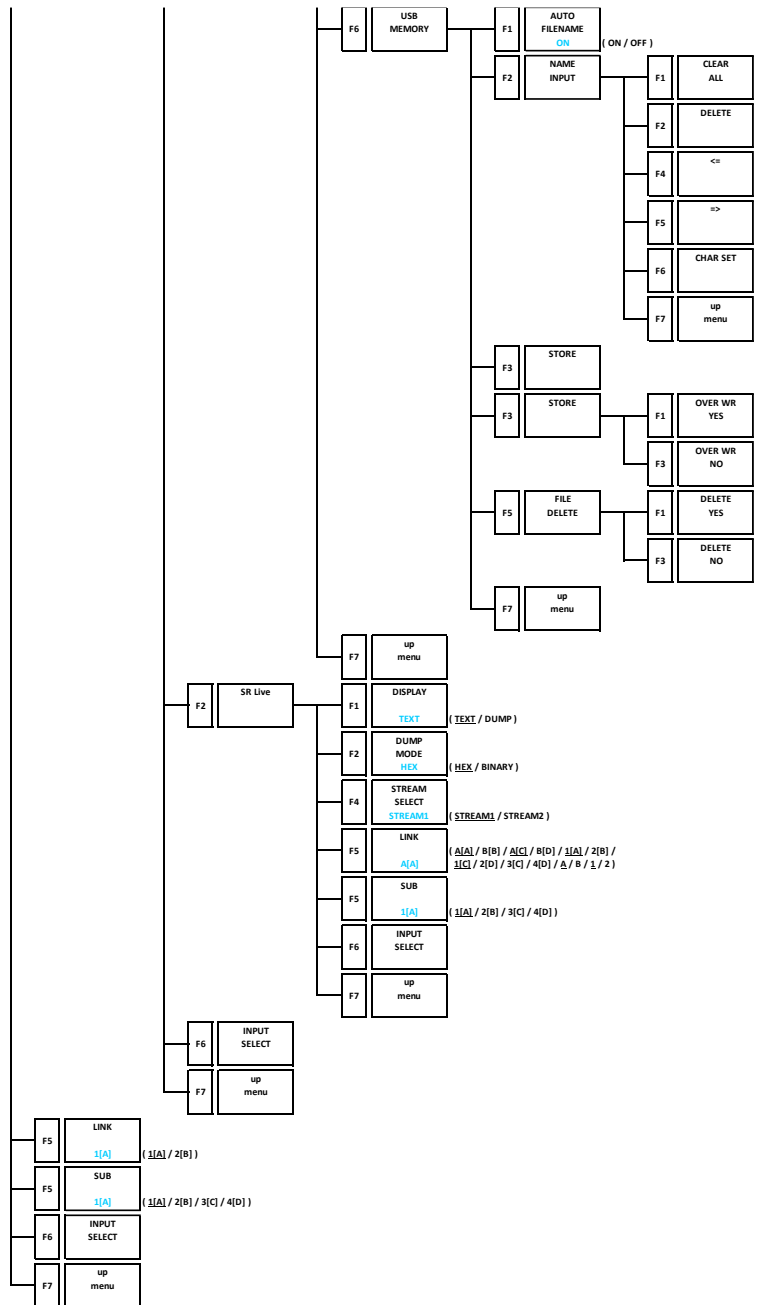

20. MENU TREE

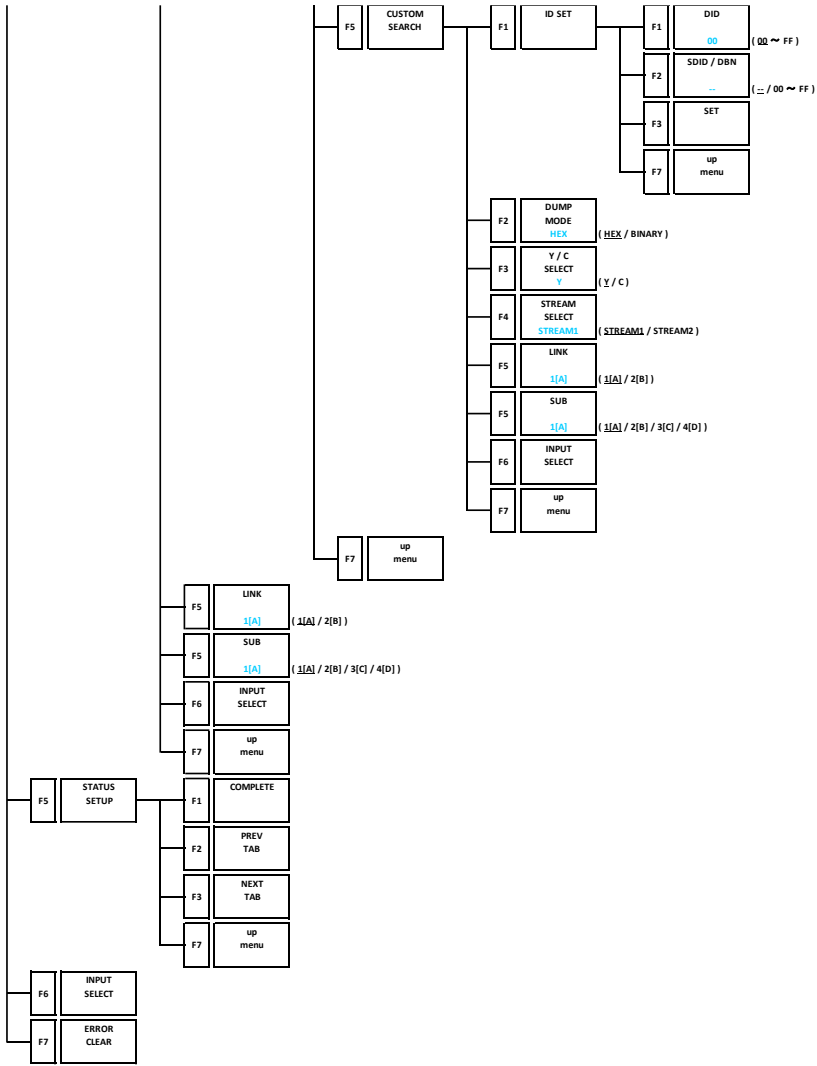

20. MENU TREE

20.11 EYE Menu (LV5300/LV5300A/LV7300-SER02)

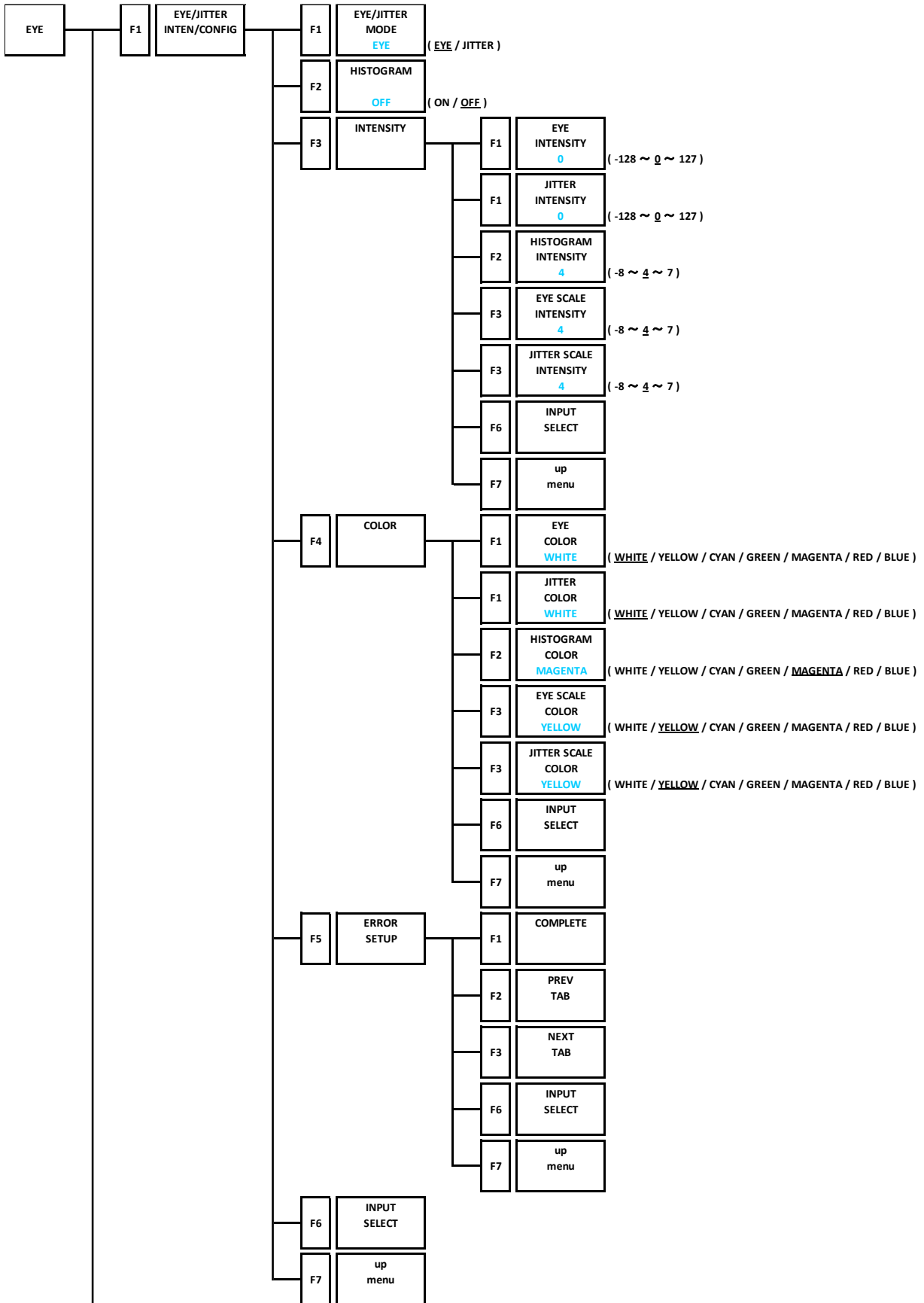

20. MENU TREE

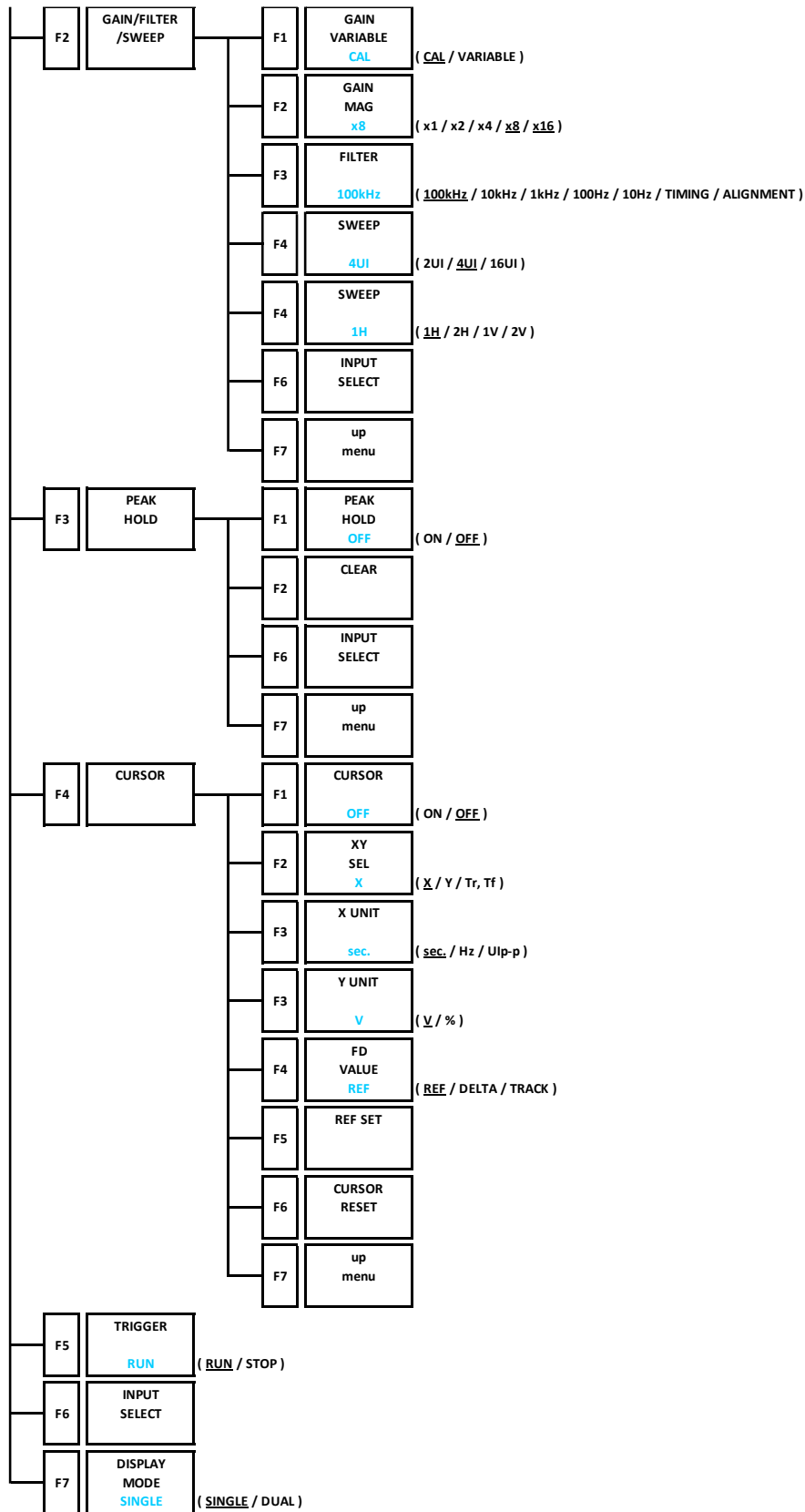

20.12 MULTI Menu

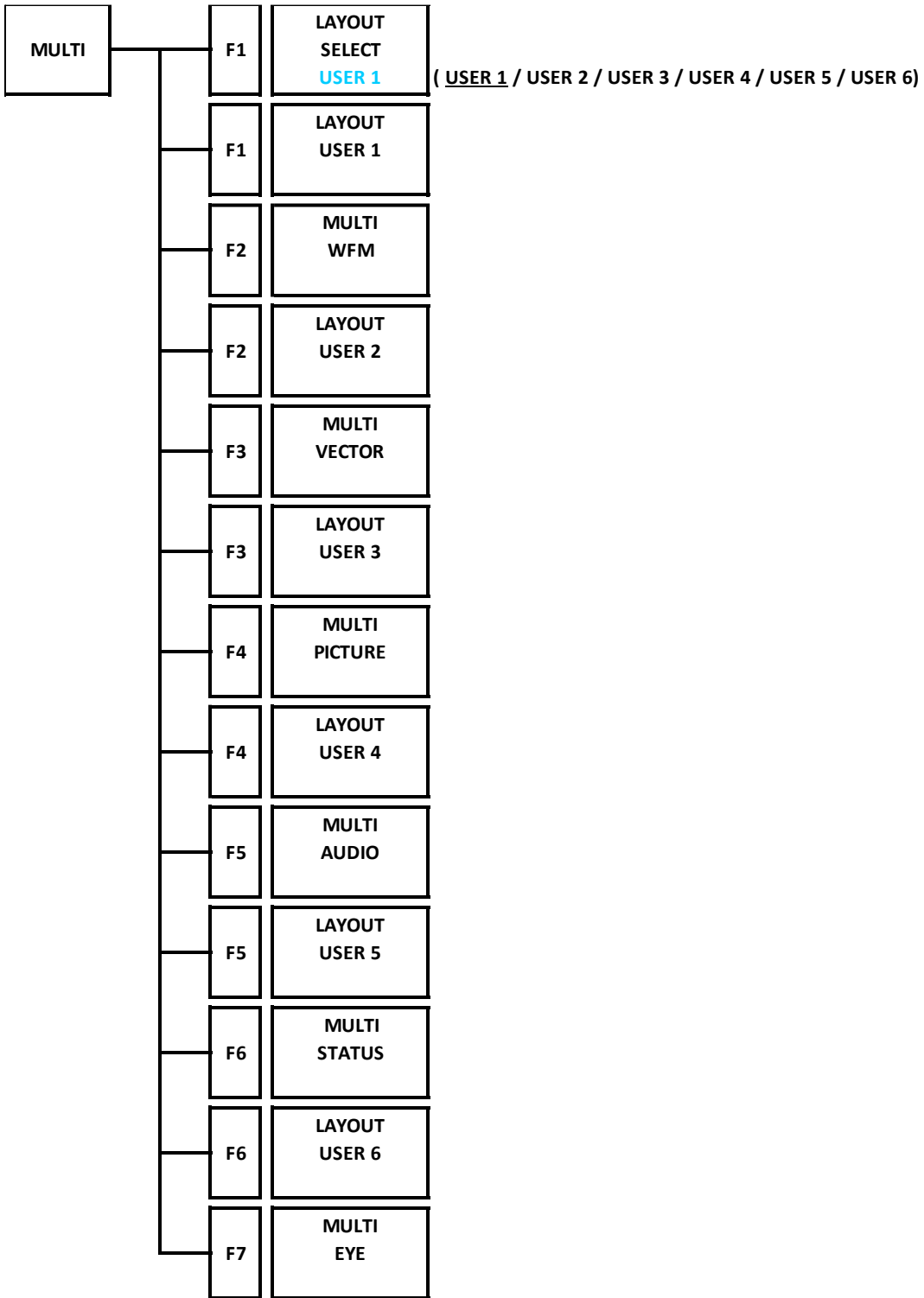

21. FIRMWARE UPDATE HISTORY

This manual is written for firmware version 6.7.

You can view the firmware version by pressing **F•3** SYSTEM INFO on the SYS menu.

- Ver. 6.7
 - [LV5300/LV5300A/LV5350/LV7300] Changed Select item of REMOTE setting so that it is not initialized when updating.
 - [LV5300/LV5300A/LV5350/LV7300-SER01/LV7300-SER02] Added simultaneous display of CINELITE %DISPLAY and CINEZONE in picture.
- Ver. 6.6
 - Minor changes
- Ver. 6.5
 - Minor changes
- Ver. 6.4
 - [LV5300/LV5300A/LV5350/LV7300-SER01/LV7300-SER02] Added color bar scale information display to the vector screen.
 - [LV5300/LV5300A/LV5350/LV7300-SER01/LV7300-SER02] SR Live Metadata Ver.1.10 in the analysis display of SR Live Metadata on the status screen is now supported.
 - [SER23] Added HDR information display to the vector screen.
- Ver. 6.3
 - Minor changes
- Ver. 6.2
 - [LV5300/LV5300A/LV5350/LV7300] NTP (SNTP) supports all time zones.
 - [LV5300/LV5300A/LV5350/LV7300-SER01/LV7300-SER02] Added a remote command to get the maximum and minimum values of Y/R/G/B/CMP by TELNET/SNMP when displaying vector 5BAR.
- Ver. 6.1
 - [LV5300/LV5300A/LV5350/LV7300-SER01/LV7300-SER02] Added color wheel display to the VECT menu.
- Ver. 6.0
 - [SER23] Improved to display HDR unit in Nits.
- Ver. 5.9
 - [LV5300/LV5300A/LV5350/LV7300] LV5300A is now supported.
 - [SER21] Improved to display "V, S, L, D" additional information in the CONTENT ADVISORY display in English subtitles (EIA-608 / 708) display of the picture.
- Ver. 5.8
 - Minor changes
- Ver. 5.7
 - Minor changes

21. FIRMWARE UPDATE HISTORY

- Ver. 5.6
 - [LV5300/LV5350/LV7300-SER01/LV7300-SER02] Improved so that the splice_request_data of SCTE-104 can be analyzed and displayed and logged in the picture and status.
 - [LV5300/LV5350/LV7300-SER01/LV7300-SER02] Improved the color gamut error in the status so that the event log now shows whether the error is due to the upper threshold or the lower threshold for each of R, G, and B.
 - [LV5300/LV5350/LV7300-SER01/LV7300-SER02] Improved the level error in the status so that the event log now shows whether the error is due to the upper threshold or the lower threshold.
- Ver. 5.5
 - Minor changes
- Ver. 5.4
 - Minor changes
- Ver. 5.3
 - [SER21] Improved so that CONTENT ADVISORY can be displayed in English closed caption (EIA-608 / 708) of the picture.
- Ver. 5.2
 - Minor changes
- Ver. 5.1
 - [SER20] Improved so that the AV PHASE measurement values of the status can be acquired by remote command (SNMP / Telnet) to the status.
- Ver. 5.0
 - [LV5300/LV5350/LV7300-SER01/LV7300-SER02] SR Live Metadata Ver.1.00 in the SR Live Metadata analysis display is now supported when the status.
- Ver. 4.9
 - [LV5300/LV5350/LV7300] Changed from "REMOTE LABEL INPUT" to "REMOTE LABEL" on the LV7290 tab in SYSTEM SETUP.
- Ver. 4.8
 - Minor changes
- Ver. 4.7
 - [LV5300/LV5350/LV7300-SER01/LV7300-SER02] Added an SCTE-104 analysis display to the status.
- Ver. 4.6
 - [SER21] Improved to display Spanish and Portuguese in English closed caption (EIA-608/708) to the picture.
 - [SER23] Improved to record the MAX FALL / MAX CLL error log when the picture.
- Ver. 4.5
 - Minor changes

21. FIRMWARE UPDATE HISTORY

- Ver. 4.4
 - Minor changes
- Ver. 4.3
 - Minor changes
- Ver. 4.2
 - Minor changes
- Ver. 4.1
 - Minor changes
- Ver. 4.0
 - Minor changes
- Ver. 3.9
 - [LV5300/LV5350/LV7300-SER01/LV7300-SER02] Added an SR Live analysis display to the status.
 - [LV5300/LV5350/LV7300-SER01/LV7300-SER02] Added the marker display supported the BT.709 color bar of the color gamut of ARIB STD-B66 and ARIB STD-B72 to the vector. (When VARIABLE SCALE is set to on and the color gamut is detected as BT.2020, this is valid.)
 - [SER21] English closed caption (EIA 708/608) now supports 4K-6G system.
- Ver. 3.8
 - Minor changes
- Ver. 3.7
 - Minor changes
- Ver. 3.6
 - [LV5300/LV5350/LV7300] Improved so that the assigned address is displayed when DHCP is selected on the SYSTEM SETUP NETWORK tab menu.
 - [SER21] English closed caption (EIA-608) now supports multiple formats. (3G-A, 3G-B-DL, 4K Dual, 4K 12G)
- Ver. 3.3
 - [LV5300/LV5350/LV7300] Added DDR3 and scaler initialization because, in rare cases, the measurement screen did not appear after startup.
 - [LV5300/LV5350/LV7300-SER01/LV7300-SER02] Fix a problem that was causing a TRS error and line number error to occur in rare cases after SDI signal detection.
 - [SER20] Improved so that the display of the peak hold value and the instantaneous value can be switched on the meter display.
- Ver. 3.0
 - [LV5300/LV5350/LV7300] Improved so that 1080/48P and 1080/47.95P can be selected for MONITOR OUT.
 - [LV5300/LV5350/LV7300-SER01/LV7300-SER02] For AV PHASE of status, the AV PHASE SETUP menu was changed from F6 to F3, and the INPUT SELECT menu was added to F6.
 - [SER26] Custom layout now supports AV PHASE.

21. FIRMWARE UPDATE HISTORY

- Ver. 2.8
 - [LV5300/LV5350/LV7300] Improved so that the waveform color can be specified when the capture is held.
 - [LV5300/LV5350/LV7300-SER01/LV7300-SER02] Variable scale is now supported for composite signals on the vector waveform display.
 - [LV5300/LV5350/LV7300-SER01/LV7300-SER02] Marker display is now supported for the guide display on the vector waveform display.
 - [LV5300/LV5350/LV7300-SER01/LV7300-SER02] Improved the visibility by making the marker lines thicker and changing the lines to broken lines on the picture marker display.
 - [LV5300/LV7300-SER02] Added a histogram to the eye pattern display.
 - [LV5300/LV7300-SER02] EYE/JITTER waveform display is now supported on the 4K 6G system.
 - [SER22] Added a white DCI point marker on the chromaticity diagram.
 - [SER23] Added a mode that synchronizes to the payload ID for SDR, HLG, and PQ.
- Ver. 2.3
 - [LV5300/LV5350/LV7300] Added the HTTP server access port (port number 8080) display on the NETWORK tab.
 - [LV5300/LV5350/LV7300-SER01/LV7300-SER02] Added the variable scale function to the vector waveform display.
 - [LV5300/LV5350/LV7300-SER01/LV7300-SER02] Added hexadecimal format display on the payload ID screen of the status display.
 - [SER23] C-Log and Log-C are now supported.
 - [SER24] Add the HDR color bar (when SER23 is enabled).
 - [SER28] 6G-SDI system is now supported.
 - [SER28] 4K 3G dual link is now supported.

Following information is for Chinese RoHS only

所含有毒有害物质信息

部件号码: LV5300



此标志适用于在中国销售的电子信息产品, 依据2006年2月28日公布的

《电子信息产品污染控制管理办法》以及SJ/T11364-2006《电子信息产品污染控制标识要求》, 表示该产品在使用完结后可再利用。数字表示的是环境保护使用期限, 只要遵守与本产品有关的安全和使用上的注意事项, 从制造日算起在数字所表示的年限内, 产品不会产生环境污染和对人体、财产的影响。

产品适当使用后报废的方法请遵从电子信息产品的回收、再利用相关法令。

详细请咨询各级政府主管部门。

产品中有毒有害物质或元素的名称及含量

部件名称 Parts	有毒有害物质或元素 Hazardous Substances in each Part					
	铅 (Pb)	汞 (Hg)	镉 (Cd)	六价铬 (Cr (VI))	多溴联苯 (PBB)	多溴二苯醚 (PBDE)
实装基板	×	○	○	○	○	○
主体部	×	○	○	○	○	○
液晶显示模组	○	○	○	○	○	○
风扇	×	○	○	○	○	○
外筐	×	○	○	○	○	○
线材料一套	×	○	○	○	○	○
附件	×	○	○	○	○	○
包装材	○	○	○	○	○	○
电池	○	○	○	○	○	○
选件						
LV5300-SER11	×	○	○	○	○	○
LV5300-SER12	×	○	○	○	○	○
备注) ○: 表示该有毒有害物质在该部件所有均质材料中的含量均在SJ/T11363-2006 规定的限量要求以下。 ×: 表示该有毒有害物质或元素至少在该部件的某一均质材料中的含量超出SJ/T11363-2006 标准规定的限量要求。						

Ver. 1

Following information is for Chinese RoHS only

所含有毒有害物质信息

部件号码: LV5300A



此标志适用于在中国销售的电子信息产品, 依据2006年2月28日公布的

《电子信息产品污染控制管理办法》以及SJ/T11364-2006《电子信息产品污染控制标识要求》, 表示该产品在使用完结后可再利用。数字表示的是环境保护使用期限, 只要遵守与本产品有关的安全和使用上的注意事项, 从制造日算起在数字所表示的年限内, 产品不会产生环境污染和对人体、财产的影响。

产品适当使用后报废的方法请遵从电子信息产品的回收、再利用相关法令。

详细请咨询各级政府主管部门。

产品中有毒有害物质或元素的名称及含量

部件名称 Parts	有毒有害物质或元素 Hazardous Substances in each Part					
	铅 (Pb)	汞 (Hg)	镉 (Cd)	六价铬 (Cr(VI))	多溴联苯 (PBB)	多溴二苯醚 (PBDE)
实装基板	×	○	○	○	○	○
主体部	×	○	○	○	○	○
液晶显示模组	○	○	○	○	○	○
风扇	×	○	○	○	○	○
外筐	×	○	○	○	○	○
线材料一套	○	○	○	○	○	○
附件	×	○	○	○	○	○
包装材	○	○	○	○	○	○
电池	○	○	○	○	○	○
选件						
LV5300-SER11	×	○	○	○	○	○
LV5300-SER12	×	○	○	○	○	○
备注) ○: 表示该有毒有害物质在该部件所有均质材料中的含量均在SJ/T11363-2006 规定的限量要求以下。 ×: 表示该有毒有害物质或元素至少在该部件的某一均质材料中的含量超出SJ/T11363-2006 标准规定的限量要求。						

Ver. 1

Following information is for Chinese RoHS only

所含有毒有害物质信息

部件号码: LV5350



此标志适用于在中国销售的电子信息产品, 依据2006年2月28日公布的

《电子信息产品污染控制管理办法》以及SJ/T11364-2006《电子信息产品污染控制标识要求》, 表示该产品在使用完结后可再利用。数字表示的是环境保护使用期限, 只要遵守与本产品有关的安全和使用上的注意事项, 从制造日算起在数字所表示的年限内, 产品不会产生环境污染和对人体、财产的影响。

产品适当使用后报废的方法请遵从电子信息产品的回收、再利用相关法令。

详细请咨询各级政府主管部门。

产品中有毒有害物质或元素的名称及含量

部件名称 Parts	有毒有害物质或元素 Hazardous Substances in each Part					
	铅 (Pb)	汞 (Hg)	镉 (Cd)	六价铬 (Cr (VI))	多溴联苯 (PBB)	多溴二苯醚 (PBDE)
实装基板	×	○	○	○	○	○
主体部	×	○	○	○	○	○
液晶显示模组	○	○	○	○	○	○
风扇	○	○	○	○	○	○
外筐	×	○	○	○	○	○
线材料一套	×	○	○	○	○	○
附件	×	○	○	○	○	○
包装材	○	○	○	○	○	○
电池	○	○	○	○	○	○
选件						
LV5350-SER11	×	○	○	○	○	○
LV5350-SER12	×	○	○	○	○	○
备注) ○: 表示该有毒有害物质在该部件所有均质材料中的含量均在SJ/T11363-2006 规定的限量要求以下。 ×: 表示该有毒有害物质或元素至少在该部件的某一均质材料中的含量超出SJ/T11363-2006 标准规定的限量要求。						

Ver. 1

Following information is for Chinese RoHS only

所含有毒有害物质信息

部件号码: LV7300



此标志适用于在中国销售的电子信息产品, 依据2006年2月28日公布的

《电子信息产品污染控制管理办法》以及SJ/T11364-2006《电子信息产品污染控制标识要求》, 表示该产品在使用完结后可再利用。数字表示的是环境保护使用期限, 只要遵守与本产品有关的安全和使用上的注意事项, 从制造日算起在数字所表示的年限内, 产品不会产生环境污染和对人体、财产的影响。

产品适当使用后报废的方法请遵从电子信息产品的回收、再利用相关法令。

详细请咨询各级政府主管部门。

产品中有毒有害物质或元素的名称及含量

部件名称 Parts	有毒有害物质或元素 Hazardous Substances in each Part					
	铅 (Pb)	汞 (Hg)	镉 (Cd)	六价铬 (Cr(VI))	多溴联苯 (PBB)	多溴二苯醚 (PBDE)
实装基板	×	○	○	○	○	○
主体部	×	○	○	○	○	○
风扇	×	○	○	○	○	○
外筐	×	○	○	○	○	○
线材料一套	○	○	○	○	○	○
附件	×	○	○	○	○	○
包装材	○	○	○	○	○	○
电池	○	○	○	○	○	○
选件						
LV7300-SER01	×	○	○	○	○	○
LV7300-SER02	×	○	○	○	○	○
备注) ○: 表示该有毒有害物质在该部件所有均质材料中的含量均在SJ/T11363-2006 规定的限量要求以下。 ×: 表示该有毒有害物质或元素至少在该部件的某一均质材料中的含量超出SJ/T11363-2006 标准规定的限量要求。						

Ver. 1

Leader Electronics Corporation

2-6-33 Tsunashimahigashi, Kohoku-ku, Yokohama-shi,
Kanagawa, 223-8505, Japan
www.leader.co.jp/en

Feb. 7, 2023 Ver. 14 (Firmware Ver. 6.7)