

What is White Rabbit?

- Developed at CERN for < 1 ns synchronization over many km
- Employs standard single-mode telecom fiber optics
- Network links support general-purpose Ethernet traffic
- Uses “time aware” concepts from Sync-E and IEEE-1588 (PTP)

Summary of our findings:

- Stability of phase across restarts ~ few ps
- Grandmaster-slave-slave2 loopback PPS stability ~ 1 ps @ 1 hour
- Grandmaster-slave 10 MHz stability ~ 100 fs @ 3 hours with tight environmental control
- Grandmaster follows input 10 MHz phase
- Input pulse-per-second is used once at startup to select 10 MHz zero crossing

Stability of WR slave 10 MHz across restarts

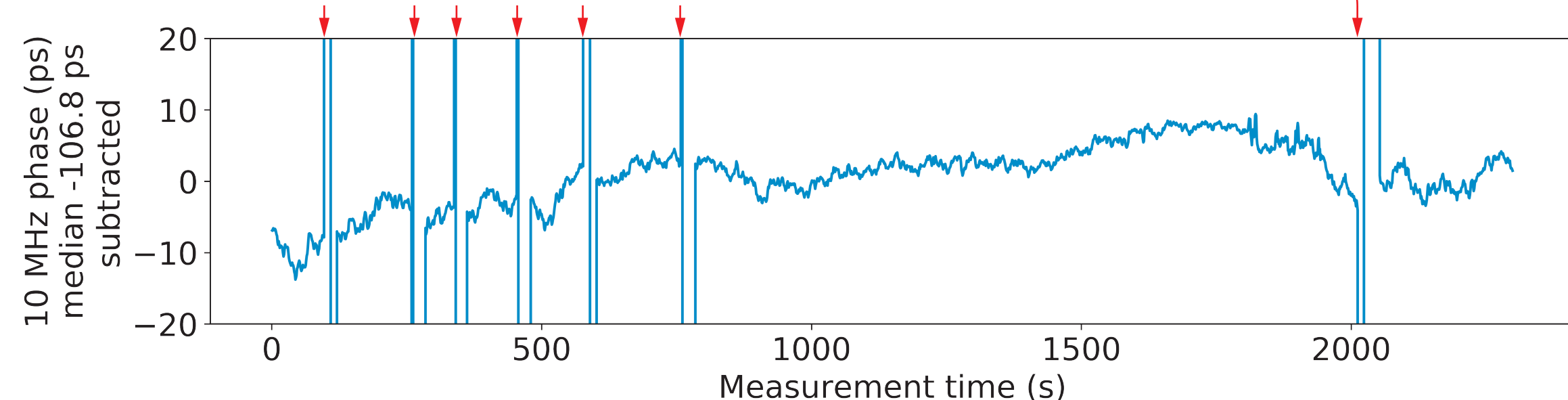

Stability of PPS vs. WR-slave2 loopback

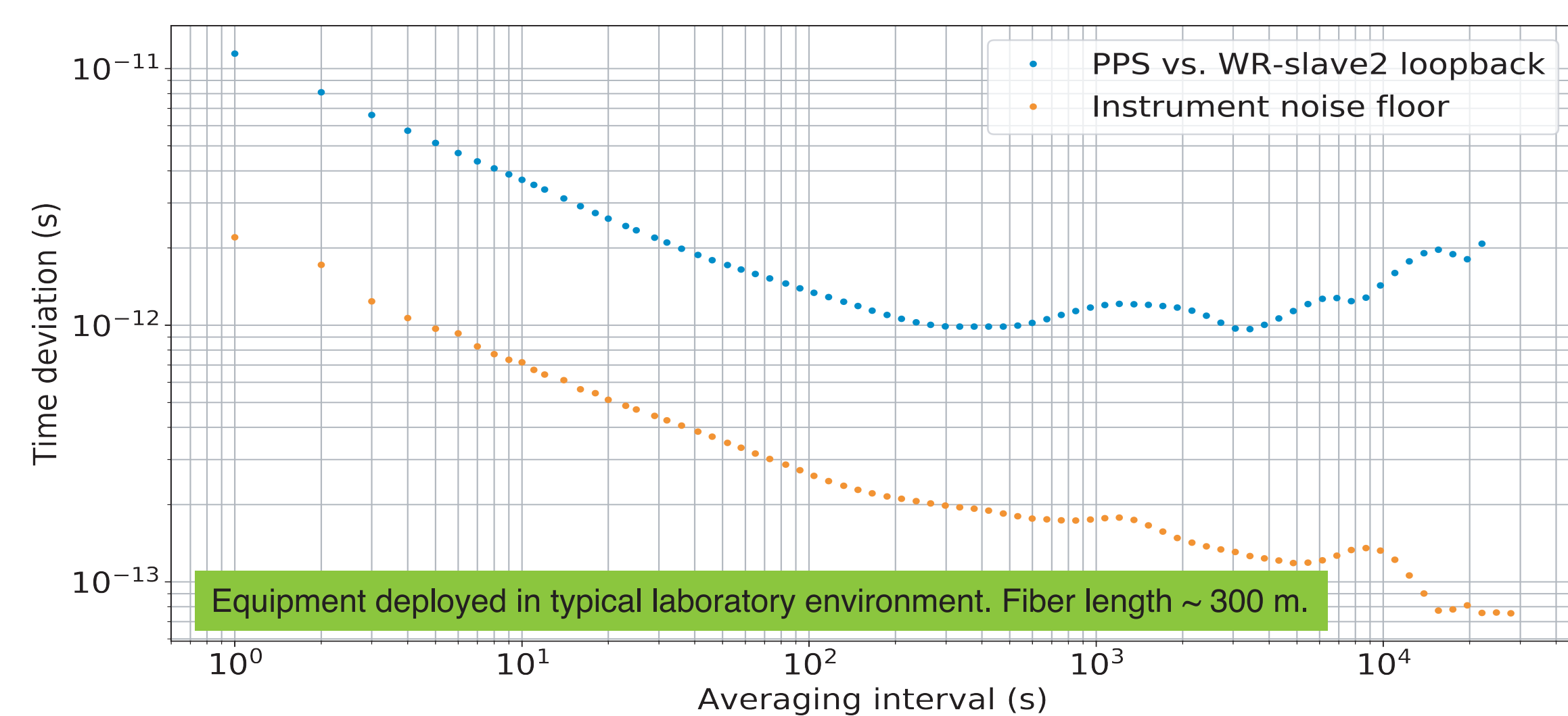
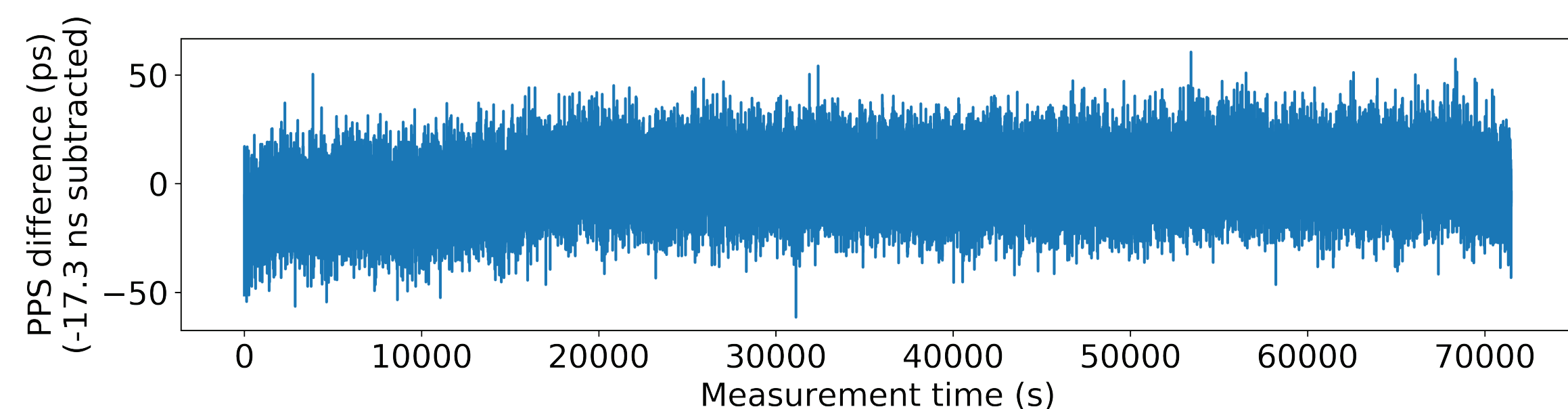

Stability of 10 MHz vs. WR-slave

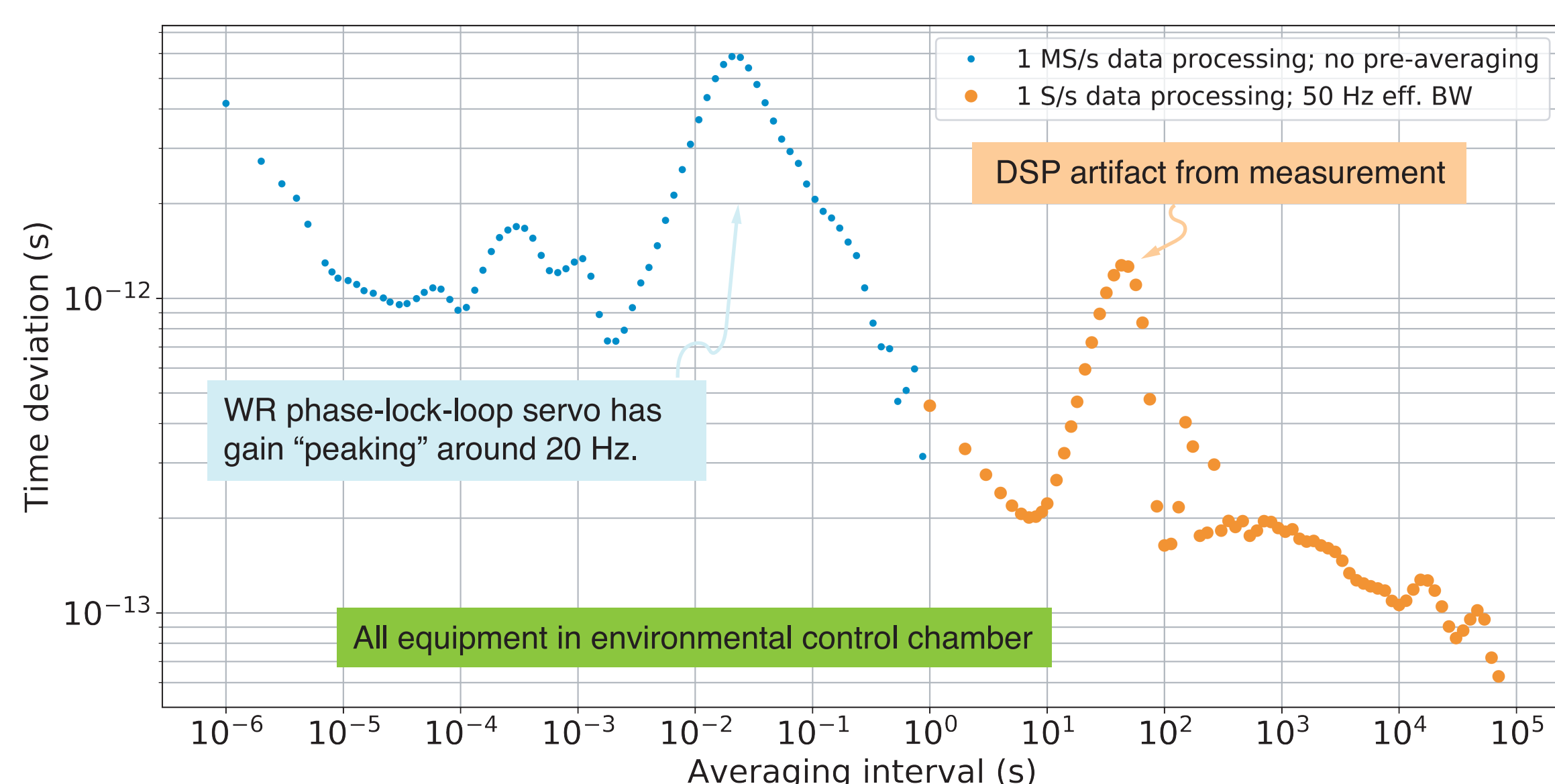

Physical basis for its high performance:

- Two-way time transfer over a single (bi-directional) fiber
- Calibrated transmission asymmetry scaling with fiber length
- Discipline of both clock frequency and time (phase) at remote “slave”

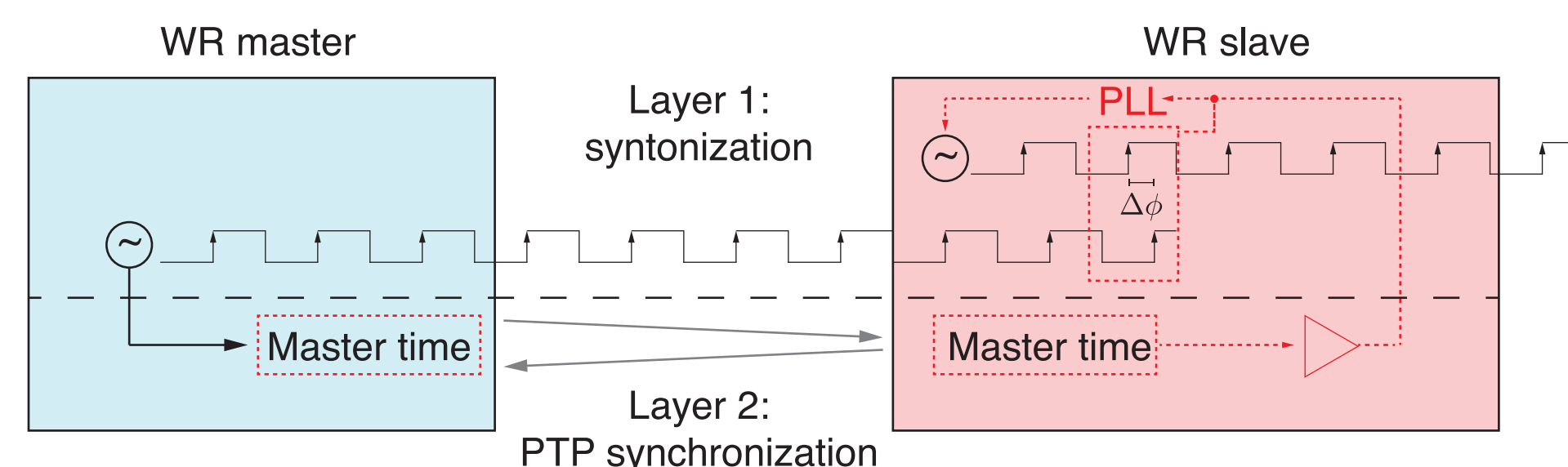

Tested equipment & methodology:

Standard NIST disclaimer: *any mention of commercial products is for information only; it does not imply recommendation or endorsement by NIST.*

White Rabbit nodes:

- SevenSols WR-LEN (2 SFP port) White Rabbit devices
- Input 10 MHz and pulse-per-second (PPS) in “grandmaster” mode
- Outputs 10 MHz and pulse-per-second in “slave” mode
- Can be configured as “slave” on one port, “master” on other, enabling loopback

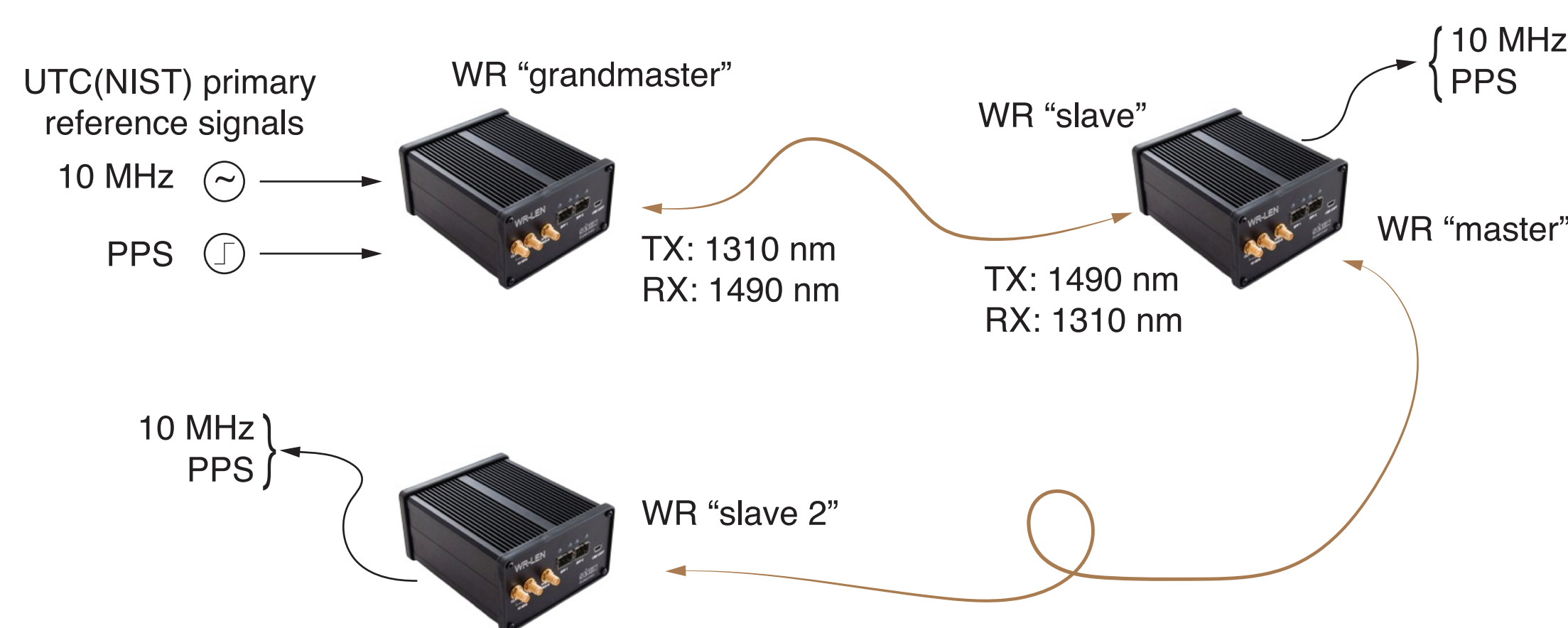

Time Interval counters (pulse-per-second measurement):

Spectracom Pendulum CNT-91
GuideTech GT668PCIe-1

10 MHz phase measurement:

Software defined radio (Ettus N210; “BasicRX” daughterboard)
High resolution phase metrology technique described in article linked below.

Data acquisition & hardware processing:

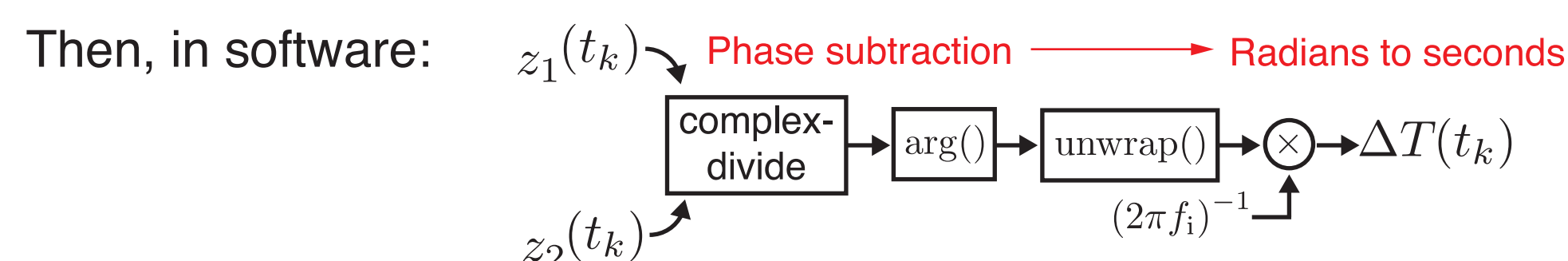
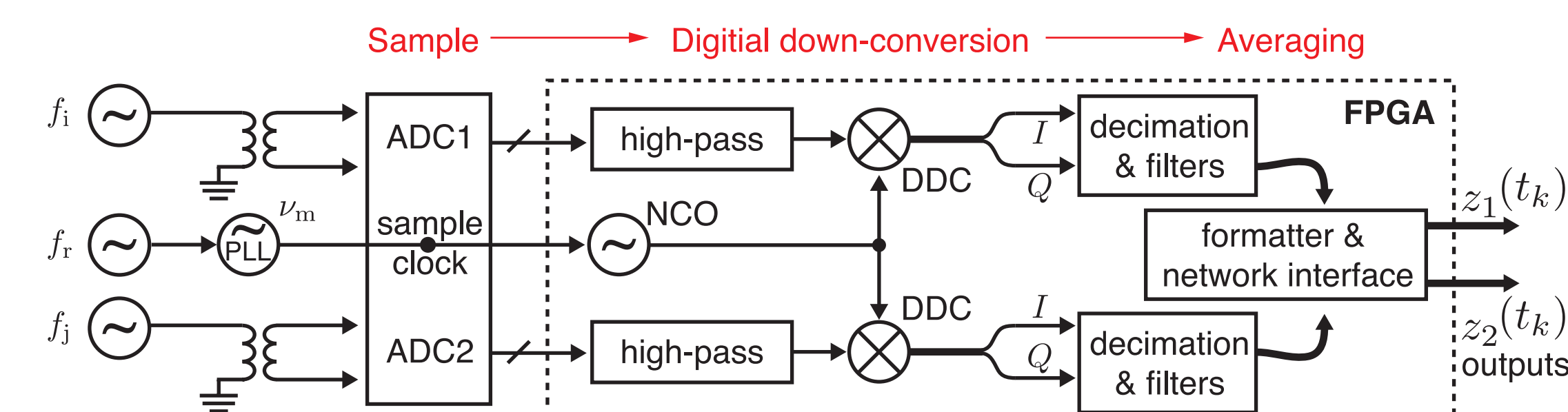

Additional information:



White Rabbit Project technical presentations
<http://www.ohwr.org/projects/white-rabbit/wiki/WRpresentations>



Oscillator metrology with software defined radio
JA Sherman, R Jördens, Rev. Sci. Instrum. **87** 054711/1-11 (2016)
<http://tf.boulder.nist.gov/general/pdf/2816.pdf>