

MPI: A Message-Passing Interface Standard

Version 3.2

(Draft)

Unofficial, for comment only

Message Passing Interface Forum

August 17, 2019

#120

MPI-4 Issue #120: MPI_Cart_create_weighted, ...
Pull Request PR98

See changes on pages

i;16;309-321;711;717;726;842;860;862-863;873;876;879-880

Plus corrections from the HW-Topo-WG meeting Sep 5, 2019

1 This document describes the Message-Passing Interface (MPI) standard, version 3.1.
2 The MPI standard includes point-to-point message-passing, collective communications, group
3 and communicator concepts, process topologies, environmental management, process crea-
4 tion and management, one-sided communications, extended collective operations, external
5 interfaces, I/O, some miscellaneous topics, and a profiling interface. Language bindings for
6 C and Fortran are defined.

7 Historically, the evolution of the standards is from MPI-1.0 (May 5, 1994) to MPI-1.1
8 (June 12, 1995) to MPI-1.2 (July 18, 1997), with several clarifications and additions and
9 published as part of the MPI-2 document, to MPI-2.0 (July 18, 1997), with new functionality,
10 to MPI-1.3 (May 30, 2008), combining for historical reasons the documents 1.1 and 1.2
11 and some errata documents to one combined document, and to MPI-2.1 (June 23, 2008),
12 combining the previous documents. Version MPI-2.2 (September 4, 2009) added additional
13 clarifications and seven new routines. Version MPI-3.0 (September 21, 2012) is an extension
14 of MPI-2.2. This version, MPI-3.1, adds clarifications and minor extensions to MPI-3.0
15

16 **Comments.** Please send comments on MPI to the MPI Forum as follows:
17

- 18 1. Subscribe to <http://lists.mpi-forum.org/mailman/listinfo.cgi/mpi-comments>
- 19 2. Send your comment to: mpi-comments@mpi-forum.org, together with the URL of
20 the version of the MPI standard and the page and line numbers on which you are
21 commenting. Only use the official versions.
22

23 Your comment will be forwarded to MPI Forum committee members for consideration.
24 Messages sent from an unsubscribed e-mail address will not be considered.
25
26
27
28
29
30
31
32
33
34
35
36
37
38
39
40
41
42
43
44

45 ©1993, 1994, 1995, 1996, 1997, 2008, 2009, 2012, 2015 University of Tennessee, Knoxville,
46 Tennessee. Permission to copy without fee all or part of this material is granted, provided
47 the University of Tennessee copyright notice and the title of this document appear, and
48 notice is given that copying is by permission of the University of Tennessee.

Version 3.1: June 4, 2015. This document contains mostly corrections and clarifications to the MPI-3.0 document. The largest change is a correction to the Fortran bindings introduced in MPI-3.0. Additionally, new functions added include routines to manipulate `MPI_Aint` values in a portable manner, nonblocking collective I/O routines, and routines to get the index value by name for `MPI_T` performance and control variables.

Version 3.0: September 21, 2012. Coincident with the development of MPI-2.2, the MPI Forum began discussions of a major extension to MPI. This document contains the MPI-3 Standard. This draft version of the MPI-3 standard contains significant extensions to MPI functionality, including nonblocking collectives, new one-sided communication operations, and Fortran 2008 bindings. Unlike MPI-2.2, this standard is considered a major update to the MPI standard. As with previous versions, new features have been adopted only when there were compelling needs for the users. Some features, however, may have more than a minor impact on existing MPI implementations.

Version 2.2: September 4, 2009. This document contains mostly corrections and clarifications to the MPI-2.1 document. A few extensions have been added; however all correct MPI-2.1 programs are correct MPI-2.2 programs. New features were adopted only when there were compelling needs for users, open source implementations, and minor impact on existing MPI implementations.

Version 2.1: June 23, 2008. This document combines the previous documents MPI-1.3 (May 30, 2008) and MPI-2.0 (July 18, 1997). Certain parts of MPI-2.0, such as some sections of Chapter 4, Miscellany, and Chapter 7, Extended Collective Operations, have been merged into the Chapters of MPI-1.3. Additional errata and clarifications collected by the MPI Forum are also included in this document.

Version 1.3: May 30, 2008. This document combines the previous documents MPI-1.1 (June 12, 1995) and the MPI-1.2 Chapter in MPI-2 (July 18, 1997). Additional errata collected by the MPI Forum referring to MPI-1.1 and MPI-1.2 are also included in this document.

Version 2.0: July 18, 1997. Beginning after the release of MPI-1.1, the MPI Forum began meeting to consider corrections and extensions. MPI-2 has been focused on process creation and management, one-sided communications, extended collective communications, external interfaces and parallel I/O. A miscellany chapter discusses items that do not fit elsewhere, in particular language interoperability.

Version 1.2: July 18, 1997. The MPI-2 Forum introduced MPI-1.2 as Chapter 3 in the standard “MPI-2: Extensions to the Message-Passing Interface”, July 18, 1997. This section contains clarifications and minor corrections to Version 1.1 of the MPI Standard. The only new function in MPI-1.2 is one for identifying to which version of the MPI Standard the implementation conforms. There are small differences between MPI-1 and MPI-1.1. There are very few differences between MPI-1.1 and MPI-1.2, but large differences between MPI-1.2 and MPI-2.

1 Version 1.1: June, 1995. Beginning in March, 1995, the Message-Passing Interface Forum
2 reconvened to correct errors and make clarifications in the MPI document of May 5, 1994,
3 referred to below as Version 1.0. These discussions resulted in Version 1.1. The changes
4 from Version 1.0 are minor. A version of this document with all changes marked is available.
5

6 Version 1.0: May, 1994. The Message-Passing Interface Forum (MPIF), with participation
7 from over 40 organizations, has been meeting since January 1993 to discuss and define a set
8 of library interface standards for message passing. MPIF is not sanctioned or supported by
9 any official standards organization.

10 The goal of the Message-Passing Interface, simply stated, is to develop a widely used
11 standard for writing message-passing programs. As such the interface should establish a
12 practical, portable, efficient, and flexible standard for message-passing.

13 This is the final report, Version 1.0, of the Message-Passing Interface Forum. This
14 document contains all the technical features proposed for the interface. This copy of the
15 draft was processed by L^AT_EX on May 5, 1994.
16
17
18
19
20
21
22
23
24
25
26
27
28
29
30
31
32
33
34
35
36
37
38
39
40
41
42
43
44
45
46
47
48

Contents

Acknowledgments	ix
1 Introduction to MPI	1
1.1 Overview and Goals	1
1.2 Background of MPI-1.0	2
1.3 Background of MPI-1.1, MPI-1.2, and MPI-2.0	2
1.4 Background of MPI-1.3 and MPI-2.1	3
1.5 Background of MPI-2.2	4
1.6 Background of MPI-3.0	4
1.7 Background of MPI-3.1	4
1.8 Who Should Use This Standard?	5
1.9 What Platforms Are Targets for Implementation?	5
1.10 What Is Included in the Standard?	5
1.11 What Is Not Included in the Standard?	6
1.12 Organization of This Document	6
2 MPI Terms and Conventions	9
2.1 Document Notation	9
2.2 Naming Conventions	9
2.3 Procedure Specification	10
2.4 Semantic Terms	11
2.5 Data Types	12
2.5.1 Opaque Objects	12
2.5.2 Array Arguments	14
2.5.3 State	14
2.5.4 Named Constants	15
2.5.5 Choice	16
2.5.6 Absolute Addresses and Relative Address Displacements	16
2.5.7 File Offsets	17
2.5.8 Counts	17
2.6 Language Binding	17
2.6.1 Deprecated and Removed Interfaces	18
2.6.2 Fortran Binding Issues	18
2.6.3 C Binding Issues	19
2.6.4 Functions and Macros	19
2.7 Processes	19
2.8 Error Handling	20

2.9	Implementation Issues	21
2.9.1	Independence of Basic Runtime Routines	21
2.9.2	Interaction with Signals	22
2.10	Examples	22
3	Point-to-Point Communication	25
3.1	Introduction	25
3.2	Blocking Send and Receive Operations	26
3.2.1	Blocking Send	26
3.2.2	Message Data	27
3.2.3	Message Envelope	29
3.2.4	Blocking Receive	30
3.2.5	Return Status	32
3.2.6	Passing MPI_STATUS_IGNORE for Status	34
3.3	Data Type Matching and Data Conversion	35
3.3.1	Type Matching Rules	35
	Type MPI_CHARACTER	36
3.3.2	Data Conversion	37
3.4	Communication Modes	39
3.5	Semantics of Point-to-Point Communication	42
3.6	Buffer Allocation and Usage	46
3.6.1	Model Implementation of Buffered Mode	48
3.7	Nonblocking Communication	49
3.7.1	Communication Request Objects	50
3.7.2	Communication Initiation	50
3.7.3	Communication Completion	54
3.7.4	Semantics of Nonblocking Communications	58
3.7.5	Multiple Completions	59
3.7.6	Non-destructive Test of status	66
3.8	Probe and Cancel	66
3.8.1	Probe	67
3.8.2	Matching Probe	70
3.8.3	Matched Receives	72
3.8.4	Cancel	73
3.9	Persistent Communication Requests	75
3.10	Send-Receive	80
3.11	Null Processes	82
4	Datatypes	85
4.1	Derived Datatypes	85
4.1.1	Type Constructors with Explicit Addresses	87
4.1.2	Datatype Constructors	87
4.1.3	Subarray Datatype Constructor	96
4.1.4	Distributed Array Datatype Constructor	98
4.1.5	Address and Size Functions	103
4.1.6	Lower-Bound and Upper-Bound Markers	106
4.1.7	Extent and Bounds of Datatypes	108
4.1.8	True Extent of Datatypes	110

4.1.9	Commit and Free	111
4.1.10	Duplicating a Datatype	113
4.1.11	Use of General Datatypes in Communication	113
4.1.12	Correct Use of Addresses	117
4.1.13	Decoding a Datatype	118
4.1.14	Examples	125
4.2	Pack and Unpack	134
4.3	Canonical MPI_PACK and MPI_UNPACK	140
5	Collective Communication	143
5.1	Introduction and Overview	143
5.2	Communicator Argument	146
5.2.1	Specifics for Intracommunicator Collective Operations	146
5.2.2	Applying Collective Operations to Intercommunicators	147
5.2.3	Specifics for Intercommunicator Collective Operations	148
5.3	Barrier Synchronization	149
5.4	Broadcast	150
5.4.1	Example using MPI_BCAST	151
5.5	Gather	151
5.5.1	Examples using MPI_GATHER, MPI_GATHERV	154
5.6	Scatter	161
5.6.1	Examples using MPI_SCATTER, MPI_SCATTERV	164
5.7	Gather-to-all	167
5.7.1	Example using MPI_ALLGATHER	169
5.8	All-to-All Scatter/Gather	170
5.9	Global Reduction Operations	175
5.9.1	Reduce	176
5.9.2	Predefined Reduction Operations	178
5.9.3	Signed Characters and Reductions	180
5.9.4	MINLOC and MAXLOC	181
5.9.5	User-Defined Reduction Operations	185
Example of User-defined Reduce	188	
5.9.6	All-Reduce	189
5.9.7	Process-Local Reduction	191
5.10	Reduce-Scatter	192
5.10.1	MPI_REDUCE_SCATTER_BLOCK	193
5.10.2	MPI_REDUCE_SCATTER	194
5.11	Scan	195
5.11.1	Inclusive Scan	195
5.11.2	Exclusive Scan	196
5.11.3	Example using MPI_SCAN	197
5.12	Nonblocking Collective Operations	199
5.12.1	Nonblocking Barrier Synchronization	201
5.12.2	Nonblocking Broadcast	202
Example using MPI_IBCAST	202	
5.12.3	Nonblocking Gather	203
5.12.4	Nonblocking Scatter	205
5.12.5	Nonblocking Gather-to-all	207

5.12.6	Nonblocking All-to-All Scatter/Gather	209
5.12.7	Nonblocking Reduce	212
5.12.8	Nonblocking All-Reduce	213
5.12.9	Nonblocking Reduce-Scatter with Equal Blocks	214
5.12.10	Nonblocking Reduce-Scatter	215
5.12.11	Nonblocking Inclusive Scan	216
5.12.12	Nonblocking Exclusive Scan	217
5.13	Persistent Collective Operations	217
5.13.1	Persistent Barrier Synchronization	219
5.13.2	Persistent Broadcast	219
5.13.3	Persistent Gather	220
5.13.4	Persistent Scatter	222
5.13.5	Persistent Gather-to-all	224
5.13.6	Persistent All-to-All Scatter/Gather	226
5.13.7	Persistent Reduce	229
5.13.8	Persistent All-Reduce	230
5.13.9	Persistent Reduce-Scatter with Equal Blocks	231
5.13.10	Persistent Reduce-Scatter	232
5.13.11	Persistent Inclusive Scan	233
5.13.12	Persistent Exclusive Scan	234
5.14	Correctness	234
6	Groups, Contexts, Communicators, and Caching	243
6.1	Introduction	243
6.1.1	Features Needed to Support Libraries	243
6.1.2	MPI's Support for Libraries	244
6.2	Basic Concepts	246
6.2.1	Groups	246
6.2.2	Contexts	246
6.2.3	Intra-Communicators	247
6.2.4	Predefined Intra-Communicators	247
6.3	Group Management	248
6.3.1	Group Accessors	248
6.3.2	Group Constructors	250
6.3.3	Group Destructors	255
6.4	Communicator Management	255
6.4.1	Communicator Accessors	255
6.4.2	Communicator Constructors	257
6.4.3	Communicator Destructors	268
6.4.4	Communicator Info	269
6.5	Motivating Examples	271
6.5.1	Current Practice #1	271
6.5.2	Current Practice #2	272
6.5.3	(Approximate) Current Practice #3	272
6.5.4	Example #4	273
6.5.5	Library Example #1	274
6.5.6	Library Example #2	276
6.6	Inter-Communication	278

6.6.1	Inter-communicator Accessors	280
6.6.2	Inter-communicator Operations	281
6.6.3	Inter-Communication Examples	283
	Example 1: Three-Group “Pipeline”	283
	Example 2: Three-Group “Ring”	285
6.7	Caching	286
6.7.1	Functionality	287
6.7.2	Communicators	288
6.7.3	Windows	293
6.7.4	Datatypes	296
6.7.5	Error Class for Invalid Keyval	300
6.7.6	Attributes Example	300
6.8	Naming Objects	302
6.9	Formalizing the Loosely Synchronous Model	306
6.9.1	Basic Statements	306
6.9.2	Models of Execution	307
	Static Communicator Allocation	307
	Dynamic Communicator Allocation	307
	The General Case	308
7	Process Topologies	309
7.1	Introduction	309
7.2	Virtual Topologies	310
7.3	Embedding in MPI	310
7.4	Overview of the Functions	311
7.5	Topology Constructors	313
	7.5.1 Cartesian Constructor	313
	7.5.2 Cartesian Convenience Functions	318
	7.5.3 Graph Constructor	321
	7.5.4 Distributed Graph Constructor	323
	7.5.5 Topology Inquiry Functions	330
	7.5.6 Cartesian Shift Coordinates	337
	7.5.7 Partitioning of Cartesian Structures	339
	7.5.8 Low-Level Topology Functions	339
7.6	Neighborhood Collective Communication	341
	7.6.1 Neighborhood Gather	342
	7.6.2 Neighbor Alltoall	346
7.7	Nonblocking Neighborhood Communication	351
	7.7.1 Nonblocking Neighborhood Gather	352
	7.7.2 Nonblocking Neighborhood Alltoall	354
7.8	Persistent Neighborhood Communication	357
	7.8.1 Persistent Neighborhood Gather	357
	7.8.2 Persistent Neighborhood Alltoall	359
7.9	An Application Example	362

8	MPI Environmental Management	367
8.1	Implementation Information	367
8.1.1	Version Inquiries	367
8.1.2	Environmental Inquiries	368
	Tag Values	369
	Host Rank	369
	IO Rank	369
	Clock Synchronization	370
	Inquire Processor Name	370
8.2	Memory Allocation	371
8.3	Error Handling	374
8.3.1	Error Handlers for Communicators	376
8.3.2	Error Handlers for Windows	378
8.3.3	Error Handlers for Files	379
8.3.4	Freeing Errorhandlers and Retrieving Error Strings	381
8.4	Error Codes and Classes	382
8.5	Error Classes, Error Codes, and Error Handlers	382
8.6	Timers and Synchronization	388
8.7	Startup	389
8.7.1	Allowing User Functions at Process Termination	395
8.7.2	Determining Whether MPI Has Finished	395
8.8	Portable MPI Process Startup	396
9	The Info Object	399
10	Process Creation and Management	405
10.1	Introduction	405
10.2	The Dynamic Process Model	406
10.2.1	Starting Processes	406
10.2.2	The Runtime Environment	406
10.3	Process Manager Interface	408
10.3.1	Processes in MPI	408
10.3.2	Starting Processes and Establishing Communication	408
10.3.3	Starting Multiple Executables and Establishing Communication	413
10.3.4	Reserved Keys	416
10.3.5	Spawn Example	417
	Manager-worker Example Using MPI_COMM_SPAWN	417
10.4	Establishing Communication	419
10.4.1	Names, Addresses, Ports, and All That	419
10.4.2	Server Routines	420
10.4.3	Client Routines	422
10.4.4	Name Publishing	424
10.4.5	Reserved Key Values	426
10.4.6	Client/Server Examples	426
	Simplest Example — Completely Portable.	426
	Ocean/Atmosphere — Relies on Name Publishing	427
	Simple Client-Server Example	427
10.5	Other Functionality	429

10.5.1	Universe Size	429
10.5.2	Singleton MPI_INIT	430
10.5.3	MPI_APPNUM	430
10.5.4	Releasing Connections	431
10.5.5	Another Way to Establish MPI Communication	433
11	One-Sided Communications	435
11.1	Introduction	435
11.2	Initialization	436
11.2.1	Window Creation	437
11.2.2	Window That Allocates Memory	439
11.2.3	Window That Allocates Shared Memory	441
11.2.4	Window of Dynamically Attached Memory	444
11.2.5	Window Destruction	447
11.2.6	Window Attributes	448
11.2.7	Window Info	449
11.3	Communication Calls	451
11.3.1	Put	452
11.3.2	Get	454
11.3.3	Examples for Communication Calls	455
11.3.4	Accumulate Functions	457
	Accumulate Function	458
	Get Accumulate Function	460
	Fetch and Op Function	461
	Compare and Swap Function	463
11.3.5	Request-based RMA Communication Operations	464
11.4	Memory Model	469
11.5	Synchronization Calls	470
11.5.1	Fence	474
11.5.2	General Active Target Synchronization	475
11.5.3	Lock	479
11.5.4	Flush and Sync	482
11.5.5	Assertions	484
11.5.6	Miscellaneous Clarifications	486
11.6	Error Handling	486
11.6.1	Error Handlers	486
11.6.2	Error Classes	486
11.7	Semantics and Correctness	487
11.7.1	Atomicity	495
11.7.2	Ordering	495
11.7.3	Progress	496
11.7.4	Registers and Compiler Optimizations	498
11.8	Examples	498

12 External Interfaces	509
12.1 Introduction	509
12.2 Generalized Requests	509
12.2.1 Examples	514
12.3 Associating Information with Status	516
12.4 MPI and Threads	518
12.4.1 General	518
12.4.2 Clarifications	519
12.4.3 Initialization	521
13 I/O	525
13.1 Introduction	525
13.1.1 Definitions	525
13.2 File Manipulation	527
13.2.1 Opening a File	527
13.2.2 Closing a File	529
13.2.3 Deleting a File	530
13.2.4 Resizing a File	531
13.2.5 Preallocating Space for a File	532
13.2.6 Querying the Size of a File	532
13.2.7 Querying File Parameters	533
13.2.8 File Info	534
Reserved File Hints	536
13.3 File Views	538
13.4 Data Access	541
13.4.1 Data Access Routines	541
Positioning	541
Synchronism	542
Coordination	542
Data Access Conventions	543
13.4.2 Data Access with Explicit Offsets	543
13.4.3 Data Access with Individual File Pointers	548
13.4.4 Data Access with Shared File Pointers	556
Noncollective Operations	557
Collective Operations	559
Seek	560
13.4.5 Split Collective Data Access Routines	562
13.5 File Interoperability	568
13.5.1 Datatypes for File Interoperability	570
13.5.2 External Data Representation: “external32”	572
13.5.3 User-Defined Data Representations	573
Extent Callback	575
Datarep Conversion Functions	575
13.5.4 Matching Data Representations	578
13.6 Consistency and Semantics	578
13.6.1 File Consistency	578
13.6.2 Random Access vs. Sequential Files	581
13.6.3 Progress	582

13.6.4	Collective File Operations	582
13.6.5	Nonblocking Collective File Operations	582
13.6.6	Type Matching	583
13.6.7	Miscellaneous Clarifications	583
13.6.8	MPI_Offset Type	583
13.6.9	Logical vs. Physical File Layout	584
13.6.10	File Size	584
13.6.11	Examples	584
	Asynchronous I/O	587
13.7	I/O Error Handling	589
13.8	I/O Error Classes	589
13.9	Examples	589
	13.9.1 Double Buffering with Split Collective I/O	589
	13.9.2 Subarray Filetype Constructor	592
14	Tool Support	595
14.1	Introduction	595
14.2	Profiling Interface	595
	14.2.1 Requirements	595
	14.2.2 Discussion	596
	14.2.3 Logic of the Design	596
	14.2.4 Miscellaneous Control of Profiling	597
	14.2.5 Profiler Implementation Example	598
	14.2.6 MPI Library Implementation Example	598
	Systems with Weak Symbols	598
	Systems Without Weak Symbols	599
	14.2.7 Complications	599
	Multiple Counting	599
	Linker Oddities	600
	Fortran Support Methods	600
	14.2.8 Multiple Levels of Interception	600
14.3	The MPI Tool Information Interface	601
	14.3.1 Verbosity Levels	602
	14.3.2 Binding MPI Tool Information Interface Variables to MPI Objects	602
	14.3.3 Convention for Returning Strings	603
	14.3.4 Initialization and Finalization	604
	14.3.5 Datatype System	605
	14.3.6 Control Variables	607
	Control Variable Query Functions	607
	Example: Printing All Control Variables	610
	Handle Allocation and Deallocation	611
	Control Variable Access Functions	612
	Example: Reading the Value of a Control Variable	613
	14.3.7 Performance Variables	614
	Performance Variable Classes	614
	Performance Variable Query Functions	616
	Performance Experiment Sessions	619
	Handle Allocation and Deallocation	619

Starting and Stopping of Performance Variables	621
Performance Variable Access Functions	622
Example: Tool to Detect Receives with Long Unexpected Message Queues	624
14.3.8 Variable Categorization	626
Category Query Functions	627
Category Member Query Functions	629
14.3.9 Return Codes for the MPI Tool Information Interface	630
14.3.10 Profiling Interface	631
15 Deprecated Interfaces	633
15.1 Deprecated since MPI-2.0	633
15.2 Deprecated since MPI-2.2	636
15.3 Deprecated since MPI-3.2	636
16 Removed Interfaces	637
16.1 Removed MPI-1 Bindings	637
16.1.1 Overview	637
16.1.2 Removed MPI-1 Functions	637
16.1.3 Removed MPI-1 Datatypes	637
16.1.4 Removed MPI-1 Constants	637
16.1.5 Removed MPI-1 Callback Prototypes	638
16.2 C++ Bindings	638
17 Backward Incompatibilities	639
17.1 Backward Incompatible since MPI-3.2	639
18 Language Bindings	641
18.1 Fortran Support	641
18.1.1 Overview	641
18.1.2 Fortran Support Through the <code>mpi_f08</code> Module	642
18.1.3 Fortran Support Through the <code>mpi</code> Module	645
18.1.4 Fortran Support Through the <code>mpif.h</code> Include File	647
18.1.5 Interface Specifications, Procedure Names, and the Profiling Interface	648
18.1.6 MPI for Different Fortran Standard Versions	653
18.1.7 Requirements on Fortran Compilers	657
18.1.8 Additional Support for Fortran Register-Memory-Synchronization .	658
18.1.9 Additional Support for Fortran Numeric Intrinsic Types	659
Parameterized Datatypes with Specified Precision and Exponent Range	660
Support for Size-specific MPI Datatypes	663
Communication With Size-specific Types	666
18.1.10 Problems With Fortran Bindings for MPI	667
18.1.11 Problems Due to Strong Typing	669
18.1.12 Problems Due to Data Copying and Sequence Association with Sub- script Triplets	669
18.1.13 Problems Due to Data Copying and Sequence Association with Vector Subscripts	672
18.1.14 Special Constants	673

18.1.15 Fortran Derived Types	673
18.1.16 Optimization Problems, an Overview	675
18.1.17 Problems with Code Movement and Register Optimization	676
Nonblocking Operations	676
Persistent Operations	677
One-sided Communication	677
MPI_BOTTOM and Combining Independent Variables in Datatypes	677
Solutions	677
The Fortran ASYNCHRONOUS Attribute	679
Calling MPI_F_SYNC_REG	680
A User Defined Routine Instead of MPI_F_SYNC_REG	681
Module Variables and COMMON Blocks	682
The (Poorly Performing) Fortran VOLATILE Attribute	682
The Fortran TARGET Attribute	682
18.1.18 Temporary Data Movement and Temporary Memory Modification	682
18.1.19 Permanent Data Movement	684
18.1.20 Comparison with C	684
18.2 Language Interoperability	689
18.2.1 Introduction	689
18.2.2 Assumptions	689
18.2.3 Initialization	689
18.2.4 Transfer of Handles	690
18.2.5 Status	692
18.2.6 MPI Opaque Objects	694
Datatypes	695
Callback Functions	696
Error Handlers	696
Reduce Operations	697
18.2.7 Attributes	697
18.2.8 Extra-State	701
18.2.9 Constants	701
18.2.10 Interlanguage Communication	702
A Language Bindings Summary	705
A.1 Defined Values and Handles	705
A.1.1 Defined Constants	705
A.1.2 Types	719
A.1.3 Prototype Definitions	720
C Bindings	720
Fortran 2008 Bindings with the mpi_f08 Module	721
Fortran Bindings with mpif.h or the mpi Module	723
A.1.4 Deprecated Prototype Definitions	725
A.1.5 Info Keys	726
A.1.6 Info Values	727
A.2 C Bindings	728
A.2.1 Point-to-Point Communication C Bindings	728
A.2.2 Datatypes C Bindings	730
A.2.3 Collective Communication C Bindings	732

A.2.4	Groups, Contexts, Communicators, and Caching C Bindings	736
A.2.5	Process Topologies C Bindings	738
A.2.6	MPI Environmental Management C Bindings	741
A.2.7	The Info Object C Bindings	742
A.2.8	Process Creation and Management C Bindings	743
A.2.9	One-Sided Communications C Bindings	743
A.2.10	External Interfaces C Bindings	745
A.2.11	I/O C Bindings	746
A.2.12	Language Bindings C Bindings	748
A.2.13	Tools / Profiling Interface C Bindings	749
A.2.14	Tools / MPI Tool Information Interface C Bindings	750
A.2.15	Deprecated C Bindings	751
A.3	Fortran 2008 Bindings with the mpi_f08 Module	752
A.3.1	Point-to-Point Communication Fortran 2008 Bindings	752
A.3.2	Datatypes Fortran 2008 Bindings	757
A.3.3	Collective Communication Fortran 2008 Bindings	762
A.3.4	Groups, Contexts, Communicators, and Caching Fortran 2008 Bindings	773
A.3.5	Process Topologies Fortran 2008 Bindings	780
A.3.6	MPI Environmental Management Fortran 2008 Bindings	786
A.3.7	The Info Object Fortran 2008 Bindings	789
A.3.8	Process Creation and Management Fortran 2008 Bindings	790
A.3.9	One-Sided Communications Fortran 2008 Bindings	791
A.3.10	External Interfaces Fortran 2008 Bindings	797
A.3.11	I/O Fortran 2008 Bindings	797
A.3.12	Language Bindings Fortran 2008 Bindings	805
A.3.13	Tools / Profiling Interface Fortran 2008 Bindings	806
A.4	Fortran Bindings with mpif.h or the mpi Module	807
A.4.1	Point-to-Point Communication Fortran Bindings	807
A.4.2	Datatypes Fortran Bindings	810
A.4.3	Collective Communication Fortran Bindings	812
A.4.4	Groups, Contexts, Communicators, and Caching Fortran Bindings .	818
A.4.5	Process Topologies Fortran Bindings	822
A.4.6	MPI Environmental Management Fortran Bindings	826
A.4.7	The Info Object Fortran Bindings	828
A.4.8	Process Creation and Management Fortran Bindings	829
A.4.9	One-Sided Communications Fortran Bindings	830
A.4.10	External Interfaces Fortran Bindings	834
A.4.11	I/O Fortran Bindings	834
A.4.12	Language Bindings Fortran Bindings	839
A.4.13	Tools / Profiling Interface Fortran Bindings	839
A.4.14	Deprecated Fortran Bindings	840
B	Change-Log	841
B.1	Changes from Version 3.1 to Version 3.2	841
B.1.1	Changes in MPI-3.2	841
B.2	Changes from Version 3.0 to Version 3.1	842
B.2.1	Fixes to Errata in Previous Versions of MPI	842
B.2.2	Changes in MPI-3.1	844

B.3	Changes from Version 2.2 to Version 3.0	845
B.3.1	Fixes to Errata in Previous Versions of MPI	845
B.3.2	Changes in MPI-3.0	846
B.4	Changes from Version 2.1 to Version 2.2	851
B.5	Changes from Version 2.0 to Version 2.1	853
Bibliography		859
General Index		864
Examples Index		869
MPI Constant and Predefined Handle Index		872
MPI Declarations Index		877
MPI Callback Function Prototype Index		878
MPI Function Index		879

List of Figures

5.1	Collective communications, an overview	145
5.2	Intercommunicator allgather	148
5.3	Intercommunicator reduce-scatter	149
5.4	Gather example	155
5.5	Gatherv example with strides	156
5.6	Gatherv example, 2-dimensional	157
5.7	Gatherv example, 2-dimensional, subarrays with different sizes	158
5.8	Gatherv example, 2-dimensional, subarrays with different sizes and strides	160
5.9	Scatter example	165
5.10	Scatterv example with strides	165
5.11	Scatterv example with different strides and counts	166
5.12	Race conditions with point-to-point and collective communications	237
5.13	Overlapping Communicators Example	241
6.1	Intercommunicator creation using MPI_COMM_CREATE	262
6.2	Intercommunicator construction with MPI_COMM_SPLIT	266
6.3	Three-group pipeline	284
6.4	Three-group ring	285
7.1	Communication model: The $\text{dim_weights}[i]=w_i$ express the total communication costs in the direction of dimension i , i.e., accumulated over all MPI processes that are part of the same surface in this direction. The figure to the right shows all communications in the positive and negative direction of dimension 1. The communication costs of one process in direction i is therefore $w_i / \prod_{j,j \neq i} d_j$ with $\text{dims}[i]=d_i$, which are returned from this procedure.	315
7.2	Example for the calculation of the weights. The data sizes g_i express the three dimensions of the total application data mesh. The virtual process grid dimensions are expressed by d_i . The figure shows the division of the total application mesh into its subdomains. The value h_i represents the halo width in a given direction when the 2-dimensional side of a subdomain is communicated to the neighbor process in that direction.	316

7.3	Example with a <code>comm_old</code> with 48 processes, <code>ndims=2</code> , <code>dim_weights=(1./4, 1./12)</code> , and <code>nsplit_types=2</code> and <code>split_types</code> , e.g., splitting into ccNUMA nodes and those into CPUs, and here with 4 cores per CPU and 4 CPUs per node. The <code>level_comms[i]</code> show this splitting of <code>comm_old</code> into hierarchical subcommunicators. The renumbering in <code>comm_cart</code> should first minimize the communication A (here, e.g., the communication between the ccNUMA nodes), then B (here, e.g., the CPU to CPU communication), and last C (here, e.g., the core to core communication)	317
7.4	Example with 24 shared memory nodes (e.g., ccNUMA nodes), 4 NUMA-nodes (e.g., CPUs) per node and 8 MPI processes (e.g., on cores) per NUMA-node. The figure shows the 3-dimensional distribution calculated by <code>MPI_CART_CREATE_WEIGHTED</code> based on weight values (1/12, 1/16, 1/8).	318
7.5	Neighborhood gather communication example.	344
7.6	Set-up of process structure for two-dimensional parallel Poisson solver.	363
7.7	Communication routine with local data copying and sparse neighborhood all-to-all.	364
7.8	Communication routine with sparse neighborhood all-to-all-w and without local data copying.	365
7.9	Two-dimensional parallel Poisson solver with persistent sparse neighborhood all-to-all-w and without local data copying.	366
11.1	Schematic description of the public/private window operations in the <code>MPI_WIN_SEPARATE</code> memory model for two overlapping windows.	470
11.2	Active target communication	472
11.3	Active target communication, with weak synchronization	473
11.4	Passive target communication	474
11.5	Active target communication with several processes	478
11.6	Symmetric communication	496
11.7	Deadlock situation	497
11.8	No deadlock	497
13.1	Etypes and filetypes	526
13.2	Partitioning a file among parallel processes	526
13.3	Displacements	539
13.4	Example array file layout	592
13.5	Example local array filetype for process 1	593
18.1	Status conversion routines	693

1
2
3
4
5
6
7
8
9
10
11
12
13
14
15
16
17
18
19
20
21
22
23
24
25
26
27
28
29
30
31
32
33
34
35
36
37
38
39
40
41
42
43
44
45
46
47
48

List of Tables

2.1	Deprecated and Removed constructs	23
3.1	Predefined MPI datatypes corresponding to Fortran datatypes	27
3.2	Predefined MPI datatypes corresponding to C datatypes	28
3.3	Predefined MPI datatypes corresponding to both C and Fortran datatypes	29
3.4	Predefined MPI datatypes corresponding to C++ datatypes	29
4.1	combiner values returned from MPI_TYPE_GET_ENVELOPE	119
6.1	MPI_COMM_* Function Behavior (in Inter-Communication Mode)	280
8.1	Error classes (Part 1)	383
8.2	Error classes (Part 2)	384
11.1	C types of attribute value argument to MPI_WIN_GET_ATTR and MPI_WIN_SET_ATTR.	448
11.2	Error classes in one-sided communication routines	486
13.1	Data access routines	541
13.2	“external32” sizes of predefined datatypes	574
13.3	I/O Error Classes	590
14.1	MPI tool information interface verbosity levels	602
14.2	Constants to identify associations of variables	603
14.3	MPI datatypes that can be used by the MPI tool information interface	605
14.4	Scopes for control variables	609
14.5	Return codes used in functions of the MPI tool information interface	632
16.1	Removed MPI-1 functions and their replacements	637
16.2	Removed MPI-1 datatypes and their replacements	638
16.3	Removed MPI-1 constants	638
16.4	Removed MPI-1 callback prototypes and their replacements	638
18.1	Specific Fortran procedure names and related calling conventions	649
18.2	Occurrence of Fortran optimization problems	675

Acknowledgments

This document is the product of a number of distinct efforts in three distinct phases: one for each of MPI-1, MPI-2, and MPI-3. This section describes these in historical order, starting with MPI-1. Some efforts, particularly parts of MPI-2, had distinct groups of individuals associated with them, and these efforts are detailed separately.

This document represents the work of many people who have served on the MPI Forum. The meetings have been attended by dozens of people from many parts of the world. It is the hard and dedicated work of this group that has led to the MPI standard.

The technical development was carried out by subgroups, whose work was reviewed by the full committee. During the period of development of the Message-Passing Interface (MPI), many people helped with this effort.

Those who served as primary coordinators in MPI-1.0 and MPI-1.1 are:

- Jack Dongarra, David Walker, Conveners and Meeting Chairs
- Ewing Lusk, Bob Knighten, Minutes
- Marc Snir, William Gropp, Ewing Lusk, Point-to-Point Communication
- Al Geist, Marc Snir, Steve Otto, Collective Communication
- Steve Otto, Editor
- Rolf Hempel, Process Topologies
- Ewing Lusk, Language Binding
- William Gropp, Environmental Management
- James Cownie, Profiling
- Tony Skjellum, Lyndon Clarke, Marc Snir, Richard Littlefield, Mark Sears, Groups, Contexts, and Communicators
- Steven Huss-Lederman, Initial Implementation Subset

The following list includes some of the active participants in the MPI-1.0 and MPI-1.1 process not mentioned above.

1	Ed Anderson	Robert Babb	Joe Baron	Eric Barszcz
2	Scott Berryman	Rob Bjornson	Nathan Doss	Anne Elster
3	Jim Feeney	Vince Fernando	Sam Fineberg	Jon Flower
4	Daniel Frye	Ian Glendinning	Adam Greenberg	Robert Harrison
5	Leslie Hart	Tom Haupt	Don Heller	Tom Henderson
6	Alex Ho	C.T. Howard Ho	Gary Howell	John Kapenga
7	James Kohl	Susan Krauss	Bob Leary	Arthur Maccabe
8	Peter Madams	Alan Mainwaring	Oliver McBryan	Phil McKinley
9	Charles Mosher	Dan Nessett	Peter Pacheco	Howard Palmer
10	Paul Pierce	Sanjay Ranka	Peter Rigsbee	Arch Robison
11	Erich Schikuta	Ambuj Singh	Alan Sussman	Robert Tomlinson
12	Robert G. Voigt	Dennis Weeks	Stephen Wheat	Steve Zenith

13
14 The University of Tennessee and Oak Ridge National Laboratory made the draft avail-
15 able by anonymous FTP mail servers and were instrumental in distributing the document.

16 The work on the MPI-1 standard was supported in part by ARPA and NSF under grant
17 ASC-9310330, the National Science Foundation Science and Technology Center Cooperative
18 Agreement No. CCR-8809615, and by the Commission of the European Community through
19 Esprit project P6643 (PPPE).

20
21 **MPI-1.2 and MPI-2.0:**

22 Those who served as primary coordinators in MPI-1.2 and MPI-2.0 are:

- 23 • Ewing Lusk, Convener and Meeting Chair
- 24 • Steve Huss-Lederman, Editor
- 25 • Ewing Lusk, Miscellany
- 26 • Bill Saphir, Process Creation and Management
- 27 • Marc Snir, One-Sided Communications
- 28 • Bill Gropp and Anthony Skjellum, Extended Collective Operations
- 29 • Steve Huss-Lederman, External Interfaces
- 30 • Bill Nitzberg, I/O
- 31 • Andrew Lumsdaine, Bill Saphir, and Jeff Squyres, Language Bindings
- 32 • Anthony Skjellum and Arkady Kanevsky, Real-Time

33
34
35
36
37
38
39
40
41 The following list includes some of the active participants who attended MPI-2 Forum
42 meetings and are not mentioned above.

43
44
45
46
47
48

Greg Astfalk	Robert Babb	Ed Benson	Rajesh Bordawekar	1
Pete Bradley	Peter Brennan	Ron Brightwell	Maciej Brodowicz	2
Eric Brunner	Greg Burns	Margaret Cahir	Pang Chen	3
Ying Chen	Albert Cheng	Yong Cho	Joel Clark	4
Lyndon Clarke	Laurie Costello	Dennis Cottel	Jim Cownie	5
Zhenqian Cui	Suresh Damodaran-Kamal		Raja Daoud	6
Judith Devaney	David DiNucci	Doug Doefler	Jack Dongarra	7
Terry Dontje	Nathan Doss	Anne Elster	Mark Fallon	8
Karl Feind	Sam Fineberg	Craig Fischberg	Stephen Fleischman	9
Ian Foster	Hubertus Franke	Richard Frost	Al Geist	10
Robert George	David Greenberg	John Hagedorn	Kei Harada	11
Leslie Hart	Shane Hebert	Rolf Hempel	Tom Henderson	12
Alex Ho	Hans-Christian Hoppe	Joefon Jann	Terry Jones	13
Karl Kesselman	Koichi Konishi	Susan Kraus	Steve Kubica	14
Steve Landherr	Mario Lauria	Mark Law	Juan Leon	15
Lloyd Lewins	Ziyang Lu	Bob Madahar	Peter Madams	16
John May	Oliver McBryan	Brian McCandless	Tyce McLarty	17
Thom McMahon	Harish Nag	Nick Nevin	Jarek Nieplocha	18
Ron Oldfield	Peter Ossadnik	Steve Otto	Peter Pacheco	19
Yoonho Park	Perry Partow	Pratap Pattnaik	Elsie Pierce	20
Paul Pierce	Heidi Poxon	Jean-Pierre Prost	Boris Protopopov	21
James Pruyve	Rolf Rabenseifner	Joe Rieken	Peter Rigsbee	22
Tom Robey	Anna Rounbehler	Nobutoshi Sagawa	Arindam Saha	23
Eric Salo	Darren Sanders	Eric Sharakan	Andrew Sherman	24
Fred Shirley	Lance Shuler	A. Gordon Smith	Ian Stockdale	25
David Taylor	Stephen Taylor	Greg Tensa	Rajeev Thakur	26
Marydell Tholburn	Dick Treumann	Simon Tsang	Manuel Ujaldon	27
David Walker	Jerrell Watts	Klaus Wolf	Parkson Wong	28
Dave Wright				29

The MPI Forum also acknowledges and appreciates the valuable input from people via e-mail and in person.

The following institutions supported the MPI-2 effort through time and travel support for the people listed above.

Argonne National Laboratory	35
Bolt, Beranek, and Newman	36
California Institute of Technology	37
Center for Computing Sciences	38
Convex Computer Corporation	39
Cray Research	40
Digital Equipment Corporation	41
Dolphin Interconnect Solutions, Inc.	42
Edinburgh Parallel Computing Centre	43
General Electric Company	44
German National Research Center for Information Technology	45
Hewlett-Packard	46
Hitachi	47
Hughes Aircraft Company	48

1 Intel Corporation
2 International Business Machines
3 Khoral Research
4 Lawrence Livermore National Laboratory
5 Los Alamos National Laboratory
6 MPI Software Technology, Inc.
7 Mississippi State University
8 NEC Corporation
9 National Aeronautics and Space Administration
10 National Energy Research Scientific Computing Center
11 National Institute of Standards and Technology
12 National Oceanic and Atmospheric Administration
13 Oak Ridge National Laboratory
14 The Ohio State University
15 PALLAS GmbH
16 Pacific Northwest National Laboratory
17 Pratt & Whitney
18 San Diego Supercomputer Center
19 Sanders, A Lockheed-Martin Company
20 Sandia National Laboratories
21 Schlumberger
22 Scientific Computing Associates, Inc.
23 Silicon Graphics Incorporated
24 Sky Computers
25 Sun Microsystems Computer Corporation
26 Syracuse University
27 The MITRE Corporation
28 Thinking Machines Corporation
29 United States Navy
30 University of Colorado
31 University of Denver
32 University of Houston
33 University of Illinois
34 University of Maryland
35 University of Notre Dame
36 University of San Francisco
37 University of Stuttgart Computing Center
38 University of Wisconsin

39 MPI-2 operated on a very tight budget (in reality, it had no budget when the first
40 meeting was announced). Many institutions helped the MPI-2 effort by supporting the
41 efforts and travel of the members of the MPI Forum. Direct support was given by NSF and
42 DARPA under NSF contract CDA-9115428 for travel by U.S. academic participants and
43 Esprit under project HPC Standards (21111) for European participants.
44
45
46
47
48

MPI-1.3 and MPI-2.1:

The editors and organizers of the combined documents have been:

- Richard Graham, Convener and Meeting Chair
- Jack Dongarra, Steering Committee
- Al Geist, Steering Committee
- Bill Gropp, Steering Committee
- Rainer Keller, Merge of MPI-1.3
- Andrew Lumsdaine, Steering Committee
- Ewing Lusk, Steering Committee, MPI-1.1-Errata (Oct. 12, 1998) MPI-2.1-Errata Ballots 1, 2 (May 15, 2002)
- Rolf Rabenseifner, Steering Committee, Merge of MPI-2.1 and MPI-2.1-Errata Ballots 3, 4 (2008)

All chapters have been revisited to achieve a consistent MPI-2.1 text. Those who served as authors for the necessary modifications are:

- Bill Gropp, Front matter, Introduction, and Bibliography
- Richard Graham, Point-to-Point Communication
- Adam Moody, Collective Communication
- Richard Treumann, Groups, Contexts, and Communicators
- Jesper Larsson Träff, Process Topologies, Info-Object, and One-Sided Communications
- George Bosilca, Environmental Management
- David Solt, Process Creation and Management
- Bronis R. de Supinski, External Interfaces, and Profiling
- Rajeev Thakur, I/O
- Jeffrey M. Squyres, Language Bindings and MPI-2.1 Secretary
- Rolf Rabenseifner, Deprecated Functions and Annex Change-Log
- Alexander Supalov and Denis Nagorny, Annex Language Bindings

The following list includes some of the active participants who attended MPI-2 Forum meetings and in the e-mail discussions of the errata items and are not mentioned above.

1	Pavan Balaji	Purushotham V. Bangalore	Brian Barrett
2	Richard Barrett	Christian Bell	Robert Blackmore
3	Gil Bloch	Ron Brightwell	Jeffrey Brown
4	Darius Buntinas	Jonathan Carter	Nathan DeBardeleben
5	Terry Dontje	Gabor Dozsa	Edric Ellis
6	Karl Feind	Edgar Gabriel	Patrick Geoffray
7	David Gingold	Dave Goodell	Erez Haba
8	Robert Harrison	Thomas Herauld	Steve Hodson
9	Torsten Hoefler	Joshua Hursey	Yann Kalemkarian
10	Matthew Koop	Quincey Koziol	Sameer Kumar
11	Miron Livny	Kannan Narasimhan	Mark Pagel
12	Avneesh Pant	Steve Poole	Howard Pritchard
13	Craig Rasmussen	Hubert Ritzdorf	Rob Ross
14	Tony Skjellum	Brian Smith	Vinod Tipparaju
15	Jesper Larsson Träff	Keith Underwood	

16
17 The MPI Forum also acknowledges and appreciates the valuable input from people via
18 e-mail and in person.

19 The following institutions supported the MPI-2 effort through time and travel support
20 for the people listed above.

- 21 Argonne National Laboratory
- 22 Bull
- 23 Cisco Systems, Inc.
- 24 Cray Inc.
- 25 The HDF Group
- 26 Hewlett-Packard
- 27 IBM T.J. Watson Research
- 28 Indiana University
- 29 Institut National de Recherche en Informatique et Automatique (INRIA)
- 30 Intel Corporation
- 31 Lawrence Berkeley National Laboratory
- 32 Lawrence Livermore National Laboratory
- 33 Los Alamos National Laboratory
- 34 Mathworks
- 35 Mellanox Technologies
- 36 Microsoft
- 37 Myricom
- 38 NEC Laboratories Europe, NEC Europe Ltd.
- 39 Oak Ridge National Laboratory
- 40 The Ohio State University
- 41 Pacific Northwest National Laboratory
- 42 QLogic Corporation
- 43 Sandia National Laboratories
- 44 SiCortex
- 45 Silicon Graphics Incorporated
- 46 Sun Microsystems, Inc.
- 47 University of Alabama at Birmingham
- 48 University of Houston

University of Illinois at Urbana-Champaign
University of Stuttgart, High Performance Computing Center Stuttgart (HLRS)
University of Tennessee, Knoxville
University of Wisconsin

Funding for the MPI Forum meetings was partially supported by award #CCF-0816909 from the National Science Foundation. In addition, the HDF Group provided travel support for one U.S. academic.

MPI-2.2:

All chapters have been revisited to achieve a consistent MPI-2.2 text. Those who served as authors for the necessary modifications are:

- William Gropp, Front matter, Introduction, and Bibliography; MPI-2.2 chair.
- Richard Graham, Point-to-Point Communication and Datatypes
- Adam Moody, Collective Communication
- Torsten Hoefler, Collective Communication and Process Topologies
- Richard Treumann, Groups, Contexts, and Communicators
- Jesper Larsson Träff, Process Topologies, Info-Object and One-Sided Communications
- George Bosilca, Datatypes and Environmental Management
- David Solt, Process Creation and Management
- Bronis R. de Supinski, External Interfaces, and Profiling
- Rajeev Thakur, I/O
- Jeffrey M. Squyres, Language Bindings and MPI-2.2 Secretary
- Rolf Rabenseifner, Deprecated Functions, Annex Change-Log, and Annex Language Bindings
- Alexander Supalov, Annex Language Bindings

The following list includes some of the active participants who attended MPI-2 Forum meetings and in the e-mail discussions of the errata items and are not mentioned above.

1	Pavan Balaji	Purushotham V. Bangalore	Brian Barrett
2	Richard Barrett	Christian Bell	Robert Blackmore
3	Gil Bloch	Ron Brightwell	Greg Bronevetsky
4	Jeff Brown	Darius Buntinas	Jonathan Carter
5	Nathan DeBardeleben	Terry Dontje	Gabor Dozsa
6	Edric Ellis	Karl Feind	Edgar Gabriel
7	Patrick Geoffray	Johann George	David Gingold
8	David Goodell	Erez Haba	Robert Harrison
9	Thomas Herault	Marc-André Hermanns	Steve Hodson
10	Joshua Hursey	Yutaka Ishikawa	Bin Jia
11	Hideyuki Jitsumoto	Terry Jones	Yann Kalemkarian
12	Ranier Keller	Matthew Koop	Quincey Koziol
13	Manojkumar Krishnan	Sameer Kumar	Miron Livny
14	Andrew Lumsdaine	Miao Luo	Ewing Lusk
15	Timothy I. Mattox	Kannan Narasimhan	Mark Pagel
16	Avneesh Pant	Steve Poole	Howard Pritchard
17	Craig Rasmussen	Hubert Ritzdorf	Rob Ross
18	Martin Schulz	Pavel Shamis	Galen Shipman
19	Christian Siebert	Anthony Skjellum	Brian Smith
20	Naoki Sueyasu	Vinod Tipparaju	Keith Underwood
21	Rolf Vandevaart	Abhinav Vishnu	Weikuan Yu

22
23 The MPI Forum also acknowledges and appreciates the valuable input from people via
24 e-mail and in person.

25 The following institutions supported the MPI-2.2 effort through time and travel support
26 for the people listed above.

- 27 Argonne National Laboratory
- 28 Auburn University
- 29 Bull
- 30 Cisco Systems, Inc.
- 31 Cray Inc.
- 32 Forschungszentrum Jülich
- 33 Fujitsu
- 34 The HDF Group
- 35 Hewlett-Packard
- 36 International Business Machines
- 37 Indiana University
- 38 Institut National de Recherche en Informatique et Automatique (INRIA)
- 39 Institute for Advanced Science & Engineering Corporation
- 40 Intel Corporation
- 41 Lawrence Berkeley National Laboratory
- 42 Lawrence Livermore National Laboratory
- 43 Los Alamos National Laboratory
- 44 Mathworks
- 45 Mellanox Technologies
- 46 Microsoft
- 47 Myricom
- 48 NEC Corporation

Oak Ridge National Laboratory	1
The Ohio State University	2
Pacific Northwest National Laboratory	3
QLogic Corporation	4
RunTime Computing Solutions, LLC	5
Sandia National Laboratories	6
SiCortex, Inc.	7
Silicon Graphics Inc.	8
Sun Microsystems, Inc.	9
Tokyo Institute of Technology	10
University of Alabama at Birmingham	11
University of Houston	12
University of Illinois at Urbana-Champaign	13
University of Stuttgart, High Performance Computing Center Stuttgart (HLRS)	14
University of Tennessee, Knoxville	15
University of Tokyo	16
University of Wisconsin	17

Funding for the MPI Forum meetings was partially supported by awards #CCF-0816909 and #CCF-1144042 from the National Science Foundation. In addition, the HDF Group provided travel support for one U.S. academic.

MPI-3.0:

MPI-3.0 is a significant effort to extend and modernize the MPI Standard. The editors and organizers of the MPI-3.0 have been:

- William Gropp, Steering committee, Front matter, Introduction, Groups, Contexts, and Communicators, One-Sided Communications, and Bibliography
- Richard Graham, Steering committee, Point-to-Point Communication, Meeting Convener, and MPI-3.0 chair
- Torsten Hoefler, Collective Communication, One-Sided Communications, and Process Topologies
- George Bosilca, Datatypes and Environmental Management
- David Solt, Process Creation and Management
- Bronis R. de Supinski, External Interfaces and Tool Support
- Rajeev Thakur, I/O and One-Sided Communications
- Darius Buntinas, Info Object
- Jeffrey M. Squyres, Language Bindings and MPI-3.0 Secretary
- Rolf Rabenseifner, Steering committee, Terms and Definitions, and Fortran Bindings, Deprecated Functions, Annex Change-Log, and Annex Language Bindings
- Craig Rasmussen, Fortran Bindings

1 The following list includes some of the active participants who attended MPI-3 Forum
2 meetings or participated in the e-mail discussions and who are not mentioned above.

3			
4	Tatsuya Abe	Tomoya Adachi	Sadaf Alam
5	Reinhold Bader	Pavan Balaji	Purushotham V. Bangalore
6	Brian Barrett	Richard Barrett	Robert Blackmore
7	Aurelien Bouteiller	Ron Brightwell	Greg Bronevetsky
8	Jed Brown	Darius Buntinas	Devendar Bureddy
9	Arno Candel	George Carr	Mohamad Chaarawi
10	Raghunath Raja Chandrasekar	James Dinan	Terry Dontje
11	Edgar Gabriel	Balazs Gerofi	Brice Goglin
12	David Goodell	Manjunath Gorentla	Erez Haba
13	Jeff Hammond	Thomas Herault	Marc-André Hermanns
14	Jennifer Herrett-Skjellum	Nathan Hjelm	Atsushi Hori
15	Joshua Hursey	Marty Itzkowitz	Yutaka Ishikawa
16	Nysal Jan	Bin Jia	Hideyuki Jitsumoto
17	Yann Kalemkarian	Krishna Kandalla	Takahiro Kawashima
18	Chulho Kim	Dries Kimpe	Christof Klausecker
19	Alice Koniges	Quincey Koziol	Dieter Kranzlmuller
20	Manojkumar Krishnan	Sameer Kumar	Eric Lantz
21	Jay Lofstead	Bill Long	Andrew Lumsdaine
22	Miao Luo	Ewing Lusk	Adam Moody
23	Nick M. Maclaren	Amith Mamidala	Guillaume Mercier
24	Scott McMillan	Douglas Miller	Kathryn Mohror
25	Tim Murray	Tomotake Nakamura	Takeshi Nanri
26	Steve Oyanagi	Mark Pagel	Swann Perarnau
27	Sreeram Potluri	Howard Pritchard	Rolf Riesen
28	Hubert Ritzdorf	Kuninobu Sasaki	Timo Schneider
29	Martin Schulz	Gilad Shainer	Christian Siebert
30	Anthony Skjellum	Brian Smith	Marc Snir
31	Raffaele Giuseppe Solca	Shinji Sumimoto	Alexander Supalov
32	Sayantana Sur	Masamichi Takagi	Fabian Tillier
33	Vinod Tipparaju	Jesper Larsson Träff	Richard Treumann
34	Keith Underwood	Rolf Vandevaart	Anh Vo
35	Abhinav Vishnu	Min Xie	Enqiang Zhou

36
37 The MPI Forum also acknowledges and appreciates the valuable input from people via
38 e-mail and in person.

39 The MPI Forum also thanks those that provided feedback during the public comment
40 period. In particular, the Forum would like to thank Jeremiah Wilcock for providing detailed
41 comments on the entire draft standard.

42 The following institutions supported the MPI-3 effort through time and travel support
43 for the people listed above.

44 Argonne National Laboratory
45 Bull
46 Cisco Systems, Inc.
47 Cray Inc.
48 CSCS

ETH Zurich	1
Fujitsu Ltd.	2
German Research School for Simulation Sciences	3
The HDF Group	4
Hewlett-Packard	5
International Business Machines	6
IBM India Private Ltd	7
Indiana University	8
Institut National de Recherche en Informatique et Automatique (INRIA)	9
Institute for Advanced Science & Engineering Corporation	10
Intel Corporation	11
Lawrence Berkeley National Laboratory	12
Lawrence Livermore National Laboratory	13
Los Alamos National Laboratory	14
Mellanox Technologies, Inc.	15
Microsoft Corporation	16
NEC Corporation	17
National Oceanic and Atmospheric Administration, Global Systems Division	18
NVIDIA Corporation	19
Oak Ridge National Laboratory	20
The Ohio State University	21
Oracle America	22
Platform Computing	23
RIKEN AICS	24
RunTime Computing Solutions, LLC	25
Sandia National Laboratories	26
Technical University of Chemnitz	27
Tokyo Institute of Technology	28
University of Alabama at Birmingham	29
University of Chicago	30
University of Houston	31
University of Illinois at Urbana-Champaign	32
University of Stuttgart, High Performance Computing Center Stuttgart (HLRS)	33
University of Tennessee, Knoxville	34
University of Tokyo	35

Funding for the MPI Forum meetings was partially supported by awards #CCF-0816909 and #CCF-1144042 from the National Science Foundation. In addition, the HDF Group and Sandia National Laboratories provided travel support for one U.S. academic each.

MPI-3.1:

MPI-3.1 is a minor update to the MPI Standard.
The editors and organizers of the MPI-3.1 have been:

- Martin Schulz, MPI-3.1 chair
- William Gropp, Steering committee, Front matter, Introduction, One-Sided Communications, and Bibliography; Overall editor

- 1 • Rolf Rabenseifner, Steering committee, Terms and Definitions, and Fortran Bindings,
2 Deprecated Functions, Annex Change-Log, and Annex Language Bindings
- 3
- 4 • Richard L. Graham, Steering committee, Meeting Convener
- 5
- 6 • Jeffrey M. Squyres, Language Bindings and MPI-3.1 Secretary
- 7
- 8 • Daniel Holmes, Point-to-Point Communication
- 9
- 10 • George Bosilca, Datatypes and Environmental Management
- 11
- 12 • Torsten Hoefler, Collective Communication and Process Topologies
- 13
- 14 • Pavan Balaji, Groups, Contexts, and Communicators, and External Interfaces
- 15
- 16 • Jeff Hammond, The Info Object
- 17
- 18 • David Solt, Process Creation and Management
- 19
- 20 • Quincey Koziol, I/O
- 21
- 22 • Kathryn Mohror, Tool Support
- 23
- 24 • Rajeev Thakur, One-Sided Communications

25 The following list includes some of the active participants who attended MPI Forum
26 meetings or participated in the e-mail discussions.

27 Charles Archer	Pavan Balaji	Purushotham V. Bangalore
28 Brian Barrett	Wesley Bland	Michael Blocksome
29 George Bosilca	Aurelien Bouteiller	Devendar Bureddy
30 Yohann Burette	Mohamad Chaarawi	Alexey Cheptsov
31 James Dinan	Dmitry Durnov	Thomas Francois
32 Edgar Gabriel	Todd Gamblin	Balazs Gerofi
33 Paddy Gillies	David Goodell	Manjunath Gorentla Venkata
34 Richard L. Graham	Ryan E. Grant	William Gropp
35 Khaled Hamidouche	Jeff Hammond	Amin Hassani
36 Marc-André Hermanns	Nathan Hjelm	Torsten Hoefler
37 Daniel Holmes	Atsushi Hori	Yutaka Ishikawa
38 Hideyuki Jitsumoto	Jithin Jose	Krishna Kandalla
39 Christos Kavouklis	Takahiro Kawashima	Chulho Kim
40 Michael Knobloch	Alice Koniges	Quincey Koziol
41 Sameer Kumar	Joshua Ladd	Ignacio Laguna
42 Huiwei Lu	Guillaume Mercier	Kathryn Mohror
43 Adam Moody	Tomotake Nakamura	Takeshi Nanri
44 Steve Oyanagi	Antonio J. Pëna	Sreeram Potluri
45 Howard Pritchard	Rolf Rabenseifner	Nicholas Radcliffe
46 Ken Raffanetti	Raghunath Raja	Craig Rasmussen
47 Davide Rossetti	Kento Sato	Martin Schulz
48 Sangmin Seo	Christian Siebert	Anthony Skjellum
	David Solt	Jeffrey M. Squyres

Hari Subramoni	Shinji Sumimoto	Alexander Supalov	1
Bronis R. de Supinski	Sayantana Sur	Masamichi Takagi	2
Keita Teranishi	Rajeev Thakur	Fabian Tillier	3
Yuichi Tsujita	Geoffroy Vallée	Rolf vandeVaart	4
Akshay Venkatesh	Jerome Vienne	Venkat Vishwanath	5
Anh Vo	Huseyin S. Yildiz	Junchao Zhang	6
Xin Zhao			7

The MPI Forum also acknowledges and appreciates the valuable input from people via e-mail and in person.

The following institutions supported the MPI-3.1 effort through time and travel support for the people listed above.

Argonne National Laboratory	13
Auburn University	14
Cisco Systems, Inc.	15
Cray	16
EPCC, The University of Edinburgh	17
ETH Zurich	18
Forschungszentrum Jülich	19
Fujitsu	20
German Research School for Simulation Sciences	21
The HDF Group	22
International Business Machines	23
INRIA	24
Intel Corporation	25
Jülich Aachen Research Alliance, High-Performance Computing (JARA-HPC)	26
Kyushu University	27
Lawrence Berkeley National Laboratory	28
Lawrence Livermore National Laboratory	29
Lenovo	30
Los Alamos National Laboratory	31
Mellanox Technologies, Inc.	32
Microsoft Corporation	33
NEC Corporation	34
NVIDIA Corporation	35
Oak Ridge National Laboratory	36
The Ohio State University	37
RIKEN AICS	38
Sandia National Laboratories	39
Texas Advanced Computing Center	40
Tokyo Institute of Technology	41
University of Alabama at Birmingham	42
University of Houston	43
University of Illinois at Urbana-Champaign	44
University of Oregon	45
University of Stuttgart, High Performance Computing Center Stuttgart (HLRS)	46
University of Tennessee, Knoxville	47
University of Tokyo	48

1
2
3
4
5
6
7
8
9
10
11
12
13
14
15
16
17
18
19
20
21
22
23
24
25
26
27
28
29
30
31
32
33
34
35
36
37
38
39
40
41
42
43
44
45
46
47
48

Chapter 1

Introduction to MPI

1.1 Overview and Goals

MPI (Message-Passing Interface) is a *message-passing library interface specification*. All parts of this definition are significant. MPI addresses primarily the message-passing parallel programming model, in which data is moved from the address space of one process to that of another process through cooperative operations on each process. Extensions to the “classical” message-passing model are provided in collective operations, remote-memory access operations, dynamic process creation, and parallel I/O. MPI is a *specification*, not an implementation; there are multiple implementations of MPI. This specification is for a *library interface*; MPI is not a language, and all MPI operations are expressed as functions, subroutines, or methods, according to the appropriate language bindings which, for C and Fortran, are part of the MPI standard. The standard has been defined through an open process by a community of parallel computing vendors, computer scientists, and application developers. The next few sections provide an overview of the history of MPI’s development.

The main advantages of establishing a message-passing standard are portability and ease of use. In a distributed memory communication environment in which the higher level routines and/or abstractions are built upon lower level message-passing routines the benefits of standardization are particularly apparent. Furthermore, the definition of a message-passing standard, such as that proposed here, provides vendors with a clearly defined base set of routines that they can implement efficiently, or in some cases for which they can provide hardware support, thereby enhancing scalability.

The goal of the Message-Passing Interface simply stated is to develop a widely used standard for writing message-passing programs. As such the interface should establish a practical, portable, efficient, and flexible standard for message passing.

A complete list of goals follows.

- Design an application programming interface (not necessarily for compilers or a system implementation library).
- Allow efficient communication: Avoid memory-to-memory copying, allow overlap of computation and communication, and offload to communication co-processors, where available.
- Allow for implementations that can be used in a heterogeneous environment.
- Allow convenient C and Fortran bindings for the interface.

- 1 • Assume a reliable communication interface: the user need not cope with communi-
2 cation failures. Such failures are dealt with by the underlying communication subsystem.
- 3
- 4 • Define an interface that can be implemented on many vendor’s platforms, with no
5 significant changes in the underlying communication and system software.
- 6
- 7 • Semantics of the interface should be language independent.
- 8
- 9 • The interface should be designed to allow for thread safety.

10 1.2 Background of MPI-1.0

12 MPI sought to make use of the most attractive features of a number of existing message-
13 passing systems, rather than selecting one of them and adopting it as the standard. Thus,
14 MPI was strongly influenced by work at the IBM T. J. Watson Research Center [1, 2],
15 Intel’s NX/2 [52], Express [13], nCUBE’s Vertex [47], p4 [8, 9], and PARMACS [5, 10].
16 Other important contributions have come from Zipcode [55, 56], Chimp [20, 21], PVM
17 [4, 18], Chameleon [28], and PICL [26].

18 The MPI standardization effort involved about 60 people from 40 organizations mainly
19 from the United States and Europe. Most of the major vendors of concurrent computers
20 were involved in MPI, along with researchers from universities, government laboratories, and
21 industry. The standardization process began with the Workshop on Standards for Message-
22 Passing in a Distributed Memory Environment, sponsored by the Center for Research on
23 Parallel Computing, held April 29-30, 1992, in Williamsburg, Virginia [63]. At this workshop
24 the basic features essential to a standard message-passing interface were discussed, and a
25 working group established to continue the standardization process.

26 A preliminary draft proposal, known as MPI-1, was put forward by Dongarra, Hempel,
27 Hey, and Walker in November 1992, and a revised version was completed in February
28 1993 [19]. MPI-1 embodied the main features that were identified at the Williamsburg
29 workshop as being necessary in a message passing standard. Since MPI-1 was primarily
30 intended to promote discussion and “get the ball rolling,” it focused mainly on point-to-point
31 communications. MPI-1 brought to the forefront a number of important standardization
32 issues, but did not include any collective communication routines and was not thread-safe.

33 In November 1992, a meeting of the MPI working group was held in Minneapolis, at
34 which it was decided to place the standardization process on a more formal footing, and to
35 generally adopt the procedures and organization of the High Performance Fortran Forum.
36 Subcommittees were formed for the major component areas of the standard, and an email
37 discussion service established for each. In addition, the goal of producing a draft MPI
38 standard by the Fall of 1993 was set. To achieve this goal the MPI working group met every
39 6 weeks for two days throughout the first 9 months of 1993, and presented the draft MPI
40 standard at the Supercomputing 93 conference in November 1993. These meetings and the
41 email discussion together constituted the MPI Forum, membership of which has been open
42 to all members of the high performance computing community.

44 1.3 Background of MPI-1.1, MPI-1.2, and MPI-2.0

46 Beginning in March 1995, the MPI Forum began meeting to consider corrections and exten-
47 sions to the original MPI Standard document [23]. The first product of these deliberations
48

was Version 1.1 of the MPI specification, released in June of 1995 [24] (see <http://www.mpi-forum.org> for official MPI document releases). At that time, effort focused in five areas.

1. Further corrections and clarifications for the MPI-1.1 document.
2. Additions to MPI-1.1 that do not significantly change its types of functionality (new datatype constructors, language interoperability, etc.).
3. Completely new types of functionality (dynamic processes, one-sided communication, parallel I/O, etc.) that are what everyone thinks of as “MPI-2 functionality.”
4. Bindings for Fortran 90 and C++. MPI-2 specifies C++ bindings for both MPI-1 and MPI-2 functions, and extensions to the Fortran 77 binding of MPI-1 and MPI-2 to handle Fortran 90 issues.
5. Discussions of areas in which the MPI process and framework seem likely to be useful, but where more discussion and experience are needed before standardization (e.g., zero-copy semantics on shared-memory machines, real-time specifications).

Corrections and clarifications (items of type 1 in the above list) were collected in Chapter 3 of the MPI-2 document: “Version 1.2 of MPI.” That chapter also contains the function for identifying the version number. Additions to MPI-1.1 (items of types 2, 3, and 4 in the above list) are in the remaining chapters of the MPI-2 document, and constitute the specification for MPI-2. Items of type 5 in the above list have been moved to a separate document, the “MPI Journal of Development” (JOD), and are not part of the MPI-2 Standard.

This structure makes it easy for users and implementors to understand what level of MPI compliance a given implementation has:

- MPI-1 compliance will mean compliance with MPI-1.3. This is a useful level of compliance. It means that the implementation conforms to the clarifications of MPI-1.1 function behavior given in Chapter 3 of the MPI-2 document. Some implementations may require changes to be MPI-1 compliant.
- MPI-2 compliance will mean compliance with all of MPI-2.1.
- The MPI Journal of Development is not part of the MPI Standard.

It is to be emphasized that forward compatibility is preserved. That is, a valid MPI-1.1 program is both a valid MPI-1.3 program and a valid MPI-2.1 program, and a valid MPI-1.3 program is a valid MPI-2.1 program.

1.4 Background of MPI-1.3 and MPI-2.1

After the release of MPI-2.0, the MPI Forum kept working on errata and clarifications for both standard documents (MPI-1.1 and MPI-2.0). The short document “Errata for MPI-1.1” was released October 12, 1998. On July 5, 2001, a first ballot of errata and clarifications for MPI-2.0 was released, and a second ballot was voted on May 22, 2002. Both votes were done electronically. Both ballots were combined into one document: “Errata for MPI-2,” May 15, 2002. This errata process was then interrupted, but the Forum and its e-mail reflectors kept working on new requests for clarification.

1 Restarting regular work of the MPI Forum was initiated in three meetings, at Eu-
2 roPVM/MPI'06 in Bonn, at EuroPVM/MPI'07 in Paris, and at SC'07 in Reno. In De-
3 cember 2007, a steering committee started the organization of new MPI Forum meetings at
4 regular 8-weeks intervals. At the January 14–16, 2008 meeting in Chicago, the MPI Forum
5 decided to combine the existing and future MPI documents to one document for each ver-
6 sion of the MPI standard. For technical and historical reasons, this series was started with
7 MPI-1.3. Additional Ballots 3 and 4 solved old questions from the errata list started in 1995
8 up to new questions from the last years. After all documents (MPI-1.1, MPI-2, Errata for
9 MPI-1.1 (Oct. 12, 1998), and MPI-2.1 Ballots 1-4) were combined into one draft document,
10 for each chapter, a chapter author and review team were defined. They cleaned up the
11 document to achieve a consistent MPI-2.1 document. The final MPI-2.1 standard document
12 was finished in June 2008, and finally released with a second vote in September 2008 in
13 the meeting at Dublin, just before EuroPVM/MPI'08. The major work of the current MPI
14 Forum is the preparation of MPI-3.

15 16 1.5 Background of MPI-2.2

17
18 MPI-2.2 is a minor update to the MPI-2.1 standard. This version addresses additional errors
19 and ambiguities that were not corrected in the MPI-2.1 standard as well as a small number
20 of extensions to MPI-2.1 that met the following criteria:

- 21
22 • Any correct MPI-2.1 program is a correct MPI-2.2 program.
- 23
24 • Any extension must have significant benefit for users.
- 25
26 • Any extension must not require significant implementation effort. To that end, all
27 such changes are accompanied by an open source implementation.

28 The discussions of MPI-2.2 proceeded concurrently with the MPI-3 discussions; in some
29 cases, extensions were proposed for MPI-2.2 but were later moved to MPI-3.

30 31 1.6 Background of MPI-3.0

32
33 MPI-3.0 is a major update to the MPI standard. The updates include the extension of
34 collective operations to include nonblocking versions, extensions to the one-sided operations,
35 and a new Fortran 2008 binding. In addition, the deprecated C++ bindings have been
36 removed, as well as many of the deprecated routines and MPI objects (such as the MPI_UB
37 datatype).

38 39 1.7 Background of MPI-3.1

40
41 MPI-3.1 is a minor update to the MPI standard. Most of the updates are corrections
42 and clarifications to the standard, especially for the Fortran bindings. New functions added
43 include routines to manipulate MPI_Aint values in a portable manner, nonblocking collective
44 I/O routines, and routines to get the index value by name for MPI_T performance and
45 control variables. A general index was also added.

1.8 Who Should Use This Standard?

This standard is intended for use by all those who want to write portable message-passing programs in Fortran and C (and access the C bindings from C++). This includes individual application programmers, developers of software designed to run on parallel machines, and creators of environments and tools. In order to be attractive to this wide audience, the standard must provide a simple, easy-to-use interface for the basic user while not semantically precluding the high-performance message-passing operations available on advanced machines.

1.9 What Platforms Are Targets for Implementation?

The attractiveness of the message-passing paradigm at least partially stems from its wide portability. Programs expressed this way may run on distributed-memory multiprocessors, networks of workstations, and combinations of all of these. In addition, shared-memory implementations, including those for multi-core processors and hybrid architectures, are possible. The paradigm will not be made obsolete by architectures combining the shared- and distributed-memory views, or by increases in network speeds. It thus should be both possible and useful to implement this standard on a great variety of machines, including those “machines” consisting of collections of other machines, parallel or not, connected by a communication network.

The interface is suitable for use by fully general MIMD programs, as well as those written in the more restricted style of SPMD. MPI provides many features intended to improve performance on scalable parallel computers with specialized interprocessor communication hardware. Thus, we expect that native, high-performance implementations of MPI will be provided on such machines. At the same time, implementations of MPI on top of standard Unix interprocessor communication protocols will provide portability to workstation clusters and heterogenous networks of workstations.

1.10 What Is Included in the Standard?

The standard includes:

- Point-to-point communication,
- Datatypes,
- Collective operations,
- Process groups,
- Communication contexts,
- Process topologies,
- Environmental management and inquiry,
- The Info object,
- Process creation and management,

- One-sided communication,
- External interfaces,
- Parallel file I/O,
- Language bindings for Fortran and C,
- Tool support.

1.11 What Is Not Included in the Standard?

The standard does not specify:

- Operations that require more operating system support than is currently standard; for example, interrupt-driven receives, remote execution, or active messages,
- Program construction tools,
- Debugging facilities.

There are many features that have been considered and not included in this standard. This happened for a number of reasons, one of which is the time constraint that was self-imposed in finishing the standard. Features that are not included can always be offered as extensions by specific implementations. Perhaps future versions of MPI will address some of these issues.

1.12 Organization of This Document

The following is a list of the remaining chapters in this document, along with a brief description of each.

- Chapter 2, [MPI Terms and Conventions](#), explains notational terms and conventions used throughout the MPI document.
- Chapter 3, [Point-to-Point Communication](#), defines the basic, pairwise communication subset of MPI. *Send* and *receive* are found here, along with many associated functions designed to make basic communication powerful and efficient.
- Chapter 4, [Datatypes](#), defines a method to describe any data layout, e.g., an array of structures in the memory, which can be used as message send or receive buffer.
- Chapter 5, [Collective Communication](#), defines process-group collective communication operations. Well known examples of this are barrier and broadcast over a group of processes (not necessarily all the processes). With MPI-2, the semantics of collective communication was extended to include intercommunicators. It also adds two new collective operations. MPI-3 adds nonblocking collective operations.
- Chapter 6, [Groups, Contexts, Communicators, and Caching](#), shows how groups of processes are formed and manipulated, how unique communication contexts are obtained, and how the two are bound together into a *communicator*.

- Chapter 7, [Process Topologies](#), explains a set of utility functions meant to assist in the mapping of process groups (a linearly ordered set) to richer topological structures such as multi-dimensional grids.
- Chapter 8, [MPI Environmental Management](#), explains how the programmer can manage and make inquiries of the current MPI environment. These functions are needed for the writing of correct, robust programs, and are especially important for the construction of highly-portable message-passing programs.
- Chapter 9, [The Info Object](#), defines an opaque object, that is used as input in several MPI routines.
- Chapter 10, [Process Creation and Management](#), defines routines that allow for creation of processes.
- Chapter 11, [One-Sided Communications](#), defines communication routines that can be completed by a single process. These include shared-memory operations (put/get) and remote accumulate operations.
- Chapter 12, [External Interfaces](#), defines routines designed to allow developers to layer on top of MPI. This includes generalized requests, routines that decode MPI opaque objects, and threads.
- Chapter 13, [I/O](#), defines MPI support for parallel I/O.
- Chapter 14, [Tool Support](#), covers interfaces that allow debuggers, performance analyzers, and other tools to obtain data about the operation of MPI processes. This chapter includes Section 14.2 ([Profiling Interface](#)), which was a chapter in previous versions of MPI.
- Chapter 15, [Deprecated Interfaces](#), describes routines that are kept for reference. However usage of these functions is discouraged, as they may be deleted in future versions of the standard.
- Chapter 16, [Removed Interfaces](#), describes routines and constructs that have been removed from MPI. These were deprecated in MPI-2, and the MPI Forum decided to remove these from the MPI-3 standard.
- Chapter 17, [Backward Incompatibilities](#), describes incompatibilities with previous versions of MPI.
- Chapter 18, [Language Bindings](#), discusses Fortran issues, and describes language interoperability aspects between C and Fortran.

The Appendices are:

- Annex A, [Language Bindings Summary](#), gives specific syntax in C and Fortran, for all MPI functions, constants, and types.
- Annex B, [Change-Log](#), summarizes some changes since the previous version of the standard.

- Several Index pages show the locations of examples, constants and predefined handles, callback routine prototypes, and all MPI functions.

MPI provides various interfaces to facilitate interoperability of distinct MPI implementations. Among these are the canonical data representation for MPI I/O and for `MPI_PACK_EXTERNAL` and `MPI_UNPACK_EXTERNAL`. The definition of an actual binding of these interfaces that will enable interoperability is outside the scope of this document.

A separate document consists of ideas that were discussed in the MPI Forum during the MPI-2 development and deemed to have value, but are not included in the MPI Standard. They are part of the “Journal of Development” (JOD), lest good ideas be lost and in order to provide a starting point for further work. The chapters in the JOD are

- Chapter 2, Spawning Independent Processes, includes some elements of dynamic process management, in particular management of processes with which the spawning processes do not intend to communicate, that the Forum discussed at length but ultimately decided not to include in the MPI Standard.
- Chapter 3, Threads and MPI, describes some of the expected interaction between an MPI implementation and a thread library in a multi-threaded environment.
- Chapter 4, Communicator ID, describes an approach to providing identifiers for communicators.
- Chapter 5, Miscellany, discusses Miscellaneous topics in the MPI JOD, in particular single-copy routines for use in shared-memory environments and new datatype constructors.
- Chapter 6, Toward a Full Fortran 90 Interface, describes an approach to providing a more elaborate Fortran 90 interface.
- Chapter 7, Split Collective Communication, describes a specification for certain non-blocking collective operations.
- Chapter 8, Real-Time MPI, discusses MPI support for real time processing.

1
2
3
4
5
6
7
8
9
10
11
12
13
14
15
16
17
18
19
20
21
22
23
24
25
26
27
28
29
30
31
32
33
34
35
36
37
38
39
40
41
42
43
44
45
46
47
48

Chapter 2

MPI Terms and Conventions

This chapter explains notational terms and conventions used throughout the MPI document, some of the choices that have been made, and the rationale behind those choices.

2.1 Document Notation

Rationale. Throughout this document, the rationale for the design choices made in the interface specification is set off in this format. Some readers may wish to skip these sections, while readers interested in interface design may want to read them carefully. (*End of rationale.*)

Advice to users. Throughout this document, material aimed at users and that illustrates usage is set off in this format. Some readers may wish to skip these sections, while readers interested in programming in MPI may want to read them carefully. (*End of advice to users.*)

Advice to implementors. Throughout this document, material that is primarily commentary to implementors is set off in this format. Some readers may wish to skip these sections, while readers interested in MPI implementations may want to read them carefully. (*End of advice to implementors.*)

2.2 Naming Conventions

In many cases MPI names for C functions are of the form `MPI_Class_action_subset`. This convention originated with MPI-1. Since MPI-2 an attempt has been made to standardize the names of MPI functions according to the following rules.

1. In C, all routines associated with a particular type of MPI object should be of the form `MPI_Class_action_subset` or, if no subset exists, of the form `MPI_Class_action`. In Fortran, all routines associated with a particular type of MPI object should be of the form `MPI_CLASS_ACTION_SUBSET` or, if no subset exists, of the form `MPI_CLASS_ACTION`.
2. If the routine is not associated with a class, the name should be of the form `MPI_Action_subset` in C and `MPI_ACTION_SUBSET` in Fortran.

- 1 3. The names of certain actions have been standardized. In particular, **Create** creates
 2 a new object, **Get** retrieves information about an object, **set** sets this information,
 3 **Delete** deletes information, **Is** asks whether or not an object has a certain property.

4
 5 C and Fortran names for some MPI functions (that were defined during the MPI-1
 6 process) violate these rules in several cases. The most common exceptions are the omission
 7 of the **Class** name from the routine and the omission of the **Action** where one can be
 8 inferred.

9 MPI identifiers are limited to 30 characters (31 with the profiling interface). This is
 10 done to avoid exceeding the limit on some compilation systems.

12 2.3 Procedure Specification

13
 14 MPI procedures are specified using a language-independent notation. The arguments of
 15 procedure calls are marked as IN, OUT, or INOUT. The meanings of these are:

- 16 • IN: the call may use the input value but does not update the argument from the
 17 perspective of the caller at any time during the call's execution,
- 18 • OUT: the call may update the argument but does not use its input value,
- 19 • INOUT: the call may both use and update the argument.

20
 21 There is one special case — if an argument is a handle to an opaque object (these
 22 terms are defined in Section 2.5.1), and the object is updated by the procedure call, then
 23 the argument is marked INOUT or OUT. It is marked this way even though the handle itself
 24 is not modified — we use the INOUT or OUT attribute to denote that what the handle
 25 references is updated.

26
 27 *Rationale.* The definition of MPI tries to avoid, to the largest possible extent, the use
 28 of INOUT arguments, because such use is error-prone, especially for scalar arguments.
 29 (*End of rationale.*)

30
 31 MPI's use of IN, OUT, and INOUT is intended to indicate to the user how an argument
 32 is to be used, but does not provide a rigorous classification that can be translated directly
 33 into all language bindings (e.g., **INTENT** in Fortran 90 bindings or **const** in C bindings).
 34 For instance, the “constant” **MPI_BOTTOM** can usually be passed to OUT buffer arguments.
 35 Similarly, **MPI_STATUS_IGNORE** can be passed as the OUT status argument.

36 A common occurrence for MPI functions is an argument that is used as IN by some pro-
 37 cesses and OUT by other processes. Such an argument is, syntactically, an INOUT argument
 38 and is marked as such, although, semantically, it is not used in one call both for input and
 39 for output on a single process.

40 Another frequent situation arises when an argument value is needed only by a subset
 41 of the processes. When an argument is not significant at a process then an arbitrary value
 42 can be passed as an argument.

43 Unless specified otherwise, an argument of type OUT or type INOUT cannot be aliased
 44 with any other argument passed to an MPI procedure. An example of argument aliasing in
 45 C appears below. If we define a C procedure like this,

```

void copyIntBuffer( int *pin, int *pout, int len )
{
    int i;
    for (i=0; i<len; ++i) *pout++ = *pin++;
}

```

then a call to it in the following code fragment has aliased arguments.

```

int a[10];
copyIntBuffer( a, a+3, 7);

```

Although the C language allows this, such usage of MPI procedures is forbidden unless otherwise specified. Note that Fortran prohibits aliasing of arguments.

All MPI functions are first specified in the language-independent notation. Immediately below this, language dependent bindings follow:

- The ISO C version of the function.
- The Fortran version used with `USE mpi_f08`.
- The Fortran version of the same function used with `USE mpi` or `INCLUDE 'mpif.h'`.

An exception is Section 14.3 “The MPI Tool Information Interface”, which only provides ISO C interfaces.

“Fortran” in this document refers to Fortran 90 and higher; see Section 2.6.

2.4 Semantic Terms

When discussing MPI procedures the following semantic terms are used.

nonblocking A procedure is nonblocking if it may return before the associated operation completes, and before the user is allowed to reuse resources (such as buffers) specified in the call. The word complete is used with respect to operations and any associated requests and/or communications. An **operation completes** when the user is allowed to reuse resources, and any output buffers have been updated.

blocking A procedure is blocking if return from the procedure indicates the user is allowed to reuse resources specified in the call.

local A procedure is local if completion of the procedure depends only on the local executing process.

non-local A procedure is non-local if completion of the operation may require the execution of some MPI procedure on another process. Such an operation may require communication occurring with another user process.

collective A procedure is collective if all processes in a process group need to invoke the procedure. A collective call may or may not be synchronizing. Collective calls over the same communicator must be executed in the same order by all members of the process group.

predefined A predefined datatype is a datatype with a predefined (constant) name (such as `MPI_INT`, `MPI_FLOAT_INT`, or `MPI_PACKED`) or a datatype constructed with `MPI_TYPE_CREATE_F90_INTEGER`, `MPI_TYPE_CREATE_F90_REAL`, or `MPI_TYPE_CREATE_F90_COMPLEX`. The former are **named** whereas the latter are **unnamed**.

derived A derived datatype is any datatype that is not predefined.

portable A datatype is portable if it is a predefined datatype, or it is derived from a portable datatype using only the type constructors `MPI_TYPE_CONTIGUOUS`, `MPI_TYPE_VECTOR`, `MPI_TYPE_INDEXED`, `MPI_TYPE_CREATE_INDEXED_BLOCK`, `MPI_TYPE_CREATE_SUBARRAY`, `MPI_TYPE_DUP`, and `MPI_TYPE_CREATE_DARRAY`. Such a datatype is portable because all displacements in the datatype are in terms of extents of one predefined datatype. Therefore, if such a datatype fits a data layout in one memory, it will fit the corresponding data layout in another memory, if the same declarations were used, even if the two systems have different architectures. On the other hand, if a datatype was constructed using `MPI_TYPE_CREATE_HINDEXED`, `MPI_TYPE_CREATE_HINDEXED_BLOCK`, `MPI_TYPE_CREATE_HVECTOR` or `MPI_TYPE_CREATE_STRUCT`, then the datatype contains explicit byte displacements (e.g., providing padding to meet alignment restrictions). These displacements are unlikely to be chosen correctly if they fit data layout on one memory, but are used for data layouts on another process, running on a processor with a different architecture.

equivalent Two datatypes are equivalent if they appear to have been created with the same sequence of calls (and arguments) and thus have the same typemap. Two equivalent datatypes do not necessarily have the same cached attributes or the same names.

2.5 Data Types

2.5.1 Opaque Objects

MPI manages **system memory** that is used for buffering messages and for storing internal representations of various MPI objects such as groups, communicators, datatypes, etc. This memory is not directly accessible to the user, and objects stored there are **opaque**: their size and shape is not visible to the user. Opaque objects are accessed via **handles**, which exist in user space. MPI procedures that operate on opaque objects are passed handle arguments to access these objects. In addition to their use by MPI calls for object access, handles can participate in assignments and comparisons.

In Fortran with `USE mpi` or `INCLUDE 'mpif.h'`, all handles have type `INTEGER`. In Fortran with `USE mpi_f08`, and in C, a different handle type is defined for each category of objects. With Fortran `USE mpi_f08`, the handles are defined as Fortran `BIND(C)` derived types that consist of only one element `INTEGER :: MPI_VAL`. The internal handle value is identical to the Fortran `INTEGER` value used in the `mpi` module and `mpif.h`. The operators `.EQ.`, `.NE.`, `==` and `/=` are overloaded to allow the comparison of these handles. The type names are identical to the names in C, except that they are not case sensitive. For example:

```

TYPE, BIND(C) :: MPI_Comm
  INTEGER      :: MPI_VAL
END TYPE MPI_Comm

```

The C types must support the use of the assignment and equality operators.

Advice to implementors. In Fortran, the handle can be an index into a table of opaque objects in a system table; in C it can be such an index or a pointer to the object. (*End of advice to implementors.*)

Rationale. Since the Fortran integer values are equivalent, applications can easily convert MPI handles between all three supported Fortran methods. For example, an integer communicator handle `COMM` can be converted directly into an exactly equivalent `mpi_f08` communicator handle named `comm_f08` by `comm_f08%MPI_VAL=COMM`, and vice versa. The use of the `INTEGER` defined handles and the `BIND(C)` derived type handles is different: Fortran 2003 (and later) define that `BIND(C)` derived types can be used within user defined common blocks, but it is up to the rules of the companion C compiler how many numerical storage units are used for these `BIND(C)` derived type handles. Most compilers use one unit for both, the `INTEGER` handles and the handles defined as `BIND(C)` derived types. (*End of rationale.*)

Advice to users. If a user wants to substitute `mpif.h` or the `mpi` module by the `mpi_f08` module and the application program stores a handle in a Fortran common block then it is necessary to change the Fortran support method in all application routines that use this common block, because the number of numerical storage units of such a handle can be different in the two modules. (*End of advice to users.*)

Opaque objects are allocated and deallocated by calls that are specific to each object type. These are listed in the sections where the objects are described. The calls accept a handle argument of matching type. In an allocate call this is an OUT argument that returns a valid reference to the object. In a call to deallocate this is an INOUT argument which returns with an “invalid handle” value. MPI provides an “invalid handle” constant for each object type. Comparisons to this constant are used to test for validity of the handle.

A call to a deallocate routine invalidates the handle and marks the object for deallocation. The object is not accessible to the user after the call. However, MPI need not deallocate the object immediately. Any operation pending (at the time of the deallocate) that involves this object will complete normally; the object will be deallocated afterwards.

An opaque object and its handle are significant only at the process where the object was created and cannot be transferred to another process.

MPI provides certain predefined opaque objects and predefined, static handles to these objects. The user must not free such objects.

Rationale. This design hides the internal representation used for MPI data structures, thus allowing similar calls in C and Fortran. It also avoids conflicts with the typing rules in these languages, and easily allows future extensions of functionality. The mechanism for opaque objects used here loosely follows the POSIX Fortran binding standard.

The explicit separation of handles in user space and objects in system space allows space-reclaiming and deallocation calls to be made at appropriate points in the user

1 program. If the opaque objects were in user space, one would have to be very careful
2 not to go out of scope before any pending operation requiring that object completed.
3 The specified design allows an object to be marked for deallocation, the user program
4 can then go out of scope, and the object itself still persists until any pending operations
5 are complete.

6 The requirement that handles support assignment/comparison is made since such op-
7 erations are common. This restricts the domain of possible implementations. The
8 alternative in C would have been to allow handles to have been an arbitrary, opaque
9 type. This would force the introduction of routines to do assignment and compar-
10 ison, adding complexity, and was therefore ruled out. In Fortran, the handles are
11 defined such that assignment and comparison are available through the operators of
12 the language or overloaded versions of these operators. (*End of rationale.*)

13
14 *Advice to users.* A user may accidentally create a dangling reference by assigning to a
15 handle the value of another handle, and then deallocating the object associated with
16 these handles. Conversely, if a handle variable is deallocated before the associated
17 object is freed, then the object becomes inaccessible (this may occur, for example, if
18 the handle is a local variable within a subroutine, and the subroutine is exited before
19 the associated object is deallocated). It is the user's responsibility to avoid adding or
20 deleting references to opaque objects, except as a result of MPI calls that allocate or
21 deallocate such objects. (*End of advice to users.*)

22
23 *Advice to implementors.* The intended semantics of opaque objects is that opaque
24 objects are separate from one another; each call to allocate such an object copies
25 all the information required for the object. Implementations may avoid excessive
26 copying by substituting referencing for copying. For example, a derived datatype
27 may contain references to its components, rather than copies of its components; a
28 call to `MPI_COMM_GROUP` may return a reference to the group associated with the
29 communicator, rather than a copy of this group. In such cases, the implementation
30 must maintain reference counts, and allocate and deallocate objects in such a way that
31 the visible effect is as if the objects were copied. (*End of advice to implementors.*)

32 33 2.5.2 Array Arguments

34
35 An MPI call may need an argument that is an array of opaque objects, or an array of
36 handles. The array-of-handles is a regular array with entries that are handles to objects
37 of the same type in consecutive locations in the array. Whenever such an array is used,
38 an additional `len` argument is required to indicate the number of valid entries (unless this
39 number can be derived otherwise). The valid entries are at the beginning of the array;
40 `len` indicates how many of them there are, and need not be the size of the entire array.
41 The same approach is followed for other array arguments. In some cases `NULL` handles are
42 considered valid entries. When a `NULL` argument is desired for an array of statuses, one
43 uses `MPI_STATUSES_IGNORE`.

44 45 2.5.3 State

46 MPI procedures use at various places arguments with *state* types. The values of such a data
47 type are all identified by names, and no operation is defined on them. For example, the
48

MPI_TYPE_CREATE_SUBARRAY routine has a state argument order with values MPI_ORDER_C and MPI_ORDER_FORTRAN.

2.5.4 Named Constants

MPI procedures sometimes assign a special meaning to a special value of a basic type argument; e.g., `tag` is an integer-valued argument of point-to-point communication operations, with a special wild-card value, `MPI_ANY_TAG`. Such arguments will have a range of regular values, which is a proper subrange of the range of values of the corresponding basic type; special values (such as `MPI_ANY_TAG`) will be outside the regular range. The range of regular values, such as `tag`, can be queried using environmental inquiry functions, see Chapter 8. The range of other values, such as `source`, depends on values given by other MPI routines (in the case of `source` it is the communicator size).

MPI also provides predefined named constant handles, such as `MPI_COMM_WORLD`.

All named constants, with the exceptions noted below for Fortran, can be used in initialization expressions or assignments, but not necessarily in array declarations or as labels in C `switch` or Fortran `select/case` statements. This implies named constants to be link-time but not necessarily compile-time constants. The named constants listed below are required to be compile-time constants in both C and Fortran. These constants do not change values during execution. Opaque objects accessed by constant handles are defined and do not change value between MPI initialization (`MPI_INIT`) and MPI completion (`MPI_FINALIZE`). The handles themselves are constants and can be also used in initialization expressions or assignments.

The constants that are required to be compile-time constants (and can thus be used for array length declarations and labels in C `switch` and Fortran `case/select` statements) are:

- MPI_MAX_PROCESSOR_NAME
- MPI_MAX_LIBRARY_VERSION_STRING
- MPI_MAX_ERROR_STRING
- MPI_MAX_DATAREP_STRING
- MPI_MAX_INFO_KEY
- MPI_MAX_INFO_VAL
- MPI_MAX_OBJECT_NAME
- MPI_MAX_PORT_NAME
- MPI_VERSION
- MPI_SUBVERSION
- MPI_STATUS_SIZE (Fortran only)
- MPI_ADDRESS_KIND (Fortran only)
- MPI_COUNT_KIND (Fortran only)
- MPI_INTEGER_KIND (Fortran only)
- MPI_OFFSET_KIND (Fortran only)
- MPI_SUBARRAYS_SUPPORTED (Fortran only)
- MPI_ASYNC_PROTECTS_NONBLOCKING (Fortran only)

The constants that cannot be used in initialization expressions or assignments in Fortran are as follows:

- MPI_BOTTOM
- MPI_STATUS_IGNORE
- MPI_STATUSES_IGNORE

```

1 MPI_ERRCODES_IGNORE
2 MPI_IN_PLACE
3 MPI_ARGV_NULL
4 MPI_ARGVS_NULL
5 MPI_UNWEIGHTED
6 MPI_WEIGHTS_EMPTY
7 MPI_WEIGHTS_EQUAL

```

#120

Advice to implementors. In Fortran the implementation of these special constants may require the use of language constructs that are outside the Fortran standard. Using special values for the constants (e.g., by defining them through `PARAMETER` statements) is not possible because an implementation cannot distinguish these values from valid data. Typically, these constants are implemented as predefined static variables (e.g., a variable in an MPI-declared `COMMON` block), relying on the fact that the target compiler passes data by address. Inside the subroutine, this address can be extracted by some mechanism outside the Fortran standard (e.g., by Fortran extensions or by implementing the function in C). (*End of advice to implementors.*)

2.5.5 Choice

MPI functions sometimes use arguments with a *choice* (or union) data type. Distinct calls to the same routine may pass by reference actual arguments of different types. The mechanism for providing such arguments will differ from language to language. For Fortran with the include file `mpif.h` or the `mpi` module, the document uses `<type>` to represent a choice variable; with the Fortran `mpi_f08` module, such arguments are declared with the Fortran 2008 + TR 29113 syntax `TYPE(*)`, `DIMENSION(..)`; for C, we use `void *`.

Advice to implementors. Implementors can freely choose how to implement choice arguments in the `mpi` module, e.g., with a non-standard compiler-dependent method that has the quality of the call mechanism in the implicit Fortran interfaces, or with the method defined for the `mpi_f08` module. See details in Section 18.1.1. (*End of advice to implementors.*)

2.5.6 Absolute Addresses and Relative Address Displacements

Some MPI procedures use *address* arguments that represent an *absolute address* in the calling program, or *relative displacement* arguments that represent differences of two absolute addresses. The datatype of such arguments is `MPI_Aint` in C and `INTEGER (KIND=MPI_ADDRESS_KIND)` in Fortran. These types must have the same width and encode address values in the same manner such that address values in one language may be passed directly to another language without conversion. There is the MPI constant `MPI_BOTTOM` to indicate the start of the address range. For retrieving absolute addresses or any calculation with absolute addresses, one should use the routines and functions provided in Section 4.1.5. Section 4.1.12 provides additional rules for the correct use of absolute addresses. For expressions with relative displacements or other usage without absolute addresses, intrinsic operators (e.g., `+`, `-`, `*`) can be used.

2.5.7 File Offsets

For I/O there is a need to give the size, displacement, and offset into a file. These quantities can easily be larger than 32 bits which can be the default size of a Fortran integer. To overcome this, these quantities are declared to be `INTEGER (KIND=MPI_OFFSET_KIND)` in Fortran. In C one uses `MPI_Offset`. These types must have the same width and encode address values in the same manner such that offset values in one language may be passed directly to another language without conversion.

2.5.8 Counts

As described above, MPI defines types (e.g., `MPI_Aint`) to address locations within memory and other types (e.g., `MPI_Offset`) to address locations within files. In addition, some MPI procedures use *count* arguments that represent a number of MPI datatypes on which to operate. At times, one needs a single type that can be used to address locations within either memory or files as well as express *count* values, and that type is `MPI_Count` in C and `INTEGER (KIND=MPI_COUNT_KIND)` in Fortran. These types must have the same width and encode values in the same manner such that count values in one language may be passed directly to another language without conversion. The size of the `MPI_Count` type is determined by the MPI implementation with the restriction that it must be minimally capable of encoding any value that may be stored in a variable of type `int`, `MPI_Aint`, or `MPI_Offset` in C and of type `INTEGER`, `INTEGER (KIND=MPI_ADDRESS_KIND)`, or `INTEGER (KIND=MPI_OFFSET_KIND)` in Fortran.

Rationale. Count values logically need to be large enough to encode any value used for expressing element counts, type maps in memory, type maps in file views, etc. For backward compatibility reasons, many MPI routines still use `int` in C and `INTEGER` in Fortran as the type of count arguments. (*End of rationale.*)

2.6 Language Binding

This section defines the rules for MPI language binding in general and for Fortran, and ISO C, in particular. (Note that ANSI C has been replaced by ISO C.) Defined here are various object representations, as well as the naming conventions used for expressing this standard. The actual calling sequences are defined elsewhere.

MPI bindings are for Fortran 90 or later, though they were originally designed to be usable in Fortran 77 environments. With the `mpi_f08` module, two new Fortran features, *assumed type* and *assumed rank*, are also required, see Section 2.5.5.

Since the word `PARAMETER` is a keyword in the Fortran language, we use the word “argument” to denote the arguments to a subroutine. These are normally referred to as parameters in C, however, we expect that C programmers will understand the word “argument” (which has no specific meaning in C), thus allowing us to avoid unnecessary confusion for Fortran programmers.

Since Fortran is case insensitive, linkers may use either lower case or upper case when resolving Fortran names. Users of case sensitive languages should avoid any prefix of the form “MPI_” and “PMPI_”, where any of the letters are either upper or lower case.

2.6.1 Deprecated and Removed Interfaces

A number of chapters refer to deprecated or replaced MPI constructs. These are constructs that continue to be part of the MPI standard, as documented in Chapter 15, but that users are recommended not to continue using, since better solutions were provided with newer versions of MPI. For example, the Fortran binding for MPI-1 functions that have address arguments uses `INTEGER`. This is not consistent with the C binding, and causes problems on machines with 32 bit `INTEGER`s and 64 bit addresses. In MPI-2, these functions were given new names with new bindings for the address arguments. The use of the old functions was declared as deprecated. For consistency, here and in a few other cases, new C functions are also provided, even though the new functions are equivalent to the old functions. The old names are deprecated.

Some of the deprecated constructs are now removed, as documented in Chapter 16. They may still be provided by an implementation for backwards compatibility, but are not required.

Table 2.1 shows a list of all of the deprecated and removed constructs. Note that some C typedefs and Fortran subroutine names are included in this list; they are the types of callback functions.

2.6.2 Fortran Binding Issues

Originally, MPI-1.1 provided bindings for Fortran 77. These bindings are retained, but they are now interpreted in the context of the Fortran 90 standard. MPI can still be used with most Fortran 77 compilers, as noted below. When the term “Fortran” is used it means Fortran 90 or later; it means Fortran 2008 + TR 29113 and later if the `mpi_f08` module is used.

All MPI names have an `MPI_` prefix, and all characters are capitals. Programs must not declare names, e.g., for variables, subroutines, functions, parameters, derived types, abstract interfaces, or modules, beginning with the prefix `MPI_`. To avoid conflicting with the profiling interface, programs must also avoid subroutines and functions with the prefix `PMPI_`. This is mandated to avoid possible name collisions.

All MPI Fortran subroutines have a return code in the last argument. With `USE mpi_f08`, this last argument is declared as `OPTIONAL`, except for user-defined callback functions (e.g., `COMM_COPY_ATTR_FUNCTION`) and their predefined callbacks (e.g., `MPI_NULL_COPY_FN`). A few MPI operations which are functions do not have the return code argument. The return code value for successful completion is `MPI_SUCCESS`. Other error codes are implementation dependent; see the error codes in Chapter 8 and Annex A.

Constants representing the maximum length of a string are one smaller in Fortran than in C as discussed in Section 18.2.9.

Handles are represented in Fortran as `INTEGER`s, or as a `BIND(C)` derived type with the `mpi_f08` module; see Section 2.5.1. Binary-valued variables are of type `LOGICAL`.

Array arguments are indexed from one.

The older MPI Fortran bindings (`mpif.h` and `use mpi`) are inconsistent with the Fortran standard in several respects. These inconsistencies, such as register optimization problems, have implications for user codes that are discussed in detail in Section 18.1.16.

2.6.3 C Binding Issues

We use the ISO C declaration format. All MPI names have an `MPI_` prefix, defined constants are in all capital letters, and defined types and functions have one capital letter after the prefix. Programs must not declare names (identifiers), e.g., for variables, functions, constants, types, or macros, beginning with any prefix of the form `MPI_`, where any of the letters are either upper or lower case. To support the profiling interface, programs must not declare functions with names beginning with any prefix of the form `PMPI_`, where any of the letters are either upper or lower case.

The definition of named constants, function prototypes, and type definitions must be supplied in an include file `mpi.h`.

Almost all C functions return an error code. The successful return code will be `MPI_SUCCESS`, but failure return codes are implementation dependent.

Type declarations are provided for handles to each category of opaque objects.

Array arguments are indexed from zero.

Logical flags are integers with value 0 meaning “false” and a non-zero value meaning “true.”

Choice arguments are pointers of type `void *`.

2.6.4 Functions and Macros

An implementation is allowed to implement `MPI_WTIME`, `PMPI_WTIME`, `MPI_WTICK`, `PMPI_WTICK`, `MPI_AINT_ADD`, `PMPI_AINT_ADD`, `MPI_AINT_DIFF`, `PMPI_AINT_DIFF`, and the handle-conversion functions (`MPI_Group_f2c`, etc.) in Section 18.2.4, and no others, as macros in C.

Advice to implementors. Implementors should document which routines are implemented as macros. (*End of advice to implementors.*)

Advice to users. If these routines are implemented as macros, they will not work with the MPI profiling interface. (*End of advice to users.*)

2.7 Processes

An MPI program consists of autonomous processes, executing their own code, in an MIMD style. The codes executed by each process need not be identical. The processes communicate via calls to MPI communication primitives. Typically, each process executes in its own address space, although shared-memory implementations of MPI are possible.

This document specifies the behavior of a parallel program assuming that only MPI calls are used. The interaction of an MPI program with other possible means of communication, I/O, and process management is not specified. Unless otherwise stated in the specification of the standard, MPI places no requirements on the result of its interaction with external mechanisms that provide similar or equivalent functionality. This includes, but is not limited to, interactions with external mechanisms for process control, shared and remote memory access, file system access and control, interprocess communication, process signaling, and terminal I/O. High quality implementations should strive to make the results of such interactions intuitive to users, and attempt to document restrictions where deemed necessary.

1 *Advice to implementors.* Implementations that support such additional mechanisms
2 for functionality supported within MPI are expected to document how these interact
3 with MPI. (*End of advice to implementors.*)
4

5 The interaction of MPI and threads is defined in Section 12.4.
6

7 2.8 Error Handling 8

9 MPI provides the user with reliable message transmission. A message sent is always received
10 correctly, and the user does not need to check for transmission errors, time-outs, or other
11 error conditions. In other words, MPI does not provide mechanisms for dealing with failures
12 in the communication system. If the MPI implementation is built on an unreliable underlying
13 mechanism, then it is the job of the implementor of the MPI subsystem to insulate the
14 user from this unreliability, or to reflect unrecoverable errors as failures. Whenever possible,
15 such failures will be reflected as errors in the relevant communication call. Similarly, MPI
16 itself provides no mechanisms for handling processor failures.

17 Of course, MPI programs may still be erroneous. A **program error** can occur when
18 an MPI call is made with an incorrect argument (non-existing destination in a send oper-
19 ation, buffer too small in a receive operation, etc.). This type of error would occur in any
20 implementation. In addition, a **resource error** may occur when a program exceeds the
21 amount of available system resources (number of pending messages, system buffers, etc.).
22 The occurrence of this type of error depends on the amount of available resources in the
23 system and the resource allocation mechanism used; this may differ from system to system.
24 A high-quality implementation will provide generous limits on the important resources so
25 as to alleviate the portability problem this represents.

26 In C and Fortran, almost all MPI calls return a code that indicates successful completion
27 of the operation. Whenever possible, MPI calls return an error code if an error occurred
28 during the call. By default, an error detected during the execution of the MPI library
29 causes the parallel computation to abort, except for file operations. However, MPI provides
30 mechanisms for users to change this default and to handle recoverable errors. The user may
31 specify that no error is fatal, and handle error codes returned by MPI calls by himself or
32 herself. Also, the user may provide his or her own error-handling routines, which will be
33 invoked whenever an MPI call returns abnormally. The MPI error handling facilities are
34 described in Section 8.3.

35 Several factors limit the ability of MPI calls to return with meaningful error codes
36 when an error occurs. MPI may not be able to detect some errors; other errors may be too
37 expensive to detect in normal execution mode; finally some errors may be “catastrophic”
38 and may prevent MPI from returning control to the caller. On the other hand, some errors
39 may be detected after the associated operation has completed; some errors may not have a
40 communicator, window, or file on which an error may be raised. In such cases, these errors
41 will be raised on the communicator `MPI_COMM_SELF`.

42 An example of such a case arises because of the nature of asynchronous communications:
43 MPI calls may initiate operations that continue asynchronously after the call returned. Thus,
44 the operation may return with a code indicating successful completion, yet later cause an
45 error exception to be raised. If there is a subsequent call that relates to the same operation
46 (e.g., a call that verifies that an asynchronous operation has completed) then the error
47 argument associated with this call will be used to indicate the nature of the error. In a
48 few cases, the error may occur after all calls that relate to the operation have completed,

so that no error value can be used to indicate the nature of the error (e.g., an error on the receiver in a send with the ready mode).

This document does not specify the state of a computation after an erroneous MPI call has occurred. The desired behavior is that a relevant error code be returned, and the effect of the error be localized to the greatest possible extent. E.g., it is highly desirable that an erroneous receive call will not cause any part of the receiver's memory to be overwritten, beyond the area specified for receiving the message.

Implementations may go beyond this document in supporting in a meaningful manner MPI calls that are defined here to be erroneous. For example, MPI specifies strict type matching rules between matching send and receive operations: it is erroneous to send a floating point variable and receive an integer. Implementations may go beyond these type matching rules, and provide automatic type conversion in such situations. It will be helpful to generate warnings for such non-conforming behavior.

MPI defines a way for users to create new error codes as defined in Section 8.5.

2.9 Implementation Issues

There are a number of areas where an MPI implementation may interact with the operating environment and system. While MPI does not mandate that any services (such as signal handling) be provided, it does strongly suggest the behavior to be provided if those services are available. This is an important point in achieving portability across platforms that provide the same set of services.

2.9.1 Independence of Basic Runtime Routines

MPI programs require that library routines that are part of the basic language environment (such as `write` in Fortran and `printf` and `malloc` in ISO C) and are executed after `MPI_INIT` and before `MPI_FINALIZE` operate independently and that their *completion* is independent of the action of other processes in an MPI program.

Note that this in no way prevents the creation of library routines that provide parallel services whose operation is collective. However, the following program is expected to complete in an ISO C environment regardless of the size of `MPI_COMM_WORLD` (assuming that `printf` is available at the executing nodes).

```
int rank;
MPI_Init((void *)0, (void *)0);
MPI_Comm_rank(MPI_COMM_WORLD, &rank);
if (rank == 0) printf("Starting program\n");
MPI_Finalize();
```

The corresponding Fortran programs are also expected to complete.

An example of what is *not* required is any particular ordering of the action of these routines when called by several tasks. For example, MPI makes neither requirements nor recommendations for the output from the following program (again assuming that I/O is available at the executing nodes).

```
MPI_Comm_rank(MPI_COMM_WORLD, &rank);
printf("Output from task rank %d\n", rank);
```

1 In addition, calls that fail because of resource exhaustion or other error are not con-
2 sidered a violation of the requirements here (however, they are required to complete, just
3 not to complete successfully).
4

5 2.9.2 Interaction with Signals

6 MPI does not specify the interaction of processes with signals and does not require that MPI
7 be signal safe. The implementation may reserve some signals for its own use. It is required
8 that the implementation document which signals it uses, and it is strongly recommended
9 that it not use `SIGALRM`, `SIGFPE`, or `SIGIO`. Implementations may also prohibit the use of
10 MPI calls from within signal handlers.
11

12 In multithreaded environments, users can avoid conflicts between signals and the MPI
13 library by catching signals only on threads that do not execute MPI calls. High quality
14 single-threaded implementations will be signal safe: an MPI call suspended by a signal will
15 resume and complete normally after the signal is handled.
16

17 2.10 Examples

18
19 The examples in this document are for illustration purposes only. They are not intended
20 to specify the standard. Furthermore, the examples have not been carefully checked or
21 verified.
22
23
24
25
26
27
28
29
30
31
32
33
34
35
36
37
38
39
40
41
42
43
44
45
46
47
48

Deprecated or removed construct	deprecated since	removed since	Replacement
MPI_ADDRESS	MPI-2.0	MPI-3.0	MPI_GET_ADDRESS
MPI_TYPE_HINDEXED	MPI-2.0	MPI-3.0	MPI_TYPE_CREATE_HINDEXED
MPI_TYPE_HVECTOR	MPI-2.0	MPI-3.0	MPI_TYPE_CREATE_HVECTOR
MPI_TYPE_STRUCT	MPI-2.0	MPI-3.0	MPI_TYPE_CREATE_STRUCT
MPI_TYPE_EXTENT	MPI-2.0	MPI-3.0	MPI_TYPE_GET_EXTENT
MPI_TYPE_UB	MPI-2.0	MPI-3.0	MPI_TYPE_GET_EXTENT
MPI_TYPE_LB	MPI-2.0	MPI-3.0	MPI_TYPE_GET_EXTENT
MPI_LB ¹	MPI-2.0	MPI-3.0	MPI_TYPE_CREATE_RESIZED
MPI_UB ¹	MPI-2.0	MPI-3.0	MPI_TYPE_CREATE_RESIZED
MPI_ERRHANDLER_CREATE	MPI-2.0	MPI-3.0	MPI_COMM_CREATE_ERRHANDLER
MPI_ERRHANDLER_GET	MPI-2.0	MPI-3.0	MPI_COMM_GET_ERRHANDLER
MPI_ERRHANDLER_SET	MPI-2.0	MPI-3.0	MPI_COMM_SET_ERRHANDLER
MPI_Handler_function ²	MPI-2.0	MPI-3.0	MPI_Comm_errhandler_function ²
MPI_KEYVAL_CREATE	MPI-2.0		MPI_COMM_CREATE_KEYVAL
MPI_KEYVAL_FREE	MPI-2.0		MPI_COMM_FREE_KEYVAL
MPI_DUP_FN ³	MPI-2.0		MPI_COMM_DUP_FN ³
MPI_NULL_COPY_FN ³	MPI-2.0		MPI_COMM_NULL_COPY_FN ³
MPI_NULL_DELETE_FN ³	MPI-2.0		MPI_COMM_NULL_DELETE_FN ³
MPI_Copy_function ²	MPI-2.0		MPI_Comm_copy_attr_function ²
COPY_FUNCTION ³	MPI-2.0		COMM_COPY_ATTR_FUNCTION ³
MPI_Delete_function ²	MPI-2.0		MPI_Comm_delete_attr_function ²
DELETE_FUNCTION ³	MPI-2.0		COMM_DELETE_ATTR_FUNCTION ³
MPI_ATTR_DELETE	MPI-2.0		MPI_COMM_DELETE_ATTR
MPI_ATTR_GET	MPI-2.0		MPI_COMM_GET_ATTR
MPI_ATTR_PUT	MPI-2.0		MPI_COMM_SET_ATTR
MPI_COMBINER_HVECTOR_INTEGER ⁴	-	MPI-3.0	MPI_COMBINER_HVECTOR ⁴
MPI_COMBINER_HINDEXED_INTEGER ⁴	-	MPI-3.0	MPI_COMBINER_HINDEXED ⁴
MPI_COMBINER_STRUCT_INTEGER ⁴	-	MPI-3.0	MPI_COMBINER_STRUCT ⁴
MPI::..	MPI-2.2	MPI-3.0	C language binding
MPI_CANCEL for send requests	MPI-3.2		no direct replacement
MPI_T_ERR_INVALID_ITEM	MPI-3.2		MPI_T_ERR_INVALID_INDEX

¹ Predefined datatype.
² Callback prototype definition.
³ Predefined callback routine.
⁴ Constant.
Other entries are regular MPI routines.

Table 2.1: Deprecated and Removed constructs

1
2
3
4
5
6
7
8
9
10
11
12
13
14
15
16
17
18
19
20
21
22
23
24
25
26
27
28
29
30
31
32
33
34
35
36
37
38
39
40
41
42
43
44
45
46
47
48

Chapter 3

Point-to-Point Communication

3.1 Introduction

Sending and receiving of messages by processes is the basic MPI communication mechanism. The basic point-to-point communication operations are **send** and **receive**. Their use is illustrated in the example below.

```
#include "mpi.h"
int main( int argc, char *argv[])
{
    char message[20];
    int myrank;
    MPI_Status status;
    MPI_Init( &argc, &argv );
    MPI_Comm_rank( MPI_COMM_WORLD, &myrank );
    if (myrank == 0) /* code for process zero */
    {
        strcpy(message,"Hello, there");
        MPI_Send(message, strlen(message)+1, MPI_CHAR, 1, 99, MPI_COMM_WORLD);
    }
    else if (myrank == 1) /* code for process one */
    {
        MPI_Recv(message, 20, MPI_CHAR, 0, 99, MPI_COMM_WORLD, &status);
        printf("received :%s:\n", message);
    }
    MPI_Finalize();
    return 0;
}
```

In this example, process zero (`myrank = 0`) sends a message to process one using the **send** operation `MPI_SEND`. The operation specifies a **send buffer** in the sender memory from which the message data is taken. In the example above, the send buffer consists of the storage containing the variable `message` in the memory of process zero. The location, size and type of the send buffer are specified by the first three parameters of the send operation. The message sent will contain the 13 characters of this variable. In addition, the send operation associates an **envelope** with the message. This envelope specifies the

1 message destination and contains distinguishing information that can be used by the **receive**
 2 operation to select a particular message. The last three parameters of the send operation,
 3 along with the rank of the sender, specify the envelope for the message sent. Process one
 4 (**myrank** = 1) receives this message with the **receive** operation `MPI_RECV`. The message to
 5 be received is selected according to the value of its envelope, and the message data is stored
 6 into the **receive buffer**. In the example above, the receive buffer consists of the storage
 7 containing the string **message** in the memory of process one. The first three parameters
 8 of the receive operation specify the location, size and type of the receive buffer. The next
 9 three parameters are used for selecting the incoming message. The last parameter is used
 10 to return information on the message just received.

11 The next sections describe the blocking send and receive operations. We discuss send,
 12 receive, blocking communication semantics, type matching requirements, type conversion in
 13 heterogeneous environments, and more general communication modes. Nonblocking com-
 14 munication is addressed next, followed by probing and canceling a message, channel-like
 15 constructs and send-receive operations, ending with a description of the “dummy” process,
 16 `MPI_PROC_NULL`.

18 3.2 Blocking Send and Receive Operations

20 3.2.1 Blocking Send

22 The syntax of the blocking send operation is given below.

24 `MPI_SEND(buf, count, datatype, dest, tag, comm)`

26	IN	<code>buf</code>	initial address of send buffer (choice)
27	IN	<code>count</code>	number of elements in send buffer (non-negative integer)
28			
29	IN	<code>datatype</code>	datatype of each send buffer element (handle)
30			
31	IN	<code>dest</code>	rank of destination (integer)
32	IN	<code>tag</code>	message tag (integer)
33	IN	<code>comm</code>	communicator (handle)
34			

35
 36 `int MPI_Send(const void* buf, int count, MPI_Datatype datatype, int dest,`
 37 `int tag, MPI_Comm comm)`

38 `MPI_Send(buf, count, datatype, dest, tag, comm, ierror)`

39 `TYPE(*), DIMENSION(..), INTENT(IN) :: buf`
 40 `INTEGER, INTENT(IN) :: count, dest, tag`
 41 `TYPE(MPI_Datatype), INTENT(IN) :: datatype`
 42 `TYPE(MPI_Comm), INTENT(IN) :: comm`
 43 `INTEGER, OPTIONAL, INTENT(OUT) :: ierror`

44 `MPI_SEND(BUF, COUNT, DATATYPE, DEST, TAG, COMM, IERROR)`

45 `<type> BUF(*)`
 46 `INTEGER COUNT, DATATYPE, DEST, TAG, COMM, IERROR`

48 The blocking semantics of this call are described in Section 3.4.

3.2.2 Message Data

The send buffer specified by the MPI_SEND operation consists of `count` successive entries of the type indicated by `datatype`, starting with the entry at address `buf`. Note that we specify the message length in terms of number of *elements*, not number of *bytes*. The former is machine independent and closer to the application level.

The data part of the message consists of a sequence of `count` values, each of the type indicated by `datatype`. `count` may be zero, in which case the data part of the message is empty. The basic datatypes that can be specified for message data values correspond to the basic datatypes of the host language. Possible values of this argument for Fortran and the corresponding Fortran types are listed in Table 3.1.

MPI datatype	Fortran datatype
MPI_INTEGER	INTEGER
MPI_REAL	REAL
MPI_DOUBLE_PRECISION	DOUBLE PRECISION
MPI_COMPLEX	COMPLEX
MPI_LOGICAL	LOGICAL
MPI_CHARACTER	CHARACTER(1)
MPI_BYTE	
MPI_PACKED	

Table 3.1: Predefined MPI datatypes corresponding to Fortran datatypes

Possible values for this argument for C and the corresponding C types are listed in Table 3.2.

The datatypes MPI_BYTE and MPI_PACKED do not correspond to a Fortran or C datatype. A value of type MPI_BYTE consists of a byte (8 binary digits). A byte is uninterpreted and is different from a character. Different machines may have different representations for characters, or may use more than one byte to represent characters. On the other hand, a byte has the same binary value on all machines. The use of the type MPI_PACKED is explained in Section 4.2.

MPI requires support of these datatypes, which match the basic datatypes of Fortran and ISO C. Additional MPI datatypes should be provided if the host language has additional data types: MPI_DOUBLE_COMPLEX for double precision complex in Fortran declared to be of type DOUBLE COMPLEX; MPI_REAL2, MPI_REAL4, and MPI_REAL8 for Fortran reals, declared to be of type REAL*2, REAL*4 and REAL*8, respectively; MPI_INTEGER1, MPI_INTEGER2, and MPI_INTEGER4 for Fortran integers, declared to be of type INTEGER*1, INTEGER*2, and INTEGER*4, respectively; etc.

Rationale. One goal of the design is to allow for MPI to be implemented as a library, with no need for additional preprocessing or compilation. Thus, one cannot assume that a communication call has information on the datatype of variables in the communication buffer; this information must be supplied by an explicit argument. The need for such datatype information will become clear in Section 3.3.2. (*End of rationale.*)

The datatypes MPI_AINT, MPI_OFFSET, and MPI_COUNT correspond to the MPI-defined C types MPI_Aint, MPI_Offset, and MPI_Count and their Fortran equivalents

MPI datatype	C datatype
MPI_CHAR	char (treated as printable character)
MPI_SHORT	signed short int
MPI_INT	signed int
MPI_LONG	signed long int
MPI_LONG_LONG_INT	signed long long int
MPI_LONG_LONG (as a synonym)	signed long long int
MPI_SIGNED_CHAR	signed char (treated as integral value)
MPI_UNSIGNED_CHAR	unsigned char (treated as integral value)
MPI_UNSIGNED_SHORT	unsigned short int
MPI_UNSIGNED	unsigned int
MPI_UNSIGNED_LONG	unsigned long int
MPI_UNSIGNED_LONG_LONG	unsigned long long int
MPI_FLOAT	float
MPI_DOUBLE	double
MPI_LONG_DOUBLE	long double
MPI_WCHAR	wchar_t (defined in <stddef.h> (treated as printable character)
MPI_C_BOOL	_Bool
MPI_INT8_T	int8_t
MPI_INT16_T	int16_t
MPI_INT32_T	int32_t
MPI_INT64_T	int64_t
MPI_UINT8_T	uint8_t
MPI_UINT16_T	uint16_t
MPI_UINT32_T	uint32_t
MPI_UINT64_T	uint64_t
MPI_C_COMPLEX	float _Complex
MPI_C_FLOAT_COMPLEX (as a synonym)	float _Complex
MPI_C_DOUBLE_COMPLEX	double _Complex
MPI_C_LONG_DOUBLE_COMPLEX	long double _Complex
MPI_BYTE	
MPI_PACKED	

Table 3.2: Predefined MPI datatypes corresponding to C datatypes

INTEGER (KIND=MPI_ADDRESS_KIND), INTEGER (KIND=MPI_OFFSET_KIND), and INTEGER (KIND=MPI_COUNT_KIND). This is described in Table 3.3. All predefined datatype handles are available in all language bindings. See Sections 18.2.6 and 18.2.10 on page 694 and 702 for information on interlanguage communication with these types.

If there is an accompanying C++ compiler then the datatypes in Table 3.4 are also supported in C and Fortran.

MPI datatype	C datatype	Fortran datatype
MPI_AINT	MPI_Aint	INTEGER (KIND=MPI_ADDRESS_KIND)
MPI_OFFSET	MPI_Offset	INTEGER (KIND=MPI_OFFSET_KIND)
MPI_COUNT	MPI_Count	INTEGER (KIND=MPI_COUNT_KIND)

Table 3.3: Predefined MPI datatypes corresponding to both C and Fortran datatypes

MPI datatype	C++ datatype
MPI_CXX_BOOL	bool
MPI_CXX_FLOAT_COMPLEX	std::complex<float>
MPI_CXX_DOUBLE_COMPLEX	std::complex<double>
MPI_CXX_LONG_DOUBLE_COMPLEX	std::complex<long double>

Table 3.4: Predefined MPI datatypes corresponding to C++ datatypes

3.2.3 Message Envelope

In addition to the data part, messages carry information that can be used to distinguish messages and selectively receive them. This information consists of a fixed number of fields, which we collectively call the **message envelope**. These fields are

source
destination
tag
communicator

The message source is implicitly determined by the identity of the message sender. The other fields are specified by arguments in the send operation.

The message destination is specified by the **dest** argument.

The integer-valued message tag is specified by the **tag** argument. This integer can be used by the program to distinguish different types of messages. The range of valid tag values is $0, \dots, \text{UB}$, where the value of **UB** is implementation dependent. It can be found by querying the value of the attribute `MPI_TAG_UB`, as described in Chapter 8. MPI requires that **UB** be no less than 32767.

The **comm** argument specifies the **communicator** that is used for the send operation. Communicators are explained in Chapter 6; below is a brief summary of their usage.

A communicator specifies the communication context for a communication operation. Each communication context provides a separate “communication universe”: messages are always received within the context they were sent, and messages sent in different contexts do not interfere.

The communicator also specifies the set of processes that share this communication context. This **process group** is ordered and processes are identified by their rank within this group. Thus, the range of valid values for **dest** is $0, \dots, n-1 \cup \{\text{MPI_PROC_NULL}\}$, where n is the number of processes in the group. (If the communicator is an inter-communicator, then destinations are identified by their rank in the remote group. See Chapter 6.)

A predefined communicator `MPI_COMM_WORLD` is provided by MPI. It allows communication with all processes that are accessible after MPI initialization and processes are identified by their rank in the group of `MPI_COMM_WORLD`.

Advice to users. Users that are comfortable with the notion of a flat name space for processes, and a single communication context, as offered by most existing communication libraries, need only use the predefined variable `MPI_COMM_WORLD` as the `comm` argument. This will allow communication with all the processes available at initialization time.

Users may define new communicators, as explained in Chapter 6. Communicators provide an important encapsulation mechanism for libraries and modules. They allow modules to have their own disjoint communication universe and their own process numbering scheme. (*End of advice to users.*)

Advice to implementors. The message envelope would normally be encoded by a fixed-length message header. However, the actual encoding is implementation dependent. Some of the information (e.g., source or destination) may be implicit, and need not be explicitly carried by messages. Also, processes may be identified by relative ranks, or absolute ids, etc. (*End of advice to implementors.*)

3.2.4 Blocking Receive

The syntax of the blocking receive operation is given below.

`MPI_RECV (buf, count, datatype, source, tag, comm, status)`

OUT	buf	initial address of receive buffer (choice)
IN	count	number of elements in receive buffer (non-negative integer)
IN	datatype	datatype of each receive buffer element (handle)
IN	source	rank of source or <code>MPI_ANY_SOURCE</code> (integer)
IN	tag	message tag or <code>MPI_ANY_TAG</code> (integer)
IN	comm	communicator (handle)
OUT	status	status object (<code>Status</code>)

```
int MPI_Recv(void* buf, int count, MPI_Datatype datatype, int source,
            int tag, MPI_Comm comm, MPI_Status *status)
```

```
MPI_Recv(buf, count, datatype, source, tag, comm, status, ierror)
```

```
TYPE(*), DIMENSION(..) :: buf
INTEGER, INTENT(IN) :: count, source, tag
TYPE(MPI_Datatype), INTENT(IN) :: datatype
TYPE(MPI_Comm), INTENT(IN) :: comm
TYPE(MPI_Status) :: status
INTEGER, OPTIONAL, INTENT(OUT) :: ierror
```

```
MPI_RECV(BUF, COUNT, DATATYPE, SOURCE, TAG, COMM, STATUS, IERROR)
```

```
<type> BUF(*)
INTEGER COUNT, DATATYPE, SOURCE, TAG, COMM, STATUS(MPI_STATUS_SIZE),
IERROR
```

The blocking semantics of this call are described in Section 3.4.

The receive buffer consists of the storage containing `count` consecutive elements of the type specified by `datatype`, starting at address `buf`. The length of the received message must be less than or equal to the length of the receive buffer. An overflow error occurs if all incoming data does not fit, without truncation, into the receive buffer.

If a message that is shorter than the receive buffer arrives, then only those locations corresponding to the (shorter) message are modified.

Advice to users. The `MPI_PROBE` function described in Section 3.8 can be used to receive messages of unknown length. (*End of advice to users.*)

Advice to implementors. Even though no specific behavior is mandated by MPI for erroneous programs, the recommended handling of overflow situations is to return in `status` information about the source and tag of the incoming message. The receive operation will return an error code. A quality implementation will also ensure that no memory that is outside the receive buffer will ever be overwritten.

In the case of a message shorter than the receive buffer, MPI is quite strict in that it allows no modification of the other locations. A more lenient statement would allow for some optimizations but this is not allowed. The implementation must be ready to end a copy into the receiver memory exactly at the end of the receive buffer, even if it is an odd address. (*End of advice to implementors.*)

The selection of a message by a receive operation is governed by the value of the message envelope. A message can be received by a receive operation if its envelope matches the `source`, `tag` and `comm` values specified by the receive operation. The receiver may specify a wildcard `MPI_ANY_SOURCE` value for `source`, and/or a wildcard `MPI_ANY_TAG` value for `tag`, indicating that any source and/or tag are acceptable. It cannot specify a wildcard value for `comm`. Thus, a message can be received by a receive operation only if it is addressed to the receiving process, has a matching communicator, has matching source unless `source=MPI_ANY_SOURCE` in the pattern, and has a matching tag unless `tag=MPI_ANY_TAG` in the pattern.

The message tag is specified by the `tag` argument of the receive operation. The argument `source`, if different from `MPI_ANY_SOURCE`, is specified as a rank within the process group associated with that same communicator (remote process group, for intercommunicators). Thus, the range of valid values for the `source` argument is $\{0, \dots, n - 1\} \cup \{\text{MPI_ANY_SOURCE}\} \cup \{\text{MPI_PROC_NULL}\}$, where n is the number of processes in this group.

Note the asymmetry between send and receive operations: A receive operation may accept messages from an arbitrary sender, on the other hand, a send operation must specify a unique receiver. This matches a “push” communication mechanism, where data transfer is effected by the sender (rather than a “pull” mechanism, where data transfer is effected by the receiver).

Source = destination is allowed, that is, a process can send a message to itself. (However, it is unsafe to do so with the blocking send and receive operations described above, since this may lead to deadlock. See Section 3.5.)

Advice to implementors. Message context and other communicator information can be implemented as an additional tag field. It differs from the regular message tag in that wild card matching is not allowed on this field, and that value setting for

1 this field is controlled by communicator manipulation functions. (*End of advice to*
 2 *implementors.*)

3
 4 The use of `dest` or `source=MPI_PROC_NULL` to define a “dummy” destination or source
 5 in any send or receive call is described in Section 3.11.

7 3.2.5 Return Status

8 The source or tag of a received message may not be known if wildcard values were used
 9 in the receive operation. Also, if multiple requests are completed by a single MPI function
 10 (see Section 3.7.5), a distinct error code may need to be returned for each request. The
 11 information is returned by the `status` argument of `MPI_RECV`. The type of `status` is MPI-
 12 defined. Status variables need to be explicitly allocated by the user, that is, they are not
 13 system objects.

14
 15 In C, `status` is a structure that contains three fields named `MPI_SOURCE`, `MPI_TAG`,
 16 and `MPI_ERROR`; the structure may contain additional fields. Thus,
 17 `status.MPI_SOURCE`, `status.MPI_TAG` and `status.MPI_ERROR` contain the source, tag, and
 18 error code, respectively, of the received message.

19 In Fortran with `USE mpi` or `INCLUDE 'mpif.h'`, `status` is an array of `INTEGER`s of size
 20 `MPI_STATUS_SIZE`. The constants `MPI_SOURCE`, `MPI_TAG` and `MPI_ERROR` are the indices
 21 of the entries that store the source, tag and error fields. Thus, `status(MPI_SOURCE)`,
 22 `status(MPI_TAG)` and `status(MPI_ERROR)` contain, respectively, the source, tag and error
 23 code of the received message.

24 With Fortran `USE mpi_f08`, `status` is defined as the Fortran `BIND(C)` derived type
 25 `TYPE(MPI_Status)` containing three public `INTEGER` fields named `MPI_SOURCE`, `MPI_TAG`,
 26 and `MPI_ERROR`. `TYPE(MPI_Status)` may contain additional, implementation-specific fields.
 27 Thus, `status%MPI_SOURCE`, `status%MPI_TAG` and `status%MPI_ERROR` contain the source,
 28 tag, and error code of a received message respectively. Additionally, within both the `mpi`
 29 and the `mpi_f08` modules, the constants `MPI_STATUS_SIZE`, `MPI_SOURCE`, `MPI_TAG`,
 30 `MPI_ERROR`, and `TYPE(MPI_Status)` are defined to allow conversion between both status
 31 representations. Conversion routines are provided in Section 18.2.5.

32 *Rationale.* The Fortran `TYPE(MPI_Status)` is defined as a `BIND(C)` derived type so
 33 that it can be used at any location where the status integer array representation can
 34 be used, e.g., in user defined common blocks. (*End of rationale.*)

35
 36 *Rationale.* It is allowed to have the same name (e.g., `MPI_SOURCE`) defined as a
 37 constant (e.g., Fortran parameter) and as a field of a derived type. (*End of rationale.*)

38
 39 In general, message-passing calls do not modify the value of the error code field of
 40 status variables. This field may be updated only by the functions in Section 3.7.5 which
 41 return multiple statuses. The field is updated if and only if such function returns with an
 42 error code of `MPI_ERR_IN_STATUS`.

43
 44 *Rationale.* The error field in status is not needed for calls that return only one status,
 45 such as `MPI_WAIT`, since that would only duplicate the information returned by the
 46 function itself. The current design avoids the additional overhead of setting it, in such
 47 cases. The field is needed for calls that return multiple statuses, since each request
 48 may have had a different failure. (*End of rationale.*)

The status argument also returns information on the length of the message received. However, this information is not directly available as a field of the status variable and a call to `MPI_GET_COUNT` is required to “decode” this information.

`MPI_GET_COUNT(status, datatype, count)`

IN	status	return status of receive operation (Status)
IN	datatype	datatype of each receive buffer entry (handle)
OUT	count	number of received entries (integer)

```
int MPI_Get_count(const MPI_Status *status, MPI_Datatype datatype,
                 int *count)
```

```
MPI_Get_count(status, datatype, count, ierror)
  TYPE(MPI_Status), INTENT(IN) :: status
  TYPE(MPI_Datatype), INTENT(IN) :: datatype
  INTEGER, INTENT(OUT) :: count
  INTEGER, OPTIONAL, INTENT(OUT) :: ierror
```

```
MPI_GET_COUNT(STATUS, DATATYPE, COUNT, IERROR)
  INTEGER STATUS(MPI_STATUS_SIZE), DATATYPE, COUNT, IERROR
```

Returns the number of entries received. (Again, we count *entries*, each of type *datatype*, not *bytes*.) The *datatype* argument should match the argument provided by the receive call that set the *status* variable. If the number of entries received exceeds the limits of the *count* parameter, then `MPI_GET_COUNT` sets the value of *count* to `MPI_UNDEFINED`. There are other situations where the value of *count* can be set to `MPI_UNDEFINED`; see Section 4.1.11.

Rationale. Some message-passing libraries use `INOUT count, tag` and `source` arguments, thus using them both to specify the selection criteria for incoming messages and return the actual envelope values of the received message. The use of a separate status argument prevents errors that are often attached with `INOUT` argument (e.g., using the `MPI_ANY_TAG` constant as the tag in a receive). Some libraries use calls that refer implicitly to the “last message received.” This is not thread safe.

The *datatype* argument is passed to `MPI_GET_COUNT` so as to improve performance. A message might be received without counting the number of elements it contains, and the *count* value is often not needed. Also, this allows the same function to be used after a call to `MPI_PROBE` or `MPI_IPROBE`. With a status from `MPI_PROBE` or `MPI_IPROBE`, the same datatypes are allowed as in a call to `MPI_RECV` to receive this message. (*End of rationale.*)

The value returned as the *count* argument of `MPI_GET_COUNT` for a *datatype* of length zero where zero bytes have been transferred is zero. If the number of bytes transferred is greater than zero, `MPI_UNDEFINED` is returned.

Rationale. Zero-length datatypes may be created in a number of cases. An important case is `MPI_TYPE_CREATE_DARRAY`, where the definition of the particular darray results in an empty block on some MPI process. Programs written in an SPMD style

1 will not check for this special case and may want to use `MPI_GET_COUNT` to check
 2 the status. (*End of rationale.*)

3
 4 *Advice to users.* The buffer size required for the receive can be affected by data con-
 5 versions and by the stride of the receive datatype. In most cases, the safest approach
 6 is to use the same datatype with `MPI_GET_COUNT` and the receive. (*End of advice*
 7 *to users.*)

8
 9 All send and receive operations use the `buf`, `count`, `datatype`, `source`, `dest`, `tag`, `comm`,
 10 and `status` arguments in the same way as the blocking `MPI_SEND` and `MPI_RECV` operations
 11 described in this section.

12 13 3.2.6 Passing `MPI_STATUS_IGNORE` for Status

14 Every call to `MPI_RECV` includes a `status` argument, wherein the system can return details
 15 about the message received. There are also a number of other MPI calls where `status`
 16 is returned. An object of type `MPI_Status` is not an MPI opaque object; its structure
 17 is declared in `mpi.h` and `mpif.h`, and it exists in the user's program. In many cases,
 18 application programs are constructed so that it is unnecessary for them to examine the
 19 `status` fields. In these cases, it is a waste for the user to allocate a status object, and it is
 20 particularly wasteful for the MPI implementation to fill in fields in this object.

21 To cope with this problem, there are two predefined constants, `MPI_STATUS_IGNORE`
 22 and `MPI_STATUSES_IGNORE`, which when passed to a receive, probe, wait, or test function,
 23 inform the implementation that the status fields are not to be filled in. Note that
 24 `MPI_STATUS_IGNORE` is not a special type of `MPI_Status` object; rather, it is a special value
 25 for the argument. In C one would expect it to be `NULL`, not the address of a special
 26 `MPI_Status`.

27 `MPI_STATUS_IGNORE`, and the array version `MPI_STATUSES_IGNORE`, can be used every-
 28 where a status argument is passed to a receive, wait, or test function. `MPI_STATUS_IGNORE`
 29 cannot be used when status is an IN argument. Note that in Fortran `MPI_STATUS_IGNORE`
 30 and `MPI_STATUSES_IGNORE` are objects like `MPI_BOTTOM` (not usable for initialization or
 31 assignment). See Section 2.5.4.

32 In general, this optimization can apply to all functions for which `status` or an array of
 33 `statuses` is an OUT argument. Note that this converts `status` into an INOUT argument. The
 34 functions that can be passed `MPI_STATUS_IGNORE` are all the various forms of `MPI_RECV`,
 35 `MPI_PROBE`, `MPI_TEST`, and `MPI_WAIT`, as well as `MPI_REQUEST_GET_STATUS`. When
 36 an array is passed, as in the `MPI_{TEST|WAIT}{ALL|SOME}` functions, a separate constant,
 37 `MPI_STATUSES_IGNORE`, is passed for the array argument. It is possible for an MPI function
 38 to return `MPI_ERR_IN_STATUS` even when `MPI_STATUS_IGNORE` or `MPI_STATUSES_IGNORE`
 39 has been passed to that function.

40 `MPI_STATUS_IGNORE` and `MPI_STATUSES_IGNORE` are not required to have the same
 41 values in C and Fortran.

42 It is not allowed to have some of the statuses in an array of statuses for
 43 `MPI_{TEST|WAIT}{ALL|SOME}` functions set to `MPI_STATUS_IGNORE`; one either specifies
 44 ignoring *all* of the statuses in such a call with `MPI_STATUSES_IGNORE`, or *none* of them by
 45 passing normal statuses in all positions in the array of statuses.

3.3 Data Type Matching and Data Conversion

3.3.1 Type Matching Rules

One can think of message transfer as consisting of the following three phases.

1. Data is pulled out of the send buffer and a message is assembled.
2. A message is transferred from sender to receiver.
3. Data is pulled from the incoming message and disassembled into the receive buffer.

Type matching has to be observed at each of these three phases: The type of each variable in the sender buffer has to match the type specified for that entry by the send operation; the type specified by the send operation has to match the type specified by the receive operation; and the type of each variable in the receive buffer has to match the type specified for that entry by the receive operation. A program that fails to observe these three rules is erroneous.

To define type matching more precisely, we need to deal with two issues: matching of types of the host language with types specified in communication operations; and matching of types at sender and receiver.

The types of a send and receive match (phase two) if both operations use identical names. That is, `MPI_INTEGER` matches `MPI_INTEGER`, `MPI_REAL` matches `MPI_REAL`, and so on. There is one exception to this rule, discussed in Section 4.2: the type `MPI_PACKED` can match any other type.

The type of a variable in a host program matches the type specified in the communication operation if the datatype name used by that operation corresponds to the basic type of the host program variable. For example, an entry with type name `MPI_INTEGER` matches a Fortran variable of type `INTEGER`. A table giving this correspondence for Fortran and C appears in Section 3.2.2. There are two exceptions to this last rule: an entry with type name `MPI_BYTE` or `MPI_PACKED` can be used to match any byte of storage (on a byte-addressable machine), irrespective of the datatype of the variable that contains this byte. The type `MPI_PACKED` is used to send data that has been explicitly packed, or receive data that will be explicitly unpacked, see Section 4.2. The type `MPI_BYTE` allows one to transfer the binary value of a byte in memory unchanged.

To summarize, the type matching rules fall into the three categories below.

- Communication of typed values (e.g., with datatype different from `MPI_BYTE`), where the datatypes of the corresponding entries in the sender program, in the send call, in the receive call and in the receiver program must all match.
- Communication of untyped values (e.g., of datatype `MPI_BYTE`), where both sender and receiver use the datatype `MPI_BYTE`. In this case, there are no requirements on the types of the corresponding entries in the sender and the receiver programs, nor is it required that they be the same.
- Communication involving packed data, where `MPI_PACKED` is used.

The following examples illustrate the first two cases.

Example 3.1 Sender and receiver specify matching types.

```

1 CALL MPI_COMM_RANK(comm, rank, ierr)
2 IF (rank.EQ.0) THEN
3     CALL MPI_SEND(a(1), 10, MPI_REAL, 1, tag, comm, ierr)
4 ELSE IF (rank.EQ.1) THEN
5     CALL MPI_RECV(b(1), 15, MPI_REAL, 0, tag, comm, status, ierr)
6 END IF

```

This code is correct if both **a** and **b** are real arrays of size ≥ 10 . (In Fortran, it might be correct to use this code even if **a** or **b** have size < 10 : e.g., when **a**(1) can be equivalenced to an array with ten reals.)

Example 3.2 Sender and receiver do not specify matching types.

```

13 CALL MPI_COMM_RANK(comm, rank, ierr)
14 IF (rank.EQ.0) THEN
15     CALL MPI_SEND(a(1), 10, MPI_REAL, 1, tag, comm, ierr)
16 ELSE IF (rank.EQ.1) THEN
17     CALL MPI_RECV(b(1), 40, MPI_BYTE, 0, tag, comm, status, ierr)
18 END IF

```

This code is erroneous, since sender and receiver do not provide matching datatype arguments.

Example 3.3 Sender and receiver specify communication of untyped values.

```

24 CALL MPI_COMM_RANK(comm, rank, ierr)
25 IF (rank.EQ.0) THEN
26     CALL MPI_SEND(a(1), 40, MPI_BYTE, 1, tag, comm, ierr)
27 ELSE IF (rank.EQ.1) THEN
28     CALL MPI_RECV(b(1), 60, MPI_BYTE, 0, tag, comm, status, ierr)
29 END IF

```

This code is correct, irrespective of the type and size of **a** and **b** (unless this results in an out of bounds memory access).

Advice to users. If a buffer of type `MPI_BYTE` is passed as an argument to `MPI_SEND`, then MPI will send the data stored at contiguous locations, starting from the address indicated by the `buf` argument. This may have unexpected results when the data layout is not as a casual user would expect it to be. For example, some Fortran compilers implement variables of type `CHARACTER` as a structure that contains the character length and a pointer to the actual string. In such an environment, sending and receiving a Fortran `CHARACTER` variable using the `MPI_BYTE` type will not have the anticipated result of transferring the character string. For this reason, the user is advised to use typed communications whenever possible. (*End of advice to users.*)

Type `MPI_CHARACTER`

The type `MPI_CHARACTER` matches one character of a Fortran variable of type `CHARACTER`, rather than the entire character string stored in the variable. Fortran variables of type `CHARACTER` or substrings are transferred as if they were arrays of characters. This is illustrated in the example below.

Example 3.4

Transfer of Fortran CHARACTERS.

```

CHARACTER*10 a
CHARACTER*10 b

CALL MPI_COMM_RANK(comm, rank, ierr)
IF (rank.EQ.0) THEN
    CALL MPI_SEND(a, 5, MPI_CHARACTER, 1, tag, comm, ierr)
ELSE IF (rank.EQ.1) THEN
    CALL MPI_RECV(b(6:10), 5, MPI_CHARACTER, 0, tag, comm, status, ierr)
END IF

```

The last five characters of string b at process 1 are replaced by the first five characters of string a at process 0.

Rationale. The alternative choice would be for MPI_CHARACTER to match a character of arbitrary length. This runs into problems.

A Fortran character variable is a constant length string, with no special termination symbol. There is no fixed convention on how to represent characters, and how to store their length. Some compilers pass a character argument to a routine as a pair of arguments, one holding the address of the string and the other holding the length of string. Consider the case of an MPI communication call that is passed a communication buffer with type defined by a derived datatype (Section 4.1). If this communicator buffer contains variables of type CHARACTER then the information on their length will not be passed to the MPI routine.

This problem forces us to provide explicit information on character length with the MPI call. One could add a length parameter to the type MPI_CHARACTER, but this does not add much convenience and the same functionality can be achieved by defining a suitable derived datatype. (*End of rationale.*)

Advice to implementors. Some compilers pass Fortran CHARACTER arguments as a structure with a length and a pointer to the actual string. In such an environment, the MPI call needs to dereference the pointer in order to reach the string. (*End of advice to implementors.*)

3.3.2 Data Conversion

One of the goals of MPI is to support parallel computations across heterogeneous environments. Communication in a heterogeneous environment may require data conversions. We use the following terminology.

type conversion changes the datatype of a value, e.g., by rounding a REAL to an INTEGER.

representation conversion changes the binary representation of a value, e.g., from Hex floating point to IEEE floating point.

The type matching rules imply that MPI communication never entails type conversion. On the other hand, MPI requires that a representation conversion be performed when a

1 typed value is transferred across environments that use different representations for the
2 datatype of this value. MPI does not specify rules for representation conversion. Such
3 conversion is expected to preserve integer, logical and character values, and to convert a
4 floating point value to the nearest value that can be represented on the target system.

5 Overflow and underflow exceptions may occur during floating point conversions. Con-
6 version of integers or characters may also lead to exceptions when a value that can be
7 represented in one system cannot be represented in the other system. An exception occur-
8 ring during representation conversion results in a failure of the communication. An error
9 occurs either in the send operation, or the receive operation, or both.

10 If a value sent in a message is untyped (i.e., of type `MPI_BYTE`), then the binary
11 representation of the byte stored at the receiver is identical to the binary representation
12 of the byte loaded at the sender. This holds true, whether sender and receiver run in the
13 same or in distinct environments. No representation conversion is required. (Note that
14 representation conversion may occur when values of type `MPI_CHARACTER` or `MPI_CHAR`
15 are transferred, for example, from an EBCDIC encoding to an ASCII encoding.)

16 No conversion need occur when an MPI program executes in a homogeneous system,
17 where all processes run in the same environment.

18 Consider the three examples, 3.1–3.3. The first program is correct, assuming that `a` and
19 `b` are `REAL` arrays of size ≥ 10 . If the sender and receiver execute in different environments,
20 then the ten real values that are fetched from the send buffer will be converted to the
21 representation for reals on the receiver site before they are stored in the receive buffer.
22 While the number of real elements fetched from the send buffer equal the number of real
23 elements stored in the receive buffer, the number of bytes stored need not equal the number
24 of bytes loaded. For example, the sender may use a four byte representation and the receiver
25 an eight byte representation for reals.

26 The second program is erroneous, and its behavior is undefined.

27 The third program is correct. The exact same sequence of forty bytes that were loaded
28 from the send buffer will be stored in the receive buffer, even if sender and receiver run in
29 a different environment. The message sent has exactly the same length (in bytes) and the
30 same binary representation as the message received. If `a` and `b` are of different types, or if
31 they are of the same type but different data representations are used, then the bits stored
32 in the receive buffer may encode values that are different from the values they encoded in
33 the send buffer.

34 Data representation conversion also applies to the envelope of a message: source, des-
35 tination and tag are all integers that may need to be converted.

36
37 *Advice to implementors.* The current definition does not require messages to carry
38 data type information. Both sender and receiver provide complete data type infor-
39 mation. In a heterogeneous environment, one can either use a machine independent
40 encoding such as XDR, or have the receiver convert from the sender representation
41 to its own, or even have the sender do the conversion.

42 Additional type information might be added to messages in order to allow the sys-
43 tem to detect mismatches between datatype at sender and receiver. This might be
44 particularly useful in a slower but safer debug mode. (*End of advice to implementors.*)
45

46 MPI requires support for inter-language communication, i.e., if messages are sent by a
47 C or C++ process and received by a Fortran process, or vice-versa. The behavior is defined
48 in Section 18.2.

3.4 Communication Modes

The send call described in Section 3.2.1 is **blocking**: it does not return until the message data and envelope have been safely stored away so that the sender is free to modify the send buffer. The message might be copied directly into the matching receive buffer, or it might be copied into a temporary system buffer.

Message buffering decouples the send and receive operations. A blocking send can complete as soon as the message was buffered, even if no matching receive has been executed by the receiver. On the other hand, message buffering can be expensive, as it entails additional memory-to-memory copying, and it requires the allocation of memory for buffering. MPI offers the choice of several communication modes that allow one to control the choice of the communication protocol.

The send call described in Section 3.2.1 uses the **standard** communication mode. In this mode, it is up to MPI to decide whether outgoing messages will be buffered. MPI may buffer outgoing messages. In such a case, the send call may complete before a matching receive is invoked. On the other hand, buffer space may be unavailable, or MPI may choose not to buffer outgoing messages, for performance reasons. In this case, the send call will not complete until a matching receive has been posted, and the data has been moved to the receiver.

Thus, a send in standard mode can be started whether or not a matching receive has been posted. It may complete before a matching receive is posted. The standard mode send is *non-local*: successful completion of the send operation may depend on the occurrence of a matching receive.

Rationale. The reluctance of MPI to mandate whether standard sends are buffering or not stems from the desire to achieve portable programs. Since any system will run out of buffer resources as message sizes are increased, and some implementations may want to provide little buffering, MPI takes the position that correct (and therefore, portable) programs do not rely on system buffering in standard mode. Buffering may improve the performance of a correct program, but it doesn't affect the result of the program. If the user wishes to guarantee a certain amount of buffering, the user-provided buffer system of Section 3.6 should be used, along with the buffered-mode send. (*End of rationale.*)

There are three additional communication modes.

A **buffered** mode send operation can be started whether or not a matching receive has been posted. It may complete before a matching receive is posted. However, unlike the standard send, this operation is *local*, and its completion does not depend on the occurrence of a matching receive. Thus, if a send is executed and no matching receive is posted, then MPI must buffer the outgoing message, so as to allow the send call to complete. An error will occur if there is insufficient buffer space. The amount of available buffer space is controlled by the user — see Section 3.6. Buffer allocation by the user may be required for the buffered mode to be effective.

A send that uses the **synchronous** mode can be started whether or not a matching receive was posted. However, the send will complete successfully only if a matching receive is posted, and the receive operation has started to receive the message sent by the synchronous send. Thus, the completion of a synchronous send not only indicates that the send buffer can be reused, but it also indicates that the receiver has reached a certain point in its

1 execution, namely that it has started executing the matching receive. If both sends and
 2 receives are blocking operations then the use of the synchronous mode provides synchronous
 3 communication semantics: a communication does not complete at either end before both
 4 processes rendezvous at the communication. A send executed in this mode is *non-local*.

5 A send that uses the **ready** communication mode may be started *only* if the matching
 6 receive is already posted. Otherwise, the operation is erroneous and its outcome is unde-
 7 fined. On some systems, this allows the removal of a hand-shake operation that is otherwise
 8 required and results in improved performance. The completion of the send operation does
 9 not depend on the status of a matching receive, and merely indicates that the send buffer
 10 can be reused. A send operation that uses the ready mode has the same semantics as a
 11 standard send operation, or a synchronous send operation; it is merely that the sender
 12 provides additional information to the system (namely that a matching receive is already
 13 posted), that can save some overhead. In a correct program, therefore, a ready send could
 14 be replaced by a standard send with no effect on the behavior of the program other than
 15 performance.

16 Three additional send functions are provided for the three additional communication
 17 modes. The communication mode is indicated by a one letter prefix: B for buffered, S for
 18 synchronous, and R for ready.

19
 20
 21 MPI_BSEND (buf, count, datatype, dest, tag, comm)

22	IN	buf	initial address of send buffer (choice)
23	IN	count	number of elements in send buffer (non-negative inte- 24 ger)
25	IN	datatype	datatype of each send buffer element (handle)
26	IN	dest	rank of destination (integer)
27	IN	tag	message tag (integer)
28	IN	comm	communicator (handle)
29			
30			

31
 32 int MPI_Bsend(const void* buf, int count, MPI_Datatype datatype, int dest,
 33 int tag, MPI_Comm comm)

34 MPI_Bsend(buf, count, datatype, dest, tag, comm, ierror)
 35 TYPE(*), DIMENSION(..), INTENT(IN) :: buf
 36 INTEGER, INTENT(IN) :: count, dest, tag
 37 TYPE(MPI_Datatype), INTENT(IN) :: datatype
 38 TYPE(MPI_Comm), INTENT(IN) :: comm
 39 INTEGER, OPTIONAL, INTENT(OUT) :: ierror
 40

41 MPI_BSEND(BUF, COUNT, DATATYPE, DEST, TAG, COMM, IERROR)
 42 <type> BUF(*)
 43 INTEGER COUNT, DATATYPE, DEST, TAG, COMM, IERROR

44 Send in buffered mode.
 45
 46
 47
 48

MPI_SSEND (buf, count, datatype, dest, tag, comm)	1
IN buf	2
	3
IN count	4
	5
IN datatype	6
	7
IN dest	8
	9
IN tag	10
	11
IN comm	12
	13
int MPI_Ssend(const void* buf, int count, MPI_Datatype datatype, int dest,	14
int tag, MPI_Comm comm)	15
MPI_Ssend(buf, count, datatype, dest, tag, comm, ierror)	16
TYPE(*), DIMENSION(..), INTENT(IN) :: buf	17
INTEGER, INTENT(IN) :: count, dest, tag	18
TYPE(MPI_Datatype), INTENT(IN) :: datatype	19
TYPE(MPI_Comm), INTENT(IN) :: comm	20
INTEGER, OPTIONAL, INTENT(OUT) :: ierror	21
MPI_SSEND(BUF, COUNT, DATATYPE, DEST, TAG, COMM, IERROR)	22
<type> BUF(*)	23
INTEGER COUNT, DATATYPE, DEST, TAG, COMM, IERROR	24
	25
Send in synchronous mode.	26
	27
MPI_RSEND (buf, count, datatype, dest, tag, comm)	28
IN buf	29
	30
IN count	31
	32
IN datatype	33
	34
IN dest	35
	36
IN tag	37
	38
IN comm	39
	40
int MPI_Rsend(const void* buf, int count, MPI_Datatype datatype, int dest,	41
int tag, MPI_Comm comm)	42
MPI_Rsend(buf, count, datatype, dest, tag, comm, ierror)	43
TYPE(*), DIMENSION(..), INTENT(IN) :: buf	44
INTEGER, INTENT(IN) :: count, dest, tag	45
TYPE(MPI_Datatype), INTENT(IN) :: datatype	46
TYPE(MPI_Comm), INTENT(IN) :: comm	47
INTEGER, OPTIONAL, INTENT(OUT) :: ierror	48
MPI_RSEND(BUF, COUNT, DATATYPE, DEST, TAG, COMM, IERROR)	

```

1 <type> BUF(*)
2 INTEGER COUNT, DATATYPE, DEST, TAG, COMM, IERROR

```

3
4 Send in ready mode.

5 There is only one receive operation, but it matches any of the send modes. The receive
6 operation described in the last section is *blocking*: it returns only after the receive buffer
7 contains the newly received message. A receive can complete before the matching send has
8 completed (of course, it can complete only after the matching send has started).

9 In a multithreaded implementation of MPI, the system may de-schedule a thread that
10 is blocked on a send or receive operation, and schedule another thread for execution in
11 the same address space. In such a case it is the user's responsibility not to modify a
12 communication buffer until the communication completes. Otherwise, the outcome of the
13 computation is undefined.

14
15 *Advice to implementors.* Since a synchronous send cannot complete before a matching
16 receive is posted, one will not normally buffer messages sent by such an operation.

17 It is recommended to choose buffering over blocking the sender, whenever possible,
18 for standard sends. The programmer can signal his or her preference for blocking the
19 sender until a matching receive occurs by using the synchronous send mode.

20 A possible communication protocol for the various communication modes is outlined
21 below.

22 *ready send:* The message is sent as soon as possible.

23
24 *synchronous send:* The sender sends a request-to-send message. The receiver stores
25 this request. When a matching receive is posted, the receiver sends back a permission-
26 to-send message, and the sender now sends the message.

27 *standard send:* First protocol may be used for short messages, and second protocol
28 for long messages.

29
30 *buffered send:* The sender copies the message into a buffer and then sends it with a
31 nonblocking send (using the same protocol as for standard send).

32 Additional control messages might be needed for flow control and error recovery. Of
33 course, there are many other possible protocols.

34 Ready send can be implemented as a standard send. In this case there will be no
35 performance advantage (or disadvantage) for the use of ready send.

36 A standard send can be implemented as a synchronous send. In such a case, no data
37 buffering is needed. However, users may expect some buffering.

38
39 In a multithreaded environment, the execution of a blocking communication should
40 block only the executing thread, allowing the thread scheduler to de-schedule this
41 thread and schedule another thread for execution. (*End of advice to implementors.*)
42

43 3.5 Semantics of Point-to-Point Communication

44
45 A valid MPI implementation guarantees certain general properties of point-to-point com-
46 munication, which are described in this section.
47
48

Order Messages are *non-overtaking*: If a sender sends two messages in succession to the same destination, and both match the same receive, then this operation cannot receive the second message if the first one is still pending. If a receiver posts two receives in succession, and both match the same message, then the second receive operation cannot be satisfied by this message, if the first one is still pending. This requirement facilitates matching of sends to receives. It guarantees that message-passing code is deterministic, if processes are single-threaded and the wildcard `MPI_ANY_SOURCE` is not used in receives. (Some of the calls described later, such as `MPI_CANCEL` or `MPI_WAITANY`, are additional sources of nondeterminism.)

If a process has a single thread of execution, then any two communications executed by this process are ordered. On the other hand, if the process is multithreaded, then the semantics of thread execution may not define a relative order between two send operations executed by two distinct threads. The operations are logically concurrent, even if one physically precedes the other. In such a case, the two messages sent can be received in any order. Similarly, if two receive operations that are logically concurrent receive two successively sent messages, then the two messages can match the two receives in either order.

Example 3.5 An example of non-overtaking messages.

```
CALL MPI_COMM_RANK(comm, rank, ierr)
IF (rank.EQ.0) THEN
    CALL MPI_BSEND(buf1, count, MPI_REAL, 1, tag, comm, ierr)
    CALL MPI_BSEND(buf2, count, MPI_REAL, 1, tag, comm, ierr)
ELSE IF (rank.EQ.1) THEN
    CALL MPI_RECV(buf1, count, MPI_REAL, 0, MPI_ANY_TAG, comm, status, ierr)
    CALL MPI_RECV(buf2, count, MPI_REAL, 0, tag, comm, status, ierr)
END IF
```

The message sent by the first send must be received by the first receive, and the message sent by the second send must be received by the second receive.

Progress If a pair of matching send and receives have been initiated on two processes, then at least one of these two operations will complete, independently of other actions in the system: the send operation will complete, unless the receive is satisfied by another message, and completes; the receive operation will complete, unless the message sent is consumed by another matching receive that was posted at the same destination process.

Example 3.6 An example of two, intertwined matching pairs.

```
CALL MPI_COMM_RANK(comm, rank, ierr)
IF (rank.EQ.0) THEN
    CALL MPI_BSEND(buf1, count, MPI_REAL, 1, tag1, comm, ierr)
    CALL MPI_SSEND(buf2, count, MPI_REAL, 1, tag2, comm, ierr)
ELSE IF (rank.EQ.1) THEN
    CALL MPI_RECV(buf1, count, MPI_REAL, 0, tag2, comm, status, ierr)
    CALL MPI_RECV(buf2, count, MPI_REAL, 0, tag1, comm, status, ierr)
END IF
```

1 Both processes invoke their first communication call. Since the first send of process zero
2 uses the buffered mode, it must complete, irrespective of the state of process one. Since
3 no matching receive is posted, the message will be copied into buffer space. (If insufficient
4 buffer space is available, then the program will fail.) The second send is then invoked. At
5 that point, a matching pair of send and receive operation is enabled, and both operations
6 must complete. Process one next invokes its second receive call, which will be satisfied by
7 the buffered message. Note that process one received the messages in the reverse order they
8 were sent.

9
10 **Fairness** MPI makes no guarantee of *fairness* in the handling of communication. Suppose
11 that a send is posted. Then it is possible that the destination process repeatedly posts a
12 receive that matches this send, yet the message is never received, because it is each time
13 overtaken by another message, sent from another source. Similarly, suppose that a receive
14 was posted by a multithreaded process. Then it is possible that messages that match this
15 receive are repeatedly received, yet the receive is never satisfied, because it is overtaken
16 by other receives posted at this node (by other executing threads). It is the programmer's
17 responsibility to prevent starvation in such situations.

18
19 **Resource limitations** Any pending communication operation consumes system resources
20 that are limited. Errors may occur when lack of resources prevent the execution of an MPI
21 call. A quality implementation will use a (small) fixed amount of resources for each pending
22 send in the ready or synchronous mode and for each pending receive. However, buffer space
23 may be consumed to store messages sent in standard mode, and must be consumed to store
24 messages sent in buffered mode, when no matching receive is available. The amount of space
25 available for buffering will be much smaller than program data memory on many systems.
26 Then, it will be easy to write programs that overrun available buffer space.

27 MPI allows the user to provide buffer memory for messages sent in the buffered mode.
28 Furthermore, MPI specifies a detailed operational model for the use of this buffer. An MPI
29 implementation is required to do no worse than implied by this model. This allows users to
30 avoid buffer overflows when they use buffered sends. Buffer allocation and use is described
31 in Section 3.6.

32 A buffered send operation that cannot complete because of a lack of buffer space is
33 erroneous. When such a situation is detected, an error is signaled that may cause the
34 program to terminate abnormally. On the other hand, a standard send operation that
35 cannot complete because of lack of buffer space will merely block, waiting for buffer space
36 to become available or for a matching receive to be posted. This behavior is preferable in
37 many situations. Consider a situation where a producer repeatedly produces new values
38 and sends them to a consumer. Assume that the producer produces new values faster
39 than the consumer can consume them. If buffered sends are used, then a buffer overflow
40 will result. Additional synchronization has to be added to the program so as to prevent
41 this from occurring. If standard sends are used, then the producer will be automatically
42 throttled, as its send operations will block when buffer space is unavailable.

43 In some situations, a lack of buffer space leads to deadlock situations. This is illustrated
44 by the examples below.

45
46 **Example 3.7** An exchange of messages.
47
48

```

CALL MPI_COMM_RANK(comm, rank, ierr)
IF (rank.EQ.0) THEN
    CALL MPI_SEND(sendbuf, count, MPI_REAL, 1, tag, comm, ierr)
    CALL MPI_RECV(recvbuf, count, MPI_REAL, 1, tag, comm, status, ierr)
ELSE IF (rank.EQ.1) THEN
    CALL MPI_RECV(recvbuf, count, MPI_REAL, 0, tag, comm, status, ierr)
    CALL MPI_SEND(sendbuf, count, MPI_REAL, 0, tag, comm, ierr)
END IF

```

This program will succeed even if no buffer space for data is available. The standard send operation can be replaced, in this example, with a synchronous send.

Example 3.8 An errant attempt to exchange messages.

```

CALL MPI_COMM_RANK(comm, rank, ierr)
IF (rank.EQ.0) THEN
    CALL MPI_RECV(recvbuf, count, MPI_REAL, 1, tag, comm, status, ierr)
    CALL MPI_SEND(sendbuf, count, MPI_REAL, 1, tag, comm, ierr)
ELSE IF (rank.EQ.1) THEN
    CALL MPI_RECV(recvbuf, count, MPI_REAL, 0, tag, comm, status, ierr)
    CALL MPI_SEND(sendbuf, count, MPI_REAL, 0, tag, comm, ierr)
END IF

```

The receive operation of the first process must complete before its send, and can complete only if the matching send of the second processor is executed. The receive operation of the second process must complete before its send and can complete only if the matching send of the first process is executed. This program will always deadlock. The same holds for any other send mode.

Example 3.9 An exchange that relies on buffering.

```

CALL MPI_COMM_RANK(comm, rank, ierr)
IF (rank.EQ.0) THEN
    CALL MPI_SEND(sendbuf, count, MPI_REAL, 1, tag, comm, ierr)
    CALL MPI_RECV(recvbuf, count, MPI_REAL, 1, tag, comm, status, ierr)
ELSE IF (rank.EQ.1) THEN
    CALL MPI_SEND(sendbuf, count, MPI_REAL, 0, tag, comm, ierr)
    CALL MPI_RECV(recvbuf, count, MPI_REAL, 0, tag, comm, status, ierr)
END IF

```

The message sent by each process has to be copied out before the send operation returns and the receive operation starts. For the program to complete, it is necessary that at least one of the two messages sent be buffered. Thus, this program can succeed only if the communication system can buffer at least count words of data.

Advice to users. When standard send operations are used, then a deadlock situation may occur where both processes are blocked because buffer space is not available. The same will certainly happen, if the synchronous mode is used. If the buffered mode is used, and not enough buffer space is available, then the program will not complete either. However, rather than a deadlock situation, we shall have a buffer overflow error.

1 A program is “safe” if no message buffering is required for the program to complete.
 2 One can replace all sends in such program with synchronous sends, and the pro-
 3 gram will still run correctly. This conservative programming style provides the best
 4 portability, since program completion does not depend on the amount of buffer space
 5 available or on the communication protocol used.

6 Many programmers prefer to have more leeway and opt to use the “unsafe” program-
 7 ming style shown in Example 3.9. In such cases, the use of standard sends is likely
 8 to provide the best compromise between performance and robustness: quality imple-
 9 mentations will provide sufficient buffering so that “common practice” programs will
 10 not deadlock. The buffered send mode can be used for programs that require more
 11 buffering, or in situations where the programmer wants more control. This mode
 12 might also be used for debugging purposes, as buffer overflow conditions are easier to
 13 diagnose than deadlock conditions.

14 Nonblocking message-passing operations, as described in Section 3.7, can be used to
 15 avoid the need for buffering outgoing messages. This prevents deadlocks due to lack
 16 of buffer space, and improves performance, by allowing overlap of computation and
 17 communication, and avoiding the overheads of allocating buffers and copying messages
 18 into buffers. (*End of advice to users.*)

21 3.6 Buffer Allocation and Usage

22 A user may specify a buffer to be used for buffering messages sent in buffered mode. Buffer-
 23 ing is done by the sender.

24 MPI_BUFFER_ATTACH(buffer, size)

25 IN buffer initial buffer address (choice)
 26 IN size buffer size, in bytes (non-negative integer)

27 int MPI_Buffer_attach(void* buffer, int size)

28 MPI_Buffer_attach(buffer, size, ierror)
 29 TYPE(*), DIMENSION(..), ASYNCHRONOUS :: buffer
 30 INTEGER, INTENT(IN) :: size
 31 INTEGER, OPTIONAL, INTENT(OUT) :: ierror

32 MPI_BUFFER_ATTACH(BUFFER, SIZE, IERROR)

33 <type> BUFFER(*)
 34 INTEGER SIZE, IERROR

35 Provides to MPI a buffer in the user’s memory to be used for buffering outgoing mes-
 36 sages. The buffer is used only by messages sent in buffered mode. Only one buffer can be
 37 attached to a process at a time. In C, buffer is the starting address of a memory region. In
 38 Fortran, one can pass the first element of a memory region or a whole array, which must be
 39 ‘simply contiguous’ (for ‘simply contiguous,’ see also Section 18.1.12).
 40
 41
 42
 43
 44
 45
 46
 47
 48

```

MPI_BUFFER_DETACH(buffer_addr, size)
    OUT    buffer_addr          initial buffer address (choice)
    OUT    size                 buffer size, in bytes (non-negative integer)

int MPI_Buffer_detach(void* buffer_addr, int* size)

MPI_Buffer_detach(buffer_addr, size, ierror)
    USE, INTRINSIC :: ISO_C_BINDING, ONLY : C_PTR
    TYPE(C_PTR), INTENT(OUT) :: buffer_addr
    INTEGER, INTENT(OUT) :: size
    INTEGER, OPTIONAL, INTENT(OUT) :: ierror

MPI_BUFFER_DETACH(BUFFER_ADDR, SIZE, IERROR)
    <type> BUFFER_ADDR(*)
    INTEGER SIZE, IERROR

```

Detach the buffer currently associated with MPI. The call returns the address and the size of the detached buffer. This operation will block until all messages currently in the buffer have been transmitted. Upon return of this function, the user may reuse or deallocate the space taken by the buffer.

Example 3.10 Calls to attach and detach buffers.

```

#define BUFFSIZE 10000
int size;
char *buff;
MPI_Buffer_attach( malloc(BUFFSIZE), BUFFSIZE);
/* a buffer of 10000 bytes can now be used by MPI_Bsend */
MPI_Buffer_detach( &buff, &size);
/* Buffer size reduced to zero */
MPI_Buffer_attach( buff, size);
/* Buffer of 10000 bytes available again */

```

Advice to users. Even though the C functions `MPI_Buffer_attach` and `MPI_Buffer_detach` both have a first argument of type `void*`, these arguments are used differently: A pointer to the buffer is passed to `MPI_Buffer_attach`; the address of the pointer is passed to `MPI_Buffer_detach`, so that this call can return the pointer value. In Fortran with the `mpi` module or `mpif.h`, the type of the `buffer_addr` argument is wrongly defined and the argument is therefore unused. In Fortran with the `mpi_f08` module, the address of the buffer is returned as `TYPE(C_PTR)`, see also Example 8.1 about the use of `C_PTR` pointers. (*End of advice to users.*)

Rationale. Both arguments are defined to be of type `void*` (rather than `void*` and `void**`, respectively), so as to avoid complex type casts. E.g., in the last example, `&buff`, which is of type `char**`, can be passed as argument to `MPI_Buffer_detach` without type casting. If the formal parameter had type `void**` then we would need a type cast before and after the call. (*End of rationale.*)

The statements made in this section describe the behavior of MPI for buffered-mode sends. When no buffer is currently associated, MPI behaves as if a zero-sized buffer is associated with the process.

1 MPI must provide as much buffering for outgoing messages *as if* outgoing message
 2 data were buffered by the sending process, in the specified buffer space, using a circular,
 3 contiguous-space allocation policy. We outline below a model implementation that defines
 4 this policy. MPI may provide more buffering, and may use a better buffer allocation algo-
 5 rithm than described below. On the other hand, MPI may signal an error whenever the
 6 simple buffering allocator described below would run out of space. In particular, if no buffer
 7 is explicitly associated with the process, then any buffered send may cause an error.

8 MPI does not provide mechanisms for querying or controlling buffering done by standard
 9 mode sends. It is expected that vendors will provide such information for their implemen-
 10 tations.

11
 12 *Rationale.* There is a wide spectrum of possible implementations of buffered com-
 13 munication: buffering can be done at sender, at receiver, or both; buffers can be
 14 dedicated to one sender-receiver pair, or be shared by all communications; buffering
 15 can be done in real or in virtual memory; it can use dedicated memory, or memory
 16 shared by other processes; buffer space may be allocated statically or be changed dy-
 17 namically; etc. It does not seem feasible to provide a portable mechanism for querying
 18 or controlling buffering that would be compatible with all these choices, yet provide
 19 meaningful information. (*End of rationale.*)

21 3.6.1 Model Implementation of Buffered Mode

22 The model implementation uses the packing and unpacking functions described in Sec-
 23 tion 4.2 and the nonblocking communication functions described in Section 3.7.

24 We assume that a circular queue of pending message entries (PME) is maintained.
 25 Each entry contains a communication request handle that identifies a pending nonblocking
 26 send, a pointer to the next entry and the packed message data. The entries are stored in
 27 successive locations in the buffer. Free space is available between the queue tail and the
 28 queue head.

29 A buffered send call results in the execution of the following code.

- 30
- 31 • Traverse sequentially the PME queue from head towards the tail, deleting all entries
 32 for communications that have completed, up to the first entry with an uncompleted
 33 request; update queue head to point to that entry.
- 34
- 35 • Compute the number, n , of bytes needed to store an entry for the new message. An
 36 upper bound on n can be computed as follows: A call to the function
 37 `MPI_PACK_SIZE(count, datatype, comm, size)`, with the `count`, `datatype` and `comm`
 38 arguments used in the `MPI_BSEND` call, returns an upper bound on the amount
 39 of space needed to buffer the message data (see Section 4.2). The MPI constant
 40 `MPI_BSEND_OVERHEAD` provides an upper bound on the additional space consumed
 41 by the entry (e.g., for pointers or envelope information).
- 42
- 43 • Find the next contiguous empty space of n bytes in buffer (space following queue tail,
 44 or space at start of buffer if queue tail is too close to end of buffer). If space is not
 45 found then raise buffer overflow error.
- 46
- 47 • Append to end of PME queue in contiguous space the new entry that contains request
 48 handle, next pointer and packed message data; `MPI_PACK` is used to pack data.

- Post nonblocking send (standard mode) for packed data.
- Return

3.7 Nonblocking Communication

One can improve performance on many systems by overlapping communication and computation. This is especially true on systems where communication can be executed autonomously by an intelligent communication controller. Light-weight threads are one mechanism for achieving such overlap. An alternative mechanism that often leads to better performance is to use **nonblocking communication**. A nonblocking **send start** call initiates the send operation, but does not complete it. The send start call can return before the message was copied out of the send buffer. A separate **send complete** call is needed to complete the communication, i.e., to verify that the data has been copied out of the send buffer. With suitable hardware, the transfer of data out of the sender memory may proceed concurrently with computations done at the sender after the send was initiated and before it completed. Similarly, a nonblocking **receive start call** initiates the receive operation, but does not complete it. The call can return before a message is stored into the receive buffer. A separate **receive complete** call is needed to complete the receive operation and verify that the data has been received into the receive buffer. With suitable hardware, the transfer of data into the receiver memory may proceed concurrently with computations done after the receive was initiated and before it completed. The use of nonblocking receives may also avoid system buffering and memory-to-memory copying, as information is provided early on the location of the receive buffer.

Nonblocking send start calls can use the same four modes as blocking sends: *standard*, *buffered*, *synchronous* and *ready*. These carry the same meaning. Sends of all modes, *ready* excepted, can be started whether a matching receive has been posted or not; a nonblocking **ready** send can be started only if a matching receive is posted. In all cases, the send start call is local: it returns immediately, irrespective of the status of other processes. If the call causes some system resource to be exhausted, then it will fail and return an error code. Quality implementations of MPI should ensure that this happens only in “pathological” cases. That is, an MPI implementation should be able to support a large number of pending nonblocking operations.

The send-complete call returns when data has been copied out of the send buffer. It may carry additional meaning, depending on the send mode.

If the send mode is **synchronous**, then the send can complete only if a matching receive has started. That is, a receive has been posted, and has been matched with the send. In this case, the send-complete call is non-local. Note that a synchronous, nonblocking send may complete, if matched by a nonblocking receive, before the receive complete call occurs. (It can complete as soon as the sender “knows” the transfer will complete, but before the receiver “knows” the transfer will complete.)

If the send mode is **buffered** then the message must be buffered if there is no pending receive. In this case, the send-complete call is local, and must succeed irrespective of the status of a matching receive.

If the send mode is **standard** then the send-complete call may return before a matching receive is posted, if the message is buffered. On the other hand, the receive-complete may not complete until a matching receive is posted, and the message was copied into the receive buffer.

1 Nonblocking sends can be matched with blocking receives, and vice-versa.
2

3 *Advice to users.* The completion of a send operation may be delayed, for standard
4 mode, and must be delayed, for synchronous mode, until a matching receive is posted.
5 The use of nonblocking sends in these two cases allows the sender to proceed ahead
6 of the receiver, so that the computation is more tolerant of fluctuations in the speeds
7 of the two processes.

8 Nonblocking sends in the buffered and ready modes have a more limited impact, e.g.,
9 the blocking version of buffered send is capable of completing regardless of when a
10 matching receive call is made. However, separating the start from the completion
11 of these sends still gives some opportunity for optimization within the MPI library.
12 For example, starting a buffered send gives an implementation more flexibility in
13 determining if and how the message is buffered. There are also advantages for both
14 nonblocking buffered and ready modes when data copying can be done concurrently
15 with computation.

16 The message-passing model implies that communication is initiated by the sender.
17 The communication will generally have lower overhead if a receive is already posted
18 when the sender initiates the communication (data can be moved directly to the
19 receive buffer, and there is no need to queue a pending send request). However, a
20 receive operation can complete only after the matching send has occurred. The use
21 of nonblocking receives allows one to achieve lower communication overheads without
22 blocking the receiver while it waits for the send. (*End of advice to users.*)
23

24 3.7.1 Communication Request Objects 25

26 Nonblocking communications use opaque **request** objects to identify communication oper-
27 ations and match the operation that initiates the communication with the operation that
28 terminates it. These are system objects that are accessed via a handle. A request object
29 identifies various properties of a communication operation, such as the send mode, the com-
30 munication buffer that is associated with it, its context, the tag and destination arguments
31 to be used for a send, or the tag and source arguments to be used for a receive. In addition,
32 this object stores information about the status of the pending communication operation.
33

34 3.7.2 Communication Initiation 35

36 We use the same naming conventions as for blocking communication: a prefix of B, S,
37 or R is used for **buffered**, **synchronous** or **ready** mode. In addition a prefix of I (for
38 **immediate**) indicates that the call is nonblocking.
39
40
41
42
43
44
45
46
47
48

```

MPI_ISEND(buf, count, datatype, dest, tag, comm, request) 1
    IN      buf      initial address of send buffer (choice) 2
    IN      count    number of elements in send buffer (non-negative inte- 3
                        ger) 4
    IN      datatype datatype of each send buffer element (handle) 6
    IN      dest     rank of destination (integer) 7
    IN      tag      message tag (integer) 9
    IN      comm     communicator (handle) 10
    OUT     request  communication request (handle) 11
                                                    12
int MPI_Isend(const void* buf, int count, MPI_Datatype datatype, int dest, 13
              int tag, MPI_Comm comm, MPI_Request *request) 14
MPI_Isend(buf, count, datatype, dest, tag, comm, request, ierror) 16
    TYPE(*), DIMENSION(..), INTENT(IN), ASYNCHRONOUS :: buf 17
    INTEGER, INTENT(IN) :: count, dest, tag 18
    TYPE(MPI_Datatype), INTENT(IN) :: datatype 19
    TYPE(MPI_Comm), INTENT(IN) :: comm 20
    TYPE(MPI_Request), INTENT(OUT) :: request 21
    INTEGER, OPTIONAL, INTENT(OUT) :: ierror 22
                                                    23
MPI_ISEND(BUF, COUNT, DATATYPE, DEST, TAG, COMM, REQUEST, IERROR) 24
    <type> BUF(*) 25
    INTEGER COUNT, DATATYPE, DEST, TAG, COMM, REQUEST, IERROR 26
    Start a standard mode, nonblocking send. 27
                                                    28
MPI_IBSEND(buf, count, datatype, dest, tag, comm, request) 29
    IN      buf      initial address of send buffer (choice) 30
    IN      count    number of elements in send buffer (non-negative inte- 31
                        ger) 32
    IN      datatype datatype of each send buffer element (handle) 35
    IN      dest     rank of destination (integer) 36
    IN      tag      message tag (integer) 37
    IN      comm     communicator (handle) 38
    OUT     request  communication request (handle) 39
                                                    40
int MPI_Ibsend(const void* buf, int count, MPI_Datatype datatype, int dest, 41
               int tag, MPI_Comm comm, MPI_Request *request) 42
MPI_Ibsend(buf, count, datatype, dest, tag, comm, request, ierror) 45
    TYPE(*), DIMENSION(..), INTENT(IN), ASYNCHRONOUS :: buf 46
    INTEGER, INTENT(IN) :: count, dest, tag 47
    TYPE(MPI_Datatype), INTENT(IN) :: datatype 48

```

```

1     TYPE(MPI_Comm), INTENT(IN) :: comm
2     TYPE(MPI_Request), INTENT(OUT) :: request
3     INTEGER, OPTIONAL, INTENT(OUT) :: ierror
4
5 MPI_IBSEND(BUF, COUNT, DATATYPE, DEST, TAG, COMM, REQUEST, IERROR)
6     <type> BUF(*)
7     INTEGER COUNT, DATATYPE, DEST, TAG, COMM, REQUEST, IERROR
8
9     Start a buffered mode, nonblocking send.
10
11 MPI_ISSEND(buf, count, datatype, dest, tag, comm, request)
12     IN        buf                initial address of send buffer (choice)
13     IN        count              number of elements in send buffer (non-negative inte-
14                                     ger)
15
16     IN        datatype           datatype of each send buffer element (handle)
17     IN        dest               rank of destination (integer)
18     IN        tag                message tag (integer)
19     IN        comm               communicator (handle)
20     IN        request            communication request (handle)
21     OUT       request
22
23     int MPI_Issend(const void* buf, int count, MPI_Datatype datatype, int dest,
24                   int tag, MPI_Comm comm, MPI_Request *request)
25
26 MPI_Issend(buf, count, datatype, dest, tag, comm, request, ierror)
27     TYPE(*), DIMENSION(..), INTENT(IN), ASYNCHRONOUS :: buf
28     INTEGER, INTENT(IN) :: count, dest, tag
29     TYPE(MPI_Datatype), INTENT(IN) :: datatype
30     TYPE(MPI_Comm), INTENT(IN) :: comm
31     TYPE(MPI_Request), INTENT(OUT) :: request
32     INTEGER, OPTIONAL, INTENT(OUT) :: ierror
33
34 MPI_ISSEND(BUF, COUNT, DATATYPE, DEST, TAG, COMM, REQUEST, IERROR)
35     <type> BUF(*)
36     INTEGER COUNT, DATATYPE, DEST, TAG, COMM, REQUEST, IERROR
37
38     Start a synchronous mode, nonblocking send.
39
40
41
42
43
44
45
46
47
48

```

```

MPI_ISEND(buf, count, datatype, dest, tag, comm, request) 1
    IN      buf      initial address of send buffer (choice) 2
    IN      count    number of elements in send buffer (non-negative inte- 3
                    ger) 4
    IN      datatype datatype of each send buffer element (handle) 5
    IN      dest     rank of destination (integer) 6
    IN      tag      message tag (integer) 7
    IN      comm     communicator (handle) 8
    OUT     request  communication request (handle) 9
                                                    10
                                                    11
                                                    12
                                                    13
int MPI_Irsend(const void* buf, int count, MPI_Datatype datatype, int dest, 14
               int tag, MPI_Comm comm, MPI_Request *request) 15
MPI_Irsend(buf, count, datatype, dest, tag, comm, request, ierror) 16
    TYPE(*), DIMENSION(..), INTENT(IN), ASYNCHRONOUS :: buf 17
    INTEGER, INTENT(IN) :: count, dest, tag 18
    TYPE(MPI_Datatype), INTENT(IN) :: datatype 19
    TYPE(MPI_Comm), INTENT(IN) :: comm 20
    TYPE(MPI_Request), INTENT(OUT) :: request 21
    INTEGER, OPTIONAL, INTENT(OUT) :: ierror 22
                                                    23
MPI_IRSEND(BUF, COUNT, DATATYPE, DEST, TAG, COMM, REQUEST, IERROR) 24
    <type> BUF(*) 25
    INTEGER COUNT, DATATYPE, DEST, TAG, COMM, REQUEST, IERROR 26
    Start a ready mode nonblocking send. 27
                                                    28
                                                    29
MPI_IRECV (buf, count, datatype, source, tag, comm, request) 30
    OUT     buf      initial address of receive buffer (choice) 31
    IN      count    number of elements in receive buffer (non-negative in- 32
                    te- 33
                    ger) 34
    IN      datatype datatype of each receive buffer element (handle) 35
    IN      source   rank of source or MPI_ANY_SOURCE (integer) 36
    IN      tag      message tag or MPI_ANY_TAG (integer) 37
    IN      comm     communicator (handle) 38
    OUT     request  communication request (handle) 39
                                                    40
                                                    41
                                                    42
int MPI_Irecv(void* buf, int count, MPI_Datatype datatype, int source, 43
               int tag, MPI_Comm comm, MPI_Request *request) 44
MPI_Irecv(buf, count, datatype, source, tag, comm, request, ierror) 45
    TYPE(*), DIMENSION(..), ASYNCHRONOUS :: buf 46
    INTEGER, INTENT(IN) :: count, source, tag 47
    TYPE(MPI_Datatype), INTENT(IN) :: datatype 48

```

```

1     TYPE(MPI_Comm), INTENT(IN) :: comm
2     TYPE(MPI_Request), INTENT(OUT) :: request
3     INTEGER, OPTIONAL, INTENT(OUT) :: ierror
4
5 MPI_Irecv(BUF, COUNT, DATATYPE, SOURCE, TAG, COMM, REQUEST, IERROR)
6     <type> BUF(*)
7     INTEGER COUNT, DATATYPE, SOURCE, TAG, COMM, REQUEST, IERROR

```

8 Start a nonblocking receive.

9 These calls allocate a communication request object and associate it with the request
10 handle (the argument `request`). The request can be used later to query the status of the
11 communication or wait for its completion.

12 A nonblocking send call indicates that the system may start copying data out of the
13 send buffer. The sender should not modify any part of the send buffer after a nonblocking
14 send operation is called, until the send completes.

15 A nonblocking receive call indicates that the system may start writing data into the re-
16 ceive buffer. The receiver should not access any part of the receive buffer after a nonblocking
17 receive operation is called, until the receive completes.

18
19 *Advice to users.* To prevent problems with the argument copying and register
20 optimization done by Fortran compilers, please note the hints in Sections 18.1.10–
21 18.1.20. (*End of advice to users.*)

22 23 3.7.3 Communication Completion

24 The functions `MPI_WAIT` and `MPI_TEST` are used to complete a nonblocking communica-
25 tion. The completion of a send operation indicates that the sender is now free to update
26 the locations in the send buffer (the send operation itself leaves the content of the send
27 buffer unchanged). It does not indicate that the message has been received, rather, it may
28 have been buffered by the communication subsystem. However, if a **synchronous** mode
29 send was used, the completion of the send operation indicates that a matching receive was
30 initiated, and that the message will eventually be received by this matching receive.

31 The completion of a receive operation indicates that the receive buffer contains the
32 received message, the receiver is now free to access it, and that the status object is set. It
33 does not indicate that the matching send operation has completed (but indicates, of course,
34 that the send was initiated).

35 We shall use the following terminology: A **null handle** is a handle with value
36 `MPI_REQUEST_NULL`. A persistent request and the handle to it are **inactive** if the request
37 is not associated with any ongoing communication (see Section 3.9). A handle is **active**
38 if it is neither null nor inactive. An **empty** status is a status which is set to return `tag`
39 `= MPI_ANY_TAG`, `source = MPI_ANY_SOURCE`, `error = MPI_SUCCESS`, and is also internally
40 configured so that calls to `MPI_GET_COUNT`, `MPI_GET_ELEMENTS`, and
41 `MPI_GET_ELEMENTS_X` return `count = 0` and `MPI_TEST_CANCELLED` returns false. We
42 set a status variable to empty when the value returned by it is not significant. Status is set
43 in this way so as to prevent errors due to accesses of stale information.

44 The fields in a **status** object returned by a call to `MPI_WAIT`, `MPI_TEST`, or any
45 of the other derived functions (`MPI_{TEST|WAIT}{ALL|SOME|ANY}`), where the `request`
46 corresponds to a send call, are undefined, with two exceptions: The error status field will
47

contain valid information if the wait or test call returned with `MPI_ERR_IN_STATUS`; and the returned status can be queried by the call `MPI_TEST_CANCELLED`.

Error codes belonging to the error class `MPI_ERR_IN_STATUS` should be returned only by the MPI completion functions that take arrays of `MPI_Status`. For the functions that take a single `MPI_Status` argument, the error code is returned by the function, and the value of the `MPI_ERROR` field in the `MPI_Status` argument is undefined (see 3.2.5).

`MPI_WAIT(request, status)`

INOUT	request	request (handle)
OUT	status	status object (<code>Status</code>)

```
int MPI_Wait(MPI_Request *request, MPI_Status *status)
```

```
MPI_Wait(request, status, ierror)
```

```
    TYPE(MPI_Request), INTENT(INOUT) :: request
```

```
    TYPE(MPI_Status) :: status
```

```
    INTEGER, OPTIONAL, INTENT(OUT) :: ierror
```

```
MPI_WAIT(REQUEST, STATUS, IERROR)
```

```
    INTEGER REQUEST, STATUS(MPI_STATUS_SIZE), IERROR
```

A call to `MPI_WAIT` returns when the operation identified by `request` is complete. If the request is an active persistent request, it is marked inactive. Any other type of request is deallocated and the request handle is set to `MPI_REQUEST_NULL`. `MPI_WAIT` is a non-local operation.

The call returns, in `status`, information on the completed operation. The content of the status object for a receive operation can be accessed as described in Section 3.2.5. The status object for a send operation may be queried by a call to `MPI_TEST_CANCELLED` (see Section 3.8).

One is allowed to call `MPI_WAIT` with a null or inactive request argument. In this case the operation returns immediately with empty `status`.

Advice to users. Successful return of `MPI_WAIT` after a `MPI_IBSEND` implies that the user send buffer can be reused — i.e., data has been sent out or copied into a buffer attached with `MPI_BUFFER_ATTACH`. Note that, at this point, we can no longer cancel the send (see Section 3.8). If a matching receive is never posted, then the buffer cannot be freed. This runs somewhat counter to the stated goal of `MPI_CANCEL` (always being able to free program space that was committed to the communication subsystem). (*End of advice to users.*)

Advice to implementors. In a multithreaded environment, a call to `MPI_WAIT` should block only the calling thread, allowing the thread scheduler to schedule another thread for execution. (*End of advice to implementors.*)

```

1 MPI_TEST(request, flag, status)
2     INOUT    request                communication request (handle)
3
4     OUT     flag                    true if operation completed (logical)
5
6     OUT     status                  status object (Status)
7
8
9 int MPI_Test(MPI_Request *request, int *flag, MPI_Status *status)
10
11 MPI_Test(request, flag, status, ierror)
12     TYPE(MPI_Request), INTENT(INOUT) :: request
13     LOGICAL, INTENT(OUT) :: flag
14     TYPE(MPI_Status) :: status
15     INTEGER, OPTIONAL, INTENT(OUT) :: ierror
16
17 MPI_TEST(REQUEST, FLAG, STATUS, IERROR)
18     LOGICAL FLAG
19     INTEGER REQUEST, STATUS(MPI_STATUS_SIZE), IERROR

```

A call to `MPI_TEST` returns `flag = true` if the operation identified by `request` is complete. In such a case, the status object is set to contain information on the completed operation. If the request is an active persistent request, it is marked as inactive. Any other type of request is deallocated and the request handle is set to `MPI_REQUEST_NULL`. The call returns `flag = false` if the operation identified by `request` is not complete. In this case, the value of the status object is undefined. `MPI_TEST` is a local operation.

The return status object for a receive operation carries information that can be accessed as described in Section 3.2.5. The status object for a send operation carries information that can be accessed by a call to `MPI_TEST_CANCELLED` (see Section 3.8).

One is allowed to call `MPI_TEST` with a null or inactive `request` argument. In such a case the operation returns with `flag = true` and empty `status`.

The functions `MPI_WAIT` and `MPI_TEST` can be used to complete both sends and receives.

Advice to users. The use of the nonblocking `MPI_TEST` call allows the user to schedule alternative activities within a single thread of execution. An event-driven thread scheduler can be emulated with periodic calls to `MPI_TEST`. (*End of advice to users.*)

Example 3.11 Simple usage of nonblocking operations and `MPI_WAIT`.

```

39 CALL MPI_COMM_RANK(comm, rank, ierr)
40 IF (rank.EQ.0) THEN
41     CALL MPI_ISEND(a(1), 10, MPI_REAL, 1, tag, comm, request, ierr)
42     **** do some computation to mask latency ****
43     CALL MPI_WAIT(request, status, ierr)
44 ELSE IF (rank.EQ.1) THEN
45     CALL MPI_Irecv(a(1), 15, MPI_REAL, 0, tag, comm, request, ierr)
46     **** do some computation to mask latency ****
47     CALL MPI_WAIT(request, status, ierr)
48 END IF

```

A request object can be deallocated by using the following operation.

```
MPI_REQUEST_FREE(request)
```

```
    INOUT    request                communication request (handle)
```

```
int MPI_Request_free(MPI_Request *request)
```

```
MPI_Request_free(request, ierror)
```

```
    TYPE(MPI_Request), INTENT(INOUT) :: request
```

```
    INTEGER, OPTIONAL, INTENT(OUT) :: ierror
```

```
MPI_REQUEST_FREE(REQUEST, IERROR)
```

```
    INTEGER REQUEST, IERROR
```

`MPI_REQUEST_FREE` is a local operation that marks the request object for deallocation and sets `request` to `MPI_REQUEST_NULL`. Ongoing communication, if any, that is associated with the request will be allowed to complete. The request will be deallocated only after its completion. Classes of operations described later in the standard, such as nonblocking collective and persistent collective (see Chapters 5 and 7), also use request objects. In the case of nonblocking collective operations and persistent collective operations, it is erroneous to call `MPI_REQUEST_FREE` unless the request is inactive.

Rationale. For point-to-point operations, the `MPI_REQUEST_FREE` mechanism is provided for reasons of performance and convenience on the sending side. (*End of rationale.*)

Advice to users. Once a request is freed by a call to `MPI_REQUEST_FREE`, it is not possible to check for the successful completion of the associated communication with calls to `MPI_WAIT` or `MPI_TEST`. Also, if an error occurs subsequently during the communication, an error code cannot be returned to the user — such an error must be treated as fatal. An active receive request should never be freed as the receiver will have no way to verify that the receive has completed and the receive buffer can be reused. (*End of advice to users.*)

Example 3.12 An example using `MPI_REQUEST_FREE`.

```
CALL MPI_COMM_RANK(MPI_COMM_WORLD, rank, ierr)
```

```
IF (rank.EQ.0) THEN
```

```
    DO i=1, n
```

```
        CALL MPI_ISEND(outval, 1, MPI_REAL, 1, 0, MPI_COMM_WORLD, req, ierr)
```

```
        CALL MPI_REQUEST_FREE(req, ierr)
```

```
        CALL MPI_IRECV(inval, 1, MPI_REAL, 1, 0, MPI_COMM_WORLD, req, ierr)
```

```
        CALL MPI_WAIT(req, status, ierr)
```

```
    END DO
```

```
ELSE IF (rank.EQ.1) THEN
```

```
    CALL MPI_IRECV(inval, 1, MPI_REAL, 0, 0, MPI_COMM_WORLD, req, ierr)
```

```
    CALL MPI_WAIT(req, status, ierr)
```

```
    DO I=1, n-1
```

```

1      CALL MPI_ISEND(outval, 1, MPI_REAL, 0, 0, MPI_COMM_WORLD, req, ierr)
2      CALL MPI_REQUEST_FREE(req, ierr)
3      CALL MPI_Irecv(inval, 1, MPI_REAL, 0, 0, MPI_COMM_WORLD, req, ierr)
4      CALL MPI_WAIT(req, status, ierr)
5  END DO
6      CALL MPI_ISEND(outval, 1, MPI_REAL, 0, 0, MPI_COMM_WORLD, req, ierr)
7      CALL MPI_WAIT(req, status, ierr)
8  END IF

```

3.7.4 Semantics of Nonblocking Communications

The semantics of nonblocking communication is defined by suitably extending the definitions in Section 3.5.

Order Nonblocking communication operations are ordered according to the execution order of the calls that initiate the communication. The non-overtaking requirement of Section 3.5 is extended to nonblocking communication, with this definition of order being used.

Example 3.13 Message ordering for nonblocking operations.

```

20 CALL MPI_COMM_RANK(comm, rank, ierr)
21 IF (RANK.EQ.0) THEN
22     CALL MPI_ISEND(a, 1, MPI_REAL, 1, 0, comm, r1, ierr)
23     CALL MPI_ISEND(b, 1, MPI_REAL, 1, 0, comm, r2, ierr)
24 ELSE IF (rank.EQ.1) THEN
25     CALL MPI_Irecv(a, 1, MPI_REAL, 0, MPI_ANY_TAG, comm, r1, ierr)
26     CALL MPI_Irecv(b, 1, MPI_REAL, 0, 0, comm, r2, ierr)
27 END IF
28 CALL MPI_WAIT(r1, status, ierr)
29 CALL MPI_WAIT(r2, status, ierr)

```

The first send of process zero will match the first receive of process one, even if both messages are sent before process one executes either receive.

Progress A call to MPI_WAIT that completes a receive will eventually terminate and return if a matching send has been started, unless the send is satisfied by another receive. In particular, if the matching send is nonblocking, then the receive should complete even if no call is executed by the sender to complete the send. Similarly, a call to MPI_WAIT that completes a send will eventually return if a matching receive has been started, unless the receive is satisfied by another send, and even if no call is executed to complete the receive.

Example 3.14 An illustration of progress semantics.

```

CALL MPI_COMM_RANK(comm, rank, ierr)
IF (RANK.EQ.0) THEN
    CALL MPI_SSEND(a, 1, MPI_REAL, 1, 0, comm, ierr)
    CALL MPI_SEND(b, 1, MPI_REAL, 1, 1, comm, ierr)
ELSE IF (rank.EQ.1) THEN
    CALL MPI_Irecv(a, 1, MPI_REAL, 0, 0, comm, r, ierr)
    CALL MPI_RECV(b, 1, MPI_REAL, 0, 1, comm, status, ierr)
    CALL MPI_WAIT(r, status, ierr)
END IF

```

This code should not deadlock in a correct MPI implementation. The first synchronous send of process zero must complete after process one posts the matching (nonblocking) receive even if process one has not yet reached the completing wait call. Thus, process zero will continue and execute the second send, allowing process one to complete execution.

If an `MPI_TEST` that completes a receive is repeatedly called with the same arguments, and a matching send has been started, then the call will eventually return `flag = true`, unless the send is satisfied by another receive. If an `MPI_TEST` that completes a send is repeatedly called with the same arguments, and a matching receive has been started, then the call will eventually return `flag = true`, unless the receive is satisfied by another send.

3.7.5 Multiple Completions

It is convenient to be able to wait for the completion of any, some, or all the operations in a list, rather than having to wait for a specific message. A call to `MPI_WAITANY` or `MPI_TESTANY` can be used to wait for the completion of one out of several operations. A call to `MPI_WAITALL` or `MPI_TESTALL` can be used to wait for all pending operations in a list. A call to `MPI_WAIT SOME` or `MPI_TEST SOME` can be used to complete all enabled operations in a list.

`MPI_WAITANY` (count, array_of_requests, index, status)

IN	count	list length (non-negative integer)
INOUT	array_of_requests	array of requests (array of handles)
OUT	index	index of handle for operation that completed (integer)
OUT	status	status object (Status)

```

int MPI_Waitany(int count, MPI_Request array_of_requests[], int *index,
                MPI_Status *status)

```

```

MPI_Waitany(count, array_of_requests, index, status, ierror)
    INTEGER, INTENT(IN) :: count
    TYPE(MPI_Request), INTENT(INOUT) :: array_of_requests(count)
    INTEGER, INTENT(OUT) :: index
    TYPE(MPI_Status) :: status
    INTEGER, OPTIONAL, INTENT(OUT) :: ierror

```

```

MPI_WAITANY(COUNT, ARRAY_OF_REQUESTS, INDEX, STATUS, IERROR)
    INTEGER COUNT, ARRAY_OF_REQUESTS(*), INDEX, STATUS(MPI_STATUS_SIZE),

```

1 IERROR

2
3 Blocks until one of the operations associated with the active requests in the array has
4 completed. If more than one operation is enabled and can terminate, one is arbitrarily
5 chosen. Returns in `index` the index of that request in the array and returns in `status` the
6 status of the completing operation. (The array is indexed from zero in C, and from one in
7 Fortran.) If the request is an active persistent request, it is marked inactive. Any other
8 type of request is deallocated and the request handle is set to `MPI_REQUEST_NULL`.

9 The `array_of_requests` list may contain null or inactive handles. If the list contains no
10 active handles (list has length zero or all entries are null or inactive), then the call returns
11 immediately with `index = MPI_UNDEFINED`, and an empty `status`.

12 The execution of `MPI_WAITANY(count, array_of_requests, index, status)` has the same
13 effect as the execution of `MPI_WAIT(&array_of_requests[i], status)`, where `i` is the value
14 returned by `index` (unless the value of `index` is `MPI_UNDEFINED`). `MPI_WAITANY` with an
15 array containing one active entry is equivalent to `MPI_WAIT`.

16
17 `MPI_TESTANY(count, array_of_requests, index, flag, status)`

18	IN	count	list length (non-negative integer)
19	INOUT	array_of_requests	array of requests (array of handles)
20	OUT	index	index of operation that completed, or
21			<code>MPI_UNDEFINED</code> if none completed (integer)
22	OUT	flag	true if one of the operations is complete (logical)
23	OUT	status	status object (Status)

24
25
26
27 `int MPI_Testany(int count, MPI_Request array_of_requests[], int *index,`
28 `int *flag, MPI_Status *status)`

29
30 `MPI_Testany(count, array_of_requests, index, flag, status, ierror)`
31 `INTEGER, INTENT(IN) :: count`
32 `TYPE(MPI_Request), INTENT(INOUT) :: array_of_requests(count)`
33 `INTEGER, INTENT(OUT) :: index`
34 `LOGICAL, INTENT(OUT) :: flag`
35 `TYPE(MPI_Status) :: status`
36 `INTEGER, OPTIONAL, INTENT(OUT) :: ierror`

37 `MPI_TESTANY(COUNT, ARRAY_OF_REQUESTS, INDEX, FLAG, STATUS, IERROR)`
38 `LOGICAL FLAG`
39 `INTEGER COUNT, ARRAY_OF_REQUESTS(*), INDEX, STATUS(MPI_STATUS_SIZE),`
40 `IERROR`

41
42 Tests for completion of either one or none of the operations associated with active
43 handles. In the former case, it returns `flag = true`, returns in `index` the index of this request
44 in the array, and returns in `status` the status of that operation. If the request is an active
45 persistent request, it is marked as inactive. Any other type of request is deallocated and
46 the handle is set to `MPI_REQUEST_NULL`. (The array is indexed from zero in C, and from
47 one in Fortran.) In the latter case (no operation completed), it returns `flag = false`, returns
48 a value of `MPI_UNDEFINED` in `index` and `status` is undefined.

The array may contain null or inactive handles. If the array contains no active handles then the call returns immediately with `flag = true`, `index = MPI_UNDEFINED`, and an empty status.

If the array of requests contains active handles then the execution of `MPI_TESTANY(count, array_of_requests, index, status)` has the same effect as the execution of `MPI_TEST(&array_of_requests[i], flag, status)`, for `i=0, 1, ..., count-1`, in some arbitrary order, until one call returns `flag = true`, or all fail. In the former case, `index` is set to the last value of `i`, and in the latter case, it is set to `MPI_UNDEFINED`. `MPI_TESTANY` with an array containing one active entry is equivalent to `MPI_TEST`.

`MPI_WAITALL(count, array_of_requests, array_of_statuses)`

IN	count	lists length (non-negative integer)
INOUT	array_of_requests	array of requests (array of handles)
OUT	array_of_statuses	array of status objects (array of Status)

```
int MPI_Waitall(int count, MPI_Request array_of_requests[],
               MPI_Status array_of_statuses[])
```

```
MPI_Waitall(count, array_of_requests, array_of_statuses, ierror)
  INTEGER, INTENT(IN) :: count
  TYPE(MPI_Request), INTENT(INOUT) :: array_of_requests(count)
  TYPE(MPI_Status) :: array_of_statuses(*)
  INTEGER, OPTIONAL, INTENT(OUT) :: ierror
```

```
MPI_WAITALL(COUNT, ARRAY_OF_REQUESTS, ARRAY_OF_STATUSES, IERROR)
  INTEGER COUNT, ARRAY_OF_REQUESTS(*)
  INTEGER ARRAY_OF_STATUSES(MPI_STATUS_SIZE,*), IERROR
```

Blocks until all communication operations associated with active handles in the list complete, and return the status of all these operations (this includes the case where no handle in the list is active). Both arrays have the same number of valid entries. The `i`-th entry in `array_of_statuses` is set to the return status of the `i`-th operation. Active persistent requests are marked inactive. Requests of any other type are deallocated and the corresponding handles in the array are set to `MPI_REQUEST_NULL`. The list may contain null or inactive handles. The call sets to empty the status of each such entry.

The error-free execution of `MPI_WAITALL(count, array_of_requests, array_of_statuses)` has the same effect as the execution of `MPI_WAIT(&array_of_request[i], &array_of_statuses[i])`, for `i=0, ..., count-1`, in some arbitrary order. `MPI_WAITALL` with an array of length one is equivalent to `MPI_WAIT`.

When one or more of the communications completed by a call to `MPI_WAITALL` fail, it is desirable to return specific information on each communication. The function `MPI_WAITALL` will return in such case the error code `MPI_ERR_IN_STATUS` and will set the error field of each status to a specific error code. This code will be `MPI_SUCCESS`, if the specific communication completed; it will be another specific error code, if it failed; or it can be `MPI_ERR_PENDING` if it has neither failed nor completed. The function `MPI_WAITALL` will return `MPI_SUCCESS` if no request had an error, or will return another error code if it failed for other reasons (such as invalid arguments). In such cases, it will not update the

1 error fields of the statuses.

2
3 *Rationale.* This design streamlines error handling in the application. The application
4 code need only test the (single) function result to determine if an error has occurred. It
5 needs to check each individual status only when an error occurred. (*End of rationale.*)
6

7
8
9 MPI_TESTALL(count, array_of_requests, flag, array_of_statuses)

10 IN count lists length (non-negative integer)
11 INOUT array_of_requests array of requests (array of handles)
12 OUT flag (logical)
13
14 OUT array_of_statuses array of status objects (array of Status)

15
16 int MPI_Testall(int count, MPI_Request array_of_requests[], int *flag,
17 MPI_Status array_of_statuses[])

18
19 MPI_Testall(count, array_of_requests, flag, array_of_statuses, ierror)
20 INTEGER, INTENT(IN) :: count
21 TYPE(MPI_Request), INTENT(INOUT) :: array_of_requests(count)
22 LOGICAL, INTENT(OUT) :: flag
23 TYPE(MPI_Status) :: array_of_statuses(*)
24 INTEGER, OPTIONAL, INTENT(OUT) :: ierror

25 MPI_TESTALL(COUNT, ARRAY_OF_REQUESTS, FLAG, ARRAY_OF_STATUSES, IERROR)
26 LOGICAL FLAG
27 INTEGER COUNT, ARRAY_OF_REQUESTS(*),
28 ARRAY_OF_STATUSES(MPI_STATUS_SIZE,*), IERROR
29

30 Returns `flag = true` if all communications associated with active handles in the array
31 have completed (this includes the case where no handle in the list is active). In this case, each
32 status entry that corresponds to an active request is set to the status of the corresponding
33 operation. Active persistent requests are marked inactive. Requests of any other type are
34 deallocated and the corresponding handles in the array are set to `MPI_REQUEST_NULL`.
35 Each status entry that corresponds to a null or inactive handle is set to empty.

36 Otherwise, `flag = false` is returned, no request is modified and the values of the status
37 entries are undefined. This is a local operation.

38 Errors that occurred during the execution of `MPI_TESTALL` are handled in the same
39 manner as errors in `MPI_WAITALL`.
40
41
42
43
44
45
46
47
48

```

MPI_WAITSSOME(incount, array_of_requests, outcount, array_of_indices, array_of_statuses) 1
2
IN      incount      length of array_of_requests (non-negative integer) 3
INOUT  array_of_requests  array of requests (array of handles) 4
OUT    outcount      number of completed requests (integer) 6
OUT    array_of_indices  array of indices of operations that completed (array of 7
                                integers) 8
OUT    array_of_statuses  array of status objects for operations that completed 9
                                (array of Status) 10
11
int MPI_Waitssome(int incount, MPI_Request array_of_requests[], 13
                  int *outcount, int array_of_indices[], 14
                  MPI_Status array_of_statuses[]) 15
16
MPI_Waitssome(incount, array_of_requests, outcount, array_of_indices, 17
              array_of_statuses, ierror) 18
    INTEGER, INTENT(IN) :: incount 19
    TYPE(MPI_Request), INTENT(INOUT) :: array_of_requests(incount) 20
    INTEGER, INTENT(OUT) :: outcount, array_of_indices(*) 21
    TYPE(MPI_Status) :: array_of_statuses(*) 22
    INTEGER, OPTIONAL, INTENT(OUT) :: ierror 23
24
MPI_WAITSSOME(INCOUNT, ARRAY_OF_REQUESTS, OUTCOUNT, ARRAY_OF_INDICES, 25
              ARRAY_OF_STATUSES, IERROR) 26
    INTEGER INCOUNT, ARRAY_OF_REQUESTS(*), OUTCOUNT, ARRAY_OF_INDICES(*), 27
    ARRAY_OF_STATUSES(MPI_STATUS_SIZE,*), IERROR 28

```

Waits until at least one of the operations associated with active handles in the list have completed. Returns in `outcount` the number of requests from the list `array_of_requests` that have completed. Returns in the first `outcount` locations of the array `array_of_indices` the indices of these operations (index within the array `array_of_requests`; the array is indexed from zero in C and from one in Fortran). Returns in the first `outcount` locations of the array `array_of_status` the status for these completed operations. Completed active persistent requests are marked as inactive. Any other type or request that completed is deallocated, and the associated handle is set to `MPI_REQUEST_NULL`.

If the list contains no active handles, then the call returns immediately with `outcount = MPI_UNDEFINED`.

When one or more of the communications completed by `MPI_WAITSSOME` fails, then it is desirable to return specific information on each communication. The arguments `outcount`, `array_of_indices` and `array_of_statuses` will be adjusted to indicate completion of all communications that have succeeded or failed. The call will return the error code `MPI_ERR_IN_STATUS` and the error field of each status returned will be set to indicate success or to indicate the specific error that occurred. The call will return `MPI_SUCCESS` if no request resulted in an error, and will return another error code if it failed for other reasons (such as invalid arguments). In such cases, it will not update the error fields of the statuses.

```
1 MPI_TESTSOME(incount, array_of_requests, outcount, array_of_indices, array_of_statuses)
```

```
2
3     IN        incount                length of array_of_requests (non-negative integer)
4
5     INOUT    array_of_requests       array of requests (array of handles)
6
7     OUT      outcount                number of completed requests (integer)
8
9     OUT      array_of_indices        array of indices of operations that completed (array of
10                                          integers)
11
12     OUT      array_of_statuses       array of status objects for operations that completed
13                                          (array of Status)
```

```
13 int MPI_Testsome(int incount, MPI_Request array_of_requests[],
14                 int *outcount, int array_of_indices[],
15                 MPI_Status array_of_statuses[])
```

```
16 MPI_Testsome(incount, array_of_requests, outcount, array_of_indices,
17             array_of_statuses, ierror)
```

```
18     INTEGER, INTENT(IN) :: incount
19     TYPE(MPI_Request), INTENT(INOUT) :: array_of_requests(incount)
20     INTEGER, INTENT(OUT) :: outcount, array_of_indices(*)
21     TYPE(MPI_Status) :: array_of_statuses(*)
22     INTEGER, OPTIONAL, INTENT(OUT) :: ierror
```

```
24 MPI_TESTSOME(INCOUNT, ARRAY_OF_REQUESTS, OUTCOUNT, ARRAY_OF_INDICES,
25             ARRAY_OF_STATUSES, IERROR)
26     INTEGER INCOUNT, ARRAY_OF_REQUESTS(*), OUTCOUNT, ARRAY_OF_INDICES(*),
27     ARRAY_OF_STATUSES(MPI_STATUS_SIZE,*), IERROR
```

29 Behaves like MPI_WAITSSOME, except that it returns immediately. If no operation has
30 completed it returns `outcount = 0`. If there is no active handle in the list it returns `outcount`
31 `= MPI_UNDEFINED`.

32 MPI_TESTSSOME is a local operation, which returns immediately, whereas
33 MPI_WAITSSOME will block until a communication completes, if it was passed a list that
34 contains at least one active handle. Both calls fulfill a **fairness** requirement: If a request
35 for a receive repeatedly appears in a list of requests passed to MPI_WAITSSOME or
36 MPI_TESTSSOME, and a matching send has been posted, then the receive will eventually
37 succeed, unless the send is satisfied by another receive; and similarly for send requests.

38 Errors that occur during the execution of MPI_TESTSSOME are handled as for
39 MPI_WAITSSOME.

40 *Advice to users.* The use of MPI_TESTSSOME is likely to be more efficient than the use
41 of MPI_TESTANY. The former returns information on all completed communications,
42 with the latter, a new call is required for each communication that completes.

44 A server with multiple clients can use MPI_WAITSSOME so as not to starve any client.
45 Clients send messages to the server with service requests. The server calls
46 MPI_WAITSSOME with one receive request for each client, and then handles all receives
47 that completed. If a call to MPI_WAITANY is used instead, then one client could starve
48 while requests from another client always sneak in first. (*End of advice to users.*)

Advice to implementors. MPI_TESTSOME should complete as many pending communications as possible. (*End of advice to implementors.*)

Example 3.15 Client-server code (starvation can occur).

```

CALL MPI_COMM_SIZE(comm, size, ierr)
CALL MPI_COMM_RANK(comm, rank, ierr)
IF(rank .GT. 0) THEN          ! client code
  DO WHILE(.TRUE.)
    CALL MPI_ISEND(a, n, MPI_REAL, 0, tag, comm, request, ierr)
    CALL MPI_WAIT(request, status, ierr)
  END DO
ELSE                          ! rank=0 -- server code
  DO i=1, size-1
    CALL MPI_Irecv(a(1,i), n, MPI_REAL, i, tag,
                  comm, request_list(i), ierr)
  END DO
  DO WHILE(.TRUE.)
    CALL MPI_WAITANY(size-1, request_list, index, status, ierr)
    CALL DO_SERVICE(a(1,index)) ! handle one message
    CALL MPI_Irecv(a(1, index), n, MPI_REAL, index, tag,
                  comm, request_list(index), ierr)
  END DO
END IF

```

Example 3.16 Same code, using MPI_WAITSSOME.

```

CALL MPI_COMM_SIZE(comm, size, ierr)
CALL MPI_COMM_RANK(comm, rank, ierr)
IF(rank .GT. 0) THEN          ! client code
  DO WHILE(.TRUE.)
    CALL MPI_ISEND(a, n, MPI_REAL, 0, tag, comm, request, ierr)
    CALL MPI_WAIT(request, status, ierr)
  END DO
ELSE                          ! rank=0 -- server code
  DO i=1, size-1
    CALL MPI_Irecv(a(1,i), n, MPI_REAL, i, tag,
                  comm, request_list(i), ierr)
  END DO
  DO WHILE(.TRUE.)
    CALL MPI_WAITSSOME(size, request_list, numdone,
                      indices, statuses, ierr)
  DO i=1, numdone
    CALL DO_SERVICE(a(1, indices(i)))
    CALL MPI_Irecv(a(1, indices(i)), n, MPI_REAL, 0, tag,
                  comm, request_list(indices(i)), ierr)
  END DO
  END DO

```

```

1      END DO
2      END DO
3  END IF

```

3.7.6 Non-destructive Test of status

This call is useful for accessing the information associated with a request, without freeing the request (in case the user is expected to access it later). It allows one to layer libraries more conveniently, since multiple layers of software may access the same completed request and extract from it the status information.

```

12 MPI_REQUEST_GET_STATUS(request, flag, status)

```

14	IN	request	request (handle)
15	OUT	flag	boolean flag, same as from MPI_TEST (logical)
16	OUT	status	status object if flag is true (Status)

```

18
19 int MPI_Request_get_status(MPI_Request request, int *flag,
20                          MPI_Status *status)

```

```

21 MPI_Request_get_status(request, flag, status, ierror)
22     TYPE(MPI_Request), INTENT(IN) :: request
23     LOGICAL, INTENT(OUT) :: flag
24     TYPE(MPI_Status) :: status
25     INTEGER, OPTIONAL, INTENT(OUT) :: ierror

```

```

26
27 MPI_REQUEST_GET_STATUS(REQUEST, FLAG, STATUS, IERROR)
28     INTEGER REQUEST, STATUS(MPI_STATUS_SIZE), IERROR
29     LOGICAL FLAG

```

Sets `flag=true` if the operation is complete, and, if so, returns in `status` the request status. However, unlike `test` or `wait`, it does not deallocate or inactivate the request; a subsequent call to `test`, `wait` or `free` should be executed with that request. It sets `flag=false` if the operation is not complete.

One is allowed to call `MPI_REQUEST_GET_STATUS` with a null or inactive request argument. In such a case the operation returns with `flag=true` and empty `status`.

3.8 Probe and Cancel

The `MPI_PROBE`, `MPI_IPROBE`, `MPI_MPROBE`, and `MPI_IMPROBE` operations allow incoming messages to be checked for, without actually receiving them. The user can then decide how to receive them, based on the information returned by the probe (basically, the information returned by `status`). In particular, the user may allocate memory for the receive buffer, according to the length of the probed message.

The `MPI_CANCEL` operation allows pending communications to be cancelled. This is required for cleanup. Posting a send or a receive ties up user resources (send or receive buffers), and a **cancel** may be needed to free these resources gracefully.

Cancelling a send request by calling `MPI_CANCEL` is deprecated.

3.8.1 Probe

`MPI_Iprobe(source, tag, comm, flag, status)`

IN	source	rank of source or <code>MPI_ANY_SOURCE</code> (integer)
IN	tag	message tag or <code>MPI_ANY_TAG</code> (integer)
IN	comm	communicator (handle)
OUT	flag	(logical)
OUT	status	status object (<code>Status</code>)

```
int MPI_Iprobe(int source, int tag, MPI_Comm comm, int *flag,
               MPI_Status *status)
```

```
MPI_Iprobe(source, tag, comm, flag, status, ierror)
```

```
    INTEGER, INTENT(IN) :: source, tag
```

```
    TYPE(MPI_Comm), INTENT(IN) :: comm
```

```
    LOGICAL, INTENT(OUT) :: flag
```

```
    TYPE(MPI_Status) :: status
```

```
    INTEGER, OPTIONAL, INTENT(OUT) :: ierror
```

```
MPI_Iprobe(SOURCE, TAG, COMM, FLAG, STATUS, IERROR)
```

```
    LOGICAL FLAG
```

```
    INTEGER SOURCE, TAG, COMM, STATUS(MPI_STATUS_SIZE), IERROR
```

`MPI_Iprobe(source, tag, comm, flag, status)` returns `flag = true` if there is a message that can be received and that matches the pattern specified by the arguments `source`, `tag`, and `comm`. The call matches the same message that would have been received by a call to `MPI_RECV(..., source, tag, comm, status)` executed at the same point in the program, and returns in `status` the same value that would have been returned by `MPI_RECV()`. Otherwise, the call returns `flag = false`, and leaves `status` undefined.

If `MPI_Iprobe` returns `flag = true`, then the content of the status object can be subsequently accessed as described in Section 3.2.5 to find the source, tag and length of the probed message.

A subsequent receive executed with the same communicator, and the source and tag returned in `status` by `MPI_Iprobe` will receive the message that was matched by the probe, if no other intervening receive occurs after the probe, and the send is not successfully cancelled before the receive. If the receiving process is multithreaded, it is the user's responsibility to ensure that the last condition holds.

The `source` argument of `MPI_Iprobe` can be `MPI_ANY_SOURCE`, and the `tag` argument can be `MPI_ANY_TAG`, so that one can probe for messages from an arbitrary source and/or with an arbitrary tag. However, a specific communication context must be provided with the `comm` argument.

It is not necessary to receive a message immediately after it has been probed for, and the same message may be probed for several times before it is received.

A probe with `MPI_PROC_NULL` as source returns `flag = true`, and the status object returns `source = MPI_PROC_NULL`, `tag = MPI_ANY_TAG`, and `count = 0`; see Section 3.11.

```

1 MPI_PROBE(source, tag, comm, status)
2     IN      source                rank of source or MPI_ANY_SOURCE (integer)
3
4     IN      tag                   message tag or MPI_ANY_TAG (integer)
5
6     IN      comm                  communicator (handle)
7
8     OUT     status                 status object (Status)

```

```

9 int MPI_Probe(int source, int tag, MPI_Comm comm, MPI_Status *status)

```

```

10 MPI_Probe(source, tag, comm, status, ierror)
11     INTEGER, INTENT(IN) :: source, tag
12     TYPE(MPI_Comm), INTENT(IN) :: comm
13     TYPE(MPI_Status) :: status
14     INTEGER, OPTIONAL, INTENT(OUT) :: ierror

```

```

15 MPI_PROBE(SOURCE, TAG, COMM, STATUS, IERROR)
16     INTEGER SOURCE, TAG, COMM, STATUS(MPI_STATUS_SIZE), IERROR

```

18 MPI_PROBE behaves like MPI_Iprobe except that it is a blocking call that returns
19 only after a matching message has been found.

20 The MPI implementation of MPI_PROBE and MPI_Iprobe needs to guarantee progress:
21 if a call to MPI_PROBE has been issued by a process, and a send that matches the probe
22 has been initiated by some process, then the call to MPI_PROBE will return, unless the
23 message is received by another concurrent receive operation (that is executed by another
24 thread at the probing process). Similarly, if a process busy waits with MPI_Iprobe and a
25 matching message has been issued, then the call to MPI_Iprobe will eventually return `flag`
26 `= true` unless the message is received by another concurrent receive operation or matched
27 by a concurrent matched probe.

29 Example 3.17

30 Use blocking probe to wait for an incoming message.

```

31
32     CALL MPI_COMM_RANK(comm, rank, ierr)
33     IF (rank.EQ.0) THEN
34         CALL MPI_SEND(i, 1, MPI_INTEGER, 2, 0, comm, ierr)
35     ELSE IF (rank.EQ.1) THEN
36         CALL MPI_SEND(x, 1, MPI_REAL, 2, 0, comm, ierr)
37     ELSE IF (rank.EQ.2) THEN
38         DO i=1, 2
39             CALL MPI_PROBE(MPI_ANY_SOURCE, 0,
40                           comm, status, ierr)
41             IF (status(MPI_SOURCE) .EQ. 0) THEN
42 100         CALL MPI_RECV(i, 1, MPI_INTEGER, 0, 0, comm, status, ierr)
43             ELSE
44 200         CALL MPI_RECV(x, 1, MPI_REAL, 1, 0, comm, status, ierr)
45             END IF
46         END DO
47     END IF
48

```

Each message is received with the right type.

Example 3.18 A similar program to the previous example, but now it has a problem.

```

CALL MPI_COMM_RANK(comm, rank, ierr)
IF (rank.EQ.0) THEN
    CALL MPI_SEND(i, 1, MPI_INTEGER, 2, 0, comm, ierr)
ELSE IF (rank.EQ.1) THEN
    CALL MPI_SEND(x, 1, MPI_REAL, 2, 0, comm, ierr)
ELSE IF (rank.EQ.2) THEN
    DO i=1, 2
        CALL MPI_PROBE(MPI_ANY_SOURCE, 0,
                        comm, status, ierr)
        IF (status(MPI_SOURCE) .EQ. 0) THEN
100           CALL MPI_RECV(i, 1, MPI_INTEGER, MPI_ANY_SOURCE,
                        0, comm, status, ierr)
        ELSE
200           CALL MPI_RECV(x, 1, MPI_REAL, MPI_ANY_SOURCE,
                        0, comm, status, ierr)
        END IF
    END DO
END IF

```

In Example 3.18, the two receive calls in statements labeled 100 and 200 in Example 3.17 slightly modified, using `MPI_ANY_SOURCE` as the source argument. The program is now incorrect: the receive operation may receive a message that is distinct from the message probed by the preceding call to `MPI_PROBE`.

Advice to users. In a multithreaded MPI program, `MPI_PROBE` and `MPI_Iprobe` might need special care. If a thread probes for a message and then immediately posts a matching receive, the receive may match a message other than that found by the probe since another thread could concurrently receive that original message [30]. `MPI_Mprobe` and `MPI_Improbe` solve this problem by matching the incoming message so that it may only be received with `MPI_Mrecv` or `MPI_Irecv` on the corresponding message handle. (*End of advice to users.*)

Advice to implementors. A call to `MPI_PROBE(source, tag, comm, status)` will match the message that would have been received by a call to `MPI_RECV(..., source, tag, comm, status)` executed at the same point. Suppose that this message has source `s`, tag `t` and communicator `c`. If the tag argument in the probe call has value `MPI_ANY_TAG` then the message probed will be the earliest pending message from source `s` with communicator `c` and any tag; in any case, the message probed will be the earliest pending message from source `s` with tag `t` and communicator `c` (this is the message that would have been received, so as to preserve message order). This message continues as the earliest pending message from source `s` with tag `t` and communicator `c`, until it is received. A receive operation subsequent to the probe that uses the same communicator as the probe and uses the tag and source values returned by the probe, must receive this message, unless it has already been received by another receive operation. (*End of advice to implementors.*)

3.8.2 Matching Probe

The function `MPI_PROBE` checks for incoming messages without receiving them. Since the list of incoming messages is global among the threads of each MPI process, it can be hard to use this functionality in threaded environments [30, 27].

Like `MPI_PROBE` and `MPI_Iprobe`, the `MPI_Mprobe` and `MPI_improbe` operations allow incoming messages to be queried without actually receiving them, except that `MPI_Mprobe` and `MPI_improbe` provide a mechanism to receive the specific message that was matched regardless of other intervening probe or receive operations. This gives the application an opportunity to decide how to receive the message, based on the information returned by the probe. In particular, the user may allocate memory for the receive buffer, according to the length of the probed message.

```
MPI_IMPROBE(source, tag, comm, flag, message, status)
```

IN	source	rank of source or <code>MPI_ANY_SOURCE</code> (integer)
IN	tag	message tag or <code>MPI_ANY_TAG</code> (integer)
IN	comm	communicator (handle)
OUT	flag	flag (logical)
OUT	message	returned message (handle)
OUT	status	status object (Status)

```
int MPI_Improbe(int source, int tag, MPI_Comm comm, int *flag,
                MPI_Message *message, MPI_Status *status)
```

```
MPI_Improbe(source, tag, comm, flag, message, status, ierror)
    INTEGER, INTENT(IN) :: source, tag
    TYPE(MPI_Comm), INTENT(IN) :: comm
    LOGICAL, INTENT(OUT) :: flag
    TYPE(MPI_Message), INTENT(OUT) :: message
    TYPE(MPI_Status) :: status
    INTEGER, OPTIONAL, INTENT(OUT) :: ierror
```

```
MPI_IMPROBE(SOURCE, TAG, COMM, FLAG, MESSAGE, STATUS, IERROR)
    INTEGER SOURCE, TAG, COMM, MESSAGE, STATUS(MPI_STATUS_SIZE), IERROR
    LOGICAL FLAG
```

`MPI_IMPROBE(source, tag, comm, flag, message, status)` returns `flag = true` if there is a message that can be received and that matches the pattern specified by the arguments `source`, `tag`, and `comm`. The call matches the same message that would have been received by a call to `MPI_RECV(..., source, tag, comm, status)` executed at the same point in the program and returns in `status` the same value that would have been returned by `MPI_RECV`. In addition, it returns in `message` a handle to the matched message. Otherwise, the call returns `flag = false`, and leaves `status` and `message` undefined.

A matched receive (`MPI_MRECV` or `MPI_imrecv`) executed with the message handle will receive the message that was matched by the probe. Unlike `MPI_Iprobe`, no other probe or receive operation may match the message returned by `MPI_IMPROBE`.

Each message returned by MPI_IMPROBE must be received with either MPI_MRECV or MPI_IMRECV.

The source argument of MPI_IMPROBE can be MPI_ANY_SOURCE, and the tag argument can be MPI_ANY_TAG, so that one can probe for messages from an arbitrary source and/or with an arbitrary tag. However, a specific communication context must be provided with the comm argument.

A synchronous send operation that is matched with MPI_IMPROBE or MPI_MPROBE will complete successfully only if both a matching receive is posted with MPI_MRECV or MPI_IMRECV, and the receive operation has started to receive the message sent by the synchronous send.

There is a special predefined message: MPI_MESSAGE_NO_PROC, which is a message which has MPI_PROC_NULL as its source process. The predefined constant MPI_MESSAGE_NULL is the value used for invalid message handles.

A matching probe with MPI_PROC_NULL as source returns flag = true, message = MPI_MESSAGE_NO_PROC, and the status object returns source = MPI_PROC_NULL, tag = MPI_ANY_TAG, and count = 0; see Section 3.11. It is not necessary to call MPI_MRECV or MPI_IMRECV with MPI_MESSAGE_NO_PROC, but it is not erroneous to do so.

Rationale. MPI_MESSAGE_NO_PROC was chosen instead of MPI_MESSAGE_PROC_NULL to avoid possible confusion as another null handle constant. (*End of rationale.*)

MPI_MPROBE(source, tag, comm, message, status)

IN	source	rank of source or MPI_ANY_SOURCE (integer)
IN	tag	message tag or MPI_ANY_TAG (integer)
IN	comm	communicator (handle)
OUT	message	returned message (handle)
OUT	status	status object (Status)

```
int MPI_Mprobe(int source, int tag, MPI_Comm comm, MPI_Message *message,
               MPI_Status *status)
```

```
MPI_Mprobe(source, tag, comm, message, status, ierror)
```

```
INTEGER, INTENT(IN) :: source, tag
TYPE(MPI_Comm), INTENT(IN) :: comm
TYPE(MPI_Message), INTENT(OUT) :: message
TYPE(MPI_Status) :: status
INTEGER, OPTIONAL, INTENT(OUT) :: ierror
```

```
MPI_MPROBE(SOURCE, TAG, COMM, MESSAGE, STATUS, IERROR)
```

```
INTEGER SOURCE, TAG, COMM, MESSAGE, STATUS(MPI_STATUS_SIZE), IERROR
```

MPI_MPROBE behaves like MPI_IMPROBE except that it is a blocking call that returns only after a matching message has been found.

The implementation of MPI_MPROBE and MPI_IMPROBE needs to guarantee progress in the same way as in the case of MPI_PROBE and MPI_Iprobe.

3.8.3 Matched Receives

The functions `MPI_MRECV` and `MPI_IMRECV` receive messages that have been previously matched by a matching probe (Section 3.8.2).

```
MPI_MRECV(buf, count, datatype, message, status)
```

OUT	buf	initial address of receive buffer (choice)
IN	count	number of elements in receive buffer (non-negative integer)
IN	datatype	datatype of each receive buffer element (handle)
INOUT	message	message (handle)
OUT	status	status object (Status)

```
int MPI_Mrecv(void* buf, int count, MPI_Datatype datatype,
              MPI_Message *message, MPI_Status *status)
```

```
MPI_Mrecv(buf, count, datatype, message, status, ierror)
```

```
TYPE(*), DIMENSION(..) :: buf
INTEGER, INTENT(IN) :: count
TYPE(MPI_Datatype), INTENT(IN) :: datatype
TYPE(MPI_Message), INTENT(INOUT) :: message
TYPE(MPI_Status) :: status
INTEGER, OPTIONAL, INTENT(OUT) :: ierror
```

```
MPI_MRECV(BUF, COUNT, DATATYPE, MESSAGE, STATUS, IERROR)
```

```
<type> BUF(*)
INTEGER COUNT, DATATYPE, MESSAGE, STATUS(MPI_STATUS_SIZE), IERROR
```

This call receives a message matched by a matching probe operation (Section 3.8.2).

The receive buffer consists of the storage containing `count` consecutive elements of the type specified by `datatype`, starting at address `buf`. The length of the received message must be less than or equal to the length of the receive buffer. An overflow error occurs if all incoming data does not fit, without truncation, into the receive buffer.

If the message is shorter than the receive buffer, then only those locations corresponding to the (shorter) message are modified.

On return from this function, the message handle is set to `MPI_MESSAGE_NULL`. All errors that occur during the execution of this operation are handled according to the error handler set for the communicator used in the matching probe call that produced the message handle.

If `MPI_MRECV` is called with `MPI_MESSAGE_NO_PROC` as the message argument, the call returns immediately with the status object set to `source = MPI_PROC_NULL`, `tag = MPI_ANY_TAG`, and `count = 0`, as if a receive from `MPI_PROC_NULL` was issued (see Section 3.11). A call to `MPI_MRECV` with `MPI_MESSAGE_NULL` is erroneous.

```

MPI_IMRECV(buf, count, datatype, message, request) 1
  OUT      buf                initial address of receive buffer (choice) 2
  IN       count              number of elements in receive buffer (non-negative in- 3
                                teger) 4
  IN       datatype           datatype of each receive buffer element (handle) 6
  INOUT    message            message (handle) 7
  OUT      request            communication request (handle) 8

```

```

int MPI_Imrecv(void* buf, int count, MPI_Datatype datatype, 10
               MPI_Message *message, MPI_Request *request) 11

```

```

MPI_Imrecv(buf, count, datatype, message, request, ierror) 13
  TYPE(*), DIMENSION(..), ASYNCHRONOUS :: buf 14
  INTEGER, INTENT(IN) :: count 15
  TYPE(MPI_Datatype), INTENT(IN) :: datatype 16
  TYPE(MPI_Message), INTENT(INOUT) :: message 17
  TYPE(MPI_Request), INTENT(OUT) :: request 18
  INTEGER, OPTIONAL, INTENT(OUT) :: ierror 19

```

```

MPI_IMRECV(BUF, COUNT, DATATYPE, MESSAGE, REQUEST, IERROR) 21
  <type> BUF(*) 22
  INTEGER COUNT, DATATYPE, MESSAGE, REQUEST, IERROR 23

```

MPI_IMRECV is the nonblocking variant of MPI_MRECV and starts a nonblocking receive of a matched message. Completion semantics are similar to MPI_IRECV as described in Section 3.7.2. On return from this function, the message handle is set to MPI_MESSAGE_NULL.

If MPI_IMRECV is called with MPI_MESSAGE_NO_PROC as the message argument, the call returns immediately with a request object which, when completed, will yield a status object set to source = MPI_PROC_NULL, tag = MPI_ANY_TAG, and count = 0, as if a receive from MPI_PROC_NULL was issued (see Section 3.11). A call to MPI_IMRECV with MPI_MESSAGE_NULL is erroneous.

Advice to implementors. If reception of a matched message is started with MPI_IMRECV, then it is possible to cancel the returned request with MPI_CANCEL. If MPI_CANCEL succeeds, the matched message must be found by a subsequent message probe (MPI_PROBE, MPI_Iprobe, MPI_Mprobe, or MPI_Improbe), received by a subsequent receive operation or cancelled by the sender. See Section 3.8.4 for details about MPI_CANCEL. The cancellation of operations initiated with MPI_IMRECV may fail. (*End of advice to implementors.*)

3.8.4 Cancel

```

MPI_CANCEL(request) 45
  IN      request            communication request (handle) 46

```

```

1 int MPI_Cancel(MPI_Request *request)
2
3 MPI_Cancel(request, ierror)
4     TYPE(MPI_Request), INTENT(IN) :: request
5     INTEGER, OPTIONAL, INTENT(OUT) :: ierror
6
7 MPI_CANCEL(REQUEST, IERROR)
8     INTEGER REQUEST, IERROR

```

A call to `MPI_CANCEL` marks for cancellation a pending, nonblocking communication operation (send or receive). Cancelling a send request by calling `MPI_CANCEL` is deprecated. The cancel call is local. It returns immediately, possibly before the communication is actually cancelled. It is still necessary to call `MPI_REQUEST_FREE`, `MPI_WAIT` or `MPI_TEST` (or any of the derived operations) with the cancelled request as argument after the call to `MPI_CANCEL`. If a communication is marked for cancellation, then a `MPI_WAIT` call for that communication is guaranteed to return, irrespective of the activities of other processes (i.e., `MPI_WAIT` behaves as a local function); similarly if `MPI_TEST` is repeatedly called in a busy wait loop for a cancelled communication, then `MPI_TEST` will eventually be successful.

`MPI_CANCEL` can be used to cancel a communication that uses a persistent request (see Section 3.9), in the same way it is used for nonpersistent requests. Cancelling a persistent send request by calling `MPI_CANCEL` is deprecated. A successful cancellation cancels the active communication, but not the request itself. After the call to `MPI_CANCEL` and the subsequent call to `MPI_WAIT` or `MPI_TEST`, the request becomes inactive and can be activated for a new communication.

The successful cancellation of a buffered send frees the buffer space occupied by the pending message. Cancelling a buffered send request by calling `MPI_CANCEL` is deprecated.

Either the cancellation succeeds, or the communication succeeds, but not both. If a send is marked for cancellation, which is deprecated, then it must be the case that either the send completes normally, in which case the message sent was received at the destination process, or that the send is successfully cancelled, in which case no part of the message was received at the destination. Then, any matching receive has to be satisfied by another send. If a receive is marked for cancellation, then it must be the case that either the receive completes normally, or that the receive is successfully cancelled, in which case no part of the receive buffer is altered. Then, any matching send has to be satisfied by another receive.

If the operation has been cancelled, then information to that effect will be returned in the status argument of the operation that completes the communication.

Rationale. Although the IN request handle parameter should not need to be passed by reference, the C binding has listed the argument type as `MPI_Request*` since MPI-1.0. This function signature therefore cannot be changed without breaking existing MPI applications. (*End of rationale.*)

```

44 MPI_TEST_CANCELLED(status, flag)
45     IN          status          status object (Status)
46     OUT        flag            (logical)

```

```

int MPI_Test_cancelled(const MPI_Status *status, int *flag)
MPI_Test_cancelled(status, flag, ierror)
    TYPE(MPI_Status), INTENT(IN) :: status
    LOGICAL, INTENT(OUT) :: flag
    INTEGER, OPTIONAL, INTENT(OUT) :: ierror
MPI_TEST_CANCELLED(STATUS, FLAG, IERROR)
    LOGICAL FLAG
    INTEGER STATUS(MPI_STATUS_SIZE), IERROR

```

Returns `flag = true` if the communication associated with the status object was cancelled successfully. In such a case, all other fields of `status` (such as `count` or `tag`) are undefined. Returns `flag = false`, otherwise. If a receive operation might be cancelled then one should call `MPI_TEST_CANCELLED` first, to check whether the operation was cancelled, before checking on the other fields of the return status.

Advice to users. Cancel can be an expensive operation that should be used only exceptionally. (*End of advice to users.*)

Advice to implementors. If a send operation uses an “eager” protocol (data is transferred to the receiver before a matching receive is posted), then the cancellation of this send may require communication with the intended receiver in order to free allocated buffers. On some systems this may require an interrupt to the intended receiver. Note that, while communication may be needed to implement `MPI_CANCEL`, this is still a local operation, since its completion does not depend on the code executed by other processes. If processing is required on another process, this should be transparent to the application (hence the need for an interrupt and an interrupt handler). (*End of advice to implementors.*)

3.9 Persistent Communication Requests

Often a communication with the same argument list (with the exception of the buffer contents) is repeatedly executed within the inner loop of a parallel computation. In such a situation, it may be possible to optimize the communication by binding the list of communication arguments to a **persistent** communication request once and, then, repeatedly using the request to initiate and complete operations. In the case of point-to-point communication, the persistent request thus created can be thought of as a communication port or a “half-channel.” It does not provide the full functionality of a conventional channel, since there is no binding of the send port to the receive port. This construct allows reduction of the overhead for communication between the process and communication controller, but not of the overhead for communication between one communication controller and another. It is not necessary that messages sent with a persistent point-to-point request be received by a receive operation using a persistent point-to-point request, or vice versa.

There are also collective communication persistent operations defined in Section 5.13 and Section 7.8. The remainder of this section covers the point-to-point persistent initialization operations and the start routines, which are used for both point-to-point and collective persistent communication.

A persistent point-to-point communication request is created using one of the five following calls. These point-to-point persistent calls involve no communication.

```

1 MPI_SEND_INIT(buf, count, datatype, dest, tag, comm, request)
2     IN      buf          initial address of send buffer (choice)
3
4     IN      count       number of elements sent (non-negative integer)
5
6     IN      datatype    type of each element (handle)
7
8     IN      dest        rank of destination (integer)
9
10    IN      tag         message tag (integer)
11
12    IN      comm        communicator (handle)
13
14    OUT     request     communication request (handle)
15
16 int MPI_Send_init(const void* buf, int count, MPI_Datatype datatype,
17                 int dest, int tag, MPI_Comm comm, MPI_Request *request)
18
19 MPI_Send_init(buf, count, datatype, dest, tag, comm, request, ierror)
20     TYPE(*), DIMENSION(..), INTENT(IN), ASYNCHRONOUS :: buf
21     INTEGER, INTENT(IN) :: count, dest, tag
22     TYPE(MPI_Datatype), INTENT(IN) :: datatype
23     TYPE(MPI_Comm), INTENT(IN) :: comm
24     TYPE(MPI_Request), INTENT(OUT) :: request
25     INTEGER, OPTIONAL, INTENT(OUT) :: ierror
26
27 MPI_SEND_INIT(BUF, COUNT, DATATYPE, DEST, TAG, COMM, REQUEST, IERROR)
28     <type> BUF(*)
29     INTEGER COUNT, DATATYPE, DEST, TAG, COMM, REQUEST, IERROR
30
31     Creates a persistent communication request for a standard mode send operation, and
32     binds to it all the arguments of a send operation.
33
34
35
36
37
38
39
40
41
42
43
44 MPI_BSEND_INIT(buf, count, datatype, dest, tag, comm, request)
45     IN      buf          initial address of send buffer (choice)
46
47     IN      count       number of elements sent (non-negative integer)
48
49     IN      datatype    type of each element (handle)
50
51     IN      dest        rank of destination (integer)
52
53     IN      tag         message tag (integer)
54
55     IN      comm        communicator (handle)
56
57     OUT     request     communication request (handle)
58
59
60 int MPI_Bsend_init(const void* buf, int count, MPI_Datatype datatype,
61                 int dest, int tag, MPI_Comm comm, MPI_Request *request)
62
63 MPI_Bsend_init(buf, count, datatype, dest, tag, comm, request, ierror)
64     TYPE(*), DIMENSION(..), INTENT(IN), ASYNCHRONOUS :: buf
65     INTEGER, INTENT(IN) :: count, dest, tag
66     TYPE(MPI_Datatype), INTENT(IN) :: datatype
67     TYPE(MPI_Comm), INTENT(IN) :: comm

```

```

TYPE(MPI_Request), INTENT(OUT) :: request      1
INTEGER, OPTIONAL, INTENT(OUT) :: ierror      2
                                                                 3
MPI_BSEND_INIT(BUF, COUNT, DATATYPE, DEST, TAG, COMM, REQUEST, IERROR)  4
<type> BUF(*)                                  5
INTEGER COUNT, DATATYPE, DEST, TAG, COMM, REQUEST, IERROR  6
                                                                 7
Creates a persistent communication request for a buffered mode send.  8
                                                                 9
MPI_SSEND_INIT(buf, count, datatype, dest, tag, comm, request) 10
IN      buf                initial address of send buffer (choice) 11
IN      count              number of elements sent (non-negative integer) 12
IN      datatype           type of each element (handle) 13
IN      dest               rank of destination (integer) 14
IN      tag                message tag (integer) 15
IN      comm               communicator (handle) 16
OUT     request            communication request (handle) 17
                                                                 18
int MPI_Ssend_init(const void* buf, int count, MPI_Datatype datatype, 19
                   int dest, int tag, MPI_Comm comm, MPI_Request *request) 20
                                                                 21
MPI_Ssend_init(buf, count, datatype, dest, tag, comm, request, ierror) 22
TYPE(*), DIMENSION(..), INTENT(IN), ASYNCHRONOUS :: buf 23
INTEGER, INTENT(IN) :: count, dest, tag 24
TYPE(MPI_Datatype), INTENT(IN) :: datatype 25
TYPE(MPI_Comm), INTENT(IN) :: comm 26
TYPE(MPI_Request), INTENT(OUT) :: request 27
INTEGER, OPTIONAL, INTENT(OUT) :: ierror 28
                                                                 29
MPI_SSEND_INIT(BUF, COUNT, DATATYPE, DEST, TAG, COMM, REQUEST, IERROR) 30
<type> BUF(*)                                  31
INTEGER COUNT, DATATYPE, DEST, TAG, COMM, REQUEST, IERROR 32
                                                                 33
Creates a persistent communication object for a synchronous mode send operation. 34
                                                                 35
MPI_RSEND_INIT(buf, count, datatype, dest, tag, comm, request) 36
IN      buf                initial address of send buffer (choice) 37
IN      count              number of elements sent (non-negative integer) 38
IN      datatype           type of each element (handle) 39
IN      dest               rank of destination (integer) 40
IN      tag                message tag (integer) 41
IN      comm               communicator (handle) 42
OUT     request            communication request (handle) 43
                                                                 44
                                                                 45
                                                                 46
                                                                 47
                                                                 48

```

```

1 int MPI_Rsend_init(const void* buf, int count, MPI_Datatype datatype,
2                   int dest, int tag, MPI_Comm comm, MPI_Request *request)
3
4 MPI_Rsend_init(buf, count, datatype, dest, tag, comm, request, ierror)
5     TYPE(*), DIMENSION(..), INTENT(IN), ASYNCHRONOUS :: buf
6     INTEGER, INTENT(IN) :: count, dest, tag
7     TYPE(MPI_Datatype), INTENT(IN) :: datatype
8     TYPE(MPI_Comm), INTENT(IN) :: comm
9     TYPE(MPI_Request), INTENT(OUT) :: request
10    INTEGER, OPTIONAL, INTENT(OUT) :: ierror
11
12 MPI_RSEND_INIT(BUF, COUNT, DATATYPE, DEST, TAG, COMM, REQUEST, IERROR)
13     <type> BUF(*)
14     INTEGER COUNT, DATATYPE, DEST, TAG, COMM, REQUEST, IERROR

```

Creates a persistent communication object for a ready mode send operation.

```

17 MPI_RECV_INIT(buf, count, datatype, source, tag, comm, request)
18
19 OUT    buf                initial address of receive buffer (choice)
20 IN     count              number of elements received (non-negative integer)
21 IN     datatype           type of each element (handle)
22 IN     source              rank of source or MPI_ANY_SOURCE (integer)
23 IN     tag                 message tag or MPI_ANY_TAG (integer)
24 IN     comm                communicator (handle)
25 OUT    request            communication request (handle)
26
27
28

```

```

29 int MPI_Recv_init(void* buf, int count, MPI_Datatype datatype, int source,
30                  int tag, MPI_Comm comm, MPI_Request *request)
31
32 MPI_Recv_init(buf, count, datatype, source, tag, comm, request, ierror)
33     TYPE(*), DIMENSION(..), ASYNCHRONOUS :: buf
34     INTEGER, INTENT(IN) :: count, source, tag
35     TYPE(MPI_Datatype), INTENT(IN) :: datatype
36     TYPE(MPI_Comm), INTENT(IN) :: comm
37     TYPE(MPI_Request), INTENT(OUT) :: request
38     INTEGER, OPTIONAL, INTENT(OUT) :: ierror
39
40 MPI_RECV_INIT(BUF, COUNT, DATATYPE, SOURCE, TAG, COMM, REQUEST, IERROR)
41     <type> BUF(*)
42     INTEGER COUNT, DATATYPE, SOURCE, TAG, COMM, REQUEST, IERROR

```

Creates a persistent communication request for a receive operation. The argument `buf` is marked as `OUT` because the user gives permission to write on the receive buffer by passing the argument to `MPI_RECV_INIT`.

A persistent communication request is inactive after it was created — no active communication is attached to the request.

A communication (send or receive) that uses a persistent request is initiated by the function `MPI_START`.

```

MPI_START(request) 1
    INOUT    request          communication request (handle) 2
                                                    3
                                                    4
int MPI_Start(MPI_Request *request) 5
MPI_Start(request, ierror) 6
    TYPE(MPI_Request), INTENT(INOUT) :: request 7
    INTEGER, OPTIONAL, INTENT(OUT) :: ierror 8
                                                    9
MPI_START(REQUEST, IERROR) 10
    INTEGER REQUEST, IERROR 11

```

The argument, `request`, is a handle returned by one of the previous five calls. The associated request should be inactive. The request becomes active once the call is made.

If the request is for a send with ready mode, then a matching receive should be posted before the call is made. The communication buffer should not be modified after the call, and until the operation completes.

The call is local, with similar semantics to the nonblocking communication operations described in Section 3.7. That is, a call to `MPI_START` with a request created by `MPI_SEND_INIT` starts a communication in the same manner as a call to `MPI_ISEND`; a call to `MPI_START` with a request created by `MPI_BSEND_INIT` starts a communication in the same manner as a call to `MPI_IBSEND`; and so on.

```

MPI_STARTALL(count, array_of_requests) 23
    IN        count          list length (non-negative integer) 25
    INOUT    array_of_requests  array of requests (array of handle) 26
                                                    27
                                                    28
int MPI_Startall(int count, MPI_Request array_of_requests[]) 29
MPI_Startall(count, array_of_requests, ierror) 30
    INTEGER, INTENT(IN) :: count 31
    TYPE(MPI_Request), INTENT(INOUT) :: array_of_requests(count) 32
    INTEGER, OPTIONAL, INTENT(OUT) :: ierror 33
                                                    34
MPI_STARTALL(COUNT, ARRAY_OF_REQUESTS, IERROR) 35
    INTEGER COUNT, ARRAY_OF_REQUESTS(*), IERROR 36

```

Start all communications associated with requests in `array_of_requests`. A call to `MPI_STARTALL(count, array_of_requests)` has the same effect as calls to `MPI_START (&array_of_requests[i])`, executed for $i=0, \dots, \text{count}-1$, in some arbitrary order.

A communication started with a call to `MPI_START` or `MPI_STARTALL` is completed by a call to `MPI_WAIT`, `MPI_TEST`, or one of the derived functions described in Section 3.7.5. The request becomes inactive after successful completion of such call. The request is not deallocated and it can be activated anew by an `MPI_START` or `MPI_STARTALL` call.

A persistent request is deallocated by a call to `MPI_REQUEST_FREE` (Section 3.7.3).

The call to `MPI_REQUEST_FREE` can occur at any point in the program after the persistent request was created. However, the request will be deallocated only after it becomes

1 inactive. Active receive requests should not be freed. Otherwise, it will not be possible to
2 check that the receive has completed. Collective operation requests (defined in Section 5.12
3 and Section 7.7 for nonblocking collective operations, and Section 5.13 and Section 7.8 for
4 persistent collective operations) must not be freed while active. It is preferable, in general,
5 to free requests when they are inactive. If this rule is followed, then the functions described
6 in this section will be invoked in a sequence of the form,

7
8 **Create (Start Complete)* Free**

9 where * indicates zero or more repetitions. If the same communication object is used in
10 several concurrent threads, it is the user's responsibility to coordinate calls so that the
11 correct sequence is obeyed.

12 A send operation initiated with MPI_START can be matched with any receive operation
13 and, likewise, a receive operation initiated with MPI_START can receive messages generated
14 by any send operation.

15
16 *Advice to users.* To prevent problems with the argument copying and register
17 optimization done by Fortran compilers, please note the hints in Sections 18.1.10–
18 18.1.20. (*End of advice to users.*)
19

20
21 **3.10 Send-Receive**

22 The **send-receive** operations combine in one call the sending of a message to one desti-
23 nation and the receiving of another message, from another process. The two (source and
24 destination) are possibly the same. A send-receive operation is very useful for executing
25 a shift operation across a chain of processes. If blocking sends and receives are used for
26 such a shift, then one needs to order the sends and receives correctly (for example, even
27 processes send, then receive, odd processes receive first, then send) so as to prevent cyclic
28 dependencies that may lead to deadlock. When a send-receive operation is used, the com-
29 munication subsystem takes care of these issues. The send-receive operation can be used
30 in conjunction with the functions described in Chapter 7 in order to perform shifts on var-
31 ious logical topologies. Also, a send-receive operation is useful for implementing remote
32 procedure calls.

33 A message sent by a send-receive operation can be received by a regular receive oper-
34 ation or probed by a probe operation; a send-receive operation can receive a message sent
35 by a regular send operation.
36
37
38
39
40
41
42
43
44
45
46
47
48

MPI_SENDRECV(sendbuf, sendcount, sendtype, dest, sendtag, recvbuf, recvcount, recvtype,			1
source, recvtag, comm, status)			2
IN	sendbuf	initial address of send buffer (choice)	3
IN	sendcount	number of elements in send buffer (non-negative integer)	4
IN	sendtype	type of elements in send buffer (handle)	5
IN	dest	rank of destination (integer)	6
IN	sendtag	send tag (integer)	7
OUT	recvbuf	initial address of receive buffer (choice)	8
IN	recvcount	number of elements in receive buffer (non-negative integer)	9
IN	recvtype	type of elements in receive buffer (handle)	10
IN	source	rank of source or MPI_ANY_SOURCE (integer)	11
IN	recvtag	receive tag or MPI_ANY_TAG (integer)	12
IN	comm	communicator (handle)	13
OUT	status	status object (Status)	14

```

int MPI_Sendrecv(const void *sendbuf, int sendcount, MPI_Datatype sendtype,
                int dest, int sendtag, void *recvbuf, int recvcount,
                MPI_Datatype recvtype, int source, int recvtag, MPI_Comm comm,
                MPI_Status *status)

```

```

MPI_Sendrecv(sendbuf, sendcount, sendtype, dest, sendtag, recvbuf,
             recvcount, recvtype, source, recvtag, comm, status, ierror)
    TYPE(*), DIMENSION(..), INTENT(IN) :: sendbuf
    TYPE(*), DIMENSION(..) :: recvbuf
    INTEGER, INTENT(IN) :: sendcount, dest, sendtag, recvcount, source,
    recvtag
    TYPE(MPI_Datatype), INTENT(IN) :: sendtype, recvtype
    TYPE(MPI_Comm), INTENT(IN) :: comm
    TYPE(MPI_Status) :: status
    INTEGER, OPTIONAL, INTENT(OUT) :: ierror

```

```

MPI_SENDRECV(SENDBUF, SENDCOUNT, SENDTYPE, DEST, SENDTAG, RECVBUF,
             RECVCOUNT, RECVTYPE, SOURCE, RECVTAG, COMM, STATUS, IERROR)
    <type> SENDBUF(*), RECVBUF(*)
    INTEGER SENDCOUNT, SENDTYPE, DEST, SENDTAG, RECVCOUNT, RECVTYPE,
    SOURCE, RECVTAG, COMM, STATUS(MPI_STATUS_SIZE), IERROR

```

Execute a blocking send and receive operation. Both send and receive use the same communicator, but possibly different tags. The send buffer and receive buffers must be disjoint, and may have different lengths and datatypes.

The semantics of a send-receive operation is what would be obtained if the caller forked two concurrent threads, one to execute the send, and one to execute the receive, followed by a join of these two threads.

```

1 MPI_SENDRECV_REPLACE(buf, count, datatype, dest, sendtag, source, recvtag, comm,
2     status)
3     INOUT   buf           initial address of send and receive buffer (choice)
4     IN      count        number of elements in send and receive buffer (non-
5     negative integer)
6     IN      datatype     type of elements in send and receive buffer (handle)
7     IN      dest         rank of destination (integer)
8     IN      sendtag     send message tag (integer)
9     IN      source       rank of source or MPI_ANY_SOURCE (integer)
10    IN      recvtag     receive message tag or MPI_ANY_TAG (integer)
11    IN      comm        communicator (handle)
12    OUT     status       status object (Status)
13
14
15
16
17 int MPI_Sendrecv_replace(void* buf, int count, MPI_Datatype datatype,
18     int dest, int sendtag, int source, int recvtag, MPI_Comm comm,
19     MPI_Status *status)
20
21 MPI_Sendrecv_replace(buf, count, datatype, dest, sendtag, source, recvtag,
22     comm, status, ierror)
23     TYPE(*), DIMENSION(..) :: buf
24     INTEGER, INTENT(IN) :: count, dest, sendtag, source, recvtag
25     TYPE(MPI_Datatype), INTENT(IN) :: datatype
26     TYPE(MPI_Comm), INTENT(IN) :: comm
27     TYPE(MPI_Status) :: status
28     INTEGER, OPTIONAL, INTENT(OUT) :: ierror
29
30 MPI_SENDRECV_REPLACE(BUF, COUNT, DATATYPE, DEST, SENDTAG, SOURCE, RECVTAG,
31     COMM, STATUS, IERROR)
32     <type> BUF(*)
33     INTEGER COUNT, DATATYPE, DEST, SENDTAG, SOURCE, RECVTAG, COMM,
34     STATUS(MPI_STATUS_SIZE), IERROR

```

Execute a blocking send and receive. The same buffer is used both for the send and for the receive, so that the message sent is replaced by the message received.

Advice to implementors. Additional intermediate buffering is needed for the “replace” variant. (*End of advice to implementors.*)

3.11 Null Processes

In many instances, it is convenient to specify a “dummy” source or destination for communication. This simplifies the code that is needed for dealing with boundaries, for example, in the case of a non-circular shift done with calls to send-receive.

The special value `MPI_PROC_NULL` can be used instead of a rank wherever a source or a destination argument is required in a call. A communication with process `MPI_PROC_NULL` has no effect. A send to `MPI_PROC_NULL` succeeds and returns as soon as possible. A receive

from MPI_PROC_NULL succeeds and returns as soon as possible with no modifications to the receive buffer. When a receive with `source = MPI_PROC_NULL` is executed then the status object returns `source = MPI_PROC_NULL`, `tag = MPI_ANY_TAG` and `count = 0`. A probe or matching probe with `source = MPI_PROC_NULL` succeeds and returns as soon as possible, and the status object returns `source = MPI_PROC_NULL`, `tag = MPI_ANY_TAG` and `count = 0`. A matching probe (cf. Section 3.8.2) with `MPI_PROC_NULL` as source returns `flag = true`, `message = MPI_MESSAGE_NO_PROC`, and the status object returns `source = MPI_PROC_NULL`, `tag = MPI_ANY_TAG`, and `count = 0`.

1
2
3
4
5
6
7
8
9
10
11
12
13
14
15
16
17
18
19
20
21
22
23
24
25
26
27
28
29
30
31
32
33
34
35
36
37
38
39
40
41
42
43
44
45
46
47
48

1
2
3
4
5
6
7
8
9
10
11
12
13
14
15
16
17
18
19
20
21
22
23
24
25
26
27
28
29
30
31
32
33
34
35
36
37
38
39
40
41
42
43
44
45
46
47
48

Chapter 4

Datatypes

Basic datatypes were introduced in Section 3.2.2 and in Section 3.3. In this chapter, this model is extended to describe any data layout. We consider general datatypes that allow one to transfer efficiently heterogeneous and noncontiguous data. We conclude with the description of calls for explicit packing and unpacking of messages.

4.1 Derived Datatypes

Up to here, all point to point communications have involved only buffers containing a sequence of identical basic datatypes. This is too constraining on two accounts. One often wants to pass messages that contain values with different datatypes (e.g., an integer count, followed by a sequence of real numbers); and one often wants to send noncontiguous data (e.g., a sub-block of a matrix). One solution is to pack noncontiguous data into a contiguous buffer at the sender site and unpack it at the receiver site. This has the disadvantage of requiring additional memory-to-memory copy operations at both sites, even when the communication subsystem has scatter-gather capabilities. Instead, MPI provides mechanisms to specify more general, mixed, and noncontiguous communication buffers. It is up to the implementation to decide whether data should be first packed in a contiguous buffer before being transmitted, or whether it can be collected directly from where it resides.

The general mechanisms provided here allow one to transfer directly, without copying, objects of various shapes and sizes. It is not assumed that the MPI library is cognizant of the objects declared in the host language. Thus, if one wants to transfer a structure, or an array section, it will be necessary to provide in MPI a definition of a communication buffer that mimics the definition of the structure or array section in question. These facilities can be used by library designers to define communication functions that can transfer objects defined in the host language — by decoding their definitions as available in a symbol table or a dope vector. Such higher-level communication functions are not part of MPI.

More general communication buffers are specified by replacing the basic datatypes that have been used so far with derived datatypes that are constructed from basic datatypes using the constructors described in this section. These methods of constructing derived datatypes can be applied recursively.

A **general datatype** is an opaque object that specifies two things:

- A sequence of basic datatypes
- A sequence of integer (byte) displacements

The displacements are not required to be positive, distinct, or in increasing order. Therefore, the order of items need not coincide with their order in store, and an item may appear more than once. We call such a pair of sequences (or sequence of pairs) a **type map**. The sequence of basic datatypes (displacements ignored) is the **type signature** of the datatype.

Let

$$Typemap = \{(type_0, disp_0), \dots, (type_{n-1}, disp_{n-1})\},$$

be such a type map, where $type_i$ are basic types, and $disp_i$ are displacements. Let

$$Typesig = \{type_0, \dots, type_{n-1}\}$$

be the associated type signature. This type map, together with a base address `buf`, specifies a communication buffer: the communication buffer that consists of n entries, where the i -th entry is at address `buf + dispi` and has type $type_i$. A message assembled from such a communication buffer will consist of n values, of the types defined by $Typesig$.

Most datatype constructors have replication count or block length arguments. Allowed values are non-negative integers. If the value is zero, no elements are generated in the type map and there is no effect on datatype bounds or extent.

We can use a handle to a general datatype as an argument in a send or receive operation, instead of a basic datatype argument. The operation `MPI_SEND(buf, 1, datatype, ...)` will use the send buffer defined by the base address `buf` and the general datatype associated with `datatype`; it will generate a message with the type signature determined by the `datatype` argument. `MPI_RECV(buf, 1, datatype, ...)` will use the receive buffer defined by the base address `buf` and the general datatype associated with `datatype`.

General datatypes can be used in all send and receive operations. We discuss, in Section 4.1.11, the case where the second argument `count` has value > 1 .

The basic datatypes presented in Section 3.2.2 are particular cases of a general datatype, and are predefined. Thus, `MPI_INT` is a predefined handle to a datatype with type map $\{(\text{int}, 0)\}$, with one entry of type `int` and displacement zero. The other basic datatypes are similar.

The **extent** of a datatype is defined to be the span from the first byte to the last byte occupied by entries in this datatype, rounded up to satisfy alignment requirements. That is, if

$$Typemap = \{(type_0, disp_0), \dots, (type_{n-1}, disp_{n-1})\},$$

then

$$\begin{aligned} lb(Typemap) &= \min_j disp_j, \\ ub(Typemap) &= \max_j (disp_j + \text{sizeof}(type_j)) + \epsilon, \text{ and} \\ extent(Typemap) &= ub(Typemap) - lb(Typemap). \end{aligned} \tag{4.1}$$

If $type_j$ requires alignment to a byte address that is a multiple of k_j , then ϵ is the least non-negative increment needed to round $extent(Typemap)$ to the next multiple of $\max_j k_j$. In Fortran, it is implementation dependent whether the MPI implementation computes the alignments k_j according to the alignments used by the compiler in common blocks, SEQUENCE derived types, BIND(C) derived types, or derived types that are neither SEQUENCE nor BIND(C). The complete definition of **extent** is given by Equation 4.1 Section 4.1.

Example 4.1 Assume that $Type = \{(double, 0), (char, 8)\}$ (a `double` at displacement zero, followed by a `char` at displacement eight). Assume, furthermore, that doubles have to be strictly aligned at addresses that are multiples of eight. Then, the extent of this datatype is 16 (9 rounded to the next multiple of 8). A datatype that consists of a character immediately followed by a double will also have an extent of 16.

Rationale. The definition of extent is motivated by the assumption that the amount of padding added at the end of each structure in an array of structures is the least needed to fulfill alignment constraints. More explicit control of the extent is provided in Section 4.1.6. Such explicit control is needed in cases where the assumption does not hold, for example, where union types are used. In Fortran, structures can be expressed with several language features, e.g., common blocks, `SEQUENCE` derived types, or `BIND(C)` derived types. The compiler may use different alignments, and therefore, it is recommended to use `MPI_TYPE_CREATE_RESIZED` for arrays of structures if an alignment may cause an alignment-gap at the end of a structure as described in Section 4.1.6 and in Section 18.1.15. (*End of rationale.*)

4.1.1 Type Constructors with Explicit Addresses

In Fortran, the functions `MPI_TYPE_CREATE_HVECTOR`, `MPI_TYPE_CREATE_HINDEXED`, `MPI_TYPE_CREATE_HINDEXED_BLOCK`, `MPI_TYPE_CREATE_STRUCT`, and `MPI_GET_ADDRESS` accept arguments of type `INTEGER(KIND=MPI_ADDRESS_KIND)`, wherever arguments of type `MPI_Aint` are used in C. On Fortran 77 systems that do not support the Fortran 90 `KIND` notation, and where addresses are 64 bits whereas default `INTEGER`s are 32 bits, these arguments will be of type `INTEGER*8`.

4.1.2 Datatype Constructors

Contiguous The simplest datatype constructor is `MPI_TYPE_CONTIGUOUS` which allows replication of a datatype into contiguous locations.

`MPI_TYPE_CONTIGUOUS(count, oldtype, newtype)`

IN	count	replication count (non-negative integer)
IN	oldtype	old datatype (handle)
OUT	newtype	new datatype (handle)

```
int MPI_Type_contiguous(int count, MPI_Datatype oldtype,
                       MPI_Datatype *newtype)
```

```
MPI_Type_contiguous(count, oldtype, newtype, ierror)
  INTEGER, INTENT(IN) :: count
  TYPE(MPI_Datatype), INTENT(IN) :: oldtype
  TYPE(MPI_Datatype), INTENT(OUT) :: newtype
  INTEGER, OPTIONAL, INTENT(OUT) :: ierror
```

```
MPI_TYPE_CONTIGUOUS(COUNT, OLDTYPE, NEWTYPE, IERROR)
  INTEGER COUNT, OLDTYPE, NEWTYPE, IERROR
```

`newtype` is the datatype obtained by concatenating `count` copies of `oldtype`. Concatenation is defined using *extent* as the size of the concatenated copies.

Example 4.2 Let `oldtype` have type map $\{(\text{double}, 0), (\text{char}, 8)\}$, with extent 16, and let `count` = 3. The type map of the datatype returned by `newtype` is

$$\{(\text{double}, 0), (\text{char}, 8), (\text{double}, 16), (\text{char}, 24), (\text{double}, 32), (\text{char}, 40)\};$$

i.e., alternating `double` and `char` elements, with displacements 0, 8, 16, 24, 32, 40.

In general, assume that the type map of `oldtype` is

$$\{(type_0, disp_0), \dots, (type_{n-1}, disp_{n-1})\},$$

with extent *ex*. Then `newtype` has a type map with `count · n` entries defined by:

$$\{(type_0, disp_0), \dots, (type_{n-1}, disp_{n-1}), (type_0, disp_0 + ex), \dots, (type_{n-1}, disp_{n-1} + ex), \\ \dots, (type_0, disp_0 + ex \cdot (\text{count} - 1)), \dots, (type_{n-1}, disp_{n-1} + ex \cdot (\text{count} - 1))\}.$$

Vector The function `MPI_TYPE_VECTOR` is a more general constructor that allows replication of a datatype into locations that consist of equally spaced blocks. Each block is obtained by concatenating the same number of copies of the old datatype. The spacing between blocks is a multiple of the extent of the old datatype.

`MPI_TYPE_VECTOR(count, blocklength, stride, oldtype, newtype)`

IN	<code>count</code>	number of blocks (non-negative integer)
IN	<code>blocklength</code>	number of elements in each block (non-negative integer)
IN	<code>stride</code>	number of elements between start of each block (integer)
IN	<code>oldtype</code>	old datatype (handle)
OUT	<code>newtype</code>	new datatype (handle)

```
int MPI_Type_vector(int count, int blocklength, int stride,
                   MPI_Datatype oldtype, MPI_Datatype *newtype)
```

```
MPI_Type_vector(count, blocklength, stride, oldtype, newtype, ierror)
  INTEGER, INTENT(IN) :: count, blocklength, stride
  TYPE(MPI_Datatype), INTENT(IN) :: oldtype
  TYPE(MPI_Datatype), INTENT(OUT) :: newtype
  INTEGER, OPTIONAL, INTENT(OUT) :: ierror
```

```
MPI_TYPE_VECTOR(COUNT, BLOCKLENGTH, STRIDE, OLDTYPE, NEWTYPE, IERROR)
  INTEGER COUNT, BLOCKLENGTH, STRIDE, OLDTYPE, NEWTYPE, IERROR
```

Example 4.3 Assume, again, that `oldtype` has type map $\{(\text{double}, 0), (\text{char}, 8)\}$, with extent 16. A call to `MPI_TYPE_VECTOR(2, 3, 4, oldtype, newtype)` will create the datatype with type map,

$$\{(\text{double}, 0), (\text{char}, 8), (\text{double}, 16), (\text{char}, 24), (\text{double}, 32), (\text{char}, 40),$$

$(\text{double}, 64), (\text{char}, 72), (\text{double}, 80), (\text{char}, 88), (\text{double}, 96), (\text{char}, 104)\}$.

That is, two blocks with three copies each of the old type, with a stride of 4 elements ($4 \cdot 16$ bytes) between the the start of each block.

Example 4.4 A call to `MPI_TYPE_VECTOR(3, 1, -2, oldtype, newtype)` will create the datatype,

$\{(\text{double}, 0), (\text{char}, 8), (\text{double}, -32), (\text{char}, -24), (\text{double}, -64), (\text{char}, -56)\}$.

In general, assume that `oldtype` has type map,

$\{(type_0, disp_0), \dots, (type_{n-1}, disp_{n-1})\}$,

with extent ex . Let `bl` be the blocklength. The newly created datatype has a type map with `count · bl · n` entries:

$\{(type_0, disp_0), \dots, (type_{n-1}, disp_{n-1}),$
 $(type_0, disp_0 + ex), \dots, (type_{n-1}, disp_{n-1} + ex), \dots,$
 $(type_0, disp_0 + (bl - 1) \cdot ex), \dots, (type_{n-1}, disp_{n-1} + (bl - 1) \cdot ex),$
 $(type_0, disp_0 + stride \cdot ex), \dots, (type_{n-1}, disp_{n-1} + stride \cdot ex), \dots,$
 $(type_0, disp_0 + (stride + bl - 1) \cdot ex), \dots, (type_{n-1}, disp_{n-1} + (stride + bl - 1) \cdot ex), \dots,$
 $(type_0, disp_0 + stride \cdot (count - 1) \cdot ex), \dots,$
 $(type_{n-1}, disp_{n-1} + stride \cdot (count - 1) \cdot ex), \dots,$
 $(type_0, disp_0 + (stride \cdot (count - 1) + bl - 1) \cdot ex), \dots,$
 $(type_{n-1}, disp_{n-1} + (stride \cdot (count - 1) + bl - 1) \cdot ex)\}$.

A call to `MPI_TYPE_CONTIGUOUS(count, oldtype, newtype)` is equivalent to a call to `MPI_TYPE_VECTOR(count, 1, 1, oldtype, newtype)`, or to a call to `MPI_TYPE_VECTOR(1, count, n, oldtype, newtype)`, `n` arbitrary.

Hvector The function `MPI_TYPE_CREATE_HVECTOR` is identical to `MPI_TYPE_VECTOR`, except that `stride` is given in bytes, rather than in elements. The use for both types of vector constructors is illustrated in Section 4.1.14. (H stands for “heterogeneous”).

`MPI_TYPE_CREATE_HVECTOR(count, blocklength, stride, oldtype, newtype)`

IN	count	number of blocks (non-negative integer)
IN	blocklength	number of elements in each block (non-negative integer)
IN	stride	number of bytes between start of each block (integer)
IN	oldtype	old datatype (handle)
OUT	newtype	new datatype (handle)

```

1 int MPI_Type_create_hvector(int count, int blocklength, MPI_Aint stride,
2     MPI_Datatype oldtype, MPI_Datatype *newtype)
3
4 MPI_Type_create_hvector(count, blocklength, stride, oldtype, newtype,
5     ierror)
6     INTEGER, INTENT(IN) :: count, blocklength
7     INTEGER(KIND=MPI_ADDRESS_KIND), INTENT(IN) :: stride
8     TYPE(MPI_Datatype), INTENT(IN) :: oldtype
9     TYPE(MPI_Datatype), INTENT(OUT) :: newtype
10    INTEGER, OPTIONAL, INTENT(OUT) :: ierror
11 MPI_TYPE_CREATE_HVECTOR(COUNT, BLOCKLENGTH, STRIDE, OLDDTYPE, NEWTYPE,
12     IERROR)
13    INTEGER COUNT, BLOCKLENGTH, OLDDTYPE, NEWTYPE, IERROR
14    INTEGER(KIND=MPI_ADDRESS_KIND) STRIDE

```

Assume that *oldtype* has type map,

$$\{(type_0, disp_0), \dots, (type_{n-1}, disp_{n-1})\},$$

with extent *ex*. Let *bl* be the blocklength. The newly created datatype has a type map with $count \cdot bl \cdot n$ entries:

$$\begin{aligned}
& \{(type_0, disp_0), \dots, (type_{n-1}, disp_{n-1}), \\
& (type_0, disp_0 + ex), \dots, (type_{n-1}, disp_{n-1} + ex), \dots, \\
& (type_0, disp_0 + (bl - 1) \cdot ex), \dots, (type_{n-1}, disp_{n-1} + (bl - 1) \cdot ex), \\
& (type_0, disp_0 + stride), \dots, (type_{n-1}, disp_{n-1} + stride), \dots, \\
& (type_0, disp_0 + stride + (bl - 1) \cdot ex), \dots, \\
& (type_{n-1}, disp_{n-1} + stride + (bl - 1) \cdot ex), \dots, \\
& (type_0, disp_0 + stride \cdot (count - 1)), \dots, (type_{n-1}, disp_{n-1} + stride \cdot (count - 1)), \dots, \\
& (type_0, disp_0 + stride \cdot (count - 1) + (bl - 1) \cdot ex), \dots, \\
& (type_{n-1}, disp_{n-1} + stride \cdot (count - 1) + (bl - 1) \cdot ex)\}.
\end{aligned}$$

Indexed The function `MPI_TYPE_INDEXED` allows replication of an old datatype into a sequence of blocks (each block is a concatenation of the old datatype), where each block can contain a different number of copies and have a different displacement. All block displacements are multiples of the old type extent.

```

MPI_TYPE_INDEXED(count, array_of_blocklengths, array_of_displacements, oldtype,
                  newtype)
1
2
IN      count      number of blocks — also number of entries in
3                  array_of_displacements and array_of_blocklengths (non-
4                  negative integer)
5
IN      array_of_blocklengths  number of elements per block (array of non-negative
6                  integers)
7
IN      array_of_displacements  displacement for each block, in multiples of oldtype
8                  extent (array of integer)
9
IN      oldtype      old datatype (handle)
10
OUT     newtype      new datatype (handle)
11
12
13
14
int MPI_Type_indexed(int count, const int array_of_blocklengths[],
15                    const int array_of_displacements[], MPI_Datatype oldtype,
16                    MPI_Datatype *newtype)
17
18
MPI_Type_indexed(count, array_of_blocklengths, array_of_displacements,
19                oldtype, newtype, ierror)
20
INTEGER, INTENT(IN) :: count, array_of_blocklengths(count),
21                array_of_displacements(count)
22
TYPE(MPI_Datatype), INTENT(IN) :: oldtype
23
TYPE(MPI_Datatype), INTENT(OUT) :: newtype
24
INTEGER, OPTIONAL, INTENT(OUT) :: ierror
25
26
MPI_TYPE_INDEXED(COUNT, ARRAY_OF_BLOCKLENGTHS, ARRAY_OF_DISPLACEMENTS,
27                OLDTYPE, NEWTYPE, IERROR)
28
INTEGER COUNT, ARRAY_OF_BLOCKLENGTHS(*), ARRAY_OF_DISPLACEMENTS(*),
29                OLDTYPE, NEWTYPE, IERROR
30
31

```

Example 4.5

Let `oldtype` have type map $\{(double, 0), (char, 8)\}$, with extent 16. Let $B = (3, 1)$ and let $D = (4, 0)$. A call to `MPI_TYPE_INDEXED(2, B, D, oldtype, newtype)` returns a datatype with type map,

$$\{(double, 64), (char, 72), (double, 80), (char, 88), (double, 96), (char, 104), \\ (double, 0), (char, 8)\}.$$

That is, three copies of the old type starting at displacement 64, and one copy starting at displacement 0.

In general, assume that `oldtype` has type map,

$$\{(type_0, disp_0), \dots, (type_{n-1}, disp_{n-1})\},$$

with extent ex . Let B be the `array_of_blocklengths` argument and D be the `array_of_displacements` argument. The newly created datatype has $n \cdot \sum_{i=0}^{count-1} B[i]$ entries:

$$\{(type_0, disp_0 + D[0] \cdot ex), \dots, (type_{n-1}, disp_{n-1} + D[0] \cdot ex), \dots,$$

```

1      (type0, disp0 + (D[0] + B[0] - 1) · ex), ...,
2
3      (typen-1, dispn-1 + (D[0] + B[0] - 1) · ex), ...,
4
5      (type0, disp0 + D[count-1] · ex), ..., (typen-1, dispn-1 + D[count-1] · ex), ...,
6
7      (type0, disp0 + (D[count-1] + B[count-1] - 1) · ex), ...,
8
9      (typen-1, dispn-1 + (D[count-1] + B[count-1] - 1) · ex)}.
```

A call to `MPI_TYPE_VECTOR(count, blocklength, stride, oldtype, newtype)` is equivalent to a call to `MPI_TYPE_INDEXED(count, B, D, oldtype, newtype)` where

$$D[j] = j \cdot \text{stride}, \quad j = 0, \dots, \text{count} - 1,$$

and

$$B[j] = \text{blocklength}, \quad j = 0, \dots, \text{count} - 1.$$

Hindexed The function `MPI_TYPE_CREATE_HINDEXED` is identical to `MPI_TYPE_INDEXED`, except that block displacements in `array_of_displacements` are specified in bytes, rather than in multiples of the `oldtype` extent.

```

MPI_TYPE_CREATE_HINDEXED(count, array_of_blocklengths, array_of_displacements,
                          oldtype, newtype)
```

IN	count	number of blocks — also number of entries in <code>array_of_displacements</code> and <code>array_of_blocklengths</code> (non-negative integer)
IN	array_of_blocklengths	number of elements in each block (array of non-negative integers)
IN	array_of_displacements	byte displacement of each block (array of integer)
IN	oldtype	old datatype (handle)
OUT	newtype	new datatype (handle)

```

int MPI_Type_create_hindexed(int count, const int array_of_blocklengths[],
                             const MPI_Aint array_of_displacements[], MPI_Datatype oldtype,
                             MPI_Datatype *newtype)
```

```

MPI_Type_create_hindexed(count, array_of_blocklengths,
                          array_of_displacements, oldtype, newtype, ierror)
INTEGER, INTENT(IN) :: count, array_of_blocklengths(count)
INTEGER(KIND=MPI_ADDRESS_KIND), INTENT(IN) ::
    array_of_displacements(count)
TYPE(MPI_Datatype), INTENT(IN) :: oldtype
TYPE(MPI_Datatype), INTENT(OUT) :: newtype
INTEGER, OPTIONAL, INTENT(OUT) :: ierror
```

```

MPI_TYPE_CREATE_HINDEXED(COUNT, ARRAY_OF_BLOCKLENGTHS,
                          ARRAY_OF_DISPLACEMENTS, OLDTYPE, NEWTYPE, IERROR)
```

```

INTEGER COUNT, ARRAY_OF_BLOCKLENGTHS(*), OLDTYPE, NEWTYPE, IERROR
INTEGER(KIND=MPI_ADDRESS_KIND) ARRAY_OF_DISPLACEMENTS(*)

```

Assume that oldtype has type map,

$$\{(type_0, disp_0), \dots, (type_{n-1}, disp_{n-1})\},$$

with extent ex . Let B be the `array_of_blocklengths` argument and D be the `array_of_displacements` argument. The newly created datatype has a type map with $n \cdot \sum_{i=0}^{count-1} B[i]$ entries:

$$\{(type_0, disp_0 + D[0]), \dots, (type_{n-1}, disp_{n-1} + D[0]), \dots,$$

$$(type_0, disp_0 + D[0] + (B[0] - 1) \cdot ex), \dots,$$

$$(type_{n-1}, disp_{n-1} + D[0] + (B[0] - 1) \cdot ex), \dots,$$

$$(type_0, disp_0 + D[count-1]), \dots, (type_{n-1}, disp_{n-1} + D[count-1]), \dots,$$

$$(type_0, disp_0 + D[count-1] + (B[count-1] - 1) \cdot ex), \dots,$$

$$(type_{n-1}, disp_{n-1} + D[count-1] + (B[count-1] - 1) \cdot ex)\}.$$

Indexed_block This function is the same as `MPI_TYPE_INDEXED` except that the block-length is the same for all blocks. There are many codes using indirect addressing arising from unstructured grids where the blocksize is always 1 (gather/scatter). The following convenience function allows for constant blocksize and arbitrary displacements.

```

MPI_TYPE_CREATE_INDEXED_BLOCK(count, blocklength, array_of_displacements, oldtype,
                               newtype)

```

IN	count	length of array of displacements (non-negative integer)
IN	blocklength	size of block (non-negative integer)
IN	array_of_displacements	array of displacements (array of integer)
IN	oldtype	old datatype (handle)
OUT	newtype	new datatype (handle)

```

int MPI_Type_create_indexed_block(int count, int blocklength,
    const int array_of_displacements[], MPI_Datatype oldtype,
    MPI_Datatype *newtype)

```

```

MPI_Type_create_indexed_block(count, blocklength, array_of_displacements,
    oldtype, newtype, ierror)
    INTEGER, INTENT(IN) :: count, blocklength,
        array_of_displacements(count)
    TYPE(MPI_Datatype), INTENT(IN) :: oldtype
    TYPE(MPI_Datatype), INTENT(OUT) :: newtype
    INTEGER, OPTIONAL, INTENT(OUT) :: ierror

```

```

1 MPI_TYPE_CREATE_INDEXED_BLOCK(COUNT, BLOCKLENGTH, ARRAY_OF_DISPLACEMENTS,
2     OLDTYPE, NEWTYPE, IERROR)
3     INTEGER COUNT, BLOCKLENGTH, ARRAY_OF_DISPLACEMENTS(*), OLDTYPE,
4     NEWTYPE, IERROR

```

Hindexed_block The function MPI_TYPE_CREATE_HINDEXED_BLOCK is identical to MPI_TYPE_CREATE_INDEXED_BLOCK, except that block displacements in array_of_displacements are specified in bytes, rather than in multiples of the oldtype extent.

```

11 MPI_TYPE_CREATE_HINDEXED_BLOCK(count, blocklength, array_of_displacements,
12     oldtype, newtype)
13
14 IN     count                length of array of displacements (non-negative integer)
15 IN     blocklength          size of block (non-negative integer)
16 IN     array_of_displacements  byte displacement of each block (array of integer)
17
18 IN     oldtype              old datatype (handle)
19 OUT    newtype              new datatype (handle)

```

```

21 int MPI_Type_create_hindexed_block(int count, int blocklength,
22     const MPI_Aint array_of_displacements[], MPI_Datatype oldtype,
23     MPI_Datatype *newtype)

```

```

25 MPI_Type_create_hindexed_block(count, blocklength, array_of_displacements,
26     oldtype, newtype, ierror)
27     INTEGER, INTENT(IN) :: count, blocklength
28     INTEGER(KIND=MPI_ADDRESS_KIND), INTENT(IN) ::
29     array_of_displacements(count)
30     TYPE(MPI_Datatype), INTENT(IN) :: oldtype
31     TYPE(MPI_Datatype), INTENT(OUT) :: newtype
32     INTEGER, OPTIONAL, INTENT(OUT) :: ierror

```

```

33 MPI_TYPE_CREATE_HINDEXED_BLOCK(COUNT, BLOCKLENGTH, ARRAY_OF_DISPLACEMENTS,
34     OLDTYPE, NEWTYPE, IERROR)
35     INTEGER COUNT, BLOCKLENGTH, OLDTYPE, NEWTYPE, IERROR
36     INTEGER(KIND=MPI_ADDRESS_KIND) ARRAY_OF_DISPLACEMENTS(*)

```

Struct MPI_TYPE_CREATE_STRUCT is the most general type constructor. It further generalizes MPI_TYPE_CREATE_HINDEXED in that it allows each block to consist of replications of different datatypes.

```

MPI_TYPE_CREATE_STRUCT(count, array_of_blocklengths, array_of_displacements,
                      array_of_types, newtype)
1
2
IN    count           number of blocks (non-negative integer) — also num-
3                                ber of entries in arrays array_of_types,
4                                array_of_displacements and array_of_blocklengths
5
IN    array_of_blocklength number of elements in each block (array of non-negative
6                                integer)
7
IN    array_of_displacements byte displacement of each block (array of integer)
8
IN    array_of_types      type of elements in each block (array of handles to
9                                datatype objects)
10
OUT   newtype            new datatype (handle)
11
12
13
14
int MPI_Type_create_struct(int count, const int array_of_blocklengths[],
15                          const MPI_Aint array_of_displacements[],
16                          const MPI_Datatype array_of_types[], MPI_Datatype *newtype)
17
MPI_Type_create_struct(count, array_of_blocklengths,
18                      array_of_displacements, array_of_types, newtype, ierror)
19
INTEGER, INTENT(IN) :: count, array_of_blocklengths(count)
20
INTEGER(KIND=MPI_ADDRESS_KIND), INTENT(IN) ::
21     array_of_displacements(count)
22
TYPE(MPI_Datatype), INTENT(IN) :: array_of_types(count)
23
TYPE(MPI_Datatype), INTENT(OUT) :: newtype
24
INTEGER, OPTIONAL, INTENT(OUT) :: ierror
25
26
MPI_TYPE_CREATE_STRUCT(COUNT, ARRAY_OF_BLOCKLENGTHS,
27                      ARRAY_OF_DISPLACEMENTS, ARRAY_OF_TYPES, NEWTYPE, IERROR)
28
INTEGER COUNT, ARRAY_OF_BLOCKLENGTHS(*), ARRAY_OF_TYPES(*), NEWTYPE,
29
IERROR
30
INTEGER(KIND=MPI_ADDRESS_KIND) ARRAY_OF_DISPLACEMENTS(*)
31
32
33

```

Example 4.6 Let `type1` have type map,

$$\{(\text{double}, 0), (\text{char}, 8)\},$$

with extent 16. Let $B = (2, 1, 3)$, $D = (0, 16, 26)$, and $T = (\text{MPI_FLOAT}, \text{type1}, \text{MPI_CHAR})$. Then a call to `MPI_TYPE_CREATE_STRUCT(3, B, D, T, newtype)` returns a datatype with type map,

$$\{(\text{float}, 0), (\text{float}, 4), (\text{double}, 16), (\text{char}, 24), (\text{char}, 26), (\text{char}, 27), (\text{char}, 28)\}.$$

That is, two copies of `MPI_FLOAT` starting at 0, followed by one copy of `type1` starting at 16, followed by three copies of `MPI_CHAR`, starting at 26. (We assume that a float occupies four bytes.)

In general, let T be the `array_of_types` argument, where $T[i]$ is a handle to,

$$\text{typemap}_i = \{(type_0^i, disp_0^i), \dots, (type_{n_i-1}^i, disp_{n_i-1}^i)\},$$

with extent ex_i . Let B be the `array_of_blocklength` argument and D be the `array_of_displacements` argument. Let c be the count argument. Then the newly created datatype has a type map with $\sum_{i=0}^{c-1} B[i] \cdot n_i$ entries:

$$\begin{aligned} & \{(type_0^0, disp_0^0 + D[0]), \dots, (type_{n_0}^0, disp_{n_0}^0 + D[0]), \dots, \\ & (type_0^0, disp_0^0 + D[0] + (B[0] - 1) \cdot ex_0), \dots, (type_{n_0}^0, disp_{n_0}^0 + D[0] + (B[0]-1) \cdot ex_0), \dots, \\ & (type_0^{c-1}, disp_0^{c-1} + D[c-1]), \dots, (type_{n_{c-1}-1}^{c-1}, disp_{n_{c-1}-1}^{c-1} + D[c-1]), \dots, \\ & (type_0^{c-1}, disp_0^{c-1} + D[c-1] + (B[c-1] - 1) \cdot ex_{c-1}), \dots, \\ & (type_{n_{c-1}-1}^{c-1}, disp_{n_{c-1}-1}^{c-1} + D[c-1] + (B[c-1]-1) \cdot ex_{c-1})\}. \end{aligned}$$

A call to `MPI_TYPE_CREATE_HINDEXED(count, B, D, oldtype, newtype)` is equivalent to a call to `MPI_TYPE_CREATE_STRUCT(count, B, D, T, newtype)`, where each entry of T is equal to `oldtype`.

4.1.3 Subarray Datatype Constructor

`MPI_TYPE_CREATE_SUBARRAY(ndims, array_of_sizes, array_of_subsizes, array_of_starts, order, oldtype, newtype)`

IN	<code>ndims</code>	number of array dimensions (positive integer)
IN	<code>array_of_sizes</code>	number of elements of type <code>oldtype</code> in each dimension of the full array (array of positive integers)
IN	<code>array_of_subsizes</code>	number of elements of type <code>oldtype</code> in each dimension of the subarray (array of positive integers)
IN	<code>array_of_starts</code>	starting coordinates of the subarray in each dimension (array of non-negative integers)
IN	<code>order</code>	array storage order flag (state)
IN	<code>oldtype</code>	array element datatype (handle)
OUT	<code>newtype</code>	new datatype (handle)

```
int MPI_Type_create_subarray(int ndims, const int array_of_sizes[],
                             const int array_of_subsizes[], const int array_of_starts[],
                             int order, MPI_Datatype oldtype, MPI_Datatype *newtype)
```

```
MPI_Type_create_subarray(ndims, array_of_sizes, array_of_subsizes,
                          array_of_starts, order, oldtype, newtype, ierror)
INTEGER, INTENT(IN) :: ndims, array_of_sizes(ndims),
                       array_of_subsizes(ndims), array_of_starts(ndims), order
TYPE(MPI_Datatype), INTENT(IN) :: oldtype
TYPE(MPI_Datatype), INTENT(OUT) :: newtype
INTEGER, OPTIONAL, INTENT(OUT) :: ierror
```

```

MPI_TYPE_CREATE_SUBARRAY(NDIMS, ARRAY_OF_SIZES, ARRAY_OF_SUBSIZES,
                          ARRAY_OF_STARTS, ORDER, OLDTYPE, NEWTYPE, IERROR)
INTEGER NDIMS, ARRAY_OF_SIZES(*), ARRAY_OF_SUBSIZES(*),
                          ARRAY_OF_STARTS(*), ORDER, OLDTYPE, NEWTYPE, IERROR

```

The subarray type constructor creates an MPI datatype describing an n -dimensional subarray of an n -dimensional array. The subarray may be situated anywhere within the full array, and may be of any nonzero size up to the size of the larger array as long as it is confined within this array. This type constructor facilitates creating filetypes to access arrays distributed in blocks among processes to a single file that contains the global array, see MPI I/O, especially Section 13.1.1.

This type constructor can handle arrays with an arbitrary number of dimensions and works for both C and Fortran ordered matrices (i.e., row-major or column-major). Note that a C program may use Fortran order and a Fortran program may use C order.

The `ndims` parameter specifies the number of dimensions in the full data array and gives the number of elements in `array_of_sizes`, `array_of_subsizes`, and `array_of_starts`.

The number of elements of type `oldtype` in each dimension of the n -dimensional array and the requested subarray are specified by `array_of_sizes` and `array_of_subsizes`, respectively. For any dimension i , it is erroneous to specify `array_of_subsizes[i] < 1` or `array_of_subsizes[i] > array_of_sizes[i]`.

The `array_of_starts` contains the starting coordinates of each dimension of the subarray. Arrays are assumed to be indexed starting from zero. For any dimension i , it is erroneous to specify `array_of_starts[i] < 0` or `array_of_starts[i] > (array_of_sizes[i] - array_of_subsizes[i])`.

Advice to users. In a Fortran program with arrays indexed starting from 1, if the starting coordinate of a particular dimension of the subarray is n , then the entry in `array_of_starts` for that dimension is $n-1$. (*End of advice to users.*)

The `order` argument specifies the storage order for the subarray as well as the full array. It must be set to one of the following:

MPI_ORDER_C The ordering used by C arrays, (i.e., row-major order)

MPI_ORDER_FORTRAN The ordering used by Fortran arrays, (i.e., column-major order)

A `ndims`-dimensional subarray (`newtype`) with no extra padding can be defined by the function `Subarray()` as follows:

```

newtype = Subarray(ndims, {size0, size1, ..., sizendims-1},
                  {subsize0, subsize1, ..., subsizendims-1},
                  {start0, start1, ..., startndims-1}, oldtype)

```

Let the typemap of `oldtype` have the form:

```

{(type0, disp0), (type1, disp1), ..., (typen-1, dispn-1)}

```

where `typei` is a predefined MPI datatype, and let `ex` be the extent of `oldtype`. Then we define the `Subarray()` function recursively using the following three equations. Equation 4.2 defines the base step. Equation 4.3 defines the recursion step when `order = MPI_ORDER_FORTRAN`, and Equation 4.4 defines the recursion step when `order = MPI_ORDER_C`. These equations use the conceptual datatypes `lb_marker` and `ub_marker`, see Section 4.1.6 for details.

$$\begin{aligned}
& \text{Subarray}(1, \{size_0\}, \{subsize_0\}, \{start_0\}, \\
& \quad \{(type_0, disp_0), (type_1, disp_1), \dots, (type_{n-1}, disp_{n-1})\}) \\
& = \{(\text{lb_marker}, 0), \\
& \quad (type_0, disp_0 + start_0 \times ex), \dots, (type_{n-1}, disp_{n-1} + start_0 \times ex), \\
& \quad (type_0, disp_0 + (start_0 + 1) \times ex), \dots, (type_{n-1}, \\
& \quad \quad disp_{n-1} + (start_0 + 1) \times ex), \dots \\
& \quad (type_0, disp_0 + (start_0 + subsize_0 - 1) \times ex), \dots, \\
& \quad \quad (type_{n-1}, disp_{n-1} + (start_0 + subsize_0 - 1) \times ex), \\
& \quad (\text{ub_marker}, size_0 \times ex)\}
\end{aligned} \tag{4.2}$$

$$\begin{aligned}
& \text{Subarray}(ndims, \{size_0, size_1, \dots, size_{ndims-1}\}, \\
& \quad \{subsize_0, subsize_1, \dots, subsize_{ndims-1}\}, \\
& \quad \{start_0, start_1, \dots, start_{ndims-1}\}, \text{oldtype}) \\
& = \text{Subarray}(ndims - 1, \{size_1, size_2, \dots, size_{ndims-1}\}, \\
& \quad \{subsize_1, subsize_2, \dots, subsize_{ndims-1}\}, \\
& \quad \{start_1, start_2, \dots, start_{ndims-1}\}, \\
& \quad \text{Subarray}(1, \{size_0\}, \{subsize_0\}, \{start_0\}, \text{oldtype}))
\end{aligned} \tag{4.3}$$

$$\begin{aligned}
& \text{Subarray}(ndims, \{size_0, size_1, \dots, size_{ndims-1}\}, \\
& \quad \{subsize_0, subsize_1, \dots, subsize_{ndims-1}\}, \\
& \quad \{start_0, start_1, \dots, start_{ndims-1}\}, \text{oldtype}) \\
& = \text{Subarray}(ndims - 1, \{size_0, size_1, \dots, size_{ndims-2}\}, \\
& \quad \{subsize_0, subsize_1, \dots, subsize_{ndims-2}\}, \\
& \quad \{start_0, start_1, \dots, start_{ndims-2}\}, \\
& \quad \text{Subarray}(1, \{size_{ndims-1}\}, \{subsize_{ndims-1}\}, \{start_{ndims-1}\}, \text{oldtype}))
\end{aligned} \tag{4.4}$$

For an example use of `MPI_TYPE_CREATE_SUBARRAY` in the context of I/O see Section 13.9.2.

4.1.4 Distributed Array Datatype Constructor

The distributed array type constructor supports HPF-like [43] data distributions. However, unlike in HPF, the storage order may be specified for C arrays as well as for Fortran arrays.

Advice to users. One can create an HPF-like file view using this type constructor as follows. Complementary filetypes are created by having every process of a group call this constructor with identical arguments (with the exception of `rank` which should be set appropriately). These filetypes (along with identical `disp` and `etype`) are then used to define the view (via `MPI_FILE_SET_VIEW`), see MPI I/O, especially Section 13.1.1 and Section 13.3. Using this view, a collective data access operation (with identical offsets) will yield an HPF-like distribution pattern. (*End of advice to users.*)

```

MPI_TYPE_CREATE_DARRAY(size, rank, ndims, array_of_gsizes, array_of_distribs,
                        array_of_dargs, array_of_psizes, order, oldtype, newtype)
1
2
3
IN    size                size of process group (positive integer)
4
IN    rank                rank in process group (non-negative integer)
5
IN    ndims              number of array dimensions as well as process grid
6                          dimensions (positive integer)
7
IN    array_of_gsizes    number of elements of type oldtype in each dimension
8                          of global array (array of positive integers)
9
IN    array_of_distribs  distribution of array in each dimension (array of state)
10
IN    array_of_dargs     distribution argument in each dimension (array of posi-
11                          tive integers)
12
IN    array_of_psizes    size of process grid in each dimension (array of positive
13                          integers)
14
IN    order              array storage order flag (state)
15
IN    oldtype            old datatype (handle)
16
OUT   newtype            new datatype (handle)
17
18
19
20
int MPI_Type_create_darray(int size, int rank, int ndims,
21                          const int array_of_gsizes[], const int array_of_distribs[],
22                          const int array_of_dargs[], const int array_of_psizes[],
23                          int order, MPI_Datatype oldtype, MPI_Datatype *newtype)
24
25
MPI_Type_create_darray(size, rank, ndims, array_of_gsizes,
26                          array_of_distribs, array_of_dargs, array_of_psizes, order,
27                          oldtype, newtype, ierror)
28
INTEGER, INTENT(IN) :: size, rank, ndims, array_of_gsizes(ndims),
29                          array_of_distribs(ndims), array_of_dargs(ndims),
30                          array_of_psizes(ndims), order
31
TYPE(MPI_Datatype), INTENT(IN) :: oldtype
32
TYPE(MPI_Datatype), INTENT(OUT) :: newtype
33
INTEGER, OPTIONAL, INTENT(OUT) :: ierror
34
35
MPI_TYPE_CREATE_DARRAY(SIZE, RANK, NDIMS, ARRAY_OF_GSIZES,
36                          ARRAY_OF_DISTRIBS, ARRAY_OF_DARGS, ARRAY_OF_PSIZEs, ORDER,
37                          OLDTYPE, NEWTYPE, IERROR)
38
INTEGER SIZE, RANK, NDIMS, ARRAY_OF_GSIZES(*), ARRAY_OF_DISTRIBS(*),
39                          ARRAY_OF_DARGS(*), ARRAY_OF_PSIZEs(*), ORDER, OLDTYPE,
40                          NEWTYPE, IERROR
41

```

MPI_TYPE_CREATE_DARRAY can be used to generate the datatypes corresponding to the distribution of an *ndims*-dimensional array of *oldtype* elements onto an *ndims*-dimensional grid of logical processes. Unused dimensions of *array_of_psizes* should be set to 1. (See Example 4.7.) For a call to MPI_TYPE_CREATE_DARRAY to be correct, the equation $\prod_{i=0}^{ndims-1} array_of_psizes[i] = size$ must be satisfied. The ordering of processes in the process grid is assumed to be row-major, as in the case of virtual Cartesian process topologies.

1 *Advice to users.* For both Fortran and C arrays, the ordering of processes in the
 2 process grid is assumed to be row-major. This is consistent with the ordering used in
 3 virtual Cartesian process topologies in MPI. To create such virtual process topologies,
 4 or to find the coordinates of a process in the process grid, etc., users may use the
 5 corresponding process topology functions, see Chapter 7. (*End of advice to users.*)

6 Each dimension of the array can be distributed in one of three ways:

- 8 • MPI_DISTRIBUTE_BLOCK - Block distribution
- 9
- 10 • MPI_DISTRIBUTE_CYCLIC - Cyclic distribution
- 11
- 12 • MPI_DISTRIBUTE_NONE - Dimension not distributed.

13 The constant MPI_DISTRIBUTE_DFLT_DARG specifies a default distribution argument.
 14 The distribution argument for a dimension that is not distributed is ignored. For any
 15 dimension i in which the distribution is MPI_DISTRIBUTE_BLOCK, it is erroneous to specify
 16 $\text{array_of_dargs}[i] * \text{array_of_psizes}[i] < \text{array_of_gsizes}[i]$.

17 For example, the HPF layout ARRAY(CYCLIC(15)) corresponds to
 18 MPI_DISTRIBUTE_CYCLIC with a distribution argument of 15, and the HPF layout AR-
 19 RAY(BLOCK) corresponds to MPI_DISTRIBUTE_BLOCK with a distribution argument of
 20 MPI_DISTRIBUTE_DFLT_DARG.

21 The `order` argument is used as in MPI_TYPE_CREATE_SUBARRAY to specify the stor-
 22 age order. Therefore, arrays described by this type constructor may be stored in Fortran
 23 (column-major) or C (row-major) order. Valid values for `order` are MPI_ORDER_FORTRAN
 24 and MPI_ORDER_C.

25 This routine creates a new MPI datatype with a typemap defined in terms of a function
 26 called “cyclic()” (see below).

27 Without loss of generality, it suffices to define the typemap for the
 28 MPI_DISTRIBUTE_CYCLIC case where MPI_DISTRIBUTE_DFLT_DARG is not used.

29 MPI_DISTRIBUTE_BLOCK and MPI_DISTRIBUTE_NONE can be reduced to the
 30 MPI_DISTRIBUTE_CYCLIC case for dimension i as follows.

31 MPI_DISTRIBUTE_BLOCK with $\text{array_of_dargs}[i]$ equal to MPI_DISTRIBUTE_DFLT_DARG
 32 is equivalent to MPI_DISTRIBUTE_CYCLIC with $\text{array_of_dargs}[i]$ set to

$$33 \quad (\text{array_of_gsizes}[i] + \text{array_of_psizes}[i] - 1) / \text{array_of_psizes}[i].$$

34

35 If $\text{array_of_dargs}[i]$ is not MPI_DISTRIBUTE_DFLT_DARG, then MPI_DISTRIBUTE_BLOCK and
 36 MPI_DISTRIBUTE_CYCLIC are equivalent.

37 MPI_DISTRIBUTE_NONE is equivalent to MPI_DISTRIBUTE_CYCLIC with
 38 $\text{array_of_dargs}[i]$ set to $\text{array_of_gsizes}[i]$.

39 Finally, MPI_DISTRIBUTE_CYCLIC with $\text{array_of_dargs}[i]$ equal to
 40 MPI_DISTRIBUTE_DFLT_DARG is equivalent to MPI_DISTRIBUTE_CYCLIC with
 41 $\text{array_of_dargs}[i]$ set to 1.

42 For MPI_ORDER_FORTRAN, an ndims -dimensional distributed array (`newtype`) is defined
 43 by the following code fragment:

```
44
45     oldtypes[0] = oldtype;
46     for (i = 0; i < ndims; i++) {
47         oldtypes[i+1] = cyclic(array_of_dargs[i],
48
```

```

        array_of_gsizes[i],
        r[i],
        array_of_psizes[i],
        oldtypes[i]);
    }
    newtype = oldtypes[ndims];

```

For MPI_ORDER_C, the code is:

```

oldtypes[0] = oldtype;
for (i = 0; i < ndims; i++) {
    oldtypes[i + 1] = cyclic(array_of_dargs[ndims - i - 1],
                            array_of_gsizes[ndims - i - 1],
                            r[ndims - i - 1],
                            array_of_psizes[ndims - i - 1],
                            oldtypes[i]);
}
newtype = oldtypes[ndims];

```

where $r[i]$ is the position of the process (with rank `rank`) in the process grid at dimension i . The values of $r[i]$ are given by the following code fragment:

```

t_rank = rank;
t_size = 1;
for (i = 0; i < ndims; i++)
    t_size *= array_of_psizes[i];
for (i = 0; i < ndims; i++) {
    t_size = t_size / array_of_psizes[i];
    r[i] = t_rank / t_size;
    t_rank = t_rank % t_size;
}

```

Let the typemap of `oldtype` have the form:

$$\{(type_0, disp_0), (type_1, disp_1), \dots, (type_{n-1}, disp_{n-1})\}$$

where $type_i$ is a predefined MPI datatype, and let ex be the extent of `oldtype`. The following function uses the conceptual datatypes `lb_marker` and `ub_marker`, see Section 4.1.6 for details.

Given the above, the function `cyclic()` is defined as follows:

```

cyclic(darg, gsize, r, psize, oldtype)
= { (lb_marker, 0),
    (type_0, disp_0 + r × darg × ex), ...,
    (type_{n-1}, disp_{n-1} + r × darg × ex),
    (type_0, disp_0 + (r × darg + 1) × ex), ...,
    (type_{n-1}, disp_{n-1} + (r × darg + 1) × ex),

```

```

1      ...
2      (type0, disp0 + ((r + 1) × darg - 1) × ex), ...,
3          (typen-1, dispn-1 + ((r + 1) × darg - 1) × ex),
4
5
6      (type0, disp0 + r × darg × ex + psize × darg × ex), ...,
7          (typen-1, dispn-1 + r × darg × ex + psize × darg × ex),
8
9      (type0, disp0 + (r × darg + 1) × ex + psize × darg × ex), ...,
10         (typen-1, dispn-1 + (r × darg + 1) × ex + psize × darg × ex),
11
12     ...
13     (type0, disp0 + ((r + 1) × darg - 1) × ex + psize × darg × ex), ...,
14         (typen-1, dispn-1 + ((r + 1) × darg - 1) × ex + psize × darg × ex),
15
16         ⋮
17     (type0, disp0 + r × darg × ex + psize × darg × ex × (count - 1)), ...,
18         (typen-1, dispn-1 + r × darg × ex + psize × darg × ex × (count - 1)),
19     (type0, disp0 + (r × darg + 1) × ex + psize × darg × ex × (count - 1)), ...,
20         (typen-1, dispn-1 + (r × darg + 1) × ex
21             + psize × darg × ex × (count - 1)),
22
23     ...
24     (type0, disp0 + (r × darg + darglast - 1) × ex
25         + psize × darg × ex × (count - 1)), ...,
26         (typen-1, dispn-1 + (r × darg + darglast - 1) × ex
27             + psize × darg × ex × (count - 1)),
28     (ub_marker, gsize * ex)
29

```

where *count* is defined by this code fragment:

```

30
31     nblocks = (gsize + (darg - 1)) / darg;
32     count = nblocks / psize;
33     left_over = nblocks - count * psize;
34     if (r < left_over)
35         count = count + 1;
36

```

Here, *nblocks* is the number of blocks that must be distributed among the processors.

Finally, *darg_{last}* is defined by this code fragment:

```

37
38
39     if ((num_in_last_cyclic = gsize % (psize * darg)) == 0)
40         darg_last = darg;
41     else {
42         darg_last = num_in_last_cyclic - darg * r;
43         if (darg_last > darg)
44             darg_last = darg;
45         if (darg_last <= 0)
46             darg_last = darg;
47     }
48

```

Example 4.7 Consider generating the filetypes corresponding to the HPF distribution:

```
<oldtype> FILEARRAY(100, 200, 300)
!HPF$ PROCESSORS PROCESSES(2, 3)
!HPF$ DISTRIBUTE FILEARRAY(CYCLIC(10), *, BLOCK) ONTO PROCESSES
```

This can be achieved by the following Fortran code, assuming there will be six processes attached to the run:

```
ndims = 3
array_of_gsizes(1) = 100
array_of_distrib(1) = MPI_DISTRIBUTE_CYCLIC
array_of_dargs(1) = 10
array_of_gsizes(2) = 200
array_of_distrib(2) = MPI_DISTRIBUTE_NONE
array_of_dargs(2) = 0
array_of_gsizes(3) = 300
array_of_distrib(3) = MPI_DISTRIBUTE_BLOCK
array_of_dargs(3) = MPI_DISTRIBUTE_DFLT_DARG
array_of_psize(1) = 2
array_of_psize(2) = 1
array_of_psize(3) = 3
call MPI_COMM_SIZE(MPI_COMM_WORLD, size, ierr)
call MPI_COMM_RANK(MPI_COMM_WORLD, rank, ierr)
call MPI_TYPE_CREATE_DARRAY(size, rank, ndims, array_of_gsizes, &
    array_of_distrib, array_of_dargs, array_of_psize, &
    MPI_ORDER_FORTRAN, oldtype, newtype, ierr)
```

4.1.5 Address and Size Functions

The displacements in a general datatype are relative to some initial buffer address. **Absolute addresses** can be substituted for these displacements: we treat them as displacements relative to “address zero,” the start of the address space. This initial address zero is indicated by the constant `MPI_BOTTOM`. Thus, a datatype can specify the absolute address of the entries in the communication buffer, in which case the `buf` argument is passed the value `MPI_BOTTOM`. Note that in Fortran `MPI_BOTTOM` is not usable for initialization or assignment, see Section 2.5.4.

The address of a location in memory can be found by invoking the function `MPI_GET_ADDRESS`. The **relative displacement** between two absolute addresses can be calculated with the function `MPI_AINT_DIFF`. A new absolute address as sum of an absolute base address and a relative displacement can be calculated with the function `MPI_AINT_ADD`. To ensure portability, arithmetic on absolute addresses should not be performed with the intrinsic operators “-” and “+”. See also Sections 2.5.6 and 4.1.12 on pages 16 and 117.

Rationale. Address sized integer values, i.e., `MPI_Aint` or `INTEGER(KIND=MPI_ADDRESS_KIND)` values, are signed integers, while absolute addresses are unsigned quantities. Direct arithmetic on addresses stored in address sized signed variables can cause overflows, resulting in undefined behavior. (*End of rationale.*)

```

1 MPI_GET_ADDRESS(location, address)
2     IN      location          location in caller memory (choice)
3
4     OUT     address          address of location (integer)

```

```

5
6 int MPI_Get_address(const void *location, MPI_Aint *address)

```

```

7 MPI_Get_address(location, address, ierror)
8     TYPE(*), DIMENSION(..), ASYNCHRONOUS :: location
9     INTEGER(KIND=MPI_ADDRESS_KIND), INTENT(OUT) :: address
10    INTEGER, OPTIONAL, INTENT(OUT) :: ierror

```

```

12 MPI_GET_ADDRESS(LOCATION, ADDRESS, IERROR)
13     <type> LOCATION(*)
14     INTEGER IERROR
15     INTEGER(KIND=MPI_ADDRESS_KIND) ADDRESS

```

```

16 Returns the (byte) address of location.

```

```

18 Rationale. In the mpi_f08 module, the location argument is not defined with
19 INTENT(IN) because existing applications may use MPI_GET_ADDRESS as a substi-
20 tute for MPI_F_SYNC_REG that was not defined before MPI-3.0. (End of rationale.)

```

```

22
23 Example 4.8 Using MPI_GET_ADDRESS for an array.

```

```

24
25 REAL A(100,100)
26 INTEGER(KIND=MPI_ADDRESS_KIND) I1, I2, DIFF
27 CALL MPI_GET_ADDRESS(A(1,1), I1, IERROR)
28 CALL MPI_GET_ADDRESS(A(10,10), I2, IERROR)
29 DIFF = MPI_AINT_DIFF(I2, I1)
30 ! The value of DIFF is 909*sizeofreal; the values of I1 and I2 are
31 ! implementation dependent.

```

```

32
33 Advice to users. C users may be tempted to avoid the usage of
34 MPI_GET_ADDRESS and rely on the availability of the address operator &. Note,
35 however, that & cast-expression is a pointer, not an address. ISO C does not require
36 that the value of a pointer (or the pointer cast to int) be the absolute address of the
37 object pointed at — although this is commonly the case. Furthermore, referencing
38 may not have a unique definition on machines with a segmented address space. The
39 use of MPI_GET_ADDRESS to “reference” C variables guarantees portability to such
40 machines as well. (End of advice to users.)

```

```

41
42 Advice to users. To prevent problems with the argument copying and register
43 optimization done by Fortran compilers, please note the hints in Sections 18.1.10–
44 18.1.20. (End of advice to users.)

```

```

45
46 To ensure portability, arithmetic on MPI addresses must be performed using the
47 MPI_AINT_ADD and MPI_AINT_DIFF functions.

```

```

48

```

MPI_AINT_ADD(base, disp) 1

IN base base address (integer) 2

IN disp displacement (integer) 3

MPI_Aint MPI_Aint_add(MPI_Aint base, MPI_Aint disp) 4

INTEGER(KIND=MPI_ADDRESS_KIND) MPI_Aint_add(base, disp) 5

INTEGER(KIND=MPI_ADDRESS_KIND), INTENT(IN) :: base, disp 6

INTEGER(KIND=MPI_ADDRESS_KIND) MPI_AINT_ADD(BASE, DISP) 7

INTEGER(KIND=MPI_ADDRESS_KIND) BASE, DISP 8

MPI_AINT_ADD produces a new MPI_Aint value that is equivalent to the sum of the base and disp arguments, where base represents a base address returned by a call to MPI_GET_ADDRESS and disp represents a signed integer displacement. The resulting address is valid only at the process that generated base, and it must correspond to a location in the same object referenced by base, as described in Section 4.1.12. The addition is performed in a manner that results in the correct MPI_Aint representation of the output address, as if the process that originally produced base had called:

```
MPI_Get_address((char *) base + disp, &result);
```

MPI_AINT_DIFF(addr1, addr2) 9

IN addr1 minuend address (integer) 10

IN addr2 subtrahend address (integer) 11

MPI_Aint MPI_Aint_diff(MPI_Aint addr1, MPI_Aint addr2) 12

INTEGER(KIND=MPI_ADDRESS_KIND) MPI_Aint_diff(addr1, addr2) 13

INTEGER(KIND=MPI_ADDRESS_KIND), INTENT(IN) :: addr1, addr2 14

INTEGER(KIND=MPI_ADDRESS_KIND) MPI_AINT_DIFF(ADDR1, ADDR2) 15

INTEGER(KIND=MPI_ADDRESS_KIND) ADDR1, ADDR2 16

MPI_AINT_DIFF produces a new MPI_Aint value that is equivalent to the difference between addr1 and addr2 arguments, where addr1 and addr2 represent addresses returned by calls to MPI_GET_ADDRESS. The resulting address is valid only at the process that generated addr1 and addr2, and addr1 and addr2 must correspond to locations in the same object in the same process, as described in Section 4.1.12. The difference is calculated in a manner that results in the signed difference from addr1 to addr2, as if the process that originally produced the addresses had called (char *) addr1 - (char *) addr2 on the addresses initially passed to MPI_GET_ADDRESS.

The following auxiliary functions provide useful information on derived datatypes.

```

1 MPI_TYPE_SIZE(datatype, size)
2     IN      datatype          datatype (handle)
3
4     OUT     size              datatype size (integer)
5
6 int MPI_Type_size(MPI_Datatype datatype, int *size)
7
8 MPI_Type_size(datatype, size, ierror)
9     TYPE(MPI_Datatype), INTENT(IN) :: datatype
10    INTEGER, INTENT(OUT) :: size
11    INTEGER, OPTIONAL, INTENT(OUT) :: ierror
12 MPI_TYPE_SIZE(DATATYPE, SIZE, IERROR)
13    INTEGER DATATYPE, SIZE, IERROR
14
15
16 MPI_TYPE_SIZE_X(datatype, size)
17     IN      datatype          datatype (handle)
18
19     OUT     size              datatype size (integer)
20
21 int MPI_Type_size_x(MPI_Datatype datatype, MPI_Count *size)
22
23 MPI_Type_size_x(datatype, size, ierror)
24     TYPE(MPI_Datatype), INTENT(IN) :: datatype
25     INTEGER(KIND=MPI_COUNT_KIND), INTENT(OUT) :: size
26     INTEGER, OPTIONAL, INTENT(OUT) :: ierror
27 MPI_TYPE_SIZE_X(DATATYPE, SIZE, IERROR)
28     INTEGER DATATYPE, IERROR
29     INTEGER(KIND=MPI_COUNT_KIND) SIZE
30

```

MPI_TYPE_SIZE and MPI_TYPE_SIZE_X set the value of `size` to the total size, in bytes, of the entries in the type signature associated with `datatype`; i.e., the total size of the data in a message that would be created with this `datatype`. Entries that occur multiple times in the `datatype` are counted with their multiplicity. For both functions, if the `OUT` parameter cannot express the value to be returned (e.g., if the parameter is too small to hold the output value), it is set to `MPI_UNDEFINED`.

4.1.6 Lower-Bound and Upper-Bound Markers

It is often convenient to define explicitly the lower bound and upper bound of a type map, and override the definition given on page 107. This allows one to define a `datatype` that has “holes” at its beginning or its end, or a `datatype` with entries that extend above the upper bound or below the lower bound. Examples of such usage are provided in Section 4.1.14. Also, the user may want to override the alignment rules that are used to compute upper bounds and extents. E.g., a C compiler may allow the user to override default alignment rules for some of the structures within a program. The user has to specify explicitly the bounds of the `datatypes` that match these structures.

To achieve this, we add two additional conceptual datatypes, **lb_marker** and **ub_marker**, that represent the lower bound and upper bound of a datatype. These conceptual datatypes occupy no space ($extent(\text{lb_marker}) = extent(\text{ub_marker}) = 0$). They do not affect the size or count of a datatype, and do not affect the content of a message created with this datatype. However, they do affect the definition of the extent of a datatype and, therefore, affect the outcome of a replication of this datatype by a datatype constructor.

Example 4.9 A call to `MPI_TYPE_CREATE_RESIZED(MPI_INT, -3, 9, type1)` creates a new datatype that has an extent of 9 (from -3 to 5, 5 included), and contains an integer at displacement 0. This is the datatype defined by the typemap $\{(\text{lb_marker}, -3), (\text{int}, 0), (\text{ub_marker}, 6)\}$. If this type is replicated twice by a call to `MPI_TYPE_CONTIGUOUS(2, type1, type2)` then the newly created type can be described by the typemap $\{(\text{lb_marker}, -3), (\text{int}, 0), (\text{int}, 9), (\text{ub_marker}, 15)\}$. (An entry of type `ub_marker` can be deleted if there is another entry of type `ub_marker` with a higher displacement; an entry of type `lb_marker` can be deleted if there is another entry of type `lb_marker` with a lower displacement.)

In general, if

$$Typemap = \{(type_0, disp_0), \dots, (type_{n-1}, disp_{n-1})\},$$

then the **lower bound** of *Typemap* is defined to be

$$lb(Typemap) = \begin{cases} \min_j disp_j & \text{if no entry has type } \text{lb_marker} \\ \min_j \{disp_j \text{ such that } type_j = \text{lb_marker}\} & \text{otherwise} \end{cases}$$

Similarly, the **upper bound** of *Typemap* is defined to be

$$ub(Typemap) = \begin{cases} \max_j (disp_j + sizeof(type_j)) + \epsilon & \text{if no entry has type } \text{ub_marker} \\ \max_j \{disp_j \text{ such that } type_j = \text{ub_marker}\} & \text{otherwise} \end{cases}$$

Then

$$extent(Typemap) = ub(Typemap) - lb(Typemap)$$

If $type_i$ requires alignment to a byte address that is a multiple of k_i , then ϵ is the least non-negative increment needed to round $extent(Typemap)$ to the next multiple of $\max_i k_i$. In Fortran, it is implementation dependent whether the MPI implementation computes the alignments k_i according to the alignments used by the compiler in common blocks, `SEQUENCE` derived types, `BIND(C)` derived types, or derived types that are neither `SEQUENCE` nor `BIND(C)`.

The formal definitions given for the various datatype constructors apply now, with the amended definition of **extent**.

Rationale. Before Fortran 2003, `MPI_TYPE_CREATE_STRUCT` could be applied to Fortran common blocks and `SEQUENCE` derived types. With Fortran 2003, this list was extended by `BIND(C)` derived types and MPI implementors have implemented the alignments k_i differently, i.e., some based on the alignments used in `SEQUENCE` derived types, and others according to `BIND(C)` derived types. (*End of rationale.*)

Advice to implementors. In Fortran, it is generally recommended to use `BIND(C)` derived types instead of common blocks or `SEQUENCE` derived types. Therefore it is recommended to calculate the alignments k_i based on `BIND(C)` derived types. (*End of advice to implementors.*)

Advice to users. Structures combining different basic datatypes should be defined so that there will be no gaps based on alignment rules. If such a datatype is used to create an array of structures, users should also avoid an alignment-gap at the end of the structure. In MPI communication, the content of such gaps would not be communicated into the receiver's buffer. For example, such an alignment-gap may occur between an odd number of `floats` or `REALs` before a `double` or `DOUBLE PRECISION` data. Such gaps may be added explicitly to both the structure and the MPI derived datatype handle because the communication of a contiguous derived datatype may be significantly faster than the communication of one that is non-contiguous because of such alignment-gaps.

Example: Instead of

```

TYPE, BIND(C) :: my_data
  REAL, DIMENSION(3) :: x
  ! there may be a gap of the size of one REAL
  ! if the alignment of a DOUBLE PRECISION is
  ! two times the size of a REAL
  DOUBLE PRECISION :: p
END TYPE

```

one should define

```

TYPE, BIND(C) :: my_data
  REAL, DIMENSION(3) :: x
  REAL :: gap1
  DOUBLE PRECISION :: p
END TYPE

```

and also include `gap1` in the matching MPI derived datatype. It is required that all processes in a communication add the same gaps, i.e., defined with the same basic datatype. Both the original and the modified structures are portable, but may have different performance implications for the communication and memory accesses during computation on systems with different alignment values.

In principle, a compiler may define an additional alignment rule for structures, e.g., to use at least 4 or 8 byte alignment, although the content may have a $max_i k_i$ alignment less than this structure alignment. To maintain portability, users should always resize structure derived datatype handles if used in an array of structures, see the Example in Section 18.1.15. (*End of advice to users.*)

4.1.7 Extent and Bounds of Datatypes

`MPI_TYPE_GET_EXTENT(datatype, lb, extent)`

IN	<code>datatype</code>	datatype to get information on (handle)
OUT	<code>lb</code>	lower bound of datatype (integer)
OUT	<code>extent</code>	extent of datatype (integer)

```

int MPI_Type_get_extent(MPI_Datatype datatype, MPI_Aint *lb,
                        MPI_Aint *extent)
MPI_Type_get_extent(datatype, lb, extent, ierror)
    TYPE(MPI_Datatype), INTENT(IN) :: datatype
    INTEGER(KIND=MPI_ADDRESS_KIND), INTENT(OUT) :: lb, extent
    INTEGER, OPTIONAL, INTENT(OUT) :: ierror
MPI_TYPE_GET_EXTENT(DATATYPE, LB, EXTENT, IERROR)
    INTEGER DATATYPE, IERROR
    INTEGER(KIND=MPI_ADDRESS_KIND) LB, EXTENT

MPI_TYPE_GET_EXTENT_X(datatype, lb, extent)
    IN      datatype      datatype to get information on (handle)
    OUT     lb             lower bound of datatype (integer)
    OUT     extent        extent of datatype (integer)

int MPI_Type_get_extent_x(MPI_Datatype datatype, MPI_Count *lb,
                          MPI_Count *extent)
MPI_Type_get_extent_x(datatype, lb, extent, ierror)
    TYPE(MPI_Datatype), INTENT(IN) :: datatype
    INTEGER(KIND=MPI_COUNT_KIND), INTENT(OUT) :: lb, extent
    INTEGER, OPTIONAL, INTENT(OUT) :: ierror
MPI_TYPE_GET_EXTENT_X(DATATYPE, LB, EXTENT, IERROR)
    INTEGER DATATYPE, IERROR
    INTEGER(KIND=MPI_COUNT_KIND) LB, EXTENT

    Returns the lower bound and the extent of datatype (as defined in Equation 4.1).
    For both functions, if either OUT parameter cannot express the value to be returned
    (e.g., if the parameter is too small to hold the output value), it is set to MPI_UNDEFINED.
    MPI allows one to change the extent of a datatype, using lower bound and upper bound
    markers. This provides control over the stride of successive datatypes that are replicated
    by datatype constructors, or are replicated by the count argument in a send or receive call.

MPI_TYPE_CREATE_RESIZED(oldtype, lb, extent, newtype)
    IN      oldtype      input datatype (handle)
    IN      lb           new lower bound of datatype (integer)
    IN      extent       new extent of datatype (integer)
    OUT     newtype      output datatype (handle)

int MPI_Type_create_resized(MPI_Datatype oldtype, MPI_Aint lb,
                            MPI_Aint extent, MPI_Datatype *newtype)
MPI_Type_create_resized(oldtype, lb, extent, newtype, ierror)

```

```

1     INTEGER(KIND=MPI_ADDRESS_KIND), INTENT(IN) :: lb, extent
2     TYPE(MPI_Datatype), INTENT(IN) :: oldtype
3     TYPE(MPI_Datatype), INTENT(OUT) :: newtype
4     INTEGER, OPTIONAL, INTENT(OUT) :: ierror
5
6 MPI_TYPE_CREATE_RESIZED(OLDTYPE, LB, EXTENT, NEWTYPE, IERROR)
7     INTEGER OLDTYPE, NEWTYPE, IERROR
8     INTEGER(KIND=MPI_ADDRESS_KIND) LB, EXTENT

```

Returns in `newtype` a handle to a new datatype that is identical to `oldtype`, except that the lower bound of this new datatype is set to be `lb`, and its upper bound is set to be `lb + extent`. Any previous `lb` and `ub` markers are erased, and a new pair of lower bound and upper bound markers are put in the positions indicated by the `lb` and `extent` arguments. This affects the behavior of the datatype when used in communication operations, with `count > 1`, and when used in the construction of new derived datatypes.

4.1.8 True Extent of Datatypes

Suppose we implement gather (see also Section 5.5) as a spanning tree implemented on top of point-to-point routines. Since the receive buffer is only valid on the root process, one will need to allocate some temporary space for receiving data on intermediate nodes. However, the datatype extent cannot be used as an estimate of the amount of space that needs to be allocated, if the user has modified the extent, for example by using `MPI_TYPE_CREATE_RESIZED`. The functions `MPI_TYPE_GET_TRUE_EXTENT` and `MPI_TYPE_GET_TRUE_EXTENT_X` are provided which return the true extent of the datatype.

```

27 MPI_TYPE_GET_TRUE_EXTENT(datatype, true_lb, true_extent)
28
29     IN          datatype          datatype to get information on (handle)
30     OUT         true_lb           true lower bound of datatype (integer)
31     OUT         true_extent       true size of datatype (integer)
32
33
34 int MPI_Type_get_true_extent(MPI_Datatype datatype, MPI_Aint *true_lb,
35                             MPI_Aint *true_extent)
36
37 MPI_Type_get_true_extent(datatype, true_lb, true_extent, ierror)
38     TYPE(MPI_Datatype), INTENT(IN) :: datatype
39     INTEGER(KIND=MPI_ADDRESS_KIND), INTENT(OUT) :: true_lb, true_extent
40     INTEGER, OPTIONAL, INTENT(OUT) :: ierror
41
42 MPI_TYPE_GET_TRUE_EXTENT(DATATYPE, TRUE_LB, TRUE_EXTENT, IERROR)
43     INTEGER DATATYPE, IERROR
44     INTEGER(KIND=MPI_ADDRESS_KIND) TRUE_LB, TRUE_EXTENT

```



```

MPI_TYPE_GET_TRUE_EXTENT_X(datatype, true_lb, true_extent) 1
    IN      datatype          datatype to get information on (handle) 2
    OUT     true_lb           true lower bound of datatype (integer) 3
    OUT     true_extent       true size of datatype (integer) 4
                                         5
                                         6
int MPI_Type_get_true_extent_x(MPI_Datatype datatype, MPI_Count *true_lb, 7
                               MPI_Count *true_extent) 8
                                         9
MPI_Type_get_true_extent_x(datatype, true_lb, true_extent, ierror) 10
    TYPE(MPI_Datatype), INTENT(IN) :: datatype 11
    INTEGER(KIND=MPI_COUNT_KIND), INTENT(OUT) :: true_lb, true_extent 12
    INTEGER, OPTIONAL, INTENT(OUT) :: ierror 13
                                         14
MPI_TYPE_GET_TRUE_EXTENT_X(DATATYPE, TRUE_LB, TRUE_EXTENT, IERROR) 15
    INTEGER DATATYPE, IERROR 16
    INTEGER(KIND=MPI_COUNT_KIND) TRUE_LB, TRUE_EXTENT 17

```

`true_lb` returns the offset of the lowest unit of store which is addressed by the datatype, i.e., the lower bound of the corresponding typemap, ignoring explicit lower bound markers. `true_extent` returns the true size of the datatype, i.e., the extent of the corresponding typemap, ignoring explicit lower bound and upper bound markers, and performing no rounding for alignment. If the typemap associated with `datatype` is

$$Typemap = \{(type_0, disp_0), \dots, (type_{n-1}, disp_{n-1})\}$$

Then

$$true_lb(Typemap) = \min_j \{disp_j : type_j \neq lb_marker, ub_marker\},$$

$$true_ub(Typemap) = \max_j \{disp_j + sizeof(type_j) : type_j \neq lb_marker, ub_marker\},$$

and

$$true_extent(Typemap) = true_ub(Typemap) - true_lb(Typemap).$$

(Readers should compare this with the definitions in Section 4.1.6 and Section 4.1.7, which describe the function `MPI_TYPE_GET_EXTENT`.)

The `true_extent` is the minimum number of bytes of memory necessary to hold a datatype, uncompressed.

For both functions, if either OUT parameter cannot express the value to be returned (e.g., if the parameter is too small to hold the output value), it is set to `MPI_UNDEFINED`.

4.1.9 Commit and Free

A datatype object has to be **committed** before it can be used in a communication. As an argument in datatype constructors, uncommitted and also committed datatypes can be used. There is no need to commit basic datatypes. They are “pre-committed.”

```

1 MPI_TYPE_COMMIT(datatype)
2     INOUT    datatype                datatype that is committed (handle)
3
4
5 int MPI_Type_commit(MPI_Datatype *datatype)
6
7 MPI_Type_commit(datatype, ierror)
8     TYPE(MPI_Datatype), INTENT(INOUT) :: datatype
9     INTEGER, OPTIONAL, INTENT(OUT) :: ierror
10
11 MPI_TYPE_COMMIT(DATATYPE, IERROR)
12     INTEGER DATATYPE, IERROR

```

The commit operation commits the datatype, that is, the formal description of a communication buffer, not the content of that buffer. Thus, after a datatype has been committed, it can be repeatedly reused to communicate the changing content of a buffer or, indeed, the content of different buffers, with different starting addresses.

Advice to implementors. The system may “compile” at commit time an internal representation for the datatype that facilitates communication, e.g., change from a compacted representation to a flat representation of the datatype, and select the most convenient transfer mechanism. (*End of advice to implementors.*)

MPI_TYPE_COMMIT will accept a committed datatype; in this case, it is equivalent to a no-op.

Example 4.10 The following code fragment gives examples of using MPI_TYPE_COMMIT.

```

26 INTEGER type1, type2
27 CALL MPI_TYPE_CONTIGUOUS(5, MPI_REAL, type1, ierr)
28     ! new type object created
29 CALL MPI_TYPE_COMMIT(type1, ierr)
30     ! now type1 can be used for communication
31 type2 = type1
32     ! type2 can be used for communication
33     ! (it is a handle to same object as type1)
34 CALL MPI_TYPE_VECTOR(3, 5, 4, MPI_REAL, type1, ierr)
35     ! new uncommitted type object created
36 CALL MPI_TYPE_COMMIT(type1, ierr)
37     ! now type1 can be used anew for communication
38
39
40
41 MPI_TYPE_FREE(datatype)
42     INOUT    datatype                datatype that is freed (handle)
43
44
45 int MPI_Type_free(MPI_Datatype *datatype)
46
47 MPI_Type_free(datatype, ierror)
48     TYPE(MPI_Datatype), INTENT(INOUT) :: datatype
49     INTEGER, OPTIONAL, INTENT(OUT) :: ierror

```

```
MPI_TYPE_FREE(DATATYPE, IERROR)
    INTEGER DATATYPE, IERROR
```

Marks the datatype object associated with `datatype` for deallocation and sets `datatype` to `MPI_DATATYPE_NULL`. Any communication that is currently using this datatype will complete normally. Freeing a datatype does not affect any other datatype that was built from the freed datatype. The system behaves as if input datatype arguments to derived datatype constructors are passed by value.

Advice to implementors. The implementation may keep a reference count of active communications that use the datatype, in order to decide when to free it. Also, one may implement constructors of derived datatypes so that they keep pointers to their datatype arguments, rather than copying them. In this case, one needs to keep track of active datatype definition references in order to know when a datatype object can be freed. (*End of advice to implementors.*)

4.1.10 Duplicating a Datatype

```
MPI_TYPE_DUP(oldtype, newtype)
```

IN	oldtype	datatype (handle)
OUT	newtype	copy of oldtype (handle)

```
int MPI_Type_dup(MPI_Datatype oldtype, MPI_Datatype *newtype)
```

```
MPI_Type_dup(oldtype, newtype, ierror)
    TYPE(MPI_Datatype), INTENT(IN) :: oldtype
    TYPE(MPI_Datatype), INTENT(OUT) :: newtype
    INTEGER, OPTIONAL, INTENT(OUT) :: ierror
```

```
MPI_TYPE_DUP(OLDTYPE, NEWTYPE, IERROR)
    INTEGER OLDTYPE, NEWTYPE, IERROR
```

`MPI_TYPE_DUP` is a type constructor which duplicates the existing `oldtype` with associated key values. For each key value, the respective copy callback function determines the attribute value associated with this key in the new communicator; one particular action that a copy callback may take is to delete the attribute from the new datatype. Returns in `newtype` a new datatype with exactly the same properties as `oldtype` and any copied cached information, see Section 6.7.4. The new datatype has identical upper bound and lower bound and yields the same net result when fully decoded with the functions in Section 4.1.13. The `newtype` has the same committed state as the old `oldtype`.

4.1.11 Use of General Datatypes in Communication

Handles to derived datatypes can be passed to a communication call wherever a datatype argument is required. A call of the form `MPI_SEND(buf, count, datatype, ...)`, where `count > 1`, is interpreted as if the call was passed a new datatype which is the concatenation of `count` copies of `datatype`. Thus, `MPI_SEND(buf, count, datatype, dest, tag, comm)` is equivalent to,

```

1 MPI_TYPE_CONTIGUOUS(count, datatype, newtype)
2 MPI_TYPE_COMMIT(newtype)
3 MPI_SEND(buf, 1, newtype, dest, tag, comm)
4 MPI_TYPE_FREE(newtype).

```

Similar statements apply to all other communication functions that have a `count` and `datatype` argument.

Suppose that a send operation `MPI_SEND(buf, count, datatype, dest, tag, comm)` is executed, where `datatype` has type map,

$$\{(type_0, disp_0), \dots, (type_{n-1}, disp_{n-1})\},$$

and extent *extent*. (Explicit lower bound and upper bound markers are not listed in the type map, but they affect the value of *extent*.) The send operation sends $n \cdot \text{count}$ entries, where entry $i \cdot n + j$ is at location $addr_{i,j} = \text{buf} + \text{extent} \cdot i + disp_j$ and has type $type_j$, for $i = 0, \dots, \text{count} - 1$ and $j = 0, \dots, n - 1$. These entries need not be contiguous, nor distinct; their order can be arbitrary.

The variable stored at address $addr_{i,j}$ in the calling program should be of a type that matches $type_j$, where type matching is defined as in Section 3.3.1. The message sent contains $n \cdot \text{count}$ entries, where entry $i \cdot n + j$ has type $type_j$.

Similarly, suppose that a receive operation `MPI_RECV(buf, count, datatype, source, tag, comm, status)` is executed, where `datatype` has type map,

$$\{(type_0, disp_0), \dots, (type_{n-1}, disp_{n-1})\},$$

with extent *extent*. (Again, explicit lower bound and upper bound markers are not listed in the type map, but they affect the value of *extent*.) This receive operation receives $n \cdot \text{count}$ entries, where entry $i \cdot n + j$ is at location $\text{buf} + \text{extent} \cdot i + disp_j$ and has type $type_j$. If the incoming message consists of k elements, then we must have $k \leq n \cdot \text{count}$; the $i \cdot n + j$ -th element of the message should have a type that matches $type_j$.

Type matching is defined according to the type signature of the corresponding datatypes, that is, the sequence of basic type components. Type matching does not depend on some aspects of the datatype definition, such as the displacements (layout in memory) or the intermediate types used.

Example 4.11 This example shows that type matching is defined in terms of the basic types that a derived type consists of.

```

35 ...
36 CALL MPI_TYPE_CONTIGUOUS(2, MPI_REAL, type2, ...)
37 CALL MPI_TYPE_CONTIGUOUS(4, MPI_REAL, type4, ...)
38 CALL MPI_TYPE_CONTIGUOUS(2, type2, type22, ...)
39 ...
40 CALL MPI_SEND(a, 4, MPI_REAL, ...)
41 CALL MPI_SEND(a, 2, type2, ...)
42 CALL MPI_SEND(a, 1, type22, ...)
43 CALL MPI_SEND(a, 1, type4, ...)
44 ...
45 CALL MPI_RECV(a, 4, MPI_REAL, ...)
46 CALL MPI_RECV(a, 2, type2, ...)
47 CALL MPI_RECV(a, 1, type22, ...)
48 CALL MPI_RECV(a, 1, type4, ...)

```

Each of the sends matches any of the receives. 1

A datatype may specify overlapping entries. The use of such a datatype in a receive operation is erroneous. (This is erroneous even if the actual message received is short enough not to write any entry more than once.) 2
3
4

Suppose that `MPI_RECV(buf, count, datatype, dest, tag, comm, status)` is executed, where `datatype` has type map, 5
6
7

$$\{(type_0, disp_0), \dots, (type_{n-1}, disp_{n-1})\}.$$
8
9

The received message need not fill all the receive buffer, nor does it need to fill a number of locations which is a multiple of n . Any number, k , of basic elements can be received, where $0 \leq k \leq count \cdot n$. The number of basic elements received can be retrieved from `status` using the query functions `MPI_GET_ELEMENTS` or `MPI_GET_ELEMENTS_X`. 10
11
12
13
14

`MPI_GET_ELEMENTS(status, datatype, count)` 15

IN	status	return status of receive operation (Status)	16
IN	datatype	datatype used by receive operation (handle)	17 18
OUT	count	number of received basic elements (integer)	19 20

```
int MPI_Get_elements(const MPI_Status *status, MPI_Datatype datatype,
                    int *count) 21  
22
```

```
MPI_Get_elements(status, datatype, count, ierror) 24
  TYPE(MPI_Status), INTENT(IN) :: status 25
  TYPE(MPI_Datatype), INTENT(IN) :: datatype 26
  INTEGER, INTENT(OUT) :: count 27
  INTEGER, OPTIONAL, INTENT(OUT) :: ierror 28
```

```
MPI_GET_ELEMENTS(STATUS, DATATYPE, COUNT, IERROR) 29
  INTEGER STATUS(MPI_STATUS_SIZE), DATATYPE, COUNT, IERROR 30  
31  
32
```

`MPI_GET_ELEMENTS_X(status, datatype, count)` 33
34

IN	status	return status of receive operation (Status)	35
IN	datatype	datatype used by receive operation (handle)	36 37
OUT	count	number of received basic elements (integer)	38 39

```
int MPI_Get_elements_x(const MPI_Status *status, MPI_Datatype datatype,
                      MPI_Count *count) 40  
41
```

```
MPI_Get_elements_x(status, datatype, count, ierror) 42
  TYPE(MPI_Status), INTENT(IN) :: status 43
  TYPE(MPI_Datatype), INTENT(IN) :: datatype 44
  INTEGER(KIND=MPI_COUNT_KIND), INTENT(OUT) :: count 45
  INTEGER, OPTIONAL, INTENT(OUT) :: ierror 46  
47
```

```
MPI_GET_ELEMENTS_X(STATUS, DATATYPE, COUNT, IERROR) 48
```

```

1     INTEGER STATUS(MPI_STATUS_SIZE), DATATYPE, IERROR
2     INTEGER(KIND=MPI_COUNT_KIND) COUNT

```

The `datatype` argument should match the argument provided by the receive call that set the `status` variable. For both functions, if the `OUT` parameter cannot express the value to be returned (e.g., if the parameter is too small to hold the output value), it is set to `MPI_UNDEFINED`.

The previously defined function `MPI_GET_COUNT` (Section 3.2.5), has a different behavior. It returns the number of “top-level entries” received, i.e. the number of “copies” of type `datatype`. In the previous example, `MPI_GET_COUNT` may return any integer value k , where $0 \leq k \leq \text{count}$. If `MPI_GET_COUNT` returns k , then the number of basic elements received (and the value returned by `MPI_GET_ELEMENTS` or `MPI_GET_ELEMENTS_X`) is $n \cdot k$. If the number of basic elements received is not a multiple of n , that is, if the receive operation has not received an integral number of `datatype` “copies,” then `MPI_GET_COUNT` sets the value of `count` to `MPI_UNDEFINED`.

Example 4.12 Usage of `MPI_GET_COUNT` and `MPI_GET_ELEMENTS`.

```

18     ...
19     CALL MPI_TYPE_CONTIGUOUS(2, MPI_REAL, Type2, ierr)
20     CALL MPI_TYPE_COMMIT(Type2, ierr)
21     ...
22     CALL MPI_COMM_RANK(comm, rank, ierr)
23     IF (rank.EQ.0) THEN
24         CALL MPI_SEND(a, 2, MPI_REAL, 1, 0, comm, ierr)
25         CALL MPI_SEND(a, 3, MPI_REAL, 1, 0, comm, ierr)
26     ELSE IF (rank.EQ.1) THEN
27         CALL MPI_RECV(a, 2, Type2, 0, 0, comm, stat, ierr)
28         CALL MPI_GET_COUNT(stat, Type2, i, ierr)      ! returns i=1
29         CALL MPI_GET_ELEMENTS(stat, Type2, i, ierr)  ! returns i=2
30         CALL MPI_RECV(a, 2, Type2, 0, 0, comm, stat, ierr)
31         CALL MPI_GET_COUNT(stat, Type2, i, ierr)    ! returns i=MPI_UNDEFINED
32         CALL MPI_GET_ELEMENTS(stat, Type2, i, ierr) ! returns i=3
33     END IF

```

The functions `MPI_GET_ELEMENTS` and `MPI_GET_ELEMENTS_X` can also be used after a probe to find the number of elements in the probed message. Note that the `MPI_GET_COUNT`, `MPI_GET_ELEMENTS`, and `MPI_GET_ELEMENTS_X` return the same values when they are used with basic datatypes as long as the limits of their respective `count` arguments are not exceeded.

Rationale. The extension given to the definition of `MPI_GET_COUNT` seems natural: one would expect this function to return the value of the `count` argument, when the receive buffer is filled. Sometimes `datatype` represents a basic unit of data one wants to transfer, for example, a record in an array of records (structures). One should be able to find out how many components were received without bothering to divide by the number of elements in each component. However, on other occasions, `datatype` is used to define a complex layout of data in the receiver memory, and does not represent a basic unit of data for transfers. In such cases, one needs to use the function `MPI_GET_ELEMENTS` or `MPI_GET_ELEMENTS_X`. (*End of rationale.*)

Advice to implementors. The definition implies that a receive cannot change the value of storage outside the entries defined to compose the communication buffer. In particular, the definition implies that padding space in a structure should not be modified when such a structure is copied from one process to another. This would prevent the obvious optimization of copying the structure, together with the padding, as one contiguous block. The implementation is free to do this optimization when it does not impact the outcome of the computation. The user can “force” this optimization by explicitly including padding as part of the message. (*End of advice to implementors.*)

4.1.12 Correct Use of Addresses

Successively declared variables in C or Fortran are not necessarily stored at contiguous locations. Thus, care must be exercised that displacements do not cross from one variable to another. Also, in machines with a segmented address space, addresses are not unique and address arithmetic has some peculiar properties. Thus, the use of **addresses**, that is, displacements relative to the start address `MPI_BOTTOM`, has to be restricted.

Variables belong to the same **sequential storage** if they belong to the same array, to the same `COMMON` block in Fortran, or to the same structure in C. Valid addresses are defined recursively as follows:

1. The function `MPI_GET_ADDRESS` returns a valid address, when passed as argument a variable of the calling program.
2. The `buf` argument of a communication function evaluates to a valid address, when passed as argument a variable of the calling program.
3. If `v` is a valid address, and `i` is an integer, then `v+i` is a valid address, provided `v` and `v+i` are in the same sequential storage.

A correct program uses only valid addresses to identify the locations of entries in communication buffers. Furthermore, if `u` and `v` are two valid addresses, then the (integer) difference `u - v` can be computed only if both `u` and `v` are in the same sequential storage. No other arithmetic operations can be meaningfully executed on addresses.

The rules above impose no constraints on the use of derived datatypes, as long as they are used to define a communication buffer that is wholly contained within the same sequential storage. However, the construction of a communication buffer that contains variables that are not within the same sequential storage must obey certain restrictions. Basically, a communication buffer with variables that are not within the same sequential storage can be used only by specifying in the communication call `buf = MPI_BOTTOM`, `count = 1`, and using a `datatype` argument where all displacements are valid (absolute) addresses.

Advice to users. It is not expected that MPI implementations will be able to detect erroneous, “out of bound” displacements — unless those overflow the user address space — since the MPI call may not know the extent of the arrays and records in the host program. (*End of advice to users.*)

Advice to implementors. There is no need to distinguish (absolute) addresses and (relative) displacements on a machine with contiguous address space: `MPI_BOTTOM` is zero, and both addresses and displacements are integers. On machines where the

1 distinction is required, addresses are recognized as expressions that involve
 2 MPI_BOTTOM. (*End of advice to implementors.*)

4.1.13 Decoding a Datatype

5 MPI datatype objects allow users to specify an arbitrary layout of data in memory. There
 6 are several cases where accessing the layout information in opaque datatype objects would
 7 be useful. The opaque datatype object has found a number of uses outside MPI. Further-
 8 more, a number of tools wish to display internal information about a datatype. To achieve
 9 this, datatype decoding functions are provided. The two functions in this section are used
 10 together to decode datatypes to recreate the calling sequence used in their initial defini-
 11 tion. These can be used to allow a user to determine the type map and type signature of a
 12 datatype.
 13

14
 15 MPI_TYPE_GET_ENVELOPE(datatype, num_integers, num_addresses, num_datatypes,
 16 combiner)

17	IN	datatype	datatype to access (handle)
18	OUT	num_integers	number of input integers used in the call constructing combiner (non-negative integer)
19	OUT	num_addresses	number of input addresses used in the call construct- ing combiner (non-negative integer)
20	OUT	num_datatypes	number of input datatypes used in the call construct- ing combiner (non-negative integer)
21	OUT	combiner	combiner (state)

22
 23
 24
 25
 26
 27
 28
 29 int MPI_Type_get_envelope(MPI_Datatype datatype, int *num_integers,
 30 int *num_addresses, int *num_datatypes, int *combiner)

31 MPI_Type_get_envelope(datatype, num_integers, num_addresses, num_datatypes,
 32 combiner, ierror)

33 TYPE(MPI_Datatype), INTENT(IN) :: datatype
 34 INTEGER, INTENT(OUT) :: num_integers, num_addresses, num_datatypes,
 35 combiner
 36 INTEGER, OPTIONAL, INTENT(OUT) :: ierror

37 MPI_TYPE_GET_ENVELOPE(DATATYPE, NUM_INTEGERS, NUM_ADDRESSES, NUM_DATATYPES,
 38 COMBINER, IERROR)
 39 INTEGER DATATYPE, NUM_INTEGERS, NUM_ADDRESSES, NUM_DATATYPES, COMBINER,
 40 IERROR
 41

42 For the given datatype, MPI_TYPE_GET_ENVELOPE returns information on the num-
 43 ber and type of input arguments used in the call that created the datatype. The number-of-
 44 arguments values returned can be used to provide sufficiently large arrays in the decoding
 45 routine MPI_TYPE_GET_CONTENTS. This call and the meaning of the returned values is
 46 described below. The combiner reflects the MPI datatype constructor call that was used in
 47 creating datatype.
 48

Rationale. By requiring that the combiner reflect the constructor used in the creation of the datatype, the decoded information can be used to effectively recreate the calling sequence used in the original creation. This is the most useful information and was felt to be reasonable even though it constrains implementations to remember the original constructor sequence even if the internal representation is different.

The decoded information keeps track of datatype duplications. This is important as one needs to distinguish between a predefined datatype and a dup of a predefined datatype. The former is a constant object that cannot be freed, while the latter is a derived datatype that can be freed. (*End of rationale.*)

The list in Table 4.1 has the values that can be returned in combiner on the left and the call associated with them on the right.

MPI_COMBINER_NAMED	a named predefined datatype
MPI_COMBINER_DUP	MPI_TYPE_DUP
MPI_COMBINER_CONTIGUOUS	MPI_TYPE_CONTIGUOUS
MPI_COMBINER_VECTOR	MPI_TYPE_VECTOR
MPI_COMBINER_HVECTOR	MPI_TYPE_CREATE_HVECTOR
MPI_COMBINER_INDEXED	MPI_TYPE_INDEXED
MPI_COMBINER_HINDEXED	MPI_TYPE_CREATE_HINDEXED
MPI_COMBINER_INDEXED_BLOCK	MPI_TYPE_CREATE_INDEXED_BLOCK
MPI_COMBINER_HINDEXED_BLOCK	MPI_TYPE_CREATE_HINDEXED_BLOCK
MPI_COMBINER_STRUCT	MPI_TYPE_CREATE_STRUCT
MPI_COMBINER_SUBARRAY	MPI_TYPE_CREATE_SUBARRAY
MPI_COMBINER_DARRAY	MPI_TYPE_CREATE_DARRAY
MPI_COMBINER_F90_REAL	MPI_TYPE_CREATE_F90_REAL
MPI_COMBINER_F90_COMPLEX	MPI_TYPE_CREATE_F90_COMPLEX
MPI_COMBINER_F90_INTEGER	MPI_TYPE_CREATE_F90_INTEGER
MPI_COMBINER_RESIZED	MPI_TYPE_CREATE_RESIZED

Table 4.1: combiner values returned from MPI_TYPE_GET_ENVELOPE

If combiner is MPI_COMBINER_NAMED then datatype is a named predefined datatype.

The actual arguments used in the creation call for a datatype can be obtained using MPI_TYPE_GET_CONTENTS.

```

1 MPI_TYPE_GET_CONTENTS(datatype, max_integers, max_addresses, max_datatypes,
2     array_of_integers, array_of_addresses, array_of_datatypes)
3
4     IN     datatype           datatype to access (handle)
5
6     IN     max_integers       number of elements in array_of_integers (non-negative
7                                     integer)
8
9     IN     max_addresses      number of elements in array_of_addresses (non-negative
10                                    integer)
11
12    OUT    array_of_integers   contains integer arguments used in constructing
13                                    datatype (array of integers)
14
15    OUT    array_of_addresses  contains address arguments used in constructing
16                                    datatype (array of integers)
17
18    OUT    array_of_datatypes  contains datatype arguments used in constructing
19                                    datatype (array of handles)

```

```

19
20 int MPI_Type_get_contents(MPI_Datatype datatype, int max_integers,
21     int max_addresses, int max_datatypes, int array_of_integers[],
22     MPI_Aint array_of_addresses[],
23     MPI_Datatype array_of_datatypes[])

```

```

24 MPI_Type_get_contents(datatype, max_integers, max_addresses, max_datatypes,
25     array_of_integers, array_of_addresses, array_of_datatypes,
26     ierror)
27     TYPE(MPI_Datatype), INTENT(IN) :: datatype
28     INTEGER, INTENT(IN) :: max_integers, max_addresses, max_datatypes
29     INTEGER, INTENT(OUT) :: array_of_integers(max_integers)
30     INTEGER(KIND=MPI_ADDRESS_KIND), INTENT(OUT) ::
31         array_of_addresses(max_addresses)
32     TYPE(MPI_Datatype), INTENT(OUT) :: array_of_datatypes(max_datatypes)
33     INTEGER, OPTIONAL, INTENT(OUT) :: ierror

```

```

34
35 MPI_TYPE_GET_CONTENTS(DATATYPE, MAX_INTEGERS, MAX_ADDRESSES, MAX_DATATYPES,
36     ARRAY_OF_INTEGERS, ARRAY_OF_ADDRESSES, ARRAY_OF_DATATYPES,
37     IERROR)
38     INTEGER DATATYPE, MAX_INTEGERS, MAX_ADDRESSES, MAX_DATATYPES,
39     ARRAY_OF_INTEGERS(*), ARRAY_OF_DATATYPES(*), IERROR
40     INTEGER(KIND=MPI_ADDRESS_KIND) ARRAY_OF_ADDRESSES(*)

```

41 datatype must be a predefined unnamed or a derived datatype; the call is erroneous if
42 datatype is a predefined named datatype.

43 The values given for max_integers, max_addresses, and max_datatypes must be at least as
44 large as the value returned in num_integers, num_addresses, and num_datatypes, respectively,
45 in the call MPI_TYPE_GET_ENVELOPE for the same datatype argument.

46
47 *Rationale.* The arguments max_integers, max_addresses, and max_datatypes allow for
48 error checking in the call. (*End of rationale.*)

The datatypes returned in `array_of_datatypes` are handles to datatype objects that are equivalent to the datatypes used in the original construction call. If these were derived datatypes, then the returned datatypes are new datatype objects, and the user is responsible for freeing these datatypes with `MPI_TYPE_FREE`. If these were predefined datatypes, then the returned datatype is equal to that (constant) predefined datatype and cannot be freed.

The committed state of returned derived datatypes is undefined, i.e., the datatypes may or may not be committed. Furthermore, the content of attributes of returned datatypes is undefined.

Note that `MPI_TYPE_GET_CONTENTS` can be invoked with a `datatype` argument that was constructed using `MPI_TYPE_CREATE_F90_REAL`, `MPI_TYPE_CREATE_F90_INTEGER`, or `MPI_TYPE_CREATE_F90_COMPLEX` (an unnamed predefined datatype). In such a case, an empty `array_of_datatypes` is returned.

Rationale. The definition of datatype equivalence implies that equivalent predefined datatypes are equal. By requiring the same handle for named predefined datatypes, it is possible to use the `==` or `.EQ.` comparison operator to determine the datatype involved. (*End of rationale.*)

Advice to implementors. The datatypes returned in `array_of_datatypes` must appear to the user as if each is an equivalent copy of the datatype used in the type constructor call. Whether this is done by creating a new datatype or via another mechanism such as a reference count mechanism is up to the implementation as long as the semantics are preserved. (*End of advice to implementors.*)

Rationale. The committed state and attributes of the returned datatype is deliberately left vague. The datatype used in the original construction may have been modified since its use in the constructor call. Attributes can be added, removed, or modified as well as having the datatype committed. The semantics given allow for a reference count implementation without having to track these changes. (*End of rationale.*)

In the deprecated datatype constructor calls, the address arguments in Fortran are of type `INTEGER`. In the preferred calls, the address arguments are of type `INTEGER(KIND=MPI_ADDRESS_KIND)`. The call `MPI_TYPE_GET_CONTENTS` returns all addresses in an argument of type `INTEGER(KIND=MPI_ADDRESS_KIND)`. This is true even if the deprecated calls were used. Thus, the location of values returned can be thought of as being returned by the C bindings. It can also be determined by examining the preferred calls for datatype constructors for the deprecated calls that involve addresses.

Rationale. By having all address arguments returned in the `array_of_addresses` argument, the result from a C and Fortran decoding of a `datatype` gives the result in the same argument. It is assumed that an integer of type `INTEGER(KIND=MPI_ADDRESS_KIND)` will be at least as large as the `INTEGER` argument used in datatype construction with the old MPI-1 calls so no loss of information will occur. (*End of rationale.*)

The following defines what values are placed in each entry of the returned arrays depending on the datatype constructor used for `datatype`. It also specifies the size of the arrays needed which is the values returned by `MPI_TYPE_GET_ENVELOPE`. In Fortran, the following calls were made:

```

1     PARAMETER (LARGE = 1000)
2     INTEGER TYPE, NI, NA, ND, COMBINER, I(LARGE), D(LARGE), IERROR
3     INTEGER (KIND=MPI_ADDRESS_KIND) A(LARGE)
4     ! CONSTRUCT DATATYPE TYPE (NOT SHOWN)
5     CALL MPI_TYPE_GET_ENVELOPE(TYPE, NI, NA, ND, COMBINER, IERROR)
6     IF ((NI .GT. LARGE) .OR. (NA .GT. LARGE) .OR. (ND .GT. LARGE)) THEN
7         WRITE (*, *) "NI, NA, OR ND = ", NI, NA, ND, &
8             " RETURNED BY MPI_TYPE_GET_ENVELOPE IS LARGER THAN LARGE = ", LARGE
9         CALL MPI_ABORT(MPI_COMM_WORLD, 99, IERROR)
10    ENDIF
11    CALL MPI_TYPE_GET_CONTENTS(TYPE, NI, NA, ND, I, A, D, IERROR)

```

or in C the analogous calls of:

```

14 #define LARGE 1000
15 int ni, na, nd, combiner, i[LARGE];
16 MPI_Aint a[LARGE];
17 MPI_Datatype type, d[LARGE];
18 /* construct datatype type (not shown) */
19 MPI_Type_get_envelope(type, &ni, &na, &nd, &combiner);
20 if ((ni > LARGE) || (na > LARGE) || (nd > LARGE)) {
21     fprintf(stderr, "ni, na, or nd = %d %d %d returned by ", ni, na, nd);
22     fprintf(stderr, "MPI_Type_get_envelope is larger than LARGE = %d\n",
23         LARGE);
24     MPI_Abort(MPI_COMM_WORLD, 99);
25 };
26 MPI_Type_get_contents(type, ni, na, nd, i, a, d);

```

In the descriptions that follow, the lower case name of arguments is used.

If combiner is `MPI_COMBINER_NAMED` then it is erroneous to call `MPI_TYPE_GET_CONTENTS`.

If combiner is `MPI_COMBINER_DUP` then

Constructor argument	C	Fortran location
oldtype	d[0]	D(1)

and `ni = 0`, `na = 0`, `nd = 1`.

If combiner is `MPI_COMBINER_CONTIGUOUS` then

Constructor argument	C	Fortran location
count	i[0]	I(1)
oldtype	d[0]	D(1)

and `ni = 1`, `na = 0`, `nd = 1`.

If combiner is `MPI_COMBINER_VECTOR` then

Constructor argument	C	Fortran location
count	i[0]	I(1)
blocklength	i[1]	I(2)
stride	i[2]	I(3)
oldtype	d[0]	D(1)

and $ni = 3$, $na = 0$, $nd = 1$.

If combiner is `MPI_COMBINER_HVECTOR` then

Constructor argument	C	Fortran location
count	<code>i[0]</code>	<code>I(1)</code>
blocklength	<code>i[1]</code>	<code>I(2)</code>
stride	<code>a[0]</code>	<code>A(1)</code>
oldtype	<code>d[0]</code>	<code>D(1)</code>

and $ni = 2$, $na = 1$, $nd = 1$.

If combiner is `MPI_COMBINER_INDEXED` then

Constructor argument	C	Fortran location
count	<code>i[0]</code>	<code>I(1)</code>
array_of_blocklengths	<code>i[1]</code> to <code>i[i[0]]</code>	<code>I(2)</code> to <code>I(I(1)+1)</code>
array_of_displacements	<code>i[i[0]+1]</code> to <code>i[2*i[0]]</code>	<code>I(I(1)+2)</code> to <code>I(2*I(1)+1)</code>
oldtype	<code>d[0]</code>	<code>D(1)</code>

and $ni = 2*count+1$, $na = 0$, $nd = 1$.

If combiner is `MPI_COMBINER_HINDEXED` then

Constructor argument	C	Fortran location
count	<code>i[0]</code>	<code>I(1)</code>
array_of_blocklengths	<code>i[1]</code> to <code>i[i[0]]</code>	<code>I(2)</code> to <code>I(I(1)+1)</code>
array_of_displacements	<code>a[0]</code> to <code>a[i[0]-1]</code>	<code>A(1)</code> to <code>A(I(1))</code>
oldtype	<code>d[0]</code>	<code>D(1)</code>

and $ni = count+1$, $na = count$, $nd = 1$.

If combiner is `MPI_COMBINER_INDEXED_BLOCK` then

Constructor argument	C	Fortran location
count	<code>i[0]</code>	<code>I(1)</code>
blocklength	<code>i[1]</code>	<code>I(2)</code>
array_of_displacements	<code>i[2]</code> to <code>i[i[0]+1]</code>	<code>I(3)</code> to <code>I(I(1)+2)</code>
oldtype	<code>d[0]</code>	<code>D(1)</code>

and $ni = count+2$, $na = 0$, $nd = 1$.

If combiner is `MPI_COMBINER_HINDEXED_BLOCK` then

Constructor argument	C	Fortran location
count	<code>i[0]</code>	<code>I(1)</code>
blocklength	<code>i[1]</code>	<code>I(2)</code>
array_of_displacements	<code>a[0]</code> to <code>a[i[0]-1]</code>	<code>A(1)</code> to <code>A(I(1))</code>
oldtype	<code>d[0]</code>	<code>D(1)</code>

and $ni = 2$, $na = count$, $nd = 1$.

If combiner is `MPI_COMBINER_STRUCT` then

Constructor argument	C	Fortran location
count	i[0]	I(1)
array_of_blocklengths	i[1] to i[i[0]]	I(2) to I(I(1)+1)
array_of_displacements	a[0] to a[i[0]-1]	A(1) to A(I(1))
array_of_types	d[0] to d[i[0]-1]	D(1) to D(I(1))

and ni = count+1, na = count, nd = count.

If combiner is MPI_COMBINER_SUBARRAY then

Constructor argument	C	Fortran location
ndims	i[0]	I(1)
array_of_sizes	i[1] to i[i[0]]	I(2) to I(I(1)+1)
array_of_subsizes	i[i[0]+1] to i[2*i[0]]	I(I(1)+2) to I(2*I(1)+1)
array_of_starts	i[2*i[0]+1] to i[3*i[0]]	I(2*I(1)+2) to I(3*I(1)+1)
order	i[3*i[0]+1]	I(3*I(1)+2)
oldtype	d[0]	D(1)

and ni = 3*ndims+2, na = 0, nd = 1.

If combiner is MPI_COMBINER_DARRAY then

Constructor argument	C	Fortran location
size	i[0]	I(1)
rank	i[1]	I(2)
ndims	i[2]	I(3)
array_of_gsizes	i[3] to i[i[2]+2]	I(4) to I(I(3)+3)
array_of_distribs	i[i[2]+3] to i[2*i[2]+2]	I(I(3)+4) to I(2*I(3)+3)
array_of_dargs	i[2*i[2]+3] to i[3*i[2]+2]	I(2*I(3)+4) to I(3*I(3)+3)
array_of_psizes	i[3*i[2]+3] to i[4*i[2]+2]	I(3*I(3)+4) to I(4*I(3)+3)
order	i[4*i[2]+3]	I(4*I(3)+4)
oldtype	d[0]	D(1)

and ni = 4*ndims+4, na = 0, nd = 1.

If combiner is MPI_COMBINER_F90_REAL then

Constructor argument	C	Fortran location
p	i[0]	I(1)
r	i[1]	I(2)

and ni = 2, na = 0, nd = 0.

If combiner is MPI_COMBINER_F90_COMPLEX then

Constructor argument	C	Fortran location
p	i[0]	I(1)
r	i[1]	I(2)

and ni = 2, na = 0, nd = 0.

If combiner is MPI_COMBINER_F90_INTEGER then

Constructor argument	C	Fortran location
r	i[0]	I(1)

and $ni = 1$, $na = 0$, $nd = 0$.

If combiner is `MPI_COMBINER_RESIZED` then

Constructor argument	C	Fortran location
<code>lb</code>	<code>a[0]</code>	<code>A(1)</code>
<code>extent</code>	<code>a[1]</code>	<code>A(2)</code>
<code>oldtype</code>	<code>d[0]</code>	<code>D(1)</code>

and $ni = 0$, $na = 2$, $nd = 1$.

4.1.14 Examples

The following examples illustrate the use of derived datatypes.

Example 4.13 Send and receive a section of a 3D array.

```

REAL a(100,100,100), e(9,9,9)
INTEGER oneslice, twoslice, threeslice, myrank, ierr
INTEGER (KIND=MPI_ADDRESS_KIND) lb, sizeofreal
INTEGER status(MPI_STATUS_SIZE)

C  extract the section a(1:17:2, 3:11, 2:10)
C  and store it in e(:, :, :).

CALL MPI_COMM_RANK(MPI_COMM_WORLD, myrank, ierr)

CALL MPI_TYPE_GET_EXTENT(MPI_REAL, lb, sizeofreal, ierr)

C  create datatype for a 1D section
CALL MPI_TYPE_VECTOR(9, 1, 2, MPI_REAL, oneslice, ierr)

C  create datatype for a 2D section
CALL MPI_TYPE_CREATE_HVECTOR(9, 1, 100*sizeofreal, oneslice,
                             twoslice, ierr)

C  create datatype for the entire section
CALL MPI_TYPE_CREATE_HVECTOR(9, 1, 100*100*sizeofreal, twoslice,
                             threeslice, ierr)

CALL MPI_TYPE_COMMIT(threeslice, ierr)
CALL MPI_SENDRECV(a(1,3,2), 1, threeslice, myrank, 0, e, 9*9*9,
                  MPI_REAL, myrank, 0, MPI_COMM_WORLD, status, ierr)

```

Example 4.14 Copy the (strictly) lower triangular part of a matrix.

```

1     REAL a(100,100), b(100,100)
2     INTEGER disp(100), blocklen(100), ltype, myrank, ierr
3     INTEGER status(MPI_STATUS_SIZE)
4
5     C     copy lower triangular part of array a
6     C     onto lower triangular part of array b
7
8     CALL MPI_COMM_RANK(MPI_COMM_WORLD, myrank, ierr)
9
10    C     compute start and size of each column
11    DO i=1, 100
12        disp(i) = 100*(i-1) + i
13        blocklen(i) = 100-i
14    END DO
15
16    C     create datatype for lower triangular part
17    CALL MPI_TYPE_INDEXED(100, blocklen, disp, MPI_REAL, ltype, ierr)
18
19    CALL MPI_TYPE_COMMIT(ltype, ierr)
20    CALL MPI_SENDRECV(a, 1, ltype, myrank, 0, b, 1,
21                    ltype, myrank, 0, MPI_COMM_WORLD, status, ierr)
22

```

Example 4.15 Transpose a matrix.

```

24    REAL a(100,100), b(100,100)
25    INTEGER row, xpose, myrank, ierr
26    INTEGER (KIND=MPI_ADDRESS_KIND) lb, sizeofreal
27    INTEGER status(MPI_STATUS_SIZE)
28
29
30    C     transpose matrix a onto b
31
32    CALL MPI_COMM_RANK(MPI_COMM_WORLD, myrank, ierr)
33
34    CALL MPI_TYPE_GET_EXTENT(MPI_REAL, lb, sizeofreal, ierr)
35
36    C     create datatype for one row
37    CALL MPI_TYPE_VECTOR(100, 1, 100, MPI_REAL, row, ierr)
38
39    C     create datatype for matrix in row-major order
40    CALL MPI_TYPE_CREATE_HVECTOR(100, 1, sizeofreal, row, xpose, ierr)
41
42    CALL MPI_TYPE_COMMIT(xpose, ierr)
43
44    C     send matrix in row-major order and receive in column major order
45    CALL MPI_SENDRECV(a, 1, xpose, myrank, 0, b, 100*100,
46                    MPI_REAL, myrank, 0, MPI_COMM_WORLD, status, ierr)
47

```

Example 4.16 Another approach to the transpose problem:

```

REAL a(100,100), b(100,100)
INTEGER row, row1
INTEGER (KIND=MPI_ADDRESS_KIND) disp(2), lb, sizeofreal
INTEGER myrank, ierr
INTEGER status(MPI_STATUS_SIZE)

CALL MPI_COMM_RANK(MPI_COMM_WORLD, myrank, ierr)

C transpose matrix a onto b

CALL MPI_TYPE_GET_EXTENT(MPI_REAL, lb, sizeofreal, ierr)

C create datatype for one row
CALL MPI_TYPE_VECTOR(100, 1, 100, MPI_REAL, row, ierr)

C create datatype for one row, with the extent of one real number
lb = 0
CALL MPI_TYPE_CREATE_RESIZED(row, lb, sizeofreal, row1, ierr)

CALL MPI_TYPE_COMMIT(row1, ierr)

C send 100 rows and receive in column major order
CALL MPI_SENDRECV(a, 100, row1, myrank, 0, b, 100*100,
                  MPI_REAL, myrank, 0, MPI_COMM_WORLD, status, ierr)

```

Example 4.17 We manipulate an array of structures.

```

struct Partstruct
{
    int    type; /* particle type */
    double d[6]; /* particle coordinates */
    char   b[7]; /* some additional information */
};

struct Partstruct    particle[1000];

int                i, dest, tag;
MPI_Comm          comm;

/* build datatype describing structure */

MPI_Datatype Particlestruct, Particletype;
MPI_Datatype type[3] = {MPI_INT, MPI_DOUBLE, MPI_CHAR};
int          blocklen[3] = {1, 6, 7};
MPI_Aint     disp[3];
MPI_Aint     base, lb, sizeofentry;

```

```

1
2  /* compute displacements of structure components */
3
4  MPI_Get_address(particle, disp);
5  MPI_Get_address(particle[0].d, disp+1);
6  MPI_Get_address(particle[0].b, disp+2);
7  base = disp[0];
8  for (i=0; i < 3; i++) disp[i] = MPI_Aint_diff(disp[i], base);
9
10 MPI_Type_create_struct(3, blocklen, disp, type, &Particlestruct);
11
12     /* If compiler does padding in mysterious ways,
13     the following may be safer */
14
15 /* compute extent of the structure */
16
17 MPI_Get_address(particle+1, &sizeofentry);
18 sizeofentry = MPI_Aint_diff(sizeofentry, base);
19
20 /* build datatype describing structure */
21
22 MPI_Type_create_resized(Particlestruct, 0, sizeofentry, &Particletype);
23
24
25         /* 4.1:
26         send the entire array */
27
28 MPI_Type_commit(&Particletype);
29 MPI_Send(particle, 1000, Particletype, dest, tag, comm);
30
31
32         /* 4.2:
33         send only the entries of type zero particles,
34         preceded by the number of such entries */
35
36 MPI_Datatype Zparticles; /* datatype describing all particles
37                          with type zero (needs to be recomputed
38                          if types change) */
39 MPI_Datatype Ztype;
40
41 int          zdisp[1000];
42 int          zblock[1000], j, k;
43 int          zzblock[2] = {1,1};
44 MPI_Aint     zzdisp[2];
45 MPI_Datatype zztype[2];
46
47 /* compute displacements of type zero particles */
48 j = 0;

```

```

for (i=0; i < 1000; i++)
    if (particle[i].type == 0)
        {
            zdisp[j] = i;
            zblock[j] = 1;
            j++;
        }

/* create datatype for type zero particles */
MPI_Type_indexed(j, zblock, zdisp, Particletype, &Zparticles);

/* prepend particle count */
MPI_Get_address(&j, zzdisp);
MPI_Get_address(particle, zzdisp+1);
zztype[0] = MPI_INT;
zztype[1] = Zparticles;
MPI_Type_create_struct(2, zzblock, zzdisp, zztype, &Ztype);

MPI_Type_commit(&Ztype);
MPI_Send(MPI_BOTTOM, 1, Ztype, dest, tag, comm);

        /* A probably more efficient way of defining Zparticles */

/* consecutive particles with index zero are handled as one block */
j=0;
for (i=0; i < 1000; i++)
    if (particle[i].type == 0)
        {
            for (k=i+1; (k < 1000)&&(particle[k].type == 0); k++);
            zdisp[j] = i;
            zblock[j] = k-i;
            j++;
            i = k;
        }
MPI_Type_indexed(j, zblock, zdisp, Particletype, &Zparticles);

        /* 4.3:
        send the first two coordinates of all entries */

MPI_Datatype Allpairs;      /* datatype for all pairs of coordinates */

MPI_Type_get_extent(Particletype, &lb, &sizeofentry);

/* sizeofentry can also be computed by subtracting the address
of particle[0] from the address of particle[1] */

```

```

1 MPI_Type_create_hvector(1000, 2, sizeofentry, MPI_DOUBLE, &Allpairs);
2 MPI_Type_commit(&Allpairs);
3 MPI_Send(particle[0].d, 1, Allpairs, dest, tag, comm);
4
5     /* an alternative solution to 4.3 */
6
7 MPI_Datatype Twodouble;
8
9 MPI_Type_contiguous(2, MPI_DOUBLE, &Twodouble);
10
11 MPI_Datatype Onepair; /* datatype for one pair of coordinates, with
12                       the extent of one particle entry */
13
14 MPI_Type_create_resized(Twodouble, 0, sizeofentry, &Onepair );
15 MPI_Type_commit(&Onepair);
16 MPI_Send(particle[0].d, 1000, Onepair, dest, tag, comm);
17
18
19

```

20 **Example 4.18** The same manipulations as in the previous example, but use absolute
21 addresses in datatypes.

```

22 struct Partstruct
23 {
24     int    type;
25     double d[6];
26     char   b[7];
27 };
28
29
30 struct Partstruct particle[1000];
31
32     /* build datatype describing first array entry */
33
34 MPI_Datatype Particletype;
35 MPI_Datatype type[3] = {MPI_INT, MPI_DOUBLE, MPI_CHAR};
36 int          block[3] = {1, 6, 7};
37 MPI_Aint     disp[3];
38
39 MPI_Get_address(particle, disp);
40 MPI_Get_address(particle[0].d, disp+1);
41 MPI_Get_address(particle[0].b, disp+2);
42 MPI_Type_create_struct(3, block, disp, type, &Particletype);
43
44 /* Particletype describes first array entry -- using absolute
45    addresses */
46
47     /* 5.1:
48    send the entire array */

```

```

1
2 MPI_Type_commit(&Particletype);
3 MPI_Send(MPI_BOTTOM, 1000, Particletype, dest, tag, comm);
4
5
6         /* 5.2:
7         send the entries of type zero,
8         preceded by the number of such entries */
9
10 MPI_Datatype Zparticles, Ztype;
11
12 int         zdisp[1000];
13 int         zblock[1000], i, j, k;
14 int         zzblock[2] = {1,1};
15 MPI_Datatype zztype[2];
16 MPI_Aint    zzdisp[2];
17
18 j=0;
19 for (i=0; i < 1000; i++)
20     if (particle[i].type == 0)
21     {
22         for (k=i+1; (k < 1000)&&(particle[k].type == 0); k++);
23         zdisp[j] = i;
24         zblock[j] = k-i;
25         j++;
26         i = k;
27     }
28 MPI_Type_indexed(j, zblock, zdisp, Particletype, &Zparticles);
29 /* Zparticles describe particles with type zero, using
30    their absolute addresses*/
31
32 /* prepend particle count */
33 MPI_Get_address(&j, zzdisp);
34 zzdisp[1] = (MPI_Aint)0;
35 zztype[0] = MPI_INT;
36 zztype[1] = Zparticles;
37 MPI_Type_create_struct(2, zzblock, zzdisp, zztype, &Ztype);
38
39 MPI_Type_commit(&Ztype);
40 MPI_Send(MPI_BOTTOM, 1, Ztype, dest, tag, comm);
41
42
43

```

Example 4.19 Handling of unions.

```

44
45 union {
46     int     ival;
47     float   fval;
48

```

```

1      } u[1000];
2
3      int    utype;
4
5      /* All entries of u have identical type; variable
6         utype keeps track of their current type */
7
8      MPI_Datatype  mpi_utype[2];
9      MPI_Aint      i, extent;
10
11     /* compute an MPI datatype for each possible union type;
12        assume values are left-aligned in union storage. */
13
14     MPI_Get_address(u, &i);
15     MPI_Get_address(u+1, &extent);
16     extent = MPI_Aint_diff(extent, i);
17
18     MPI_Type_create_resized(MPI_INT, 0, extent, &mpi_utype[0]);
19
20     MPI_Type_create_resized(MPI_FLOAT, 0, extent, &mpi_utype[1]);
21
22     for(i=0; i<2; i++) MPI_Type_commit(&mpi_utype[i]);
23
24     /* actual communication */
25
26     MPI_Send(u, 1000, mpi_utype[utype], dest, tag, comm);
27

```

Example 4.20 This example shows how a datatype can be decoded. The routine `printdatatype` prints out the elements of the datatype. Note the use of `MPI_Type_free` for datatypes that are not predefined.

```

32     /*
33        Example of decoding a datatype.
34
35        Returns 0 if the datatype is predefined, 1 otherwise
36        */
37     #include <stdio.h>
38     #include <stdlib.h>
39     #include "mpi.h"
40     int printdatatype(MPI_Datatype datatype)
41     {
42         int *array_of_ints;
43         MPI_Aint *array_of_adds;
44         MPI_Datatype *array_of_dtypes;
45         int num_ints, num_adds, num_dtypes, combiner;
46         int i;
47
48         MPI_Type_get_envelope(datatype,

```

```

                                &num_ints, &num_adds, &num_dtypes, &combiner); 1
switch (combiner) { 2
case MPI_COMBINER_NAMED: 3
    printf("Datatype is named:"); 4
    /* To print the specific type, we can match against the 5
       predefined forms. We can NOT use a switch statement here 6
       We could also use MPI_TYPE_GET_NAME if we preferred to use 7
       names that the user may have changed. 8
    */ 9
    if (datatype == MPI_INT) printf( "MPI_INT\n" ); 10
    else if (datatype == MPI_DOUBLE) printf( "MPI_DOUBLE\n" ); 11
    ... else test for other types ... 12
    return 0; 13
    break; 14
case MPI_COMBINER_STRUCT: 15
case MPI_COMBINER_STRUCT_INTEGER: 16
    printf("Datatype is struct containing"); 17
    array_of_ints = (int *)malloc(num_ints * sizeof(int)); 18
    array_of_adds = 19
        (MPI_Aint *) malloc(num_adds * sizeof(MPI_Aint)); 20
    array_of_dtypes = (MPI_Datatype *) 21
        malloc(num_dtypes * sizeof(MPI_Datatype)); 22
    MPI_Type_get_contents(datatype, num_ints, num_adds, num_dtypes, 23
        array_of_ints, array_of_adds, array_of_dtypes); 24
    printf(" %d datatypes:\n", array_of_ints[0]); 25
    for (i=0; i<array_of_ints[0]; i++) { 26
        printf("blocklength %d, displacement %ld, type:\n", 27
            array_of_ints[i+1], (long)array_of_adds[i]); 28
        if (printdatatype(array_of_dtypes[i])) { 29
            /* Note that we free the type ONLY if it 30
               is not predefined */ 31
            MPI_Type_free(&array_of_dtypes[i]); 32
        } 33
    } 34
    free(array_of_ints); 35
    free(array_of_adds); 36
    free(array_of_dtypes); 37
    break; 38
    ... other combiner values ... 39
default: 40
    printf("Unrecognized combiner type\n"); 41
} 42
return 1; 43
} 44
} 45
} 46
} 47
} 48

```

4.2 Pack and Unpack

Some existing communication libraries provide pack/unpack functions for sending noncontiguous data. In these, the user explicitly packs data into a contiguous buffer before sending it, and unpacks it from a contiguous buffer after receiving it. Derived datatypes, which are described in Section 4.1, allow one, in most cases, to avoid explicit packing and unpacking. The user specifies the layout of the data to be sent or received, and the communication library directly accesses a noncontiguous buffer. The pack/unpack routines are provided for compatibility with previous libraries. Also, they provide some functionality that is not otherwise available in MPI. For instance, a message can be received in several parts, where the receive operation done on a later part may depend on the content of a former part. Another use is that outgoing messages may be explicitly buffered in user supplied space, thus overriding the system buffering policy. Finally, the availability of pack and unpack operations facilitates the development of additional communication libraries layered on top of MPI.

```
MPI_PACK(inbuf, incount, datatype, outbuf, outsize, position, comm)
```

IN	inbuf	input buffer start (choice)
IN	incount	number of input data items (non-negative integer)
IN	datatype	datatype of each input data item (handle)
OUT	outbuf	output buffer start (choice)
IN	outsize	output buffer size, in bytes (non-negative integer)
INOUT	position	current position in buffer, in bytes (integer)
IN	comm	communicator for packed message (handle)

```
int MPI_Pack(const void* inbuf, int incount, MPI_Datatype datatype,
            void *outbuf, int outsize, int *position, MPI_Comm comm)
```

```
MPI_Pack(inbuf, incount, datatype, outbuf, outsize, position, comm, ierror)
    TYPE(*), DIMENSION(..), INTENT(IN) :: inbuf
    TYPE(*), DIMENSION(..) :: outbuf
    INTEGER, INTENT(IN) :: incount, outsize
    TYPE(MPI_Datatype), INTENT(IN) :: datatype
    INTEGER, INTENT(INOUT) :: position
    TYPE(MPI_Comm), INTENT(IN) :: comm
    INTEGER, OPTIONAL, INTENT(OUT) :: ierror
```

```
MPI_PACK(INBUF, INCOUNT, DATATYPE, OUTBUF, OUTSIZE, POSITION, COMM, IERROR)
    <type> INBUF(*), OUTBUF(*)
    INTEGER INCOUNT, DATATYPE, OUTSIZE, POSITION, COMM, IERROR
```

Packs the message in the send buffer specified by `inbuf`, `incount`, `datatype` into the buffer space specified by `outbuf` and `outsize`. The input buffer can be any communication buffer allowed in `MPI_SEND`. The output buffer is a contiguous storage area containing `outsize` bytes, starting at the address `outbuf` (length is counted in *bytes*, not elements, as if it were a communication buffer for a message of type `MPI_PACKED`).

The input value of `position` is the first location in the output buffer to be used for packing. `position` is incremented by the size of the packed message, and the output value of `position` is the first location in the output buffer following the locations occupied by the packed message. The `comm` argument is the communicator that will be subsequently used for sending the packed message.

```
MPI_UNPACK(inbuf, insize, position, outbuf, outcount, datatype, comm)
```

IN	inbuf	input buffer start (choice)
IN	insize	size of input buffer, in bytes (non-negative integer)
INOUT	position	current position in bytes (integer)
OUT	outbuf	output buffer start (choice)
IN	outcount	number of items to be unpacked (integer)
IN	datatype	datatype of each output data item (handle)
IN	comm	communicator for packed message (handle)

```
int MPI_Unpack(const void* inbuf, int insize, int *position, void *outbuf,
               int outcount, MPI_Datatype datatype, MPI_Comm comm)
```

```
MPI_Unpack(inbuf, insize, position, outbuf, outcount, datatype, comm,
            ierror)
```

```
TYPE(*), DIMENSION(..), INTENT(IN) :: inbuf
TYPE(*), DIMENSION(..) :: outbuf
INTEGER, INTENT(IN) :: insize, outcount
INTEGER, INTENT(INOUT) :: position
TYPE(MPI_Datatype), INTENT(IN) :: datatype
TYPE(MPI_Comm), INTENT(IN) :: comm
INTEGER, OPTIONAL, INTENT(OUT) :: ierror
```

```
MPI_UNPACK(INBUF, INSIZE, POSITION, OUTBUF, OUTCOUNT, DATATYPE, COMM,
            IERROR)
```

```
<type> INBUF(*), OUTBUF(*)
INTEGER INSIZE, POSITION, OUTCOUNT, DATATYPE, COMM, IERROR
```

Unpacks a message into the receive buffer specified by `outbuf`, `outcount`, `datatype` from the buffer space specified by `inbuf` and `insize`. The output buffer can be any communication buffer allowed in `MPI_RECV`. The input buffer is a contiguous storage area containing `insize` bytes, starting at address `inbuf`. The input value of `position` is the first location in the input buffer occupied by the packed message. `position` is incremented by the size of the packed message, so that the output value of `position` is the first location in the input buffer after the locations occupied by the message that was unpacked. `comm` is the communicator used to receive the packed message.

Advice to users. Note the difference between `MPI_RECV` and `MPI_UNPACK`: in `MPI_RECV`, the count argument specifies the maximum number of items that can be received. The actual number of items received is determined by the length of the incoming message. In `MPI_UNPACK`, the count argument specifies the actual

1 number of items that are unpacked; the “size” of the corresponding message is the
 2 increment in **position**. The reason for this change is that the “incoming message size”
 3 is not predetermined since the user decides how much to unpack; nor is it easy to
 4 determine the “message size” from the number of items to be unpacked. In fact, in a
 5 heterogeneous system, this number may not be determined *a priori*. (*End of advice*
 6 *to users.*)

7
 8 To understand the behavior of **pack** and **unpack**, it is convenient to think of the data
 9 part of a message as being the sequence obtained by concatenating the successive values sent
 10 in that message. The **pack** operation stores this sequence in the buffer space, as if sending
 11 the message to that buffer. The **unpack** operation retrieves this sequence from buffer space,
 12 as if receiving a message from that buffer. (It is helpful to think of internal Fortran files or
 13 **sscanf** in C, for a similar function.)

14 Several messages can be successively packed into one **packing unit**. This is effected
 15 by several successive **related** calls to **MPI_PACK**, where the first call provides **position = 0**,
 16 and each successive call inputs the value of **position** that was output by the previous call,
 17 and the same values for **outbuf**, **outcount** and **comm**. This packing unit now contains the
 18 equivalent information that would have been stored in a message by one send call with a
 19 send buffer that is the “concatenation” of the individual send buffers.

20 A packing unit can be sent using type **MPI_PACKED**. Any point to point or collective
 21 communication function can be used to move the sequence of bytes that forms the packing
 22 unit from one process to another. This packing unit can now be received using any receive
 23 operation, with any datatype: the type matching rules are relaxed for messages sent with
 24 type **MPI_PACKED**.

25 A message sent with any type (including **MPI_PACKED**) can be received using the type
 26 **MPI_PACKED**. Such a message can then be unpacked by calls to **MPI_UNPACK**.

27 A packing unit (or a message created by a regular, “typed” send) can be unpacked into
 28 several successive messages. This is effected by several successive related calls to
 29 **MPI_UNPACK**, where the first call provides **position = 0**, and each successive call inputs the
 30 value of **position** that was output by the previous call, and the same values for **inbuf**, **insize**
 31 and **comm**.

32 The concatenation of two packing units is not necessarily a packing unit; nor is a
 33 substring of a packing unit necessarily a packing unit. Thus, one cannot concatenate two
 34 packing units and then unpack the result as one packing unit; nor can one unpack a substring
 35 of a packing unit as a separate packing unit. Each packing unit, that was created by a related
 36 sequence of **pack** calls, or by a regular send, must be unpacked as a unit, by a sequence of
 37 related **unpack** calls.

38
 39 *Rationale.* The restriction on “atomic” packing and unpacking of packing units
 40 allows the implementation to add at the head of packing units additional information,
 41 such as a description of the sender architecture (to be used for type conversion, in a
 42 heterogeneous environment) (*End of rationale.*)

43
 44 The following call allows the user to find out how much space is needed to pack a
 45 message and, thus, manage space allocation for buffers.

MPI_PACK_SIZE(incount, datatype, comm, size)	1
IN incount	2
	3
IN datatype	4
	5
IN comm	6
	7
OUT size	8
	9

```
int MPI_Pack_size(int incount, MPI_Datatype datatype, MPI_Comm comm,
                 int *size)
10
11
```

```
MPI_Pack_size(incount, datatype, comm, size, ierror)
12
INTEGER, INTENT(IN) :: incount
13
TYPE(MPI_Datatype), INTENT(IN) :: datatype
14
TYPE(MPI_Comm), INTENT(IN) :: comm
15
INTEGER, INTENT(OUT) :: size
16
INTEGER, OPTIONAL, INTENT(OUT) :: ierror
17
18
```

```
MPI_PACK_SIZE(INCOUNT, DATATYPE, COMM, SIZE, IERROR)
19
INTEGER INCOUNT, DATATYPE, COMM, SIZE, IERROR
20
```

A call to MPI_PACK_SIZE(incount, datatype, comm, size) returns in size an upper bound on the increment in position that is effected by a call to MPI_PACK(inbuf, incount, datatype, outbuf, outcount, position, comm). If the packed size of the datatype cannot be expressed by the size parameter, then MPI_PACK_SIZE sets the value of size to MPI_UNDEFINED.

Rationale. The call returns an upper bound, rather than an exact bound, since the exact amount of space needed to pack the message may depend on the context (e.g., first message packed in a packing unit may take more space). (*End of rationale.*)

Example 4.21 An example using MPI_PACK.

```
int position, i, j, a[2];
char buff[1000];

MPI_Comm_rank(MPI_COMM_WORLD, &myrank);
if (myrank == 0)
{
    /* SENDER CODE */

    position = 0;
    MPI_Pack(&i, 1, MPI_INT, buff, 1000, &position, MPI_COMM_WORLD);
    MPI_Pack(&j, 1, MPI_INT, buff, 1000, &position, MPI_COMM_WORLD);
    MPI_Send(buff, position, MPI_PACKED, 1, 0, MPI_COMM_WORLD);
}
else /* RECEIVER CODE */
    MPI_Recv(a, 2, MPI_INT, 0, 0, MPI_COMM_WORLD, MPI_STATUS_IGNORE);
```

Example 4.22 An elaborate example.

```

1  int  position, i;
2  float a[1000];
3  char  buff[1000];
4
5  MPI_Comm_rank(MPI_COMM_WORLD, &myrank);
6  if (myrank == 0)
7  {
8      /* SENDER CODE */
9
10     int len[2];
11     MPI_Aint disp[2];
12     MPI_Datatype type[2], newtype;
13
14     /* build datatype for i followed by a[0]...a[i-1] */
15
16     len[0] = 1;
17     len[1] = i;
18     MPI_Get_address(&i, disp);
19     MPI_Get_address(a, disp+1);
20     type[0] = MPI_INT;
21     type[1] = MPI_FLOAT;
22     MPI_Type_create_struct(2, len, disp, type, &newtype);
23     MPI_Type_commit(&newtype);
24
25     /* Pack i followed by a[0]...a[i-1]*/
26
27     position = 0;
28     MPI_Pack(MPI_BOTTOM, 1, newtype, buff, 1000, &position, MPI_COMM_WORLD);
29
30     /* Send */
31
32     MPI_Send(buff, position, MPI_PACKED, 1, 0,
33             MPI_COMM_WORLD);
34
35     /* *****
36     One can replace the last three lines with
37     MPI_Send(MPI_BOTTOM, 1, newtype, 1, 0, MPI_COMM_WORLD);
38     ***** */
39 }
40 else if (myrank == 1)
41 {
42     /* RECEIVER CODE */
43
44     MPI_Status status;
45
46     /* Receive */
47
48     MPI_Recv(buff, 1000, MPI_PACKED, 0, 0, MPI_COMM_WORLD, &status);

```

```

/* Unpack i */
position = 0;
MPI_Unpack(buff, 1000, &position, &i, 1, MPI_INT, MPI_COMM_WORLD);

/* Unpack a[0]...a[i-1] */
MPI_Unpack(buff, 1000, &position, a, i, MPI_FLOAT, MPI_COMM_WORLD);
}

```

Example 4.23 Each process sends a count, followed by count characters to the root; the root concatenates all characters into one string.

```

int count, gsize, counts[64], totalcount, k1, k2, k,
    displs[64], position, concat_pos;
char chr[100], *lbuf, *rbuf, *cbuf;

MPI_Comm_size(comm, &gsize);
MPI_Comm_rank(comm, &myrank);

/* allocate local pack buffer */
MPI_Pack_size(1, MPI_INT, comm, &k1);
MPI_Pack_size(count, MPI_CHAR, comm, &k2);
k = k1+k2;
lbuf = (char *)malloc(k);

/* pack count, followed by count characters */
position = 0;
MPI_Pack(&count, 1, MPI_INT, lbuf, k, &position, comm);
MPI_Pack(chr, count, MPI_CHAR, lbuf, k, &position, comm);

if (myrank != root) {
    /* gather at root sizes of all packed messages */
    MPI_Gather(&position, 1, MPI_INT, NULL, 0,
              MPI_DATATYPE_NULL, root, comm);

    /* gather at root packed messages */
    MPI_Gatherv(lbuf, position, MPI_PACKED, NULL,
               NULL, NULL, MPI_DATATYPE_NULL, root, comm);
} else { /* root code */
    /* gather sizes of all packed messages */
    MPI_Gather(&position, 1, MPI_INT, counts, 1,
              MPI_INT, root, comm);

    /* gather all packed messages */
    displs[0] = 0;
    for (i=1; i < gsize; i++)

```

```

1     displs[i] = displs[i-1] + counts[i-1];
2     totalcount = displs[gsize-1] + counts[gsize-1];
3     rbuf = (char *)malloc(totalcount);
4     cbuf = (char *)malloc(totalcount);
5     MPI_Gatherv(lbuf, position, MPI_PACKED, rbuf,
6               counts, displs, MPI_PACKED, root, comm);
7
8     /* unpack all messages and concatenate strings */
9     concat_pos = 0;
10    for (i=0; i < gsize; i++) {
11        position = 0;
12        MPI_Unpack(rbuf+displs[i], totalcount-displs[i],
13                 &position, &count, 1, MPI_INT, comm);
14        MPI_Unpack(rbuf+displs[i], totalcount-displs[i],
15                 &position, cbuf+concat_pos, count, MPI_CHAR, comm);
16        concat_pos += count;
17    }
18    cbuf[concat_pos] = '\0';
19 }
20
21
22

```

4.3 Canonical MPI_PACK and MPI_UNPACK

These functions read/write data to/from the buffer in the “external32” data format specified in Section 13.5.2, and calculate the size needed for packing. Their first arguments specify the data format, for future extensibility, but currently the only valid value of the `datarep` argument is “external32.”

Advice to users. These functions could be used, for example, to send typed data in a portable format from one MPI implementation to another. (*End of advice to users.*)

The buffer will contain exactly the packed data, without headers. `MPI_BYTE` should be used to send and receive data that is packed using `MPI_PACK_EXTERNAL`.

Rationale. `MPI_PACK_EXTERNAL` specifies that there is no header on the message and further specifies the exact format of the data. Since `MPI_PACK` may (and is allowed to) use a header, the datatype `MPI_PACKED` cannot be used for data packed with `MPI_PACK_EXTERNAL`. (*End of rationale.*)

```

MPI_PACK_EXTERNAL(datarep, inbuf, incount, datatype, outbuf, outsize, position) 1
IN      datarep      data representation (string) 2
IN      inbuf        input buffer start (choice) 3
IN      incount      number of input data items (integer) 4
IN      datatype     datatype of each input data item (handle) 5
OUT     outbuf       output buffer start (choice) 6
IN      outsize      output buffer size, in bytes (integer) 7
INOUT   position     current position in buffer, in bytes (integer) 8
                                                    9
                                                    10
                                                    11
int MPI_Pack_external(const char datarep[], const void *inbuf, int incount, 12
                    MPI_Datatype datatype, void *outbuf, MPI_Aint outsize, 13
                    MPI_Aint *position) 14
                                                    15
MPI_Pack_external(datarep, inbuf, incount, datatype, outbuf, outsize, 16
                 position, ierror) 17
CHARACTER(LEN=*), INTENT(IN) :: datarep 18
TYPE(*), DIMENSION(..), INTENT(IN) :: inbuf 19
TYPE(*), DIMENSION(..) :: outbuf 20
INTEGER, INTENT(IN) :: incount 21
TYPE(MPI_Datatype), INTENT(IN) :: datatype 22
INTEGER(KIND=MPI_ADDRESS_KIND), INTENT(IN) :: outsize 23
INTEGER(KIND=MPI_ADDRESS_KIND), INTENT(INOUT) :: position 24
INTEGER, OPTIONAL, INTENT(OUT) :: ierror 25
                                                    26
MPI_PACK_EXTERNAL(DATAREP, INBUF, INCOUNT, DATATYPE, OUTBUF, OUTSIZE, 27
                 POSITION, IERROR) 28
INTEGER INCOUNT, DATATYPE, IERROR 29
INTEGER(KIND=MPI_ADDRESS_KIND) OUTSIZE, POSITION 30
CHARACTER*(*) DATAREP 31
<type> INBUF(*), OUTBUF(*) 32
                                                    33
                                                    34
MPI_UNPACK_EXTERNAL(datarep, inbuf, insize, position, outbuf, outsize, position) 35
IN      datarep      data representation (string) 36
IN      inbuf        input buffer start (choice) 37
IN      insize       input buffer size, in bytes (integer) 38
INOUT   position     current position in buffer, in bytes (integer) 39
OUT     outbuf       output buffer start (choice) 40
IN      outcount     number of output data items (integer) 41
IN      datatype     datatype of output data item (handle) 42
                                                    43
                                                    44
                                                    45
int MPI_Unpack_external(const char datarep[], const void *inbuf, 46
                    MPI_Aint insize, MPI_Aint *position, void *outbuf, 47
                    int outcount, MPI_Datatype datatype) 48

```

```

1 MPI_Unpack_external(datarep, inbuf, insize, position, outbuf, outcount,
2     datatype, ierror)
3     CHARACTER(LEN=*), INTENT(IN) :: datarep
4     TYPE(*), DIMENSION(..), INTENT(IN) :: inbuf
5     TYPE(*), DIMENSION(..) :: outbuf
6     INTEGER(KIND=MPI_ADDRESS_KIND), INTENT(IN) :: insize
7     INTEGER(KIND=MPI_ADDRESS_KIND), INTENT(INOUT) :: position
8     INTEGER, INTENT(IN) :: outcount
9     TYPE(MPI_Datatype), INTENT(IN) :: datatype
10    INTEGER, OPTIONAL, INTENT(OUT) :: ierror
11
12 MPI_UNPACK_EXTERNAL(DATAREP, INBUF, INSIZE, POSITION, OUTBUF, OUTCOUNT,
13     DATATYPE, IERROR)
14    INTEGER OUTCOUNT, DATATYPE, IERROR
15    INTEGER(KIND=MPI_ADDRESS_KIND) INSIZE, POSITION
16    CHARACTER*(*) DATAREP
17    <type> INBUF(*), OUTBUF(*)
18
19
20 MPI_PACK_EXTERNAL_SIZE(datarep, incount, datatype, size)
21    IN        datarep                data representation (string)
22    IN        incount                number of input data items (integer)
23    IN        datatype                datatype of each input data item (handle)
24    OUT       size                    output buffer size, in bytes (integer)
25
26
27 int MPI_Pack_external_size(const char datarep[], int incount,
28     MPI_Datatype datatype, MPI_Aint *size)
29
30 MPI_Pack_external_size(datarep, incount, datatype, size, ierror)
31     TYPE(MPI_Datatype), INTENT(IN) :: datatype
32     INTEGER, INTENT(IN) :: incount
33     CHARACTER(LEN=*), INTENT(IN) :: datarep
34     INTEGER(KIND=MPI_ADDRESS_KIND), INTENT(OUT) :: size
35     INTEGER, OPTIONAL, INTENT(OUT) :: ierror
36
37 MPI_PACK_EXTERNAL_SIZE(DATAREP, INCOUNT, DATATYPE, SIZE, IERROR)
38     INTEGER INCOUNT, DATATYPE, IERROR
39     INTEGER(KIND=MPI_ADDRESS_KIND) SIZE
40     CHARACTER*(*) DATAREP
41
42
43
44
45
46
47
48

```

1
2
3
4
5
6
7
8
9
10
11
12
13
14
15
16
17
18
19
20
21
22
23
24
25
26
27
28
29
30
31
32
33
34
35
36
37
38
39
40
41
42
43
44
45
46
47
48

Chapter 5

Collective Communication

5.1 Introduction and Overview

Collective communication is defined as communication that involves a group or groups of processes. The functions of this type provided by MPI are the following:

- `MPI_BARRIER`, `MPI_IBARRIER`: Barrier synchronization across all members of a group (Section 5.3 and Section 5.12.1).
- `MPI_BCAST`, `MPI_IBCAST`: Broadcast from one member to all members of a group (Section 5.4 and Section 5.12.2). This is shown as “broadcast” in Figure 5.1.
- `MPI_GATHER`, `MPI_IGATHER`, `MPI_GATHERV`, `MPI_IGATHERV`: Gather data from all members of a group to one member (Section 5.5 and Section 5.12.3). This is shown as “gather” in Figure 5.1.
- `MPI_SCATTER`, `MPI_ISCATTER`, `MPI_SCATTERV`, `MPI_ISCATTERV`: Scatter data from one member to all members of a group (Section 5.6 and Section 5.12.4). This is shown as “scatter” in Figure 5.1.
- `MPI_ALLGATHER`, `MPI_IALLGATHER`, `MPI_ALLGATHERV`, `MPI_IALLGATHERV`: A variation on Gather where all members of a group receive the result (Section 5.7 and Section 5.12.5). This is shown as “allgather” in Figure 5.1.
- `MPI_ALLTOALL`, `MPI_IALLTOALL`, `MPI_ALLTOALLV`, `MPI_IALLTOALLV`, `MPI_ALLTOALLW`, `MPI_IALLTOALLW`: Scatter/Gather data from all members to all members of a group (also called complete exchange) (Section 5.8 and Section 5.12.6). This is shown as “complete exchange” in Figure 5.1.
- `MPI_ALLREDUCE`, `MPI_IALLREDUCE`, `MPI_REDUCE`, `MPI_IREDUCE`: Global reduction operations such as sum, max, min, or user-defined functions, where the result is returned to all members of a group (Section 5.9.6 and Section 5.12.8) and a variation where the result is returned to only one member (Section 5.9 and Section 5.12.7).
- `MPI_REDUCE_SCATTER_BLOCK`, `MPI_IREDUCE_SCATTER_BLOCK`, `MPI_REDUCE_SCATTER`, `MPI_IREDUCE_SCATTER`: A combined reduction and scatter operation (Section 5.10, Section 5.12.9, and Section 5.12.10).

- `MPI_SCAN`, `MPI_ISCAN`, `MPI_EXSCAN`, `MPI_IEXSCAN`: Scan across all members of a group (also called prefix) (Section 5.11, Section 5.11.2, Section 5.12.11, and Section 5.12.12).

One of the key arguments in a call to a collective routine is a communicator that defines the group or groups of participating processes and provides a context for the operation. This is discussed further in Section 5.2. The syntax and semantics of the collective operations are defined to be consistent with the syntax and semantics of the point-to-point operations. Thus, general datatypes are allowed and must match between sending and receiving processes as specified in Chapter 4. Several collective routines such as broadcast and gather have a single originating or receiving process. Such a process is called the *root*. Some arguments in the collective functions are specified as “significant only at root,” and are ignored for all participants except the root. The reader is referred to Chapter 4 for information concerning communication buffers, general datatypes and type matching rules, and to Chapter 6 for information on how to define groups and create communicators.

The type-matching conditions for the collective operations are more strict than the corresponding conditions between sender and receiver in point-to-point. Namely, for collective operations, the amount of data sent must exactly match the amount of data specified by the receiver. Different type maps (the layout in memory, see Section 4.1) between sender and receiver are still allowed.

Collective operations can (but are not required to) complete as soon as the caller’s participation in the collective communication is finished. A blocking operation is complete as soon as the call returns. A nonblocking (immediate) call requires a separate completion call (cf. Section 3.7). The completion of a collective operation indicates that the caller is free to modify locations in the communication buffer. It does not indicate that other processes in the group have completed or even started the operation (unless otherwise implied by the description of the operation). Thus, a collective communication operation may, or may not, have the effect of synchronizing all calling processes. This statement excludes, of course, the barrier operation.

Collective communication calls may use the same communicators as point-to-point communication; MPI guarantees that messages generated on behalf of collective communication calls will not be confused with messages generated by point-to-point communication. The collective operations do not have a message tag argument. A more detailed discussion of correct use of collective routines is found in Section 5.14.

Rationale. The equal-data restriction (on type matching) was made so as to avoid the complexity of providing a facility analogous to the status argument of `MPI_RECV` for discovering the amount of data sent. Some of the collective routines would require an array of status values.

The statements about synchronization are made so as to allow a variety of implementations of the collective functions.

(End of rationale.)

Advice to users. It is dangerous to rely on synchronization side-effects of the collective operations for program correctness. For example, even though a particular implementation may provide a broadcast routine with a side-effect of synchronization, the standard does not require this, and a program that relies on this will not be portable.

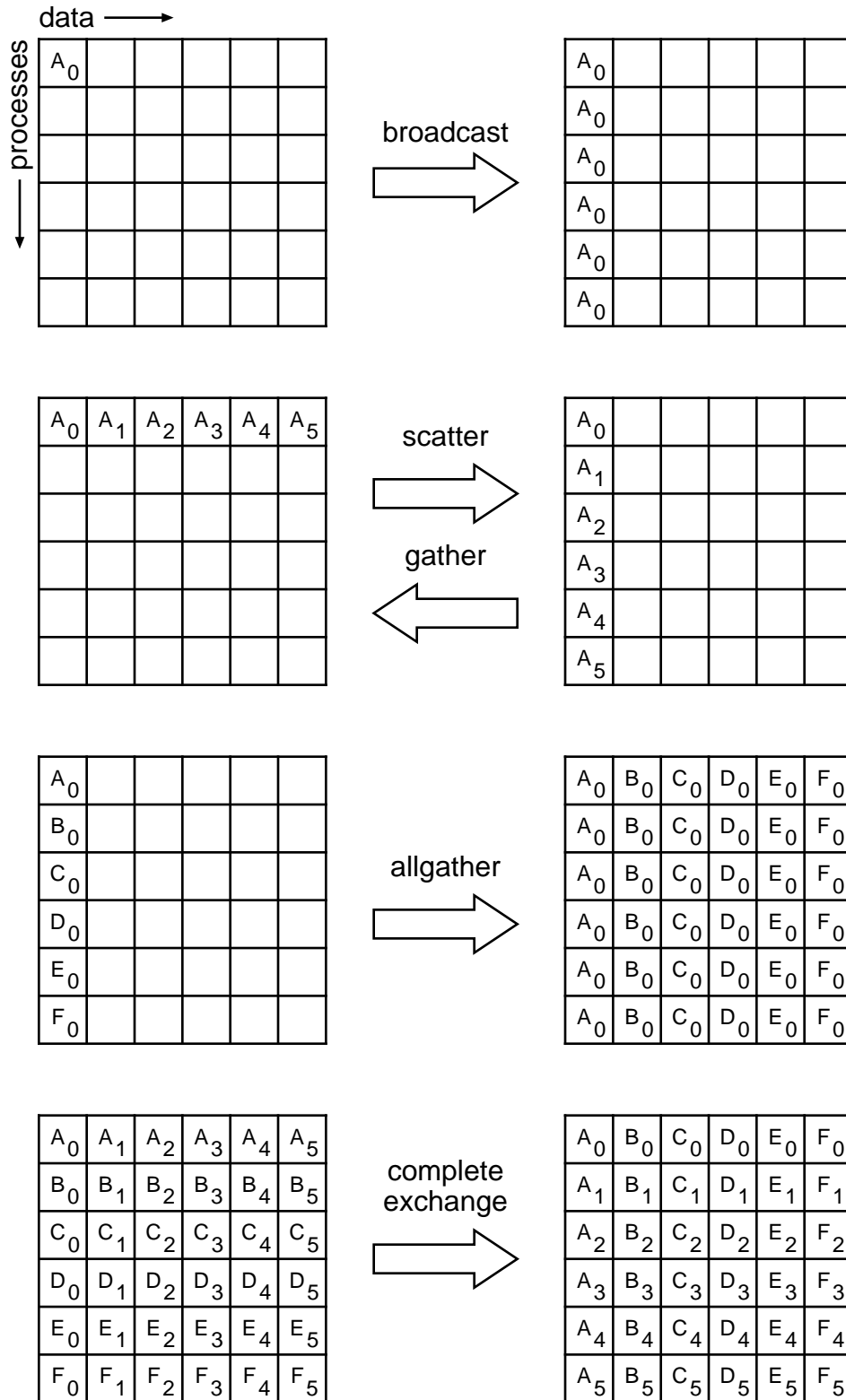

Figure 5.1: Collective move functions illustrated for a group of six processes. In each case, each row of boxes represents data locations in one process. Thus, in the broadcast, initially just the first process contains the data A_0 , but after the broadcast all processes contain it.

1
2
3
4
5
6
7
8
9
10
11
12
13
14
15
16
17
18
19
20
21
22
23
24
25
26
27
28
29
30
31
32
33
34
35
36
37
38
39
40
41
42
43
44
45
46
47
48

1 On the other hand, a correct, portable program must allow for the fact that a collective
2 call *may* be synchronizing. Though one cannot rely on any synchronization side-effect,
3 one must program so as to allow it. These issues are discussed further in Section 5.14.
4 (*End of advice to users.*)

5
6 *Advice to implementors.* While vendors may write optimized collective routines
7 matched to their architectures, a complete library of the collective communication
8 routines can be written entirely using the MPI point-to-point communication func-
9 tions and a few auxiliary functions. If implementing on top of point-to-point, a hidden,
10 special communicator might be created for the collective operation so as to avoid inter-
11 ference with any on-going point-to-point communication at the time of the collective
12 call. This is discussed further in Section 5.14. (*End of advice to implementors.*)

13
14 Many of the descriptions of the collective routines provide illustrations in terms of
15 blocking MPI point-to-point routines. These are intended solely to indicate what data is
16 sent or received by what process. Many of these examples are *not* correct MPI programs;
17 for purposes of simplicity, they often assume infinite buffering.

18 19 5.2 Communicator Argument

20
21 The key concept of the collective functions is to have a group or groups of participating
22 processes. The routines do not have group identifiers as explicit arguments. Instead, there
23 is a communicator argument. Groups and communicators are discussed in full detail in
24 Chapter 6. For the purposes of this chapter, it is sufficient to know that there are two types
25 of communicators: *intra-communicators* and *inter-communicators*. An intracommunicator
26 can be thought of as an identifier for a single group of processes linked with a context. An
27 intercommunicator identifies two distinct groups of processes linked with a context.

28 29 5.2.1 Specifics for Intracommunicator Collective Operations

30
31 All processes in the group identified by the intracommunicator must call the collective
32 routine.

33 In many cases, collective communication can occur “in place” for intracommunicators,
34 with the output buffer being identical to the input buffer. This is specified by providing
35 a special argument value, `MPI_IN_PLACE`, instead of the send buffer or the receive buffer
36 argument, depending on the operation performed.

37
38 *Rationale.* The “in place” operations are provided to reduce unnecessary memory
39 motion by both the MPI implementation and by the user. Note that while the simple
40 check of testing whether the send and receive buffers have the same address will
41 work for some cases (e.g., `MPI_ALLREDUCE`), they are inadequate in others (e.g.,
42 `MPI_GATHER`, with root not equal to zero). Further, Fortran explicitly prohibits
43 aliasing of arguments; the approach of using a special value to denote “in place”
44 operation eliminates that difficulty. (*End of rationale.*)

45
46 *Advice to users.* By allowing the “in place” option, the receive buffer in many of the
47 collective calls becomes a send-and-receive buffer. For this reason, a Fortran binding
48 that includes `INTENT` must mark these as `INOUT`, not `OUT`.

Note that `MPI_IN_PLACE` is a special kind of value; it has the same restrictions on its use that `MPI_BOTTOM` has. (*End of advice to users.*)

5.2.2 Applying Collective Operations to Intercommunicators

To understand how collective operations apply to intercommunicators, we can view most MPI intracommunicator collective operations as fitting one of the following categories (see, for instance, [58]):

All-To-All All processes contribute to the result. All processes receive the result.

- `MPI_ALLGATHER`, `MPI_IALLGATHER`, `MPI_ALLGATHERV`,
`MPI_IALLGATHERV`
- `MPI_ALLTOALL`, `MPI_IALLTOALL`, `MPI_ALLTOALLV`, `MPI_IALLTOALLV`,
`MPI_ALLTOALLW`, `MPI_IALLTOALLW`
- `MPI_ALLREDUCE`, `MPI_IALLREDUCE`, `MPI_REDUCE_SCATTER_BLOCK`,
`MPI_IREDUCE_SCATTER_BLOCK`, `MPI_REDUCE_SCATTER`,
`MPI_IREDUCE_SCATTER`
- `MPI_BARRIER`, `MPI_IBARRIER`

All-To-One All processes contribute to the result. One process receives the result.

- `MPI_GATHER`, `MPI_IGATHER`, `MPI_GATHERV`, `MPI_IGATHERV`
- `MPI_REDUCE`, `MPI_IREDUCE`

One-To-All One process contributes to the result. All processes receive the result.

- `MPI_BCAST`, `MPI_IBCAST`
- `MPI_SCATTER`, `MPI_ISCATTER`, `MPI_SCATTERV`, `MPI_ISCATTERV`

Other Collective operations that do not fit into one of the above categories.

- `MPI_SCAN`, `MPI_ISCAN`, `MPI_EXSCAN`, `MPI_IEXSCAN`

The data movement patterns of `MPI_SCAN`, `MPI_ISCAN`, `MPI_EXSCAN`, and `MPI_IEXSCAN` do not fit this taxonomy.

The application of collective communication to intercommunicators is best described in terms of two groups. For example, an all-to-all `MPI_ALLGATHER` operation can be described as collecting data from all members of one group with the result appearing in all members of the other group (see Figure 5.2). As another example, a one-to-all `MPI_BCAST` operation sends data from one member of one group to all members of the other group. Collective computation operations such as `MPI_REDUCE_SCATTER` have a similar interpretation (see Figure 5.3). For intracommunicators, these two groups are the same. For intercommunicators, these two groups are distinct. For the all-to-all operations, each such operation is described in two phases, so that it has a symmetric, full-duplex behavior.

The following collective operations also apply to intercommunicators:

- `MPI_BARRIER`, `MPI_IBARRIER`
- `MPI_BCAST`, `MPI_IBCAST`

- 1 • MPI_GATHER, MPI_IGATHER, MPI_GATHERV, MPI_IGATHERV,
- 2
- 3 • MPI_SCATTER, MPI_ISCATTER, MPI_SCATTERV, MPI_ISCATTERV,
- 4
- 5 • MPI_ALLGATHER, MPI_IALLGATHER, MPI_ALLGATHERV, MPI_IALLGATHERV,
- 6
- 7 • MPI_ALLTOALL, MPI_IALLTOALL, MPI_ALLTOALLV, MPI_IALLTOALLV,
- 8 MPI_ALLTOALLW, MPI_IALLTOALLW,
- 9
- 10 • MPI_ALLREDUCE, MPI_IALLREDUCE, MPI_REDUCE, MPI_IREDUCE,
- 11
- 12 • MPI_REDUCE_SCATTER_BLOCK, MPI_IREDUCE_SCATTER_BLOCK,
- 13 MPI_REDUCE_SCATTER, MPI_IREDUCE_SCATTER.

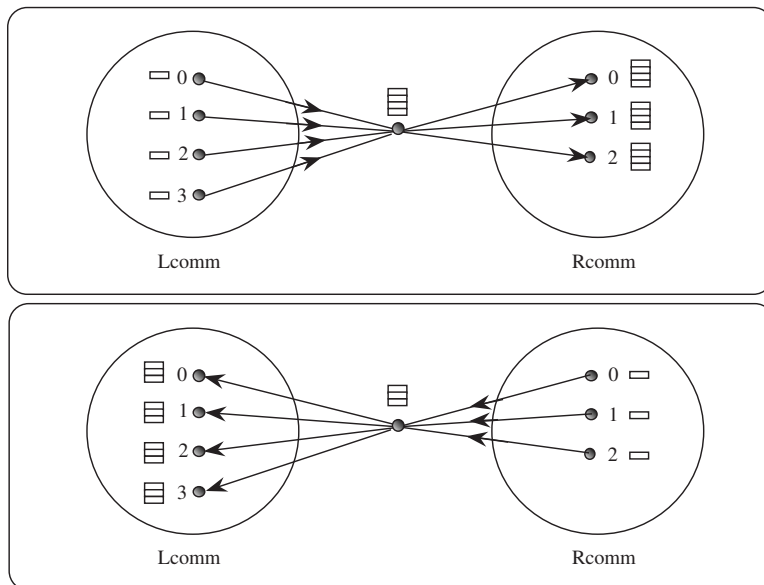

Figure 5.2: Intercommunicator allgather. The focus of data to one process is represented, not mandated by the semantics. The two phases do allgathers in both directions.

5.2.3 Specifics for Intercommunicator Collective Operations

All processes in both groups identified by the intercommunicator must call the collective routine.

Note that the “in place” option for intracommunicators does not apply to intercommunicators since in the intercommunicator case there is no communication from a process to itself.

For intercommunicator collective communication, if the operation is in the All-To-One or One-To-All categories, then the transfer is unidirectional. The direction of the transfer is indicated by a special value of the root argument. In this case, for the group containing the root process, all processes in the group must call the routine using a special argument for the root. For this, the root process uses the special root value `MPI_ROOT`; all other processes in the same group as the root use `MPI_PROC_NULL`. All processes in the other group (the group that is the remote group relative to the root process) must call the collective routine

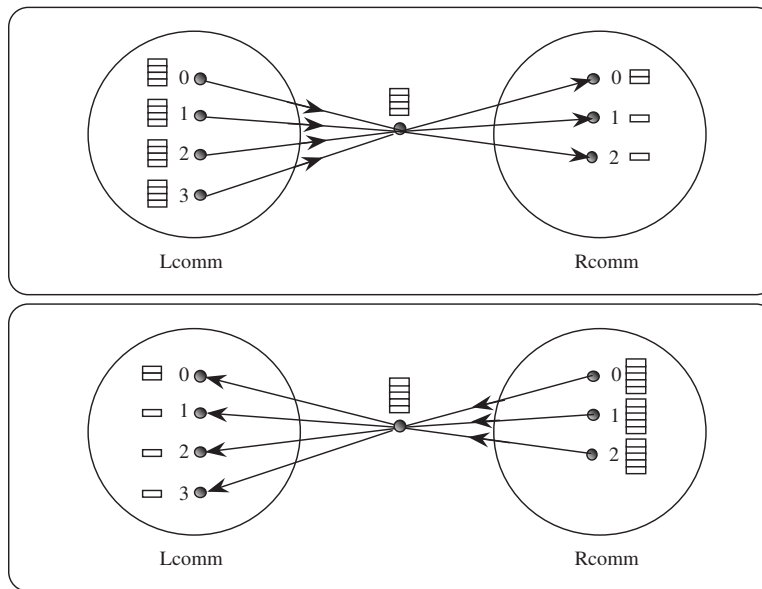

Figure 5.3: Intercommunicator reduce-scatter. The focus of data to one process is represented, not mandated by the semantics. The two phases do reduce-scatters in both directions.

and provide the rank of the root. If the operation is in the All-To-All category, then the transfer is bidirectional.

Rationale. Operations in the All-To-One and One-To-All categories are unidirectional by nature, and there is a clear way of specifying direction. Operations in the All-To-All category will often occur as part of an exchange, where it makes sense to communicate in both directions at once. (*End of rationale.*)

5.3 Barrier Synchronization

`MPI_BARRIER(comm)`

IN comm communicator (handle)

```
int MPI_Barrier(MPI_Comm comm)
```

```
MPI_Barrier(comm, ierror)
```

```
  TYPE(MPI_Comm), INTENT(IN) :: comm
```

```
  INTEGER, OPTIONAL, INTENT(OUT) :: ierror
```

```
MPI_BARRIER(COMM, IERROR)
```

```
  INTEGER COMM, IERROR
```

If `comm` is an intracommunicator, `MPI_BARRIER` blocks the caller until all group members have called it. The call returns at any process only after all group members have entered the call.

If `comm` is an intercommunicator, `MPI_BARRIER` involves two groups. The call returns at processes in one group (group A) of the intercommunicator only after all members of the other group (group B) have entered the call (and vice versa). A process may return from the call before all processes in its own group have entered the call.

5.4 Broadcast

`MPI_BCAST(buffer, count, datatype, root, comm)`

INOUT	<code>buffer</code>	starting address of buffer (choice)
IN	<code>count</code>	number of entries in buffer (non-negative integer)
IN	<code>datatype</code>	data type of buffer (handle)
IN	<code>root</code>	rank of broadcast root (integer)
IN	<code>comm</code>	communicator (handle)

```
int MPI_Bcast(void* buffer, int count, MPI_Datatype datatype, int root,
             MPI_Comm comm)
```

```
MPI_Bcast(buffer, count, datatype, root, comm, ierror)
```

```
TYPE(*), DIMENSION(..) :: buffer
INTEGER, INTENT(IN) :: count, root
TYPE(MPI_Datatype), INTENT(IN) :: datatype
TYPE(MPI_Comm), INTENT(IN) :: comm
INTEGER, OPTIONAL, INTENT(OUT) :: ierror
```

```
MPI_BCAST(BUFFER, COUNT, DATATYPE, ROOT, COMM, IERROR)
```

```
<type> BUFFER(*)
INTEGER COUNT, DATATYPE, ROOT, COMM, IERROR
```

If `comm` is an intracommunicator, `MPI_BCAST` broadcasts a message from the process with rank `root` to all processes of the group, itself included. It is called by all members of the group using the same arguments for `comm` and `root`. On return, the content of `root`'s buffer is copied to all other processes.

General, derived datatypes are allowed for `datatype`. The type signature of `count`, `datatype` on any process must be equal to the type signature of `count`, `datatype` at the root. This implies that the amount of data sent must be equal to the amount received, pairwise between each process and the root. `MPI_BCAST` and all other data-movement collective routines make this restriction. Distinct type maps between sender and receiver are still allowed.

The “in place” option is not meaningful here.

If `comm` is an intercommunicator, then the call involves all processes in the intercommunicator, but with one group (group A) defining the root process. All processes in the other group (group B) pass the same value in argument `root`, which is the rank of the root in group A. The root passes the value `MPI_ROOT` in `root`. All other processes in group A pass the value `MPI_PROC_NULL` in `root`. Data is broadcast from the root to all processes

in group B. The buffer arguments of the processes in group B must be consistent with the buffer argument of the root.

5.4.1 Example using MPI_BCAST

The examples in this section use intracommunicators.

Example 5.1

Broadcast 100 ints from process 0 to every process in the group.

```
MPI_Comm comm;
int array[100];
int root=0;
...
MPI_Bcast(array, 100, MPI_INT, root, comm);
```

As in many of our example code fragments, we assume that some of the variables (such as `comm` in the above) have been assigned appropriate values.

5.5 Gather

`MPI_GATHER(sendbuf, sendcount, sendtype, recvbuf, recvcount, recvtype, root, comm)`

IN	<code>sendbuf</code>	starting address of send buffer (choice)
IN	<code>sendcount</code>	number of elements in send buffer (non-negative integer)
IN	<code>sendtype</code>	data type of send buffer elements (handle)
OUT	<code>recvbuf</code>	address of receive buffer (choice, significant only at root)
IN	<code>recvcount</code>	number of elements for any single receive (non-negative integer, significant only at root)
IN	<code>recvtype</code>	data type of recv buffer elements (significant only at root) (handle)
IN	<code>root</code>	rank of receiving process (integer)
IN	<code>comm</code>	communicator (handle)

```
int MPI_Gather(const void* sendbuf, int sendcount, MPI_Datatype sendtype,
              void* recvbuf, int recvcount, MPI_Datatype recvtype, int root,
              MPI_Comm comm)
```

```
MPI_Gather(sendbuf, sendcount, sendtype, recvbuf, recvcount, recvtype,
           root, comm, ierror)
```

```
TYPE(*), DIMENSION(..), INTENT(IN) :: sendbuf
TYPE(*), DIMENSION(..) :: recvbuf
INTEGER, INTENT(IN) :: sendcount, recvcount, root
```

```

1     TYPE(MPI_Datatype), INTENT(IN) :: sendtype, recvtype
2     TYPE(MPI_Comm), INTENT(IN) :: comm
3     INTEGER, OPTIONAL, INTENT(OUT) :: ierror
4
5     MPI_GATHER(SENDBUF, SENDCOUNT, SENDTYPE, RECVBUF, REVCOUNT, RECVTYPE,
6               ROOT, COMM, IERROR)
7     <type> SENDBUF(*), RECVBUF(*)
8     INTEGER SENDCOUNT, SENDTYPE, REVCOUNT, RECVTYPE, ROOT, COMM, IERROR

```

If `comm` is an intracommunicator, each process (root process included) sends the contents of its send buffer to the root process. The root process receives the messages and stores them in rank order. The outcome is *as if* each of the n processes in the group (including the root process) had executed a call to

```
MPI_Send(sendbuf, sendcount, sendtype, root , ...),
```

and the root had executed n calls to

```
MPI_Recv(recvbuf+i·recvcount·extent(recvtype), recvcount, recvtype, i,...),
```

where `extent(recvtype)` is the type extent obtained from a call to `MPI_Type_get_extent`.

An alternative description is that the n messages sent by the processes in the group are concatenated in rank order, and the resulting message is received by the root as if by a call to `MPI_RECV(recvbuf, recvcount·n, recvtype, ...)`.

The receive buffer is ignored for all non-root processes.

General, derived datatypes are allowed for both `sendtype` and `recvtype`. The type signature of `sendcount`, `sendtype` on each process must be equal to the type signature of `recvcount`, `recvtype` at the root. This implies that the amount of data sent must be equal to the amount of data received, pairwise between each process and the root. Distinct type maps between sender and receiver are still allowed.

All arguments to the function are significant on process `root`, while on other processes, only arguments `sendbuf`, `sendcount`, `sendtype`, `root`, and `comm` are significant. The arguments `root` and `comm` must have identical values on all processes.

The specification of counts and types should not cause any location on the root to be written more than once. Such a call is erroneous.

Note that the `recvcount` argument at the root indicates the number of items it receives from *each* process, not the total number of items it receives.

The “in place” option for intracommunicators is specified by passing `MPI_IN_PLACE` as the value of `sendbuf` at the root. In such a case, `sendcount` and `sendtype` are ignored, and the contribution of the root to the gathered vector is assumed to be already in the correct place in the receive buffer.

If `comm` is an intercommunicator, then the call involves all processes in the intercommunicator, but with one group (group A) defining the root process. All processes in the other group (group B) pass the same value in argument `root`, which is the rank of the root in group A. The root passes the value `MPI_ROOT` in `root`. All other processes in group A pass the value `MPI_PROC_NULL` in `root`. Data is gathered from all processes in group B to the root. The send buffer arguments of the processes in group B must be consistent with the receive buffer argument of the root.

```

MPI_GATHERV(sendbuf, sendcount, sendtype, recvbuf, recvcoun
1
2
3
4
5
6
7
8
9
10
11
12
13
14
15
16
17
18
19
20
21
22
23
24
25
26
27
28
29
30
31
32
33
34
35
36
37
38
39
40
41
42
43
44
45
46
47
48

```

IN **sendbuf** starting address of send buffer (choice)
IN **sendcount** number of elements in send buffer (non-negative integer)
IN **sendtype** data type of send buffer elements (handle)
OUT **recvbuf** address of receive buffer (choice, significant only at root)
IN **recvcoun**ts non-negative integer array (of length group size) containing the number of elements that are received from each process (significant only at root)
IN **displs** integer array (of length group size). Entry *i* specifies the displacement relative to **recvbuf** at which to place the incoming data from process *i* (significant only at root)
IN **recvtype** data type of recv buffer elements (significant only at root) (handle)
IN **root** rank of receiving process (integer)
IN **comm** communicator (handle)

```

int MPI_Gatherv(const void* sendbuf, int sendcount, MPI_Datatype sendtype,
void* recvbuf, const int recvcoun[] , const int displs[] ,
MPI_Datatype recvtype, int root, MPI_Comm comm)
MPI_Gatherv(sendbuf, sendcount, sendtype, recvbuf, recvcoun
recvtype, root, comm, ierror)
TYPE(*), DIMENSION(..), INTENT(IN) :: sendbuf
TYPE(*), DIMENSION(..) :: recvbuf
INTEGER, INTENT(IN) :: sendcount, recvcoun(*), displs(*), root
TYPE(MPI_Datatype), INTENT(IN) :: sendtype, recvtype
TYPE(MPI_Comm), INTENT(IN) :: comm
INTEGER, OPTIONAL, INTENT(OUT) :: ierror
MPI_GATHERV(SENDBUF, SENDCOUNT, SENDTYPE, RECVBUF, RECVCOUNTS, DISPLS,
RECVTYPE, ROOT, COMM, IERROR)
<type> SENDBUF(*), RECVBUF(*)
INTEGER SENDCOUNT, SENDTYPE, RECVCOUNTS(*), DISPLS(*), RECVTYPE, ROOT,
COMM, IERROR
MPI_GATHERV extends the functionality of MPI_GATHER by allowing a varying count
of data from each process, since recvcounts is now an array. It also allows more flexibility
as to where the data is placed on the root, by providing the new argument, displs.
If comm is an intracommunicator, the outcome is as if each process, including the root
process, sends a message to the root,
MPI_Send(sendbuf, sendcount, sendtype, root, ...),

```

1 and the root executes `n` receives,

2
3 `MPI_Recv(recvbuf+displs[j]·extent(recvtype), recvcounts[j], recvtype, i, ...)`.

4
5 The data received from process `j` is placed into `recvbuf` of the root process beginning at
6 offset `displs[j]` elements (in terms of the `recvtype`).

7 The receive buffer is ignored for all non-root processes.

8 The type signature implied by `sendcount`, `sendtype` on process `i` must be equal to the
9 type signature implied by `recvcounts[i]`, `recvtype` at the root. This implies that the amount
10 of data sent must be equal to the amount of data received, pairwise between each process
11 and the root. Distinct type maps between sender and receiver are still allowed, as illustrated
12 in Example 5.6.

13 All arguments to the function are significant on process `root`, while on other processes,
14 only arguments `sendbuf`, `sendcount`, `sendtype`, `root`, and `comm` are significant. The arguments
15 `root` and `comm` must have identical values on all processes.

16 The specification of counts, types, and displacements should not cause any location on
17 the root to be written more than once. Such a call is erroneous.

18 The “in place” option for intracommunicators is specified by passing `MPI_IN_PLACE` as
19 the value of `sendbuf` at the root. In such a case, `sendcount` and `sendtype` are ignored, and
20 the contribution of the root to the gathered vector is assumed to be already in the correct
21 place in the receive buffer.

22 If `comm` is an intercommunicator, then the call involves all processes in the intercom-
23 municator, but with one group (group A) defining the root process. All processes in the
24 other group (group B) pass the same value in argument `root`, which is the rank of the root
25 in group A. The root passes the value `MPI_ROOT` in `root`. All other processes in group A
26 pass the value `MPI_PROC_NULL` in `root`. Data is gathered from all processes in group B to
27 the root. The send buffer arguments of the processes in group B must be consistent with
28 the receive buffer argument of the root.

29 30 5.5.1 Examples using `MPI_GATHER`, `MPI_GATHERV`

31 The examples in this section use intracommunicators.

32 33 **Example 5.2**

34 Gather 100 ints from every process in group to root. See Figure 5.4.

```
35
36 MPI_Comm comm;
37 int gsize, sendarray[100];
38 int root, *rbuf;
39 ...
40 MPI_Comm_size(comm, &gsize);
41 rbuf = (int *)malloc(gsize*100*sizeof(int));
42 MPI_Gather(sendarray, 100, MPI_INT, rbuf, 100, MPI_INT, root, comm);
43
```

44 45 **Example 5.3**

46 Previous example modified — only the root allocates memory for the receive buffer.

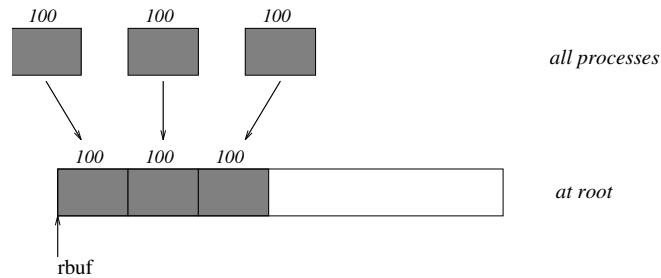

Figure 5.4: The root process gathers 100 ints from each process in the group.

```

MPI_Comm comm;
int gsize, sendarray[100];
int root, myrank, *rbuf;
...
MPI_Comm_rank(comm, &myrank);
if (myrank == root) {
    MPI_Comm_size(comm, &gsize);
    rbuf = (int *)malloc(gsize*100*sizeof(int));
}
MPI_Gather(sendarray, 100, MPI_INT, rbuf, 100, MPI_INT, root, comm);

```

Example 5.4

Do the same as the previous example, but use a derived datatype. Note that the type cannot be the entire set of `gsize*100` ints since type matching is defined pairwise between the root and each process in the gather.

```

MPI_Comm comm;
int gsize, sendarray[100];
int root, *rbuf;
MPI_Datatype rtype;
...
MPI_Comm_size(comm, &gsize);
MPI_Type_contiguous(100, MPI_INT, &rtype);
MPI_Type_commit(&rtype);
rbuf = (int *)malloc(gsize*100*sizeof(int));
MPI_Gather(sendarray, 100, MPI_INT, rbuf, 1, rtype, root, comm);

```

Example 5.5

Now have each process send 100 ints to root, but place each set (of 100) `stride` ints apart at receiving end. Use `MPI_GATHERV` and the `displs` argument to achieve this effect. Assume `stride` ≥ 100 . See Figure 5.5.

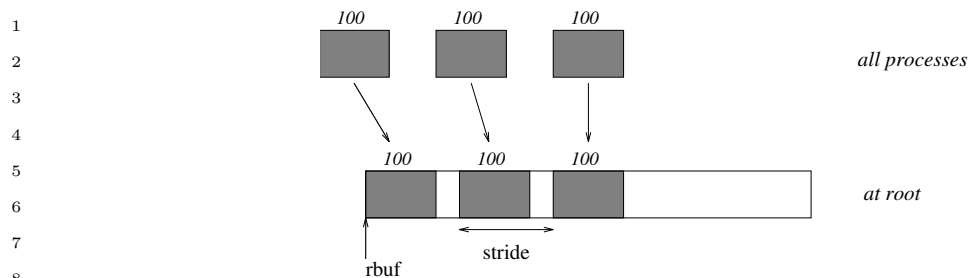

Figure 5.5: The root process gathers 100 ints from each process in the group, each set is placed *stride* ints apart.

```

13     MPI_Comm comm;
14     int gsize, sendarray[100];
15     int root, *rbuf, stride;
16     int *displs, i, *rcounts;
17
18     ...
19
20     MPI_Comm_size(comm, &gsize);
21     rbuf = (int *)malloc(gsize*stride*sizeof(int));
22     displs = (int *)malloc(gsize*sizeof(int));
23     rcounts = (int *)malloc(gsize*sizeof(int));
24     for (i=0; i<gsize; ++i) {
25         displs[i] = i*stride;
26         rcounts[i] = 100;
27     }
28     MPI_Gatherv(sendarray, 100, MPI_INT, rbuf, rcounts, displs, MPI_INT,
29                root, comm);

```

Note that the program is erroneous if *stride* < 100.

Example 5.6

Same as Example 5.5 on the receiving side, but send the 100 ints from the 0th column of a 100×150 int array, in C. See Figure 5.6.

```

36     MPI_Comm comm;
37     int gsize, sendarray[100][150];
38     int root, *rbuf, stride;
39     MPI_Datatype stype;
40     int *displs, i, *rcounts;
41
42     ...
43
44     MPI_Comm_size(comm, &gsize);
45     rbuf = (int *)malloc(gsize*stride*sizeof(int));
46     displs = (int *)malloc(gsize*sizeof(int));
47     rcounts = (int *)malloc(gsize*sizeof(int));
48     for (i=0; i<gsize; ++i) {

```

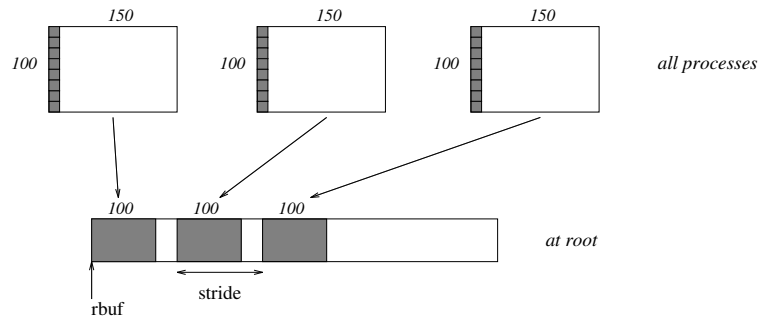

Figure 5.6: The root process gathers column 0 of a 100×150 C array, and each set is placed `stride` ints apart.

```

        displs[i] = i*stride;
        rcounts[i] = 100;
    }
    /* Create datatype for 1 column of array
    */
    MPI_Type_vector(100, 1, 150, MPI_INT, &stype);
    MPI_Type_commit(&stype);
    MPI_Gatherv(sendarray, 1, stype, rbuf, rcounts, displs, MPI_INT,
                root, comm);

```

Example 5.7

Process i sends $(100-i)$ ints from the i -th column of a 100×150 int array, in C. It is received into a buffer with stride, as in the previous two examples. See Figure 5.7.

```

MPI_Comm comm;
int gsize, sendarray[100][150], *sptr;
int root, *rbuf, stride, myrank;
MPI_Datatype stype;
int *displs, i, *rcounts;

...

MPI_Comm_size(comm, &gsize);
MPI_Comm_rank(comm, &myrank);
rbuf = (int *)malloc(gsize*stride*sizeof(int));
displs = (int *)malloc(gsize*sizeof(int));
rcounts = (int *)malloc(gsize*sizeof(int));
for (i=0; i<gsize; ++i) {
    displs[i] = i*stride;
    rcounts[i] = 100-i;    /* note change from previous example */
}
/* Create datatype for the column we are sending
*/
MPI_Type_vector(100-myrank, 1, 150, MPI_INT, &stype);
MPI_Type_commit(&stype);

```

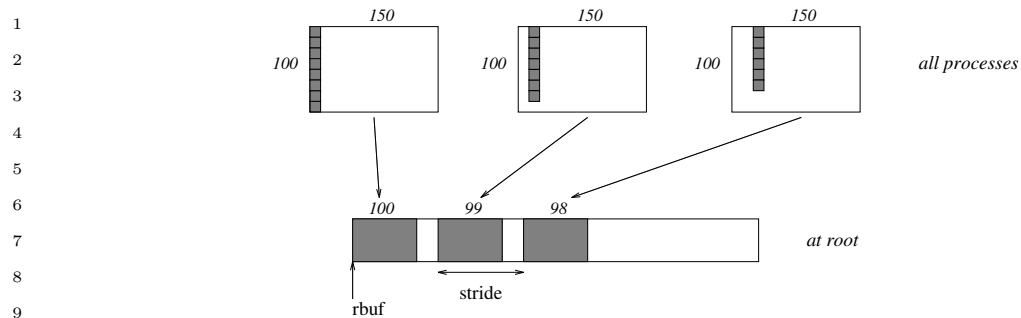

Figure 5.7: The root process gathers $100-i$ ints from column i of a 100×150 C array, and each set is placed `stride` ints apart.

```

14     /* sptr is the address of start of "myrank" column
15     */
16     sptr = &sendarray[0][myrank];
17     MPI_Gatherv(sptr, 1, stype, rbuf, rcounts, displs, MPI_INT,
18                root, comm);

```

Note that a different amount of data is received from each process.

Example 5.8

Same as Example 5.7, but done in a different way at the sending end. We create a datatype that causes the correct striding at the sending end so that we read a column of a C array. A similar thing was done in Example 4.16, Section 4.1.14.

```

26     MPI_Comm comm;
27     int gsize, sendarray[100][150], *sptr;
28     int root, *rbuf, stride, myrank;
29     MPI_Datatype stype;
30     int *displs, i, *rcounts;
31
32     ...
33
34     MPI_Comm_size(comm, &gsize);
35     MPI_Comm_rank(comm, &myrank);
36     rbuf = (int *)malloc(gsize*stride*sizeof(int));
37     displs = (int *)malloc(gsize*sizeof(int));
38     rcounts = (int *)malloc(gsize*sizeof(int));
39     for (i=0; i<gsize; ++i) {
40         displs[i] = i*stride;
41         rcounts[i] = 100-i;
42     }
43     /* Create datatype for one int, with extent of entire row
44     */
45     MPI_Type_create_resized(MPI_INT, 0, 150*sizeof(int), &stype);
46     MPI_Type_commit(&stype);
47     sptr = &sendarray[0][myrank];
48     MPI_Gatherv(sptr, 100-myrank, stype, rbuf, rcounts, displs, MPI_INT,

```



```
root, comm);
```

Example 5.9

Same as Example 5.7 at sending side, but at receiving side we make the stride between received blocks vary from block to block. See Figure 5.8.

```

MPI_Comm comm;
int gsize, sendarray[100][150], *sptr;
int root, *rbuf, *stride, myrank, bufsize;
MPI_Datatype stype;
int *displs, i, *rcounts, offset;

...

MPI_Comm_size(comm, &gsize);
MPI_Comm_rank(comm, &myrank);

stride = (int *)malloc(gsize*sizeof(int));
...
/* stride[i] for i = 0 to gsize-1 is set somehow
*/

/* set up displs and rcounts vectors first
*/
displs = (int *)malloc(gsize*sizeof(int));
rcounts = (int *)malloc(gsize*sizeof(int));
offset = 0;
for (i=0; i<gsize; ++i) {
    displs[i] = offset;
    offset += stride[i];
    rcounts[i] = 100-i;
}
/* the required buffer size for rbuf is now easily obtained
*/
bufsize = displs[gsize-1]+rcounts[gsize-1];
rbuf = (int *)malloc(bufsize*sizeof(int));
/* Create datatype for the column we are sending
*/
MPI_Type_vector(100-myrank, 1, 150, MPI_INT, &stype);
MPI_Type_commit(&stype);
sptr = &sendarray[0][myrank];
MPI_Gatherv(sptr, 1, stype, rbuf, rcounts, displs, MPI_INT,
            root, comm);

```

Example 5.10

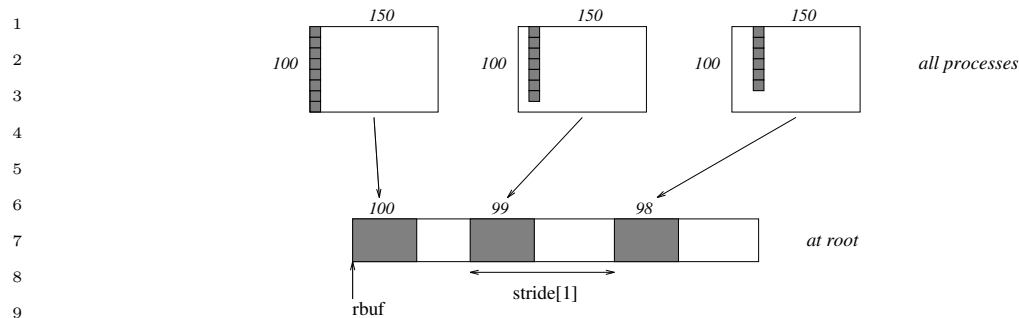

Figure 5.8: The root process gathers $100-i$ ints from column i of a 100×150 C array, and each set is placed $\text{stride}[i]$ ints apart (a varying stride).

Process i sends num ints from the i -th column of a 100×150 int array, in C. The complicating factor is that the various values of num are not known to *root*, so a separate gather must first be run to find these out. The data is placed contiguously at the receiving end.

```

19     MPI_Comm comm;
20     int gsize, sendarray[100][150], *sptr;
21     int root, *rbuf, myrank;
22     MPI_Datatype stype;
23     int *displs, i, *rcounts, num;
24
25     ...
26
27     MPI_Comm_size(comm, &gsize);
28     MPI_Comm_rank(comm, &myrank);
29
30     /* First, gather nums to root
31      */
32     rcounts = (int *)malloc(gsize*sizeof(int));
33     MPI_Gather(&num, 1, MPI_INT, rcounts, 1, MPI_INT, root, comm);
34     /* root now has correct rcounts, using these we set displs[] so
35      * that data is placed contiguously (or concatenated) at receive end
36      */
37     displs = (int *)malloc(gsize*sizeof(int));
38     displs[0] = 0;
39     for (i=1; i<gsize; ++i) {
40         displs[i] = displs[i-1]+rcounts[i-1];
41     }
42     /* And, create receive buffer
43      */
44     rbuf = (int *)malloc(gsize*(displs[gsize-1]+rcounts[gsize-1])
45                                     *sizeof(int));
46     /* Create datatype for one int, with extent of entire row
47      */
48     MPI_Type_create_resized( MPI_INT, 0, 150*sizeof(int), &stype);

```

```

MPI_Type_commit(&stype);
sptr = &sendarray[0][myrank];
MPI_Gatherv(sptr, num, stype, rbuf, rcounts, displs, MPI_INT,
                                                    root, comm);

```

5.6 Scatter

MPI_SCATTER(sendbuf, sendcount, sendtype, recvbuf, recvcount, recvtype, root, comm)

IN	sendbuf	address of send buffer (choice, significant only at root)
IN	sendcount	number of elements sent to each process (non-negative integer, significant only at root)
IN	sendtype	data type of send buffer elements (significant only at root) (handle)
OUT	recvbuf	address of receive buffer (choice)
IN	recvcount	number of elements in receive buffer (non-negative integer)
IN	recvtype	data type of receive buffer elements (handle)
IN	root	rank of sending process (integer)
IN	comm	communicator (handle)

```

int MPI_Scatter(const void* sendbuf, int sendcount, MPI_Datatype sendtype,
               void* recvbuf, int recvcount, MPI_Datatype recvtype, int root,
               MPI_Comm comm)

```

```

MPI_Scatter(sendbuf, sendcount, sendtype, recvbuf, recvcount, recvtype,
            root, comm, ierror)
    TYPE(*), DIMENSION(..), INTENT(IN) :: sendbuf
    TYPE(*), DIMENSION(..) :: recvbuf
    INTEGER, INTENT(IN) :: sendcount, recvcount, root
    TYPE(MPI_Datatype), INTENT(IN) :: sendtype, recvtype
    TYPE(MPI_Comm), INTENT(IN) :: comm
    INTEGER, OPTIONAL, INTENT(OUT) :: ierror

```

```

MPI_SCATTER(SENDBUF, SENDCOUNT, SENDTYPE, RECVBUF, REVCOUNT, RECVTYPE,
            ROOT, COMM, IERROR)
<type> SENDBUF(*), RECVBUF(*)
INTEGER SENDCOUNT, SENDTYPE, REVCOUNT, RECVTYPE, ROOT, COMM, IERROR

```

MPI_SCATTER is the inverse operation to MPI_GATHER.

If comm is an intracommunicator, the outcome is *as if* the root executed n send operations,

```
MPI_Send(sendbuf+i·sendcount·extent(sendtype), sendcount, sendtype, i,...),
```

and each process executed a receive,

1 MPI_Recv(recvbuf, recvcount, recvtype, i,...).

2
3 An alternative description is that the root sends a message with MPI_Send(sendbuf,
4 sendcount·n, sendtype, ...). This message is split into n equal segments, the i-th segment is
5 sent to the i-th process in the group, and each process receives this message as above.

6 The send buffer is ignored for all non-root processes.

7 The type signature associated with sendcount, sendtype at the root must be equal to
8 the type signature associated with recvcount, recvtype at all processes (however, the type
9 maps may be different). This implies that the amount of data sent must be equal to the
10 amount of data received, pairwise between each process and the root. Distinct type maps
11 between sender and receiver are still allowed.

12 All arguments to the function are significant on process root, while on other processes,
13 only arguments recvbuf, recvcount, recvtype, root, and comm are significant. The arguments
14 root and comm must have identical values on all processes.

15 The specification of counts and types should not cause any location on the root to be
16 read more than once.

17
18 *Rationale.* Though not needed, the last restriction is imposed so as to achieve
19 symmetry with MPI_GATHER, where the corresponding restriction (a multiple-write
20 restriction) is necessary. (*End of rationale.*)

21
22 The “in place” option for intracommunicators is specified by passing MPI_IN_PLACE as
23 the value of recvbuf at the root. In such a case, recvcount and recvtype are ignored, and
24 root “sends” no data to itself. The scattered vector is still assumed to contain n segments,
25 where n is the group size; the root-th segment, which root should “send to itself,” is not
26 moved.

27 If comm is an intercommunicator, then the call involves all processes in the intercom-
28 municator, but with one group (group A) defining the root process. All processes in the
29 other group (group B) pass the same value in argument root, which is the rank of the root
30 in group A. The root passes the value MPI_ROOT in root. All other processes in group A
31 pass the value MPI_PROC_NULL in root. Data is scattered from the root to all processes in
32 group B. The receive buffer arguments of the processes in group B must be consistent with
33 the send buffer argument of the root.

```

MPI_SCATTERV(sendbuf, sendcounts, displs, sendtype, recvbuf, recvcount, recvtype, root,
             comm)
1
2
3
IN    sendbuf          address of send buffer (choice, significant only at root)
4
IN    sendcounts       non-negative integer array (of length group size) spec-
5
6
7
IN    displs           integer array (of length group size). Entry i specifies
8
9
10
IN    sendtype         data type of send buffer elements (handle)
11
OUT   recvbuf          address of receive buffer (choice)
12
IN    recvcount        number of elements in receive buffer (non-negative in-
13
14
15
IN    recvtype         data type of receive buffer elements (handle)
16
IN    root             rank of sending process (integer)
17
IN    comm             communicator (handle)
18
19
int MPI_Scatterv(const void* sendbuf, const int sendcounts[],
                const int displs[], MPI_Datatype sendtype, void* recvbuf,
                int recvcount, MPI_Datatype recvtype, int root, MPI_Comm comm)
20
21
22
23
MPI_Scatterv(sendbuf, sendcounts, displs, sendtype, recvbuf, recvcount,
             recvtype, root, comm, ierror)
24
25
TYPE(*), DIMENSION(..), INTENT(IN) :: sendbuf
26
TYPE(*), DIMENSION(..) :: recvbuf
27
INTEGER, INTENT(IN) :: sendcounts(*), displs(*), recvcount, root
28
TYPE(MPI_Datatype), INTENT(IN) :: sendtype, recvtype
29
TYPE(MPI_Comm), INTENT(IN) :: comm
30
INTEGER, OPTIONAL, INTENT(OUT) :: ierror
31
32
MPI_SCATTERV(SENDBUF, SENDCOUNTS, DISPLS, SENDTYPE, RECVBUF, RECVCOUNT,
             RECVTYPE, ROOT, COMM, IERROR)
33
34
<type> SENDBUF(*), RECVBUF(*)
35
INTEGER SENDCOUNTS(*), DISPLS(*), SENDTYPE, RECVCOUNT, RECVTYPE, ROOT,
36
37
COMM, IERROR
38
MPI_SCATTERV is the inverse operation to MPI_GATHERV.
39
MPI_SCATTERV extends the functionality of MPI_SCATTER by allowing a varying
40
41
42
count of data to be sent to each process, since sendcounts is now an array. It also allows
43
44
45
more flexibility as to where the data is taken from on the root, by providing an additional
46
47
48
argument, displs.
If comm is an intracommunicator, the outcome is as if the root executed n send oper-
ations,
MPI_Send(sendbuf+displs[i]·extent(sendtype), sendcounts[i], sendtype, i,...),
and each process executed a receive,

```

1 MPI_Recv(recvbuf, recvcount, recvtype, i,...).

2
3 The send buffer is ignored for all non-root processes.

4 The type signature implied by `sendcount[i]`, `sendtype` at the root must be equal to the
5 type signature implied by `recvcount`, `recvtype` at process `i` (however, the type maps may be
6 different). This implies that the amount of data sent must be equal to the amount of data
7 received, pairwise between each process and the root. Distinct type maps between sender
8 and receiver are still allowed.

9 All arguments to the function are significant on process `root`, while on other processes,
10 only arguments `recvbuf`, `recvcount`, `recvtype`, `root`, and `comm` are significant. The arguments
11 `root` and `comm` must have identical values on all processes.

12 The specification of counts, types, and displacements should not cause any location on
13 the root to be read more than once.

14 The “in place” option for intracommunicators is specified by passing `MPI_IN_PLACE` as
15 the value of `recvbuf` at the root. In such a case, `recvcount` and `recvtype` are ignored, and
16 root “sends” no data to itself. The scattered vector is still assumed to contain n segments,
17 where n is the group size; the $root$ -th segment, which root should “send to itself,” is not
18 moved.

19 If `comm` is an intercommunicator, then the call involves all processes in the intercom-
20 municator, but with one group (group A) defining the root process. All processes in the
21 other group (group B) pass the same value in argument `root`, which is the rank of the root
22 in group A. The root passes the value `MPI_ROOT` in `root`. All other processes in group A
23 pass the value `MPI_PROC_NULL` in `root`. Data is scattered from the root to all processes in
24 group B. The receive buffer arguments of the processes in group B must be consistent with
25 the send buffer argument of the root.

26 27 5.6.1 Examples using MPI_SCATTER, MPI_SCATTERV

28 The examples in this section use intracommunicators.

29 30 **Example 5.11**

31 The reverse of Example 5.2. Scatter sets of 100 ints from the root to each process in
32 the group. See Figure 5.9.

```
33
34 MPI_Comm comm;
35 int gsize,*sendbuf;
36 int root, rbuf[100];
37 ...
38 MPI_Comm_size(comm, &gsize);
39 sendbuf = (int *)malloc(gsize*100*sizeof(int));
40 ...
41 MPI_Scatter(sendbuf, 100, MPI_INT, rbuf, 100, MPI_INT, root, comm);
42
43
```

44 **Example 5.12**

45 The reverse of Example 5.5. The root process scatters sets of 100 ints to the other
46 processes, but the sets of 100 are *stride ints* apart in the sending buffer. Requires use of
47 `MPI_SCATTERV`. Assume $stride \geq 100$. See Figure 5.10.

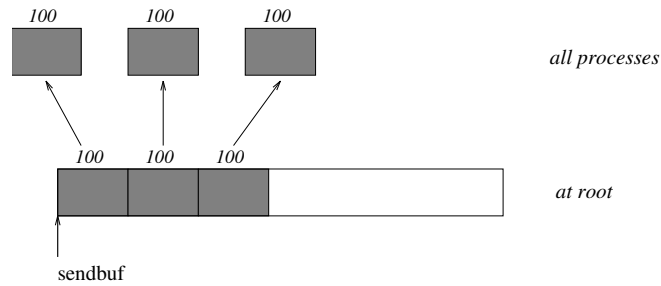

Figure 5.9: The root process scatters sets of 100 ints to each process in the group.

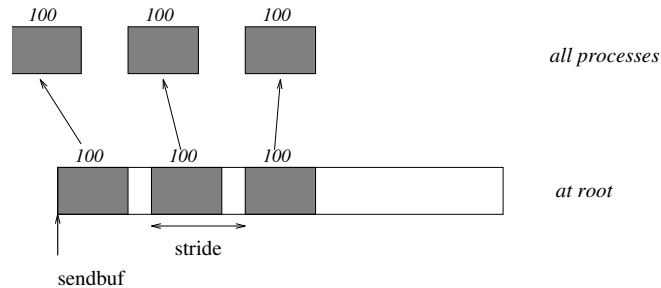

Figure 5.10: The root process scatters sets of 100 ints, moving by `stride` ints from send to send in the scatter.

```

MPI_Comm comm;
int gsize,*sendbuf;
int root, rbuf[100], i, *displs, *counts;

...

MPI_Comm_size(comm, &gsize);
sendbuf = (int *)malloc(gsize*stride*sizeof(int));
...
displs = (int *)malloc(gsize*sizeof(int));
counts = (int *)malloc(gsize*sizeof(int));
for (i=0; i<gsize; ++i) {
    displs[i] = i*stride;
    counts[i] = 100;
}
MPI_Scatterv(sendbuf, counts, displs, MPI_INT, rbuf, 100, MPI_INT,
            root, comm);

```

Example 5.13

The reverse of Example 5.9. We have a varying stride between blocks at sending (root) side, at the receiving side we receive into the i -th column of a 100×150 C array. See Figure 5.11.

```

MPI_Comm comm;
int gsize,recvarray[100][150],*rptr;

```

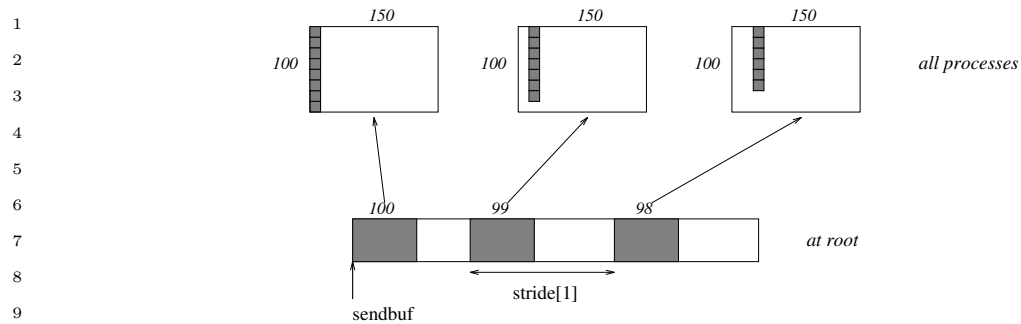

Figure 5.11: The root scatters blocks of $100-i$ ints into column i of a 100×150 C array. At the sending side, the blocks are $\text{stride}[i]$ ints apart.

```

14     int root, *sendbuf, myrank, *stride;
15     MPI_Datatype rtype;
16     int i, *displs, *scounts, offset;
17     ...
18     MPI_Comm_size(comm, &gsize);
19     MPI_Comm_rank(comm, &myrank);
20
21     stride = (int *)malloc(gsize*sizeof(int));
22     ...
23     /* stride[i] for i = 0 to gsize-1 is set somehow
24      * sendbuf comes from elsewhere
25      */
26     ...
27     displs = (int *)malloc(gsize*sizeof(int));
28     scounts = (int *)malloc(gsize*sizeof(int));
29     offset = 0;
30     for (i=0; i<gsize; ++i) {
31         displs[i] = offset;
32         offset += stride[i];
33         scounts[i] = 100 - i;
34     }
35     /* Create datatype for the column we are receiving
36      */
37     MPI_Type_vector(100-myrank, 1, 150, MPI_INT, &rtype);
38     MPI_Type_commit(&rtype);
39     rptr = &recvarray[0][myrank];
40     MPI_Scatterv(sendbuf, scounts, displs, MPI_INT, rptr, 1, rtype,
41                 root, comm);

```

5.7 Gather-to-all

MPI_ALLGATHER(sendbuf, sendcount, sendtype, recvbuf, recvcnt, recvtype, comm)			1
			2
			3
			4
IN	sendbuf	starting address of send buffer (choice)	5
IN	sendcount	number of elements in send buffer (non-negative integer)	6
			7
IN	sendtype	data type of send buffer elements (handle)	8
OUT	recvbuf	address of receive buffer (choice)	9
IN	recvcnt	number of elements received from any process (non-negative integer)	10
			11
IN	recvtype	data type of receive buffer elements (handle)	12
IN	comm	communicator (handle)	13
			14
			15
			16
			17

```
int MPI_Allgather(const void* sendbuf, int sendcount,
                 MPI_Datatype sendtype, void* recvbuf, int recvcnt,
                 MPI_Datatype recvtype, MPI_Comm comm)
```

```
MPI_Allgather(sendbuf, sendcount, sendtype, recvbuf, recvcnt, recvtype,
              comm, ierror)
    TYPE(*), DIMENSION(..), INTENT(IN) :: sendbuf
    TYPE(*), DIMENSION(..) :: recvbuf
    INTEGER, INTENT(IN) :: sendcount, recvcnt
    TYPE(MPI_Datatype), INTENT(IN) :: sendtype, recvtype
    TYPE(MPI_Comm), INTENT(IN) :: comm
    INTEGER, OPTIONAL, INTENT(OUT) :: ierror
```

```
MPI_ALLGATHER(SENDBUF, SENDCOUNT, SENDTYPE, RECVBUF, RECVCOUNT, RECVTYPE,
              COMM, IERROR)
    <type> SENDBUF(*), RECVBUF(*)
    INTEGER SENDCOUNT, SENDTYPE, RECVCOUNT, RECVTYPE, COMM, IERROR
```

MPI_ALLGATHER can be thought of as MPI_GATHER, but where all processes receive the result, instead of just the root. The block of data sent from the *j*-th process is received by every process and placed in the *j*-th block of the buffer *recvbuf*.

The type signature associated with *sendcount*, *sendtype*, at a process must be equal to the type signature associated with *recvcnt*, *recvtype* at any other process.

If *comm* is an intracommunicator, the outcome of a call to MPI_ALLGATHER(...) is as if all processes executed *n* calls to

```
MPI_Gather(sendbuf, sendcount, sendtype, recvbuf, recvcnt,
           recvtype, root, comm)
```

for *root* = 0 , . . . , *n*-1. The rules for correct usage of MPI_ALLGATHER are easily found from the corresponding rules for MPI_GATHER.

The “in place” option for intracommunicators is specified by passing the value MPI_IN_PLACE to the argument *sendbuf* at all processes. *sendcount* and *sendtype* are ignored.

1 Then the input data of each process is assumed to be in the area where that process would
 2 receive its own contribution to the receive buffer.

3 If `comm` is an intercommunicator, then each process of one group (group A) contributes
 4 `sendcount` data items; these data are concatenated and the result is stored at each process
 5 in the other group (group B). Conversely the concatenation of the contributions of the
 6 processes in group B is stored at each process in group A. The send buffer arguments in
 7 group A must be consistent with the receive buffer arguments in group B, and vice versa.
 8

9 *Advice to users.* The communication pattern of `MPI_ALLGATHER` executed on an
 10 intercommunication domain need not be symmetric. The number of items sent by
 11 processes in group A (as specified by the arguments `sendcount`, `sendtype` in group A
 12 and the arguments `recvcount`, `recvtype` in group B), need not equal the number of
 13 items sent by processes in group B (as specified by the arguments `sendcount`, `sendtype`
 14 in group B and the arguments `recvcount`, `recvtype` in group A). In particular, one can
 15 move data in only one direction by specifying `sendcount = 0` for the communication
 16 in the reverse direction. (*End of advice to users.*)
 17
 18

19 `MPI_ALLGATHERV(sendbuf, sendcount, sendtype, recvbuf, recvcnts, displs, recvtype, comm)`
 20

21			
22	IN	<code>sendbuf</code>	starting address of send buffer (choice)
23	IN	<code>sendcount</code>	number of elements in send buffer (non-negative integer)
24			
25	IN	<code>sendtype</code>	data type of send buffer elements (handle)
26	OUT	<code>recvbuf</code>	address of receive buffer (choice)
27	IN	<code>recvcnts</code>	non-negative integer array (of length group size) containing the number of elements that are received from each process
28			
29	IN	<code>displs</code>	integer array (of length group size). Entry <code>i</code> specifies the displacement (relative to <code>recvbuf</code>) at which to place the incoming data from process <code>i</code>
30			
31	IN	<code>recvtype</code>	data type of receive buffer elements (handle)
32	IN	<code>comm</code>	communicator (handle)
33			
34			
35			
36			
37			

```

38 int MPI_Allgatherv(const void* sendbuf, int sendcount,
39                 MPI_Datatype sendtype, void* recvbuf, const int recvcnts[],
40                 const int displs[], MPI_Datatype recvtype, MPI_Comm comm)
41
42 MPI_Allgatherv(sendbuf, sendcount, sendtype, recvbuf, recvcnts, displs,
43               recvtype, comm, ierror)
44 TYPE(*), DIMENSION(..), INTENT(IN) :: sendbuf
45 TYPE(*), DIMENSION(..) :: recvbuf
46 INTEGER, INTENT(IN) :: sendcount, recvcnts(*), displs(*)
47 TYPE(MPI_Datatype), INTENT(IN) :: sendtype, recvtype
48 TYPE(MPI_Comm), INTENT(IN) :: comm

```

```

    INTEGER, OPTIONAL, INTENT(OUT) :: ierror
MPI_ALLGATHERV(SENDBUF, SENDCOUNT, SENDTYPE, RECVBUF, RECVCOUNTS, DISPLS,
               RECVTYPE, COMM, IERROR)
<type> SENDBUF(*), RECVBUF(*)
    INTEGER SENDCOUNT, SENDTYPE, RECVCOUNTS(*), DISPLS(*), RECVTYPE, COMM,
               IERROR

```

MPI_ALLGATHERV can be thought of as MPI_GATHERV, but where all processes receive the result, instead of just the root. The block of data sent from the j -th process is received by every process and placed in the j -th block of the buffer `recvbuf`. These blocks need not all be the same size.

The type signature associated with `sendcount`, `sendtype`, at process j must be equal to the type signature associated with `recvcounts[j]`, `recvtype` at any other process.

If `comm` is an intracommunicator, the outcome is as if all processes executed calls to

```

MPI_Gatherv(sendbuf, sendcount, sendtype, recvbuf, recvcounts, displs,
            recvtype, root, comm),

```

for `root = 0, ..., n-1`. The rules for correct usage of MPI_ALLGATHERV are easily found from the corresponding rules for MPI_GATHERV.

The “in place” option for intracommunicators is specified by passing the value `MPI_IN_PLACE` to the argument `sendbuf` at all processes. In such a case, `sendcount` and `sendtype` are ignored, and the input data of each process is assumed to be in the area where that process would receive its own contribution to the receive buffer.

If `comm` is an intercommunicator, then each process of one group (group A) contributes `sendcount` data items; these data are concatenated and the result is stored at each process in the other group (group B). Conversely the concatenation of the contributions of the processes in group B is stored at each process in group A. The send buffer arguments in group A must be consistent with the receive buffer arguments in group B, and vice versa.

5.7.1 Example using MPI_ALLGATHER

The example in this section uses intracommunicators.

Example 5.14

The all-gather version of Example 5.2. Using MPI_ALLGATHER, we will gather 100 `ints` from every process in the group to every process.

```

MPI_Comm comm;
int gsize, sendarray[100];
int *rbuf;
...
MPI_Comm_size(comm, &gsize);
rbuf = (int *)malloc(gsize*100*sizeof(int));
MPI_Allgather(sendarray, 100, MPI_INT, rbuf, 100, MPI_INT, comm);

```

After the call, every process has the group-wide concatenation of the sets of data.

5.8 All-to-All Scatter/Gather

```

1 MPI_ALLTOALL(sendbuf, sendcount, sendtype, recvbuf, recvcnt, recvtype, comm)
2
3
4
5 MPI_ALLTOALL(sendbuf, sendcount, sendtype, recvbuf, recvcnt, recvtype, comm)
6     IN      sendbuf      starting address of send buffer (choice)
7     IN      sendcount    number of elements sent to each process (non-negative
8                          integer)
9     IN      sendtype     data type of send buffer elements (handle)
10    OUT     recvbuf      address of receive buffer (choice)
11    IN      recvcnt      number of elements received from any process (non-
12                          negative integer)
13    IN      recvtype     data type of receive buffer elements (handle)
14    IN      comm         communicator (handle)
15
16
17

```

```

18 int MPI_Alltoall(const void* sendbuf, int sendcount, MPI_Datatype sendtype,
19                void* recvbuf, int recvcnt, MPI_Datatype recvtype,
20                MPI_Comm comm)
21
22

```

```

23 MPI_Alltoall(sendbuf, sendcount, sendtype, recvbuf, recvcnt, recvtype,
24             comm, ierror)
25

```

```

26     TYPE(*), DIMENSION(..), INTENT(IN) :: sendbuf
27     TYPE(*), DIMENSION(..) :: recvbuf
28     INTEGER, INTENT(IN) :: sendcount, recvcnt
29     TYPE(MPI_Datatype), INTENT(IN) :: sendtype, recvtype
30     TYPE(MPI_Comm), INTENT(IN) :: comm
31     INTEGER, OPTIONAL, INTENT(OUT) :: ierror
32

```

```

33 MPI_ALLTOALL(SENDBUF, SENDCOUNT, SENDTYPE, RECVBUF, RECVCOUNT, RECVTYPE,
34             COMM, IERROR)
35

```

```

36     <type> SENDBUF(*), RECVBUF(*)
37     INTEGER SENDCOUNT, SENDTYPE, RECVCOUNT, RECVTYPE, COMM, IERROR
38

```

MPI_ALLTOALL is an extension of MPI_ALLGATHER to the case where each process sends distinct data to each of the receivers. The j -th block sent from process i is received by process j and is placed in the i -th block of `recvbuf`.

The type signature associated with `sendcount`, `sendtype`, at a process must be equal to the type signature associated with `recvcnt`, `recvtype` at any other process. This implies that the amount of data sent must be equal to the amount of data received, pairwise between every pair of processes. As usual, however, the type maps may be different.

If `comm` is an intracommunicator, the outcome is as if each process executed a send to each process (itself included) with a call to,

```
MPI_Send(sendbuf+i·sendcount·extent(sendtype),sendcount,sendtype,i, ...),
```

and a receive from every other process with a call to,

```
MPI_Recv(recvbuf+i·recvcnt·extent(recvtype),recvcnt,recvtype,i,...).
```

All arguments on all processes are significant. The argument `comm` must have identical values on all processes.

The “in place” option for intracommunicators is specified by passing `MPI_IN_PLACE` to the argument `sendbuf` at *all* processes. In such a case, `sendcount` and `sendtype` are ignored. The data to be sent is taken from the `recvbuf` and replaced by the received data. Data sent and received must have the same type map as specified by `recvcount` and `recvtype`.

Rationale. For large `MPI_ALLTOALL` instances, allocating both send and receive buffers may consume too much memory. The “in place” option effectively halves the application memory consumption and is useful in situations where the data to be sent will not be used by the sending process after the `MPI_ALLTOALL` exchange (e.g., in parallel Fast Fourier Transforms). (*End of rationale.*)

Advice to implementors. Users may opt to use the “in place” option in order to conserve memory. Quality MPI implementations should thus strive to minimize system buffering. (*End of advice to implementors.*)

If `comm` is an intercommunicator, then the outcome is as if each process in group A sends a message to each process in group B, and vice versa. The *j*-th send buffer of process *i* in group A should be consistent with the *i*-th receive buffer of process *j* in group B, and vice versa.

Advice to users. When a complete exchange is executed on an intercommunication domain, then the number of data items sent from processes in group A to processes in group B need not equal the number of items sent in the reverse direction. In particular, one can have unidirectional communication by specifying `sendcount = 0` in the reverse direction. (*End of advice to users.*)

```

1 MPI_ALLTOALLV(sendbuf, sendcounts, sdispls, sendtype, recvbuf, recvcoun
2         recvtype, comm)
3
4     IN        sendbuf        starting address of send buffer (choice)
5
6     IN        sendcounts     non-negative integer array (of length group size) spec-
7         ifying the number of elements to send to each rank
8
9     IN        sdispls        integer array (of length group size). Entry j specifies
10         the displacement (relative to sendbuf) from which to
11         take the outgoing data destined for process j
12
13     IN        sendtype       data type of send buffer elements (handle)
14
15     OUT       recvbuf        address of receive buffer (choice)
16
17     IN        recvcoun
18         counts              non-negative integer array (of length group size) spec-
19         ifying the number of elements that can be received
20         from each rank
21
22     IN        rdispls        integer array (of length group size). Entry i specifies
23         the displacement (relative to recvbuf) at which to place
24         the incoming data from process i
25
26     IN        recvtype       data type of receive buffer elements (handle)
27
28     IN        comm           communicator (handle)

```

```

29
30 int MPI_Alltoallv(const void* sendbuf, const int sendcounts[],
31         const int sdispls[], MPI_Datatype sendtype, void* recvbuf,
32         const int recvcoun
33         counts[], const int rdispls[],
34         MPI_Datatype recvtype, MPI_Comm comm)
35
36 MPI_Alltoallv(sendbuf, sendcounts, sdispls, sendtype, recvbuf, recvcoun
37         counts,
38         rdispls, recvtype, comm, ierror)
39
40     TYPE(*), DIMENSION(..), INTENT(IN) :: sendbuf
41     TYPE(*), DIMENSION(..) :: recvbuf
42     INTEGER, INTENT(IN) :: sendcounts(*), sdispls(*), recvcoun
43         counts(*),
44         rdispls(*)
45     TYPE(MPI_Datatype), INTENT(IN) :: sendtype, recvtype
46     TYPE(MPI_Comm), INTENT(IN) :: comm
47     INTEGER, OPTIONAL, INTENT(OUT) :: ierror
48
49 MPI_ALLTOALLV(SENDBUF, SENDCOUNTS, SDISPLS, SENDTYPE, RECVBUF, RECVCOUNTS,
50         RDISPLS, RECVTYPE, COMM, IERROR)
51
52     <type> SENDBUF(*), RECVBUF(*)
53     INTEGER SENDCOUNTS(*), SDISPLS(*), SENDTYPE, REVCOUNTS(*), RDISPLS(*),
54         RECVTYPE, COMM, IERROR

```

MPI_ALLTOALLV adds flexibility to MPI_ALLTOALL in that the location of data for the send is specified by `sdispls` and the location of the placement of the data on the receive side is specified by `rdispls`.

If `comm` is an intracommunicator, then the j -th block sent from process i is received by process j and is placed in the i -th block of `recvbuf`. These blocks need not all have the same size.

The type signature associated with `sendcounts[j]`, `sendtype` at process `i` must be equal to the type signature associated with `recvcounts[i]`, `recvtype` at process `j`. This implies that the amount of data sent must be equal to the amount of data received, pairwise between every pair of processes. Distinct type maps between sender and receiver are still allowed.

The outcome is as if each process sent a message to every other process with,

```
MPI_Send(sendbuf+sdispls[i]·extent(sendtype),sendcounts[i],sendtype,i,...),
```

and received a message from every other process with a call to

```
MPI_Recv(recvbuf+rdispls[j]·extent(recvtype),recvcounts[j],recvtype,j,...).
```

All arguments on all processes are significant. The argument `comm` must have identical values on all processes.

The “in place” option for intracommunicators is specified by passing `MPI_IN_PLACE` to the argument `sendbuf` at *all* processes. In such a case, `sendcounts`, `sdispls` and `sendtype` are ignored. The data to be sent is taken from the `recvbuf` and replaced by the received data. Data sent and received must have the same type map as specified by the `recvcounts` array and the `recvtype`, and is taken from the locations of the receive buffer specified by `rdispls`.

Advice to users. Specifying the “in place” option (which must be given on all processes) implies that the same amount and type of data is sent and received between any two processes in the group of the communicator. Different pairs of processes can exchange different amounts of data. Users must ensure that `recvcounts[j]` and `recvtype` on process `i` match `recvcounts[i]` and `recvtype` on process `j`. This symmetric exchange can be useful in applications where the data to be sent will not be used by the sending process after the `MPI_ALLTOALLV` exchange. (*End of advice to users.*)

If `comm` is an intercommunicator, then the outcome is as if each process in group A sends a message to each process in group B, and vice versa. The `j`-th send buffer of process `i` in group A should be consistent with the `i`-th receive buffer of process `j` in group B, and vice versa.

Rationale. The definitions of `MPI_ALLTOALL` and `MPI_ALLTOALLV` give as much flexibility as one would achieve by specifying `n` independent, point-to-point communications, with two exceptions: all messages use the same datatype, and messages are scattered from (or gathered to) sequential storage. (*End of rationale.*)

Advice to implementors. Although the discussion of collective communication in terms of point-to-point operation implies that each message is transferred directly from sender to receiver, implementations may use a tree communication pattern. Messages can be forwarded by intermediate nodes where they are split (for scatter) or concatenated (for gather), if this is more efficient. (*End of advice to implementors.*)

```

1 MPI_ALLTOALLW(sendbuf, sendcounts, sdispls, sendtypes, recvbuf, recvcoun
2         recvtypes, comm)
3
4     IN     sendbuf           starting address of send buffer (choice)
5
6     IN     sendcounts       non-negative integer array (of length group size) spec-
7         ifying the number of elements to send to each rank
8
9     IN     sdispls          integer array (of length group size). Entry j specifies
10        the displacement in bytes (relative to sendbuf) from
11        which to take the outgoing data destined for process j
12        (array of integers)
13
14     IN     sendtypes        array of datatypes (of length group size). Entry j spec-
15        ifies the type of data to send to process j (array of
16        handles)
17
18     OUT    recvbuf          address of receive buffer (choice)
19
20     IN     recvcoun
21         counts             non-negative integer array (of length group size) spec-
22        ifying the number of elements that can be received
23        from each rank
24
25     IN     rdispls          integer array (of length group size). Entry i specifies
26        the displacement in bytes (relative to recvbuf) at which
27        to place the incoming data from process i (array of
28        integers)
29
30     IN     recvtypes        array of datatypes (of length group size). Entry i spec-
31        ifies the type of data received from process i (array of
32        handles)
33
34     IN     comm             communicator (handle)
35
36 int MPI_Alltoallw(const void* sendbuf, const int sendcounts[],
37                 const int sdispls[], const MPI_Datatype sendtypes[],
38                 void* recvbuf, const int recvcoun
39         counts[], const int rdispls[],
40                 const MPI_Datatype recvtypes[], MPI_Comm comm)
41
42 MPI_Alltoallw(sendbuf, sendcounts, sdispls, sendtypes, recvbuf, recvcoun
43         counts,
44         rdispls, recvtypes, comm, ierror)
45     TYPE(*), DIMENSION(..), INTENT(IN) :: sendbuf
46     TYPE(*), DIMENSION(..) :: recvbuf
47     INTEGER, INTENT(IN) :: sendcounts(*), sdispls(*), recvcoun
48         counts(*),
49         rdispls(*)
50     TYPE(MPI_Datatype), INTENT(IN) :: sendtypes(*)
51     TYPE(MPI_Datatype), INTENT(IN) :: recvtypes(*)
52     TYPE(MPI_Comm), INTENT(IN) :: comm
53     INTEGER, OPTIONAL, INTENT(OUT) :: ierror
54
55 MPI_ALLTOALLW(SENDBUF, SENDCOUNTS, SDISPLS, SENDTYPES, RECVBUF, RECVCOUNTS,
56         RDISPLS, RECVTYPES, COMM, IERROR)
57     <type> SENDBUF(*), RECVBUF(*)
58     INTEGER SENDCOUNTS(*), SDISPLS(*), SENDTYPES(*), REVCOUNTS(*),
59         RDISPLS(*), RECVTYPES(*), COMM, IERROR

```

MPI_ALLTOALLW is the most general form of complete exchange. Like MPI_TYPE_CREATE_STRUCT, the most general type constructor, MPI_ALLTOALLW allows separate specification of count, displacement and datatype. In addition, to allow maximum flexibility, the displacement of blocks within the send and receive buffers is specified in bytes.

If `comm` is an intracommunicator, then the j -th block sent from process i is received by process j and is placed in the i -th block of `recvbuf`. These blocks need not all have the same size.

The type signature associated with `sendcounts[j]`, `sendtypes[j]` at process i must be equal to the type signature associated with `recvcounts[i]`, `recvtypes[i]` at process j . This implies that the amount of data sent must be equal to the amount of data received, pairwise between every pair of processes. Distinct type maps between sender and receiver are still allowed.

The outcome is as if each process sent a message to every other process with

```
MPI_Send(sendbuf+sdispls[i],sendcounts[i],sendtypes[i] ,i,...),
```

and received a message from every other process with a call to

```
MPI_Recv(recvbuf+rdispls[i],recvcounts[i],recvtypes[i] ,i,...).
```

All arguments on all processes are significant. The argument `comm` must describe the same communicator on all processes.

Like for MPI_ALLTOALLV, the “in place” option for intracommunicators is specified by passing MPI_IN_PLACE to the argument `sendbuf` at *all* processes. In such a case, `sendcounts`, `sdispls` and `sendtypes` are ignored. The data to be sent is taken from the `recvbuf` and replaced by the received data. Data sent and received must have the same type map as specified by the `recvcounts` and `recvtypes` arrays, and is taken from the locations of the receive buffer specified by `rdispls`.

If `comm` is an intercommunicator, then the outcome is as if each process in group A sends a message to each process in group B, and vice versa. The j -th send buffer of process i in group A should be consistent with the i -th receive buffer of process j in group B, and vice versa.

Rationale. The MPI_ALLTOALLW function generalizes several MPI functions by carefully selecting the input arguments. For example, by making all but one process have `sendcounts[i] = 0`, this achieves an MPI_SCATTERW function. (*End of rationale.*)

5.9 Global Reduction Operations

The functions in this section perform a global reduce operation (for example sum, maximum, and logical and) across all members of a group. The reduction operation can be either one of a predefined list of operations, or a user-defined operation. The global reduction functions come in several flavors: a reduce that returns the result of the reduction to one member of a group, an all-reduce that returns this result to all members of a group, and two scan (parallel prefix) operations. In addition, a reduce-scatter operation combines the functionality of a reduce and of a scatter operation.

5.9.1 Reduce

```

4 MPI_REDUCE(sendbuf, recvbuf, count, datatype, op, root, comm)

```

6	IN	sendbuf	address of send buffer (choice)
7	OUT	recvbuf	address of receive buffer (choice, significant only at root)
9	IN	count	number of elements in send buffer (non-negative integer)
11	IN	datatype	data type of elements of send buffer (handle)
12	IN	op	reduce operation (handle)
13	IN	root	rank of root process (integer)
14	IN	comm	communicator (handle)

```

17
18 int MPI_Reduce(const void* sendbuf, void* recvbuf, int count,
19               MPI_Datatype datatype, MPI_Op op, int root, MPI_Comm comm)

```

```

20 MPI_Reduce(sendbuf, recvbuf, count, datatype, op, root, comm, ierror)

```

```

21     TYPE(*), DIMENSION(..), INTENT(IN) :: sendbuf
22     TYPE(*), DIMENSION(..) :: recvbuf
23     INTEGER, INTENT(IN) :: count, root
24     TYPE(MPI_Datatype), INTENT(IN) :: datatype
25     TYPE(MPI_Op), INTENT(IN) :: op
26     TYPE(MPI_Comm), INTENT(IN) :: comm
27     INTEGER, OPTIONAL, INTENT(OUT) :: ierror

```

```

28
29 MPI_REDUCE(SENDBUF, RECVBUF, COUNT, DATATYPE, OP, ROOT, COMM, IERROR)

```

```

30     <type> SENDBUF(*), RECVBUF(*)
31     INTEGER COUNT, DATATYPE, OP, ROOT, COMM, IERROR

```

If `comm` is an intracommunicator, `MPI_REDUCE` combines the elements provided in the input buffer of each process in the group, using the operation `op`, and returns the combined value in the output buffer of the process with rank `root`. The input buffer is defined by the arguments `sendbuf`, `count` and `datatype`; the output buffer is defined by the arguments `recvbuf`, `count` and `datatype`; both have the same number of elements, with the same type. The routine is called by all group members using the same arguments for `count`, `datatype`, `op`, `root` and `comm`. Thus, all processes provide input buffers of the same length, with elements of the same type as the output buffer at the root. Each process can provide one element, or a sequence of elements, in which case the combine operation is executed element-wise on each entry of the sequence. For example, if the operation is `MPI_MAX` and the send buffer contains two elements that are floating point numbers (`count = 2` and `datatype = MPI_FLOAT`), then `recvbuf(1) = global max(sendbuf(1))` and `recvbuf(2) = global max(sendbuf(2))`.

Section 5.9.2, lists the set of predefined operations provided by MPI. That section also enumerates the datatypes to which each operation can be applied.

In addition, users may define their own operations that can be overloaded to operate on several datatypes, either basic or derived. This is further explained in Section 5.9.5.

The operation `op` is always assumed to be associative. All predefined operations are also assumed to be commutative. Users may define operations that are assumed to be associative, but not commutative. The “canonical” evaluation order of a reduction is determined by the ranks of the processes in the group. However, the implementation can take advantage of associativity, or associativity and commutativity in order to change the order of evaluation. This may change the result of the reduction for operations that are not strictly associative and commutative, such as floating point addition.

Advice to implementors. It is strongly recommended that `MPI_REDUCE` be implemented so that the same result be obtained whenever the function is applied on the same arguments, appearing in the same order. Note that this may prevent optimizations that take advantage of the physical location of ranks. (*End of advice to implementors.*)

Advice to users. Some applications may not be able to ignore the non-associative nature of floating-point operations or may use user-defined operations (see Section 5.9.5) that require a special reduction order and cannot be treated as associative. Such applications should enforce the order of evaluation explicitly. For example, in the case of operations that require a strict left-to-right (or right-to-left) evaluation order, this could be done by gathering all operands at a single process (e.g., with `MPI_GATHER`), applying the reduction operation in the desired order (e.g., with `MPI_REDUCE_LOCAL`), and if needed, broadcast or scatter the result to the other processes (e.g., with `MPI_BCAST`). (*End of advice to users.*)

The `datatype` argument of `MPI_REDUCE` must be compatible with `op`. Predefined operators work only with the MPI types listed in Section 5.9.2 and Section 5.9.4. Furthermore, the `datatype` and `op` given for predefined operators must be the same on all processes.

Note that it is possible for users to supply different user-defined operations to `MPI_REDUCE` in each process. MPI does not define which operations are used on which operands in this case. User-defined operators may operate on general, derived datatypes. In this case, each argument that the reduce operation is applied to is one element described by such a datatype, which may contain several basic values. This is further explained in Section 5.9.5.

Advice to users. Users should make no assumptions about how `MPI_REDUCE` is implemented. It is safest to ensure that the same function is passed to `MPI_REDUCE` by each process. (*End of advice to users.*)

Overlapping datatypes are permitted in “send” buffers. Overlapping datatypes in “receive” buffers are erroneous and may give unpredictable results.

The “in place” option for intracommunicators is specified by passing the value `MPI_IN_PLACE` to the argument `sendbuf` at the root. In such a case, the input data is taken at the root from the receive buffer, where it will be replaced by the output data.

If `comm` is an intercommunicator, then the call involves all processes in the intercommunicator, but with one group (group A) defining the root process. All processes in the other group (group B) pass the same value in argument `root`, which is the rank of the root in group A. The root passes the value `MPI_ROOT` in `root`. All other processes in group A pass the value `MPI_PROC_NULL` in `root`. Only send buffer arguments are significant in group B and only receive buffer arguments are significant at the root.

5.9.2 Predefined Reduction Operations

The following predefined operations are supplied for `MPI_REDUCE` and related functions `MPI_ALLREDUCE`, `MPI_REDUCE_SCATTER_BLOCK`, `MPI_REDUCE_SCATTER`, `MPI_SCAN`, `MPI_EXSCAN`, all nonblocking variants of those (see Section 5.12), and `MPI_REDUCE_LOCAL`. These operations are invoked by placing the following in `op`.

Name	Meaning
<code>MPI_MAX</code>	maximum
<code>MPI_MIN</code>	minimum
<code>MPI_SUM</code>	sum
<code>MPI_PROD</code>	product
<code>MPI_LAND</code>	logical and
<code>MPI_BAND</code>	bit-wise and
<code>MPI_LOR</code>	logical or
<code>MPI BOR</code>	bit-wise or
<code>MPI_LXOR</code>	logical exclusive or (xor)
<code>MPI_BXOR</code>	bit-wise exclusive or (xor)
<code>MPI_MAXLOC</code>	max value and location
<code>MPI_MINLOC</code>	min value and location

The two operations `MPI_MINLOC` and `MPI_MAXLOC` are discussed separately in Section 5.9.4. For the other predefined operations, we enumerate below the allowed combinations of `op` and `datatype` arguments. First, define groups of MPI basic datatypes in the following way.

C integer:	<code>MPI_INT</code> , <code>MPI_LONG</code> , <code>MPI_SHORT</code> , <code>MPI_UNSIGNED_SHORT</code> , <code>MPI_UNSIGNED</code> , <code>MPI_UNSIGNED_LONG</code> , <code>MPI_LONG_LONG_INT</code> , <code>MPI_LONG_LONG</code> (as synonym), <code>MPI_UNSIGNED_LONG_LONG</code> , <code>MPI_SIGNED_CHAR</code> , <code>MPI_UNSIGNED_CHAR</code> , <code>MPI_INT8_T</code> , <code>MPI_INT16_T</code> , <code>MPI_INT32_T</code> , <code>MPI_INT64_T</code> , <code>MPI_UINT8_T</code> , <code>MPI_UINT16_T</code> , <code>MPI_UINT32_T</code> , and <code>MPI_UINT64_T</code>
Fortran integer:	<code>MPI_INTEGER</code> and handles returned from <code>MPI_TYPE_CREATE_F90_INTEGER</code> and, if available, <code>MPI_INTEGER1</code> , <code>MPI_INTEGER2</code> , <code>MPI_INTEGER4</code> , <code>MPI_INTEGER8</code> , and <code>MPI_INTEGER16</code>
Floating point:	<code>MPI_FLOAT</code> , <code>MPI_DOUBLE</code> , <code>MPI_REAL</code> , <code>MPI_DOUBLE_PRECISION</code> , <code>MPI_LONG_DOUBLE</code> , and handles returned from

	MPI_TYPE_CREATE_F90_REAL	1
	and, if available, MPI_REAL2,	2
	MPI_REAL4, MPI_REAL8, and MPI_REAL16	3
Logical:	MPI_LOGICAL, MPI_C_BOOL,	4
	and MPI_CXX_BOOL	5
Complex:	MPI_COMPLEX, MPI_C_COMPLEX,	6
	MPI_C_FLOAT_COMPLEX (as synonym),	7
	MPI_C_DOUBLE_COMPLEX,	8
	MPI_C_LONG_DOUBLE_COMPLEX,	9
	MPI_CXX_FLOAT_COMPLEX,	10
	MPI_CXX_DOUBLE_COMPLEX,	11
	MPI_CXX_LONG_DOUBLE_COMPLEX,	12
	and handles returned from	13
	MPI_TYPE_CREATE_F90_COMPLEX	14
	and, if available, MPI_DOUBLE_COMPLEX,	15
	MPI_COMPLEX4, MPI_COMPLEX8,	16
	MPI_COMPLEX16, and MPI_COMPLEX32	17
Byte:	MPI_BYTE	18
Multi-language types:	MPI_AINT, MPI_OFFSET, and MPI_COUNT	19

Now, the valid datatypes for each operation are specified below.

Op	Allowed Types	22
MPI_MAX, MPI_MIN	C integer, Fortran integer, Floating point, Multi-language types	23
MPI_SUM, MPI_PROD	C integer, Fortran integer, Floating point, Complex, Multi-language types	24
MPI_LAND, MPI_LOR, MPI_LXOR	C integer, Logical	25
MPI_BAND, MPI_BOR, MPI_BXOR	C integer, Fortran integer, Byte, Multi-language types	26

These operations together with all listed datatypes are valid in all supported programming languages, see also Reduce Operations on page 694 in Section 18.2.6.

The following examples use intracommunicators.

Example 5.15

A routine that computes the dot product of two vectors that are distributed across a group of processes and returns the answer at node zero.

```

1  SUBROUTINE PAR_BLAS1(m, a, b, c, comm)
2  REAL a(m), b(m)          ! local slice of array
3  REAL c                   ! result (at node zero)
4  REAL sum
5  INTEGER m, comm, i, ierr
6
7  ! local sum
8  sum = 0.0
9  DO i = 1, m
10     sum = sum + a(i)*b(i)
11 END DO
12
13 ! global sum
14 CALL MPI_REDUCE(sum, c, 1, MPI_REAL, MPI_SUM, 0, comm, ierr)
15 RETURN
16 END

```

Example 5.16

A routine that computes the product of a vector and an array that are distributed across a group of processes and returns the answer at node zero.

```

22 SUBROUTINE PAR_BLAS2(m, n, a, b, c, comm)
23 REAL a(m), b(m,n)      ! local slice of array
24 REAL c(n)              ! result
25 REAL sum(n)
26 INTEGER n, comm, i, j, ierr
27
28 ! local sum
29 DO j= 1, n
30     sum(j) = 0.0
31     DO i = 1, m
32         sum(j) = sum(j) + a(i)*b(i,j)
33     END DO
34 END DO
35
36 ! global sum
37 CALL MPI_REDUCE(sum, c, n, MPI_REAL, MPI_SUM, 0, comm, ierr)
38
39 ! return result at node zero (and garbage at the other nodes)
40 RETURN
41 END

```

5.9.3 Signed Characters and Reductions

The types `MPI_SIGNED_CHAR` and `MPI_UNSIGNED_CHAR` can be used in reduction operations. `MPI_CHAR`, `MPI_WCHAR`, and `MPI_CHARACTER` (which represent printable characters) cannot be used in reduction operations. In a heterogeneous environment, `MPI_CHAR`, `MPI_WCHAR`, and `MPI_CHARACTER` will be translated so as to preserve the printable

character, whereas `MPI_SIGNED_CHAR` and `MPI_UNSIGNED_CHAR` will be translated so as to preserve the integer value.

Advice to users. The types `MPI_CHAR`, `MPI_WCHAR`, and `MPI_CHARACTER` are intended for characters, and so will be translated to preserve the printable representation, rather than the integer value, if sent between machines with different character codes. The types `MPI_SIGNED_CHAR` and `MPI_UNSIGNED_CHAR` should be used in C if the integer value should be preserved. (*End of advice to users.*)

5.9.4 MINLOC and MAXLOC

The operator `MPI_MINLOC` is used to compute a global minimum and also an index attached to the minimum value. `MPI_MAXLOC` similarly computes a global maximum and index. One application of these is to compute a global minimum (maximum) and the rank of the process containing this value.

The operation that defines `MPI_MAXLOC` is:

$$\begin{pmatrix} u \\ i \end{pmatrix} \circ \begin{pmatrix} v \\ j \end{pmatrix} = \begin{pmatrix} w \\ k \end{pmatrix}$$

where

$$w = \max(u, v)$$

and

$$k = \begin{cases} i & \text{if } u > v \\ \min(i, j) & \text{if } u = v \\ j & \text{if } u < v \end{cases}$$

`MPI_MINLOC` is defined similarly:

$$\begin{pmatrix} u \\ i \end{pmatrix} \circ \begin{pmatrix} v \\ j \end{pmatrix} = \begin{pmatrix} w \\ k \end{pmatrix}$$

where

$$w = \min(u, v)$$

and

$$k = \begin{cases} i & \text{if } u < v \\ \min(i, j) & \text{if } u = v \\ j & \text{if } u > v \end{cases}$$

Both operations are associative and commutative. Note that if `MPI_MAXLOC` is applied to reduce a sequence of pairs $(u_0, 0), (u_1, 1), \dots, (u_{n-1}, n-1)$, then the value returned is (u, r) , where $u = \max_i u_i$ and r is the index of the first global maximum in the sequence. Thus, if each process supplies a value and its rank within the group, then a reduce operation with `op = MPI_MAXLOC` will return the maximum value and the rank of the first process with that value. Similarly, `MPI_MINLOC` can be used to return a minimum and its index. More generally, `MPI_MINLOC` computes a *lexicographic minimum*, where elements are ordered

1 according to the first component of each pair, and ties are resolved according to the second
 2 component.

3 The reduce operation is defined to operate on arguments that consist of a pair: value
 4 and index. For both Fortran and C, types are provided to describe the pair. The potentially
 5 mixed-type nature of such arguments is a problem in Fortran. The problem is circumvented,
 6 for Fortran, by having the MPI-provided type consist of a pair of the same type as value,
 7 and coercing the index to this type also. In C, the MPI-provided pair type has distinct
 8 types and the index is an `int`.

9 In order to use `MPI_MINLOC` and `MPI_MAXLOC` in a reduce operation, one must provide
 10 a `datatype` argument that represents a pair (value and index). MPI provides nine such
 11 predefined datatypes. The operations `MPI_MAXLOC` and `MPI_MINLOC` can be used with
 12 each of the following datatypes.

13
 14 Fortran:

15 Name	Description
16 <code>MPI_2REAL</code>	pair of <code>REAL</code> s
17 <code>MPI_2DOUBLE_PRECISION</code>	pair of <code>DOUBLE PRECISION</code> variables
18 <code>MPI_2INTEGER</code>	pair of <code>INTEGER</code> s

19
 20
 21 C:

22 Name	Description
23 <code>MPI_FLOAT_INT</code>	<code>float</code> and <code>int</code>
24 <code>MPI_DOUBLE_INT</code>	<code>double</code> and <code>int</code>
25 <code>MPI_LONG_INT</code>	<code>long</code> and <code>int</code>
26 <code>MPI_2INT</code>	pair of <code>int</code>
27 <code>MPI_SHORT_INT</code>	<code>short</code> and <code>int</code>
28 <code>MPI_LONG_DOUBLE_INT</code>	<code>long double</code> and <code>int</code>

29 The datatype `MPI_2REAL` is *as if* defined by the following (see Section 4.1).
 30

```
31 MPI_Type_contiguous(2, MPI_REAL, MPI_2REAL);
```

32
 33 Similar statements apply for `MPI_2INTEGER`, `MPI_2DOUBLE_PRECISION`, and `MPI_2INT`.

34 The datatype `MPI_SHORT_INT` is *as if* defined by the following sequence of instructions.

```
35  

  36 struct mystruct {  

  37     short val;  

  38     int rank;  

  39 };  

  40 type[0] = MPI_SHORT;  

  41 type[1] = MPI_INT;  

  42 disp[0] = 0;  

  43 disp[1] = offsetof(struct mystruct, rank);  

  44 block[0] = 1;  

  45 block[1] = 1;  

  46 MPI_Type_create_struct(2, block, disp, type, MPI_SHORT_INT);
```

Similar statements apply for MPI_FLOAT_INT, MPI_LONG_INT and MPI_DOUBLE_INT. 1

The following examples use intracommunicators. 2

Example 5.17 3

Each process has an array of 30 doubles, in C. For each of the 30 locations, compute 4
the value and rank of the process containing the largest value. 5

```

... 6
/* each process has an array of 30 double: ain[30] 7
*/ 8
double ain[30], aout[30]; 9
int ind[30]; 10
struct { 11
    double val; 12
    int rank; 13
} in[30], out[30]; 14
int i, myrank, root; 15

MPI_Comm_rank(comm, &myrank); 16
for (i=0; i<30; ++i) { 17
    in[i].val = ain[i]; 18
    in[i].rank = myrank; 19
} 20
MPI_Reduce(in, out, 30, MPI_DOUBLE_INT, MPI_MAXLOC, root, comm); 21
/* At this point, the answer resides on process root 22
*/ 23
if (myrank == root) { 24
    /* read ranks out 25
    */ 26
    for (i=0; i<30; ++i) { 27
        aout[i] = out[i].val; 28
        ind[i] = out[i].rank; 29
    } 30
} 31
} 32
} 33
} 34
} 35
} 36
} 37
} 38
} 39
} 40
} 41
} 42
} 43
} 44
} 45
} 46
} 47
} 48

```

Example 5.18 36

Same example, in Fortran. 37

```

... 38
! each process has an array of 30 double: ain(30) 39
40
DOUBLE PRECISION ain(30), aout(30) 41
INTEGER ind(30) 42
DOUBLE PRECISION in(2,30), out(2,30) 43
INTEGER i, myrank, root, ierr 44

CALL MPI_COMM_RANK(comm, myrank, ierr) 45
DO I=1, 30 46
47
48

```

```

1         in(1,i) = ain(i)
2         in(2,i) = myrank      ! myrank is coerced to a double
3     END DO
4
5     CALL MPI_REDUCE(in, out, 30, MPI_2DOUBLE_PRECISION, MPI_MAXLOC, root,
6                                     comm, ierr)
7
8     ! At this point, the answer resides on process root
9
10    IF (myrank .EQ. root) THEN
11        ! read ranks out
12        DO I= 1, 30
13            aout(i) = out(1,i)
14            ind(i) = out(2,i) ! rank is coerced back to an integer
15        END DO
16    END IF

```

Example 5.19

Each process has a non-empty array of values. Find the minimum global value, the rank of the process that holds it and its index on this process.

```

21 #define LEN 1000
22
23 float val[LEN];          /* local array of values */
24 int count;              /* local number of values */
25 int myrank, minrank, minindex;
26 float minval;
27
28 struct {
29     float value;
30     int index;
31 } in, out;
32
33     /* local minloc */
34 in.value = val[0];
35 in.index = 0;
36 for (i=1; i < count; i++)
37     if (in.value > val[i]) {
38         in.value = val[i];
39         in.index = i;
40     }
41
42     /* global minloc */
43 MPI_Comm_rank(comm, &myrank);
44 in.index = myrank*LEN + in.index;
45 MPI_Reduce( &in, &out, 1, MPI_FLOAT_INT, MPI_MINLOC, root, comm );
46     /* At this point, the answer resides on process root
47        */
48

```

```

if (myrank == root) {
    /* read answer out
    */
    minval = out.value;
    minrank = out.index / LEN;
    minindex = out.index % LEN;
}

```

Rationale. The definition of MPI_MINLOC and MPI_MAXLOC given here has the advantage that it does not require any special-case handling of these two operations: they are handled like any other reduce operation. A programmer can provide his or her own definition of MPI_MAXLOC and MPI_MINLOC, if so desired. The disadvantage is that values and indices have to be first interleaved, and that indices and values have to be coerced to the same type, in Fortran. (*End of rationale.*)

5.9.5 User-Defined Reduction Operations

MPI_OP_CREATE(user_fn, commute, op)

IN	user_fn	user defined function (function)
IN	commute	true if commutative; false otherwise.
OUT	op	operation (handle)

```
int MPI_Op_create(MPI_User_function* user_fn, int commute, MPI_Op* op)
```

```

MPI_Op_create(user_fn, commute, op, ierror)
  PROCEDURE(MPI_User_function) :: user_fn
  LOGICAL, INTENT(IN) :: commute
  TYPE(MPI_Op), INTENT(OUT) :: op
  INTEGER, OPTIONAL, INTENT(OUT) :: ierror

```

```
MPI_OP_CREATE( USER_FN, COMMUTE, OP, IERROR)
```

```

EXTERNAL USER_FN
LOGICAL COMMUTE
INTEGER OP, IERROR

```

MPI_OP_CREATE binds a user-defined reduction operation to an `op` handle that can subsequently be used in MPI_REDUCE, MPI_ALLREDUCE, MPI_REDUCE_SCATTER_BLOCK, MPI_REDUCE_SCATTER, MPI_SCAN, MPI_EXSCAN, all nonblocking variants of those (see Section 5.12), and MPI_REDUCE_LOCAL. The user-defined operation is assumed to be associative. If `commute = true`, then the operation should be both commutative and associative. If `commute = false`, then the order of operands is fixed and is defined to be in ascending, process rank order, beginning with process zero. The order of evaluation can be changed, taking advantage of the associativity of the operation. If `commute = true` then the order of evaluation can be changed, taking advantage of commutativity and associativity.

The argument `user_fn` is the user-defined function, which must have the following four arguments: `invec`, `inoutvec`, `len`, and `datatype`.

1 The ISO C prototype for the function is the following.

```
2 typedef void MPI_User_function(void* invec, void* inoutvec, int *len,
3 MPI_Datatype *datatype);
```

4 The Fortran declarations of the user-defined function `user_fn` appear below.

```
5 ABSTRACT INTERFACE
```

```
6 SUBROUTINE MPI_User_function(invec, inoutvec, len, datatype)
7 USE, INTRINSIC :: ISO_C_BINDING, ONLY : C_PTR
8 TYPE(C_PTR), VALUE :: invec, inoutvec
9 INTEGER :: len
10 TYPE(MPI_Datatype) :: datatype
```

```
11 SUBROUTINE USER_FUNCTION(INVEC, INOUTVEC, LEN, DATATYPE)
12 <type> INVEC(LEN), INOUTVEC(LEN)
13 INTEGER LEN, DATATYPE
```

14 The `datatype` argument is a handle to the data type that was passed into the call to `MPI_REDUCE`. The user reduce function should be written such that the following holds: Let $u[0], \dots, u[\text{len}-1]$ be the `len` elements in the communication buffer described by the arguments `invec`, `len` and `datatype` when the function is invoked; let $v[0], \dots, v[\text{len}-1]$ be `len` elements in the communication buffer described by the arguments `inoutvec`, `len` and `datatype` when the function is invoked; let $w[0], \dots, w[\text{len}-1]$ be `len` elements in the communication buffer described by the arguments `inoutvec`, `len` and `datatype` when the function returns; then $w[i] = u[i] \circ v[i]$, for $i=0, \dots, \text{len}-1$, where \circ is the reduce operation that the function computes.

15 Informally, we can think of `invec` and `inoutvec` as arrays of `len` elements that `user_fn` is combining. The result of the reduction over-writes values in `inoutvec`, hence the name. Each invocation of the function results in the pointwise evaluation of the reduce operator on `len` elements: i.e., the function returns in `inoutvec[i]` the value `invec[i] \circ inoutvec[i]`, for $i=0, \dots, \text{count}-1$, where \circ is the combining operation computed by the function.

16 *Rationale.* The `len` argument allows `MPI_REDUCE` to avoid calling the function for each element in the input buffer. Rather, the system can choose to apply the function to chunks of input. In C, it is passed in as a reference for reasons of compatibility with Fortran.

17 By internally comparing the value of the `datatype` argument to known, global handles, it is possible to overload the use of a single user-defined function for several, different data types. (*End of rationale.*)

18 General datatypes may be passed to the user function. However, use of datatypes that are not contiguous is likely to lead to inefficiencies.

19 No MPI communication function may be called inside the user function. `MPI_ABORT` may be called inside the function in case of an error.

20 *Advice to users.* Suppose one defines a library of user-defined reduce functions that are overloaded: the `datatype` argument is used to select the right execution path at each invocation, according to the types of the operands. The user-defined reduce function cannot “decode” the `datatype` argument that it is passed, and cannot identify, by itself, the correspondence between the `datatype` handles and the `datatype` they represent.

This correspondence was established when the datatypes were created. Before the library is used, a library initialization preamble must be executed. This preamble code will define the datatypes that are used by the library, and store handles to these datatypes in global, static variables that are shared by the user code and the library code.

The Fortran version of MPI_REDUCE will invoke a user-defined reduce function using the Fortran calling conventions and will pass a Fortran-type datatype argument; the C version will use C calling convention and the C representation of a datatype handle. Users who plan to mix languages should define their reduction functions accordingly. (*End of advice to users.*)

Advice to implementors. We outline below a naive and inefficient implementation of MPI_REDUCE not supporting the “in place” option.

```

MPI_Comm_size(comm, &groupsize);
MPI_Comm_rank(comm, &rank);
if (rank > 0) {
    MPI_Recv(tempbuf, count, datatype, rank-1,...);
    User_reduce(tempbuf, sendbuf, count, datatype);
}
if (rank < groupsize-1) {
    MPI_Send(sendbuf, count, datatype, rank+1, ...);
}
/* answer now resides in process groupsize-1 ... now send to root
*/
if (rank == root) {
    MPI_Irecv(recvbuf, count, datatype, groupsize-1,..., &req);
}
if (rank == groupsize-1) {
    MPI_Send(sendbuf, count, datatype, root, ...);
}
if (rank == root) {
    MPI_Wait(&req, &status);
}

```

The reduction computation proceeds, sequentially, from process 0 to process `groupsize-1`. This order is chosen so as to respect the order of a possibly non-commutative operator defined by the function `User_reduce()`. A more efficient implementation is achieved by taking advantage of associativity and using a logarithmic tree reduction. Commutativity can be used to advantage, for those cases in which the `commute` argument to `MPI_OP_CREATE` is true. Also, the amount of temporary buffer required can be reduced, and communication can be pipelined with computation, by transferring and reducing the elements in chunks of size `len < count`.

The predefined reduce operations can be implemented as a library of user-defined operations. However, better performance might be achieved if MPI_REDUCE handles these functions as a special case. (*End of advice to implementors.*)

```

1 MPI_OP_FREE(op)
2     INOUT    op                operation (handle)
3
4
5 int MPI_Op_free(MPI_Op *op)
6 MPI_Op_free(op, ierror)
7     TYPE(MPI_Op), INTENT(INOUT) :: op
8     INTEGER, OPTIONAL, INTENT(OUT) :: ierror
9
10 MPI_OP_FREE(OP, IERROR)
11     INTEGER OP, IERROR
12
13     Marks a user-defined reduction operation for deallocation and sets op to MPI_OP_NULL.
14
15 Example of User-defined Reduce
16
17 It is time for an example of user-defined reduction. The example in this section uses an
18 intracommunicator.
19
20 Example 5.20 Compute the product of an array of complex numbers, in C.
21
22 typedef struct {
23     double real,imag;
24 } Complex;
25
26 /* the user-defined function
27 */
28 void myProd(void *inP, void *inoutP, int *len, MPI_Datatype *dptr)
29 {
30     int i;
31     Complex c;
32     Complex *in = (Complex *)inP, *inout = (Complex *)inoutP;
33
34     for (i=0; i< *len; ++i) {
35         c.real = inout->real*in->real -
36             inout->imag*in->imag;
37         c.imag = inout->real*in->imag +
38             inout->imag*in->real;
39         *inout = c;
40         in++; inout++;
41     }
42 }
43
44 /* and, to call it...
45 */
46 ...
47
48     /* each process has an array of 100 Complexes
49     */

```

```

Complex a[100], answer[100];
MPI_Op myOp;
MPI_Datatype ctype;

/* explain to MPI how type Complex is defined
 */
MPI_Type_contiguous(2, MPI_DOUBLE, &ctype);
MPI_Type_commit(&ctype);
/* create the complex-product user-op
 */
MPI_Op_create( myProd, 1, &myOp );

MPI_Reduce(a, answer, 100, ctype, myOp, root, comm);

/* At this point, the answer, which consists of 100 Complexes,
 * resides on process root
 */

```

Example 5.21 How to use the `mpi_f08` interface of the Fortran `MPI_User_function`.

```

subroutine my_user_function( invec, inoutvec, len, type )  bind(c)
  use, intrinsic :: iso_c_binding, only : c_ptr, c_f_pointer
  use mpi_f08
  type(c_ptr), value :: invec, inoutvec
  integer :: len
  type(MPI_Datatype) :: type
  real, pointer :: invec_r(:), inoutvec_r(:)
  if (type%MPI_VAL == MPI_REAL%MPI_VAL) then
    call c_f_pointer(invec, invec_r, (/ len /) )
    call c_f_pointer(inoutvec, inoutvec_r, (/ len /) )
    inoutvec_r = invec_r + inoutvec_r
  end if
end subroutine

```

5.9.6 All-Reduce

MPI includes a variant of the reduce operations where the result is returned to all processes in a group. MPI requires that all processes from the same group participating in these operations receive identical results.

```

1 MPI_ALLREDUCE(sendbuf, recvbuf, count, datatype, op, comm)
2     IN      sendbuf          starting address of send buffer (choice)
3
4     OUT    recvbuf          starting address of receive buffer (choice)
5
6     IN      count           number of elements in send buffer (non-negative inte-
7                               ger)
8
9     IN      datatype        data type of elements of send buffer (handle)
10
11    IN      op               operation (handle)
12
13    IN      comm            communicator (handle)
14
15 int MPI_Allreduce(const void* sendbuf, void* recvbuf, int count,
16                  MPI_Datatype datatype, MPI_Op op, MPI_Comm comm)
17
18 MPI_Allreduce(sendbuf, recvbuf, count, datatype, op, comm, ierror)
19     TYPE(*), DIMENSION(..), INTENT(IN) :: sendbuf
20     TYPE(*), DIMENSION(..) :: recvbuf
21     INTEGER, INTENT(IN) :: count
22     TYPE(MPI_Datatype), INTENT(IN) :: datatype
23     TYPE(MPI_Op), INTENT(IN) :: op
24     TYPE(MPI_Comm), INTENT(IN) :: comm
25     INTEGER, OPTIONAL, INTENT(OUT) :: ierror
26
27 MPI_ALLREDUCE(SENDBUF, RECVBUFF, COUNT, DATATYPE, OP, COMM, IERROR)
28     <type> SENDBUF(*), RECVBUFF(*)
29     INTEGER COUNT, DATATYPE, OP, COMM, IERROR

```

If `comm` is an intracommunicator, `MPI_ALLREDUCE` behaves the same as `MPI_REDUCE` except that the result appears in the receive buffer of all the group members.

Advice to implementors. The all-reduce operations can be implemented as a reduce, followed by a broadcast. However, a direct implementation can lead to better performance. (*End of advice to implementors.*)

The “in place” option for intracommunicators is specified by passing the value `MPI_IN_PLACE` to the argument `sendbuf` at all processes. In this case, the input data is taken at each process from the receive buffer, where it will be replaced by the output data.

If `comm` is an intercommunicator, then the result of the reduction of the data provided by processes in group A is stored at each process in group B, and vice versa. Both groups should provide `count` and `datatype` arguments that specify the same type signature.

The following example uses an intracommunicator.

Example 5.22

A routine that computes the product of a vector and an array that are distributed across a group of processes and returns the answer at all nodes (see also Example 5.16).

```

SUBROUTINE PAR_BLAS2(m, n, a, b, c, comm)      1
REAL a(m), b(m,n)      ! local slice of array  2
REAL c(n)              ! result                3
REAL sum(n)            4
INTEGER n, comm, i, j, ierr                    5

! local sum                                           7
DO j= 1, n                                           8
  sum(j) = 0.0                                       9
  DO i = 1, m                                       10
    sum(j) = sum(j) + a(i)*b(i,j)                  11
  END DO                                           12
END DO                                           13

! global sum                                           15
CALL MPI_ALLREDUCE(sum, c, n, MPI_REAL, MPI_SUM, comm, ierr) 16

! return result at all nodes                           18
RETURN                                           19
END                                           20

```

5.9.7 Process-Local Reduction

The functions in this section are of importance to library implementors who may want to implement special reduction patterns that are otherwise not easily covered by the standard MPI operations.

The following function applies a reduction operator to local arguments.

```

MPI_REDUCE_LOCAL(inbuf, inoutbuf, count, datatype, op)  29
IN      inbuf      input buffer (choice)              31
INOUT  inoutbuf   combined input and output buffer (choice) 32
IN      count      number of elements in inbuf and inoutbuf buffers (non- 33
                  negative integer)                  34
IN      datatype   data type of elements of inbuf and inoutbuf buffers 36
                  (handle)                            37
IN      op         operation (handle)                 38

int MPI_Reduce_local(const void* inbuf, void* inoutbuf, int count, 40
                    MPI_Datatype datatype, MPI_Op op)              41

MPI_Reduce_local(inbuf, inoutbuf, count, datatype, op, ierror)    43
  TYPE(*), DIMENSION(..), INTENT(IN) :: inbuf                    44
  TYPE(*), DIMENSION(..) :: inoutbuf                            45
  INTEGER, INTENT(IN) :: count                                  46
  TYPE(MPI_Datatype), INTENT(IN) :: datatype                    47
  TYPE(MPI_Op), INTENT(IN) :: op                               48

```

```

1     INTEGER, OPTIONAL, INTENT(OUT) :: ierror
2
3     MPI_REDUCE_LOCAL(INBUF, INOUTBUF, COUNT, DATATYPE, OP, IERROR)
4         <type> INBUF(*), INOUTBUF(*)
5         INTEGER COUNT, DATATYPE, OP, IERROR

```

The function applies the operation given by `op` element-wise to the elements of `inbuf` and `inoutbuf` with the result stored element-wise in `inoutbuf`, as explained for user-defined operations in Section 5.9.5. Both `inbuf` and `inoutbuf` (input as well as result) have the same number of elements given by `count` and the same datatype given by `datatype`. The `MPI_IN_PLACE` option is not allowed.

Reduction operations can be queried for their commutativity.

```

13
14 MPI_OP_COMMUTATIVE(op, commute)
15     IN      op                operation (handle)
16     OUT    commute           true if op is commutative, false otherwise (logical)
17
18
19 int MPI_Op_commutative(MPI_Op op, int *commute)
20
21 MPI_Op_commutative(op, commute, ierror)
22     TYPE(MPI_Op), INTENT(IN) :: op
23     LOGICAL, INTENT(OUT) :: commute
24     INTEGER, OPTIONAL, INTENT(OUT) :: ierror
25
26 MPI_OP_COMMUTATIVE(OP, COMMUTE, IERROR)
27     LOGICAL COMMUTE
28     INTEGER OP, IERROR

```

5.10 Reduce-Scatter

MPI includes variants of the reduce operations where the result is scattered to all processes in a group on return. One variant scatters equal-sized blocks to all processes, while another variant scatters blocks that may vary in size for each process.

5.10.1 MPI_REDUCE_SCATTER_BLOCK

MPI_REDUCE_SCATTER_BLOCK(sendbuf, recvbuf, recvcnt, datatype, op, comm)			4
IN	sendbuf	starting address of send buffer (choice)	5
OUT	recvbuf	starting address of receive buffer (choice)	6
IN	recvcnt	element count per block (non-negative integer)	7
IN	datatype	data type of elements of send and receive buffers (handle)	8
IN	op	operation (handle)	9
IN	comm	communicator (handle)	10

```

int MPI_Reduce_scatter_block(const void* sendbuf, void* recvbuf,
                             int recvcnt, MPI_Datatype datatype, MPI_Op op,
                             MPI_Comm comm)

```

```

MPI_Reduce_scatter_block(sendbuf, recvbuf, recvcnt, datatype, op, comm,
                          ierror)
    TYPE(*), DIMENSION(..), INTENT(IN) :: sendbuf
    TYPE(*), DIMENSION(..) :: recvbuf
    INTEGER, INTENT(IN) :: recvcnt
    TYPE(MPI_Datatype), INTENT(IN) :: datatype
    TYPE(MPI_Op), INTENT(IN) :: op
    TYPE(MPI_Comm), INTENT(IN) :: comm
    INTEGER, OPTIONAL, INTENT(OUT) :: ierror

```

```

MPI_REDUCE_SCATTER_BLOCK(SENDBUF, RECVBUF, RECVCOUNT, DATATYPE, OP, COMM,
                          IERROR)
    <type> SENDBUF(*), RECVBUF(*)
    INTEGER REVCOUNT, DATATYPE, OP, COMM, IERROR

```

If `comm` is an intracommunicator, `MPI_REDUCE_SCATTER_BLOCK` first performs a global, element-wise reduction on vectors of count = $n \times \text{recvcnt}$ elements in the send buffers defined by `sendbuf`, count and `datatype`, using the operation `op`, where n is the number of processes in the group of `comm`. The routine is called by all group members using the same arguments for `recvcnt`, `datatype`, `op` and `comm`. The resulting vector is treated as n consecutive blocks of `recvcnt` elements that are scattered to the processes of the group. The i -th block is sent to process i and stored in the receive buffer defined by `recvbuf`, `recvcnt`, and `datatype`.

Advice to implementors. The `MPI_REDUCE_SCATTER_BLOCK` routine is functionally equivalent to: an `MPI_REDUCE` collective operation with count equal to `recvcnt*n`, followed by an `MPI_SCATTER` with `sendcount` equal to `recvcnt`. However, a direct implementation may run faster. (*End of advice to implementors.*)

The “in place” option for intracommunicators is specified by passing `MPI_IN_PLACE` in the `sendbuf` argument on *all* processes. In this case, the input data is taken from the receive buffer.

1 If `comm` is an intercommunicator, then the result of the reduction of the data provided
 2 by processes in one group (group A) is scattered among processes in the other group (group
 3 B) and vice versa. Within each group, all processes provide the same value for the `recvcount`
 4 argument, and provide input vectors of `count = n*recvcount` elements stored in the send
 5 buffers, where `n` is the size of the group. The number of elements `count` must be the same
 6 for the two groups. The resulting vector from the other group is scattered in blocks of
 7 `recvcount` elements among the processes in the group.

9 *Rationale.* The last restriction is needed so that the length of the send buffer of
 10 one group can be determined by the local `recvcount` argument of the other group.
 11 Otherwise, a communication is needed to figure out how many elements are reduced.
 12 (*End of rationale.*)

14 5.10.2 MPI_REDUCE_SCATTER

15 MPI_REDUCE_SCATTER extends the functionality of MPI_REDUCE_SCATTER_BLOCK
 16 such that the scattered blocks can vary in size. Block sizes are determined by the `recvcounts`
 17 array, such that the `i`-th block contains `recvcounts[i]` elements.

20 MPI_REDUCE_SCATTER(`sendbuf`, `recvbuf`, `recvcounts`, `datatype`, `op`, `comm`)

22	IN	<code>sendbuf</code>	starting address of send buffer (choice)
23	OUT	<code>recvbuf</code>	starting address of receive buffer (choice)
24	IN	<code>recvcounts</code>	non-negative integer array (of length group size) spec- 25 ifying the number of elements of the result distributed 26 to each process.
27			
28	IN	<code>datatype</code>	data type of elements of send and receive buffers (han- 29 dle)
30	IN	<code>op</code>	operation (handle)
31	IN	<code>comm</code>	communicator (handle)

```
33 int MPI_Reduce_scatter(const void* sendbuf, void* recvbuf,
34                       const int recvcounts[], MPI_Datatype datatype, MPI_Op op,
35                       MPI_Comm comm)
36
```

```
37 MPI_Reduce_scatter(sendbuf, recvbuf, recvcounts, datatype, op, comm,
38                   ierror)
```

```
39 TYPE(*), DIMENSION(..), INTENT(IN) :: sendbuf
40 TYPE(*), DIMENSION(..) :: recvbuf
41 INTEGER, INTENT(IN) :: recvcounts(*)
42 TYPE(MPI_Datatype), INTENT(IN) :: datatype
43 TYPE(MPI_Op), INTENT(IN) :: op
44 TYPE(MPI_Comm), INTENT(IN) :: comm
45 INTEGER, OPTIONAL, INTENT(OUT) :: ierror
```

```
46 MPI_REDUCE_SCATTER(SENDBUF, RECVBUF, RECVCOUNTS, DATATYPE, OP, COMM,
47                   IERROR)
48
```

```
<type> SENDBUF(*), RECVBUF(*)
INTEGER RECVCOUNTS(*), DATATYPE, OP, COMM, IERROR
```

If `comm` is an intracommunicator, `MPI_REDUCE_SCATTER` first performs a global, element-wise reduction on vectors of `count = \sum_{i=0}^{n-1} recvcounts[i]` elements in the send buffers defined by `sendbuf`, `count` and `datatype`, using the operation `op`, where `n` is the number of processes in the group of `comm`. The routine is called by all group members using the same arguments for `recvcounts`, `datatype`, `op` and `comm`. The resulting vector is treated as `n` consecutive blocks where the number of elements of the `i`-th block is `recvcounts[i]`. The blocks are scattered to the processes of the group. The `i`-th block is sent to process `i` and stored in the receive buffer defined by `recvbuf`, `recvcounts[i]` and `datatype`.

Advice to implementors. The `MPI_REDUCE_SCATTER` routine is functionally equivalent to: an `MPI_REDUCE` collective operation with `count` equal to the sum of `recvcounts[i]` followed by `MPI_SCATTERV` with `sendcounts` equal to `recvcounts`. However, a direct implementation may run faster. (*End of advice to implementors.*)

The “in place” option for intracommunicators is specified by passing `MPI_IN_PLACE` in the `sendbuf` argument. In this case, the input data is taken from the receive buffer. It is not required to specify the “in place” option on all processes, since the processes for which `recvcounts[i] == 0` may not have allocated a receive buffer.

If `comm` is an intercommunicator, then the result of the reduction of the data provided by processes in one group (group A) is scattered among processes in the other group (group B), and vice versa. Within each group, all processes provide the same `recvcounts` argument, and provide input vectors of `count = \sum_{i=0}^{n-1} recvcounts[i]` elements stored in the send buffers, where `n` is the size of the group. The resulting vector from the other group is scattered in blocks of `recvcounts[i]` elements among the processes in the group. The number of elements count must be the same for the two groups.

Rationale. The last restriction is needed so that the length of the send buffer can be determined by the sum of the local `recvcounts` entries. Otherwise, a communication is needed to figure out how many elements are reduced. (*End of rationale.*)

5.11 Scan

5.11.1 Inclusive Scan

```
MPI_SCAN(sendbuf, recvbuf, count, datatype, op, comm)
```

IN	sendbuf	starting address of send buffer (choice)
OUT	recvbuf	starting address of receive buffer (choice)
IN	count	number of elements in input buffer (non-negative integer)
IN	datatype	data type of elements of input buffer (handle)
IN	op	operation (handle)
IN	comm	communicator (handle)

```

1  int MPI_Scan(const void* sendbuf, void* recvbuf, int count,
2              MPI_Datatype datatype, MPI_Op op, MPI_Comm comm)
3
4  MPI_Scan(sendbuf, recvbuf, count, datatype, op, comm, ierror)
5      TYPE(*), DIMENSION(..), INTENT(IN) :: sendbuf
6      TYPE(*), DIMENSION(..) :: recvbuf
7      INTEGER, INTENT(IN) :: count
8      TYPE(MPI_Datatype), INTENT(IN) :: datatype
9      TYPE(MPI_Op), INTENT(IN) :: op
10     TYPE(MPI_Comm), INTENT(IN) :: comm
11     INTEGER, OPTIONAL, INTENT(OUT) :: ierror
12
13 MPI_SCAN(SENDBUF, RECVBUF, COUNT, DATATYPE, OP, COMM, IERROR)
14     <type> SENDBUF(*), RECVBUF(*)
15     INTEGER COUNT, DATATYPE, OP, COMM, IERROR

```

If `comm` is an intracommunicator, `MPI_SCAN` is used to perform a prefix reduction on data distributed across the group. The operation returns, in the receive buffer of the process with rank `i`, the reduction of the values in the send buffers of processes with ranks `0, ..., i` (inclusive). The routine is called by all group members using the same arguments for `count`, `datatype`, `op` and `comm`, except that for user-defined operations, the same rules apply as for `MPI_REDUCE`. The type of operations supported, their semantics, and the constraints on send and receive buffers are as for `MPI_REDUCE`.

The “in place” option for intracommunicators is specified by passing `MPI_IN_PLACE` in the `sendbuf` argument. In this case, the input data is taken from the receive buffer, and replaced by the output data.

This operation is invalid for intercommunicators.

5.11.2 Exclusive Scan

```

31 MPI_EXSCAN(sendbuf, recvbuf, count, datatype, op, comm)
32     IN      sendbuf      starting address of send buffer (choice)
33     OUT    recvbuf      starting address of receive buffer (choice)
34     IN      count        number of elements in input buffer (non-negative in-
35                       teger)
36     IN      datatype     data type of elements of input buffer (handle)
37     IN      op           operation (handle)
38     IN      comm         intracommunicator (handle)
39
40
41
42 int MPI_Exscan(const void* sendbuf, void* recvbuf, int count,
43               MPI_Datatype datatype, MPI_Op op, MPI_Comm comm)
44
45 MPI_Exscan(sendbuf, recvbuf, count, datatype, op, comm, ierror)
46     TYPE(*), DIMENSION(..), INTENT(IN) :: sendbuf
47     TYPE(*), DIMENSION(..) :: recvbuf
48     INTEGER, INTENT(IN) :: count

```

```

TYPE(MPI_Datatype), INTENT(IN) :: datatype
TYPE(MPI_Op), INTENT(IN) :: op
TYPE(MPI_Comm), INTENT(IN) :: comm
INTEGER, OPTIONAL, INTENT(OUT) :: ierror
MPI_EXSCAN(SENDBUF, RECVBUF, COUNT, DATATYPE, OP, COMM, IERROR)
<type> SENDBUF(*), RECVBUF(*)
INTEGER COUNT, DATATYPE, OP, COMM, IERROR

```

If `comm` is an intracommunicator, `MPI_EXSCAN` is used to perform a prefix reduction on data distributed across the group. The value in `recvbuf` on the process with rank 0 is undefined, and `recvbuf` is not significant on process 0. The value in `recvbuf` on the process with rank 1 is defined as the value in `sendbuf` on the process with rank 0. For processes with rank $i > 1$, the operation returns, in the receive buffer of the process with rank i , the reduction of the values in the send buffers of processes with ranks $0, \dots, i-1$ (inclusive). The routine is called by all group members using the same arguments for `count`, `datatype`, `op` and `comm`, except that for user-defined operations, the same rules apply as for `MPI_REDUCE`. The type of operations supported, their semantics, and the constraints on send and receive buffers, are as for `MPI_REDUCE`.

The “in place” option for intracommunicators is specified by passing `MPI_IN_PLACE` in the `sendbuf` argument. In this case, the input data is taken from the receive buffer, and replaced by the output data. The receive buffer on rank 0 is not changed by this operation.

This operation is invalid for intercommunicators.

Rationale. The exclusive scan is more general than the inclusive scan. Any inclusive scan operation can be achieved by using the exclusive scan and then locally combining the local contribution. Note that for non-invertable operations such as `MPI_MAX`, the exclusive scan cannot be computed with the inclusive scan. (*End of rationale.*)

5.11.3 Example using MPI_SCAN

The example in this section uses an intracommunicator.

Example 5.23

This example uses a user-defined operation to produce a *segmented scan*. A segmented scan takes, as input, a set of values and a set of logicals, and the logicals delineate the various segments of the scan. For example:

<i>values</i>	v_1	v_2	v_3	v_4	v_5	v_6	v_7	v_8
<i>logicals</i>	0	0	1	1	1	0	0	1
<i>result</i>	v_1	$v_1 + v_2$	v_3	$v_3 + v_4$	$v_3 + v_4 + v_5$	v_6	$v_6 + v_7$	v_8

The operator that produces this effect is

$$\begin{pmatrix} u \\ i \end{pmatrix} \circ \begin{pmatrix} v \\ j \end{pmatrix} = \begin{pmatrix} w \\ j \end{pmatrix},$$

where

$$w = \begin{cases} u + v & \text{if } i = j \\ v & \text{if } i \neq j \end{cases}.$$

1 Note that this is a non-commutative operator. C code that implements it is given
2 below.

```
3
4 typedef struct {
5     double val;
6     int log;
7 } SegScanPair;
8
9 /* the user-defined function
10 */
11 void segScan(SegScanPair *in, SegScanPair *inout, int *len,
12             MPI_Datatype *dptr)
13 {
14     int i;
15     SegScanPair c;
16
17     for (i=0; i< *len; ++i) {
18         if (in->log == inout->log)
19             c.val = in->val + inout->val;
20         else
21             c.val = inout->val;
22         c.log = inout->log;
23         *inout = c;
24         in++; inout++;
25     }
26 }
```

27 Note that the inout argument to the user-defined function corresponds to the right-
28 hand operand of the operator. When using this operator, we must be careful to specify that
29 it is non-commutative, as in the following.

```
30
31     int i,base;
32     SegScanPair a, answer;
33     MPI_Op myOp;
34     MPI_Datatype type[2] = {MPI_DOUBLE, MPI_INT};
35     MPI_Aint disp[2];
36     int blocklen[2] = { 1, 1};
37     MPI_Datatype sspair;
38
39     /* explain to MPI how type SegScanPair is defined
40 */
41     MPI_Get_address( &a, disp);
42     MPI_Get_address( &a.log, disp+1);
43     base = disp[0];
44     for (i=0; i<2; ++i) disp[i] -= base;
45     MPI_Type_create_struct( 2, blocklen, disp, type, &sspair );
46     MPI_Type_commit( &sspair );
47     /* create the segmented-scan user-op
48 */
```



```

MPI_Op_create(segScan, 0, &myOp);
...
MPI_Scan( &a, &answer, 1, sspair, myOp, comm );

```

5.12 Nonblocking Collective Operations

As described in Section 3.7, performance of many applications can be improved by overlapping communication and computation, and many systems enable this. Nonblocking collective operations combine the potential benefits of nonblocking point-to-point operations, to exploit overlap and to avoid synchronization, with the optimized implementation and message scheduling provided by collective operations [31, 35]. One way of doing this would be to perform a blocking collective operation in a separate thread. An alternative mechanism that often leads to better performance (e.g., avoids context switching, scheduler overheads, and thread management) is to use nonblocking collective communication [33].

The nonblocking collective communication model is similar to the model used for nonblocking point-to-point communication. A nonblocking call initiates a collective operation, which must be completed in a separate completion call. Once initiated, the operation may progress independently of any computation or other communication at participating processes. In this manner, nonblocking collective operations can mitigate possible synchronizing effects of collective operations by running them in the “background.” In addition to enabling communication-computation overlap, nonblocking collective operations can perform collective operations on overlapping communicators, which would lead to deadlocks with blocking operations. Their semantic advantages can also be useful in combination with point-to-point communication.

As in the nonblocking point-to-point case, all calls are local and return immediately, irrespective of the status of other processes. The call initiates the operation, which indicates that the system may start to copy data out of the send buffer and into the receive buffer. Once initiated, all associated send buffers and buffers associated with input arguments (such as arrays of counts, displacements, or datatypes in the vector versions of the collectives) should not be modified, and all associated receive buffers should not be accessed, until the collective operation completes. The call returns a request handle, which must be passed to a completion call.

All completion calls (e.g., MPI_WAIT) described in Section 3.7.3 are supported for nonblocking collective operations. Similarly to the blocking case, nonblocking collective operations are considered to be complete when the local part of the operation is finished, i.e., for the caller, the semantics of the operation are guaranteed and all buffers can be safely accessed and modified. Completion does not indicate that other processes have completed or even started the operation (unless otherwise implied by the description of the operation). Completion of a particular nonblocking collective operation also does not indicate completion of any other posted nonblocking collective (or send-receive) operations, whether they are posted before or after the completed operation.

Advice to users. Users should be aware that implementations are allowed, but not required (with exception of MPI_IBARRIER), to synchronize processes during the completion of a nonblocking collective operation. (*End of advice to users.*)

Upon returning from a completion call in which a nonblocking collective operation completes, the MPI_ERROR field in the associated status object is set appropriately, see

1 Section 3.2.5 on page 32. The values of the MPI_SOURCE and MPI_TAG fields are unde-
2 fined. It is valid to mix different request types (i.e., any combination of collective requests,
3 I/O requests, generalized requests, or point-to-point requests) in functions that enable mul-
4 tiple completions (e.g., MPI_WAITALL). It is erroneous to call MPI_REQUEST_FREE or
5 MPI_CANCEL for a request associated with a nonblocking collective operation. Nonblock-
6 ing collective requests created using the APIs described in this section are not persistent.
7 However, persistent collective requests can be created using persistent collective operations
8 described in Sections 5.13 and 7.8.

9
10 *Rationale.* Freeing an active nonblocking collective request could cause similar
11 problems as discussed for point-to-point requests (see Section 3.7.3). Cancelling a
12 request is not supported because the semantics of this operation are not well-defined.
13 (*End of rationale.*)

14
15 Multiple nonblocking collective operations can be outstanding on a single communi-
16 cator. If the nonblocking call causes some system resource to be exhausted, then it will
17 fail and generate an MPI exception. Quality implementations of MPI should ensure that
18 this happens only in pathological cases. That is, an MPI implementation should be able to
19 support a large number of pending nonblocking operations.

20 Unlike point-to-point operations, nonblocking collective operations do not match with
21 blocking collective operations, and collective operations do not have a tag argument. All
22 processes must call collective operations (blocking and nonblocking) in the same order
23 per communicator. In particular, once a process calls a collective operation, all other
24 processes in the communicator must eventually call the same collective operation, and no
25 other collective operation with the same communicator in between. This is consistent with
26 the ordering rules for blocking collective operations in threaded environments.

27 *Rationale.* Matching blocking and nonblocking collective operations is not allowed
28 because the implementation might use different communication algorithms for the two
29 cases. Blocking collective operations may be optimized for minimal time to comple-
30 tion, while nonblocking collective operations may balance time to completion with
31 CPU overhead and asynchronous progression.

32 The use of tags for collective operations can prevent certain hardware optimizations.
33 (*End of rationale.*)

34
35 *Advice to users.* If program semantics require matching blocking and nonblocking
36 collective operations, then a nonblocking collective operation can be initiated and
37 immediately completed with a blocking wait to emulate blocking behavior. (*End of*
38 *advice to users.*)

39
40 In terms of data movement, each nonblocking collective operation has the same effect as
41 its blocking counterpart for intracommunicators and intercommunicators after completion.
42 Likewise, upon completion, nonblocking collective reduction operations have the same effect
43 as their blocking counterparts, and the same restrictions and recommendations on reduction
44 orders apply.

45 The use of the “in place” option is allowed exactly as described for the corresponding
46 blocking collective operations. When using the “in place” option, message buffers function
47 as both send and receive buffers. Such buffers should not be modified or accessed until the
48 operation completes.

Progression rules for nonblocking collective operations are similar to progression of nonblocking point-to-point operations, refer to Section 3.7.4.

Advice to implementors. Nonblocking collective operations can be implemented with local execution schedules [34] using nonblocking point-to-point communication and a reserved tag-space. (*End of advice to implementors.*)

5.12.1 Nonblocking Barrier Synchronization

`MPI_IBARRIER(comm ,request)`

IN	comm	communicator (handle)
OUT	request	communication request (handle)

`int MPI_Ibarrier(MPI_Comm comm, MPI_Request *request)`

`MPI_Ibarrier(comm, request, ierror)`

TYPE(MPI_Comm), INTENT(IN) ::	comm
TYPE(MPI_Request), INTENT(OUT) ::	request
INTEGER, OPTIONAL, INTENT(OUT) ::	ierror

`MPI_IBARRIER(COMM, REQUEST, IERROR)`

`INTEGER COMM, REQUEST, IERROR`

`MPI_IBARRIER` is a nonblocking version of `MPI_BARRIER`. By calling `MPI_IBARRIER`, a process notifies that it has reached the barrier. The call returns immediately, independent of whether other processes have called `MPI_IBARRIER`. The usual barrier semantics are enforced at the corresponding completion operation (test or wait), which in the intra-communicator case will complete only after all other processes in the communicator have called `MPI_IBARRIER`. In the intercommunicator case, it will complete when all processes in the remote group have called `MPI_IBARRIER`.

Advice to users. A nonblocking barrier can be used to hide latency. Moving independent computations between the `MPI_IBARRIER` and the subsequent completion call can overlap the barrier latency and therefore shorten possible waiting times. The semantic properties are also useful when mixing collective operations and point-to-point messages. (*End of advice to users.*)

5.12.2 Nonblocking Broadcast

```

MPI_IBCAST(buffer, count, datatype, root, comm, request)
    INOUT    buffer                starting address of buffer (choice)
    IN       count                 number of entries in buffer (non-negative integer)
    IN       datatype              data type of buffer (handle)
    IN       root                  rank of broadcast root (integer)
    IN       comm                  communicator (handle)
    OUT      request                communication request (handle)

```

```

int MPI_Ibcast(void* buffer, int count, MPI_Datatype datatype, int root,
               MPI_Comm comm, MPI_Request *request)

```

```

MPI_Ibcast(buffer, count, datatype, root, comm, request, ierror)
    TYPE(*), DIMENSION(..), ASYNCHRONOUS :: buffer
    INTEGER, INTENT(IN) :: count, root
    TYPE(MPI_Datatype), INTENT(IN) :: datatype
    TYPE(MPI_Comm), INTENT(IN) :: comm
    TYPE(MPI_Request), INTENT(OUT) :: request
    INTEGER, OPTIONAL, INTENT(OUT) :: ierror

```

```

MPI_IBCAST(BUFFER, COUNT, DATATYPE, ROOT, COMM, REQUEST, IERROR)
    <type> BUFFER(*)
    INTEGER COUNT, DATATYPE, ROOT, COMM, REQUEST, IERROR

```

This call starts a nonblocking variant of MPI_BCAST (see Section 5.4).

Example using MPI_IBCAST

The example in this section uses an intracommunicator.

Example 5.24

Start a broadcast of 100 ints from process 0 to every process in the group, perform some computation on independent data, and then complete the outstanding broadcast operation.

```

MPI_Comm comm;
int array1[100], array2[100];
int root=0;
MPI_Request req;
...
MPI_Ibcast(array1, 100, MPI_INT, root, comm, &req);
compute(array2, 100);
MPI_Wait(&req, MPI_STATUS_IGNORE);

```

5.12.3 Nonblocking Gather

```
MPI_IGATHER(sendbuf, sendcount, sendtype, recvbuf, recvcount, recvtype, root, comm,
            request)
```

IN	sendbuf	starting address of send buffer (choice)
IN	sendcount	number of elements in send buffer (non-negative integer)
IN	sendtype	data type of send buffer elements (handle)
OUT	recvbuf	address of receive buffer (choice, significant only at root)
IN	recvcount	number of elements for any single receive (non-negative integer, significant only at root)
IN	recvtype	data type of recv buffer elements (significant only at root) (handle)
IN	root	rank of receiving process (integer)
IN	comm	communicator (handle)
OUT	request	communication request (handle)

```
int MPI_Igather(const void* sendbuf, int sendcount, MPI_Datatype sendtype,
               void* recvbuf, int recvcount, MPI_Datatype recvtype, int root,
               MPI_Comm comm, MPI_Request *request)
```

```
MPI_Igather(sendbuf, sendcount, sendtype, recvbuf, recvcount, recvtype,
            root, comm, request, ierror)
    TYPE(*), DIMENSION(..), INTENT(IN), ASYNCHRONOUS :: sendbuf
    TYPE(*), DIMENSION(..), ASYNCHRONOUS :: recvbuf
    INTEGER, INTENT(IN) :: sendcount, recvcount, root
    TYPE(MPI_Datatype), INTENT(IN) :: sendtype, recvtype
    TYPE(MPI_Comm), INTENT(IN) :: comm
    TYPE(MPI_Request), INTENT(OUT) :: request
    INTEGER, OPTIONAL, INTENT(OUT) :: ierror
```

```
MPI_IGATHER(SENDBUF, SENDCOUNT, SENDTYPE, RECVBUF, REVCOUNT, RECVTYPE,
            ROOT, COMM, REQUEST, IERROR)
    <type> SENDBUF(*), RECVBUF(*)
    INTEGER SENDCOUNT, SENDTYPE, REVCOUNT, RECVTYPE, ROOT, COMM, REQUEST,
    IERROR
```

This call starts a nonblocking variant of MPI_GATHER (see Section 5.5).

```

1 MPI_IGATHERV(sendbuf, sendcount, sendtype, recvbuf, recvcnts, displs, recvtype, root,
2             comm, request)
3
4     IN      sendbuf      starting address of send buffer (choice)
5
6     IN      sendcount    number of elements in send buffer (non-negative integer)
7
8     IN      sendtype     data type of send buffer elements (handle)
9
10    OUT     recvbuf      address of receive buffer (choice, significant only at root)
11
12    IN      recvcnts     non-negative integer array (of length group size) containing the number of elements that are received from each process (significant only at root)
13
14    IN      displs      integer array (of length group size). Entry i specifies the displacement relative to recvbuf at which to place the incoming data from process i (significant only at root)
15
16
17
18    IN      recvtype     data type of recv buffer elements (significant only at root) (handle)
19
20
21    IN      root        rank of receiving process (integer)
22
23    IN      comm        communicator (handle)
24
25    OUT     request     communication request (handle)

```

```

26 int MPI_Igatherv(const void* sendbuf, int sendcount, MPI_Datatype sendtype,
27                void* recvbuf, const int recvcnts[], const int displs[],
28                MPI_Datatype recvtype, int root, MPI_Comm comm,
29                MPI_Request *request)

```

```

30 MPI_Igatherv(sendbuf, sendcount, sendtype, recvbuf, recvcnts, displs,
31             recvtype, root, comm, request, ierror)
32     TYPE(*), DIMENSION(..), INTENT(IN), ASYNCHRONOUS :: sendbuf
33     TYPE(*), DIMENSION(..), ASYNCHRONOUS :: recvbuf
34     INTEGER, INTENT(IN) :: sendcount, root
35     INTEGER, INTENT(IN), ASYNCHRONOUS :: recvcnts(*), displs(*)
36     TYPE(MPI_Datatype), INTENT(IN) :: sendtype, recvtype
37     TYPE(MPI_Comm), INTENT(IN) :: comm
38     TYPE(MPI_Request), INTENT(OUT) :: request
39     INTEGER, OPTIONAL, INTENT(OUT) :: ierror

```

```

40 MPI_IGATHERV(SENDBUF, SENDCOUNT, SENDTYPE, RECVBUF, RECVCOUNTS, DISPLS,
41             RECVTYPE, ROOT, COMM, REQUEST, IERROR)
42 <type> SENDBUF(*), RECVBUF(*)
43 INTEGER SENDCOUNT, SENDTYPE, RECVCOUNTS(*), DISPLS(*), RECVTYPE, ROOT,
44     COMM, REQUEST, IERROR

```

45 This call starts a nonblocking variant of `MPI_GATHERV` (see Section 5.5).

46
47
48

5.12.4 Nonblocking Scatter

			1
			2
			3
			4
			5
			6
IN	sendbuf	address of send buffer (choice, significant only at root)	7
IN	sendcount	number of elements sent to each process (non-negative integer, significant only at root)	8
			9
IN	sendtype	data type of send buffer elements (significant only at root) (handle)	10
			11
OUT	recvbuf	address of receive buffer (choice)	12
IN	recvcount	number of elements in receive buffer (non-negative integer)	13
			14
IN	recvtype	data type of receive buffer elements (handle)	15
			16
IN	root	rank of sending process (integer)	17
			18
IN	comm	communicator (handle)	19
			20
OUT	request	communication request (handle)	21

```
int MPI_Iscatter(const void* sendbuf, int sendcount, MPI_Datatype sendtype,
                void* recvbuf, int recvcount, MPI_Datatype recvtype, int root,
                MPI_Comm comm, MPI_Request *request)
```

```
MPI_Iscatter(sendbuf, sendcount, sendtype, recvbuf, recvcount, recvtype,
             root, comm, request, ierror)
    TYPE(*), DIMENSION(..), INTENT(IN), ASYNCHRONOUS :: sendbuf
    TYPE(*), DIMENSION(..), ASYNCHRONOUS :: recvbuf
    INTEGER, INTENT(IN) :: sendcount, recvcount, root
    TYPE(MPI_Datatype), INTENT(IN) :: sendtype, recvtype
    TYPE(MPI_Comm), INTENT(IN) :: comm
    TYPE(MPI_Request), INTENT(OUT) :: request
    INTEGER, OPTIONAL, INTENT(OUT) :: ierror
```

```
MPI_ISCATTER(SENDBUF, SENDCOUNT, SENDTYPE, RECVBUF, RECVCOUNT, RECVTYPE,
             ROOT, COMM, REQUEST, IERROR)
    <type> SENDBUF(*), RECVBUF(*)
    INTEGER SENDCOUNT, SENDTYPE, RECVCOUNT, RECVTYPE, ROOT, COMM, REQUEST,
    IERROR
```

This call starts a nonblocking variant of MPI_SCATTER (see Section 5.6).

```

1 MPI_ISCATTERV(sendbuf, sendcounts, displs, sendtype, recvbuf, recvcount, recvtype, root,
2               comm, request)
3
4     IN      sendbuf      address of send buffer (choice, significant only at root)
5
6     IN      sendcounts   non-negative integer array (of length group size) spec-
7                           ifying the number of elements to send to each rank
8
9     IN      displs      integer array (of length group size). Entry i specifies
10                          the displacement (relative to sendbuf) from which to
11                          take the outgoing data to process i
12
13     IN      sendtype     data type of send buffer elements (handle)
14
15     OUT     recvbuf      address of receive buffer (choice)
16
17     IN      recvcount    number of elements in receive buffer (non-negative in-
18                          teger)
19
20     IN      recvtype     data type of receive buffer elements (handle)
21
22     IN      root         rank of sending process (integer)
23
24     IN      comm         communicator (handle)
25
26     OUT     request      communication request (handle)

```

```

21
22 int MPI_Iscatterv(const void* sendbuf, const int sendcounts[],
23                 const int displs[], MPI_Datatype sendtype, void* recvbuf,
24                 int recvcount, MPI_Datatype recvtype, int root, MPI_Comm comm,
25                 MPI_Request *request)

```

```

26 MPI_Iscatterv(sendbuf, sendcounts, displs, sendtype, recvbuf, recvcount,
27              recvtype, root, comm, request, ierror)
28     TYPE(*), DIMENSION(..), INTENT(IN), ASYNCHRONOUS :: sendbuf
29     TYPE(*), DIMENSION(..), ASYNCHRONOUS :: recvbuf
30     INTEGER, INTENT(IN), ASYNCHRONOUS :: sendcounts(*), displs(*)
31     INTEGER, INTENT(IN) :: recvcount, root
32     TYPE(MPI_Datatype), INTENT(IN) :: sendtype, recvtype
33     TYPE(MPI_Comm), INTENT(IN) :: comm
34     TYPE(MPI_Request), INTENT(OUT) :: request
35     INTEGER, OPTIONAL, INTENT(OUT) :: ierror

```

```

36
37 MPI_ISCATTERV(SENDBUF, SENDCOUNTS, DISPLS, SENDTYPE, RECVBUFFER, RECVCOUNT,
38              RECVTYPE, ROOT, COMM, REQUEST, IERROR)
39 <type> SENDBUF(*), RECVBUFFER(*)
40 INTEGER SENDCOUNTS(*), DISPLS(*), SENDTYPE, RECVCOUNT, RECVTYPE, ROOT,
41     COMM, REQUEST, IERROR

```

42 This call starts a nonblocking variant of MPI_SCATTERV (see Section 5.6).

43
44
45
46
47
48

5.12.5 Nonblocking Gather-to-all

```

MPI_IALLGATHER(sendbuf, sendcount, sendtype, recvbuf, recvcount, recvtype, comm,
               request)
IN      sendbuf          starting address of send buffer (choice)
IN      sendcount        number of elements in send buffer (non-negative integer)
IN      sendtype         data type of send buffer elements (handle)
OUT     recvbuf          address of receive buffer (choice)
IN      recvcount        number of elements received from any process (non-negative integer)
IN      recvtype         data type of receive buffer elements (handle)
IN      comm             communicator (handle)
OUT     request          communication request (handle)

int MPI_Iallgather(const void* sendbuf, int sendcount,
                  MPI_Datatype sendtype, void* recvbuf, int recvcount,
                  MPI_Datatype recvtype, MPI_Comm comm, MPI_Request *request)
MPI_Iallgather(sendbuf, sendcount, sendtype, recvbuf, recvcount, recvtype,
               comm, request, ierror)
TYPE(*), DIMENSION(..), INTENT(IN), ASYNCHRONOUS :: sendbuf
TYPE(*), DIMENSION(..), ASYNCHRONOUS :: recvbuf
INTEGER, INTENT(IN) :: sendcount, recvcount
TYPE(MPI_Datatype), INTENT(IN) :: sendtype, recvtype
TYPE(MPI_Comm), INTENT(IN) :: comm
TYPE(MPI_Request), INTENT(OUT) :: request
INTEGER, OPTIONAL, INTENT(OUT) :: ierror

MPI_IALLGATHER(SENDBUF, SENDCOUNT, SENDTYPE, RECVBUF, RECVCOUNT, RECVTYPE,
               COMM, REQUEST, IERROR)
<type> SENDBUF(*), RECVBUF(*)
INTEGER SENDCOUNT, SENDTYPE, RECVCOUNT, RECVTYPE, COMM, REQUEST, IERROR

This call starts a nonblocking variant of MPI_ALLGATHER (see Section 5.7).

```

```

1 MPI_IALLGATHERV(sendbuf, sendcount, sendtype, recvbuf, recvcoun
2                 request)
3
4     IN      sendbuf      starting address of send buffer (choice)
5
6     IN      sendcount    number of elements in send buffer (non-negative inte-
7
8     IN      sendtype     data type of send buffer elements (handle)
9
10    OUT     recvbuf      address of receive buffer (choice)
11
12    IN      recvcoun
13           counts       non-negative integer array (of length group size) con-
14
15                    taining the number of elements that are received from
16                    each process
17
18    IN      displs       integer array (of length group size). Entry i specifies
19
20                    the displacement (relative to recvbuf) at which to place
21                    the incoming data from process i
22
23    IN      recvtype     data type of receive buffer elements (handle)
24
25    IN      comm         communicator (handle)
26
27    OUT     request      communication request (handle)

```

```

21 int MPI_Iallgatherv(const void* sendbuf, int sendcount,
22                   MPI_Datatype sendtype, void* recvbuf, const int recvcoun
23                   ts[], const int displs[], MPI_Datatype recvtype, MPI_Comm comm,
24                   MPI_Request* request)
25

```

```

26 MPI_Iallgatherv(sendbuf, sendcount, sendtype, recvbuf, recvcoun
27                ts, displs, recvtype, comm, request, ierror)
28     TYPE(*), DIMENSION(..), INTENT(IN), ASYNCHRONOUS :: sendbuf
29     TYPE(*), DIMENSION(..), ASYNCHRONOUS :: recvbuf
30     INTEGER, INTENT(IN) :: sendcount
31     INTEGER, INTENT(IN), ASYNCHRONOUS :: recvcoun
32     ts(*), displs(*)
33     TYPE(MPI_Datatype), INTENT(IN) :: sendtype, recvtype
34     TYPE(MPI_Comm), INTENT(IN) :: comm
35     TYPE(MPI_Request), INTENT(OUT) :: request
36     INTEGER, OPTIONAL, INTENT(OUT) :: ierror

```

```

36 MPI_IALLGATHERV(SENDBUF, SENDCOUNT, SENDTYPE, RECVBUF, RECVCOUNTS, DISPLS,
37                RECVTYPE, COMM, REQUEST, IERROR)
38     <type> SENDBUF(*), RECVBUF(*)
39     INTEGER SENDCOUNT, SENDTYPE, RECVCOUNTS(*), DISPLS(*), RECVTYPE, COMM,
40     REQUEST, IERROR

```

41 This call starts a nonblocking variant of `MPI_ALLGATHERV` (see Section 5.7).

```

42
43
44
45
46
47
48

```

5.12.6 Nonblocking All-to-All Scatter/Gather

`MPI_IALLTOALL(sendbuf, sendcount, sendtype, recvbuf, recvcount, recvtype, comm, request)`

IN	<code>sendbuf</code>	starting address of send buffer (choice)	
IN	<code>sendcount</code>	number of elements sent to each process (non-negative integer)	
IN	<code>sendtype</code>	data type of send buffer elements (handle)	
OUT	<code>recvbuf</code>	address of receive buffer (choice)	
IN	<code>recvcount</code>	number of elements received from any process (non-negative integer)	
IN	<code>recvtype</code>	data type of receive buffer elements (handle)	
IN	<code>comm</code>	communicator (handle)	
OUT	<code>request</code>	communication request (handle)	

```

int MPI_Ialltoall(const void* sendbuf, int sendcount,
                 MPI_Datatype sendtype, void* recvbuf, int recvcount,
                 MPI_Datatype recvtype, MPI_Comm comm, MPI_Request *request)
MPI_Ialltoall(sendbuf, sendcount, sendtype, recvbuf, recvcount, recvtype,
              comm, request, ierror)
    TYPE(*), DIMENSION(..), INTENT(IN), ASYNCHRONOUS :: sendbuf
    TYPE(*), DIMENSION(..), ASYNCHRONOUS :: recvbuf
    INTEGER, INTENT(IN) :: sendcount, recvcount
    TYPE(MPI_Datatype), INTENT(IN) :: sendtype, recvtype
    TYPE(MPI_Comm), INTENT(IN) :: comm
    TYPE(MPI_Request), INTENT(OUT) :: request
    INTEGER, OPTIONAL, INTENT(OUT) :: ierror
MPI_IALLTOALL(SENDBUF, SENDCOUNT, SENDTYPE, RECVBUF, REVCOUNT, RECVTYPE,
              COMM, REQUEST, IERROR)
<type> SENDBUF(*), RECVBUF(*)
INTEGER SENDCOUNT, SENDTYPE, REVCOUNT, RECVTYPE, COMM, REQUEST, IERROR
This call starts a nonblocking variant of MPI_ALLTOALL (see Section 5.8).

```

```

1 MPI_IALLTOALLV(sendbuf, sendcounts, sdispls, sendtype, recvbuf, recvcounts, rdispls,
2     recvtype, comm, request)
3
4     IN     sendbuf           starting address of send buffer (choice)
5
6     IN     sendcounts       non-negative integer array (of length group size) spec-
7     ifying the number of elements to send to each rank
8
9     IN     sdispls          integer array (of length group size). Entry j specifies
10    the displacement (relative to sendbuf) from which to
11    take the outgoing data destined for process j
12
13    IN     sendtype         data type of send buffer elements (handle)
14
15    OUT    recvbuf          address of receive buffer (choice)
16
17    IN     recvcounts       non-negative integer array (of length group size) spec-
18    ifying the number of elements that can be received
19    from each rank
20
21    IN     rdispls          integer array (of length group size). Entry i specifies
22    the displacement (relative to recvbuf) at which to place
23    the incoming data from process i
24
25    IN     recvtype         data type of receive buffer elements (handle)
26
27    IN     comm              communicator (handle)
28
29    OUT    request          communication request (handle)

```

```

24
25 int MPI_Ialltoallv(const void* sendbuf, const int sendcounts[],
26     const int sdispls[], MPI_Datatype sendtype, void* recvbuf,
27     const int recvcounts[], const int rdispls[],
28     MPI_Datatype recvtype, MPI_Comm comm, MPI_Request *request)
29
30 MPI_Ialltoallv(sendbuf, sendcounts, sdispls, sendtype, recvbuf, recvcounts,
31     rdispls, recvtype, comm, request, ierror)
32     TYPE(*), DIMENSION(..), INTENT(IN), ASYNCHRONOUS :: sendbuf
33     TYPE(*), DIMENSION(..), ASYNCHRONOUS :: recvbuf
34     INTEGER, INTENT(IN), ASYNCHRONOUS :: sendcounts(*), sdispls(*),
35     recvcounts(*), rdispls(*)
36     TYPE(MPI_Datatype), INTENT(IN) :: sendtype, recvtype
37     TYPE(MPI_Comm), INTENT(IN) :: comm
38     TYPE(MPI_Request), INTENT(OUT) :: request
39     INTEGER, OPTIONAL, INTENT(OUT) :: ierror
40
41 MPI_IALLTOALLV(SENDBUF, SENDCOUNTS, SDISPLS, SENDTYPE, RECVBUF, RECVCOUNTS,
42     RDISPLS, RECVTYPE, COMM, REQUEST, IERROR)
43     <type> SENDBUF(*), RECVBUF(*)
44     INTEGER SENDCOUNTS(*), SDISPLS(*), SENDTYPE, RECVCOUNTS(*), RDISPLS(*),
45     RECVTYPE, COMM, REQUEST, IERROR

```

This call starts a nonblocking variant of MPI_ALLTOALLV (see Section 5.8).

MPI_IALLTOALLW(sendbuf, sendcounts, sdispls, sendtypes, recvbuf, recvcoun-			1
recvtypes, comm, request)			2
IN	sendbuf	starting address of send buffer (choice)	3
IN	sendcounts	integer array (of length group size) specifying the num-	4
		ber of elements to send to each rank (array of non-	5
		negative integers)	6
IN	sdispls	integer array (of length group size). Entry j specifies	7
		the displacement in bytes (relative to sendbuf) from	8
		which to take the outgoing data destined for process j	9
		(array of integers)	10
IN	sendtypes	array of datatypes (of length group size). Entry j spec-	11
		ifies the type of data to send to process j (array of	12
		handles)	13
OUT	recvbuf	address of receive buffer (choice)	14
IN	recvcoun-	integer array (of length group size) specifying the num-	15
	ts	ber of elements that can be received from each rank	16
		(array of non-negative integers)	17
IN	rdispls	integer array (of length group size). Entry i specifies	18
		the displacement in bytes (relative to recvbuf) at which	19
		to place the incoming data from process i (array of	20
		integers)	21
IN	recvtypes	array of datatypes (of length group size). Entry i spec-	22
		ifies the type of data received from process i (array of	23
		handles)	24
IN	comm	communicator (handle)	25
OUT	request	communication request (handle)	26
			27
			28
			29
			30
			31
int MPI_Ialltoallw(const void* sendbuf, const int sendcounts[],			32
const int sdispls[], const MPI_Datatype sendtypes[],			33
void* recvbuf, const int recvcoun-			34
ts[], const int rdispls[],			35
const MPI_Datatype recvtypes[], MPI_Comm comm,			36
MPI_Request *request)			37
MPI_Ialltoallw(sendbuf, sendcounts, sdispls, sendtypes, recvbuf,			38
recvcoun-			39
ts, rdispls, recvtypes, comm, request, ierror)			40
TYPE(*), DIMENSION(..), INTENT(IN), ASYNCHRONOUS :: sendbuf			41
TYPE(*), DIMENSION(..), ASYNCHRONOUS :: recvbuf			42
INTEGER, INTENT(IN), ASYNCHRONOUS :: sendcounts(*), sdispls(*),			43
recvcoun-			44
ts(*), rdispls(*)			45
TYPE(MPI_Datatype), INTENT(IN), ASYNCHRONOUS :: sendtypes(*),			46
recvtypes(*)			47
TYPE(MPI_Comm), INTENT(IN) :: comm			48
TYPE(MPI_Request), INTENT(OUT) :: request			
INTEGER, OPTIONAL, INTENT(OUT) :: ierror			

```

1 MPI_IALLTOALLW(SENDBUF, SENDCOUNTS, SDISPLS, SENDTYPES, RECVBUF,
2               RECVCOUNTS, RDISPLS, RECVTYPES, COMM, REQUEST, IERROR)
3   <type> SENDBUF(*), RECVBUF(*)
4   INTEGER SENDCOUNTS(*), SDISPLS(*), SENDTYPES(*), RECVCOUNTS(*),
5           RDISPLS(*), RECVTYPES(*), COMM, REQUEST, IERROR

```

This call starts a nonblocking variant of MPI_ALLTOALLW (see Section 5.8).

5.12.7 Nonblocking Reduce

```

12 MPI_IREDUCE(sendbuf, recvbuf, count, datatype, op, root, comm, request)

```

13	IN	sendbuf	address of send buffer (choice)
14	OUT	recvbuf	address of receive buffer (choice, significant only at root)
15			
16			
17	IN	count	number of elements in send buffer (non-negative integer)
18			
19	IN	datatype	data type of elements of send buffer (handle)
20	IN	op	reduce operation (handle)
21			
22	IN	root	rank of root process (integer)
23	IN	comm	communicator (handle)
24			
25	OUT	request	communication request (handle)

```

26
27 int MPI_Ireduce(const void* sendbuf, void* recvbuf, int count,
28               MPI_Datatype datatype, MPI_Op op, int root, MPI_Comm comm,
29               MPI_Request *request)

```

```

30 MPI_Ireduce(sendbuf, recvbuf, count, datatype, op, root, comm, request,
31            ierror)
32   TYPE(*), DIMENSION(..), INTENT(IN), ASYNCHRONOUS :: sendbuf
33   TYPE(*), DIMENSION(..), ASYNCHRONOUS :: recvbuf
34   INTEGER, INTENT(IN) :: count, root
35   TYPE(MPI_Datatype), INTENT(IN) :: datatype
36   TYPE(MPI_Op), INTENT(IN) :: op
37   TYPE(MPI_Comm), INTENT(IN) :: comm
38   TYPE(MPI_Request), INTENT(OUT) :: request
39   INTEGER, OPTIONAL, INTENT(OUT) :: ierror

```

```

40
41 MPI_IREDUCE(SENDBUF, RECVBUF, COUNT, DATATYPE, OP, ROOT, COMM, REQUEST,
42            IERROR)
43   <type> SENDBUF(*), RECVBUF(*)
44   INTEGER COUNT, DATATYPE, OP, ROOT, COMM, REQUEST, IERROR

```

This call starts a nonblocking variant of MPI_REDUCE (see Section 5.9.1).

Advice to implementors. The implementation is explicitly allowed to use different algorithms for blocking and nonblocking reduction operations that might change the

order of evaluation of the operations. However, as for `MPI_REDUCE`, it is strongly recommended that `MPI_IREDUCE` be implemented so that the same result be obtained whenever the function is applied on the same arguments, appearing in the same order. Note that this may prevent optimizations that take advantage of the physical location of processes. (*End of advice to implementors.*)

Advice to users. For operations which are not truly associative, the result delivered upon completion of the nonblocking reduction may not exactly equal the result delivered by the blocking reduction, even when specifying the same arguments in the same order. (*End of advice to users.*)

5.12.8 Nonblocking All-Reduce

`MPI_IALLREDUCE`(sendbuf, recvbuf, count, datatype, op, comm, request)

IN	sendbuf	starting address of send buffer (choice)
OUT	recvbuf	starting address of receive buffer (choice)
IN	count	number of elements in send buffer (non-negative integer)
IN	datatype	data type of elements of send buffer (handle)
IN	op	operation (handle)
IN	comm	communicator (handle)
OUT	request	communication request (handle)

```
int MPI_Iallreduce(const void* sendbuf, void* recvbuf, int count,
                  MPI_Datatype datatype, MPI_Op op, MPI_Comm comm,
                  MPI_Request *request)
```

```
MPI_Iallreduce(sendbuf, recvbuf, count, datatype, op, comm, request,
               ierror)
```

```
TYPE(*), DIMENSION(..), INTENT(IN), ASYNCHRONOUS :: sendbuf
```

```
TYPE(*), DIMENSION(..), ASYNCHRONOUS :: recvbuf
```

```
INTEGER, INTENT(IN) :: count
```

```
TYPE(MPI_Datatype), INTENT(IN) :: datatype
```

```
TYPE(MPI_Op), INTENT(IN) :: op
```

```
TYPE(MPI_Comm), INTENT(IN) :: comm
```

```
TYPE(MPI_Request), INTENT(OUT) :: request
```

```
INTEGER, OPTIONAL, INTENT(OUT) :: ierror
```

```
MPI_IALLREDUCE(SENDBUF, RECVBUF, COUNT, DATATYPE, OP, COMM, REQUEST,
               IERROR)
```

```
<type> SENDBUF(*), RECVBUF(*)
```

```
INTEGER COUNT, DATATYPE, OP, COMM, REQUEST, IERROR
```

This call starts a nonblocking variant of `MPI_ALLREDUCE` (see Section 5.9.6).

5.12.9 Nonblocking Reduce-Scatter with Equal Blocks

```

4 MPI_IREDUCE_SCATTER_BLOCK(sendbuf, recvbuf, recvcnt, datatype, op, comm, request)

```

6	IN	sendbuf	starting address of send buffer (choice)
7			
8	OUT	recvbuf	starting address of receive buffer (choice)
9	IN	recvcnt	element count per block (non-negative integer)
10			
11	IN	datatype	data type of elements of send and receive buffers (handle)
12			
13	IN	op	operation (handle)
14	IN	comm	communicator (handle)
15			
16	OUT	request	communication request (handle)

```

17
18 int MPI_Ireduce_scatter_block(const void* sendbuf, void* recvbuf,
19                               int recvcnt, MPI_Datatype datatype, MPI_Op op,
20                               MPI_Comm comm, MPI_Request *request)

```

```

21 MPI_Ireduce_scatter_block(sendbuf, recvbuf, recvcnt, datatype, op, comm,
22                           request, ierror)

```

```

23     TYPE(*), DIMENSION(..), INTENT(IN), ASYNCHRONOUS :: sendbuf
24     TYPE(*), DIMENSION(..), ASYNCHRONOUS :: recvbuf
25     INTEGER, INTENT(IN) :: recvcnt
26     TYPE(MPI_Datatype), INTENT(IN) :: datatype
27     TYPE(MPI_Op), INTENT(IN) :: op
28     TYPE(MPI_Comm), INTENT(IN) :: comm
29     TYPE(MPI_Request), INTENT(OUT) :: request
30     INTEGER, OPTIONAL, INTENT(OUT) :: ierror

```

```

31
32 MPI_IREDUCE_SCATTER_BLOCK(SENDBUF, RECVBUF, RECVCOUNT, DATATYPE, OP, COMM,
33                           REQUEST, IERROR)

```

```

34     <type> SENDBUF(*), RECVBUF(*)
35     INTEGER RECVCOUNT, DATATYPE, OP, COMM, REQUEST, IERROR

```

36 This call starts a nonblocking variant of MPI_REDUCE_SCATTER_BLOCK (see Section 5.10.1).

5.12.10 Nonblocking Reduce-Scatter

`MPI_IREDUCE_SCATTER`(sendbuf, recvbuf, recvcnts, datatype, op, comm, request)

IN	sendbuf	starting address of send buffer (choice)
OUT	recvbuf	starting address of receive buffer (choice)
IN	recvcnts	non-negative integer array specifying the number of elements in result distributed to each process. Array must be identical on all calling processes.
IN	datatype	data type of elements of input buffer (handle)
IN	op	operation (handle)
IN	comm	communicator (handle)
OUT	request	communication request (handle)

```
int MPI_Ireduce_scatter(const void* sendbuf, void* recvbuf,
    const int recvcnts[], MPI_Datatype datatype, MPI_Op op,
    MPI_Comm comm, MPI_Request *request)
```

```
MPI_Ireduce_scatter(sendbuf, recvbuf, recvcnts, datatype, op, comm,
    request, ierror)
```

```
TYPE(*), DIMENSION(..), INTENT(IN), ASYNCHRONOUS :: sendbuf
```

```
TYPE(*), DIMENSION(..), ASYNCHRONOUS :: recvbuf
```

```
INTEGER, INTENT(IN), ASYNCHRONOUS :: recvcnts(*)
```

```
TYPE(MPI_Datatype), INTENT(IN) :: datatype
```

```
TYPE(MPI_Op), INTENT(IN) :: op
```

```
TYPE(MPI_Comm), INTENT(IN) :: comm
```

```
TYPE(MPI_Request), INTENT(OUT) :: request
```

```
INTEGER, OPTIONAL, INTENT(OUT) :: ierror
```

```
MPI_IREDUCE_SCATTER(SENDBUF, RECVBUF, RECVCOUNTS, DATATYPE, OP, COMM,
    REQUEST, IERROR)
```

```
<type> SENDBUF(*), RECVBUF(*)
```

```
INTEGER RECVCOUNTS(*), DATATYPE, OP, COMM, REQUEST, IERROR
```

This call starts a nonblocking variant of `MPI_REDUCE_SCATTER` (see Section 5.10.2).

5.12.11 Nonblocking Inclusive Scan

```

4 MPI_ISCAN(sendbuf, recvbuf, count, datatype, op, comm, request)

```

5	IN	sendbuf	starting address of send buffer (choice)
6			
7	OUT	recvbuf	starting address of receive buffer (choice)
8	IN	count	number of elements in input buffer (non-negative integer)
9			
10	IN	datatype	data type of elements of input buffer (handle)
11	IN	op	operation (handle)
12	IN	comm	communicator (handle)
13	IN	comm	communicator (handle)
14	OUT	request	communication request (handle)
15			

```

16
17 int MPI_Iscan(const void* sendbuf, void* recvbuf, int count,
18             MPI_Datatype datatype, MPI_Op op, MPI_Comm comm,
19             MPI_Request *request)

```

```

20 MPI_Iscan(sendbuf, recvbuf, count, datatype, op, comm, request, ierror)
21     TYPE(*), DIMENSION(..), INTENT(IN), ASYNCHRONOUS :: sendbuf
22     TYPE(*), DIMENSION(..), ASYNCHRONOUS :: recvbuf
23     INTEGER, INTENT(IN) :: count
24     TYPE(MPI_Datatype), INTENT(IN) :: datatype
25     TYPE(MPI_Op), INTENT(IN) :: op
26     TYPE(MPI_Comm), INTENT(IN) :: comm
27     TYPE(MPI_Request), INTENT(OUT) :: request
28     INTEGER, OPTIONAL, INTENT(OUT) :: ierror
29

```

```

30 MPI_ISCAN(SENDBUF, RECVBUF, COUNT, DATATYPE, OP, COMM, REQUEST, IERROR)
31     <type> SENDBUF(*), RECVBUF(*)
32     INTEGER COUNT, DATATYPE, OP, COMM, REQUEST, IERROR

```

33 This call starts a nonblocking variant of MPI_SCAN (see Section 5.11).

5.12.12 Nonblocking Exclusive Scan

```
MPI_IEXSCAN(sendbuf, recvbuf, count, datatype, op, comm, request)
```

IN	sendbuf	starting address of send buffer (choice)
OUT	recvbuf	starting address of receive buffer (choice)
IN	count	number of elements in input buffer (non-negative integer)
IN	datatype	data type of elements of input buffer (handle)
IN	op	operation (handle)
IN	comm	intracommunicator (handle)
OUT	request	communication request (handle)

```
int MPI_Iexscan(const void* sendbuf, void* recvbuf, int count,
               MPI_Datatype datatype, MPI_Op op, MPI_Comm comm,
               MPI_Request *request)
```

```
MPI_Iexscan(sendbuf, recvbuf, count, datatype, op, comm, request, ierror)
  TYPE(*), DIMENSION(..), INTENT(IN), ASYNCHRONOUS :: sendbuf
  TYPE(*), DIMENSION(..), ASYNCHRONOUS :: recvbuf
  INTEGER, INTENT(IN) :: count
  TYPE(MPI_Datatype), INTENT(IN) :: datatype
  TYPE(MPI_Op), INTENT(IN) :: op
  TYPE(MPI_Comm), INTENT(IN) :: comm
  TYPE(MPI_Request), INTENT(OUT) :: request
  INTEGER, OPTIONAL, INTENT(OUT) :: ierror
```

```
MPI_IEXSCAN(SENDBUF, RECVBUF, COUNT, DATATYPE, OP, COMM, REQUEST, IERROR)
  <type> SENDBUF(*), RECVBUF(*)
  INTEGER COUNT, DATATYPE, OP, COMM, REQUEST, IERROR
```

This call starts a nonblocking variant of MPI_EXSCAN (see Section 5.11.2).

5.13 Persistent Collective Operations

Many parallel computation algorithms involve repetitively executing a collective communication operation with the same arguments each time. As with persistent point-to-point operations (see Section 3.9), persistent collective operations allow the MPI programmer to specify operations that will be reused frequently (with fixed arguments). MPI can be designed to select a more efficient way to perform the collective operation based on the parameters specified when the operation is initialized. This “planned-transfer” approach can offer significant performance benefits for programs with repetitive communication patterns.

In terms of data movement, each persistent collective operation has the same effect as its blocking and nonblocking counterparts for intracommunicators and intercommunicators after completion. Likewise, upon completion, persistent collective reduction operations

1 perform the same operation as their blocking and nonblocking counterparts, and the same
2 restrictions and recommendations on reduction orders apply (see also Section 5.9.1).

3 Initialization calls for MPI persistent collective operations are non-local and follow all
4 the existing rules for collective operations, in particular ordering; programs that do not
5 conform to these restrictions are erroneous. After initialization, all arrays associated with
6 input arguments (such as arrays of counts, displacements, and datatypes in the vector
7 versions of the collectives) must not be modified until the corresponding persistent request
8 is freed with `MPI_REQUEST_FREE`.

9 The `request` argument is an output argument that can be used zero or more times with
10 `MPI_START` or `MPI_STARTALL` in order to start the collective operation. The `request` is
11 initially inactive after the initialization call. Once initialized, persistent collective operations
12 can be started in any order and the order can differ among processes in the communicator.

13
14 *Rationale.* All ordering requirements that an implementation may need to match
15 up collective operations across the communicator are achieved through the ordering
16 requirements of the initialization functions. This enables out-of-order starts for the
17 persistent operations, and particularly supports their use in `MPI_STARTALL`. (*End of*
18 *rationale.*)

19
20 *Advice to implementors.* An MPI implementation should do no worse than duplicat-
21 ing the communicator during the initialization function, caching the input arguments,
22 and calling the appropriate nonblocking collective function, using the cached argu-
23 ments, during `MPI_START`. High-quality implementations should be able to amortize
24 setup costs and further optimize by taking advantage of early-binding, such as effi-
25 cient and effective pre-allocation of certain resources and algorithm selection. (*End*
26 *of advice to implementors.*)

27 A request must be inactive when it is started. Starting the operation makes the request
28 active. Once any process starts a persistent collective operation, it must complete that
29 operation and all other processes in the communicator must eventually start (and complete)
30 the same persistent collective operation. Persistent collective operations cannot be matched
31 with blocking or nonblocking collective operations. Completion of a persistent collective
32 operation makes the corresponding request inactive. After starting a persistent collective
33 operation, all associated send buffers must not be modified and all associated receive buffers
34 must not be accessed until the corresponding persistent request is completed.

35 Completing a persistent collective request, for example using `MPI_TEST` or
36 `MPI_WAIT`, makes it inactive, but does not free the request. This is the same behavior as
37 for persistent point-to-point requests. Inactive persistent collective requests can be freed
38 using `MPI_REQUEST_FREE`. It is erroneous to free an active persistent collective request.
39 Persistent collective operations cannot be canceled; it is erroneous to use `MPI_CANCEL` on
40 a persistent collective request.

41 For every nonblocking collective communication operation in MPI, there is a corre-
42 sponding persistent collective operation with the analogous API signature.

43 The collective persistent API signatures include an `MPI_INFO` object in order to support
44 optimization hints and other information that may be non-standard. Persistent collective
45 operations may be optimized during communicator creation or by the initialization opera-
46 tion of an individual persistent collective. Note that communicator-scoped hints should be
47 provided using `MPI_COMM_SET_INFO` while, for operation-scoped hints, they are supplied
48 to the persistent collective communication initialization functions using the `info` argument.

5.13.1 Persistent Barrier Synchronization

MPI_BARRIER_INIT(comm, info, request)

IN	comm	communicator (handle)
IN	info	info argument (handle)
OUT	request	communication request (handle)

```
int MPI_Barrier_init(MPI_Comm comm, MPI_Info info, MPI_Request *request)
```

```
MPI_Barrier_init(comm, info, request, ierror)
    TYPE(MPI_Comm), INTENT(IN) :: comm
    TYPE(MPI_Info), INTENT(IN) :: info
    TYPE(MPI_Request), INTENT(OUT) :: request
    INTEGER, OPTIONAL, INTENT(OUT) :: ierror
```

```
MPI_BARRIER_INIT(COMM, INFO, REQUEST, IERROR)
    INTEGER COMM, INFO, REQUEST, IERROR
```

Creates a persistent collective communication request for the barrier operation.

5.13.2 Persistent Broadcast

MPI_BCAST_INIT(buffer, count, datatype, root, comm, info, request)

INOUT	buffer	starting address of buffer (choice)
IN	count	number of entries in buffer (non-negative integer)
IN	datatype	data type of buffer (handle)
IN	root	rank of broadcast root (integer)
IN	comm	communicator (handle)
IN	info	info argument (handle)
OUT	request	communication request (handle)

```
int MPI_Bcast_init(void* buffer, int count, MPI_Datatype datatype,
    int root, MPI_Comm comm, MPI_Info info, MPI_Request *request)
```

```
MPI_Bcast_init(buffer, count, datatype, root, comm, info, request, ierror)
    TYPE(*), DIMENSION(..), ASYNCHRONOUS :: buffer
    INTEGER, INTENT(IN) :: count, root
    TYPE(MPI_Datatype), INTENT(IN) :: datatype
    TYPE(MPI_Comm), INTENT(IN) :: comm
    TYPE(MPI_Info), INTENT(IN) :: info
    TYPE(MPI_Request), INTENT(OUT) :: request
    INTEGER, OPTIONAL, INTENT(OUT) :: ierror
```

```
MPI_BCAST_INIT(BUFFER, COUNT, DATATYPE, ROOT, COMM, INFO, REQUEST, IERROR)
```

```

1     <type> BUFFER(*)
2     INTEGER COUNT, DATATYPE, ROOT, COMM, INFO, REQUEST, IERROR

```

Creates a persistent collective communication request for the broadcast operation.

5.13.3 Persistent Gather

```

9     MPI_GATHER_INIT(sendbuf, sendcount, sendtype, recvbuf, recvcount, recvtype, root, comm,
10                    info, request)

```

11	IN	sendbuf	starting address of send buffer (choice)
12	IN	sendcount	number of elements in send buffer (non-negative integer)
13			
14			
15	IN	sendtype	data type of send buffer elements (handle)
16	OUT	recvbuf	address of receive buffer (choice, significant only at root)
17			
18			
19	IN	recvcount	number of elements for any single receive (non-negative integer, significant only at root)
20			
21	IN	recvtype	data type of recv buffer elements (significant only at root) (handle)
22			
23	IN	root	rank of receiving process (integer)
24	IN	comm	communicator (handle)
25	IN	info	info argument (handle)
26	IN	info	info argument (handle)
27	OUT	request	communication request (handle)
28			

```

29     int MPI_Gather_init(const void* sendbuf, int sendcount,
30                       MPI_Datatype sendtype, void* recvbuf, int recvcount,
31                       MPI_Datatype recvtype, int root, MPI_Comm comm, MPI_Info info,
32                       MPI_Request *request)
33

```

```

34     MPI_Gather_init(sendbuf, sendcount, sendtype, recvbuf, recvcount, recvtype,
35                   root, comm, info, request, ierror)
36     TYPE(*), DIMENSION(..), INTENT(IN), ASYNCHRONOUS :: sendbuf
37     TYPE(*), DIMENSION(..), ASYNCHRONOUS :: recvbuf
38     INTEGER, INTENT(IN) :: sendcount, recvcount, root
39     TYPE(MPI_Datatype), INTENT(IN) :: sendtype, recvtype
40     TYPE(MPI_Comm), INTENT(IN) :: comm
41     TYPE(MPI_Info), INTENT(IN) :: info
42     TYPE(MPI_Request), INTENT(OUT) :: request
43     INTEGER, OPTIONAL, INTENT(OUT) :: ierror

```

```

44     MPI_GATHER_INIT(SENDBUF, SENDCOUNT, SENDTYPE, RECVBUF, REVCOUNT, RECVTYPE,
45                   ROOT, COMM, INFO, REQUEST, IERROR)
46     <type> SENDBUF(*), RECVBUF(*)
47     INTEGER SENDCOUNT, SENDTYPE, REVCOUNT, RECVTYPE, ROOT, COMM, INFO,
48

```

REQUEST, IERROR

Creates a persistent collective communication request for the gather operation.

`MPI_GATHERV_INIT(sendbuf, sendcount, sendtype, recvbuf, recvcnts, displs, recvtype, root, comm, info, request)`

IN	sendbuf	starting address of send buffer (choice)	1
IN	sendcount	number of elements in send buffer (non-negative integer)	2
IN	sendtype	data type of send buffer elements (handle)	3
OUT	recvbuf	address of receive buffer (choice, significant only at root)	4
IN	recvcnts	non-negative integer array (of length group size) containing the number of elements that are received from each process (significant only at root)	5
IN	displs	integer array (of length group size). Entry <i>i</i> specifies the displacement relative to <code>recvbuf</code> at which to place the incoming data from process <i>i</i> (significant only at root)	6
IN	recvtype	data type of recv buffer elements (significant only at root) (handle)	7
IN	root	rank of receiving process (integer)	8
IN	comm	communicator (handle)	9
IN	info	info argument (handle)	10
OUT	request	communication request (handle)	11

```
int MPI_Gatherv_init(const void* sendbuf, int sendcount,
                    MPI_Datatype sendtype, void* recvbuf, const int recvcnts[],
                    const int displs[], MPI_Datatype recvtype, int root,
                    MPI_Comm comm, MPI_Info info, MPI_Request *request)
```

```
MPI_Gatherv_init(sendbuf, sendcount, sendtype, recvbuf, recvcnts, displs,
                 recvtype, root, comm, info, request, ierror)
    TYPE(*), DIMENSION(..), INTENT(IN), ASYNCHRONOUS :: sendbuf
    TYPE(*), DIMENSION(..), ASYNCHRONOUS :: recvbuf
    INTEGER, INTENT(IN) :: sendcount, root
    INTEGER, INTENT(IN), ASYNCHRONOUS :: recvcnts(*), displs(*)
    TYPE(MPI_Datatype), INTENT(IN) :: sendtype, recvtype
    TYPE(MPI_Comm), INTENT(IN) :: comm
    TYPE(MPI_Info), INTENT(IN) :: info
    TYPE(MPI_Request), INTENT(OUT) :: request
    INTEGER, OPTIONAL, INTENT(OUT) :: ierror
```

```
MPI_GATHERV_INIT(SENDBUF, SENDCOUNT, SENDTYPE, RECVBUF, RECVCOUNTS, DISPLS,
                 RECVTYPE, ROOT, COMM, INFO, REQUEST, IERROR)
```

```

1 <type> SENDBUF(*), RECVBUF(*)
2 INTEGER SENDCOUNT, SENDTYPE, RECVCOUNTS(*), DISPLS(*), RECVTYP, ROOT,
3 COMM, INFO, REQUEST, IERROR

```

Creates a persistent collective communication request for the gather operation.

5.13.4 Persistent Scatter

```

10 MPI_SCATTER_INIT(sendbuf, sendcount, sendtype, recvbuf, recvcount, recvtpe, root, comm,
11 info, request)

```

12	IN	sendbuf	address of send buffer (choice, significant only at root)
13	IN	sendcount	number of elements sent to each process (non-negative integer, significant only at root)
14			
15			
16	IN	sendtype	data type of send buffer elements (significant only at root) (handle)
17			
18	OUT	recvbuf	address of receive buffer (choice)
19	IN	recvcount	number of elements in receive buffer (non-negative integer)
20			
21			
22	IN	recvtpe	data type of receive buffer elements (handle)
23	IN	root	rank of sending process (integer)
24	IN	comm	communicator (handle)
25	IN	info	info argument (handle)
26	IN	info	info argument (handle)
27	OUT	request	communication request (handle)
28			

```

29 int MPI_Scatter_init(const void* sendbuf, int sendcount,
30 MPI_Datatype sendtype, void* recvbuf, int recvcount,
31 MPI_Datatype recvtpe, int root, MPI_Comm comm, MPI_Info info,
32 MPI_Request *request)
33

```

```

34 MPI_Scatter_init(sendbuf, sendcount, sendtype, recvbuf, recvcount,
35 recvtpe, root, comm, info, request, ierror)
36 TYPE(*), DIMENSION(..), INTENT(IN), ASYNCHRONOUS :: sendbuf
37 TYPE(*), DIMENSION(..), ASYNCHRONOUS :: recvbuf
38 INTEGER, INTENT(IN) :: sendcount, recvcount, root
39 TYPE(MPI_Datatype), INTENT(IN) :: sendtype, recvtpe
40 TYPE(MPI_Comm), INTENT(IN) :: comm
41 TYPE(MPI_Info), INTENT(IN) :: info
42 TYPE(MPI_Request), INTENT(OUT) :: request
43 INTEGER, OPTIONAL, INTENT(OUT) :: ierror

```

```

44 MPI_SCATTER_INIT(SENDBUF, SENDCOUNT, SENDTYPE, RECVBUF, RECVCOUNT,
45 RECVTYP, ROOT, COMM, INFO, REQUEST, IERROR)
46 <type> SENDBUF(*), RECVBUF(*)
47 INTEGER SENDCOUNT, SENDTYPE, RECVCOUNT, RECVTYP, ROOT, COMM, INFO,
48

```

REQUEST, IERROR

Creates a persistent collective communication request for the scatter operation.

MPI_SCATTERV_INIT(sendbuf, sendcounts, displs, sendtype, recvbuf, recvcount, recvtype, root, comm, info, request)

IN	sendbuf	address of send buffer (choice, significant only at root)
IN	sendcounts	non-negative integer array (of length group size) specifying the number of elements to send to each rank
IN	displs	integer array (of length group size). Entry <i>i</i> specifies the displacement (relative to <code>sendbuf</code>) from which to take the outgoing data to process <i>i</i>
IN	sendtype	data type of send buffer elements (handle)
OUT	recvbuf	address of receive buffer (choice)
IN	recvcount	number of elements in receive buffer (non-negative integer)
IN	recvtype	data type of receive buffer elements (handle)
IN	root	rank of sending process (integer)
IN	comm	communicator (handle)
IN	info	info argument (handle)
OUT	request	communication request (handle)

```
int MPI_Scatterv_init(const void* sendbuf, const int sendcounts[],
                    const int displs[], MPI_Datatype sendtype, void* recvbuf,
                    int recvcount, MPI_Datatype recvtype, int root, MPI_Comm comm,
                    MPI_Info info, MPI_Request *request)
```

```
MPI_Scatterv_init(sendbuf, sendcounts, displs, sendtype, recvbuf,
                 recvcount, recvtype, root, comm, info, request, ierror)
    TYPE(*), DIMENSION(..), INTENT(IN), ASYNCHRONOUS :: sendbuf
    TYPE(*), DIMENSION(..), ASYNCHRONOUS :: recvbuf
    INTEGER, INTENT(IN), ASYNCHRONOUS :: sendcounts(*), displs(*)
    INTEGER, INTENT(IN) :: recvcount, root
    TYPE(MPI_Datatype), INTENT(IN) :: sendtype, recvtype
    TYPE(MPI_Comm), INTENT(IN) :: comm
    TYPE(MPI_Info), INTENT(IN) :: info
    TYPE(MPI_Request), INTENT(OUT) :: request
    INTEGER, OPTIONAL, INTENT(OUT) :: ierror
```

```
MPI_SCATTERV_INIT(SENDBUF, SENDCOUNTS, DISPLS, SENDTYPE, RECVBUF,
                 RECVCOUNT, RECVTYPE, ROOT, COMM, INFO, REQUEST, IERROR)
    <type> SENDBUF(*), RECVBUF(*)
    INTEGER SENDCOUNTS(*), DISPLS(*), SENDTYPE, RECVCOUNT, RECVTYPE, ROOT,
    COMM, INFO, REQUEST, IERROR
```

Creates a persistent collective communication request for the scatterv operation.

5.13.5 Persistent Gather-to-all

```

1 MPI_ALLGATHER_INIT(sendbuf, sendcount, sendtype, recvbuf, recvcount, recvtype, comm,
2
3
4 info, request)
5
6
7 IN      sendbuf      starting address of send buffer (choice)
8
9 IN      sendcount    number of elements in send buffer (non-negative inte-
10
11 ger)
12
13 IN      sendtype     data type of send buffer elements (handle)
14
15 OUT     recvbuf      address of receive buffer (choice)
16
17 IN      recvcount    number of elements received from any process (non-
18
19 negative integer)
20
21 IN      recvtype     data type of receive buffer elements (handle)
22
23 IN      comm         communicator (handle)
24
25 IN      info         info argument (handle)
26
27 OUT     request      communication request (handle)

```

```

21 int MPI_Allgather_init(const void* sendbuf, int sendcount,
22
23 MPI_Datatype sendtype, void* recvbuf, int recvcount,
24
25 MPI_Datatype recvtype, MPI_Comm comm, MPI_Info info,
26
27 MPI_Request *request)
28
29 MPI_Allgather_init(sendbuf, sendcount, sendtype, recvbuf, recvcount,
30
31 recvtype, comm, info, request, ierror)
32
33 TYPE(*), DIMENSION(..), INTENT(IN), ASYNCHRONOUS :: sendbuf
34
35 TYPE(*), DIMENSION(..), ASYNCHRONOUS :: recvbuf
36
37 INTEGER, INTENT(IN) :: sendcount, recvcount
38
39 TYPE(MPI_Datatype), INTENT(IN) :: sendtype, recvtype
40
41 TYPE(MPI_Comm), INTENT(IN) :: comm
42
43 TYPE(MPI_Info), INTENT(IN) :: info
44
45 TYPE(MPI_Request), INTENT(OUT) :: request
46
47 INTEGER, OPTIONAL, INTENT(OUT) :: ierror
48
49 MPI_ALLGATHER_INIT(SENDBUF, SENDCOUNT, SENDTYPE, RECVBUF, RECVCOUNT,
50
51 RECVTYPE, COMM, INFO, REQUEST, IERROR)
52
53 <type> SENDBUF(*), RECVBUF(*)
54
55 INTEGER SENDCOUNT, SENDTYPE, RECVCOUNT, RECVTYPE, COMM, INFO, REQUEST,
56
57 IERROR

```

Creates a persistent collective communication request for the allgather operation.

```

MPI_ALLGATHERV_INIT(sendbuf, sendcount, sendtype, recvbuf, recvcoun- 1
                    t, displ, recvtype, comm, info, request)      2
IN    sendbuf        starting address of send buffer (choice)      3
IN    sendcount      number of elements in send buffer (non-negative 4
                    integer)                                     5
IN    sendtype       data type of send buffer elements (handle)   6
OUT   recvbuf        address of receive buffer (choice)           7
IN    recvcoun-     non-negative integer array (of length group size) 8
      t             containing the number of elements that are received 9
                    from each process                             10
IN    displ         integer array (of length group size). Entry i 11
                    specifies the displacement (relative to recvbuf) 12
                    at which to place the incoming data from process 13
                    i                                           14
IN    recvtype       data type of receive buffer elements (handle) 15
IN    comm           communicator (handle)                         16
IN    info           info argument (handle)                       17
OUT   request        communication request (handle)               18
int MPI_Allgather- 19
v_init(const void* sendbuf, int sendcount,
        MPI_Datatype sendtype, void* recvbuf, const int recvcoun- 20
ts[],
        const int displs[], MPI_Datatype recvtype, MPI_Comm comm, 21
        MPI_Info info, MPI_Request* request)                      22
MPI_Allgather- 23
v_init(sendbuf, sendcount, sendtype, recvbuf, recvcoun-
ts,
        displs, recvtype, comm, info, request, ierror)           24
TYPE(*), DIMENSION(..), INTENT(IN), ASYNCHRONOUS :: sendbuf     25
TYPE(*), DIMENSION(..), ASYNCHRONOUS :: recvbuf                 26
INTEGER, INTENT(IN) :: sendcount                                27
INTEGER, INTENT(IN), ASYNCHRONOUS :: recvcoun-
ts(*), displs(*)                                               28
TYPE(MPI_Datatype), INTENT(IN) :: sendtype, recvtype           29
TYPE(MPI_Comm), INTENT(IN) :: comm                             30
TYPE(MPI_Info), INTENT(IN) :: info                             31
TYPE(MPI_Request), INTENT(OUT) :: request                       32
INTEGER, OPTIONAL, INTENT(OUT) :: ierror                        33
MPI_ALLGATHERV_INIT(SENDBUF, SENDCOUNT, SENDTYPE, RECVBUF, RECV- 34
COUNTS,
                    DISPLS, RECVTYPE, COMM, INFO, REQUEST, IERROR) 35
<type> SENDBUF(*), RECVBUF(*)                                   36
INTEGER SENDCOUNT, SENDTYPE, RECVCOUNTS(*), DISPLS(*), RECV- 37
TYPE, COMM,
                    INFO, REQUEST, IERROR                       38
Creates a persistent collective communication request for the all- 39
gather operation.                                             40

```

5.13.6 Persistent All-to-All Scatter/Gather

```

4 MPI_ALLTOALL_INIT(sendbuf, sendcount, sendtype, recvbuf, recvcount, recvtype, comm, info,
5     request)

```

6	IN	sendbuf	starting address of send buffer (choice)
7			
8	IN	sendcount	number of elements sent to each process (non-negative integer)
9			
10	IN	sendtype	data type of send buffer elements (handle)
11			
12	OUT	recvbuf	address of receive buffer (choice)
13	IN	recvcount	number of elements received from any process (non-negative integer)
14			
15	IN	recvtype	data type of receive buffer elements (handle)
16			
17	IN	comm	communicator (handle)
18	IN	info	info argument (handle)
19	OUT	request	communication request (handle)
20			

```

21 int MPI_Alltoall_init(const void* sendbuf, int sendcount,
22     MPI_Datatype sendtype, void* recvbuf, int recvcount,
23     MPI_Datatype recvtype, MPI_Comm comm, MPI_Info info,
24     MPI_Request *request)
25
26 MPI_Alltoall_init(sendbuf, sendcount, sendtype, recvbuf, recvcount,
27     recvtype, comm, info, request, ierror)
28     TYPE(*), DIMENSION(..), INTENT(IN), ASYNCHRONOUS :: sendbuf
29     TYPE(*), DIMENSION(..), ASYNCHRONOUS :: recvbuf
30     INTEGER, INTENT(IN) :: sendcount, recvcount
31     TYPE(MPI_Datatype), INTENT(IN) :: sendtype, recvtype
32     TYPE(MPI_Comm), INTENT(IN) :: comm
33     TYPE(MPI_Info), INTENT(IN) :: info
34     TYPE(MPI_Request), INTENT(OUT) :: request
35     INTEGER, OPTIONAL, INTENT(OUT) :: ierror

```

```

36 MPI_ALLTOALL_INIT(SENDBUF, SENDCOUNT, SENDTYPE, RECVBUF, REVCOUNT,
37     RECVTYPE, COMM, INFO, REQUEST, IERROR)
38     <type> SENDBUF(*), RECVBUF(*)
39     INTEGER SENDCOUNT, SENDTYPE, REVCOUNT, RECVTYPE, COMM, INFO, REQUEST,
40     IERROR

```

Creates a persistent collective communication request for the alltoall operation.

MPI_ALLTOALLV_INIT(sendbuf, sendcounts, sdispls, sendtype, recvbuf, recvcounts, rdispls,			1
recvtype, comm, info, request)			2
IN	sendbuf	starting address of send buffer (choice)	3
			4
IN	sendcounts	non-negative integer array (of length group size) specifying the number of elements to send to each rank	5
			6
IN	sdispls	integer array (of length group size). Entry j specifies the displacement (relative to sendbuf) from which to take the outgoing data destined for process j	7
			8
			9
IN	sendtype	data type of send buffer elements (handle)	10
OUT	recvbuf	address of receive buffer (choice)	11
			12
IN	recvcounts	non-negative integer array (of length group size) specifying the number of elements that can be received from each rank	13
			14
			15
IN	rdispls	integer array (of length group size). Entry i specifies the displacement (relative to recvbuf) at which to place the incoming data from process i	16
			17
			18
			19
IN	recvtype	data type of receive buffer elements (handle)	20
IN	comm	communicator (handle)	21
IN	info	info argument (handle)	22
			23
OUT	request	communication request (handle)	24
			25
int MPI_Alltoallv_init(const void* sendbuf, const int sendcounts[],			26
const int sdispls[], MPI_Datatype sendtype, void* recvbuf,			27
const int recvcounts[], const int rdispls[],			28
MPI_Datatype recvtype, MPI_Comm comm, MPI_info info,			29
MPI_Request *request)			30
			31
MPI_Alltoallv_init(sendbuf, sendcounts, sdispls, sendtype, recvbuf,			32
recvcounts, rdispls, recvtype, comm, info, request, ierror)			33
TYPE(*), DIMENSION(..), INTENT(IN), ASYNCHRONOUS :: sendbuf			34
TYPE(*), DIMENSION(..), ASYNCHRONOUS :: recvbuf			35
INTEGER, INTENT(IN), ASYNCHRONOUS :: sendcounts(*), sdispls(*),			36
recvcounts(*), rdispls(*)			37
TYPE(MPI_Datatype), INTENT(IN) :: sendtype, recvtype			38
TYPE(MPI_Comm), INTENT(IN) :: comm			39
TYPE(MPI_Info), INTENT(IN) :: info			40
TYPE(MPI_Request), INTENT(OUT) :: request			41
INTEGER, OPTIONAL, INTENT(OUT) :: ierror			42
			43
MPI_ALLTOALLV_INIT(SENDBUF, SENDCOUNTS, SDISPLS, SENDTYPE, RECVBUF,			44
RECVCOUNTS, RDISPLS, RECVTYPE, COMM, INFO, REQUEST, IERROR)			45
<type> SENDBUF(*), RECVBUF(*)			46
INTEGER SENDCOUNTS(*), SDISPLS(*), SENDTYPE, RECVCOUNTS(*), RDISPLS(*),			47
RECVTYPE, COMM, INFO, REQUEST, IERROR			48

Creates a persistent collective communication request for the alltoallv operation.

```

1      MPI_ALLTOALLW_INIT(sendbuf, sendcounts, sdispls, sendtypes, recvbuf, recvcounts, rdispls,
2
3
4      recvtypes, comm, info, request)
5
6      IN      sendbuf      starting address of send buffer (choice)
7
8      IN      sendcounts   integer array (of length group size) specifying the num-
9
10     ber of elements to send to each rank (array of non-
11
12     negative integers)
13
14     IN      sdispls      integer array (of length group size). Entry j specifies
15
16     the displacement in bytes (relative to sendbuf) from
17
18     which to take the outgoing data destined for process j
19
20     (array of integers)
21
22     IN      sendtypes     array of datatypes (of length group size). Entry j spec-
23
24     ifies the type of data to send to process j (array of
25
26     handles)
27
28     OUT     recvbuf      address of receive buffer (choice)
29
30     IN      recvcounts   integer array (of length group size) specifying the num-
31
32     ber of elements that can be received from each rank
33
34     (array of non-negative integers)
35
36     IN      rdispls      integer array (of length group size). Entry i specifies
37
38     the displacement in bytes (relative to recvbuf) at which
39
40     to place the incoming data from process i (array of
41
42     integers)
43
44     IN      recvtypes     array of datatypes (of length group size). Entry i spec-
45
46     ifies the type of data received from process i (array of
47
48     handles)
49
50     IN      comm         communicator (handle)
51
52     IN      info         info argument (handle)
53
54     OUT     request      communication request (handle)

```

```

35
36 int MPI_Alltoallw_init(const void* sendbuf, const int sendcounts[],
37
38     const int sdispls[], const MPI_Datatype sendtypes[],
39
40     void* recvbuf, const int recvcounts[], const int rdispls[],
41
42     const MPI_Datatype recvtypes[], MPI_Comm comm, MPI_Info info,
43
44     MPI_Request *request)

```

```

45 MPI_Alltoallw_init(sendbuf, sendcounts, sdispls, sendtypes, recvbuf,
46
47     recvcounts, rdispls, recvtypes, comm, info, request, ierror)
48
49     TYPE(*), DIMENSION(..), INTENT(IN), ASYNCHRONOUS :: sendbuf
50
51     TYPE(*), DIMENSION(..), ASYNCHRONOUS :: recvbuf
52
53     INTEGER, INTENT(IN), ASYNCHRONOUS :: sendcounts(*), sdispls(*),
54
55     recvcounts(*), rdispls(*)
56
57     TYPE(MPI_Datatype), INTENT(IN), ASYNCHRONOUS :: sendtypes(*),
58
59     recvtypes(*)

```

```

TYPE(MPI_Comm), INTENT(IN) :: comm
TYPE(MPI_Info), INTENT(IN) :: info
TYPE(MPI_Request), INTENT(OUT) :: request
INTEGER, OPTIONAL, INTENT(OUT) :: ierror

MPI_ALLTOALLW_INIT(SENDBUF, SENDCOUNTS, SDISPLS, SENDTYPES, RECVBUF,
RECVCOUNTS, RDISPLS, RECVTYPES, COMM, INFO, REQUEST, IERROR)
<type> SENDBUF(*), RECVBUF(*)
INTEGER SENDCOUNTS(*), SDISPLS(*), SENDTYPES(*), RECVCOUNTS(*),
RDISPLS(*), RECVTYPES(*), COMM, INFO, REQUEST, IERROR

Creates a persistent collective communication request for the alltoallw operation.

```

5.13.7 Persistent Reduce

```

MPI_REDUCE_INIT(sendbuf, recvbuf, count, datatype, op, root, comm, info, request)

IN      sendbuf      address of send buffer (choice)
OUT     recvbuf      address of receive buffer (choice, significant only at
                        root)
IN      count        number of elements in send buffer (non-negative inte-
                        ger)
IN      datatype     data type of elements of send buffer (handle)
IN      op           reduce operation (handle)
IN      root         rank of root process (integer)
IN      comm         communicator (handle)
IN      info         info argument (handle)
OUT     request      communication request (handle)

int MPI_Reduce_init(const void* sendbuf, void* recvbuf, int count,
MPI_Datatype datatype, MPI_Op op, int root, MPI_Comm comm,
MPI_Info info, MPI_Request *request)

MPI_Reduce_init(sendbuf, recvbuf, count, datatype, op, root, comm, info,
request, ierror)
TYPE(*), DIMENSION(..), INTENT(IN), ASYNCHRONOUS :: sendbuf
TYPE(*), DIMENSION(..), ASYNCHRONOUS :: recvbuf
INTEGER, INTENT(IN) :: count, root
TYPE(MPI_Datatype), INTENT(IN) :: datatype
TYPE(MPI_Op), INTENT(IN) :: op
TYPE(MPI_Comm), INTENT(IN) :: comm
TYPE(MPI_Info), INTENT(IN) :: info
TYPE(MPI_Request), INTENT(OUT) :: request
INTEGER, OPTIONAL, INTENT(OUT) :: ierror

```

```

1 MPI_REDUCE_INIT(SENDBUF, RECVBUF, COUNT, DATATYPE, OP, ROOT, COMM, INFO,
2     REQUEST, IERROR)
3     <type> SENDBUF(*), RECVBUF(*)
4     INTEGER COUNT, DATATYPE, OP, ROOT, COMM, INFO, REQUEST, IERROR

```

Creates a persistent collective communication request for the reduce operation.

5.13.8 Persistent All-Reduce

```

11 MPI_ALLREDUCE_INIT(sendbuf, recvbuf, count, datatype, op, comm, info, request)
12     IN     sendbuf           starting address of send buffer (choice)
13     OUT    recvbuf          starting address of receive buffer (choice)
14     IN     count            number of elements in send buffer (non-negative inte-
15                                     ger)
16     IN     datatype         data type of elements of send buffer (handle)
17     IN     op               operation (handle)
18     IN     comm             communicator (handle)
19     IN     info             info argument (handle)
20     IN     info             info argument (handle)
21     IN     info             info argument (handle)
22     OUT    request          communication request (handle)

```

```

25 int MPI_Allreduce_init(const void* sendbuf, void* recvbuf, int count,
26     MPI_Datatype datatype, MPI_Op op, MPI_Comm comm,
27     MPI_Info info, MPI_Request *request)

```

```

28 MPI_Allreduce_init(sendbuf, recvbuf, count, datatype, op, comm, info,
29     request, ierror)
30     TYPE(*), DIMENSION(..), INTENT(IN), ASYNCHRONOUS :: sendbuf
31     TYPE(*), DIMENSION(..), ASYNCHRONOUS :: recvbuf
32     INTEGER, INTENT(IN) :: count
33     TYPE(MPI_Datatype), INTENT(IN) :: datatype
34     TYPE(MPI_Op), INTENT(IN) :: op
35     TYPE(MPI_Comm), INTENT(IN) :: comm
36     TYPE(MPI_Info), INTENT(IN) :: info
37     TYPE(MPI_Request), INTENT(OUT) :: request
38     INTEGER, OPTIONAL, INTENT(OUT) :: ierror

```

```

40 MPI_ALLREDUCE_INIT(SENDBUF, RECVBUF, COUNT, DATATYPE, OP, COMM, INFO,
41     REQUEST, IERROR)
42     <type> SENDBUF(*), RECVBUF(*)
43     INTEGER COUNT, DATATYPE, OP, COMM, INFO, REQUEST, IERROR

```

Creates a persistent collective communication request for the allreduce operation.

5.13.9 Persistent Reduce-Scatter with Equal Blocks

```
MPI_REDUCE_SCATTER_BLOCK_INIT(sendbuf, recvbuf, recvcnt, datatype, op, comm,
                               info, request)
```

IN	sendbuf	starting address of send buffer (choice)	
OUT	recvbuf	starting address of receive buffer (choice)	
IN	recvcnt	element count per block (non-negative integer)	
IN	datatype	data type of elements of send and receive buffers (handle)	
IN	op	operation (handle)	
IN	comm	communicator (handle)	
IN	info	info argument (handle)	
OUT	request	communication request (handle)	

```
int MPI_Reduce_scatter_block_init(const void* sendbuf, void* recvbuf,
                                  int recvcnt, MPI_Datatype datatype, MPI_Op op,
                                  MPI_Comm comm, MPI_Info info, MPI_Request *request)
```

```
MPI_Reduce_scatter_block_init(sendbuf, recvbuf, recvcnt, datatype, op,
                               comm, info, request, ierror)
```

```
TYPE(*), DIMENSION(..), INTENT(IN), ASYNCHRONOUS :: sendbuf
```

```
TYPE(*), DIMENSION(..), ASYNCHRONOUS :: recvbuf
```

```
INTEGER, INTENT(IN) :: recvcnt
```

```
TYPE(MPI_Datatype), INTENT(IN) :: datatype
```

```
TYPE(MPI_Op), INTENT(IN) :: op
```

```
TYPE(MPI_Comm), INTENT(IN) :: comm
```

```
TYPE(MPI_Info), INTENT(IN) :: info
```

```
TYPE(MPI_Request), INTENT(OUT) :: request
```

```
INTEGER, OPTIONAL, INTENT(OUT) :: ierror
```

```
MPI_REDUCE_SCATTER_BLOCK_INIT(SENDBUF, RECVBUF, RECVCOUNT, DATATYPE, OP,
                               COMM, INFO, REQUEST, IERROR)
```

```
<type> SENDBUF(*), RECVBUF(*)
```

```
INTEGER RECVCOUNT, DATATYPE, OP, COMM, INFO, REQUEST, IERROR
```

Creates a persistent collective communication request for the reduce-scatter with equal blocks operation.

5.13.10 Persistent Reduce-Scatter

```

4 MPI_REDUCE_SCATTER_INIT(sendbuf, recvbuf, recvcnts, datatype, op, comm, info, re-
5     quest)

```

6	IN	sendbuf	starting address of send buffer (choice)
7			
8	OUT	recvbuf	starting address of receive buffer (choice)
9			
10	IN	recvcnts	non-negative integer array specifying the number of
11			elements in result distributed to each process. Array
12			must be identical on all calling processes.
13	IN	datatype	data type of elements of input buffer (handle)
14	IN	op	operation (handle)
15	IN	comm	communicator (handle)
16			
17	IN	info	info argument (handle)
18	OUT	request	communication request (handle)

```

19
20 int MPI_Reduce_scatter_init(const void* sendbuf, void* recvbuf,
21     const int recvcnts[], MPI_Datatype datatype, MPI_Op op,
22     MPI_Comm comm, MPI_Info info, MPI_Request *request)

```

```

23 MPI_Reduce_scatter_init(sendbuf, recvbuf, recvcnts, datatype, op, comm,
24     info, request, ierror)

```

```

25     TYPE(*), DIMENSION(..), INTENT(IN), ASYNCHRONOUS :: sendbuf
26     TYPE(*), DIMENSION(..), ASYNCHRONOUS :: recvbuf
27     INTEGER, INTENT(IN), ASYNCHRONOUS :: recvcnts(*)
28     TYPE(MPI_Datatype), INTENT(IN) :: datatype
29     TYPE(MPI_Op), INTENT(IN) :: op
30     TYPE(MPI_Comm), INTENT(IN) :: comm
31     TYPE(MPI_Info), INTENT(IN) :: info
32     TYPE(MPI_Request), INTENT(OUT) :: request
33     INTEGER, OPTIONAL, INTENT(OUT) :: ierror

```

```

34
35 MPI_REDUCE_SCATTER_INIT(SENDBUF, RECVBUF, RECVCOUNTS, DATATYPE, OP, COMM,
36     INFO, REQUEST, IERROR)

```

```

37     <type> SENDBUF(*), RECVBUF(*)
38     INTEGER RECVCOUNTS(*), DATATYPE, OP, COMM, INFO, REQUEST, IERROR

```

Creates a persistent collective communication request for the reduce-scatter operation.

5.13.11 Persistent Inclusive Scan

```

MPI_SCAN_INIT(sendbuf, recvbuf, count, datatype, op, comm, info, request)
    IN      sendbuf      starting address of send buffer (choice)
    OUT     recvbuf      starting address of receive buffer (choice)
    IN      count        number of elements in input buffer (non-negative in-
                        teger)
    IN      datatype     data type of elements of input buffer (handle)
    IN      op           operation (handle)
    IN      comm         communicator (handle)
    IN      info         info argument (handle)
    OUT     request      communication request (handle)

int MPI_Scan_init(const void* sendbuf, void* recvbuf, int count,
                 MPI_Datatype datatype, MPI_Op op, MPI_Comm comm,
                 MPI_Info info, MPI_Request *request)

MPI_Scan_init(sendbuf, recvbuf, count, datatype, op, comm, info, request,
              ierror)
    TYPE(*), DIMENSION(..), INTENT(IN), ASYNCHRONOUS :: sendbuf
    TYPE(*), DIMENSION(..), ASYNCHRONOUS :: recvbuf
    INTEGER, INTENT(IN) :: count
    TYPE(MPI_Datatype), INTENT(IN) :: datatype
    TYPE(MPI_Op), INTENT(IN) :: op
    TYPE(MPI_Comm), INTENT(IN) :: comm
    TYPE(MPI_Info), INTENT(IN) :: info
    TYPE(MPI_Request), INTENT(OUT) :: request
    INTEGER, OPTIONAL, INTENT(OUT) :: ierror

MPI_SCAN_INIT(SENDBUF, RECVBUF, COUNT, DATATYPE, OP, COMM, INFO, REQUEST,
              IERROR)
    <type> SENDBUF(*), RECVBUF(*)
    INTEGER COUNT, DATATYPE, OP, COMM, INFO, REQUEST, IERROR

Creates a persistent collective communication request for the inclusive scan operation.

```

5.13.12 Persistent Exclusive Scan

MPI_EXSCAN_INIT(sendbuf, recvbuf, count, datatype, op, comm, info, request)			
IN	sendbuf		starting address of send buffer (choice)
OUT	recvbuf		starting address of receive buffer (choice)
IN	count		number of elements in input buffer (non-negative integer)
IN	datatype		data type of elements of input buffer (handle)
IN	op		operation (handle)
IN	comm		intracommunicator (handle)
IN	info		info argument (handle)
OUT	request		communication request (handle)

```

int MPI_Exscan_init(const void* sendbuf, void* recvbuf, int count,
                   MPI_Datatype datatype, MPI_Op op, MPI_Comm comm,
                   MPI_Info info, MPI_Request *request)
MPI_Exscan_init(sendbuf, recvbuf, count, datatype, op, comm, info, request,
                ierror)
    TYPE(*), DIMENSION(..), INTENT(IN), ASYNCHRONOUS :: sendbuf
    TYPE(*), DIMENSION(..), ASYNCHRONOUS :: recvbuf
    INTEGER, INTENT(IN) :: count
    TYPE(MPI_Datatype), INTENT(IN) :: datatype
    TYPE(MPI_Op), INTENT(IN) :: op
    TYPE(MPI_Comm), INTENT(IN) :: comm
    TYPE(MPI_Info), INTENT(IN) :: info
    TYPE(MPI_Request), INTENT(OUT) :: request
    INTEGER, OPTIONAL, INTENT(OUT) :: ierror
MPI_EXSCAN_INIT(SENDBUF, RECVBUF, COUNT, DATATYPE, OP, COMM, INFO, REQUEST,
                IERROR)
    <type> SENDBUF(*), RECVBUF(*)
    INTEGER COUNT, DATATYPE, OP, COMM, INFO, REQUEST, IERROR

```

Creates a persistent collective communication request for the exclusive scan operation.

5.14 Correctness

A correct, portable program must invoke collective communications so that deadlock will not occur, whether collective communications are synchronizing or not. The following examples illustrate dangerous use of collective routines on intracommunicators.

Example 5.25

The following is erroneous.

```

switch(rank) {
  case 0:
    MPI_Bcast(buf1, count, type, 0, comm);
    MPI_Bcast(buf2, count, type, 1, comm);
    break;
  case 1:
    MPI_Bcast(buf2, count, type, 1, comm);
    MPI_Bcast(buf1, count, type, 0, comm);
    break;
}

```

We assume that the group of `comm` is $\{0,1\}$. Two processes execute two broadcast operations in reverse order. If the operation is synchronizing then a deadlock will occur.

Collective operations must be executed in the same order at all members of the communication group.

Example 5.26

The following is erroneous.

```

switch(rank) {
  case 0:
    MPI_Bcast(buf1, count, type, 0, comm0);
    MPI_Bcast(buf2, count, type, 2, comm2);
    break;
  case 1:
    MPI_Bcast(buf1, count, type, 1, comm1);
    MPI_Bcast(buf2, count, type, 0, comm0);
    break;
  case 2:
    MPI_Bcast(buf1, count, type, 2, comm2);
    MPI_Bcast(buf2, count, type, 1, comm1);
    break;
}

```

Assume that the group of `comm0` is $\{0,1\}$, of `comm1` is $\{1, 2\}$ and of `comm2` is $\{2,0\}$. If the broadcast is a synchronizing operation, then there is a cyclic dependency: the broadcast in `comm2` completes only after the broadcast in `comm0`; the broadcast in `comm0` completes only after the broadcast in `comm1`; and the broadcast in `comm1` completes only after the broadcast in `comm2`. Thus, the code will deadlock.

Collective operations must be executed in an order so that no cyclic dependencies occur. Nonblocking collective operations can alleviate this issue.

Example 5.27

The following is erroneous.

```

1  switch(rank) {
2      case 0:
3          MPI_Bcast(buf1, count, type, 0, comm);
4          MPI_Send(buf2, count, type, 1, tag, comm);
5          break;
6      case 1:
7          MPI_Recv(buf2, count, type, 0, tag, comm, status);
8          MPI_Bcast(buf1, count, type, 0, comm);
9          break;
10 }

```

12 Process zero executes a broadcast, followed by a blocking send operation. Process one
13 first executes a blocking receive that matches the send, followed by broadcast call that
14 matches the broadcast of process zero. This program may deadlock. The broadcast call on
15 process zero *may* block until process one executes the matching broadcast call, so that the
16 send is not executed. Process one will definitely block on the receive and so, in this case,
17 never executes the broadcast.

18 The relative order of execution of collective operations and point-to-point operations
19 should be such, so that even if the collective operations and the point-to-point operations
20 are synchronizing, no deadlock will occur.

21 **Example 5.28**

22 An unsafe, non-deterministic program.

```

23
24 switch(rank) {
25     case 0:
26         MPI_Bcast(buf1, count, type, 0, comm);
27         MPI_Send(buf2, count, type, 1, tag, comm);
28         break;
29     case 1:
30         MPI_Recv(buf2, count, type, MPI_ANY_SOURCE, tag, comm, status);
31         MPI_Bcast(buf1, count, type, 0, comm);
32         MPI_Recv(buf2, count, type, MPI_ANY_SOURCE, tag, comm, status);
33         break;
34     case 2:
35         MPI_Send(buf2, count, type, 1, tag, comm);
36         MPI_Bcast(buf1, count, type, 0, comm);
37         break;
38 }
39

```

40 All three processes participate in a broadcast. Process 0 sends a message to process
41 1 after the broadcast, and process 2 sends a message to process 1 before the broadcast.
42 Process 1 receives before and after the broadcast, with a wildcard source argument.

43 Two possible executions of this program, with different matchings of sends and receives,
44 are illustrated in Figure 5.12. Note that the second execution has the peculiar effect that
45 a send executed after the broadcast is received at another node before the broadcast. This
46 example illustrates the fact that one should not rely on collective communication functions
47 to have particular synchronization effects. A program that works correctly only when the
48 first execution occurs (only when broadcast is synchronizing) is erroneous.

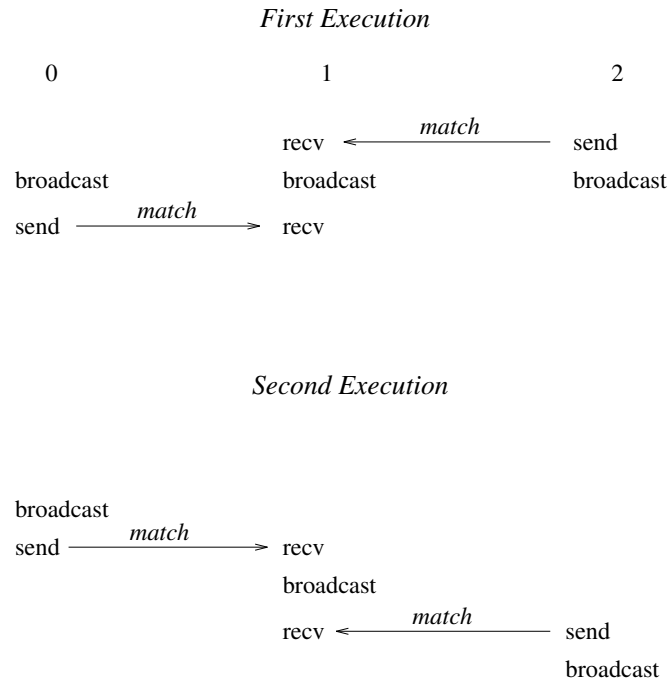

Figure 5.12: A race condition causes non-deterministic matching of sends and receives. One cannot rely on synchronization from a broadcast to make the program deterministic.

Finally, in multithreaded implementations, one can have more than one, concurrently executing, collective communication call at a process. In these situations, it is the user’s responsibility to ensure that the same communicator is not used concurrently by two different collective communication calls at the same process.

Advice to implementors. Assume that broadcast is implemented using point-to-point MPI communication. Suppose the following two rules are followed.

1. All receives specify their source explicitly (no wildcards).
2. Each process sends all messages that pertain to one collective call before sending any message that pertain to a subsequent collective call.

Then, messages belonging to successive broadcasts cannot be confused, as the order of point-to-point messages is preserved.

It is the implementor’s responsibility to ensure that point-to-point messages are not confused with collective messages. One way to accomplish this is, whenever a communicator is created, to also create a “hidden communicator” for collective communication. One could achieve a similar effect more cheaply, for example, by using a hidden tag or context bit to indicate whether the communicator is used for point-to-point or collective communication. (*End of advice to implementors.*)

Example 5.29

Blocking and nonblocking collective operations can be interleaved, i.e., a blocking collective operation can be posted even if there is a nonblocking collective operation outstanding.

```

1 MPI_Request req;
2
3 MPI_Ibarrier(comm, &req);
4 MPI_Bcast(buf1, count, type, 0, comm);
5 MPI_Wait(&req, MPI_STATUS_IGNORE);
6

```

Each process starts a nonblocking barrier operation, participates in a blocking broadcast and then waits until every other process started the barrier operation. This effectively turns the broadcast into a synchronizing broadcast with possible communication/communication overlap (MPI_Bcast is allowed, but not required to synchronize).

Example 5.30

The starting order of collective operations on a particular communicator defines their matching. The following example shows an erroneous matching of different collective operations on the same communicator.

```

16 MPI_Request req;
17 switch(rank) {
18     case 0:
19         /* erroneous matching */
20         MPI_Ibarrier(comm, &req);
21         MPI_Bcast(buf1, count, type, 0, comm);
22         MPI_Wait(&req, MPI_STATUS_IGNORE);
23         break;
24     case 1:
25         /* erroneous matching */
26         MPI_Bcast(buf1, count, type, 0, comm);
27         MPI_Ibarrier(comm, &req);
28         MPI_Wait(&req, MPI_STATUS_IGNORE);
29         break;
30 }
31

```

This ordering would match MPI_Ibarrier on rank 0 with MPI_Bcast on rank 1 which is erroneous and the program behavior is undefined. However, if such an order is required, the user must create different duplicate communicators and perform the operations on them. If started with two processes, the following program would be correct:

```

37 MPI_Request req;
38 MPI_Comm dupcomm;
39 MPI_Comm_dup(comm, &dupcomm);
40 switch(rank) {
41     case 0:
42         MPI_Ibarrier(comm, &req);
43         MPI_Bcast(buf1, count, type, 0, dupcomm);
44         MPI_Wait(&req, MPI_STATUS_IGNORE);
45         break;
46     case 1:
47         MPI_Bcast(buf1, count, type, 0, dupcomm);
48         MPI_Ibarrier(comm, &req);

```



```

    MPI_Wait(&req, MPI_STATUS_IGNORE);      1
    break;                                  2
}                                           3

```

Advice to users. The use of different communicators offers some flexibility regarding the matching of nonblocking collective operations. In this sense, communicators could be used as an equivalent to tags. However, communicator construction might induce overheads so that this should be used carefully. (*End of advice to users.*)

Example 5.31

Nonblocking collective operations can rely on the same progression rules as nonblocking point-to-point messages. Thus, if started with two processes, the following program is a valid MPI program and is guaranteed to terminate:

```

MPI_Request req;                            14
                                           15
switch(rank) {                              16
    case 0:                                  17
        MPI_Ibarrier(comm, &req);          18
        MPI_Wait(&req, MPI_STATUS_IGNORE); 19
        MPI_Send(buf, count, dtype, 1, tag, comm); 20
        break;                              21
    case 1:                                  22
        MPI_Ibarrier(comm, &req);          23
        MPI_Recv(buf, count, dtype, 0, tag, comm, MPI_STATUS_IGNORE); 24
        MPI_Wait(&req, MPI_STATUS_IGNORE); 25
        break;                              26
}                                           27

```

The MPI library must progress the barrier in the MPI_Recv call. Thus, the MPI_Wait call in rank 0 will eventually complete, which enables the matching MPI_Send so all calls eventually return.

Example 5.32

Blocking and nonblocking collective operations do not match. The following example is erroneous.

```

MPI_Request req;                            36
                                           37
switch(rank) {                              38
    case 0:                                  39
        /* erroneous false matching of Alltoall and Ialltoall */ 40
        MPI_Ialltoall(sbuf, scnt, stype, rbuf, rcnt, rtype, comm, &req); 41
        MPI_Wait(&req, MPI_STATUS_IGNORE); 42
        break;                              43
    case 1:                                  44
        /* erroneous false matching of Alltoall and Ialltoall */ 45
        MPI_Alltoall(sbuf, scnt, stype, rbuf, rcnt, rtype, comm); 46
        break;                              47
}                                           48

```

Example 5.33

Collective and point-to-point requests can be mixed in functions that enable multiple completions. If started with two processes, the following program is valid.

```
MPI_Request reqs[2];

switch(rank) {
  case 0:
    MPI_Ibarrier(comm, &reqs[0]);
    MPI_Send(buf, count, dtype, 1, tag, comm);
    MPI_Wait(&reqs[0], MPI_STATUS_IGNORE);
    break;
  case 1:
    MPI_Irecv(buf, count, dtype, 0, tag, comm, &reqs[0]);
    MPI_Ibarrier(comm, &reqs[1]);
    MPI_Waitall(2, reqs, MPI_STATUSES_IGNORE);
    break;
}
```

The `MPI_Waitall` call returns only after the barrier and the receive completed.

Example 5.34

Multiple nonblocking collective operations can be outstanding on a single communicator and match in order.

```
MPI_Request reqs[3];

compute(buf1);
MPI_Ibcast(buf1, count, type, 0, comm, &reqs[0]);
compute(buf2);
MPI_Ibcast(buf2, count, type, 0, comm, &reqs[1]);
compute(buf3);
MPI_Ibcast(buf3, count, type, 0, comm, &reqs[2]);
MPI_Waitall(3, reqs, MPI_STATUSES_IGNORE);
```

Advice to users. Pipelining and double-buffering techniques can efficiently be used to overlap computation and communication. However, having too many outstanding requests might have a negative impact on performance. (*End of advice to users.*)

Advice to implementors. The use of pipelining may generate many outstanding requests. A high-quality hardware-supported implementation with limited resources should be able to fall back to a software implementation if its resources are exhausted. In this way, the implementation could limit the number of outstanding requests only by the available memory. (*End of advice to implementors.*)

Example 5.35

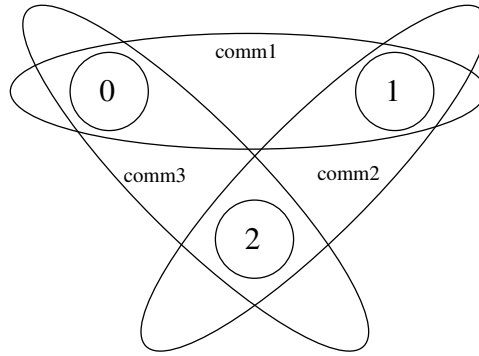

Figure 5.13: Example with overlapping communicators.

Nonblocking collective operations can also be used to enable simultaneous collective operations on multiple overlapping communicators (see Figure 5.13). The following example is started with three processes and three communicators. The first communicator `comm1` includes ranks 0 and 1, `comm2` includes ranks 1 and 2, and `comm3` spans ranks 0 and 2. It is not possible to perform a blocking collective operation on all communicators because there exists no deadlock-free order to invoke them. However, nonblocking collective operations can easily be used to achieve this task.

```

MPI_Request reqs[2];

switch(rank) {
  case 0:
    MPI_Iallreduce(sbuf1, rbuf1, count, dtype, MPI_SUM, comm1, &reqs[0]);
    MPI_Iallreduce(sbuf3, rbuf3, count, dtype, MPI_SUM, comm3, &reqs[1]);
    break;
  case 1:
    MPI_Iallreduce(sbuf1, rbuf1, count, dtype, MPI_SUM, comm1, &reqs[0]);
    MPI_Iallreduce(sbuf2, rbuf2, count, dtype, MPI_SUM, comm2, &reqs[1]);
    break;
  case 2:
    MPI_Iallreduce(sbuf2, rbuf2, count, dtype, MPI_SUM, comm2, &reqs[0]);
    MPI_Iallreduce(sbuf3, rbuf3, count, dtype, MPI_SUM, comm3, &reqs[1]);
    break;
}
MPI_Waitall(2, reqs, MPI_STATUSES_IGNORE);

```

Advice to users. This method can be useful if overlapping neighboring regions (halo or ghost zones) are used in collective operations. The sequence of the two calls in each process is irrelevant because the two nonblocking operations are performed on different communicators. (*End of advice to users.*)

Example 5.36

The progress of multiple outstanding nonblocking collective operations is completely independent.

```
1 MPI_Request reqs[2];
2
3 compute(buf1);
4 MPI_Ibcast(buf1, count, type, 0, comm, &reqs[0]);
5 compute(buf2);
6 MPI_Ibcast(buf2, count, type, 0, comm, &reqs[1]);
7 MPI_Wait(&reqs[1], MPI_STATUS_IGNORE);
8 /* nothing is known about the status of the first bcast here */
9 MPI_Wait(&reqs[0], MPI_STATUS_IGNORE);
10
```

11 Finishing the second MPI_IBCAST is completely independent of the first one. This
12 means that it is not guaranteed that the first broadcast operation is finished or even started
13 after the second one is completed via reqs[1].

14

15

16

17

18

19

20

21

22

23

24

25

26

27

28

29

30

31

32

33

34

35

36

37

38

39

40

41

42

43

44

45

46

47

48

1
2
3
4
5
6
7
8
9
10
11
12
13
14
15
16
17
18
19
20
21
22
23
24
25
26
27
28
29
30
31
32
33
34
35
36
37
38
39
40
41
42
43
44
45
46
47
48

Chapter 6

Groups, Contexts, Communicators, and Caching

6.1 Introduction

This chapter introduces MPI features that support the development of parallel libraries. Parallel libraries are needed to encapsulate the distracting complications inherent in parallel implementations of key algorithms. They help to ensure consistent correctness of such procedures, and provide a “higher level” of portability than MPI itself can provide. As such, libraries prevent each programmer from repeating the work of defining consistent data structures, data layouts, and methods that implement key algorithms (such as matrix operations). Since the best libraries come with several variations on parallel systems (different data layouts, different strategies depending on the size of the system or problem, or type of floating point), this too needs to be hidden from the user.

We refer the reader to [57] and [3] for further information on writing libraries in MPI, using the features described in this chapter.

6.1.1 Features Needed to Support Libraries

The key features needed to support the creation of robust parallel libraries are as follows:

- Safe communication space, that guarantees that libraries can communicate as they need to, without conflicting with communication extraneous to the library,
- Group scope for collective operations, that allow libraries to avoid unnecessarily synchronizing uninvolved processes (potentially running unrelated code),
- Abstract process naming to allow libraries to describe their communication in terms suitable to their own data structures and algorithms,
- The ability to “adorn” a set of communicating processes with additional user-defined attributes, such as extra collective operations. This mechanism should provide a means for the user or library writer effectively to extend a message-passing notation.

In addition, a unified mechanism or object is needed for conveniently denoting communication context, the group of communicating processes, to house abstract process naming, and to store adornments.

6.1.2 MPI's Support for Libraries

The corresponding concepts that MPI provides, specifically to support robust libraries, are as follows:

- **Contexts** of communication,
- **Groups** of processes,
- **Virtual topologies**,
- **Attribute caching**,
- **Communicators**.

Communicators (see [22, 55, 59]) encapsulate all of these ideas in order to provide the appropriate scope for all communication operations in MPI. Communicators are divided into two kinds: intra-communicators for operations within a single group of processes and inter-communicators for operations between two groups of processes.

Caching. Communicators (see below) provide a “caching” mechanism that allows one to associate new attributes with communicators, on par with MPI built-in features. This can be used by advanced users to adorn communicators further, and by MPI to implement some communicator functions. For example, the virtual-topology functions described in Chapter 7 are likely to be supported this way.

Groups. Groups define an ordered collection of processes, each with a rank, and it is this group that defines the low-level names for inter-process communication (ranks are used for sending and receiving). Thus, groups define a scope for process names in point-to-point communication. In addition, groups define the scope of collective operations. Groups may be manipulated separately from communicators in MPI, but only communicators can be used in communication operations.

Intra-communicators. The most commonly used means for message passing in MPI is via intra-communicators. Intra-communicators contain an instance of a group, contexts of communication for both point-to-point and collective communication, and the ability to include virtual topology and other attributes. These features work as follows:

- **Contexts** provide the ability to have separate safe “universes” of message-passing in MPI. A context is akin to an additional tag that differentiates messages. The system manages this differentiation process. The use of separate communication contexts by distinct libraries (or distinct library invocations) insulates communication internal to the library execution from external communication. This allows the invocation of the library even if there are pending communications on “other” communicators, and avoids the need to synchronize entry or exit into library code. Pending point-to-point communications are also guaranteed not to interfere with collective communications within a single communicator.
- **Groups** define the participants in the communication (see above) of a communicator.

- A **virtual topology** defines a special mapping of the ranks in a group to and from a topology. Special constructors for communicators are defined in Chapter 7 to provide this feature. Intra-communicators as described in this chapter do not have topologies.
- **Attributes** define the local information that the user or library has added to a communicator for later reference.

Advice to users. The practice in many communication libraries is that there is a unique, predefined communication universe that includes all processes available when the parallel program is initiated; the processes are assigned consecutive ranks. Participants in a point-to-point communication are identified by their rank; a collective communication (such as broadcast) always involves all processes. This practice can be followed in MPI by using the predefined communicator `MPI_COMM_WORLD`. *Users who are satisfied with this practice can plug in `MPI_COMM_WORLD` wherever a communicator argument is required, and can consequently disregard the rest of this chapter. (End of advice to users.)*

Inter-communicators. The discussion has dealt so far with **intra-communication**: communication within a group. MPI also supports **inter-communication**: communication between two non-overlapping groups. When an application is built by composing several parallel modules, it is convenient to allow one module to communicate with another using local ranks for addressing within the second module. This is especially convenient in a client-server computing paradigm, where either client or server are parallel. The support of inter-communication also provides a mechanism for the extension of MPI to a dynamic model where not all processes are preallocated at initialization time. In such a situation, it becomes necessary to support communication across “universes.” Inter-communication is supported by objects called **inter-communicators**. These objects bind two groups together with communication contexts shared by both groups. For inter-communicators, these features work as follows:

- Contexts provide the ability to have a separate safe “universe” of message-passing between the two groups. A send in the local group is always a receive in the remote group, and vice versa. The system manages this differentiation process. The use of separate communication contexts by distinct libraries (or distinct library invocations) insulates communication internal to the library execution from external communication. This allows the invocation of the library even if there are pending communications on “other” communicators, and avoids the need to synchronize entry or exit into library code.
- A local and remote group specify the recipients and destinations for an inter-communicator.
- Virtual topology is undefined for an inter-communicator.
- As before, attributes cache defines the local information that the user or library has added to a communicator for later reference.

MPI provides mechanisms for creating and manipulating inter-communicators. They are used for point-to-point and collective communication in an related manner to intra-communicators. Users who do not need inter-communication in their applications can safely

1 ignore this extension. Users who require inter-communication between overlapping groups
 2 must layer this capability on top of MPI.
 3

4 6.2 Basic Concepts 5

6 In this section, we turn to a more formal definition of the concepts introduced above.
 7

8 6.2.1 Groups 9

10 A **group** is an ordered set of process identifiers (henceforth processes); processes are
 11 implementation-dependent objects. Each process in a group is associated with an inte-
 12 ger **rank**. Ranks are contiguous and start from zero. Groups are represented by opaque
 13 **group objects**, and hence cannot be directly transferred from one process to another. A
 14 group is used within a communicator to describe the participants in a communication “uni-
 15 verse” and to rank such participants (thus giving them unique names within that “universe”
 16 of communication).

17 There is a special pre-defined group: `MPI_GROUP_EMPTY`, which is a group with no
 18 members. The predefined constant `MPI_GROUP_NULL` is the value used for invalid group
 19 handles.
 20

21 *Advice to users.* `MPI_GROUP_EMPTY`, which is a valid handle to an empty group,
 22 should not be confused with `MPI_GROUP_NULL`, which in turn is an invalid handle.
 23 The former may be used as an argument to group operations; the latter, which is
 24 returned when a group is freed, is not a valid argument. (*End of advice to users.*)
 25

26 *Advice to implementors.* A group may be represented by a virtual-to-real process-
 27 address-translation table. Each communicator object (see below) would have a pointer
 28 to such a table.

29 Simple implementations of MPI will enumerate groups, such as in a table. However,
 30 more advanced data structures make sense in order to improve scalability and memory
 31 usage with large numbers of processes. Such implementations are possible with MPI.
 32 (*End of advice to implementors.*)
 33

34 6.2.2 Contexts 35

36 A **context** is a property of communicators (defined next) that allows partitioning of the
 37 communication space. A message sent in one context cannot be received in another context.
 38 Furthermore, where permitted, collective operations are independent of pending point-to-
 39 point operations. Contexts are not explicit MPI objects; they appear only as part of the
 40 realization of communicators (below).
 41

42 *Advice to implementors.* Distinct communicators in the same process have distinct
 43 contexts. A context is essentially a system-managed tag (or tags) needed to make
 44 a communicator safe for point-to-point and MPI-defined collective communication.
 45 Safety means that collective and point-to-point communication within one commu-
 46 nicator do not interfere, and that communication over distinct communicators don’t
 47 interfere.
 48

A possible implementation for a context is as a supplemental tag attached to messages on send and matched on receive. Each intra-communicator stores the value of its two tags (one for point-to-point and one for collective communication). Communicator-generating functions use a collective communication to agree on a new group-wide unique context.

Analogously, in inter-communication, two context tags are stored per communicator, one used by group A to send and group B to receive, and a second used by group B to send and for group A to receive.

Since contexts are not explicit objects, other implementations are also possible. (*End of advice to implementors.*)

6.2.3 Intra-Communicators

Intra-communicators bring together the concepts of group and context. To support implementation-specific optimizations, and application topologies (defined in the next chapter, Chapter 7), communicators may also “cache” additional information (see Section 6.7). MPI communication operations reference communicators to determine the scope and the “communication universe” in which a point-to-point or collective operation is to operate.

Each communicator contains a group of valid participants; this group always includes the local process. The source and destination of a message is identified by process rank within that group.

For collective communication, the intra-communicator specifies the set of processes that participate in the collective operation (and their order, when significant). Thus, the communicator restricts the “spatial” scope of communication, and provides machine-independent process addressing through ranks.

Intra-communicators are represented by opaque **intra-communicator objects**, and hence cannot be directly transferred from one process to another.

6.2.4 Predefined Intra-Communicators

An initial intra-communicator `MPI_COMM_WORLD` of all processes the local process can communicate with after initialization (itself included) is defined once `MPI_INIT` or `MPI_INIT_THREAD` has been called. In addition, the communicator `MPI_COMM_SELF` is provided, which includes only the process itself.

The predefined constant `MPI_COMM_NULL` is the value used for invalid communicator handles.

In a static-process-model implementation of MPI, all processes that participate in the computation are available after MPI is initialized. For this case, `MPI_COMM_WORLD` is a communicator of all processes available for the computation; this communicator has the same value in all processes. In an implementation of MPI where processes can dynamically join an MPI execution, it may be the case that a process starts an MPI computation without having access to all other processes. In such situations, `MPI_COMM_WORLD` is a communicator incorporating all processes with which the joining process can immediately communicate. Therefore, `MPI_COMM_WORLD` may simultaneously represent disjoint groups in different processes.

All MPI implementations are required to provide the `MPI_COMM_WORLD` communicator. It cannot be deallocated during the life of a process. The group corresponding to this communicator does not appear as a pre-defined constant, but it may be accessed using

1 MPI_COMM_GROUP (see below). MPI does not specify the correspondence between the
 2 process rank in MPI_COMM_WORLD and its (machine-dependent) absolute address. Neither
 3 does MPI specify the function of the host process, if any. Other implementation-dependent,
 4 predefined communicators may also be provided.

6 6.3 Group Management

8 This section describes the manipulation of process groups in MPI. These operations are
 9 local and their execution does not require interprocess communication.

11 6.3.1 Group Accessors

14 MPI_GROUP_SIZE(group, size)

16	IN	group	group (handle)
17	OUT	size	number of processes in the group (integer)

19 int MPI_Group_size(MPI_Group group, int *size)

21 MPI_Group_size(group, size, ierror)
 22 TYPE(MPI_Group), INTENT(IN) :: group
 23 INTEGER, INTENT(OUT) :: size
 24 INTEGER, OPTIONAL, INTENT(OUT) :: ierror

25 MPI_GROUP_SIZE(GROUP, SIZE, IERROR)
 26 INTEGER GROUP, SIZE, IERROR

29 MPI_GROUP_RANK(group, rank)

31	IN	group	group (handle)
32	OUT	rank	rank of the calling process in group, or 33 MPI_UNDEFINED if the process is not a member (in- 34 teger)

36 int MPI_Group_rank(MPI_Group group, int *rank)

38 MPI_Group_rank(group, rank, ierror)
 39 TYPE(MPI_Group), INTENT(IN) :: group
 40 INTEGER, INTENT(OUT) :: rank
 41 INTEGER, OPTIONAL, INTENT(OUT) :: ierror

42 MPI_GROUP_RANK(GROUP, RANK, IERROR)
 43 INTEGER GROUP, RANK, IERROR

```

MPI_GROUP_TRANSLATE_RANKS(group1, n, ranks1, group2, ranks2)
IN      group1                group1 (handle)
IN      n                      number of ranks in ranks1 and ranks2 arrays (integer)
IN      ranks1                 array of zero or more valid ranks in group1
IN      group2                 group2 (handle)
OUT     ranks2                 array of corresponding ranks in group2,
                              MPI_UNDEFINED when no correspondence exists.

```

```

int MPI_Group_translate_ranks(MPI_Group group1, int n, const int ranks1[],
                             MPI_Group group2, int ranks2[])

```

```

MPI_Group_translate_ranks(group1, n, ranks1, group2, ranks2, ierror)
  TYPE(MPI_Group), INTENT(IN) :: group1, group2
  INTEGER, INTENT(IN) :: n, ranks1(n)
  INTEGER, INTENT(OUT) :: ranks2(n)
  INTEGER, OPTIONAL, INTENT(OUT) :: ierror

```

```

MPI_GROUP_TRANSLATE_RANKS(GROUP1, N, RANKS1, GROUP2, RANKS2, IERROR)
  INTEGER GROUP1, N, RANKS1(*), GROUP2, RANKS2(*), IERROR

```

This function is important for determining the relative numbering of the same processes in two different groups. For instance, if one knows the ranks of certain processes in the group of `MPI_COMM_WORLD`, one might want to know their ranks in a subset of that group.

`MPI_PROC_NULL` is a valid rank for input to `MPI_GROUP_TRANSLATE_RANKS`, which returns `MPI_PROC_NULL` as the translated rank.

```

MPI_GROUP_COMPARE(group1, group2, result)

```

```

IN      group1                first group (handle)
IN      group2                second group (handle)
OUT     result                 result (integer)

```

```

int MPI_Group_compare(MPI_Group group1, MPI_Group group2, int *result)

```

```

MPI_Group_compare(group1, group2, result, ierror)
  TYPE(MPI_Group), INTENT(IN) :: group1, group2
  INTEGER, INTENT(OUT) :: result
  INTEGER, OPTIONAL, INTENT(OUT) :: ierror

```

```

MPI_GROUP_COMPARE(GROUP1, GROUP2, RESULT, IERROR)
  INTEGER GROUP1, GROUP2, RESULT, IERROR

```

`MPI_IDENT` results if the group members and group order is exactly the same in both groups. This happens for instance if `group1` and `group2` are the same handle. `MPI_SIMILAR` results if the group members are the same but the order is different. `MPI_UNEQUAL` results otherwise.

6.3.2 Group Constructors

Group constructors are used to subset and superset existing groups. These constructors construct new groups from existing groups. These are local operations, and distinct groups may be defined on different processes; a process may also define a group that does not include itself. Consistent definitions are required when groups are used as arguments in communicator-building functions. MPI does not provide a mechanism to build a group from scratch, but only from other, previously defined groups. The base group, upon which all other groups are defined, is the group associated with the initial communicator `MPI_COMM_WORLD` (accessible through the function `MPI_COMM_GROUP`).

Rationale. In what follows, there is no group duplication function analogous to `MPI_COMM_DUP`, defined later in this chapter. There is no need for a group duplicator. A group, once created, can have several references to it by making copies of the handle. The following constructors address the need for subsets and supersets of existing groups. (*End of rationale.*)

Advice to implementors. Each group constructor behaves as if it returned a new group object. When this new group is a copy of an existing group, then one can avoid creating such new objects, using a reference-count mechanism. (*End of advice to implementors.*)

```
MPI_COMM_GROUP(comm, group)
```

IN	comm	communicator (handle)
OUT	group	group corresponding to comm (handle)

```
int MPI_Comm_group(MPI_Comm comm, MPI_Group *group)
```

```
MPI_Comm_group(comm, group, ierror)
  TYPE(MPI_Comm), INTENT(IN) :: comm
  TYPE(MPI_Group), INTENT(OUT) :: group
  INTEGER, OPTIONAL, INTENT(OUT) :: ierror
```

```
MPI_COMM_GROUP(COMM, GROUP, IERROR)
  INTEGER COMM, GROUP, IERROR
```

`MPI_COMM_GROUP` returns in `group` a handle to the group of `comm`.

```
MPI_GROUP_UNION(group1, group2, newgroup)
```

IN	group1	first group (handle)
IN	group2	second group (handle)
OUT	newgroup	union group (handle)

```
int MPI_Group_union(MPI_Group group1, MPI_Group group2,
  MPI_Group *newgroup)
```

```

MPI_Group_union(group1, group2, newgroup, ierror)           1
    TYPE(MPI_Group), INTENT(IN) :: group1, group2          2
    TYPE(MPI_Group), INTENT(OUT) :: newgroup                3
    INTEGER, OPTIONAL, INTENT(OUT) :: ierror                4
                                                            5
MPI_GROUP_UNION(GROUP1, GROUP2, NEWGROUP, IERROR)          6
    INTEGER GROUP1, GROUP2, NEWGROUP, IERROR                7
                                                            8
                                                            9
MPI_GROUP_INTERSECTION(group1, group2, newgroup)           10
    IN      group1      first group (handle)                11
    IN      group2      second group (handle)                12
    OUT     newgroup     intersection group (handle)         13
                                                            14
                                                            15
int MPI_Group_intersection(MPI_Group group1, MPI_Group group2,
    MPI_Group *newgroup)                                    16
                                                            17
MPI_Group_intersection(group1, group2, newgroup, ierror)    18
    TYPE(MPI_Group), INTENT(IN) :: group1, group2          19
    TYPE(MPI_Group), INTENT(OUT) :: newgroup                20
    INTEGER, OPTIONAL, INTENT(OUT) :: ierror                21
                                                            22
MPI_GROUP_INTERSECTION(GROUP1, GROUP2, NEWGROUP, IERROR)  23
    INTEGER GROUP1, GROUP2, NEWGROUP, IERROR                24
                                                            25
                                                            26
MPI_GROUP_DIFFERENCE(group1, group2, newgroup)             27
    IN      group1      first group (handle)                28
    IN      group2      second group (handle)                29
    OUT     newgroup     difference group (handle)           30
                                                            31
                                                            32
int MPI_Group_difference(MPI_Group group1, MPI_Group group2,
    MPI_Group *newgroup)                                    33
                                                            34
                                                            35
MPI_Group_difference(group1, group2, newgroup, ierror)     36
    TYPE(MPI_Group), INTENT(IN) :: group1, group2          37
    TYPE(MPI_Group), INTENT(OUT) :: newgroup                38
    INTEGER, OPTIONAL, INTENT(OUT) :: ierror                39
                                                            40
MPI_GROUP_DIFFERENCE(GROUP1, GROUP2, NEWGROUP, IERROR)    41
    INTEGER GROUP1, GROUP2, NEWGROUP, IERROR                42

```

The set-like operations are defined as follows: 43

union All elements of the first group (*group1*), followed by all elements of second group 44
(*group2*) not in the first group. 45

intersect all elements of the first group that are also in the second group, ordered as in 47
the first group. 48

difference all elements of the first group that are not in the second group, ordered as in the first group.

Note that for these operations the order of processes in the output group is determined primarily by order in the first group (if possible) and then, if necessary, by order in the second group. Neither union nor intersection are commutative, but both are associative.

The new group can be empty, that is, equal to `MPI_GROUP_EMPTY`.

`MPI_GROUP_INCL(group, n, ranks, newgroup)`

IN	group	group (handle)
IN	n	number of elements in array ranks (and size of newgroup) (integer)
IN	ranks	ranks of processes in group to appear in newgroup (array of integers)
OUT	newgroup	new group derived from above, in the order defined by ranks (handle)

```
int MPI_Group_incl(MPI_Group group, int n, const int ranks[],
                  MPI_Group *newgroup)
```

```
MPI_Group_incl(group, n, ranks, newgroup, ierror)
```

```
TYPE(MPI_Group), INTENT(IN) :: group
INTEGER, INTENT(IN) :: n, ranks(n)
TYPE(MPI_Group), INTENT(OUT) :: newgroup
INTEGER, OPTIONAL, INTENT(OUT) :: ierror
```

```
MPI_GROUP_INCL(GROUP, N, RANKS, NEWGROUP, IERROR)
```

```
INTEGER GROUP, N, RANKS(*), NEWGROUP, IERROR
```

The function `MPI_GROUP_INCL` creates a group `newgroup` that consists of the `n` processes in `group` with ranks `ranks[0], . . . , ranks[n-1]`; the process with rank `i` in `newgroup` is the process with rank `ranks[i]` in `group`. Each of the `n` elements of `ranks` must be a valid rank in `group` and all elements must be distinct, or else the program is erroneous. If `n = 0`, then `newgroup` is `MPI_GROUP_EMPTY`. This function can, for instance, be used to reorder the elements of a group. See also `MPI_GROUP_COMPARE`.

`MPI_GROUP_EXCL(group, n, ranks, newgroup)`

IN	group	group (handle)
IN	n	number of elements in array ranks (integer)
IN	ranks	array of integer ranks in group not to appear in newgroup
OUT	newgroup	new group derived from above, preserving the order defined by group (handle)

```

int MPI_Group_excl(MPI_Group group, int n, const int ranks[],
                  MPI_Group *newgroup)
MPI_Group_excl(group, n, ranks, newgroup, ierror)
  TYPE(MPI_Group), INTENT(IN) :: group
  INTEGER, INTENT(IN) :: n, ranks(n)
  TYPE(MPI_Group), INTENT(OUT) :: newgroup
  INTEGER, OPTIONAL, INTENT(OUT) :: ierror
MPI_GROUP_EXCL(GROUP, N, RANKS, NEWGROUP, IERROR)
  INTEGER GROUP, N, RANKS(*), NEWGROUP, IERROR

```

The function `MPI_GROUP_EXCL` creates a group of processes `newgroup` that is obtained by deleting from `group` those processes with ranks `ranks[0]` ,... `ranks[n-1]`. The ordering of processes in `newgroup` is identical to the ordering in `group`. Each of the `n` elements of `ranks` must be a valid rank in `group` and all elements must be distinct; otherwise, the program is erroneous. If `n = 0`, then `newgroup` is identical to `group`.

```

MPI_GROUP_RANGE_INCL(group, n, ranges, newgroup)
  IN      group          group (handle)
  IN      n              number of triplets in array ranges (integer)
  IN      ranges         a one-dimensional array of integer triplets, of the form
                        (first rank, last rank, stride) indicating ranks in group
                        of processes to be included in newgroup
  OUT     newgroup       new group derived from above, in the order defined by
                        ranges (handle)

```

```

int MPI_Group_range_incl(MPI_Group group, int n, int ranges[][3],
                        MPI_Group *newgroup)
MPI_Group_range_incl(group, n, ranges, newgroup, ierror)
  TYPE(MPI_Group), INTENT(IN) :: group
  INTEGER, INTENT(IN) :: n, ranges(3,n)
  TYPE(MPI_Group), INTENT(OUT) :: newgroup
  INTEGER, OPTIONAL, INTENT(OUT) :: ierror
MPI_GROUP_RANGE_INCL(GROUP, N, RANGES, NEWGROUP, IERROR)
  INTEGER GROUP, N, RANGES(3,*), NEWGROUP, IERROR

```

If `ranges` consists of the triplets

$$(first_1, last_1, stride_1), \dots, (first_n, last_n, stride_n)$$

then `newgroup` consists of the sequence of processes in `group` with ranks

$$first_1, first_1 + stride_1, \dots, first_1 + \left\lfloor \frac{last_1 - first_1}{stride_1} \right\rfloor stride_1, \dots,$$

$$first_n, first_n + stride_n, \dots, first_n + \left\lfloor \frac{last_n - first_n}{stride_n} \right\rfloor stride_n.$$

Each computed rank must be a valid rank in `group` and all computed ranks must be distinct, or else the program is erroneous. Note that we may have $first_i > last_i$, and $stride_i$ may be negative, but cannot be zero.

The functionality of this routine is specified to be equivalent to expanding the array of ranges to an array of the included ranks and passing the resulting array of ranks and other arguments to `MPI_GROUP_INCL`. A call to `MPI_GROUP_INCL` is equivalent to a call to `MPI_GROUP_RANGE_INCL` with each rank `i` in `ranks` replaced by the triplet `(i,i,1)` in the argument `ranges`.

```
MPI_GROUP_RANGE_EXCL(group, n, ranges, newgroup)
```

IN	group	group (handle)
IN	n	number of elements in array ranges (integer)
IN	ranges	a one-dimensional array of integer triplets of the form (first rank, last rank, stride), indicating the ranks in group of processes to be excluded from the output group newgroup.
OUT	newgroup	new group derived from above, preserving the order in group (handle)

```
int MPI_Group_range_excl(MPI_Group group, int n, int ranges[][3],
                        MPI_Group *newgroup)
```

```
MPI_Group_range_excl(group, n, ranges, newgroup, ierror)
    TYPE(MPI_Group), INTENT(IN) :: group
    INTEGER, INTENT(IN) :: n, ranges(3,n)
    TYPE(MPI_Group), INTENT(OUT) :: newgroup
    INTEGER, OPTIONAL, INTENT(OUT) :: ierror
```

```
MPI_GROUP_RANGE_EXCL(GROUP, N, RANGES, NEWGROUP, IERROR)
    INTEGER GROUP, N, RANGES(3,*), NEWGROUP, IERROR
```

Each computed rank must be a valid rank in `group` and all computed ranks must be distinct, or else the program is erroneous.

The functionality of this routine is specified to be equivalent to expanding the array of ranges to an array of the excluded ranks and passing the resulting array of ranks and other arguments to `MPI_GROUP_EXCL`. A call to `MPI_GROUP_EXCL` is equivalent to a call to `MPI_GROUP_RANGE_EXCL` with each rank `i` in `ranks` replaced by the triplet `(i,i,1)` in the argument `ranges`.

Advice to users. The range operations do not explicitly enumerate ranks, and therefore are more scalable if implemented efficiently. Hence, we recommend MPI programmers to use them whenever possible, as high-quality implementations will take advantage of this fact. (*End of advice to users.*)

Advice to implementors. The range operations should be implemented, if possible, without enumerating the group members, in order to obtain better scalability (time and space). (*End of advice to implementors.*)

6.3.3 Group Destructors

MPI_GROUP_FREE(group)

INOUT	group	group (handle)
-------	-------	----------------

int MPI_Group_free(MPI_Group *group)

MPI_Group_free(group, ierror)

TYPE(MPI_Group),	INTENT(INOUT) ::	group
------------------	------------------	-------

INTEGER, OPTIONAL,	INTENT(OUT) ::	ierror
--------------------	----------------	--------

MPI_GROUP_FREE(GROUP, IERROR)

INTEGER	GROUP, IERROR
---------	---------------

This operation marks a group object for deallocation. The handle `group` is set to `MPI_GROUP_NULL` by the call. Any on-going operation using this group will complete normally.

Advice to implementors. One can keep a reference count that is incremented for each call to `MPI_COMM_GROUP`, `MPI_COMM_CREATE`, `MPI_COMM_DUP`, and `MPI_COMM_IDUP`, and decremented for each call to `MPI_GROUP_FREE` or `MPI_COMM_FREE`; the group object is ultimately deallocated when the reference count drops to zero. (*End of advice to implementors.*)

6.4 Communicator Management

This section describes the manipulation of communicators in MPI. Operations that access communicators are local and their execution does not require interprocess communication. Operations that create communicators are collective and may require interprocess communication.

Advice to implementors. High-quality implementations should amortize the overheads associated with the creation of communicators (for the same group, or subsets thereof) over several calls, by allocating multiple contexts with one collective communication. (*End of advice to implementors.*)

6.4.1 Communicator Accessors

The following are all local operations.

MPI_COMM_SIZE(comm, size)

IN	comm	communicator (handle)
----	------	-----------------------

OUT	size	number of processes in the group of <code>comm</code> (integer)
-----	------	---

int MPI_Comm_size(MPI_Comm comm, int *size)

MPI_Comm_size(comm, size, ierror)

```

1     TYPE(MPI_Comm), INTENT(IN) :: comm
2     INTEGER, INTENT(OUT) :: size
3     INTEGER, OPTIONAL, INTENT(OUT) :: ierror
4
5 MPI_COMM_SIZE(COMM, SIZE, IERROR)
6     INTEGER COMM, SIZE, IERROR

```

Rationale. This function is equivalent to accessing the communicator’s group with `MPI_COMM_GROUP` (see above), computing the size using `MPI_GROUP_SIZE`, and then freeing the temporary group via `MPI_GROUP_FREE`. However, this function is so commonly used that this shortcut was introduced. (*End of rationale.*)

Advice to users. This function indicates the number of processes involved in a communicator. For `MPI_COMM_WORLD`, it indicates the total number of processes available unless the number of processes has been changed by using the functions described in Chapter 10; note that the number of processes in `MPI_COMM_WORLD` does not change during the life of an MPI program.

This call is often used with the next call to determine the amount of concurrency available for a specific library or program. The following call, `MPI_COMM_RANK` indicates the rank of the process that calls it in the range from $0 \dots \text{size}-1$, where `size` is the return value of `MPI_COMM_SIZE`. (*End of advice to users.*)

```

23
24 MPI_COMM_RANK(comm, rank)
25
26     IN         comm                communicator (handle)
27     OUT        rank                rank of the calling process in group of comm (integer)
28
29
30 int MPI_Comm_rank(MPI_Comm comm, int *rank)
31
32 MPI_Comm_rank(comm, rank, ierror)
33     TYPE(MPI_Comm), INTENT(IN) :: comm
34     INTEGER, INTENT(OUT) :: rank
35     INTEGER, OPTIONAL, INTENT(OUT) :: ierror
36
37 MPI_COMM_RANK(COMM, RANK, IERROR)
38     INTEGER COMM, RANK, IERROR

```

Rationale. This function is equivalent to accessing the communicator’s group with `MPI_COMM_GROUP` (see above), computing the rank using `MPI_GROUP_RANK`, and then freeing the temporary group via `MPI_GROUP_FREE`. However, this function is so commonly used that this shortcut was introduced. (*End of rationale.*)

Advice to users. This function gives the rank of the process in the particular communicator’s group. It is useful, as noted above, in conjunction with `MPI_COMM_SIZE`.

Many programs will be written with the master-slave model, where one process (such as the rank-zero process) will play a supervisory role, and the other processes will serve as compute nodes. In this framework, the two preceding calls are useful for

determining the roles of the various processes of a communicator. (*End of advice to users.*)

MPI_COMM_COMPARE(comm1, comm2, result)

IN	comm1	first communicator (handle)
IN	comm2	second communicator (handle)
OUT	result	result (integer)

```
int MPI_Comm_compare(MPI_Comm comm1, MPI_Comm comm2, int *result)
```

```
MPI_Comm_compare(comm1, comm2, result, ierror)
    TYPE(MPI_Comm), INTENT(IN) :: comm1, comm2
    INTEGER, INTENT(OUT) :: result
    INTEGER, OPTIONAL, INTENT(OUT) :: ierror
```

```
MPI_COMM_COMPARE(COMM1, COMM2, RESULT, IERROR)
    INTEGER COMM1, COMM2, RESULT, IERROR
```

MPI_IDENT results if and only if comm1 and comm2 are handles for the same object (identical groups and same contexts). MPI_CONGRUENT results if the underlying groups are identical in constituents and rank order; these communicators differ only by context. MPI_SIMILAR results if the group members of both communicators are the same but the rank order differs. MPI_UNEQUAL results otherwise.

6.4.2 Communicator Constructors

The following are collective functions that are invoked by all processes in the group or groups associated with comm, with the exception of MPI_COMM_CREATE_GROUP, which is invoked only by the processes in the group of the new communicator being constructed.

Rationale. Note that there is a chicken-and-egg aspect to MPI in that a communicator is needed to create a new communicator. The base communicator for all MPI communicators is predefined outside of MPI, and is MPI_COMM_WORLD. This model was arrived at after considerable debate, and was chosen to increase “safety” of programs written in MPI. (*End of rationale.*)

This chapter presents the following communicator construction routines:

MPI_COMM_CREATE, MPI_COMM_DUP, MPI_COMM_IDUP, MPI_COMM_DUP_WITH_INFO, MPI_COMM_IDUP_WITH_INFO and MPI_COMM_SPLIT can be used to create both intracommunicators and intercommunicators; MPI_COMM_CREATE_GROUP and MPI_INTERCOMM_MERGE (see Section 6.6.2) can be used to create intracommunicators; and MPI_INTERCOMM_CREATE (see Section 6.6.2) can be used to create intercommunicators.

An intracommunicator involves a single group while an intercommunicator involves two groups. Where the following discussions address intercommunicator semantics, the two groups in an intercommunicator are called the *left* and *right* groups. A process in an intercommunicator is a member of either the left or the right group. From the point of view

of that process, the group that the process is a member of is called the *local group*; the other group (relative to that process) is the *remote group*. The left and right group labels give us a way to describe the two groups in an intercommunicator that is not relative to any particular process (as the local and remote groups are).

```

MPI_COMM_DUP(comm, newcomm)
    IN      comm      communicator (handle)
    OUT     newcomm   copy of comm (handle)

```

```
int MPI_Comm_dup(MPI_Comm comm, MPI_Comm *newcomm)
```

```

MPI_Comm_dup(comm, newcomm, ierror)
    TYPE(MPI_Comm), INTENT(IN) :: comm
    TYPE(MPI_Comm), INTENT(OUT) :: newcomm
    INTEGER, OPTIONAL, INTENT(OUT) :: ierror

```

```

MPI_COMM_DUP(COMM, NEWCOMM, IERROR)
    INTEGER COMM, NEWCOMM, IERROR

```

`MPI_COMM_DUP` duplicates the existing communicator `comm` with associated key values and topology information. For each key value, the respective copy callback function determines the attribute value associated with this key in the new communicator; one particular action that a copy callback may take is to delete the attribute from the new communicator. `MPI_COMM_DUP` returns in `newcomm` a new communicator with the same group or groups, same topology, and any copied cached information, but a new context (see Section 6.7.1).

Advice to users. This operation is used to provide a parallel library with a duplicate communication space that has the same properties as the original communicator. This includes any attributes (see below) and topologies (see Chapter 7). This call is valid even if there are pending point-to-point communications involving the communicator `comm`. A typical call might involve a `MPI_COMM_DUP` at the beginning of the parallel call, and an `MPI_COMM_FREE` of that duplicated communicator at the end of the call. Other models of communicator management are also possible.

This call applies to both intra- and inter-communicators. (*End of advice to users.*)

Advice to implementors. One need not actually copy the group information, but only add a new reference and increment the reference count. Copy on write can be used for the cached information. (*End of advice to implementors.*)

```

MPI_COMM_DUP_WITH_INFO(comm, info, newcomm)
    IN      comm      communicator (handle)
    IN      info      info object (handle)
    OUT     newcomm   copy of comm (handle)

```

```

int MPI_Comm_dup_with_info(MPI_Comm comm, MPI_Info info, MPI_Comm *newcomm)
MPI_Comm_dup_with_info(comm, info, newcomm, ierror)
    TYPE(MPI_Comm), INTENT(IN) :: comm
    TYPE(MPI_Info), INTENT(IN) :: info
    TYPE(MPI_Comm), INTENT(OUT) :: newcomm
    INTEGER, OPTIONAL, INTENT(OUT) :: ierror

```

```

MPI_COMM_DUP_WITH_INFO(COMM, INFO, NEWCOMM, IERROR)
    INTEGER COMM, INFO, NEWCOMM, IERROR

```

MPI_COMM_DUP_WITH_INFO behaves exactly as MPI_COMM_DUP except that the hints provided by the argument `info` are associated with the output communicator `newcomm`.

Rationale. It is expected that some hints will only be valid at communicator creation time. However, for legacy reasons, most communicator creation calls do not provide an `info` argument. One may associate `info` hints with a duplicate of any communicator at creation time through a call to MPI_COMM_DUP_WITH_INFO. (*End of rationale.*)

```

MPI_COMM_IDUP(comm, newcomm, request)

```

IN	<code>comm</code>	communicator (handle)
OUT	<code>newcomm</code>	copy of <code>comm</code> (handle)
OUT	<code>request</code>	communication request (handle)

```

int MPI_Comm_idup(MPI_Comm comm, MPI_Comm *newcomm, MPI_Request *request)
MPI_Comm_idup(comm, newcomm, request, ierror)
    TYPE(MPI_Comm), INTENT(IN) :: comm
    TYPE(MPI_Comm), INTENT(OUT), ASYNCHRONOUS :: newcomm
    TYPE(MPI_Request), INTENT(OUT) :: request
    INTEGER, OPTIONAL, INTENT(OUT) :: ierror

```

```

MPI_COMM_IDUP(COMM, NEWCOMM, REQUEST, IERROR)
    INTEGER COMM, NEWCOMM, REQUEST, IERROR

```

MPI_COMM_IDUP is a nonblocking variant of MPI_COMM_DUP. With the exception of its nonblocking behavior, the semantics of MPI_COMM_IDUP are as if MPI_COMM_DUP was executed at the time that MPI_COMM_IDUP is called. For example, attributes changed after MPI_COMM_IDUP will not be copied to the new communicator. All restrictions and assumptions for nonblocking collective operations (see Section 5.12) apply to MPI_COMM_IDUP and the returned request.

It is erroneous to use the communicator `newcomm` as an input argument to other MPI functions before the MPI_COMM_IDUP operation completes.

```

1 MPI_COMM_IDUP_WITH_INFO(comm, info, newcomm, request)
2     IN      comm      communicator (handle)
3
4     IN      info      info object (handle)
5
6     OUT     newcomm    copy of comm (handle)
7
8     OUT     request    communication request (handle)
9
10
11 int MPI_Comm_idup_with_info(MPI_Comm comm, MPI_Info info,
12                             MPI_Comm *newcomm, MPI_Request *request)
13
14 MPI_Comm_idup_with_info(comm, info, newcomm, request, ierror)
15     TYPE(MPI_Comm), INTENT(IN) :: comm
16     TYPE(MPI_Info), INTENT(IN) :: info
17     TYPE(MPI_Comm), INTENT(OUT), ASYNCHRONOUS :: newcomm
18     TYPE(MPI_Request), INTENT(OUT) :: request
19     INTEGER, OPTIONAL, INTENT(OUT) :: ierror

```

```

20 MPI_COMM_IDUP_WITH_INFO(COMM, INFO, NEWCOMM, REQUEST, IERROR)
21     INTEGER COMM, INFO, NEWCOMM, REQUEST, IERROR

```

22 MPI_COMM_IDUP_WITH_INFO is a nonblocking variant of
23 MPI_COMM_DUP_WITH_INFO. With the exception of its nonblocking behavior, the se-
24 mantics of MPI_COMM_IDUP_WITH_INFO are as if MPI_COMM_DUP_WITH_INFO was
25 executed at the time that MPI_COMM_IDUP_WITH_INFO is called. For example, attributes
26 or info hints changed after MPI_COMM_IDUP_WITH_INFO will not be copied to the new
27 communicator. All restrictions and assumptions for nonblocking collective operations (see
28 Section 5.12) apply to MPI_COMM_IDUP_WITH_INFO and the returned request.

29 It is erroneous to use the communicator newcomm as an input argument to other MPI
30 functions before the MPI_COMM_IDUP_WITH_INFO operation completes.

31 *Rationale.* The MPI_COMM_IDUP and MPI_COMM_IDUP_WITH_INFO functions
32 are crucial for the development of purely nonblocking libraries (see [37]). (*End of*
33 *rationale.*)

```

34
35 MPI_COMM_CREATE(comm, group, newcomm)
36
37     IN      comm      communicator (handle)
38
39     IN      group     group, which is a subset of the group of comm (handle)
40
41     OUT     newcomm    new communicator (handle)
42
43
44 int MPI_Comm_create(MPI_Comm comm, MPI_Group group, MPI_Comm *newcomm)
45
46 MPI_Comm_create(comm, group, newcomm, ierror)
47     TYPE(MPI_Comm), INTENT(IN) :: comm
48     TYPE(MPI_Group), INTENT(IN) :: group
49     TYPE(MPI_Comm), INTENT(OUT) :: newcomm
50     INTEGER, OPTIONAL, INTENT(OUT) :: ierror

```

```
MPI_COMM_CREATE(COMM, GROUP, NEWCOMM, IERROR)
    INTEGER COMM, GROUP, NEWCOMM, IERROR
```

If `comm` is an intracommunicator, this function returns a new communicator `newcomm` with communication group defined by the `group` argument. No cached information propagates from `comm` to `newcomm`. Each process must call `MPI_COMM_CREATE` with a `group` argument that is a subgroup of the `group` associated with `comm`; this could be `MPI_GROUP_EMPTY`. The processes may specify different values for the `group` argument. If a process calls with a non-empty `group` then all processes in that `group` must call the function with the same `group` as argument, that is the same processes in the same order. Otherwise, the call is erroneous. This implies that the set of groups specified across the processes must be disjoint. If the calling process is a member of the group given as `group` argument, then `newcomm` is a communicator with `group` as its associated group. In the case that a process calls with a `group` to which it does not belong, e.g., `MPI_GROUP_EMPTY`, then `MPI_COMM_NULL` is returned as `newcomm`. The function is collective and must be called by all processes in the group of `comm`.

Rationale. The interface supports the original mechanism from MPI-1.1, which required the same `group` in all processes of `comm`. It was extended in MPI-2.2 to allow the use of disjoint subgroups in order to allow implementations to eliminate unnecessary communication that `MPI_COMM_SPLIT` would incur when the user already knows the membership of the disjoint subgroups. (*End of rationale.*)

Rationale. The requirement that the entire group of `comm` participate in the call stems from the following considerations:

- It allows the implementation to layer `MPI_COMM_CREATE` on top of regular collective communications.
- It provides additional safety, in particular in the case where partially overlapping groups are used to create new communicators.
- It permits implementations to sometimes avoid communication related to context creation.

(*End of rationale.*)

Advice to users. `MPI_COMM_CREATE` provides a means to subset a group of processes for the purpose of separate MIMD computation, with separate communication space. `newcomm`, which emerges from `MPI_COMM_CREATE`, can be used in subsequent calls to `MPI_COMM_CREATE` (or other communicator constructors) to further subdivide a computation into parallel sub-computations. A more general service is provided by `MPI_COMM_SPLIT`, below. (*End of advice to users.*)

Advice to implementors. When calling `MPI_COMM_DUP`, all processes call with the same `group` (the `group` associated with the communicator). When calling `MPI_COMM_CREATE`, the processes provide the same `group` or disjoint subgroups. For both calls, it is theoretically possible to agree on a group-wide unique context with no communication. However, local execution of these functions requires use of a larger context name space and reduces error checking. Implementations may strike various compromises between these conflicting goals, such as bulk allocation of multiple contexts in one collective operation.

1 Important: If new communicators are created without synchronizing the processes
 2 involved then the communication system must be able to cope with messages arriving
 3 in a context that has not yet been allocated at the receiving process. (*End of advice*
 4 *to implementors.*)
 5

6 If `comm` is an intercommunicator, then the output communicator is also an intercommuni-
 7 cator where the local group consists only of those processes contained in `group` (see Fig-
 8 ure 6.1). The `group` argument should only contain those processes in the local group of
 9 the input intercommunicator that are to be a part of `newcomm`. All processes in the same
 10 local group of `comm` must specify the same value for `group`, i.e., the same members in the
 11 same order. If either `group` does not specify at least one process in the local group of the
 12 intercommunicator, or if the calling process is not included in the `group`, `MPI_COMM_NULL`
 13 is returned.

14
 15 *Rationale.* In the case where either the left or right group is empty, a null communi-
 16 cator is returned instead of an intercommunicator with `MPI_GROUP_EMPTY` because
 17 the side with the empty group must return `MPI_COMM_NULL`. (*End of rationale.*)
 18

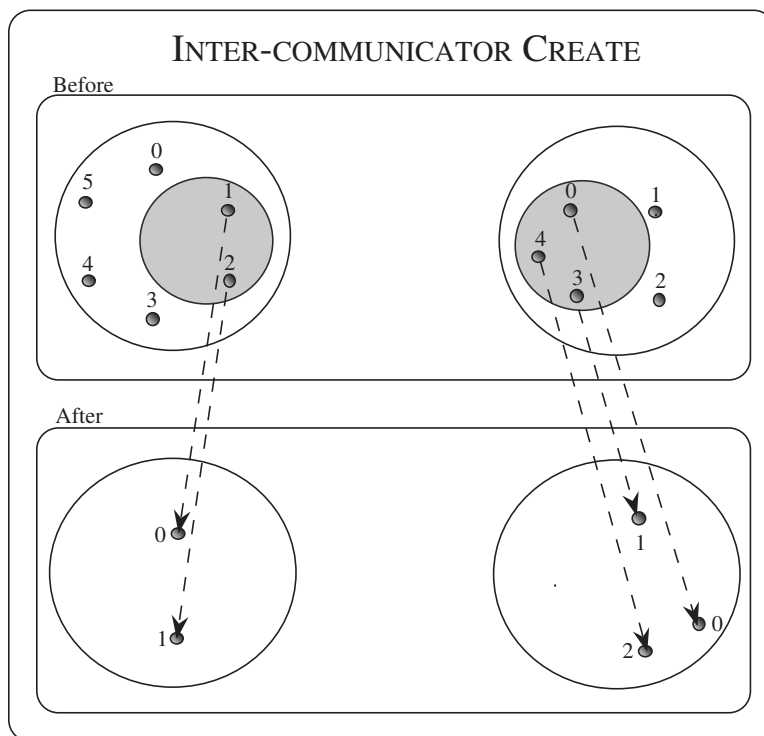

41 Figure 6.1: Intercommunicator creation using `MPI_COMM_CREATE` extended to intercommuni-
 42 cators. The input groups are those in the grey circle.

43
 44 **Example 6.1** The following example illustrates how the first node in the left side of an
 45 intercommunicator could be joined with all members on the right side of an intercommuni-
 46 cator to form a new intercommunicator.
 47
 48

```

MPI_Comm inter_comm, new_inter_comm;
MPI_Group local_group, group;
int rank = 0; /* rank on left side to include in
              new inter-comm */

/* Construct the original intercommunicator: "inter_comm" */
...

/* Construct the group of processes to be in new
intercommunicator */
if (/* I'm on the left side of the intercommunicator */) {
    MPI_Comm_group ( inter_comm, &local_group );
    MPI_Group_incl ( local_group, 1, &rank, &group );
    MPI_Group_free ( &local_group );
}
else
    MPI_Comm_group ( inter_comm, &group );

MPI_Comm_create ( inter_comm, group, &new_inter_comm );
MPI_Group_free( &group );

```

MPI_COMM_CREATE_GROUP(comm, group, tag, newcomm)

IN	comm	intracommunicator (handle)
IN	group	group, which is a subset of the group of comm (handle)
IN	tag	tag (integer)
OUT	newcomm	new communicator (handle)

```

int MPI_Comm_create_group(MPI_Comm comm, MPI_Group group, int tag,
                        MPI_Comm *newcomm)

MPI_Comm_create_group(comm, group, tag, newcomm, ierror)
    TYPE(MPI_Comm), INTENT(IN) :: comm
    TYPE(MPI_Group), INTENT(IN) :: group
    INTEGER, INTENT(IN) :: tag
    TYPE(MPI_Comm), INTENT(OUT) :: newcomm
    INTEGER, OPTIONAL, INTENT(OUT) :: ierror

MPI_COMM_CREATE_GROUP(COMM, GROUP, TAG, NEWCOMM, IERROR)
    INTEGER COMM, GROUP, TAG, NEWCOMM, IERROR

MPI_COMM_CREATE_GROUP is similar to MPI_COMM_CREATE; however,
MPI_COMM_CREATE must be called by all processes in the group of
comm, whereas MPI_COMM_CREATE_GROUP must be called by all processes in group,
which is a subgroup of the group of comm. In addition, MPI_COMM_CREATE_GROUP
requires that comm is an intracommunicator. MPI_COMM_CREATE_GROUP returns a new
intracommunicator, newcomm, for which the group argument defines the communication

```

group. No cached information propagates from `comm` to `newcomm`. Each process must provide a group argument that is a subgroup of the group associated with `comm`; this could be `MPI_GROUP_EMPTY`. If a non-empty group is specified, then all processes in that group must call the function, and each of these processes must provide the same arguments, including a group that contains the same members with the same ordering. Otherwise the call is erroneous. If the calling process is a member of the group given as the `group` argument, then `newcomm` is a communicator with `group` as its associated group. If the calling process is not a member of `group`, e.g., `group` is `MPI_GROUP_EMPTY`, then the call is a local operation and `MPI_COMM_NULL` is returned as `newcomm`.

Rationale. Functionality similar to `MPI_COMM_CREATE_GROUP` can be implemented through repeated `MPI_INTERCOMM_CREATE` and `MPI_INTERCOMM_MERGE` calls that start with the `MPI_COMM_SELF` communicators at each process in `group` and build up an intracommunicator with `group` `group` [17]. Such an algorithm requires the creation of many intermediate communicators; `MPI_COMM_CREATE_GROUP` can provide a more efficient implementation that avoids this overhead. (*End of rationale.*)

Advice to users. An intercommunicator can be created collectively over processes in the union of the local and remote groups by creating the local communicator using `MPI_COMM_CREATE_GROUP` and using that communicator as the local communicator argument to `MPI_INTERCOMM_CREATE`. (*End of advice to users.*)

The `tag` argument does not conflict with tags used in point-to-point communication and is not permitted to be a wildcard. If multiple threads at a given process perform concurrent `MPI_COMM_CREATE_GROUP` operations, the user must distinguish these operations by providing different `tag` or `comm` arguments.

Advice to users. `MPI_COMM_CREATE` may provide lower overhead than `MPI_COMM_CREATE_GROUP` because it can take advantage of collective communication on `comm` when constructing `newcomm`. (*End of advice to users.*)

```
MPI_COMM_SPLIT(comm, color, key, newcomm)
```

IN	<code>comm</code>	communicator (handle)
IN	<code>color</code>	control of subset assignment (integer)
IN	<code>key</code>	control of rank assignment (integer)
OUT	<code>newcomm</code>	new communicator (handle)

```
int MPI_Comm_split(MPI_Comm comm, int color, int key, MPI_Comm *newcomm)
```

```
MPI_Comm_split(comm, color, key, newcomm, ierror)
```

```
TYPE(MPI_Comm), INTENT(IN) :: comm
INTEGER, INTENT(IN) :: color, key
TYPE(MPI_Comm), INTENT(OUT) :: newcomm
INTEGER, OPTIONAL, INTENT(OUT) :: ierror
```

```
MPI_COMM_SPLIT(COMM, COLOR, KEY, NEWCOMM, IERROR)
```

INTEGER COMM, COLOR, KEY, NEWCOMM, IERROR

This function partitions the group associated with `comm` into disjoint subgroups, one for each value of `color`. Each subgroup contains all processes of the same color. Within each subgroup, the processes are ranked in the order defined by the value of the argument `key`, with ties broken according to their rank in the old group. A new communicator is created for each subgroup and returned in `newcomm`. A process may supply the color value `MPI_UNDEFINED`, in which case `newcomm` returns `MPI_COMM_NULL`. This is a collective call, but each process is permitted to provide different values for `color` and `key`.

With an intracommunicator `comm`, a call to `MPI_COMM_CREATE(comm, group, newcomm)` is equivalent to a call to `MPI_COMM_SPLIT(comm, color, key, newcomm)`, where processes that are members of their `group` argument provide `color = number of the group` (based on a unique numbering of all disjoint groups) and `key = rank in group`, and all processes that are not members of their `group` argument provide `color = MPI_UNDEFINED`.

The value of `color` must be non-negative or `MPI_UNDEFINED`.

Advice to users. This is an extremely powerful mechanism for dividing a single communicating group of processes into k subgroups, with k chosen implicitly by the user (by the number of colors asserted over all the processes). Each resulting communicator will be non-overlapping. Such a division could be useful for defining a hierarchy of computations, such as for multigrid, or linear algebra. For intracommunicators, `MPI_COMM_SPLIT` provides similar capability as `MPI_COMM_CREATE` to split a communicating group into disjoint subgroups. `MPI_COMM_SPLIT` is useful when some processes do not have complete information of the other members in their group, but all processes know (the color of) the group to which they belong. In this case, the MPI implementation discovers the other group members via communication. `MPI_COMM_CREATE` is useful when all processes have complete information of the members of their group. In this case, MPI can avoid the extra communication required to discover group membership. `MPI_COMM_CREATE_GROUP` is useful when all processes in a given group have complete information of the members of their group and synchronization with processes outside the group can be avoided.

Multiple calls to `MPI_COMM_SPLIT` can be used to overcome the requirement that any call have no overlap of the resulting communicators (each process is of only one color per call). In this way, multiple overlapping communication structures can be created. Creative use of the `color` and `key` in such splitting operations is encouraged.

Note that, for a fixed `color`, the keys need not be unique. It is `MPI_COMM_SPLIT`'s responsibility to sort processes in ascending order according to this key, and to break ties in a consistent way. If all the keys are specified in the same way, then all the processes in a given color will have the relative rank order as they did in their parent group.

Essentially, making the key value zero for all processes of a given color means that one does not really care about the rank-order of the processes in the new communicator. (*End of advice to users.*)

Rationale. `color` is restricted to be non-negative, so as not to conflict with the value assigned to `MPI_UNDEFINED`. (*End of rationale.*)

The result of `MPI_COMM_SPLIT` on an intercommunicator is that those processes on the left with the same `color` as those processes on the right combine to create a new intercom-

1 communicator. The key argument describes the relative rank of processes on each side of the
 2 intercommunicator (see Figure 6.2). For those colors that are specified only on one side of
 3 the intercommunicator, MPI_COMM_NULL is returned. MPI_COMM_NULL is also returned
 4 to those processes that specify MPI_UNDEFINED as the color.

5 *Advice to users.* For intercommunicators, MPI_COMM_SPLIT is more general than
 6 MPI_COMM_CREATE. A single call to MPI_COMM_SPLIT can create a set of disjoint
 7 intercommunicators, while a call to MPI_COMM_CREATE creates only one. (*End of*
 8 *advice to users.*)
 9

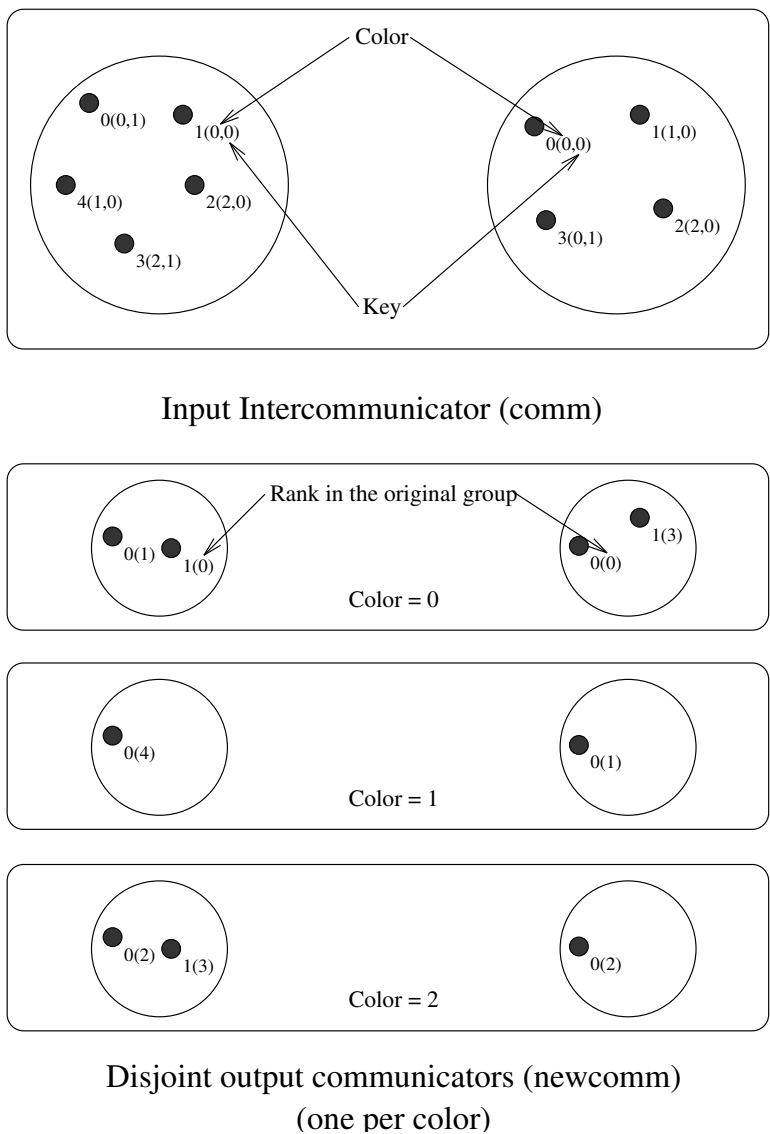

43 Figure 6.2: Intercommunicator construction achieved by splitting an existing intercommuni-
 44 cator with MPI_COMM_SPLIT extended to intercommunicators.

45

46 **Example 6.2** (Parallel client-server model). The following client code illustrates how clients
 47 on the left side of an intercommunicator could be assigned to a single server from a pool of
 48 servers on the right side of an intercommunicator.

```

/* Client code */
MPI_Comm multiple_server_comm;
MPI_Comm single_server_comm;
int color, rank, num_servers;

/* Create intercommunicator with clients and servers:
   multiple_server_comm */
...

/* Find out the number of servers available */
MPI_Comm_remote_size ( multiple_server_comm, &num_servers );

/* Determine my color */
MPI_Comm_rank ( multiple_server_comm, &rank );
color = rank % num_servers;

/* Split the intercommunicator */
MPI_Comm_split ( multiple_server_comm, color, rank,
                &single_server_comm );

```

The following is the corresponding server code:

```

/* Server code */
MPI_Comm multiple_client_comm;
MPI_Comm single_server_comm;
int rank;

/* Create intercommunicator with clients and servers:
   multiple_client_comm */
...

/* Split the intercommunicator for a single server per group
   of clients */
MPI_Comm_rank ( multiple_client_comm, &rank );
MPI_Comm_split ( multiple_client_comm, rank, 0,
                &single_server_comm );

```

MPI_COMM_SPLIT_TYPE(comm, split_type, key, info, newcomm)

IN	comm	communicator (handle)
IN	split_type	type of processes to be grouped together (integer)
IN	key	control of rank assignment (integer)
IN	info	info argument (handle)
OUT	newcomm	new communicator (handle)

```

int MPI_Comm_split_type(MPI_Comm comm, int split_type, int key,
                       MPI_Info info, MPI_Comm *newcomm)

```

```

1 MPI_Comm_split_type(comm, split_type, key, info, newcomm, ierror)
2     TYPE(MPI_Comm), INTENT(IN) :: comm
3     INTEGER, INTENT(IN) :: split_type, key
4     TYPE(MPI_Info), INTENT(IN) :: info
5     TYPE(MPI_Comm), INTENT(OUT) :: newcomm
6     INTEGER, OPTIONAL, INTENT(OUT) :: ierror
7
8 MPI_COMM_SPLIT_TYPE(COMM, SPLIT_TYPE, KEY, INFO, NEWCOMM, IERROR)
9     INTEGER COMM, SPLIT_TYPE, KEY, INFO, NEWCOMM, IERROR

```

This function partitions the group associated with `comm` into disjoint subgroups, based on the type specified by `split_type`. Each subgroup contains all processes of the same type. Within each subgroup, the processes are ranked in the order defined by the value of the argument `key`, with ties broken according to their rank in the old group. A new communicator is created for each subgroup and returned in `newcomm`. This is a collective call; all processes must provide the same `split_type`, but each process is permitted to provide different values for `key`. An exception to this rule is that a process may supply the type value `MPI_UNDEFINED`, in which case `newcomm` returns `MPI_COMM_NULL`.

The following type is predefined by MPI:

`MPI_COMM_TYPE_SHARED` — this type splits the communicator into subcommunicators, each of which can create a shared memory region.

Advice to implementors. Implementations can define their own types, or use the `info` argument, to assist in creating communicators that help expose platform-specific information to the application. (*End of advice to implementors.*)

6.4.3 Communicator Destructors

```

29 MPI_COMM_FREE(comm)
30     INOUT    comm                communicator to be destroyed (handle)
31
32
33 int MPI_Comm_free(MPI_Comm *comm)
34
35 MPI_Comm_free(comm, ierror)
36     TYPE(MPI_Comm), INTENT(INOUT) :: comm
37     INTEGER, OPTIONAL, INTENT(OUT) :: ierror
38
39 MPI_COMM_FREE(COMM, IERROR)
40     INTEGER COMM, IERROR

```

This collective operation marks the communication object for deallocation. The `handle` is set to `MPI_COMM_NULL`. Any pending operations that use this communicator will complete normally; the object is actually deallocated only if there are no other active references to it. This call applies to intra- and inter-communicators. The delete callback functions for all cached attributes (see Section 6.7) are called in arbitrary order.

Advice to implementors. Though collective, it is anticipated that this operation will normally be implemented to be local, though a debugging version of an MPI library might choose to synchronize. (*End of advice to implementors.*)

6.4.4 Communicator Info

Hints specified via info (see Chapter 9) allow a user to provide information to direct optimization. Providing hints may enable an implementation to deliver increased performance or minimize use of system resources. An implementation is free to ignore all hints; however, applications must comply with any info hints they provide that are used by the MPI implementation (i.e., are returned by a call to `MPI_COMM_GET_INFO`) and that place a restriction on the behavior of the application. Hints are specified on a per communicator basis, in `MPI_COMM_DUP_WITH_INFO`, `MPI_COMM_IDUP_WITH_INFO`, `MPI_COMM_SET_INFO`, `MPI_COMM_SPLIT_TYPE`, `MPI_DIST_GRAPH_CREATE`, and `MPI_DIST_GRAPH_CREATE_ADJACENT`, via the opaque info object. When an info object that specifies a subset of valid hints is passed to `MPI_COMM_SET_INFO`, there will be no effect on previously set or defaulted hints that the info does not specify.

Advice to implementors. It may happen that a program is coded with hints for one system, and later executes on another system that does not support these hints. In general, unsupported hints should simply be ignored. Needless to say, no hint can be mandatory. However, for each hint used by a specific implementation, a default value must be provided when the user does not specify a value for this hint. (*End of advice to implementors.*)

Info hints are not propagated by MPI from one communicator to another. The following info keys are valid for all communicators.

`mpi_assert_no_any_tag` (**boolean, default: false**): If set to true, then the implementation may assume that the process will not use the `MPI_ANY_TAG` wildcard on the given communicator.

`mpi_assert_no_any_source` (**boolean, default: false**): If set to true, then the implementation may assume that the process will not use the `MPI_ANY_SOURCE` wildcard on the given communicator.

`mpi_assert_exact_length` (**boolean, default: false**): If set to true, then the implementation may assume that the lengths of messages received by the process are equal to the lengths of the corresponding receive buffers, for point-to-point communication operations on the given communicator.

`mpi_assert_allow_overtaking` (**boolean, default: false**): If set to true, then the implementation may assume that point-to-point communications on the given communicator do not rely on the non-overtaking rule specified in Section 3.5. In other words, the application asserts that send operations are not required to be matched at the receiver in the order in which the send operations were posted by the sender, and receive operations are not required to be matched in the order in which they were posted by the receiver.

Advice to users. Use of the `mpi_assert_allow_overtaking` info key can result in nondeterminism in the message matching order. (*End of advice to users.*)

Advice to users. Some optimizations may only be possible when all processes in the group of the communicator provide a given info key with the same value. (*End of advice to users.*)

```

1 MPI_COMM_SET_INFO(comm, info)
2     INOUT    comm                communicator (handle)
3
4     IN      info                info object (handle)

```

```

5
6 int MPI_Comm_set_info(MPI_Comm comm, MPI_Info info)

```

```

7 MPI_Comm_set_info(comm, info, ierror)
8     TYPE(MPI_Comm), INTENT(IN) :: comm
9     TYPE(MPI_Info), INTENT(IN) :: info
10    INTEGER, OPTIONAL, INTENT(OUT) :: ierror
11

```

```

12 MPI_COMM_SET_INFO(COMM, INFO, IERROR)
13    INTEGER COMM, INFO, IERROR

```

MPI_COMM_SET_INFO updates the hints of the communicator associated with `comm` using the hints provided in `info`. This operation has no effect on previously set or defaulted hints that are not specified by `info`. It also has no effect on previously set or defaulted hints that are specified by `info`, but are ignored by the MPI implementation in this call to MPI_COMM_SET_INFO. MPI_COMM_SET_INFO is a collective routine. The `info` object may be different on each process, but any `info` entries that an implementation requires to be the same on all processes must appear with the same value in each process's `info` object.

Advice to users. Some `info` items that an implementation can use when it creates a communicator cannot easily be changed once the communicator has been created. Thus, an implementation may ignore hints issued in this call that it would have accepted in a creation call. An implementation may also be unable to update certain `info` hints in a call to MPI_COMM_SET_INFO. MPI_COMM_GET_INFO can be used to determine whether updates to existing `info` hints were ignored by the implementation. (*End of advice to users.*)

Advice to users. Setting `info` hints on the predefined communicators MPI_COMM_WORLD and MPI_COMM_SELF may have unintended effects, as changes to these global objects may affect all components of the application, including libraries and tools. Users must ensure that all components of the application that use a given communicator, including libraries and tools, can comply with any `info` hints associated with that communicator. (*End of advice to users.*)

```

38
39 MPI_COMM_GET_INFO(comm, info_used)
40     IN      comm                communicator object (handle)
41
42     OUT    info_used            new info object (handle)

```

```

43
44 int MPI_Comm_get_info(MPI_Comm comm, MPI_Info *info_used)

```

```

45 MPI_Comm_get_info(comm, info_used, ierror)
46     TYPE(MPI_Comm), INTENT(IN) :: comm
47     TYPE(MPI_Info), INTENT(OUT) :: info_used
48     INTEGER, OPTIONAL, INTENT(OUT) :: ierror

```



```
MPI_COMM_GET_INFO(COMM, INFO_USED, IERROR)
    INTEGER COMM, INFO_USED, IERROR
```

MPI_COMM_GET_INFO returns a new info object containing the hints of the communicator associated with `comm`. The current setting of all hints related to this communicator is returned in `info_used`. An MPI implementation is required to return all hints that are supported by the implementation and have default values specified; any user-supplied hints that were not ignored by the implementation; and any additional hints that were set by the implementation. If no such hints exist, a handle to a newly created info object is returned that contains no key/value pair. The user is responsible for freeing `info_used` via `MPI_INFO_FREE`.

6.5 Motivating Examples

6.5.1 Current Practice #1

Example #1a:

```
int main(int argc, char *argv[])
{
    int me, size;
    ...
    MPI_Init ( &argc, &argv );
    MPI_Comm_rank (MPI_COMM_WORLD, &me);
    MPI_Comm_size (MPI_COMM_WORLD, &size);

    (void)printf ("Process %d size %d\n", me, size);
    ...
    MPI_Finalize();
    return 0;
}
```

Example #1a is a do-nothing program that initializes itself, and refers to the “all” communicator, and prints a message. It terminates itself too. This example does not imply that MPI supports `printf`-like communication itself.

Example #1b (supposing that `size` is even):

```
int main(int argc, char *argv[])
{
    int me, size;
    int SOME_TAG = 0;
    ...
    MPI_Init(&argc, &argv);

    MPI_Comm_rank(MPI_COMM_WORLD, &me); /* local */
    MPI_Comm_size(MPI_COMM_WORLD, &size); /* local */

    if((me % 2) == 0)
    {
        /* send unless highest-numbered process */
    }
}
```

```

1         if((me + 1) < size)
2             MPI_Send(..., me + 1, SOME_TAG, MPI_COMM_WORLD);
3     }
4     else
5         MPI_Recv(..., me - 1, SOME_TAG, MPI_COMM_WORLD, &status);
6
7     ...
8     MPI_Finalize();
9     return 0;
10 }

```

Example #1b schematically illustrates message exchanges between “even” and “odd” processes in the “all” communicator.

6.5.2 Current Practice #2

```

16 int main(int argc, char *argv[])
17 {
18     int me, count;
19     void *data;
20     ...
21
22     MPI_Init(&argc, &argv);
23     MPI_Comm_rank(MPI_COMM_WORLD, &me);
24
25     if(me == 0)
26     {
27         /* get input, create buffer ‘‘data’’ */
28         ...
29     }
30
31     MPI_Bcast(data, count, MPI_BYTE, 0, MPI_COMM_WORLD);
32
33     ...
34     MPI_Finalize();
35     return 0;
36 }

```

This example illustrates the use of a collective communication.

6.5.3 (Approximate) Current Practice #3

```

42 int main(int argc, char *argv[])
43 {
44     int me, count, count2;
45     void *send_buf, *recv_buf, *send_buf2, *recv_buf2;
46     MPI_Group group_world, grpem;
47     MPI_Comm commslave;
48     static int ranks[] = {0};

```

```

...
MPI_Init(&argc, &argv);
MPI_Comm_group(MPI_COMM_WORLD, &group_world);
MPI_Comm_rank(MPI_COMM_WORLD, &me); /* local */

MPI_Group_excl(group_world, 1, ranks, &grpem); /* local */
MPI_Comm_create(MPI_COMM_WORLD, grpem, &commslave);

if(me != 0)
{
    /* compute on slave */
    ...
    MPI_Reduce(send_buf,recv_buf,count, MPI_INT, MPI_SUM, 1, commslave);
    ...
    MPI_Comm_free(&commslave);
}
/* zero falls through immediately to this reduce, others do later... */
MPI_Reduce(send_buf2, recv_buf2, count2,
           MPI_INT, MPI_SUM, 0, MPI_COMM_WORLD);

MPI_Group_free(&group_world);
MPI_Group_free(&grpem);
MPI_Finalize();
return 0;
}

```

This example illustrates how a group consisting of all but the zeroth process of the “all” group is created, and then how a communicator is formed (`commslave`) for that new group. The new communicator is used in a collective call, and all processes execute a collective call in the `MPI_COMM_WORLD` context. This example illustrates how the two communicators (that inherently possess distinct contexts) protect communication. That is, communication in `MPI_COMM_WORLD` is insulated from communication in `commslave`, and vice versa.

In summary, “group safety” is achieved via communicators because distinct contexts within communicators are enforced to be unique on any process.

6.5.4 Example #4

The following example is meant to illustrate “safety” between point-to-point and collective communication. MPI guarantees that a single communicator can do safe point-to-point and collective communication.

```

#define TAG_ARBITRARY 12345
#define SOME_COUNT    50

int main(int argc, char *argv[])
{
    int me;
    MPI_Request request[2];
    MPI_Status status[2];
}

```

```

1     MPI_Group group_world, subgroup;
2     int ranks[] = {2, 4, 6, 8};
3     MPI_Comm the_comm;
4     ...
5     MPI_Init(&argc, &argv);
6     MPI_Comm_group(MPI_COMM_WORLD, &group_world);
7
8     MPI_Group_incl(group_world, 4, ranks, &subgroup); /* local */
9     MPI_Group_rank(subgroup, &me);      /* local */
10
11    MPI_Comm_create(MPI_COMM_WORLD, subgroup, &the_comm);
12
13    if(me != MPI_UNDEFINED)
14    {
15        MPI_Irecv(buff1, count, MPI_DOUBLE, MPI_ANY_SOURCE, TAG_ARBITRARY,
16                the_comm, request);
17        MPI_Isend(buff2, count, MPI_DOUBLE, (me+1)%4, TAG_ARBITRARY,
18                the_comm, request+1);
19        for(i = 0; i < SOME_COUNT; i++)
20            MPI_Reduce(..., the_comm);
21        MPI_Waitall(2, request, status);
22
23        MPI_Comm_free(&the_comm);
24    }
25
26    MPI_Group_free(&group_world);
27    MPI_Group_free(&subgroup);
28    MPI_Finalize();
29    return 0;
30 }

```

6.5.5 Library Example #1

The main program:

```

35    int main(int argc, char *argv[])
36    {
37        int done = 0;
38        user_lib_t *libh_a, *libh_b;
39        void *dataset1, *dataset2;
40        ...
41        MPI_Init(&argc, &argv);
42        ...
43        init_user_lib(MPI_COMM_WORLD, &libh_a);
44        init_user_lib(MPI_COMM_WORLD, &libh_b);
45        ...
46        user_start_op(libh_a, dataset1);
47        user_start_op(libh_b, dataset2);
48

```

```

...
while(!done)
{
    /* work */
    ...
    MPI_Reduce(..., MPI_COMM_WORLD);
    ...
    /* see if done */
    ...
}
user_end_op(libh_a);
user_end_op(libh_b);

uninit_user_lib(libh_a);
uninit_user_lib(libh_b);
MPI_Finalize();
return 0;
}

```

The user library initialization code:

```

void init_user_lib(MPI_Comm comm, user_lib_t **handle)
{
    user_lib_t *save;

    user_lib_initsave(&save); /* local */
    MPI_Comm_dup(comm, &(save -> comm));

    /* other inits */
    ...

    *handle = save;
}

```

User start-up code:

```

void user_start_op(user_lib_t *handle, void *data)
{
    MPI_Irecv( ..., handle->comm, &(handle -> irecv_handle) );
    MPI_Isend( ..., handle->comm, &(handle -> isend_handle) );
}

```

User communication clean-up code:

```

void user_end_op(user_lib_t *handle)
{
    MPI_Status status;
    MPI_Wait(& handle -> isend_handle, &status);
    MPI_Wait(& handle -> irecv_handle, &status);
}

```

1 User object clean-up code:

```

2
3    void uninit_user_lib(user_lib_t *handle)
4    {
5       MPI_Comm_free(&(handle -> comm));
6       free(handle);
7    }

```

8 6.5.6 Library Example #2

9 The main program:

```

10
11
12    int main(int argc, char *argv[])
13    {
14       int ma, mb;
15       MPI_Group group_world, group_a, group_b;
16       MPI_Comm comm_a, comm_b;
17
18       static int list_a[] = {0, 1};
19    #if defined(EXAMPLE_2B) || defined(EXAMPLE_2C)
20       static int list_b[] = {0, 2 ,3};
21    #else/* EXAMPLE_2A */
22       static int list_b[] = {0, 2};
23    #endif
24       int size_list_a = sizeof(list_a)/sizeof(int);
25       int size_list_b = sizeof(list_b)/sizeof(int);
26
27       ...
28       MPI_Init(&argc, &argv);
29       MPI_Comm_group(MPI_COMM_WORLD, &group_world);
30
31       MPI_Group_incl(group_world, size_list_a, list_a, &group_a);
32       MPI_Group_incl(group_world, size_list_b, list_b, &group_b);
33
34       MPI_Comm_create(MPI_COMM_WORLD, group_a, &comm_a);
35       MPI_Comm_create(MPI_COMM_WORLD, group_b, &comm_b);
36
37       if(comm_a != MPI_COMM_NULL)
38           MPI_Comm_rank(comm_a, &ma);
39       if(comm_b != MPI_COMM_NULL)
40           MPI_Comm_rank(comm_b, &mb);
41
42       if(comm_a != MPI_COMM_NULL)
43           lib_call(comm_a);
44
45       if(comm_b != MPI_COMM_NULL)
46        {
47           lib_call(comm_b);
48           lib_call(comm_b);

```

```

}
1
2
if(comm_a != MPI_COMM_NULL)
3
    MPI_Comm_free(&comm_a);
4
if(comm_b != MPI_COMM_NULL)
5
    MPI_Comm_free(&comm_b);
6
MPI_Group_free(&group_a);
7
MPI_Group_free(&group_b);
8
MPI_Group_free(&group_world);
9
MPI_Finalize();
10
return 0;
11
}
12

```

The library:

```

13
14
void lib_call(MPI_Comm comm)
15
{
16
    int me, done = 0;
17
    MPI_Status status;
18
    MPI_Comm_rank(comm, &me);
19
    if(me == 0)
20
        while(!done)
21
            {
22
                MPI_Recv(..., MPI_ANY_SOURCE, MPI_ANY_TAG, comm, &status);
23
                ...
24
            }
25
        else
26
            {
27
                /* work */
28
                MPI_Send(..., 0, ARBITRARY_TAG, comm);
29
                ....
30
            }
31
}
32
#ifdef EXAMPLE_2C
33
    /* include (resp, exclude) for safety (resp, no safety): */
34
    MPI_Barrier(comm);
35
#endif
36
}
37

```

The above example is really three examples, depending on whether or not one includes rank 3 in `list_b`, and whether or not a synchronize is included in `lib_call`. This example illustrates that, despite contexts, subsequent calls to `lib_call` with the same context need not be safe from one another (colloquially, “back-masking”). Safety is realized if the `MPI_Barrier` is added. What this demonstrates is that libraries have to be written carefully, even with contexts. When rank 3 is excluded, then the synchronize is not needed to get safety from back-masking.

Algorithms like “reduce” and “allreduce” have strong enough source selectivity properties so that they are inherently okay (no back-masking), provided that MPI provides basic guarantees. So are multiple calls to a typical tree-broadcast algorithm with the same root or different roots (see [59]). Here we rely on two guarantees of MPI: pairwise ordering of

1 messages between processes in the same context, and source selectivity — deleting either
 2 feature removes the guarantee that back-masking cannot be required.

3 Algorithms that try to do non-deterministic broadcasts or other calls that include wild-
 4 card operations will not generally have the good properties of the deterministic implemen-
 5 tations of “reduce,” “allreduce,” and “broadcast.” Such algorithms would have to utilize
 6 the monotonically increasing tags (within a communicator scope) to keep things straight.

7 All of the foregoing is a supposition of “collective calls” implemented with point-to-
 8 point operations. MPI implementations may or may not implement collective calls using
 9 point-to-point operations. These algorithms are used to illustrate the issues of correctness
 10 and safety, independent of how MPI implements its collective calls. See also Section 6.9.

12 6.6 Inter-Communication

14 This section introduces the concept of inter-communication and describes the portions of
 15 MPI that support it. It describes support for writing programs that contain user-level
 16 servers.

17 All communication described thus far has involved communication between processes
 18 that are members of the same group. This type of communication is called “**intra-com-**
 19 **munication**” and the communicator used is called an “**intra-communicator**,” as we have
 20 noted earlier in the chapter.

21 In modular and multi-disciplinary applications, different process groups execute distinct
 22 modules and processes within different modules communicate with one another in a pipeline
 23 or a more general module graph. In these applications, the most natural way for a process
 24 to specify a target process is by the rank of the target process within the target group. In
 25 applications that contain internal user-level servers, each server may be a process group that
 26 provides services to one or more clients, and each client may be a process group that uses the
 27 services of one or more servers. It is again most natural to specify the target process by rank
 28 within the target group in these applications. This type of communication is called “**int-**
 29 **er-communication**” and the communicator used is called an “**inter-communicator**,” as
 30 introduced earlier.

31 An **inter-communication** is a point-to-point communication between processes in
 32 different groups. The group containing a process that initiates an inter-communication
 33 operation is called the “local group,” that is, the sender in a send and the receiver in a
 34 receive. The group containing the target process is called the “remote group,” that is,
 35 the receiver in a send and the sender in a receive. As in intra-communication, the target
 36 process is specified using a (communicator, rank) pair. Unlike intra-communication, the rank
 37 is relative to a second, remote group.

38 All inter-communicator constructors are blocking except for MPI_COMM_IDUP and
 39 require that the local and remote groups be disjoint.

41 *Advice to users.* The groups must be disjoint for several reasons. Primarily, this
 42 is the intent of the intercommunicators — to provide a communicator for commu-
 43 nication between disjoint groups. This is reflected in the definition of
 44 MPI_INTERCOMM_MERGE, which allows the user to control the ranking of the pro-
 45 cesses in the created intracommunicator; this ranking makes little sense if the groups
 46 are not disjoint. In addition, the natural extension of collective operations to inter-
 47 communicators makes the most sense when the groups are disjoint. (*End of advice to*
 48 *users.*)

Here is a summary of the properties of inter-communication and inter-communicators:

- The syntax of point-to-point and collective communication is the same for both inter- and intra-communication. The same communicator can be used both for send and for receive operations.
- A target process is addressed by its rank in the remote group, both for sends and for receives.
- Communications using an inter-communicator are guaranteed not to conflict with any communications that use a different communicator.
- A communicator will provide either intra- or inter-communication, never both.

The routine `MPI_COMM_TEST_INTER` may be used to determine if a communicator is an inter- or intra-communicator. Inter-communicators can be used as arguments to some of the other communicator access routines. Inter-communicators cannot be used as input to some of the constructor routines for intra-communicators (for instance, `MPI_CART_CREATE`).

Advice to implementors. For the purpose of point-to-point communication, communicators can be represented in each process by a tuple consisting of:

group
send_context
receive_context
source

For inter-communicators, *group* describes the remote group, and *source* is the rank of the process in the local group. For intra-communicators, *group* is the communicator group (remote=local), *source* is the rank of the process in this group, and *send context* and *receive context* are identical. A group can be represented by a rank-to-absolute-address translation table.

The inter-communicator cannot be discussed sensibly without considering processes in both the local and remote groups. Imagine a process **P** in group \mathcal{P} , which has an inter-communicator $\mathbf{C}_{\mathcal{P}}$, and a process **Q** in group \mathcal{Q} , which has an inter-communicator $\mathbf{C}_{\mathcal{Q}}$. Then

- $\mathbf{C}_{\mathcal{P}}.\mathbf{group}$ describes the group \mathcal{Q} and $\mathbf{C}_{\mathcal{Q}}.\mathbf{group}$ describes the group \mathcal{P} .
- $\mathbf{C}_{\mathcal{P}}.\mathbf{send_context} = \mathbf{C}_{\mathcal{Q}}.\mathbf{receive_context}$ and the context is unique in \mathcal{Q} ;
 $\mathbf{C}_{\mathcal{P}}.\mathbf{receive_context} = \mathbf{C}_{\mathcal{Q}}.\mathbf{send_context}$ and this context is unique in \mathcal{P} .
- $\mathbf{C}_{\mathcal{P}}.\mathbf{source}$ is rank of **P** in \mathcal{P} and $\mathbf{C}_{\mathcal{Q}}.\mathbf{source}$ is rank of **Q** in \mathcal{Q} .

Assume that **P** sends a message to **Q** using the inter-communicator. Then **P** uses the **group** table to find the absolute address of **Q**; **source** and **send_context** are appended to the message.

Assume that **Q** posts a receive with an explicit source argument using the inter-communicator. Then **Q** matches **receive_context** to the message context and source argument to the message source.

The same algorithm is appropriate for intra-communicators as well.

In order to support inter-communicator accessors and constructors, it is necessary to supplement this model with additional structures, that store information about the local communication group, and additional safe contexts. (*End of advice to implementors.*)

6.6.1 Inter-communicator Accessors

```
MPI_COMM_TEST_INTER(comm, flag)
```

```
IN      comm      communicator (handle)
OUT     flag      (logical)
```

```
int MPI_Comm_test_inter(MPI_Comm comm, int *flag)
```

```
MPI_Comm_test_inter(comm, flag, ierror)
    TYPE(MPI_Comm), INTENT(IN) :: comm
    LOGICAL, INTENT(OUT) :: flag
    INTEGER, OPTIONAL, INTENT(OUT) :: ierror
```

```
MPI_COMM_TEST_INTER(COMM, FLAG, IERROR)
    INTEGER COMM, IERROR
    LOGICAL FLAG
```

This local routine allows the calling process to determine if a communicator is an inter-communicator or an intra-communicator. It returns true if it is an inter-communicator, otherwise false.

When an inter-communicator is used as an input argument to the communicator accessors described above under intra-communication, the following table describes behavior.

MPI_COMM_SIZE	returns the size of the local group.
MPI_COMM_GROUP	returns the local group.
MPI_COMM_RANK	returns the rank in the local group

Table 6.1: MPI_COMM_* Function Behavior (in Inter-Communication Mode)

Furthermore, the operation MPI_COMM_COMPARE is valid for inter-communicators. Both communicators must be either intra- or inter-communicators, or else MPI_UNEQUAL results. Both corresponding local and remote groups must compare correctly to get the results MPI_CONGRUENT or MPI_SIMILAR. In particular, it is possible for MPI_SIMILAR to result because either the local or remote groups were similar but not identical.

The following accessors provide consistent access to the remote group of an inter-communicator. The following are all local operations.

```

MPI_COMM_REMOTE_SIZE(comm, size) 1
    IN      comm                    inter-communicator (handle) 2
    OUT     size                    number of processes in the remote group of comm 3
                                      (integer) 4
                                      5
                                      6
int MPI_Comm_remote_size(MPI_Comm comm, int *size) 7
MPI_Comm_remote_size(comm, size, ierror) 8
    TYPE(MPI_Comm), INTENT(IN) :: comm 9
    INTEGER, INTENT(OUT) :: size 10
    INTEGER, OPTIONAL, INTENT(OUT) :: ierror 11
MPI_COMM_REMOTE_SIZE(COMM, SIZE, IERROR) 12
    INTEGER COMM, SIZE, IERROR 13
                                      14
                                      15
                                      16
MPI_COMM_REMOTE_GROUP(comm, group) 17
    IN      comm                    inter-communicator (handle) 18
    OUT     group                   remote group corresponding to comm (handle) 19
                                      20
                                      21
int MPI_Comm_remote_group(MPI_Comm comm, MPI_Group *group) 22
MPI_Comm_remote_group(comm, group, ierror) 23
    TYPE(MPI_Comm), INTENT(IN) :: comm 24
    TYPE(MPI_Group), INTENT(OUT) :: group 25
    INTEGER, OPTIONAL, INTENT(OUT) :: ierror 26
MPI_COMM_REMOTE_GROUP(COMM, GROUP, IERROR) 27
    INTEGER COMM, GROUP, IERROR 28
                                      29
                                      30

```

Rationale. Symmetric access to both the local and remote groups of an inter-communicator is important, so this function, as well as MPI_COMM_REMOTE_SIZE have been provided. (*End of rationale.*)

6.6.2 Inter-communicator Operations

This section introduces four blocking inter-communicator operations.

MPI_INTERCOMM_CREATE is used to bind two intra-communicators into an inter-communicator; the function MPI_INTERCOMM_MERGE creates an intra-communicator by merging the local and remote groups of an inter-communicator. The functions MPI_COMM_DUP and MPI_COMM_FREE, introduced previously, duplicate and free an inter-communicator, respectively.

Overlap of local and remote groups that are bound into an inter-communicator is prohibited. If there is overlap, then the program is erroneous and is likely to deadlock. (If a process is multithreaded, and MPI calls block only a thread, rather than a process, then “dual membership” can be supported. It is then the user’s responsibility to make sure that calls on behalf of the two “roles” of a process are executed by two independent threads.)

1 The function `MPI_INTERCOMM_CREATE` can be used to create an inter-communicator
 2 from two existing intra-communicators, in the following situation: At least one selected
 3 member from each group (the “group leader”) has the ability to communicate with the
 4 selected member from the other group; that is, a “peer” communicator exists to which both
 5 leaders belong, and each leader knows the rank of the other leader in this peer communicator.
 6 Furthermore, members of each group know the rank of their leader.

7 Construction of an inter-communicator from two intra-communicators requires separate
 8 collective operations in the local group and in the remote group, as well as a point-to-point
 9 communication between a process in the local group and a process in the remote group.

10 In standard MPI implementations (with static process allocation at initialization), the
 11 `MPI_COMM_WORLD` communicator (or preferably a dedicated duplicate thereof) can be this
 12 peer communicator. For applications that have used `spawn` or `join`, it may be necessary to
 13 first create an intracommunicator to be used as peer.

14 The application topology functions described in Chapter 7 do not apply to inter-
 15 communicators. Users that require this capability should utilize
 16 `MPI_INTERCOMM_MERGE` to build an intra-communicator, then apply the graph or carte-
 17 sian topology capabilities to that intra-communicator, creating an appropriate topology-
 18 oriented intra-communicator. Alternatively, it may be reasonable to devise one’s own ap-
 19 plication topology mechanisms for this case, without loss of generality.

```
21
22 MPI_INTERCOMM_CREATE(local_comm, local_leader, peer_comm, remote_leader, tag,
23                       newintercomm)
```

24	IN	local_comm	local intra-communicator (handle)
25	IN	local_leader	rank of local group leader in local_comm (integer)
26	IN	peer_comm	“peer” communicator; significant only at the
27			local_leader (handle)
28			
29	IN	remote_leader	rank of remote group leader in peer_comm; significant
30			only at the local_leader (integer)
31	IN	tag	tag (integer)
32			
33	OUT	newintercomm	new inter-communicator (handle)

```
34
35 int MPI_Intercomm_create(MPI_Comm local_comm, int local_leader,
36                         MPI_Comm peer_comm, int remote_leader, int tag,
37                         MPI_Comm *newintercomm)
38
39 MPI_Intercomm_create(local_comm, local_leader, peer_comm, remote_leader,
40                     tag, newintercomm, ierror)
41
42 TYPE(MPI_Comm), INTENT(IN) :: local_comm, peer_comm
43 INTEGER, INTENT(IN) :: local_leader, remote_leader, tag
44 TYPE(MPI_Comm), INTENT(OUT) :: newintercomm
45 INTEGER, OPTIONAL, INTENT(OUT) :: ierror
46
47 MPI_INTERCOMM_CREATE(LOCAL_COMM, LOCAL_LEADER, PEER_COMM, REMOTE_LEADER,
48                     TAG, NEWINTERCOMM, IERROR)
49
50 INTEGER LOCAL_COMM, LOCAL_LEADER, PEER_COMM, REMOTE_LEADER, TAG,
51 NEWINTERCOMM, IERROR
```

This call creates an inter-communicator. It is collective over the union of the local and remote groups. Processes should provide identical `local_comm` and `local_leader` arguments within each group. Wildcards are not permitted for `remote_leader`, `local_leader`, and `tag`.

```
MPI_INTERCOMM_MERGE(intercomm, high, newintracomm)
```

IN	<code>intercomm</code>	Inter-Communicator (handle)
IN	<code>high</code>	(logical)
OUT	<code>newintracomm</code>	new intra-communicator (handle)

```
int MPI_Intercomm_merge(MPI_Comm intercomm, int high,
                        MPI_Comm *newintracomm)
```

```
MPI_Intercomm_merge(intercomm, high, newintracomm, ierror)
```

```
TYPE(MPI_Comm), INTENT(IN) :: intercomm
LOGICAL, INTENT(IN) :: high
TYPE(MPI_Comm), INTENT(OUT) :: newintracomm
INTEGER, OPTIONAL, INTENT(OUT) :: ierror
```

```
MPI_INTERCOMM_MERGE(INTERCOMM, HIGH, NEWINTRACOMM, IERROR)
```

```
INTEGER INTERCOMM, NEWINTRACOMM, IERROR
LOGICAL HIGH
```

This function creates an intra-communicator from the union of the two groups that are associated with `intercomm`. All processes should provide the same `high` value within each of the two groups. If processes in one group provided the value `high = false` and processes in the other group provided the value `high = true` then the union orders the “low” group before the “high” group. If all processes provided the same `high` argument then the order of the union is arbitrary. This call is blocking and collective within the union of the two groups.

The error handler on the new intercommunicator in each process is inherited from the communicator that contributes the local group. Note that this can result in different processes in the same communicator having different error handlers.

Advice to implementors. The implementation of `MPI_INTERCOMM_MERGE`, `MPI_COMM_FREE`, and `MPI_COMM_DUP` are similar to the implementation of `MPI_INTERCOMM_CREATE`, except that contexts private to the input inter-communicator are used for communication between group leaders rather than contexts inside a bridge communicator. (*End of advice to implementors.*)

6.6.3 Inter-Communication Examples

Example 1: Three-Group “Pipeline”

Groups 0 and 1 communicate. Groups 1 and 2 communicate. Therefore, group 0 requires one inter-communicator, group 1 requires two inter-communicators, and group 2 requires 1 inter-communicator.

```
int main(int argc, char *argv[])
```

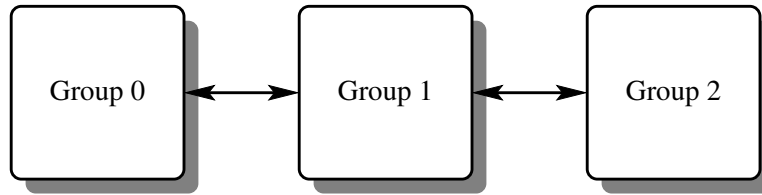

Figure 6.3: Three-group pipeline

```

1
2
3
4
5
6
7
8
9
10 {
11 MPI_Comm myComm; /* intra-communicator of local sub-group */
12 MPI_Comm myFirstComm; /* inter-communicator */
13 MPI_Comm mySecondComm; /* second inter-communicator (group 1 only) */
14 int membershipKey;
15 int rank;
16
17 MPI_Init(&argc, &argv);
18 MPI_Comm_rank(MPI_COMM_WORLD, &rank);
19
20 /* User code must generate membershipKey in the range [0, 1, 2] */
21 membershipKey = rank % 3;
22
23 /* Build intra-communicator for local sub-group */
24 MPI_Comm_split(MPI_COMM_WORLD, membershipKey, rank, &myComm);
25
26 /* Build inter-communicators. Tags are hard-coded. */
27 if (membershipKey == 0)
28 {
29     /* Group 0 communicates with group 1. */
30     MPI_Intercomm_create( myComm, 0, MPI_COMM_WORLD, 1,
31                           1, &myFirstComm);
32 }
33 else if (membershipKey == 1)
34 {
35     /* Group 1 communicates with groups 0 and 2. */
36     MPI_Intercomm_create( myComm, 0, MPI_COMM_WORLD, 0,
37                           1, &myFirstComm);
38     MPI_Intercomm_create( myComm, 0, MPI_COMM_WORLD, 2,
39                           12, &mySecondComm);
40 }
41 else if (membershipKey == 2)
42 {
43     /* Group 2 communicates with group 1. */
44     MPI_Intercomm_create( myComm, 0, MPI_COMM_WORLD, 1,
45                           12, &myFirstComm);
46 }
47
48 /* Do work ... */
49
50 switch(membershipKey) /* free communicators appropriately */
51 {

```

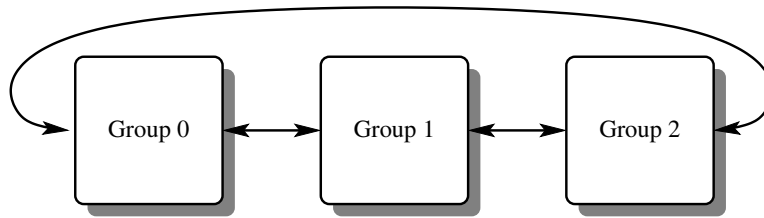

Figure 6.4: Three-group ring

```

case 1:
    MPI_Comm_free(&mySecondComm);
case 0:
case 2:
    MPI_Comm_free(&myFirstComm);
    break;
}

MPI_Finalize();
return 0;
}

```

Example 2: Three-Group “Ring”

Groups 0 and 1 communicate. Groups 1 and 2 communicate. Groups 0 and 2 communicate. Therefore, each requires two inter-communicators.

```

int main(int argc, char *argv[])
{
    MPI_Comm    myComm;        /* intra-communicator of local sub-group */
    MPI_Comm    myFirstComm; /* inter-communicators */
    MPI_Comm    mySecondComm;
    int membershipKey;
    int rank;

    MPI_Init(&argc, &argv);
    MPI_Comm_rank(MPI_COMM_WORLD, &rank);
    ...

    /* User code must generate membershipKey in the range [0, 1, 2] */
    membershipKey = rank % 3;

    /* Build intra-communicator for local sub-group */
    MPI_Comm_split(MPI_COMM_WORLD, membershipKey, rank, &myComm);

    /* Build inter-communicators. Tags are hard-coded. */
    if (membershipKey == 0)
    {
        /* Group 0 communicates with groups 1 and 2. */
        MPI_Intercomm_create(myComm, 0, MPI_COMM_WORLD, 1,

```

```

1           1, &myFirstComm);
2     MPI_Intercomm_create( myComm, 0, MPI_COMM_WORLD, 2,
3                           2, &mySecondComm);
4   }
5   else if (membershipKey == 1)
6   {           /* Group 1 communicates with groups 0 and 2. */
7     MPI_Intercomm_create( myComm, 0, MPI_COMM_WORLD, 0,
8                           1, &myFirstComm);
9     MPI_Intercomm_create( myComm, 0, MPI_COMM_WORLD, 2,
10                          12, &mySecondComm);
11  }
12  else if (membershipKey == 2)
13  {           /* Group 2 communicates with groups 0 and 1. */
14    MPI_Intercomm_create( myComm, 0, MPI_COMM_WORLD, 0,
15                          2, &myFirstComm);
16    MPI_Intercomm_create( myComm, 0, MPI_COMM_WORLD, 1,
17                          12, &mySecondComm);
18  }
19
20  /* Do some work ... */
21
22  /* Then free communicators before terminating... */
23  MPI_Comm_free(&myFirstComm);
24  MPI_Comm_free(&mySecondComm);
25  MPI_Comm_free(&myComm);
26  MPI_Finalize();
27  return 0;
28  }

```

6.7 Caching

MPI provides a “caching” facility that allows an application to attach arbitrary pieces of information, called **attributes**, to three kinds of MPI objects, communicators, windows, and datatypes. More precisely, the caching facility allows a portable library to do the following:

- pass information between calls by associating it with an MPI intra- or inter-communicator, window, or datatype,
- quickly retrieve that information, and
- be guaranteed that out-of-date information is never retrieved, even if the object is freed and its handle subsequently reused by MPI.

The caching capabilities, in some form, are required by built-in MPI routines such as collective communication and application topology. Defining an interface to these capabilities as part of the MPI standard is valuable because it permits routines like collective communication and application topologies to be implemented as portable code, and also because it makes MPI more extensible by allowing user-written routines to use standard MPI calling sequences.

Advice to users. The communicator `MPI_COMM_SELF` is a suitable choice for posting process-local attributes, via this attribute-caching mechanism. (*End of advice to users.*)

Rationale. In one extreme one can allow caching on all opaque handles. The other extreme is to only allow it on communicators. Caching has a cost associated with it and should only be allowed when it is clearly needed and the increased cost is modest. This is the reason that windows and datatypes were added but not other handles. (*End of rationale.*)

One difficulty is the potential for size differences between Fortran integers and C pointers. For this reason, the Fortran versions of these routines use integers of kind `MPI_ADDRESS_KIND`.

Advice to implementors. High-quality implementations should raise an error when a keyval that was created by a call to `MPI_XXX_CREATE_KEYVAL` is used with an object of the wrong type with a call to `MPI_YYY_GET_ATTR`, `MPI_YYY_SET_ATTR`, `MPI_YYY_DELETE_ATTR`, or `MPI_YYY_FREE_KEYVAL`. To do so, it is necessary to maintain, with each keyval, information on the type of the associated user function. (*End of advice to implementors.*)

6.7.1 Functionality

Attributes can be attached to communicators, windows, and datatypes. Attributes are local to the process and specific to the communicator to which they are attached. Attributes are not propagated by MPI from one communicator to another except when the communicator is duplicated using `MPI_COMM_DUP` or `MPI_COMM_IDUP` (and even then the application must give specific permission through callback functions for the attribute to be copied).

Advice to users. Attributes in C are of type `void *`. Typically, such an attribute will be a pointer to a structure that contains further information, or a handle to an MPI object. In Fortran, attributes are of type `INTEGER`. Such attribute can be a handle to an MPI object, or just an integer-valued attribute. (*End of advice to users.*)

Advice to implementors. Attributes are scalar values, equal in size to, or larger than a C-language pointer. Attributes can always hold an MPI handle. (*End of advice to implementors.*)

The caching interface defined here requires that attributes be stored by MPI opaquely within a communicator, window, and datatype. Accessor functions include the following:

- obtain a key value (used to identify an attribute); the user specifies “callback” functions by which MPI informs the application when the communicator is destroyed or copied.
- store and retrieve the value of an attribute;

Advice to implementors. Caching and callback functions are only called synchronously, in response to explicit application requests. This avoids problems that result from repeated crossings between user and system space. (This synchronous calling rule is a general property of MPI.)

The choice of key values is under control of MPI. This allows MPI to optimize its implementation of attribute sets. It also avoids conflict between independent modules caching information on the same communicators.

A much smaller interface, consisting of just a callback facility, would allow the entire caching facility to be implemented by portable code. However, with the minimal callback interface, some form of table searching is implied by the need to handle arbitrary communicators. In contrast, the more complete interface defined here permits rapid access to attributes through the use of pointers in communicators (to find the attribute table) and cleverly chosen key values (to retrieve individual attributes). In light of the efficiency “hit” inherent in the minimal interface, the more complete interface defined here is seen to be superior. (*End of advice to implementors.*)

MPI provides the following services related to caching. They are all process local.

6.7.2 Communicators

Functions for caching on communicators are:

```
MPI_COMM_CREATE_KEYVAL(comm_copy_attr_fn, comm_delete_attr_fn, comm_keyval,
                        extra_state)
```

IN	comm_copy_attr_fn	copy callback function for comm_keyval (function)
IN	comm_delete_attr_fn	delete callback function for comm_keyval (function)
OUT	comm_keyval	key value for future access (integer)
IN	extra_state	extra state for callback functions

```
int MPI_Comm_create_keyval(MPI_Comm_copy_attr_function *comm_copy_attr_fn,
                          MPI_Comm_delete_attr_function *comm_delete_attr_fn,
                          int *comm_keyval, void *extra_state)
```

```
MPI_Comm_create_keyval(comm_copy_attr_fn, comm_delete_attr_fn, comm_keyval,
                      extra_state, ierror)
```

```
PROCEDURE(MPI_Comm_copy_attr_function) :: comm_copy_attr_fn
PROCEDURE(MPI_Comm_delete_attr_function) :: comm_delete_attr_fn
INTEGER, INTENT(OUT) :: comm_keyval
INTEGER(KIND=MPI_ADDRESS_KIND), INTENT(IN) :: extra_state
INTEGER, OPTIONAL, INTENT(OUT) :: ierror
```

```
MPI_COMM_CREATE_KEYVAL(COMM_COPY_ATTR_FN, COMM_DELETE_ATTR_FN, COMM_KEYVAL,
                      EXTRA_STATE, IERROR)
```

```
EXTERNAL COMM_COPY_ATTR_FN, COMM_DELETE_ATTR_FN
INTEGER COMM_KEYVAL, IERROR
INTEGER(KIND=MPI_ADDRESS_KIND) EXTRA_STATE
```

Generates a new attribute key. Keys are locally unique in a process, and opaque to user, though they are explicitly stored in integers. Once allocated, the key value can be used to associate attributes and access them on any locally defined communicator.

The C callback functions are:

```

typedef int MPI_Comm_copy_attr_function(MPI_Comm oldcomm, int comm_keyval,
    void *extra_state, void *attribute_val_in,
    void *attribute_val_out, int *flag);

```

and

```

typedef int MPI_Comm_delete_attr_function(MPI_Comm comm, int comm_keyval,
    void *attribute_val, void *extra_state);

```

which are the same as the MPI-1.1 calls but with a new name. The old names are deprecated. With the `mpi_f08` module, the Fortran callback functions are:

ABSTRACT INTERFACE

```

SUBROUTINE MPI_Comm_copy_attr_function(oldcomm, comm_keyval, extra_state,
    attribute_val_in, attribute_val_out, flag, ierror)
    TYPE(MPI_Comm) :: oldcomm
    INTEGER :: comm_keyval, ierror
    INTEGER(KIND=MPI_ADDRESS_KIND) :: extra_state, attribute_val_in,
    attribute_val_out
    LOGICAL :: flag

```

and

ABSTRACT INTERFACE

```

SUBROUTINE MPI_Comm_delete_attr_function(comm, comm_keyval,
    attribute_val, extra_state, ierror)
    TYPE(MPI_Comm) :: comm
    INTEGER :: comm_keyval, ierror
    INTEGER(KIND=MPI_ADDRESS_KIND) :: attribute_val, extra_state

```

With the `mpi` module and `mpif.h`, the Fortran callback functions are:

```

SUBROUTINE COMM_COPY_ATTR_FUNCTION(OLDCOMM, COMM_KEYVAL, EXTRA_STATE,
    ATTRIBUTE_VAL_IN, ATTRIBUTE_VAL_OUT, FLAG, IERROR)
    INTEGER OLDCOMM, COMM_KEYVAL, IERROR
    INTEGER(KIND=MPI_ADDRESS_KIND) EXTRA_STATE, ATTRIBUTE_VAL_IN,
    ATTRIBUTE_VAL_OUT
    LOGICAL FLAG

```

and

```

SUBROUTINE COMM_DELETE_ATTR_FUNCTION(COMM, COMM_KEYVAL, ATTRIBUTE_VAL,
    EXTRA_STATE, IERROR)
    INTEGER COMM, COMM_KEYVAL, IERROR
    INTEGER(KIND=MPI_ADDRESS_KIND) ATTRIBUTE_VAL, EXTRA_STATE

```

The `comm_copy_attr_fn` function is invoked when a communicator is duplicated by `MPI_COMM_DUP` or `MPI_COMM_IDUP`. `comm_copy_attr_fn` should be of type `MPI_Comm_copy_attr_function`. The copy callback function is invoked for each key value in `oldcomm` in arbitrary order. Each call to the copy callback is made with a key value and its corresponding attribute. If it returns `flag = 0` or `.FALSE.`, then the attribute is deleted in the duplicated communicator. Otherwise (`flag = 1` or `.TRUE.`), the new attribute value is set to the value returned in `attribute_val_out`. The function returns `MPI_SUCCESS` on success and an error code on failure (in which case `MPI_COMM_DUP` or `MPI_COMM_IDUP` will fail).

1 The argument `comm_copy_attr_fn` may be specified as `MPI_COMM_NULL_COPY_FN`
 2 or `MPI_COMM_DUP_FN` from either C or Fortran. `MPI_COMM_NULL_COPY_FN` is a
 3 function that does nothing other than returning `flag = 0` or `.FALSE.` (depending on whether
 4 the keyval was created with a C or Fortran binding to `MPI_COMM_CREATE_KEYVAL`) and
 5 `MPI_SUCCESS`. `MPI_COMM_DUP_FN` is a simple-minded copy function that sets `flag = 1` or
 6 `.TRUE.`, returns the value of `attribute_val_in` in `attribute_val_out`, and returns `MPI_SUCCESS`.
 7 These replace the MPI-1 predefined callbacks `MPI_NULL_COPY_FN` and `MPI_DUP_FN`,
 8 whose use is deprecated.

9
 10 *Advice to users.* Even though both formal arguments `attribute_val_in` and
 11 `attribute_val_out` are of type `void *`, their usage differs. The C copy function is passed
 12 by MPI in `attribute_val_in` the *value* of the attribute, and in `attribute_val_out` the
 13 *address* of the attribute, so as to allow the function to return the (new) attribute
 14 value. The use of type `void *` for both is to avoid messy type casts.

15 A valid copy function is one that completely duplicates the information by making
 16 a full duplicate copy of the data structures implied by an attribute; another might
 17 just make another reference to that data structure, while using a reference-count
 18 mechanism. Other types of attributes might not copy at all (they might be specific
 19 to `oldcomm` only). (*End of advice to users.*)

20
 21 *Advice to implementors.* A C interface should be assumed for copy and delete
 22 functions associated with key values created in C; a Fortran calling interface should
 23 be assumed for key values created in Fortran. (*End of advice to implementors.*)

24
 25 Analogous to `comm_copy_attr_fn` is a callback deletion function, defined as follows.
 26 The `comm_delete_attr_fn` function is invoked when a communicator is deleted by
 27 `MPI_COMM_FREE` or when a call is made explicitly to `MPI_COMM_DELETE_ATTR`.
 28 `comm_delete_attr_fn` should be of type `MPI_Comm_delete_attr_function`.

29 This function is called by `MPI_COMM_FREE`, `MPI_COMM_DELETE_ATTR`, and
 30 `MPI_COMM_SET_ATTR` to do whatever is needed to remove an attribute. The function
 31 returns `MPI_SUCCESS` on success and an error code on failure (in which case
 32 `MPI_COMM_FREE` will fail).

33 The argument `comm_delete_attr_fn` may be specified as
 34 `MPI_COMM_NULL_DELETE_FN` from either C or Fortran.
 35 `MPI_COMM_NULL_DELETE_FN` is a function that does nothing, other than returning
 36 `MPI_SUCCESS`. `MPI_COMM_NULL_DELETE_FN` replaces `MPI_NULL_DELETE_FN`, whose
 37 use is deprecated.

38 If an attribute copy function or attribute delete function returns other than
 39 `MPI_SUCCESS`, then the call that caused it to be invoked (for example, `MPI_COMM_FREE`),
 40 is erroneous.

41 The special key value `MPI_KEYVAL_INVALID` is never returned by
 42 `MPI_COMM_CREATE_KEYVAL`. Therefore, it can be used for static initialization of key
 43 values.

44
 45 *Advice to implementors.* The predefined Fortran functions
 46 `MPI_COMM_NULL_COPY_FN`, `MPI_COMM_DUP_FN`, and
 47 `MPI_COMM_NULL_DELETE_FN` are defined in the `mpi` module (and `mpif.h`) and
 48 the `mpi_f08` module with the same name, but with different interfaces. Each function

can coexist twice with the same name in the same MPI library, one routine as an implicit interface outside of the `mpi` module, i.e., declared as `EXTERNAL`, and the other routine within `mpi_f08` declared with `CONTAINS`. These routines have different link names, which are also different to the link names used for the routines used in C. (*End of advice to implementors.*)

Advice to users. Callbacks, including the predefined Fortran functions `MPI_COMM_NULL_COPY_FN`, `MPI_COMM_DUP_FN`, and `MPI_COMM_NULL_DELETE_FN` should not be passed from one application routine that uses the `mpi_f08` module to another application routine that uses the `mpi` module or `mpif.h`, and vice versa; see also the advice to users on page 696. (*End of advice to users.*)

`MPI_COMM_FREE_KEYVAL(comm_keyval)`

INOUT `comm_keyval` key value (integer)

`int MPI_Comm_free_keyval(int *comm_keyval)`

`MPI_Comm_free_keyval(comm_keyval, ierror)`

INTEGER, INTENT(INOUT) :: `comm_keyval`

INTEGER, OPTIONAL, INTENT(OUT) :: `ierror`

`MPI_COMM_FREE_KEYVAL(COMM_KEYVAL, IERROR)`

INTEGER `COMM_KEYVAL`, `IERROR`

Frees an extant attribute key. This function sets the value of `keyval` to `MPI_KEYVAL_INVALID`. Note that it is not erroneous to free an attribute key that is in use, because the actual free does not transpire until after all references (in other communicators on the process) to the key have been freed. These references need to be explicitly freed by the program, either via calls to `MPI_COMM_DELETE_ATTR` that free one attribute instance, or by calls to `MPI_COMM_FREE` that free all attribute instances associated with the freed communicator.

`MPI_COMM_SET_ATTR(comm, comm_keyval, attribute_val)`

INOUT `comm` communicator from which attribute will be attached (handle)

IN `comm_keyval` key value (integer)

IN `attribute_val` attribute value

`int MPI_Comm_set_attr(MPI_Comm comm, int comm_keyval, void *attribute_val)`

`MPI_Comm_set_attr(comm, comm_keyval, attribute_val, ierror)`

TYPE(`MPI_Comm`), INTENT(IN) :: `comm`

INTEGER, INTENT(IN) :: `comm_keyval`

INTEGER(KIND=`MPI_ADDRESS_KIND`), INTENT(IN) :: `attribute_val`

INTEGER, OPTIONAL, INTENT(OUT) :: `ierror`

```

1 MPI_COMM_SET_ATTR(COMM, COMM_KEYVAL, ATTRIBUTE_VAL, IERROR)
2     INTEGER COMM, COMM_KEYVAL, IERROR
3     INTEGER(KIND=MPI_ADDRESS_KIND) ATTRIBUTE_VAL

```

This function stores the stipulated attribute value `attribute_val` for subsequent retrieval by `MPI_COMM_GET_ATTR`. If the value is already present, then the outcome is as if `MPI_COMM_DELETE_ATTR` was first called to delete the previous value (and the callback function `comm_delete_attr_fn` was executed), and a new value was next stored. The call is erroneous if there is no key with value `keyval`; in particular `MPI_KEYVAL_INVALID` is an erroneous key value. The call will fail if the `comm_delete_attr_fn` function returned an error code other than `MPI_SUCCESS`.

```

13 MPI_COMM_GET_ATTR(comm, comm_keyval, attribute_val, flag)
14     IN         comm                communicator to which the attribute is attached (handle)
15
16     IN         comm_keyval         key value (integer)
17
18     OUT        attribute_val       attribute value, unless flag = false
19
20     OUT        flag                false if no attribute is associated with the key (logical)

```

```

21
22 int MPI_Comm_get_attr(MPI_Comm comm, int comm_keyval, void *attribute_val,
23                     int *flag)

```

```

24 MPI_Comm_get_attr(comm, comm_keyval, attribute_val, flag, ierror)
25     TYPE(MPI_Comm), INTENT(IN) :: comm
26     INTEGER, INTENT(IN) :: comm_keyval
27     INTEGER(KIND=MPI_ADDRESS_KIND), INTENT(OUT) :: attribute_val
28     LOGICAL, INTENT(OUT) :: flag
29     INTEGER, OPTIONAL, INTENT(OUT) :: ierror

```

```

31 MPI_COMM_GET_ATTR(COMM, COMM_KEYVAL, ATTRIBUTE_VAL, FLAG, IERROR)
32     INTEGER COMM, COMM_KEYVAL, IERROR
33     INTEGER(KIND=MPI_ADDRESS_KIND) ATTRIBUTE_VAL
34     LOGICAL FLAG

```

Retrieves attribute value by key. The call is erroneous if there is no key with value `keyval`. On the other hand, the call is correct if the key value exists, but no attribute is attached on `comm` for that key; in such case, the call returns `flag = false`. In particular `MPI_KEYVAL_INVALID` is an erroneous key value.

Advice to users. The call to `MPI_Comm_set_attr` passes in `attribute_val` the *value* of the attribute; the call to `MPI_Comm_get_attr` passes in `attribute_val` the *address* of the location where the attribute value is to be returned. Thus, if the attribute value itself is a pointer of type `void*`, then the actual `attribute_val` parameter to `MPI_Comm_set_attr` will be of type `void*` and the actual `attribute_val` parameter to `MPI_Comm_get_attr` will be of type `void**`. (*End of advice to users.*)

Rationale. The use of a formal parameter `attribute_val` of type `void*` (rather than `void**`) avoids the messy type casting that would be needed if the attribute value is

declared with a type other than void*. (*End of rationale.*)

MPI_COMM_DELETE_ATTR(comm, comm_keyval)

INOUT comm communicator from which the attribute is deleted (handle)

IN comm_keyval key value (integer)

int MPI_Comm_delete_attr(MPI_Comm comm, int comm_keyval)

MPI_Comm_delete_attr(comm, comm_keyval, ierror)

TYPE(MPI_Comm), INTENT(IN) :: comm

INTEGER, INTENT(IN) :: comm_keyval

INTEGER, OPTIONAL, INTENT(OUT) :: ierror

MPI_COMM_DELETE_ATTR(COMM, COMM_KEYVAL, IERROR)

INTEGER COMM, COMM_KEYVAL, IERROR

Delete attribute from cache by key. This function invokes the attribute delete function `comm_delete_attr_fn` specified when the keyval was created. The call will fail if the `comm_delete_attr_fn` function returns an error code other than `MPI_SUCCESS`.

Whenever a communicator is replicated using the function `MPI_COMM_DUP` or `MPI_COMM_IDUP`, all call-back copy functions for attributes that are currently set are invoked (in arbitrary order). Whenever a communicator is deleted using the function `MPI_COMM_FREE` all callback delete functions for attributes that are currently set are invoked.

6.7.3 Windows

The functions for caching on windows are:

MPI_WIN_CREATE_KEYVAL(win_copy_attr_fn, win_delete_attr_fn, win_keyval, extra_state)

IN win_copy_attr_fn copy callback function for win_keyval (function)

IN win_delete_attr_fn delete callback function for win_keyval (function)

OUT win_keyval key value for future access (integer)

IN extra_state extra state for callback functions

int MPI_Win_create_keyval(MPI_Win_copy_attr_function *win_copy_attr_fn,

MPI_Win_delete_attr_function *win_delete_attr_fn,

int *win_keyval, void *extra_state)

MPI_Win_create_keyval(win_copy_attr_fn, win_delete_attr_fn, win_keyval, extra_state, ierror)

PROCEDURE(MPI_Win_copy_attr_function) :: win_copy_attr_fn

PROCEDURE(MPI_Win_delete_attr_function) :: win_delete_attr_fn

```

1     INTEGER, INTENT(OUT) :: win_keyval
2     INTEGER(KIND=MPI_ADDRESS_KIND), INTENT(IN) :: extra_state
3     INTEGER, OPTIONAL, INTENT(OUT) :: ierror
4
5     MPI_WIN_CREATE_KEYVAL(WIN_COPY_ATTR_FN, WIN_DELETE_ATTR_FN, WIN_KEYVAL,
6                           EXTRA_STATE, IERROR)
7     EXTERNAL WIN_COPY_ATTR_FN, WIN_DELETE_ATTR_FN
8     INTEGER WIN_KEYVAL, IERROR
9     INTEGER(KIND=MPI_ADDRESS_KIND) EXTRA_STATE

```

10 The argument `win_copy_attr_fn` may be specified as `MPI_WIN_NULL_COPY_FN` or
11 `MPI_WIN_DUP_FN` from either C or Fortran. `MPI_WIN_NULL_COPY_FN` is a function
12 that does nothing other than returning `flag = 0` and `MPI_SUCCESS`. `MPI_WIN_DUP_FN` is
13 a simple-minded copy function that sets `flag = 1`, returns the value of `attribute_val_in` in
14 `attribute_val_out`, and returns `MPI_SUCCESS`.

15 The argument `win_delete_attr_fn` may be specified as `MPI_WIN_NULL_DELETE_FN`
16 from either C or Fortran. `MPI_WIN_NULL_DELETE_FN` is a function that does nothing,
17 other than returning `MPI_SUCCESS`.

18 The C callback functions are:

```

19 typedef int MPI_Win_copy_attr_function(MPI_Win oldwin, int win_keyval,
20                                       void *extra_state, void *attribute_val_in,
21                                       void *attribute_val_out, int *flag);

```

22 and

```

23 typedef int MPI_Win_delete_attr_function(MPI_Win win, int win_keyval,
24                                         void *attribute_val, void *extra_state);

```

26 With the `mpi_f08` module, the Fortran callback functions are:

```

27 ABSTRACT INTERFACE
28   SUBROUTINE MPI_Win_copy_attr_function(oldwin, win_keyval, extra_state,
29   attribute_val_in, attribute_val_out, flag, ierror)
30     TYPE(MPI_Win) :: oldwin
31     INTEGER :: win_keyval, ierror
32     INTEGER(KIND=MPI_ADDRESS_KIND) :: extra_state, attribute_val_in,
33     attribute_val_out
34     LOGICAL :: flag

```

36 and

```

37 ABSTRACT INTERFACE
38   SUBROUTINE MPI_Win_delete_attr_function(win, win_keyval, attribute_val,
39   extra_state, ierror)
40     TYPE(MPI_Win) :: win
41     INTEGER :: win_keyval, ierror
42     INTEGER(KIND=MPI_ADDRESS_KIND) :: attribute_val, extra_state

```

43 With the `mpi` module and `mpif.h`, the Fortran callback functions are:

```

44 SUBROUTINE WIN_COPY_ATTR_FUNCTION(OLDWIN, WIN_KEYVAL, EXTRA_STATE,
45   ATTRIBUTE_VAL_IN, ATTRIBUTE_VAL_OUT, FLAG, IERROR)
46   INTEGER OLDWIN, WIN_KEYVAL, IERROR
47   INTEGER(KIND=MPI_ADDRESS_KIND) EXTRA_STATE, ATTRIBUTE_VAL_IN,

```

48

```

        ATTRIBUTE_VAL_OUT                                1
    LOGICAL FLAG                                        2
and                                                    3
SUBROUTINE WIN_DELETE_ATTR_FUNCTION(WIN, WIN_KEYVAL, ATTRIBUTE_VAL, 4
        EXTRA_STATE, IERROR)                            5
    INTEGER WIN, WIN_KEYVAL, IERROR                      6
    INTEGER(KIND=MPI_ADDRESS_KIND) ATTRIBUTE_VAL, EXTRA_STATE 7
    8
    If an attribute copy function or attribute delete function returns other than 9
    MPI_SUCCESS, then the call that caused it to be invoked (for example, MPI_WIN_FREE), is 10
    erroneous.                                           11
    12
MPI_WIN_FREE_KEYVAL(win_keyval)                        13
    INOUT  win_keyval                                   key value (integer) 14
    15
int MPI_Win_free_keyval(int *win_keyval)              16
MPI_Win_free_keyval(win_keyval, ierror)               17
    INTEGER, INTENT(INOUT) :: win_keyval                18
    INTEGER, OPTIONAL, INTENT(OUT) :: ierror           19
MPI_WIN_FREE_KEYVAL(WIN_KEYVAL, IERROR)              20
    INTEGER WIN_KEYVAL, IERROR                          21
    22
MPI_WIN_SET_ATTR(win, win_keyval, attribute_val)      23
    INOUT  win                                         window to which attribute will be attached (handle) 24
    IN     win_keyval                                   key value (integer) 25
    IN     attribute_val                               attribute value      26
int MPI_Win_set_attr(MPI_Win win, int win_keyval, void *attribute_val) 27
MPI_Win_set_attr(win, win_keyval, attribute_val, ierror) 28
    TYPE(MPI_Win), INTENT(IN) :: win                    29
    INTEGER, INTENT(IN) :: win_keyval                   30
    INTEGER(KIND=MPI_ADDRESS_KIND), INTENT(IN) :: attribute_val 31
    INTEGER, OPTIONAL, INTENT(OUT) :: ierror            32
MPI_WIN_SET_ATTR(WIN, WIN_KEYVAL, ATTRIBUTE_VAL, IERROR) 33
    INTEGER WIN, WIN_KEYVAL, IERROR                      34
    INTEGER(KIND=MPI_ADDRESS_KIND) ATTRIBUTE_VAL         35
    36
    37
    38
    39
    40
    41
    42
    43
    44
    45
    46
    47
    48

```

```

1 MPI_WIN_GET_ATTR(win, win_keyval, attribute_val, flag)
2     IN      win                window to which the attribute is attached (handle)
3
4     IN      win_keyval         key value (integer)
5
6     OUT     attribute_val       attribute value, unless flag = false
7
8     OUT     flag                false if no attribute is associated with the key (logical)
9
10
11 int MPI_Win_get_attr(MPI_Win win, int win_keyval, void *attribute_val,
12                     int *flag)
13
14 MPI_Win_get_attr(win, win_keyval, attribute_val, flag, ierror)
15     TYPE(MPI_Win), INTENT(IN) :: win
16     INTEGER, INTENT(IN) :: win_keyval
17     INTEGER(KIND=MPI_ADDRESS_KIND), INTENT(OUT) :: attribute_val
18     LOGICAL, INTENT(OUT) :: flag
19     INTEGER, OPTIONAL, INTENT(OUT) :: ierror
20
21 MPI_WIN_GET_ATTR(WIN, WIN_KEYVAL, ATTRIBUTE_VAL, FLAG, IERROR)
22     INTEGER WIN, WIN_KEYVAL, IERROR
23     INTEGER(KIND=MPI_ADDRESS_KIND) ATTRIBUTE_VAL
24     LOGICAL FLAG
25
26
27 MPI_WIN_DELETE_ATTR(win, win_keyval)
28
29     INOUT   win                window from which the attribute is deleted (handle)
30
31     IN      win_keyval         key value (integer)
32
33
34 int MPI_Win_delete_attr(MPI_Win win, int win_keyval)
35
36 MPI_Win_delete_attr(win, win_keyval, ierror)
37     TYPE(MPI_Win), INTENT(IN) :: win
38     INTEGER, INTENT(IN) :: win_keyval
39     INTEGER, OPTIONAL, INTENT(OUT) :: ierror
40
41 MPI_WIN_DELETE_ATTR(WIN, WIN_KEYVAL, IERROR)
42     INTEGER WIN, WIN_KEYVAL, IERROR
43
44
45
46
47
48

```

6.7.4 Datatypes

The new functions for caching on datatypes are:

	MPI_TYPE_CREATE_KEYVAL(type_copy_attr_fn, type_delete_attr_fn, type_keyval,	1	
	extra_state)	2	
IN	type_copy_attr_fn	copy callback function for type_keyval (function)	3
IN	type_delete_attr_fn	delete callback function for type_keyval (function)	4
OUT	type_keyval	key value for future access (integer)	6
IN	extra_state	extra state for callback functions	7

```

int MPI_Type_create_keyval(MPI_Type_copy_attr_function *type_copy_attr_fn,
                           MPI_Type_delete_attr_function *type_delete_attr_fn,
                           int *type_keyval, void *extra_state)

```

```

MPI_Type_create_keyval(type_copy_attr_fn, type_delete_attr_fn, type_keyval,
                       extra_state, ierror)
PROCEDURE(MPI_Type_copy_attr_function) :: type_copy_attr_fn
PROCEDURE(MPI_Type_delete_attr_function) :: type_delete_attr_fn
INTEGER, INTENT(OUT) :: type_keyval
INTEGER(KIND=MPI_ADDRESS_KIND), INTENT(IN) :: extra_state
INTEGER, OPTIONAL, INTENT(OUT) :: ierror

```

```

MPI_TYPE_CREATE_KEYVAL(TYPE_COPY_ATTR_FN, TYPE_DELETE_ATTR_FN, TYPE_KEYVAL,
                       EXTRA_STATE, IERROR)
EXTERNAL TYPE_COPY_ATTR_FN, TYPE_DELETE_ATTR_FN
INTEGER TYPE_KEYVAL, IERROR
INTEGER(KIND=MPI_ADDRESS_KIND) EXTRA_STATE

```

The argument `type_copy_attr_fn` may be specified as `MPI_TYPE_NULL_COPY_FN` or `MPI_TYPE_DUP_FN` from either C or Fortran. `MPI_TYPE_NULL_COPY_FN` is a function that does nothing other than returning `flag = 0` and `MPI_SUCCESS`. `MPI_TYPE_DUP_FN` is a simple-minded copy function that sets `flag = 1`, returns the value of `attribute_val_in` in `attribute_val_out`, and returns `MPI_SUCCESS`.

The argument `type_delete_attr_fn` may be specified as `MPI_TYPE_NULL_DELETE_FN` from either C or Fortran. `MPI_TYPE_NULL_DELETE_FN` is a function that does nothing, other than returning `MPI_SUCCESS`.

The C callback functions are:

```

typedef int MPI_Type_copy_attr_function(MPI_Datatype oldtype,
                                       int type_keyval, void *extra_state, void *attribute_val_in,
                                       void *attribute_val_out, int *flag);

```

and

```

typedef int MPI_Type_delete_attr_function(MPI_Datatype datatype,
                                       int type_keyval, void *attribute_val, void *extra_state);

```

With the `mpi_f08` module, the Fortran callback functions are:

```

ABSTRACT INTERFACE
SUBROUTINE MPI_Type_copy_attr_function(oldtype, type_keyval, extra_state,
attribute_val_in, attribute_val_out, flag, ierror)
TYPE(MPI_Datatype) :: oldtype
INTEGER :: type_keyval, ierror

```

```

1      INTEGER(KIND=MPI_ADDRESS_KIND) ::  extra_state, attribute_val_in,
2      attribute_val_out
3      LOGICAL ::  flag

```

4 and

```

5 ABSTRACT INTERFACE
6   SUBROUTINE MPI_Type_delete_attr_function(datatype, type_keyval,
7     attribute_val, extra_state, ierror)
8     TYPE(MPI_Datatype) ::  datatype
9     INTEGER ::  type_keyval, ierror
10    INTEGER(KIND=MPI_ADDRESS_KIND) ::  attribute_val, extra_state

```

12 With the mpi module and mpif.h, the Fortran callback functions are:

```

13 SUBROUTINE TYPE_COPY_ATTR_FUNCTION(OLDTYPE, TYPE_KEYVAL, EXTRA_STATE,
14   ATTRIBUTE_VAL_IN, ATTRIBUTE_VAL_OUT, FLAG, IERROR)
15   INTEGER OLDTYPE, TYPE_KEYVAL, IERROR
16   INTEGER(KIND=MPI_ADDRESS_KIND) EXTRA_STATE,
17   ATTRIBUTE_VAL_IN, ATTRIBUTE_VAL_OUT
18   LOGICAL FLAG

```

19 and

```

20 SUBROUTINE TYPE_DELETE_ATTR_FUNCTION(DATATYPE, TYPE_KEYVAL, ATTRIBUTE_VAL,
21   EXTRA_STATE, IERROR)
22   INTEGER DATATYPE, TYPE_KEYVAL, IERROR
23   INTEGER(KIND=MPI_ADDRESS_KIND) ATTRIBUTE_VAL, EXTRA_STATE

```

25 If an attribute copy function or attribute delete function returns other than
26 MPI_SUCCESS, then the call that caused it to be invoked (for example, MPI_TYPE_FREE),
27 is erroneous.

28

```

29
30 MPI_TYPE_FREE_KEYVAL(type_keyval)
31   INOUT   type_keyval           key value (integer)
32

```

```

33 int MPI_Type_free_keyval(int *type_keyval)
34 MPI_Type_free_keyval(type_keyval, ierror)
35   INTEGER, INTENT(INOUT) ::  type_keyval
36   INTEGER, OPTIONAL, INTENT(OUT) ::  ierror
37
38 MPI_TYPE_FREE_KEYVAL(TYPE_KEYVAL, IERROR)
39   INTEGER TYPE_KEYVAL, IERROR
40

```

41

42

43

44

45

46

47

48

```

MPI_TYPE_SET_ATTR(datatype, type_keyval, attribute_val) 1
    INOUT datatype datatype to which attribute will be attached (handle) 2
    IN type_keyval key value (integer) 3
    IN attribute_val attribute value 4
    5
    6
int MPI_Type_set_attr(MPI_Datatype datatype, int type_keyval, 7
    void *attribute_val) 8
    9
MPI_Type_set_attr(datatype, type_keyval, attribute_val, ierror) 10
    TYPE(MPI_Datatype), INTENT(IN) :: datatype 11
    INTEGER, INTENT(IN) :: type_keyval 12
    INTEGER(KIND=MPI_ADDRESS_KIND), INTENT(IN) :: attribute_val 13
    INTEGER, OPTIONAL, INTENT(OUT) :: ierror 14
MPI_TYPE_SET_ATTR(DATATYPE, TYPE_KEYVAL, ATTRIBUTE_VAL, IERROR) 15
    INTEGER DATATYPE, TYPE_KEYVAL, IERROR 16
    INTEGER(KIND=MPI_ADDRESS_KIND) ATTRIBUTE_VAL 17
    18
    19
MPI_TYPE_GET_ATTR(datatype, type_keyval, attribute_val, flag) 20
    IN datatype datatype to which the attribute is attached (handle) 21
    IN type_keyval key value (integer) 22
    OUT attribute_val attribute value, unless flag = false 23
    OUT flag false if no attribute is associated with the key (logical) 24
    25
    26
int MPI_Type_get_attr(MPI_Datatype datatype, int type_keyval, 27
    void *attribute_val, int *flag) 28
    29
MPI_Type_get_attr(datatype, type_keyval, attribute_val, flag, ierror) 30
    TYPE(MPI_Datatype), INTENT(IN) :: datatype 31
    INTEGER, INTENT(IN) :: type_keyval 32
    INTEGER(KIND=MPI_ADDRESS_KIND), INTENT(OUT) :: attribute_val 33
    LOGICAL, INTENT(OUT) :: flag 34
    INTEGER, OPTIONAL, INTENT(OUT) :: ierror 35
    36
MPI_TYPE_GET_ATTR(DATATYPE, TYPE_KEYVAL, ATTRIBUTE_VAL, FLAG, IERROR) 37
    INTEGER DATATYPE, TYPE_KEYVAL, IERROR 38
    INTEGER(KIND=MPI_ADDRESS_KIND) ATTRIBUTE_VAL 39
    LOGICAL FLAG 40
    41
    42
MPI_TYPE_DELETE_ATTR(datatype, type_keyval) 43
    INOUT datatype datatype from which the attribute is deleted (handle) 44
    IN type_keyval key value (integer) 45
    46
    47
int MPI_Type_delete_attr(MPI_Datatype datatype, int type_keyval) 48

```

```

1 MPI_Type_delete_attr(datatype, type_keyval, ierror)
2     TYPE(MPI_Datatype), INTENT(IN) :: datatype
3     INTEGER, INTENT(IN) :: type_keyval
4     INTEGER, OPTIONAL, INTENT(OUT) :: ierror
5
6 MPI_TYPE_DELETE_ATTR(DATATYPE, TYPE_KEYVAL, IERROR)
7     INTEGER DATATYPE, TYPE_KEYVAL, IERROR
8

```

6.7.5 Error Class for Invalid Keyval

Key values for attributes are system-allocated, by `MPI_{TYPE,COMM,WIN}_CREATE_KEYVAL`. Only such values can be passed to the functions that use key values as input arguments. In order to signal that an erroneous key value has been passed to one of these functions, there is a new MPI error class: `MPI_ERR_KEYVAL`. It can be returned by `MPI_ATTR_PUT`, `MPI_ATTR_GET`, `MPI_ATTR_DELETE`, `MPI_KEYVAL_FREE`, `MPI_{TYPE,COMM,WIN}_DELETE_ATTR`, `MPI_{TYPE,COMM,WIN}_SET_ATTR`, `MPI_{TYPE,COMM,WIN}_GET_ATTR`, `MPI_{TYPE,COMM,WIN}_FREE_KEYVAL`, `MPI_COMM_DUP`, `MPI_COMM_IDUP`, `MPI_COMM_DISCONNECT`, and `MPI_COMM_FREE`. The last four are included because `keyval` is an argument to the copy and delete functions for attributes.

6.7.6 Attributes Example

Advice to users. This example shows how to write a collective communication operation that uses caching to be more efficient after the first call. (*End of advice to users.*)

```

28 /* key for this module's stuff: */
29 static int gop_key = MPI_KEYVAL_INVALID;
30
31 typedef struct
32 {
33     int ref_count;          /* reference count */
34     /* other stuff, whatever else we want */
35 } gop_stuff_type;
36
37 void Efficient_Collective_Op (MPI_Comm comm, ...)
38 {
39     gop_stuff_type *gop_stuff;
40     MPI_Group      group;
41     int            foundflag;
42
43     MPI_Comm_group(comm, &group);
44
45     if (gop_key == MPI_KEYVAL_INVALID) /* get a key on first call ever */
46     {
47         if ( ! MPI_Comm_create_keyval( gop_stuff_copier,
48                                         gop_stuff_destructor,

```

```

        &gop_key, (void *)0) ) {
1
    /* get the key while assigning its copy and delete callback
2
       behavior. */
3
    } else
4
        MPI_Abort (comm, 99);
5
    }
6
7
MPI_Comm_get_attr (comm, gop_key, &gop_stuff, &foundflag);
8
if (foundflag)
9
{ /* This module has executed in this group before.
10
   We will use the cached information */
11
}
12
else
13
{ /* This is a group that we have not yet cached anything in.
14
   We will now do so.
15
   */
16
17
   /* First, allocate storage for the stuff we want,
18
      and initialize the reference count */
19
20
   gop_stuff = (gop_stuff_type *) malloc (sizeof(gop_stuff_type));
21
   if (gop_stuff == NULL) { /* abort on out-of-memory error */ }
22
23
   gop_stuff -> ref_count = 1;
24
25
   /* Second, fill in *gop_stuff with whatever we want.
26
      This part isn't shown here */
27
28
   /* Third, store gop_stuff as the attribute value */
29
   MPI_Comm_set_attr (comm, gop_key, gop_stuff);
30
}
31
/* Then, in any case, use contents of *gop_stuff
32
   to do the global op ... */
33
}
34
35
/* The following routine is called by MPI when a group is freed */
36
37
int gop_stuff_destructor (MPI_Comm comm, int keyval, void *gop_stuffP,
38
                          void *extra)
39
{
40
    gop_stuff_type *gop_stuff = (gop_stuff_type *)gop_stuffP;
41
    if (keyval != gop_key) { /* abort -- programming error */ }
42
43
    /* The group's being freed removes one reference to gop_stuff */
44
    gop_stuff -> ref_count -= 1;
45
46
    /* If no references remain, then free the storage */
47
    if (gop_stuff -> ref_count == 0) {
48

```

```

1     free((void *)gop_stuff);
2     }
3     return MPI_SUCCESS;
4     }
5
6     /* The following routine is called by MPI when a group is copied */
7     int gop_stuff_copier (MPI_Comm comm, int keyval, void *extra,
8     void *gop_stuff_inP, void *gop_stuff_outP, int *flag)
9     {
10    gop_stuff_type *gop_stuff_in = (gop_stuff_type *)gop_stuff_inP;
11    gop_stuff_type **gop_stuff_out = (gop_stuff_type **)gop_stuff_outP;
12    if (keyval != gop_key) { /* abort -- programming error */ }
13
14    /* The new group adds one reference to this gop_stuff */
15    gop_stuff_in -> ref_count += 1;
16    *gop_stuff_out = gop_stuff_in;
17    return MPI_SUCCESS;
18    }
19
20
21

```

6.8 Naming Objects

There are many occasions on which it would be useful to allow a user to associate a printable identifier with an MPI communicator, window, or datatype, for instance error reporting, debugging, and profiling. The names attached to opaque objects do not propagate when the object is duplicated or copied by MPI routines. For communicators this can be achieved using the following two functions.

MPI_COMM_SET_NAME (comm, comm_name)

INOUT	comm	communicator whose identifier is to be set (handle)
IN	comm_name	the character string which is remembered as the name (string)

```
int MPI_Comm_set_name(MPI_Comm comm, const char *comm_name)
```

```

MPI_Comm_set_name(comm, comm_name, ierror)
    TYPE(MPI_Comm), INTENT(IN) :: comm
    CHARACTER(LEN=*), INTENT(IN) :: comm_name
    INTEGER, OPTIONAL, INTENT(OUT) :: ierror

```

```

MPI_COMM_SET_NAME(COMM, COMM_NAME, IERROR)
    INTEGER COMM, IERROR
    CHARACTER*(*) COMM_NAME

```

MPI_COMM_SET_NAME allows a user to associate a name string with a communicator. The character string which is passed to **MPI_COMM_SET_NAME** will be saved inside the MPI library (so it can be freed by the caller immediately after the call, or allocated on the

stack). Leading spaces in `name` are significant but trailing ones are not.

`MPI_COMM_SET_NAME` is a local (non-collective) operation, which only affects the name of the communicator as seen in the process which made the `MPI_COMM_SET_NAME` call. There is no requirement that the same (or any) name be assigned to a communicator in every process where it exists.

Advice to users. Since `MPI_COMM_SET_NAME` is provided to help debug code, it is sensible to give the same name to a communicator in all of the processes where it exists, to avoid confusion. (*End of advice to users.*)

The length of the name which can be stored is limited to the value of `MPI_MAX_OBJECT_NAME` in Fortran and `MPI_MAX_OBJECT_NAME-1` in C to allow for the null terminator. Attempts to put names longer than this will result in truncation of the name. `MPI_MAX_OBJECT_NAME` must have a value of at least 64.

Advice to users. Under circumstances of store exhaustion an attempt to put a name of any length could fail, therefore the value of `MPI_MAX_OBJECT_NAME` should be viewed only as a strict upper bound on the name length, not a guarantee that setting names of less than this length will always succeed. (*End of advice to users.*)

Advice to implementors. Implementations which pre-allocate a fixed size space for a name should use the length of that allocation as the value of `MPI_MAX_OBJECT_NAME`. Implementations which allocate space for the name from the heap should still define `MPI_MAX_OBJECT_NAME` to be a relatively small value, since the user has to allocate space for a string of up to this size when calling `MPI_COMM_GET_NAME`. (*End of advice to implementors.*)

`MPI_COMM_GET_NAME` (`comm`, `comm_name`, `resultlen`)

IN	<code>comm</code>	communicator whose name is to be returned (handle)
OUT	<code>comm_name</code>	the name previously stored on the communicator, or an empty string if no such name exists (string)
OUT	<code>resultlen</code>	length of returned name (integer)

```
int MPI_Comm_get_name(MPI_Comm comm, char *comm_name, int *resultlen)
```

```
MPI_Comm_get_name(comm, comm_name, resultlen, ierror)
```

```
TYPE(MPI_Comm), INTENT(IN) :: comm
```

```
CHARACTER(LEN=MPI_MAX_OBJECT_NAME), INTENT(OUT) :: comm_name
```

```
INTEGER, INTENT(OUT) :: resultlen
```

```
INTEGER, OPTIONAL, INTENT(OUT) :: ierror
```

```
MPI_COMM_GET_NAME(COMM, COMM_NAME, RESULTLEN, IERROR)
```

```
INTEGER COMM, RESULTLEN, IERROR
```

```
CHARACTER*(*) COMM_NAME
```

`MPI_COMM_GET_NAME` returns the last name which has previously been associated with the given communicator. The name may be set and retrieved from any language. The

1 same name will be returned independent of the language used. `name` should be allocated
 2 so that it can hold a resulting string of length `MPI_MAX_OBJECT_NAME` characters.
 3 `MPI_COMM_GET_NAME` returns a copy of the set name in `name`.

4 In C, a null character is additionally stored at `name[resultlen]`. The value of `resultlen`
 5 cannot be larger than `MPI_MAX_OBJECT_NAME-1`. In Fortran, `name` is padded on the
 6 right with blank characters. The value of `resultlen` cannot be larger than
 7 `MPI_MAX_OBJECT_NAME`.

8 If the user has not associated a name with a communicator, or an error occurs,
 9 `MPI_COMM_GET_NAME` will return an empty string (all spaces in Fortran, "" in C). The
 10 three predefined communicators will have predefined names associated with them. Thus,
 11 the names of `MPI_COMM_WORLD`, `MPI_COMM_SELF`, and the communicator returned by
 12 `MPI_COMM_GET_PARENT` (if not `MPI_COMM_NULL`) will have the default of
 13 `MPI_COMM_WORLD`, `MPI_COMM_SELF`, and `MPI_COMM_PARENT`. The fact that the system
 14 may have chosen to give a default name to a communicator does not prevent the user from
 15 setting a name on the same communicator; doing this removes the old name and assigns
 16 the new one.

17
 18 *Rationale.* We provide separate functions for setting and getting the name of a com-
 19 municator, rather than simply providing a predefined attribute key for the following
 20 reasons:

- 21 • It is not, in general, possible to store a string as an attribute from Fortran.
- 22 • It is not easy to set up the delete function for a string attribute unless it is known
 23 to have been allocated from the heap.
- 24 • To make the attribute key useful additional code to call `strdup` is necessary. If
 25 this is not standardized then users have to write it. This is extra unneeded work
 26 which we can easily eliminate.
- 27 • The Fortran binding is not trivial to write (it will depend on details of the
 28 Fortran compilation system), and will not be portable. Therefore it should be in
 29 the library rather than in user code.

30
 31
 32 (*End of rationale.*)

33
 34 *Advice to users.* The above definition means that it is safe simply to print the string
 35 returned by `MPI_COMM_GET_NAME`, as it is always a valid string even if there was
 36 no name.

37 Note that associating a name with a communicator has no effect on the semantics of
 38 an MPI program, and will (necessarily) increase the store requirement of the program,
 39 since the names must be saved. Therefore there is no requirement that users use these
 40 functions to associate names with communicators. However debugging and profiling
 41 MPI applications may be made easier if names are associated with communicators,
 42 since the debugger or profiler should then be able to present information in a less
 43 cryptic manner. (*End of advice to users.*)

44
 45 The following functions are used for setting and getting names of datatypes. The
 46 constant `MPI_MAX_OBJECT_NAME` also applies to these names.

MPI_TYPE_SET_NAME (datatype, type_name)	1
INOUT datatype datatype whose identifier is to be set (handle)	2
IN type_name the character string which is remembered as the name	3
(string)	4
	5
	6
int MPI_Type_set_name(MPI_Datatype datatype, const char *type_name)	7
	8
MPI_Type_set_name(datatype, type_name, ierror)	9
TYPE(MPI_Datatype), INTENT(IN) :: datatype	10
CHARACTER(LEN=*), INTENT(IN) :: type_name	11
INTEGER, OPTIONAL, INTENT(OUT) :: ierror	12
MPI_TYPE_SET_NAME(DATATYPE, TYPE_NAME, IERROR)	13
INTEGER DATATYPE, IERROR	14
CHARACTER*(*) TYPE_NAME	15
	16
	17
MPI_TYPE_GET_NAME (datatype, type_name, resultlen)	18
IN datatype datatype whose name is to be returned (handle)	19
OUT type_name the name previously stored on the datatype, or a empty	20
string if no such name exists (string)	21
OUT resultlen length of returned name (integer)	22
	23
	24
	25
int MPI_Type_get_name(MPI_Datatype datatype, char *type_name,	26
int *resultlen)	27
	28
MPI_Type_get_name(datatype, type_name, resultlen, ierror)	29
TYPE(MPI_Datatype), INTENT(IN) :: datatype	30
CHARACTER(LEN=MPI_MAX_OBJECT_NAME), INTENT(OUT) :: type_name	31
INTEGER, INTENT(OUT) :: resultlen	32
INTEGER, OPTIONAL, INTENT(OUT) :: ierror	33
MPI_TYPE_GET_NAME(DATATYPE, TYPE_NAME, RESULTLEN, IERROR)	34
INTEGER DATATYPE, RESULTLEN, IERROR	35
CHARACTER*(*) TYPE_NAME	36
	37
Named predefined datatypes have the default names of the datatype name. For exam-	38
ple, MPI_WCHAR has the default name of MPI_WCHAR.	39
The following functions are used for setting and getting names of windows. The con-	40
stant MPI_MAX_OBJECT_NAME also applies to these names.	41
	42
MPI_WIN_SET_NAME (win, win_name)	43
INOUT win window whose identifier is to be set (handle)	44
IN win_name the character string which is remembered as the name	45
(string)	46
	47
	48

```

1  int MPI_Win_set_name(MPI_Win win, const char *win_name)
2
3  MPI_Win_set_name(win, win_name, ierror)
4      TYPE(MPI_Win), INTENT(IN) :: win
5      CHARACTER(LEN=*), INTENT(IN) :: win_name
6      INTEGER, OPTIONAL, INTENT(OUT) :: ierror
7
8  MPI_WIN_SET_NAME(WIN, WIN_NAME, IERROR)
9      INTEGER WIN, IERROR
10     CHARACTER*(*) WIN_NAME
11
12 MPI_WIN_GET_NAME (win, win_name, resultlen)
13
14     IN        win                window whose name is to be returned (handle)
15     OUT      win_name            the name previously stored on the window, or a empty
16                                     string if no such name exists (string)
17     OUT      resultlen          length of returned name (integer)
18
19
20 int MPI_Win_get_name(MPI_Win win, char *win_name, int *resultlen)
21
22 MPI_Win_get_name(win, win_name, resultlen, ierror)
23     TYPE(MPI_Win), INTENT(IN) :: win
24     CHARACTER(LEN=MPI_MAX_OBJECT_NAME), INTENT(OUT) :: win_name
25     INTEGER, INTENT(OUT) :: resultlen
26     INTEGER, OPTIONAL, INTENT(OUT) :: ierror
27
28 MPI_WIN_GET_NAME(WIN, WIN_NAME, RESULTLEN, IERROR)
29     INTEGER WIN, RESULTLEN, IERROR
30     CHARACTER*(*) WIN_NAME

```

6.9 Formalizing the Loosely Synchronous Model

In this section, we make further statements about the loosely synchronous model, with particular attention to intra-communication.

6.9.1 Basic Statements

When a caller passes a communicator (that contains a context and group) to a callee, that communicator must be free of side effects throughout execution of the subprogram: there should be no active operations on that communicator that might involve the process. This provides one model in which libraries can be written, and work “safely.” For libraries so designated, the callee has permission to do whatever communication it likes with the communicator, and under the above guarantee knows that no other communications will interfere. Since we permit good implementations to create new communicators without synchronization (such as by preallocated contexts on communicators), this does not impose a significant overhead.

This form of safety is analogous to other common computer-science usages, such as passing a descriptor of an array to a library routine. The library routine has every right to expect such a descriptor to be valid and modifiable.

6.9.2 Models of Execution

In the loosely synchronous model, transfer of control to a **parallel procedure** is effected by having each executing process invoke the procedure. The invocation is a collective operation: it is executed by all processes in the execution group, and invocations are similarly ordered at all processes. However, the invocation need not be synchronized.

We say that a parallel procedure is *active* in a process if the process belongs to a group that may collectively execute the procedure, and some member of that group is currently executing the procedure code. If a parallel procedure is active in a process, then this process may be receiving messages pertaining to this procedure, even if it does not currently execute the code of this procedure.

Static Communicator Allocation

This covers the case where, at any point in time, at most one invocation of a parallel procedure can be active at any process, and the group of executing processes is fixed. For example, all invocations of parallel procedures involve all processes, processes are single-threaded, and there are no recursive invocations.

In such a case, a communicator can be statically allocated to each procedure. The static allocation can be done in a preamble, as part of initialization code. If the parallel procedures can be organized into libraries, so that only one procedure of each library can be concurrently active in each processor, then it is sufficient to allocate one communicator per library.

Dynamic Communicator Allocation

Calls of parallel procedures are well-nested if a new parallel procedure is always invoked in a subset of a group executing the same parallel procedure. Thus, processes that execute the same parallel procedure have the same execution stack.

In such a case, a new communicator needs to be dynamically allocated for each new invocation of a parallel procedure. The allocation is done by the caller. A new communicator can be generated by a call to `MPI_COMM_DUP`, if the callee execution group is identical to the caller execution group, or by a call to `MPI_COMM_SPLIT` if the caller execution group is split into several subgroups executing distinct parallel routines. The new communicator is passed as an argument to the invoked routine.

The need for generating a new communicator at each invocation can be alleviated or avoided altogether in some cases: If the execution group is not split, then one can allocate a stack of communicators in a preamble, and next manage the stack in a way that mimics the stack of recursive calls.

One can also take advantage of the well-ordering property of communication to avoid confusing caller and callee communication, even if both use the same communicator. To do so, one needs to abide by the following two rules:

- messages sent before a procedure call (or before a return from the procedure) are also received before the matching call (or return) at the receiving end;

- messages are always selected by source (no use is made of `MPI_ANY_SOURCE`).

The General Case

In the general case, there may be multiple concurrently active invocations of the same parallel procedure within the same group; invocations may not be well-nested. A new communicator needs to be created for each invocation. It is the user's responsibility to make sure that, should two distinct parallel procedures be invoked concurrently on overlapping sets of processes, communicator creation is properly coordinated.

1
2
3
4
5
6
7
8
9
10
11
12
13
14
15
16
17
18
19
20
21
22
23
24
25
26
27
28
29
30
31
32
33
34
35
36
37
38
39
40
41
42
43
44
45
46
47
48

Chapter 7

Process Topologies

7.1 Introduction

This chapter discusses the MPI topology mechanism. A topology is an extra, optional attribute that one can give to an intra-communicator; topologies cannot be added to inter-communicators. A topology can provide a convenient naming mechanism for the processes of a group (within a communicator), and additionally, may assist the runtime system in mapping the processes onto hardware. Cartesian topologies may provide an optimized n -dimensional factorization of the number of processes that fits to the application needs and also helps to minimize the communication overhead.

#120

As stated in Chapter 6, a process group in MPI is a collection of n processes. Each process in the group is assigned a rank between 0 and $n-1$. In many parallel applications a linear ranking of processes does not adequately reflect the logical communication pattern of the processes (which is usually determined by the underlying problem geometry and the numerical algorithm used). Often the processes are arranged in topological patterns such as two- or three-dimensional grids. More generally, the logical process arrangement is described by a graph. In this chapter we will refer to this logical process arrangement as the “virtual topology.”

A clear distinction must be made between the virtual process topology and the topology of the underlying, physical hardware. The virtual topology can be exploited by the system in the assignment of processes to physical processors, if this helps to improve the communication performance on a given machine. How this mapping is done, however, is outside the scope of MPI. The description of the virtual topology, on the other hand, depends only on the application, and is machine-independent. The functions that are described in this chapter deal with machine-independent mapping and communication on virtual process topologies.

Some additional info arguments and functions are provided to further specify relevant aspects of the underlying hardware to permit the user to influence the mapping of the processes to the hardware resources.

#120

Rationale. Though physical mapping is not discussed, the existence of the virtual topology information may be used as advice by the runtime system. There are well-known techniques for mapping grid/torus structures to hardware topologies such as hypercubes or grids. For more complicated graph structures good heuristics often yield nearly optimal results [45]. On the other hand, if there is no way for the user to specify the logical process arrangement as a “virtual topology,” a random mapping

is most likely to result. On some machines, this will lead to unnecessary contention in the interconnection network. Some details about predicted and measured performance improvements that result from good process-to-processor mapping on modern wormhole-routing architectures can be found in [11, 12].

Besides possible performance benefits, the virtual topology can function as a convenient, process-naming structure, with significant benefits for program readability and notational power in message-passing programming. (*End of rationale.*)

7.2 Virtual Topologies

The communication pattern of a set of processes can be represented by a graph. The nodes represent processes, and the edges connect processes that communicate with each other. MPI provides message-passing between any pair of processes in a group. There is no requirement for opening a channel explicitly. Therefore, a “missing link” in the user-defined process graph does not prevent the corresponding processes from exchanging messages. It means rather that this connection is neglected in the virtual topology. This strategy implies that the topology gives no convenient way of naming this pathway of communication. Another possible consequence is that an automatic mapping tool (if one exists for the runtime environment) will not take account of this edge when mapping.

Specifying the virtual topology in terms of a graph is sufficient for all applications. However, in many applications the graph structure is regular, and the detailed set-up of the graph would be inconvenient for the user and might be less efficient at run time. A large fraction of all parallel applications use process topologies like rings, two- or higher-dimensional grids, or tori. These structures are completely defined by the number of dimensions and the numbers of processes in each coordinate direction. Also, the mapping of grids and tori is generally an easier problem than that of general graphs. Thus, it is desirable to address these cases explicitly. For those Cartesian topologies, an additional functionality exists: before setting up the Cartesian topology for a given number of dimensions n , the number of processes must be factorized into n factors d_i specifying the number of processes in each dimension i . This factorization can be influenced by the application, e.g., by providing the total data mesh size information, but also by the MPI library by choosing a factorization that tries to minimize the communication overhead on the given hardware resources.

Process coordinates in a Cartesian structure begin their numbering at 0. Row-major numbering is always used for the processes in a Cartesian structure. This means that, for example, the relation between group rank and coordinates for four processes in a (2×2) grid is as follows.

coord (0,0):	rank 0
coord (0,1):	rank 1
coord (1,0):	rank 2
coord (1,1):	rank 3

7.3 Embedding in MPI

The support for virtual topologies as defined in this chapter is consistent with other parts of MPI, and, whenever possible, makes use of functions that are defined elsewhere. Topology information is associated with communicators. It is added to communicators using the caching mechanism described in Chapter 6.

7.4 Overview of the Functions

MPI supports three topology types: **Cartesian**, **graph**, and **distributed graph**. The functions `MPI_CART_CREATE` and `MPI_CART_CREATE_WEIGHTED` are used to create Cartesian topologies, the function `MPI_GRAPH_CREATE` is used to create graph topologies, and the functions `MPI_DIST_GRAPH_CREATE_ADJACENT` and `MPI_DIST_GRAPH_CREATE` are used to create distributed graph topologies. These topology creation functions are collective. As with other collective calls, the program must be written to work correctly, whether the call synchronizes or not.

The topology creation functions take as input an existing communicator `comm_old`, which defines the set of processes on which the topology is to be mapped. For `MPI_GRAPH_CREATE`, `MPI_CART_CREATE`, and `MPI_CART_CREATE_WEIGHTED`, all input arguments must have identical values on all processes of the group of `comm_old`. When calling `MPI_GRAPH_CREATE`, each process specifies all nodes and edges in the graph. In contrast, the functions `MPI_DIST_GRAPH_CREATE_ADJACENT` or `MPI_DIST_GRAPH_CREATE` are used to specify the graph in a distributed fashion, whereby each process only specifies a subset of the edges in the graph such that the entire graph structure is defined collectively across the set of processes. Therefore the processes provide different values for the arguments specifying the graph. However, all processes must give the same value for `reorder` and the `info` argument. In all cases, a new communicator `comm_topol` is created that carries the topological structure as cached information (see Chapter 6). In analogy to function `MPI_COMM_CREATE`, no cached information propagates from `comm_old` to `comm_topol`.

`MPI_CART_CREATE` can be used to describe Cartesian structures of arbitrary dimension. For each coordinate direction one specifies whether the process structure is periodic or not. Note that an n -dimensional hypercube is an n -dimensional torus with 2 processes per coordinate direction. Thus, special support for hypercube structures is not necessary. The local auxiliary functions `MPI_DIMS_CREATE` and `MPI_DIMS_CREATE_WEIGHTED` can be used to compute a balanced or a not equally balanced distribution of processes (e.g., for cubic and cuboidal grids) among a given number of dimensions. `MPI_CART_CREATE_WEIGHTED` combines both functionalities, the factorization of a given number of processes into the given number of dimensions and the set up of a Cartesian virtual topology for both cases, equally and not equally balanced. Even more, this routine was designed to better support the optimization of communications on hierarchical multi-level hardware topologies.

Advice to users. If an application uses the MPI routine `MPI_DIMS_CREATE` or `MPI_DIMS_CREATE_WEIGHTED` or its own factorization code in combination with the `MPI_CART_CREATE` routine with `reorder=true`, then it is recommended to substitute this combination by one call to `MPI_CART_CREATE_WEIGHTED`, because this routine enables a factorization that takes both the given hardware (through the communicator argument) and also application information (through the weights argument) into account. (*End of advice to users.*)

Rationale. `MPI_CART_CREATE` was not deprecated because it is still useful if the factorization of the number of processes is fixed or reordering of the processes is not desired. `MPI_DIMS_CREATE` was not deprecated because it may be used for any other purpose where an unweighted balanced factorization is needed.

#120

MPI_DIMS_CREATE_WEIGHTED was added for any case where a weighted factorization is needed and MPI_CART_CREATE_WEIGHTED is not applicable. (*End of rationale.*)

MPI defines functions to query a communicator for topology information. The function MPI_TOPO_TEST is used to query for the type of topology associated with a communicator. Depending on the topology type, different information can be extracted. For a graph topology, the functions MPI_GRAPHDIMS_GET and MPI_GRAPH_GET return the values that were specified in the call to MPI_GRAPH_CREATE. Additionally, the functions MPI_GRAPH_NEIGHBORS_COUNT and MPI_GRAPH_NEIGHBORS can be used to obtain the neighbors of an arbitrary node in the graph. For a distributed graph topology, the functions MPI_DIST_GRAPH_NEIGHBORS_COUNT and MPI_DIST_GRAPH_NEIGHBORS can be used to obtain the neighbors of the calling process. For a Cartesian topology, the functions MPI_CARTDIM_GET and MPI_CART_GET return the values that were specified in the call to MPI_CART_CREATE. Additionally, the functions MPI_CART_RANK and MPI_CART_COORDS translate Cartesian coordinates into a group rank, and vice-versa. The function MPI_CART_SHIFT provides the information needed to communicate with neighbors along a Cartesian dimension. All of these query functions are local.

For Cartesian topologies, the function MPI_CART_SUB can be used to extract a Cartesian subspace (analogous to MPI_COMM_SPLIT). This function is collective over the input communicator's group.

The two additional functions, MPI_GRAPH_MAP and MPI_CART_MAP, are, in general, not called by the user directly. However, together with the communicator manipulation functions presented in Chapter 6, they are sufficient to implement all other topology functions. Section 7.5.8 outlines such an implementation.

The neighborhood collective communication routines MPI_NEIGHBOR_ALLGATHER, MPI_NEIGHBOR_ALLGATHERV, MPI_NEIGHBOR_ALLTOALL, MPI_NEIGHBOR_ALLTOALLV, and MPI_NEIGHBOR_ALLTOALLW communicate with the nearest neighbors on the topology associated with the communicator. The nonblocking variants are MPI_INEIGHBOR_ALLGATHER, MPI_INEIGHBOR_ALLGATHERV, MPI_INEIGHBOR_ALLTOALL, MPI_INEIGHBOR_ALLTOALLV, and MPI_INEIGHBOR_ALLTOALLW.

7.5 Topology Constructors

7.5.1 Cartesian Constructor

`MPI_CART_CREATE(comm_old, ndims, dims, periods, reorder, comm_cart)`

IN	<code>comm_old</code>	input communicator (handle)
IN	<code>ndims</code>	number of dimensions of Cartesian grid (integer)
IN	<code>dims</code>	integer array of size <code>ndims</code> specifying the number of processes in each dimension
IN	<code>periods</code>	logical array of size <code>ndims</code> specifying whether the grid is periodic (<code>true</code>) or not (<code>false</code>) in each dimension
IN	<code>reorder</code>	ranking may be reordered (<code>true</code>) or not (<code>false</code>) (logical)
OUT	<code>comm_cart</code>	communicator with new Cartesian topology (handle)

```
int MPI_Cart_create(MPI_Comm comm_old, int ndims, const int dims[],
                  const int periods[], int reorder, MPI_Comm *comm_cart)
```

```
MPI_Cart_create(comm_old, ndims, dims, periods, reorder, comm_cart, ierror)
    TYPE(MPI_Comm), INTENT(IN) :: comm_old
    INTEGER, INTENT(IN) :: ndims, dims(ndims)
    LOGICAL, INTENT(IN) :: periods(ndims), reorder
    TYPE(MPI_Comm), INTENT(OUT) :: comm_cart
    INTEGER, OPTIONAL, INTENT(OUT) :: ierror
```

```
MPI_CART_CREATE(COMM_OLD, NDIMS, DIMS, PERIODS, REORDER, COMM_CART, IERROR)
    INTEGER COMM_OLD, NDIMS, DIMS(*), COMM_CART, IERROR
    LOGICAL PERIODS(*), REORDER
```

`MPI_CART_CREATE` returns a handle to a new communicator to which the Cartesian topology information is attached. If `reorder = false` then the rank of each process in the new group is identical to its rank in the old group. Otherwise, the function may reorder the processes (possibly so as to choose a good embedding of the virtual topology onto the physical machine). If the total size of the Cartesian grid is smaller than the size of the group of `comm_old`, then some processes are returned `MPI_COMM_NULL`, in analogy to `MPI_COMM_SPLIT`. If `ndims` is zero then a zero-dimensional Cartesian topology is created. The call is erroneous if it specifies a grid that is larger than the group size or if `ndims` is negative.

for instance,

Advice to implementors. An implementation path to calculate an optimized rank reordering on a hierarchical hardware (e.g., a cluster of multi CPU nodes with multi core sockets) is described in [15]. (End of advice to implementors.)

CPUs

, e.g.,

#120

#120

```

1 MPI_CART_CREATE_WEIGHTED(comm_old, ndims, dim_weights, periods, info, dims,
2     comm_cart)
3
4     IN      comm_old      input communicator (handle)
5
6     IN      ndims         number of dimensions of Cartesian grid (integer)
7
8     IN      dim_weights   double array of size ndims specifying total communi-
9     cation costs in each direction
10
11     IN      periods       logical array of size ndims specifying whether the grid
12     is periodic (true) or not (false) in each dimension
13
14     INOUT   dims          integer array of size ndims specifying the number of
15     processes in each dimension
16
17     OUT     comm_cart     communicator with new Cartesian topology (handle)

```

```

16 int MPI_Cart_create_weighted(MPI_Comm comm_old, int ndims,
17     const double dim_weights[], const int periods[],
18     MPI_Info info, int dims[], MPI_Comm *comm_cart)
19

```

```

20 MPI_Cart_create_weighted(comm_old, ndims, dim_weights, periods, info, dims,
21     comm_cart, ierror)

```

```

22     TYPE(MPI_Comm), INTENT(IN) :: comm_old
23     INTEGER, INTENT(IN) :: ndims
24     DOUBLE PRECISION, INTENT(IN) :: dim_weights(ndims)
25     LOGICAL, INTENT(IN) :: periods(ndims)
26     TYPE(MPI_Info), INTENT(IN) :: info
27     INTEGER, INTENT(INOUT) :: dims(ndims)
28     TYPE(MPI_Comm), INTENT(OUT) :: comm_cart
29     INTEGER, OPTIONAL, INTENT(OUT) :: ierror

```

```

30 MPI_CART_CREATE_WEIGHTED(COMM_OLD, NDIMS, DIM_WEIGHTS, PERIODS, INFO, DIMS,
31     COMM_CART, IERROR)

```

```

32     INTEGER COMM_OLD, NDIMS, INFO, DIMS(*), COMM_CART, IERROR
33     DOUBLE PRECISION DIM_WEIGHTS(*)
34     LOGICAL PERIODS(*)

```

MPI_CART_CREATE_WEIGHTED returns a handle to a new communicator to which the Cartesian topology information is attached. The call is collective over the group of `comm_old`. This routine expects that the total communication costs in a dimension i is proportional to `dim_weights[i]`. This routine chooses a `ndims`-dimensional factorization of the number of processes of the process group of `comm_old` into the array `dims` and an appropriate reordering of the ranks of `comm_old` into the ranks of `comm_cart`, such that the maximum of the accumulated communication time per process over all processes is minimized. Figure 7.1 shows the weights `dim_weights[i]` as w_i in the case of three dimensions. Based on the chosen factorization, the communication weight per process is then $w_i / \prod_{j,j \neq i} \text{dims}[j]$.

An application can supply the special value `MPI_WEIGHTS_EQUAL` for the `dim_weights` array to indicate that all weights are identical. Note that `MPI_WEIGHTS_EQUAL` is not a special weight value; rather it is a special value for the total array argument. In

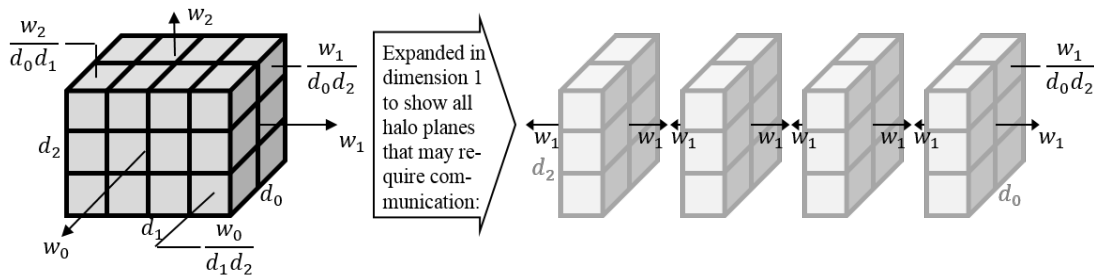

Figure 7.1: Communication model: The `dim_weights[i]=wi` express the **total** communication costs in the direction of dimension i , i.e., accumulated over all MPI processes that are part of the same surface in this direction. The figure to the right shows all communications in the positive and negative direction of dimension 1. The communication costs of one process in direction i is therefore $w_i / \prod_{j,j \neq i} d_j$ with `dims[i]=di`, which are returned from this procedure.

Fortran, `MPI_WEIGHTS_EQUAL` is an object like `MPI_BOTTOM` (not usable for initialization or assignment), see Section 2.5.4. The caller may further constrain the operation of this routine by specifying elements of array `dims`. If `dims[i]` is set to a positive number, the routine will not modify the number of processes in dimension i ; only those entries where `dims[i] = 0` are modified by the call. Negative input values of `dims[i]` are erroneous. An error will occur if the size of the group of `comm_old` is not a multiple of $\prod_{i, \text{dims}[i] \neq 0} \text{dims}[i]$. If all `dims[i]` are positive and $\prod_i \text{dims}[i]$ is smaller than the size of the group of `comm_old`, then some processes will return `MPI_COMM_NULL`, in analogy to `MPI_COMM_SPLIT`.

The `info` argument can further influence process reordering. If `ndims` is zero then it is required that the size of the group of `comm_old` is one, `dims` is neither evaluated nor changed and a zero-dimensional Cartesian topology is created.

Advice to users. If the whole data mesh is an `ndims`-dimensional array with sizes $g[i]$ in each dimension, the total array size is $G = \prod_j g[j]$, and the accumulated communication size in each dimension (and there, positive and negative in each dimension) is $h[i] \cdot G/g[i]$ with $h[i]$ expressing the amount of data to be communicated per data mesh point (e.g., halo width) and if there is an additional multiplicative cost factor $c[i]$ (e.g., representing different communication costs due to contiguous or strided data in different directions), then the weight should be specified as $2 \cdot h[i] \cdot c[i] \cdot G/g[i]$ or after removing common factors $h[i] \cdot c[i]/g[i]$, or in the case of equal halo widths $h[i]$ and equal communication costs $c[i]$, the `dim_weights[i]` are just $1.0/g[i]$. Note that a floating point divide is required. Figure 7.2 shows a 3-dimensional example. Note that for minimizing the communication time per process, this routine typically tries to choose a factorization of the number of processes N into $N = \prod_i d_i$ so that the communication in each direction, i.e., $w_i / \prod_{j,j \neq i} d_j$ is similar, and also chooses a rank reordering that most of the communication is along the fastest hardware communication links (e.g., intra-node) and only a small amount along slower links (e.g., inter-node). (*End of advice to users.*)

Note that it is hard to estimate the factors $c[i]$. Therefore the MPI library provides three double precision floating point constants that can be used as an estimate:

#120

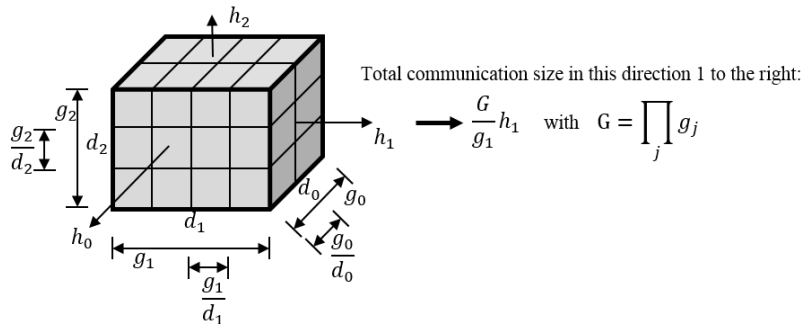

Figure 7.2: Example for the calculation of the weights. The data sizes g_i express the three dimensions of the total application data mesh. The virtual process grid dimensions are expressed by d_i . The figure shows the division of the total application mesh into its subdomains. The value h_i represents the halo width in a given direction when the 2-dimensional side of a subdomain is communicated to the neighbor process in that direction.

MPI_COSTS_CONTIGUOUS: The value is normalized to 1.0 and represents the communication costs in sec/byte when communicating a contiguous subset of an n -dimensional data mesh, for example by using `MPI_TYPE_CREATE_SUBARRAY` with a subset in C only in the first dimension(s) or in Fortran last dimension(s).

MPI_COSTS_STRIDED: The value represents the usually higher communication costs if the data is strided but still with larger chunks, such as using `MPI_TYPE_CREATE_SUBARRAY` with only one contiguous dimension (in C, the last one, in Fortran the first one).

MPI_COSTS_SCATTERED: The value represents the usually higher communication costs if the data is scattered, such as using `MPI_TYPE_CREATE_SUBARRAY` with only a small subset (e.g., with halo size) in C in the last dimension and in Fortran the first one.

Advice to implementors. These constants should reflect the communication on the slowest communication path (e.g., inter-node communication, rather than intra-node communication) for example for a 3-dimensional data mesh using 10% of the available memory. (*End of advice to implementors.*)

Rationale. `MPI_CART_CREATE_WEIGHTED` is usually called very early after the initialization of MPI. It returns the dimensions d_i , which are used to set up the subdomains, which itself are the basis to define the derived datatypes used for the communication. This is one of the reason why `MPI_CART_CREATE_WEIGHTED` has not arrays with datatype handles and the $g[i]$ and $h[i]$ for each dimension as input argument. (*End of rationale.*)

In the case of a multi-level hierarchical hardware, the user of this routine can further constrain the reordering of the process ranks with the `info` argument by choosing split levels which should mark slower to faster connectivity. Each split level can be defined through a split type constant, for example, `MPI_COMM_TYPE_SHARED` or `MPI_COMM_TYPE_HW_SUBDOMAIN` as an input argument for `MPI_COMM_SPLIT_TYPE`,

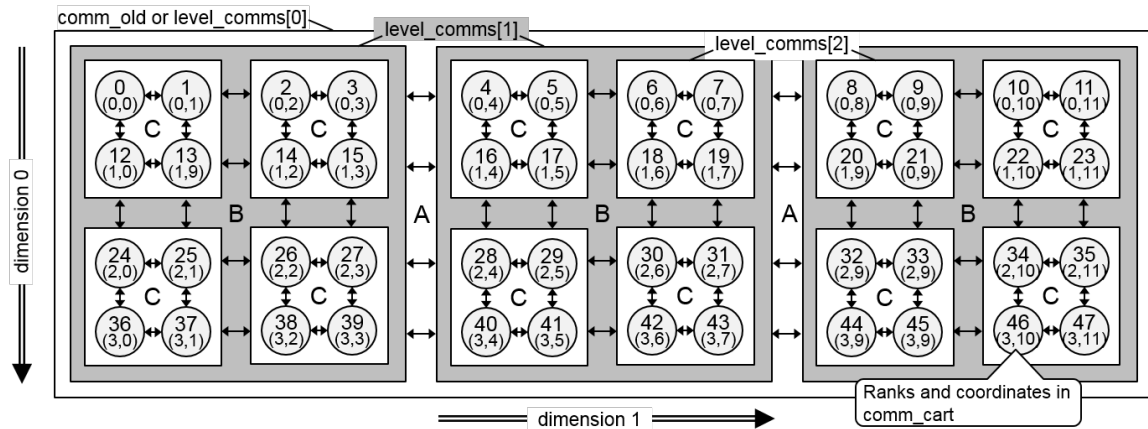

Figure 7.3: Example with a `comm_old` with 48 processes, `ndims=2`, `dim_weights=(1./4, 1./12)`, and `nsplit_types=2` and `split_types`, e.g., splitting into ccNUMA nodes and those into CPUs, and here with 4 cores per CPU and 4 CPUs per node. The `level_comms[i]` show this splitting of `comm_old` into hierarchical subcommunicators. The renumbering in `comm_cart` should first minimize the communication A (here, e.g., the communication between the ccNUMA nodes), then B (here, e.g., the CPU to CPU communication), and last C (here, e.g., the core to core communication)

possibly together with additional information through an `info` argument for such call. Figure 7.3 gives an example in which `comm_old` is split with the first split level into `level_comms[1]`, and those communicators then with the second split level into `level_comms[2]`. Using such split levels, this routine shall first try to minimize the communication within `level_comms[0]=comm_old` between the processes belonging to different `level_comms[1]`, here marked with A, and second within `level_comms[1]` between processes belonging to different `level_comms[2]`, here marked with B, and so on. For this, the `info` key `mpi_split_levels` is reserved. The value for this key is a comma separated list of split levels. Each split level can be

- an integer representing a split type, or
- an integer representing a split type followed by a sequence of key=value pairs; each pair is prefixed with a “/”.

Hereby, the split type must be valid for using as `split_type` in `MPI_COMM_SPLIT_TYPE`, and the key=value pairs have the same meaning as if they were provided through an `info` handle for such splitting of the communicator.

If a value in this comma separated list does not produce a valid communicator (see `MPI_COMM_SPLIT_TYPE`) then this value and the rest of the list is ignored.

Example 7.1 With the following example, an `info` handle is created using `MPI_COMM_TYPE_SHARED` as first split level and `MPI_COMM_TYPE_HW_SUBDOMAIN` together with the key=value pair “`mpi_hw_domain_type=NUMANode`”. Figure 7.4 shows a possible result for this example.

#120

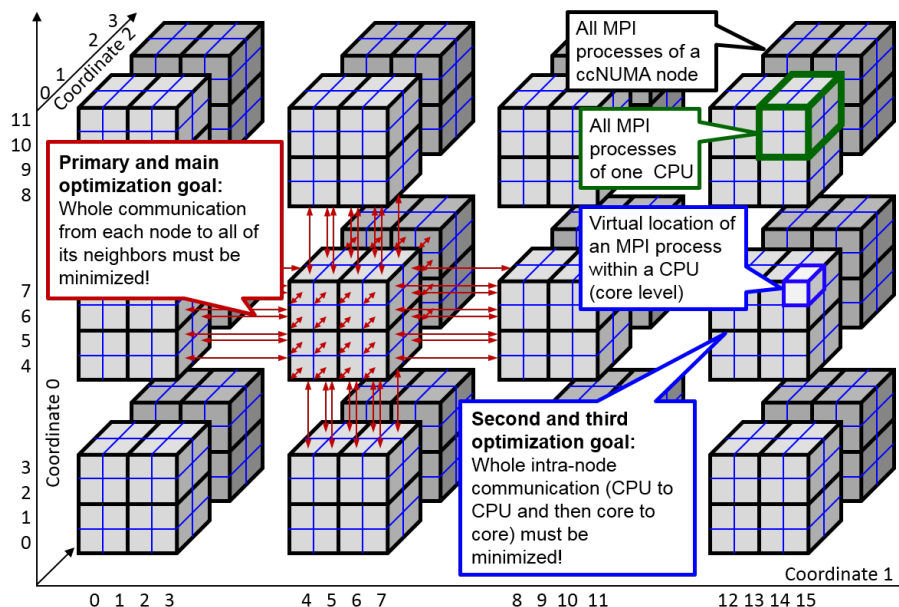

Figure 7.4: Example with 24 shared memory nodes (e.g., ccNUMA nodes), 4 NUMA-nodes (e.g., CPUs) per node and 8 MPI processes (e.g., on cores) per NUMA-node. The figure shows the 3-dimensional distribution calculated by `MPI_CART_CREATE_WEIGHTED` based on weight values (1/12, 1/16, 1/8).

```

25 char value[200];
26 MPI_Info_create(&info);
27 sprintf(value, "%d,%d/%s=%s",
28         MPI_COMM_TYPE_SHARED,
29         MPI_COMM_TYPE_HW_SUBDOMAIN, "mpi_hw_domain_type", "NUMANode");
30 MPI_Info_set(info, "mpi_split_levels", value);

```

Advice to users. A suitable restriction (binding) of the MPI processes onto the hardware resources is required for splitting `comm_old` into all requested split levels, see also the description of `MPI_COMM_SPLIT_TYPE` in Section 6.4.2. (*End of advice to users.*)

#120

7.5.2 Cartesian Convenience Functions

For Cartesian topologies, the function `MPI_DIMS_CREATE` helps the user select a balanced distribution of processes per coordinate direction, depending on the number of processes in the group to be balanced and optional constraints that can be specified by the user. One use is to partition all the processes (the size of `MPI_COMM_WORLD`'s group) into an n -dimensional topology. `MPI_DIMS_CREATE_WEIGHTED` helps to find a distribution of processes for which the implied communication is minimized for cuboidal grids rather than balancing the number of processes in each direction.

#120

```

MPI_DIMS_CREATE(nnodes, ndims, dims)
    IN          nnodes          number of nodes in a grid (integer)
    IN          ndims          number of Cartesian dimensions (integer)
    INOUT       dims           integer array of size ndims specifying the number of
                              nodes in each dimension

int MPI_Dims_create(int nnodes, int ndims, int dims[])

MPI_Dims_create(nnodes, ndims, dims, ierror)
    INTEGER, INTENT(IN) :: nnodes, ndims
    INTEGER, INTENT(INOUT) :: dims(ndims)
    INTEGER, OPTIONAL, INTENT(OUT) :: ierror

MPI_DIMS_CREATE(NNODES, NDIMS, DIMS, IERROR)
    INTEGER NNODES, NDIMS, DIMS(*), IERROR

```

The entries in the array `dims` are set to describe a Cartesian grid with `ndims` dimensions and a total of `nnodes` nodes. The dimensions are set to be as close to each other as possible, using an appropriate divisibility algorithm. The caller may further constrain the operation of this routine by specifying elements of array `dims`. If `dims[i]` is set to a positive number, the routine will not modify the number of nodes in dimension `i`; only those entries where `dims[i] = 0` are modified by the call.

Negative input values of `dims[i]` are erroneous. An error will occur if `nnodes` is not a multiple of

$$\prod_{i, \text{dims}[i] \neq 0} \text{dims}[i].$$

For `dims[i]` set by the call, `dims[i]` will be ordered in non-increasing order. Array `dims` is suitable for use as input to routine `MPI_CART_CREATE`. `MPI_DIMS_CREATE` is local. If `ndims` is zero and `nnodes` is one, `dims` is neither evaluated nor changed and `MPI_DIMS_CREATE` returns `MPI_SUCCESS`.

Example 7.2

dims before call	function call	dims on return
(0,0)	<code>MPI_DIMS_CREATE(6, 2, dims)</code>	(3,2)
(0,0)	<code>MPI_DIMS_CREATE(7, 2, dims)</code>	(7,1)
(0,3,0)	<code>MPI_DIMS_CREATE(6, 3, dims)</code>	(2,3,1)
(0,3,0)	<code>MPI_DIMS_CREATE(7, 3, dims)</code>	erroneous call

Advice to implementors. For the `dims[i]` set by the call, the sum of these `dims[i]` should be minimized. For the case of several possibilities, the difference between the smallest and largest dimension should be minimized. If there are still several possibilities, then the largest dimension should be minimized. Examples: 360 nodes can be factorized into 3 dimensions as $360=10 \times 6 \times 6$ and $360=9 \times 8 \times 5$, both having equal (and minimal) sum $\sum n_i = 22$ and difference $\Delta = 4$. The first and second criteria would allow both results, but the third one would choose $9 \times 8 \times 5$. For N below 50,000, there are only two cases in which the difference-criterion alone would have implied a factorization

#120

that has a larger (and therefore worse) sum, for example $N=35200 = 40 \times 40 \times 22$ (with $\Sigma=102, \Delta=18$) = $44 \times 32 \times 25$ (with $\Sigma=101, \Delta=19$). Although these examples are rare cases, it is recommended to use all three criteria [48]. (*End of advice to implementors.*)

#120

```

MPI_DIMS_CREATE_WEIGHTED(nnodes, ndims, dim_weights, periods, info, dims)
    IN      nnodes          number of nodes in a grid (integer)
    IN      ndims           number of Cartesian dimensions (integer)
    IN      dim_weights     double array of size ndims specifying accumulated communication costs in each direction
    IN      periods        logical array of size ndims specifying whether the grid is periodic (true) or not (false) in each dimension
    IN      info            info argument (handle)
    INOUT   dims            integer array of size ndims specifying the number of nodes in each dimension

```

```

int MPI_Dims_create_weighted(int nnodes, int ndims,
    const double dim_weights[], const int periods[],
    MPI_Info info, int dims[])
MPI_Dims_create_weighted(nnodes, ndims, dim_weights, periods, info, dims,
    ierror)
    INTEGER, INTENT(IN) :: nnodes, ndims
    DOUBLE PRECISION, INTENT(IN) :: dim_weights(ndims)
    LOGICAL, INTENT(IN) :: periods(ndims)
    TYPE(MPI_Info), INTENT(IN) :: info
    INTEGER, INTENT(INOUT) :: dims(ndims)
    INTEGER, OPTIONAL, INTENT(OUT) :: ierror
MPI_DIMS_CREATE_WEIGHTED(NNODES, NDIMS, DIM_WEIGHTS, PERIODS, INFO, DIMS,
    IERROR)
    INTEGER NNODES, INFO, NDIMS, DIMS(*), IERROR
    DOUBLE PRECISION DIM_WEIGHTS(*)
    LOGICAL PERIODS(*)

```

The entries in the array `dims` are set to describe a Cartesian grid with `ndims` dimensions and a total of `nnodes` nodes. The argument `dim_weights` has the same meaning as in `MPI_CART_CREATE_WEIGHTED`. See also the advice to users there. The caller may further constrain the operation of this routine by specifying elements of array `dims`. If `dims[i]` is set to a positive number, the routine will not modify the number of nodes in dimension `i`; only those entries where `dims[i] = 0` are modified by the call. Negative input values of `dims[i]` are erroneous. An error will occur if `nnodes` is not a multiple of $\prod_{i, \text{dims}[i] \neq 0} \text{dims}[i]$. For `dims[i]` set by the call and which have identical `dim_weights[i]`, `dims[i]` will be ordered in non-increasing order. The array `dims` is suitable for use as input to routine `MPI_CART_CREATE`.

`MPI_DIMS_CREATE_WEIGHTED` is local. The `periods` and `info` arguments can further influence the factorization. If `ndims` is zero and `nnodes` is one, `dims` is neither evaluated nor

changed and `MPI_DIMS_CREATE_WEIGHTED` returns `MPI_SUCCESS`.

The factorization of `nnodes` into the array `dims` is chosen in a way to minimize the communication according to the given weights; which implies that this function looks for a factorization with minimal sum $\sum_i \text{dim_weights}[i] \cdot \text{dims}[i]$.

Rationale. As shown in Figure 7.1 on page 315, the accumulated communication costs per node (in positive and negative direction of all dimensions) would be $C = 2 \sum_i w_i / \prod_{j, j \neq i} d_j$. With `nnodes` = $N = \prod_j d_j$, the cost can be calculated as $C = \frac{2}{N} \sum_i w_i d_i$. (*End of rationale.*)

Advice to implementors. An implementation path is described in [48], containing a modified factorization based on [61]. (*End of advice to implementors.*)

7.5.3 Graph Constructor

`MPI_GRAPH_CREATE(comm_old, nnodes, index, edges, reorder, comm_graph)`

IN	<code>comm_old</code>	input communicator (handle)
IN	<code>nnodes</code>	number of nodes in graph (integer)
IN	<code>index</code>	array of integers describing node degrees (see below)
IN	<code>edges</code>	array of integers describing graph edges (see below)
IN	<code>reorder</code>	ranking may be reordered (true) or not (false) (logical)
OUT	<code>comm_graph</code>	communicator with graph topology added (handle)

```
int MPI_Graph_create(MPI_Comm comm_old, int nnodes, const int index[],
                    const int edges[], int reorder, MPI_Comm *comm_graph)
```

```
MPI_Graph_create(comm_old, nnodes, index, edges, reorder, comm_graph,
                 ierror)
```

```
TYPE(MPI_Comm), INTENT(IN) :: comm_old
INTEGER, INTENT(IN) :: nnodes, index(nnodes), edges(*)
LOGICAL, INTENT(IN) :: reorder
TYPE(MPI_Comm), INTENT(OUT) :: comm_graph
INTEGER, OPTIONAL, INTENT(OUT) :: ierror
```

```
MPI_GRAPH_CREATE(COMM_OLD, NNODES, INDEX, EDGES, REORDER, COMM_GRAPH,
                 IERROR)
```

```
INTEGER COMM_OLD, NNODES, INDEX(*), EDGES(*), COMM_GRAPH, IERROR
LOGICAL REORDER
```

`MPI_GRAPH_CREATE` returns a handle to a new communicator to which the graph topology information is attached. If `reorder = false` then the rank of each process in the new group is identical to its rank in the old group. Otherwise, the function may reorder the processes. If the size, `nnodes`, of the graph is smaller than the size of the group of `comm_old`, then some processes are returned `MPI_COMM_NULL`, in analogy to `MPI_CART_CREATE` and `MPI_COMM_SPLIT`. If the graph is empty, i.e., `nnodes == 0`, then `MPI_COMM_NULL`

is returned in all processes. The call is erroneous if it specifies a graph that is larger than the group size of the input communicator.

The three parameters `nnodes`, `index` and `edges` define the graph structure. `nnodes` is the number of nodes of the graph. The nodes are numbered from 0 to `nnodes-1`. The i -th entry of array `index` stores the total number of neighbors of the first i graph nodes. The lists of neighbors of nodes 0, 1, ..., `nnodes-1` are stored in consecutive locations in array `edges`. The array `edges` is a flattened representation of the edge lists. The total number of entries in `index` is `nnodes` and the total number of entries in `edges` is equal to the number of graph edges.

The definitions of the arguments `nnodes`, `index`, and `edges` are illustrated with the following simple example.

Example 7.3

Assume there are four processes 0, 1, 2, 3 with the following adjacency matrix:

process	neighbors
0	1, 3
1	0
2	3
3	0, 2

Then, the input arguments are:

```
nnodes = 4
index = 2, 3, 4, 6
edges = 1, 3, 0, 3, 0, 2
```

Thus, in C, `index[0]` is the degree of node zero, and `index[i] - index[i-1]` is the degree of node i , $i=1, \dots, \text{nnodes}-1$; the list of neighbors of node zero is stored in `edges[j]`, for $0 \leq j \leq \text{index}[0] - 1$ and the list of neighbors of node i , $i > 0$, is stored in `edges[j]`, $\text{index}[i-1] \leq j \leq \text{index}[i] - 1$.

In Fortran, `index(1)` is the degree of node zero, and `index(i+1) - index(i)` is the degree of node i , $i=1, \dots, \text{nnodes}-1$; the list of neighbors of node zero is stored in `edges(j)`, for $1 \leq j \leq \text{index}(1)$ and the list of neighbors of node i , $i > 0$, is stored in `edges(j)`, $\text{index}(i)+1 \leq j \leq \text{index}(i+1)$.

A single process is allowed to be defined multiple times in the list of neighbors of a process (i.e., there may be multiple edges between two processes). A process is also allowed to be a neighbor to itself (i.e., a self loop in the graph). The adjacency matrix is allowed to be non-symmetric.

Advice to users. Performance implications of using multiple edges or a non-symmetric adjacency matrix are not defined. The definition of a node-neighbor edge does not imply a direction of the communication. (*End of advice to users.*)

Advice to implementors. The following topology information is likely to be stored with a communicator:

- Type of topology (Cartesian/graph),
- For a Cartesian topology:

1. `ndims` (number of dimensions),
 2. `dims` (numbers of processes per coordinate direction),
 3. `periods` (periodicity information),
 4. `own_position` (own position in grid, could also be computed from rank and `dims`)
- For a graph topology:
 1. `index`,
 2. `edges`,
 which are the vectors defining the graph structure.

For a graph structure the number of nodes is equal to the number of processes in the group. Therefore, the number of nodes does not have to be stored explicitly. An additional zero entry at the start of array `index` simplifies access to the topology information. (*End of advice to implementors.*)

7.5.4 Distributed Graph Constructor

`MPI_GRAPH_CREATE` requires that each process passes the full (global) communication graph to the call. This limits the scalability of this constructor. With the distributed graph interface, the communication graph is specified in a fully distributed fashion. Each process specifies only the part of the communication graph of which it is aware. Typically, this could be the set of processes from which the process will eventually receive or get data, or the set of processes to which the process will send or put data, or some combination of such edges. Two different interfaces can be used to create a distributed graph topology. `MPI_DIST_GRAPH_CREATE_ADJACENT` creates a distributed graph communicator with each process specifying each of its incoming and outgoing (adjacent) edges in the logical communication graph and thus requires minimal communication during creation. `MPI_DIST_GRAPH_CREATE` provides full flexibility such that any process can indicate that communication will occur between any pair of processes in the graph.

To provide better possibilities for optimization by the MPI library, the distributed graph constructors permit weighted communication edges and take an `info` argument that can further influence process reordering or other optimizations performed by the MPI library. For example, hints can be provided on how edge weights are to be interpreted, the quality of the reordering, and/or the time permitted for the MPI library to process the graph.

```

1 MPI_DIST_GRAPH_CREATE_ADJACENT(comm_old, indegree, sources, sourceweights,
2     outdegree, destinations, destweights, info, reorder, comm_dist_graph)
3
4     IN     comm_old           input communicator (handle)
5
6     IN     indegree          size of sources and sourceweights arrays (non-negative
7     integer)
8
9     IN     sources            ranks of processes for which the calling process is a
10    destination (array of non-negative integers)
11
12    IN     sourceweights       weights of the edges into the calling process (array of
13    non-negative integers)
14
15    IN     outdegree          size of destinations and destweights arrays (non-negative
16    integer)
17
18    IN     destinations        ranks of processes for which the calling process is a
19    source (array of non-negative integers)
20
21    IN     destweights         weights of the edges out of the calling process (array
22    of non-negative integers)
23
24    IN     info                hints on optimization and interpretation of weights
25    (handle)
26
27    IN     reorder             the ranks may be reordered (true) or not (false) (logi-
28    cal)
29
30    OUT    comm_dist_graph     communicator with distributed graph topology (han-
31    dle)
32
33 int MPI_Dist_graph_create_adjacent(MPI_Comm comm_old, int indegree,
34     const int sources[], const int sourceweights[], int outdegree,
35     const int destinations[], const int destweights[],
36     MPI_Info info, int reorder, MPI_Comm *comm_dist_graph)
37
38 MPI_Dist_graph_create_adjacent(comm_old, indegree, sources, sourceweights,
39     outdegree, destinations, destweights, info, reorder,
40     comm_dist_graph, ierror)
41
42     TYPE(MPI_Comm), INTENT(IN) :: comm_old
43     INTEGER, INTENT(IN) :: indegree, sources(indegree), outdegree,
44     destinations(outdegree)
45     INTEGER, INTENT(IN) :: sourceweights(*), destweights(*)
46     TYPE(MPI_Info), INTENT(IN) :: info
47     LOGICAL, INTENT(IN) :: reorder
48     TYPE(MPI_Comm), INTENT(OUT) :: comm_dist_graph
49     INTEGER, OPTIONAL, INTENT(OUT) :: ierror
50
51 MPI_DIST_GRAPH_CREATE_ADJACENT(COMM_OLD, INDEGREE, SOURCES, SOURCEWEIGHTS,
52     OUTDEGREE, DESTINATIONS, DESTWEIGHTS, INFO, REORDER,
53     COMM_DIST_GRAPH, IERROR)
54
55     INTEGER COMM_OLD, INDEGREE, SOURCES(*), SOURCEWEIGHTS(*), OUTDEGREE,
56     DESTINATIONS(*), DESTWEIGHTS(*), INFO, COMM_DIST_GRAPH,
57     IERROR

```

LOGICAL REORDER

MPI_DIST_GRAPH_CREATE_ADJACENT returns a handle to a new communicator to which the distributed graph topology information is attached. Each process passes all information about its incoming and outgoing edges in the virtual distributed graph topology. The calling processes must ensure that each edge of the graph is described in the source and in the destination process with the same weights. If there are multiple edges for a given (source,dest) pair, then the sequence of the weights of these edges does not matter. The complete communication topology is the combination of all edges shown in the sources arrays of all processes in comm_old, which must be identical to the combination of all edges shown in the destinations arrays. Source and destination ranks must be process ranks of comm_old. This allows a fully distributed specification of the communication graph. Isolated processes (i.e., processes with no outgoing or incoming edges, that is, processes that have specified indegree and outdegree as zero and thus do not occur as source or destination rank in the graph specification) are allowed.

The call creates a new communicator comm_dist_graph of distributed graph topology type to which topology information has been attached. The number of processes in comm_dist_graph is identical to the number of processes in comm_old. The call to MPI_DIST_GRAPH_CREATE_ADJACENT is collective.

Weights are specified as non-negative integers and can be used to influence the process remapping strategy and other internal MPI optimizations. For instance, approximate count arguments of later communication calls along specific edges could be used as their edge weights. Multiplicity of edges can likewise indicate more intense communication between pairs of processes. However, the exact meaning of edge weights is not specified by the MPI standard and is left to the implementation. In C or Fortran, an application can supply the special value MPI_UNWEIGHTED for the weight array to indicate that all edges have the same (effectively no) weight. It is erroneous to supply MPI_UNWEIGHTED for some but not all processes of comm_old. If the graph is weighted but indegree or outdegree is zero, then MPI_WEIGHTS_EMPTY or any arbitrary array may be passed to sourceweights or destweights respectively. Note that MPI_UNWEIGHTED and MPI_WEIGHTS_EMPTY are not special weight values; rather they are special values for the total array argument. In Fortran, MPI_UNWEIGHTED and MPI_WEIGHTS_EMPTY are objects like MPI_BOTTOM (not usable for initialization or assignment), see Section 2.5.4.

Advice to users. In the case of an empty weights array argument passed while constructing a weighted graph, one should not pass NULL because the value of MPI_UNWEIGHTED may be equal to NULL. The value of this argument would then be indistinguishable from MPI_UNWEIGHTED to the implementation. In this case MPI_WEIGHTS_EMPTY should be used instead. (*End of advice to users.*)

Advice to implementors. It is recommended that MPI_UNWEIGHTED not be implemented as NULL. (*End of advice to implementors.*)

Rationale. To ensure backward compatibility, MPI_UNWEIGHTED may still be implemented as NULL. See Annex B.3. (*End of rationale.*)

The meaning of the info and reorder arguments is defined in the description of the following routine.

```

1 MPI_DIST_GRAPH_CREATE(comm_old, n, sources, degrees, destinations, weights, info,
2     reorder, comm_dist_graph)
3
4     IN     comm_old         input communicator (handle)
5
6     IN     n                number of source nodes for which this process specifies
7     edges (non-negative integer)
8
9     IN     sources          array containing the n source nodes for which this pro-
10    cess specifies edges (array of non-negative integers)
11
12    IN     degrees          array specifying the number of destinations for each
13    source node in the source node array (array of non-
14    negative integers)
15
16    IN     destinations      destination nodes for the source nodes in the source
17    node array (array of non-negative integers)
18
19    IN     weights           weights for source to destination edges (array of non-
20    negative integers)
21
22    IN     info              hints on optimization and interpretation of weights
23    (handle)
24
25    IN     reorder           the process may be reordered (true) or not (false) (log-
26    ical)
27
28    OUT    comm_dist_graph   communicator with distributed graph topology added
29    (handle)
30
31 int MPI_Dist_graph_create(MPI_Comm comm_old, int n, const int sources[],
32     const int degrees[], const int destinations[],
33     const int weights[], MPI_Info info, int reorder,
34     MPI_Comm *comm_dist_graph)
35
36 MPI_Dist_graph_create(comm_old, n, sources, degrees, destinations, weights,
37     info, reorder, comm_dist_graph, ierror)
38     TYPE(MPI_Comm), INTENT(IN) :: comm_old
39     INTEGER, INTENT(IN) :: n, sources(n), degrees(n), destinations(*)
40     INTEGER, INTENT(IN) :: weights(*)
41     TYPE(MPI_Info), INTENT(IN) :: info
42     LOGICAL, INTENT(IN) :: reorder
43     TYPE(MPI_Comm), INTENT(OUT) :: comm_dist_graph
44     INTEGER, OPTIONAL, INTENT(OUT) :: ierror
45
46 MPI_DIST_GRAPH_CREATE(COMM_OLD, N, SOURCES, DEGREES, DESTINATIONS, WEIGHTS,
47     INFO, REORDER, COMM_DIST_GRAPH, IERROR)
48     INTEGER COMM_OLD, N, SOURCES(*), DEGREES(*), DESTINATIONS(*),
49     WEIGHTS(*), INFO, COMM_DIST_GRAPH, IERROR
50     LOGICAL REORDER

```

MPI_DIST_GRAPH_CREATE returns a handle to a new communicator to which the distributed graph topology information is attached. Concretely, each process calls the constructor with a set of directed (source,destination) communication edges as described below. Every process passes an array of n source nodes in the sources array. For each source node, a

non-negative number of destination nodes is specified in the `degrees` array. The destination nodes are stored in the corresponding consecutive segment of the `destinations` array. More precisely, if the *i*-th node in `sources` is *s*, this specifies `degrees[i]` edges (*s*,*d*) with *d* of the *j*-th such edge stored in `destinations[degrees[0]+...+degrees[i-1]+j]`. The weight of this edge is stored in `weights[degrees[0]+...+degrees[i-1]+j]`. Both the `sources` and the `destinations` arrays may contain the same node more than once, and the order in which nodes are listed as destinations or sources is not significant. Similarly, different processes may specify edges with the same source and destination nodes. Source and destination nodes must be process ranks of `comm_old`. Different processes may specify different numbers of source and destination nodes, as well as different source to destination edges. This allows a fully distributed specification of the communication graph. Isolated processes (i.e., processes with no outgoing or incoming edges, that is, processes that do not occur as source or destination node in the graph specification) are allowed.

The call creates a new communicator `comm_dist_graph` of distributed graph topology type to which topology information has been attached. The number of processes in `comm_dist_graph` is identical to the number of processes in `comm_old`. The call to `MPI_DIST_GRAPH_CREATE` is collective.

If `reorder = false`, all processes will have the same rank in `comm_dist_graph` as in `comm_old`. If `reorder = true` then the MPI library is free to remap to other processes (of `comm_old`) in order to improve communication on the edges of the communication graph. The weight associated with each edge is a hint to the MPI library about the amount or intensity of communication on that edge, and may be used to compute a “best” reordering.

Weights are specified as non-negative integers and can be used to influence the process remapping strategy and other internal MPI optimizations. For instance, approximate count arguments of later communication calls along specific edges could be used as their edge weights. Multiplicity of edges can likewise indicate more intense communication between pairs of processes. However, the exact meaning of edge weights is not specified by the MPI standard and is left to the implementation. In C or Fortran, an application can supply the special value `MPI_UNWEIGHTED` for the weight array to indicate that all edges have the same (effectively no) weight. It is erroneous to supply `MPI_UNWEIGHTED` for some but not all processes of `comm_old`. If the graph is weighted but `n = 0`, then `MPI_WEIGHTS_EMPTY` or any arbitrary array may be passed to `weights`. Note that `MPI_UNWEIGHTED` and `MPI_WEIGHTS_EMPTY` are not special weight values; rather they are special values for the total array argument. In Fortran, `MPI_UNWEIGHTED` and `MPI_WEIGHTS_EMPTY` are objects like `MPI_BOTTOM` (not usable for initialization or assignment). See Section 2.5.4.

Advice to users. In the case of an empty `weights` array argument passed while constructing a weighted graph, one should not pass `NULL` because the value of `MPI_UNWEIGHTED` may be equal to `NULL`. The value of this argument would then be indistinguishable from `MPI_UNWEIGHTED` to the implementation. `MPI_WEIGHTS_EMPTY` should be used instead. (*End of advice to users.*)

Advice to implementors. It is recommended that `MPI_UNWEIGHTED` not be implemented as `NULL`. (*End of advice to implementors.*)

Rationale. To ensure backward compatibility, `MPI_UNWEIGHTED` may still be implemented as `NULL`. See Annex B.3. (*End of rationale.*)

The meaning of the `weights` argument can be influenced by the `info` argument. `Info` arguments can be used to guide the mapping; possible options include minimizing the

1 maximum number of edges between processes on different SMP nodes, or minimizing the
 2 sum of all such edges. An MPI implementation is not obliged to follow specific hints, and it
 3 is valid for an MPI implementation not to do any reordering. An MPI implementation may
 4 specify more info key-value pairs. All processes must specify the same set of key-value info
 5 pairs.

7 *Advice to implementors.* MPI implementations must document any additionally
 8 supported key-value info pairs. MPI_INFO_NULL is always valid, and may indicate the
 9 default creation of the distributed graph topology to the MPI library.

10 An implementation does not explicitly need to construct the topology from its dis-
 11 tributed parts. However, all processes can construct the full topology from the dis-
 12 tributed specification and use this in a call to MPI_GRAPH_CREATE to create the
 13 topology. This may serve as a reference implementation of the functionality, and
 14 may be acceptable for small communicators. However, a scalable high-quality im-
 15 plementation would save the topology graph in a distributed way. (*End of advice to*
 16 *implementors.*)

19 **Example 7.4** As for Example 7.3, assume there are four processes 0, 1, 2, 3 with the
 20 following adjacency matrix and unit edge weights:

process	neighbors
0	1, 3
1	0
2	3
3	0, 2

27 With MPI_DIST_GRAPH_CREATE, this graph could be constructed in many different ways.
 28 One way would be that each process specifies its outgoing edges. The arguments per process
 29 would be:

process	n	sources	degrees	destinations	weights
0	1	0	2	1,3	1,1
1	1	1	1	0	1
2	1	2	1	3	1
3	1	3	2	0,2	1,1

36 Another way would be to pass the whole graph on process 0, which could be done with
 37 the following arguments per process:

process	n	sources	degrees	destinations	weights
0	4	0,1,2,3	2,1,1,2	1,3,0,3,0,2	1,1,1,1,1,1
1	0	-	-	-	-
2	0	-	-	-	-
3	0	-	-	-	-

45 In both cases above, the application could supply MPI_UNWEIGHTED instead of explic-
 46 itly providing identical weights.

47 MPI_DIST_GRAPH_CREATE_ADJACENT could be used to specify this graph using the
 48 following arguments:

process	indegree	sources	sourceweights	outdegree	destinations	destweights
0	2	1,3	1,1	2	1,3	1,1
1	1	0	1	1	0	1
2	1	3	1	1	3	1
3	2	0,2	1,1	2	0,2	1,1

Example 7.5 A two-dimensional $P \times Q$ torus where all processes communicate along the dimensions and along the diagonal edges. This cannot be modeled with Cartesian topologies, but can easily be captured with `MPI_DIST_GRAPH_CREATE` as shown in the following code. In this example, the communication along the dimensions is twice as heavy as the communication along the diagonals:

```

/*
Input:      dimensions P, Q
Condition:  number of processes equal to P*Q; otherwise only
            ranks smaller than P*Q participate
*/
int rank, x, y;
int sources[1], degrees[1];
int destinations[8], weights[8];
MPI_Comm comm_dist_graph;

MPI_Comm_rank(MPI_COMM_WORLD, &rank);

/* get x and y dimension */
y=rank/P; x=rank%P;

/* get my communication partners along x dimension */
destinations[0] = P*y+(x+1)%P; weights[0] = 2;
destinations[1] = P*y+(P+x-1)%P; weights[1] = 2;

/* get my communication partners along y dimension */
destinations[2] = P*((y+1)%Q)+x; weights[2] = 2;
destinations[3] = P*((Q+y-1)%Q)+x; weights[3] = 2;

/* get my communication partners along diagonals */
destinations[4] = P*((y+1)%Q)+(x+1)%P; weights[4] = 1;
destinations[5] = P*((Q+y-1)%Q)+(x+1)%P; weights[5] = 1;
destinations[6] = P*((y+1)%Q)+(P+x-1)%P; weights[6] = 1;
destinations[7] = P*((Q+y-1)%Q)+(P+x-1)%P; weights[7] = 1;

sources[0] = rank;
degrees[0] = 8;
MPI_Dist_graph_create(MPI_COMM_WORLD, 1, sources, degrees, destinations,
                      weights, MPI_INFO_NULL, 1, &comm_dist_graph);

```

7.5.5 Topology Inquiry Functions

If a topology has been defined with one of the above functions, then the topology information can be looked up using inquiry functions. They all are local calls.

`MPI_TOPO_TEST(comm, status)`

IN	comm	communicator (handle)
OUT	status	topology type of communicator comm (state)

```
int MPI_Topo_test(MPI_Comm comm, int *status)
```

```
MPI_Topo_test(comm, status, ierror)
  TYPE(MPI_Comm), INTENT(IN) :: comm
  INTEGER, INTENT(OUT) :: status
  INTEGER, OPTIONAL, INTENT(OUT) :: ierror
```

```
MPI_TOPO_TEST(COMM, STATUS, IERROR)
  INTEGER COMM, STATUS, IERROR
```

The function `MPI_TOPO_TEST` returns the type of topology that is assigned to a communicator.

The output value `status` is one of the following:

<code>MPI_GRAPH</code>	graph topology
<code>MPI_CART</code>	Cartesian topology
<code>MPI_DIST_GRAPH</code>	distributed graph topology
<code>MPI_UNDEFINED</code>	no topology

`MPI_GRAPHDIMS_GET(comm, nnodes, nedges)`

IN	comm	communicator for group with graph structure (handle)
OUT	nnodes	number of nodes in graph (integer) (same as number of processes in the group)
OUT	nedges	number of edges in graph (integer)

```
int MPI_Graphdims_get(MPI_Comm comm, int *nnodes, int *nedges)
```

```
MPI_Graphdims_get(comm, nnodes, nedges, ierror)
  TYPE(MPI_Comm), INTENT(IN) :: comm
  INTEGER, INTENT(OUT) :: nnodes, nedges
  INTEGER, OPTIONAL, INTENT(OUT) :: ierror
```

```
MPI_GRAPHDIMS_GET(COMM, NNODES, NEDGES, IERROR)
  INTEGER COMM, NNODES, NEDGES, IERROR
```

Functions `MPI_GRAPHDIMS_GET` and `MPI_GRAPH_GET` retrieve the graph-topology information that was associated with a communicator by `MPI_GRAPH_CREATE`.

The information provided by `MPI_GRAPHDIMS_GET` can be used to dimension the vectors `index` and `edges` correctly for the following call to `MPI_GRAPH_GET`.

```
MPI_GRAPH_GET(comm, maxindex, maxedges, index, edges)
```

IN	<code>comm</code>	communicator with graph structure (handle)
IN	<code>maxindex</code>	length of vector <code>index</code> in the calling program (integer)
IN	<code>maxedges</code>	length of vector <code>edges</code> in the calling program (integer)
OUT	<code>index</code>	array of integers containing the graph structure (for details see the definition of <code>MPI_GRAPH_CREATE</code>)
OUT	<code>edges</code>	array of integers containing the graph structure

```
int MPI_Graph_get(MPI_Comm comm, int maxindex, int maxedges, int index[],
                 int edges[])
```

```
MPI_Graph_get(comm, maxindex, maxedges, index, edges, ierror)
```

```
TYPE(MPI_Comm), INTENT(IN) :: comm
INTEGER, INTENT(IN) :: maxindex, maxedges
INTEGER, INTENT(OUT) :: index(maxindex), edges(maxedges)
INTEGER, OPTIONAL, INTENT(OUT) :: ierror
```

```
MPI_GRAPH_GET(COMM, MAXINDEX, MAXEDGES, INDEX, EDGES, IERROR)
```

```
INTEGER COMM, MAXINDEX, MAXEDGES, INDEX(*), EDGES(*), IERROR
```

```
MPI_CARTDIM_GET(comm, ndims)
```

IN	<code>comm</code>	communicator with Cartesian structure (handle)
OUT	<code>ndims</code>	number of dimensions of the Cartesian structure (integer)

```
int MPI_Cartdim_get(MPI_Comm comm, int *ndims)
```

```
MPI_Cartdim_get(comm, ndims, ierror)
```

```
TYPE(MPI_Comm), INTENT(IN) :: comm
INTEGER, INTENT(OUT) :: ndims
INTEGER, OPTIONAL, INTENT(OUT) :: ierror
```

```
MPI_CARTDIM_GET(COMM, NDIMS, IERROR)
```

```
INTEGER COMM, NDIMS, IERROR
```

The functions `MPI_CARTDIM_GET` and `MPI_CART_GET` return the Cartesian topology information that was associated with a communicator by `MPI_CART_CREATE`. If `comm` is associated with a zero-dimensional Cartesian topology, `MPI_CARTDIM_GET` returns `ndims=0` and `MPI_CART_GET` will keep all output arguments unchanged.

```

1 MPI_CART_GET(comm, maxdims, dims, periods, coords)
2     IN      comm      communicator with Cartesian structure (handle)
3
4     IN      maxdims   length of vectors dims, periods, and
5                        coords in the calling program (integer)
6
7     OUT     dims      number of processes for each Cartesian dimension (ar-
8                        ray of integer)
9
10    OUT     periods   periodicity (true/false) for each Cartesian dimension
11                        (array of logical)
12
13    OUT     coords    coordinates of calling process in Cartesian structure
14                        (array of integer)
15
16 int MPI_Cart_get(MPI_Comm comm, int maxdims, int dims[], int periods[],
17                 int coords[])
18
19 MPI_Cart_get(comm, maxdims, dims, periods, coords, ierror)
20     TYPE(MPI_Comm), INTENT(IN) :: comm
21     INTEGER, INTENT(IN) :: maxdims
22     INTEGER, INTENT(OUT) :: dims(maxdims), coords(maxdims)
23     LOGICAL, INTENT(OUT) :: periods(maxdims)
24     INTEGER, OPTIONAL, INTENT(OUT) :: ierror
25
26 MPI_CART_GET(COMM, MAXDIMS, DIMS, PERIODS, COORDS, IERROR)
27     INTEGER COMM, MAXDIMS, DIMS(*), COORDS(*), IERROR
28     LOGICAL PERIODS(*)
29
30 MPI_CART_RANK(comm, coords, rank)
31     IN      comm      communicator with Cartesian structure (handle)
32
33     IN      coords    integer array (of size ndims) specifying the Cartesian
34                        coordinates of a process
35
36     OUT     rank      rank of specified process (integer)
37
38 int MPI_Cart_rank(MPI_Comm comm, const int coords[], int *rank)
39
40 MPI_Cart_rank(comm, coords, rank, ierror)
41     TYPE(MPI_Comm), INTENT(IN) :: comm
42     INTEGER, INTENT(IN) :: coords(*)
43     INTEGER, INTENT(OUT) :: rank
44     INTEGER, OPTIONAL, INTENT(OUT) :: ierror
45
46 MPI_CART_RANK(COMM, COORDS, RANK, IERROR)
47     INTEGER COMM, COORDS(*), RANK, IERROR

```

For a process group with Cartesian structure, the function `MPI_CART_RANK` translates the logical process coordinates to process ranks as they are used by the point-to-point routines.

For dimension i with `periods(i) = true`, if the coordinate, `coords(i)`, is out of range, that is, `coords(i) < 0` or `coords(i) ≥ dims(i)`, it is shifted back to the interval $0 ≤ \text{coords}(i) < \text{dims}(i)$ automatically. Out-of-range coordinates are erroneous for non-periodic dimensions.

If `comm` is associated with a zero-dimensional Cartesian topology, `coords` is not significant and 0 is returned in `rank`.

`MPI_CART_COORDS(comm, rank, maxdims, coords)`

IN	<code>comm</code>	communicator with Cartesian structure (handle)
IN	<code>rank</code>	rank of a process within group of <code>comm</code> (integer)
IN	<code>maxdims</code>	length of vector <code>coords</code> in the calling program (integer)
OUT	<code>coords</code>	integer array (of size <code>ndims</code>) containing the Cartesian coordinates of specified process (array of integers)

```
int MPI_Cart_coords(MPI_Comm comm, int rank, int maxdims, int coords[])
```

```
MPI_Cart_coords(comm, rank, maxdims, coords, ierror)
```

```
TYPE(MPI_Comm), INTENT(IN) :: comm
INTEGER, INTENT(IN) :: rank, maxdims
INTEGER, INTENT(OUT) :: coords(maxdims)
INTEGER, OPTIONAL, INTENT(OUT) :: ierror
```

```
MPI_CART_COORDS(COMM, RANK, MAXDIMS, COORDS, IERROR)
```

```
INTEGER COMM, RANK, MAXDIMS, COORDS(*), IERROR
```

The inverse mapping, rank-to-coordinates translation is provided by `MPI_CART_COORDS`.

If `comm` is associated with a zero-dimensional Cartesian topology, `coords` will be unchanged.

`MPI_GRAPH_NEIGHBORS_COUNT(comm, rank, nneighbors)`

IN	<code>comm</code>	communicator with graph topology (handle)
IN	<code>rank</code>	rank of process in group of <code>comm</code> (integer)
OUT	<code>nneighbors</code>	number of neighbors of specified process (integer)

```
int MPI_Graph_neighbors_count(MPI_Comm comm, int rank, int *nneighbors)
```

```
MPI_Graph_neighbors_count(comm, rank, nneighbors, ierror)
```

```
TYPE(MPI_Comm), INTENT(IN) :: comm
INTEGER, INTENT(IN) :: rank
INTEGER, INTENT(OUT) :: nneighbors
INTEGER, OPTIONAL, INTENT(OUT) :: ierror
```

```
MPI_GRAPH_NEIGHBORS_COUNT(COMM, RANK, NNEIGHBORS, IERROR)
```

```
INTEGER COMM, RANK, NNEIGHBORS, IERROR
```

```

1 MPI_GRAPH_NEIGHBORS(comm, rank, maxneighbors, neighbors)
2     IN      comm      communicator with graph topology (handle)
3
4     IN      rank      rank of process in group of comm (integer)
5
6     IN      maxneighbors size of array neighbors (integer)
7
8     OUT     neighbors  ranks of processes that are neighbors to specified pro-
9                          cess (array of integer)

```

```

9
10 int MPI_Graph_neighbors(MPI_Comm comm, int rank, int maxneighbors,
11                        int neighbors[])

```

```

12 MPI_Graph_neighbors(comm, rank, maxneighbors, neighbors, ierror)
13     TYPE(MPI_Comm), INTENT(IN) :: comm
14     INTEGER, INTENT(IN) :: rank, maxneighbors
15     INTEGER, INTENT(OUT) :: neighbors(maxneighbors)
16     INTEGER, OPTIONAL, INTENT(OUT) :: ierror

```

```

17
18 MPI_GRAPH_NEIGHBORS(COMM, RANK, MAXNEIGHBORS, NEIGHBORS, IERROR)
19     INTEGER COMM, RANK, MAXNEIGHBORS, NEIGHBORS(*), IERROR

```

MPI_GRAPH_NEIGHBORS_COUNT and MPI_GRAPH_NEIGHBORS provide adjacency information for a graph topology. The returned count and array of neighbors for the queried rank will both include *all* neighbors and reflect the same edge ordering as was specified by the original call to MPI_GRAPH_CREATE. Specifically, MPI_GRAPH_NEIGHBORS_COUNT and MPI_GRAPH_NEIGHBORS will return values based on the original index and edges array passed to MPI_GRAPH_CREATE (for the purpose of this example, we assume that index[-1] is zero):

- The number of neighbors (nneighbors) returned from MPI_GRAPH_NEIGHBORS_COUNT will be (index[rank] - index[rank-1]).
- The neighbors array returned from MPI_GRAPH_NEIGHBORS will be edges[index[rank-1]] through edges[index[rank]-1].

Example 7.6

Assume there are four processes 0, 1, 2, 3 with the following adjacency matrix (note that some neighbors are listed multiple times):

process	neighbors
0	1, 1, 3
1	0, 0
2	3
3	0, 2, 2

Thus, the input arguments to MPI_GRAPH_CREATE are:

```

46 nnodes = 4
47 index = 3, 5, 6, 9
48 edges = 1, 1, 3, 0, 0, 3, 0, 2, 2

```

Therefore, calling `MPI_GRAPH_NEIGHBORS_COUNT` and `MPI_GRAPH_NEIGHBORS` for each of the 4 processes will return:

Input rank	Count	Neighbors
0	3	1, 1, 3
1	2	0, 0
2	1	3
3	3	0, 2, 2

Example 7.7

Suppose that `comm` is a communicator with a shuffle-exchange topology. The group has 2^n members. Each process is labeled by a_1, \dots, a_n with $a_i \in \{0, 1\}$, and has three neighbors: $\text{exchange}(a_1, \dots, a_n) = a_1, \dots, a_{n-1}, \bar{a}_n$ ($\bar{a} = 1 - a$), $\text{shuffle}(a_1, \dots, a_n) = a_2, \dots, a_n, a_1$, and $\text{unshuffle}(a_1, \dots, a_n) = a_n, a_1, \dots, a_{n-1}$. The graph adjacency list is illustrated below for $n = 3$.

node	exchange neighbors(1)	shuffle neighbors(2)	unshuffle neighbors(3)
0 (000)	1	0	0
1 (001)	0	2	4
2 (010)	3	4	1
3 (011)	2	6	5
4 (100)	5	1	2
5 (101)	4	3	6
6 (110)	7	5	3
7 (111)	6	7	7

Suppose that the communicator `comm` has this topology associated with it. The following code fragment cycles through the three types of neighbors and performs an appropriate permutation for each.

```

! assume: each process has stored a real number A.
! extract neighborhood information
    CALL MPI_COMM_RANK(comm, myrank, ierr)
    CALL MPI_GRAPH_NEIGHBORS(comm, myrank, 3, neighbors, ierr)
! perform exchange permutation
    CALL MPI_SENDRECV_REPLACE(A, 1, MPI_REAL, neighbors(1), 0, &
        neighbors(1), 0, comm, status, ierr)
! perform shuffle permutation
    CALL MPI_SENDRECV_REPLACE(A, 1, MPI_REAL, neighbors(2), 0, &
        neighbors(3), 0, comm, status, ierr)
! perform unshuffle permutation
    CALL MPI_SENDRECV_REPLACE(A, 1, MPI_REAL, neighbors(3), 0, &
        neighbors(2), 0, comm, status, ierr)

```

`MPI_DIST_GRAPH_NEIGHBORS_COUNT` and `MPI_DIST_GRAPH_NEIGHBORS` provide adjacency information for a distributed graph topology.

```

1 MPI_DIST_GRAPH_NEIGHBORS_COUNT(comm, indegree, outdegree, weighted)
2   IN      comm      communicator with distributed graph topology (han-
3             dle)
4
5   OUT     indegree   number of edges into this process (non-negative inte-
6             ger)
7
8   OUT     outdegree  number of edges out of this process (non-negative in-
9             teger)
10
11  OUT     weighted   false if MPI_UNWEIGHTED was supplied during crea-
12                    tion, true otherwise (logical)
13
14  int MPI_Dist_graph_neighbors_count(MPI_Comm comm, int *indegree,
15                                     int *outdegree, int *weighted)
16
17  MPI_Dist_graph_neighbors_count(comm, indegree, outdegree, weighted, ierror)
18  TYPE(MPI_Comm), INTENT(IN) :: comm
19  INTEGER, INTENT(OUT) :: indegree, outdegree
20  LOGICAL, INTENT(OUT) :: weighted
21  INTEGER, OPTIONAL, INTENT(OUT) :: ierror
22
23  MPI_DIST_GRAPH_NEIGHBORS_COUNT(COMM, INDEGREE, OUTDEGREE, WEIGHTED, IERROR)
24  INTEGER COMM, INDEGREE, OUTDEGREE, IERROR
25  LOGICAL WEIGHTED
26
27  MPI_DIST_GRAPH_NEIGHBORS(comm, maxindegree, sources, sourceweights, maxoutdegree,
28                          destinations, destweights)
29
30  IN      comm      communicator with distributed graph topology (han-
31             dle)
32
33  IN      maxindegree size of sources and sourceweights arrays (non-negative
34             integer)
35
36  OUT     sources    processes for which the calling process is a destination
37             (array of non-negative integers)
38
39  OUT     sourceweights weights of the edges into the calling process (array of
40             non-negative integers)
41
42  IN      maxoutdegree size of destinations and destweights arrays
43             (non-negative integer)
44
45  OUT     destinations processes for which the calling process is a source (ar-
46             ray of non-negative integers)
47
48  OUT     destweights weights of the edges out of the calling process (array
49             of non-negative integers)
50
51  int MPI_Dist_graph_neighbors(MPI_Comm comm, int maxindegree, int sources[],
52                              int sourceweights[], int maxoutdegree, int destinations[],
53                              int destweights[])

```

```

MPI_Dist_graph_neighbors(comm, maxindegree, sources, sourceweights,
                        maxoutdegree, destinations, destweights, ierror)
    TYPE(MPI_Comm), INTENT(IN) :: comm
    INTEGER, INTENT(IN) :: maxindegree, maxoutdegree
    INTEGER, INTENT(OUT) :: sources(maxindegree),
                        destinations(maxoutdegree)
    INTEGER :: sourceweights(*), destweights(*)
    INTEGER, OPTIONAL, INTENT(OUT) :: ierror

MPI_DIST_GRAPH_NEIGHBORS(COMM, MAXINDEGREE, SOURCES, SOURCEWEIGHTS,
                        MAXOUTDEGREE, DESTINATIONS, DESTWEIGHTS, IERROR)
    INTEGER COMM, MAXINDEGREE, SOURCES(*), SOURCEWEIGHTS(*), MAXOUTDEGREE,
                        DESTINATIONS(*), DESTWEIGHTS(*), IERROR

```

These calls are local. The number of edges into and out of the process returned by `MPI_DIST_GRAPH_NEIGHBORS_COUNT` are the total number of such edges given in the call to `MPI_DIST_GRAPH_CREATE_ADJACENT` or `MPI_DIST_GRAPH_CREATE` (potentially by processes other than the calling process in the case of `MPI_DIST_GRAPH_CREATE`). Multiply defined edges are all counted and returned by `MPI_DIST_GRAPH_NEIGHBORS` in some order. If `MPI_UNWEIGHTED` is supplied for `sourceweights` or `destweights` or both, or if `MPI_UNWEIGHTED` was supplied during the construction of the graph then no weight information is returned in that array or those arrays. If the communicator was created with `MPI_DIST_GRAPH_CREATE_ADJACENT` then for each rank in `comm`, the order of the values in `sources` and `destinations` is identical to the input that was used by the process with the same rank in `comm_old` in the creation call. If the communicator was created with `MPI_DIST_GRAPH_CREATE` then the only requirement on the order of values in `sources` and `destinations` is that two calls to the routine with same input argument `comm` will return the same sequence of edges. If `maxindegree` or `maxoutdegree` is smaller than the numbers returned by `MPI_DIST_GRAPH_NEIGHBORS_COUNT`, then only the first part of the full list is returned.

Advice to implementors. Since the query calls are defined to be local, each process needs to store the list of its neighbors with incoming and outgoing edges. Communication is required at the collective `MPI_DIST_GRAPH_CREATE` call in order to compute the neighbor lists for each process from the distributed graph specification. (*End of advice to implementors.*)

7.5.6 Cartesian Shift Coordinates

If the process topology is a Cartesian structure, an `MPI_SENDRECV` operation may be used along a coordinate direction to perform a shift of data. As input, `MPI_SENDRECV` takes the rank of a source process for the receive, and the rank of a destination process for the send. If the function `MPI_CART_SHIFT` is called for a Cartesian process group, it provides the calling process with the above identifiers, which then can be passed to `MPI_SENDRECV`. The user specifies the coordinate direction and the size of the step (positive or negative). The function is local.

```

1 MPI_CART_SHIFT(comm, direction, disp, rank_source, rank_dest)
2     IN          comm          communicator with Cartesian structure (handle)
3
4     IN          direction      coordinate dimension of shift (integer)
5
6     IN          disp           displacement (> 0: upwards shift, < 0: downwards
7                               shift) (integer)
8
9     OUT         rank_source    rank of source process (integer)
10
11    OUT         rank_dest      rank of destination process (integer)
12
13 int MPI_Cart_shift(MPI_Comm comm, int direction, int disp,
14                   int *rank_source, int *rank_dest)
15
16 MPI_Cart_shift(comm, direction, disp, rank_source, rank_dest, ierror)
17     TYPE(MPI_Comm), INTENT(IN) :: comm
18     INTEGER, INTENT(IN) :: direction, disp
19     INTEGER, INTENT(OUT) :: rank_source, rank_dest
20     INTEGER, OPTIONAL, INTENT(OUT) :: ierror
21
22 MPI_CART_SHIFT(COMM, DIRECTION, DISP, RANK_SOURCE, RANK_DEST, IERROR)
23     INTEGER COMM, DIRECTION, DISP, RANK_SOURCE, RANK_DEST, IERROR

```

The `direction` argument indicates the coordinate dimension to be traversed by the shift. The dimensions are numbered from 0 to `ndims-1`, where `ndims` is the number of dimensions.

Depending on the periodicity of the Cartesian group in the specified coordinate direction, `MPI_CART_SHIFT` provides the identifiers for a circular or an end-off shift. In the case of an end-off shift, the value `MPI_PROC_NULL` may be returned in `rank_source` or `rank_dest`, indicating that the source or the destination for the shift is out of range.

It is erroneous to call `MPI_CART_SHIFT` with a `direction` that is either negative or greater than or equal to the number of dimensions in the Cartesian communicator. This implies that it is erroneous to call `MPI_CART_SHIFT` with a `comm` that is associated with a zero-dimensional Cartesian topology.

Example 7.8

The communicator, `comm`, has a two-dimensional, periodic, Cartesian topology associated with it. A two-dimensional array of `REALs` is stored one element per process, in variable `A`. One wishes to skew this array, by shifting column `i` (vertically, i.e., along the column) by `i` steps.

```

32 ....
33
34 ! find process rank
35     CALL MPI_COMM_RANK(comm, rank, ierr)
36
37 ! find Cartesian coordinates
38     CALL MPI_CART_COORDS(comm, rank, maxdims, coords, ierr)
39
40 ! compute shift source and destination
41     CALL MPI_CART_SHIFT(comm, 0, coords(2), source, dest, ierr)
42
43 ! skew array
44     CALL MPI_SENDRECV_REPLACE(A, 1, MPI_REAL, dest, 0, source, 0, comm, &
45                               status, ierr)
46
47
48

```

Advice to users. In Fortran, the dimension indicated by `DIRECTION = i` has `DIMS(i+1)` nodes, where `DIMS` is the array that was used to create the grid. In C, the dimension indicated by `direction = i` is the dimension specified by `dims[i]`. (*End of advice to users.*)

7.5.7 Partitioning of Cartesian Structures

`MPI_CART_SUB(comm, remain_dims, newcomm)`

IN	<code>comm</code>	communicator with Cartesian structure (handle)
IN	<code>remain_dims</code>	the <i>i</i> -th entry of <code>remain_dims</code> specifies whether the <i>i</i> -th dimension is kept in the subgrid (<code>true</code>) or is dropped (<code>false</code>) (logical vector)
OUT	<code>newcomm</code>	communicator containing the subgrid that includes the calling process (handle)

`int MPI_Cart_sub(MPI_Comm comm, const int remain_dims[], MPI_Comm *newcomm)`

`MPI_Cart_sub(comm, remain_dims, newcomm, ierror)`

```

TYPE(MPI_Comm), INTENT(IN) :: comm
LOGICAL, INTENT(IN) :: remain_dims(*)
TYPE(MPI_Comm), INTENT(OUT) :: newcomm
INTEGER, OPTIONAL, INTENT(OUT) :: ierror

```

`MPI_CART_SUB(COMM, REMAIN_DIMS, NEWCOMM, IERROR)`

```

INTEGER COMM, NEWCOMM, IERROR
LOGICAL REMAIN_DIMS(*)

```

If a Cartesian topology has been created with `MPI_CART_CREATE`, the function `MPI_CART_SUB` can be used to partition the communicator group into subgroups that form lower-dimensional Cartesian subgrids, and to build for each subgroup a communicator with the associated subgrid Cartesian topology. If all entries in `remain_dims` are false or `comm` is already associated with a zero-dimensional Cartesian topology then `newcomm` is associated with a zero-dimensional Cartesian topology. (This function is closely related to `MPI_COMM_SPLIT`.)

Example 7.9

Assume that `MPI_CART_CREATE(..., comm)` has defined a $(2 \times 3 \times 4)$ grid. Let `remain_dims = (true, false, true)`. Then a call to

```
MPI_CART_SUB(comm, remain_dims, comm_new);
```

will create three communicators each with eight processes in a 2×4 Cartesian topology. If `remain_dims = (false, false, true)` then the call to `MPI_CART_SUB(comm, remain_dims, comm_new)` will create six non-overlapping communicators, each with four processes, in a one-dimensional Cartesian topology.

7.5.8 Low-Level Topology Functions

The two additional functions introduced in this section can be used to implement all other topology functions. In general they will not be called by the user directly, unless he or she

is creating additional virtual topology capability other than that provided by MPI. The two calls are both local.

```
MPI_CART_MAP(comm, ndims, dims, periods, newrank)
```

IN	comm	input communicator (handle)
IN	ndims	number of dimensions of Cartesian structure (integer)
IN	dims	integer array of size ndims specifying the number of processes in each coordinate direction
IN	periods	logical array of size ndims specifying the periodicity specification in each coordinate direction
OUT	newrank	reordered rank of the calling process; MPI_UNDEFINED if calling process does not belong to grid (integer)

```
int MPI_Cart_map(MPI_Comm comm, int ndims, const int dims[],
                const int periods[], int *newrank)
```

```
MPI_Cart_map(comm, ndims, dims, periods, newrank, ierror)
```

```
TYPE(MPI_Comm), INTENT(IN) :: comm
INTEGER, INTENT(IN) :: ndims, dims(ndims)
LOGICAL, INTENT(IN) :: periods(ndims)
INTEGER, INTENT(OUT) :: newrank
INTEGER, OPTIONAL, INTENT(OUT) :: ierror
```

```
MPI_CART_MAP(COMM, NDIMS, DIMS, PERIODS, NEWRANK, IERROR)
```

```
INTEGER COMM, NDIMS, DIMS(*), NEWRANK, IERROR
LOGICAL PERIODS(*)
```

MPI_CART_MAP computes an “optimal” placement for the calling process on the physical machine. A possible implementation of this function is to always return the rank of the calling process, that is, not to perform any reordering.

Advice to implementors. The function MPI_CART_CREATE(comm, ndims, dims, periods, reorder, comm_cart), with reorder = true can be implemented by calling MPI_CART_MAP(comm, ndims, dims, periods, newrank), then calling MPI_COMM_SPLIT(comm, color, key, comm_cart), with color = 0 if newrank ≠ MPI_UNDEFINED, color = MPI_UNDEFINED otherwise, and key = newrank. If ndims is zero then a zero-dimensional Cartesian topology is created.

The function MPI_CART_SUB(comm, remain_dims, comm_new) can be implemented by a call to MPI_COMM_SPLIT(comm, color, key, comm_new), using a single number encoding of the lost dimensions as color and a single number encoding of the preserved dimensions as key.

All other Cartesian topology functions can be implemented locally, using the topology information that is cached with the communicator. (*End of advice to implementors.*)

The corresponding function for graph structures is as follows.

```

MPI_GRAPH_MAP(comm, nnodes, index, edges, newrank) 1
    IN      comm      input communicator (handle) 2
    IN      nnodes    number of graph nodes (integer) 3
    IN      index     integer array specifying the graph structure, see 4
                        MPI_GRAPH_CREATE 5
    IN      edges     integer array specifying the graph structure 6
    OUT     newrank   reordered rank of the calling process; 7
                        MPI_UNDEFINED if the calling process does not be- 8
                        long to graph (integer) 9
int MPI_Graph_map(MPI_Comm comm, int nnodes, const int index[], 10
                  const int edges[], int *newrank) 11
MPI_Graph_map(comm, nnodes, index, edges, newrank, ierror) 12
    TYPE(MPI_Comm), INTENT(IN) :: comm 13
    INTEGER, INTENT(IN) :: nnodes, index(nnodes), edges(*) 14
    INTEGER, INTENT(OUT) :: newrank 15
    INTEGER, OPTIONAL, INTENT(OUT) :: ierror 16
MPI_GRAPH_MAP(COMM, NNODES, INDEX, EDGES, NEWRANK, IERROR) 17
    INTEGER COMM, NNODES, INDEX(*), EDGES(*), NEWRANK, IERROR 18

```

Advice to implementors. The function `MPI_GRAPH_CREATE(comm, nnodes, index, edges, reorder, comm_graph)`, with `reorder = true` can be implemented by calling `MPI_GRAPH_MAP(comm, nnodes, index, edges, newrank)`, then calling `MPI_COMM_SPLIT(comm, color, key, comm_graph)`, with `color = 0` if `newrank \neq MPI_UNDEFINED`, `color = MPI_UNDEFINED` otherwise, and `key = newrank`.

All other graph topology functions can be implemented locally, using the topology information that is cached with the communicator. (*End of advice to implementors.*)

7.6 Neighborhood Collective Communication on Process Topologies

MPI process topologies specify a communication graph, but they implement no communication function themselves. Many applications require sparse nearest neighbor communications that can be expressed as graph topologies. We now describe several collective operations that perform communication along the edges of a process topology. All of these functions are collective; i.e., they must be called by all processes in the specified communicator. See Section 5 for an overview of other dense (global) collective communication operations and the semantics of collective operations.

If the graph was created with `MPI_DIST_GRAPH_CREATE_ADJACENT` with `sources` and `destinations` containing `0, ..., n-1`, where `n` is the number of processes in the group of `comm_old` (i.e., the graph is fully connected and also includes an edge from each node to itself), then the sparse neighborhood communication routine performs the same data exchange as the corresponding dense (fully-connected) collective operation. In the case of a Cartesian communicator, only nearest neighbor communication is provided, corresponding to `rank_source` and `rank_dest` in `MPI_CART_SHIFT` with input `disp=1`.

1 *Rationale.* Neighborhood collective communications enable communication on a
2 process topology. This high-level specification of data exchange among neighboring
3 processes enables optimizations in the MPI library because the communication pattern
4 is known statically (the topology). Thus, the implementation can compute optimized
5 message schedules during creation of the topology [36]. This functionality can signif-
6 icantly simplify the implementation of neighbor exchanges [32]. (*End of rationale.*)
7

8 For a distributed graph topology, created with `MPI_DIST_GRAPH_CREATE`, the se-
9 quence of neighbors in the send and receive buffers at each process is defined as the sequence
10 returned by `MPI_DIST_GRAPH_NEIGHBORS` for destinations and sources, respectively. For
11 a general graph topology, created with `MPI_GRAPH_CREATE`, the use of neighborhood col-
12 lective communication is restricted to adjacency matrices, where the number of edges be-
13 tween any two processes is defined to be the same for both processes (i.e., with a symmetric
14 adjacency matrix). In this case, the order of neighbors in the send and receive buffers is
15 defined as the sequence of neighbors as returned by `MPI_GRAPH_NEIGHBORS`. Note that
16 general graph topologies should generally be replaced by the distributed graph topologies.

17 For a Cartesian topology, created with `MPI_CART_CREATE`, the sequence of neigh-
18 bors in the send and receive buffers at each process is defined by order of the dimensions,
19 first the neighbor in the negative direction and then in the positive direction with dis-
20 placement 1. The numbers of sources and destinations in the communication routines are
21 $2 \cdot \text{ndims}$ with `ndims` defined in `MPI_CART_CREATE`. If a neighbor does not exist, i.e., at
22 the border of a Cartesian topology in the case of a non-periodic virtual grid dimension (i.e.,
23 `periods[...]==false`), then this neighbor is defined to be `MPI_PROC_NULL`.

24 If a neighbor in any of the functions is `MPI_PROC_NULL`, then the neighborhood collec-
25 tive communication behaves like a point-to-point communication with `MPI_PROC_NULL` in
26 this direction. That is, the buffer is still part of the sequence of neighbors but it is neither
27 communicated nor updated.
28

29 7.6.1 Neighborhood Gather

30 In this function, each process i gathers data items from each process j if an edge (j, i) exists
31 in the topology graph, and each process i sends the same data items to all processes j where
32 an edge (i, j) exists. The send buffer is sent to each neighboring process and the l -th block
33 in the receive buffer is received from the l -th neighbor.
34
35
36
37
38
39
40
41
42
43
44
45
46
47
48

```

MPI_NEIGHBOR_ALLGATHER(sendbuf, sendcount, sendtype, recvbuf, recvcount, recvtype,
                        comm)
IN      sendbuf          starting address of send buffer (choice)
IN      sendcount        number of elements sent to each neighbor (non-negative
                          integer)
IN      sendtype         data type of send buffer elements (handle)
OUT     recvbuf          starting address of receive buffer (choice)
IN      recvcount        number of elements received from each neighbor (non-
                          negative integer)
IN      recvtype         data type of receive buffer elements (handle)
IN      comm             communicator with topology structure (handle)

```

```

int MPI_Neighbor_allgather(const void* sendbuf, int sendcount,
                          MPI_Datatype sendtype, void* recvbuf, int recvcount,
                          MPI_Datatype recvtype, MPI_Comm comm)

```

```

MPI_Neighbor_allgather(sendbuf, sendcount, sendtype, recvbuf, recvcount,
                       recvtype, comm, ierror)
TYPE(*), DIMENSION(..), INTENT(IN) :: sendbuf
TYPE(*), DIMENSION(..) :: recvbuf
INTEGER, INTENT(IN) :: sendcount, recvcount
TYPE(MPI_Datatype), INTENT(IN) :: sendtype, recvtype
TYPE(MPI_Comm), INTENT(IN) :: comm
INTEGER, OPTIONAL, INTENT(OUT) :: ierror

```

```

MPI_NEIGHBOR_ALLGATHER(SENDBUF, SENDCOUNT, SENDTYPE, RECVBUF, RECVCOUNT,
                       RECVTYPE, COMM, IERROR)
<type> SENDBUF(*), RECVBUF(*)
INTEGER SENDCOUNT, SENDTYPE, RECVCOUNT, RECVTYPE, COMM, IERROR

```

This function supports Cartesian communicators, graph communicators, and distributed graph communicators as described in Section 7.6. If `comm` is a distributed graph communicator, the outcome is as if each process executed sends to each of its outgoing neighbors and receives from each of its incoming neighbors:

```

MPI_Dist_graph_neighbors_count(comm,&indegree,&outdegree,&weighted);
int *srcs=(int*)malloc(indegree*sizeof(int));
int *dsts=(int*)malloc(outdegree*sizeof(int));
MPI_Dist_graph_neighbors(comm,indegree,srcs,MPI_UNWEIGHTED,
                        outdegree,dsts,MPI_UNWEIGHTED);
int k,l;

/* assume sendbuf and recvbuf are of type (char*) */
for(k=0; k<outdegree; ++k)
    MPI_Isend(sendbuf,sendcount,sendtype,dsts[k],...);

for(l=0; l<indegree; ++l)

```

```

1  MPI_Irecv(recvbuf+1*recvcount*extent(recvtype),recvcount,recvtype,
2          srcs[1],...);
3
4  MPI_Waitall(...);
5

```

Figure 7.5 shows the neighborhood gather communication of one process with outgoing neighbors $d_0 \dots d_3$ and incoming neighbors $s_0 \dots s_5$. The process will send its `sendbuf` to all four destinations (outgoing neighbors) and it will receive the contribution from all six sources (incoming neighbors) into separate locations of its receive buffer.

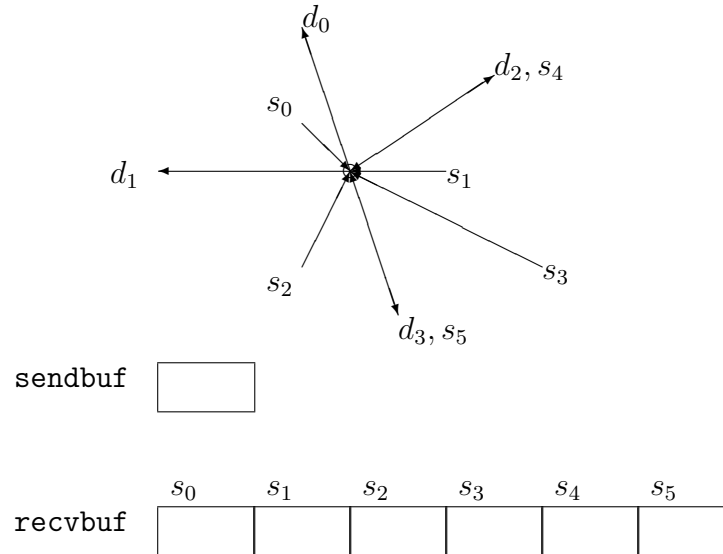

Figure 7.5: Neighborhood gather communication example.

All arguments are significant on all processes and the argument `comm` must have identical values on all processes.

The type signature associated with `sendcount`, `sendtype`, at a process must be equal to the type signature associated with `recvcount`, `recvtype` at all other processes. This implies that the amount of data sent must be equal to the amount of data received, pairwise between every pair of communicating processes. Distinct type maps between sender and receiver are still allowed.

Rationale. For optimization reasons, the same type signature is required independently of whether the topology graph is connected or not. (*End of rationale.*)

The “in place” option is not meaningful for this operation.

The vector variant of `MPI_NEIGHBOR_ALLGATHER` allows one to gather different numbers of elements from each neighbor.

```

MPI_NEIGHBOR_ALLGATHERV(sendbuf, sendcount, sendtype, recvbuf, recvcnts, displs,
                        recvtype, comm)
1
2
3
IN    sendbuf          starting address of send buffer (choice)
4
IN    sendcount        number of elements sent to each neighbor (non-negative
5
6
integer)
7
IN    sendtype         data type of send buffer elements (handle)
8
OUT   recvbuf          starting address of receive buffer (choice)
9
IN    recvcnts         non-negative integer array (of length indegree) con-
10
11
taining the number of elements that are received from
12
each neighbor
13
IN    displs           integer array (of length indegree). Entry i specifies the
14
15
displacement (relative to recvbuf) at which to place the
16
incoming data from neighbor i
17
IN    recvtype         data type of receive buffer elements (handle)
18
IN    comm             communicator with topology structure (handle)
19
int MPI_Neighbor_allgatherv(const void* sendbuf, int sendcount,
20
                           MPI_Datatype sendtype, void* recvbuf, const int recvcnts[],
21
                           const int displs[], MPI_Datatype recvtype, MPI_Comm comm)
22
MPI_Neighbor_allgatherv(sendbuf, sendcount, sendtype, recvbuf, recvcnts,
23
                        displs, recvtype, comm, ierror)
24
TYPE(*), DIMENSION(..), INTENT(IN) :: sendbuf
25
TYPE(*), DIMENSION(..) :: recvbuf
26
INTEGER, INTENT(IN) :: sendcount, recvcnts(*), displs(*)
27
TYPE(MPI_Datatype), INTENT(IN) :: sendtype, recvtype
28
TYPE(MPI_Comm), INTENT(IN) :: comm
29
INTEGER, OPTIONAL, INTENT(OUT) :: ierror
30
MPI_NEIGHBOR_ALLGATHERV(SENDBUF, SENDCOUNT, SENDTYPE, RECVBUF, RECVCOUNTS,
31
                        DISPLS, RECVTYPE, COMM, IERROR)
32
<type> SENDBUF(*), RECVBUF(*)
33
INTEGER SENDCOUNT, SENDTYPE, RECVCOUNTS(*), DISPLS(*), RECVTYPE, COMM,
34
IERROR
35
36

```

This function supports Cartesian communicators, graph communicators, and distributed graph communicators as described in Section 7.6. If `comm` is a distributed graph communicator, the outcome is as if each process executed sends to each of its outgoing neighbors and receives from each of its incoming neighbors:

```

MPI_Dist_graph_neighbors_count(comm,&indegree,&outdegree,&weighted);
int *srcs=(int*)malloc(indegree*sizeof(int));
int *dsts=(int*)malloc(outdegree*sizeof(int));
MPI_Dist_graph_neighbors(comm,indegree,srcs,MPI_UNWEIGHTED,
                        outdegree,dsts,MPI_UNWEIGHTED);
int k,l;

```

```

1
2 /* assume sendbuf and recvbuf are of type (char*) */
3 for(k=0; k<outdegree; ++k)
4     MPI_Isend(sendbuf, sendcount, sendtype, dsts[k], ...);
5
6 for(l=0; l<indegree; ++l)
7     MPI_Irecv(recvbuf+displs[l]*extent(recvtype), recvcnts[l], recvtype,
8             srcs[l], ...);
9
10 MPI_Waitall(...);
11

```

The type signature associated with `sendcount`, `sendtype`, at process j must be equal to the type signature associated with `recvcnts[l]`, `recvtype` at any other process with `srcs[l]==j`. This implies that the amount of data sent must be equal to the amount of data received, pairwise between every pair of communicating processes. Distinct type maps between sender and receiver are still allowed. The data received from the l -th neighbor is placed into `recvbuf` beginning at offset `displs[l]` elements (in terms of the `recvtype`).

The “in place” option is not meaningful for this operation.

All arguments are significant on all processes and the argument `comm` must have identical values on all processes.

7.6.2 Neighbor Alltoall

In this function, each process i receives data items from each process j if an edge (j, i) exists in the topology graph or Cartesian topology. Similarly, each process i sends data items to all processes j where an edge (i, j) exists. This call is more general than `MPI_NEIGHBOR_ALLGATHER` in that different data items can be sent to each neighbor. The k -th block in send buffer is sent to the k -th neighboring process and the l -th block in the receive buffer is received from the l -th neighbor.

```

31 MPI_NEIGHBOR_ALLTOALL(sendbuf, sendcount, sendtype, recvbuf, recvcnt, recvtype,
32                       comm)
33
34 IN     sendbuf           starting address of send buffer (choice)
35 IN     sendcount        number of elements sent to each neighbor (non-negative
36                               integer)
37 IN     sendtype         data type of send buffer elements (handle)
38 OUT   recvbuf          starting address of receive buffer (choice)
39 IN     recvcnt         number of elements received from each neighbor (non-
40                               negative integer)
41
42 IN     recvtype        data type of receive buffer elements (handle)
43
44 IN     comm            communicator with topology structure (handle)
45
46 int MPI_Neighbor_alltoall(const void* sendbuf, int sendcount,
47                          MPI_Datatype sendtype, void* recvbuf, int recvcnt,
48                          MPI_Datatype recvtype, MPI_Comm comm)

```

```

MPI_Neighbor_alltoall(sendbuf, sendcount, sendtype, recvbuf, recvcount,
                      recvtype, comm, ierror)
    TYPE(*), DIMENSION(..), INTENT(IN) :: sendbuf
    TYPE(*), DIMENSION(..) :: recvbuf
    INTEGER, INTENT(IN) :: sendcount, recvcount
    TYPE(MPI_Datatype), INTENT(IN) :: sendtype, recvtype
    TYPE(MPI_Comm), INTENT(IN) :: comm
    INTEGER, OPTIONAL, INTENT(OUT) :: ierror
MPI_NEIGHBOR_ALLTOALL(SENDBUF, SENDCOUNT, SENDTYPE, RECVBUF, RECVCOUNT,
                      RECVTYPE, COMM, IERROR)
<type> SENDBUF(*), RECVBUF(*)
INTEGER SENDCOUNT, SENDTYPE, RECVCOUNT, RECVTYPE, COMM, IERROR

```

This function supports Cartesian communicators, graph communicators, and distributed graph communicators as described in Section 7.6. If `comm` is a distributed graph communicator, the outcome is as if each process executed sends to each of its outgoing neighbors and receives from each of its incoming neighbors:

```

MPI_Dist_graph_neighbors_count(comm,&indegree,&outdegree,&weighted);
int *srcs=(int*)malloc(indegree*sizeof(int));
int *dsts=(int*)malloc(outdegree*sizeof(int));
MPI_Dist_graph_neighbors(comm,indegree,srcs,MPI_UNWEIGHTED,
                        outdegree,dsts,MPI_UNWEIGHTED);
int k,l;
/* assume sendbuf and recvbuf are of type (char*) */
for(k=0; k<outdegree; ++k)
    MPI_Isend(sendbuf+k*sendcount*extent(sendtype),sendcount,sendtype,
              dsts[k],...);
for(l=0; l<indegree; ++l)
    MPI_Irecv(recvbuf+l*recvcount*extent(recvtype),recvcount,recvtype,
              srcs[l],...);
MPI_Waitall(...);

```

The type signature associated with `sendcount`, `sendtype`, at a process must be equal to the type signature associated with `recvcount`, `recvtype` at any other process. This implies that the amount of data sent must be equal to the amount of data received, pairwise between every pair of communicating processes. Distinct type maps between sender and receiver are still allowed.

The “in place” option is not meaningful for this operation.

All arguments are significant on all processes and the argument `comm` must have identical values on all processes.

The vector variant of `MPI_NEIGHBOR_ALLTOALL` allows sending/receiving different numbers of elements to and from each neighbor.

```

1 MPI_NEIGHBOR_ALLTOALLV(sendbuf, sendcounts, sdispls, sendtype, recvbuf, recvcoun
2     rdispls, recvtype, comm)
3
4     IN     sendbuf     starting address of send buffer (choice)
5
6     IN     sendcounts  non-negative integer array (of length outdegree) speci-
7     fying the number of elements to send to each neighbor
8
9     IN     sdispls     integer array (of length outdegree). Entry j specifies
10    the displacement (relative to sendbuf) from which to
11    send the outgoing data to neighbor j
12
13    IN     sendtype    data type of send buffer elements (handle)
14
15    OUT    recvbuf     starting address of receive buffer (choice)
16
17    IN     recvcoun
18    ts               non-negative integer array (of length indegree) speci-
19    fying the number of elements that are received from
20    each neighbor
21
22    IN     rdispls     integer array (of length indegree). Entry i specifies the
23    displacement (relative to recvbuf) at which to place the
24    incoming data from neighbor i
25
26    IN     recvtype    data type of receive buffer elements (handle)
27
28    IN     comm        communicator with topology structure (handle)

```

```

29
30 int MPI_Neighbor_alltoallv(const void* sendbuf, const int sendcounts[],
31     const int sdispls[], MPI_Datatype sendtype, void* recvbuf,
32     const int recvcoun
33     ts[], const int rdispls[],
34     MPI_Datatype recvtype, MPI_Comm comm)

```

```

35 MPI_Neighbor_alltoallv(sendbuf, sendcounts, sdispls, sendtype, recvbuf,
36     recvcoun
37     ts, rdispls, recvtype, comm, ierror)
38
39     TYPE(*), DIMENSION(..), INTENT(IN) :: sendbuf
40
41     TYPE(*), DIMENSION(..) :: recvbuf
42
43     INTEGER, INTENT(IN) :: sendcounts(*), sdispls(*), recvcoun
44     ts(*),
45     rdispls(*)
46
47     TYPE(MPI_Datatype), INTENT(IN) :: sendtype, recvtype
48
49     TYPE(MPI_Comm), INTENT(IN) :: comm
50
51     INTEGER, OPTIONAL, INTENT(OUT) :: ierror

```

```

52 MPI_NEIGHBOR_ALLTOALLV(SENDBUF, SENDCOUNTS, SDISPLS, SENDTYPE, RECVBUF,
53     RECVCOUNTS, RDISPLS, RECVTYPE, COMM, IERROR)
54
55     <type> SENDBUF(*), RECVBUF(*)
56
57     INTEGER SENDCOUNTS(*), SDISPLS(*), SENDTYPE, RECVCOUNTS(*), RDISPLS(*),
58     RECVTYPE, COMM, IERROR

```

59 This function supports Cartesian communicators, graph communicators, and distributed
60 graph communicators as described in Section 7.6. If `comm` is a distributed graph commu-
61 nicator, the outcome is as if each process executed sends to each of its outgoing neighbors
62 and receives from each of its incoming neighbors:

```

63 MPI_Dist_graph_neighbors_count(comm, &indegree, &outdegree, &weighted);

```

```

int *srcs=(int*)malloc(indegree*sizeof(int));           1
int *dsts=(int*)malloc(outdegree*sizeof(int));         2
MPI_Dist_graph_neighbors(comm,indegree,srcs,MPI_UNWEIGHTED, 3
                        outdegree,dsts,MPI_UNWEIGHTED); 4
int k,l;                                               5
                                                        6
/* assume sendbuf and recvbuf are of type (char*) */   7
for(k=0; k<outdegree; ++k)                             8
    MPI_Isend(sendbuf+sdispls[k]*extent(sendtype),sendcounts[k],sendtype, 9
              dsts[k],...);                             10
                                                        11
for(l=0; l<indegree; ++l)                             12
    MPI_Irecv(recvbuf+rdispls[l]*extent(recvtype),recvcounts[l],recvtype, 13
              srcs[l],...);                             14
                                                        15
MPI_Waitall(...);                                     16
                                                        17

```

The type signature associated with `sendcounts[k]`, `sendtype` with `dsts[k]==j` at process `i` must be equal to the type signature associated with `recvcounts[l]`, `recvtype` with `srcs[l]==i` at process `j`. This implies that the amount of data sent must be equal to the amount of data received, pairwise between every pair of communicating processes. Distinct type maps between sender and receiver are still allowed. The data in the `sendbuf` beginning at offset `sdispls[k]` elements (in terms of the `sendtype`) is sent to the `k`-th outgoing neighbor. The data received from the `l`-th incoming neighbor is placed into `recvbuf` beginning at offset `rdispls[l]` elements (in terms of the `recvtype`).

The “in place” option is not meaningful for this operation.

All arguments are significant on all processes and the argument `comm` must have identical values on all processes.

`MPI_NEIGHBOR_ALLTOALLW` allows one to send and receive with different datatypes to and from each neighbor.

```

1 MPI_NEIGHBOR_ALLTOALLW(sendbuf, sendcounts, sdispls, sendtypes, recvbuf, recvcounts,
2   rdispls, recvtypes, comm)
3
4   IN      sendbuf      starting address of send buffer (choice)
5
6   IN      sendcounts   non-negative integer array (of length outdegree) speci-
7   fying the number of elements to send to each neighbor
8
9   IN      sdispls     integer array (of length outdegree). Entry j specifies
10  the displacement in bytes (relative to sendbuf) from
11  which to take the outgoing data destined for neighbor
12  j (array of integers)
13
14  IN      sendtypes    array of datatypes (of length outdegree). Entry j spec-
15  ifies the type of data to send to neighbor j (array of
16  handles)
17
18  OUT     recvbuf      starting address of receive buffer (choice)
19
20  IN      recvcounts   non-negative integer array (of length indegree) speci-
21  fying the number of elements that are received from
22  each neighbor
23
24  IN      rdispls     integer array (of length indegree). Entry i specifies the
25  displacement in bytes (relative to recvbuf) at which
26  to place the incoming data from neighbor i (array of
27  integers)
28
29  IN      recvtypes    array of datatypes (of length indegree). Entry i spec-
30  ifies the type of data received from neighbor i (array
31  of handles)
32
33  IN      comm         communicator with topology structure (handle)
34
35  int MPI_Neighbor_alltoallw(const void* sendbuf, const int sendcounts[],
36   const MPI_Aint sdispls[], const MPI_Datatype sendtypes[],
37   void* recvbuf, const int recvcounts[],
38   const MPI_Aint rdispls[], const MPI_Datatype recvtypes[],
39   MPI_Comm comm)
40
41  MPI_Neighbor_alltoallw(sendbuf, sendcounts, sdispls, sendtypes, recvbuf,
42   recvcounts, rdispls, recvtypes, comm, ierror)
43  TYPE(*), DIMENSION(..), INTENT(IN) :: sendbuf
44  TYPE(*), DIMENSION(..) :: recvbuf
45  INTEGER, INTENT(IN) :: sendcounts(*), recvcounts(*)
46  INTEGER(KIND=MPI_ADDRESS_KIND), INTENT(IN) :: sdispls(*), rdispls(*)
47  TYPE(MPI_Datatype), INTENT(IN) :: sendtypes(*), recvtypes(*)
48  TYPE(MPI_Comm), INTENT(IN) :: comm
49  INTEGER, OPTIONAL, INTENT(OUT) :: ierror
50
51  MPI_NEIGHBOR_ALLTOALLW(SENDBUF, SENDCOUNTS, SDISPLS, SENDTYPES, RECVBUF,
52   RECVCOUNTS, RDISPLS, RECVTYPES, COMM, IERROR)
53  <type> SENDBUF(*), RECVBUF(*)
54  INTEGER(KIND=MPI_ADDRESS_KIND) SDISPLS(*), RDISPLS(*)
55  INTEGER SENDCOUNTS(*), SENDTYPES(*), RECVCOUNTS(*), RECVTYPES(*), COMM,

```

IERROR

This function supports Cartesian communicators, graph communicators, and distributed graph communicators as described in Section 7.6. If `comm` is a distributed graph communicator, the outcome is as if each process executed sends to each of its outgoing neighbors and receives from each of its incoming neighbors:

```

MPI_Dist_graph_neighbors_count(comm,&indegree,&outdegree,&weighted);
int *srcs=(int*)malloc(indegree*sizeof(int));
int *dsts=(int*)malloc(outdegree*sizeof(int));
MPI_Dist_graph_neighbors(comm,indegree,srcs,MPI_UNWEIGHTED,
                        outdegree,dsts,MPI_UNWEIGHTED);

int k,l;

/* assume sendbuf and recvbuf are of type (char*) */
for(k=0; k<outdegree; ++k)
    MPI_Isend(sendbuf+sdispls[k],sendcounts[k], sendtypes[k],dsts[k],...);

for(l=0; l<indegree; ++l)
    MPI_Irecv(recvbuf+rdispls[l],recvcounts[l], recvtypes[l],srcs[l],...);

MPI_Waitall(...);

```

The type signature associated with `sendcounts[k]`, `sendtypes[k]` with `dsts[k]==j` at process `i` must be equal to the type signature associated with `recvcounts[l]`, `recvtypes[l]` with `srcs[l]==i` at process `j`. This implies that the amount of data sent must be equal to the amount of data received, pairwise between every pair of communicating processes. Distinct type maps between sender and receiver are still allowed.

The “in place” option is not meaningful for this operation.

All arguments are significant on all processes and the argument `comm` must have identical values on all processes.

7.7 Nonblocking Neighborhood Communication on Process Topologies

Nonblocking variants of the neighborhood collective operations allow relaxed synchronization and overlapping of computation and communication. The semantics are similar to nonblocking collective operations as described in Section 5.12.

7.7.1 Nonblocking Neighborhood Gather

```

1  MPI_INEIGHBOR_ALLGATHER(sendbuf, sendcount, sendtype, recvbuf, recvcount, recvtype,
2
3
4  comm, request)
5
6
7  IN      sendbuf      starting address of send buffer (choice)
8
9  IN      sendcount    number of elements sent to each neighbor (non-negative
10     integer)
11
12 IN      sendtype     data type of send buffer elements (handle)
13
14 OUT     recvbuf      starting address of receive buffer (choice)
15
16 IN      recvcount    number of elements received from each neighbor (non-
17     negative integer)
18
19 IN      recvtype     data type of receive buffer elements (handle)
20
21 IN      comm         communicator with topology structure (handle)
22
23 OUT     request      communication request (handle)

```

```

24 int MPI_Ineighbor_allgather(const void* sendbuf, int sendcount,
25     MPI_Datatype sendtype, void* recvbuf, int recvcount,
26     MPI_Datatype recvtype, MPI_Comm comm, MPI_Request *request)

```

```

27 MPI_Ineighbor_allgather(sendbuf, sendcount, sendtype, recvbuf, recvcount,
28     recvtype, comm, request, ierror)
29     TYPE(*), DIMENSION(..), INTENT(IN), ASYNCHRONOUS :: sendbuf
30     TYPE(*), DIMENSION(..), ASYNCHRONOUS :: recvbuf
31     INTEGER, INTENT(IN) :: sendcount, recvcount
32     TYPE(MPI_Datatype), INTENT(IN) :: sendtype, recvtype
33     TYPE(MPI_Comm), INTENT(IN) :: comm
34     TYPE(MPI_Request), INTENT(OUT) :: request
35     INTEGER, OPTIONAL, INTENT(OUT) :: ierror

```

```

36 MPI_INEIGHBOR_ALLGATHER(SENDBUF, SENDCOUNT, SENDTYPE, RECVBUF, REVCOUNT,
37     RECVTYPE, COMM, REQUEST, IERROR)
38     <type> SENDBUF(*), RECVBUF(*)
39     INTEGER SENDCOUNT, SENDTYPE, REVCOUNT, RECVTYPE, COMM, REQUEST, IERROR

```

This call starts a nonblocking variant of MPI_NEIGHBOR_ALLGATHER.

```

MPI_INEIGHBOR_ALLGATHERV(sendbuf, sendcount, sendtype, recvbuf, recvcoun
    recvtype, comm, request)
IN      sendbuf      starting address of send buffer (choice)
IN      sendcount    number of elements sent to each neighbor (non-negative
                    integer)
IN      sendtype     data type of send buffer elements (handle)
OUT     recvbuf      starting address of receive buffer (choice)
IN      recvcoun
    counts          non-negative integer array (of length indegree) con-
                    taining the number of elements that are received from
                    each neighbor
IN      displs      integer array (of length indegree). Entry i specifies the
                    displacement (relative to recvbuf) at which to place the
                    incoming data from neighbor i
IN      recvtype     data type of receive buffer elements (handle)
IN      comm         communicator with topology structure (handle)
OUT     request      communication request (handle)

int MPI_Ineighbor_allgatherv(const void* sendbuf, int sendcount,
    MPI_Datatype sendtype, void* recvbuf, const int recvcoun
    ts[],
    const int displs[], MPI_Datatype recvtype, MPI_Comm comm,
    MPI_Request *request)
MPI_Ineighbor_allgatherv(sendbuf, sendcount, sendtype, recvbuf, recvcoun
    ts,
    displs, recvtype, comm, request, ierror)
    TYPE(*), DIMENSION(..), INTENT(IN), ASYNCHRONOUS :: sendbuf
    TYPE(*), DIMENSION(..), ASYNCHRONOUS :: recvbuf
    INTEGER, INTENT(IN) :: sendcount
    INTEGER, INTENT(IN), ASYNCHRONOUS :: recvcoun
    ts(*), displs(*)
    TYPE(MPI_Datatype), INTENT(IN) :: sendtype, recvtype
    TYPE(MPI_Comm), INTENT(IN) :: comm
    TYPE(MPI_Request), INTENT(OUT) :: request
    INTEGER, OPTIONAL, INTENT(OUT) :: ierror

MPI_INEIGHBOR_ALLGATHERV(SENDBUF, SENDCOUNT, SENDTYPE, RECVBUF, RECVCOUNTS,
    DISPLS, RECVTYPE, COMM, REQUEST, IERROR)
<type> SENDBUF(*), RECVBUF(*)
INTEGER SENDCOUNT, SENDTYPE, REVCOUNTS(*), DISPLS(*), RECVTYPE, COMM,
    REQUEST, IERROR

```

This call starts a nonblocking variant of MPI_NEIGHBOR_ALLGATHERV.

7.7.2 Nonblocking Neighborhood Alltoall

```

1  MPI_INEIGHBOR_ALLTOALL(sendbuf, sendcount, sendtype, recvbuf, recvcount, recvtype,
2
3
4      comm, request)
5
6
7  IN      sendbuf      starting address of send buffer (choice)
8
9  IN      sendcount    number of elements sent to each neighbor (non-negative
10
11          integer)
12
13  IN      sendtype     data type of send buffer elements (handle)
14
15  OUT     recvbuf      starting address of receive buffer (choice)
16
17  IN      recvcount    number of elements received from each neighbor (non-
18
19          negative integer)
20
21  IN      recvtype     data type of receive buffer elements (handle)
22
23  IN      comm         communicator with topology structure (handle)
24
25  OUT     request      communication request (handle)

```

```

26 int MPI_Ineighbor_alltoall(const void* sendbuf, int sendcount,
27     MPI_Datatype sendtype, void* recvbuf, int recvcount,
28     MPI_Datatype recvtype, MPI_Comm comm, MPI_Request *request)

```

```

29 MPI_Ineighbor_alltoall(sendbuf, sendcount, sendtype, recvbuf, recvcount,
30     recvtype, comm, request, ierror)
31     TYPE(*), DIMENSION(..), INTENT(IN), ASYNCHRONOUS :: sendbuf
32     TYPE(*), DIMENSION(..), ASYNCHRONOUS :: recvbuf
33     INTEGER, INTENT(IN) :: sendcount, recvcount
34     TYPE(MPI_Datatype), INTENT(IN) :: sendtype, recvtype
35     TYPE(MPI_Comm), INTENT(IN) :: comm
36     TYPE(MPI_Request), INTENT(OUT) :: request
37     INTEGER, OPTIONAL, INTENT(OUT) :: ierror
38
39 MPI_INEIGHBOR_ALLTOALL(SENDBUF, SENDCOUNT, SENDTYPE, RECVBUF, RECVCOUNT,
40     RECVTYPE, COMM, REQUEST, IERROR)
41
42 <type> SENDBUF(*), RECVBUF(*)
43
44 INTEGER SENDCOUNT, SENDTYPE, RECVCOUNT, RECVTYPE, COMM, REQUEST, IERROR

```

This call starts a nonblocking variant of MPI_NEIGHBOR_ALLTOALL.

MPI_INEIGHBOR_ALLTOALLV(sendbuf, sendcounts, sdispls, sendtype, recvbuf, recvcounts,			1
rdispls, recvtype, comm, request)			2
IN	sendbuf	starting address of send buffer (choice)	3
IN	sendcounts	non-negative integer array (of length outdegree) specifying the number of elements to send to each neighbor	4
IN	sdispls	integer array (of length outdegree). Entry j specifies the displacement (relative to sendbuf) from which send the outgoing data to neighbor j	5
IN	sendtype	data type of send buffer elements (handle)	6
OUT	recvbuf	starting address of receive buffer (choice)	7
IN	recvcounts	non-negative integer array (of length indegree) specifying the number of elements that are received from each neighbor	8
IN	rdispls	integer array (of length indegree). Entry i specifies the displacement (relative to recvbuf) at which to place the incoming data from neighbor i	9
IN	recvtype	data type of receive buffer elements (handle)	10
IN	comm	communicator with topology structure (handle)	11
OUT	request	communication request (handle)	12
int MPI_Ineighbor_alltoallv(const void* sendbuf, const int sendcounts[],			13
const int sdispls[], MPI_Datatype sendtype, void* recvbuf,			14
const int recvcounts[], const int rdispls[],			15
MPI_Datatype recvtype, MPI_Comm comm, MPI_Request *request)			16
MPI_Ineighbor_alltoallv(sendbuf, sendcounts, sdispls, sendtype, recvbuf,			17
recvcounts, rdispls, recvtype, comm, request, ierror)			18
TYPE(*), DIMENSION(..), INTENT(IN), ASYNCHRONOUS :: sendbuf			19
TYPE(*), DIMENSION(..), ASYNCHRONOUS :: recvbuf			20
INTEGER, INTENT(IN), ASYNCHRONOUS :: sendcounts(*), sdispls(*),			21
recvcounts(*), rdispls(*)			22
TYPE(MPI_Datatype), INTENT(IN) :: sendtype, recvtype			23
TYPE(MPI_Comm), INTENT(IN) :: comm			24
TYPE(MPI_Request), INTENT(OUT) :: request			25
INTEGER, OPTIONAL, INTENT(OUT) :: ierror			26
MPI_INEIGHBOR_ALLTOALLV(SENDBUF, SENDCOUNTS, SDISPLS, SENDTYPE, RECVBUF,			27
RECVCOUNTS, RDISPLS, RECVTYPE, COMM, REQUEST, IERROR)			28
<type> SENDBUF(*), RECVBUF(*)			29
INTEGER SENDCOUNTS(*), SDISPLS(*), SENDTYPE, RECVCOUNTS(*), RDISPLS(*),			30
RECVTYPE, COMM, REQUEST, IERROR			31
This call starts a nonblocking variant of MPI_NEIGHBOR_ALLTOALLV.			32

```

1 MPI_INEIGHBOR_ALLTOALLW(sendbuf, sendcounts, sdispls, sendtypes, recvbuf, recvcounts,
2   rdispls, recvtypes, comm, request)
3
4   IN      sendbuf      starting address of send buffer (choice)
5
6   IN      sendcounts   non-negative integer array (of length outdegree) speci-
7   fying the number of elements to send to each neighbor
8
9   IN      sdispls      integer array (of length outdegree). Entry j specifies
10  the displacement in bytes (relative to sendbuf) from
11  which to take the outgoing data destined for neighbor
12  j (array of integers)
13
14  IN      sendtypes     array of datatypes (of length outdegree). Entry j spec-
15  ifies the type of data to send to neighbor j (array of
16  handles)
17
18  OUT     recvbuf       starting address of receive buffer (choice)
19
20  IN      recvcounts    non-negative integer array (of length indegree) speci-
21  fying the number of elements that are received from
22  each neighbor
23
24  IN      rdispls       integer array (of length indegree). Entry i specifies the
25  displacement in bytes (relative to recvbuf) at which
26  to place the incoming data from neighbor i (array of
27  integers)
28
29  IN      recvtypes     array of datatypes (of length indegree). Entry i spec-
30  ifies the type of data received from neighbor i (array
31  of handles)
32
33  IN      comm          communicator with topology structure (handle)
34
35  OUT     request       communication request (handle)
36
37  int MPI_Ineighbor_alltoallw(const void* sendbuf, const int sendcounts[],
38   const MPI_Aint sdispls[], const MPI_Datatype sendtypes[],
39   void* recvbuf, const int recvcounts[],
40   const MPI_Aint rdispls[], const MPI_Datatype recvtypes[],
41   MPI_Comm comm, MPI_Request *request)
42
43  MPI_Ineighbor_alltoallw(sendbuf, sendcounts, sdispls, sendtypes, recvbuf,
44   recvcounts, rdispls, recvtypes, comm, request, ierror)
45  TYPE(*), DIMENSION(..), INTENT(IN), ASYNCHRONOUS :: sendbuf
46  TYPE(*), DIMENSION(..), ASYNCHRONOUS :: recvbuf
47  INTEGER, INTENT(IN), ASYNCHRONOUS :: sendcounts(*), recvcounts(*)
48  INTEGER(KIND=MPI_ADDRESS_KIND), INTENT(IN), ASYNCHRONOUS ::
49   sdispls(*), rdispls(*)
50  TYPE(MPI_Datatype), INTENT(IN), ASYNCHRONOUS :: sendtypes(*),
51   recvtypes(*)
52  TYPE(MPI_Comm), INTENT(IN) :: comm
53  TYPE(MPI_Request), INTENT(OUT) :: request
54  INTEGER, OPTIONAL, INTENT(OUT) :: ierror

```

```

MPI_INEIGHBOR_ALLTOALLW(SENDBUF, SENDCOUNTS, SDISPLS, SENDTYPES, RECVBUF,
                        RECVCOUNTS, RDISPLS, RECVTYPES, COMM, REQUEST, IERROR)
<type> SENDBUF(*), RECVBUF(*)
INTEGER(KIND=MPI_ADDRESS_KIND) SDISPLS(*), RDISPLS(*)
INTEGER SENDCOUNTS(*), SENDTYPES(*), RECVCOUNTS(*), RECVTYPES(*), COMM,
                        REQUEST, IERROR

```

This call starts a nonblocking variant of MPI_NEIGHBOR_ALLTOALLW.

7.8 Persistent Neighborhood Communication on Process Topologies

Persistent variants of the neighborhood collective operations can offer significant performance benefits for programs with repetitive communication patterns. The semantics are similar to persistent collective operations as described in Section 5.13.

7.8.1 Persistent Neighborhood Gather

```

MPI_NEIGHBOR_ALLGATHER_INIT(sendbuf, sendcount, sendtype, recvbuf, recvcoun,
                            recvtype, comm, info, request)

```

IN	sendbuf	starting address of send buffer (choice)
IN	sendcount	number of elements sent to each neighbor (non-negative integer)
IN	sendtype	data type of send buffer elements (handle)
OUT	recvbuf	starting address of receive buffer (choice)
IN	recvcoun	number of elements received from each neighbor (non-negative integer)
IN	recvtype	data type of receive buffer elements (handle)
IN	comm	communicator with topology structure (handle)
IN	info	info argument (handle)
OUT	request	communication request (handle)

```

int MPI_Neighbor_allgather_init(const void* sendbuf, int sendcount,
                               MPI_Datatype sendtype, void* recvbuf, int recvcoun,
                               MPI_Datatype recvtype, MPI_Comm comm, MPI_Info info,
                               MPI_Request *request)

```

```

MPI_Neighbor_allgather_init(sendbuf, sendcount, sendtype, recvbuf,
                            recvcoun, recvtype, comm, info, request, ierror)
TYPE(*), DIMENSION(..), INTENT(IN), ASYNCHRONOUS :: sendbuf
TYPE(*), DIMENSION(..), ASYNCHRONOUS :: recvbuf
INTEGER, INTENT(IN) :: sendcount, recvcoun
TYPE(MPI_Datatype), INTENT(IN) :: sendtype, recvtype
TYPE(MPI_Comm), INTENT(IN) :: comm
TYPE(MPI_Info), INTENT(IN) :: info

```

```

1     TYPE(MPI_Request), INTENT(OUT) :: request
2     INTEGER, OPTIONAL, INTENT(OUT) :: ierror
3
4 MPI_NEIGHBOR_ALLGATHER_INIT(SENDBUF, SENDCOUNT, SENDTYPE, RECVBUF,
5     RECVCOUNT, RECVMODE, COMM, INFO, REQUEST, IERROR)
6     <type> SENDBUF(*), RECVBUF(*)
7     INTEGER SENDCOUNT, SENDTYPE, RECVCOUNT, RECVMODE, COMM, INFO, REQUEST,
8     IERROR
9
10    Creates a persistent collective communication request for the neighborhood allgather
11    operation.
12
13 MPI_NEIGHBOR_ALLGATHERV_INIT(sendbuf, sendcount, sendtype, recvbuf, recvcnts,
14     displs, recvmode, comm, info, request)
15
16 IN     sendbuf           starting address of send buffer (choice)
17 IN     sendcount        number of elements sent to each neighbor (non-negative
18                                     integer)
19 IN     sendtype         data type of send buffer elements (handle)
20 OUT    recvbuf          starting address of receive buffer (choice)
21 IN     recvcnts         non-negative integer array (of length indegree) con-
22                                     taining the number of elements that are received from
23                                     each neighbor
24
25 IN     displs           integer array (of length indegree). Entry i specifies the
26                                     displacement (relative to recvbuf) at which to place the
27                                     incoming data from neighbor i
28
29 IN     recvmode         data type of receive buffer elements (handle)
30 IN     comm             communicator with topology structure (handle)
31 IN     info             info argument (handle)
32 OUT    request          communication request (handle)
33
34 int MPI_Neighbor_allgatherv_init(const void* sendbuf, int sendcount,
35     MPI_Datatype sendtype, void* recvbuf, const int recvcnts[],
36     const int displs[], MPI_Datatype recvmode, MPI_Comm comm,
37     MPI_Info info, MPI_Request *request)
38
39 MPI_Neighbor_allgatherv_init(sendbuf, sendcount, sendtype, recvbuf,
40     recvcnts, displs, recvmode, comm, info, request, ierror)
41 TYPE(*), DIMENSION(..), INTENT(IN), ASYNCHRONOUS :: sendbuf
42 TYPE(*), DIMENSION(..), ASYNCHRONOUS :: recvbuf
43 INTEGER, INTENT(IN) :: sendcount
44 INTEGER, INTENT(IN), ASYNCHRONOUS :: recvcnts(*), displs(*)
45 TYPE(MPI_Datatype), INTENT(IN) :: sendtype, recvmode
46 TYPE(MPI_Comm), INTENT(IN) :: comm
47 TYPE(MPI_Info), INTENT(IN) :: info
48 TYPE(MPI_Request), INTENT(OUT) :: request

```



```

    INTEGER, OPTIONAL, INTENT(OUT) :: ierror
MPI_NEIGHBOR_ALLGATHERV_INIT(SENDBUF, SENDCOUNT, SENDTYPE, RECVBUF,
    RECVCOUNTS, DISPLS, RECVTYPE, COMM, INFO, REQUEST, IERROR)
<type> SENDBUF(*), RECVBUF(*)
    INTEGER SENDCOUNT, SENDTYPE, RECVCOUNTS(*), DISPLS(*), RECVTYPE, COMM,
    INFO, REQUEST, IERROR

```

Creates a persistent collective communication request for the neighborhood allgather operation.

7.8.2 Persistent Neighborhood Alltoall

```

MPI_NEIGHBOR_ALLTOALL_INIT(sendbuf, sendcount, sendtype, recvbuf, recvcount,
    recvtype, comm, info, request)

IN      sendbuf      starting address of send buffer (choice)
IN      sendcount    number of elements sent to each neighbor (non-negative
                    integer)
IN      sendtype     data type of send buffer elements (handle)
OUT     recvbuf      starting address of receive buffer (choice)
IN      recvcount    number of elements received from each neighbor (non-
                    negative integer)
IN      recvtype     data type of receive buffer elements (handle)
IN      comm         communicator with topology structure (handle)
IN      info         info argument (handle)
OUT     request      communication request (handle)

int MPI_Neighbor_alltoall_init(const void* sendbuf, int sendcount,
    MPI_Datatype sendtype, void* recvbuf, int recvcount,
    MPI_Datatype recvtype, MPI_Comm comm, MPI_Info info,
    MPI_Request *request)

MPI_Neighbor_alltoall_init(sendbuf, sendcount, sendtype, recvbuf,
    recvcount, recvtype, comm, info, request, ierror)
TYPE(*), DIMENSION(..), INTENT(IN), ASYNCHRONOUS :: sendbuf
TYPE(*), DIMENSION(..), ASYNCHRONOUS :: recvbuf
INTEGER, INTENT(IN) :: sendcount, recvcount
TYPE(MPI_Datatype), INTENT(IN) :: sendtype, recvtype
TYPE(MPI_Comm), INTENT(IN) :: comm
TYPE(MPI_Info), INTENT(IN) :: info
TYPE(MPI_Request), INTENT(OUT) :: request
INTEGER, OPTIONAL, INTENT(OUT) :: ierror

MPI_NEIGHBOR_ALLTOALL_INIT(SENDBUF, SENDCOUNT, SENDTYPE, RECVBUF,
    RECVCOUNT, RECVTYPE, COMM, INFO, REQUEST, IERROR)

```

```

1     <type> SENDBUF(*), RECVBUF(*)
2     INTEGER SENDCOUNT, SENDTYPE, RECVCOUNT, RECVMODE, COMM, INFO, REQUEST,
3         IERROR

```

Creates a persistent collective communication request for the neighborhood alltoall operation.

```

8 MPI_NEIGHBOR_ALLTOALLV_INIT(sendbuf, sendcounts, sdispls, sendtype, recvbuf,
9     recvcounts, rdispls, recvtype, comm, info, request)
10
11 IN     sendbuf           starting address of send buffer (choice)
12 IN     sendcounts       non-negative integer array (of length outdegree) speci-
13         fying the number of elements to send to each neighbor
14 IN     sdispls          integer array (of length outdegree). Entry j specifies
15         the displacement (relative to sendbuf) from which send
16         the outgoing data to neighbor j
17 IN     sendtype         data type of send buffer elements (handle)
18 OUT    recvbuf          starting address of receive buffer (choice)
19 IN     recvcounts       non-negative integer array (of length indegree) speci-
20         fying the number of elements that are received from
21         each neighbor
22 IN     rdispls          integer array (of length indegree). Entry i specifies the
23         displacement (relative to recvbuf) at which to place the
24         incoming data from neighbor i
25 IN     recvtype         data type of receive buffer elements (handle)
26 IN     comm             communicator with topology structure (handle)
27 IN     info             info argument (handle)
28 OUT    request         communication request (handle)

```

```

33 int MPI_Neighbor_alltoallv_init(const void* sendbuf,
34     const int sendcounts[], const int sdispls[],
35     MPI_Datatype sendtype, void* recvbuf, const int recvcounts[],
36     const int rdispls[], MPI_Datatype recvtype, MPI_Comm comm,
37     MPI_Info info, MPI_Request *request)

```

```

38 MPI_Neighbor_alltoallv_init(sendbuf, sendcounts, sdispls, sendtype,
39     recvbuf, recvcounts, rdispls, recvtype, comm, info, request,
40     ierror)
41 TYPE(*), DIMENSION(..), INTENT(IN), ASYNCHRONOUS :: sendbuf
42 TYPE(*), DIMENSION(..), ASYNCHRONOUS :: recvbuf
43 INTEGER, INTENT(IN), ASYNCHRONOUS :: sendcounts(*), sdispls(*),
44     recvcounts(*), rdispls(*)
45 TYPE(MPI_Datatype), INTENT(IN) :: sendtype, recvtype
46 TYPE(MPI_Comm), INTENT(IN) :: comm
47 TYPE(MPI_Info), INTENT(IN) :: info

```

```

TYPE(MPI_Request), INTENT(OUT) :: request      1
INTEGER, OPTIONAL, INTENT(OUT) :: ierror      2
                                                    3
MPI_NEIGHBOR_ALLTOALLV_INIT(SENDBUF, SENDCOUNTS, SDISPLS, SENDTYPE,
    RECVBUF, RECVCOUNTS, RDISPLS, RECVTYPE, COMM, INFO, REQUEST,
    IERROR)                                    4
<type> SENDBUF(*), RECVBUF(*)                  5
INTEGER SENDCOUNTS(*), SDISPLS(*), SENDTYPE, RECVCOUNTS(*), RDISPLS(*),
    RECVTYPE, COMM, INFO, REQUEST, IERROR      6
                                                    7
Creates a persistent collective communication request for the neighborhood alltoallv
operation.                                     8
                                                    9
                                                    10
                                                    11
                                                    12
                                                    13
MPI_NEIGHBOR_ALLTOALLW_INIT(sendbuf, sendcounts, sdispls, sendtypes, recvbuf,
    recvcounts, rdispls, recvtypes, comm, info, request) 14
IN      sendbuf      starting address of send buffer (choice) 16
IN      sendcounts   non-negative integer array (of length outdegree) speci- 17
                    fying the number of elements to send to each neighbor 18
IN      sdispls      integer array (of length outdegree). Entry j specifies 19
                    the displacement in bytes (relative to sendbuf) from 20
                    which to take the outgoing data destined for neighbor 21
                    j (array of integers) 22
IN      sendtypes    array of datatypes (of length outdegree). Entry j spec- 24
                    ifies the type of data to send to neighbor j (array of 25
                    handles) 26
OUT     recvbuf      starting address of receive buffer (choice) 27
IN      recvcounts   non-negative integer array (of length indegree) speci- 28
                    fying the number of elements that are received from 29
                    each neighbor 30
IN      rdispls      integer array (of length indegree). Entry i specifies the 32
                    displacement in bytes (relative to recvbuf) at which 33
                    to place the incoming data from neighbor i (array of 34
                    integers) 35
IN      recvtypes    array of datatypes (of length indegree). Entry i spec- 36
                    ifies the type of data received from neighbor i (array 37
                    of handles) 38
IN      comm         communicator with topology structure (handle) 39
IN      info         info argument (handle) 40
OUT     request      communication request (handle) 41
                                                    42
                                                    43
int MPI_Neighbor_alltoallw_init(const void* sendbuf, 44
    const int sendcounts[], const MPI_Aint sdispls[], 45
    const MPI_Datatype sendtypes[], void* recvbuf, 46
    const int recvcounts[], const MPI_Aint rdispls[], 47
    MPI_Request request, MPI_Ierror* ierror) 48

```

```

1      const MPI_Datatype recvtypes[], MPI_Comm comm, MPI_Info info,
2      MPI_Request *request)
3
4  MPI_Neighbor_alltoallw_init(sendbuf, sendcounts, sdispls, sendtypes,
5      recvbuf, recvcounts, rdispls, recvtypes, comm, info, request,
6      ierror)
7      TYPE(*), DIMENSION(..), INTENT(IN), ASYNCHRONOUS :: sendbuf
8      TYPE(*), DIMENSION(..), ASYNCHRONOUS :: recvbuf
9      INTEGER, INTENT(IN), ASYNCHRONOUS :: sendcounts(*), recvcounts(*)
10     INTEGER(KIND=MPI_ADDRESS_KIND), INTENT(IN), ASYNCHRONOUS ::
11         sdispls(*), rdispls(*)
12     TYPE(MPI_Datatype), INTENT(IN), ASYNCHRONOUS :: sendtypes(*),
13         recvtypes(*)
14     TYPE(MPI_Comm), INTENT(IN) :: comm
15     TYPE(MPI_Info), INTENT(IN) :: info
16     TYPE(MPI_Request), INTENT(OUT) :: request
17     INTEGER, OPTIONAL, INTENT(OUT) :: ierror
18
19 MPI_NEIGHBOR_ALLTOALLW_INIT(SENDBUF, SENDCOUNTS, SDISPLS, SENDTYPES,
20     RECVBUF, RECVCOUNTS, RDISPLS, RECVTYPES, COMM, INFO, REQUEST,
21     IERROR)
22     <type> SENDBUF(*), RECVBUF(*)
23     INTEGER(KIND=MPI_ADDRESS_KIND) SDISPLS(*), RDISPLS(*)
24     INTEGER SENDCOUNTS(*), SENDTYPES(*), RECVCOUNTS(*), RECVTYPES(*), COMM,
25     INFO, REQUEST, IERROR

```

Creates a persistent collective communication request for the neighborhood alltoallw operation.

7.9 An Application Example

Example 7.10 The example in Figures 7.6-7.9 shows how the grid definition and inquiry functions can be used in an application program. A partial differential equation, for instance the Poisson equation, is to be solved on a rectangular domain. First, the processes organize themselves in a two-dimensional structure. Each process then inquires about the ranks of its neighbors in the four directions (up, down, right, left). The numerical problem is solved by an iterative method, the details of which are hidden in the subroutine `relax`.

In each relaxation step each process computes new values for the solution grid function at the points `u(1:100,1:100)` owned by the process. Then the values at inter-process boundaries have to be exchanged with neighboring processes. For example, the newly calculated values in `u(1,1:100)` must be sent into the halo cells `u(101,1:100)` of the left-hand neighbor with coordinates `(own_coord(1)-1,own_coord(2))`.

```

1
2
3
4
5
6
7
INTEGER ndims, num_neigh
8
LOGICAL reorder
9
PARAMETER (ndims=2, num_neigh=4, reorder=.true.)
10
INTEGER comm, comm_size, comm_cart, dims(ndims), ierr
11
INTEGER neigh_rank(num_neigh), own_coords(ndims), i, j, it
12
LOGICAL periods(ndims)
13
REAL u(0:101,0:101), f(0:101,0:101)
14
DATA dims / ndims * 0 /
15
comm = MPI_COMM_WORLD
16
CALL MPI_COMM_SIZE(comm, comm_size, ierr)
17
! Set process grid size and periodicity
18
CALL MPI_DIMS_CREATE(comm_size, ndims, dims, ierr)
19
periods(1) = .TRUE.
20
periods(2) = .TRUE.
21
! Create a grid structure in WORLD group and inquire about own position
22
CALL MPI_CART_CREATE (comm, ndims, dims, periods, reorder, &
23
                     comm_cart, ierr)
24
CALL MPI_CART_GET (comm_cart, ndims, dims, periods, own_coords, ierr)
25
i = own_coords(1)
26
j = own_coords(2)
27
! Look up the ranks for the neighbors. Own process coordinates are (i,j).
28
! Neighbors are (i-1,j), (i+1,j), (i,j-1), (i,j+1) modulo (dims(1),dims(2))
29
CALL MPI_CART_SHIFT (comm_cart, 0,1, neigh_rank(1),neigh_rank(2), ierr)
30
CALL MPI_CART_SHIFT (comm_cart, 1,1, neigh_rank(3),neigh_rank(4), ierr)
31
! Initialize the grid functions and start the iteration
32
CALL init (u, f)
33
DO it=1,100
34
    CALL relax (u, f)
35
    ! Exchange data with neighbor processes
36
    CALL exchange (u, comm_cart, neigh_rank, num_neigh)
37
END DO
38
CALL output (u)
39
40
41
42
43
44
45
46
47
48

```

Figure 7.6: Set-up of process structure for two-dimensional parallel Poisson solver.

```

1
2
3
4
5
6
7
8
9
10
11 SUBROUTINE exchange (u, comm_cart, neigh_rank, num_neigh)
12 REAL u(0:101,0:101)
13 INTEGER comm_cart, num_neigh, neigh_rank(num_neigh)
14 REAL sndbuf(100,num_neigh), rcvbuf(100,num_neigh)
15 INTEGER ierr
16 sndbuf(1:100,1) = u( 1,1:100)
17 sndbuf(1:100,2) = u(100,1:100)
18 sndbuf(1:100,3) = u(1:100, 1)
19 sndbuf(1:100,4) = u(1:100,100)
20 CALL MPI_NEIGHBOR_ALLTOALL (sndbuf, 100, MPI_REAL, rcvbuf, 100, MPI_REAL, &
21                             comm_cart, ierr)
22 ! instead of
23 ! DO i=1,num_neigh
24 !   CALL MPI_Irecv(rcvbuf(1,i),100,MPI_REAL,neigh_rank(i),...,rq(2*i-1),&
25 !                 ierr)
26 !   CALL MPI_Isend(sndbuf(1,i),100,MPI_REAL,neigh_rank(i),...,rq(2*i  ),&
27 !                 ierr)
28 ! END DO
29 ! CALL MPI_WAITALL (2*num_neigh, rq, statuses, ierr)
30
31 u( 0,1:100) = rcvbuf(1:100,1)
32 u(101,1:100) = rcvbuf(1:100,2)
33 u(1:100, 0) = rcvbuf(1:100,3)
34 u(1:100,101) = rcvbuf(1:100,4)
35 END
36

```

Figure 7.7: Communication routine with local data copying and sparse neighborhood all-to-all.

```

1
2
3
4
SUBROUTINE exchange (u, comm_cart, neigh_rank, num_neigh)
5
IMPLICIT NONE
6
USE MPI
7
REAL u(0:101,0:101)
8
INTEGER comm_cart, num_neigh, neigh_rank(num_neigh)
9
INTEGER sndcounts(num_neigh), sndtypes(num_neigh)
10
INTEGER rcvcounts(num_neigh), rcvtypes(num_neigh)
11
INTEGER (KIND=MPI_ADDRESS_KIND) lb, sizeofreal
12
INTEGER (KIND=MPI_ADDRESS_KIND) sdispls(num_neigh), rdispls(num_neigh)
13
INTEGER type_vec, ierr
14
! The following initialization need to be done only once
15
! before the first call of exchange.
16
CALL MPI_TYPE_GET_EXTENT (MPI_REAL, lb, sizeofreal, ierr)
17
CALL MPI_TYPE_VECTOR (100, 1, 102, MPI_REAL, type_vec, ierr)
18
CALL MPI_TYPE_COMMIT (type_vec, ierr)
19
sndtypes(1:2) = type_vec
20
sndcounts(1:2) = 1
21
sndtypes(3:4) = MPI_REAL
22
sndcounts(3:4) = 100
23
rcvtypes = sndtypes
24
rcvcounts = sndcounts
25
sdispls(1) = ( 1 + 1*102) * sizeofreal ! first element of u( 1 , 1:100)
26
sdispls(2) = (100 + 1*102) * sizeofreal ! first element of u(100 , 1:100)
27
sdispls(3) = ( 1 + 1*102) * sizeofreal ! first element of u( 1:100, 1 )
28
sdispls(4) = ( 1 + 100*102) * sizeofreal ! first element of u( 1:100,100 )
29
rdispls(1) = ( 0 + 1*102) * sizeofreal ! first element of u( 0 , 1:100)
30
rdispls(2) = (101 + 1*102) * sizeofreal ! first element of u(101 , 1:100)
31
rdispls(3) = ( 1 + 0*102) * sizeofreal ! first element of u( 1:100, 0 )
32
rdispls(4) = ( 1 + 101*102) * sizeofreal ! first element of u( 1:100,101 )
33
! the following communication has to be done in each call of exchange
34
CALL MPI_NEIGHBOR_ALLTOALLW (u, sndcounts, sdispls, sndtypes, &
35
u, rcvcounts, rdispls, rcvtypes, &
36
comm_cart, ierr)
37
! The following finalizing need to be done only once
38
! after the last call of exchange.
39
CALL MPI_TYPE_FREE (type_vec, ierr)
40
END
41
42

```

Figure 7.8: Communication routine with sparse neighborhood all-to-all-w and without local data copying.

```

1  INTEGER ndims, num_neigh
2  LOGICAL reorder
3  PARAMETER (ndims=2, num_neigh=4, reorder=.true.)
4  INTEGER comm, comm_size, comm_cart, dims(ndims), it, ierr
5  LOGICAL periods(ndims)
6  REAL u(0:101,0:101), f(0:101,0:101)
7  DATA dims / ndims * 0 /
8  INTEGER sndcounts(num_neigh), sndtypes(num_neigh)
9  INTEGER rcvcounts(num_neigh), rcvtypes(num_neigh)
10 INTEGER (KIND=MPI_ADDRESS_KIND) lb, sizeofreal
11 INTEGER (KIND=MPI_ADDRESS_KIND) sdispls(num_neigh), rdispls(num_neigh)
12 INTEGER type_vec, request, status
13 comm = MPI_COMM_WORLD
14 CALL MPI_COMM_SIZE(comm, comm_size, ierr)
15 ! Set process grid size and periodicity
16 CALL MPI_DIMS_CREATE(comm_size, ndims, dims, ierr)
17 periods(1) = .TRUE.
18 periods(2) = .TRUE.
19 ! Create a grid structure in WORLD group
20 CALL MPI_CART_CREATE (comm, ndims, dims, periods, reorder, &
21                      comm_cart, ierr)
22 ! Create datatypes for the neighborhood communication
23 !
24 ! Insert code from example in Figure 7.4 to create and initialize
25 ! sndcounts, sdispls, sndtypes, rcvcounts, rdispls, and rcvtypes
26 !
27 ! Initialize the neighborhood all-to-all-w operation
28 CALL MPI_NEIGHBOR_ALLTOALLW_INIT (u, sndcounts, sdispls, sndtypes, &
29                                   u, rcvcounts, rdispls, rcvtypes, &
30                                   comm_cart, info, request, ierr)
31 ! Initialize the grid functions and start the iteration
32 CALL init (u, f)
33 DO it=1,100
34 ! Start data exchange with neighbor processes
35 CALL MPI_START(request, ierr)
36 ! Compute inner cells
37 CALL relax_inner (u, f)
38 ! Check on completion of neighbor exchange
39 CALL MPI_WAIT(request, status, ierr)
40 ! Compute edge cells
41 CALL relax_edges (u, f)
42 END DO
43 CALL output (u)
44 CALL MPI_REQUEST_FREE (request, ierr)
45 CALL MPI_TYPE_FREE (type_vec, ierr)

```

47 Figure 7.9: Two-dimensional parallel Poisson solver with persistent sparse neighborhood
48 all-to-all-w and without local data copying.

Chapter 8

MPI Environmental Management

This chapter discusses routines for getting and, where appropriate, setting various parameters that relate to the MPI implementation and the execution environment (such as error handling). The procedures for entering and leaving the MPI execution environment are also described here.

8.1 Implementation Information

8.1.1 Version Inquiries

In order to cope with changes to the MPI Standard, there are both compile-time and run-time ways to determine which version of the standard is in use in the environment one is using.

The “version” will be represented by two separate integers, for the version and subversion: In C,

```
#define MPI_VERSION    3
#define MPI_SUBVERSION 1
```

in Fortran,

```
INTEGER :: MPI_VERSION, MPI_SUBVERSION
PARAMETER (MPI_VERSION    = 3)
PARAMETER (MPI_SUBVERSION = 1)
```

For runtime determination,

`MPI_GET_VERSION(version, subversion)`

OUT	version	version number (integer)
OUT	subversion	subversion number (integer)

```
int MPI_Get_version(int *version, int *subversion)
```

```
MPI_Get_version(version, subversion, ierror)
  INTEGER, INTENT(OUT) :: version, subversion
  INTEGER, OPTIONAL, INTENT(OUT) :: ierror
```

```

1 MPI_GET_VERSION(VERSION, SUBVERSION, IERROR)
2   INTEGER VERSION, SUBVERSION, IERROR

```

MPI_GET_VERSION can be called before MPI_INIT and after MPI_FINALIZE. This function must always be thread-safe, as defined in Section 12.4. Valid (MPI_VERSION, MPI_SUBVERSION) pairs in this and previous versions of the MPI standard are (3,1), (3,0), (2,2), (2,1), (2,0), and (1,2).

```

9 MPI_GET_LIBRARY_VERSION(version, resultlen)

```

10	OUT	version	version string (string)
11			
12	OUT	resultlen	Length (in printable characters) of the result returned
13			in version (integer)
14			

```

15 int MPI_Get_library_version(char *version, int *resultlen)

```

```

16 MPI_Get_library_version(version, resultlen, ierror)
17   CHARACTER(LEN=MPI_MAX_LIBRARY_VERSION_STRING), INTENT(OUT) :: version
18   INTEGER, INTENT(OUT) :: resultlen
19   INTEGER, OPTIONAL, INTENT(OUT) :: ierror
20

```

```

21 MPI_GET_LIBRARY_VERSION(VERSION, RESULTLEN, IERROR)
22   CHARACTER*(*) VERSION
23   INTEGER RESULTLEN, IERROR

```

This routine returns a string representing the version of the MPI library. The version argument is a character string for maximum flexibility.

Advice to implementors. An implementation of MPI should return a different string for every change to its source code or build that could be visible to the user. (*End of advice to implementors.*)

The argument `version` must represent storage that is MPI_MAX_LIBRARY_VERSION_STRING characters long. MPI_GET_LIBRARY_VERSION may write up to this many characters into `version`.

The number of characters actually written is returned in the output argument, `resultlen`. In C, a null character is additionally stored at `version[resultlen]`. The value of `resultlen` cannot be larger than MPI_MAX_LIBRARY_VERSION_STRING - 1. In Fortran, `version` is padded on the right with blank characters. The value of `resultlen` cannot be larger than MPI_MAX_LIBRARY_VERSION_STRING.

MPI_GET_LIBRARY_VERSION can be called before MPI_INIT and after MPI_FINALIZE. This function must always be thread-safe, as defined in Section 12.4.

8.1.2 Environmental Inquiries

A set of attributes that describe the execution environment are attached to the communicator MPI_COMM_WORLD when MPI is initialized. The values of these attributes can be inquired by using the function MPI_COMM_GET_ATTR described in Section 6.7 and in Section 18.2.7. It is erroneous to delete these attributes, free their keys, or change their values.

The list of predefined attribute keys include

MPI_TAG_UB Upper bound for tag value.

MPI_HOST Host process rank, if such exists, MPI_PROC_NULL, otherwise.

MPI_IO rank of a node that has regular I/O facilities (possibly myrank). Nodes in the same communicator may return different values for this parameter.

MPI_WTIME_IS_GLOBAL Boolean variable that indicates whether clocks are synchronized.

Vendors may add implementation-specific parameters (such as node number, real memory size, virtual memory size, etc.)

These predefined attributes do not change value between MPI initialization (MPI_INIT) and MPI completion (MPI_FINALIZE), and cannot be updated or deleted by users.

Advice to users. Note that in the C binding, the value returned by these attributes is a *pointer* to an `int` containing the requested value. (*End of advice to users.*)

The required parameter values are discussed in more detail below:

Tag Values

Tag values range from 0 to the value returned for MPI_TAG_UB, inclusive. These values are guaranteed to be unchanging during the execution of an MPI program. In addition, the tag upper bound value must be *at least* 32767. An MPI implementation is free to make the value of MPI_TAG_UB larger than this; for example, the value $2^{30} - 1$ is also a valid value for MPI_TAG_UB.

The attribute MPI_TAG_UB has the same value on all processes of MPI_COMM_WORLD.

Host Rank

The value returned for MPI_HOST gets the rank of the *HOST* process in the group associated with communicator MPI_COMM_WORLD, if there is such. MPI_PROC_NULL is returned if there is no host. MPI does not specify what it means for a process to be a *HOST*, nor does it require that a *HOST* exists.

The attribute MPI_HOST has the same value on all processes of MPI_COMM_WORLD.

IO Rank

The value returned for MPI_IO is the rank of a processor that can provide language-standard I/O facilities. For Fortran, this means that all of the Fortran I/O operations are supported (e.g., OPEN, REWIND, WRITE). For C, this means that all of the ISO C I/O operations are supported (e.g., fopen, fprintf, lseek).

If every process can provide language-standard I/O, then the value MPI_ANY_SOURCE will be returned. Otherwise, if the calling process can provide language-standard I/O, then its rank will be returned. Otherwise, if some process can provide language-standard I/O then the rank of one such process will be returned. The same value need not be returned by all processes. If no process can provide language-standard I/O, then the value MPI_PROC_NULL will be returned.

Advice to users. Note that input is not collective, and this attribute does *not* indicate which process can or does provide input. (*End of advice to users.*)

1 Clock Synchronization

2 The value returned for `MPI_WTIME_IS_GLOBAL` is 1 if clocks at all processes in
 3 `MPI_COMM_WORLD` are synchronized, 0 otherwise. A collection of clocks is considered
 4 synchronized if explicit effort has been taken to synchronize them. The expectation is that
 5 the variation in time, as measured by calls to `MPI_WTIME`, will be less than one half the
 6 round-trip time for an MPI message of length zero. If time is measured at a process just
 7 before a send and at another process just after a matching receive, the second time should
 8 be always higher than the first one.

9 The attribute `MPI_WTIME_IS_GLOBAL` need not be present when the clocks are not
 10 synchronized (however, the attribute key `MPI_WTIME_IS_GLOBAL` is always valid). This
 11 attribute may be associated with communicators other than `MPI_COMM_WORLD`.

12 The attribute `MPI_WTIME_IS_GLOBAL` has the same value on all processes of
 13 `MPI_COMM_WORLD`.

14 Inquire Processor Name

15 MPI_GET_PROCESSOR_NAME(name, resultlen)

16	OUT	name	A unique specifier for the actual (as opposed to virtual) node.
17	OUT	resultlen	Length (in printable characters) of the result returned in name

```
18
19 int MPI_Get_processor_name(char *name, int *resultlen)
```

```
20 MPI_Get_processor_name(name, resultlen, ierror)
21 CHARACTER(LEN=MPI_MAX_PROCESSOR_NAME), INTENT(OUT) :: name
22 INTEGER, INTENT(OUT) :: resultlen
23 INTEGER, OPTIONAL, INTENT(OUT) :: ierror
```

```
24 MPI_GET_PROCESSOR_NAME(NAME, RESULTLEN, IERROR)
25 CHARACTER*(*) NAME
26 INTEGER RESULTLEN, IERROR
```

27 This routine returns the name of the processor on which it was called at the moment
 28 of the call. The name is a character string for maximum flexibility. From this value it
 29 must be possible to identify a specific piece of hardware; possible values include “processor
 30 9 in rack 4 of mpp.cs.org” and “231” (where 231 is the actual processor number in the
 31 running homogeneous system). The argument `name` must represent storage that is at least
 32 `MPI_MAX_PROCESSOR_NAME` characters long. `MPI_GET_PROCESSOR_NAME` may write
 33 up to this many characters into `name`.

34 The number of characters actually written is returned in the output argument, `resultlen`.
 35 In C, a null character is additionally stored at `name[resultlen]`. The value of `resultlen` cannot
 36 be larger than `MPI_MAX_PROCESSOR_NAME-1`. In Fortran, `name` is padded on the right with
 37 blank characters. The value of `resultlen` cannot be larger than `MPI_MAX_PROCESSOR_NAME`.

38 *Rationale.* This function allows MPI implementations that do process migration to
 39 return the current processor. Note that nothing in MPI *requires* or defines process

migration; this definition of `MPI_GET_PROCESSOR_NAME` simply allows such an implementation. (*End of rationale.*)

Advice to users. The user must provide at least `MPI_MAX_PROCESSOR_NAME` space to write the processor name — processor names can be this long. The user should examine the output argument, `resultlen`, to determine the actual length of the name. (*End of advice to users.*)

8.2 Memory Allocation

In some systems, message-passing and remote-memory-access (RMA) operations run faster when accessing specially allocated memory (e.g., memory that is shared by the other processes in the communicating group on an SMP). MPI provides a mechanism for allocating and freeing such special memory. The use of such memory for message-passing or RMA is not mandatory, and this memory can be used without restrictions as any other dynamically allocated memory. However, implementations may restrict the use of some RMA functionality as defined in Section 11.5.3.

`MPI_ALLOC_MEM(size, info, baseptr)`

IN	size	size of memory segment in bytes (non-negative integer)
IN	info	info argument (handle)
OUT	baseptr	pointer to beginning of memory segment allocated

```
int MPI_Alloc_mem(MPI_Aint size, MPI_Info info, void *baseptr)
```

```
MPI_Alloc_mem(size, info, baseptr, ierror)
  USE, INTRINSIC :: ISO_C_BINDING, ONLY : C_PTR
  INTEGER(KIND=MPI_ADDRESS_KIND), INTENT(IN) :: size
  TYPE(MPI_Info), INTENT(IN) :: info
  TYPE(C_PTR), INTENT(OUT) :: baseptr
  INTEGER, OPTIONAL, INTENT(OUT) :: ierror
```

```
MPI_ALLOC_MEM(SIZE, INFO, BASEPTR, IERROR)
  INTEGER INFO, IERROR
  INTEGER(KIND=MPI_ADDRESS_KIND) SIZE, BASEPTR
```

If the Fortran compiler provides `TYPE(C_PTR)`, then the following generic interface must be provided in the `mpi` module and should be provided in `mpif.h` through overloading, i.e., with the same routine name as the routine with `INTEGER(KIND=MPI_ADDRESS_KIND) BASEPTR`, but with a different specific procedure name:

```
INTERFACE MPI_ALLOC_MEM
  SUBROUTINE MPI_ALLOC_MEM(SIZE, INFO, BASEPTR, IERROR)
    IMPORT :: MPI_ADDRESS_KIND
    INTEGER INFO, IERROR
    INTEGER(KIND=MPI_ADDRESS_KIND) SIZE, BASEPTR
```

```

1      END SUBROUTINE
2      SUBROUTINE MPI_ALLOC_MEM_CPTR(SIZE, INFO, BASEPTR, IERROR)
3          USE, INTRINSIC :: ISO_C_BINDING, ONLY : C_PTR
4          IMPORT :: MPI_ADDRESS_KIND
5          INTEGER :: INFO, IERROR
6          INTEGER(KIND=MPI_ADDRESS_KIND) :: SIZE
7          TYPE(C_PTR) :: BASEPTR
8      END SUBROUTINE
9  END INTERFACE

```

The base procedure name of this overloaded function is `MPI_ALLOC_MEM_CPTR`. The implied specific procedure names are described in Section 18.1.5.

The `info` argument can be used to provide directives that control the desired location of the allocated memory. Such a directive does not affect the semantics of the call. Valid `info` values are implementation-dependent; a null directive value of `info = MPI_INFO_NULL` is always valid.

The function `MPI_ALLOC_MEM` may return an error code of class `MPI_ERR_NO_MEM` to indicate it failed because memory is exhausted.

```

20 MPI_FREE_MEM(base)

```

IN	base	initial address of memory segment allocated by
		<code>MPI_ALLOC_MEM</code> (choice)

```

25 int MPI_Free_mem(void *base)

```

```

26 MPI_Free_mem(base, ierror)

```

```

27     TYPE(*), DIMENSION(..), INTENT(IN), ASYNCHRONOUS :: base
28     INTEGER, OPTIONAL, INTENT(OUT) :: ierror

```

```

30 MPI_FREE_MEM(BASE, IERROR)

```

```

31     <type> BASE(*)
32     INTEGER IERROR

```

The function `MPI_FREE_MEM` may return an error code of class `MPI_ERR_BASE` to indicate an invalid base argument.

Rationale. The C bindings of `MPI_ALLOC_MEM` and `MPI_FREE_MEM` are similar to the bindings for the `malloc` and `free` C library calls: a call to `MPI_Alloc_mem(..., &base)` should be paired with a call to `MPI_Free_mem(base)` (one less level of indirection). Both arguments are declared to be of same type `void*` so as to facilitate type casting. The Fortran binding is consistent with the C bindings: the Fortran `MPI_ALLOC_MEM` call returns in `baseptr` the `TYPE(C_PTR)` pointer or the (integer valued) address of the allocated memory. The `base` argument of `MPI_FREE_MEM` is a choice argument, which passes (a reference to) the variable stored at that location. (*End of rationale.*)

Advice to implementors. If `MPI_ALLOC_MEM` allocates special memory, then a design similar to the design of C `malloc` and `free` functions has to be used, in order

to find out the size of a memory segment, when the segment is freed. If no special memory is used, `MPI_ALLOC_MEM` simply invokes `malloc`, and `MPI_FREE_MEM` invokes `free`.

A call to `MPI_ALLOC_MEM` can be used in shared memory systems to allocate memory in a shared memory segment. (*End of advice to implementors.*)

Example 8.1 Example of use of `MPI_ALLOC_MEM`, in Fortran with `TYPE(C_PTR)` pointers. We assume 4-byte REALs.

```

USE mpi_f08 ! or USE mpi      (not guaranteed with INCLUDE 'mpif.h')
USE, INTRINSIC :: ISO_C_BINDING
TYPE(C_PTR) :: p
REAL, DIMENSION(:,:), POINTER :: a ! no memory is allocated
INTEGER, DIMENSION(2) :: shape
INTEGER(KIND=MPI_ADDRESS_KIND) :: size
shape = (/100,100/)
size = 4 * shape(1) * shape(2) ! assuming 4 bytes per REAL
CALL MPI_Alloc_mem(size,MPI_INFO_NULL,p,ierr) ! memory is allocated and
CALL C_F_POINTER(p, a, shape) ! intrinsic ! now accessible via a(i,j)
... ! in ISO_C_BINDING
a(3,5) = 2.71;
...
CALL MPI_Free_mem(a, ierr) ! memory is freed

```

Example 8.2 Example of use of `MPI_ALLOC_MEM`, in Fortran with non-standard *Cray-pointers*. We assume 4-byte REALs, and assume that these pointers are address-sized.

```

REAL A
POINTER (P, A(100,100)) ! no memory is allocated
INTEGER(KIND=MPI_ADDRESS_KIND) SIZE
SIZE = 4*100*100
CALL MPI_ALLOC_MEM(SIZE, MPI_INFO_NULL, P, IERR)
! memory is allocated
...
A(3,5) = 2.71;
...
CALL MPI_FREE_MEM(A, IERR) ! memory is freed

```

This code is not Fortran 77 or Fortran 90 code. Some compilers may not support this code or need a special option, e.g., the GNU gFortran compiler needs `-fcray-pointer`.

Advice to implementors. Some compilers map Cray-pointers to address-sized integers, some to `TYPE(C_PTR)` pointers (e.g., Cray Fortran, version 7.3.3). From the user's viewpoint, this mapping is irrelevant because Examples 8.2 should work correctly with an MPI-3.0 (or later) library if Cray-pointers are available. (*End of advice to implementors.*)

Example 8.3 Same example, in C.

```

1   float  (* f)[100][100];
2   /* no memory is allocated */
3   MPI_Alloc_mem(sizeof(float)*100*100, MPI_INFO_NULL, &f);
4   /* memory allocated */
5   ...
6   (*f)[5][3] = 2.71;
7   ...
8   MPI_Free_mem(f);
9

```

8.3 Error Handling

An MPI implementation cannot or may choose not to handle some errors that occur during MPI calls. These can include errors that generate exceptions or traps, such as floating point errors or access violations. The set of errors that are handled by MPI is implementation-dependent. Each such error generates an **MPI exception**.

The above text takes precedence over any text on error handling within this document. Specifically, text that states that errors *will* be handled should be read as *may* be handled. More background information about how MPI treats errors can be found in Section 2.8.

A user can associate error handlers to three types of objects: communicators, windows, and files. The specified error handling routine will be used for any MPI exception that occurs during a call to MPI for the respective object. MPI calls that are not related to any objects are considered to be attached to the communicator MPI_COMM_SELF. The attachment of error handlers to objects is purely local: different processes may attach different error handlers to corresponding objects.

Several predefined error handlers are available in MPI:

MPI_ERRORS_ARE_FATAL The handler, when called, causes the program to abort all connected processes. This is similar to calling MPI_ABORT using a communicator containing all connected processes with an implementation-specific value as the `errorcode` argument.

MPI_ERRORS_ABORT The handler, when called, is invoked on a communicator in a manner similar to calling MPI_ABORT on that communicator. If the error handler is invoked on an window or a file, it is similar to calling MPI_ABORT using a communicator containing the group of MPI processes associated with the window or file, respectively. In either case, the value that would be provided as the `errorcode` argument to MPI_ABORT is implementation-specific.

MPI_ERRORS_RETURN The handler has no effect other than returning the error code to the user.

Advice to implementors. The implementation-specific error information resulting from MPI_ERRORS_ARE_FATAL and MPI_ERRORS_ABORT provided to the invoking environment should be meaningful to the end-user, for example a predefined error class. (*End of advice to implementors.*)

Implementations may provide additional predefined error handlers and programmers can code their own error handlers.

After initialization, the error handler `MPI_ERRORS_ARE_FATAL` is associated by default with `MPI_COMM_WORLD`, `MPI_COMM_SELF`, and the communicator returned by `MPI_COMM_GET_PARENT` (if any). Thus, if the user chooses not to control error handling, every error that MPI handles is treated as fatal. Since (almost) all MPI calls return an error code, a user may choose to handle errors in its main code, by testing the return code of MPI calls and executing a suitable recovery code when the call was not successful. In this case, the error handler `MPI_ERRORS_RETURN` will be used. Usually it is more convenient and more efficient not to test for errors after each MPI call, and have such error handled by a non-trivial MPI error handler.

After an error is detected, MPI will provide the user as much information as possible about that error using error classes. Some errors might prevent MPI from completing further API calls successfully and those functions will continue to report errors until the cause of the error is corrected or the user terminates the application. The user can make the determination of whether or not to attempt to continue after detecting such an error.

Advice to users. For example, users may be unable to correct errors corresponding to some error classes, such as `MPI_ERR_INTERN`. Such errors may cause subsequent MPI calls to complete in error. (*End of advice to users.*)

Advice to implementors. A high-quality implementation will, to the greatest possible extent, circumscribe the impact of an error, so that normal processing can continue after an error handler was invoked. The implementation documentation will provide information on the possible effect of each class of errors and available recovery actions. (*End of advice to implementors.*)

An MPI error handler is an opaque object, which is accessed by a handle. MPI calls are provided to create new error handlers, to associate error handlers with objects, and to test which error handler is associated with an object. C has distinct typedefs for user defined error handling callback functions that accept communicator, file, and window arguments. In Fortran there are three user routines.

An error handler object is created by a call to `MPI_XXX_CREATE_ERRHANDLER`, where XXX is, respectively, `COMM`, `WIN`, or `FILE`.

An error handler is attached to a communicator, window, or file by a call to `MPI_XXX_SET_ERRHANDLER`. The error handler must be either a predefined error handler, or an error handler that was created by a call to `MPI_XXX_CREATE_ERRHANDLER`, with matching XXX. The predefined error handlers `MPI_ERRORS_RETURN` and `MPI_ERRORS_ARE_FATAL` can be attached to communicators, windows, and files.

The error handler currently associated with a communicator, window, or file can be retrieved by a call to `MPI_XXX_GET_ERRHANDLER`.

The MPI function `MPI_ERRHANDLER_FREE` can be used to free an error handler that was created by a call to `MPI_XXX_CREATE_ERRHANDLER`.

`MPI_{COMM,WIN,FILE}_GET_ERRHANDLER` behave as if a new error handler object is created. That is, once the error handler is no longer needed, `MPI_ERRHANDLER_FREE` should be called with the error handler returned from `MPI_{COMM,WIN,FILE}_GET_ERRHANDLER` to mark the error handler for deallocation. This provides behavior similar to that of `MPI_COMM_GROUP` and `MPI_GROUP_FREE`.

Advice to implementors. High-quality implementations should raise an error when an error handler that was created by a call to `MPI_XXX_CREATE_ERRHANDLER` is

1 attached to an object of the wrong type with a call to `MPI_YYY_SET_ERRHANDLER`.
 2 To do so, it is necessary to maintain, with each error handler, information on the
 3 typedef of the associated user function. (*End of advice to implementors.*)
 4

5 The syntax for these calls is given below.
 6

7 8.3.1 Error Handlers for Communicators

8
 9
 10 `MPI_COMM_CREATE_ERRHANDLER(comm_errhandler_fn, errhandler)`
 11
 12 IN `comm_errhandler_fn` user defined error handling procedure (function)
 13 OUT `errhandler` MPI error handler (handle)
 14

15 `int MPI_Comm_create_errhandler(MPI_Comm_errhandler_function`
 16 `*comm_errhandler_fn, MPI_Errhandler *errhandler)`
 17
 18 `MPI_Comm_create_errhandler(comm_errhandler_fn, errhandler, ierror)`
 19 `PROCEDURE(MPI_Comm_errhandler_function) :: comm_errhandler_fn`
 20 `TYPE(MPI_Errhandler), INTENT(OUT) :: errhandler`
 21 `INTEGER, OPTIONAL, INTENT(OUT) :: ierror`
 22
 23 `MPI_COMM_CREATE_ERRHANDLER(COMM_ERRHANDLER_FN, ERRHANDLER, IERROR)`
 24 `EXTERNAL COMM_ERRHANDLER_FN`
 25 `INTEGER ERRHANDLER, IERROR`

26 Creates an error handler that can be attached to communicators.

27 The user routine should be, in C, a function of type `MPI_Comm_errhandler_function`, which
 28 is defined as

29 `typedef void MPI_Comm_errhandler_function(MPI_Comm *, int *, ...);`

30 The first argument is the communicator in use. The second is the error code to be
 31 returned by the MPI routine that raised the error. If the routine would have returned
 32 `MPI_ERR_IN_STATUS`, it is the error code returned in the status for the request that caused
 33 the error handler to be invoked. The remaining arguments are “`varargs`” arguments whose
 34 number and meaning is implementation-dependent. An implementation should clearly doc-
 35 ument these arguments. Addresses are used so that the handler may be written in Fortran.
 36 With the Fortran `mpi_f08` module, the user routine `comm_errhandler_fn` should be of the
 37 form:

38 `ABSTRACT INTERFACE`
 39 `SUBROUTINE MPI_Comm_errhandler_function(comm, error_code)`
 40 `TYPE(MPI_Comm) :: comm`
 41 `INTEGER :: error_code`
 42

43 With the Fortran `mpi` module and `mpif.h`, the user routine `COMM_ERRHANDLER_FN`
 44 should be of the form:

45 `SUBROUTINE COMM_ERRHANDLER_FUNCTION(COMM, ERROR_CODE)`
 46 `INTEGER COMM, ERROR_CODE`
 47
 48

Rationale. The variable argument list is provided because it provides an ISO-standard hook for providing additional information to the error handler; without this hook, ISO C prohibits additional arguments. (*End of rationale.*)

Advice to users. A newly created communicator inherits the error handler that is associated with the “parent” communicator. In particular, the user can specify a “global” error handler for all communicators by associating this handler with the communicator MPI_COMM_WORLD immediately after initialization. (*End of advice to users.*)

MPI_COMM_SET_ERRHANDLER(comm, errhandler)

INOUT	comm	communicator (handle)
IN	errhandler	new error handler for communicator (handle)

int MPI_Comm_set_errhandler(MPI_Comm comm, MPI_Errhandler errhandler)

MPI_Comm_set_errhandler(comm, errhandler, ierror)
 TYPE(MPI_Comm), INTENT(IN) :: comm
 TYPE(MPI_Errhandler), INTENT(IN) :: errhandler
 INTEGER, OPTIONAL, INTENT(OUT) :: ierror

MPI_COMM_SET_ERRHANDLER(COMM, ERRHANDLER, IERROR)
 INTEGER COMM, ERRHANDLER, IERROR

Attaches a new error handler to a communicator. The error handler must be either a predefined error handler, or an error handler created by a call to MPI_COMM_CREATE_ERRHANDLER.

MPI_COMM_GET_ERRHANDLER(comm, errhandler)

IN	comm	communicator (handle)
OUT	errhandler	error handler currently associated with communicator (handle)

int MPI_Comm_get_errhandler(MPI_Comm comm, MPI_Errhandler *errhandler)

MPI_Comm_get_errhandler(comm, errhandler, ierror)
 TYPE(MPI_Comm), INTENT(IN) :: comm
 TYPE(MPI_Errhandler), INTENT(OUT) :: errhandler
 INTEGER, OPTIONAL, INTENT(OUT) :: ierror

MPI_COMM_GET_ERRHANDLER(COMM, ERRHANDLER, IERROR)
 INTEGER COMM, ERRHANDLER, IERROR

Retrieves the error handler currently associated with a communicator.

For example, a library function may register at its entry point the current error handler for a communicator, set its own private error handler for this communicator, and restore before exiting the previous error handler.

8.3.2 Error Handlers for Windows

```
1 MPI_WIN_CREATE_ERRHANDLER(win_errhandler_fn, errhandler)
```

```
2
3
4
5     IN        win_errhandler_fn        user defined error handling procedure (function)
```

```
6     OUT       errhandler                MPI error handler (handle)
```

```
7
8
9     int MPI_Win_create_errhandler(MPI_Win_errhandler_function
10                                *win_errhandler_fn, MPI_Errhandler *errhandler)
```

```
11
12 MPI_Win_create_errhandler(win_errhandler_fn, errhandler, ierror)
13     PROCEDURE(MPI_Win_errhandler_function) :: win_errhandler_fn
14     TYPE(MPI_Errhandler), INTENT(OUT) :: errhandler
15     INTEGER, OPTIONAL, INTENT(OUT) :: ierror
```

```
16 MPI_WIN_CREATE_ERRHANDLER(WIN_ERRHANDLER_FN, ERRHANDLER, IERROR)
17     EXTERNAL WIN_ERRHANDLER_FN
18     INTEGER ERRHANDLER, IERROR
```

```
19
20     Creates an error handler that can be attached to a window object. The user routine
21     should be, in C, a function of type MPI_Win_errhandler_function which is defined as
22     typedef void MPI_Win_errhandler_function(MPI_Win *, int *, ...);
```

```
23
24     The first argument is the window in use, the second is the error code to be returned.
25     With the Fortran mpi_f08 module, the user routine win_errhandler_fn should be of the form:
26     ABSTRACT INTERFACE
```

```
27     SUBROUTINE MPI_Win_errhandler_function(win, error_code)
28         TYPE(MPI_Win) :: win
29         INTEGER :: error_code
```

```
30
31     With the Fortran mpi module and mpif.h, the user routine WIN_ERRHANDLER_FN should
32     be of the form:
```

```
33     SUBROUTINE WIN_ERRHANDLER_FUNCTION(WIN, ERROR_CODE)
34         INTEGER WIN, ERROR_CODE
```

```
35
36 MPI_WIN_SET_ERRHANDLER(win, errhandler)
```

```
37     INOUT     win                        window (handle)
```

```
38     IN        errhandler                new error handler for window (handle)
```

```
39
40
41     int MPI_Win_set_errhandler(MPI_Win win, MPI_Errhandler errhandler)
```

```
42
43 MPI_Win_set_errhandler(win, errhandler, ierror)
44     TYPE(MPI_Win), INTENT(IN) :: win
45     TYPE(MPI_Errhandler), INTENT(IN) :: errhandler
46     INTEGER, OPTIONAL, INTENT(OUT) :: ierror
```

```
47 MPI_WIN_SET_ERRHANDLER(WIN, ERRHANDLER, IERROR)
48     INTEGER WIN, ERRHANDLER, IERROR
```

Attaches a new error handler to a window. The error handler must be either a pre-defined error handler, or an error handler created by a call to MPI_WIN_CREATE_ERRHANDLER.

MPI_WIN_GET_ERRHANDLER(win, errhandler)

IN	win	window (handle)
OUT	errhandler	error handler currently associated with window (handle)

```
int MPI_Win_get_errhandler(MPI_Win win, MPI_Errhandler *errhandler)
```

```
MPI_Win_get_errhandler(win, errhandler, ierror)
    TYPE(MPI_Win), INTENT(IN) :: win
    TYPE(MPI_Errhandler), INTENT(OUT) :: errhandler
    INTEGER, OPTIONAL, INTENT(OUT) :: ierror
```

```
MPI_WIN_GET_ERRHANDLER(WIN, ERRHANDLER, IERROR)
    INTEGER WIN, ERRHANDLER, IERROR
```

Retrieves the error handler currently associated with a window.

8.3.3 Error Handlers for Files

MPI_FILE_CREATE_ERRHANDLER(file_errhandler_fn, errhandler)

IN	file_errhandler_fn	user defined error handling procedure (function)
OUT	errhandler	MPI error handler (handle)

```
int MPI_File_create_errhandler(MPI_File_errhandler_function
    *file_errhandler_fn, MPI_Errhandler *errhandler)
```

```
MPI_File_create_errhandler(file_errhandler_fn, errhandler, ierror)
    PROCEDURE(MPI_File_errhandler_function) :: file_errhandler_fn
    TYPE(MPI_Errhandler), INTENT(OUT) :: errhandler
    INTEGER, OPTIONAL, INTENT(OUT) :: ierror
```

```
MPI_FILE_CREATE_ERRHANDLER(FILE_ERRHANDLER_FN, ERRHANDLER, IERROR)
    EXTERNAL FILE_ERRHANDLER_FN
    INTEGER ERRHANDLER, IERROR
```

Creates an error handler that can be attached to a file object. The user routine should be, in C, a function of type MPI_File_errhandler_function, which is defined as

```
typedef void MPI_File_errhandler_function(MPI_File *, int *, ...);
```

The first argument is the file in use, the second is the error code to be returned.

With the Fortran mpi_f08 module, the user routine file_errhandler_fn should be of the form:

```
ABSTRACT INTERFACE
```

```
    SUBROUTINE MPI_File_errhandler_function(file, error_code)
```

```

1      TYPE(MPI_File) :: file
2      INTEGER :: error_code

```

With the Fortran `mpi` module and `mpif.h`, the user routine `FILE_ERRHANDLER_FN` should be of the form:

```

3
4
5      SUBROUTINE FILE_ERRHANDLER_FUNCTION(FILE, ERROR_CODE)
6          INTEGER FILE, ERROR_CODE
7
8
9

```

```

10     MPI_FILE_SET_ERRHANDLER(file, errhandler)

```

```

11     INOUT   file                file (handle)

```

```

12     IN      errhandler          new error handler for file (handle)
13
14

```

```

15     int MPI_File_set_errhandler(MPI_File file, MPI_Errhandler errhandler)

```

```

16     MPI_File_set_errhandler(file, errhandler, ierror)

```

```

17         TYPE(MPI_File), INTENT(IN) :: file

```

```

18         TYPE(MPI_Errhandler), INTENT(IN) :: errhandler

```

```

19         INTEGER, OPTIONAL, INTENT(OUT) :: ierror
20
21

```

```

22     MPI_FILE_SET_ERRHANDLER(FILE, ERRHANDLER, IERROR)

```

```

23         INTEGER FILE, ERRHANDLER, IERROR
24
25

```

Attaches a new error handler to a file. The error handler must be either a predefined error handler, or an error handler created by a call to `MPI_FILE_CREATE_ERRHANDLER`.

```

26
27     MPI_FILE_GET_ERRHANDLER(file, errhandler)

```

```

28     IN      file                file (handle)

```

```

29     OUT    errhandler          error handler currently associated with file (handle)
30
31

```

```

32     int MPI_File_get_errhandler(MPI_File file, MPI_Errhandler *errhandler)

```

```

33     MPI_File_get_errhandler(file, errhandler, ierror)

```

```

34         TYPE(MPI_File), INTENT(IN) :: file

```

```

35         TYPE(MPI_Errhandler), INTENT(OUT) :: errhandler

```

```

36         INTEGER, OPTIONAL, INTENT(OUT) :: ierror
37
38

```

```

39     MPI_FILE_GET_ERRHANDLER(FILE, ERRHANDLER, IERROR)

```

```

40         INTEGER FILE, ERRHANDLER, IERROR
41
42

```

Retrieves the error handler currently associated with a file.

```

43
44
45
46
47
48

```

8.3.4 Freeing Errorhandlers and Retrieving Error Strings

MPI_ERRHANDLER_FREE(errhandler)

INOUT errhandler MPI error handler (handle)

```
int MPI_Errhandler_free(MPI_Errhandler *errhandler)
```

```
MPI_Errhandler_free(errhandler, ierror)
    TYPE(MPI_Errhandler), INTENT(INOUT) :: errhandler
    INTEGER, OPTIONAL, INTENT(OUT) :: ierror
```

```
MPI_ERRHANDLER_FREE(ERRHANDLER, IERROR)
    INTEGER ERRHANDLER, IERROR
```

Marks the error handler associated with `errhandler` for deallocation and sets `errhandler` to `MPI_ERRHANDLER_NULL`. The error handler will be deallocated after all the objects associated with it (communicator, window, or file) have been deallocated.

MPI_ERROR_STRING(errorcode, string, resultlen)

IN errorcode Error code returned by an MPI routine

OUT string Text that corresponds to the errorcode

OUT resultlen Length (in printable characters) of the result returned in string

```
int MPI_Error_string(int errorcode, char *string, int *resultlen)
```

```
MPI_Error_string(errorcode, string, resultlen, ierror)
    INTEGER, INTENT(IN) :: errorcode
    CHARACTER(LEN=MPI_MAX_ERROR_STRING), INTENT(OUT) :: string
    INTEGER, INTENT(OUT) :: resultlen
    INTEGER, OPTIONAL, INTENT(OUT) :: ierror
```

```
MPI_ERROR_STRING(ERRORCODE, STRING, RESULTLEN, IERROR)
    INTEGER ERRORCODE, RESULTLEN, IERROR
    CHARACTER*(*) STRING
```

Returns the error string associated with an error code or class. The argument `string` must represent storage that is at least `MPI_MAX_ERROR_STRING` characters long. The number of characters actually written is returned in the output argument, `resultlen`.

Rationale. The form of this function was chosen to make the Fortran and C bindings similar. A version that returns a pointer to a string has two difficulties. First, the return string must be statically allocated and different for each error message (allowing the pointers returned by successive calls to `MPI_ERROR_STRING` to point to the correct message). Second, in Fortran, a function declared as returning `CHARACTER*(*)` can not be referenced in, for example, a `PRINT` statement. (*End of rationale.*)

8.4 Error Codes and Classes

The error codes returned by MPI are left entirely to the implementation (with the exception of `MPI_SUCCESS`). This is done to allow an implementation to provide as much information as possible in the error code (for use with `MPI_ERROR_STRING`).

To make it possible for an application to interpret an error code, the routine `MPI_ERROR_CLASS` converts any error code into one of a small set of standard error codes, called *error classes*. Valid error classes are shown in Table 8.1 and Table 8.2.

The error classes are a subset of the error codes: an MPI function may return an error class number; and the function `MPI_ERROR_STRING` can be used to compute the error string associated with an error class. The values defined for MPI error classes are valid MPI error codes.

The error codes satisfy,

$$0 = \text{MPI_SUCCESS} < \text{MPI_ERR_}\dots \leq \text{MPI_ERR_LASTCODE}.$$

Rationale. The difference between `MPI_ERR_UNKNOWN` and `MPI_ERR_OTHER` is that `MPI_ERROR_STRING` can return useful information about `MPI_ERR_OTHER`.

Note that `MPI_SUCCESS = 0` is necessary to be consistent with C practice; the separation of error classes and error codes allows us to define the error classes this way. Having a known `LASTCODE` is often a nice sanity check as well. (*End of rationale.*)

`MPI_ERROR_CLASS(errorcode, errorclass)`

IN	errorcode	Error code returned by an MPI routine
OUT	errorclass	Error class associated with errorcode

`int MPI_Error_class(int errorcode, int *errorclass)`

`MPI_Error_class(errorcode, errorclass, ierror)`

INTEGER, INTENT(IN) :: errorcode
 INTEGER, INTENT(OUT) :: errorclass
 INTEGER, OPTIONAL, INTENT(OUT) :: ierror

`MPI_ERROR_CLASS(ERRORCODE, ERRORCLASS, IERROR)`

INTEGER ERRORCODE, ERRORCLASS, IERROR

The function `MPI_ERROR_CLASS` maps each standard error code (error class) onto itself.

8.5 Error Classes, Error Codes, and Error Handlers

Users may want to write a layered library on top of an existing MPI implementation, and this library may have its own set of error codes and classes. An example of such a library is an I/O library based on MPI, see Chapter 13. For this purpose, functions are needed to:

1. add a new error class to the ones an MPI implementation already knows.
2. associate error codes with this error class, so that `MPI_ERROR_CLASS` works.

		1
		2
MPI_SUCCESS	No error	3
MPI_ERR_BUFFER	Invalid buffer pointer	4
MPI_ERR_COUNT	Invalid count argument	5
MPI_ERR_TYPE	Invalid datatype argument	6
MPI_ERR_TAG	Invalid tag argument	7
MPI_ERR_COMM	Invalid communicator	8
MPI_ERR_RANK	Invalid rank	9
MPI_ERR_REQUEST	Invalid request (handle)	10
MPI_ERR_ROOT	Invalid root	11
MPI_ERR_GROUP	Invalid group	12
MPI_ERR_OP	Invalid operation	13
MPI_ERR_TOPOLOGY	Invalid topology	14
MPI_ERR_DIMS	Invalid dimension argument	15
MPI_ERR_ARG	Invalid argument of some other kind	16
MPI_ERR_UNKNOWN	Unknown error	17
MPI_ERR_TRUNCATE	Message truncated on receive	18
MPI_ERR_OTHER	Known error not in this list	19
MPI_ERR_INTERN	Internal MPI (implementation) error	20
MPI_ERR_IN_STATUS	Error code is in status	21
MPI_ERR_PENDING	Pending request	22
MPI_ERR_KEYVAL	Invalid keyval has been passed	23
MPI_ERR_NO_MEM	MPI_ALLOC_MEM failed because memory is exhausted	24
		25
MPI_ERR_BASE	Invalid base passed to MPI_FREE_MEM	26
MPI_ERR_INFO_KEY	Key longer than MPI_MAX_INFO_KEY	27
MPI_ERR_INFO_VALUE	Value longer than MPI_MAX_INFO_VAL	28
MPI_ERR_INFO_NOKEY	Invalid key passed to MPI_INFO_DELETE	29
MPI_ERR_SPAWN	Error in spawning processes	30
MPI_ERR_PORT	Invalid port name passed to MPI_COMM_CONNECT	31
		32
MPI_ERR_SERVICE	Invalid service name passed to MPI_UNPUBLISH_NAME	33
		34
MPI_ERR_NAME	Invalid service name passed to MPI_LOOKUP_NAME	35
		36
MPI_ERR_WIN	Invalid win argument	37
MPI_ERR_SIZE	Invalid size argument	38
MPI_ERR_DISP	Invalid disp argument	39
MPI_ERR_INFO	Invalid info argument	40
MPI_ERR_LOCKTYPE	Invalid locktype argument	41
MPI_ERR_ASSERT	Invalid assert argument	42
MPI_ERR_RMA_CONFLICT	Conflicting accesses to window	43
MPI_ERR_RMA_SYNC	Wrong synchronization of RMA calls	44
		45
		46
		47
		48

Table 8.1: Error classes (Part 1)

1		
2		
3		
4		
5	MPI_ERR_RMA_RANGE	Target memory is not part of the window (in the case of a window created with MPI_WIN_CREATE_DYNAMIC, target memory is not attached)
6		
7		
8		
9	MPI_ERR_RMA_ATTACH	Memory cannot be attached (e.g., because of resource exhaustion)
10		
11	MPI_ERR_RMA_SHARED	Memory cannot be shared (e.g., some process in the group of the specified communicator cannot expose shared memory)
12		
13		
14	MPI_ERR_RMA_FLAVOR	Passed window has the wrong flavor for the called function
15		
16	MPI_ERR_FILE	Invalid file handle
17	MPI_ERR_NOT_SAME	Collective argument not identical on all processes, or collective routines called in a different order by different processes
18		
19		
20	MPI_ERR_AMODE	Error related to the <code>amode</code> passed to MPI_FILE_OPEN
21		
22	MPI_ERR_UNSUPPORTED_DATAREP	Unsupported <code>datarep</code> passed to MPI_FILE_SET_VIEW
23		
24	MPI_ERR_UNSUPPORTED_OPERATION	Unsupported operation, such as seeking on a file which supports sequential access only
25		
26	MPI_ERR_NO_SUCH_FILE	File does not exist
27	MPI_ERR_FILE_EXISTS	File exists
28	MPI_ERR_BAD_FILE	Invalid file name (e.g., path name too long)
29	MPI_ERR_ACCESS	Permission denied
30	MPI_ERR_NO_SPACE	Not enough space
31	MPI_ERR_QUOTA	Quota exceeded
32	MPI_ERR_READ_ONLY	Read-only file or file system
33	MPI_ERR_FILE_IN_USE	File operation could not be completed, as the file is currently open by some process
34		
35	MPI_ERR_DUP_DATAREP	Conversion functions could not be registered because a data representation identifier that was already defined was passed to MPI_REGISTER_DATAREP
36		
37		
38		
39	MPI_ERR_CONVERSION	An error occurred in a user supplied data conversion function.
40		
41	MPI_ERR_IO	Other I/O error
42	MPI_ERR_LASTCODE	Last error code
43		

Table 8.2: Error classes (Part 2)

3. associate strings with these error codes, so that MPI_ERROR_STRING works.
4. invoke the error handler associated with a communicator, window, or object.

Several functions are provided to do this. They are all local. No functions are provided to free error classes or codes: it is not expected that an application will generate them in significant numbers.

MPI_ADD_ERROR_CLASS(errorclass)

OUT errorclass value for the new error class (integer)

int MPI_Add_error_class(int *errorclass)

MPI_Add_error_class(errorclass, ierror)

INTEGER, INTENT(OUT) :: errorclass

INTEGER, OPTIONAL, INTENT(OUT) :: ierror

MPI_ADD_ERROR_CLASS(ERRORCLASS, IERROR)

INTEGER ERRORCLASS, IERROR

Creates a new error class and returns the value for it.

Rationale. To avoid conflicts with existing error codes and classes, the value is set by the implementation and not by the user. (*End of rationale.*)

Advice to implementors. A high-quality implementation will return the value for a new errorclass in the same deterministic way on all processes. (*End of advice to implementors.*)

Advice to users. Since a call to MPI_ADD_ERROR_CLASS is local, the same errorclass may not be returned on all processes that make this call. Thus, it is not safe to assume that registering a new error on a set of processes at the same time will yield the same errorclass on all of the processes. However, if an implementation returns the new errorclass in a deterministic way, and they are always generated in the same order on the same set of processes (for example, all processes), then the value will be the same. However, even if a deterministic algorithm is used, the value can vary across processes. This can happen, for example, if different but overlapping groups of processes make a series of calls. As a result of these issues, getting the “same” error on multiple processes may not cause the same value of error code to be generated. (*End of advice to users.*)

The value of MPI_ERR_LASTCODE is a constant value and is not affected by new user-defined error codes and classes. Instead, a predefined attribute key MPI_LASTUSEDPCODE is associated with MPI_COMM_WORLD. The attribute value corresponding to this key is the current maximum error class including the user-defined ones. This is a local value and may be different on different processes. The value returned by this key is always greater than or equal to MPI_ERR_LASTCODE.

Advice to users. The value returned by the key MPI_LASTUSEDPCODE will not change unless the user calls a function to explicitly add an error class/code. In a multi-threaded environment, the user must take extra care in assuming this value has not

1 changed. Note that error codes and error classes are not necessarily dense. A user
 2 may not assume that each error class below MPI_LASTUSEDPCODE is valid. (*End of*
 3 *advice to users.*)
 4
 5

6 MPI_ADD_ERROR_CODE(errorclass, errorcode)

7
 8 IN errorclass error class (integer)
 9 OUT errorcode new error code to associated with errorclass (integer)
 10

11
 12 int MPI_Add_error_code(int errorclass, int *errorcode)

13 MPI_Add_error_code(errorclass, errorcode, ierror)

14 INTEGER, INTENT(IN) :: errorclass

15 INTEGER, INTENT(OUT) :: errorcode

16 INTEGER, OPTIONAL, INTENT(OUT) :: ierror
 17

18 MPI_ADD_ERROR_CODE(ERRORCLASS, ERRORCODE, IERROR)

19 INTEGER ERRORCLASS, ERRORCODE, IERROR

20 Creates new error code associated with errorclass and returns its value in errorcode.
 21

22 *Rationale.* To avoid conflicts with existing error codes and classes, the value of the
 23 new error code is set by the implementation and not by the user. (*End of rationale.*)
 24

25 *Advice to implementors.* A high-quality implementation will return the value for
 26 a new errorcode in the same deterministic way on all processes. (*End of advice to*
 27 *implementors.*)
 28
 29

30 MPI_ADD_ERROR_STRING(errorcode, string)

31
 32 IN errorcode error code or class (integer)

33 IN string text corresponding to errorcode (string)
 34

35
 36 int MPI_Add_error_string(int errorcode, const char *string)

37 MPI_Add_error_string(errorcode, string, ierror)

38 INTEGER, INTENT(IN) :: errorcode

39 CHARACTER(LEN=*), INTENT(IN) :: string

40 INTEGER, OPTIONAL, INTENT(OUT) :: ierror
 41

42 MPI_ADD_ERROR_STRING(ERRORCODE, STRING, IERROR)

43 INTEGER ERRORCODE, IERROR

44 CHARACTER*(*) STRING
 45

46 Associates an error string with an error code or class. The string must be no more
 47 than MPI_MAX_ERROR_STRING characters long. The length of the string is as defined in the
 48 calling language. The length of the string does not include the null terminator in C. Trailing
 blanks will be stripped in Fortran. Calling MPI_ADD_ERROR_STRING for an errorcode that

already has a string will replace the old string with the new string. It is erroneous to call `MPI_ADD_ERROR_STRING` for an error code or class with a value \leq `MPI_ERR_LASTCODE`.

If `MPI_ERROR_STRING` is called when no string has been set, it will return a empty string (all spaces in Fortran, "" in C).

Section 8.3 describes the methods for creating and associating error handlers with communicators, files, and windows.

`MPI_COMM_CALL_ERRHANDLER(comm, errorcode)`

IN	comm	communicator with error handler (handle)
IN	errorcode	error code (integer)

`int MPI_Comm_call_errhandler(MPI_Comm comm, int errorcode)`

`MPI_Comm_call_errhandler(comm, errorcode, ierror)`

TYPE(MPI_Comm), INTENT(IN) ::	comm
INTEGER, INTENT(IN) ::	errorcode
INTEGER, OPTIONAL, INTENT(OUT) ::	ierror

`MPI_COMM_CALL_ERRHANDLER(COMM, ERRORCODE, IERROR)`

INTEGER COMM, ERRORCODE, IERROR

This function invokes the error handler assigned to the communicator with the error code supplied. This function returns `MPI_SUCCESS` in C and the same value in `IERROR` if the error handler was successfully called (assuming the process is not aborted and the error handler returns).

`MPI_WIN_CALL_ERRHANDLER(win, errorcode)`

IN	win	window with error handler (handle)
IN	errorcode	error code (integer)

`int MPI_Win_call_errhandler(MPI_Win win, int errorcode)`

`MPI_Win_call_errhandler(win, errorcode, ierror)`

TYPE(MPI_Win), INTENT(IN) ::	win
INTEGER, INTENT(IN) ::	errorcode
INTEGER, OPTIONAL, INTENT(OUT) ::	ierror

`MPI_WIN_CALL_ERRHANDLER(WIN, ERRORCODE, IERROR)`

INTEGER WIN, ERRORCODE, IERROR

This function invokes the error handler assigned to the window with the error code supplied. This function returns `MPI_SUCCESS` in C and the same value in `IERROR` if the error handler was successfully called (assuming the process is not aborted and the error handler returns).

Advice to users. As with communicators, the default error handler for windows is `MPI_ERRORS_ARE_FATAL`. (*End of advice to users.*)

```

1 MPI_FILE_CALL_ERRHANDLER(fh, errorcode)
2     IN      fh                file with error handler (handle)
3
4     IN      errorcode        error code (integer)

```

```

5
6 int MPI_File_call_errhandler(MPI_File fh, int errorcode)

```

```

7 MPI_File_call_errhandler(fh, errorcode, ierror)
8     TYPE(MPI_File), INTENT(IN) :: fh
9     INTEGER, INTENT(IN) :: errorcode
10    INTEGER, OPTIONAL, INTENT(OUT) :: ierror
11

```

```

12 MPI_FILE_CALL_ERRHANDLER(FH, ERRORCODE, IERROR)
13     INTEGER FH, ERRORCODE, IERROR

```

This function invokes the error handler assigned to the file with the error code supplied. This function returns `MPI_SUCCESS` in C and the same value in `IERROR` if the error handler was successfully called (assuming the process is not aborted and the error handler returns).

Advice to users. Unlike errors on communicators and windows, the default behavior for files is to have `MPI_ERRORS_RETURN`. (*End of advice to users.*)

Advice to users. Users are warned that handlers should not be called recursively with `MPI_COMM_CALL_ERRHANDLER`, `MPI_FILE_CALL_ERRHANDLER`, or `MPI_WIN_CALL_ERRHANDLER`. Doing this can create a situation where an infinite recursion is created. This can occur if `MPI_COMM_CALL_ERRHANDLER`, `MPI_FILE_CALL_ERRHANDLER`, or `MPI_WIN_CALL_ERRHANDLER` is called inside an error handler.

Error codes and classes are associated with a process. As a result, they may be used in any error handler. Error handlers should be prepared to deal with any error code they are given. Furthermore, it is good practice to only call an error handler with the appropriate error codes. For example, file errors would normally be sent to the file error handler. (*End of advice to users.*)

8.6 Timers and Synchronization

MPI defines a timer. A timer is specified even though it is not “message-passing,” because timing parallel programs is important in “performance debugging” and because existing timers (both in POSIX 1003.1-1988 and 1003.4D 14.1 and in Fortran 90) are either inconvenient or do not provide adequate access to high resolution timers. See also Section 2.6.4.

```

41 MPI_WTIME()

```

```

42 double MPI_Wtime(void)

```

```

43 DOUBLE PRECISION MPI_Wtime()

```

```

44 DOUBLE PRECISION MPI_WTIME()

```

MPI_WTIME returns a floating-point number of seconds, representing elapsed wall-clock time since some time in the past.

The “time in the past” is guaranteed not to change during the life of the process. The user is responsible for converting large numbers of seconds to other units if they are preferred.

This function is portable (it returns seconds, not “ticks”), it allows high-resolution, and carries no unnecessary baggage. One would use it like this:

```
{
    double starttime, endtime;
    starttime = MPI_Wtime();
    .... stuff to be timed ...
    endtime   = MPI_Wtime();
    printf("That took %f seconds\n",endtime-starttime);
}
```

The times returned are local to the node that called them. There is no requirement that different nodes return “the same time.” (But see also the discussion of MPI_WTIME_IS_GLOBAL in Section 8.1.2).

MPI_WTICK()

```
double MPI_Wtick(void)
DOUBLE PRECISION MPI_Wtick()
DOUBLE PRECISION MPI_WTICK()
```

MPI_WTICK returns the resolution of MPI_WTIME in seconds. That is, it returns, as a double precision value, the number of seconds between successive clock ticks. For example, if the clock is implemented by the hardware as a counter that is incremented every millisecond, the value returned by MPI_WTICK should be 10^{-3} .

8.7 Startup

One goal of MPI is to achieve *source code portability*. By this we mean that a program written using MPI and complying with the relevant language standards is portable as written, and must not require any source code changes when moved from one system to another. This explicitly does *not* say anything about how an MPI program is started or launched from the command line, nor what the user must do to set up the environment in which an MPI program will run. However, an implementation may require some setup to be performed before other MPI routines may be called. To provide for this, MPI includes an initialization routine MPI_INIT.

MPI_INIT()

```
int MPI_Init(int *argc, char ***argv)
MPI_Init(ierror)
```

```

1     INTEGER, OPTIONAL, INTENT(OUT) :: ierror
2
3 MPI_INIT(IERROR)
4     INTEGER IERROR

```

All MPI programs must contain exactly one call to an MPI initialization routine: `MPI_INIT` or `MPI_INIT_THREAD`. Subsequent calls to any initialization routines are erroneous. The only MPI functions that may be invoked before the MPI initialization routines are called are `MPI_GET_VERSION`, `MPI_GET_LIBRARY_VERSION`, `MPI_INITIALIZED`, `MPI_FINALIZED`, and any function with the prefix `MPI_T_` (within the constraints for functions with this prefix listed in Section 14.3.4). The version for ISO C accepts the `argc` and `argv` that are provided by the arguments to `main` or `NULL`:

```

12
13 int main(int argc, char *argv[])
14 {
15     MPI_Init(&argc, &argv);
16
17     /* parse arguments */
18     /* main program    */
19
20     MPI_Finalize();    /* see below */
21     return 0;
22 }

```

The Fortran version takes only `IERROR`.

Conforming implementations of MPI are required to allow applications to pass `NULL` for both the `argc` and `argv` arguments of `main` in C.

After MPI is initialized, the application can access information about the execution environment by querying the predefined info object `MPI_INFO_ENV`. The following keys are predefined for this object, corresponding to the arguments of `MPI_COMM_SPAWN` or of `mpiexec`:

`command` Name of program executed.

`argv` Space separated arguments to command.

`maxprocs` Maximum number of MPI processes to start.

`soft` Allowed values for number of processors.

`host` Hostname.

`arch` Architecture name.

`wdir` Working directory of the MPI process.

`file` Value is the name of a file in which additional information is specified.

`thread_level` Requested level of thread support, if requested before the program started execution.

Note that all values are strings. Thus, the maximum number of processes is represented by a string such as “1024” and the requested level is represented by a string such as “MPI_THREAD_SINGLE”.

The info object MPI_INFO_ENV need not contain a (key,value) pair for each of these predefined keys; the set of (key,value) pairs provided is implementation-dependent. Implementations may provide additional, implementation specific, (key,value) pairs.

In case where the MPI processes were started with MPI_COMM_SPAWN_MULTIPLE or, equivalently, with a startup mechanism that supports multiple process specifications, then the values stored in the info object MPI_INFO_ENV at a process are those values that affect the local MPI process.

Example 8.4 If MPI is started with a call to

```
mpiexec -n 5 -arch sun ocean : -n 10 -arch rs6000 atmos
```

Then the first 5 processes will have in their MPI_INFO_ENV object the pairs (command, ocean), (maxprocs, 5), and (arch, sun). The next 10 processes will have in MPI_INFO_ENV (command, atmos), (maxprocs, 10), and (arch, rs6000)

Advice to users. The values passed in MPI_INFO_ENV are the values of the arguments passed to the mechanism that started the MPI execution — not the actual value provided. Thus, the value associated with maxprocs is the number of MPI processes requested; it can be larger than the actual number of processes obtained, if the soft option was used. (*End of advice to users.*)

Advice to implementors. High-quality implementations will provide a (key,value) pair for each parameter that can be passed to the command that starts an MPI program. (*End of advice to implementors.*)

MPI_FINALIZE()

```
int MPI_Finalize(void)
```

```
MPI_Finalize(ierr)
```

```
    INTEGER, OPTIONAL, INTENT(OUT) :: ierr
```

```
MPI_FINALIZE(IERROR)
```

```
    INTEGER IERROR
```

This routine cleans up all MPI state. If an MPI program terminates normally (i.e., not due to a call to MPI_ABORT or an unrecoverable error) then each process must call MPI_FINALIZE before it exits.

Before an MPI process invokes MPI_FINALIZE, the process must perform all MPI calls needed to complete its involvement in MPI communications: It must locally complete all MPI operations that it initiated and must execute matching calls needed to complete MPI communications initiated by other processes. For example, if the process executed a non-blocking send, it must eventually call MPI_WAIT, MPI_TEST, MPI_REQUEST_FREE, or any derived function; if the process is the target of a send, then it must post the matching receive; if it is part of a group executing a collective operation, then it must have completed its participation in the operation.

1 The call to `MPI_FINALIZE` does not free objects created by MPI calls; these objects are
 2 freed using `MPI_XXX_FREE` calls.

3 `MPI_FINALIZE` is collective over all connected processes. If no processes were spawned,
 4 accepted or connected then this means over `MPI_COMM_WORLD`; otherwise it is collective
 5 over the union of all processes that have been and continue to be connected, as explained
 6 in Section 10.5.4.

7 The following examples illustrates these rules

8
 9 **Example 8.5** The following code is correct

```
10
11      Process 0                Process 1
12      -----                -----
13      MPI_Init();              MPI_Init();
14      MPI_Send(dest=1);        MPI_Recv(src=0);
15      MPI_Finalize();          MPI_Finalize();
16
```

17 **Example 8.6** Without a matching receive, the program is erroneous

```
18
19      Process 0                Process 1
20      -----                -----
21      MPI_Init();              MPI_Init();
22      MPI_Send (dest=1);
23      MPI_Finalize();          MPI_Finalize();
24
```

25 **Example 8.7** This program is correct: Process 0 calls `MPI_Finalize` after it has executed
 26 the MPI calls that complete the send operation. Likewise, process 1 executes the MPI call
 27 that completes the matching receive operation before it calls `MPI_Finalize`.
 28

```
29      Process 0                Proces 1
30      -----                -----
31      MPI_Init();              MPI_Init();
32      MPI_Isend(dest=1);        MPI_Recv(src=0);
33      MPI_Request_free();       MPI_Finalize();
34      MPI_Finalize();          exit();
35      exit();
36
```

37 **Example 8.8** This program is correct. The attached buffer is a resource allocated by the
 38 user, not by MPI; it is available to the user after MPI is finalized.
 39

```
40      Process 0                Process 1
41      -----                -----
42      MPI_Init();              MPI_Init();
43      buffer = malloc(1000000); MPI_Recv(src=0);
44      MPI_Buffer_attach();      MPI_Finalize();
45      MPI_Send(dest=1));       exit();
46      MPI_Finalize();
47      free(buffer);
48      exit();
```

Example 8.9 This program is correct. The cancel operation must succeed, since the send cannot complete normally. The wait operation, after the call to `MPI_Cancel`, is local — no matching MPI call is required on process 1. Cancelling a send request by calling `MPI_CANCEL` is deprecated.

```

Process 0                                Process 1
-----                                -
MPI_Issend(dest=1);                      MPI_Finalize();
MPI_Cancel();
MPI_Wait();
MPI_Finalize();

```

Advice to implementors. Even though a process has executed all MPI calls needed to complete the communications it is involved with, such communication may not yet be completed from the viewpoint of the underlying MPI system. For example, a blocking send may have returned, even though the data is still buffered at the sender in an MPI buffer; an MPI process may receive a cancel request for a message it has completed receiving. The MPI implementation must ensure that a process has completed any involvement in MPI communication before `MPI_FINALIZE` returns. Thus, if a process exits after the call to `MPI_FINALIZE`, this will not cause an ongoing communication to fail. The MPI implementation should also complete freeing all objects marked for deletion by MPI calls that freed them. (*End of advice to implementors.*)

Once `MPI_FINALIZE` returns, no MPI routine (not even `MPI_INIT`) may be called, except for `MPI_GET_VERSION`, `MPI_GET_LIBRARY_VERSION`, `MPI_INITIALIZED`, `MPI_FINALIZED`, and any function with the prefix `MPI_T_` (within the constraints for functions with this prefix listed in Section 14.3.4).

Although it is not required that all processes return from `MPI_FINALIZE`, it is required that at least process 0 in `MPI_COMM_WORLD` return, so that users can know that the MPI portion of the computation is over. In addition, in a POSIX environment, users may desire to supply an exit code for each process that returns from `MPI_FINALIZE`.

Example 8.10 The following illustrates the use of requiring that at least one process return and that it be known that process 0 is one of the processes that return. One wants code like the following to work no matter how many processes return.

```

...
MPI_Comm_rank(MPI_COMM_WORLD, &myrank);
...
MPI_Finalize();
if (myrank == 0) {
    resultfile = fopen("outfile","w");
    dump_results(resultfile);
    fclose(resultfile);
}
exit(0);

```

1 MPI_INITIALIZED(flag)

2 OUT flag Flag is true if MPI_INIT has been called and false
3 otherwise.
4

5
6 int MPI_Initialized(int *flag)

7 MPI_Initialized(flag, ierror)

8 LOGICAL, INTENT(OUT) :: flag

9 INTEGER, OPTIONAL, INTENT(OUT) :: ierror

10
11 MPI_INITIALIZED(FLAG, IERROR)

12 LOGICAL FLAG

13 INTEGER IERROR

14 This routine may be used to determine whether MPI_INIT has been called.
15 MPI_INITIALIZED returns true if the calling process has called MPI_INIT. Whether
16 MPI_FINALIZE has been called does not affect the behavior of MPI_INITIALIZED. It is one
17 of the few routines that may be called before MPI_INIT is called. This function must always
18 be thread-safe, as defined in Section 12.4.
19

20
21 MPI_ABORT(comm, errorcode)

22 IN comm communicator of tasks to abort

23 IN errorcode error code to return to invoking environment
24

25
26 int MPI_Abort(MPI_Comm comm, int errorcode)

27 MPI_Abort(comm, errorcode, ierror)

28 TYPE(MPI_Comm), INTENT(IN) :: comm

29 INTEGER, INTENT(IN) :: errorcode

30 INTEGER, OPTIONAL, INTENT(OUT) :: ierror
31

32 MPI_ABORT(COMM, ERRORCODE, IERROR)

33 INTEGER COMM, ERRORCODE, IERROR
34

35 This routine makes a “best attempt” to abort all tasks in the group of comm. This
36 function does not require that the invoking environment take any action with the error
37 code. However, a Unix or POSIX environment should handle this as a **return errorcode**
38 from the main program.

39 It may not be possible for an MPI implementation to abort only the processes repre-
40 sented by comm if this is a subset of the processes. In this case, the MPI implementation
41 should attempt to abort all the connected processes but should not abort any unconnected
42 processes. If no processes were spawned, accepted, or connected then this has the effect of
43 aborting all the processes associated with MPI_COMM_WORLD.

44 *Advice to implementors.* After aborting a subset of processes, a high quality im-
45 plementation should be able to provide error handling for communicators, windows,
46 and files involving both aborted and non-aborted processes. As an example, if the
47 user changes the error handler for MPI_COMM_WORLD to MPI_ERRORS_RETURN or a
48 custom error handler, when a subset of MPI_COMM_WORLD is aborted, the remaining

processes in MPI_COMM_WORLD should be able to continue communicating with each other and receive appropriate error codes when attempting communication with an aborted process. (*End of advice to implementors.*)

Advice to users. Whether the `errorcode` is returned from the executable or from the MPI process startup mechanism (e.g., `mpiexec`), is an aspect of quality of the MPI library but not mandatory. (*End of advice to users.*)

Advice to implementors. Where possible, a high-quality implementation will try to return the `errorcode` from the MPI process startup mechanism (e.g. `mpiexec` or `singleton init`). (*End of advice to implementors.*)

8.7.1 Allowing User Functions at Process Termination

There are times in which it would be convenient to have actions happen when an MPI process finishes. For example, a routine may do initializations that are useful until the MPI job (or that part of the job that being terminated in the case of dynamically created processes) is finished. This can be accomplished in MPI by attaching an attribute to `MPI_COMM_SELF` with a callback function. When `MPI_FINALIZE` is called, it will first execute the equivalent of an `MPI_COMM_FREE` on `MPI_COMM_SELF`. This will cause the delete callback function to be executed on all keys associated with `MPI_COMM_SELF`, in the reverse order that they were set on `MPI_COMM_SELF`. If no key has been attached to `MPI_COMM_SELF`, then no callback is invoked. The “freeing” of `MPI_COMM_SELF` occurs before any other parts of MPI are affected. Thus, for example, calling `MPI_FINALIZED` will return `false` in any of these callback functions. Once done with `MPI_COMM_SELF`, the order and rest of the actions taken by `MPI_FINALIZE` is not specified.

Advice to implementors. Since attributes can be added from any supported language, the MPI implementation needs to remember the creating language so the correct callback is made. Implementations that use the attribute delete callback on `MPI_COMM_SELF` internally should register their internal callbacks before returning from `MPI_INIT` / `MPI_INIT_THREAD`, so that libraries or applications will not have portions of the MPI implementation shut down before the application-level callbacks are made. (*End of advice to implementors.*)

8.7.2 Determining Whether MPI Has Finished

One of the goals of MPI was to allow for layered libraries. In order for a library to do this cleanly, it needs to know if MPI is active. In MPI the function `MPI_INITIALIZED` was provided to tell if MPI had been initialized. The problem arises in knowing if MPI has been finalized. Once MPI has been finalized it is no longer active and cannot be restarted. A library needs to be able to determine this to act accordingly. To achieve this the following function is needed:

```
MPI_FINALIZED(flag)
```

```
    OUT    flag                true if MPI was finalized (logical)
```

```
int MPI_Finalized(int *flag)
```

```

1 MPI_Finalized(flag, ierror)
2     LOGICAL, INTENT(OUT) :: flag
3     INTEGER, OPTIONAL, INTENT(OUT) :: ierror
4
5 MPI_FINALIZED(FLAG, IERROR)
6     LOGICAL FLAG
7     INTEGER IERROR

```

This routine returns true if MPI_FINALIZE has completed. It is valid to call MPI_FINALIZED before MPI_INIT and after MPI_FINALIZE. This function must always be thread-safe, as defined in Section 12.4.

Advice to users. MPI is “active” and it is thus safe to call MPI functions if MPI_INIT has completed and MPI_FINALIZE has not completed. If a library has no other way of knowing whether MPI is active or not, then it can use MPI_INITIALIZED and MPI_FINALIZED to determine this. For example, MPI is “active” in callback functions that are invoked during MPI_FINALIZE. (*End of advice to users.*)

8.8 Portable MPI Process Startup

A number of implementations of MPI provide a startup command for MPI programs that is of the form

```
mpirun <mpirun arguments> <program> <program arguments>
```

Separating the command to start the program from the program itself provides flexibility, particularly for network and heterogeneous implementations. For example, the startup script need not run on one of the machines that will be executing the MPI program itself.

Having a standard startup mechanism also extends the portability of MPI programs one step further, to the command lines and scripts that manage them. For example, a validation suite script that runs hundreds of programs can be a portable script if it is written using such a standard startup mechanism. In order that the “standard” command not be confused with existing practice, which is not standard and not portable among implementations, instead of `mpirun` MPI specifies `mpiexec`.

While a standardized startup mechanism improves the usability of MPI, the range of environments is so diverse (e.g., there may not even be a command line interface) that MPI cannot mandate such a mechanism. Instead, MPI specifies an `mpiexec` startup command and recommends but does not require it, as advice to implementors. However, if an implementation does provide a command called `mpiexec`, it must be of the form described below.

It is suggested that

```
mpiexec -n <numprocs> <program>
```

be at least one way to start `<program>` with an initial MPI_COMM_WORLD whose group contains `<numprocs>` processes. Other arguments to `mpiexec` may be implementation-dependent.

Advice to implementors. Implementors, if they do provide a special startup command for MPI programs, are advised to give it the following form. The syntax is chosen in

order that `mpiexec` be able to be viewed as a command-line version of `MPI_COMM_SPAWN` (See Section 10.3.4).

Analogous to `MPI_COMM_SPAWN`, we have

```
mpiexec -n <maxprocs>
        -soft < >
        -host < >
        -arch < >
        -wdir < >
        -path < >
        -file < >
        ...
        <command line>
```

for the case where a single command line for the application program and its arguments will suffice. See Section 10.3.4 for the meanings of these arguments. For the case corresponding to `MPI_COMM_SPAWN_MULTIPLE` there are two possible formats:

Form A:

```
mpiexec { <above arguments> } : { ... } : { ... } : ... : { ... }
```

As with `MPI_COMM_SPAWN`, all the arguments are optional. (Even the `-n x` argument is optional; the default is implementation dependent. It might be 1, it might be taken from an environment variable, or it might be specified at compile time.) The names and meanings of the arguments are taken from the keys in the `info` argument to `MPI_COMM_SPAWN`. There may be other, implementation-dependent arguments as well.

Note that Form A, though convenient to type, prevents colons from being program arguments. Therefore an alternate, file-based form is allowed:

Form B:

```
mpiexec -configfile <filename>
```

where the lines of `<filename>` are of the form separated by the colons in Form A. Lines beginning with `#` are comments, and lines may be continued by terminating the partial line with `\`.

Example 8.11 Start 16 instances of `myprog` on the current or default machine:

```
mpiexec -n 16 myprog
```

Example 8.12 Start 10 processes on the machine called `ferrari`:

```
mpiexec -n 10 -host ferrari myprog
```

1 **Example 8.13** Start three copies of the same program with different command-line
2 arguments:

```
3  
4       mpiexec myprog infile1 : myprog infile2 : myprog infile3  
5
```

6
7 **Example 8.14** Start the `ocean` program on five Suns and the `atmos` program on 10
8 RS/6000's:

```
9  
10       mpiexec -n 5 -arch sun ocean : -n 10 -arch rs6000 atmos  
11
```

12 It is assumed that the implementation in this case has a method for choosing hosts of
13 the appropriate type. Their ranks are in the order specified.

14
15 **Example 8.15** Start the `ocean` program on five Suns and the `atmos` program on 10
16 RS/6000's (Form B):

```
17  
18       mpiexec -configfile myfile  
19
```

20 where `myfile` contains

```
21  
22       -n 5 -arch sun     ocean  
23       -n 10 -arch rs6000 atmos  
24
```

25 (*End of advice to implementors.*)
26
27
28
29
30
31
32
33
34
35
36
37
38
39
40
41
42
43
44
45
46
47
48

Chapter 9

The Info Object

Many of the routines in MPI take an argument `info`. `info` is an opaque object with a handle of type `MPI_Info` in C and Fortran with the `mpi_f08` module, and `INTEGER` in Fortran with the `mpi` module or the include file `mpif.h`. It stores an unordered set of (key,value) pairs (both key and value are strings). A key can have only one value. MPI reserves several keys and requires that if an implementation uses a reserved key, it must provide the specified functionality. An implementation is not required to support these keys and may support any others not reserved by MPI. Some info hints allow the MPI library to restrict its support for certain operations in order to improve performance or resource utilization. If an application provides such an info hint, it must be compatible with any changes in the behavior of the MPI library that are allowed by the info hint.

An implementation must support info objects as caches for arbitrary (key,value) pairs, regardless of whether it recognizes the key. Each function that takes hints in the form of an `MPI_Info` must be prepared to ignore any key it does not recognize. This description of info objects does not attempt to define how a particular function should react if it recognizes a key but not the associated value. `MPI_INFO_GET_NKEYS`, `MPI_INFO_GET_NTHKEY`, `MPI_INFO_GET_VALUELEN`, and `MPI_INFO_GET` must retain all (key,value) pairs so that layered functionality can also use the `Info` object.

Keys have an implementation-defined maximum length of `MPI_MAX_INFO_KEY`, which is at least 32 and at most 255. Values have an implementation-defined maximum length of `MPI_MAX_INFO_VAL`. In Fortran, leading and trailing spaces are stripped from both. Returned values will never be larger than these maximum lengths. Both key and value are case sensitive.

Rationale. Keys have a maximum length because the set of known keys will always be finite and known to the implementation and because there is no reason for keys to be complex. The small maximum size allows applications to declare keys of size `MPI_MAX_INFO_KEY`. The limitation on value sizes is so that an implementation is not forced to deal with arbitrarily long strings. (*End of rationale.*)

Advice to users. `MPI_MAX_INFO_VAL` might be very large, so it might not be wise to declare a string of that size. (*End of advice to users.*)

When `info` is used as an argument to a nonblocking routine, it is parsed before that routine returns, so that it may be modified or freed immediately after return.

When the descriptions refer to a key or value as being a boolean, an integer, or a list, they mean the string representation of these types. An implementation may define its own

rules for how info value strings are converted to other types, but to ensure portability, every implementation must support the following representations. Valid values for a boolean must include the strings “true” and “false” (all lowercase). For integers, valid values must include string representations of decimal values of integers that are within the range of a standard integer type in the program. (However it is possible that not every integer is a valid value for a given key.) On positive numbers, + signs are optional. No space may appear between a + or – sign and the leading digit of a number. For comma separated lists, the string must contain valid elements separated by commas. Leading and trailing spaces are stripped automatically from the types of info values described above and for each element of a comma separated list. These rules apply to all info values of these types. Implementations are free to specify a different interpretation for values of other info keys.

MPI_INFO_CREATE(info)

OUT info info object created (handle)

```
int MPI_Info_create(MPI_Info *info)
```

```
MPI_Info_create(info, ierror)
```

```
TYPE(MPI_Info), INTENT(OUT) :: info
```

```
INTEGER, OPTIONAL, INTENT(OUT) :: ierror
```

```
MPI_INFO_CREATE(INFO, IERROR)
```

```
INTEGER INFO, IERROR
```

MPI_INFO_CREATE creates a new info object. The newly created object contains no key/value pairs.

MPI_INFO_SET(info, key, value)

INOUT info info object (handle)

IN key key (string)

IN value value (string)

```
int MPI_Info_set(MPI_Info info, const char *key, const char *value)
```

```
MPI_Info_set(info, key, value, ierror)
```

```
TYPE(MPI_Info), INTENT(IN) :: info
```

```
CHARACTER(LEN=*), INTENT(IN) :: key, value
```

```
INTEGER, OPTIONAL, INTENT(OUT) :: ierror
```

```
MPI_INFO_SET(INFO, KEY, VALUE, IERROR)
```

```
INTEGER INFO, IERROR
```

```
CHARACTER*(*) KEY, VALUE
```

MPI_INFO_SET adds the (key,value) pair to info, and overrides the value if a value for the same key was previously set. key and value are null-terminated strings in C. In Fortran, leading and trailing spaces in key and value are stripped. If either key or value are larger than the allowed maximums, the errors MPI_ERR_INFO_KEY or MPI_ERR_INFO_VALUE are

raised, respectively.

`MPI_INFO_DELETE(info, key)`

INOUT	info	info object (handle)
IN	key	key (string)

`int MPI_Info_delete(MPI_Info info, const char *key)`

`MPI_Info_delete(info, key, ierror)`

TYPE(MPI_Info), INTENT(IN) ::	info
CHARACTER(LEN=*), INTENT(IN) ::	key
INTEGER, OPTIONAL, INTENT(OUT) ::	ierror

`MPI_INFO_DELETE(INFO, KEY, IERROR)`

INTEGER	INFO, IERROR
CHARACTER*(*)	KEY

`MPI_INFO_DELETE` deletes a (key,value) pair from `info`. If `key` is not defined in `info`, the call raises an error of class `MPI_ERR_INFO_NOKEY`.

`MPI_INFO_GET(info, key, valuelen, value, flag)`

IN	info	info object (handle)
IN	key	key (string)
IN	valuelen	length of value arg (integer)
OUT	value	value (string)
OUT	flag	true if key defined, false if not (boolean)

`int MPI_Info_get(MPI_Info info, const char *key, int valuelen, char *value, int *flag)`

`MPI_Info_get(info, key, valuelen, value, flag, ierror)`

TYPE(MPI_Info), INTENT(IN) ::	info
CHARACTER(LEN=*), INTENT(IN) ::	key
INTEGER, INTENT(IN) ::	valuelen
CHARACTER(LEN=valuelen), INTENT(OUT) ::	value
LOGICAL, INTENT(OUT) ::	flag
INTEGER, OPTIONAL, INTENT(OUT) ::	ierror

`MPI_INFO_GET(INFO, KEY, VALUELEN, VALUE, FLAG, IERROR)`

INTEGER	INFO, VALUELEN, IERROR
CHARACTER*(*)	KEY, VALUE
LOGICAL	FLAG

This function retrieves the value associated with `key` in a previous call to `MPI_INFO_SET`. If such a key exists, it sets `flag` to `true` and returns the value in `value`, otherwise it sets `flag` to `false` and leaves `value` unchanged. `valuelen` is the number of characters

1 available in value. If it is less than the actual size of the value, the value is truncated. In
 2 C, `valuelen` should be one less than the amount of allocated space to allow for the null
 3 terminator.

4 If `key` is larger than `MPI_MAX_INFO_KEY`, the call is erroneous.

6 `MPI_INFO_GET_VALUELEN`(`info`, `key`, `valuelen`, `flag`)

8	IN	<code>info</code>	info object (handle)
9	IN	<code>key</code>	key (string)
10	OUT	<code>valuelen</code>	length of value arg (integer)
11	OUT	<code>flag</code>	true if key defined, false if not (boolean)

12
 13
 14 `int MPI_Info_get_valuelen(MPI_Info info, const char *key, int *valuelen,`
 15 `int *flag)`

16
 17 `MPI_Info_get_valuelen`(`info`, `key`, `valuelen`, `flag`, `ierror`)

18 `TYPE(MPI_Info), INTENT(IN) :: info`
 19 `CHARACTER(LEN=*), INTENT(IN) :: key`
 20 `INTEGER, INTENT(OUT) :: valuelen`
 21 `LOGICAL, INTENT(OUT) :: flag`
 22 `INTEGER, OPTIONAL, INTENT(OUT) :: ierror`

23 `MPI_INFO_GET_VALUELEN`(`INFO`, `KEY`, `VALUELEN`, `FLAG`, `IERROR`)

24 `INTEGER INFO, VALUELEN, IERROR`
 25 `LOGICAL FLAG`
 26 `CHARACTER*(*) KEY`

27
 28 Retrieves the length of the value associated with `key`. If `key` is defined, `valuelen` is set to
 29 the length of its associated value and `flag` is set to true. If `key` is not defined, `valuelen` is not
 30 touched and `flag` is set to false. The length returned in C does not include the end-of-string
 31 character.

32 If `key` is larger than `MPI_MAX_INFO_KEY`, the call is erroneous.

33
 34 `MPI_INFO_GET_NKEYS`(`info`, `nkeys`)

35	IN	<code>info</code>	info object (handle)
36	OUT	<code>nkeys</code>	number of defined keys (integer)

37
 38
 39 `int MPI_Info_get_nkeys(MPI_Info info, int *nkeys)`

40
 41 `MPI_Info_get_nkeys`(`info`, `nkeys`, `ierror`)

42 `TYPE(MPI_Info), INTENT(IN) :: info`
 43 `INTEGER, INTENT(OUT) :: nkeys`
 44 `INTEGER, OPTIONAL, INTENT(OUT) :: ierror`

45
 46 `MPI_INFO_GET_NKEYS`(`INFO`, `NKEYS`, `IERROR`)

47 `INTEGER INFO, NKEYS, IERROR`

48 `MPI_INFO_GET_NKEYS` returns the number of currently defined keys in `info`.

MPI_INFO_GET_NTHKEY(info, n, key)	1
IN info info object (handle)	2
	3
IN n key number (integer)	4
OUT key key (string)	5
	6
int MPI_Info_get_nthkey(MPI_Info info, int n, char *key)	7
	8
MPI_Info_get_nthkey(info, n, key, ierror)	9
TYPE(MPI_Info), INTENT(IN) :: info	10
INTEGER, INTENT(IN) :: n	11
CHARACTER(LEN=*), INTENT(OUT) :: key	12
INTEGER, OPTIONAL, INTENT(OUT) :: ierror	13
	14
MPI_INFO_GET_NTHKEY(INFO, N, KEY, IERROR)	15
INTEGER INFO, N, IERROR	16
CHARACTER*(*) KEY	17
	18
This function returns the n th defined key in <code>info</code> . Keys are numbered $0 \dots N - 1$ where	19
N is the value returned by <code>MPI_INFO_GET_NKEYS</code> . All keys between 0 and $N - 1$ are	20
guaranteed to be defined. The number of a given key does not change as long as <code>info</code> is not	21
modified with <code>MPI_INFO_SET</code> or <code>MPI_INFO_DELETE</code> .	22
	23
MPI_INFO_DUP(info, newinfo)	24
IN info info object (handle)	25
OUT newinfo info object (handle)	26
	27
	28
int MPI_Info_dup(MPI_Info info, MPI_Info *newinfo)	29
	30
MPI_Info_dup(info, newinfo, ierror)	31
TYPE(MPI_Info), INTENT(IN) :: info	32
TYPE(MPI_Info), INTENT(OUT) :: newinfo	33
INTEGER, OPTIONAL, INTENT(OUT) :: ierror	34
	35
MPI_INFO_DUP(INFO, NEWINFO, IERROR)	36
INTEGER INFO, NEWINFO, IERROR	37
	38
MPI_INFO_DUP duplicates an existing info object, creating a new object, with the	39
same (key,value) pairs and the same ordering of keys.	40
	41
MPI_INFO_FREE(info)	42
INOUT info info object (handle)	43
	44
int MPI_Info_free(MPI_Info *info)	45
	46
MPI_Info_free(info, ierror)	47
TYPE(MPI_Info), INTENT(INOUT) :: info	48
INTEGER, OPTIONAL, INTENT(OUT) :: ierror	

```
1 MPI_INFO_FREE(INFO, IERROR)
2     INTEGER INFO, IERROR
```

3
4 This function frees info and sets it to MPI_INFO_NULL. The value of an info argument is
5 interpreted each time the info is passed to a routine. Changes to an info after return from
6 a routine do not affect that interpretation.

7
8
9
10
11
12
13
14
15
16
17
18
19
20
21
22
23
24
25
26
27
28
29
30
31
32
33
34
35
36
37
38
39
40
41
42
43
44
45
46
47
48

1
2
3
4
5
6
7
8
9
10
11
12
13
14
15
16
17
18
19
20
21
22
23
24
25
26
27
28
29
30
31
32
33
34
35
36
37
38
39
40
41
42
43
44
45
46
47
48

Chapter 10

Process Creation and Management

10.1 Introduction

MPI is primarily concerned with communication rather than process or resource management. However, it is necessary to address these issues to some degree in order to define a useful framework for communication. This chapter presents a set of MPI interfaces that allows for a variety of approaches to process management while placing minimal restrictions on the execution environment.

The MPI model for process creation allows both the creation of an initial set of processes related by their membership in a common MPI_COMM_WORLD and the creation and management of processes after an MPI application has been started. A major impetus for the latter form of process creation comes from the PVM [25] research effort. This work has provided a wealth of experience with process management and resource control that illustrates their benefits and potential pitfalls.

The MPI Forum decided not to address resource control because it was not able to design a portable interface that would be appropriate for the broad spectrum of existing and potential resource and process controllers. Resource control can encompass a wide range of abilities, including adding and deleting nodes from a virtual parallel machine, reserving and scheduling resources, managing compute partitions of an MPP, and returning information about available resources. MPI assumes that resource control is provided externally — probably by computer vendors, in the case of tightly coupled systems, or by a third party software package when the environment is a cluster of workstations.

The reasons for including process management in MPI are both technical and practical. Important classes of message-passing applications require process control. These include task farms, serial applications with parallel modules, and problems that require a run-time assessment of the number and type of processes that should be started. On the practical side, users of workstation clusters who are migrating from PVM to MPI may be accustomed to using PVM's capabilities for process and resource management. The lack of these features would be a practical stumbling block to migration.

The following goals are central to the design of MPI process management:

- The MPI process model must apply to the vast majority of current parallel environments. These include everything from tightly integrated MPPs to heterogeneous networks of workstations.
- MPI must not take over operating system responsibilities. It should instead provide a

1 clean interface between an application and system software.

- 2
- 3 • MPI must guarantee communication determinism in the presense of dynamic processes,
4 i.e., dynamic process management must not introduce unavoidable race conditions.
- 5
- 6 • MPI must not contain features that compromise performance.

7 The process management model addresses these issues in two ways. First, MPI remains
8 primarily a communication library. It does not manage the parallel environment in which
9 a parallel program executes, though it provides a minimal interface between an application
10 and external resource and process managers.

11 Second, MPI maintains a consistent concept of a communicator, regardless of how its
12 members came into existence. A communicator is never changed once created, and it is
13 always created using deterministic collective operations.

14 10.2 The Dynamic Process Model

15 The dynamic process model allows for the creation and cooperative termination of processes
16 after an MPI application has started. It provides a mechanism to establish communication
17 between the newly created processes and the existing MPI application. It also provides a
18 mechanism to establish communication between two existing MPI applications, even when
19 one did not “start” the other.
20
21
22

23 10.2.1 Starting Processes

24 MPI applications may start new processes through an interface to an external process man-
25 ager.

26 MPI_COMM_SPAWN starts MPI processes and establishes communication with them,
27 returning an intercommunicator. MPI_COMM_SPAWN_MULTIPLE starts several different
28 binaries (or the same binary with different arguments), placing them in the same
29 MPI_COMM_WORLD and returning an intercommunicator.

30 MPI uses the group abstraction to represent processes. A process is identified by a
31 (group, rank) pair.
32
33

34 10.2.2 The Runtime Environment

35 The MPI_COMM_SPAWN and MPI_COMM_SPAWN_MULTIPLE routines provide an inter-
36 face between MPI and the *runtime environment* of an MPI application. The difficulty is
37 that there is an enormous range of runtime environments and application requirements, and
38 MPI must not be tailored to any particular one. Examples of such environments are:
39

- 40
- 41 • **MPP managed by a batch queueing system.** Batch queueing systems generally
42 allocate resources before an application begins, enforce limits on resource use (CPU
43 time, memory use, etc.), and do not allow a change in resource allocation after a
44 job begins. Moreover, many MPPs have special limitations or extensions, such as a
45 limit on the number of processes that may run on one processor, or the ability to
46 gang-schedule processes of a parallel application.
- 47
- 48

- **Network of workstations with PVM.** PVM (Parallel Virtual Machine) allows a user to create a “virtual machine” out of a network of workstations. An application may extend the virtual machine or manage processes (create, kill, redirect output, etc.) through the PVM library. Requests to manage the machine or processes may be intercepted and handled by an external resource manager.
- **Network of workstations managed by a load balancing system.** A load balancing system may choose the location of spawned processes based on dynamic quantities, such as load average. It may transparently migrate processes from one machine to another when a resource becomes unavailable.
- **Large SMP with Unix.** Applications are run directly by the user. They are scheduled at a low level by the operating system. Processes may have special scheduling characteristics (gang-scheduling, processor affinity, deadline scheduling, processor locking, etc.) and be subject to OS resource limits (number of processes, amount of memory, etc.).

MPI assumes, implicitly, the existence of an environment in which an application runs. It does not provide “operating system” services, such as a general ability to query what processes are running, to kill arbitrary processes, to find out properties of the runtime environment (how many processors, how much memory, etc.).

Complex interaction of an MPI application with its runtime environment should be done through an environment-specific API. An example of such an API would be the PVM task and machine management routines — `pvm_addhosts`, `pvm_config`, `pvm_tasks`, etc., possibly modified to return an MPI (group, rank) when possible. A Condor or PBS API would be another possibility.

At some low level, obviously, MPI must be able to interact with the runtime system, but the interaction is not visible at the application level and the details of the interaction are not specified by the MPI standard.

In many cases, it is impossible to keep environment-specific information out of the MPI interface without seriously compromising MPI functionality. To permit applications to take advantage of environment-specific functionality, many MPI routines take an `info` argument that allows an application to specify environment-specific information. There is a tradeoff between functionality and portability: applications that make use of environment-specific `info` are not portable.

MPI does not require the existence of an underlying “virtual machine” model, in which there is a consistent global view of an MPI application and an implicit “operating system” managing resources and processes. For instance, processes spawned by one task may not be visible to another; additional hosts added to the runtime environment by one process may not be visible in another process; tasks spawned by different processes may not be automatically distributed over available resources.

Interaction between MPI and the runtime environment is limited to the following areas:

- A process may start new processes with `MPI_COMM_SPAWN` and `MPI_COMM_SPAWN_MULTIPLE`.
- When a process spawns a child process, it may optionally use an `info` argument to tell the runtime environment where or how to start the process. This extra information may be opaque to MPI.

- An attribute `MPI_UNIVERSE_SIZE` (See Section 10.5.1) on `MPI_COMM_WORLD` tells a program how “large” the initial runtime environment is, namely how many processes can usefully be started in all. One can subtract the size of `MPI_COMM_WORLD` from this value to find out how many processes might usefully be started in addition to those already running.

10.3 Process Manager Interface

10.3.1 Processes in MPI

A process is represented in MPI by a (group, rank) pair. A (group, rank) pair specifies a unique process but a process does not determine a unique (group, rank) pair, since a process may belong to several groups.

10.3.2 Starting Processes and Establishing Communication

The following routine starts a number of MPI processes and establishes communication with them, returning an intercommunicator.

Advice to users. It is possible in MPI to start a static SPMD or MPMD application by first starting one process and having that process start its siblings with `MPI_COMM_SPAWN`. This practice is discouraged primarily for reasons of performance. If possible, it is preferable to start all processes at once, as a single MPI application. (*End of advice to users.*)

`MPI_COMM_SPAWN(command, argv, maxprocs, info, root, comm, intercomm,
array_of_errcodes)`

IN	command	name of program to be spawned (string, significant only at root)
IN	argv	arguments to <code>command</code> (array of strings, significant only at root)
IN	maxprocs	maximum number of processes to start (integer, significant only at root)
IN	info	a set of key-value pairs telling the runtime system where and how to start the processes (handle, significant only at root)
IN	root	rank of process in which previous arguments are examined (integer)
IN	comm	intracommunicator containing group of spawning processes (handle)
OUT	intercomm	intercommunicator between original group and the newly spawned group (handle)
OUT	array_of_errcodes	one code per process (array of integer)

```

int MPI_Comm_spawn(const char *command, char *argv[], int maxprocs,
                  MPI_Info info, int root, MPI_Comm comm, MPI_Comm *intercomm,
                  int array_of_errcodes[])
MPI_Comm_spawn(command, argv, maxprocs, info, root, comm, intercomm,
              array_of_errcodes, ierror)
CHARACTER(LEN=*), INTENT(IN) :: command, argv(*)
INTEGER, INTENT(IN) :: maxprocs, root
TYPE(MPI_Info), INTENT(IN) :: info
TYPE(MPI_Comm), INTENT(IN) :: comm
TYPE(MPI_Comm), INTENT(OUT) :: intercomm
INTEGER :: array_of_errcodes(*)
INTEGER, OPTIONAL, INTENT(OUT) :: ierror
MPI_COMM_SPAWN(COMMAND, ARGV, MAXPROCS, INFO, ROOT, COMM, INTERCOMM,
              ARRAY_OF_ERRCODES, IERROR)
CHARACTER*(*) COMMAND, ARGV(*)
INTEGER INFO, MAXPROCS, ROOT, COMM, INTERCOMM, ARRAY_OF_ERRCODES(*),
              IERROR

```

MPI_COMM_SPAWN tries to start `maxprocs` identical copies of the MPI program specified by `command`, establishing communication with them and returning an intercommunicator. The spawned processes are referred to as children. The children have their own MPI_COMM_WORLD, which is separate from that of the parents. MPI_COMM_SPAWN is collective over `comm`, and also may not return until MPI_INIT has been called in the children. Similarly, MPI_INIT in the children may not return until all parents have called MPI_COMM_SPAWN. In this sense, MPI_COMM_SPAWN in the parents and MPI_INIT in the children form a collective operation over the union of parent and child processes. The intercommunicator returned by MPI_COMM_SPAWN contains the parent processes in the local group and the child processes in the remote group. The ordering of processes in the local and remote groups is the same as the ordering of the group of the `comm` in the parents and of MPI_COMM_WORLD of the children, respectively. This intercommunicator can be obtained in the children through the function MPI_COMM_GET_PARENT.

Advice to users. An implementation may automatically establish communication before MPI_INIT is called by the children. Thus, completion of MPI_COMM_SPAWN in the parent does not necessarily mean that MPI_INIT has been called in the children (although the returned intercommunicator can be used immediately). (*End of advice to users.*)

The command argument The command argument is a string containing the name of a program to be spawned. The string is null-terminated in C. In Fortran, leading and trailing spaces are stripped. MPI does not specify how to find the executable or how the working directory is determined. These rules are implementation-dependent and should be appropriate for the runtime environment.

Advice to implementors. The implementation should use a natural rule for finding executables and determining working directories. For instance, a homogeneous system with a global file system might look first in the working directory of the spawning

1 process, or might search the directories in a PATH environment variable as do Unix
 2 shells. An implementation on top of PVM would use PVM's rules for finding exe-
 3 cutables (usually in \$HOME/pvm3/bin/\$PVM_ARCH). An MPI implementation running
 4 under POE on an IBM SP would use POE's method of finding executables. An imple-
 5 mentation should document its rules for finding executables and determining working
 6 directories, and a high-quality implementation should give the user some control over
 7 these rules. (*End of advice to implementors.*)
 8

9 If the program named in `command` does not call `MPI_INIT`, but instead forks a process
 10 that calls `MPI_INIT`, the results are undefined. Implementations may allow this case to
 11 work but are not required to.

12
 13 *Advice to users.* MPI does not say what happens if the program you start is a
 14 shell script and that shell script starts a program that calls `MPI_INIT`. Though some
 15 implementations may allow you to do this, they may also have restrictions, such as
 16 requiring that arguments supplied to the shell script be supplied to the program, or
 17 requiring that certain parts of the environment not be changed. (*End of advice to*
 18 *users.*)
 19

20 The `argv` argument `argv` is an array of strings containing arguments that are passed to
 21 the program. The first element of `argv` is the first argument passed to `command`, not, as
 22 is conventional in some contexts, the command itself. The argument list is terminated by
 23 NULL in C and an empty string in Fortran. In Fortran, leading and trailing spaces are
 24 always stripped, so that a string consisting of all spaces is considered an empty string. The
 25 constant `MPI_ARGV_NULL` may be used in C and Fortran to indicate an empty argument
 26 list. In C this constant is the same as NULL.
 27

28 **Example 10.1** Examples of `argv` in C and Fortran

29 To run the program "ocean" with arguments "-gridfile" and "ocean1.grd" in C:

```
30 char command[] = "ocean";
31 char *argv[] = {"-gridfile", "ocean1.grd", NULL};
32 MPI_Comm_spawn(command, argv, ...);
33
```

34 or, if not everything is known at compile time:

```
35
36 char *command;
37 char **argv;
38 command = "ocean";
39 argv=(char **)malloc(3 * sizeof(char *));
40 argv[0] = "-gridfile";
41 argv[1] = "ocean1.grd";
42 argv[2] = NULL;
43 MPI_Comm_spawn(command, argv, ...);
44
```

45 In Fortran:

46
 47
 48

```

CHARACTER*25 command, argv(3)
command = ' ocean '
argv(1) = ' -gridfile '
argv(2) = ' ocean1.grd'
argv(3) = ' '
call MPI_COMM_SPAWN(command, argv, ...)

```

Arguments are supplied to the program if this is allowed by the operating system. In C, the `MPI_COMM_SPAWN` argument `argv` differs from the `argv` argument of `main` in two respects. First, it is shifted by one element. Specifically, `argv[0]` of `main` is provided by the implementation and conventionally contains the name of the program (given by `command`). `argv[1]` of `main` corresponds to `argv[0]` in `MPI_COMM_SPAWN`, `argv[2]` of `main` to `argv[1]` of `MPI_COMM_SPAWN`, etc. Passing an `argv` of `MPI_ARGV_NULL` to `MPI_COMM_SPAWN` results in `main` receiving `argc` of 1 and an `argv` whose element 0 is (conventionally) the name of the program. Second, `argv` of `MPI_COMM_SPAWN` must be null-terminated, so that its length can be determined.

If a Fortran implementation supplies routines that allow a program to obtain its arguments, the arguments may be available through that mechanism. In C, if the operating system does not support arguments appearing in `argv` of `main()`, the MPI implementation may add the arguments to the `argv` that is passed to `MPI_INIT`.

The `maxprocs` argument `MPI` tries to spawn `maxprocs` processes. If it is unable to spawn `maxprocs` processes, it raises an error of class `MPI_ERR_SPAWN`.

An implementation may allow the `info` argument to change the default behavior, such that if the implementation is unable to spawn all `maxprocs` processes, it may spawn a smaller number of processes instead of raising an error. In principle, the `info` argument may specify an arbitrary set $\{m_i : 0 \leq m_i \leq \text{maxprocs}\}$ of allowed values for the number of processes spawned. The set $\{m_i\}$ does not necessarily include the value `maxprocs`. If an implementation is able to spawn one of these allowed numbers of processes, `MPI_COMM_SPAWN` returns successfully and the number of spawned processes, m , is given by the size of the remote group of `intercomm`. If m is less than `maxproc`, reasons why the other processes were not spawned are given in `array_of_errcodes` as described below. If it is not possible to spawn one of the allowed numbers of processes, `MPI_COMM_SPAWN` raises an error of class `MPI_ERR_SPAWN`.

A spawn call with the default behavior is called *hard*. A spawn call for which fewer than `maxprocs` processes may be returned is called *soft*. See Section 10.3.4 for more information on the `soft` key for `info`.

Advice to users. By default, requests are hard and MPI errors are fatal. This means that by default there will be a fatal error if MPI cannot spawn all the requested processes. If you want the behavior “spawn as many processes as possible, up to N ,” you should do a soft spawn, where the set of allowed values $\{m_i\}$ is $\{0 \dots N\}$. However, this is not completely portable, as implementations are not required to support soft spawning. (*End of advice to users.*)

The `info` argument The `info` argument to all of the routines in this chapter is an opaque handle of type `MPI_Info` in C and Fortran with the `mpi_f08` module and `INTEGER` in Fortran with the `mpi` module or the include file `mpif.h`. It is a container for a

number of user-specified (key,value) pairs. key and value are strings (null-terminated `char*` in C, `character*(*)` in Fortran). Routines to create and manipulate the `info` argument are described in Chapter 9.

For the `SPAWN` calls, `info` provides additional (and possibly implementation-dependent) instructions to MPI and the runtime system on how to start processes. An application may pass `MPI_INFO_NULL` in C or Fortran. Portable programs not requiring detailed control over process locations should use `MPI_INFO_NULL`.

MPI does not specify the content of the `info` argument, except to reserve a number of special key values (see Section 10.3.4). The `info` argument is quite flexible and could even be used, for example, to specify the executable and its command-line arguments. In this case the `command` argument to `MPI_COMM_SPAWN` could be empty. The ability to do this follows from the fact that MPI does not specify how an executable is found, and the `info` argument can tell the runtime system where to “find” the executable “” (empty string). Of course a program that does this will not be portable across MPI implementations.

The root argument All arguments before the root argument are examined only on the process whose rank in `comm` is equal to `root`. The value of these arguments on other processes is ignored.

The array_of_errcodes argument The `array_of_errcodes` is an array of length `maxprocs` in which MPI reports the status of each process that MPI was requested to start. If all `maxprocs` processes were spawned, `array_of_errcodes` is filled in with the value `MPI_SUCCESS`. If only m ($0 \leq m < \text{maxprocs}$) processes are spawned, m of the entries will contain `MPI_SUCCESS` and the rest will contain an implementation-specific error code indicating the reason MPI could not start the process. MPI does not specify which entries correspond to failed processes. An implementation may, for instance, fill in error codes in one-to-one correspondence with a detailed specification in the `info` argument. These error codes all belong to the error class `MPI_ERR_SPAWN` if there was no error in the argument list. In C or Fortran, an application may pass `MPI_ERRCODES_IGNORE` if it is not interested in the error codes.

Advice to implementors. `MPI_ERRCODES_IGNORE` in Fortran is a special type of constant, like `MPI_BOTTOM`. See the discussion in Section 2.5.4. (*End of advice to implementors.*)

`MPI_COMM_GET_PARENT(parent)`

OUT parent the parent communicator (handle)

```
int MPI_Comm_get_parent(MPI_Comm *parent)
```

```
MPI_Comm_get_parent(parent, ierror)
    TYPE(MPI_Comm), INTENT(OUT) :: parent
    INTEGER, OPTIONAL, INTENT(OUT) :: ierror
```

```
MPI_COMM_GET_PARENT(PARENT, IERROR)
    INTEGER PARENT, IERROR
```

If a process was started with `MPI_COMM_SPAWN` or `MPI_COMM_SPAWN_MULTIPLE`, `MPI_COMM_GET_PARENT` returns the “parent” intercommunicator of the current process.

This parent intercommunicator is created implicitly inside of `MPI_INIT` and is the same intercommunicator returned by `SPAWN` in the parents.

If the process was not spawned, `MPI_COMM_GET_PARENT` returns `MPI_COMM_NULL`.

After the parent communicator is freed or disconnected, `MPI_COMM_GET_PARENT` returns `MPI_COMM_NULL`.

Advice to users. `MPI_COMM_GET_PARENT` returns a handle to a single intercommunicator. Calling `MPI_COMM_GET_PARENT` a second time returns a handle to the same intercommunicator. Freeing the handle with `MPI_COMM_DISCONNECT` or `MPI_COMM_FREE` will cause other references to the intercommunicator to become invalid (dangling). Note that calling `MPI_COMM_FREE` on the parent communicator is not useful. (*End of advice to users.*)

Rationale. The desire of the Forum was to create a constant `MPI_COMM_PARENT` similar to `MPI_COMM_WORLD`. Unfortunately such a constant cannot be used (syntactically) as an argument to `MPI_COMM_DISCONNECT`, which is explicitly allowed. (*End of rationale.*)

10.3.3 Starting Multiple Executables and Establishing Communication

While `MPI_COMM_SPAWN` is sufficient for most cases, it does not allow the spawning of multiple binaries, or of the same binary with multiple sets of arguments. The following routine spawns multiple binaries or the same binary with multiple sets of arguments, establishing communication with them and placing them in the same `MPI_COMM_WORLD`.

```

1 MPI_COMM_SPAWN_MULTIPLE(count, array_of_commands, array_of_argv,
2     array_of_maxprocs, array_of_info, root, comm, intercomm, array_of_errcodes)
3
4     IN     count           number of commands (positive integer, significant to
5                               MPI only at root — see advice to users)
6
7     IN     array_of_commands  programs to be executed (array of strings, significant
8                               only at root)
9
10    IN     array_of_argv      arguments for commands (array of array of strings,
11                               significant only at root)
12
13    IN     array_of_maxprocs   maximum number of processes to start for each com-
14                               mand (array of integer, significant only at root)
15
16    IN     array_of_info      info objects telling the runtime system where and how
17                               to start processes (array of handles, significant only at
18                               root)
19
20    IN     comm               intracommunicator containing group of spawning pro-
21                               cesses (handle)
22
23    OUT    intercomm          intercommunicator between original group and newly
24                               spawned group (handle)
25
26    OUT    array_of_errcodes   one error code per process (array of integer)
27
28 int MPI_Comm_spawn_multiple(int count, char *array_of_commands[],
29     char **array_of_argv[], const int array_of_maxprocs[],
30     const MPI_Info array_of_info[], int root, MPI_Comm comm,
31     MPI_Comm *intercomm, int array_of_errcodes[])
32
33 MPI_Comm_spawn_multiple(count, array_of_commands, array_of_argv,
34     array_of_maxprocs, array_of_info, root, comm, intercomm,
35     array_of_errcodes, ierror)
36
37     INTEGER, INTENT(IN) :: count, array_of_maxprocs(*), root
38     CHARACTER(LEN=*), INTENT(IN) :: array_of_commands(*)
39     CHARACTER(LEN=*), INTENT(IN) :: array_of_argv(count, *)
40     TYPE(MPI_Info), INTENT(IN) :: array_of_info(*)
41     TYPE(MPI_Comm), INTENT(IN) :: comm
42     TYPE(MPI_Comm), INTENT(OUT) :: intercomm
43     INTEGER :: array_of_errcodes(*)
44     INTEGER, OPTIONAL, INTENT(OUT) :: ierror
45
46 MPI_COMM_SPAWN_MULTIPLE(COUNT, ARRAY_OF_COMMANDS, ARRAY_OF_ARGV,
47     ARRAY_OF_MAXPROCS, ARRAY_OF_INFO, ROOT, COMM, INTERCOMM,
48     ARRAY_OF_ERRCODES, IERROR)
49
50     INTEGER COUNT, ARRAY_OF_INFO(*), ARRAY_OF_MAXPROCS(*), ROOT, COMM,
51     INTERCOMM, ARRAY_OF_ERRCODES(*), IERROR
52     CHARACTER*(*) ARRAY_OF_COMMANDS(*), ARRAY_OF_ARGV(COUNT, *)

```

MPI_COMM_SPAWN_MULTIPLE is identical to MPI_COMM_SPAWN except that there are multiple executable specifications. The first argument, `count`, gives the number of specifications. Each of the next four arguments are simply arrays of the corresponding arguments in MPI_COMM_SPAWN. For the Fortran version of `array_of_argv`, the element `array_of_argv(i,j)` is the j -th argument to command number i .

Rationale. This may seem backwards to Fortran programmers who are familiar with Fortran's column-major ordering. However, it is necessary to do it this way to allow MPI_COMM_SPAWN to sort out arguments. Note that the leading dimension of `array_of_argv` *must* be the same as `count`. Also note that Fortran rules for sequence association allow a different value in the first dimension; in this case, the sequence of array elements is interpreted by MPI_COMM_SPAWN_MULTIPLE as if the sequence is stored in an array defined with the first dimension set to `count`. This Fortran feature allows an implementor to define MPI_ARGVS_NULL (see below) with fixed dimensions, e.g., (1,1), or only with one dimension, e.g., (1). (*End of rationale.*)

Advice to users. The argument `count` is interpreted by MPI only at the root, as is `array_of_argv`. Since the leading dimension of `array_of_argv` is `count`, a non-positive value of `count` at a non-root node could theoretically cause a runtime bounds check error, even though `array_of_argv` should be ignored by the subroutine. If this happens, you should explicitly supply a reasonable value of `count` on the non-root nodes. (*End of advice to users.*)

In any language, an application may use the constant MPI_ARGVS_NULL (which is likely to be `(char ***)0` in C) to specify that no arguments should be passed to any commands. The effect of setting individual elements of `array_of_argv` to MPI_ARGV_NULL is not defined. To specify arguments for some commands but not others, the commands without arguments should have a corresponding `argv` whose first element is null (`(char *)0` in C and empty string in Fortran). In Fortran at non-root processes, the `count` argument must be set to a value that is consistent with the provided `array_of_argv` although the content of these arguments has no meaning for this operation.

All of the spawned processes have the same MPI_COMM_WORLD. Their ranks in MPI_COMM_WORLD correspond directly to the order in which the commands are specified in MPI_COMM_SPAWN_MULTIPLE. Assume that m_1 processes are generated by the first command, m_2 by the second, etc. The processes corresponding to the first command have ranks $0, 1, \dots, m_1 - 1$. The processes in the second command have ranks $m_1, m_1 + 1, \dots, m_1 + m_2 - 1$. The processes in the third have ranks $m_1 + m_2, m_1 + m_2 + 1, \dots, m_1 + m_2 + m_3 - 1$, etc.

Advice to users. Calling MPI_COMM_SPAWN multiple times would create many sets of children with different MPI_COMM_WORLDS whereas MPI_COMM_SPAWN_MULTIPLE creates children with a single MPI_COMM_WORLD, so the two methods are not completely equivalent. There are also two performance-related reasons why, if you need to spawn multiple executables, you may want to use MPI_COMM_SPAWN_MULTIPLE instead of calling MPI_COMM_SPAWN several times. First, spawning several things at once may be faster than spawning them sequentially. Second, in some implementations, communication between processes spawned at the same time may be faster than communication between processes spawned separately. (*End of advice to users.*)

The `array_of_errcodes` argument is a 1-dimensional array of size $\sum_{i=1}^{count} n_i$, where n_i is the i -th element of `array_of_maxprocs`. Command number i corresponds to the n_i contiguous slots in this array from element $\sum_{j=1}^{i-1} n_j$ to $[\sum_{j=1}^i n_j] - 1$. Error codes are treated as for `MPI_COMM_SPAWN`.

Example 10.2 Examples of `array_of_argv` in C and Fortran

To run the program “ocean” with arguments “-gridfile” and “ocean1.grd” and the program “atmos” with argument “atmos.grd” in C:

```

char *array_of_commands[2] = {"ocean", "atmos"};
char **array_of_argv[2];
char *argv0[] = {"-gridfile", "ocean1.grd", (char *)0};
char *argv1[] = {"atmos.grd", (char *)0};
array_of_argv[0] = argv0;
array_of_argv[1] = argv1;
MPI_Comm_spawn_multiple(2, array_of_commands, array_of_argv, ...);

```

Here is how you do it in Fortran:

```

CHARACTER*25 commands(2), array_of_argv(2, 3)
commands(1) = ' ocean '
array_of_argv(1, 1) = ' -gridfile '
array_of_argv(1, 2) = ' ocean1.grd'
array_of_argv(1, 3) = ' '

commands(2) = ' atmos '
array_of_argv(2, 1) = ' atmos.grd '
array_of_argv(2, 2) = ' '

call MPI_COMM_SPAWN_MULTIPLE(2, commands, array_of_argv, ...)

```

10.3.4 Reserved Keys

The following keys are reserved. An implementation is not required to interpret these keys, but if it does interpret the key, it must provide the functionality described.

host Value is a hostname. The format of the hostname is determined by the implementation.

arch Value is an architecture name. Valid architecture names and what they mean are determined by the implementation.

wdir Value is the name of a directory on a machine on which the spawned process(es) execute(s). This directory is made the working directory of the executing process(es). The format of the directory name is determined by the implementation.

path Value is a directory or set of directories where the implementation should look for the executable. The format of `path` is determined by the implementation.

file Value is the name of a file in which additional information is specified. The format of the filename and internal format of the file are determined by the implementation.

soft Value specifies a set of numbers which are allowed values for the number of processes that MPI_COMM_SPAWN (et al.) may create. The format of the value is a comma-separated list of Fortran-90 triplets each of which specifies a set of integers and which together specify the set formed by the union of these sets. Negative values in this set and values greater than maxprocs are ignored. MPI will spawn the largest number of processes it can, consistent with some number in the set. The order in which triplets are given is not significant.

By Fortran-90 triplets, we mean:

1. a means a
2. $a:b$ means $a, a + 1, a + 2, \dots, b$
3. $a:b:c$ means $a, a + c, a + 2c, \dots, a + ck$, where for $c > 0$, k is the largest integer for which $a + ck \leq b$ and for $c < 0$, k is the largest integer for which $a + ck \geq b$. If $b > a$ then c must be positive. If $b < a$ then c must be negative.

Examples:

1. $a:b$ gives a range between a and b
2. $0:N$ gives full “soft” functionality
3. $1,2,4,8,16,32,64,128,256,512,1024,2048,4096$ allows a power-of-two number of processes.
4. $2:10000:2$ allows an even number of processes.
5. $2:10:2,7$ allows 2, 4, 6, 7, 8, or 10 processes.

10.3.5 Spawn Example

Manager-worker Example Using MPI_COMM_SPAWN

```

/* manager */
#include "mpi.h"
int main(int argc, char *argv[])
{
    int world_size, universe_size, *universe_sizep, flag;
    MPI_Comm everyone;          /* intercommunicator */
    char worker_program[100];

    MPI_Init(&argc, &argv);
    MPI_Comm_size(MPI_COMM_WORLD, &world_size);

    if (world_size != 1)    error("Top heavy with management");

    MPI_Comm_get_attr(MPI_COMM_WORLD, MPI_UNIVERSE_SIZE,
                      &universe_sizep, &flag);
    if (!flag) {
        printf("This MPI does not support UNIVERSE_SIZE. How many\n\
processes total?");
        scanf("%d", &universe_size);
    } else universe_size = *universe_sizep;

```

```
1  if (universe_size == 1) error("No room to start workers");
2
3  /*
4   * Now spawn the workers. Note that there is a run-time determination
5   * of what type of worker to spawn, and presumably this calculation must
6   * be done at run time and cannot be calculated before starting
7   * the program. If everything is known when the application is
8   * first started, it is generally better to start them all at once
9   * in a single MPI_COMM_WORLD.
10  */
11
12  choose_worker_program(worker_program);
13  MPI_Comm_spawn(worker_program, MPI_ARGV_NULL, universe_size-1,
14                MPI_INFO_NULL, 0, MPI_COMM_SELF, &everyone,
15                MPI_ERRCODES_IGNORE);
16  /*
17   * Parallel code here. The communicator "everyone" can be used
18   * to communicate with the spawned processes, which have ranks 0,..
19   * MPI_UNIVERSE_SIZE-1 in the remote group of the intercommunicator
20   * "everyone".
21  */
22
23  MPI_Finalize();
24  return 0;
25 }
26
27 /* worker */
28
29 #include "mpi.h"
30 int main(int argc, char *argv[])
31 {
32     int size;
33     MPI_Comm parent;
34     MPI_Init(&argc, &argv);
35     MPI_Comm_get_parent(&parent);
36     if (parent == MPI_COMM_NULL) error("No parent!");
37     MPI_Comm_remote_size(parent, &size);
38     if (size != 1) error("Something's wrong with the parent");
39
40     /*
41      * Parallel code here.
42      * The manager is represented as the process with rank 0 in (the remote
43      * group of) the parent communicator. If the workers need to communicate
44      * among themselves, they can use MPI_COMM_WORLD.
45     */
46
47     MPI_Finalize();
48     return 0;
```

}

10.4 Establishing Communication

This section provides functions that establish communication between two sets of MPI processes that do not share a communicator.

Some situations in which these functions are useful are:

1. Two parts of an application that are started independently need to communicate.
2. A visualization tool wants to attach to a running process.
3. A server wants to accept connections from multiple clients. Both clients and server may be parallel programs.

In each of these situations, MPI must establish communication channels where none existed before, and there is no parent/child relationship. The routines described in this section establish communication between the two sets of processes by creating an MPI intercommunicator, where the two groups of the intercommunicator are the original sets of processes.

Establishing contact between two groups of processes that do not share an existing communicator is a collective but asymmetric process. One group of processes indicates its willingness to accept connections from other groups of processes. We will call this group the (parallel) *server*, even if this is not a client/server type of application. The other group connects to the server; we will call it the *client*.

Advice to users. While the names *client* and *server* are used throughout this section, MPI does not guarantee the traditional robustness of client/server systems. The functionality described in this section is intended to allow two cooperating parts of the same application to communicate with one another. For instance, a client that gets a segmentation fault and dies, or one that does not participate in a collective operation may cause a server to crash or hang. (*End of advice to users.*)

10.4.1 Names, Addresses, Ports, and All That

Almost all of the complexity in MPI client/server routines addresses the question “how does the client find out how to contact the server?” The difficulty, of course, is that there is no existing communication channel between them, yet they must somehow agree on a rendezvous point where they will establish communication.

Agreeing on a rendezvous point always involves a third party. The third party may itself provide the rendezvous point or may communicate rendezvous information from server to client. Complicating matters might be the fact that a client does not really care what server it contacts, only that it be able to get in touch with one that can handle its request.

Ideally, MPI can accommodate a wide variety of run-time systems while retaining the ability to write simple, portable code. The following should be compatible with MPI:

- The server resides at a well-known internet address host:port.
- The server prints out an address to the terminal; the user gives this address to the client program.

- 1 • The server places the address information on a nameserver, where it can be retrieved
- 2 with an agreed-upon name.
- 3
- 4 • The server to which the client connects is actually a broker, acting as a middleman
- 5 between the client and the real server.

6
7 MPI does not require a nameserver, so not all implementations will be able to support
8 all of the above scenarios. However, MPI provides an optional nameserver interface, and is
9 compatible with external name servers.

10 A `port_name` is a *system-supplied* string that encodes a low-level network address at
11 which a server can be contacted. Typically this is an IP address and a port number, but
12 an implementation is free to use any protocol. The server establishes a `port_name` with
13 the `MPI_OPEN_PORT` routine. It accepts a connection to a given port with
14 `MPI_COMM_ACCEPT`. A client uses `port_name` to connect to the server.

15 By itself, the `port_name` mechanism is completely portable, but it may be clumsy
16 to use because of the necessity to communicate `port_name` to the client. It would be more
17 convenient if a server could specify that it be known by an *application-supplied* `service_name`
18 so that the client could connect to that `service_name` without knowing the `port_name`.

19 An MPI implementation may allow the server to publish a (`port_name`, `service_name`)
20 pair with `MPI_PUBLISH_NAME` and the client to retrieve the port name from the service
21 name with `MPI_LOOKUP_NAME`. This allows three levels of portability, with increasing
22 levels of functionality.

- 23 1. Applications that do not rely on the ability to publish names are the most portable.
24 Typically the `port_name` must be transferred “by hand” from server to client.
- 25
- 26 2. Applications that use the `MPI_PUBLISH_NAME` mechanism are completely portable
27 among implementations that provide this service. To be portable among all imple-
28 mentations, these applications should have a fall-back mechanism that can be used
29 when names are not published.
- 30 3. Applications may ignore MPI’s name publishing functionality and use their own mech-
31 anism (possibly system-supplied) to publish names. This allows arbitrary flexibility
32 but is not portable.
- 33

34 10.4.2 Server Routines

35
36 A server makes itself available with two routines. First it must call `MPI_OPEN_PORT` to
37 establish a port at which it may be contacted. Secondly it must call `MPI_COMM_ACCEPT`
38 to accept connections from clients.

39
40 `MPI_OPEN_PORT`(`info`, `port_name`)

42 IN	<code>info</code>	implementation-specific information on how to estab-
		lish an address (handle)
44 OUT	<code>port_name</code>	newly established port (string)

46 `int MPI_Open_port(MPI_Info info, char *port_name)`

47
48 `MPI_Open_port`(`info`, `port_name`, `ierror`)

```

TYPE(MPI_Info), INTENT(IN) :: info
CHARACTER(LEN=MPI_MAX_PORT_NAME), INTENT(OUT) :: port_name
INTEGER, OPTIONAL, INTENT(OUT) :: ierror
MPI_OPEN_PORT(INFO, PORT_NAME, IERROR)
CHARACTER*(*) PORT_NAME
INTEGER INFO, IERROR

```

This function establishes a network address, encoded in the `port_name` string, at which the server will be able to accept connections from clients. `port_name` is supplied by the system, possibly using information in the `info` argument.

MPI copies a system-supplied port name into `port_name`. `port_name` identifies the newly opened port and can be used by a client to contact the server. The maximum size string that may be supplied by the system is `MPI_MAX_PORT_NAME`.

Advice to users. The system copies the port name into `port_name`. The application must pass a buffer of sufficient size to hold this value. (*End of advice to users.*)

`port_name` is essentially a network address. It is unique within the communication universe to which it belongs (determined by the implementation), and may be used by any client within that communication universe. For instance, if it is an internet (host:port) address, it will be unique on the internet. If it is a low level switch address on an IBM SP, it will be unique to that SP.

Advice to implementors. These examples are not meant to constrain implementations. A `port_name` could, for instance, contain a user name or the name of a batch job, as long as it is unique within some well-defined communication domain. The larger the communication domain, the more useful MPI's client/server functionality will be. (*End of advice to implementors.*)

The precise form of the address is implementation-defined. For instance, an internet address may be a host name or IP address, or anything that the implementation can decode into an IP address. A port name may be reused after it is freed with `MPI_CLOSE_PORT` and released by the system.

Advice to implementors. Since the user may type in `port_name` by hand, it is useful to choose a form that is easily readable and does not have embedded spaces. (*End of advice to implementors.*)

`info` may be used to tell the implementation how to establish the address. It may, and usually will, be `MPI_INFO_NULL` in order to get the implementation defaults.

```

MPI_CLOSE_PORT(port_name)
IN          port_name          a port (string)
int MPI_Close_port(const char *port_name)
MPI_Close_port(port_name, ierror)
CHARACTER(LEN=*), INTENT(IN) :: port_name
INTEGER, OPTIONAL, INTENT(OUT) :: ierror

```

```

1 MPI_CLOSE_PORT(PORT_NAME, IERROR)
2     CHARACTER*(*) PORT_NAME
3     INTEGER IERROR

```

This function releases the network address represented by `port_name`.

```

7 MPI_COMM_ACCEPT(port_name, info, root, comm, newcomm)
8
9     IN     port_name           port name (string, used only on root)
10    IN     info                implementation-dependent information (handle, used
11                                only on root)
12    IN     root                rank in comm of root node (integer)
13    IN     comm                intracommunicator over which call is collective (han-
14                                dle)
15
16    OUT    newcomm             intercommunicator with client as remote group (han-
17                                dle)

```

```

19 int MPI_Comm_accept(const char *port_name, MPI_Info info, int root,
20                    MPI_Comm comm, MPI_Comm *newcomm)

```

```

21
22 MPI_Comm_accept(port_name, info, root, comm, newcomm, ierror)
23     CHARACTER(LEN=*), INTENT(IN) :: port_name
24     TYPE(MPI_Info), INTENT(IN) :: info
25     INTEGER, INTENT(IN) :: root
26     TYPE(MPI_Comm), INTENT(IN) :: comm
27     TYPE(MPI_Comm), INTENT(OUT) :: newcomm
28     INTEGER, OPTIONAL, INTENT(OUT) :: ierror

```

```

29 MPI_COMM_ACCEPT(PORT_NAME, INFO, ROOT, COMM, NEWCOMM, IERROR)
30     CHARACTER*(*) PORT_NAME
31     INTEGER INFO, ROOT, COMM, NEWCOMM, IERROR

```

`MPI_COMM_ACCEPT` establishes communication with a client. It is collective over the calling communicator. It returns an intercommunicator that allows communication with the client.

The `port_name` must have been established through a call to `MPI_OPEN_PORT`.

`info` can be used to provide directives that may influence the behavior of the `ACCEPT` call.

10.4.3 Client Routines

There is only one routine on the client side.

```

MPI_COMM_CONNECT(port_name, info, root, comm, newcomm) 1
    IN      port_name      network address (string, used only on root) 2
    IN      info           implementation-dependent information (handle, used 3
                        only on root) 4
    IN      root           rank in comm of root node (integer) 5
    IN      comm           intracommunicator over which call is collective (han- 6
                        dle) 7
    OUT     newcomm        intercommunicator with server as remote group (han- 8
                        dle) 9
                                10
                                11
                                12
int MPI_Comm_connect(const char *port_name, MPI_Info info, int root, 13
                    MPI_Comm comm, MPI_Comm *newcomm) 14
MPI_Comm_connect(port_name, info, root, comm, newcomm, ierror) 15
    CHARACTER(LEN=*) , INTENT(IN) :: port_name 16
    TYPE(MPI_Info) , INTENT(IN) :: info 17
    INTEGER , INTENT(IN) :: root 18
    TYPE(MPI_Comm) , INTENT(IN) :: comm 19
    TYPE(MPI_Comm) , INTENT(OUT) :: newcomm 20
    INTEGER , OPTIONAL , INTENT(OUT) :: ierror 21
                                22
MPI_COMM_CONNECT(PORT_NAME, INFO, ROOT, COMM, NEWCOMM, IERROR) 23
    CHARACTER*(*) PORT_NAME 24
    INTEGER INFO, ROOT, COMM, NEWCOMM, IERROR 25
                                26

```

This routine establishes communication with a server specified by `port_name`. It is collective over the calling communicator and returns an intercommunicator in which the remote group participated in an `MPI_COMM_ACCEPT`.

If the named port does not exist (or has been closed), `MPI_COMM_CONNECT` raises an error of class `MPI_ERR_PORT`.

If the port exists, but does not have a pending `MPI_COMM_ACCEPT`, the connection attempt will eventually time out after an implementation-defined time, or succeed when the server calls `MPI_COMM_ACCEPT`. In the case of a time out, `MPI_COMM_CONNECT` raises an error of class `MPI_ERR_PORT`.

Advice to implementors. The time out period may be arbitrarily short or long. However, a high-quality implementation will try to queue connection attempts so that a server can handle simultaneous requests from several clients. A high-quality implementation may also provide a mechanism, through the `info` arguments to `MPI_OPEN_PORT`, `MPI_COMM_ACCEPT`, and/or `MPI_COMM_CONNECT`, for the user to control timeout and queuing behavior. (*End of advice to implementors.*)

MPI provides no guarantee of fairness in servicing connection attempts. That is, connection attempts are not necessarily satisfied in the order they were initiated and competition from other connection attempts may prevent a particular connection attempt from being satisfied.

`port_name` is the address of the server. It must be the same as the name returned by `MPI_OPEN_PORT` on the server. Some freedom is allowed here. If there are equivalent

forms of `port_name`, an implementation may accept them as well. For instance, if `port_name` is `(hostname:port)`, an implementation may accept `(ip_address:port)` as well.

10.4.4 Name Publishing

The routines in this section provide a mechanism for publishing names. A `(service_name, port_name)` pair is published by the server, and may be retrieved by a client using the `service_name` only. An MPI implementation defines the *scope* of the `service_name`, that is, the domain over which the `service_name` can be retrieved. If the domain is the empty set, that is, if no client can retrieve the information, then we say that name publishing is not supported. Implementations should document how the scope is determined. High-quality implementations will give some control to users through the `info` arguments to name publishing functions. Examples are given in the descriptions of individual functions.

```
MPI_PUBLISH_NAME(service_name, info, port_name)
```

IN	<code>service_name</code>	a service name to associate with the port (string)
IN	<code>info</code>	implementation-specific information (handle)
IN	<code>port_name</code>	a port name (string)

```
int MPI_Publish_name(const char *service_name, MPI_Info info,
                    const char *port_name)
```

```
MPI_Publish_name(service_name, info, port_name, ierror)
    TYPE(MPI_Info), INTENT(IN) :: info
    CHARACTER(LEN=*), INTENT(IN) :: service_name, port_name
    INTEGER, OPTIONAL, INTENT(OUT) :: ierror
```

```
MPI_PUBLISH_NAME(SERVICE_NAME, INFO, PORT_NAME, IERROR)
    INTEGER INFO, IERROR
    CHARACTER*(*) SERVICE_NAME, PORT_NAME
```

This routine publishes the pair `(port_name, service_name)` so that an application may retrieve a system-supplied `port_name` using a well-known `service_name`.

The implementation must define the *scope* of a published service name, that is, the domain over which the service name is unique, and conversely, the domain over which the `(port name, service name)` pair may be retrieved. For instance, a service name may be unique to a job (where job is defined by a distributed operating system or batch scheduler), unique to a machine, or unique to a Kerberos realm. The scope may depend on the `info` argument to `MPI_PUBLISH_NAME`.

MPI permits publishing more than one `service_name` for a single `port_name`. On the other hand, if `service_name` has already been published within the scope determined by `info`, the behavior of `MPI_PUBLISH_NAME` is undefined. An MPI implementation may, through a mechanism in the `info` argument to `MPI_PUBLISH_NAME`, provide a way to allow multiple servers with the same service in the same scope. In this case, an implementation-defined policy will determine which of several port names is returned by `MPI_LOOKUP_NAME`.

Note that while `service_name` has a limited scope, determined by the implementation, `port_name` always has global scope within the communication universe used by the imple-

mentation (i.e., it is globally unique).

`port_name` should be the name of a port established by `MPI_OPEN_PORT` and not yet released by `MPI_CLOSE_PORT`. If it is not, the result is undefined.

Advice to implementors. In some cases, an MPI implementation may use a name service that a user can also access directly. In this case, a name published by MPI could easily conflict with a name published by a user. In order to avoid such conflicts, MPI implementations should mangle service names so that they are unlikely to conflict with user code that makes use of the same service. Such name mangling will of course be completely transparent to the user.

The following situation is problematic but unavoidable, if we want to allow implementations to use nameservers. Suppose there are multiple instances of “ocean” running on a machine. If the scope of a service name is confined to a job, then multiple oceans can coexist. If an implementation provides site-wide scope, however, multiple instances are not possible as all calls to `MPI_PUBLISH_NAME` after the first may fail. There is no universal solution to this.

To handle these situations, a high-quality implementation should make it possible to limit the domain over which names are published. (*End of advice to implementors.*)

```
MPI_UNPUBLISH_NAME(service_name, info, port_name)
```

IN	<code>service_name</code>	a service name (string)
IN	<code>info</code>	implementation-specific information (handle)
IN	<code>port_name</code>	a port name (string)

```
int MPI_Unpublish_name(const char *service_name, MPI_Info info,
                      const char *port_name)
```

```
MPI_Unpublish_name(service_name, info, port_name, ierror)
  CHARACTER(LEN=*) , INTENT(IN) :: service_name, port_name
  TYPE(MPI_Info) , INTENT(IN) :: info
  INTEGER, OPTIONAL, INTENT(OUT) :: ierror
```

```
MPI_UNPUBLISH_NAME(SERVICE_NAME, INFO, PORT_NAME, IERROR)
  INTEGER INFO, IERROR
  CHARACTER*(*) SERVICE_NAME, PORT_NAME
```

This routine unpublishes a service name that has been previously published. Attempting to unpublish a name that has not been published or has already been unpublished is erroneous and is indicated by the error class `MPI_ERR_SERVICE`.

All published names must be unpublished before the corresponding port is closed and before the publishing process exits. The behavior of `MPI_UNPUBLISH_NAME` is implementation dependent when a process tries to unpublish a name that it did not publish.

If the `info` argument was used with `MPI_PUBLISH_NAME` to tell the implementation how to publish names, the implementation may require that `info` passed to `MPI_UNPUBLISH_NAME` contain information to tell the implementation how to unpublish a name.

```

1 MPI_LOOKUP_NAME(service_name, info, port_name)
2     IN      service_name      a service name (string)
3
4     IN      info              implementation-specific information (handle)
5
6     OUT     port_name         a port name (string)

```

```

7 int MPI_Lookup_name(const char *service_name, MPI_Info info,
8                   char *port_name)
9

```

```

10 MPI_Lookup_name(service_name, info, port_name, ierror)
11     CHARACTER(LEN=*), INTENT(IN) :: service_name
12     TYPE(MPI_Info), INTENT(IN) :: info
13     CHARACTER(LEN=MPI_MAX_PORT_NAME), INTENT(OUT) :: port_name
14     INTEGER, OPTIONAL, INTENT(OUT) :: ierror

```

```

15 MPI_LOOKUP_NAME(SERVICE_NAME, INFO, PORT_NAME, IERROR)
16     CHARACTER*(*) SERVICE_NAME, PORT_NAME
17     INTEGER INFO, IERROR
18

```

This function retrieves a `port_name` published by `MPI_PUBLISH_NAME` with `service_name`. If `service_name` has not been published, it raises an error in the error class `MPI_ERR_NAME`. The application must supply a `port_name` buffer large enough to hold the largest possible port name (see discussion above under `MPI_OPEN_PORT`).

If an implementation allows multiple entries with the same `service_name` within the same scope, a particular `port_name` is chosen in a way determined by the implementation.

If the `info` argument was used with `MPI_PUBLISH_NAME` to tell the implementation how to publish names, a similar `info` argument may be required for `MPI_LOOKUP_NAME`.

10.4.5 Reserved Key Values

The following key values are reserved. An implementation is not required to interpret these key values, but if it does interpret the key value, it must provide the functionality described.

`ip_port` Value contains IP port number at which to establish a `port`. (Reserved for `MPI_OPEN_PORT` only).

`ip_address` Value contains IP address at which to establish a `port`. If the address is not a valid IP address of the host on which the `MPI_OPEN_PORT` call is made, the results are undefined. (Reserved for `MPI_OPEN_PORT` only).

10.4.6 Client/Server Examples

Simplest Example — Completely Portable.

The following example shows the simplest way to use the client/server interface. It does not use service names at all.

On the server side:

```

47     char myport[MPI_MAX_PORT_NAME];
48     MPI_Comm intercomm;

```

```

/* ... */
MPI_Open_port(MPI_INFO_NULL, myport);
printf("port name is: %s\n", myport);

MPI_Comm_accept(myport, MPI_INFO_NULL, 0, MPI_COMM_SELF, &intercomm);
/* do something with intercomm */

```

The server prints out the port name to the terminal and the user must type it in when starting up the client (assuming the MPI implementation supports stdin such that this works). On the client side:

```

MPI_Comm intercomm;
char name[MPI_MAX_PORT_NAME];
printf("enter port name: ");
gets(name);
MPI_Comm_connect(name, MPI_INFO_NULL, 0, MPI_COMM_SELF, &intercomm);

```

Ocean/Atmosphere — Relies on Name Publishing

In this example, the “ocean” application is the “server” side of a coupled ocean-atmosphere climate model. It assumes that the MPI implementation publishes names.

```

MPI_Open_port(MPI_INFO_NULL, port_name);
MPI_Publish_name("ocean", MPI_INFO_NULL, port_name);

MPI_Comm_accept(port_name, MPI_INFO_NULL, 0, MPI_COMM_SELF, &intercomm);
/* do something with intercomm */
MPI_Unpublish_name("ocean", MPI_INFO_NULL, port_name);

```

On the client side:

```

MPI_Lookup_name("ocean", MPI_INFO_NULL, port_name);
MPI_Comm_connect(port_name, MPI_INFO_NULL, 0, MPI_COMM_SELF,
                 &intercomm);

```

Simple Client-Server Example

This is a simple example; the server accepts only a single connection at a time and serves that connection until the client requests to be disconnected. The server is a single process.

Here is the server. It accepts a single connection and then processes data until it receives a message with tag 1. A message with tag 0 tells the server to exit.

```

#include "mpi.h"
int main(int argc, char *argv[])
{
    MPI_Comm client;
    MPI_Status status;
    char port_name[MPI_MAX_PORT_NAME];

```

```

1   double buf[MAX_DATA];
2   int    size, again;
3
4   MPI_Init(&argc, &argv);
5   MPI_Comm_size(MPI_COMM_WORLD, &size);
6   if (size != 1) error(FATAL, "Server too big");
7   MPI_Open_port(MPI_INFO_NULL, port_name);
8   printf("server available at %s\n", port_name);
9   while (1) {
10      MPI_Comm_accept(port_name, MPI_INFO_NULL, 0, MPI_COMM_WORLD,
11                      &client);
12      again = 1;
13      while (again) {
14          MPI_Recv(buf, MAX_DATA, MPI_DOUBLE,
15                  MPI_ANY_SOURCE, MPI_ANY_TAG, client, &status);
16          switch (status.MPI_TAG) {
17              case 0: MPI_Comm_free(&client);
18                      MPI_Close_port(port_name);
19                      MPI_Finalize();
20                      return 0;
21              case 1: MPI_Comm_disconnect(&client);
22                      again = 0;
23                      break;
24              case 2: /* do something */
25                      ...
26              default:
27                      /* Unexpected message type */
28                      MPI_Abort(MPI_COMM_WORLD, 1);
29          }
30      }
31  }
32 }
33
34 Here is the client.
35
36 #include "mpi.h"
37 int main( int argc, char **argv )
38 {
39     MPI_Comm server;
40     double buf[MAX_DATA];
41     char port_name[MPI_MAX_PORT_NAME];
42
43     MPI_Init( &argc, &argv );
44     strcpy( port_name, argv[1] );/* assume server's name is cmd-line arg */
45
46     MPI_Comm_connect( port_name, MPI_INFO_NULL, 0, MPI_COMM_WORLD,
47                      &server );
48

```

```

while (!done) {
    tag = 2; /* Action to perform */
    MPI_Send( buf, n, MPI_DOUBLE, 0, tag, server );
    /* etc */
}
MPI_Send( buf, 0, MPI_DOUBLE, 0, 1, server );
MPI_Comm_disconnect( &server );
MPI_Finalize();
return 0;
}

```

10.5 Other Functionality

10.5.1 Universe Size

Many “dynamic” MPI applications are expected to exist in a static runtime environment, in which resources have been allocated before the application is run. When a user (or possibly a batch system) runs one of these quasi-static applications, she will usually specify a number of processes to start and a total number of processes that are expected. An application simply needs to know how many slots there are, i.e., how many processes it should spawn.

MPI provides an attribute on `MPI_COMM_WORLD`, `MPI_UNIVERSE_SIZE`, that allows the application to obtain this information in a portable manner. This attribute indicates the total number of processes that are expected. In Fortran, the attribute is the integer value. In C, the attribute is a pointer to the integer value. An application typically subtracts the size of `MPI_COMM_WORLD` from `MPI_UNIVERSE_SIZE` to find out how many processes it should spawn. `MPI_UNIVERSE_SIZE` is initialized in `MPI_INIT` and is not changed by MPI. If defined, it has the same value on all processes of `MPI_COMM_WORLD`. `MPI_UNIVERSE_SIZE` is determined by the application startup mechanism in a way not specified by MPI. (The size of `MPI_COMM_WORLD` is another example of such a parameter.)

Possibilities for how `MPI_UNIVERSE_SIZE` might be set include

- A `-universe_size` argument to a program that starts MPI processes.
- Automatic interaction with a batch scheduler to figure out how many processors have been allocated to an application.
- An environment variable set by the user.
- Extra information passed to `MPI_COMM_SPAWN` through the `info` argument.

An implementation must document how `MPI_UNIVERSE_SIZE` is set. An implementation may not support the ability to set `MPI_UNIVERSE_SIZE`, in which case the attribute `MPI_UNIVERSE_SIZE` is not set.

`MPI_UNIVERSE_SIZE` is a recommendation, not necessarily a hard limit. For instance, some implementations may allow an application to spawn 50 processes per processor, if they are requested. However, it is likely that the user only wants to spawn one process per processor.

`MPI_UNIVERSE_SIZE` is assumed to have been specified when an application was started, and is in essence a portable mechanism to allow the user to pass to the application (through

1 the MPI process startup mechanism, such as `mpiexec`) a piece of critical runtime informa-
2 tion. Note that no interaction with the runtime environment is required. If the runtime
3 environment changes size while an application is running, `MPI_UNIVERSE_SIZE` is not up-
4 dated, and the application must find out about the change through direct communication
5 with the runtime system.

7 10.5.2 Singleton `MPI_INIT`

8
9 A high-quality implementation will allow any process (including those not started with a
10 “parallel application” mechanism) to become an MPI process by calling `MPI_INIT`. Such
11 a process can then connect to other MPI processes using the `MPI_COMM_ACCEPT` and
12 `MPI_COMM_CONNECT` routines, or spawn other MPI processes. MPI does not mandate
13 this behavior, but strongly encourages it where technically feasible.

14
15 *Advice to implementors.* To start MPI processes belonging to the same
16 `MPI_COMM_WORLD` requires some special coordination. The processes must be started
17 at the “same” time, they must have a mechanism to establish communication, etc.
18 Either the user or the operating system must take special steps beyond simply starting
19 processes.

20 When an application enters `MPI_INIT`, clearly it must be able to determine if these
21 special steps were taken. If a process enters `MPI_INIT` and determines that no
22 special steps were taken (i.e., it has not been given the information to form an
23 `MPI_COMM_WORLD` with other processes) it succeeds and forms a singleton MPI pro-
24 gram, that is, one in which `MPI_COMM_WORLD` has size 1.

25 In some implementations, MPI may not be able to function without an “MPI environ-
26 ment.” For example, MPI may require that daemons be running or MPI may not be
27 able to work at all on the front-end of an MPP. In this case, an MPI implementation
28 may either

- 29 1. Create the environment (e.g., start a daemon) or
- 30 2. Raise an error if it cannot create the environment and the environment has not
31 been started independently.

32
33 A high-quality implementation will try to create a singleton MPI process and not raise
34 an error.

35
36 (*End of advice to implementors.*)

37 10.5.3 `MPI_APPNUM`

38
39 There is a predefined attribute `MPI_APPNUM` of `MPI_COMM_WORLD`. In Fortran, the at-
40 tribute is an integer value. In C, the attribute is a pointer to an integer value. If a process
41 was spawned with `MPI_COMM_SPAWN_MULTIPLE`, `MPI_APPNUM` is the command number
42 that generated the current process. Numbering starts from zero. If a process was spawned
43 with `MPI_COMM_SPAWN`, it will have `MPI_APPNUM` equal to zero.

44
45 Additionally, if the process was not started by a spawn call, but by an implementation-
46 specific startup mechanism that can handle multiple process specifications, `MPI_APPNUM`
47 should be set to the number of the corresponding process specification. In particular, if it
48 is started with

```
mpirexec spec0 [: spec1 : spec2 : ...]
```

MPI_APPNUM should be set to the number of the corresponding specification.

If an application was not spawned with MPI_COMM_SPAWN or MPI_COMM_SPAWN_MULTIPLE, and MPI_APPNUM does not make sense in the context of the implementation-specific startup mechanism, MPI_APPNUM is not set.

MPI implementations may optionally provide a mechanism to override the value of MPI_APPNUM through the info argument. MPI reserves the following key for all SPAWN calls.

appnum Value contains an integer that overrides the default value for MPI_APPNUM in the child.

Rationale. When a single application is started, it is able to figure out how many processes there are by looking at the size of MPI_COMM_WORLD. An application consisting of multiple SPMD sub-applications has no way to find out how many sub-applications there are and to which sub-application the process belongs. While there are ways to figure it out in special cases, there is no general mechanism. MPI_APPNUM provides such a general mechanism. (*End of rationale.*)

10.5.4 Releasing Connections

Before a client and server connect, they are independent MPI applications. An error in one does not affect the other. After establishing a connection with MPI_COMM_CONNECT and MPI_COMM_ACCEPT, an error in one may affect the other. It is desirable for a client and server to be able to disconnect, so that an error in one will not affect the other. Similarly, it might be desirable for a parent and child to disconnect, so that errors in the child do not affect the parent, or vice-versa.

- Two processes are **connected** if there is a communication path (direct or indirect) between them. More precisely:
 1. Two processes are connected if
 - (a) they both belong to the same communicator (inter- or intra-, including MPI_COMM_WORLD) *or*
 - (b) they have previously belonged to a communicator that was freed with MPI_COMM_FREE instead of MPI_COMM_DISCONNECT *or*
 - (c) they both belong to the group of the same window or filehandle.
 2. If A is connected to B and B to C, then A is connected to C.
- Two processes are **disconnected** (also **independent**) if they are not connected.
- By the above definitions, connectivity is a transitive property, and divides the universe of MPI processes into disconnected (independent) sets (equivalence classes) of processes.
- Processes which are connected, but do not share the same MPI_COMM_WORLD, may become disconnected (independent) if the communication path between them is broken by using MPI_COMM_DISCONNECT.

The following additional rules apply to MPI routines in other chapters:

- `MPI_FINALIZE` is collective over a set of connected processes.
- `MPI_ABORT` does not abort independent processes. It may abort all processes in the caller's `MPI_COMM_WORLD` (ignoring its `comm` argument). Additionally, it may abort connected processes as well, though it makes a “best attempt” to abort only the processes in `comm`.
- If a process terminates without calling `MPI_FINALIZE`, independent processes are not affected but the effect on connected processes is not defined.

`MPI_COMM_DISCONNECT(comm)`

INOUT `comm` communicator (handle)

```
int MPI_Comm_disconnect(MPI_Comm *comm)
```

```
MPI_Comm_disconnect(comm, ierror)
```

```
  TYPE(MPI_Comm), INTENT(INOUT) :: comm
```

```
  INTEGER, OPTIONAL, INTENT(OUT) :: ierror
```

```
MPI_COMM_DISCONNECT(COMM, IERROR)
```

```
  INTEGER COMM, IERROR
```

This function waits for all pending communication on `comm` to complete internally, deallocates the communicator object, and sets the handle to `MPI_COMM_NULL`. It is a collective operation.

It may not be called with the communicator `MPI_COMM_WORLD` or `MPI_COMM_SELF`.

`MPI_COMM_DISCONNECT` may be called only if all communication is complete and matched, so that buffered data can be delivered to its destination. This requirement is the same as for `MPI_FINALIZE`.

`MPI_COMM_DISCONNECT` has the same action as `MPI_COMM_FREE`, except that it waits for pending communication to finish internally and enables the guarantee about the behavior of disconnected processes.

Advice to users. To disconnect two processes you may need to call `MPI_COMM_DISCONNECT`, `MPI_WIN_FREE`, and `MPI_FILE_CLOSE` to remove all communication paths between the two processes. Note that it may be necessary to disconnect several communicators (or to free several windows or files) before two processes are completely independent. (*End of advice to users.*)

Rationale. It would be nice to be able to use `MPI_COMM_FREE` instead, but that function explicitly does not wait for pending communication to complete. (*End of rationale.*)

10.5.5 Another Way to Establish MPI Communication

```
MPI_COMM_JOIN(fd, intercomm)
```

IN	fd	socket file descriptor
OUT	intercomm	new intercommunicator (handle)

```
int MPI_Comm_join(int fd, MPI_Comm *intercomm)
```

```
MPI_Comm_join(fd, intercomm, ierror)
```

```
    INTEGER, INTENT(IN) :: fd
    TYPE(MPI_Comm), INTENT(OUT) :: intercomm
    INTEGER, OPTIONAL, INTENT(OUT) :: ierror
```

```
MPI_COMM_JOIN(FD, INTERCOMM, IERROR)
```

```
    INTEGER FD, INTERCOMM, IERROR
```

`MPI_COMM_JOIN` is intended for MPI implementations that exist in an environment supporting the Berkeley Socket interface [46, 51]. Implementations that exist in an environment not supporting Berkeley Sockets should provide the entry point for `MPI_COMM_JOIN` and should return `MPI_COMM_NULL`.

This call creates an intercommunicator from the union of two MPI processes which are connected by a socket. `MPI_COMM_JOIN` should normally succeed if the local and remote processes have access to the same implementation-defined MPI communication universe.

Advice to users. An MPI implementation may require a specific communication medium for MPI communication, such as a shared memory segment or a special switch. In this case, it may not be possible for two processes to successfully join even if there is a socket connecting them and they are using the same MPI implementation. (*End of advice to users.*)

Advice to implementors. A high-quality implementation will attempt to establish communication over a slow medium if its preferred one is not available. If implementations do not do this, they must document why they cannot do MPI communication over the medium used by the socket (especially if the socket is a TCP connection). (*End of advice to implementors.*)

`fd` is a file descriptor representing a socket of type `SOCK_STREAM` (a two-way reliable byte-stream connection). Nonblocking I/O and asynchronous notification via `SIGIO` must not be enabled for the socket. The socket must be in a connected state. The socket must be quiescent when `MPI_COMM_JOIN` is called (see below). It is the responsibility of the application to create the socket using standard socket API calls.

`MPI_COMM_JOIN` must be called by the process at each end of the socket. It does not return until both processes have called `MPI_COMM_JOIN`. The two processes are referred to as the local and remote processes.

MPI uses the socket to bootstrap creation of the intercommunicator, and for nothing else. Upon return from `MPI_COMM_JOIN`, the file descriptor will be open and quiescent (see below).

1 If MPI is unable to create an intercommunicator, but is able to leave the socket in its
2 original state, with no pending communication, it succeeds and sets `intercomm` to
3 `MPI_COMM_NULL`.

4 The socket must be quiescent before `MPI_COMM_JOIN` is called and after
5 `MPI_COMM_JOIN` returns. More specifically, on entry to `MPI_COMM_JOIN`, a `read` on the
6 socket will not read any data that was written to the socket before the remote process called
7 `MPI_COMM_JOIN`. On exit from `MPI_COMM_JOIN`, a `read` will not read any data that was
8 written to the socket before the remote process returned from `MPI_COMM_JOIN`. It is the
9 responsibility of the application to ensure the first condition, and the responsibility of the
10 MPI implementation to ensure the second. In a multithreaded application, the application
11 must ensure that one thread does not access the socket while another is calling
12 `MPI_COMM_JOIN`, or call `MPI_COMM_JOIN` concurrently.

13
14 *Advice to implementors.* MPI is free to use any available communication path(s)
15 for MPI messages in the new communicator; the socket is only used for the initial
16 handshaking. (*End of advice to implementors.*)

17
18 `MPI_COMM_JOIN` uses non-MPI communication to do its work. The interaction of
19 non-MPI communication with pending MPI communication is not defined. Therefore, the
20 result of calling `MPI_COMM_JOIN` on two connected processes (see Section 10.5.4 for the
21 definition of connected) is undefined.

22 The returned communicator may be used to establish MPI communication with addi-
23 tional processes, through the usual MPI communicator creation mechanisms.

1
2
3
4
5
6
7
8
9
10
11
12
13
14
15
16
17
18
19
20
21
22
23
24
25
26
27
28
29
30
31
32
33
34
35
36
37
38
39
40
41
42
43
44
45
46
47
48

Chapter 11

One-Sided Communications

11.1 Introduction

Remote Memory Access (RMA) extends the communication mechanisms of MPI by allowing one process to specify all communication parameters, both for the sending side and for the receiving side. This mode of communication facilitates the coding of some applications with dynamically changing data access patterns where the data distribution is fixed or slowly changing. In such a case, each process can compute what data it needs to access or to update at other processes. However, the programmer may not be able to easily determine which data in a process may need to be accessed or to be updated by operations executed by a different process, and may not even know which processes may perform such updates. Thus, the transfer parameters are all available only on one side. Regular send/receive communication requires matching operations by sender and receiver. In order to issue the matching operations, an application needs to distribute the transfer parameters. This distribution may require all processes to participate in a time-consuming global computation, or to poll for potential communication requests to receive and upon which to act periodically. The use of RMA communication mechanisms avoids the need for global computations or explicit polling. A generic example of this nature is the execution of an assignment of the form $A = B(\text{map})$, where `map` is a permutation vector, and `A`, `B`, and `map` are distributed in the same manner.

Message-passing communication achieves two effects: *communication* of data from sender to receiver and *synchronization* of sender with receiver. The RMA design separates these two functions. The following communication calls are provided:

- Remote write: `MPI_PUT`, `MPI_RPUT`
- Remote read: `MPI_GET`, `MPI_RGET`
- Remote update: `MPI_ACCUMULATE`, `MPI_RACCUMULATE`
- Remote read and update: `MPI_GET_ACCUMULATE`, `MPI_RGET_ACCUMULATE`, and `MPI_FETCH_AND_OP`
- Remote atomic swap operations: `MPI_COMPARE_AND_SWAP`

This chapter refers to an operations set that includes all remote update, remote read and update, and remote atomic swap operations as “accumulate” operations.

1 MPI supports two fundamentally different *memory models*: *separate* and *unified*. The
2 separate model makes no assumption about memory consistency and is highly portable.
3 This model is similar to that of weakly coherent memory systems: the user must impose
4 correct ordering of memory accesses through synchronization calls. The unified model can
5 exploit cache-coherent hardware and hardware-accelerated, one-sided operations that are
6 commonly available in high-performance systems. The two different models are discussed
7 in detail in Section 11.4. Both models support several synchronization calls to support
8 different synchronization styles.

9 The design of the RMA functions allows implementors to take advantage of fast or
10 asynchronous communication mechanisms provided by various platforms, such as coherent
11 or noncoherent shared memory, DMA engines, hardware-supported put/get operations, and
12 communication coprocessors. The most frequently used RMA communication mechanisms
13 can be layered on top of message-passing. However, certain RMA functions might need
14 support for asynchronous communication agents in software (handlers, threads, etc.) in a
15 distributed memory environment.

16 We shall denote by **origin** the process that performs the call, and by **target** the
17 process in which the memory is accessed. Thus, in a put operation, source=origin and
18 destination=target; in a get operation, source=target and destination=origin.
19

20 11.2 Initialization

21
22 MPI provides the following window initialization functions: `MPI_WIN_CREATE`,
23 `MPI_WIN_ALLOCATE`, `MPI_WIN_ALLOCATE_SHARED`, and
24 `MPI_WIN_CREATE_DYNAMIC`, which are collective on an intracommunicator.
25 `MPI_WIN_CREATE` allows each process to specify a “window” in its memory that is made
26 accessible to accesses by remote processes. The call returns an opaque object that represents
27 the group of processes that own and access the set of windows, and the attributes of each
28 window, as specified by the initialization call. `MPI_WIN_ALLOCATE` differs from
29 `MPI_WIN_CREATE` in that the user does not pass allocated memory;
30 `MPI_WIN_ALLOCATE` returns a pointer to memory allocated by the MPI implementation.
31 `MPI_WIN_ALLOCATE_SHARED` differs from `MPI_WIN_ALLOCATE` in that the allocated
32 memory can be accessed from all processes in the window’s group with direct load/store
33 instructions. Some restrictions may apply to the specified communicator.
34 `MPI_WIN_CREATE_DYNAMIC` creates a window that allows the user to dynamically control
35 which memory is exposed by the window.
36
37
38
39
40
41
42
43
44
45
46
47
48

11.2.1 Window Creation

```
MPI_WIN_CREATE(base, size, disp_unit, info, comm, win)
```

IN	base	initial address of window (choice)
IN	size	size of window in bytes (non-negative integer)
IN	disp_unit	local unit size for displacements, in bytes (positive integer)
IN	info	info argument (handle)
IN	comm	intra-communicator (handle)
OUT	win	window object returned by the call (handle)

```
int MPI_Win_create(void *base, MPI_Aint size, int disp_unit, MPI_Info info,
                  MPI_Comm comm, MPI_Win *win)
```

```
MPI_Win_create(base, size, disp_unit, info, comm, win, ierror)
```

```
TYPE(*), DIMENSION(..), ASYNCHRONOUS :: base
INTEGER(KIND=MPI_ADDRESS_KIND), INTENT(IN) :: size
INTEGER, INTENT(IN) :: disp_unit
TYPE(MPI_Info), INTENT(IN) :: info
TYPE(MPI_Comm), INTENT(IN) :: comm
TYPE(MPI_Win), INTENT(OUT) :: win
INTEGER, OPTIONAL, INTENT(OUT) :: ierror
```

```
MPI_WIN_CREATE(BASE, SIZE, DISP_UNIT, INFO, COMM, WIN, IERROR)
```

```
<type> BASE(*)
INTEGER(KIND=MPI_ADDRESS_KIND) SIZE
INTEGER DISP_UNIT, INFO, COMM, WIN, IERROR
```

This is a collective call executed by all processes in the group of `comm`. It returns a window object that can be used by these processes to perform RMA operations. Each process specifies a window of existing memory that it exposes to RMA accesses by the processes in the group of `comm`. The window consists of `size` bytes, starting at address `base`. In C, `base` is the starting address of a memory region. In Fortran, one can pass the first element of a memory region or a whole array, which must be ‘simply contiguous’ (for ‘simply contiguous,’ see also Section 18.1.12). A process may elect to expose no memory by specifying `size = 0`.

The displacement unit argument is provided to facilitate address arithmetic in RMA operations: the target displacement argument of an RMA operation is scaled by the factor `disp_unit` specified by the target process, at window creation.

Rationale. The window size is specified using an address-sized integer, rather than a basic integer type, to allow windows that span more memory than can be described with a basic integer type. (*End of rationale.*)

Advice to users. Common choices for `disp_unit` are 1 (no scaling), and (in C syntax) `sizeof(type)`, for a window that consists of an array of elements of type `type`. The

latter choice will allow one to use array indices in RMA calls, and have those scaled correctly to byte displacements, even in a heterogeneous environment. (*End of advice to users.*)

The `info` argument provides optimization hints to the runtime about the expected usage pattern of the window. The following info keys are predefined:

`no_locks` — if set to `true`, then the implementation may assume that passive target synchronization (i.e., `MPI_WIN_LOCK`, `MPI_WIN_LOCK_ALL`) will not be used on the given window. This implies that this window is not used for 3-party communication, and RMA can be implemented with no (less) asynchronous agent activity at this process.

`accumulate_ordering` — controls the ordering of accumulate operations at the target. See Section 11.7.2 for details.

`accumulate_ops` — if set to `same_op`, the implementation will assume that all concurrent accumulate calls to the same target address will use the same operation. If set to `same_op_no_op`, then the implementation will assume that all concurrent accumulate calls to the same target address will use the same operation or `MPI_NO_OP`. This can eliminate the need to protect access for certain operation types where the hardware can guarantee atomicity. The default is `same_op_no_op`.

`same_size` — if set to `true`, then the implementation may assume that the argument `size` is identical on all processes, and that all processes have provided this info key with the same value.

`same_disp_unit` — if set to `true`, then the implementation may assume that the argument `disp_unit` is identical on all processes, and that all processes have provided this info key with the same value.

Advice to users. The info query mechanism described in Section 11.2.7 can be used to query the specified info arguments for windows that have been passed to a library. It is recommended that libraries check attached info keys for each passed window. (*End of advice to users.*)

The various processes in the group of `comm` may specify completely different target windows, in location, size, displacement units, and info arguments. As long as all the get, put and accumulate accesses to a particular process fit their specific target window this should pose no problem. The same area in memory may appear in multiple windows, each associated with a different window object. However, concurrent communications to distinct, overlapping windows may lead to undefined results.

Rationale. The reason for specifying the memory that may be accessed from another process in an RMA operation is to permit the programmer to specify what memory can be a target of RMA operations and for the implementation to enforce that specification. For example, with this definition, a server process can safely allow a client process to use RMA operations, knowing that (under the assumption that the MPI implementation does enforce the specified limits on the exposed memory) an error in the client cannot affect any memory other than what was explicitly exposed. (*End of rationale.*)

Advice to users. A window can be created in any part of the process memory. However, on some systems, the performance of windows in memory allocated by MPI_ALLOC_MEM (Section 8.2) will be better. Also, on some systems, performance is improved when window boundaries are aligned at “natural” boundaries (word, double-word, cache line, page frame, etc.). (*End of advice to users.*)

Advice to implementors. In cases where RMA operations use different mechanisms in different memory areas (e.g., load/store in a shared memory segment, and an asynchronous handler in private memory), the MPI_WIN_CREATE call needs to figure out which type of memory is used for the window. To do so, MPI maintains, internally, the list of memory segments allocated by MPI_ALLOC_MEM, or by other, implementation-specific, mechanisms, together with information on the type of memory segment allocated. When a call to MPI_WIN_CREATE occurs, then MPI checks which segment contains each window, and decides, accordingly, which mechanism to use for RMA operations.

Vendors may provide additional, implementation-specific mechanisms to allocate or to specify memory regions that are preferable for use in one-sided communication. In particular, such mechanisms can be used to place static variables into such preferred regions.

Implementors should document any performance impact of window alignment. (*End of advice to implementors.*)

11.2.2 Window That Allocates Memory

MPI_WIN_ALLOCATE(size, disp_unit, info, comm, baseptr, win)

IN	size	size of window in bytes (non-negative integer)
IN	disp_unit	local unit size for displacements, in bytes (positive integer)
IN	info	info argument (handle)
IN	comm	intra-communicator (handle)
OUT	baseptr	initial address of window (choice)
OUT	win	window object returned by the call (handle)

```
int MPI_Win_allocate(MPI_Aint size, int disp_unit, MPI_Info info,
                    MPI_Comm comm, void *baseptr, MPI_Win *win)
```

```
MPI_Win_allocate(size, disp_unit, info, comm, baseptr, win, ierror)
```

```
USE, INTRINSIC :: ISO_C_BINDING, ONLY : C_PTR
INTEGER(KIND=MPI_ADDRESS_KIND), INTENT(IN) :: size
INTEGER, INTENT(IN) :: disp_unit
TYPE(MPI_Info), INTENT(IN) :: info
TYPE(MPI_Comm), INTENT(IN) :: comm
TYPE(C_PTR), INTENT(OUT) :: baseptr
TYPE(MPI_Win), INTENT(OUT) :: win
```

```

1     INTEGER, OPTIONAL, INTENT(OUT) :: ierror
2
3     MPI_WIN_ALLOCATE(SIZE, DISP_UNIT, INFO, COMM, BASEPTR, WIN, IERROR)
4     INTEGER DISP_UNIT, INFO, COMM, WIN, IERROR
5     INTEGER(KIND=MPI_ADDRESS_KIND) SIZE, BASEPTR

```

This is a collective call executed by all processes in the group of `comm`. On each process, it allocates memory of at least `size` bytes, returns a pointer to it, and returns a window object that can be used by all processes in `comm` to perform RMA operations. The returned memory consists of `size` bytes local to each process, starting at address `baseptr` and is associated with the window as if the user called `MPI_WIN_CREATE` on existing memory. The size argument may be different at each process and `size = 0` is valid; however, a library might allocate and expose more memory in order to create a fast, globally symmetric allocation. The discussion of and rationales for `MPI_ALLOC_MEM` and `MPI_FREE_MEM` in Section 8.2 also apply to `MPI_WIN_ALLOCATE`; in particular, see the rationale in Section 8.2 for an explanation of the type used for `baseptr`.

If the Fortran compiler provides `TYPE(C_PTR)`, then the following generic interface must be provided in the `mpi` module and should be provided in `mpif.h` through overloading, i.e., with the same routine name as the routine with `INTEGER(KIND=MPI_ADDRESS_KIND) BASEPTR`, but with a different specific procedure name:

```

21  INTERFACE MPI_WIN_ALLOCATE
22      SUBROUTINE MPI_WIN_ALLOCATE(SIZE, DISP_UNIT, INFO, COMM, BASEPTR, &
23                                  WIN, IERROR)
24          IMPORT :: MPI_ADDRESS_KIND
25          INTEGER DISP_UNIT, INFO, COMM, WIN, IERROR
26          INTEGER(KIND=MPI_ADDRESS_KIND) SIZE, BASEPTR
27      END SUBROUTINE
28      SUBROUTINE MPI_WIN_ALLOCATE_CPTR(SIZE, DISP_UNIT, INFO, COMM, BASEPTR, &
29                                      WIN, IERROR)
30          USE, INTRINSIC :: ISO_C_BINDING, ONLY : C_PTR
31          IMPORT :: MPI_ADDRESS_KIND
32          INTEGER :: DISP_UNIT, INFO, COMM, WIN, IERROR
33          INTEGER(KIND=MPI_ADDRESS_KIND) :: SIZE
34          TYPE(C_PTR) :: BASEPTR
35      END SUBROUTINE
36  END INTERFACE

```

The base procedure name of this overloaded function is `MPI_WIN_ALLOCATE_CPTR`. The implied specific procedure names are described in Section 18.1.5.

Rationale. By allocating (potentially aligned) memory instead of allowing the user to pass in an arbitrary buffer, this call can improve the performance for systems with remote direct memory access. This also permits the collective allocation of memory and supports what is sometimes called the “symmetric allocation” model that can be more scalable (for example, the implementation can arrange to return an address for the allocated memory that is the same on all processes). (*End of rationale.*)

The `info` argument can be used to specify hints similar to the `info` argument for `MPI_WIN_CREATE` and `MPI_ALLOC_MEM`.

11.2.3 Window That Allocates Shared Memory

```
MPI_WIN_ALLOCATE_SHARED(size, disp_unit, info, comm, baseptr, win)
```

IN	size	size of local window in bytes (non-negative integer)
IN	disp_unit	local unit size for displacements, in bytes (positive integer)
IN	info	info argument (handle)
IN	comm	intra-communicator (handle)
OUT	baseptr	address of local allocated window segment (choice)
OUT	win	window object returned by the call (handle)

```
int MPI_Win_allocate_shared(MPI_Aint size, int disp_unit, MPI_Info info,
                           MPI_Comm comm, void *baseptr, MPI_Win *win)
```

```
MPI_Win_allocate_shared(size, disp_unit, info, comm, baseptr, win, ierror)
    USE, INTRINSIC :: ISO_C_BINDING, ONLY : C_PTR
    INTEGER(KIND=MPI_ADDRESS_KIND), INTENT(IN) :: size
    INTEGER, INTENT(IN) :: disp_unit
    TYPE(MPI_Info), INTENT(IN) :: info
    TYPE(MPI_Comm), INTENT(IN) :: comm
    TYPE(C_PTR), INTENT(OUT) :: baseptr
    TYPE(MPI_Win), INTENT(OUT) :: win
    INTEGER, OPTIONAL, INTENT(OUT) :: ierror
```

```
MPI_WIN_ALLOCATE_SHARED(SIZE, DISP_UNIT, INFO, COMM, BASEPTR, WIN, IERROR)
    INTEGER DISP_UNIT, INFO, COMM, WIN, IERROR
    INTEGER(KIND=MPI_ADDRESS_KIND) SIZE, BASEPTR
```

This is a collective call executed by all processes in the group of `comm`. On each process, it allocates memory of at least `size` bytes that is shared among all processes in `comm`, and returns a pointer to the locally allocated segment in `baseptr` that can be used for load/store accesses on the calling process. The locally allocated memory can be the target of load/store accesses by remote processes; the base pointers for other processes can be queried using the function `MPI_WIN_SHARED_QUERY`. The call also returns a window object that can be used by all processes in `comm` to perform RMA operations. The `size` argument may be different at each process and `size = 0` is valid. It is the user's responsibility to ensure that the communicator `comm` represents a group of processes that can create a shared memory segment that can be accessed by all processes in the group. The discussions of rationales for `MPI_ALLOC_MEM` and `MPI_FREE_MEM` in Section 8.2 also apply to `MPI_WIN_ALLOCATE_SHARED`; in particular, see the rationale in Section 8.2 for an explanation of the type used for `baseptr`. The allocated memory is contiguous across process ranks unless the `info` key `alloc_shared_noncontig` is specified. Contiguous across process ranks means that the first address in the memory segment of process i is consecutive with the last address in the memory segment of process $i - 1$. This may enable the user to calculate remote address offsets with local information only.

1 If the Fortran compiler provides `TYPE(C_PTR)`, then the following generic interface must
 2 be provided in the `mpi` module and should be provided in `mpif.h` through overloading,
 3 i.e., with the same routine name as the routine with `INTEGER(KIND=MPI_ADDRESS_KIND)`
 4 `BASEPTR`, but with a different specific procedure name:

```
5
6 INTERFACE MPI_WIN_ALLOCATE_SHARED
7     SUBROUTINE MPI_WIN_ALLOCATE_SHARED(SIZE, DISP_UNIT, INFO, COMM, &
8         BASEPTR, WIN, IERROR)
9         IMPORT :: MPI_ADDRESS_KIND
10        INTEGER DISP_UNIT, INFO, COMM, WIN, IERROR
11        INTEGER(KIND=MPI_ADDRESS_KIND) SIZE, BASEPTR
12    END SUBROUTINE
13    SUBROUTINE MPI_WIN_ALLOCATE_SHARED_CPTR(SIZE, DISP_UNIT, INFO, COMM, &
14        BASEPTR, WIN, IERROR)
15        USE, INTRINSIC :: ISO_C_BINDING, ONLY : C_PTR
16        IMPORT :: MPI_ADDRESS_KIND
17        INTEGER :: DISP_UNIT, INFO, COMM, WIN, IERROR
18        INTEGER(KIND=MPI_ADDRESS_KIND) :: SIZE
19        TYPE(C_PTR) :: BASEPTR
20    END SUBROUTINE
21 END INTERFACE
22
```

23 The base procedure name of this overloaded function is
 24 `MPI_WIN_ALLOCATE_SHARED_CPTR`. The implied specific procedure names are described
 25 in Section [18.1.5](#).

26 The `info` argument can be used to specify hints similar to the `info` argument for
 27 `MPI_WIN_CREATE`, `MPI_WIN_ALLOCATE`, and `MPI_ALLOC_MEM`. The additional `info`
 28 key `alloc_shared_noncontig` allows the library to optimize the layout of the shared memory
 29 segments in memory.

30
 31 *Advice to users.* If the `info` key `alloc_shared_noncontig` is not set to true, the allocation
 32 strategy is to allocate contiguous memory across process ranks. This may limit the
 33 performance on some architectures because it does not allow the implementation to
 34 modify the data layout (e.g., padding to reduce access latency). (*End of advice to*
 35 *users.*)

36
 37 *Advice to implementors.* If the user sets the `info` key `alloc_shared_noncontig` to true,
 38 the implementation can allocate the memory requested by each process in a location
 39 that is close to this process. This can be achieved by padding or allocating memory
 40 in special memory segments. Both techniques may make the address space across
 41 consecutive ranks noncontiguous. (*End of advice to implementors.*)

42
 43 The consistency of load/store accesses from/to the shared memory as observed by the
 44 user program depends on the architecture. A consistent view can be created in the *unified*
 45 *memory model* (see Section [11.4](#)) by utilizing the window synchronization functions (see
 46 Section [11.5](#)) or explicitly completing outstanding store accesses (e.g., by calling
 47 `MPI_WIN_FLUSH`). MPI does not define semantics for accessing shared memory windows
 48 in the *separate memory model*.

MPI_WIN_SHARED_QUERY(win, rank, size, disp_unit, baseptr)			1
IN	win	shared memory window object (handle)	2
IN	rank	rank in the group of window win (non-negative integer) or MPI_PROC_NULL	3
OUT	size	size of the window segment (non-negative integer)	4
OUT	disp_unit	local unit size for displacements, in bytes (positive integer)	5
OUT	baseptr	address for load/store access to window segment (choice)	6

```

int MPI_Win_shared_query(MPI_Win win, int rank, MPI_Aint *size,
                        int *disp_unit, void *baseptr)

```

```

MPI_Win_shared_query(win, rank, size, disp_unit, baseptr, ierror)
  USE, INTRINSIC :: ISO_C_BINDING, ONLY : C_PTR
  TYPE(MPI_Win), INTENT(IN) :: win
  INTEGER, INTENT(IN) :: rank
  INTEGER(KIND=MPI_ADDRESS_KIND), INTENT(OUT) :: size
  INTEGER, INTENT(OUT) :: disp_unit
  TYPE(C_PTR), INTENT(OUT) :: baseptr
  INTEGER, OPTIONAL, INTENT(OUT) :: ierror

```

```

MPI_WIN_SHARED_QUERY(WIN, RANK, SIZE, DISP_UNIT, BASEPTR, IERROR)
  INTEGER WIN, RANK, DISP_UNIT, IERROR
  INTEGER (KIND=MPI_ADDRESS_KIND) SIZE, BASEPTR

```

This function queries the process-local address for remote memory segments created with MPI_WIN_ALLOCATE_SHARED. This function can return different process-local addresses for the same physical memory on different processes. The returned memory can be used for load/store accesses subject to the constraints defined in Section 11.7. This function can only be called with windows of flavor MPI_WIN_FLAVOR_SHARED. If the passed window is not of flavor MPI_WIN_FLAVOR_SHARED, the error MPI_ERR_RMA_FLAVOR is raised. When rank is MPI_PROC_NULL, the pointer, disp_unit, and size returned are the pointer, disp_unit, and size of the memory segment belonging the lowest rank that specified size > 0. If all processes in the group attached to the window specified size = 0, then the call returns size = 0 and a baseptr as if MPI_ALLOC_MEM was called with size = 0.

If the Fortran compiler provides TYPE(C_PTR), then the following generic interface must be provided in the mpi module and should be provided in mpif.h through overloading, i.e., with the same routine name as the routine with INTEGER(KIND=MPI_ADDRESS_KIND) BASEPTR, but with a different specific procedure name:

```

INTERFACE MPI_WIN_SHARED_QUERY
  SUBROUTINE MPI_WIN_SHARED_QUERY(WIN, RANK, SIZE, DISP_UNIT, &
                                BASEPTR, IERROR)
    IMPORT :: MPI_ADDRESS_KIND
    INTEGER WIN, RANK, DISP_UNIT, IERROR
    INTEGER (KIND=MPI_ADDRESS_KIND) SIZE, BASEPTR
  END SUBROUTINE

```

```

1      END SUBROUTINE
2      SUBROUTINE MPI_WIN_SHARED_QUERY_CPTR(WIN, RANK, SIZE, DISP_UNIT, &
3          BASEPTR, IERROR)
4          USE, INTRINSIC :: ISO_C_BINDING, ONLY : C_PTR
5          IMPORT :: MPI_ADDRESS_KIND
6          INTEGER :: WIN, RANK, DISP_UNIT, IERROR
7          INTEGER(KIND=MPI_ADDRESS_KIND) :: SIZE
8          TYPE(C_PTR) :: BASEPTR
9      END SUBROUTINE
10     END INTERFACE

```

The base procedure name of this overloaded function is `MPI_WIN_SHARED_QUERY_CPTR`. The implied specific procedure names are described in Section 18.1.5.

11.2.4 Window of Dynamically Attached Memory

The MPI-2 RMA model requires the user to identify the local memory that may be a target of RMA calls at the time the window is created. This has advantages for both the programmer (only this memory can be updated by one-sided operations and provides greater safety) and the MPI implementation (special steps may be taken to make one-sided access to such memory more efficient). However, consider implementing a modifiable linked list using RMA operations; as new items are added to the list, memory must be allocated. In a C or C++ program, this memory is typically allocated using `malloc` or `new` respectively. In MPI-2 RMA, the programmer must create a window with a predefined amount of memory and then implement routines for allocating memory from within the window's memory. In addition, there is no easy way to handle the situation where the predefined amount of memory turns out to be inadequate. To support this model, the routine `MPI_WIN_CREATE_DYNAMIC` creates a window that makes it possible to expose memory without remote synchronization. It must be used in combination with the local routines `MPI_WIN_ATTACH` and `MPI_WIN_DETACH`.

```

33 MPI_WIN_CREATE_DYNAMIC(info, comm, win)

```

34	IN	info	info argument (handle)
35	IN	comm	intra-communicator (handle)
36	OUT	win	window object returned by the call (handle)

```

37
38
39 int MPI_Win_create_dynamic(MPI_Info info, MPI_Comm comm, MPI_Win *win)

```

```

40
41 MPI_Win_create_dynamic(info, comm, win, ierror)
42     TYPE(MPI_Info), INTENT(IN) :: info
43     TYPE(MPI_Comm), INTENT(IN) :: comm
44     TYPE(MPI_Win), INTENT(OUT) :: win
45     INTEGER, OPTIONAL, INTENT(OUT) :: ierror

```

```

46 MPI_WIN_CREATE_DYNAMIC(INFO, COMM, WIN, IERROR)
47     INTEGER INFO, COMM, WIN, IERROR
48

```

This is a collective call executed by all processes in the group of `comm`. It returns a window `win` without memory attached. Existing process memory can be attached as described below. This routine returns a window object that can be used by these processes to perform RMA operations on attached memory. Because this window has special properties, it will sometimes be referred to as a *dynamic* window.

The `info` argument can be used to specify hints similar to the `info` argument for `MPI_WIN_CREATE`.

In the case of a window created with `MPI_WIN_CREATE_DYNAMIC`, the `target_disp` for all RMA functions is the address at the target; i.e., the effective `window_base` is `MPI_BOTTOM` and the `disp_unit` is one. For dynamic windows, the `target_disp` argument to RMA communication operations is not restricted to non-negative values. Users should use `MPI_GET_ADDRESS` at the target process to determine the address of a target memory location and communicate this address to the origin process.

Advice to users. Users are cautioned that displacement arithmetic can overflow in variables of type `MPI_Aint` and result in unexpected values on some platforms. The `MPI_AINT_ADD` and `MPI_AINT_DIFF` functions can be used to safely perform address arithmetic with `MPI_Aint` displacements. (*End of advice to users.*)

Advice to implementors. In environments with heterogeneous data representations, care must be exercised in communicating addresses between processes. For example, it is possible that an address valid at the target process (for example, a 64-bit pointer) cannot be expressed as an address at the origin (for example, the origin uses 32-bit pointers). For this reason, a portable MPI implementation should ensure that the type `MPI_AINT` (see Table 3.3) is able to store addresses from any process. (*End of advice to implementors.*)

Memory at the target cannot be accessed with this window until that memory has been attached using the function `MPI_WIN_ATTACH`. That is, in addition to using `MPI_WIN_CREATE_DYNAMIC` to create an MPI window, the user must use `MPI_WIN_ATTACH` before any local memory may be the target of an MPI RMA operation. Only memory that is currently accessible may be attached.

`MPI_WIN_ATTACH(win, base, size)`

IN	<code>win</code>	window object (handle)
IN	<code>base</code>	initial address of memory to be attached
IN	<code>size</code>	size of memory to be attached in bytes

`int MPI_Win_attach(MPI_Win win, void *base, MPI_Aint size)`

`MPI_Win_attach(win, base, size, ierror)`

<code>TYPE(MPI_Win)</code> , <code>INTENT(IN)</code>	::	<code>win</code>
<code>TYPE(*)</code> , <code>DIMENSION(..)</code> , <code>ASYNCHRONOUS</code>	::	<code>base</code>
<code>INTEGER(KIND=MPI_ADDRESS_KIND)</code> , <code>INTENT(IN)</code>	::	<code>size</code>
<code>INTEGER</code> , <code>OPTIONAL</code> , <code>INTENT(OUT)</code>	::	<code>ierror</code>

`MPI_WIN_ATTACH(WIN, BASE, SIZE, IERROR)`

```

1     INTEGER WIN, IERROR
2     <type> BASE(*)
3     INTEGER (KIND=MPI_ADDRESS_KIND) SIZE

```

Attaches a local memory region beginning at `base` for remote access within the given window. The memory region specified must not contain any part that is already attached to the window `win`, that is, attaching overlapping memory concurrently within the same window is erroneous. The argument `win` must be a window that was created with `MPI_WIN_CREATE_DYNAMIC`. The local memory region attached to the window consists of `size` bytes, starting at address `base`. In C, `base` is the starting address of a memory region. In Fortran, one can pass the first element of a memory region or a whole array, which must be ‘simply contiguous’ (for ‘simply contiguous,’ see Section 18.1.12). Multiple (but non-overlapping) memory regions may be attached to the same window.

Rationale. Requiring that memory be explicitly attached before it is exposed to one-sided access by other processes can simplify implementations and improve performance. The ability to make memory available for RMA operations without requiring a collective `MPI_WIN_CREATE` call is needed for some one-sided programming models. (*End of rationale.*)

Advice to users. Attaching memory to a window may require the use of scarce resources; thus, attaching large regions of memory is not recommended in portable programs. Attaching memory to a window may fail if sufficient resources are not available; this is similar to the behavior of `MPI_ALLOC_MEM`.

The user is also responsible for ensuring that `MPI_WIN_ATTACH` at the target has returned before a process attempts to target that memory with an MPI RMA call.

Performing an RMA operation to memory that has not been attached to a window created with `MPI_WIN_CREATE_DYNAMIC` is erroneous. (*End of advice to users.*)

Advice to implementors. A high-quality implementation will attempt to make as much memory available for attaching as possible. Any limitations should be documented by the implementor. (*End of advice to implementors.*)

Attaching memory is a local operation as defined by MPI, which means that the call is not collective and completes without requiring any MPI routine to be called in any other process. Memory may be detached with the routine `MPI_WIN_DETACH`. After memory has been detached, it may not be the target of an MPI RMA operation on that window (unless the memory is re-attached with `MPI_WIN_ATTACH`).

```

40 MPI_WIN_DETACH(win, base)

```

42	IN	win	window object (handle)
43	IN	base	initial address of memory to be detached

```

45 int MPI_Win_detach(MPI_Win win, const void *base)

```

```

47 MPI_Win_detach(win, base, ierror)
48     TYPE(MPI_Win), INTENT(IN) :: win

```



```

TYPE(*), DIMENSION(..), ASYNCHRONOUS :: base
INTEGER, OPTIONAL, INTENT(OUT) :: ierror

```

```
MPI_WIN_DETACH(WIN, BASE, IERROR)
```

```

INTEGER WIN, IERROR

```

```

<type> BASE(*)

```

Detaches a previously attached memory region beginning at `base`. The arguments `base` and `win` must match the arguments passed to a previous call to `MPI_WIN_ATTACH`.

Advice to users. Detaching memory may permit the implementation to make more efficient use of special memory or provide memory that may be needed by a subsequent `MPI_WIN_ATTACH`. Users are encouraged to detach memory that is no longer needed. Memory should be detached before it is freed by the user. (*End of advice to users.*)

Memory becomes detached when the associated dynamic memory window is freed, see Section [11.2.5](#).

11.2.5 Window Destruction

```
MPI_WIN_FREE(win)
```

```

INOUT win window object (handle)

```

```

int MPI_Win_free(MPI_Win *win)

```

```

MPI_Win_free(win, ierror)

```

```

TYPE(MPI_Win), INTENT(INOUT) :: win

```

```

INTEGER, OPTIONAL, INTENT(OUT) :: ierror

```

```

MPI_WIN_FREE(WIN, IERROR)

```

```

INTEGER WIN, IERROR

```

Frees the window object `win` and returns a null handle (equal to `MPI_WIN_NULL`). This is a collective call executed by all processes in the group associated with `win`. `MPI_WIN_FREE(win)` can be invoked by a process only after it has completed its involvement in RMA communications on window `win`: e.g., the process has called `MPI_WIN_FENCE`, or called `MPI_WIN_WAIT` to match a previous call to `MPI_WIN_POST` or called `MPI_WIN_COMPLETE` to match a previous call to `MPI_WIN_START` or called `MPI_WIN_UNLOCK` to match a previous call to `MPI_WIN_LOCK`. The memory associated with windows created by a call to `MPI_WIN_CREATE` may be freed after the call returns. If the window was created with `MPI_WIN_ALLOCATE`, `MPI_WIN_FREE` will free the window memory that was allocated in `MPI_WIN_ALLOCATE`. If the window was created with `MPI_WIN_ALLOCATE_SHARED`, `MPI_WIN_FREE` will free the window memory that was allocated in `MPI_WIN_ALLOCATE_SHARED`.

Freeing a window that was created with a call to `MPI_WIN_CREATE_DYNAMIC` detaches all associated memory; i.e., it has the same effect as if all attached memory was detached by calls to `MPI_WIN_DETACH`.

Advice to implementors. MPI_WIN_FREE requires a barrier synchronization: no process can return from free until all processes in the group of win call free. This ensures that no process will attempt to access a remote window (e.g., with lock/unlock) after it was freed. The only exception to this rule is when the user sets the no_locks info key to true when creating the window. In that case, an MPI implementation may free the local window without barrier synchronization. (*End of advice to implementors.*)

11.2.6 Window Attributes

The following attributes are cached with a window when the window is created.

MPI_WIN_BASE	window base address.
MPI_WIN_SIZE	window size, in bytes.
MPI_WIN_DISP_UNIT	displacement unit associated with the window.
MPI_WIN_CREATE_FLAVOR	how the window was created.
MPI_WIN_MODEL	memory model for window.

In C, calls to MPI_Win_get_attr(win, MPI_WIN_BASE, &base, &flag), MPI_Win_get_attr(win, MPI_WIN_SIZE, &size, &flag), MPI_Win_get_attr(win, MPI_WIN_DISP_UNIT, &disp_unit, &flag), MPI_Win_get_attr(win, MPI_WIN_CREATE_FLAVOR, &create_kind, &flag), and MPI_Win_get_attr(win, MPI_WIN_MODEL, &memory_model, &flag) will return in base a pointer to the start of the window win, and will return in size, disp_unit, create_kind, and memory_model pointers to the size, displacement unit of the window, the kind of routine used to create the window, and the memory model, respectively. A detailed listing of the type of the pointer in the attribute value argument to MPI_WIN_GET_ATTR and MPI_WIN_SET_ATTR is shown in Table 11.1.

Attribute	C Type
MPI_WIN_BASE	void *
MPI_WIN_SIZE	MPI_Aint *
MPI_WIN_DISP_UNIT	int *
MPI_WIN_CREATE_FLAVOR	int *
MPI_WIN_MODEL	int *

Table 11.1: C types of attribute value argument to MPI_WIN_GET_ATTR and MPI_WIN_SET_ATTR.

In Fortran, calls to MPI_WIN_GET_ATTR(win, MPI_WIN_BASE, base, flag, ierror), MPI_WIN_GET_ATTR(win, MPI_WIN_SIZE, size, flag, ierror), MPI_WIN_GET_ATTR(win, MPI_WIN_DISP_UNIT, disp_unit, flag, ierror), MPI_WIN_GET_ATTR(win, MPI_WIN_CREATE_FLAVOR, create_kind, flag, ierror), and MPI_WIN_GET_ATTR(win, MPI_WIN_MODEL, memory_model, flag, ierror) will return in base, size, disp_unit, create_kind, and memory_model the (integer representation of) the base address, the size, the displacement unit of the window win, the kind of routine used to create the window, and the memory model, respectively.

The values of create_kind are

MPI_WIN_FLAVOR_CREATE	Window was created with MPI_WIN_CREATE.	1
MPI_WIN_FLAVOR_ALLOCATE	Window was created with MPI_WIN_ALLOCATE.	2 3
MPI_WIN_FLAVOR_DYNAMIC	Window was created with MPI_WIN_CREATE_DYNAMIC.	4 5
MPI_WIN_FLAVOR_SHARED	Window was created with MPI_WIN_ALLOCATE_SHARED.	6 7

The values of `memory_model` are `MPI_WIN_SEPARATE` and `MPI_WIN_UNIFIED`. The meaning of these is described in Section 11.4.

In the case of windows created with `MPI_WIN_CREATE_DYNAMIC`, the base address is `MPI_BOTTOM` and the size is 0. In C, pointers are returned, and in Fortran, the values are returned, for the respective attributes. (The window attribute access functions are defined in Section 6.7.3.) The value returned for an attribute on a window is constant over the lifetime of the window.

The other “window attribute,” namely the group of processes attached to the window, can be retrieved using the call below.

`MPI_WIN_GET_GROUP(win, group)`

IN	<code>win</code>	window object (handle)	20
OUT	<code>group</code>	group of processes which share access to the window (handle)	21 22 23

```
int MPI_Win_get_group(MPI_Win win, MPI_Group *group)
```

```
MPI_Win_get_group(win, group, ierror)
  TYPE(MPI_Win), INTENT(IN) :: win
  TYPE(MPI_Group), INTENT(OUT) :: group
  INTEGER, OPTIONAL, INTENT(OUT) :: ierror
```

```
MPI_WIN_GET_GROUP(WIN, GROUP, IERROR)
  INTEGER WIN, GROUP, IERROR
```

`MPI_WIN_GET_GROUP` returns a duplicate of the group of the communicator used to create the window associated with `win`. The group is returned in `group`.

11.2.7 Window Info

Hints specified via `info` (see Section 9) allow a user to provide information to direct optimization. Providing hints may enable an implementation to deliver increased performance or use system resources more efficiently. An implementation is free to ignore all hints; however, applications must comply with any `info` hints they provide that are used by the MPI implementation (i.e., are returned by a call to `MPI_WIN_GET_INFO`) and that place a restriction on the behavior of the application. Hints are specified on a per window basis, in window creation functions and `MPI_WIN_SET_INFO`, via the opaque `info` object. When an `info` object that specifies a subset of valid hints is passed to `MPI_WIN_SET_INFO` there will be no effect on previously set or default hints that the `info` does not specify.

Advice to implementors. It may happen that a program is coded with hints for one system, and later executes on another system that does not support these hints. In general, unsupported hints should simply be ignored. Needless to say, no hint can be mandatory. However, for each hint used by a specific implementation, a default value must be provided when the user does not specify a value for the hint. (*End of advice to implementors.*)

MPI_WIN_SET_INFO(win, info)

INOUT	win	window object (handle)
IN	info	info object (handle)

```
int MPI_Win_set_info(MPI_Win win, MPI_Info info)
```

```
MPI_Win_set_info(win, info, ierror)
    TYPE(MPI_Win), INTENT(IN) :: win
    TYPE(MPI_Info), INTENT(IN) :: info
    INTEGER, OPTIONAL, INTENT(OUT) :: ierror
```

```
MPI_WIN_SET_INFO(WIN, INFO, IERROR)
    INTEGER WIN, INFO, IERROR
```

MPI_WIN_SET_INFO updates the hints of the window associated with win using the hints provided in info. This operation has no effect on previously set or defaulted hints that are not specified by info. It also has no effect on previously set or defaulted hints that are specified by info, but are ignored by the MPI implementation in this call to MPI_WIN_SET_INFO. The call is collective on the group of win. The info object may be different on each process, but any info entries that an implementation requires to be the same on all processes must appear with the same value in each process's info object.

Advice to users. Some info items that an implementation can use when it creates a window cannot easily be changed once the window has been created. Thus, an implementation may ignore hints issued in this call that it would have accepted in a creation call. An implementation may also be unable to update certain info hints in a call to MPI_WIN_SET_INFO. MPI_WIN_GET_INFO can be used to determine whether info changes were ignored by the implementation. (*End of advice to users.*)

MPI_WIN_GET_INFO(win, info_used)

IN	win	window object (handle)
OUT	info_used	new info object (handle)

```
int MPI_Win_get_info(MPI_Win win, MPI_Info *info_used)
```

```
MPI_Win_get_info(win, info_used, ierror)
    TYPE(MPI_Win), INTENT(IN) :: win
    TYPE(MPI_Info), INTENT(OUT) :: info_used
```

```

    INTEGER, OPTIONAL, INTENT(OUT) :: ierror
MPI_WIN_GET_INFO(WIN, INFO_USED, IERROR)
    INTEGER WIN, INFO_USED, IERROR

```

MPI_WIN_GET_INFO returns a new info object containing the hints of the window associated with win. The current setting of all hints related to this window is returned in info_used. An MPI implementation is required to return all hints that are supported by the implementation and have default values specified; any user-supplied hints that were not ignored by the implementation; and any additional hints that were set by the implementation. If no such hints exist, a handle to a newly created info object is returned that contains no key/value pair. The user is responsible for freeing info_used via MPI_INFO_FREE.

11.3 Communication Calls

MPI supports the following RMA communication calls: MPI_PUT and MPI_RPUT transfer data from the caller memory (origin) to the target memory; MPI_GET and MPI_RGET transfer data from the target memory to the caller memory; MPI_ACCUMULATE and MPI_RACCUMULATE update locations in the target memory, e.g., by adding to these locations values sent from the caller memory; MPI_GET_ACCUMULATE, MPI_RGET_ACCUMULATE, and MPI_FETCH_AND_OP perform atomic read-modify-write and return the data before the accumulate operation; and MPI_COMPARE_AND_SWAP performs a remote atomic compare and swap operation. These operations are *nonblocking*: the call initiates the transfer, but the transfer may continue after the call returns. The transfer is completed, at the origin or both the origin and the target, when a subsequent *synchronization* call is issued by the caller on the involved window object. These synchronization calls are described in Section 11.5. Transfers can also be completed with calls to flush routines; see Section 11.5.4 for details. For the MPI_RPUT, MPI_RGET, MPI_RACCUMULATE, and MPI_RGET_ACCUMULATE calls, the transfer can be locally completed by using the MPI test or wait operations described in Section 3.7.3.

The local communication buffer of an RMA call should not be updated, and the local communication buffer of a get call should not be accessed after the RMA call until the operation completes at the origin.

The resulting data values, or outcome, of concurrent conflicting accesses to the same memory locations is undefined; if a location is updated by a put or accumulate operation, then the outcome of loads or other RMA operations is undefined until the updating operation has completed at the target. There is one exception to this rule; namely, the same location can be updated by several concurrent accumulate calls, the outcome being as if these updates occurred in some order. In addition, the outcome of concurrent load/store and RMA updates to the same memory location is undefined. These restrictions are described in more detail in Section 11.7.

The calls use general datatype arguments to specify communication buffers at the origin and at the target. Thus, a transfer operation may also gather data at the source and scatter it at the destination. However, all arguments specifying both communication buffers are provided by the caller.

For all RMA calls, the target process may be identical with the origin process; i.e., a process may use an RMA operation to move data in its memory.

Rationale. The choice of supporting “self-communication” is the same as for message-

1 passing. It simplifies some coding, and is very useful with accumulate operations, to
 2 allow atomic updates of local variables. (*End of rationale.*)

3
 4 MPI_PROC_NULL is a valid target rank in all MPI RMA communication calls. The effect
 5 is the same as for MPI_PROC_NULL in MPI point-to-point communication. After any RMA
 6 operation with rank MPI_PROC_NULL, it is still necessary to finish the RMA epoch with the
 7 synchronization method that started the epoch.

9 11.3.1 Put

10 The execution of a put operation is similar to the execution of a send by the origin process
 11 and a matching receive by the target process. The obvious difference is that all arguments
 12 are provided by one call — the call executed by the origin process.

13
 14
 15 MPI_PUT(origin_addr, origin_count, origin_datatype, target_rank, target_disp, target_count,
 16 target_datatype, win)

17	IN	origin_addr	initial address of origin buffer (choice)
18	IN	origin_count	number of entries in origin buffer (non-negative integer)
19			
20			
21	IN	origin_datatype	datatype of each entry in origin buffer (handle)
22	IN	target_rank	rank of target (non-negative integer)
23			
24	IN	target_disp	displacement from start of window to target buffer (non-negative integer)
25			
26	IN	target_count	number of entries in target buffer (non-negative integer)
27			
28	IN	target_datatype	datatype of each entry in target buffer (handle)
29			
30	IN	win	window object used for communication (handle)

31
 32 int MPI_Put(const void *origin_addr, int origin_count,
 33 MPI_Datatype origin_datatype, int target_rank,
 34 MPI_Aint target_disp, int target_count,
 35 MPI_Datatype target_datatype, MPI_Win win)
 36
 37 MPI_Put(origin_addr, origin_count, origin_datatype, target_rank,
 38 target_disp, target_count, target_datatype, win, ierror)
 39 TYPE(*), DIMENSION(..), INTENT(IN), ASYNCHRONOUS :: origin_addr
 40 INTEGER, INTENT(IN) :: origin_count, target_rank, target_count
 41 TYPE(MPI_Datatype), INTENT(IN) :: origin_datatype, target_datatype
 42 INTEGER(KIND=MPI_ADDRESS_KIND), INTENT(IN) :: target_disp
 43 TYPE(MPI_Win), INTENT(IN) :: win
 44 INTEGER, OPTIONAL, INTENT(OUT) :: ierror
 45
 46 MPI_PUT(ORIGIN_ADDR, ORIGIN_COUNT, ORIGIN_DATATYPE, TARGET_RANK,
 47 TARGET_DISP, TARGET_COUNT, TARGET_DATATYPE, WIN, IERROR)
 48 <type> ORIGIN_ADDR(*)
 INTEGER(KIND=MPI_ADDRESS_KIND) TARGET_DISP

INTEGER ORIGIN_COUNT, ORIGIN_DATATYPE, TARGET_RANK, TARGET_COUNT,
TARGET_DATATYPE, WIN, IERROR

Transfers `origin_count` successive entries of the type specified by the `origin_datatype`, starting at address `origin_addr` on the origin node, to the target node specified by the `win`, `target_rank` pair. The data are written in the target buffer at address `target_addr = window_base + target_disp × disp_unit`, where `window_base` and `disp_unit` are the base address and window displacement unit specified at window initialization, by the target process.

The target buffer is specified by the arguments `target_count` and `target_datatype`.

The data transfer is the same as that which would occur if the origin process executed a send operation with arguments `origin_addr`, `origin_count`, `origin_datatype`, `target_rank`, `tag`, `comm`, and the target process executed a receive operation with arguments `target_addr`, `target_count`, `target_datatype`, `source`, `tag`, `comm`, where `target_addr` is the target buffer address computed as explained above, the values of `tag` are arbitrary valid matching tag values, and `comm` is a communicator for the group of `win`.

The communication must satisfy the same constraints as for a similar message-passing communication. The `target_datatype` may not specify overlapping entries in the target buffer. The message sent must fit, without truncation, in the target buffer. Furthermore, the target buffer must fit in the target window or in attached memory in a dynamic window.

The `target_datatype` argument is a handle to a datatype object defined at the origin process. However, this object is interpreted at the target process: the outcome is as if the target datatype object was defined at the target process by the same sequence of calls used to define it at the origin process. The target datatype must contain only relative displacements, not absolute addresses. The same holds for `get` and `accumulate` operations.

Advice to users. The `target_datatype` argument is a handle to a datatype object that is defined at the origin process, even though it defines a data layout in the target process memory. This causes no problems in a homogeneous environment, or in a heterogeneous environment if only portable datatypes are used (portable datatypes are defined in Section 2.4).

The performance of a `put` transfer can be significantly affected, on some systems, by the choice of window location and the shape and location of the origin and target buffer: transfers to a target window in memory allocated by `MPI_ALLOC_MEM` or `MPI_WIN_ALLOCATE` may be much faster on shared memory systems; transfers from contiguous buffers will be faster on most, if not all, systems; the alignment of the communication buffers may also impact performance. (*End of advice to users.*)

Advice to implementors. A high-quality implementation will attempt to prevent remote accesses to memory outside the window that was exposed by the process. This is important both for debugging purposes and for protection with client-server codes that use RMA. That is, a high-quality implementation will check, if possible, window bounds on each RMA call, and raise an MPI exception at the origin call if an out-of-bound situation occurs. Note that the condition can be checked at the origin. Of course, the added safety achieved by such checks has to be weighed against the added cost of such checks. (*End of advice to implementors.*)

11.3.2 Get

```

1  MPI_GET(origin_addr, origin_count, origin_datatype, target_rank, target_disp, target_count,
2  target_datatype, win)
3
4  OUT    origin_addr    initial address of origin buffer (choice)
5
6  IN     origin_count   number of entries in origin buffer (non-negative inte-
7  ger)
8
9  IN     origin_datatype datatype of each entry in origin buffer (handle)
10
11  IN     target_rank    rank of target (non-negative integer)
12
13  IN     target_disp    displacement from window start to the beginning of
14  the target buffer (non-negative integer)
15
16  IN     target_count   number of entries in target buffer (non-negative inte-
17  ger)
18
19  IN     target_datatype datatype of each entry in target buffer (handle)
20
21  IN     win            window object used for communication (handle)

```

```

22  int MPI_Get(void *origin_addr, int origin_count,
23             MPI_Datatype origin_datatype, int target_rank,
24             MPI_Aint target_disp, int target_count,
25             MPI_Datatype target_datatype, MPI_Win win)
26
27  MPI_Get(origin_addr, origin_count, origin_datatype, target_rank,
28          target_disp, target_count, target_datatype, win, ierror)
29
30  TYPE(*), DIMENSION(..), ASYNCHRONOUS :: origin_addr
31  INTEGER, INTENT(IN) :: origin_count, target_rank, target_count
32  TYPE(MPI_Datatype), INTENT(IN) :: origin_datatype, target_datatype
33  INTEGER(KIND=MPI_ADDRESS_KIND), INTENT(IN) :: target_disp
34  TYPE(MPI_Win), INTENT(IN) :: win
35  INTEGER, OPTIONAL, INTENT(OUT) :: ierror
36
37  MPI_GET(ORIGIN_ADDR, ORIGIN_COUNT, ORIGIN_DATATYPE, TARGET_RANK,
38          TARGET_DISP, TARGET_COUNT, TARGET_DATATYPE, WIN, IERROR)
39
40  <type> ORIGIN_ADDR(*)
41  INTEGER(KIND=MPI_ADDRESS_KIND) TARGET_DISP
42  INTEGER ORIGIN_COUNT, ORIGIN_DATATYPE, TARGET_RANK, TARGET_COUNT,
43  TARGET_DATATYPE, WIN, IERROR

```

Similar to MPI_PUT, except that the direction of data transfer is reversed. Data are copied from the target memory to the origin. The `origin_datatype` may not specify overlapping entries in the origin buffer. The target buffer must be contained within the target window or within attached memory in a dynamic window, and the copied data must fit, without truncation, in the origin buffer.

11.3.3 Examples for Communication Calls

These examples show the use of the MPI_GET function. As all MPI RMA communication functions are nonblocking, they must be completed. In the following, this is accomplished with the routine MPI_WIN_FENCE, introduced in Section 11.5.

Example 11.1 We show how to implement the generic indirect assignment $A = B(\text{map})$, where A , B , and map have the same distribution, and map is a permutation. To simplify, we assume a block distribution with equal size blocks.

```

SUBROUTINE MAPVALS(A, B, map, m, comm, p)
USE MPI
INTEGER m, map(m), comm, p
REAL A(m), B(m)

INTEGER otype(p), oindex(m),      & ! used to construct origin datatypes
      ttype(p), tindex(m),        & ! used to construct target datatypes
      count(p), total(p),         &
      disp_int, win, ierr
INTEGER (KIND=MPI_ADDRESS_KIND) lowerbound, size, realextent, disp_aint

! This part does the work that depends on the locations of B.
! Can be reused while this does not change

CALL MPI_TYPE_GET_EXTENT(MPI_REAL, lowerbound, realextent, ierr)
disp_int = realextent
size = m * realextent
CALL MPI_WIN_CREATE(B, size, disp_int, MPI_INFO_NULL, &
                   comm, win, ierr)

! This part does the work that depends on the value of map and
! the locations of the arrays.
! Can be reused while these do not change

! Compute number of entries to be received from each process

DO i=1,p
  count(i) = 0
END DO
DO i=1,m
  j = map(i)/m+1
  count(j) = count(j)+1
END DO

total(1) = 0
DO i=2,p
  total(i) = total(i-1) + count(i-1)
END DO

```

```

1 DO i=1,p
2   count(i) = 0
3 END DO
4
5 ! compute origin and target indices of entries.
6 ! entry i at current process is received from location
7 ! k at process (j-1), where map(i) = (j-1)*m + (k-1),
8 ! j = 1..p and k = 1..m
9
10 DO i=1,m
11   j = map(i)/m+1
12   k = MOD(map(i),m)+1
13   count(j) = count(j)+1
14   oindex(total(j) + count(j)) = i
15   tindex(total(j) + count(j)) = k
16 END DO
17
18 ! create origin and target datatypes for each get operation
19 DO i=1,p
20   CALL MPI_TYPE_CREATE_INDEXED_BLOCK(count(i), 1, &
21                                     oindex(total(i)+1:total(i)+count(i)), &
22                                     MPI_REAL, otype(i), ierr)
23   CALL MPI_TYPE_COMMIT(otype(i), ierr)
24   CALL MPI_TYPE_CREATE_INDEXED_BLOCK(count(i), 1, &
25                                     tindex(total(i)+1:total(i)+count(i)), &
26                                     MPI_REAL, ttype(i), ierr)
27   CALL MPI_TYPE_COMMIT(ttype(i), ierr)
28 END DO
29
30 ! this part does the assignment itself
31 CALL MPI_WIN_FENCE(0, win, ierr)
32 disp_aint = 0
33 DO i=1,p
34   CALL MPI_GET(A, 1, otype(i), i-1, disp_aint, 1, ttype(i), win, ierr)
35 END DO
36 CALL MPI_WIN_FENCE(0, win, ierr)
37
38 CALL MPI_WIN_FREE(win, ierr)
39 DO i=1,p
40   CALL MPI_TYPE_FREE(otype(i), ierr)
41   CALL MPI_TYPE_FREE(ttype(i), ierr)
42 END DO
43 RETURN
44 END

```

Example 11.2

48

A simpler version can be written that does not require that a datatype be built for the target buffer. But, one then needs a separate get call for each entry, as illustrated below. This code is much simpler, but usually much less efficient, for large arrays.

```

SUBROUTINE MAPVALS(A, B, map, m, comm, p)
USE MPI
INTEGER m, map(m), comm, p
REAL A(m), B(m)
INTEGER disp_int, win, ierr
INTEGER (KIND=MPI_ADDRESS_KIND) lowerbound, size, realextent, disp_aint

CALL MPI_TYPE_GET_EXTENT(MPI_REAL, lowerbound, realextent, ierr)
disp_int = realextent
size = m * realextent
CALL MPI_WIN_CREATE(B, size, disp_int, MPI_INFO_NULL, &
                   comm, win, ierr)

CALL MPI_WIN_FENCE(0, win, ierr)
DO i=1,m
  j = map(i)/m
  disp_aint = MOD(map(i),m)
  CALL MPI_GET(A(i), 1, MPI_REAL, j, disp_aint, 1, MPI_REAL, win, ierr)
END DO
CALL MPI_WIN_FENCE(0, win, ierr)
CALL MPI_WIN_FREE(win, ierr)
RETURN
END

```

11.3.4 Accumulate Functions

It is often useful in a put operation to combine the data moved to the target process with the data that resides at that process, rather than replacing it. This will allow, for example, the accumulation of a sum by having all involved processes add their contributions to the sum variable in the memory of one process. The accumulate functions have slightly different semantics with respect to overlapping data accesses than the put and get functions; see Section 11.7 for details.

1 Accumulate Function

```

2
3
4 MPI_ACCUMULATE(origin_addr, origin_count, origin_datatype, target_rank, target_disp,
5               target_count, target_datatype, op, win)
6
7   IN      origin_addr      initial address of buffer (choice)
8   IN      origin_count     number of entries in buffer (non-negative integer)
9   IN      origin_datatype   datatype of each entry (handle)
10  IN      target_rank       rank of target (non-negative integer)
11  IN      target_disp       displacement from start of window to beginning of tar-
12  IN      target_disp       get buffer (non-negative integer)
13
14  IN      target_count      number of entries in target buffer (non-negative inte-
15  IN      target_count      ger)
16  IN      target_datatype   datatype of each entry in target buffer (handle)
17  IN      op                reduce operation (handle)
18  IN      win               window object (handle)
19
20
21
22 int MPI_Accumulate(const void *origin_addr, int origin_count,
23                  MPI_Datatype origin_datatype, int target_rank,
24                  MPI_Aint target_disp, int target_count,
25                  MPI_Datatype target_datatype, MPI_Op op, MPI_Win win)
26
27 MPI_Accumulate(origin_addr, origin_count, origin_datatype, target_rank,
28               target_disp, target_count, target_datatype, op, win, ierror)
29
30 TYPE(*), DIMENSION(..), INTENT(IN), ASYNCHRONOUS :: origin_addr
31 INTEGER, INTENT(IN) :: origin_count, target_rank, target_count
32 TYPE(MPI_Datatype), INTENT(IN) :: origin_datatype, target_datatype
33 INTEGER(KIND=MPI_ADDRESS_KIND), INTENT(IN) :: target_disp
34 TYPE(MPI_Op), INTENT(IN) :: op
35 TYPE(MPI_Win), INTENT(IN) :: win
36 INTEGER, OPTIONAL, INTENT(OUT) :: ierror
37
38 MPI_ACCUMULATE(ORIGIN_ADDR, ORIGIN_COUNT, ORIGIN_DATATYPE, TARGET_RANK,
39               TARGET_DISP, TARGET_COUNT, TARGET_DATATYPE, OP, WIN, IERROR)
40
41 <type> ORIGIN_ADDR(*)
42 INTEGER(KIND=MPI_ADDRESS_KIND) TARGET_DISP
43 INTEGER ORIGIN_COUNT, ORIGIN_DATATYPE, TARGET_RANK, TARGET_COUNT,
44 TARGET_DATATYPE, OP, WIN, IERROR

```

42 Accumulate the contents of the origin buffer (as defined by `origin_addr`, `origin_count`, and `origin_datatype`) to the buffer specified by arguments `target_count` and `target_datatype`, at offset `target_disp`, in the target window specified by `target_rank` and `win`, using the operation `op`. This is like `MPI_PUT` except that data is combined into the target area instead of overwriting it.

47 Any of the predefined operations for `MPI_REDUCE` can be used. User-defined functions cannot be used. For example, if `op` is `MPI_SUM`, each element of the origin buffer is added

to the corresponding element in the target, replacing the former value in the target. 1

Each datatype argument must be a predefined datatype or a derived datatype, where 2
all basic components are of the same predefined datatype. Both datatype arguments must 3
be constructed from the same predefined datatype. The operation `op` applies to elements of 4
that predefined type. The parameter `target_datatype` must not specify overlapping entries, 5
and the target buffer must fit in the target window. 6

A new predefined operation, `MPI_REPLACE`, is defined. It corresponds to the associative 7
function $f(a, b) = b$; i.e., the current value in the target memory is replaced by the value 8
supplied by the origin. 9

`MPI_REPLACE` can be used only in `MPI_ACCUMULATE`, `MPI_RACCUMULATE`, 10
`MPI_GET_ACCUMULATE`, `MPI_FETCH_AND_OP`, and `MPI_RGET_ACCUMULATE`, but not 11
in collective reduction operations such as `MPI_REDUCE`. 12

Advice to users. `MPI_PUT` is a special case of `MPI_ACCUMULATE`, with the op- 13
eration `MPI_REPLACE`. Note, however, that `MPI_PUT` and `MPI_ACCUMULATE` have 14
different constraints on concurrent updates. (*End of advice to users.*) 15
16

Example 11.3 We want to compute $B(j) = \sum_{\text{map}(i)=j} A(i)$. The arrays `A`, `B`, and `map` 17
are distributed in the same manner. We write the simple version. 18
19

```

SUBROUTINE SUM(A, B, map, m, comm, p)
USE MPI
INTEGER m, map(m), comm, p, win, ierr, disp_int
REAL A(m), B(m)
INTEGER (KIND=MPI_ADDRESS_KIND) lowerbound, size, realextent, disp_aint

CALL MPI_TYPE_GET_EXTENT(MPI_REAL, lowerbound, realextent, ierr)
size = m * realextent
disp_int = realextent
CALL MPI_WIN_CREATE(B, size, disp_int, MPI_INFO_NULL, &
                    comm, win, ierr)

CALL MPI_WIN_FENCE(0, win, ierr)
DO i=1,m
  j = map(i)/m
  disp_aint = MOD(map(i),m)
  CALL MPI_ACCUMULATE(A(i), 1, MPI_REAL, j, disp_aint, 1, MPI_REAL, &
                     MPI_SUM, win, ierr)
END DO
CALL MPI_WIN_FENCE(0, win, ierr)

CALL MPI_WIN_FREE(win, ierr)
RETURN
END

```

This code is identical to the code in Example 11.2, except that a call to get has been 20
replaced by a call to accumulate. (Note that, if `map` is one-to-one, the code computes 21
 $B = A(\text{map}^{-1})$, which is the reverse assignment to the one computed in that previous 22
23
24
25
26
27
28
29
30
31
32
33
34
35
36
37
38
39
40
41
42
43
44
45
46
47
48

example.) In a similar manner, we can replace in Example 11.1, the call to `get` by a call to `accumulate`, thus performing the computation with only one communication between any two processes.

Get Accumulate Function

It is often useful to have fetch-and-accumulate semantics such that the remote data is returned to the caller before the sent data is accumulated into the remote data. The `get` and `accumulate` steps are executed atomically for each basic element in the datatype (see Section 11.7 for details). The predefined operation `MPI_REPLACE` provides fetch-and-set behavior.

```

MPI_GET_ACCUMULATE(origin_addr, origin_count, origin_datatype, result_addr,
                   result_count, result_datatype, target_rank, target_disp, target_count,
                   target_datatype, op, win)

```

IN	<code>origin_addr</code>	initial address of buffer (choice)
IN	<code>origin_count</code>	number of entries in origin buffer (non-negative integer)
IN	<code>origin_datatype</code>	datatype of each entry in origin buffer (handle)
OUT	<code>result_addr</code>	initial address of result buffer (choice)
IN	<code>result_count</code>	number of entries in result buffer (non-negative integer)
IN	<code>result_datatype</code>	datatype of each entry in result buffer (handle)
IN	<code>target_rank</code>	rank of target (non-negative integer)
IN	<code>target_disp</code>	displacement from start of window to beginning of target buffer (non-negative integer)
IN	<code>target_count</code>	number of entries in target buffer (non-negative integer)
IN	<code>target_datatype</code>	datatype of each entry in target buffer (handle)
IN	<code>op</code>	reduce operation (handle)
IN	<code>win</code>	window object (handle)

```

int MPI_Get_accumulate(const void *origin_addr, int origin_count,
                      MPI_Datatype origin_datatype, void *result_addr,
                      int result_count, MPI_Datatype result_datatype,
                      int target_rank, MPI_Aint target_disp, int target_count,
                      MPI_Datatype target_datatype, MPI_Op op, MPI_Win win)

```

```

MPI_Get_accumulate(origin_addr, origin_count, origin_datatype, result_addr,
                  result_count, result_datatype, target_rank, target_disp,
                  target_count, target_datatype, op, win, ierror)

```

```

TYPE(*), DIMENSION(..), INTENT(IN), ASYNCHRONOUS :: origin_addr
TYPE(*), DIMENSION(..), ASYNCHRONOUS :: result_addr
INTEGER, INTENT(IN) :: origin_count, result_count, target_rank,

```

```

        target_count
TYPE(MPI_Datatype), INTENT(IN) :: origin_datatype, target_datatype,
        result_datatype
INTEGER(KIND=MPI_ADDRESS_KIND), INTENT(IN) :: target_disp
TYPE(MPI_Op), INTENT(IN) :: op
TYPE(MPI_Win), INTENT(IN) :: win
INTEGER, OPTIONAL, INTENT(OUT) :: ierror
MPI_GET_ACCUMULATE(ORIGIN_ADDR, ORIGIN_COUNT, ORIGIN_DATATYPE, RESULT_ADDR,
        RESULT_COUNT, RESULT_DATATYPE, TARGET_RANK, TARGET_DISP,
        TARGET_COUNT, TARGET_DATATYPE, OP, WIN, IERROR)
<type> ORIGIN_ADDR(*), RESULT_ADDR(*)
INTEGER(KIND=MPI_ADDRESS_KIND) TARGET_DISP
INTEGER ORIGIN_COUNT, ORIGIN_DATATYPE, RESULT_COUNT, RESULT_DATATYPE,
        TARGET_RANK, TARGET_COUNT, TARGET_DATATYPE, OP, WIN, IERROR

```

Accumulate `origin_count` elements of type `origin_datatype` from the origin buffer (`origin_addr`) to the buffer at offset `target_disp`, in the target window specified by `target_rank` and `win`, using the operation `op` and return in the result buffer `result_addr` the content of the target buffer before the accumulation, specified by `target_disp`, `target_count`, and `target_datatype`. The data transferred from origin to target must fit, without truncation, in the target buffer. Likewise, the data copied from target to origin must fit, without truncation, in the result buffer.

The origin and result buffers (`origin_addr` and `result_addr`) must be disjoint. Each datatype argument must be a predefined datatype or a derived datatype where all basic components are of the same predefined datatype. All datatype arguments must be constructed from the same predefined datatype. The operation `op` applies to elements of that predefined type. `target_datatype` must not specify overlapping entries, and the target buffer must fit in the target window or in attached memory in a dynamic window. The operation is executed atomically for each basic datatype; see Section 11.7 for details.

Any of the predefined operations for `MPI_REDUCE`, as well as `MPI_NO_OP` or `MPI_REPLACE` can be specified as `op`. User-defined functions cannot be used. A new predefined operation, `MPI_NO_OP`, is defined. It corresponds to the associative function $f(a, b) = a$; i.e., the current value in the target memory is returned in the result buffer at the origin and no operation is performed on the target buffer. When `MPI_NO_OP` is specified as the operation, the `origin_addr`, `origin_count`, and `origin_datatype` arguments are ignored. `MPI_NO_OP` can be used only in `MPI_GET_ACCUMULATE`, `MPI_RGET_ACCUMULATE`, and `MPI_FETCH_AND_OP`. `MPI_NO_OP` cannot be used in `MPI_ACCUMULATE`, `MPI_RACCUMULATE`, or collective reduction operations, such as `MPI_REDUCE` and others.

Advice to users. `MPI_GET` is similar to `MPI_GET_ACCUMULATE`, with the operation `MPI_NO_OP`. Note, however, that `MPI_GET` and `MPI_GET_ACCUMULATE` have different constraints on concurrent updates. (*End of advice to users.*)

Fetch and Op Function

The generic functionality of `MPI_GET_ACCUMULATE` might limit the performance of fetch-and-increment or fetch-and-add calls that might be supported by special hardware operations. `MPI_FETCH_AND_OP` thus allows for a fast implementation of a commonly used

subset of the functionality of MPI_GET_ACCUMULATE.

MPI_FETCH_AND_OP(origin_addr, result_addr, datatype, target_rank, target_disp, op, win)

IN	origin_addr	initial address of buffer (choice)
OUT	result_addr	initial address of result buffer (choice)
IN	datatype	datatype of the entry in origin, result, and target buffers (handle)
IN	target_rank	rank of target (non-negative integer)
IN	target_disp	displacement from start of window to beginning of target buffer (non-negative integer)
IN	op	reduce operation (handle)
IN	win	window object (handle)

```
int MPI_Fetch_and_op(const void *origin_addr, void *result_addr,
                    MPI_Datatype datatype, int target_rank, MPI_Aint target_disp,
                    MPI_Op op, MPI_Win win)
```

```
MPI_Fetch_and_op(origin_addr, result_addr, datatype, target_rank,
                 target_disp, op, win, ierror)
    TYPE(*), DIMENSION(..), INTENT(IN), ASYNCHRONOUS :: origin_addr
    TYPE(*), DIMENSION(..), ASYNCHRONOUS :: result_addr
    TYPE(MPI_Datatype), INTENT(IN) :: datatype
    INTEGER, INTENT(IN) :: target_rank
    INTEGER(KIND=MPI_ADDRESS_KIND), INTENT(IN) :: target_disp
    TYPE(MPI_Op), INTENT(IN) :: op
    TYPE(MPI_Win), INTENT(IN) :: win
    INTEGER, OPTIONAL, INTENT(OUT) :: ierror
```

```
MPI_FETCH_AND_OP(ORIGIN_ADDR, RESULT_ADDR, DATATYPE, TARGET_RANK,
                 TARGET_DISP, OP, WIN, IERROR)
    <type> ORIGIN_ADDR(*), RESULT_ADDR(*)
    INTEGER(KIND=MPI_ADDRESS_KIND) TARGET_DISP
    INTEGER DATATYPE, TARGET_RANK, OP, WIN, IERROR
```

Accumulate one element of type `datatype` from the origin buffer (`origin_addr`) to the buffer at offset `target_disp`, in the target window specified by `target_rank` and `win`, using the operation `op` and return in the result buffer `result_addr` the content of the target buffer before the accumulation.

The origin and result buffers (`origin_addr` and `result_addr`) must be disjoint. Any of the predefined operations for MPI_REDUCE, as well as MPI_NO_OP or MPI_REPLACE, can be specified as `op`; user-defined functions cannot be used. The `datatype` argument must be a predefined datatype. The operation is executed atomically.

Compare and Swap Function

Another useful operation is an atomic compare and swap where the value at the origin is compared to the value at the target, which is atomically replaced by a third value only if the values at origin and target are equal.

```
MPI_COMPARE_AND_SWAP(origin_addr, compare_addr, result_addr, datatype, target_rank,
                      target_disp, win)
```

IN	origin_addr	initial address of buffer (choice)
IN	compare_addr	initial address of compare buffer (choice)
OUT	result_addr	initial address of result buffer (choice)
IN	datatype	datatype of the element in all buffers (handle)
IN	target_rank	rank of target (non-negative integer)
IN	target_disp	displacement from start of window to beginning of target buffer (non-negative integer)
IN	win	window object (handle)

```
int MPI_Compare_and_swap(const void *origin_addr, const void *compare_addr,
                        void *result_addr, MPI_Datatype datatype, int target_rank,
                        MPI_Aint target_disp, MPI_Win win)
```

```
MPI_Compare_and_swap(origin_addr, compare_addr, result_addr, datatype,
                    target_rank, target_disp, win, ierror)
    TYPE(*), DIMENSION(..), INTENT(IN), ASYNCHRONOUS :: origin_addr
    TYPE(*), DIMENSION(..), INTENT(IN), ASYNCHRONOUS :: compare_addr
    TYPE(*), DIMENSION(..), ASYNCHRONOUS :: result_addr
    TYPE(MPI_Datatype), INTENT(IN) :: datatype
    INTEGER, INTENT(IN) :: target_rank
    INTEGER(KIND=MPI_ADDRESS_KIND), INTENT(IN) :: target_disp
    TYPE(MPI_Win), INTENT(IN) :: win
    INTEGER, OPTIONAL, INTENT(OUT) :: ierror
```

```
MPI_COMPARE_AND_SWAP(ORIGIN_ADDR, COMPARE_ADDR, RESULT_ADDR, DATATYPE,
                    TARGET_RANK, TARGET_DISP, WIN, IERROR)
    <type> ORIGIN_ADDR(*), COMPARE_ADDR(*), RESULT_ADDR(*)
    INTEGER(KIND=MPI_ADDRESS_KIND) TARGET_DISP
    INTEGER DATATYPE, TARGET_RANK, WIN, IERROR
```

This function compares one element of type `datatype` in the compare buffer `compare_addr` with the buffer at offset `target_disp` in the target window specified by `target_rank` and `win` and replaces the value at the target with the value in the origin buffer `origin_addr` if the compare buffer and the target buffer are identical. The original value at the target is returned in the buffer `result_addr`. The parameter `datatype` must belong to one of the following categories of predefined datatypes: C integer, Fortran integer, Logical, Multi-language types, or Byte as specified in Section 5.9.2. The origin and result buffers (`origin_addr` and `result_addr`) must be disjoint.

11.3.5 Request-based RMA Communication Operations

Request-based RMA communication operations allow the user to associate a request handle with the RMA operations and test or wait for the completion of these requests using the functions described in Section 3.7.3. Request-based RMA operations are only valid within a passive target epoch (see Section 11.5).

Upon returning from a completion call in which an RMA operation completes, the `MPI_ERROR` field in the associated status object is set appropriately (see Section 3.2.5). All other fields of status and the results of status query functions (e.g., `MPI_GET_COUNT`) are undefined. It is valid to mix different request types (e.g., any combination of RMA requests, collective requests, I/O requests, generalized requests, or point-to-point requests) in functions that enable multiple completions (e.g., `MPI_WAITALL`). It is erroneous to call `MPI_REQUEST_FREE` or `MPI_CANCEL` for a request associated with an RMA operation. RMA requests are not persistent.

The end of the epoch, or explicit bulk synchronization using `MPI_WIN_FLUSH`, `MPI_WIN_FLUSH_ALL`, `MPI_WIN_FLUSH_LOCAL`, or `MPI_WIN_FLUSH_LOCAL_ALL`, also indicates completion of the RMA operations. However, users must still wait or test on the request handle to allow the MPI implementation to clean up any resources associated with these requests; in such cases the wait operation will complete locally.

```
MPI_RPUT(origin_addr, origin_count, origin_datatype, target_rank, target_disp, target_count,
        target_datatype, win, request)
```

IN	<code>origin_addr</code>	initial address of origin buffer (choice)
IN	<code>origin_count</code>	number of entries in origin buffer (non-negative integer)
IN	<code>origin_datatype</code>	datatype of each entry in origin buffer (handle)
IN	<code>target_rank</code>	rank of target (non-negative integer)
IN	<code>target_disp</code>	displacement from start of window to target buffer (non-negative integer)
IN	<code>target_count</code>	number of entries in target buffer (non-negative integer)
IN	<code>target_datatype</code>	datatype of each entry in target buffer (handle)
IN	<code>win</code>	window object used for communication (handle)
OUT	<code>request</code>	RMA request (handle)

```
int MPI_Rput(const void *origin_addr, int origin_count,
            MPI_Datatype origin_datatype, int target_rank,
            MPI_Aint target_disp, int target_count,
            MPI_Datatype target_datatype, MPI_Win win,
            MPI_Request *request)

MPI_Rput(origin_addr, origin_count, origin_datatype, target_rank,
        target_disp, target_count, target_datatype, win, request,
        ierror)
```

```

TYPE(*), DIMENSION(..), INTENT(IN), ASYNCHRONOUS :: origin_addr      1
INTEGER, INTENT(IN) :: origin_count, target_rank, target_count      2
TYPE(MPI_Datatype), INTENT(IN) :: origin_datatype, target_datatype  3
INTEGER(KIND=MPI_ADDRESS_KIND), INTENT(IN) :: target_disp          4
TYPE(MPI_Win), INTENT(IN) :: win                                   5
TYPE(MPI_Request), INTENT(OUT) :: request                          6
INTEGER, OPTIONAL, INTENT(OUT) :: ierror                          7
                                                                    8
MPI_RPUT(ORIGIN_ADDR, ORIGIN_COUNT, ORIGIN_DATATYPE, TARGET_RANK,   9
        TARGET_DISP, TARGET_COUNT, TARGET_DATATYPE, WIN, REQUEST, 10
        IERROR)                                                  11
<type> ORIGIN_ADDR(*)                                           12
INTEGER(KIND=MPI_ADDRESS_KIND) TARGET_DISP                       13
INTEGER ORIGIN_COUNT, ORIGIN_DATATYPE, TARGET_RANK, TARGET_COUNT, 14
        TARGET_DATATYPE, WIN, REQUEST, IERROR                    15

```

MPI_RPUT is similar to MPI_PUT (Section 11.3.1), except that it allocates a communication request object and associates it with the request handle (the argument `request`). The completion of an MPI_RPUT operation (i.e., after the corresponding test or wait) indicates that the sender is now free to update the locations in the origin buffer. It does not indicate that the data is available at the target window. If remote completion is required, MPI_WIN_FLUSH, MPI_WIN_FLUSH_ALL, MPI_WIN_UNLOCK, or MPI_WIN_UNLOCK_ALL can be used.

```

MPI_RGET(origin_addr, origin_count, origin_datatype, target_rank, target_disp, target_count,
        target_datatype, win, request)

```

OUT	origin_addr	initial address of origin buffer (choice)	27
IN	origin_count	number of entries in origin buffer (non-negative integer)	28
IN	origin_datatype	datatype of each entry in origin buffer (handle)	29
IN	target_rank	rank of target (non-negative integer)	30
IN	target_disp	displacement from window start to the beginning of the target buffer (non-negative integer)	31
IN	target_count	number of entries in target buffer (non-negative integer)	32
IN	target_datatype	datatype of each entry in target buffer (handle)	33
IN	win	window object used for communication (handle)	34
OUT	request	RMA request (handle)	35

```

int MPI_Rget(void *origin_addr, int origin_count,
             MPI_Datatype origin_datatype, int target_rank,
             MPI_Aint target_disp, int target_count,
             MPI_Datatype target_datatype, MPI_Win win,
             MPI_Request *request)

```

```

1 MPI_Rget(origin_addr, origin_count, origin_datatype, target_rank,
2         target_disp, target_count, target_datatype, win, request,
3         ierror)
4     TYPE(*), DIMENSION(..), ASYNCHRONOUS :: origin_addr
5     INTEGER, INTENT(IN) :: origin_count, target_rank, target_count
6     TYPE(MPI_Datatype), INTENT(IN) :: origin_datatype, target_datatype
7     INTEGER(KIND=MPI_ADDRESS_KIND), INTENT(IN) :: target_disp
8     TYPE(MPI_Win), INTENT(IN) :: win
9     TYPE(MPI_Request), INTENT(OUT) :: request
10    INTEGER, OPTIONAL, INTENT(OUT) :: ierror

```

```

11 MPI_RGET(ORIGIN_ADDR, ORIGIN_COUNT, ORIGIN_DATATYPE, TARGET_RANK,
12         TARGET_DISP, TARGET_COUNT, TARGET_DATATYPE, WIN, REQUEST,
13         IERROR)
14 <type> ORIGIN_ADDR(*)
15 INTEGER(KIND=MPI_ADDRESS_KIND) TARGET_DISP
16 INTEGER ORIGIN_COUNT, ORIGIN_DATATYPE, TARGET_RANK, TARGET_COUNT,
17         TARGET_DATATYPE, WIN, REQUEST, IERROR

```

19 MPI_RGET is similar to MPI_GET (Section 11.3.2), except that it allocates a commu-
20 nication request object and associates it with the request handle (the argument `request`)
21 that can be used to wait or test for completion. The completion of an MPI_RGET operation
22 indicates that the data is available in the origin buffer. If `origin_addr` points to memory
23 attached to a window, then the data becomes available in the private copy of this window.

```

24
25
26 MPI_RACCUMULATE(origin_addr, origin_count, origin_datatype, target_rank, target_disp,
27                target_count, target_datatype, op, win, request)
28
29 IN      origin_addr      initial address of buffer (choice)
30 IN      origin_count     number of entries in buffer (non-negative integer)
31 IN      origin_datatype  datatype of each entry in origin buffer (handle)
32 IN      target_rank      rank of target (non-negative integer)
33 IN      target_disp      displacement from start of window to beginning of tar-
34                          get buffer (non-negative integer)
35
36 IN      target_count     number of entries in target buffer (non-negative inte-
37                          ger)
38 IN      target_datatype  datatype of each entry in target buffer (handle)
39 IN      op               reduce operation (handle)
40 IN      win              window object (handle)
41 OUT     request          RMA request (handle)

```

```

42
43
44 int MPI_Raccumulate(const void *origin_addr, int origin_count,
45                   MPI_Datatype origin_datatype, int target_rank,
46                   MPI_Aint target_disp, int target_count,
47                   MPI_Datatype target_datatype, MPI_Op op, MPI_Win win,
48                   MPI_Request *request)

```

```

MPI_Raccumulate(origin_addr, origin_count, origin_datatype, target_rank,
                target_disp, target_count, target_datatype, op, win, request,
                ierror)
    TYPE(*), DIMENSION(..), INTENT(IN), ASYNCHRONOUS :: origin_addr
    INTEGER, INTENT(IN) :: origin_count, target_rank, target_count
    TYPE(MPI_Datatype), INTENT(IN) :: origin_datatype, target_datatype
    INTEGER(KIND=MPI_ADDRESS_KIND), INTENT(IN) :: target_disp
    TYPE(MPI_Op), INTENT(IN) :: op
    TYPE(MPI_Win), INTENT(IN) :: win
    TYPE(MPI_Request), INTENT(OUT) :: request
    INTEGER, OPTIONAL, INTENT(OUT) :: ierror

```

```

MPI_RACCUMULATE(ORIGIN_ADDR, ORIGIN_COUNT, ORIGIN_DATATYPE, TARGET_RANK,
                TARGET_DISP, TARGET_COUNT, TARGET_DATATYPE, OP, WIN, REQUEST,
                IERROR)
    <type> ORIGIN_ADDR(*)
    INTEGER(KIND=MPI_ADDRESS_KIND) TARGET_DISP
    INTEGER ORIGIN_COUNT, ORIGIN_DATATYPE, TARGET_RANK, TARGET_COUNT,
    TARGET_DATATYPE, OP, WIN, REQUEST, IERROR

```

MPI_RACCUMULATE is similar to MPI_ACCUMULATE (Section 11.3.4), except that it allocates a communication request object and associates it with the request handle (the argument request) that can be used to wait or test for completion. The completion of an MPI_RACCUMULATE operation indicates that the origin buffer is free to be updated. It does not indicate that the operation has completed at the target window.

```

1 MPI_RGET_ACCUMULATE(origin_addr, origin_count, origin_datatype, result_addr,
2     result_count, result_datatype, target_rank, target_disp, target_count,
3     target_datatype, op, win, request)
4
5     IN     origin_addr     initial address of buffer (choice)
6
7     IN     origin_count    number of entries in origin buffer (non-negative inte-
8
9     IN     origin_datatype datatype of each entry in origin buffer (handle)
10
11    OUT    result_addr     initial address of result buffer (choice)
12
13    IN     result_count    number of entries in result buffer (non-negative inte-
14
15    IN     result_datatype datatype of each entry in result buffer (handle)
16
17    IN     target_rank     rank of target (non-negative integer)
18
19    IN     target_disp     displacement from start of window to beginning of tar-
20
21    IN     target_count    number of entries in target buffer (non-negative inte-
22
23    IN     target_datatype datatype of each entry in target buffer (handle)
24
25    IN     op              reduce operation (handle)
26
27    IN     win             window object (handle)
28
29    OUT    request         RMA request (handle)
30
31
32
33 int MPI_Rget_accumulate(const void *origin_addr, int origin_count,
34     MPI_Datatype origin_datatype, void *result_addr,
35     int result_count, MPI_Datatype result_datatype,
36     int target_rank, MPI_Aint target_disp, int target_count,
37     MPI_Datatype target_datatype, MPI_Op op, MPI_Win win,
38     MPI_Request *request)
39
40 MPI_Rget_accumulate(origin_addr, origin_count, origin_datatype,
41     result_addr, result_count, result_datatype, target_rank,
42     target_disp, target_count, target_datatype, op, win, request,
43     ierror)
44     TYPE(*), DIMENSION(..), INTENT(IN), ASYNCHRONOUS :: origin_addr
45     TYPE(*), DIMENSION(..), ASYNCHRONOUS :: result_addr
46     INTEGER, INTENT(IN) :: origin_count, result_count, target_rank,
47     target_count
48     TYPE(MPI_Datatype), INTENT(IN) :: origin_datatype, target_datatype,
49     result_datatype
50     INTEGER(KIND=MPI_ADDRESS_KIND), INTENT(IN) :: target_disp
51     TYPE(MPI_Op), INTENT(IN) :: op
52     TYPE(MPI_Win), INTENT(IN) :: win
53     TYPE(MPI_Request), INTENT(OUT) :: request
54     INTEGER, OPTIONAL, INTENT(OUT) :: ierror

```

```

MPI_RGET_ACCUMULATE(ORIGIN_ADDR, ORIGIN_COUNT, ORIGIN_DATATYPE,
                    RESULT_ADDR, RESULT_COUNT, RESULT_DATATYPE, TARGET_RANK,
                    TARGET_DISP, TARGET_COUNT, TARGET_DATATYPE, OP, WIN, REQUEST,
                    IERROR)
<type> ORIGIN_ADDR(*), RESULT_ADDR(*)
INTEGER(KIND=MPI_ADDRESS_KIND) TARGET_DISP
INTEGER ORIGIN_COUNT, ORIGIN_DATATYPE, RESULT_COUNT, RESULT_DATATYPE,
        TARGET_RANK, TARGET_COUNT, TARGET_DATATYPE, OP, WIN, REQUEST,
        IERROR

```

MPI_RGET_ACCUMULATE is similar to MPI_GET_ACCUMULATE (Section 11.3.4), except that it allocates a communication request object and associates it with the request handle (the argument *request*) that can be used to wait or test for completion. The completion of an MPI_RGET_ACCUMULATE operation indicates that the data is available in the result buffer and the origin buffer is free to be updated. It does not indicate that the operation has been completed at the target window.

11.4 Memory Model

The memory semantics of RMA are best understood by using the concept of *public* and *private* window copies. We assume that systems have a public memory region that is addressable by all processes (e.g., the shared memory in shared memory machines or the exposed main memory in distributed memory machines). In addition, most machines have fast private buffers (e.g., transparent caches or explicit communication buffers) local to each process where copies of data elements from the main memory can be stored for faster access. Such buffers are either coherent, i.e., all updates to main memory are reflected in all private copies consistently, or non-coherent, i.e., conflicting accesses to main memory need to be synchronized and updated in all private copies explicitly. Coherent systems allow direct updates to remote memory without any participation of the remote side. Non-coherent systems, however, need to call RMA functions in order to reflect updates to the public window in their private memory. Thus, in coherent memory, the public and the private window are identical while they remain logically separate in the non-coherent case. MPI thus differentiates between two **memory models** called **RMA unified**, if public and private window are logically identical, and **RMA separate**, otherwise.

In the RMA separate model, there is only one instance of each variable in process memory, but a distinct *public* copy of the variable for each window that contains it. A load accesses the instance in process memory (this includes MPI sends). A local store accesses and updates the instance in process memory (this includes MPI receives), but the update may affect other public copies of the same locations. A get on a window accesses the public copy of that window. A put or accumulate on a window accesses and updates the public copy of that window, but the update may affect the private copy of the same locations in process memory, and public copies of other overlapping windows. This is illustrated in Figure 11.1.

In the RMA unified model, public and private copies are identical and updates via put or accumulate calls are eventually observed by load operations without additional RMA calls. A store access to a window is eventually visible to remote get or accumulate calls without additional RMA calls. These stronger semantics of the RMA unified model allow the user to omit some synchronization calls and potentially improve performance.

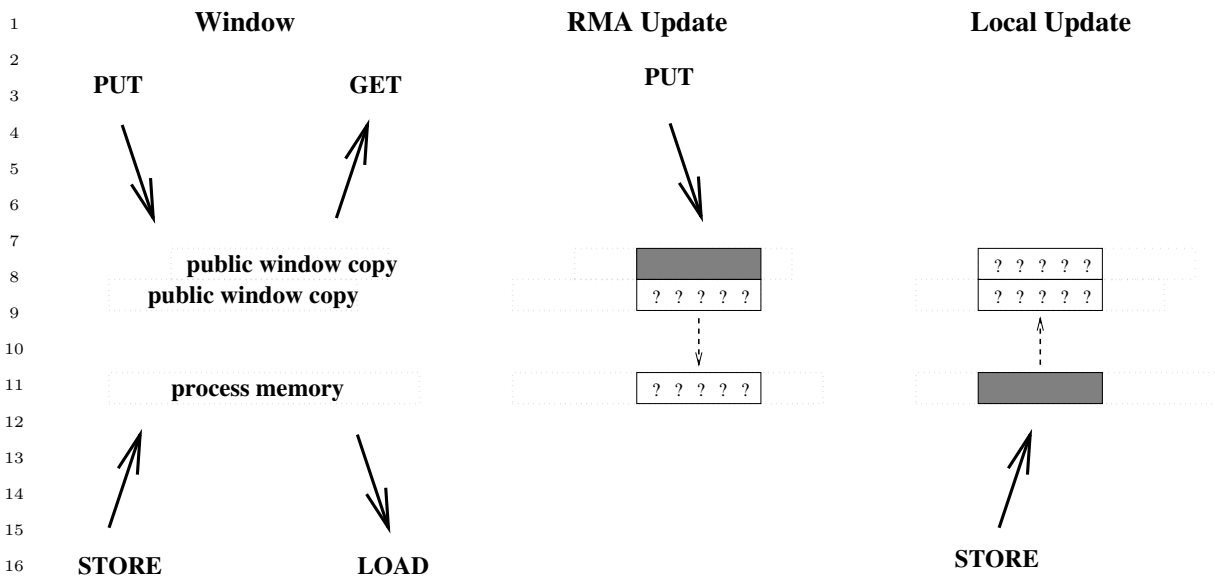

Figure 11.1: Schematic description of the public/private window operations in the MPI_WIN_SEPARATE memory model for two overlapping windows.

Advice to users. If accesses in the RMA unified model are not synchronized (with locks or flushes, see Section 11.5.3), load and store operations might observe changes to the memory while they are in progress. The order in which data is written is not specified unless further synchronization is used. This might lead to inconsistent views on memory and programs that assume that a transfer is complete by only checking parts of the message are erroneous. (*End of advice to users.*)

The memory model for a particular RMA window can be determined by accessing the attribute MPI_WIN_MODEL. If the memory model is the unified model, the value of this attribute is MPI_WIN_UNIFIED; otherwise, the value is MPI_WIN_SEPARATE.

11.5 Synchronization Calls

RMA communications fall in two categories:

- **active target communication**, where data is moved from the memory of one process to the memory of another, and both are explicitly involved in the communication. This communication pattern is similar to message passing, except that all the data transfer arguments are provided by one process, and the second process only participates in the synchronization.
- **passive target communication**, where data is moved from the memory of one process to the memory of another, and only the origin process is explicitly involved in the transfer. Thus, two origin processes may communicate by accessing the same location in a target window. The process that owns the target window may be distinct from the two communicating processes, in which case it does not participate explicitly in the communication. This communication paradigm is closest to a shared memory model, where shared data can be accessed by all processes, irrespective of location.

RMA communication calls with argument `win` must occur at a process only within an **access epoch** for `win`. Such an epoch starts with an RMA synchronization call on `win`; it proceeds with zero or more RMA communication calls (e.g., `MPI_PUT`, `MPI_GET` or `MPI_ACCUMULATE`) on `win`; it completes with another synchronization call on `win`. This allows users to amortize one synchronization with multiple data transfers and provide implementors more flexibility in the implementation of RMA operations.

Distinct access epochs for `win` at the same process must be disjoint. On the other hand, epochs pertaining to different `win` arguments may overlap. Local operations or other MPI calls may also occur during an epoch.

In active target communication, a target window can be accessed by RMA operations only within an **exposure epoch**. Such an epoch is started and completed by RMA synchronization calls executed by the target process. Distinct exposure epochs at a process on the same window must be disjoint, but such an exposure epoch may overlap with exposure epochs on other windows or with access epochs for the same or other `win` arguments. There is a one-to-one matching between access epochs at origin processes and exposure epochs on target processes: RMA operations issued by an origin process for a target window will access that target window during the same exposure epoch if and only if they were issued during the same access epoch.

In passive target communication the target process does not execute RMA synchronization calls, and there is no concept of an exposure epoch.

MPI provides three synchronization mechanisms:

1. The `MPI_WIN_FENCE` collective synchronization call supports a simple synchronization pattern that is often used in parallel computations: namely a loosely-synchronous model, where global computation phases alternate with global communication phases. This mechanism is most useful for loosely synchronous algorithms where the graph of communicating processes changes very frequently, or where each process communicates with many others.

This call is used for active target communication. An access epoch at an origin process or an exposure epoch at a target process are started and completed by calls to `MPI_WIN_FENCE`. A process can access windows at all processes in the group of `win` during such an access epoch, and the local window can be accessed by all processes in the group of `win` during such an exposure epoch.

2. The four functions `MPI_WIN_START`, `MPI_WIN_COMPLETE`, `MPI_WIN_POST`, and `MPI_WIN_WAIT` can be used to restrict synchronization to the minimum: only pairs of communicating processes synchronize, and they do so only when a synchronization is needed to order correctly RMA accesses to a window with respect to local accesses to that same window. This mechanism may be more efficient when each process communicates with few (logical) neighbors, and the communication graph is fixed or changes infrequently.

These calls are used for active target communication. An access epoch is started at the origin process by a call to `MPI_WIN_START` and is terminated by a call to `MPI_WIN_COMPLETE`. The start call has a group argument that specifies the group of target processes for that epoch. An exposure epoch is started at the target process by a call to `MPI_WIN_POST` and is completed by a call to `MPI_WIN_WAIT`. The post call has a group argument that specifies the set of origin processes for that epoch.

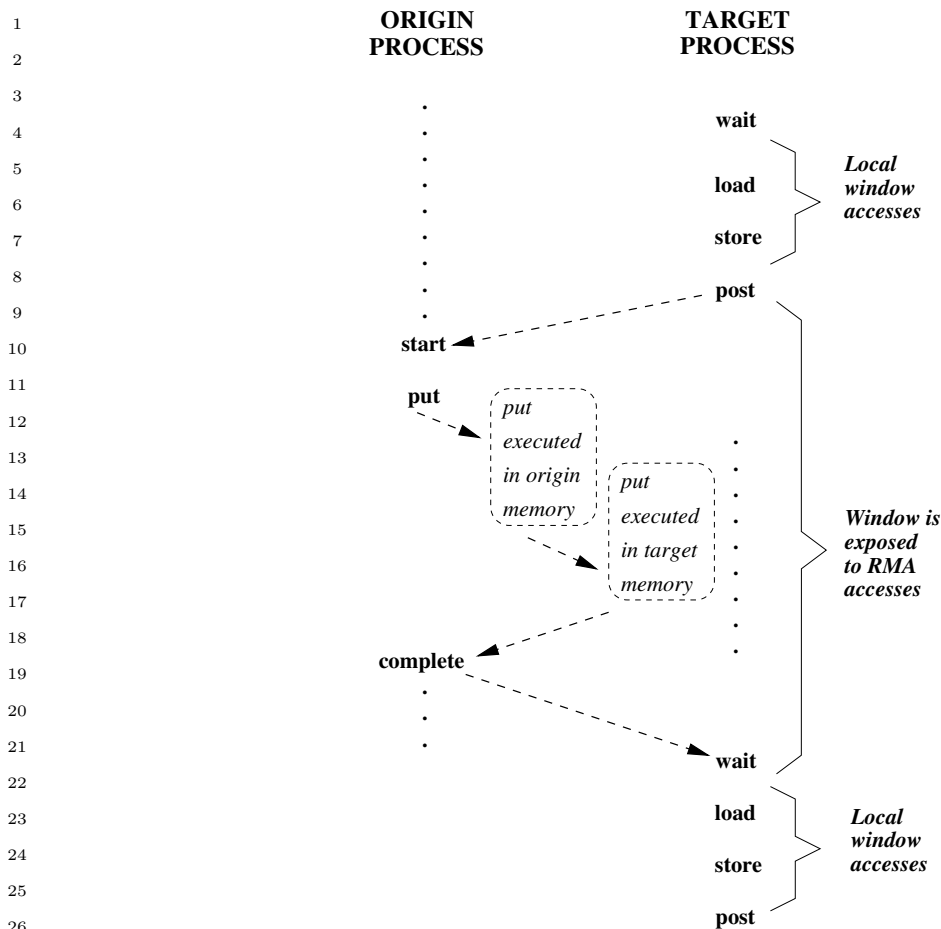

Figure 11.2: Active target communication. Dashed arrows represent synchronizations (ordering of events).

- Finally, shared lock access is provided by the functions `MPI_WIN_LOCK`, `MPI_WIN_LOCK_ALL`, `MPI_WIN_UNLOCK`, and `MPI_WIN_UNLOCK_ALL`. `MPI_WIN_LOCK` and `MPI_WIN_UNLOCK` also provide exclusive lock capability. Lock synchronization is useful for MPI applications that emulate a shared memory model via MPI calls; e.g., in a “billboard” model, where processes can, at random times, access or update different parts of the billboard.

These four calls provide passive target communication. An access epoch is started by a call to `MPI_WIN_LOCK` or `MPI_WIN_LOCK_ALL` and terminated by a call to `MPI_WIN_UNLOCK` or `MPI_WIN_UNLOCK_ALL`, respectively.

Figure 11.2 illustrates the general synchronization pattern for active target communication. The synchronization between `post` and `start` ensures that the `put` call of the origin process does not start until the target process exposes the window (with the `post` call); the target process will expose the window only after preceding local accesses to the window have completed. The synchronization between `complete` and `wait` ensures that the `put` call of the origin process completes before the window is unexposed (with the `wait` call). The target process will execute following local accesses to the target window only after the `wait` returned.

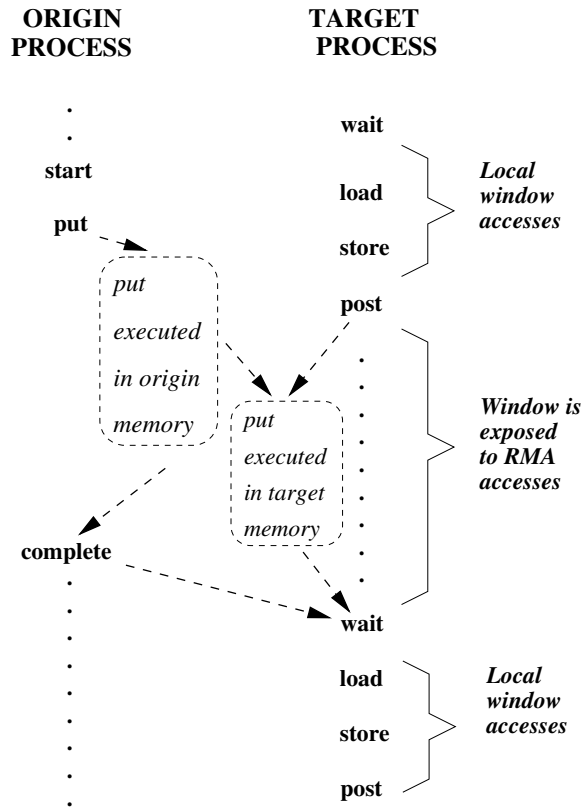

Figure 11.3: Active target communication, with weak synchronization. Dashed arrows represent synchronizations (ordering of events)

Figure 11.2 shows operations occurring in the natural temporal order implied by the synchronizations: the `post` occurs before the matching `start`, and `complete` occurs before the matching `wait`. However, such **strong synchronization** is more than needed for correct ordering of window accesses. The semantics of MPI calls allow **weak synchronization**, as illustrated in Figure 11.3. The access to the target window is delayed until the window is exposed, after the `post`. However the `start` may complete earlier; the `put` and `complete` may also terminate earlier, if put data is buffered by the implementation. The synchronization calls order correctly window accesses, but do not necessarily synchronize other operations. This weaker synchronization semantic allows for more efficient implementations.

Figure 11.4 illustrates the general synchronization pattern for passive target communication. The first origin process communicates data to the second origin process, through the memory of the target process; the target process is not explicitly involved in the communication. The `lock` and `unlock` calls ensure that the two RMA accesses do not occur concurrently. However, they do *not* ensure that the `put` by origin 1 will precede the `get` by origin 2.

Rationale. RMA does not define fine-grained mutexes in memory (only logical coarse-grained process locks). MPI provides the primitives (compare and swap, accumulate, send/receive, etc.) needed to implement high-level synchronization operations. (*End of rationale.*)

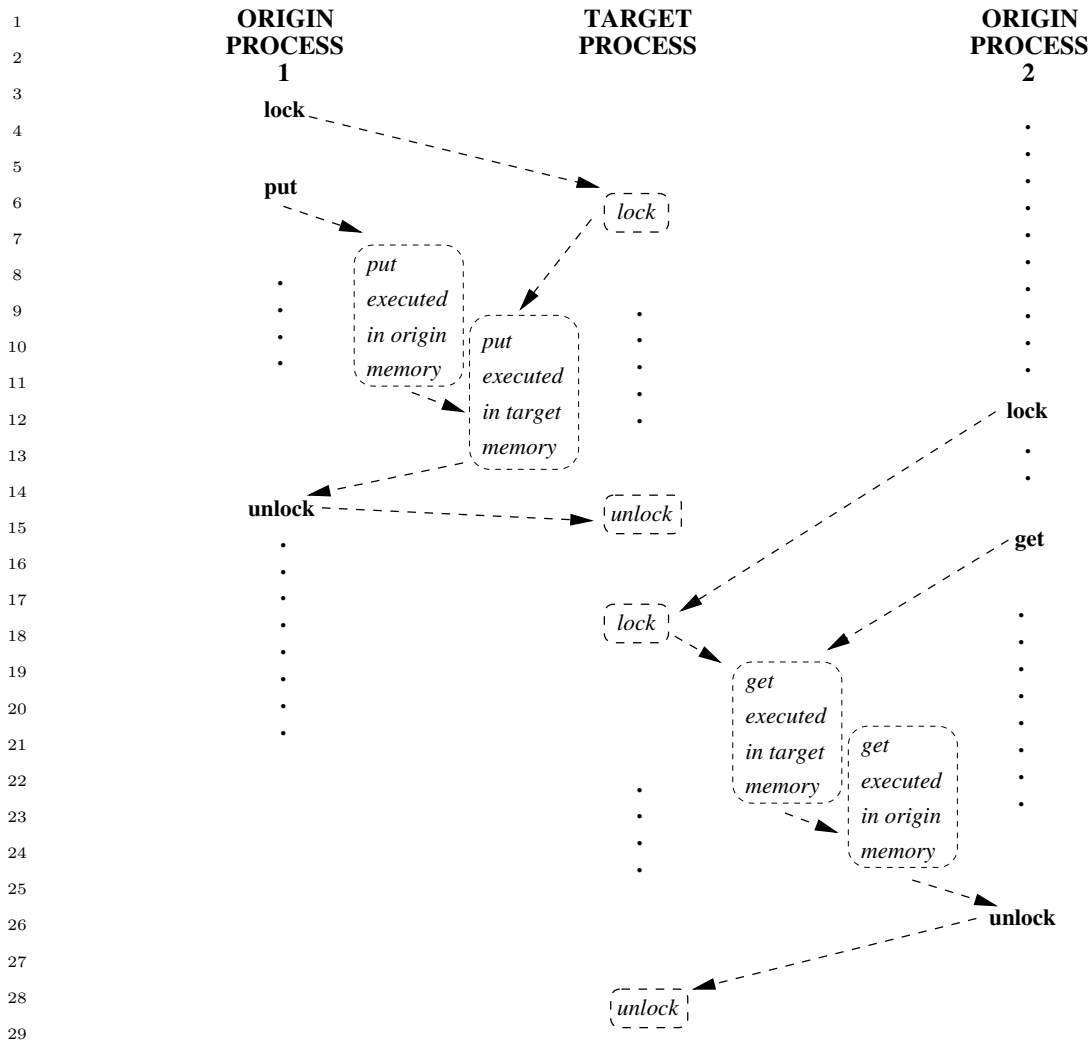

Figure 11.4: Passive target communication. Dashed arrows represent synchronizations (ordering of events).

11.5.1 Fence

```
MPI_WIN_FENCE(assert, win)
```

```
IN      assert          program assertion (integer)
IN      win             window object (handle)
```

```
int MPI_Win_fence(int assert, MPI_Win win)
```

```
MPI_Win_fence(assert, win, ierror)
    INTEGER, INTENT(IN) :: assert
    TYPE(MPI_Win), INTENT(IN) :: win
    INTEGER, OPTIONAL, INTENT(OUT) :: ierror
```

```
MPI_WIN_FENCE(ASSERT, WIN, IERROR)
```

INTEGER ASSERT, WIN, IERROR

The MPI call `MPI_WIN_FENCE(assert, win)` synchronizes RMA calls on `win`. The call is collective on the group of `win`. All RMA operations on `win` originating at a given process and started before the fence call will complete at that process before the fence call returns. They will be completed at their target before the fence call returns at the target. RMA operations on `win` started by a process after the fence call returns will access their target window only after `MPI_WIN_FENCE` has been called by the target process.

The call completes an RMA access epoch if it was preceded by another fence call and the local process issued RMA communication calls on `win` between these two calls. The call completes an RMA exposure epoch if it was preceded by another fence call and the local window was the target of RMA accesses between these two calls. The call starts an RMA access epoch if it is followed by another fence call and by RMA communication calls issued between these two fence calls. The call starts an exposure epoch if it is followed by another fence call and the local window is the target of RMA accesses between these two fence calls. Thus, the fence call is equivalent to calls to a subset of `post`, `start`, `complete`, `wait`.

A fence call usually entails a barrier synchronization: a process completes a call to `MPI_WIN_FENCE` only after all other processes in the group entered their matching call. However, a call to `MPI_WIN_FENCE` that is known not to end any epoch (in particular, a call with `assert` equal to `MPI_MODE_NOPRECEDE`) does not necessarily act as a barrier.

The `assert` argument is used to provide assertions on the context of the call that may be used for various optimizations. This is described in Section 11.5.5. A value of `assert = 0` is always valid.

Advice to users. Calls to `MPI_WIN_FENCE` should both precede and follow calls to RMA communication functions that are synchronized with fence calls. (*End of advice to users.*)

11.5.2 General Active Target Synchronization

`MPI_WIN_START(group, assert, win)`

IN	<code>group</code>	group of target processes (handle)
IN	<code>assert</code>	program assertion (integer)
IN	<code>win</code>	window object (handle)

`int MPI_Win_start(MPI_Group group, int assert, MPI_Win win)`

`MPI_Win_start(group, assert, win, ierror)`

TYPE(MPI_Group), INTENT(IN) ::	<code>group</code>
INTEGER, INTENT(IN) ::	<code>assert</code>
TYPE(MPI_Win), INTENT(IN) ::	<code>win</code>
INTEGER, OPTIONAL, INTENT(OUT) ::	<code>ierror</code>

`MPI_WIN_START(GROUP, ASSERT, WIN, IERROR)`

INTEGER GROUP, ASSERT, WIN, IERROR

Starts an RMA access epoch for `win`. RMA calls issued on `win` during this epoch must access only windows at processes in `group`. Each process in `group` must issue a matching

call to `MPI_WIN_POST`. RMA accesses to each target window will be delayed, if necessary, until the target process executed the matching call to `MPI_WIN_POST`. `MPI_WIN_START` is allowed to block until the corresponding `MPI_WIN_POST` calls are executed, but is not required to.

The `assert` argument is used to provide assertions on the context of the call that may be used for various optimizations. This is described in Section 11.5.5. A value of `assert = 0` is always valid.

```
MPI_WIN_COMPLETE(win)
```

```
IN      win                window object (handle)
```

```
int MPI_Win_complete(MPI_Win win)
```

```
MPI_Win_complete(win, ierror)
```

```
    TYPE(MPI_Win), INTENT(IN) :: win
```

```
    INTEGER, OPTIONAL, INTENT(OUT) :: ierror
```

```
MPI_WIN_COMPLETE(WIN, IERROR)
```

```
    INTEGER WIN, IERROR
```

Completes an RMA access epoch on `win` started by a call to `MPI_WIN_START`. All RMA communication calls issued on `win` during this epoch will have completed at the origin when the call returns.

`MPI_WIN_COMPLETE` enforces completion of preceding RMA calls at the origin, but not at the target. A put or accumulate call may not have completed at the target when it has completed at the origin.

Consider the sequence of calls in the example below.

Example 11.4

```
MPI_Win_start(group, flag, win);
```

```
MPI_Put(..., win);
```

```
MPI_Win_complete(win);
```

The call to `MPI_WIN_COMPLETE` does not return until the put call has completed at the origin; and the target window will be accessed by the put operation only after the call to `MPI_WIN_START` has matched a call to `MPI_WIN_POST` by the target process. This still leaves much choice to implementors. The call to `MPI_WIN_START` can block until the matching call to `MPI_WIN_POST` occurs at all target processes. One can also have implementations where the call to `MPI_WIN_START` is nonblocking, but the call to `MPI_PUT` blocks until the matching call to `MPI_WIN_POST` occurs; or implementations where the first two calls are nonblocking, but the call to `MPI_WIN_COMPLETE` blocks until the call to `MPI_WIN_POST` occurred; or even implementations where all three calls can complete before any target process has called `MPI_WIN_POST` — the data put must be buffered, in this last case, so as to allow the put to complete at the origin ahead of its completion at the target. However, once the call to `MPI_WIN_POST` is issued, the sequence above must complete, without further dependencies.

```

MPI_WIN_POST(group, assert, win) 1
    IN      group                group of origin processes (handle) 2
    IN      assert               program assertion (integer) 3
    IN      win                  window object (handle) 4
                                5
                                6

```

```

int MPI_Win_post(MPI_Group group, int assert, MPI_Win win) 7
                                8

```

```

MPI_Win_post(group, assert, win, ierror) 9
    TYPE(MPI_Group), INTENT(IN) :: group 10
    INTEGER, INTENT(IN) :: assert 11
    TYPE(MPI_Win), INTENT(IN) :: win 12
    INTEGER, OPTIONAL, INTENT(OUT) :: ierror 13

```

```

MPI_WIN_POST(GROUP, ASSERT, WIN, IERROR) 14
    INTEGER GROUP, ASSERT, WIN, IERROR 15
                                16

```

Starts an RMA exposure epoch for the local window associated with `win`. Only processes in `group` should access the window with RMA calls on `win` during this epoch. Each process in `group` must issue a matching call to `MPI_WIN_START`. `MPI_WIN_POST` does not block.

```

MPI_WIN_WAIT(win) 21
    IN      win                  window object (handle) 22
                                23
                                24

```

```

int MPI_Win_wait(MPI_Win win) 25
                                26

```

```

MPI_Win_wait(win, ierror) 27
    TYPE(MPI_Win), INTENT(IN) :: win 28
    INTEGER, OPTIONAL, INTENT(OUT) :: ierror 29

```

```

MPI_WIN_WAIT(WIN, IERROR) 30
    INTEGER WIN, IERROR 31
                                32

```

Completes an RMA exposure epoch started by a call to `MPI_WIN_POST` on `win`. This call matches calls to `MPI_WIN_COMPLETE(win)` issued by each of the origin processes that were granted access to the window during this epoch. The call to `MPI_WIN_WAIT` will block until all matching calls to `MPI_WIN_COMPLETE` have occurred. This guarantees that all these origin processes have completed their RMA accesses to the local window. When the call returns, all these RMA accesses will have completed at the target window.

Figure 11.5 illustrates the use of these four functions. Process 0 puts data in the windows of processes 1 and 2 and process 3 puts data in the window of process 2. Each start call lists the ranks of the processes whose windows will be accessed; each post call lists the ranks of the processes that access the local window. The figure illustrates a possible timing for the events, assuming strong synchronization; in a weak synchronization, the start, put or complete calls may occur ahead of the matching post calls.

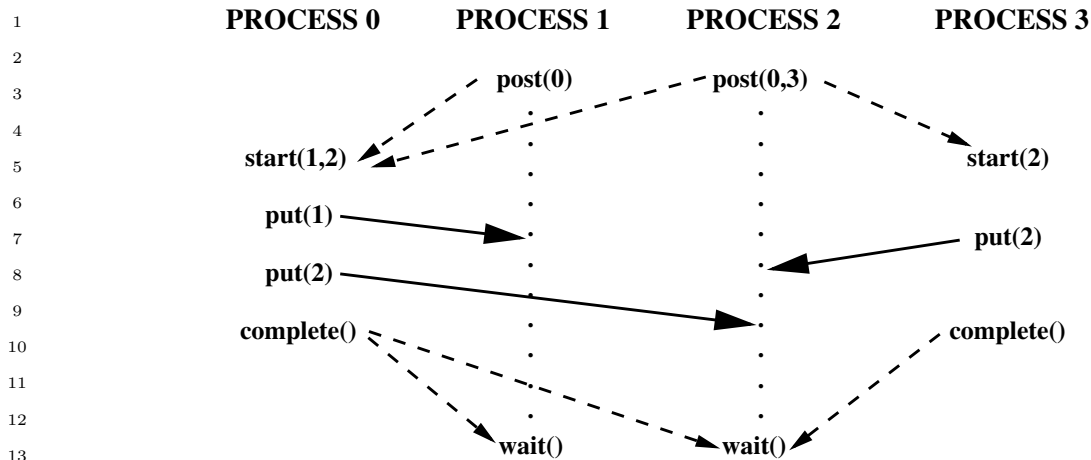

Figure 11.5: Active target communication. Dashed arrows represent synchronizations and solid arrows represent data transfer.

```
MPI_WIN_TEST(win, flag)
```

IN	win	window object (handle)
OUT	flag	success flag (logical)

```
int MPI_Win_test(MPI_Win win, int *flag)
```

```
MPI_Win_test(win, flag, ierror)
    TYPE(MPI_Win), INTENT(IN) :: win
    LOGICAL, INTENT(OUT) :: flag
    INTEGER, OPTIONAL, INTENT(OUT) :: ierror
```

```
MPI_WIN_TEST(WIN, FLAG, IERROR)
    INTEGER WIN, IERROR
    LOGICAL FLAG
```

This is the nonblocking version of `MPI_WIN_WAIT`. It returns `flag = true` if all accesses to the local window by the group to which it was exposed by the corresponding `MPI_WIN_POST` call have been completed as signalled by matching `MPI_WIN_COMPLETE` calls, and `flag = false` otherwise. In the former case `MPI_WIN_WAIT` would have returned immediately. The effect of return of `MPI_WIN_TEST` with `flag = true` is the same as the effect of a return of `MPI_WIN_WAIT`. If `flag = false` is returned, then the call has no visible effect.

`MPI_WIN_TEST` should be invoked only where `MPI_WIN_WAIT` can be invoked. Once the call has returned `flag = true`, it must not be invoked anew, until the window is posted anew.

Assume that window `win` is associated with a “hidden” communicator `wincomm`, used for communication by the processes of `win`. The rules for matching of post and start calls and for matching complete and wait calls can be derived from the rules for matching sends and receives, by considering the following (partial) model implementation.

`MPI_WIN_POST(group,0,win)` initiates a nonblocking send with tag `tag0` to each process in `group`, using `wincomm`. There is no need to wait for the completion of these sends.

MPI_WIN_START(group,0,win) initiates a nonblocking receive with tag `tag0` from each process in `group`, using `wincomm`. An RMA access to a window in target process `i` is delayed until the receive from `i` is completed.

MPI_WIN_COMPLETE(win) initiates a nonblocking send with tag `tag1` to each process in the group of the preceding start call. No need to wait for the completion of these sends.

MPI_WIN_WAIT(win) initiates a nonblocking receive with tag `tag1` from each process in the group of the preceding post call. Wait for the completion of all receives.

No races can occur in a correct program: each of the sends matches a unique receive, and vice versa.

Rationale. The design for general active target synchronization requires the user to provide complete information on the communication pattern, at each end of a communication link: each origin specifies a list of targets, and each target specifies a list of origins. This provides maximum flexibility (hence, efficiency) for the implementor: each synchronization can be initiated by either side, since each “knows” the identity of the other. This also provides maximum protection from possible races. On the other hand, the design requires more information than RMA needs: in general, it is sufficient for the origin to know the rank of the target, but not vice versa. Users that want more “anonymous” communication will be required to use the fence or lock mechanisms. (*End of rationale.*)

Advice to users. Assume a communication pattern that is represented by a directed graph $G = \langle V, E \rangle$, where $V = \{0, \dots, n - 1\}$ and $ij \in E$ if origin process i accesses the window at target process j . Then each process i issues a call to `MPI_WIN_POST(ingroupi, ...)`, followed by a call to `MPI_WIN_START(outgroupi, ...)`, where $outgroup_i = \{j : ij \in E\}$ and $ingroup_i = \{j : ji \in E\}$. A call is a noop, and can be skipped, if the `group` argument is empty. After the communications calls, each process that issued a start will issue a complete. Finally, each process that issued a post will issue a wait.

Note that each process may call with a `group` argument that has different members. (*End of advice to users.*)

11.5.3 Lock

`MPI_WIN_LOCK(lock_type, rank, assert, win)`

IN	<code>lock_type</code>	either <code>MPI_LOCK_EXCLUSIVE</code> or <code>MPI_LOCK_SHARED</code> (state)
IN	<code>rank</code>	rank of locked window (non-negative integer)
IN	<code>assert</code>	program assertion (integer)
IN	<code>win</code>	window object (handle)

`int MPI_Win_lock(int lock_type, int rank, int assert, MPI_Win win)`

```

1 MPI_Win_lock(lock_type, rank, assert, win, ierror)
2     INTEGER, INTENT(IN) :: lock_type, rank, assert
3     TYPE(MPI_Win), INTENT(IN) :: win
4     INTEGER, OPTIONAL, INTENT(OUT) :: ierror

```

```

5
6 MPI_WIN_LOCK(LOCK_TYPE, RANK, ASSERT, WIN, IERROR)
7     INTEGER LOCK_TYPE, RANK, ASSERT, WIN, IERROR

```

8 Starts an RMA access epoch. The window at the process with rank `rank` can be accessed
9 by RMA operations on `win` during that epoch. Multiple RMA access epochs (with calls
10 to `MPI_WIN_LOCK`) can occur simultaneously; however, each access epoch must target a
11 different process.

```

12
13
14 MPI_WIN_LOCK_ALL(assert, win)

```

```

15     IN          assert                program assertion (integer)
16     IN          win                   window object (handle)

```

```

17
18
19 int MPI_Win_lock_all(int assert, MPI_Win win)

```

```

20 MPI_Win_lock_all(assert, win, ierror)
21     INTEGER, INTENT(IN) :: assert
22     TYPE(MPI_Win), INTENT(IN) :: win
23     INTEGER, OPTIONAL, INTENT(OUT) :: ierror

```

```

24
25 MPI_WIN_LOCK_ALL(ASSERT, WIN, IERROR)
26     INTEGER ASSERT, WIN, IERROR

```

27 Starts an RMA access epoch to all processes in `win`, with a lock type of
28 `MPI_LOCK_SHARED`. During the epoch, the calling process can access the window memory on
29 all processes in `win` by using RMA operations. A window locked with `MPI_WIN_LOCK_ALL`
30 must be unlocked with `MPI_WIN_UNLOCK_ALL`. This routine is not collective — the `ALL`
31 refers to a lock on all members of the group of the window.

32
33 *Advice to users.* There may be additional overheads associated with using
34 `MPI_WIN_LOCK` and `MPI_WIN_LOCK_ALL` concurrently on the same window. These
35 overheads could be avoided by specifying the assertion `MPI_MODE_NOCHECK` when
36 possible (see Section 11.5.5). (*End of advice to users.*)

```

37
38
39 MPI_WIN_UNLOCK(rank, win)

```

```

40
41     IN          rank                   rank of window (non-negative integer)
42     IN          win                   window object (handle)

```

```

43
44
45 int MPI_Win_unlock(int rank, MPI_Win win)

```

```

46 MPI_Win_unlock(rank, win, ierror)
47     INTEGER, INTENT(IN) :: rank
48     TYPE(MPI_Win), INTENT(IN) :: win

```

```

    INTEGER, OPTIONAL, INTENT(OUT) :: ierror
MPI_WIN_UNLOCK(RANK, WIN, IERROR)
    INTEGER RANK, WIN, IERROR

    Completes an RMA access epoch started by a call to MPI_WIN_LOCK on window win.
    RMA operations issued during this period will have completed both at the origin and at the
    target when the call returns.

MPI_WIN_UNLOCK_ALL(win)
    IN          win          window object (handle)

int MPI_Win_unlock_all(MPI_Win win)
MPI_Win_unlock_all(win, ierror)
    TYPE(MPI_Win), INTENT(IN) :: win
    INTEGER, OPTIONAL, INTENT(OUT) :: ierror

MPI_WIN_UNLOCK_ALL(WIN, IERROR)
    INTEGER WIN, IERROR

```

Completes a shared RMA access epoch started by a call to MPI_WIN_LOCK_ALL on window win. RMA operations issued during this epoch will have completed both at the origin and at the target when the call returns.

Locks are used to protect accesses to the locked target window effected by RMA calls issued between the lock and unlock calls, and to protect load/store accesses to a locked local or shared memory window executed between the lock and unlock calls. Accesses that are protected by an exclusive lock will not be concurrent at the window site with other accesses to the same window that are lock protected. Accesses that are protected by a shared lock will not be concurrent at the window site with accesses protected by an exclusive lock to the same window.

It is erroneous to have a window locked and exposed (in an exposure epoch) concurrently. For example, a process may not call MPI_WIN_LOCK to lock a target window if the target process has called MPI_WIN_POST and has not yet called MPI_WIN_WAIT; it is erroneous to call MPI_WIN_POST while the local window is locked.

Rationale. An alternative is to require MPI to enforce mutual exclusion between exposure epochs and locking periods. But this would entail additional overheads when locks or active target synchronization do not interact in support of those rare interactions between the two mechanisms. The programming style that we encourage here is that a set of windows is used with only one synchronization mechanism at a time, with shifts from one mechanism to another being rare and involving global synchronization. (*End of rationale.*)

Advice to users. Users need to use explicit synchronization code in order to enforce mutual exclusion between locking periods and exposure epochs on a window. (*End of advice to users.*)

1 Implementors may restrict the use of RMA communication that is synchronized by
 2 lock calls to windows in memory allocated by MPI_ALLOC_MEM (Section 8.2),
 3 MPI_WIN_ALLOCATE (Section 11.2.2), or attached with MPI_WIN_ATTACH
 4 (Section 11.2.4). Locks can be used portably only in such memory.

6 *Rationale.* The implementation of passive target communication when memory
 7 is not shared may require an asynchronous software agent. Such an agent can be
 8 implemented more easily, and can achieve better performance, if restricted to specially
 9 allocated memory. It can be avoided altogether if shared memory is used. It seems
 10 natural to impose restrictions that allows one to use shared memory for third party
 11 communication in shared memory machines.

12 (*End of rationale.*)

14 Consider the sequence of calls in the example below.

16 Example 11.5

```
17 MPI_Win_lock(MPI_LOCK_EXCLUSIVE, rank, assert, win);
18 MPI_Put(..., rank, ..., win);
19 MPI_Win_unlock(rank, win);
20
```

21 The call to MPI_WIN_UNLOCK will not return until the put transfer has completed at
 22 the origin and at the target. This still leaves much freedom to implementors. The call to
 23 MPI_WIN_LOCK may block until an exclusive lock on the window is acquired; or, the first
 24 two calls may not block, while MPI_WIN_UNLOCK blocks until a lock is acquired — the
 25 update of the target window is then postponed until the call to MPI_WIN_UNLOCK occurs.
 26 However, if the call to MPI_WIN_LOCK is used to lock a local window, then the call must
 27 block until the lock is acquired, since the lock may protect local load/store accesses to the
 28 window issued after the lock call returns.

30 11.5.4 Flush and Sync

31 All flush and sync functions can be called only within passive target epochs.

```
34 MPI_WIN_FLUSH(rank, win)
```

36	IN	rank	rank of target window (non-negative integer)
37	IN	win	window object (handle)

```
39 int MPI_Win_flush(int rank, MPI_Win win)
40
41 MPI_Win_flush(rank, win, ierror)
42     INTEGER, INTENT(IN) :: rank
43     TYPE(MPI_Win), INTENT(IN) :: win
44     INTEGER, OPTIONAL, INTENT(OUT) :: ierror
45
46 MPI_WIN_FLUSH(RANK, WIN, IERROR)
47     INTEGER RANK, WIN, IERROR
48
```

MPI_WIN_FLUSH completes all outstanding RMA operations initiated by the calling process to the target rank on the specified window. The operations are completed both at the origin and at the target.

MPI_WIN_FLUSH_ALL(win)

IN win window object (handle)

int MPI_Win_flush_all(MPI_Win win)

MPI_Win_flush_all(win, ierror)

TYPE(MPI_Win), INTENT(IN) :: win

INTEGER, OPTIONAL, INTENT(OUT) :: ierror

MPI_WIN_FLUSH_ALL(WIN, IERROR)

INTEGER WIN, IERROR

All RMA operations issued by the calling process to any target on the specified window prior to this call and in the specified window will have completed both at the origin and at the target when this call returns.

MPI_WIN_FLUSH_LOCAL(rank, win)

IN rank rank of target window (non-negative integer)

IN win window object (handle)

int MPI_Win_flush_local(int rank, MPI_Win win)

MPI_Win_flush_local(rank, win, ierror)

INTEGER, INTENT(IN) :: rank

TYPE(MPI_Win), INTENT(IN) :: win

INTEGER, OPTIONAL, INTENT(OUT) :: ierror

MPI_WIN_FLUSH_LOCAL(RANK, WIN, IERROR)

INTEGER RANK, WIN, IERROR

Locally completes at the origin all outstanding RMA operations initiated by the calling process to the target process specified by rank on the specified window. For example, after this routine completes, the user may reuse any buffers provided to put, get, or accumulate operations.

MPI_WIN_FLUSH_LOCAL_ALL(win)

IN win window object (handle)

int MPI_Win_flush_local_all(MPI_Win win)

MPI_Win_flush_local_all(win, ierror)

TYPE(MPI_Win), INTENT(IN) :: win

INTEGER, OPTIONAL, INTENT(OUT) :: ierror

1 MPI_WIN_FLUSH_LOCAL_ALL(WIN, IERROR)

2 INTEGER WIN, IERROR

3
4 All RMA operations issued to any target prior to this call in this window will have
5 completed at the origin when MPI_WIN_FLUSH_LOCAL_ALL returns.

6
7 MPI_WIN_SYNC(win)

8 IN win window object (handle)

9
10
11 int MPI_Win_sync(MPI_Win win)

12 MPI_Win_sync(win, ierror)

13 TYPE(MPI_Win), INTENT(IN) :: win

14 INTEGER, OPTIONAL, INTENT(OUT) :: ierror

15
16 MPI_WIN_SYNC(WIN, IERROR)

17 INTEGER WIN, IERROR

18
19 The call MPI_WIN_SYNC synchronizes the private and public window copies of win.
20 For the purposes of synchronizing the private and public window, MPI_WIN_SYNC has the
21 effect of ending and reopening an access and exposure epoch on the window (note that it
22 does not actually end an epoch or complete any pending MPI RMA operations).

23 11.5.5 Assertions

24
25 The assert argument in the calls MPI_WIN_POST, MPI_WIN_START, MPI_WIN_FENCE,
26 MPI_WIN_LOCK, and MPI_WIN_LOCK_ALL is used to provide assertions on the context of
27 the call that may be used to optimize performance. The assert argument does not change
28 program semantics if it provides correct information on the program — it is erroneous to
29 provide incorrect information. Users may always provide `assert = 0` to indicate a general
30 case where no guarantees are made.

31
32 *Advice to users.* Many implementations may not take advantage of the information
33 in `assert`; some of the information is relevant only for noncoherent shared memory ma-
34 chines. Users should consult their implementation’s manual to find which information
35 is useful on each system. On the other hand, applications that provide correct asser-
36 tions whenever applicable are portable and will take advantage of assertion specific
37 optimizations whenever available. (*End of advice to users.*)

38
39 *Advice to implementors.* Implementations can always ignore the
40 `assert` argument. Implementors should document which `assert` values are significant
41 on their implementation. (*End of advice to implementors.*)

42
43 `assert` is the bit-vector OR of zero or more of the following integer constants:
44 MPI_MODE_NOCHECK, MPI_MODE_NOSTORE, MPI_MODE_NOPUT,
45 MPI_MODE_NOPRECEDE, and MPI_MODE_NOSUCCEED. The significant options are listed
46 below for each call.

47
48 *Advice to users.* C/C++ users can use bit vector or (|) to combine these constants;
Fortran 90 users can use the bit-vector IOR intrinsic. Alternatively, Fortran users can

portably use integer addition to OR the constants (each constant should appear at most once in the addition!). (*End of advice to users.*)

MPI_WIN_START:

MPI_MODE_NOCHECK — the matching calls to MPI_WIN_POST have already completed on all target processes when the call to MPI_WIN_START is made. The nocheck option can be specified in a start call if and only if it is specified in each matching post call. This is similar to the optimization of “ready-send” that may save a handshake when the handshake is implicit in the code. (However, ready-send is matched by a regular receive, whereas both start and post must specify the nocheck option.)

MPI_WIN_POST:

MPI_MODE_NOCHECK — the matching calls to MPI_WIN_START have not yet occurred on any origin processes when the call to MPI_WIN_POST is made. The nocheck option can be specified by a post call if and only if it is specified by each matching start call.

MPI_MODE_NOSTORE — the local window was not updated by stores (or local get or receive calls) since last synchronization. This may avoid the need for cache synchronization at the post call.

MPI_MODE_NOPUT — the local window will not be updated by put or accumulate calls after the post call, until the ensuing (wait) synchronization. This may avoid the need for cache synchronization at the wait call.

MPI_WIN_FENCE:

MPI_MODE_NOSTORE — the local window was not updated by stores (or local get or receive calls) since last synchronization.

MPI_MODE_NOPUT — the local window will not be updated by put or accumulate calls after the fence call, until the ensuing (fence) synchronization.

MPI_MODE_NOPRECEDE — the fence does not complete any sequence of locally issued RMA calls. If this assertion is given by any process in the window group, then it must be given by all processes in the group.

MPI_MODE_NOSUCCEED — the fence does not start any sequence of locally issued RMA calls. If the assertion is given by any process in the window group, then it must be given by all processes in the group.

MPI_WIN_LOCK, MPI_WIN_LOCK_ALL:

MPI_MODE_NOCHECK — no other process holds, or will attempt to acquire, a conflicting lock, while the caller holds the window lock. This is useful when mutual exclusion is achieved by other means, but the coherence operations that may be attached to the lock and unlock calls are still required.

Advice to users. Note that the nostore and noprecede flags provide information on what happened *before* the call; the noput and nosucceed flags provide information on what will happen *after* the call. (*End of advice to users.*)

11.5.6 Miscellaneous Clarifications

Once an RMA routine completes, it is safe to free any opaque objects passed as arguments to that routine. For example, the `datatype` argument of a `MPI_PUT` call can be freed as soon as the call returns, even though the communication may not be complete.

As in message-passing, datatypes must be committed before they can be used in RMA communication.

11.6 Error Handling

11.6.1 Error Handlers

Errors occurring during calls to routines that create MPI windows (e.g., `MPI_WIN_CREATE` (`...,comm,...`)) cause the error handler currently associated with `comm` to be invoked. All other RMA calls have an input `win` argument. When an error occurs during such a call, the error handler currently associated with `win` is invoked.

The default error handler associated with `win` is `MPI_ERRORS_ARE_FATAL`. Users may change this default by explicitly associating a new error handler with `win` (see Section 8.3).

11.6.2 Error Classes

The error classes for one-sided communication are defined in Table 11.2. RMA routines may (and almost certainly will) use other MPI error classes, such as `MPI_ERR_OP` or `MPI_ERR_RANK`.

<code>MPI_ERR_WIN</code>	invalid <code>win</code> argument
<code>MPI_ERR_BASE</code>	invalid <code>base</code> argument
<code>MPI_ERR_SIZE</code>	invalid <code>size</code> argument
<code>MPI_ERR_DISP</code>	invalid <code>disp</code> argument
<code>MPI_ERR_LOCKTYPE</code>	invalid <code>locktype</code> argument
<code>MPI_ERR_ASSERT</code>	invalid <code>assert</code> argument
<code>MPI_ERR_RMA_CONFLICT</code>	conflicting accesses to window
<code>MPI_ERR_RMA_SYNC</code>	invalid synchronization of RMA calls
<code>MPI_ERR_RMA_RANGE</code>	target memory is not part of the window (in the case of a window created with <code>MPI_WIN_CREATE_DYNAMIC</code> , target memory is not attached)
<code>MPI_ERR_RMA_ATTACH</code>	memory cannot be attached (e.g., because of resource exhaustion)
<code>MPI_ERR_RMA_SHARED</code>	memory cannot be shared (e.g., some process in the group of the specified communicator cannot expose shared memory)
<code>MPI_ERR_RMA_FLAVOR</code>	passed window has the wrong flavor for the called function

Table 11.2: Error classes in one-sided communication routines

11.7 Semantics and Correctness

The following rules specify the latest time at which an operation must complete at the origin or the target. The update performed by a get call in the origin process memory is visible when the get operation is complete at the origin (or earlier); the update performed by a put or accumulate call in the public copy of the target window is visible when the put or accumulate has completed at the target (or earlier). The rules also specify the latest time at which an update of one window copy becomes visible in another overlapping copy.

1. An RMA operation is completed at the origin by the ensuing call to `MPI_WIN_COMPLETE`, `MPI_WIN_FENCE`, `MPI_WIN_FLUSH`, `MPI_WIN_FLUSH_ALL`, `MPI_WIN_FLUSH_LOCAL`, `MPI_WIN_FLUSH_LOCAL_ALL`, `MPI_WIN_UNLOCK`, or `MPI_WIN_UNLOCK_ALL` that synchronizes this access at the origin.
2. If an RMA operation is completed at the origin by a call to `MPI_WIN_FENCE` then the operation is completed at the target by the matching call to `MPI_WIN_FENCE` by the target process.
3. If an RMA operation is completed at the origin by a call to `MPI_WIN_COMPLETE` then the operation is completed at the target by the matching call to `MPI_WIN_WAIT` by the target process.
4. If an RMA operation is completed at the origin by a call to `MPI_WIN_UNLOCK`, `MPI_WIN_UNLOCK_ALL`, `MPI_WIN_FLUSH(rank=target)`, or `MPI_WIN_FLUSH_ALL`, then the operation is completed at the target by that same call.
5. An update of a location in a private window copy in process memory becomes visible in the public window copy at latest when an ensuing call to `MPI_WIN_POST`, `MPI_WIN_FENCE`, `MPI_WIN_UNLOCK`, `MPI_WIN_UNLOCK_ALL`, or `MPI_WIN_SYNC` is executed on that window by the window owner. In the RMA unified memory model, an update of a location in a private window in process memory becomes visible without additional RMA calls.
6. An update by a put or accumulate call to a public window copy becomes visible in the private copy in process memory at latest when an ensuing call to `MPI_WIN_WAIT`, `MPI_WIN_FENCE`, `MPI_WIN_LOCK`, `MPI_WIN_LOCK_ALL`, or `MPI_WIN_SYNC` is executed on that window by the window owner. In the RMA unified memory model, an update by a put or accumulate call to a public window copy eventually becomes visible in the private copy in process memory without additional RMA calls.

The `MPI_WIN_FENCE` or `MPI_WIN_WAIT` call that completes the transfer from public copy to private copy (6) is the same call that completes the put or accumulate operation in the window copy (2, 3). If a put or accumulate access was synchronized with a lock, then the update of the public window copy is complete as soon as the updating process executed `MPI_WIN_UNLOCK` or `MPI_WIN_UNLOCK_ALL`. In the RMA separate memory model, the update of a private copy in the process memory may be delayed until the target process executes a synchronization call on that window (6). Thus, updates to process memory can always be delayed in the RMA separate memory model until the process executes a suitable

1 synchronization call, while they must complete in the RMA unified model without additional
2 synchronization calls. If fence or post-start-complete-wait synchronization is used, updates
3 to a public window copy can be delayed in both memory models until the window owner
4 executes a synchronization call. When passive target synchronization is used, it is necessary
5 to update the public window copy even if the window owner does not execute any related
6 synchronization call.

7 The rules above also define, by implication, when an update to a public window copy
8 becomes visible in another overlapping public window copy. Consider, for example, two
9 overlapping windows, win1 and win2. A call to `MPI_WIN_FENCE(0, win1)` by the window
10 owner makes visible in the process memory previous updates to window win1 by remote
11 processes. A subsequent call to `MPI_WIN_FENCE(0, win2)` makes these updates visible in
12 the public copy of win2.

13 The behavior of some MPI RMA operations may be *undefined* in certain situations. For
14 example, the result of several origin processes performing concurrent `MPI_PUT` operations
15 to the same target location is undefined. In addition, the result of a single origin process
16 performing multiple `MPI_PUT` operations to the same target location within the same
17 access epoch is also undefined. The result at the target may have all of the data from one
18 of the `MPI_PUT` operations (the “last” one, in some sense), bytes from some of each of the
19 operations, or something else. In MPI-2, such operations were *erroneous*. That meant that
20 an MPI implementation was permitted to signal an MPI exception. Thus, user programs or
21 tools that used MPI RMA could not portably permit such operations, even if the application
22 code could function correctly with such an undefined result. In MPI-3, these operations are
23 not erroneous, but do not have a defined behavior.

24 *Rationale.* As discussed in [6], requiring operations such as overlapping puts to
25 be erroneous makes it difficult to use MPI RMA to implement programming models—
26 such as Unified Parallel C (UPC) or SHMEM—that permit these operations. Further,
27 while MPI-2 defined these operations as erroneous, the MPI Forum is unaware of any
28 implementation that enforces this rule, as it would require significant overhead. Thus,
29 relaxing this condition does not impact existing implementations or applications. (*End*
30 *of rationale.*)

31 *Advice to implementors.* Overlapping accesses are undefined. However, to assist
32 users in debugging code, implementations may wish to provide a mode in which such
33 operations are detected and reported to the user. Note, however, that in MPI-3, such
34 operations must not generate an MPI exception. (*End of advice to implementors.*)

35
36
37 A program with a well-defined outcome in the `MPI_WIN_SEPARATE` memory model
38 must obey the following rules.

- 39 S1. A location in a window must not be accessed with load/store operations once an
40 update to that location has started, until the update becomes visible in the private
41 window copy in process memory.
- 42
43 S2. A location in a window must not be accessed as a target of an RMA operation once
44 an update to that location has started, until the update becomes visible in the public
45 window copy. There is one exception to this rule, in the case where the same variable
46 is updated by two concurrent accumulates with the same predefined datatype, on
47 the same window. Additional restrictions on the operation apply, see the info key
48 `accumulate_ops` in Section 11.2.1.

- S3. A put or accumulate must not access a target window once a store or a put or accumulate update to another (overlapping) target window has started on a location in the target window, until the update becomes visible in the public copy of the window. Conversely, a store to process memory to a location in a window must not start once a put or accumulate update to that target window has started, until the put or accumulate update becomes visible in process memory. In both cases, the restriction applies to operations even if they access disjoint locations in the window.

Rationale. The last constraint on correct RMA accesses may seem unduly restrictive, as it forbids concurrent accesses to nonoverlapping locations in a window. The reason for this constraint is that, on some architectures, explicit coherence restoring operations may be needed at synchronization points. A different operation may be needed for locations that were updated by stores and for locations that were remotely updated by put or accumulate operations. Without this constraint, the MPI library would have to track precisely which locations in a window were updated by a put or accumulate call. The additional overhead of maintaining such information is considered prohibitive. (*End of rationale.*)

Note that `MPI_WIN_SYNC` may be used within a passive target epoch to synchronize the private and public window copies (that is, updates to one are made visible to the other).

In the `MPI_WIN_UNIFIED` memory model, the rules are simpler because the public and private windows are the same. However, there are restrictions to avoid concurrent access to the same memory locations by different processes. The rules that a program with a well-defined outcome must obey in this case are:

- U1. A location in a window must not be accessed with load/store operations once an update to that location has started, until the update is complete, subject to the following special case.
- U2. Accessing a location in the window that is also the target of a remote update is valid (not erroneous) but the precise result will depend on the behavior of the implementation. Updates from a remote process will appear in the memory of the target, but there are no atomicity or ordering guarantees if more than one byte is updated. Updates are stable in the sense that once data appears in memory of the target, the data remains until replaced by another update. This permits polling on a location for a change from zero to non-zero or for a particular value, but not polling and comparing the relative magnitude of values. Users are cautioned that polling on one memory location and then accessing a different memory location has defined behavior only if the other rules given here and in this chapter are followed.

Advice to users. Some compiler optimizations can result in code that maintains the sequential semantics of the program, but violates this rule by introducing temporary values into locations in memory. Most compilers only apply such transformations under very high levels of optimization and users should be aware that such aggressive optimization may produce unexpected results. (*End of advice to users.*)

- U3. Updating a location in the window with a store operation that is also the target of a remote read (but not update) is valid (not erroneous) but the precise result

will depend on the behavior of the implementation. Store updates will appear in memory, but there are no atomicity or ordering guarantees if more than one byte is updated. Updates are stable in the sense that once data appears in memory, the data remains until replaced by another update. This permits updates to memory with store operations without requiring an RMA epoch. Users are cautioned that remote accesses to a window that is updated by the local process has defined behavior only if the other rules given here and elsewhere in this chapter are followed.

- U4. A location in a window must not be accessed as a target of an RMA operation once an update to that location has started and until the update completes at the target. There is one exception to this rule: in the case where the same location is updated by two concurrent accumulates with the same predefined datatype on the same window. Additional restrictions on the operation apply; see the info key `accumulate_ops` in Section 11.2.1.
- U5. A put or accumulate must not access a target window once a store, put, or accumulate update to another (overlapping) target window has started on the same location in the target window and until the update completes at the target window. Conversely, a store operation to a location in a window must not start once a put or accumulate update to the same location in that target window has started and until the put or accumulate update completes at the target.

Advice to users. In the unified memory model, in the case where the window is in shared memory, `MPI_WIN_SYNC` can be used to order store operations and make store updates to the window visible to other processes and threads. Use of this routine is necessary to ensure portable behavior when point-to-point, collective, or shared memory synchronization is used in place of an RMA synchronization routine. `MPI_WIN_SYNC` should be called by the writer before the non-RMA synchronization operation and by the reader after the non-RMA synchronization, as shown in Example 11.21. (*End of advice to users.*)

A program that violates these rules has undefined behavior.

Advice to users. A user can write correct programs by following the following rules:

fence: During each period between fence calls, each window is either updated by put or accumulate calls, or updated by stores, but not both. Locations updated by put or accumulate calls should not be accessed during the same period (with the exception of concurrent updates to the same location by accumulate calls). Locations accessed by get calls should not be updated during the same period.

post-start-complete-wait: A window should not be updated with store operations while posted if it is being updated by put or accumulate calls. Locations updated by put or accumulate calls should not be accessed while the window is posted (with the exception of concurrent updates to the same location by accumulate calls). Locations accessed by get calls should not be updated while the window is posted.

With the post-start synchronization, the target process can tell the origin process that its window is now ready for RMA access; with the complete-wait synchronization, the origin process can tell the target process that it has finished its RMA accesses to the window.

lock: Updates to the window are protected by exclusive locks if they may conflict. Nonconflicting accesses (such as read-only accesses or accumulate accesses) are protected by shared locks, both for load/store accesses and for RMA accesses.

changing window or synchronization mode: One can change synchronization mode, or change the window used to access a location that belongs to two overlapping windows, when the process memory and the window copy are guaranteed to have the same values. This is true after a local call to `MPI_WIN_FENCE`, if RMA accesses to the window are synchronized with fences; after a local call to `MPI_WIN_WAIT`, if the accesses are synchronized with post-start-complete-wait; after the call at the origin (local or remote) to `MPI_WIN_UNLOCK` or `MPI_WIN_UNLOCK_ALL` if the accesses are synchronized with locks.

In addition, a process should not access the local buffer of a get operation until the operation is complete, and should not update the local buffer of a put or accumulate operation until that operation is complete.

The RMA synchronization operations define when updates are guaranteed to become visible in public and private windows. Updates may become visible earlier, but such behavior is implementation dependent. (*End of advice to users.*)

The semantics are illustrated by the following examples:

Example 11.6 The following example demonstrates updating a memory location inside a window for the separate memory model, according to Rule 5. The `MPI_WIN_LOCK` and `MPI_WIN_UNLOCK` calls around the store to X in process B are necessary to ensure consistency between the public and private copies of the window.

<pre> Process A: MPI_Barrier MPI_Win_lock(EXCLUSIVE,B) MPI_Get(X) /* ok, read from public window */ MPI_Win_unlock(B) </pre>	<pre> Process B: window location X MPI_Win_lock(EXCLUSIVE,B) store X /* local update to private copy of B */ MPI_Win_unlock(B) /* now visible in public window */ MPI_Barrier </pre>
--	--

Example 11.7 In the RMA unified model, although the public and private copies of the windows are synchronized, caution must be used when combining load/stores and multi-process synchronization. Although the following example appears correct, the compiler or hardware may delay the store to X after the barrier, possibly resulting in the `MPI_GET` returning an incorrect value of X.

```

1 Process A:           Process B:
2                       window location X
3
4                       store X /* update to private & public copy of B */
5 MPI_Barrier          MPI_Barrier
6 MPI_Win_lock_all
7 MPI_Get(X) /* ok, read from window */
8 MPI_Win_flush_local(B)
9 /* read value in X */
10 MPI_Win_unlock_all
11

```

12 MPI_BARRIER provides process synchronization, but not memory synchronization. The
 13 example could potentially be made safe through the use of compiler- and hardware-specific
 14 notations to ensure the store to X occurs before process B enters the MPI_BARRIER. The
 15 use of one-sided synchronization calls, as shown in Example 11.6, also ensures the correct
 16 result.

17 **Example 11.8** The following example demonstrates the reading of a memory location
 18 updated by a remote process (Rule 6) in the RMA separate memory model. Although the
 19 MPI_WIN_UNLOCK on process A and the MPI_BARRIER ensure that the public copy on
 20 process B reflects the updated value of X, the call to MPI_WIN_LOCK by process B is
 21 necessary to synchronize the private copy with the public copy.
 22

```

23 Process A:           Process B:
24                       window location X
25
26 MPI_Win_lock(EXCLUSIVE,B)
27 MPI_Put(X) /* update to public window */
28 MPI_Win_unlock(B)
29
30 MPI_Barrier          MPI_Barrier
31
32                       MPI_Win_lock(EXCLUSIVE,B)
33                       /* now visible in private copy of B */
34                       load X
35                       MPI_Win_unlock(B)
36

```

37 Note that in this example, the barrier is not critical to the semantic correctness. The
 38 use of exclusive locks guarantees a remote process will not modify the public copy after
 39 MPI_WIN_LOCK synchronizes the private and public copies. A polling implementation
 40 looking for changes in X on process B would be semantically correct. The barrier is required
 41 to ensure that process A performs the put operation before process B performs the load of
 42 X.

43 **Example 11.9** Similar to Example 11.7, the following example is unsafe even in the unified
 44 model, because the load of X can not be guaranteed to occur after the MPI_BARRIER. While
 45 Process B does not need to explicitly synchronize the public and private copies through
 46 MPI_WIN_LOCK as the MPI_PUT will update both the public and private copies of the
 47 window, the scheduling of the load could result in old values of X being returned. Compiler
 48

and hardware specific notations could ensure the load occurs after the data is updated, or explicit one-sided synchronization calls can be used to ensure the proper result.

```

Process A:
MPI_Win_lock_all
MPI_Put(X) /* update to window */
MPI_Win_flush(B)

MPI_Barrier

MPI_Win_unlock_all

Process B:
window location X

MPI_Barrier
load X

```

Example 11.10 The following example further clarifies Rule 5. `MPI_WIN_LOCK` and `MPI_WIN_LOCK_ALL` do *not* update the public copy of a window with changes to the private copy. Therefore, there is no guarantee that process A in the following sequence will see the value of X as updated by the local store by process B before the lock.

```

Process A:
MPI_Barrier

MPI_Win_lock(SHARED,B)
MPI_Get(X) /* X may be the X before the store */
MPI_Win_unlock(B)

Process B:
window location X

store X /* update to private copy of B */
MPI_Win_lock(SHARED,B)
MPI_Barrier

MPI_Win_unlock(B)
/* update on X now visible in public window */

```

The addition of an `MPI_WIN_SYNC` before the call to `MPI_BARRIER` by process B would guarantee process A would see the updated value of X, as the public copy of the window would be explicitly synchronized with the private copy.

Example 11.11 Similar to the previous example, Rule 5 can have unexpected implications for general active target synchronization with the RMA separate memory model. It is *not* guaranteed that process B reads the value of X as per the local update by process A, because neither `MPI_WIN_WAIT` nor `MPI_WIN_COMPLETE` calls by process A ensure visibility in the public window copy.

```

Process A:
window location X
window location Y

store Y
MPI_Win_post(A,B) /* Y visible in public window */
MPI_Win_start(A)

Process B:
MPI_Win_start(A)

```

```

1
2 store X /* update to private window */
3
4 MPI_Win_complete          MPI_Win_complete
5 MPI_Win_wait
6 /* update on X may not yet visible in public window */
7
8 MPI_Barrier                MPI_Barrier
9
10                            MPI_Win_lock(EXCLUSIVE,A)
11                            MPI_Get(X) /* may return an obsolete value */
12                            MPI_Get(Y)
13                            MPI_Win_unlock(A)
14

```

15 To allow process B to read the value of X stored by A the local store must be replaced by
16 a local MPI_PUT that updates the public window copy. Note that by this replacement X
17 may become visible in the private copy of process A only after the MPI_WIN_WAIT call in
18 process A. The update to Y made before the MPI_WIN_POST call is visible in the public
19 window after the MPI_WIN_POST call and therefore process B will read the proper value
20 of Y. The MPI_GET(Y) call could be moved to the epoch started by the MPI_WIN_START
21 operation, and process B would still get the value stored by process A.

22 **Example 11.12** The following example demonstrates the interaction of general active
23 target synchronization with local read operations with the RMA separate memory model.
24 Rules 5 and 6 do *not* guarantee that the private copy of X at process B has been updated
25 before the load takes place.

```

27 Process A:                  Process B:
28                             window location X
29
30 MPI_Win_lock(EXCLUSIVE,B)
31 MPI_Put(X) /* update to public window */
32 MPI_Win_unlock(B)
33
34 MPI_Barrier                MPI_Barrier
35
36                             MPI_Win_post(B)
37                             MPI_Win_start(B)
38
39                             load X /* access to private window */
40                             /* may return an obsolete value */
41
42                             MPI_Win_complete
43                             MPI_Win_wait
44

```

45 To ensure that the value put by process A is read, the local load must be replaced with a
46 local MPI_GET operation, or must be placed after the call to MPI_WIN_WAIT.

47
48

11.7.1 Atomicity

The outcome of concurrent accumulate operations to the same location with the same predefined datatype is as if the accumulates were done at that location in some serial order. Additional restrictions on the operation apply; see the info key `accumulate_ops` in Section 11.2.1. Concurrent accumulate operations with different origin and target pairs are not ordered. Thus, there is no guarantee that the entire call to an accumulate operation is executed atomically. The effect of this lack of atomicity is limited: The previous correctness conditions imply that a location updated by a call to an accumulate operation cannot be accessed by a load or an RMA call other than accumulate until the accumulate operation has completed (at the target). Different interleavings can lead to different results only to the extent that computer arithmetics are not truly associative or commutative. The outcome of accumulate operations with overlapping types of different sizes or target displacements is undefined.

11.7.2 Ordering

Accumulate calls enable element-wise atomic read and write to remote memory locations. MPI specifies ordering between accumulate operations from one process to the same (or overlapping) memory locations at another process on a per-datatype granularity. The default ordering is strict ordering, which guarantees that overlapping updates from the same source to a remote location are committed in program order and that reads (e.g., with `MPI_GET_ACCUMULATE`) and writes (e.g., with `MPI_ACCUMULATE`) are executed and committed in program order. Ordering only applies to operations originating at the same origin that access overlapping target memory regions. MPI does not provide any guarantees for accesses or updates from different origin processes to overlapping target memory regions.

The default strict ordering may incur a significant performance penalty. MPI specifies the info key `accumulate_ordering` to allow relaxation of the ordering semantics when specified to any window creation function. The values for this key are as follows. If set to `none`, then no ordering will be guaranteed for accumulate calls. This was the behavior for RMA in MPI-2 but is *not* the default in MPI-3. The key can be set to a comma-separated list of required access orderings at the target. Allowed values in the comma-separated list are `rar`, `war`, `raw`, and `waw` for read-after-read, write-after-read, read-after-write, and write-after-write ordering, respectively. These indicate whether operations of the specified type complete in the order they were issued. For example, `raw` means that any writes must complete at the target before subsequent reads. These ordering requirements apply only to operations issued by the same origin process and targeting the same target process. The default value for `accumulate_ordering` is `rar,raw,war,waw`, which implies that writes complete at the target in the order in which they were issued, reads complete at the target before any writes that are issued after the reads, and writes complete at the target before any reads that are issued after the writes. Any subset of these four orderings can be specified. For example, if only read-after-read and write-after-write ordering is required, then the value of the `accumulate_ordering` key could be set to `rar,waw`. The order of values is not significant.

Note that the above ordering semantics apply only to accumulate operations, not put and get. Put and get within an epoch are unordered.

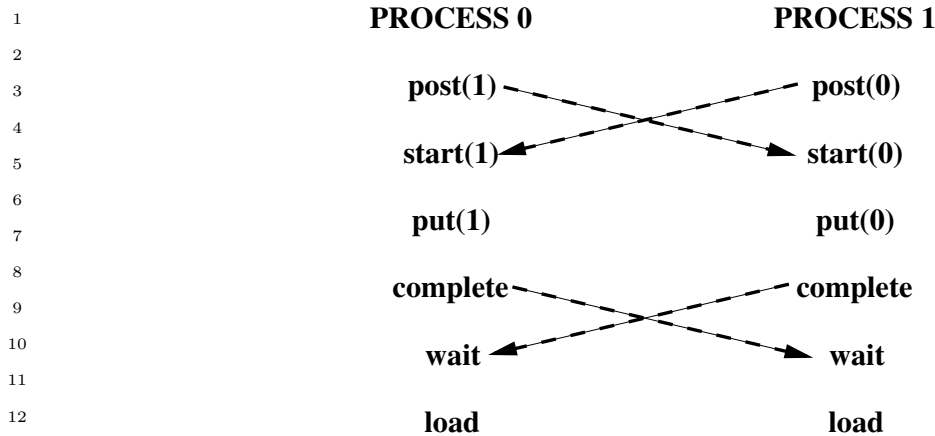

Figure 11.6: Symmetric communication

11.7.3 Progress

One-sided communication has the same progress requirements as point-to-point communication: once a communication is enabled it is guaranteed to complete. RMA calls must have local semantics, except when required for synchronization with other RMA calls.

There is some fuzziness in the definition of the time when a RMA communication becomes enabled. This fuzziness provides to the implementor more flexibility than with point-to-point communication. Access to a target window becomes enabled once the corresponding synchronization (such as `MPI_WIN_FENCE` or `MPI_WIN_POST`) has executed. On the origin process, an RMA communication may become enabled as soon as the corresponding put, get or accumulate call has executed, or as late as when the ensuing synchronization call is issued. Once the communication is enabled both at the origin and at the target, the communication must complete.

Consider the code fragment in Example 11.4. Some of the calls may block if the target window is not posted. However, if the target window is posted, then the code fragment must complete. The data transfer may start as soon as the put call occurs, but may be delayed until the ensuing complete call occurs.

Consider the code fragment in Example 11.5. Some of the calls may block if another process holds a conflicting lock. However, if no conflicting lock is held, then the code fragment must complete.

Consider the code illustrated in Figure 11.6. Each process updates the window of the other process using a put operation, then accesses its own window. The post calls are nonblocking, and should complete. Once the post calls occur, RMA access to the windows is enabled, so that each process should complete the sequence of calls start-put-complete. Once these are done, the wait calls should complete at both processes. Thus, this communication should not deadlock, irrespective of the amount of data transferred.

Assume, in the last example, that the order of the post and start calls is reversed at each process. Then, the code may deadlock, as each process may block on the start call, waiting for the matching post to occur. Similarly, the program will deadlock if the order of the complete and wait calls is reversed at each process.

The following two examples illustrate the fact that the synchronization between complete and wait is not symmetric: the wait call blocks until the complete executes, but not vice versa. Consider the code illustrated in Figure 11.7. This code will deadlock: the wait

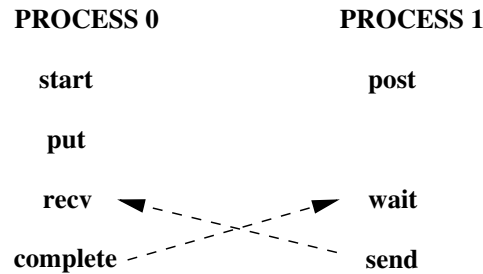

Figure 11.7: Deadlock situation

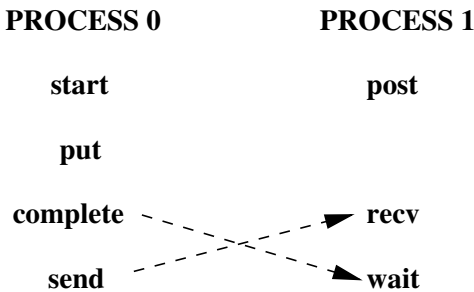

Figure 11.8: No deadlock

of process 1 blocks until process 0 calls complete, and the receive of process 0 blocks until process 1 calls send. Consider, on the other hand, the code illustrated in Figure 11.8. This code will not deadlock. Once process 1 calls post, then the sequence start, put, complete on process 0 can proceed to completion. Process 0 will reach the send call, allowing the receive call of process 1 to complete.

Rationale. MPI implementations must guarantee that a process makes progress on all enabled communications it participates in, while blocked on an MPI call. This is true for send-receive communication and applies to RMA communication as well. Thus, in the example in Figure 11.8, the put and complete calls of process 0 should complete while process 1 is blocked on the receive call. This may require the involvement of process 1, e.g., to transfer the data put, while it is blocked on the receive call.

A similar issue is whether such progress must occur while a process is busy computing, or blocked in a non-MPI call. Suppose that in the last example the send-receive pair is replaced by a write-to-socket/read-from-socket pair. Then MPI does not specify whether deadlock is avoided. Suppose that the blocking receive of process 1 is replaced by a very long compute loop. Then, according to one interpretation of the MPI standard, process 0 must return from the complete call after a bounded delay, even if process 1 does not reach any MPI call in this period of time. According to another interpretation, the complete call may block until process 1 reaches the wait call, or reaches another MPI call. The qualitative behavior is the same, under both interpretations, unless a process is caught in an infinite compute loop, in which case the difference may not matter. However, the quantitative expectations are different. Different MPI implementations reflect these different interpretations. While this ambiguity is unfortunate, the MPI Forum decided not to define which interpretation of the standard is the correct one, since the issue is contentious. (*End of rationale.*)

11.7.4 Registers and Compiler Optimizations

Advice to users. All the material in this section is an advice to users. (*End of advice to users.*)

A coherence problem exists between variables kept in registers and the memory values of these variables. An RMA call may access a variable in memory (or cache), while the up-to-date value of this variable is in register. A get will not return the latest variable value, and a put may be overwritten when the register is stored back in memory. Note that these issues are unrelated to the RMA memory model; that is, these issues apply even if the memory model is `MPI_WIN_UNIFIED`.

The problem is illustrated by the following code:

Source of Process 1	Source of Process 2	Executed in Process 2
<code>bbbb = 777</code>	<code>buff = 999</code>	<code>reg_A:=999</code>
<code>call MPI_WIN_FENCE</code>	<code>call MPI_WIN_FENCE</code>	
<code>call MPI_PUT(bbbb</code>		<code>stop appl.thread</code>
<code>into buff of process 2)</code>		<code>buff:=777 in PUT handler</code>
		<code>continue appl.thread</code>
<code>call MPI_WIN_FENCE</code>	<code>call MPI_WIN_FENCE</code>	
	<code>ccc = buff</code>	<code>ccc:=reg_A</code>

In this example, variable `buff` is allocated in the register `reg_A` and therefore `ccc` will have the old value of `buff` and not the new value `777`.

This problem, which also afflicts in some cases send/receive communication, is discussed more at length in Section [18.1.16](#).

Programs written in C avoid this problem, because of the semantics of C. Many Fortran compilers will avoid this problem, without disabling compiler optimizations. However, in order to avoid register coherence problems in a completely portable manner, users should restrict their use of RMA windows to variables stored in modules or `COMMON` blocks. To prevent problems with the argument copying and register optimization done by Fortran compilers, please note the hints in Sections [18.1.10–18.1.20](#). Sections [18.1.17](#) to [18.1.17](#) discuss several solutions for the problem in this example.

11.8 Examples

Example 11.13 The following example shows a generic loosely synchronous, iterative code, using fence synchronization. The window at each process consists of array `A`, which contains the origin and target buffers of the put calls.

```

...
while(!converged(A)){
  update(A);
  MPI_Win_fence(MPI_MODE_NOPRECEDE, win);
  for(i=0; i < toneighbors; i++)
    MPI_Put(&frombuf[i], 1, fromtype[i], toneighbor[i],
           todisp[i], 1, totype[i], win);
  MPI_Win_fence((MPI_MODE_NOSTORE | MPI_MODE_NOSUCCEED), win);
}

```

The same code could be written with `get` rather than `put`. Note that, during the communication phase, each window is concurrently read (as origin buffer of puts) and written (as target buffer of puts). This is OK, provided that there is no overlap between the target buffer of a put and another communication buffer.

Example 11.14 Same generic example, with more computation/communication overlap. We assume that the update phase is broken into two subphases: the first, where the “boundary,” which is involved in communication, is updated, and the second, where the “core,” which neither uses nor provides communicated data, is updated.

```
...
while(!converged(A)){
    update_boundary(A);
    MPI_Win_fence((MPI_MODE_NOPUT | MPI_MODE_NOPRECEDE), win);
    for(i=0; i < fromneighbors; i++)
        MPI_Get(&tobuf[i], 1, totype[i], fromneighbor[i],
                fromdisp[i], 1, fromtype[i], win);
    update_core(A);
    MPI_Win_fence(MPI_MODE_NOSUCCEED, win);
}
```

The `get` communication can be concurrent with the core update, since they do not access the same locations, and the local update of the origin buffer by the `get` call can be concurrent with the local update of the core by the `update_core` call. In order to get similar overlap with `put` communication we would need to use separate windows for the core and for the boundary. This is required because we do not allow local stores to be concurrent with puts on the same, or on overlapping, windows.

Example 11.15 Same code as in Example 11.13, rewritten using `post-start-complete-wait`.

```
...
while(!converged(A)){
    update(A);
    MPI_Win_post(fromgroup, 0, win);
    MPI_Win_start(togroup, 0, win);
    for(i=0; i < toneighbors; i++)
        MPI_Put(&frombuf[i], 1, fromtype[i], toneighbor[i],
                todisp[i], 1, totype[i], win);
    MPI_Win_complete(win);
    MPI_Win_wait(win);
}
```

Example 11.16 Same example, with split phases, as in Example 11.14.

```
...
while(!converged(A)){
    update_boundary(A);
    MPI_Win_post(togroup, MPI_MODE_NOPUT, win);
    MPI_Win_start(fromgroup, 0, win);
```

```

1   for(i=0; i < fromneighbors; i++)
2       MPI_Get(&tobuf[i], 1, totype[i], fromneighbor[i],
3             fromdisp[i], 1, fromtype[i], win);
4   update_core(A);
5   MPI_Win_complete(win);
6   MPI_Win_wait(win);
7 }

```

Example 11.17 A checkerboard, or double buffer communication pattern, that allows more computation/communication overlap. Array A0 is updated using values of array A1, and vice versa. We assume that communication is symmetric: if process A gets data from process B, then process B gets data from process A. Window wini consists of array Ai.

```

14 ...
15 if (!converged(A0,A1))
16     MPI_Win_post(neighbors, (MPI_MODE_NOCHECK | MPI_MODE_NOPUT), win0);
17 MPI_Barrier(comm0);
18 /* the barrier is needed because the start call inside the
19 loop uses the nocheck option */
20 while(!converged(A0, A1)){
21     /* communication on A0 and computation on A1 */
22     update2(A1, A0); /* local update of A1 that depends on A0 (and A1) */
23     MPI_Win_start(neighbors, MPI_MODE_NOCHECK, win0);
24     for(i=0; i < fromneighbors; i++)
25         MPI_Get(&tobuf0[i], 1, totype0[i], neighbor[i],
26               fromdisp0[i], 1, fromtype0[i], win0);
27     update1(A1); /* local update of A1 that is
28                 concurrent with communication that updates A0 */
29     MPI_Win_post(neighbors, (MPI_MODE_NOCHECK | MPI_MODE_NOPUT), win1);
30     MPI_Win_complete(win0);
31     MPI_Win_wait(win0);
32
33     /* communication on A1 and computation on A0 */
34     update2(A0, A1); /* local update of A0 that depends on A1 (and A0) */
35     MPI_Win_start(neighbors, MPI_MODE_NOCHECK, win1);
36     for(i=0; i < fromneighbors; i++)
37         MPI_Get(&tobuf1[i], 1, totype1[i], neighbor[i],
38               fromdisp1[i], 1, fromtype1[i], win1);
39     update1(A0); /* local update of A0 that depends on A0 only,
40                 concurrent with communication that updates A1 */
41     if (!converged(A0,A1))
42         MPI_Win_post(neighbors, (MPI_MODE_NOCHECK | MPI_MODE_NOPUT), win0);
43     MPI_Win_complete(win1);
44     MPI_Win_wait(win1);
45 }

```

A process posts the local window associated with win0 before it completes RMA accesses to the remote windows associated with win1. When the wait(win1) call returns, then all

neighbors of the calling process have posted the windows associated with `win0`. Conversely, when the `wait(win0)` call returns, then all neighbors of the calling process have posted the windows associated with `win1`. Therefore, the `nocheck` option can be used with the calls to `MPI_WIN_START`.

Put calls can be used, instead of get calls, if the area of array `A0` (resp. `A1`) used by the `update(A1, A0)` (resp. `update(A0, A1)`) call is disjoint from the area modified by the RMA communication. On some systems, a put call may be more efficient than a get call, as it requires information exchange only in one direction.

In the next several examples, for conciseness, the expression

```
z = MPI_Get_accumulate(...)
```

means to perform an `MPI_GET_ACCUMULATE` with the result buffer (given by `result_addr` in the description of `MPI_GET_ACCUMULATE`) on the left side of the assignment, in this case, `z`. This format is also used with `MPI_COMPARE_AND_SWAP`.

Example 11.18 The following example implements a naive, non-scalable counting semaphore. The example demonstrates the use of `MPI_WIN_SYNC` to manipulate the public copy of `X`, as well as `MPI_WIN_FLUSH` to complete operations without ending the access epoch opened with `MPI_WIN_LOCK_ALL`. To avoid the rules regarding synchronization of the public and private copies of windows, `MPI_ACCUMULATE` and `MPI_GET_ACCUMULATE` are used to write to or read from the local public copy.

Process A:	Process B:
<code>MPI_Win_lock_all</code>	<code>MPI_Win_lock_all</code>
window location <code>X</code>	
<code>X=2</code>	
<code>MPI_Win_sync</code>	
<code>MPI_Barrier</code>	<code>MPI_Barrier</code>
<code>MPI_Accumulate(X, MPI_SUM, -1)</code>	<code>MPI_Accumulate(X, MPI_SUM, -1)</code>
stack variable <code>z</code>	stack variable <code>z</code>
do	do
<code>z = MPI_Get_accumulate(X,</code>	<code>z = MPI_Get_accumulate(X,</code>
<code>MPI_NO_OP, 0)</code>	<code>MPI_NO_OP, 0)</code>
<code>MPI_Win_flush(A)</code>	<code>MPI_Win_flush(A)</code>
while(<code>z!=0</code>)	while(<code>z!=0</code>)
<code>MPI_Win_unlock_all</code>	<code>MPI_Win_unlock_all</code>

Example 11.19 Implementing a critical region between two processes (Peterson's algorithm). Despite their appearance in the following example, `MPI_WIN_LOCK_ALL` and `MPI_WIN_UNLOCK_ALL` are not collective calls, but it is frequently useful to start shared access epochs to all processes from all other processes in a window. Once the access epochs are established, accumulate communication operations and flush and sync synchronization operations can be used to read from or write to the public copy of the window.

```

1 Process A:                               Process B:
2 window location X                         window location Y
3 window location T
4
5 MPI_Win_lock_all                           MPI_Win_lock_all
6 X=1                                         Y=1
7 MPI_Win_sync                               MPI_Win_sync
8 MPI_Barrier                               MPI_Barrier
9 MPI_Accumulate(T, MPI_REPLACE, 1)         MPI_Accumulate(T, MPI_REPLACE, 0)
10 stack variables t,y                       stack variable t,x
11 t=1                                        t=0
12 y=MPI_Get_accumulate(Y,                   x=MPI_Get_accumulate(X,
13     MPI_NO_OP, 0)                           MPI_NO_OP, 0)
14 while(y==1 && t==1) do                     while(x==1 && t==0) do
15     y=MPI_Get_accumulate(Y,                 x=MPI_Get_accumulate(X,
16     MPI_NO_OP, 0)                           MPI_NO_OP, 0)
17     t=MPI_Get_accumulate(T,                 t=MPI_Get_accumulate(T,
18     MPI_NO_OP, 0)                           MPI_NO_OP, 0)
19     MPI_Win_flush_all                       MPI_Win_flush(A)
20 done                                       done
21 // critical region                         // critical region
22 MPI_Accumulate(X, MPI_REPLACE, 0)         MPI_Accumulate(Y, MPI_REPLACE, 0)
23 MPI_Win_unlock_all                       MPI_Win_unlock_all
24

```

25 **Example 11.20** Implementing a critical region between multiple processes with compare
26 and swap. The call to `MPI_WIN_SYNC` is necessary on Process A after local initialization
27 of A to guarantee the public copy has been updated with the initialization value found in
28 the private copy. It would also be valid to call `MPI_ACCUMULATE` with `MPI_REPLACE` to
29 directly initialize the public copy. A call to `MPI_WIN_FLUSH` would be necessary to assure
30 A in the public copy of Process A had been updated before the barrier.

```

32 Process A:                               Process B...:
33 MPI_Win_lock_all                           MPI_Win_lock_all
34 atomic location A
35 A=0
36 MPI_Win_sync
37 MPI_Barrier                               MPI_Barrier
38 stack variable r=1                         stack variable r=1
39 while(r != 0) do                           while(r != 0) do
40     r = MPI_Compare_and_swap(A, 0, 1)       r = MPI_Compare_and_swap(A, 0, 1)
41     MPI_Win_flush(A)                       MPI_Win_flush(A)
42 done                                       done
43 // critical region                         // critical region
44 r = MPI_Compare_and_swap(A, 1, 0)         r = MPI_Compare_and_swap(A, 1, 0)
45 MPI_Win_unlock_all                       MPI_Win_unlock_all
46

```

47 **Example 11.21** The following example demonstrates the proper synchronization in the
48 unified memory model when a data transfer is implemented with load and store in the

case of windows in shared memory (instead of `MPI_PUT` or `MPI_GET`) and the synchronization between processes is performed using point-to-point communication. The synchronization between processes must be supplemented with a memory synchronization through calls to `MPI_WIN_SYNC`, which act locally as a processor-memory barrier. In Fortran, if `MPI_ASYNC_PROTECTS_NONBLOCKING` is `.FALSE.` or the variable `X` is not declared as `ASYNCHRONOUS`, reordering of the accesses to the variable `X` must be prevented with `MPI_F_SYNC_REG` operations. (No equivalent function is needed in C.)

The variable `X` is contained within a shared memory window and `X` corresponds to the same memory location at both processes. The `MPI_WIN_SYNC` operation performed by process A ensures completion of the load/store operations issued by process A. The `MPI_WIN_SYNC` operation performed by process B ensures that process A's updates to `X` are visible to process B.

Process A	Process B
<code>MPI_WIN_LOCK_ALL(MPI_MODE_NOCHECK,win)</code>	<code>MPI_WIN_LOCK_ALL(MPI_MODE_NOCHECK,win)</code>
<code>DO ...</code>	<code>DO ...</code>
<code>X=...</code>	
<code>MPI_F_SYNC_REG(X)</code>	
<code>MPI_WIN_SYNC(win)</code>	
<code>MPI_SEND</code>	<code>MPI_RECV</code>
	<code>MPI_WIN_SYNC(win)</code>
	<code>MPI_F_SYNC_REG(X)</code>
	<code>print X</code>
	<code>MPI_F_SYNC_REG(X)</code>
<code>MPI_RECV</code>	<code>MPI_SEND</code>
<code>MPI_F_SYNC_REG(X)</code>	
<code>END DO</code>	<code>END DO</code>
<code>MPI_WIN_UNLOCK_ALL(win)</code>	<code>MPI_WIN_UNLOCK_ALL(win)</code>

Example 11.22 The following example shows how request-based operations can be used to overlap communication with computation. Each process fetches, processes, and writes the result for `NSTEPS` chunks of data. Instead of a single buffer, `M` local buffers are used to allow up to `M` communication operations to overlap with computation.

```

int          i, j;
MPI_Win     win;
MPI_Request  put_req[M] = { MPI_REQUEST_NULL };
MPI_Request  get_req;
double      *baseptr;
double      data[M][N];

```

```

1 MPI_Win_allocate(NSTEPS*N*sizeof(double), sizeof(double), MPI_INFO_NULL,
2   MPI_COMM_WORLD, &baseptr, &win);
3
4 MPI_Win_lock_all(0, win);
5
6 for (i = 0; i < NSTEPS; i++) {
7   if (i<M)
8     j=i;
9   else
10    MPI_Waitany(M, put_req, &j, MPI_STATUS_IGNORE);
11
12    MPI_Rget(data[j], N, MPI_DOUBLE, target, i*N, N, MPI_DOUBLE, win,
13      &get_req);
14    MPI_Wait(&get_req, MPI_STATUS_IGNORE);
15    compute(i, data[j], ...);
16    MPI_Rput(data[j], N, MPI_DOUBLE, target, i*N, N, MPI_DOUBLE, win,
17      &put_req[j]);
18  }
19
20 MPI_Waitall(M, put_req, MPI_STATUSES_IGNORE);
21 MPI_Win_unlock_all(win);
22
23

```

Example 11.23 The following example constructs a distributed shared linked list using dynamic windows. Initially process 0 creates the head of the list, attaches it to the window, and broadcasts the pointer to all processes. All processes then concurrently append N new elements to the list. When a process attempts to attach its element to the tail of the list it may discover that its tail pointer is stale and it must chase ahead to the new tail before the element can be attached. This example requires some modification to work in an environment where the layout of the structures is different on different processes.

```

31 ...
32 #define NUM_ELEMS 10
33
34 #define LLIST_ELEM_NEXT_RANK ( offsetof(llist_elem_t, next) + \
35   offsetof(llist_ptr_t, rank) )
36 #define LLIST_ELEM_NEXT_DISP ( offsetof(llist_elem_t, next) + \
37   offsetof(llist_ptr_t, disp) )
38
39 /* Linked list pointer */
40 typedef struct {
41   MPI_Aint disp;
42   int      rank;
43 } llist_ptr_t;
44
45 /* Linked list element */
46 typedef struct {
47   llist_ptr_t next;
48

```

```

    int value;
} llist_elem_t;

const llist_ptr_t nil = { (MPI_Aint) MPI_BOTTOM, -1 };

/* List of locally allocated list elements. */
static llist_elem_t **my_elems = NULL;
static int my_elems_size = 0;
static int my_elems_count = 0;

/* Allocate a new shared linked list element */
MPI_Aint alloc_elem(int value, MPI_Win win) {
    MPI_Aint disp;
    llist_elem_t *elem_ptr;

    /* Allocate the new element and register it with the window */
    MPI_Alloc_mem(sizeof(llist_elem_t), MPI_INFO_NULL, &elem_ptr);
    elem_ptr->value = value;
    elem_ptr->next = nil;
    MPI_Win_attach(win, elem_ptr, sizeof(llist_elem_t));

    /* Add the element to the list of local elements so we can free
       it later. */
    if (my_elems_size == my_elems_count) {
        my_elems_size += 100;
        my_elems = realloc(my_elems, my_elems_size*sizeof(void*));
    }
    my_elems[my_elems_count] = elem_ptr;
    my_elems_count++;

    MPI_Get_address(elem_ptr, &disp);
    return disp;
}

int main(int argc, char *argv[]) {
    int          procid, nproc, i;
    MPI_Win      llist_win;
    llist_ptr_t  head_ptr, tail_ptr;

    MPI_Init(&argc, &argv);

    MPI_Comm_rank(MPI_COMM_WORLD, &procid);
    MPI_Comm_size(MPI_COMM_WORLD, &nproc);

    MPI_Win_create_dynamic(MPI_INFO_NULL, MPI_COMM_WORLD, &llist_win);

    /* Process 0 creates the head node */
    if (procid == 0)

```

```

1     head_ptr.disp = alloc_elem(-1, llist_win);
2
3     /* Broadcast the head pointer to everyone */
4     head_ptr.rank = 0;
5     MPI_Bcast(&head_ptr.disp, 1, MPI_AINT, 0, MPI_COMM_WORLD);
6     tail_ptr = head_ptr;
7
8     /* Lock the window for shared access to all targets */
9     MPI_Win_lock_all(0, llist_win);
10
11    /* All processes concurrently append NUM_ELEMS elements to the list */
12    for (i = 0; i < NUM_ELEMS; i++) {
13        llist_ptr_t new_elem_ptr;
14        int success;
15
16        /* Create a new list element and attach it to the window */
17        new_elem_ptr.rank = procid;
18        new_elem_ptr.disp = alloc_elem(procid, llist_win);
19
20        /* Append the new node to the list. This might take multiple
21         attempts if others have already appended and our tail pointer
22         is stale. */
23        do {
24            llist_ptr_t next_tail_ptr = nil;
25
26            MPI_Compare_and_swap((void*) &new_elem_ptr.rank, (void*) &nil.rank,
27                                (void*)&next_tail_ptr.rank, MPI_INT, tail_ptr.rank,
28                                MPI_Aint_add(tail_ptr.disp, LLIST_ELEM_NEXT_RANK),
29                                llist_win);
30
31            MPI_Win_flush(tail_ptr.rank, llist_win);
32            success = (next_tail_ptr.rank == nil.rank);
33
34            if (success) {
35                MPI_Accumulate(&new_elem_ptr.disp, 1, MPI_AINT, tail_ptr.rank,
36                              MPI_Aint_add(tail_ptr.disp, LLIST_ELEM_NEXT_DISP), 1,
37                              MPI_AINT, MPI_REPLACE, llist_win);
38
39                MPI_Win_flush(tail_ptr.rank, llist_win);
40                tail_ptr = new_elem_ptr;
41
42            } else {
43                /* Tail pointer is stale, fetch the displacement. May take
44                 multiple tries if it is being updated. */
45                do {
46                    MPI_Get_accumulate( NULL, 0, MPI_AINT, &next_tail_ptr.disp,
47                                        1, MPI_AINT, tail_ptr.rank,
48                                        MPI_Aint_add(tail_ptr.disp, LLIST_ELEM_NEXT_DISP),

```

```
        1, MPI_AINT, MPI_NO_OP, llist_win);                                1
                                                                                               2
        MPI_Win_flush(tail_ptr.rank, llist_win);                               3
    } while (next_tail_ptr.disp == nil.disp);                               4
    tail_ptr = next_tail_ptr;                                               5
}                                                                                               6
} while (!success);                                                         7
}                                                                                               8
                                                                                               9
MPI_Win_unlock_all(llist_win);                                             10
MPI_Barrier( MPI_COMM_WORLD );                                             11
                                                                                               12
/* Free all the elements in the list */                                     13
for ( ; my_elems_count > 0; my_elems_count--) {                             14
    MPI_Win_detach(llist_win,my_elems[my_elems_count-1]);                 15
    MPI_Free_mem(my_elems[my_elems_count-1]);                             16
}                                                                                               17
MPI_Win_free(&llist_win);                                                  18
...                                                                           19
                                                                                               20
                                                                                               21
                                                                                               22
                                                                                               23
                                                                                               24
                                                                                               25
                                                                                               26
                                                                                               27
                                                                                               28
                                                                                               29
                                                                                               30
                                                                                               31
                                                                                               32
                                                                                               33
                                                                                               34
                                                                                               35
                                                                                               36
                                                                                               37
                                                                                               38
                                                                                               39
                                                                                               40
                                                                                               41
                                                                                               42
                                                                                               43
                                                                                               44
                                                                                               45
                                                                                               46
                                                                                               47
                                                                                               48
```

1
2
3
4
5
6
7
8
9
10
11
12
13
14
15
16
17
18
19
20
21
22
23
24
25
26
27
28
29
30
31
32
33
34
35
36
37
38
39
40
41
42
43
44
45
46
47
48

1
2
3
4
5
6
7
8
9
10
11
12
13
14
15
16
17
18
19
20
21
22
23
24
25
26
27
28
29
30
31
32
33
34
35
36
37
38
39
40
41
42
43
44
45
46
47
48

Chapter 12

External Interfaces

12.1 Introduction

This chapter begins with calls used to create **generalized requests**, which allow users to create new nonblocking operations with an interface similar to what is present in MPI. These calls can be used to layer new functionality on top of MPI. Next, Section 12.3 deals with setting the information found in `status`. This functionality is needed for generalized requests.

The chapter continues, in Section 12.4, with a discussion of how threads are to be handled in MPI. Although thread compliance is not required, the standard specifies how threads are to work if they are provided.

12.2 Generalized Requests

The goal of generalized requests is to allow users to define new nonblocking operations. Such an outstanding nonblocking operation is represented by a (generalized) request. A fundamental property of nonblocking operations is that progress toward the completion of this operation occurs asynchronously, i.e., concurrently with normal program execution. Typically, this requires execution of code concurrently with the execution of the user code, e.g., in a separate thread or in a signal handler. Operating systems provide a variety of mechanisms in support of concurrent execution. MPI does not attempt to standardize or to replace these mechanisms: it is assumed programmers who wish to define new asynchronous operations will use the mechanisms provided by the underlying operating system. Thus, the calls in this section only provide a means for defining the effect of MPI calls such as `MPI_WAIT` or `MPI_CANCEL` when they apply to generalized requests, and for signaling to MPI the completion of a generalized operation.

Rationale. It is tempting to also define an MPI standard mechanism for achieving concurrent execution of user-defined nonblocking operations. However, it is difficult to define such a mechanism without consideration of the specific mechanisms used in the operating system. The Forum feels that concurrency mechanisms are a proper part of the underlying operating system and should not be standardized by MPI; the MPI standard should only deal with the interaction of such mechanisms with MPI. (*End of rationale.*)

1 For a regular request, the operation associated with the request is performed by
 2 the MPI implementation, and the operation completes without intervention by the ap-
 3 plication. For a generalized request, the operation associated with the request is per-
 4 formed by the application; therefore, the application must notify MPI through a call to
 5 MPI_GREQUEST_COMPLETE when the operation completes. MPI maintains the “comple-
 6 tion” status of generalized requests. Any other request state has to be maintained by the
 7 user.

8 A new generalized request is started with

```
9
10 MPI_GREQUEST_START(query_fn, free_fn, cancel_fn, extra_state, request)
11
12 IN      query_fn      callback function invoked when request status is queried
13                          (function)
14 IN      free_fn       callback function invoked when request is freed (func-
15                          tion)
16 IN      cancel_fn     callback function invoked when request is cancelled
17                          (function)
18 IN      extra_state   extra state
19 OUT     request       generalized request (handle)
```

```
22
23 int MPI_Grequest_start(MPI_Grequest_query_function *query_fn,
24                       MPI_Grequest_free_function *free_fn,
25                       MPI_Grequest_cancel_function *cancel_fn, void *extra_state,
26                       MPI_Request *request)
27 MPI_Grequest_start(query_fn, free_fn, cancel_fn, extra_state, request,
28                   ierror)
29 PROCEDURE(MPI_Grequest_query_function) :: query_fn
30 PROCEDURE(MPI_Grequest_free_function) :: free_fn
31 PROCEDURE(MPI_Grequest_cancel_function) :: cancel_fn
32 INTEGER(KIND=MPI_ADDRESS_KIND), INTENT(IN) :: extra_state
33 TYPE(MPI_Request), INTENT(OUT) :: request
34 INTEGER, OPTIONAL, INTENT(OUT) :: ierror
35
36 MPI_GREQUEST_START(QUERY_FN, FREE_FN, CANCEL_FN, EXTRA_STATE, REQUEST,
37                   IERROR)
38 INTEGER REQUEST, IERROR
39 EXTERNAL QUERY_FN, FREE_FN, CANCEL_FN
40 INTEGER (KIND=MPI_ADDRESS_KIND) EXTRA_STATE
```

41
 42 *Advice to users.* Note that a generalized request is of the same type as regular
 43 requests, in C and Fortran. (*End of advice to users.*)

44
 45 The call starts a generalized request and returns a handle to it in request.

46 The syntax and meaning of the callback functions are listed below. All callback func-
 47 tions are passed the extra_state argument that was associated with the request by the
 48

starting call `MPI_GREQUEST_START`; `extra_state` can be used to maintain user-defined state for the request. 1
2

In C, the query function is 3

```
typedef int MPI_Grequest_query_function(void *extra_state, 4
                                       MPI_Status *status); 5
```

in Fortran with the `mpi_f08` module 6

ABSTRACT INTERFACE 7

```
SUBROUTINE MPI_Grequest_query_function(extra_state, status, ierror) 8
  TYPE(MPI_Status) :: status 9
  INTEGER(KIND=MPI_ADDRESS_KIND) :: extra_state 10
  INTEGER :: ierror 11
```

in Fortran with the `mpi` module and `mpif.h` 12

```
SUBROUTINE GREQUEST_QUERY_FUNCTION(EXTRA_STATE, STATUS, IERROR) 13
  INTEGER STATUS(MPI_STATUS_SIZE), IERROR 14
  INTEGER(KIND=MPI_ADDRESS_KIND) EXTRA_STATE 15
```

The `query_fn` function computes the status that should be returned for the generalized request. The status also includes information about successful/unsuccesful cancellation of the request (result to be returned by `MPI_TEST_CANCELLED`). 16
17
18
19
20

The `query_fn` callback is invoked by the `MPI_{WAIT|TEST}{ANY|SOME|ALL}` call that completed the generalized request associated with this callback. The callback function is also invoked by calls to `MPI_REQUEST_GET_STATUS`, if the request is complete when the call occurs. In both cases, the callback is passed a reference to the corresponding status variable passed by the user to the MPI call; the status set by the callback function is returned by the MPI call. If the user provided `MPI_STATUS_IGNORE` or `MPI_STATUSES_IGNORE` to the MPI function that causes `query_fn` to be called, then MPI will pass a valid status object to `query_fn`, and this status will be ignored upon return of the callback function. Note that `query_fn` is invoked only after `MPI_GREQUEST_COMPLETE` is called on the request; it may be invoked several times for the same generalized request, e.g., if the user calls `MPI_REQUEST_GET_STATUS` several times for this request. Note also that a call to `MPI_{WAIT|TEST}{SOME|ALL}` may cause multiple invocations of `query_fn` callback functions, one for each generalized request that is completed by the MPI call. The order of these invocations is not specified by MPI. 21
22
23
24
25
26
27
28
29
30
31
32
33
34

In C, the free function is 35

```
typedef int MPI_Grequest_free_function(void *extra_state); 36
```

in Fortran with the `mpi_f08` module 37

ABSTRACT INTERFACE 38

```
SUBROUTINE MPI_Grequest_free_function(extra_state, ierror) 39
  INTEGER(KIND=MPI_ADDRESS_KIND) :: extra_state 40
  INTEGER :: ierror 41
```

in Fortran with the `mpi` module and `mpif.h` 42

```
SUBROUTINE GREQUEST_FREE_FUNCTION(EXTRA_STATE, IERROR) 43
  INTEGER IERROR 44
  INTEGER(KIND=MPI_ADDRESS_KIND) EXTRA_STATE 45
```

1 The `free_fn` function is invoked to clean up user-allocated resources when the generalized
2 request is freed.

3 The `free_fn` callback is invoked by the `MPI_{WAIT|TEST}{ANY|SOME|ALL}` call that
4 completed the generalized request associated with this callback. `free_fn` is invoked after
5 the call to `query_fn` for the same request. However, if the MPI call completed multiple
6 generalized requests, the order in which `free_fn` callback functions are invoked is not specified
7 by MPI.

8 The `free_fn` callback is also invoked for generalized requests that are freed by a call
9 to `MPI_REQUEST_FREE` (no call to `MPI_{WAIT|TEST}{ANY|SOME|ALL}` will occur for
10 such a request). In this case, the callback function will be called either in the MPI call
11 `MPI_REQUEST_FREE(request)`, or in the MPI call `MPI_GREQUEST_COMPLETE(request)`,
12 whichever happens last, i.e., in this case the actual freeing code is executed as soon as both
13 calls `MPI_REQUEST_FREE` and `MPI_GREQUEST_COMPLETE` have occurred. The `request`
14 is not deallocated until after `free_fn` completes. Note that `free_fn` will be invoked only once
15 per request by a correct program.

16
17 *Advice to users.* Calling `MPI_REQUEST_FREE(request)` will cause the `request` handle
18 to be set to `MPI_REQUEST_NULL`. This handle to the generalized request is no longer
19 valid. However, user copies of this handle are valid until after `free_fn` completes since
20 MPI does not deallocate the object until then. Since `free_fn` is not called until after
21 `MPI_GREQUEST_COMPLETE`, the user copy of the handle can be used to make this
22 call. Users should note that MPI will deallocate the object after `free_fn` executes. At
23 this point, user copies of the `request` handle no longer point to a valid request. MPI will
24 not set user copies to `MPI_REQUEST_NULL` in this case, so it is up to the user to avoid
25 accessing this stale handle. This is a special case in which MPI defers deallocating the
26 object until a later time that is known by the user. (*End of advice to users.*)

27 In C, the cancel function is

```
28 typedef int MPI_Grequest_cancel_function(void *extra_state, int complete);
```

29 in Fortran with the `mpi_f08` module

```
30 ABSTRACT INTERFACE
```

```
31 SUBROUTINE MPI_Grequest_cancel_function(extra_state, complete, ierror)
```

```
32 INTEGER(KIND=MPI_ADDRESS_KIND) :: extra_state
```

```
33 LOGICAL :: complete
```

```
34 INTEGER :: ierror
```

35 in Fortran with the `mpi` module and `mpif.h`

```
36 SUBROUTINE GREQUEST_CANCEL_FUNCTION(EXTRA_STATE, COMPLETE, IERROR)
```

```
37 INTEGER IERROR
```

```
38 INTEGER(KIND=MPI_ADDRESS_KIND) EXTRA_STATE
```

```
39 LOGICAL COMPLETE
```

40 The `cancel_fn` function is invoked to start the cancelation of a generalized request.
41 It is called by `MPI_CANCEL(request)`. MPI passes `complete=true` to the callback function
42 if `MPI_GREQUEST_COMPLETE` was already called on the request, and
43 `complete=false` otherwise.

44 All callback functions return an error code. The code is passed back and dealt with as
45 appropriate for the error code by the MPI function that invoked the callback function. For
46 example, if error codes are returned then the error code returned by the callback function
47

will be returned by the MPI function that invoked the callback function. In the case of an MPI_{WAIT|TEST}{ANY} call that invokes both `query_fn` and `free_fn`, the MPI call will return the error code returned by the last callback, namely `free_fn`. If one or more of the requests in a call to MPI_{WAIT|TEST}{SOME|ALL} failed, then the MPI call will return MPI_ERR_IN_STATUS. In such a case, if the MPI call was passed an array of statuses, then MPI will return in each of the statuses that correspond to a completed generalized request the error code returned by the corresponding invocation of its `free_fn` callback function. However, if the MPI function was passed MPI_STATUSES_IGNORE, then the individual error codes returned by each callback functions will be lost.

Advice to users. `query_fn` must *not* set the error field of `status` since `query_fn` may be called by MPI_WAIT or MPI_TEST, in which case the error field of `status` should not change. The MPI library knows the “context” in which `query_fn` is invoked and can decide correctly when to put the returned error code in the error field of `status`. (*End of advice to users.*)

MPI_GREQUEST_COMPLETE(request)

INOUT request generalized request (handle)

```
int MPI_Grequest_complete(MPI_Request request)
```

```
MPI_Grequest_complete(request, ierror)
```

```
    TYPE(MPI_Request), INTENT(IN) :: request
```

```
    INTEGER, OPTIONAL, INTENT(OUT) :: ierror
```

```
MPI_GREQUEST_COMPLETE(REQUEST, IERROR)
```

```
    INTEGER REQUEST, IERROR
```

The call informs MPI that the operations represented by the generalized request `request` are complete (see definitions in Section 2.4). A call to MPI_WAIT(request, status) will return and a call to MPI_TEST(request, flag, status) will return flag=true only after a call to MPI_GREQUEST_COMPLETE has declared that these operations are complete.

MPI imposes no restrictions on the code executed by the callback functions. However, new nonblocking operations should be defined so that the general semantic rules about MPI calls such as MPI_TEST, MPI_REQUEST_FREE, or MPI_CANCEL still hold. For example, these calls are supposed to be local and nonblocking. Therefore, the callback functions `query_fn`, `free_fn`, or `cancel_fn` should invoke blocking MPI communication calls only if the context is such that these calls are guaranteed to return in finite time. Once MPI_CANCEL is invoked, the cancelled operation should complete in finite time, irrespective of the state of other processes (the operation has acquired “local” semantics). It should either succeed, or fail without side-effects. The user should guarantee these same properties for newly defined operations.

Advice to implementors. A call to MPI_GREQUEST_COMPLETE may unblock a blocked user process/thread. The MPI library should ensure that the blocked user computation will resume. (*End of advice to implementors.*)

12.2.1 Examples

Example 12.1 This example shows the code for a user-defined reduce operation on an `int` using a binary tree: each non-root node receives two messages, sums them, and sends them up. We assume that no status is returned and that the operation cannot be cancelled.

```

7 typedef struct {
8     MPI_Comm comm;
9     int tag;
10    int root;
11    int valin;
12    int *valout;
13    MPI_Request request;
14 } ARGS;
15
16
17 int myreduce(MPI_Comm comm, int tag, int root,
18             int valin, int *valout, MPI_Request *request)
19 {
20     ARGS *args;
21     pthread_t thread;
22
23     /* start request */
24     MPI_Grequest_start(query_fn, free_fn, cancel_fn, NULL, request);
25
26     args = (ARGS*)malloc(sizeof(ARGS));
27     args->comm = comm;
28     args->tag = tag;
29     args->root = root;
30     args->valin = valin;
31     args->valout = valout;
32     args->request = *request;
33
34     /* spawn thread to handle request */
35     /* The availability of the pthread_create call is system dependent */
36     pthread_create(&thread, NULL, reduce_thread, args);
37
38     return MPI_SUCCESS;
39 }
40
41 /* thread code */
42 void* reduce_thread(void *ptr)
43 {
44     int lchild, rchild, parent, lval, rval, val;
45     MPI_Request req[2];
46     ARGS *args;
47
48     args = (ARGS*)ptr;

```

```

1
2
3
4
5
6
7
8
9
10
11
12
13
14
15
16
17
18
19
20
21
22
23
24
25
26
27
28
29
30
31
32
33
34
35
36
37
38
39
40
41
42
43
44
45
46
47
48

```

```

/* compute left and right child and parent in tree; set
   to MPI_PROC_NULL if does not exist */
/* code not shown */
...

MPI_Irecv(&lval, 1, MPI_INT, lchild, args->tag, args->comm, &req[0]);
MPI_Irecv(&rval, 1, MPI_INT, rchild, args->tag, args->comm, &req[1]);
MPI_Waitall(2, req, MPI_STATUSES_IGNORE);
val = lval + args->valin + rval;
MPI_Send( &val, 1, MPI_INT, parent, args->tag, args->comm );
if (parent == MPI_PROC_NULL) *(args->valout) = val;
MPI_Grequest_complete((args->request));
free(ptr);
return(NULL);
}

int query_fn(void *extra_state, MPI_Status *status)
{
    /* always send just one int */
    MPI_Status_set_elements(status, MPI_INT, 1);
    /* can never cancel so always true */
    MPI_Status_set_cancelled(status, 0);
    /* choose not to return a value for this */
    status->MPI_SOURCE = MPI_UNDEFINED;
    /* tag has no meaning for this generalized request */
    status->MPI_TAG = MPI_UNDEFINED;
    /* this generalized request never fails */
    return MPI_SUCCESS;
}

int free_fn(void *extra_state)
{
    /* this generalized request does not need to do any freeing */
    /* as a result it never fails here */
    return MPI_SUCCESS;
}

int cancel_fn(void *extra_state, int complete)
{
    /* This generalized request does not support cancelling.
       Abort if not already done.  If done then treat as if cancel failed.*/
    if (!complete) {
        fprintf(stderr,
            "Cannot cancel generalized request - aborting program\n");
        MPI_Abort(MPI_COMM_WORLD, 99);
    }
}

```

```

1     }
2     return MPI_SUCCESS;
3 }

```

12.3 Associating Information with Status

MPI supports several different types of requests besides those for point-to-point operations. These range from MPI calls for I/O to generalized requests. It is desirable to allow these calls to use the same request mechanism, which allows one to wait or test on different types of requests. However, `MPI_{TEST|WAIT}_{ANY|SOME|ALL}` returns a status with information about the request. With the generalization of requests, one needs to define what information will be returned in the status object.

Each MPI call fills in the appropriate fields in the status object. Any unused fields will have undefined values. A call to `MPI_{TEST|WAIT}_{ANY|SOME|ALL}` can modify any of the fields in the status object. Specifically, it can modify fields that are undefined. The fields with meaningful values for a given request are defined in the sections with the new request.

Generalized requests raise additional considerations. Here, the user provides the functions to deal with the request. Unlike other MPI calls, the user needs to provide the information to be returned in the status. The status argument is provided directly to the callback function where the status needs to be set. Users can directly set the values in 3 of the 5 status values. The count and cancel fields are opaque. To overcome this, these calls are provided:

`MPI_STATUS_SET_ELEMENTS(status, datatype, count)`

INOUT	status	status with which to associate count (Status)
IN	datatype	datatype associated with count (handle)
IN	count	number of elements to associate with status (integer)

```

int MPI_Status_set_elements(MPI_Status *status, MPI_Datatype datatype,
                           int count)

```

```

MPI_Status_set_elements(status, datatype, count, ierror)

```

```

    TYPE(MPI_Status), INTENT(INOUT) :: status
    TYPE(MPI_Datatype), INTENT(IN)  :: datatype
    INTEGER, INTENT(IN)             :: count
    INTEGER, OPTIONAL, INTENT(OUT) :: ierror

```

```

MPI_STATUS_SET_ELEMENTS(STATUS, DATATYPE, COUNT, IERROR)

```

```

    INTEGER STATUS(MPI_STATUS_SIZE), DATATYPE, COUNT, IERROR

```

```

MPI_STATUS_SET_ELEMENTS_X(status, datatype, count) 1
    INOUT    status                                status with which to associate count (Status) 2
    IN       datatype                              datatype associated with count (handle) 3
    IN       count                                  number of elements to associate with status (integer) 4
                                                    5
int MPI_Status_set_elements_x(MPI_Status *status, MPI_Datatype datatype, 6
                              MPI_Count count) 7
MPI_Status_set_elements_x(status, datatype, count, ierror) 8
    TYPE(MPI_Status), INTENT(INOUT) :: status 9
    TYPE(MPI_Datatype), INTENT(IN) :: datatype 10
    INTEGER(KIND = MPI_COUNT_KIND), INTENT(IN) :: count 11
    INTEGER, OPTIONAL, INTENT(OUT) :: ierror 12
MPI_STATUS_SET_ELEMENTS_X(STATUS, DATATYPE, COUNT, IERROR) 13
    INTEGER STATUS(MPI_STATUS_SIZE), DATATYPE, IERROR 14
    INTEGER (KIND=MPI_COUNT_KIND) COUNT 15

```

These functions modify the opaque part of status so that a call to MPI_GET_ELEMENTS or MPI_GET_ELEMENTS_X will return count. MPI_GET_COUNT will return a compatible value.

Rationale. The number of elements is set instead of the count because the former can deal with a nonintegral number of datatypes. (*End of rationale.*)

A subsequent call to MPI_GET_COUNT(status, datatype, count), MPI_GET_ELEMENTS(status, datatype, count), or MPI_GET_ELEMENTS_X(status, datatype, count) must use a datatype argument that has the same type signature as the datatype argument that was used in the call to MPI_STATUS_SET_ELEMENTS or MPI_STATUS_SET_ELEMENTS_X.

Rationale. The requirement of matching type signatures for these calls is similar to the restriction that holds when count is set by a receive operation: in that case, the calls to MPI_GET_COUNT, MPI_GET_ELEMENTS, and MPI_GET_ELEMENTS_X must use a datatype with the same signature as the datatype used in the receive call. (*End of rationale.*)

```

MPI_STATUS_SET_CANCELLED(status, flag) 36
    INOUT    status                                status with which to associate cancel flag (Status) 37
    IN       flag                                  if true indicates request was cancelled (logical) 38
                                                    39
int MPI_Status_set_cancelled(MPI_Status *status, int flag) 40
MPI_Status_set_cancelled(status, flag, ierror) 41
    TYPE(MPI_Status), INTENT(INOUT) :: status 42
    LOGICAL, INTENT(IN) :: flag 43
    INTEGER, OPTIONAL, INTENT(OUT) :: ierror 44

```

```

1 MPI_STATUS_SET_CANCELLED(STATUS, FLAG, IERROR)
2     INTEGER STATUS(MPI_STATUS_SIZE), IERROR
3     LOGICAL FLAG

```

If `flag` is set to `true` then a subsequent call to `MPI_TEST_CANCELLED(status, flag)` will also return `flag = true`, otherwise it will return `false`.

Advice to users. Users are advised not to reuse the status fields for values other than those for which they were intended. Doing so may lead to unexpected results when using the status object. For example, calling `MPI_GET_ELEMENTS` may cause an error if the value is out of range or it may be impossible to detect such an error. The `extra_state` argument provided with a generalized request can be used to return information that does not logically belong in status. Furthermore, modifying the values in a status set internally by MPI, e.g., `MPI_RECV`, may lead to unpredictable results and is strongly discouraged. (*End of advice to users.*)

12.4 MPI and Threads

This section specifies the interaction between MPI calls and threads. The section lists minimal requirements for **thread compliant** MPI implementations and defines functions that can be used for initializing the thread environment. MPI may be implemented in environments where threads are not supported or perform poorly. Therefore, MPI implementations are not required to be thread compliant as defined in this section. Regardless of whether or not the MPI implementation is thread compliant, `MPI_INITIALIZED`, `MPI_FINALIZED`, `MPI_QUERY_THREAD`, `MPI_IS_THREAD_MAIN`, `MPI_GET_VERSION` and `MPI_GET_LIBRARY_VERSION` must always be thread-safe. When a thread is executing one of these routines, if another concurrently running thread also makes an MPI call, the outcome will be as if the calls executed in some order.

This section generally assumes a thread package similar to POSIX threads [40], but the syntax and semantics of thread calls are not specified here — these are beyond the scope of this document.

12.4.1 General

In a thread-compliant implementation, an MPI process is a process that may be multi-threaded. Each thread can issue MPI calls; however, threads are not separately addressable: a rank in a send or receive call identifies a process, not a thread. A message sent to a process can be received by any thread in this process.

Rationale. This model corresponds to the POSIX model of interprocess communication: the fact that a process is multi-threaded, rather than single-threaded, does not affect the external interface of this process. MPI implementations in which MPI ‘processes’ are POSIX threads inside a single POSIX process are not thread-compliant by this definition (indeed, their “processes” are single-threaded). (*End of rationale.*)

Advice to users. It is the user’s responsibility to prevent races when threads within the same application post conflicting communication calls. The user can make sure that two threads in the same process will not issue conflicting communication calls by using distinct communicators at each thread. (*End of advice to users.*)

The two main requirements for a thread-compliant implementation are listed below.

1. All MPI calls are *thread-safe*, i.e., two concurrently running threads may make MPI calls and the outcome will be as if the calls executed in some order, even if their execution is interleaved.
2. Blocking MPI calls will block the calling thread only, allowing another thread to execute, if available. The calling thread will be blocked until the event on which it is waiting occurs. Once the blocked communication is enabled and can proceed, then the call will complete and the thread will be marked runnable, within a finite time. A blocked thread will not prevent progress of other runnable threads on the same process, and will not prevent them from executing MPI calls.

Example 12.2 Process 0 consists of two threads. The first thread executes a blocking send call `MPI_Send(buff1, count, type, 0, 0, comm)`, whereas the second thread executes a blocking receive call `MPI_Recv(buff2, count, type, 0, 0, comm, &status)`, i.e., the first thread sends a message that is received by the second thread. This communication should always succeed. According to the first requirement, the execution will correspond to some interleaving of the two calls. According to the second requirement, a call can only block the calling thread and cannot prevent progress of the other thread. If the send call went ahead of the receive call, then the sending thread may block, but this will not prevent the receiving thread from executing. Thus, the receive call will occur. Once both calls occur, the communication is enabled and both calls will complete. On the other hand, a single-threaded process that posts a send, followed by a matching receive, may deadlock. The progress requirement for multithreaded implementations is stronger, as a blocked call cannot prevent progress in other threads.

Advice to implementors. MPI calls can be made thread-safe by executing only one at a time, e.g., by protecting MPI code with one process-global lock. However, blocked operations cannot hold the lock, as this would prevent progress of other threads in the process. The lock is held only for the duration of an atomic, locally-completing suboperation such as posting a send or completing a send, and is released in between. Finer locks can provide more concurrency, at the expense of higher locking overheads. Concurrency can also be achieved by having some of the MPI protocol executed by separate server threads. (*End of advice to implementors.*)

12.4.2 Clarifications

Initialization and Completion The call to `MPI_FINALIZE` should occur on the same thread that initialized MPI. We call this thread the **main thread**. The call should occur only after all process threads have completed their MPI calls, and have no pending communications or I/O operations.

Rationale. This constraint simplifies implementation. (*End of rationale.*)

Multiple threads completing the same request. A program in which two threads block, waiting on the same request, is erroneous. Similarly, the same request cannot appear in the array of requests of two concurrent `MPI_{WAIT|TEST}{ANY|SOME|ALL}` calls. In MPI, a request can only be completed once. Any combination of wait or test that violates this rule is erroneous.

1 *Rationale.* This restriction is consistent with the view that a multithreaded execution
2 corresponds to an interleaving of the MPI calls. In a single threaded implementation,
3 once a wait is posted on a request the request handle will be nullified before it is
4 possible to post a second wait on the same handle. With threads, an
5 MPI_WAIT{ANY|SOME|ALL} may be blocked without having nullified its request(s)
6 so it becomes the user's responsibility to avoid using the same request in an MPI_WAIT
7 on another thread. This constraint also simplifies implementation, as only one thread
8 will be blocked on any communication or I/O event. (*End of rationale.*)
9

10 **Probe** A receive call that uses source and tag values returned by a preceding call to
11 MPI_PROBE or MPI_IPROBE will receive the message matched by the probe call only
12 if there was no other matching receive after the probe and before that receive. In a multi-
13 threaded environment, it is up to the user to enforce this condition using suitable mutual
14 exclusion logic. This can be enforced by making sure that each communicator is used by
15 only one thread on each process. Alternatively, MPI_MPROBE or MPI_IMPROBE can be
16 used.
17

18 **Collective calls** Matching of collective calls on a communicator, window, or file handle is
19 done according to the order in which the calls are issued at each process. If concurrent
20 threads issue such calls on the same communicator, window or file handle, it is up to the
21 user to make sure the calls are correctly ordered, using interthread synchronization.
22

23 *Advice to users.* With three concurrent threads in each MPI process of a communica-
24 tor `comm`, it is allowed that thread A in each MPI process calls a collective operation
25 on `comm`, thread B calls a file operation on an existing filehandle that was formerly
26 opened on `comm`, and thread C invokes one-sided operations on an existing window
27 handle that was also formerly created on `comm`. (*End of advice to users.*)
28

29 *Rationale.* As specified in MPI_FILE_OPEN and MPI_WIN_CREATE, a file handle
30 and a window handle inherit only the group of processes of the underlying communi-
31 cator, but not the communicator itself. Accesses to communicators, window handles
32 and file handles cannot affect one another. (*End of rationale.*)
33

34 *Advice to implementors.* If the implementation of file or window operations internally
35 uses MPI communication then a duplicated communicator may be cached on the file
36 or window object. (*End of advice to implementors.*)
37

38 **Exception handlers** An exception handler does not necessarily execute in the context of the
39 thread that made the exception-raising MPI call; the exception handler may be executed
40 by a thread that is distinct from the thread that will return the error code.
41

42 *Rationale.* The MPI implementation may be multithreaded, so that part of the
43 communication protocol may execute on a thread that is distinct from the thread
44 that made the MPI call. The design allows the exception handler to be executed on
45 the thread where the exception occurred. (*End of rationale.*)
46
47
48

Interaction with signals and cancellations The outcome is undefined if a thread that executes an MPI call is cancelled (by another thread), or if a thread catches a signal while executing an MPI call. However, a thread of an MPI process may terminate, and may catch signals or be cancelled by another thread when not executing MPI calls.

Rationale. Few C library functions are signal safe, and many have cancellation points — points at which the thread executing them may be cancelled. The above restriction simplifies implementation (no need for the MPI library to be “async-cancel-safe” or “async-signal-safe”). (*End of rationale.*)

Advice to users. Users can catch signals in separate, non-MPI threads (e.g., by masking signals on MPI calling threads, and unmasking them in one or more non-MPI threads). A good programming practice is to have a distinct thread blocked in a call to `sigwait` for each user expected signal that may occur. Users must not catch signals used by the MPI implementation; as each MPI implementation is required to document the signals used internally, users can avoid these signals. (*End of advice to users.*)

Advice to implementors. The MPI library should not invoke library calls that are not thread safe, if multiple threads execute. (*End of advice to implementors.*)

12.4.3 Initialization

The following function may be used to initialize MPI, and to initialize the MPI thread environment, instead of `MPI_INIT`.

`MPI_INIT_THREAD(required, provided)`

IN	required	desired level of thread support (integer)
OUT	provided	provided level of thread support (integer)

`int MPI_Init_thread(int *argc, char ***argv, int required, int *provided)`

`MPI_Init_thread(required, provided, ierror)`

INTEGER, INTENT(IN)	::	required
INTEGER, INTENT(OUT)	::	provided
INTEGER, OPTIONAL, INTENT(OUT)	::	ierror

`MPI_INIT_THREAD(REQUIRED, PROVIDED, IERROR)`

`INTEGER REQUIRED, PROVIDED, IERROR`

Advice to users. In C, the passing of `argc` and `argv` is optional, as with `MPI_INIT` as discussed in Section 8.7. In C, null pointers may be passed in their place. (*End of advice to users.*)

This call initializes MPI in the same way that a call to `MPI_INIT` would. In addition, it initializes the thread environment. The argument `required` is used to specify the desired level of thread support. The possible values are listed in increasing order of thread support.

1 **MPI_THREAD_SINGLE** Only one thread will execute.

2
3 **MPI_THREAD_FUNNELED** The process may be multi-threaded, but the application must
4 ensure that only the main thread makes MPI calls (for the definition of main thread,
5 see `MPI_IS_THREAD_MAIN` on page 524).

6 **MPI_THREAD_SERIALIZED** The process may be multi-threaded, and multiple threads may
7 make MPI calls, but only one at a time: MPI calls are not made concurrently from
8 two distinct threads (all MPI calls are “serialized”).
9

10 **MPI_THREAD_MULTIPLE** Multiple threads may call MPI, with no restrictions.

11 These values are monotonic; i.e., `MPI_THREAD_SINGLE` < `MPI_THREAD_FUNNELED` <
12 `MPI_THREAD_SERIALIZED` < `MPI_THREAD_MULTIPLE`.

13 Different processes in `MPI_COMM_WORLD` may require different levels of thread sup-
14 port.

15 The call returns in provided information about the actual level of thread support that
16 will be provided by MPI. It can be one of the four values listed above.

17 The level(s) of thread support that can be provided by `MPI_INIT_THREAD` will depend
18 on the implementation, and may depend on information provided by the user before the
19 program started to execute (e.g., with arguments to `mpiexec`). If possible, the call will
20 return `provided = required`. Failing this, the call will return the least supported level such
21 that `provided > required` (thus providing a stronger level of support than required by the
22 user). Finally, if the user requirement cannot be satisfied, then the call will return in
23 `provided` the highest supported level.
24

25 A **thread compliant** MPI implementation will be able to return `provided`
26 = `MPI_THREAD_MULTIPLE`. Such an implementation may always return `provided`
27 = `MPI_THREAD_MULTIPLE`, irrespective of the value of `required`.

28 An MPI library that is not thread compliant must always return
29 `provided=MPI_THREAD_SINGLE`, even if `MPI_INIT_THREAD` is called on a multithreaded
30 process. The library should also return correct values for the MPI calls that can be executed
31 before initialization, even if multiple threads have been spawned.

32 *Rationale.* Such code is erroneous, but if the MPI initialization is performed by a
33 library, the error cannot be detected until `MPI_INIT_THREAD` is called. The require-
34 ments in the previous paragraph ensure that the error can be properly detected. (*End*
35 *of rationale.*)
36

37 A call to `MPI_INIT` has the same effect as a call to `MPI_INIT_THREAD` with a `required`
38 = `MPI_THREAD_SINGLE`.

39 Vendors may provide (implementation dependent) means to specify the level(s) of
40 thread support available when the MPI program is started, e.g., with arguments to `mpiexec`.
41 This will affect the outcome of calls to `MPI_INIT` and `MPI_INIT_THREAD`. Suppose, for
42 example, that an MPI program has been started so that only `MPI_THREAD_MULTIPLE` is
43 available. Then `MPI_INIT_THREAD` will return `provided = MPI_THREAD_MULTIPLE`, irre-
44 spective of the value of `required`; a call to `MPI_INIT` will also initialize the MPI thread support
45 level to `MPI_THREAD_MULTIPLE`. Suppose, instead, that an MPI program has been started
46 so that all four levels of thread support are available. Then, a call to `MPI_INIT_THREAD`
47 will return `provided = required`; alternatively, a call to `MPI_INIT` will initialize the MPI
48 thread support level to `MPI_THREAD_SINGLE`.

Rationale. Various optimizations are possible when MPI code is executed single-threaded, or is executed on multiple threads, but not concurrently: mutual exclusion code may be omitted. Furthermore, if only one thread executes, then the MPI library can use library functions that are not thread safe, without risking conflicts with user threads. Also, the model of one communication thread, multiple computation threads fits many applications well, e.g., if the process code is a sequential Fortran/C program with MPI calls that has been parallelized by a compiler for execution on an SMP node, in a cluster of SMPs, then the process computation is multi-threaded, but MPI calls will likely execute on a single thread.

The design accommodates a static specification of the thread support level, for environments that require static binding of libraries, and for compatibility for current multi-threaded MPI codes. (*End of rationale.*)

Advice to implementors. If `provided` is not `MPI_THREAD_SINGLE` then the MPI library should not invoke C or Fortran library calls that are not thread safe, e.g., in an environment where `malloc` is not thread safe, then `malloc` should not be used by the MPI library.

Some implementors may want to use different MPI libraries for different levels of thread support. They can do so using dynamic linking and selecting which library will be linked when `MPI_INIT_THREAD` is invoked. If this is not possible, then optimizations for lower levels of thread support will occur only when the level of thread support required is specified at link time.

Note that `required` need not be the same value on all processes of `MPI_COMM_WORLD`. (*End of advice to implementors.*)

The following function can be used to query the current level of thread support.

```
MPI_QUERY_THREAD(provided)
```

```
OUT    provided                provided level of thread support (integer)
```

```
int MPI_Query_thread(int *provided)
```

```
MPI_Query_thread(provided, ierror)
```

```
    INTEGER, INTENT(OUT) :: provided
```

```
    INTEGER, OPTIONAL, INTENT(OUT) :: ierror
```

```
MPI_QUERY_THREAD(PROVIDED, IERROR)
```

```
    INTEGER PROVIDED, IERROR
```

The call returns in `provided` the current level of thread support, which will be the value returned in `provided` by `MPI_INIT_THREAD`, if MPI was initialized by a call to `MPI_INIT_THREAD()`.

```

1 MPI_IS_THREAD_MAIN(flag)
2   OUT   flag           true if calling thread is main thread, false otherwise
3                               (logical)
4
5
6

```

```

6 int MPI_Is_thread_main(int *flag)
7 MPI_Is_thread_main(flag, ierror)
8   LOGICAL, INTENT(OUT) :: flag
9   INTEGER, OPTIONAL, INTENT(OUT) :: ierror
10

```

```

11 MPI_IS_THREAD_MAIN(FLAG, IERROR)
12   LOGICAL FLAG
13   INTEGER IERROR

```

This function can be called by a thread to determine if it is the main thread (the thread that called `MPI_INIT` or `MPI_INIT_THREAD`).

All routines listed in this section must be supported by all MPI implementations.

Rationale. MPI libraries are required to provide these calls even if they do not support threads, so that portable code that contains invocations to these functions can link correctly. `MPI_INIT` continues to be supported so as to provide compatibility with current MPI codes. (*End of rationale.*)

Advice to users. It is possible to spawn threads before MPI is initialized, but no MPI call other than `MPI_GET_VERSION`, `MPI_INITIALIZED`, or `MPI_FINALIZED` should be executed by these threads, until `MPI_INIT_THREAD` is invoked by one thread (which, thereby, becomes the main thread). In particular, it is possible to enter the MPI execution with a multi-threaded process.

The level of thread support provided is a global property of the MPI process that can be specified only once, when MPI is initialized on that process (or before). Portable third party libraries have to be written so as to accommodate any provided level of thread support. Otherwise, their usage will be restricted to specific level(s) of thread support. If such a library can run only with specific level(s) of thread support, e.g., only with `MPI_THREAD_MULTIPLE`, then `MPI_QUERY_THREAD` can be used to check whether the user initialized MPI to the correct level of thread support and, if not, raise an exception. (*End of advice to users.*)

Chapter 13

I/O

13.1 Introduction

POSIX provides a model of a widely portable file system, but the portability and optimization needed for parallel I/O cannot be achieved with the POSIX interface.

The significant optimizations required for efficiency (e.g., grouping [49], collective buffering [7, 16, 50, 54, 60], and disk-directed I/O [44]) can only be implemented if the parallel I/O system provides a high-level interface supporting partitioning of file data among processes and a collective interface supporting complete transfers of global data structures between process memories and files. In addition, further efficiencies can be gained via support for asynchronous I/O, strided accesses, and control over physical file layout on storage devices (disks). The I/O environment described in this chapter provides these facilities.

Instead of defining I/O access modes to express the common patterns for accessing a shared file (broadcast, reduction, scatter, gather), we chose another approach in which data partitioning is expressed using derived datatypes. Compared to a limited set of predefined access patterns, this approach has the advantage of added flexibility and expressiveness.

13.1.1 Definitions

file An MPI file is an ordered collection of typed data items. MPI supports random or sequential access to any integral set of these items. A file is opened collectively by a group of processes. All collective I/O calls on a file are collective over this group.

displacement A file *displacement* is an absolute byte position relative to the beginning of a file. The displacement defines the location where a *view* begins. Note that a “file displacement” is distinct from a “typemap displacement.”

etype An *etype* (*elementary* datatype) is the unit of data access and positioning. It can be any MPI predefined or derived datatype. Derived etypes can be constructed using any of the MPI datatype constructor routines, provided all resulting typemap displacements are non-negative and monotonically nondecreasing. Data access is performed in etype units, reading or writing whole data items of type etype. Offsets are expressed as a count of etypes; file pointers point to the beginning of etypes. Depending on context, the term “etype” is used to describe one of three aspects of an elementary datatype: a particular MPI type, a data item of that type, or the extent of that type.

filetype A *filetype* is the basis for partitioning a file among processes and defines a template for accessing the file. A filetype is either a single etype or a derived MPI datatype constructed from multiple instances of the same etype. In addition, the extent of any hole in the filetype must be a multiple of the etype’s extent. The displacements in the typemap of the filetype are not required to be distinct, but they must be non-negative and monotonically nondecreasing.

view A *view* defines the current set of data visible and accessible from an open file as an ordered set of etypes. Each process has its own view of the file, defined by three quantities: a displacement, an etype, and a filetype. The pattern described by a filetype is repeated, beginning at the displacement, to define the view. The pattern of repetition is defined to be the same pattern that `MPI_TYPE_CONTIGUOUS` would produce if it were passed the filetype and an arbitrarily large count. Figure 13.1 shows how the tiling works; note that the filetype in this example must have explicit lower and upper bounds set in order for the initial and final holes to be repeated in the view. Views can be changed by the user during program execution. The default view is a linear byte stream (displacement is zero, etype and filetype equal to `MPI_BYTE`).

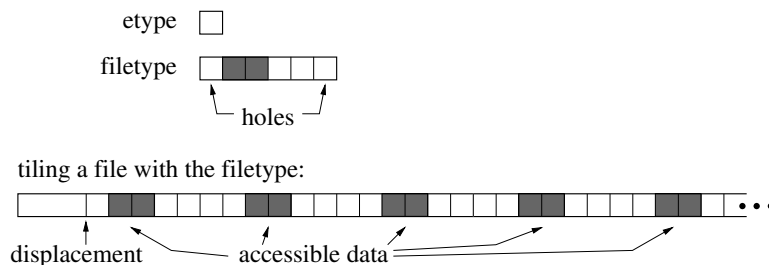

Figure 13.1: Etypes and filetypes

A group of processes can use complementary views to achieve a global data distribution such as a scatter/gather pattern (see Figure 13.2).

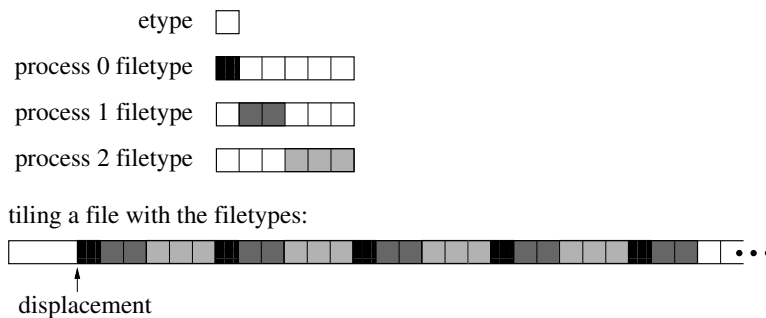

Figure 13.2: Partitioning a file among parallel processes

offset An *offset* is a position in the file relative to the current view, expressed as a count of etypes. Holes in the view’s filetype are skipped when calculating this position. Offset 0 is the location of the first etype visible in the view (after skipping the displacement and any initial holes in the view). For example, an offset of 2 for process 1 in Figure 13.2 is the position of the eighth etype in the file after the displacement. An “explicit offset” is an offset that is used as an argument in explicit data access routines.

file size and end of file The *size* of an MPI file is measured in bytes from the beginning of the file. A newly created file has a size of zero bytes. Using the size as an absolute displacement gives the position of the byte immediately following the last byte in the file. For any given view, the *end of file* is the offset of the first etype accessible in the current view starting after the last byte in the file.

file pointer A *file pointer* is an implicit offset maintained by MPI. “Individual file pointers” are file pointers that are local to each process that opened the file. A “shared file pointer” is a file pointer that is shared by the group of processes that opened the file.

file handle A *file handle* is an opaque object created by `MPI_FILE_OPEN` and freed by `MPI_FILE_CLOSE`. All operations on an open file reference the file through the file handle.

13.2 File Manipulation

13.2.1 Opening a File

`MPI_FILE_OPEN(comm, filename, amode, info, fh)`

IN	<code>comm</code>	communicator (handle)
IN	<code>filename</code>	name of file to open (string)
IN	<code>amode</code>	file access mode (integer)
IN	<code>info</code>	info object (handle)
OUT	<code>fh</code>	new file handle (handle)

```
int MPI_File_open(MPI_Comm comm, const char *filename, int amode,
                 MPI_Info info, MPI_File *fh)
```

```
MPI_File_open(comm, filename, amode, info, fh, ierror)
```

```
TYPE(MPI_Comm), INTENT(IN) :: comm
CHARACTER(LEN=*), INTENT(IN) :: filename
INTEGER, INTENT(IN) :: amode
TYPE(MPI_Info), INTENT(IN) :: info
TYPE(MPI_File), INTENT(OUT) :: fh
INTEGER, OPTIONAL, INTENT(OUT) :: ierror
```

```
MPI_FILE_OPEN(COMM, FILENAME, AMODE, INFO, FH, IERROR)
```

```
CHARACTER*(*) FILENAME
INTEGER COMM, AMODE, INFO, FH, IERROR
```

`MPI_FILE_OPEN` opens the file identified by the file name `filename` on all processes in the `comm` communicator group. `MPI_FILE_OPEN` is a collective routine: all processes must provide the same value for `amode`, and all processes must provide filenames that reference the same file. (Values for `info` may vary.) `comm` must be an intracommunicator; it is erroneous to pass an intercommunicator to `MPI_FILE_OPEN`. Errors in `MPI_FILE_OPEN` are raised using the default file error handler (see Section 13.7). A process can open a file independently of

1 other processes by using the `MPI_COMM_SELF` communicator. The file handle returned, `fh`,
 2 can be subsequently used to access the file until the file is closed using `MPI_FILE_CLOSE`.
 3 Before calling `MPI_FINALIZE`, the user is required to close (via `MPI_FILE_CLOSE`) all files
 4 that were opened with `MPI_FILE_OPEN`. Note that the communicator `comm` is unaffected
 5 by `MPI_FILE_OPEN` and continues to be usable in all MPI routines (e.g., `MPI_SEND`).
 6 Furthermore, the use of `comm` will not interfere with I/O behavior.

7 The format for specifying the file name in the `filename` argument is implementation
 8 dependent and must be documented by the implementation.

9
 10 *Advice to implementors.* An implementation may require that `filename` include a
 11 string or strings specifying additional information about the file. Examples include
 12 the type of filesystem (e.g., a prefix of `ufs:`), a remote hostname (e.g., a prefix of
 13 `machine.univ.edu:`), or a file password (e.g., a suffix of `/PASSWORD=SECRET`). (*End*
 14 *of advice to implementors.*)

15
 16 *Advice to users.* On some implementations of MPI, the file namespace may not be
 17 identical from all processes of all applications. For example, `"/tmp/foo"` may denote
 18 different files on different processes, or a single file may have many names, dependent
 19 on process location. The user is responsible for ensuring that a single file is referenced
 20 by the `filename` argument, as it may be impossible for an implementation to detect
 21 this type of namespace error. (*End of advice to users.*)

22
 23 Initially, all processes view the file as a linear byte stream, and each process views data
 24 in its own native representation (no data representation conversion is performed). (POSIX
 25 files are linear byte streams in the native representation.) The file view can be changed via
 26 the `MPI_FILE_SET_VIEW` routine.

27 The following access modes are supported (specified in `amode`, a bit vector OR of the
 28 following integer constants):

- 29 ● `MPI_MODE_RDONLY` — read only,
- 30 ● `MPI_MODE_RDWR` — reading and writing,
- 31 ● `MPI_MODE_WRONLY` — write only,
- 32 ● `MPI_MODE_CREATE` — create the file if it does not exist,
- 33 ● `MPI_MODE_EXCL` — error if creating file that already exists,
- 34 ● `MPI_MODE_DELETE_ON_CLOSE` — delete file on close,
- 35 ● `MPI_MODE_UNIQUE_OPEN` — file will not be concurrently opened elsewhere,
- 36 ● `MPI_MODE_SEQUENTIAL` — file will only be accessed sequentially,
- 37 ● `MPI_MODE_APPEND` — set initial position of all file pointers to end of file.

38
 39 *Advice to users.* C users can use bit vector OR (`|`) to combine these constants; Fortran
 40 90 users can use the bit vector `IOR` intrinsic. Fortran 77 users can use (nonportably)
 41 bit vector `IOR` on systems that support it. Alternatively, Fortran users can portably
 42 use integer addition to OR the constants (each constant should appear at most once
 43 in the addition.). (*End of advice to users.*)

Advice to implementors. The values of these constants must be defined such that the bitwise OR and the sum of any distinct set of these constants is equivalent. (*End of advice to implementors.*)

The modes `MPI_MODE_RDONLY`, `MPI_MODE_RDWR`, `MPI_MODE_WRONLY`, `MPI_MODE_CREATE`, and `MPI_MODE_EXCL` have identical semantics to their POSIX counterparts [40]. Exactly one of `MPI_MODE_RDONLY`, `MPI_MODE_RDWR`, or `MPI_MODE_WRONLY`, must be specified. It is erroneous to specify `MPI_MODE_CREATE` or `MPI_MODE_EXCL` in conjunction with `MPI_MODE_RDONLY`; it is erroneous to specify `MPI_MODE_SEQUENTIAL` together with `MPI_MODE_RDWR`.

The `MPI_MODE_DELETE_ON_CLOSE` mode causes the file to be deleted (equivalent to performing an `MPI_FILE_DELETE`) when the file is closed.

The `MPI_MODE_UNIQUE_OPEN` mode allows an implementation to optimize access by eliminating the overhead of file locking. It is erroneous to open a file in this mode unless the file will not be concurrently opened elsewhere.

Advice to users. For `MPI_MODE_UNIQUE_OPEN`, *not opened elsewhere* includes both inside and outside the MPI environment. In particular, one needs to be aware of potential external events which may open files (e.g., automated backup facilities). When `MPI_MODE_UNIQUE_OPEN` is specified, the user is responsible for ensuring that no such external events take place. (*End of advice to users.*)

The `MPI_MODE_SEQUENTIAL` mode allows an implementation to optimize access to some sequential devices (tapes and network streams). It is erroneous to attempt nonsequential access to a file that has been opened in this mode.

Specifying `MPI_MODE_APPEND` only guarantees that all shared and individual file pointers are positioned at the initial end of file when `MPI_FILE_OPEN` returns. Subsequent positioning of file pointers is application dependent. In particular, the implementation does not ensure that all writes are appended.

Errors related to the access mode are raised in the class `MPI_ERR_AMODE`.

The `info` argument is used to provide information regarding file access patterns and file system specifics (see Section 13.2.8). The constant `MPI_INFO_NULL` can be used when no `info` needs to be specified.

Advice to users. Some file attributes are inherently implementation dependent (e.g., file permissions). These attributes must be set using either the `info` argument or facilities outside the scope of MPI. (*End of advice to users.*)

Files are opened by default using nonatomic mode file consistency semantics (see Section 13.6.1). The more stringent atomic mode consistency semantics, required for atomicity of conflicting accesses, can be set using `MPI_FILE_SET_ATOMICITY`.

13.2.2 Closing a File

`MPI_FILE_CLOSE(fh)`

INOUT `fh` file handle (handle)

```

1  int MPI_File_close(MPI_File *fh)
2
3  MPI_File_close(fh, ierror)
4      TYPE(MPI_File), INTENT(INOUT) :: fh
5      INTEGER, OPTIONAL, INTENT(OUT) :: ierror
6
7  MPI_FILE_CLOSE(FH, IERROR)
8      INTEGER FH, IERROR

```

MPI_FILE_CLOSE first synchronizes file state (equivalent to performing an MPI_FILE_SYNC), then closes the file associated with fh. The file is deleted if it was opened with access mode MPI_MODE_DELETE_ON_CLOSE (equivalent to performing an MPI_FILE_DELETE). MPI_FILE_CLOSE is a collective routine.

Advice to users. If the file is deleted on close, and there are other processes currently accessing the file, the status of the file and the behavior of future accesses by these processes are implementation dependent. (*End of advice to users.*)

The user is responsible for ensuring that all outstanding nonblocking requests and split collective operations associated with fh made by a process have completed before that process calls MPI_FILE_CLOSE.

The MPI_FILE_CLOSE routine deallocates the file handle object and sets fh to MPI_FILE_NULL.

13.2.3 Deleting a File

```

26  MPI_FILE_DELETE(filename, info)
27
28      IN          filename          name of file to delete (string)
29      IN          info              info object (handle)
30
31  int MPI_File_delete(const char *filename, MPI_Info info)
32
33  MPI_File_delete(filename, info, ierror)
34      CHARACTER(LEN=*), INTENT(IN) :: filename
35      TYPE(MPI_Info), INTENT(IN) :: info
36      INTEGER, OPTIONAL, INTENT(OUT) :: ierror
37
38  MPI_FILE_DELETE(FILENAME, INFO, IERROR)
39      CHARACTER*(*) FILENAME
40      INTEGER INFO, IERROR

```

MPI_FILE_DELETE deletes the file identified by the file name filename. If the file does not exist, MPI_FILE_DELETE raises an error in the class MPI_ERR_NO_SUCH_FILE.

The info argument can be used to provide information regarding file system specifics (see Section 13.2.8). The constant MPI_INFO_NULL refers to the null info, and can be used when no info needs to be specified.

If a process currently has the file open, the behavior of any access to the file (as well as the behavior of any outstanding accesses) is implementation dependent. In addition, whether an open file is deleted or not is also implementation dependent. If the file is not

deleted, an error in the class `MPI_ERR_FILE_IN_USE` or `MPI_ERR_ACCESS` will be raised. Errors are raised using the default error handler (see Section 13.7).

13.2.4 Resizing a File

`MPI_FILE_SET_SIZE(fh, size)`

INOUT	fh	file handle (handle)
IN	size	size to truncate or expand file (integer)

`int MPI_File_set_size(MPI_File fh, MPI_Offset size)`

```
MPI_File_set_size(fh, size, ierror)
    TYPE(MPI_File), INTENT(IN) :: fh
    INTEGER(KIND=MPI_OFFSET_KIND), INTENT(IN) :: size
    INTEGER, OPTIONAL, INTENT(OUT) :: ierror
```

```
MPI_FILE_SET_SIZE(FH, SIZE, IERROR)
    INTEGER FH, IERROR
    INTEGER(KIND=MPI_OFFSET_KIND) SIZE
```

`MPI_FILE_SET_SIZE` resizes the file associated with the file handle `fh`. `size` is measured in bytes from the beginning of the file. `MPI_FILE_SET_SIZE` is collective; all processes in the group must pass identical values for `size`.

If `size` is smaller than the current file size, the file is truncated at the position defined by `size`. The implementation is free to deallocate file blocks located beyond this position.

If `size` is larger than the current file size, the file size becomes `size`. Regions of the file that have been previously written are unaffected. The values of data in the new regions in the file (those locations with displacements between old file size and `size`) are undefined. It is implementation dependent whether the `MPI_FILE_SET_SIZE` routine allocates file space — use `MPI_FILE_PREALLOCATE` to force file space to be reserved.

`MPI_FILE_SET_SIZE` does not affect the individual file pointers or the shared file pointer. If `MPI_MODE_SEQUENTIAL` mode was specified when the file was opened, it is erroneous to call this routine.

Advice to users. It is possible for the file pointers to point beyond the end of file after a `MPI_FILE_SET_SIZE` operation truncates a file. This is valid, and equivalent to seeking beyond the current end of file. (*End of advice to users.*)

All nonblocking requests and split collective operations on `fh` must be completed before calling `MPI_FILE_SET_SIZE`. Otherwise, calling `MPI_FILE_SET_SIZE` is erroneous. As far as consistency semantics are concerned, `MPI_FILE_SET_SIZE` is a write operation that conflicts with operations that access bytes at displacements between the old and new file sizes (see Section 13.6.1).

13.2.5 Preallocating Space for a File

MPI_FILE_PREALLOCATE(fh, size)

INOUT	fh	file handle (handle)
IN	size	size to preallocate file (integer)

```
int MPI_File_preallocate(MPI_File fh, MPI_Offset size)
```

```
MPI_File_preallocate(fh, size, ierror)
    TYPE(MPI_File), INTENT(IN) :: fh
    INTEGER(KIND=MPI_OFFSET_KIND), INTENT(IN) :: size
    INTEGER, OPTIONAL, INTENT(OUT) :: ierror
```

```
MPI_FILE_PREALLOCATE(FH, SIZE, IERROR)
    INTEGER FH, IERROR
    INTEGER(KIND=MPI_OFFSET_KIND) SIZE
```

MPI_FILE_PREALLOCATE ensures that storage space is allocated for the first `size` bytes of the file associated with `fh`. MPI_FILE_PREALLOCATE is collective; all processes in the group must pass identical values for `size`. Regions of the file that have previously been written are unaffected. For newly allocated regions of the file, MPI_FILE_PREALLOCATE has the same effect as writing undefined data. If `size` is larger than the current file size, the file size increases to `size`. If `size` is less than or equal to the current file size, the file size is unchanged.

The treatment of file pointers, pending nonblocking accesses, and file consistency is the same as with MPI_FILE_SET_SIZE. If MPI_MODE_SEQUENTIAL mode was specified when the file was opened, it is erroneous to call this routine.

Advice to users. In some implementations, file preallocation may be expensive. (*End of advice to users.*)

13.2.6 Querying the Size of a File

MPI_FILE_GET_SIZE(fh, size)

IN	fh	file handle (handle)
OUT	size	size of the file in bytes (integer)

```
int MPI_File_get_size(MPI_File fh, MPI_Offset *size)
```

```
MPI_File_get_size(fh, size, ierror)
    TYPE(MPI_File), INTENT(IN) :: fh
    INTEGER(KIND=MPI_OFFSET_KIND), INTENT(OUT) :: size
    INTEGER, OPTIONAL, INTENT(OUT) :: ierror
```

```
MPI_FILE_GET_SIZE(FH, SIZE, IERROR)
    INTEGER FH, IERROR
```

```
INTEGER(KIND=MPI_OFFSET_KIND) SIZE
```

MPI_FILE_GET_SIZE returns, in `size`, the current size in bytes of the file associated with the file handle `fh`. As far as consistency semantics are concerned, MPI_FILE_GET_SIZE is a data access operation (see Section 13.6.1).

13.2.7 Querying File Parameters

```
MPI_FILE_GET_GROUP(fh, group)
```

```
IN      fh                file handle (handle)
OUT     group             group which opened the file (handle)
```

```
int MPI_File_get_group(MPI_File fh, MPI_Group *group)
```

```
MPI_File_get_group(fh, group, ierror)
  TYPE(MPI_File), INTENT(IN) :: fh
  TYPE(MPI_Group), INTENT(OUT) :: group
  INTEGER, OPTIONAL, INTENT(OUT) :: ierror
```

```
MPI_FILE_GET_GROUP(FH, GROUP, IERROR)
  INTEGER FH, GROUP, IERROR
```

MPI_FILE_GET_GROUP returns a duplicate of the group of the communicator used to open the file associated with `fh`. The group is returned in `group`. The user is responsible for freeing `group`.

```
MPI_FILE_GET_AMODE(fh, amode)
```

```
IN      fh                file handle (handle)
OUT     amode             file access mode used to open the file (integer)
```

```
int MPI_File_get_amode(MPI_File fh, int *amode)
```

```
MPI_File_get_amode(fh, amode, ierror)
  TYPE(MPI_File), INTENT(IN) :: fh
  INTEGER, INTENT(OUT) :: amode
  INTEGER, OPTIONAL, INTENT(OUT) :: ierror
```

```
MPI_FILE_GET_AMODE(FH, AMODE, IERROR)
  INTEGER FH, AMODE, IERROR
```

MPI_FILE_GET_AMODE returns, in `amode`, the access mode of the file associated with `fh`.

Example 13.1 In Fortran 77, decoding an `amode` bit vector will require a routine such as the following:

```

1      SUBROUTINE BIT_QUERY(TEST_BIT, MAX_BIT, AMODE, BIT_FOUND)
2      !
3      ! TEST IF THE INPUT TEST_BIT IS SET IN THE INPUT AMODE
4      ! IF SET, RETURN 1 IN BIT_FOUND, 0 OTHERWISE
5      !
6      INTEGER TEST_BIT, AMODE, BIT_FOUND, CP_AMODE, HIFOUND
7      BIT_FOUND = 0
8      CP_AMODE = AMODE
9      100 CONTINUE
10     LBIT = 0
11     HIFOUND = 0
12     DO 20 L = MAX_BIT, 0, -1
13         MATCHER = 2**L
14         IF (CP_AMODE .GE. MATCHER .AND. HIFOUND .EQ. 0) THEN
15             HIFOUND = 1
16             LBIT = MATCHER
17             CP_AMODE = CP_AMODE - MATCHER
18         END IF
19     20 CONTINUE
20     IF (HIFOUND .EQ. 1 .AND. LBIT .EQ. TEST_BIT) BIT_FOUND = 1
21     IF (BIT_FOUND .EQ. 0 .AND. HIFOUND .EQ. 1 .AND. &
22         CP_AMODE .GT. 0) GO TO 100
23     END
24

```

This routine could be called successively to decode amode, one bit at a time. For example, the following code fragment would check for MPI_MODE_RDONLY.

```

27     CALL BIT_QUERY(MPI_MODE_RDONLY, 30, AMODE, BIT_FOUND)
28     IF (BIT_FOUND .EQ. 1) THEN
29         PRINT *, ' FOUND READ-ONLY BIT IN AMODE=', AMODE
30     ELSE
31         PRINT *, ' READ-ONLY BIT NOT FOUND IN AMODE=', AMODE
32     END IF
33

```

13.2.8 File Info

Hints specified via info (see Chapter 9) allow a user to provide information such as file access patterns and file system specifics to direct optimization. Providing hints may enable an implementation to deliver increased I/O performance or minimize the use of system resources. An implementation is free to ignore all hints; however, applications must comply with any info hints they provide that are used by the MPI implementation (i.e., are returned by a call to MPI_FILE_GET_INFO) and that place a restriction on the behavior of the application. Hints are specified on a per file basis, in MPI_FILE_OPEN, MPI_FILE_DELETE, MPI_FILE_SET_VIEW, and MPI_FILE_SET_INFO, via the opaque info object. When an info object that specifies a subset of valid hints is passed to MPI_FILE_SET_VIEW or MPI_FILE_SET_INFO, there will be no effect on previously set or defaulted hints that the info does not specify.

Advice to implementors. It may happen that a program is coded with hints for one system, and later executes on another system that does not support these hints. In

general, unsupported hints should simply be ignored. Needless to say, no hint can be mandatory. However, for each hint used by a specific implementation, a default value must be provided when the user does not specify a value for this hint. (*End of advice to implementors.*)

MPI_FILE_SET_INFO(fh, info)

INOUT	fh	file handle (handle)
IN	info	info object (handle)

int MPI_File_set_info(MPI_File fh, MPI_Info info)

MPI_File_set_info(fh, info, ierror)
 TYPE(MPI_File), INTENT(IN) :: fh
 TYPE(MPI_Info), INTENT(IN) :: info
 INTEGER, OPTIONAL, INTENT(OUT) :: ierror

MPI_FILE_SET_INFO(FH, INFO, IERROR)

INTEGER FH, INFO, IERROR

MPI_FILE_SET_INFO updates the hints of the file associated with fh using the hints provided in info. This operation has no effect on previously set or defaulted hints that are not specified by info. It also has no effect on previously set or defaulted hints that are specified by info, but are ignored by the MPI implementation in this call to MPI_FILE_SET_INFO. MPI_FILE_SET_INFO is a collective routine. The info object may be different on each process, but any info entries that an implementation requires to be the same on all processes must appear with the same value in each process's info object.

Advice to users. Many info items that an implementation can use when it creates or opens a file cannot easily be changed once the file has been created or opened. Thus, an implementation may ignore hints issued in this call that it would have accepted in an open call. An implementation may also be unable to update certain info hints in a call to MPI_FILE_SET_VIEW or MPI_FILE_SET_INFO. MPI_FILE_GET_INFO can be used to determine whether info changes were ignored by the implementation. (*End of advice to users.*)

MPI_FILE_GET_INFO(fh, info_used)

IN	fh	file handle (handle)
OUT	info_used	new info object (handle)

int MPI_File_get_info(MPI_File fh, MPI_Info *info_used)

MPI_File_get_info(fh, info_used, ierror)
 TYPE(MPI_File), INTENT(IN) :: fh
 TYPE(MPI_Info), INTENT(OUT) :: info_used
 INTEGER, OPTIONAL, INTENT(OUT) :: ierror

```

1 MPI_FILE_GET_INFO(FH, INFO_USED, IERROR)
2     INTEGER FH, INFO_USED, IERROR

```

MPI_FILE_GET_INFO returns a new info object containing the hints of the file associated with `fh`. The current setting of all hints related to this file is returned in `info_used`. An MPI implementation is required to return all hints that are supported by the implementation and have default values specified; any user-supplied hints that were not ignored by the implementation; and any additional hints that were set by the implementation. If no such hints exist, a handle to a newly created info object is returned that contains no key/value pairs. The user is responsible for freeing `info_used` via `MPI_INFO_FREE`.

Reserved File Hints

Some potentially useful hints (info key values) are outlined below. The following key values are reserved. An implementation is not required to interpret these key values, but if it does interpret the key value, it must provide the functionality described. (For more details on “info,” see Chapter 9.)

These hints mainly affect access patterns and the layout of data on parallel I/O devices. For each hint name introduced, we describe the purpose of the hint, and the type of the hint value. The “[**SAME**]” annotation specifies that the hint values provided by all participating processes must be identical; otherwise the program is erroneous. In addition, some hints are context dependent, and are only used by an implementation at specific times (e.g., `file_perm` is only useful during file creation).

access_style (comma separated list of strings): This hint specifies the manner in which the file will be accessed until the file is closed or until the `access_style` key value is altered. The hint value is a comma separated list of the following: `read_once`, `write_once`, `read_mostly`, `write_mostly`, `sequential`, `reverse_sequential`, and `random`.

collective_buffering (boolean) [SAME]: This hint specifies whether the application may benefit from collective buffering. Collective buffering is an optimization performed on collective accesses. Accesses to the file are performed on behalf of all processes in the group by a number of target nodes. These target nodes coalesce small requests into large disk accesses. Valid values for this key are `true` and `false`. Collective buffering parameters are further directed via additional hints: `cb_block_size`, `cb_buffer_size`, and `cb_nodes`.

cb_block_size (integer) [SAME]: This hint specifies the block size to be used for collective buffering file access. *Target nodes* access data in chunks of this size. The chunks are distributed among target nodes in a round-robin (cyclic) pattern.

cb_buffer_size (integer) [SAME]: This hint specifies the total buffer space that can be used for collective buffering on each target node, usually a multiple of `cb_block_size`.

cb_nodes (integer) [SAME]: This hint specifies the number of target nodes to be used for collective buffering.

chunked (comma separated list of integers) [SAME]: This hint specifies that the file consists of a multidimensional array that is often accessed by subarrays. The value for this hint is a comma separated list of array dimensions, starting from the most significant one (for an array stored in row-major order, as in C, the most significant

dimension is the first one; for an array stored in column-major order, as in Fortran, the most significant dimension is the last one, and array dimensions should be reversed).

chunked_item (comma separated list of integers) [SAME]: This hint specifies the size of each array entry, in bytes.

chunked_size (comma separated list of integers) [SAME]: This hint specifies the dimensions of the subarrays. This is a comma separated list of array dimensions, starting from the most significant one.

filename (string): This hint specifies the file name used when the file was opened. If the implementation is capable of returning the file name of an open file, it will be returned using this key by `MPI_FILE_GET_INFO`. This key is ignored when passed to `MPI_FILE_OPEN`, `MPI_FILE_SET_VIEW`, `MPI_FILE_SET_INFO`, and `MPI_FILE_DELETE`.

file_perm (string) [SAME]: This hint specifies the file permissions to use for file creation. Setting this hint is only useful when passed to `MPI_FILE_OPEN` with an `amode` that includes `MPI_MODE_CREATE`. The set of valid values for this key is implementation dependent.

io_node_list (comma separated list of strings) [SAME]: This hint specifies the list of I/O devices that should be used to store the file. This hint is most relevant when the file is created.

nb_proc (integer) [SAME]: This hint specifies the number of parallel processes that will typically be assigned to run programs that access this file. This hint is most relevant when the file is created.

num_io_nodes (integer) [SAME]: This hint specifies the number of I/O devices in the system. This hint is most relevant when the file is created.

striping_factor (integer) [SAME]: This hint specifies the number of I/O devices that the file should be striped across, and is relevant only when the file is created.

striping_unit (integer) [SAME]: This hint specifies the suggested striping unit to be used for this file. The striping unit is the amount of consecutive data assigned to one I/O device before progressing to the next device, when striping across a number of devices. It is expressed in bytes. This hint is relevant only when the file is created.

13.3 File Views

```

1  MPI_FILE_SET_VIEW(fh, disp, etype, filetype, datarep, info)
2
3
4
5  MPI_FILE_SET_VIEW(fh, disp, etype, filetype, datarep, info)
6      INOUT    fh                file handle (handle)
7      IN      disp              displacement (integer)
8      IN      etype            elementary datatype (handle)
9      IN      filetype          filetype (handle)
10     IN      datarep           data representation (string)
11     IN      info              info object (handle)
12
13
14
15  int MPI_File_set_view(MPI_File fh, MPI_Offset disp, MPI_Datatype etype,
16                      MPI_Datatype filetype, const char *datarep, MPI_Info info)
17
18  MPI_File_set_view(fh, disp, etype, filetype, datarep, info, ierror)
19      TYPE(MPI_File), INTENT(IN) :: fh
20      INTEGER(KIND=MPI_OFFSET_KIND), INTENT(IN) :: disp
21      TYPE(MPI_Datatype), INTENT(IN) :: etype, filetype
22      CHARACTER(LEN=*), INTENT(IN) :: datarep
23      TYPE(MPI_Info), INTENT(IN) :: info
24      INTEGER, OPTIONAL, INTENT(OUT) :: ierror
25
26  MPI_FILE_SET_VIEW(FH, DISP, ETYPE, FILETYPE, DATAREP, INFO, IERROR)
27      INTEGER FH, ETYPE, FILETYPE, INFO, IERROR
28      CHARACTER*(*) DATAREP
29      INTEGER(KIND=MPI_OFFSET_KIND) DISP

```

The `MPI_FILE_SET_VIEW` routine changes the process's view of the data in the file. The start of the view is set to `disp`; the type of data is set to `etype`; the distribution of data to processes is set to `filetype`; and the representation of data in the file is set to `datarep`. In addition, `MPI_FILE_SET_VIEW` resets the individual file pointers and the shared file pointer to zero. `MPI_FILE_SET_VIEW` is collective; the values for `datarep` and the extents of `etype` in the file data representation must be identical on all processes in the group; values for `disp`, `filetype`, and `info` may vary. The datatypes passed in `etype` and `filetype` must be committed.

The `etype` always specifies the data layout in the file. If `etype` is a portable datatype (see Section 2.4), the extent of `etype` is computed by scaling any displacements in the datatype to match the file data representation. If `etype` is not a portable datatype, no scaling is done when computing the extent of `etype`. The user must be careful when using nonportable `etypes` in heterogeneous environments; see Section 13.5.1 for further details.

If `MPI_MODE_SEQUENTIAL` mode was specified when the file was opened, the special displacement `MPI_DISPLACEMENT_CURRENT` must be passed in `disp`. This sets the displacement to the current position of the shared file pointer. `MPI_DISPLACEMENT_CURRENT` is invalid unless the `amode` for the file has `MPI_MODE_SEQUENTIAL` set.

Rationale. For some sequential files, such as those corresponding to magnetic tapes or streaming network connections, the *displacement* may not be meaningful.

MPI_DISPLACEMENT_CURRENT allows the view to be changed for these types of files. (End of rationale.)

Advice to implementors. It is expected that a call to MPI_FILE_SET_VIEW will immediately follow MPI_FILE_OPEN in numerous instances. A high-quality implementation will ensure that this behavior is efficient. (End of advice to implementors.)

The `disp` displacement argument specifies the position (absolute offset in bytes from the beginning of the file) where the view begins.

Advice to users. `disp` can be used to skip headers or when the file includes a sequence of data segments that are to be accessed in different patterns (see Figure 13.3). Separate views, each using a different displacement and filetype, can be used to access each segment.

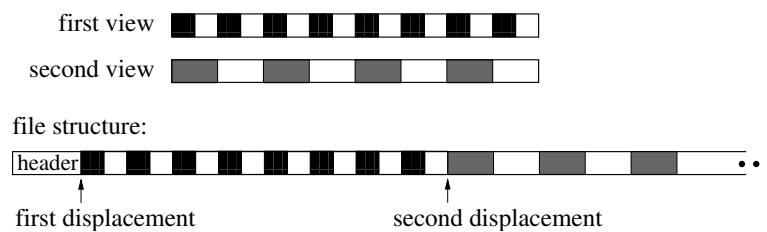

Figure 13.3: Displacements

(End of advice to users.)

An *etype* (*elementary datatype*) is the unit of data access and positioning. It can be any MPI predefined or derived datatype. Derived etypes can be constructed by using any of the MPI datatype constructor routines, provided all resulting typemap displacements are non-negative and monotonically nondecreasing. Data access is performed in etype units, reading or writing whole data items of type etype. Offsets are expressed as a count of etypes; file pointers point to the beginning of etypes.

Advice to users. In order to ensure interoperability in a heterogeneous environment, additional restrictions must be observed when constructing the etype (see Section 13.5). (End of advice to users.)

A filetype is either a single etype or a derived MPI datatype constructed from multiple instances of the same etype. In addition, the extent of any hole in the filetype must be a multiple of the etype’s extent. These displacements are not required to be distinct, but they cannot be negative, and they must be monotonically nondecreasing.

If the file is opened for writing, neither the etype nor the filetype is permitted to contain overlapping regions. This restriction is equivalent to the “datatype used in a receive cannot specify overlapping regions” restriction for communication. Note that filetypes from different processes may still overlap each other.

If a filetype has holes in it, then the data in the holes is inaccessible to the calling process. However, the `disp`, `etype`, and `filetype` arguments can be changed via future calls to MPI_FILE_SET_VIEW to access a different part of the file.

It is erroneous to use absolute addresses in the construction of the etype and filetype.

1 The `info` argument is used to provide information regarding file access patterns and file
 2 system specifics to direct optimization (see Section 13.2.8). The constant `MPI_INFO_NULL`
 3 refers to the null info and can be used when no info needs to be specified.

4 The `datarep` argument is a string that specifies the representation of data in the file.
 5 See the file interoperability section (Section 13.5) for details and a discussion of valid values.

6 The user is responsible for ensuring that all nonblocking requests and split collective
 7 operations on `fh` have been completed before calling `MPI_FILE_SET_VIEW` — otherwise,
 8 the call to `MPI_FILE_SET_VIEW` is erroneous.

9
 10
 11 `MPI_FILE_GET_VIEW(fh, disp, etype, filetype, datarep)`

12	IN	<code>fh</code>	file handle (handle)
13	OUT	<code>disp</code>	displacement (integer)
14	OUT	<code>etype</code>	elementary datatype (handle)
15	OUT	<code>filetype</code>	filetype (handle)
16	OUT	<code>filetype</code>	filetype (handle)
17	OUT	<code>datarep</code>	data representation (string)

18
 19
 20 `int MPI_File_get_view(MPI_File fh, MPI_Offset *disp, MPI_Datatype *etype,`
 21 `MPI_Datatype *filetype, char *datarep)`

22 `MPI_File_get_view(fh, disp, etype, filetype, datarep, ierror)`

23 `TYPE(MPI_File), INTENT(IN) :: fh`
 24 `INTEGER(KIND=MPI_OFFSET_KIND), INTENT(OUT) :: disp`
 25 `TYPE(MPI_Datatype), INTENT(OUT) :: etype, filetype`
 26 `CHARACTER(LEN=*), INTENT(OUT) :: datarep`
 27 `INTEGER, OPTIONAL, INTENT(OUT) :: ierror`

28
 29 `MPI_FILE_GET_VIEW(FH, DISP, ETYPE, FILETYPE, DATAREP, IERROR)`

30 `INTEGER FH, ETYPE, FILETYPE, IERROR`
 31 `CHARACTER*(*) DATAREP`
 32 `INTEGER(KIND=MPI_OFFSET_KIND) DISP`

33 `MPI_FILE_GET_VIEW` returns the process's view of the data in the file. The current
 34 value of the displacement is returned in `disp`. The `etype` and `filetype` are new datatypes with
 35 typemaps equal to the typemaps of the current `etype` and `filetype`, respectively.

36 The data representation is returned in `datarep`. The user is responsible for ensuring
 37 that `datarep` is large enough to hold the returned data representation string. The length of
 38 a data representation string is limited to the value of `MPI_MAX_DATAREP_STRING`.

39 In addition, if a portable datatype was used to set the current view, then the corre-
 40 sponding datatype returned by `MPI_FILE_GET_VIEW` is also a portable datatype. If `etype`
 41 or `filetype` are derived datatypes, the user is responsible for freeing them. The `etype` and
 42 `filetype` returned are both in a committed state.

13.4 Data Access

13.4.1 Data Access Routines

Data is moved between files and processes by issuing read and write calls. There are three orthogonal aspects to data access: positioning (explicit offset *vs.* implicit file pointer), synchronism (blocking *vs.* nonblocking and split collective), and coordination (noncollective *vs.* collective). The following combinations of these data access routines, including two types of file pointers (individual and shared) are provided in Table 13.1.

positioning	synchronism	coordination	
		<i>noncollective</i>	<i>collective</i>
<i>explicit offsets</i>	<i>blocking</i>	MPI_FILE_READ_AT MPI_FILE_WRITE_AT	MPI_FILE_READ_AT_ALL MPI_FILE_WRITE_AT_ALL
	<i>nonblocking</i>	MPI_FILE_IREAD_AT MPI_FILE_IWRITE_AT	MPI_FILE_IREAD_AT_ALL MPI_FILE_IWRITE_AT_ALL
	<i>split collective</i>	N/A	MPI_FILE_READ_AT_ALL_BEGIN MPI_FILE_READ_AT_ALL_END MPI_FILE_WRITE_AT_ALL_BEGIN MPI_FILE_WRITE_AT_ALL_END
<i>individual file pointers</i>	<i>blocking</i>	MPI_FILE_READ MPI_FILE_WRITE	MPI_FILE_READ_ALL MPI_FILE_WRITE_ALL
	<i>nonblocking</i>	MPI_FILE_IREAD MPI_FILE_IWRITE	MPI_FILE_IREAD_ALL MPI_FILE_IWRITE_ALL
	<i>split collective</i>	N/A	MPI_FILE_READ_ALL_BEGIN MPI_FILE_READ_ALL_END MPI_FILE_WRITE_ALL_BEGIN MPI_FILE_WRITE_ALL_END
<i>shared file pointer</i>	<i>blocking</i>	MPI_FILE_READ_SHARED MPI_FILE_WRITE_SHARED	MPI_FILE_READ_ORDERED MPI_FILE_WRITE_ORDERED
	<i>nonblocking</i>	MPI_FILE_IREAD_SHARED MPI_FILE_IWRITE_SHARED	N/A
	<i>split collective</i>	N/A	MPI_FILE_READ_ORDERED_BEGIN MPI_FILE_READ_ORDERED_END MPI_FILE_WRITE_ORDERED_BEGIN MPI_FILE_WRITE_ORDERED_END

Table 13.1: Data access routines

POSIX `read()/fread()` and `write()/fwrite()` are blocking, noncollective operations and use individual file pointers. The MPI equivalents are `MPI_FILE_READ` and `MPI_FILE_WRITE`.

Implementations of data access routines may buffer data to improve performance. This does not affect reads, as the data is always available in the user’s buffer after a read operation completes. For writes, however, the `MPI_FILE_SYNC` routine provides the only guarantee that data has been transferred to the storage device.

Positioning

MPI provides three types of positioning for data access routines: **explicit offsets**, **individual file pointers**, and **shared file pointers**. The different positioning methods may be mixed within the same program and do not affect each other.

The data access routines that accept explicit offsets contain `_AT` in their name (e.g., `MPI_FILE_WRITE_AT`). Explicit offset operations perform data access at the file position given directly as an argument — no file pointer is used nor updated. Note that this is not equivalent to an atomic seek-and-read or seek-and-write operation, as no “seek” is issued. Operations with explicit offsets are described in Section 13.4.2.

The names of the individual file pointer routines contain no positional qualifier (e.g., `MPI_FILE_WRITE`). Operations with individual file pointers are described in Section 13.4.3. The data access routines that use shared file pointers contain `_SHARED` or `_ORDERED`

1 in their name (e.g., `MPI_FILE_WRITE_SHARED`). Operations with shared file pointers are
 2 described in Section 13.4.4.

3 The main semantic issues with MPI-maintained file pointers are how and when they are
 4 updated by I/O operations. In general, each I/O operation leaves the file pointer pointing to
 5 the next data item after the last one that is accessed by the operation. In a nonblocking or
 6 split collective operation, the pointer is updated by the call that initiates the I/O, possibly
 7 before the access completes.

8 More formally,

$$9 \quad new_file_offset = old_file_offset + \frac{elements(datatype)}{elements(etype)} \times count$$

12 where *count* is the number of *datatype* items to be accessed, *elements(X)* is the number of
 13 predefined datatypes in the typemap of *X*, and *old_file_offset* is the value of the implicit
 14 offset before the call. The file position, *new_file_offset*, is in terms of a count of etypes
 15 relative to the current view.

17 Synchronism

18 MPI supports blocking and nonblocking I/O routines.

19 A *blocking* I/O call will not return until the I/O request is completed.

20 A *nonblocking* I/O call initiates an I/O operation, but does not wait for it to complete.
 21 Given suitable hardware, this allows the transfer of data out of and into the user's buffer
 22 to proceed concurrently with computation. A separate *request complete* call (`MPI_WAIT`,
 23 `MPI_TEST`, or any of their variants) is needed to complete the I/O request, i.e., to confirm
 24 that the data has been read or written and that it is safe for the user to reuse the buffer.
 25 The nonblocking versions of the routines are named `MPI_FILE_IXXX`, where the *I* stands
 26 for immediate.

27 It is erroneous to access the local buffer of a nonblocking data access operation, or to
 28 use that buffer as the source or target of other communications, between the initiation and
 29 completion of the operation.

30 The split collective routines support a restricted form of “nonblocking” operations for
 31 collective data access (see Section 13.4.5).

34 Coordination

35 Every noncollective data access routine `MPI_FILE_XXX` has a collective counterpart. For
 36 most routines, this counterpart is `MPI_FILE_XXX_ALL` or a pair of `MPI_FILE_XXX_BEGIN`
 37 and `MPI_FILE_XXX_END`. The counterparts to the `MPI_FILE_XXX_SHARED` routines are
 38 `MPI_FILE_XXX_ORDERED`.

39 The completion of a noncollective call only depends on the activity of the calling pro-
 40 cess. However, the completion of a collective call (which must be called by all members of
 41 the process group) may depend on the activity of the other processes participating in the
 42 collective call. See Section 13.6.4 for rules on semantics of collective calls.

43 Collective operations may perform much better than their noncollective counterparts,
 44 as global data accesses have significant potential for automatic optimization.

Data Access Conventions

Data is moved between files and processes by calling read and write routines. Read routines move data from a file into memory. Write routines move data from memory into a file. The file is designated by a file handle, `fh`. The location of the file data is specified by an offset into the current view. The data in memory is specified by a triple: `buf`, `count`, and `datatype`. Upon completion, the amount of data accessed by the calling process is returned in a `status`.

An offset designates the starting position in the file for an access. The offset is always in `etype` units relative to the current view. Explicit offset routines pass `offset` as an argument (negative values are erroneous). The file pointer routines use implicit offsets maintained by MPI.

A data access routine attempts to transfer (read or write) `count` data items of type `datatype` between the user's buffer `buf` and the file. The `datatype` passed to the routine must be a committed `datatype`. The layout of data in memory corresponding to `buf`, `count`, `datatype` is interpreted the same way as in MPI communication functions; see Section 3.2.2 and Section 4.1.11. The data is accessed from those parts of the file specified by the current view (Section 13.3). The type signature of `datatype` must match the type signature of some number of contiguous copies of the `etype` of the current view. As in a receive, it is erroneous to specify a `datatype` for reading that contains overlapping regions (areas of memory which would be stored into more than once).

The nonblocking data access routines indicate that MPI can start a data access and associate a request handle, `request`, with the I/O operation. Nonblocking operations are completed via `MPI_TEST`, `MPI_WAIT`, or any of their variants.

Data access operations, when completed, return the amount of data accessed in `status`.

Advice to users. To prevent problems with the argument copying and register optimization done by Fortran compilers, please note the hints in Sections 18.1.10–18.1.20. (*End of advice to users.*)

For blocking routines, `status` is returned directly. For nonblocking routines and split collective routines, `status` is returned when the operation is completed. The number of `datatype` entries and predefined elements accessed by the calling process can be extracted from `status` by using `MPI_GET_COUNT` and `MPI_GET_ELEMENTS` (or `MPI_GET_ELEMENTS_X`), respectively. The interpretation of the `MPI_ERROR` field is the same as for other operations — normally undefined, but meaningful if an MPI routine returns `MPI_ERR_IN_STATUS`. The user can pass (in C and Fortran) `MPI_STATUS_IGNORE` in the `status` argument if the return value of this argument is not needed. The `status` can be passed to `MPI_TEST_CANCELLED` to determine if the operation was cancelled. All other fields of `status` are undefined.

When reading, a program can detect the end of file by noting that the amount of data read is less than the amount requested. Writing past the end of file increases the file size. The amount of data accessed will be the amount requested, unless an error is raised (or a read reaches the end of file).

13.4.2 Data Access with Explicit Offsets

If `MPI_MODE_SEQUENTIAL` mode was specified when the file was opened, it is erroneous to call the routines in this section.

```

1 MPI_FILE_READ_AT(fh, offset, buf, count, datatype, status)
2     IN      fh                file handle (handle)
3
4     IN      offset            file offset (integer)
5
6     OUT     buf                initial address of buffer (choice)
7
8     IN      count              number of elements in buffer (integer)
9
10    IN      datatype           datatype of each buffer element (handle)
11
12    OUT     status              status object (Status)
13
14 int MPI_File_read_at(MPI_File fh, MPI_Offset offset, void *buf, int count,
15                     MPI_Datatype datatype, MPI_Status *status)
16
17 MPI_File_read_at(fh, offset, buf, count, datatype, status, ierror)
18     TYPE(MPI_File), INTENT(IN) :: fh
19     INTEGER(KIND=MPI_OFFSET_KIND), INTENT(IN) :: offset
20     TYPE(*), DIMENSION(..) :: buf
21     INTEGER, INTENT(IN) :: count
22     TYPE(MPI_Datatype), INTENT(IN) :: datatype
23     TYPE(MPI_Status) :: status
24     INTEGER, OPTIONAL, INTENT(OUT) :: ierror
25
26 MPI_FILE_READ_AT(FH, OFFSET, BUF, COUNT, DATATYPE, STATUS, IERROR)
27     <type> BUF(*)
28     INTEGER FH, COUNT, DATATYPE, STATUS(MPI_STATUS_SIZE), IERROR
29     INTEGER(KIND=MPI_OFFSET_KIND) OFFSET
30
31 MPI_FILE_READ_AT reads a file beginning at the position specified by offset.
32
33 MPI_FILE_READ_AT_ALL(fh, offset, buf, count, datatype, status)
34
35     IN      fh                file handle (handle)
36
37     IN      offset            file offset (integer)
38
39     OUT     buf                initial address of buffer (choice)
40
41     IN      count              number of elements in buffer (integer)
42
43     IN      datatype           datatype of each buffer element (handle)
44
45     OUT     status              status object (Status)
46
47 int MPI_File_read_at_all(MPI_File fh, MPI_Offset offset, void *buf,
48                          int count, MPI_Datatype datatype, MPI_Status *status)
49
50 MPI_File_read_at_all(fh, offset, buf, count, datatype, status, ierror)
51     TYPE(MPI_File), INTENT(IN) :: fh
52     INTEGER(KIND=MPI_OFFSET_KIND), INTENT(IN) :: offset
53     TYPE(*), DIMENSION(..) :: buf
54     INTEGER, INTENT(IN) :: count
55     TYPE(MPI_Datatype), INTENT(IN) :: datatype
56     TYPE(MPI_Status) :: status

```

```

    INTEGER, OPTIONAL, INTENT(OUT) :: ierror
MPI_FILE_READ_AT_ALL(FH, OFFSET, BUF, COUNT, DATATYPE, STATUS, IERROR)
    <type> BUF(*)
    INTEGER FH, COUNT, DATATYPE, STATUS(MPI_STATUS_SIZE), IERROR
    INTEGER(KIND=MPI_OFFSET_KIND) OFFSET

```

MPI_FILE_READ_AT_ALL is a collective version of the blocking MPI_FILE_READ_AT interface.

```

MPI_FILE_WRITE_AT(fh, offset, buf, count, datatype, status)
    INOUT  fh                file handle (handle)
    IN     offset            file offset (integer)
    IN     buf               initial address of buffer (choice)
    IN     count             number of elements in buffer (integer)
    IN     datatype          datatype of each buffer element (handle)
    OUT    status            status object (Status)

```

```

int MPI_File_write_at(MPI_File fh, MPI_Offset offset, const void *buf,
                    int count, MPI_Datatype datatype, MPI_Status *status)

```

```

MPI_File_write_at(fh, offset, buf, count, datatype, status, ierror)
    TYPE(MPI_File), INTENT(IN) :: fh
    INTEGER(KIND=MPI_OFFSET_KIND), INTENT(IN) :: offset
    TYPE(*), DIMENSION(..), INTENT(IN) :: buf
    INTEGER, INTENT(IN) :: count
    TYPE(MPI_Datatype), INTENT(IN) :: datatype
    TYPE(MPI_Status) :: status
    INTEGER, OPTIONAL, INTENT(OUT) :: ierror

```

```

MPI_FILE_WRITE_AT(FH, OFFSET, BUF, COUNT, DATATYPE, STATUS, IERROR)
    <type> BUF(*)
    INTEGER FH, COUNT, DATATYPE, STATUS(MPI_STATUS_SIZE), IERROR
    INTEGER(KIND=MPI_OFFSET_KIND) OFFSET

```

MPI_FILE_WRITE_AT writes a file beginning at the position specified by offset.

```

MPI_FILE_WRITE_AT_ALL(fh, offset, buf, count, datatype, status)
    INOUT  fh                file handle (handle)
    IN     offset            file offset (integer)
    IN     buf               initial address of buffer (choice)
    IN     count             number of elements in buffer (integer)
    IN     datatype          datatype of each buffer element (handle)
    OUT    status            status object (Status)

```

```

1  int MPI_File_write_at_all(MPI_File fh, MPI_Offset offset, const void *buf,
2      int count, MPI_Datatype datatype, MPI_Status *status)
3
4  MPI_File_write_at_all(fh, offset, buf, count, datatype, status, ierror)
5      TYPE(MPI_File), INTENT(IN) :: fh
6      INTEGER(KIND=MPI_OFFSET_KIND), INTENT(IN) :: offset
7      TYPE(*), DIMENSION(..), INTENT(IN) :: buf
8      INTEGER, INTENT(IN) :: count
9      TYPE(MPI_Datatype), INTENT(IN) :: datatype
10     TYPE(MPI_Status) :: status
11     INTEGER, OPTIONAL, INTENT(OUT) :: ierror
12
13 MPI_FILE_WRITE_AT_ALL(FH, OFFSET, BUF, COUNT, DATATYPE, STATUS, IERROR)
14     <type> BUF(*)
15     INTEGER FH, COUNT, DATATYPE, STATUS(MPI_STATUS_SIZE), IERROR
16     INTEGER(KIND=MPI_OFFSET_KIND) OFFSET
17
18     MPI_FILE_WRITE_AT_ALL is a collective version of the blocking
19     MPI_FILE_WRITE_AT interface.
20
21 MPI_FILE_IREAD_AT(fh, offset, buf, count, datatype, request)
22     IN      fh                file handle (handle)
23     IN      offset            file offset (integer)
24     OUT     buf                initial address of buffer (choice)
25     IN      count             number of elements in buffer (integer)
26     IN      datatype          datatype of each buffer element (handle)
27     OUT     request            request object (handle)
28
29
30
31 int MPI_File_iread_at(MPI_File fh, MPI_Offset offset, void *buf, int count,
32     MPI_Datatype datatype, MPI_Request *request)
33
34 MPI_File_iread_at(fh, offset, buf, count, datatype, request, ierror)
35     TYPE(MPI_File), INTENT(IN) :: fh
36     INTEGER(KIND=MPI_OFFSET_KIND), INTENT(IN) :: offset
37     TYPE(*), DIMENSION(..), ASYNCHRONOUS :: buf
38     INTEGER, INTENT(IN) :: count
39     TYPE(MPI_Datatype), INTENT(IN) :: datatype
40     TYPE(MPI_Request), INTENT(OUT) :: request
41     INTEGER, OPTIONAL, INTENT(OUT) :: ierror
42
43 MPI_FILE_IREAD_AT(FH, OFFSET, BUF, COUNT, DATATYPE, REQUEST, IERROR)
44     <type> BUF(*)
45     INTEGER FH, COUNT, DATATYPE, REQUEST, IERROR
46     INTEGER(KIND=MPI_OFFSET_KIND) OFFSET
47
48     MPI_FILE_IREAD_AT is a nonblocking version of the MPI_FILE_READ_AT interface.

```

```

MPI_FILE_IREAD_AT_ALL(fh, offset, buf, count, datatype, request) 1
    IN      fh      file handle (handle) 2
    IN      offset  file offset (integer) 3
    OUT     buf      initial address of buffer (choice) 4
    IN      count   number of elements in buffer (integer) 5
    IN      datatype  datatype of each buffer element (handle) 6
    OUT     request  request object (handle) 7
    8
    9
    10
int MPI_File_iread_at_all(MPI_File fh, MPI_Offset offset, void *buf, 11
    int count, MPI_Datatype datatype, MPI_Request *request) 12
    13
MPI_File_iread_at_all(fh, offset, buf, count, datatype, request, ierror) 14
    TYPE(MPI_File), INTENT(IN) :: fh 15
    INTEGER(KIND=MPI_OFFSET_KIND), INTENT(IN) :: offset 16
    TYPE(*), DIMENSION(..), ASYNCHRONOUS :: buf 17
    INTEGER, INTENT(IN) :: count 18
    TYPE(MPI_Datatype), INTENT(IN) :: datatype 19
    TYPE(MPI_Request), INTENT(OUT) :: request 20
    INTEGER, OPTIONAL, INTENT(OUT) :: ierror 21
    22
MPI_FILE_IREAD_AT_ALL(FH, OFFSET, BUF, COUNT, DATATYPE, REQUEST, IERROR) 23
    <type> BUF(*) 24
    INTEGER FH, COUNT, DATATYPE, REQUEST, IERROR 25
    INTEGER(KIND=MPI_OFFSET_KIND) OFFSET 26
    27
    MPI_FILE_IREAD_AT_ALL is a nonblocking version of MPI_FILE_READ_AT_ALL. See 28
    Section 13.6.5 for semantics of nonblocking collective file operations. 29
    30
MPI_FILE_IWRITE_AT(fh, offset, buf, count, datatype, request) 31
    INOUT   fh      file handle (handle) 32
    IN      offset  file offset (integer) 33
    IN      buf      initial address of buffer (choice) 34
    IN      count   number of elements in buffer (integer) 35
    IN      datatype  datatype of each buffer element (handle) 36
    OUT     request  request object (handle) 37
    38
    39
    40
int MPI_File_ fwrite_at(MPI_File fh, MPI_Offset offset, const void *buf, 41
    int count, MPI_Datatype datatype, MPI_Request *request) 42
    43
MPI_File_ fwrite_at(fh, offset, buf, count, datatype, request, ierror) 44
    TYPE(MPI_File), INTENT(IN) :: fh 45
    INTEGER(KIND=MPI_OFFSET_KIND), INTENT(IN) :: offset 46
    TYPE(*), DIMENSION(..), INTENT(IN), ASYNCHRONOUS :: buf 47
    INTEGER, INTENT(IN) :: count 48
    TYPE(MPI_Datatype), INTENT(IN) :: datatype

```

```

1     TYPE(MPI_Request), INTENT(OUT) :: request
2     INTEGER, OPTIONAL, INTENT(OUT) :: ierror

```

```

3
4 MPI_FILE_IWRITE_AT(FH, OFFSET, BUF, COUNT, DATATYPE, REQUEST, IERROR)
5     <type> BUF(*)
6     INTEGER FH, COUNT, DATATYPE, REQUEST, IERROR
7     INTEGER(KIND=MPI_OFFSET_KIND) OFFSET

```

8 MPI_FILE_IWRITE_AT is a nonblocking version of the MPI_FILE_WRITE_AT interface.

9

10

```

11 MPI_FILE_IWRITE_AT_ALL(fh, offset, buf, count, datatype, request)

```

```

12 INOUT fh file handle (handle)
13 IN offset file offset (integer)
14 IN buf initial address of buffer (choice)
15 IN count number of elements in buffer (integer)
16 IN datatype datatype of each buffer element (handle)
17 IN request request object (handle)
18
19 OUT request request object (handle)

```

20

```

21 int MPI_File_ fwrite_at_all(MPI_File fh, MPI_Offset offset, const void *buf,
22     int count, MPI_Datatype datatype, MPI_Request *request)

```

23

```

24 MPI_File_ fwrite_at_all(fh, offset, buf, count, datatype, request, ierror)
25     TYPE(MPI_File), INTENT(IN) :: fh
26     INTEGER(KIND=MPI_OFFSET_KIND), INTENT(IN) :: offset
27     TYPE(*), DIMENSION(..), INTENT(IN), ASYNCHRONOUS :: buf
28     INTEGER, INTENT(IN) :: count
29     TYPE(MPI_Datatype), INTENT(IN) :: datatype
30     TYPE(MPI_Request), INTENT(OUT) :: request
31     INTEGER, OPTIONAL, INTENT(OUT) :: ierror

```

```

32 MPI_FILE_IWRITE_AT_ALL(FH, OFFSET, BUF, COUNT, DATATYPE, REQUEST, IERROR)
33     <type> BUF(*)
34     INTEGER FH, COUNT, DATATYPE, REQUEST, IERROR
35     INTEGER(KIND=MPI_OFFSET_KIND) OFFSET

```

36 MPI_FILE_IWRITE_AT_ALL is a nonblocking version of MPI_FILE_WRITE_AT_ALL.

37

38 13.4.3 Data Access with Individual File Pointers

39 MPI maintains one individual file pointer per process per file handle. The current value
40 of this pointer implicitly specifies the offset in the data access routines described in this
41 section. These routines only use and update the individual file pointers maintained by MPI.
42 The shared file pointer is not used nor updated.

43 The individual file pointer routines have the same semantics as the data access with
44 explicit offset routines described in Section 13.4.2, with the following modification:

45

- 46 • the offset is defined to be the current value of the MPI-maintained individual file
47 pointer.

48

After an individual file pointer operation is initiated, the individual file pointer is updated to point to the next etype after the last one that will be accessed. The file pointer is updated relative to the current view of the file.

If `MPI_MODE_SEQUENTIAL` mode was specified when the file was opened, it is erroneous to call the routines in this section, with the exception of `MPI_FILE_GET_BYTE_OFFSET`.

`MPI_FILE_READ(fh, buf, count, datatype, status)`

INOUT	fh	file handle (handle)
OUT	buf	initial address of buffer (choice)
IN	count	number of elements in buffer (integer)
IN	datatype	datatype of each buffer element (handle)
OUT	status	status object (Status)

```
int MPI_File_read(MPI_File fh, void *buf, int count, MPI_Datatype datatype,
                 MPI_Status *status)
```

```
MPI_File_read(fh, buf, count, datatype, status, ierror)
```

```
TYPE(MPI_File), INTENT(IN) :: fh
TYPE(*), DIMENSION(..) :: buf
INTEGER, INTENT(IN) :: count
TYPE(MPI_Datatype), INTENT(IN) :: datatype
TYPE(MPI_Status) :: status
INTEGER, OPTIONAL, INTENT(OUT) :: ierror
```

```
MPI_FILE_READ(FH, BUF, COUNT, DATATYPE, STATUS, IERROR)
```

```
<type> BUF(*)
INTEGER FH, COUNT, DATATYPE, STATUS(MPI_STATUS_SIZE), IERROR
```

`MPI_FILE_READ` reads a file using the individual file pointer.

Example 13.2 The following Fortran code fragment is an example of reading a file until the end of file is reached:

```
! Read a preexisting input file until all data has been read.
! Call routine "process_input" if all requested data is read.
! The Fortran 90 "exit" statement exits the loop.

integer bufsize, numread, totprocessed, status(MPI_STATUS_SIZE)
parameter (bufsize=100)
real localbuffer(bufsize)
integer (kind=MPI_OFFSET_KIND) zero

zero = 0

call MPI_FILE_OPEN( MPI_COMM_WORLD, 'myoldfile', &
                   MPI_MODE_RDONLY, MPI_INFO_NULL, myfh, ierr )
call MPI_FILE_SET_VIEW( myfh, zero, MPI_REAL, MPI_REAL, 'native', &
```

```

1           MPI_INFO_NULL, ierr )
2   totprocessed = 0
3   do
4       call MPI_FILE_READ( myfh, localbuffer, bufsize, MPI_REAL, &
5                           status, ierr )
6       call MPI_GET_COUNT( status, MPI_REAL, numread, ierr )
7       call process_input( localbuffer, numread )
8       totprocessed = totprocessed + numread
9       if ( numread < bufsize ) exit
10  enddo
11
12  write(6,1001) numread, bufsize, totprocessed
13  1001 format( "No more data: read", I3, "and expected", I3, &
14             "Processed total of", I6, "before terminating job." )
15
16  call MPI_FILE_CLOSE( myfh, ierr )
17
18
19
20  MPI_FILE_READ_ALL(fh, buf, count, datatype, status)
21  INOUT   fh                file handle (handle)
22  OUT     buf               initial address of buffer (choice)
23
24  IN      count             number of elements in buffer (integer)
25  IN      datatype         datatype of each buffer element (handle)
26  OUT     status            status object (Status)
27
28
29  int MPI_File_read_all(MPI_File fh, void *buf, int count,
30                       MPI_Datatype datatype, MPI_Status *status)
31  MPI_File_read_all(fh, buf, count, datatype, status, ierror)
32  TYPE(MPI_File), INTENT(IN) :: fh
33  TYPE(*), DIMENSION(..) :: buf
34  INTEGER, INTENT(IN) :: count
35  TYPE(MPI_Datatype), INTENT(IN) :: datatype
36  TYPE(MPI_Status) :: status
37  INTEGER, OPTIONAL, INTENT(OUT) :: ierror
38
39  MPI_FILE_READ_ALL(FH, BUF, COUNT, DATATYPE, STATUS, IERROR)
40  <type> BUF(*)
41  INTEGER FH, COUNT, DATATYPE, STATUS(MPI_STATUS_SIZE), IERROR
42  MPI_FILE_READ_ALL is a collective version of the blocking MPI_FILE_READ interface.
43
44
45
46
47
48

```



```

MPI_FILE_WRITE(fh, buf, count, datatype, status) 1
    INOUT fh file handle (handle) 2
    IN buf initial address of buffer (choice) 3
    IN count number of elements in buffer (integer) 4
    IN datatype datatype of each buffer element (handle) 5
    OUT status status object (Status) 6
    7
    8
    9
int MPI_File_write(MPI_File fh, const void *buf, int count, 10
    MPI_Datatype datatype, MPI_Status *status) 11
    12
MPI_File_write(fh, buf, count, datatype, status, ierror) 13
    TYPE(MPI_File), INTENT(IN) :: fh 14
    TYPE(*), DIMENSION(..), INTENT(IN) :: buf 15
    INTEGER, INTENT(IN) :: count 16
    TYPE(MPI_Datatype), INTENT(IN) :: datatype 17
    TYPE(MPI_Status) :: status 18
    INTEGER, OPTIONAL, INTENT(OUT) :: ierror 19
MPI_FILE_WRITE(FH, BUF, COUNT, DATATYPE, STATUS, IERROR) 20
    <type> BUF(*) 21
    INTEGER FH, COUNT, DATATYPE, STATUS(MPI_STATUS_SIZE), IERROR 22
    23
    MPI_FILE_WRITE writes a file using the individual file pointer. 24
    25
    26
MPI_FILE_WRITE_ALL(fh, buf, count, datatype, status) 27
    INOUT fh file handle (handle) 28
    IN buf initial address of buffer (choice) 29
    IN count number of elements in buffer (integer) 30
    IN datatype datatype of each buffer element (handle) 31
    OUT status status object (Status) 32
    33
    34
    35
int MPI_File_write_all(MPI_File fh, const void *buf, int count, 36
    MPI_Datatype datatype, MPI_Status *status) 37
    38
MPI_File_write_all(fh, buf, count, datatype, status, ierror) 39
    TYPE(MPI_File), INTENT(IN) :: fh 40
    TYPE(*), DIMENSION(..), INTENT(IN) :: buf 41
    INTEGER, INTENT(IN) :: count 42
    TYPE(MPI_Datatype), INTENT(IN) :: datatype 43
    TYPE(MPI_Status) :: status 44
    INTEGER, OPTIONAL, INTENT(OUT) :: ierror 45
MPI_FILE_WRITE_ALL(FH, BUF, COUNT, DATATYPE, STATUS, IERROR) 46
    <type> BUF(*) 47
    INTEGER FH, COUNT, DATATYPE, STATUS(MPI_STATUS_SIZE), IERROR 48
    49

```

1 MPI_FILE_WRITE_ALL is a collective version of the blocking MPI_FILE_WRITE inter-
2 face.

3
4
5 MPI_FILE_IREAD(fh, buf, count, datatype, request)

6	INOUT	fh	file handle (handle)
7	OUT	buf	initial address of buffer (choice)
8			
9	IN	count	number of elements in buffer (integer)
10	IN	datatype	datatype of each buffer element (handle)
11			
12	OUT	request	request object (handle)

13
14 `int MPI_File_iread(MPI_File fh, void *buf, int count,`
15 `MPI_Datatype datatype, MPI_Request *request)`

16 `MPI_File_iread(fh, buf, count, datatype, request, ierror)`
17 `TYPE(MPI_File), INTENT(IN) :: fh`
18 `TYPE(*), DIMENSION(..), ASYNCHRONOUS :: buf`
19 `INTEGER, INTENT(IN) :: count`
20 `TYPE(MPI_Datatype), INTENT(IN) :: datatype`
21 `TYPE(MPI_Request), INTENT(OUT) :: request`
22 `INTEGER, OPTIONAL, INTENT(OUT) :: ierror`

23
24 `MPI_FILE_IREAD(FH, BUF, COUNT, DATATYPE, REQUEST, IERROR)`
25 `<type> BUF(*)`
26 `INTEGER FH, COUNT, DATATYPE, REQUEST, IERROR`

27 MPI_FILE_IREAD is a nonblocking version of the MPI_FILE_READ interface.

28
29 **Example 13.3** The following Fortran code fragment illustrates file pointer update seman-
30 tics:

31
32 `! Read the first twenty real words in a file into two local`
33 `! buffers. Note that when the first MPI_FILE_IREAD returns,`
34 `! the file pointer has been updated to point to the`
35 `! eleventh real word in the file.`
36
37 `integer bufsize, req1, req2`
38 `integer, dimension(MPI_STATUS_SIZE) :: status1, status2`
39 `parameter (bufsize=10)`
40 `real buf1(bufsize), buf2(bufsize)`
41 `integer (kind=MPI_OFFSET_KIND) zero`
42
43 `zero = 0`
44 `call MPI_FILE_OPEN(MPI_COMM_WORLD, 'myoldfile', &`
45 `MPI_MODE_RDONLY, MPI_INFO_NULL, myfh, ierr)`
46 `call MPI_FILE_SET_VIEW(myfh, zero, MPI_REAL, MPI_REAL, 'native', &`
47 `MPI_INFO_NULL, ierr)`
48 `call MPI_FILE_IREAD(myfh, buf1, bufsize, MPI_REAL, &`

```

        req1, ierr )
call MPI_FILE_IREAD( myfh, buf2, bufsize, MPI_REAL, &
        req2, ierr )

call MPI_WAIT( req1, status1, ierr )
call MPI_WAIT( req2, status2, ierr )

call MPI_FILE_CLOSE( myfh, ierr )

MPI_FILE_IREAD_ALL(fh, buf, count, datatype, request)
INOUT fh file handle (handle)
OUT buf initial address of buffer (choice)
IN count number of elements in buffer (integer)
IN datatype datatype of each buffer element (handle)
OUT request request object (handle)

int MPI_File_iread_all(MPI_File fh, void *buf, int count,
        MPI_Datatype datatype, MPI_Request *request)

MPI_File_iread_all(fh, buf, count, datatype, request, ierror)
TYPE(MPI_File), INTENT(IN) :: fh
TYPE(*), DIMENSION(..), ASYNCHRONOUS :: buf
INTEGER, INTENT(IN) :: count
TYPE(MPI_Datatype), INTENT(IN) :: datatype
TYPE(MPI_Request), INTENT(OUT) :: request
INTEGER, OPTIONAL, INTENT(OUT) :: ierror

MPI_FILE_IREAD_ALL(FH, BUF, COUNT, DATATYPE, REQUEST, IERROR)
<type> BUF(*)
INTEGER FH, COUNT, DATATYPE, REQUEST, IERROR

MPI_FILE_IREAD_ALL is a nonblocking version of MPI_FILE_READ_ALL.

MPI_FILE_IWRITE(fh, buf, count, datatype, request)
INOUT fh file handle (handle)
IN buf initial address of buffer (choice)
IN count number of elements in buffer (integer)
IN datatype datatype of each buffer element (handle)
OUT request request object (handle)

int MPI_File_ fwrite(MPI_File fh, const void *buf, int count,
        MPI_Datatype datatype, MPI_Request *request)

MPI_File_ fwrite(fh, buf, count, datatype, request, ierror)

```

```

1     TYPE(MPI_File), INTENT(IN) :: fh
2     TYPE(*), DIMENSION(..), INTENT(IN), ASYNCHRONOUS :: buf
3     INTEGER, INTENT(IN) :: count
4     TYPE(MPI_Datatype), INTENT(IN) :: datatype
5     TYPE(MPI_Request), INTENT(OUT) :: request
6     INTEGER, OPTIONAL, INTENT(OUT) :: ierror
7
8 MPI_FILE_IWRITE(FH, BUF, COUNT, DATATYPE, REQUEST, IERROR)
9     <type> BUF(*)
10    INTEGER FH, COUNT, DATATYPE, REQUEST, IERROR
11
12    MPI_FILE_IWRITE is a nonblocking version of the MPI_FILE_WRITE interface.
13
14 MPI_FILE_IWRITE_ALL(fh, buf, count, datatype, request)
15     INOUT   fh                file handle (handle)
16     IN      buf                initial address of buffer (choice)
17
18     IN      count              number of elements in buffer (integer)
19
20     IN      datatype           datatype of each buffer element (handle)
21
22     OUT     request             request object (handle)
23
24 int MPI_File_irewrite_all(MPI_File fh, const void *buf, int count,
25                            MPI_Datatype datatype, MPI_Request *request)
26
27 MPI_File_irewrite_all(fh, buf, count, datatype, request, ierror)
28     TYPE(MPI_File), INTENT(IN) :: fh
29     TYPE(*), DIMENSION(..), INTENT(IN), ASYNCHRONOUS :: buf
30     INTEGER, INTENT(IN) :: count
31     TYPE(MPI_Datatype), INTENT(IN) :: datatype
32     TYPE(MPI_Request), INTENT(OUT) :: request
33     INTEGER, OPTIONAL, INTENT(OUT) :: ierror
34
35 MPI_FILE_IWRITE_ALL(FH, BUF, COUNT, DATATYPE, REQUEST, IERROR)
36     <type> BUF(*)
37     INTEGER FH, COUNT, DATATYPE, REQUEST, IERROR
38
39    MPI_FILE_IWRITE_ALL is a nonblocking version of MPI_FILE_WRITE_ALL.
40
41 MPI_FILE_SEEK(fh, offset, whence)
42     INOUT   fh                file handle (handle)
43     IN      offset              file offset (integer)
44     IN      whence              update mode (state)
45
46 int MPI_File_seek(MPI_File fh, MPI_Offset offset, int whence)
47
48 MPI_File_seek(fh, offset, whence, ierror)
49     TYPE(MPI_File), INTENT(IN) :: fh

```

```

    INTEGER(KIND=MPI_OFFSET_KIND), INTENT(IN) :: offset
    INTEGER, INTENT(IN) :: whence
    INTEGER, OPTIONAL, INTENT(OUT) :: ierror
MPI_FILE_SEEK(FH, OFFSET, WHENCE, IERROR)
    INTEGER FH, WHENCE, IERROR
    INTEGER(KIND=MPI_OFFSET_KIND) OFFSET

```

MPI_FILE_SEEK updates the individual file pointer according to `whence`, which has the following possible values:

- MPI_SEEK_SET: the pointer is set to `offset`
- MPI_SEEK_CUR: the pointer is set to the current pointer position plus `offset`
- MPI_SEEK_END: the pointer is set to the end of file plus `offset`

The `offset` can be negative, which allows seeking backwards. It is erroneous to seek to a negative position in the view.

```

MPI_FILE_GET_POSITION(fh, offset)

```

IN	fh	file handle (handle)
OUT	offset	offset of individual pointer (integer)

```

int MPI_File_get_position(MPI_File fh, MPI_Offset *offset)

```

```

MPI_File_get_position(fh, offset, ierror)
    TYPE(MPI_File), INTENT(IN) :: fh
    INTEGER(KIND=MPI_OFFSET_KIND), INTENT(OUT) :: offset
    INTEGER, OPTIONAL, INTENT(OUT) :: ierror

```

```

MPI_FILE_GET_POSITION(FH, OFFSET, IERROR)

```

```

    INTEGER FH, IERROR
    INTEGER(KIND=MPI_OFFSET_KIND) OFFSET

```

MPI_FILE_GET_POSITION returns, in `offset`, the current position of the individual file pointer in `etype` units relative to the current view.

Advice to users. The `offset` can be used in a future call to MPI_FILE_SEEK using `whence = MPI_SEEK_SET` to return to the current position. To set the displacement to the current file pointer position, first convert `offset` into an absolute byte position using MPI_FILE_GET_BYTE_OFFSET, then call MPI_FILE_SET_VIEW with the resulting displacement. (*End of advice to users.*)

```

MPI_FILE_GET_BYTE_OFFSET(fh, offset, disp)

```

IN	fh	file handle (handle)
IN	offset	offset (integer)
OUT	disp	absolute byte position of offset (integer)

```

1  int MPI_File_get_byte_offset(MPI_File fh, MPI_Offset offset,
2                               MPI_Offset *disp)

```

```

3
4  MPI_File_get_byte_offset(fh, offset, disp, ierror)
5      TYPE(MPI_File), INTENT(IN) :: fh
6      INTEGER(KIND=MPI_OFFSET_KIND), INTENT(IN) :: offset
7      INTEGER(KIND=MPI_OFFSET_KIND), INTENT(OUT) :: disp
8      INTEGER, OPTIONAL, INTENT(OUT) :: ierror

```

```

9  MPI_FILE_GET_BYTE_OFFSET(FH, OFFSET, DISP, IERROR)
10     INTEGER FH, IERROR
11     INTEGER(KIND=MPI_OFFSET_KIND) OFFSET, DISP

```

12
13 MPI_FILE_GET_BYTE_OFFSET converts a view-relative offset into an absolute byte
14 position. The absolute byte position (from the beginning of the file) of `offset` relative to the
15 current view of `fh` is returned in `disp`.

16 13.4.4 Data Access with Shared File Pointers

17
18 MPI maintains exactly one shared file pointer per collective MPI_FILE_OPEN (shared among
19 processes in the communicator group). The current value of this pointer implicitly specifies
20 the offset in the data access routines described in this section. These routines only use and
21 update the shared file pointer maintained by MPI. The individual file pointers are not used
22 nor updated.

23 The shared file pointer routines have the same semantics as the data access with explicit
24 offset routines described in Section 13.4.2, with the following modifications:

- 25
- 26 • the `offset` is defined to be the current value of the MPI-maintained shared file pointer,
- 27
- 28 • the effect of multiple calls to shared file pointer routines is defined to behave as if the
- 29 calls were serialized, and
- 30
- 31 • the use of shared file pointer routines is erroneous unless all processes use the same
- 32 file view.

33 For the noncollective shared file pointer routines, the serialization ordering is not determin-
34 istic. The user needs to use other synchronization means to enforce a specific order.

35 After a shared file pointer operation is initiated, the shared file pointer is updated to
36 point to the next etype after the last one that will be accessed. The file pointer is updated
37 relative to the current view of the file.

Noncollective Operations

MPI_FILE_READ_SHARED(fh, buf, count, datatype, status)

INOUT	fh	file handle (handle)
OUT	buf	initial address of buffer (choice)
IN	count	number of elements in buffer (integer)
IN	datatype	datatype of each buffer element (handle)
OUT	status	status object (Status)

```
int MPI_File_read_shared(MPI_File fh, void *buf, int count,
                        MPI_Datatype datatype, MPI_Status *status)
```

```
MPI_File_read_shared(fh, buf, count, datatype, status, ierror)
    TYPE(MPI_File), INTENT(IN) :: fh
    TYPE(*), DIMENSION(..) :: buf
    INTEGER, INTENT(IN) :: count
    TYPE(MPI_Datatype), INTENT(IN) :: datatype
    TYPE(MPI_Status) :: status
    INTEGER, OPTIONAL, INTENT(OUT) :: ierror
```

```
MPI_FILE_READ_SHARED(FH, BUF, COUNT, DATATYPE, STATUS, IERROR)
    <type> BUF(*)
    INTEGER FH, COUNT, DATATYPE, STATUS(MPI_STATUS_SIZE), IERROR
```

MPI_FILE_READ_SHARED reads a file using the shared file pointer.

MPI_FILE_WRITE_SHARED(fh, buf, count, datatype, status)

INOUT	fh	file handle (handle)
IN	buf	initial address of buffer (choice)
IN	count	number of elements in buffer (integer)
IN	datatype	datatype of each buffer element (handle)
OUT	status	status object (Status)

```
int MPI_File_write_shared(MPI_File fh, const void *buf, int count,
                        MPI_Datatype datatype, MPI_Status *status)
```

```
MPI_File_write_shared(fh, buf, count, datatype, status, ierror)
    TYPE(MPI_File), INTENT(IN) :: fh
    TYPE(*), DIMENSION(..), INTENT(IN) :: buf
    INTEGER, INTENT(IN) :: count
    TYPE(MPI_Datatype), INTENT(IN) :: datatype
    TYPE(MPI_Status) :: status
    INTEGER, OPTIONAL, INTENT(OUT) :: ierror
```

```
MPI_FILE_WRITE_SHARED(FH, BUF, COUNT, DATATYPE, STATUS, IERROR)
```

```

1     <type> BUF(*)
2     INTEGER FH, COUNT, DATATYPE, STATUS(MPI_STATUS_SIZE), IERROR
3
4     MPI_FILE_WRITE_SHARED writes a file using the shared file pointer.
5
6 MPI_FILE_IREAD_SHARED(fh, buf, count, datatype, request)
7
8     INOUT   fh                file handle (handle)
9
10    OUT     buf                initial address of buffer (choice)
11
12    IN      count              number of elements in buffer (integer)
13
14    IN      datatype           datatype of each buffer element (handle)
15
16    OUT     request            request object (handle)
17
18 int MPI_File_iread_shared(MPI_File fh, void *buf, int count,
19                          MPI_Datatype datatype, MPI_Request *request)
20
21 MPI_File_iread_shared(fh, buf, count, datatype, request, ierror)
22     TYPE(MPI_File), INTENT(IN) :: fh
23     TYPE(*), DIMENSION(..), ASYNCHRONOUS :: buf
24     INTEGER, INTENT(IN) :: count
25     TYPE(MPI_Datatype), INTENT(IN) :: datatype
26     TYPE(MPI_Request), INTENT(OUT) :: request
27     INTEGER, OPTIONAL, INTENT(OUT) :: ierror
28
29 MPI_FILE_IREAD_SHARED(FH, BUF, COUNT, DATATYPE, REQUEST, IERROR)
30     <type> BUF(*)
31     INTEGER FH, COUNT, DATATYPE, REQUEST, IERROR
32
33 MPI_FILE_IREAD_SHARED is a nonblocking version of the MPI_FILE_READ_SHARED
34 interface.
35
36 MPI_FILE_IWRITE_SHARED(fh, buf, count, datatype, request)
37
38    INOUT   fh                file handle (handle)
39
40    IN      buf                initial address of buffer (choice)
41
42    IN      count              number of elements in buffer (integer)
43
44    IN      datatype           datatype of each buffer element (handle)
45
46    OUT     request            request object (handle)
47
48 int MPI_File_iwrite_shared(MPI_File fh, const void *buf, int count,
49                          MPI_Datatype datatype, MPI_Request *request)
50
51 MPI_File_iwrite_shared(fh, buf, count, datatype, request, ierror)
52     TYPE(MPI_File), INTENT(IN) :: fh
53     TYPE(*), DIMENSION(..), INTENT(IN), ASYNCHRONOUS :: buf
54     INTEGER, INTENT(IN) :: count
55     TYPE(MPI_Datatype), INTENT(IN) :: datatype

```



```

    TYPE(MPI_Request), INTENT(OUT) :: request      1
    INTEGER, OPTIONAL, INTENT(OUT) :: ierror      2
                                                    3
MPI_FILE_IWRITE_SHARED(FH, BUF, COUNT, DATATYPE, REQUEST, IERROR)  4
    <type> BUF(*)                                5
    INTEGER FH, COUNT, DATATYPE, REQUEST, IERROR  6

```

MPI_FILE_IWRITE_SHARED is a nonblocking version of the MPI_FILE_WRITE_SHARED interface.

Collective Operations

The semantics of a collective access using a shared file pointer is that the accesses to the file will be in the order determined by the ranks of the processes within the group. For each process, the location in the file at which data is accessed is the position at which the shared file pointer would be after all processes whose ranks within the group less than that of this process had accessed their data. In addition, in order to prevent subsequent shared offset accesses by the same processes from interfering with this collective access, the call might return only after all the processes within the group have initiated their accesses. When the call returns, the shared file pointer points to the next etype accessible, according to the file view used by all processes, after the last etype requested.

Advice to users. There may be some programs in which all processes in the group need to access the file using the shared file pointer, but the program may not *require* that data be accessed in order of process rank. In such programs, using the shared ordered routines (e.g., MPI_FILE_WRITE_ORDERED rather than MPI_FILE_WRITE_SHARED) may enable an implementation to optimize access, improving performance. (*End of advice to users.*)

Advice to implementors. Accesses to the data requested by all processes do not have to be serialized. Once all processes have issued their requests, locations within the file for all accesses can be computed, and accesses can proceed independently from each other, possibly in parallel. (*End of advice to implementors.*)

```

MPI_FILE_READ_ORDERED(fh, buf, count, datatype, status)  35
    INOUT  fh                file handle (handle)      36
    OUT    buf               initial address of buffer (choice)  37
    IN     count             number of elements in buffer (integer)  38
    IN     datatype          datatype of each buffer element (handle)  39
    OUT    status            status object (Status)      40
                                                    41
int MPI_File_read_ordered(MPI_File fh, void *buf, int count,  42
                          MPI_Datatype datatype, MPI_Status *status)  43
                                                    44
MPI_File_read_ordered(fh, buf, count, datatype, status, ierror)  45
    TYPE(MPI_File), INTENT(IN) :: fh                46
                                                    47
                                                    48

```

```

1     TYPE(*), DIMENSION(..) :: buf
2     INTEGER, INTENT(IN) :: count
3     TYPE(MPI_Datatype), INTENT(IN) :: datatype
4     TYPE(MPI_Status) :: status
5     INTEGER, OPTIONAL, INTENT(OUT) :: ierror
6
7 MPI_FILE_READ_ORDERED(FH, BUF, COUNT, DATATYPE, STATUS, IERROR)
8     <type> BUF(*)
9     INTEGER FH, COUNT, DATATYPE, STATUS(MPI_STATUS_SIZE), IERROR
10
11 MPI_FILE_READ_ORDERED is a collective version of the MPI_FILE_READ_SHARED
12 interface.
13
14 MPI_FILE_WRITE_ORDERED(fh, buf, count, datatype, status)
15     INOUT   fh                file handle (handle)
16     IN      buf                initial address of buffer (choice)
17     IN      count              number of elements in buffer (integer)
18     IN      datatype           datatype of each buffer element (handle)
19     OUT     status              status object (Status)
20
21
22
23 int MPI_File_write_ordered(MPI_File fh, const void *buf, int count,
24                             MPI_Datatype datatype, MPI_Status *status)
25
26 MPI_File_write_ordered(fh, buf, count, datatype, status, ierror)
27     TYPE(MPI_File), INTENT(IN) :: fh
28     TYPE(*), DIMENSION(..), INTENT(IN) :: buf
29     INTEGER, INTENT(IN) :: count
30     TYPE(MPI_Datatype), INTENT(IN) :: datatype
31     TYPE(MPI_Status) :: status
32     INTEGER, OPTIONAL, INTENT(OUT) :: ierror
33
34 MPI_FILE_WRITE_ORDERED(FH, BUF, COUNT, DATATYPE, STATUS, IERROR)
35     <type> BUF(*)
36     INTEGER FH, COUNT, DATATYPE, STATUS(MPI_STATUS_SIZE), IERROR
37
38 MPI_FILE_WRITE_ORDERED is a collective version of the MPI_FILE_WRITE_SHARED
39 interface.
40
41 Seek
42
43 If MPI_MODE_SEQUENTIAL mode was specified when the file was opened, it is erroneous
44 to call the following two routines (MPI_FILE_SEEK_SHARED and
45 MPI_FILE_GET_POSITION_SHARED).
46
47
48

```

```

MPI_FILE_SEEK_SHARED(fh, offset, whence) 1
    INOUT fh file handle (handle) 2
    IN offset file offset (integer) 3
    IN whence update mode (state) 4
    5
    6
int MPI_File_seek_shared(MPI_File fh, MPI_Offset offset, int whence) 7
MPI_File_seek_shared(fh, offset, whence, ierror) 8
    TYPE(MPI_File), INTENT(IN) :: fh 9
    INTEGER(KIND=MPI_OFFSET_KIND), INTENT(IN) :: offset 10
    INTEGER, INTENT(IN) :: whence 11
    INTEGER, OPTIONAL, INTENT(OUT) :: ierror 12
MPI_FILE_SEEK_SHARED(FH, OFFSET, WHENCE, IERROR) 13
    INTEGER FH, WHENCE, IERROR 14
    INTEGER(KIND=MPI_OFFSET_KIND) OFFSET 15
    16
    MPI_FILE_SEEK_SHARED updates the shared file pointer according to whence, which 17
    has the following possible values: 18
    19
    • MPI_SEEK_SET: the pointer is set to offset 20
    • MPI_SEEK_CUR: the pointer is set to the current pointer position plus offset 21
    • MPI_SEEK_END: the pointer is set to the end of file plus offset 22
    23
    MPI_FILE_SEEK_SHARED is collective; all the processes in the communicator group 24
    associated with the file handle fh must call MPI_FILE_SEEK_SHARED with the same values 25
    for offset and whence. 26
    The offset can be negative, which allows seeking backwards. It is erroneous to seek to 27
    a negative position in the view. 28
    29
    30
    31
MPI_FILE_GET_POSITION_SHARED(fh, offset) 32
    IN fh file handle (handle) 33
    OUT offset offset of shared pointer (integer) 34
    35
    36
int MPI_File_get_position_shared(MPI_File fh, MPI_Offset *offset) 37
MPI_File_get_position_shared(fh, offset, ierror) 38
    TYPE(MPI_File), INTENT(IN) :: fh 39
    INTEGER(KIND=MPI_OFFSET_KIND), INTENT(OUT) :: offset 40
    INTEGER, OPTIONAL, INTENT(OUT) :: ierror 41
MPI_FILE_GET_POSITION_SHARED(FH, OFFSET, IERROR) 42
    INTEGER FH, IERROR 43
    INTEGER(KIND=MPI_OFFSET_KIND) OFFSET 44
    45
    MPI_FILE_GET_POSITION_SHARED returns, in offset, the current position of the 46
    shared file pointer in etype units relative to the current view. 47
    48

```

Advice to users. The offset can be used in a future call to `MPI_FILE_SEEK_SHARED` using `whence = MPI_SEEK_SET` to return to the current position. To set the displacement to the current file pointer position, first convert `offset` into an absolute byte position using `MPI_FILE_GET_BYTE_OFFSET`, then call `MPI_FILE_SET_VIEW` with the resulting displacement. (*End of advice to users.*)

13.4.5 Split Collective Data Access Routines

MPI provides a restricted form of “nonblocking collective” I/O operations for all data accesses using split collective data access routines. These routines are referred to as “split” collective routines because a single collective operation is split in two: a begin routine and an end routine. The begin routine begins the operation, much like a nonblocking data access (e.g., `MPI_FILE_IREAD`). The end routine completes the operation, much like the matching test or wait (e.g., `MPI_WAIT`). As with nonblocking data access operations, the user must not use the buffer passed to a begin routine while the routine is outstanding; the operation must be completed with an end routine before it is safe to free buffers, etc.

Split collective data access operations on a file handle `fh` are subject to the semantic rules given below.

- On any MPI process, each file handle may have at most one active split collective operation at any time.
- Begin calls are collective over the group of processes that participated in the collective open and follow the ordering rules for collective calls.
- End calls are collective over the group of processes that participated in the collective open and follow the ordering rules for collective calls. Each end call matches the preceding begin call for the same collective operation. When an “end” call is made, exactly one unmatched “begin” call for the same operation must precede it.
- An implementation is free to implement any split collective data access routine using the corresponding blocking collective routine when either the begin call (e.g., `MPI_FILE_READ_ALL_BEGIN`) or the end call (e.g., `MPI_FILE_READ_ALL_END`) is issued. The begin and end calls are provided to allow the user and MPI implementation to optimize the collective operation.
- Split collective operations do not match the corresponding regular collective operation. For example, in a single collective read operation, an `MPI_FILE_READ_ALL` on one process does not match an `MPI_FILE_READ_ALL_BEGIN/MPI_FILE_READ_ALL_END` pair on another process.
- Split collective routines must specify a buffer in both the begin and end routines. By specifying the buffer that receives data in the end routine, we can avoid the problems described in “A Problem with Code Movements and Register Optimization,” Section 18.1.17, but not all of the problems, such as those described in Sections 18.1.12, 18.1.13, and 18.1.16.
- No collective I/O operations are permitted on a file handle concurrently with a split collective access on that file handle (i.e., between the begin and end of the access). That is

```

MPI_File_read_all_begin(fh, ...);
...
MPI_File_read_all(fh, ...);
...
MPI_File_read_all_end(fh, ...);

```

is erroneous.

- In a multithreaded implementation, any split collective begin and end operation called by a process must be called from the same thread. This restriction is made to simplify the implementation in the multithreaded case. (Note that we have already disallowed having two threads begin a split collective operation on the same file handle since only one split collective operation can be active on a file handle at any time.)

The arguments for these routines have the same meaning as for the equivalent collective versions (e.g., the argument definitions for `MPI_FILE_READ_ALL_BEGIN` and `MPI_FILE_READ_ALL_END` are equivalent to the arguments for `MPI_FILE_READ_ALL`). The begin routine (e.g., `MPI_FILE_READ_ALL_BEGIN`) begins a split collective operation that, when completed with the matching end routine (i.e., `MPI_FILE_READ_ALL_END`) produces the result as defined for the equivalent collective routine (i.e., `MPI_FILE_READ_ALL`).

For the purpose of consistency semantics (Section 13.6.1), a matched pair of split collective data access operations (e.g., `MPI_FILE_READ_ALL_BEGIN` and `MPI_FILE_READ_ALL_END`) compose a single data access.

`MPI_FILE_READ_AT_ALL_BEGIN(fh, offset, buf, count, datatype)`

IN	fh	file handle (handle)
IN	offset	file offset (integer)
OUT	buf	initial address of buffer (choice)
IN	count	number of elements in buffer (integer)
IN	datatype	datatype of each buffer element (handle)

```

int MPI_File_read_at_all_begin(MPI_File fh, MPI_Offset offset, void *buf,
                               int count, MPI_Datatype datatype)

```

```

MPI_File_read_at_all_begin(fh, offset, buf, count, datatype, ierror)
    TYPE(MPI_File), INTENT(IN) :: fh
    INTEGER(KIND=MPI_OFFSET_KIND), INTENT(IN) :: offset
    TYPE(*), DIMENSION(..), ASYNCHRONOUS :: buf
    INTEGER, INTENT(IN) :: count
    TYPE(MPI_Datatype), INTENT(IN) :: datatype
    INTEGER, OPTIONAL, INTENT(OUT) :: ierror

```

```

MPI_FILE_READ_AT_ALL_BEGIN(FH, OFFSET, BUF, COUNT, DATATYPE, IERROR)
    <type> BUF(*)
    INTEGER FH, COUNT, DATATYPE, IERROR
    INTEGER(KIND=MPI_OFFSET_KIND) OFFSET

```

```

1 MPI_FILE_READ_AT_ALL_END(fh, buf, status)
2     IN      fh                file handle (handle)
3
4     OUT     buf                initial address of buffer (choice)
5
6     OUT     status             status object (Status)
7
8
9 int MPI_File_read_at_all_end(MPI_File fh, void *buf, MPI_Status *status)
10
11 MPI_File_read_at_all_end(fh, buf, status, ierror)
12     TYPE(MPI_File), INTENT(IN) :: fh
13     TYPE(*), DIMENSION(..), ASYNCHRONOUS :: buf
14     TYPE(MPI_Status) :: status
15     INTEGER, OPTIONAL, INTENT(OUT) :: ierror
16
17 MPI_FILE_READ_AT_ALL_END(FH, BUF, STATUS, IERROR)
18     <type> BUF(*)
19     INTEGER FH, STATUS(MPI_STATUS_SIZE), IERROR
20
21 MPI_FILE_WRITE_AT_ALL_BEGIN(fh, offset, buf, count, datatype)
22     INOUT   fh                file handle (handle)
23
24     IN      offset            file offset (integer)
25
26     IN      buf                initial address of buffer (choice)
27
28     IN      count              number of elements in buffer (integer)
29
30     IN      datatype           datatype of each buffer element (handle)
31
32
33 int MPI_File_write_at_all_begin(MPI_File fh, MPI_Offset offset,
34     const void *buf, int count, MPI_Datatype datatype)
35
36 MPI_File_write_at_all_begin(fh, offset, buf, count, datatype, ierror)
37     TYPE(MPI_File), INTENT(IN) :: fh
38     INTEGER(KIND=MPI_OFFSET_KIND), INTENT(IN) :: offset
39     TYPE(*), DIMENSION(..), INTENT(IN), ASYNCHRONOUS :: buf
40     INTEGER, INTENT(IN) :: count
41     TYPE(MPI_Datatype), INTENT(IN) :: datatype
42     INTEGER, OPTIONAL, INTENT(OUT) :: ierror
43
44 MPI_FILE_WRITE_AT_ALL_BEGIN(FH, OFFSET, BUF, COUNT, DATATYPE, IERROR)
45     <type> BUF(*)
46     INTEGER FH, COUNT, DATATYPE, IERROR
47     INTEGER(KIND=MPI_OFFSET_KIND) OFFSET
48

```

```

MPI_FILE_WRITE_AT_ALL_END(fh, buf, status) 1
    INOUT fh file handle (handle) 2
    IN buf initial address of buffer (choice) 3
    OUT status status object (Status) 4
    5
    6
int MPI_File_write_at_all_end(MPI_File fh, const void *buf, 7
    MPI_Status *status) 8
    9
MPI_File_write_at_all_end(fh, buf, status, ierror) 10
    TYPE(MPI_File), INTENT(IN) :: fh 11
    TYPE(*), DIMENSION(..), INTENT(IN), ASYNCHRONOUS :: buf 12
    TYPE(MPI_Status) :: status 13
    INTEGER, OPTIONAL, INTENT(OUT) :: ierror 14
    15
MPI_FILE_WRITE_AT_ALL_END(FH, BUF, STATUS, IERROR) 16
    <type> BUF(*) 17
    INTEGER FH, STATUS(MPI_STATUS_SIZE), IERROR 18
    19
    20
MPI_FILE_READ_ALL_BEGIN(fh, buf, count, datatype) 21
    INOUT fh file handle (handle) 22
    OUT buf initial address of buffer (choice) 23
    IN count number of elements in buffer (integer) 24
    IN datatype datatype of each buffer element (handle) 25
    26
    27
int MPI_File_read_all_begin(MPI_File fh, void *buf, int count, 28
    MPI_Datatype datatype) 29
    30
MPI_File_read_all_begin(fh, buf, count, datatype, ierror) 31
    TYPE(MPI_File), INTENT(IN) :: fh 32
    TYPE(*), DIMENSION(..), ASYNCHRONOUS :: buf 33
    INTEGER, INTENT(IN) :: count 34
    TYPE(MPI_Datatype), INTENT(IN) :: datatype 35
    INTEGER, OPTIONAL, INTENT(OUT) :: ierror 36
    37
MPI_FILE_READ_ALL_BEGIN(FH, BUF, COUNT, DATATYPE, IERROR) 38
    <type> BUF(*) 39
    INTEGER FH, COUNT, DATATYPE, IERROR 40
    41
    42
MPI_FILE_READ_ALL_END(fh, buf, status) 43
    INOUT fh file handle (handle) 44
    OUT buf initial address of buffer (choice) 45
    OUT status status object (Status) 46
    47
    48

```

```

1  int MPI_File_read_all_end(MPI_File fh, void *buf, MPI_Status *status)
2
3  MPI_File_read_all_end(fh, buf, status, ierror)
4      TYPE(MPI_File), INTENT(IN) :: fh
5      TYPE(*), DIMENSION(..), ASYNCHRONOUS :: buf
6      TYPE(MPI_Status) :: status
7      INTEGER, OPTIONAL, INTENT(OUT) :: ierror
8
9  MPI_FILE_READ_ALL_END(FH, BUF, STATUS, IERROR)
10     <type> BUF(*)
11     INTEGER FH, STATUS(MPI_STATUS_SIZE), IERROR
12
13
14 MPI_FILE_WRITE_ALL_BEGIN(fh, buf, count, datatype)
15     INOUT   fh                file handle (handle)
16     IN     buf                initial address of buffer (choice)
17     IN     count              number of elements in buffer (integer)
18     IN     datatype           datatype of each buffer element (handle)
19
20
21 int MPI_File_write_all_begin(MPI_File fh, const void *buf, int count,
22                             MPI_Datatype datatype)
23
24 MPI_File_write_all_begin(fh, buf, count, datatype, ierror)
25     TYPE(MPI_File), INTENT(IN) :: fh
26     TYPE(*), DIMENSION(..), INTENT(IN), ASYNCHRONOUS :: buf
27     INTEGER, INTENT(IN) :: count
28     TYPE(MPI_Datatype), INTENT(IN) :: datatype
29     INTEGER, OPTIONAL, INTENT(OUT) :: ierror
30
31 MPI_FILE_WRITE_ALL_BEGIN(FH, BUF, COUNT, DATATYPE, IERROR)
32     <type> BUF(*)
33     INTEGER FH, COUNT, DATATYPE, IERROR
34
35
36 MPI_FILE_WRITE_ALL_END(fh, buf, status)
37     INOUT   fh                file handle (handle)
38     IN     buf                initial address of buffer (choice)
39     OUT    status              status object (Status)
40
41
42 int MPI_File_write_all_end(MPI_File fh, const void *buf,
43                             MPI_Status *status)
44
45 MPI_File_write_all_end(fh, buf, status, ierror)
46     TYPE(MPI_File), INTENT(IN) :: fh
47     TYPE(*), DIMENSION(..), INTENT(IN), ASYNCHRONOUS :: buf
48     TYPE(MPI_Status) :: status
49     INTEGER, OPTIONAL, INTENT(OUT) :: ierror

```



```

MPI_FILE_WRITE_ALL_END(FH, BUF, STATUS, IERROR) 1
    <type> BUF(*) 2
    INTEGER FH, STATUS(MPI_STATUS_SIZE), IERROR 3
    4
    5
MPI_FILE_READ_ORDERED_BEGIN(fh, buf, count, datatype) 6
    INOUT fh file handle (handle) 7
    OUT buf initial address of buffer (choice) 8
    IN count number of elements in buffer (integer) 9
    IN datatype datatype of each buffer element (handle) 10
    11
    12
int MPI_File_read_ordered_begin(MPI_File fh, void *buf, int count, 13
    MPI_Datatype datatype) 14
MPI_File_read_ordered_begin(fh, buf, count, datatype, ierror) 15
    TYPE(MPI_File), INTENT(IN) :: fh 16
    TYPE(*), DIMENSION(..), ASYNCHRONOUS :: buf 17
    INTEGER, INTENT(IN) :: count 18
    TYPE(MPI_Datatype), INTENT(IN) :: datatype 19
    INTEGER, OPTIONAL, INTENT(OUT) :: ierror 20
    21
    22
MPI_FILE_READ_ORDERED_BEGIN(FH, BUF, COUNT, DATATYPE, IERROR) 23
    <type> BUF(*) 24
    INTEGER FH, COUNT, DATATYPE, IERROR 25
    26
    27
MPI_FILE_READ_ORDERED_END(fh, buf, status) 28
    INOUT fh file handle (handle) 29
    OUT buf initial address of buffer (choice) 30
    OUT status status object (Status) 31
    32
    33
int MPI_File_read_ordered_end(MPI_File fh, void *buf, MPI_Status *status) 34
MPI_File_read_ordered_end(fh, buf, status, ierror) 35
    TYPE(MPI_File), INTENT(IN) :: fh 36
    TYPE(*), DIMENSION(..), ASYNCHRONOUS :: buf 37
    TYPE(MPI_Status) :: status 38
    INTEGER, OPTIONAL, INTENT(OUT) :: ierror 39
    40
    41
MPI_FILE_READ_ORDERED_END(FH, BUF, STATUS, IERROR) 42
    <type> BUF(*) 43
    INTEGER FH, STATUS(MPI_STATUS_SIZE), IERROR 44
    45
    46
    47
    48

```

```

1 MPI_FILE_WRITE_ORDERED_BEGIN(fh, buf, count, datatype)
2     INOUT    fh                file handle (handle)
3
4     IN      buf                initial address of buffer (choice)
5
6     IN      count              number of elements in buffer (integer)
7
8     IN      datatype           datatype of each buffer element (handle)
9
10
11 int MPI_File_write_ordered_begin(MPI_File fh, const void *buf, int count,
12                                 MPI_Datatype datatype)
13
14 MPI_File_write_ordered_begin(fh, buf, count, datatype, ierror)
15     TYPE(MPI_File), INTENT(IN) :: fh
16     TYPE(*), DIMENSION(..), INTENT(IN), ASYNCHRONOUS :: buf
17     INTEGER, INTENT(IN) :: count
18     TYPE(MPI_Datatype), INTENT(IN) :: datatype
19     INTEGER, OPTIONAL, INTENT(OUT) :: ierror
20
21 MPI_FILE_WRITE_ORDERED_BEGIN(FH, BUF, COUNT, DATATYPE, IERROR)
22     <type> BUF(*)
23     INTEGER FH, COUNT, DATATYPE, IERROR
24
25 MPI_FILE_WRITE_ORDERED_END(fh, buf, status)
26
27     INOUT    fh                file handle (handle)
28
29     IN      buf                initial address of buffer (choice)
30
31     OUT     status              status object (Status)
32
33
34 int MPI_File_write_ordered_end(MPI_File fh, const void *buf,
35                                 MPI_Status *status)
36
37 MPI_File_write_ordered_end(fh, buf, status, ierror)
38     TYPE(MPI_File), INTENT(IN) :: fh
39     TYPE(*), DIMENSION(..), INTENT(IN), ASYNCHRONOUS :: buf
40     TYPE(MPI_Status) :: status
41     INTEGER, OPTIONAL, INTENT(OUT) :: ierror
42
43 MPI_FILE_WRITE_ORDERED_END(FH, BUF, STATUS, IERROR)
44     <type> BUF(*)
45     INTEGER FH, STATUS(MPI_STATUS_SIZE), IERROR
46
47
48

```

13.5 File Interoperability

At the most basic level, file interoperability is the ability to read the information previously written to a file — not just the bits of data, but the actual information the bits represent. MPI guarantees full interoperability within a single MPI environment, and supports increased interoperability outside that environment through the external data representation (Section 13.5.2) as well as the data conversion functions (Section 13.5.3).

Interoperability within a single MPI environment (which could be considered “operability”) ensures that file data written by one MPI process can be read by any other MPI process, subject to the consistency constraints (see Section 13.6.1), provided that it would have been possible to start the two processes simultaneously and have them reside in a single MPI_COMM_WORLD. Furthermore, both processes must see the same data values at every absolute byte offset in the file for which data was written.

This single environment file interoperability implies that file data is accessible regardless of the number of processes.

There are three aspects to file interoperability:

- transferring the bits,
- converting between different file structures, and
- converting between different machine representations.

The first two aspects of file interoperability are beyond the scope of this standard, as both are highly machine dependent. However, transferring the bits of a file into and out of the MPI environment (e.g., by writing a file to tape) is required to be supported by all MPI implementations. In particular, an implementation must specify how familiar operations similar to POSIX `cp`, `rm`, and `mv` can be performed on the file. Furthermore, it is expected that the facility provided maintains the correspondence between absolute byte offsets (e.g., after possible file structure conversion, the data bits at byte offset 102 in the MPI environment are at byte offset 102 outside the MPI environment). As an example, a simple off-line conversion utility that transfers and converts files between the native file system and the MPI environment would suffice, provided it maintained the offset coherence mentioned above. In a high-quality implementation of MPI, users will be able to manipulate MPI files using the same or similar tools that the native file system offers for manipulating its files.

The remaining aspect of file interoperability, converting between different machine representations, is supported by the typing information specified in the `etype` and `filetype`. This facility allows the information in files to be shared between any two applications, regardless of whether they use MPI, and regardless of the machine architectures on which they run.

MPI supports multiple data representations: “native,” “internal,” and “external32.” An implementation may support additional data representations. MPI also supports user-defined data representations (see Section 13.5.3). The “native” and “internal” data representations are implementation dependent, while the “external32” representation is common to all MPI implementations and facilitates file interoperability. The data representation is specified in the `datarep` argument to `MPI_FILE_SET_VIEW`.

Advice to users. MPI is not guaranteed to retain knowledge of what data representation was used when a file is written. Therefore, to correctly retrieve file data, an MPI application is responsible for specifying the same data representation as was used to create the file. (*End of advice to users.*)

“native” Data in this representation is stored in a file exactly as it is in memory. The advantage of this data representation is that data precision and I/O performance are not lost in type conversions with a purely homogeneous environment. The disadvantage is the loss of transparent interoperability within a heterogeneous MPI environment.

1 *Advice to users.* This data representation should only be used in a homogeneous
 2 MPI environment, or when the MPI application is capable of performing the data
 3 type conversions itself. (*End of advice to users.*)

4
 5 *Advice to implementors.* When implementing read and write operations on
 6 top of MPI message-passing, the message data should be typed as MPI_BYTE
 7 to ensure that the message routines do not perform any type conversions on the
 8 data. (*End of advice to implementors.*)

9
 10 **“internal”** This data representation can be used for I/O operations in a homogeneous
 11 or heterogeneous environment; the implementation will perform type conversions if
 12 necessary. The implementation is free to store data in any format of its choice, with
 13 the restriction that it will maintain constant extents for all predefined datatypes in any
 14 one file. The environment in which the resulting file can be reused is implementation-
 15 defined and must be documented by the implementation.

16
 17 *Rationale.* This data representation allows the implementation to perform I/O
 18 efficiently in a heterogeneous environment, though with implementation-defined
 19 restrictions on how the file can be reused. (*End of rationale.*)

20
 21 *Advice to implementors.* Since “external32” is a superset of the functionality
 22 provided by “internal,” an implementation may choose to implement “internal”
 23 as “external32.” (*End of advice to implementors.*)

24
 25 **“external32”** This data representation states that read and write operations convert all
 26 data from and to the “external32” representation defined in Section 13.5.2. The data
 27 conversion rules for communication also apply to these conversions (see Section 3.3.2).
 28 The data on the storage medium is always in this canonical representation, and the
 29 data in memory is always in the local process’s native representation.

30 This data representation has several advantages. First, all processes reading the file
 31 in a heterogeneous MPI environment will automatically have the data converted to
 32 their respective native representations. Second, the file can be exported from one MPI
 33 environment and imported into any other MPI environment with the guarantee that
 34 the second environment will be able to read all the data in the file.

35 The disadvantage of this data representation is that data precision and I/O perfor-
 36 mance may be lost in data type conversions.

37
 38 *Advice to implementors.* When implementing read and write operations on top
 39 of MPI message-passing, the message data should be converted to and from the
 40 “external32” representation in the client, and sent as type MPI_BYTE. This will
 41 avoid possible double data type conversions and the associated further loss of
 42 precision and performance. (*End of advice to implementors.*)

43 44 13.5.1 Datatypes for File Interoperability

45 If the file data representation is other than “native,” care must be taken in constructing
 46 etypes and filetypes. Any of the datatype constructor functions may be used; however,
 47 for those functions that accept displacements in bytes, the displacements must be specified
 48

in terms of their values in the file for the file data representation being used. MPI will interpret these byte displacements as is; no scaling will be done. The function `MPI_FILE_GET_TYPE_EXTENT` can be used to calculate the extents of datatypes in the file. For etypes and filetypes that are portable datatypes (see Section 2.4), MPI will scale any displacements in the datatypes to match the file data representation. Datatypes passed as arguments to read/write routines specify the data layout in memory; therefore, they must always be constructed using displacements corresponding to displacements in memory.

Advice to users. One can logically think of the file as if it were stored in the memory of a file server. The `etype` and `filetype` are interpreted as if they were defined at this file server, by the same sequence of calls used to define them at the calling process. If the data representation is “native”, then this logical file server runs on the same architecture as the calling process, so that these types define the same data layout on the file as they would define in the memory of the calling process. If the `etype` and `filetype` are portable datatypes, then the data layout defined in the file is the same as would be defined in the calling process memory, up to a scaling factor. The routine `MPI_FILE_GET_TYPE_EXTENT` can be used to calculate this scaling factor. Thus, two equivalent, portable datatypes will define the same data layout in the file, even in a heterogeneous environment with “internal”, “external32”, or user defined data representations. Otherwise, the `etype` and `filetype` must be constructed so that their typemap and extent are the same on any architecture. This can be achieved if they have an explicit upper bound and lower bound (defined using `MPI_TYPE_CREATE_RESIZED`). This condition must also be fulfilled by any datatype that is used in the construction of the `etype` and `filetype`, if this datatype is replicated contiguously, either explicitly, by a call to `MPI_TYPE_CONTIGUOUS`, or implicitly, by a blocklength argument that is greater than one. If an `etype` or `filetype` is not portable, and has a typemap or extent that is architecture dependent, then the data layout specified by it on a file is implementation dependent.

File data representations other than “native” may be different from corresponding data representations in memory. Therefore, for these file data representations, it is important not to use hardwired byte offsets for file positioning, including the initial displacement that specifies the view. When a portable datatype (see Section 2.4) is used in a data access operation, any holes in the datatype are scaled to match the data representation. However, note that this technique only works when all the processes that created the file view build their etypes from the same predefined datatypes. For example, if one process uses an `etype` built from `MPI_INT` and another uses an `etype` built from `MPI_FLOAT`, the resulting views may be nonportable because the relative sizes of these types may differ from one data representation to another. (*End of advice to users.*)

`MPI_FILE_GET_TYPE_EXTENT(fh, datatype, extent)`

IN	fh	file handle (handle)
IN	datatype	datatype (handle)
OUT	extent	datatype extent (integer)

```

1 int MPI_File_get_type_extent(MPI_File fh, MPI_Datatype datatype,
2     MPI_Aint *extent)
3
4 MPI_File_get_type_extent(fh, datatype, extent, ierror)
5     TYPE(MPI_File), INTENT(IN) :: fh
6     TYPE(MPI_Datatype), INTENT(IN) :: datatype
7     INTEGER(KIND=MPI_ADDRESS_KIND), INTENT(OUT) :: extent
8     INTEGER, OPTIONAL, INTENT(OUT) :: ierror
9
10 MPI_FILE_GET_TYPE_EXTENT(FH, DATATYPE, EXTENT, IERROR)
11     INTEGER FH, DATATYPE, IERROR
12     INTEGER(KIND=MPI_ADDRESS_KIND) EXTENT

```

Returns the extent of `datatype` in the file `fh`. This extent will be the same for all processes accessing the file `fh`. If the current view uses a user-defined data representation (see Section 13.5.3), MPI uses the `dtype_file_extent_fn` callback to calculate the extent.

Advice to implementors. In the case of user-defined data representations, the extent of a derived datatype can be calculated by first determining the extents of the predefined datatypes in this derived datatype using `dtype_file_extent_fn` (see Section 13.5.3).
(*End of advice to implementors.*)

13.5.2 External Data Representation: “external32”

All MPI implementations are required to support the data representation defined in this section. Support of optional datatypes (e.g., `MPI_INTEGER2`) is not required.

All floating point values are in big-endian IEEE format [38] of the appropriate size. Floating point values are represented by one of three IEEE formats. These are the IEEE “Single,” “Double,” and “Double Extended” formats, requiring 4, 8, and 16 bytes of storage, respectively. For the IEEE “Double Extended” formats, MPI specifies a Format Width of 16 bytes, with 15 exponent bits, bias = +16383, 112 fraction bits, and an encoding analogous to the “Double” format. All integral values are in two’s complement big-endian format. Big-endian means most significant byte at lowest address byte. For C `_Bool`, Fortran `LOGICAL`, and C++ `bool`, 0 implies false and nonzero implies true. C `float` `_Complex`, `double` `_Complex`, and `long double` `_Complex`, Fortran `COMPLEX` and `DOUBLE COMPLEX`, and other complex types are represented by a pair of floating point format values for the real and imaginary components. Characters are in ISO 8859-1 format [39]. Wide characters (of type `MPI_WCHAR`) are in Unicode format [62].

All signed numerals (e.g., `MPI_INT`, `MPI_REAL`) have the sign bit at the most significant bit. `MPI_COMPLEX` and `MPI_DOUBLE_COMPLEX` have the sign bit of the real and imaginary parts at the most significant bit of each part.

According to IEEE specifications [38], the “NaN” (not a number) is system dependent. It should not be interpreted within MPI as anything other than “NaN.”

Advice to implementors. The MPI treatment of “NaN” is similar to the approach used in XDR (see <https://www.ietf.org/rfc/rfc1832.txt>). (*End of advice to implementors.*)

All data is byte aligned, regardless of type. All data items are stored contiguously in the file (if the file view is contiguous).

Advice to implementors. All bytes of LOGICAL and bool must be checked to determine the value. (*End of advice to implementors.*)

Advice to users. The type MPI_PACKED is treated as bytes and is not converted. The user should be aware that MPI_PACK has the option of placing a header in the beginning of the pack buffer. (*End of advice to users.*)

The sizes of the predefined datatypes returned from MPI_TYPE_CREATE_F90_REAL, MPI_TYPE_CREATE_F90_COMPLEX, and MPI_TYPE_CREATE_F90_INTEGER are defined in Section 18.1.9, page 663.

Advice to implementors. When converting a larger size integer to a smaller size integer, only the least significant bytes are moved. Care must be taken to preserve the sign bit value. This allows no conversion errors if the data range is within the range of the smaller size integer. (*End of advice to implementors.*)

Table 13.2 specifies the sizes of predefined datatypes in “external32” format.

13.5.3 User-Defined Data Representations

There are two situations that cannot be handled by the required representations:

1. a user wants to write a file in a representation unknown to the implementation, and
2. a user wants to read a file written in a representation unknown to the implementation.

User-defined data representations allow the user to insert a third party converter into the I/O stream to do the data representation conversion.

```
MPI_REGISTER_DATAREP(datarep, read_conversion_fn, write_conversion_fn,
                    dtype_file_extent_fn, extra_state)
```

IN	datarep	data representation identifier (string)
IN	read_conversion_fn	function invoked to convert from file representation to native representation (function)
IN	write_conversion_fn	function invoked to convert from native representation to file representation (function)
IN	dtype_file_extent_fn	function invoked to get the extent of a datatype as represented in the file (function)
IN	extra_state	extra state

```
int MPI_Register_datarep(const char *datarep,
                       MPI_Datarep_conversion_function *read_conversion_fn,
                       MPI_Datarep_conversion_function *write_conversion_fn,
                       MPI_Datarep_extent_function *dtype_file_extent_fn,
                       void *extra_state)
```

```
MPI_Register_datarep(datarep, read_conversion_fn, write_conversion_fn,
                    dtype_file_extent_fn, extra_state, ierror)
```

Type	Length	Optional Type	Length
MPI_PACKED	1	MPI_INTEGER1	1
MPI_BYTE	1	MPI_INTEGER2	2
MPI_CHAR	1	MPI_INTEGER4	4
MPI_UNSIGNED_CHAR	1	MPI_INTEGER8	8
MPI_SIGNED_CHAR	1	MPI_INTEGER16	16
MPI_WCHAR	2		
MPI_SHORT	2	MPI_REAL2	2
MPI_UNSIGNED_SHORT	2	MPI_REAL4	4
MPI_INT	4	MPI_REAL8	8
MPI_UNSIGNED	4	MPI_REAL16	16
MPI_LONG	4		
MPI_UNSIGNED_LONG	4	MPI_COMPLEX4	2*2
MPI_LONG_LONG_INT	8	MPI_COMPLEX8	2*4
MPI_UNSIGNED_LONG_LONG	8	MPI_COMPLEX16	2*8
MPI_FLOAT	4	MPI_COMPLEX32	2*16
MPI_DOUBLE	8		
MPI_LONG_DOUBLE	16		
MPI_C_BOOL	1		
MPI_INT8_T	1	C++ Types	Length
MPI_INT16_T	2	-----	-----
MPI_INT32_T	4	MPI_CXX_BOOL	1
MPI_INT64_T	8	MPI_CXX_FLOAT_COMPLEX	2*4
MPI_UINT8_T	1	MPI_CXX_DOUBLE_COMPLEX	2*8
MPI_UINT16_T	2	MPI_CXX_LONG_DOUBLE_COMPLEX	2*16
MPI_UINT32_T	4		
MPI_UINT64_T	8		
MPI_AINT	8		
MPI_COUNT	8		
MPI_OFFSET	8		
MPI_C_COMPLEX	2*4		
MPI_C_FLOAT_COMPLEX	2*4		
MPI_C_DOUBLE_COMPLEX	2*8		
MPI_C_LONG_DOUBLE_COMPLEX	2*16		
MPI_CHARACTER	1		
MPI_LOGICAL	4		
MPI_INTEGER	4		
MPI_REAL	4		
MPI_DOUBLE_PRECISION	8		
MPI_COMPLEX	2*4		
MPI_DOUBLE_COMPLEX	2*8		

Table 13.2: “external32” sizes of predefined datatypes

```

CHARACTER(LEN=*), INTENT(IN) :: datarep 1
PROCEDURE(MPI_Datarep_conversion_function) :: read_conversion_fn 2
PROCEDURE(MPI_Datarep_conversion_function) :: write_conversion_fn 3
PROCEDURE(MPI_Datarep_extent_function) :: dtype_file_extent_fn 4
INTEGER(KIND=MPI_ADDRESS_KIND), INTENT(IN) :: extra_state 5
INTEGER, OPTIONAL, INTENT(OUT) :: ierror 6
MPI_REGISTER_DATAREP(DATAREP, READ_CONVERSION_FN, WRITE_CONVERSION_FN, 7
                     DTYPE_FILE_EXTENT_FN, EXTRA_STATE, IERROR) 8
CHARACTER*(*) DATAREP 9
EXTERNAL READ_CONVERSION_FN, WRITE_CONVERSION_FN, DTYPE_FILE_EXTENT_FN 10
INTEGER(KIND=MPI_ADDRESS_KIND) EXTRA_STATE 11
INTEGER IERROR 12

```

The call associates `read_conversion_fn`, `write_conversion_fn`, and `dtype_file_extent_fn` with the data representation identifier `datarep`. `datarep` can then be used as an argument to `MPI_FILE_SET_VIEW`, causing subsequent data access operations to call the conversion functions to convert all data items accessed between file data representation and native representation. `MPI_REGISTER_DATAREP` is a local operation and only registers the data representation for the calling MPI process. If `datarep` is already defined, an error in the error class `MPI_ERR_DUP_DATAREP` is raised using the default file error handler (see Section 13.7). The length of a data representation string is limited to the value of `MPI_MAX_DATAREP_STRING`. `MPI_MAX_DATAREP_STRING` must have a value of at least 64. No routines are provided to delete data representations and free the associated resources; it is not expected that an application will generate them in significant numbers.

Extent Callback

```

typedef int MPI_Datarep_extent_function(MPI_Datatype datatype, 26
                                       MPI_Aint *file_extent, void *extra_state); 27
ABSTRACT INTERFACE 28
  SUBROUTINE MPI_Datarep_extent_function(datatype, extent, extra_state, 29
                                       ierror) 30
    TYPE(MPI_Datatype) :: datatype 31
    INTEGER(KIND=MPI_ADDRESS_KIND) :: extent, extra_state 32
    INTEGER :: ierror 33
  SUBROUTINE DATAREP_EXTENT_FUNCTION(DATATYPE, EXTENT, EXTRA_STATE, IERROR) 34
    INTEGER DATATYPE, IERROR 35
    INTEGER(KIND=MPI_ADDRESS_KIND) EXTENT, EXTRA_STATE 36

```

The function `dtype_file_extent_fn` must return, in `file_extent`, the number of bytes required to store `datatype` in the file representation. The function is passed, in `extra_state`, the argument that was passed to the `MPI_REGISTER_DATAREP` call. MPI will only call this routine with predefined datatypes employed by the user.

Datarep Conversion Functions

```

typedef int MPI_Datarep_conversion_function(void *userbuf, 45
                                           MPI_Datatype datatype, int count, void *filebuf, 46
                                           47
                                           48

```

```

1           MPI_Offset position, void *extra_state);
2
3 ABSTRACT INTERFACE
4   SUBROUTINE MPI_Datarep_conversion_function(userbuf, datatype, count,
5     filebuf, position, extra_state, ierror)
6     USE, INTRINSIC :: ISO_C_BINDING, ONLY : C_PTR
7     TYPE(C_PTR), VALUE :: userbuf, filebuf
8     TYPE(MPI_Datatype) :: datatype
9     INTEGER :: count, ierror
10    INTEGER(KIND=MPI_OFFSET_KIND) :: position
11    INTEGER(KIND=MPI_ADDRESS_KIND) :: extra_state
12
13 SUBROUTINE DATAREP_CONVERSION_FUNCTION(USERBUF, DATATYPE, COUNT, FILEBUF,
14   POSITION, EXTRA_STATE, IERROR)
15 <TYPE> USERBUF(*), FILEBUF(*)
16 INTEGER COUNT, DATATYPE, IERROR
17 INTEGER(KIND=MPI_OFFSET_KIND) POSITION
18 INTEGER(KIND=MPI_ADDRESS_KIND) EXTRA_STATE

```

The function `read_conversion_fn` must convert from file data representation to native representation. Before calling this routine, MPI allocates and fills `filebuf` with `count` contiguous data items. The type of each data item matches the corresponding entry for the predefined `datatype` in the type signature of `datatype`. The function is passed, in `extra_state`, the argument that was passed to the `MPI_REGISTER_DATAREP` call. The function must copy all `count` data items from `filebuf` to `userbuf` in the distribution described by `datatype`, converting each data item from file representation to native representation. `datatype` will be equivalent to the `datatype` that the user passed to the read function. If the size of `datatype` is less than the size of the `count` data items, the conversion function must treat `datatype` as being contiguously tiled over the `userbuf`. The conversion function must begin storing converted data at the location in `userbuf` specified by `position` into the (tiled) `datatype`.

Advice to users. Although the conversion functions have similarities to `MPI_PACK` and `MPI_UNPACK`, one should note the differences in the use of the arguments `count` and `position`. In the conversion functions, `count` is a count of data items (i.e., count of typemap entries of `datatype`), and `position` is an index into this typemap. In `MPI_PACK`, `incount` refers to the number of whole `datatypes`, and `position` is a number of bytes. (*End of advice to users.*)

Advice to implementors. A converted read operation could be implemented as follows:

1. Get file extent of all data items
2. Allocate a `filebuf` large enough to hold all `count` data items
3. Read data from file into `filebuf`
4. Call `read_conversion_fn` to convert data and place it into `userbuf`
5. Deallocate `filebuf`

(*End of advice to implementors.*)

If MPI cannot allocate a buffer large enough to hold all the data to be converted from a read operation, it may call the conversion function repeatedly using the same `datatype` and `userbuf`, and reading successive chunks of data to be converted in `filebuf`. For the first call (and in the case when all the data to be converted fits into `filebuf`), MPI will call the function with `position` set to zero. Data converted during this call will be stored in the `userbuf` according to the first `count` data items in `datatype`. Then in subsequent calls to the conversion function, MPI will increment the value in `position` by the `count` of items converted in the previous call, and the `userbuf` pointer will be unchanged.

Rationale. Passing the conversion function a position and one datatype for the transfer allows the conversion function to decode the datatype only once and cache an internal representation of it on the datatype. Then on subsequent calls, the conversion function can use the `position` to quickly find its place in the datatype and continue storing converted data where it left off at the end of the previous call. (*End of rationale.*)

Advice to users. Although the conversion function may usefully cache an internal representation on the datatype, it should not cache any state information specific to an ongoing conversion operation, since it is possible for the same datatype to be used concurrently in multiple conversion operations. (*End of advice to users.*)

The function `write_conversion_fn` must convert from native representation to file data representation. Before calling this routine, MPI allocates `filebuf` of a size large enough to hold `count` contiguous data items. The type of each data item matches the corresponding entry for the predefined datatype in the type signature of `datatype`. The function must copy `count` data items from `userbuf` in the distribution described by `datatype`, to a contiguous distribution in `filebuf`, converting each data item from native representation to file representation. If the size of `datatype` is less than the size of `count` data items, the conversion function must treat `datatype` as being contiguously tiled over the `userbuf`.

The function must begin copying at the location in `userbuf` specified by `position` into the (tiled) `datatype`. `datatype` will be equivalent to the datatype that the user passed to the write function. The function is passed, in `extra_state`, the argument that was passed to the `MPI_REGISTER_DATAREP` call.

The predefined constant `MPI_CONVERSION_FN_NULL` may be used as either `write_conversion_fn` or `read_conversion_fn`. In that case, MPI will not attempt to invoke `write_conversion_fn` or `read_conversion_fn`, respectively, but will perform the requested data access using the native data representation.

An MPI implementation must ensure that all data accessed is converted, either by using a `filebuf` large enough to hold all the requested data items or else by making repeated calls to the conversion function with the same `datatype` argument and appropriate values for `position`.

An implementation will only invoke the callback routines in this section (`read_conversion_fn`, `write_conversion_fn`, and `dtype_file_extent_fn`) when one of the read or write routines in Section 13.4, or `MPI_FILE_GET_TYPE_EXTENT` is called by the user. `dtype_file_extent_fn` will only be passed predefined datatypes employed by the user. The conversion functions will only be passed datatypes equivalent to those that the user has passed to one of the routines noted above.

1 The conversion functions must be reentrant. User defined data representations are
2 restricted to use byte alignment for all types. Furthermore, it is erroneous for the conversion
3 functions to call any collective routines or to free `datatype`.

4 The conversion functions should return an error code. If the returned error code has
5 a value other than `MPI_SUCCESS`, the implementation will raise an error in the class
6 `MPI_ERR_CONVERSION`.

8 13.5.4 Matching Data Representations

9
10 It is the user’s responsibility to ensure that the data representation used to read data from
11 a file is *compatible* with the data representation that was used to write that data to the file.

12 In general, using the same data representation name when writing and reading a file
13 does not guarantee that the representation is compatible. Similarly, using different repre-
14 sentation names on two different implementations may yield compatible representations.

15 Compatibility can be obtained when “external32” representation is used, although
16 precision may be lost and the performance may be less than when “native” representation is
17 used. Compatibility is guaranteed using “external32” provided at least one of the following
18 conditions is met.

- 19 • The data access routines directly use types enumerated in Section 13.5.2, that are
20 supported by all implementations participating in the I/O. The predefined type used
21 to write a data item must also be used to read a data item.
- 22 • In the case of Fortran 90 programs, the programs participating in the data accesses
23 obtain compatible datatypes using MPI routines that specify precision and/or range
24 (Section 18.1.9).
- 25 • For any given data item, the programs participating in the data accesses use compat-
26 ible predefined types to write and read the data item.

27
28
29 User-defined data representations may be used to provide an implementation compat-
30 ibility with another implementation’s “native” or “internal” representation.

31
32 *Advice to users.* Section 18.1.9 defines routines that support the use of matching
33 datatypes in heterogeneous environments and contains examples illustrating their use.
34 (*End of advice to users.*)

36 13.6 Consistency and Semantics

37 13.6.1 File Consistency

38
39 Consistency semantics define the outcome of multiple accesses to a single file. All file
40 accesses in MPI are relative to a specific file handle created from a collective open. MPI
41 provides three levels of consistency: sequential consistency among all accesses using a single
42 file handle, sequential consistency among all accesses using file handles created from a single
43 collective open with atomic mode enabled, and user-imposed consistency among accesses
44 other than the above. Sequential consistency means the behavior of a set of operations will
45 be as if the operations were performed in some serial order consistent with program order;
46 each access appears atomic, although the exact ordering of accesses is unspecified. User-
47 imposed consistency may be obtained using program order and calls to `MPI_FILE_SYNC`.

Let FH_1 be the set of file handles created from one particular collective open of the file FOO , and FH_2 be the set of file handles created from a different collective open of FOO . Note that nothing restrictive is said about FH_1 and FH_2 : the sizes of FH_1 and FH_2 may be different, the groups of processes used for each open may or may not intersect, the file handles in FH_1 may be destroyed before those in FH_2 are created, etc. Consider the following three cases: a single file handle (e.g., $fh_1 \in FH_1$), two file handles created from a single collective open (e.g., $fh_{1a} \in FH_1$ and $fh_{1b} \in FH_1$), and two file handles from different collective opens (e.g., $fh_1 \in FH_1$ and $fh_2 \in FH_2$).

For the purpose of consistency semantics, a matched pair (Section 13.4.5) of split collective data access operations (e.g., `MPI_FILE_READ_ALL_BEGIN` and `MPI_FILE_READ_ALL_END`) compose a single data access operation. Similarly, a non-blocking data access routine (e.g., `MPI_FILE_IREAD`) and the routine which completes the request (e.g., `MPI_WAIT`) also compose a single data access operation. For all cases below, these data access operations are subject to the same constraints as blocking data access operations.

Advice to users. For an `MPI_FILE_IREAD` and `MPI_WAIT` pair, the operation begins when `MPI_FILE_IREAD` is called and ends when `MPI_WAIT` returns. (*End of advice to users.*)

Assume that A_1 and A_2 are two data access operations. Let D_1 (D_2) be the set of absolute byte displacements of every byte accessed in A_1 (A_2). The two data accesses *overlap* if $D_1 \cap D_2 \neq \emptyset$. The two data accesses *conflict* if they overlap and at least one is a write access.

Let SEQ_{fh} be a sequence of file operations on a single file handle, bracketed by `MPI_FILE_SYNC`s on that file handle. (Both opening and closing a file implicitly perform an `MPI_FILE_SYNC`.) SEQ_{fh} is a “write sequence” if any of the data access operations in the sequence are writes or if any of the file manipulation operations in the sequence change the state of the file (e.g., `MPI_FILE_SET_SIZE` or `MPI_FILE_PREALLOCATE`). Given two sequences, SEQ_1 and SEQ_2 , we say they are not *concurrent* if one sequence is guaranteed to completely precede the other (temporally).

The requirements for guaranteeing sequential consistency among all accesses to a particular file are divided into the three cases given below. If any of these requirements are not met, then the value of all data in that file is implementation dependent.

Case 1: $fh_1 \in FH_1$ All operations on fh_1 are sequentially consistent if atomic mode is set. If nonatomic mode is set, then all operations on fh_1 are sequentially consistent if they are either nonconcurrent, nonconflicting, or both.

Case 2: $fh_{1a} \in FH_1$ and $fh_{1b} \in FH_1$ Assume A_1 is a data access operation using fh_{1a} , and A_2 is a data access operation using fh_{1b} . If for any access A_1 , there is no access A_2 that conflicts with A_1 , then MPI guarantees sequential consistency.

However, unlike POSIX semantics, the default MPI semantics for conflicting accesses do not guarantee sequential consistency. If A_1 and A_2 conflict, sequential consistency can be guaranteed by either enabling atomic mode via the `MPI_FILE_SET_ATOMICITY` routine, or meeting the condition described in Case 3 below.

1 Case 3: $fh_1 \in FH_1$ and $fh_2 \in FH_2$ Consider access to a single file using file handles from
 2 distinct collective opens. In order to guarantee sequential consistency, `MPI_FILE_SYNC`
 3 must be used (both opening and closing a file implicitly perform an `MPI_FILE_SYNC`).

4 Sequential consistency is guaranteed among accesses to a single file if for any write
 5 sequence SEQ_1 to the file, there is no sequence SEQ_2 to the file which is *concurrent* with
 6 SEQ_1 . To guarantee sequential consistency when there are write sequences,
 7 `MPI_FILE_SYNC` must be used together with a mechanism that guarantees nonconcurrency
 8 of the sequences.

9 See the examples in Section 13.6.11 for further clarification of some of these consistency
 10 semantics.

11
 12
 13 `MPI_FILE_SET_ATOMICITY(fh, flag)`

14	INOUT	fh	file handle (handle)
15	IN	flag	true to set atomic mode, false to set nonatomic mode
16			(logical)

17
 18
 19 `int MPI_File_set_atomicity(MPI_File fh, int flag)`

20 `MPI_File_set_atomicity(fh, flag, ierror)`

21	TYPE(MPI_File), INTENT(IN) :: fh
22	LOGICAL, INTENT(IN) :: flag
23	INTEGER, OPTIONAL, INTENT(OUT) :: ierror

24
 25 `MPI_FILE_SET_ATOMICITY(FH, FLAG, IERROR)`

26	INTEGER FH, IERROR
27	LOGICAL FLAG

28 Let FH be the set of file handles created by one collective open. The consistency
 29 semantics for data access operations using FH is set by collectively calling
 30 `MPI_FILE_SET_ATOMICITY` on FH . `MPI_FILE_SET_ATOMICITY` is collective; all pro-
 31 cesses in the group must pass identical values for `fh` and `flag`. If `flag` is true, atomic mode is
 32 set; if `flag` is false, nonatomic mode is set.

33 Changing the consistency semantics for an open file only affects new data accesses.
 34 All completed data accesses are guaranteed to abide by the consistency semantics in effect
 35 during their execution. Nonblocking data accesses and split collective operations that have
 36 not completed (e.g., via `MPI_WAIT`) are only guaranteed to abide by nonatomic mode
 37 consistency semantics.

38
 39 *Advice to implementors.* Since the semantics guaranteed by atomic mode are stronger
 40 than those guaranteed by nonatomic mode, an implementation is free to adhere to
 41 the more stringent atomic mode semantics for outstanding requests. (*End of advice*
 42 *to implementors.*)

```

MPI_FILE_GET_ATOMICITY(fh, flag)
    IN      fh          file handle (handle)
    OUT     flag        true if atomic mode, false if nonatomic mode (logical)

```

```
int MPI_File_get_atomicity(MPI_File fh, int *flag)
```

```

MPI_File_get_atomicity(fh, flag, ierror)
    TYPE(MPI_File), INTENT(IN) :: fh
    LOGICAL, INTENT(OUT) :: flag
    INTEGER, OPTIONAL, INTENT(OUT) :: ierror

```

```

MPI_FILE_GET_ATOMICITY(FH, FLAG, IERROR)
    INTEGER FH, IERROR
    LOGICAL FLAG

```

MPI_FILE_GET_ATOMICITY returns the current consistency semantics for data access operations on the set of file handles created by one collective open. If `flag` is true, atomic mode is enabled; if `flag` is false, nonatomic mode is enabled.

```
MPI_FILE_SYNC(fh)
```

```
    INOUT fh          file handle (handle)
```

```
int MPI_File_sync(MPI_File fh)
```

```

MPI_File_sync(fh, ierror)
    TYPE(MPI_File), INTENT(IN) :: fh
    INTEGER, OPTIONAL, INTENT(OUT) :: ierror

```

```

MPI_FILE_SYNC(FH, IERROR)
    INTEGER FH, IERROR

```

Calling MPI_FILE_SYNC with `fh` causes all previous writes to `fh` by the calling process to be transferred to the storage device. If other processes have made updates to the storage device, then all such updates become visible to subsequent reads of `fh` by the calling process. MPI_FILE_SYNC may be necessary to ensure sequential consistency in certain cases (see above).

MPI_FILE_SYNC is a collective operation.

The user is responsible for ensuring that all nonblocking requests and split collective operations on `fh` have been completed before calling MPI_FILE_SYNC — otherwise, the call to MPI_FILE_SYNC is erroneous.

13.6.2 Random Access vs. Sequential Files

MPI distinguishes ordinary random access files from sequential stream files, such as pipes and tape files. Sequential stream files must be opened with the MPI_MODE_SEQUENTIAL flag set in the `amode`. For these files, the only permitted data access operations are shared file pointer reads and writes. Filetypes and etypes with holes are erroneous. In addition, the notion of file pointer is not meaningful; therefore, calls to MPI_FILE_SEEK_SHARED and MPI_FILE_GET_POSITION_SHARED are erroneous, and the pointer update rules specified

1 for the data access routines do not apply. The amount of data accessed by a data access
2 operation will be the amount requested unless the end of file is reached or an error is raised.

3
4 *Rationale.* This implies that reading on a pipe will always wait until the requested
5 amount of data is available or until the process writing to the pipe has issued an end
6 of file. (*End of rationale.*)

7
8 Finally, for some sequential files, such as those corresponding to magnetic tapes or
9 streaming network connections, writes to the file may be destructive. In other words, a
10 write may act as a truncate (a `MPI_FILE_SET_SIZE` with size set to the current position)
11 followed by the write.

12 13 13.6.3 Progress

14 The progress rules of MPI are both a promise to users and a set of constraints on imple-
15 mentors. In cases where the progress rules restrict possible implementation choices more
16 than the interface specification alone, the progress rules take precedence.

17 All blocking routines must complete in finite time unless an exceptional condition (such
18 as resource exhaustion) causes an error.

19 Nonblocking data access routines inherit the following progress rule from nonblocking
20 point to point communication: a nonblocking write is equivalent to a nonblocking send for
21 which a receive is eventually posted, and a nonblocking read is equivalent to a nonblocking
22 receive for which a send is eventually posted.

23 Finally, an implementation is free to delay progress of collective routines until all pro-
24 cesses in the group associated with the collective call have invoked the routine. Once all
25 processes in the group have invoked the routine, the progress rule of the equivalent noncol-
26 lective routine must be followed.

27 28 29 13.6.4 Collective File Operations

30 Collective file operations are subject to the same restrictions as collective communication
31 operations. For a complete discussion, please refer to the semantics set forth in Section 5.14.

32 Collective file operations are collective over a duplicate of the communicator used to
33 open the file — this duplicate communicator is implicitly specified via the file handle ar-
34 gument. Different processes can pass different values for other arguments of a collective
35 routine unless specified otherwise.

36 37 13.6.5 Nonblocking Collective File Operations

38 Nonblocking collective file operations are defined only for data access routines with explicit
39 offsets and individual file pointers but not with shared file pointers.

40 Nonblocking collective file operations are subject to the same restrictions as blocking
41 collective I/O operations. All processes belonging to the group of the communicator that
42 was used to open the file must call collective I/O operations (blocking and nonblocking)
43 in the same order. This is consistent with the ordering rules for collective operations in
44 threaded environments. For a complete discussion, please refer to the semantics set forth
45 in Section 5.14.

46 Nonblocking collective I/O operations do not match with blocking collective I/O oper-
47 ations. Multiple nonblocking collective I/O operations can be outstanding on a single file
48

handle. High quality MPI implementations should be able to support a large number of pending nonblocking I/O operations.

All nonblocking collective I/O calls are local and return immediately, irrespective of the status of other processes. The call initiates the operation which may progress independently of any communication, computation, or I/O. The call returns a request handle, which must be passed to a completion call. Input buffers should not be modified and output buffers should not be accessed before the completion call returns. The same progress rules described for nonblocking collective operations apply for nonblocking collective I/O operations. For a complete discussion, please refer to the semantics set forth in Section 5.12.

13.6.6 Type Matching

The type matching rules for I/O mimic the type matching rules for communication with one exception: if `etype` is `MPI_BYTE`, then this matches any `datatype` in a data access operation. In general, the `etype` of data items written must match the `etype` used to read the items, and for each data access operation, the current `etype` must also match the type declaration of the data access buffer.

Advice to users. In most cases, use of `MPI_BYTE` as a wild card will defeat the file interoperability features of MPI. File interoperability can only perform automatic conversion between heterogeneous data representations when the exact datatypes accessed are explicitly specified. (*End of advice to users.*)

13.6.7 Miscellaneous Clarifications

Once an I/O routine completes, it is safe to free any opaque objects passed as arguments to that routine. For example, the `comm` and `info` used in an `MPI_FILE_OPEN`, or the `etype` and `filetype` used in an `MPI_FILE_SET_VIEW`, can be freed without affecting access to the file. Note that for nonblocking routines and split collective operations, the operation must be completed before it is safe to reuse data buffers passed as arguments.

As in communication, datatypes must be committed before they can be used in file manipulation or data access operations. For example, the `etype` and `filetype` must be committed before calling `MPI_FILE_SET_VIEW`, and the `datatype` must be committed before calling `MPI_FILE_READ` or `MPI_FILE_WRITE`.

13.6.8 MPI_Offset Type

`MPI_Offset` is an integer type of size sufficient to represent the size (in bytes) of the largest file supported by MPI. Displacements and offsets are always specified as values of type `MPI_Offset`.

In Fortran, the corresponding integer is an integer with kind parameter `MPI_OFFSET_KIND`, which is defined in the `mpi_f08` module, the `mpi` module and the `mpif.h` include file.

In Fortran 77 environments that do not support `KIND` parameters, `MPI_Offset` arguments should be declared as an `INTEGER` of suitable size. The language interoperability implications for `MPI_Offset` are similar to those for addresses (see Section 18.2).

13.6.9 Logical vs. Physical File Layout

MPI specifies how the data should be laid out in a virtual file structure (the view), not how that file structure is to be stored on one or more disks. Specification of the physical file structure was avoided because it is expected that the mapping of files to disks will be system specific, and any specific control over file layout would therefore restrict program portability. However, there are still cases where some information may be necessary to optimize file layout. This information can be provided as *hints* specified via `info` when a file is created (see Section 13.2.8).

13.6.10 File Size

The size of a file may be increased by writing to the file after the current end of file. The size may also be changed by calling MPI *size changing* routines, such as `MPI_FILE_SET_SIZE`. A call to a size changing routine does not necessarily change the file size. For example, calling `MPI_FILE_PREALLOCATE` with a size less than the current size does not change the size.

Consider a set of bytes that has been written to a file since the most recent call to a size changing routine, or since `MPI_FILE_OPEN` if no such routine has been called. Let the *high byte* be the byte in that set with the largest displacement. The file size is the larger of

- One plus the displacement of the high byte.
- The size immediately after the size changing routine, or `MPI_FILE_OPEN`, returned.

When applying consistency semantics, calls to `MPI_FILE_SET_SIZE` and `MPI_FILE_PREALLOCATE` are considered writes to the file (which conflict with operations that access bytes at displacements between the old and new file sizes), and `MPI_FILE_GET_SIZE` is considered a read of the file (which overlaps with all accesses to the file).

Advice to users. Any sequence of operations containing the collective routines `MPI_FILE_SET_SIZE` and `MPI_FILE_PREALLOCATE` is a write sequence. As such, sequential consistency in nonatomic mode is not guaranteed unless the conditions in Section 13.6.1 are satisfied. (*End of advice to users.*)

File pointer update semantics (i.e., file pointers are updated by the amount accessed) are only guaranteed if file size changes are sequentially consistent.

Advice to users. Consider the following example. Given two operations made by separate processes to a file containing 100 bytes: an `MPI_FILE_READ` of 10 bytes and an `MPI_FILE_SET_SIZE` to 0 bytes. If the user does not enforce sequential consistency between these two operations, the file pointer may be updated by the amount requested (10 bytes) even if the amount accessed is zero bytes. (*End of advice to users.*)

13.6.11 Examples

The examples in this section illustrate the application of the MPI consistency and semantics guarantees. These address

- conflicting accesses on file handles obtained from a single collective open, and
- all accesses on file handles obtained from two separate collective opens.

The simplest way to achieve consistency for conflicting accesses is to obtain sequential consistency by setting atomic mode. For the code below, process 1 will read either 0 or 10 integers. If the latter, every element of `b` will be 5. If nonatomic mode is set, the results of the read are undefined.

```

/* Process 0 */
int i, a[10];
int TRUE = 1;

for ( i=0;i<10;i++)
    a[i] = 5;

MPI_File_open( MPI_COMM_WORLD, "workfile",
               MPI_MODE_RDWR | MPI_MODE_CREATE, MPI_INFO_NULL, &fh0 );
MPI_File_set_view( fh0, 0, MPI_INT, MPI_INT, "native", MPI_INFO_NULL );
MPI_File_set_atomicity( fh0, TRUE );
MPI_File_write_at(fh0, 0, a, 10, MPI_INT, &status);
/* MPI_Barrier( MPI_COMM_WORLD ); */

/* Process 1 */
int b[10];
int TRUE = 1;
MPI_File_open( MPI_COMM_WORLD, "workfile",
               MPI_MODE_RDWR | MPI_MODE_CREATE, MPI_INFO_NULL, &fh1 );
MPI_File_set_view( fh1, 0, MPI_INT, MPI_INT, "native", MPI_INFO_NULL );
MPI_File_set_atomicity( fh1, TRUE );
/* MPI_Barrier( MPI_COMM_WORLD ); */
MPI_File_read_at(fh1, 0, b, 10, MPI_INT, &status);

```

A user may guarantee that the write on process 0 precedes the read on process 1 by imposing temporal order with, for example, calls to `MPI_BARRIER`.

Advice to users. Routines other than `MPI_BARRIER` may be used to impose temporal order. In the example above, process 0 could use `MPI_SEND` to send a 0 byte message, received by process 1 using `MPI_RECV`. (*End of advice to users.*)

Alternatively, a user can impose consistency with nonatomic mode set:

```

/* Process 0 */
int i, a[10];
for ( i=0;i<10;i++)
    a[i] = 5;

MPI_File_open( MPI_COMM_WORLD, "workfile",
               MPI_MODE_RDWR | MPI_MODE_CREATE, MPI_INFO_NULL, &fh0 );
MPI_File_set_view( fh0, 0, MPI_INT, MPI_INT, "native", MPI_INFO_NULL );

```

```

1 MPI_File_write_at(fh0, 0, a, 10, MPI_INT, &status );
2 MPI_File_sync( fh0 );
3 MPI_Barrier( MPI_COMM_WORLD );
4 MPI_File_sync( fh0 );
5
6 /* Process 1 */
7 int b[10];
8 MPI_File_open( MPI_COMM_WORLD, "workfile",
9               MPI_MODE_RDWR | MPI_MODE_CREATE, MPI_INFO_NULL, &fh1 );
10 MPI_File_set_view( fh1, 0, MPI_INT, MPI_INT, "native", MPI_INFO_NULL );
11 MPI_File_sync( fh1 );
12 MPI_Barrier( MPI_COMM_WORLD );
13 MPI_File_sync( fh1 );
14 MPI_File_read_at(fh1, 0, b, 10, MPI_INT, &status );

```

15 The “sync-barrier-sync” construct is required because:

- 17 • The barrier ensures that the write on process 0 occurs before the read on process 1.
- 18
- 19 • The first sync guarantees that the data written by all processes is transferred to the
- 20 storage device.
- 21
- 22 • The second sync guarantees that all data which has been transferred to the storage
- 23 device is visible to all processes. (This does not affect process 0 in this example.)

24 The following program represents an erroneous attempt to achieve consistency by elim-

25 inating the apparently superfluous second “sync” call for each process.

```

26 /* ----- THIS EXAMPLE IS ERRONEOUS ----- */
27 /* Process 0 */
28 int i, a[10];
29 for ( i=0;i<10;i++)
30     a[i] = 5;
31
32 MPI_File_open( MPI_COMM_WORLD, "workfile",
33               MPI_MODE_RDWR | MPI_MODE_CREATE, MPI_INFO_NULL, &fh0 );
34 MPI_File_set_view( fh0, 0, MPI_INT, MPI_INT, "native", MPI_INFO_NULL );
35 MPI_File_write_at(fh0, 0, a, 10, MPI_INT, &status );
36 MPI_File_sync( fh0 );
37 MPI_Barrier( MPI_COMM_WORLD );
38
39 /* Process 1 */
40 int b[10];
41 MPI_File_open( MPI_COMM_WORLD, "workfile",
42               MPI_MODE_RDWR | MPI_MODE_CREATE, MPI_INFO_NULL, &fh1 );
43 MPI_File_set_view( fh1, 0, MPI_INT, MPI_INT, "native", MPI_INFO_NULL );
44 MPI_Barrier( MPI_COMM_WORLD );
45 MPI_File_sync( fh1 );
46 MPI_File_read_at(fh1, 0, b, 10, MPI_INT, &status );
47
48 /* ----- THIS EXAMPLE IS ERRONEOUS ----- */

```

The above program also violates the MPI rule against out-of-order collective operations and will deadlock for implementations in which MPI_FILE_SYNC blocks.

Advice to users. Some implementations may choose to implement MPI_FILE_SYNC as a temporally synchronizing function. When using such an implementation, the “sync-barrier-sync” construct above can be replaced by a single “sync.” The results of using such code with an implementation for which MPI_FILE_SYNC is not temporally synchronizing is undefined. (*End of advice to users.*)

Asynchronous I/O

The behavior of asynchronous I/O operations is determined by applying the rules specified above for synchronous I/O operations.

The following examples all access a preexisting file “myfile.” Word 10 in myfile initially contains the integer 2. Each example writes and reads word 10.

First consider the following code fragment:

```
int a = 4, b, TRUE=1;
MPI_File_open( MPI_COMM_WORLD, "myfile",
               MPI_MODE_RDWR, MPI_INFO_NULL, &fh );
MPI_File_set_view( fh, 0, MPI_INT, MPI_INT, "native", MPI_INFO_NULL );
/* MPI_File_set_atomicsity( fh, TRUE ); Use this to set atomic mode. */
MPI_File_iread_at(fh, 10, &b, 1, MPI_INT, &reqs[1]);
MPI_File_iwrite_at(fh, 10, &a, 1, MPI_INT, &reqs[0]);
MPI_Waitall(2, reqs, statuses);
```

For asynchronous data access operations, MPI specifies that the access occurs at any time between the call to the asynchronous data access routine and the return from the corresponding request complete routine. Thus, executing either the read before the write, or the write before the read is consistent with program order. If atomic mode is set, then MPI guarantees sequential consistency, and the program will read either 2 or 4 into b. If atomic mode is not set, then sequential consistency is not guaranteed and the program may read something other than 2 or 4 due to the conflicting data access.

Similarly, the following code fragment does not order file accesses:

```
int a = 4, b;
MPI_File_open( MPI_COMM_WORLD, "myfile",
               MPI_MODE_RDWR, MPI_INFO_NULL, &fh );
MPI_File_set_view( fh, 0, MPI_INT, MPI_INT, "native", MPI_INFO_NULL );
/* MPI_File_set_atomicsity( fh, TRUE ); Use this to set atomic mode. */
MPI_File_iread_at(fh, 10, &b, 1, MPI_INT, &reqs[1]);
MPI_File_iwrite_at(fh, 10, &a, 1, MPI_INT, &reqs[0]);
MPI_Wait(&reqs[0], &status);
MPI_Wait(&reqs[1], &status);
```

If atomic mode is set, either 2 or 4 will be read into b. Again, MPI does not guarantee sequential consistency in nonatomic mode.

On the other hand, the following code fragment:

```

1  int a = 4, b;
2  MPI_File_open( MPI_COMM_WORLD, "myfile",
3                MPI_MODE_RDWR, MPI_INFO_NULL, &fh );
4  MPI_File_set_view( fh, 0, MPI_INT, MPI_INT, "native", MPI_INFO_NULL );
5  MPI_File_irewrite_at(fh, 10, &a, 1, MPI_INT, &reqs[0]);
6  MPI_Wait(&reqs[0], &status);
7  MPI_File_iread_at(fh, 10, &b, 1, MPI_INT, &reqs[1]);
8  MPI_Wait(&reqs[1], &status);

```

9 defines the same ordering as:

```

11 int a = 4, b;
12 MPI_File_open( MPI_COMM_WORLD, "myfile",
13               MPI_MODE_RDWR, MPI_INFO_NULL, &fh );
14 MPI_File_set_view( fh, 0, MPI_INT, MPI_INT, "native", MPI_INFO_NULL );
15 MPI_File_write_at(fh, 10, &a, 1, MPI_INT, &status );
16 MPI_File_read_at(fh, 10, &b, 1, MPI_INT, &status );
17

```

18 Since

- 19 • nonconcurrent operations on a single file handle are sequentially consistent, and
- 20 • the program fragments specify an order for the operations,

21 MPI guarantees that both program fragments will read the value 4 into b. There is no need
22 to set atomic mode for this example.

23 Similar considerations apply to conflicting accesses of the form:

```

24 MPI_File_irewrite_all(fh,...);
25 MPI_File_iread_all(fh,...);
26 MPI_Waitall(...);

```

27 In addition, as mentioned in Section 13.6.5, nonblocking collective I/O operations have
28 to be called in the same order on the file handle by all processes.

29 Similar considerations apply to conflicting accesses of the form:

```

30 MPI_File_write_all_begin(fh,...);
31 MPI_File_iread(fh,...);
32 MPI_Wait(fh,...);
33 MPI_File_write_all_end(fh,...);

```

34 Recall that constraints governing consistency and semantics are not relevant to the
35 following:

```

36 MPI_File_write_all_begin(fh,...);
37 MPI_File_read_all_begin(fh,...);
38 MPI_File_read_all_end(fh,...);
39 MPI_File_write_all_end(fh,...);

```

40 since split collective operations on the same file handle may not overlap (see Section 13.4.5).

41
42
43
44
45
46
47
48

13.7 I/O Error Handling

By default, communication errors are fatal — `MPI_ERRORS_ARE_FATAL` is the default error handler associated with `MPI_COMM_WORLD`. I/O errors are usually less catastrophic (e.g., “file not found”) than communication errors, and common practice is to catch these errors and continue executing. For this reason, MPI provides additional error facilities for I/O.

Advice to users. MPI does not specify the state of a computation after an erroneous MPI call has occurred. A high-quality implementation will support the I/O error handling facilities, allowing users to write programs using common practice for I/O. (*End of advice to users.*)

Like communicators, each file handle has an error handler associated with it. The MPI I/O error handling routines are defined in Section 8.3.

When MPI calls a user-defined error handler resulting from an error on a particular file handle, the first two arguments passed to the file error handler are the file handle and the error code. For I/O errors that are not associated with a valid file handle (e.g., in `MPI_FILE_OPEN` or `MPI_FILE_DELETE`), the first argument passed to the error handler is `MPI_FILE_NULL`.

I/O error handling differs from communication error handling in another important aspect. By default, the predefined error handler for file handles is `MPI_ERRORS_RETURN`. The default file error handler has two purposes: when a new file handle is created (by `MPI_FILE_OPEN`), the error handler for the new file handle is initially set to the default error handler, and I/O routines that have no valid file handle on which to raise an error (e.g., `MPI_FILE_OPEN` or `MPI_FILE_DELETE`) use the default file error handler. The default file error handler can be changed by specifying `MPI_FILE_NULL` as the `fh` argument to `MPI_FILE_SET_ERRHANDLER`. The current value of the default file error handler can be determined by passing `MPI_FILE_NULL` as the `fh` argument to `MPI_FILE_GET_ERRHANDLER`.

Rationale. For communication, the default error handler is inherited from `MPI_COMM_WORLD`. In I/O, there is no analogous “root” file handle from which default properties can be inherited. Rather than invent a new global file handle, the default file error handler is manipulated as if it were attached to `MPI_FILE_NULL`. (*End of rationale.*)

13.8 I/O Error Classes

The implementation dependent error codes returned by the I/O routines can be converted into the error classes defined in Table 13.3.

In addition, calls to routines in this chapter may raise errors in other MPI classes, such as `MPI_ERR_TYPE`.

13.9 Examples

13.9.1 Double Buffering with Split Collective I/O

This example shows how to overlap computation and output. The computation is performed by the function `compute_buffer()`.

1		
2		
3		
4		
5		
6		
7		
8		
9		
10		
11	MPI_ERR_FILE	Invalid file handle
12	MPI_ERR_NOT_SAME	Collective argument not identical on all
13		processes, or collective routines called in
14		a different order by different processes
15	MPI_ERR_AMODE	Error related to the <code>amode</code> passed to
16		<code>MPI_FILE_OPEN</code>
17	MPI_ERR_UNSUPPORTED_DATAREP	Unsupported <code>datarep</code> passed to
18		<code>MPI_FILE_SET_VIEW</code>
19	MPI_ERR_UNSUPPORTED_OPERATION	Unsupported operation, such as seeking on
20		a file which supports sequential access only
21	MPI_ERR_NO_SUCH_FILE	File does not exist
22	MPI_ERR_FILE_EXISTS	File exists
23	MPI_ERR_BAD_FILE	Invalid file name (e.g., path name too long)
24	MPI_ERR_ACCESS	Permission denied
25	MPI_ERR_NO_SPACE	Not enough space
26	MPI_ERR_QUOTA	Quota exceeded
27	MPI_ERR_READ_ONLY	Read-only file or file system
28	MPI_ERR_FILE_IN_USE	File operation could not be completed, as
29		the file is currently open by some process
30	MPI_ERR_DUP_DATAREP	Conversion functions could not be regis-
31		tered because a data representation identi-
32		fier that was already defined was passed to
33		<code>MPI_REGISTER_DATAREP</code>
34	MPI_ERR_CONVERSION	An error occurred in a user supplied data
35		conversion function.
36	MPI_ERR_IO	Other I/O error
37		

Table 13.3: I/O Error Classes

38
39
40
41
42
43
44
45
46
47
48

```

/*===== 1
* 2
* Function:          double_buffer 3
* 4
* Synopsis: 5
* void double_buffer( 6
*     MPI_File fh,          ** IN 7
*     MPI_Datatype buftype, ** IN 8
*     int bufcount         ** IN 9
* ) 10
* 11
* Description: 12
* Performs the steps to overlap computation with a collective write 13
* by using a double-buffering technique. 14
* 15
* Parameters: 16
* fh                previously opened MPI file handle 17
* buftype           MPI datatype for memory layout 18
*                  (Assumes a compatible view has been set on fh) 19
* bufcount         # buftype elements to transfer 20
*-----*/ 21
22
/* this macro switches which buffer "x" is pointing to */ 23
#define TOGGLE_PTR(x) ((x)==(buffer1)) ? (x=buffer2) : (x=buffer1) 24
25
void double_buffer( MPI_File fh, MPI_Datatype buftype, int bufcount) 26
{ 27
28
    MPI_Status status;          /* status for MPI calls */ 29
    float *buffer1, *buffer2; /* buffers to hold results */ 30
    float *compute_buf_ptr;    /* destination buffer */ 31
                                /* for computing */ 32
    float *write_buf_ptr;      /* source for writing */ 33
    int done;                  /* determines when to quit */ 34
25
    /* buffer initialization */ 36
    buffer1 = (float *) 37
                malloc(bufcount*sizeof(float)); 38
    buffer2 = (float *) 39
                malloc(bufcount*sizeof(float)); 40
    compute_buf_ptr = buffer1; /* initially point to buffer1 */ 41
    write_buf_ptr   = buffer1; /* initially point to buffer1 */ 42
43
44
    /* DOUBLE-BUFFER prolog: 45
     * compute buffer1; then initiate writing buffer1 to disk 46
     */ 47
    compute_buffer(compute_buf_ptr, bufcount, &done); 48
}

```

```

1  MPI_File_write_all_begin(fh, write_buf_ptr, bufcount, buftype);
2
3  /* DOUBLE-BUFFER steady state:
4   * Overlap writing old results from buffer pointed to by write_buf_ptr
5   * with computing new results into buffer pointed to by compute_buf_ptr.
6   *
7   * There is always one write-buffer and one compute-buffer in use
8   * during steady state.
9   */
10 while (!done) {
11     TOGGLE_PTR(compute_buf_ptr);
12     compute_buffer(compute_buf_ptr, bufcount, &done);
13     MPI_File_write_all_end(fh, write_buf_ptr, &status);
14     TOGGLE_PTR(write_buf_ptr);
15     MPI_File_write_all_begin(fh, write_buf_ptr, bufcount, buftype);
16 }
17
18 /* DOUBLE-BUFFER epilog:
19  * wait for final write to complete.
20  */
21 MPI_File_write_all_end(fh, write_buf_ptr, &status);
22
23
24 /* buffer cleanup */
25 free(buffer1);
26 free(buffer2);
27 }
28
29

```

13.9.2 Subarray Filetype Constructor

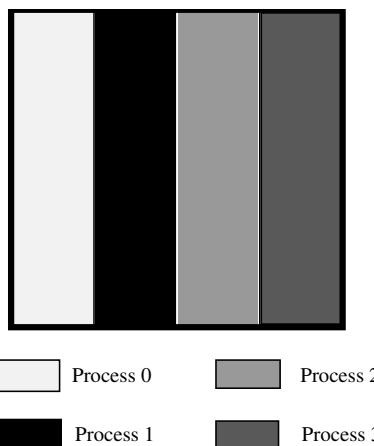

Figure 13.4: Example array file layout

Assume we are writing out a 100x100 2D array of double precision floating point numbers that is distributed among 4 processes such that each process has a block of 25 columns

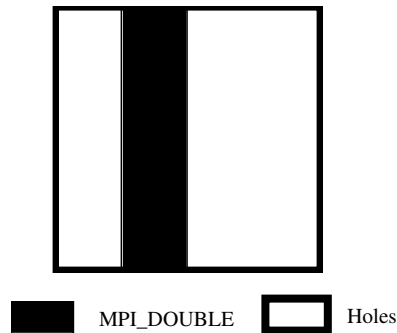

Figure 13.5: Example local array filetype for process 1

(e.g., process 0 has columns 0–24, process 1 has columns 25–49, etc.; see Figure 13.4). To create the filetypes for each process one could use the following C program (see Section 4.1.3):

```

double subarray[100][25];
MPI_Datatype filetype;
int sizes[2], subsizes[2], starts[2];
int rank;

MPI_Comm_rank(MPI_COMM_WORLD, &rank);
sizes[0]=100; sizes[1]=100;
subsizes[0]=100; subsizes[1]=25;
starts[0]=0; starts[1]=rank*subsizes[1];

MPI_Type_create_subarray(2, sizes, subsizes, starts, MPI_ORDER_C,
                        MPI_DOUBLE, &filetype);

```

Or, equivalently in Fortran:

```

double precision subarray(100,25)
integer filetype, rank, ierror
integer sizes(2), subsizes(2), starts(2)

call MPI_COMM_RANK(MPI_COMM_WORLD, rank, ierror)
sizes(1)=100
sizes(2)=100
subsizes(1)=100
subsizes(2)=25
starts(1)=0
starts(2)=rank*subsizes(2)

call MPI_TYPE_CREATE_SUBARRAY(2, sizes, subsizes, starts, &
                             MPI_ORDER_FORTRAN, MPI_DOUBLE_PRECISION, &
                             filetype, ierror)

```

The generated filetype will then describe the portion of the file contained within the

1 process's subarray with holes for the space taken by the other processes. Figure 13.5 shows
2 the filetype created for process 1.
3
4
5
6
7
8
9
10
11
12
13
14
15
16
17
18
19
20
21
22
23
24
25
26
27
28
29
30
31
32
33
34
35
36
37
38
39
40
41
42
43
44
45
46
47
48

Chapter 14

Tool Support

14.1 Introduction

This chapter discusses interfaces that allow debuggers, performance analyzers, and other tools to extract information about the operation of MPI processes. Specifically, this chapter defines both the MPI profiling interface (Section 14.2), which supports the transparent interception and inspection of MPI calls, and the MPI tool information interface (Section 14.3), which supports the inspection and manipulation of MPI control and performance variables. The interfaces described in this chapter are all defined in the context of an MPI process, i.e., are callable from the same code that invokes other MPI functions.

14.2 Profiling Interface

14.2.1 Requirements

To meet the requirements for the MPI profiling interface, an implementation of the MPI functions *must*

1. provide a mechanism through which all of the MPI defined functions, except those allowed as macros (See Section 2.6.4), may be accessed with a name shift. This requires, in C and Fortran, an alternate entry point name, with the prefix `PMPI_` for each MPI function in each provided language binding and language support method. For routines implemented as macros, it is still required that the `PMPI_` version be supplied and work as expected, but it is not possible to replace at link time the `MPI_` version with a user-defined version.

For Fortran, the different support methods cause several specific procedure names. Therefore, several profiling routines (with these specific procedure names) are needed for each Fortran MPI routine, as described in Section 18.1.5.

2. ensure that those MPI functions that are not replaced may still be linked into an executable image without causing name clashes.
3. document the implementation of different language bindings of the MPI interface if they are layered on top of each other, so that the profiler developer knows whether she must implement the profile interface for each binding, or can economize by implementing it only for the lowest level routines.

- 1 4. where the implementation of different language bindings is done through a layered
 2 approach (e.g., the Fortran binding is a set of “wrapper” functions that call the C
 3 implementation), ensure that these wrapper functions are separable from the rest of
 4 the library.

5 This separability is necessary to allow a separate profiling library to be correctly
 6 implemented, since (at least with Unix linker semantics) the profiling library must
 7 contain these wrapper functions if it is to perform as expected. This requirement
 8 allows the person who builds the profiling library to extract these functions from the
 9 original MPI library and add them into the profiling library without bringing along
 10 any other unnecessary code.
 11

- 12 5. provide a no-op routine `MPI_PCONTROL` in the MPI library.
 13

14 14.2.2 Discussion

15 The objective of the MPI profiling interface is to ensure that it is relatively easy for authors
 16 of profiling (and other similar) tools to interface their codes to MPI implementations on
 17 different machines.
 18

19 Since MPI is a machine independent standard with many different implementations,
 20 it is unreasonable to expect that the authors of profiling tools for MPI will have access to
 21 the source code that implements MPI on any particular machine. It is therefore necessary
 22 to provide a mechanism by which the implementors of such tools can collect whatever
 23 performance information they wish *without* access to the underlying implementation.

24 We believe that having such an interface is important if MPI is to be attractive to end
 25 users, since the availability of many different tools will be a significant factor in attracting
 26 users to the MPI standard.

27 The profiling interface is just that, an interface. It says *nothing* about the way in which
 28 it is used. There is therefore no attempt to lay down what information is collected through
 29 the interface, or how the collected information is saved, filtered, or displayed.

30 While the initial impetus for the development of this interface arose from the desire to
 31 permit the implementation of profiling tools, it is clear that an interface like that specified
 32 may also prove useful for other purposes, such as “internetworking” multiple MPI imple-
 33 mentations. Since all that is defined is an interface, there is no objection to its being used
 34 wherever it is useful.

35 As the issues being addressed here are intimately tied up with the way in which ex-
 36 ecutable images are built, which may differ greatly on different machines, the examples
 37 given below should be treated solely as one way of implementing the objective of the MPI
 38 profiling interface. The actual requirements made of an implementation are those detailed
 39 in the Requirements section above, the whole of the rest of this section is only present as
 40 justification and discussion of the logic for those requirements.

41 The examples below show one way in which an implementation could be constructed to
 42 meet the requirements on a Unix system (there are doubtless others that would be equally
 43 valid).
 44

45 14.2.3 Logic of the Design

46 Provided that an MPI implementation meets the requirements above, it is possible for
 47 the implementor of the profiling system to intercept the MPI calls that are made by the
 48

user program. She can then collect whatever information she requires before calling the underlying MPI implementation (through its name shifted entry points) to achieve the desired effects.

14.2.4 Miscellaneous Control of Profiling

There is a clear requirement for the user code to be able to control the profiler dynamically at run time. This capability is normally used for (at least) the purposes of

- Enabling and disabling profiling depending on the state of the calculation.
- Flushing trace buffers at non-critical points in the calculation.
- Adding user events to a trace file.

These requirements are met by use of `MPI_PCONTROL`.

`MPI_PCONTROL(level, ...)`

IN level Profiling level (integer)

`int MPI_Pcontrol(const int level, ...)`

`MPI_Pcontrol(level)`
 INTEGER, INTENT(IN) :: level

`MPI_PCONTROL(LEVEL)`
 INTEGER LEVEL

MPI libraries themselves make no use of this routine, and simply return immediately to the user code. However the presence of calls to this routine allows a profiling package to be explicitly called by the user.

Since MPI has no control of the implementation of the profiling code, we are unable to specify precisely the semantics that will be provided by calls to `MPI_PCONTROL`. This vagueness extends to the number of arguments to the function, and their datatypes.

However to provide some level of portability of user codes to different profiling libraries, we request the following meanings for certain values of level.

- `level==0` Profiling is disabled.
- `level==1` Profiling is enabled at a normal default level of detail.
- `level==2` Profile buffers are flushed, which may be a no-op in some profilers.
- All other values of `level` have profile library defined effects and additional arguments.

We also request that the default state after MPI has been initialized is for profiling to be enabled at the normal default level. (i.e., as if `MPI_PCONTROL` had just been called with the argument 1). This allows users to link with a profiling library and to obtain profile output without having to modify their source code at all.

The provision of `MPI_PCONTROL` as a no-op in the standard MPI library supports the collection of more detailed profiling information with source code that can still link against the standard MPI library.

14.2.5 Profiler Implementation Example

A profiler can accumulate the total amount of data sent by the `MPI_SEND` function, along with the total elapsed time spent in the function as the following example shows:

Example 14.1

```

1  static int totalBytes = 0;
2  static double totalTime = 0.0;
3
4  int MPI_Send(const void* buffer, int count, MPI_Datatype datatype,
5              int dest, int tag, MPI_Comm comm)
6  {
7      double tstart = MPI_Wtime();      /* Pass on all arguments */
8      int size;
9      int result = PMPI_Send(buffer, count, datatype, dest, tag, comm);
10
11     totalTime += MPI_Wtime() - tstart;    /* and time */
12
13     MPI_Type_size(datatype, &size); /* Compute size */
14     totalBytes += count*size;
15
16     return result;
17 }

```

14.2.6 MPI Library Implementation Example

If the MPI library is implemented in C on a Unix system, then there are various options, including the two presented here, for supporting the name-shift requirement. The choice between these two options depends partly on whether the linker and compiler support weak symbols.

Systems with Weak Symbols

If the compiler and linker support weak external symbols (e.g., Solaris 2.x, other System V.4 machines), then only a single library is required as the following example shows:

Example 14.2

```

37 #pragma weak MPI_Example = PMPI_Example
38
39 int PMPI_Example(/* appropriate args */)
40 {
41     /* Useful content */
42 }

```

The effect of this `#pragma` is to define the external symbol `MPI_Example` as a weak definition. This means that the linker will not complain if there is another definition of the symbol (for instance in the profiling library); however if no other definition exists, then the linker will use the weak definition.

Systems Without Weak Symbols

In the absence of weak symbols then one possible solution would be to use the C macro preprocessor as the following example shows:

Example 14.3

```

#ifdef PROFILELIB
#   ifdef __STDC__
#       define FUNCTION(name) P##name
#   else
#       define FUNCTION(name) P/**/name
#   endif
#else
#   define FUNCTION(name) name
#endif

```

Each of the user visible functions in the library would then be declared thus

```

int FUNCTION(MPI_Example)(/* appropriate args */)
{
    /* Useful content */
}

```

The same source file can then be compiled to produce both versions of the library, depending on the state of the PROFILELIB macro symbol.

It is required that the standard MPI library be built in such a way that the inclusion of MPI functions can be achieved one at a time. This is a somewhat unpleasant requirement, since it may mean that each external function has to be compiled from a separate file. However this is necessary so that the author of the profiling library need only define those MPI functions that she wishes to intercept, references to any others being fulfilled by the normal MPI library. Therefore the link step can look something like this

```
% cc ... -lmyprof -lpmi -lmpi
```

Here `libmyprof.a` contains the profiler functions that intercept some of the MPI functions, `libpmi.a` contains the “name shifted” MPI functions, and `libmpi.a` contains the normal definitions of the MPI functions.

14.2.7 Complications

Multiple Counting

Since parts of the MPI library may themselves be implemented using more basic MPI functions (e.g., a portable implementation of the collective operations implemented using point to point communications), there is potential for profiling functions to be called from within an MPI function that was called from a profiling function. This could lead to “double counting” of the time spent in the inner routine. Since this effect could actually be useful under some circumstances (e.g., it might allow one to answer the question “How much time is spent in the point to point routines when they are called from collective functions?”), we have decided not to enforce any restrictions on the author of the MPI library that would

1 overcome this. Therefore the author of the profiling library should be aware of this problem,
2 and guard against it. In a single-threaded world this is easily achieved through use of a
3 static variable in the profiling code that remembers if you are already inside a profiling
4 routine. It becomes more complex in a multi-threaded environment (as does the meaning
5 of the times recorded).

7 Linker Oddities

8
9 The Unix linker traditionally operates in one pass: the effect of this is that functions from
10 libraries are only included in the image if they are needed at the time the library is scanned.
11 When combined with weak symbols, or multiple definitions of the same function, this can
12 cause odd (and unexpected) effects.

13 Consider, for instance, an implementation of MPI in which the Fortran binding is
14 achieved by using wrapper functions on top of the C implementation. The author of the
15 profile library then assumes that it is reasonable only to provide profile functions for the C
16 binding, since Fortran will eventually call these, and the cost of the wrappers is assumed
17 to be small. However, if the wrapper functions are not in the profiling library, then none
18 of the profiled entry points will be undefined when the profiling library is called. Therefore
19 none of the profiling code will be included in the image. When the standard MPI library
20 is scanned, the Fortran wrappers will be resolved, and will also pull in the base versions of
21 the MPI functions. The overall effect is that the code will link successfully, but will not be
22 profiled.

23 To overcome this we must ensure that the Fortran wrapper functions are included in
24 the profiling version of the library. We ensure that this is possible by requiring that these
25 be separable from the rest of the base MPI library. This allows them to be copied out of
26 the base library and into the profiling one using a tool such as `ar`.

28 Fortran Support Methods

29 The different Fortran support methods and possible options for the support of subarrays
30 (depending on whether the compiler can support `TYPE(*)`, `DIMENSION(..)` choice buffers)
31 imply different specific procedure names for the same Fortran MPI routine. The rules and
32 implications for the profiling interface are described in Section [18.1.5](#).

34 14.2.8 Multiple Levels of Interception

35
36 The scheme given here does not directly support the nesting of profiling functions, since it
37 provides only a single alternative name for each MPI function. Consideration was given to
38 an implementation that would allow multiple levels of call interception, however we were
39 unable to construct an implementation of this that did not have the following disadvantages

- 40 • assuming a particular implementation language,
- 41 • imposing a run time cost even when no profiling was taking place.

42
43
44 Since one of the objectives of MPI is to permit efficient, low latency implementations, and
45 it is not the business of a standard to require a particular implementation language, we
46 decided to accept the scheme outlined above.

47 Note, however, that it is possible to use the scheme above to implement a multi-level
48 system, since the function called by the user may call many different profiling functions

before calling the underlying MPI function. This capability has been demonstrated in the P^NMPI tool infrastructure [53].

14.3 The MPI Tool Information Interface

MPI implementations often use internal variables to control their operation and performance. Understanding and manipulating these variables can provide a more efficient execution environment or improve performance for many applications. This section describes the MPI tool information interface, which provides a mechanism for MPI implementors to expose variables, each of which represents a particular property, setting, or performance measurement from within the MPI implementation. The interface is split into two parts: the first part provides information about and supports the setting of control variables through which the MPI implementation tunes its configuration. The second part provides access to performance variables that can provide insight into internal performance information of the MPI implementation.

To avoid restrictions on the MPI implementation, the MPI tool information interface allows the implementation to specify which control and performance variables exist. Additionally, the user of the MPI tool information interface can obtain metadata about each available variable, such as its datatype, and a textual description. The MPI tool information interface provides the necessary routines to find all variables that exist in a particular MPI implementation, to query their properties, to retrieve descriptions about their meaning, and to access and, if appropriate, to alter their values.

Variables and categories across connected MPI processes with equivalent names are required to have the same meaning (see the definition of “equivalent” as related to strings in Section 14.3.3). Furthermore, enumerations with equivalent names across connected MPI processes are required to have the same meaning, but are allowed to comprise different enumeration items. Enumeration items that have equivalent names across connected MPI processes in enumerations with the same meaning must also have the same meaning. In order for variables and categories to have the same meaning, routines in the tools information interface that return details for those variables and categories have requirements on what parameters must be identical. These requirements are specified in their respective sections.

Rationale. The intent of requiring the same meaning for entities with equivalent names is to enforce consistency across connected MPI processes. For example, variables describing the number of packets sent on different types of network devices should have different names to reflect their potentially different meanings. (*End of rationale.*)

The MPI tool information interface can be used independently from the MPI communication functionality. In particular, the routines of this interface can be called before MPI is initialized and after MPI is finalized. In order to support this behavior cleanly, the MPI tool information interface uses separate initialization and finalization routines. All identifiers used in the MPI tool information interface have the prefix MPI_T_.

On success, all MPI tool information interface routines return MPI_SUCCESS, otherwise they return an appropriate and unique return code indicating the reason why the call was not successfully completed. Details on return codes can be found in Section 14.3.9. However, unsuccessful calls to the MPI tool information interface are not fatal and do not impact the execution of subsequent MPI routines.

Since the MPI tool information interface primarily focuses on tools and support libraries, MPI implementations are only required to provide C bindings for functions and constants introduced in this section. Except where otherwise noted, all conventions and principles governing the C bindings of the MPI API also apply to the MPI tool information interface, which is available by including the `mpi.h` header file. All routines in this interface have local semantics.

Advice to users. The number and type of control variables and performance variables can vary between MPI implementations, platforms and different builds of the same implementation on the same platform as well as between runs. Hence, any application relying on a particular variable will not be portable. Further, there is no guarantee that the number of variables and variable indices are the same across connected MPI processes.

This interface is primarily intended for performance monitoring tools, support tools, and libraries controlling the application's environment. When maximum portability is desired, application programmers should either avoid using the MPI tool information interface or avoid being dependent on the existence of a particular control or performance variable. (*End of advice to users.*)

14.3.1 Verbosity Levels

The MPI tool information interface provides access to internal configuration and performance information through a set of control and performance variables defined by the MPI implementation. Since some implementations may export a large number of variables, variables are classified by a verbosity level that categorizes both their intended audience (end users, performance tuners or MPI implementors) and a relative measure of level of detail (basic, detailed or all). These verbosity levels are described by a single integer. Table 14.1 lists the constants for all possible verbosity levels. The values of the constants are monotonic in the order listed in the table; i.e., `MPI_T_VERBOSITY_USER_BASIC` < `MPI_T_VERBOSITY_USER_DETAIL` < ... < `MPI_T_VERBOSITY_MPIDEV_ALL`.

<code>MPI_T_VERBOSITY_USER_BASIC</code>	Basic information of interest to users
<code>MPI_T_VERBOSITY_USER_DETAIL</code>	Detailed information of interest to users
<code>MPI_T_VERBOSITY_USER_ALL</code>	All remaining information of interest to users
<code>MPI_T_VERBOSITY_TUNER_BASIC</code>	Basic information required for tuning
<code>MPI_T_VERBOSITY_TUNER_DETAIL</code>	Detailed information required for tuning
<code>MPI_T_VERBOSITY_TUNER_ALL</code>	All remaining information required for tuning
<code>MPI_T_VERBOSITY_MPIDEV_BASIC</code>	Basic information for MPI implementors
<code>MPI_T_VERBOSITY_MPIDEV_DETAIL</code>	Detailed information for MPI implementors
<code>MPI_T_VERBOSITY_MPIDEV_ALL</code>	All remaining information for MPI implementors

Table 14.1: MPI tool information interface verbosity levels

14.3.2 Binding MPI Tool Information Interface Variables to MPI Objects

Each MPI tool information interface variable provides access to a particular control setting or performance property of the MPI implementation. A variable may refer to a specific

MPI object such as a communicator, datatype, or one-sided communication window, or the variable may refer more generally to the MPI environment of the process. Except for the last case, the variable must be bound to exactly one MPI object before it can be used. Table 14.2 lists all MPI object types to which an MPI tool information interface variable can be bound, together with the matching constant that MPI tool information interface routines return to identify the object type.

Constant	MPI object
MPI_T_BIND_NO_OBJECT	N/A; applies globally to entire MPI process
MPI_T_BIND_MPI_COMM	MPI communicators
MPI_T_BIND_MPI_DATATYPE	MPI datatypes
MPI_T_BIND_MPI_ERRHANDLER	MPI error handlers
MPI_T_BIND_MPI_FILE	MPI file handles
MPI_T_BIND_MPI_GROUP	MPI groups
MPI_T_BIND_MPI_OP	MPI reduction operators
MPI_T_BIND_MPI_REQUEST	MPI requests
MPI_T_BIND_MPI_WIN	MPI windows for one-sided communication
MPI_T_BIND_MPI_MESSAGE	MPI message object
MPI_T_BIND_MPI_INFO	MPI info object

Table 14.2: Constants to identify associations of variables

Rationale. Some variables have meanings tied to a specific MPI object. Examples include the number of send or receive operations that use a particular datatype, the number of times a particular error handler has been called, or the communication protocol and “eager limit” used for a particular communicator. Creating a new MPI tool information interface variable for each MPI object would cause the number of variables to grow without bound, since they cannot be reused to avoid naming conflicts. By associating MPI tool information interface variables with a specific MPI object, the MPI implementation only must specify and maintain a single variable, which can then be applied to as many MPI objects of the respective type as created during the program’s execution. (*End of rationale.*)

14.3.3 Convention for Returning Strings

Several MPI tool information interface functions return one or more strings. These functions have two arguments for each string to be returned: an OUT parameter that identifies a pointer to the buffer in which the string will be returned, and an IN/OUT parameter to pass the length of the buffer. The user is responsible for the memory allocation of the buffer and must pass the size of the buffer (n) as the length argument. Let n be the length value specified to the function. On return, the function writes at most $n - 1$ of the string’s characters into the buffer, followed by a null terminator. If the returned string’s length is greater than or equal to n , the string will be truncated to $n - 1$ characters. In this case, the length of the string plus one (for the terminating null character) is returned in the length argument. If the user passes the null pointer as the buffer argument or passes 0 as the length argument, the function does not return the string and only returns the length of the string plus one in the length argument. If the user passes the null pointer as the length argument, the buffer argument is ignored and nothing is returned.

MPI implementations behave as if they have an internal character array that is copied to the output character array supplied by the user. Such output strings are only defined to be equivalent if their notional source-internal character arrays are identical (up to and including the null terminator), even if the output string is truncated due to a small input length parameter n .

14.3.4 Initialization and Finalization

The MPI tool information interface requires a separate set of initialization and finalization routines.

`MPI_T_INIT_THREAD(required, provided)`

IN	required	desired level of thread support (integer)
OUT	provided	provided level of thread support (integer)

`int MPI_T_init_thread(int required, int *provided)`

All programs or tools that use the MPI tool information interface must initialize the MPI tool information interface in the processes that will use the interface before calling any other of its routines. A user can initialize the MPI tool information interface by calling `MPI_T_INIT_THREAD`, which can be called multiple times. In addition, this routine initializes the thread environment for all routines in the MPI tool information interface. Calling this routine when the MPI tool information interface is already initialized has no effect beyond increasing the reference count of how often the interface has been initialized. The argument `required` is used to specify the desired level of thread support. The possible values and their semantics are identical to the ones that can be used with `MPI_INIT_THREAD` listed in Section 12.4. The call returns in `provided` information about the actual level of thread support that will be provided by the MPI implementation for calls to MPI tool information interface routines. It can be one of the four values listed in Section 12.4.

The MPI specification does not require all MPI processes to exist before MPI is initialized. If the MPI tool information interface is used before initialization of MPI, the user is responsible for ensuring that the MPI tool information interface is initialized on all processes it is used in. Processes created by the MPI implementation during initialization inherit the status of the MPI tool information interface (whether it is initialized or not as well as all active sessions and handles) from the process from which they are created.

Processes created at runtime as a result of calls to MPI's dynamic process management require their own initialization before they can use the MPI tool information interface.

Advice to users. If `MPI_T_INIT_THREAD` is called before `MPI_INIT_THREAD`, the requested and granted thread level for `MPI_T_INIT_THREAD` may influence the behavior and return value of `MPI_INIT_THREAD`. The same is true for the reverse order. (*End of advice to users.*)

Advice to implementors. MPI implementations should strive to make as many control or performance variables available before MPI initialization (instead of adding them during initialization) to allow tools the most flexibility. In particular, control variables should be available before MPI initialization if their value cannot be changed after MPI initialization. (*End of advice to implementors.*)

MPI_T_FINALIZE()

```
int MPI_T_finalize(void)
```

This routine finalizes the use of the MPI tool information interface and may be called as often as the corresponding MPI_T_INIT_THREAD routine up to the current point of execution. Calling it more times returns a corresponding error code. As long as the number of calls to MPI_T_FINALIZE is smaller than the number of calls to MPI_T_INIT_THREAD up to the current point of execution, the MPI tool information interface remains initialized and calls to its routines are permissible. Further, additional calls to MPI_T_INIT_THREAD after one or more calls to MPI_T_FINALIZE are permissible.

Once MPI_T_FINALIZE is called the same number of times as the routine MPI_T_INIT_THREAD up to the current point of execution, the MPI tool information interface is no longer initialized. The user can reinitialize the interface by a subsequent call to MPI_T_INIT_THREAD.

At the end of the program execution, unless MPI_ABORT is called, an application must have called MPI_T_INIT_THREAD and MPI_T_FINALIZE an equal number of times.

14.3.5 Datatype System

All variables managed through the MPI tool information interface represent their values through typed buffers of a given length and type using an MPI datatype (similar to regular send/receive buffers). Since the initialization of the MPI tool information interface is separate from the initialization of MPI, MPI tool information interface routines can be called before MPI initialization. Consequently, these routines can also use MPI datatypes before MPI initialization. Therefore, within the context of the MPI tool information interface, it is permissible to use a subset of MPI datatypes as specified below before MPI initialization.

```
MPI_INT
MPI_UNSIGNED
MPI_UNSIGNED_LONG
MPI_UNSIGNED_LONG_LONG
MPI_COUNT
MPI_CHAR
MPI_DOUBLE
```

Table 14.3: MPI datatypes that can be used by the MPI tool information interface

Rationale. The MPI tool information interface relies mainly on unsigned datatypes for integer values since most variables are expected to represent counters or resource sizes. MPI_INT is provided for additional flexibility and is expected to be used mainly for control variables and enumeration types (see below).

Providing all basic datatypes, in particular providing all signed and unsigned variants of integer types, would lead to a larger number of types, which tools need to interpret. This would cause unnecessary complexity in the implementation of tools based on the MPI tool information interface. (*End of rationale.*)

The MPI tool information interface only relies on a subset of the basic MPI datatypes and does not use any derived MPI datatypes. Table 14.3 lists all MPI datatypes that can be returned by the MPI tool information interface to represent its variables.

The use of the datatype MPI_CHAR in the MPI tool information interface implies a null-terminated character array, i.e., a string in the C language. If a variable has type MPI_CHAR, the value of the count parameter returned by MPI_T_CVAR_HANDLE_ALLOC and MPI_T_PVAR_HANDLE_ALLOC must be large enough to include any valid value, including its terminating null character. The contents of returned MPI_CHAR arrays are only defined from index 0 through the location of the first null character.

Rationale. The MPI tool information interface requires a significantly simpler type system than MPI itself. Therefore, only its required subset must be present before MPI initialization and MPI implementations do not need to initialize the complete MPI datatype system. (*End of rationale.*)

For variables of type MPI_INT, an MPI implementation can provide additional information by associating names with a fixed number of values. We refer to this information in the following as an enumeration. In this case, the respective calls that provide additional metadata for each control or performance variable, i.e., MPI_T_CVAR_GET_INFO (Section 14.3.6) and MPI_T_PVAR_GET_INFO (Section 14.3.7), return a handle of type MPI_T_enum that can be passed to the following functions to extract additional information. Thus, the MPI implementation can describe variables with a fixed set of values that each represents a particular state. Each enumeration type can have N different values, with a fixed N that can be queried using MPI_T_ENUM_GET_INFO.

```
MPI_T_ENUM_GET_INFO(enumtype, num, name, name_len)
    IN      enumtype      enumeration to be queried (handle)
    OUT     num           number of discrete values represented by this enumer-
                        ation (integer)
    OUT     name          buffer to return the string containing the name of the
                        enumeration (string)
    INOUT   name_len     length of the string and/or buffer for name (integer)
```

```
int MPI_T_enum_get_info(MPI_T_enum enumtype, int *num, char *name,
                        int *name_len)
```

If `enumtype` is a valid enumeration, this routine returns the number of items represented by this enumeration type as well as its name. N must be greater than 0, i.e., the enumeration must represent at least one value.

The arguments `name` and `name_len` are used to return the name of the enumeration as described in Section 14.3.3.

The routine is required to return a name of at least length one. This name must be unique with respect to all other names for enumerations that the MPI implementation uses.

Names associated with individual values in each enumeration `enumtype` can be queried using MPI_T_ENUM_GET_ITEM.

MPI_T_ENUM_GET_ITEM(enumtype, index, value, name, name_len)			1
IN	enumtype	enumeration to be queried (handle)	2
IN	index	number of the value to be queried in this enumeration (integer)	3
OUT	value	variable value (integer)	4
OUT	name	buffer to return the string containing the name of the enumeration item (string)	5
INOUT	name_len	length of the string and/or buffer for name (integer)	6
int MPI_T_enum_get_item(MPI_T_enum enumtype, int index, int *value, char *name, int *name_len)			7

The arguments `name` and `name_len` are used to return the name of the enumeration item as described in Section 14.3.3.

If completed successfully, the routine returns the name/value pair that describes the enumeration at the specified index. The call is further required to return a name of at least length one. This name must be unique with respect to all other names of items for the same enumeration.

14.3.6 Control Variables

The routines described in this section of the MPI tool information interface specification focus on the ability to list, query, and possibly set control variables exposed by the MPI implementation. These variables can typically be used by the user to fine tune properties and configuration settings of the MPI implementation. On many systems, such variables can be set using environment variables, although other configuration mechanisms may be available, such as configuration files or central configuration registries. A typical example that is available in several existing MPI implementations is the ability to specify an “eager limit,” i.e., an upper bound on the size of messages sent or received using an eager protocol.

Control Variable Query Functions

An MPI implementation exports a set of N control variables through the MPI tool information interface. If N is zero, then the MPI implementation does not export any control variables, otherwise the provided control variables are indexed from 0 to $N - 1$. This index number is used in subsequent calls to identify the individual variables.

An MPI implementation is allowed to increase the number of control variables during the execution of an MPI application when new variables become available through dynamic loading. However, MPI implementations are not allowed to change the index of a control variable or to delete a variable once it has been added to the set. When a variable becomes inactive, e.g., through dynamic unloading, accessing its value should return a corresponding error code.

Advice to users. While the MPI tool information interface guarantees that indices or variable properties do not change during a particular run of an MPI program, it does not provide a similar guarantee between runs. (*End of advice to users.*)

The following function can be used to query the number of control variables, *num_cvar*:

```
1 MPI_T_CVAR_GET_NUM(num_cvar)
```

```
2
3
4
5     OUT     num_cvar           returns number of control variables (integer)
6
```

```
7 int MPI_T_cvar_get_num(int *num_cvar)
8
```

The function `MPI_T_CVAR_GET_INFO` provides access to additional information for each variable.

```
9
10
11
12 MPI_T_CVAR_GET_INFO(cvar_index, name, name_len, verbosity, datatype, enumtype, desc,
13                    desc_len, bind, scope)
14
```

```
15     IN     cvar_index         index of the control variable to be queried, value be-
16                                     tween 0 and num_cvar - 1 (integer)
```

```
17     OUT     name              buffer to return the string containing the name of the
18                                     control variable (string)
```

```
19     INOUT   name_len         length of the string and/or buffer for name (integer)
```

```
20     OUT     verbosity        verbosity level of this variable (integer)
```

```
21     OUT     datatype         MPI datatype of the information stored in the control
22                                     variable (handle)
```

```
23
24     OUT     enumtype         optional descriptor for enumeration information (han-
25                                     dle)
```

```
26     OUT     desc             buffer to return the string containing a description of
27                                     the control variable (string)
```

```
28
29     INOUT   desc_len        length of the string and/or buffer for desc (integer)
```

```
30     OUT     bind             type of MPI object to which this variable must be
31                                     bound (integer)
```

```
32     OUT     scope           scope of when changes to this variable are possible
33                                     (integer)
34
```

```
35
36 int MPI_T_cvar_get_info(int cvar_index, char *name, int *name_len,
37                        int *verbosity, MPI_Datatype *datatype, MPI_T_enum *enumtype,
38                        char *desc, int *desc_len, int *bind, int *scope)
39
```

After a successful call to `MPI_T_CVAR_GET_INFO` for a particular variable, subsequent calls to this routine that query information about the same variable must return the same information. An MPI implementation is not allowed to alter any of the returned values.

If any OUT parameter to `MPI_T_CVAR_GET_INFO` is a NULL pointer, the implementation will ignore the parameter and not return a value for the parameter.

The arguments *name* and *name_len* are used to return the name of the control variable as described in Section 14.3.3.

If completed successfully, the routine is required to return a name of at least length one. The name must be unique with respect to all other names for control variables used by the MPI implementation.

The argument `verbosity` returns the verbosity level of the variable (see Section 14.3.1).

The argument `datatype` returns the MPI datatype that is used to represent the control variable.

If the variable is of type `MPI_INT`, MPI can optionally specify an enumeration for the values represented by this variable and return it in `enumtype`. In this case, MPI returns an enumeration identifier, which can then be used to gather more information as described in Section 14.3.5. Otherwise, `enumtype` is set to `MPI_T_ENUM_NULL`. If the datatype is not `MPI_INT` or the argument `enumtype` is the null pointer, no enumeration type is returned.

The arguments `desc` and `desc_len` are used to return a description of the control variable as described in Section 14.3.3.

Returning a description is optional. If an MPI implementation does not return a description, the first character for `desc` must be set to the null character and `desc_len` must be set to one at the return of this call.

The parameter `bind` returns the type of the MPI object to which the variable must be bound or the value `MPI_T_BIND_NO_OBJECT` (see Section 14.3.2).

The scope of a variable determines whether changing a variable's value is either local to the MPI process or must be done by the user across multiple connected MPI processes. The latter is further split into variables that require changes in a group of MPI processes and those that require collective changes among all connected MPI processes. Both cases can require variables on all participating MPI processes either to be set to consistent (but potentially different) values or to equal values. The description provided with the variable must contain an explanation about the requirements and/or restrictions for setting the particular variable.

On successful return from `MPI_T_CVAR_GET_INFO`, the argument `scope` will be set to one of the constants listed in Table 14.4.

If the name of a control variable is equivalent across connected MPI processes, the following OUT parameters must be identical: `verbosity`, `datatype`, `enumtype`, `bind`, and `scope`. The returned description must be equivalent.

Scope Constant	Description
<code>MPI_T_SCOPE_CONSTANT</code>	read-only, value is constant
<code>MPI_T_SCOPE_READONLY</code>	read-only, cannot be written, but can change
<code>MPI_T_SCOPE_LOCAL</code>	may be writeable, writing is a local operation
<code>MPI_T_SCOPE_GROUP</code>	may be writeable, must be set to consistent values across a group of connected MPI processes
<code>MPI_T_SCOPE_GROUP_EQ</code>	may be writeable, must be set to the same value across a group of connected MPI processes
<code>MPI_T_SCOPE_ALL</code>	may be writeable, must be set to consistent values across all connected MPI processes
<code>MPI_T_SCOPE_ALL_EQ</code>	may be writeable, must be set to the same value across all connected MPI processes

Table 14.4: Scopes for control variables

Advice to users. The `scope` of a variable only indicates if a variable might be changeable; it is not a guarantee that it can be changed at any time. (*End of advice to users.*)

```

1 MPI_T_CVAR_GET_INDEX(name, cvar_index)
2     IN          name                name of the control variable (string)
3
4     OUT        cvar_index          index of the control variable (integer)

```

```

5
6 int MPI_T_cvar_get_index(const char *name, int *cvar_index)

```

7 MPI_T_CVAR_GET_INDEX is a function for retrieving the index of a control variable
8 given a known variable name. The name parameter is provided by the caller, and cvar_index
9 is returned by the MPI implementation. The name parameter is a string terminated with a
10 null character.

11 This routine returns MPI_SUCCESS on success and returns MPI_T_ERR_INVALID_NAME
12 if name does not match the name of any control variable provided by the implementation
13 at the time of the call.

14
15 *Rationale.* This routine is provided to enable fast retrieval of control variables by
16 a tool, assuming it knows the name of the variable for which it is looking. The
17 number of variables exposed by the implementation can change over time, so it is not
18 possible for the tool to simply iterate over the list of variables once at initialization.
19 Although using MPI implementation specific variable names is not portable across MPI
20 implementations, tool developers may choose to take this route for lower overhead at
21 runtime because the tool will not have to iterate over the entire set of variables to
22 find a specific one. (*End of rationale.*)

23
24 Example: Printing All Control Variables

25 26 27 **Example 14.4**

28 The following example shows how the MPI tool information interface can be used to
29 query and to print the names of all available control variables.

```

30 #include <stdio.h>
31 #include <stdlib.h>
32 #include <mpi.h>
33
34
35 int main(int argc, char *argv[]) {
36     int i, err, num, namelen, bind, verbose, scope;
37     int threadsupport;
38     char name[100];
39     MPI_Datatype datatype;
40
41     err=MPI_T_init_thread(MPI_THREAD_SINGLE,&threadsupport);
42     if (err!=MPI_SUCCESS)
43         return err;
44
45     err=MPI_T_cvar_get_num(&num);
46     if (err!=MPI_SUCCESS)
47         return err;

```

```

for (i=0; i<num; i++) {
    namelen=100;
    err=MPI_T_cvar_get_info(i, name, &namelen,
        &verbose, &datatype, NULL,
        NULL, NULL, /*no description */
        &bind, &scope);
    if (err!=MPI_SUCCESS && err!=MPI_T_ERR_INVALID_INDEX) return err;
    printf("Var %i: %s\n", i, name);
}

err=MPI_T_finalize();
if (err!=MPI_SUCCESS)
    return 1;
else
    return 0;
}

```

Handle Allocation and Deallocation

Before reading or writing the value of a variable, a user must first allocate a handle of type `MPI_T_cvar_handle` for the variable by binding it to an MPI object (see also Section 14.3.2).

Rationale. Handles used in the MPI tool information interface are distinct from handles used in the remaining parts of the MPI standard because they must be usable before MPI is initialized and after MPI is finalized. Further, accessing handles, in particular for performance variables, can be time critical and having a separate handle space enables optimizations. (*End of rationale.*)

`MPI_T_CVAR_HANDLE_ALLOC(cvar_index, obj_handle, handle, count)`

IN	<code>cvar_index</code>	index of control variable for which handle is to be allocated (index)
IN	<code>obj_handle</code>	reference to a handle of the MPI object to which this variable is supposed to be bound (pointer)
OUT	<code>handle</code>	allocated handle (handle)
OUT	<code>count</code>	number of elements used to represent this variable (integer)

```

int MPI_T_cvar_handle_alloc(int cvar_index, void *obj_handle,
    MPI_T_cvar_handle *handle, int *count)

```

This routine binds the control variable specified by the argument `index` to an MPI object. The object is passed in the argument `obj_handle` as an address to a local variable that stores the object's handle. The argument `obj_handle` is ignored if the `MPI_T_CVAR_GET_INFO` call for this control variable returned `MPI_T_BIND_NO_OBJECT` in the argument `bind`. The handle allocated to reference the variable is returned in the argument `handle`. Upon successful return, `count` contains the number of elements (of the datatype returned by a previous `MPI_T_CVAR_GET_INFO` call) used to represent this variable.

1 *Advice to users.* The count can be different based on the MPI object to which the
 2 control variable was bound. For example, variables bound to communicators could
 3 have a count that matches the size of the communicator.

4 It is not portable to pass references to predefined MPI object handles, such as
 5 MPI_COMM_WORLD to this routine, since their implementation depends on the MPI
 6 library. Instead, such object handles should be stored in a local variable and the
 7 address of this local variable should be passed into MPI_T_CVAR_HANDLE_ALLOC.
 8 (*End of advice to users.*)
 9

10 The value of `cvar_index` should be in the range 0 to `num_cvar - 1`, where `num_cvar`
 11 is the number of available control variables as determined from a prior call to
 12 MPI_T_CVAR_GET_NUM. The type of the MPI object it references must be consistent
 13 with the type returned in the `bind` argument in a prior call to MPI_T_CVAR_GET_INFO.
 14

15 MPI_T_CVAR_HANDLE_FREE(handle)

16 INOUT handle handle to be freed (handle)

17
 18
 19 `int MPI_T_cvar_handle_free(MPI_T_cvar_handle *handle)`
 20

21 When a handle is no longer needed, a user of the MPI tool information interface should
 22 call MPI_T_CVAR_HANDLE_FREE to free the handle and the associated resources in the
 23 MPI implementation. On a successful return, MPI sets the handle to
 24 MPI_T_CVAR_HANDLE_NULL.
 25

26 Control Variable Access Functions

27
 28
 29 MPI_T_CVAR_READ(handle, buf)

30 IN handle handle to the control variable to be read (handle)
 31 OUT buf initial address of storage location for variable value
 32 (choice)
 33
 34

35 `int MPI_T_cvar_read(MPI_T_cvar_handle handle, void* buf)`
 36

37 This routine queries the value of a control variable identified by the argument `handle` and
 38 stores the result in the buffer identified by the parameter `buf`. The user must ensure that the
 39 buffer is of the appropriate size to hold the entire value of the control variable (based on the
 40 returned datatype and count from prior corresponding calls to MPI_T_CVAR_GET_INFO
 41 and MPI_T_CVAR_HANDLE_ALLOC, respectively).
 42

43 MPI_T_CVAR_WRITE(handle, buf)

44 IN handle handle to the control variable to be written (handle)
 45 IN buf initial address of storage location for variable value
 46 (choice)
 47
 48

```
int MPI_T_cvar_write(MPI_T_cvar_handle handle, const void* buf)
```

This routine sets the value of the control variable identified by the argument `handle` to the data stored in the buffer identified by the parameter `buf`. The user must ensure that the buffer is of the appropriate size to hold the entire value of the control variable (based on the returned datatype and count from prior corresponding calls to `MPI_T_CVAR_GET_INFO` and `MPI_T_CVAR_HANDLE_ALLOC`, respectively).

If the variable has a global scope (as returned by a prior corresponding `MPI_T_CVAR_GET_INFO` call), any write call to this variable must be issued by the user in all connected (as defined in Section 10.5.4) MPI processes. If the variable has group scope, any write call to this variable must be issued by the user in all MPI processes in the group, which must be described by the MPI implementation in the description by the `MPI_T_CVAR_GET_INFO`.

In both cases, the user must ensure that the writes in all participating MPI processes are consistent. If the scope is either `MPI_T_SCOPE_ALL_EQ` or `MPI_T_SCOPE_GROUP_EQ` this means that the variable in all connected MPI processes or MPI processes of the group, respectively, must be set to the same value.

If it is not possible to change the variable at the time the call is made, the function returns either `MPI_T_ERR_CVAR_SET_NOT_NOW`, if there may be a later time at which the variable could be set, or `MPI_T_ERR_CVAR_SET_NEVER`, if the variable cannot be set for the remainder of the application's execution.

Example: Reading the Value of a Control Variable

Example 14.5

The following example shows a routine that can be used to query the value with a control variable with a given index. The example assumes that the variable is intended to be bound to an MPI communicator.

```
int getValue_int_comm(int index, MPI_Comm comm, int *val) {
    int err,count;
    MPI_T_cvar_handle handle;

    /* This example assumes that the variable index */
    /* can be bound to a communicator */

    err=MPI_T_cvar_handle_alloc(index,&comm,&handle,&count);
    if (err!=MPI_SUCCESS) return err;

    /* The following assumes that the variable is */
    /* represented by a single integer */

    err=MPI_T_cvar_read(handle,val);
    if (err!=MPI_SUCCESS) return err;

    err=MPI_T_cvar_handle_free(&handle);
    return err;
}
```

14.3.7 Performance Variables

The following section focuses on the ability to list and to query performance variables provided by the MPI implementation. Performance variables provide insight into MPI implementation specific internals and can represent information such as the state of the MPI implementation (e.g., waiting blocked, receiving, not active), aggregated timing data for submodules, or queue sizes and lengths.

Rationale. The interface for performance variables is separate from the interface for control variables, since performance variables have different requirements and parameters. By keeping them separate, the interface provides cleaner semantics and allows for more performance optimization opportunities. (*End of rationale.*)

Performance Variable Classes

Each performance variable is associated with a class that describes its basic semantics, possible datatypes, basic behavior, its starting value, whether it can overflow, and when and how an MPI implementation can change the variable's value. The starting value is the value that is assigned to the variable the first time that it is used or whenever it is reset.

Advice to users. If a performance variable belongs to a class that can overflow, it is up to the user to protect against this overflow, e.g., by frequently reading and resetting the variable value. (*End of advice to users.*)

Advice to implementors. MPI implementations should use large enough datatypes for each performance variable to avoid overflows under normal circumstances. (*End of advice to implementors.*)

The classes are defined by the following constants:

- **MPI_T_PVAR_CLASS_STATE**

A performance variable in this class represents a set of discrete states. Variables of this class are represented by `MPI_INT` and can be set by the MPI implementation at any time. Variables of this type should be described further using an enumeration, as discussed in Section 14.3.5. The starting value is the current state of the implementation at the time that the starting value is set. MPI implementations must ensure that variables of this class cannot overflow.

- **MPI_T_PVAR_CLASS_LEVEL**

A performance variable in this class represents a value that describes the utilization level of a resource. The value of a variable of this class can change at any time to match the current utilization level of the resource. Values returned from variables in this class are non-negative and represented by one of the following datatypes: `MPI_UNSIGNED`, `MPI_UNSIGNED_LONG`, `MPI_UNSIGNED_LONG_LONG`, `MPI_DOUBLE`. The starting value is the current utilization level of the resource at the time that the starting value is set. MPI implementations must ensure that variables of this class cannot overflow.

- **MPI_T_PVAR_CLASS_SIZE**

A performance variable in this class represents a value that is the size of a resource. Values returned from variables in this class are non-negative and represented by one

of the following datatypes: MPI_UNSIGNED, MPI_UNSIGNED_LONG, MPI_UNSIGNED_LONG_LONG, MPI_DOUBLE. The starting value is the current size of the resource at the time that the starting value is set. MPI implementations must ensure that variables of this class cannot overflow.

- MPI_T_PVAR_CLASS_PERCENTAGE

The value of a performance variable in this class represents the percentage utilization of a finite resource. The value of a variable of this class can change at any time to match the current utilization level of the resource. It will be returned as an MPI_DOUBLE datatype. The value must always be between 0.0 (resource not used at all) and 1.0 (resource completely used). The starting value is the current percentage utilization level of the resource at the time that the starting value is set. MPI implementations must ensure that variables of this class cannot overflow.

- MPI_T_PVAR_CLASS_HIGHWATERMARK

A performance variable in this class represents a value that describes the high watermark utilization of a resource. The value of a variable of this class is non-negative and grows monotonically from the initialization or reset of the variable. It can be represented by one of the following datatypes: MPI_UNSIGNED, MPI_UNSIGNED_LONG, MPI_UNSIGNED_LONG_LONG, MPI_DOUBLE. The starting value is the current utilization level of the resource at the time that the variable is started or reset. MPI implementations must ensure that variables of this class cannot overflow.

- MPI_T_PVAR_CLASS_LOWWATERMARK

A performance variable in this class represents a value that describes the low watermark utilization of a resource. The value of a variable of this class is non-negative and decreases monotonically from the initialization or reset of the variable. It can be represented by one of the following datatypes: MPI_UNSIGNED, MPI_UNSIGNED_LONG, MPI_UNSIGNED_LONG_LONG, MPI_DOUBLE. The starting value is the current utilization level of the resource at the time that the variable is started or reset. MPI implementations must ensure that variables of this class cannot overflow.

- MPI_T_PVAR_CLASS_COUNTER

A performance variable in this class counts the number of occurrences of a specific event (e.g., the number of memory allocations within an MPI library). The value of a variable of this class increases monotonically from the initialization or reset of the performance variable by one for each specific event that is observed. Values must be non-negative and represented by one of the following datatypes: MPI_UNSIGNED, MPI_UNSIGNED_LONG, MPI_UNSIGNED_LONG_LONG. The starting value for variables of this class is 0. Variables of this class can overflow.

- MPI_T_PVAR_CLASS_AGGREGATE

The value of a performance variable in this class is an aggregated value that represents a sum of arguments processed during a specific event (e.g., the amount of memory allocated by all memory allocations). This class is similar to the counter class, but instead of counting individual events, the value can be incremented by arbitrary amounts. The value of a variable of this class increases monotonically from the initialization or reset of the performance variable. It must be non-negative and represented by one of the following datatypes: MPI_UNSIGNED, MPI_UNSIGNED_LONG,

1 MPI_UNSIGNED_LONG_LONG, MPI_DOUBLE. The starting value for variables of this
 2 class is 0. Variables of this class can overflow.

3
 4 ● MPI_T_PVAR_CLASS_TIMER

5 The value of a performance variable in this class represents the aggregated time that
 6 the MPI implementation spends executing a particular event, type of event, or section
 7 of the MPI library. This class has the same basic semantics as
 8 MPI_T_PVAR_CLASS_AGGREGATE, but explicitly records a timing value. The value of
 9 a variable of this class increases monotonically from the initialization or reset of the
 10 performance variable. It must be non-negative and represented by one of the following
 11 datatypes: MPI_UNSIGNED, MPI_UNSIGNED_LONG, MPI_UNSIGNED_LONG_LONG,
 12 MPI_DOUBLE. The starting value for variables of this class is 0. If the type
 13 MPI_DOUBLE is used, the units that represent time in this datatype must match the
 14 units used by MPI_WTIME. Otherwise, the time units should be documented, e.g.,
 15 in the description returned by MPI_T_PVAR_GET_INFO. Variables of this class can
 16 overflow.

17 ● MPI_T_PVAR_CLASS_GENERIC

18 This class can be used to describe a variable that does not fit into any of the
 19 other classes. For variables in this class, the starting value is variable-specific and
 20 implementation-defined.
 21

22
 23 Performance Variable Query Functions

24 An MPI implementation exports a set of N performance variables through the MPI tool
 25 information interface. If N is zero, then the MPI implementation does not export any
 26 performance variables; otherwise the provided performance variables are indexed from 0 to
 27 $N - 1$. This index number is used in subsequent calls to identify the individual variables.

28 An MPI implementation is allowed to increase the number of performance variables
 29 during the execution of an MPI application when new variables become available through
 30 dynamic loading. However, MPI implementations are not allowed to change the index of
 31 a performance variable or to delete a variable once it has been added to the set. When
 32 a variable becomes inactive, e.g., through dynamic unloading, accessing its value should
 33 return a corresponding error code.

34 The following function can be used to query the number of performance variables, N :

35
 36
 37 MPI_T_PVAR_GET_NUM(num_pvar)

38 OUT num_pvar returns number of performance variables (integer)

39
 40 int MPI_T_pvar_get_num(int *num_pvar)

41
 42 The function MPI_T_PVAR_GET_INFO provides access to additional information for
 43 each variable.
 44
 45
 46
 47
 48

MPI_T_PVAR_GET_INFO(pvar_index, name, name_len, verbosity, varclass, datatype,			1
enumtype, desc, desc_len, bind, readonly, continuous, atomic)			2
IN	pvar_index	index of the performance variable to be queried between 0 and <i>num_pvar</i> - 1 (integer)	3
			4
OUT	name	buffer to return the string containing the name of the performance variable (string)	5
			6
INOUT	name_len	length of the string and/or buffer for name (integer)	7
			8
OUT	verbosity	verbosity level of this variable (integer)	9
			10
OUT	var_class	class of performance variable (integer)	11
			12
OUT	datatype	MPI datatype of the information stored in the performance variable (handle)	13
			14
OUT	enumtype	optional descriptor for enumeration information (handle)	15
			16
OUT	desc	buffer to return the string containing a description of the performance variable (string)	17
			18
INOUT	desc_len	length of the string and/or buffer for desc (integer)	19
			20
OUT	bind	type of MPI object to which this variable must be bound (integer)	21
			22
OUT	readonly	flag indicating whether the variable can be written/reset (integer)	23
			24
OUT	continuous	flag indicating whether the variable can be started and stopped or is continuously active (integer)	25
			26
OUT	atomic	flag indicating whether the variable can be atomically read and reset (integer)	27
			28
			29
int MPI_T_pvar_get_info(int pvar_index, char *name, int *name_len,			30
int *verbosity, int *var_class, MPI_Datatype *datatype,			31
MPI_T_enum *enumtype, char *desc, int *desc_len, int *bind,			32
int *readonly, int *continuous, int *atomic)			33
			34

After a successful call to MPI_T_PVAR_GET_INFO for a particular variable, subsequent calls to this routine that query information about the same variable must return the same information. An MPI implementation is not allowed to alter any of the returned values.

If any OUT parameter to MPI_T_PVAR_GET_INFO is a NULL pointer, the implementation will ignore the parameter and not return a value for the parameter.

The arguments name and name_len are used to return the name of the performance variable as described in Section 14.3.3. If completed successfully, the routine is required to return a name of at least length one.

The argument verbosity returns the verbosity level of the variable (see Section 14.3.1).

The class of the performance variable is returned in the parameter var_class. The class must be one of the constants defined in Section 14.3.7.

The combination of the name and the class of the performance variable must be unique with respect to all other names for performance variables used by the MPI implementation.

Advice to implementors. Groups of variables that belong closely together, but have different classes, can have the same name. This choice is useful, e.g., to refer to multiple variables that describe a single resource (like the level, the total size, as well as high and low watermarks). (*End of advice to implementors.*)

The argument `datatype` returns the MPI datatype that is used to represent the performance variable.

If the variable is of type `MPI_INT`, MPI can optionally specify an enumeration for the values represented by this variable and return it in `enumtype`. In this case, MPI returns an enumeration identifier, which can then be used to gather more information as described in Section 14.3.5. Otherwise, `enumtype` is set to `MPI_T_ENUM_NULL`. If the datatype is not `MPI_INT` or the argument `enumtype` is the null pointer, no enumeration type is returned.

Returning a description is optional. If an MPI implementation does not return a description, the first character for `desc` must be set to the null character and `desc_len` must be set to one at the return from this function.

The parameter `bind` returns the type of the MPI object to which the variable must be bound or the value `MPI_T_BIND_NO_OBJECT` (see Section 14.3.2).

Upon return, the argument `readonly` is set to zero if the variable can be written or reset by the user. It is set to one if the variable can only be read.

Upon return, the argument `continuous` is set to zero if the variable can be started and stopped by the user, i.e., it is possible for the user to control if and when the value of a variable is updated. It is set to one if the variable is always active and cannot be controlled by the user.

Upon return, the argument `atomic` is set to zero if the variable cannot be read and reset atomically. Only variables for which the call sets `atomic` to one can be used in a call to `MPI_T_PVAR_READRESET`.

If a performance variable has an equivalent name and has the same class across connected MPI processes, the following OUT parameters must be identical: `verbosity`, `varclass`, `datatype`, `enumtype`, `bind`, `readonly`, `continuous`, and `atomic`. The returned description must be equivalent.

```
MPI_T_PVAR_GET_INDEX(name, var_class, pvar_index)
```

IN	<code>name</code>	the name of the performance variable (string)
IN	<code>var_class</code>	the class of the performance variable (integer)
OUT	<code>pvar_index</code>	the index of the performance variable (integer)

```
int MPI_T_pvar_get_index(const char *name, int var_class, int *pvar_index)
```

`MPI_T_PVAR_GET_INDEX` is a function for retrieving the index of a performance variable given a known variable name and class. The `name` and `var_class` parameters are provided by the caller, and `pvar_index` is returned by the MPI implementation. The `name` parameter is a string terminated with a null character.

This routine returns `MPI_SUCCESS` on success and returns `MPI_T_ERR_INVALID_NAME` if `name` does not match the name of any performance variable of the specified `var_class` provided by the implementation at the time of the call.

Rationale. This routine is provided to enable fast retrieval of performance variables by a tool, assuming it knows the name of the variable for which it is looking. The number of variables exposed by the implementation can change over time, so it is not possible for the tool to simply iterate over the list of variables once at initialization. Although using MPI implementation specific variable names is not portable across MPI implementations, tool developers may choose to take this route for lower overhead at runtime because the tool will not have to iterate over the entire set of variables to find a specific one. (*End of rationale.*)

Performance Experiment Sessions

Within a single program, multiple components can use the MPI tool information interface. To avoid collisions with respect to accesses to performance variables, users of the MPI tool information interface must first create a session. Subsequent calls that access performance variables can then be made within the context of this session. Any call executed in a session must not influence the results in any other session.

MPI_T_PVAR_SESSION_CREATE(session)

OUT session identifier of performance session (handle)

```
int MPI_T_pvar_session_create(MPI_T_pvar_session *session)
```

This call creates a new session for accessing performance variables and returns a handle for this session in the argument `session` of type `MPI_T_pvar_session`.

MPI_T_PVAR_SESSION_FREE(session)

INOUT session identifier of performance experiment session (handle)

```
int MPI_T_pvar_session_free(MPI_T_pvar_session *session)
```

This call frees an existing session. Calls to the MPI tool information interface can no longer be made within the context of a session after it is freed. On a successful return, MPI sets the session identifier to `MPI_T_PVAR_SESSION_NULL`.

Handle Allocation and Deallocation

Before using a performance variable, a user must first allocate a handle of type `MPI_T_pvar_handle` for the variable by binding it to an MPI object (see also Section [14.3.2](#)).

```

1 MPI_T_PVAR_HANDLE_ALLOC(session, pvar_index, obj_handle, handle, count)
2     IN      session          identifier of performance experiment session (handle)
3
4     IN      pvar_index       index of performance variable for which handle is to
5                               be allocated (integer)
6
7     IN      obj_handle       reference to a handle of the MPI object to which this
8                               variable is supposed to be bound (pointer)
9
10    OUT     handle           allocated handle (handle)
11
12    OUT     count            number of elements used to represent this variable (in-
13                               teger)

```

```

14 int MPI_T_pvar_handle_alloc(MPI_T_pvar_session session, int pvar_index,
15                             void *obj_handle, MPI_T_pvar_handle *handle, int *count)

```

This routine binds the performance variable specified by the argument `index` to an MPI object in the session identified by the parameter `session`. The object is passed in the argument `obj_handle` as an address to a local variable that stores the object's handle. The argument `obj_handle` is ignored if the `MPI_T_PVAR_GET_INFO` call for this performance variable returned `MPI_T_BIND_NO_OBJECT` in the argument `bind`. The handle allocated to reference the variable is returned in the argument `handle`. Upon successful return, `count` contains the number of elements (of the datatype returned by a previous `MPI_T_PVAR_GET_INFO` call) used to represent this variable.

Advice to users. The `count` can be different based on the MPI object to which the performance variable was bound. For example, variables bound to communicators could have a count that matches the size of the communicator.

It is not portable to pass references to predefined MPI object handles, such as `MPI_COMM_WORLD`, to this routine, since their implementation depends on the MPI library. Instead, such an object handle should be stored in a local variable and the address of this local variable should be passed into `MPI_T_PVAR_HANDLE_ALLOC`. (*End of advice to users.*)

The value of `index` should be in the range 0 to `num_pvar - 1`, where `num_pvar` is the number of available performance variables as determined from a prior call to `MPI_T_PVAR_GET_NUM`. The type of the MPI object it references must be consistent with the type returned in the `bind` argument in a prior call to `MPI_T_PVAR_GET_INFO`.

For all routines in the rest of this section that take both `handle` and `session` as IN or INOUT arguments, if the `handle` argument passed in is not associated with the `session` argument, `MPI_T_ERR_INVALID_HANDLE` is returned.

```

42 MPI_T_PVAR_HANDLE_FREE(session, handle)
43     IN      session          identifier of performance experiment session (handle)
44
45     INOUT   handle           handle to be freed (handle)

```

```

47 int MPI_T_pvar_handle_free(MPI_T_pvar_session session,
48                             MPI_T_pvar_handle *handle)

```

When a handle is no longer needed, a user of the MPI tool information interface should call `MPI_T_PVAR_HANDLE_FREE` to free the handle in the session identified by the parameter `session` and the associated resources in the MPI implementation. On a successful return, MPI sets the handle to `MPI_T_PVAR_HANDLE_NULL`.

Starting and Stopping of Performance Variables

Performance variables that have the continuous flag set during the query operation are continuously operating once a handle has been allocated. Such variables may be queried at any time, but they cannot be started or stopped by the user. All other variables are in a stopped state after their handle has been allocated; their values are not updated until they have been started by the user.

`MPI_T_PVAR_START(session, handle)`

IN	<code>session</code>	identifier of performance experiment session (handle)
IN	<code>handle</code>	handle of a performance variable (handle)

`int MPI_T_pvar_start(MPI_T_pvar_session session, MPI_T_pvar_handle handle)`

This function starts the performance variable with the handle identified by the parameter `handle` in the session identified by the parameter `session`.

If the constant `MPI_T_PVAR_ALL_HANDLES` is passed in `handle`, the MPI implementation attempts to start all variables within the session identified by the parameter `session` for which handles have been allocated. In this case, the routine returns `MPI_SUCCESS` if all variables are started successfully (even if there are no non-continuous variables to be started), otherwise `MPI_T_ERR_PVAR_NO_STARTSTOP` is returned. Continuous variables and variables that are already started are ignored when `MPI_T_PVAR_ALL_HANDLES` is specified.

`MPI_T_PVAR_STOP(session, handle)`

IN	<code>session</code>	identifier of performance experiment session (handle)
IN	<code>handle</code>	handle of a performance variable (handle)

`int MPI_T_pvar_stop(MPI_T_pvar_session session, MPI_T_pvar_handle handle)`

This function stops the performance variable with the handle identified by the parameter `handle` in the session identified by the parameter `session`.

If the constant `MPI_T_PVAR_ALL_HANDLES` is passed in `handle`, the MPI implementation attempts to stop all variables within the session identified by the parameter `session` for which handles have been allocated. In this case, the routine returns `MPI_SUCCESS` if all variables are stopped successfully (even if there are no non-continuous variables to be stopped), otherwise `MPI_T_ERR_PVAR_NO_STARTSTOP` is returned. Continuous variables and variables that are already stopped are ignored when `MPI_T_PVAR_ALL_HANDLES` is specified.

1 Performance Variable Access Functions

2
3
4 MPI_T_PVAR_READ(session, handle, buf)

5
6 IN session identifier of performance experiment session (handle)
7 IN handle handle of a performance variable (handle)
8 OUT buf initial address of storage location for variable value
9 (choice)
10

11
12 `int MPI_T_pvar_read(MPI_T_pvar_session session, MPI_T_pvar_handle handle,`
13 `void* buf)`

14 The MPI_T_PVAR_READ call queries the value of the performance variable with the
15 handle `handle` in the session identified by the parameter `session` and stores the result in the
16 buffer identified by the parameter `buf`. The user is responsible to ensure that the buffer
17 is of the appropriate size to hold the entire value of the performance variable (based on
18 the datatype and count returned by the corresponding previous calls to
19 MPI_T_PVAR_GET_INFO and MPI_T_PVAR_HANDLE_ALLOC, respectively).

20 The constant MPI_T_PVAR_ALL_HANDLES cannot be used as an argument for the func-
21 tion MPI_T_PVAR_READ.
22

23
24 MPI_T_PVAR_WRITE(session,handle, buf)

25 IN session identifier of performance experiment session (handle)
26 IN handle handle of a performance variable (handle)
27 IN buf initial address of storage location for variable value
28 (choice)
29

30
31 `int MPI_T_pvar_write(MPI_T_pvar_session session, MPI_T_pvar_handle handle,`
32 `const void* buf)`

33 The MPI_T_PVAR_WRITE call attempts to write the value of the performance variable
34 with the handle identified by the parameter `handle` in the session identified by the parameter
35 `session`. The value to be written is passed in the buffer identified by the parameter
36 `buf`. The user must ensure that the buffer is of the appropriate size to hold the entire value of the per-
37 formance variable (based on the datatype and count returned by the corresponding previous
38 calls to MPI_T_PVAR_GET_INFO and MPI_T_PVAR_HANDLE_ALLOC, respectively).
39

40 If it is not possible to change the variable, the function returns
41 MPI_T_ERR_PVAR_NO_WRITE.

42 The constant MPI_T_PVAR_ALL_HANDLES cannot be used as an argument for the func-
43 tion MPI_T_PVAR_WRITE.
44
45
46
47
48

MPI_T_PVAR_RESET(session, handle) 1

IN session identifier of performance experiment session (handle) 2

IN handle handle of a performance variable (handle) 3

int MPI_T_pvar_reset(MPI_T_pvar_session session, MPI_T_pvar_handle handle) 4

The MPI_T_PVAR_RESET call sets the performance variable with the handle identified by the parameter handle to its starting value specified in Section 14.3.7. If it is not possible to change the variable, the function returns MPI_T_ERR_PVAR_NO_WRITE. 5

If the constant MPI_T_PVAR_ALL_HANDLES is passed in handle, the MPI implementation attempts to reset all variables within the session identified by the parameter session for which handles have been allocated. In this case, the routine returns MPI_SUCCESS if all variables are reset successfully (even if there are no valid handles or all are read-only), otherwise MPI_T_ERR_PVAR_NO_WRITE is returned. Read-only variables are ignored when MPI_T_PVAR_ALL_HANDLES is specified. 6

MPI_T_PVAR_READRESET(session, handle, buf) 7

IN session identifier of performance experiment session (handle) 8

IN handle handle of a performance variable (handle) 9

OUT buf initial address of storage location for variable value (choice) 10

int MPI_T_pvar_readreset(MPI_T_pvar_session session,
MPI_T_pvar_handle handle, void* buf) 11

This call atomically combines the functionality of MPI_T_PVAR_READ and MPI_T_PVAR_RESET with the same semantics as if these two calls were called separately. If atomic operations on this variable are not supported, this routine returns MPI_T_ERR_PVAR_NO_ATOMIC. 12

The constant MPI_T_PVAR_ALL_HANDLES cannot be used as an argument for the function MPI_T_PVAR_READRESET. 13

Advice to implementors. Sampling-based tools rely on the ability to call the MPI tool information interface, in particular routines to start, stop, read, write, and reset performance variables, from any program context, including asynchronous contexts such as signal handlers. MPI implementations should strive, if possible in their particular environment, to enable these usage scenarios for all or a subset of the routines mentioned above. If implementing only a subset, the read, write, and reset routines are typically the most critical for sampling based tools. An MPI implementation should clearly document any restrictions on the program contexts in which the MPI tool information interface can be used. Restrictions might include guaranteeing usage outside of all signals or outside a specific set of signals. Any restrictions could be documented, for example, through the description returned by MPI_T_PVAR_GET_INFO. (*End of advice to implementors.*) 14

Rationale. All routines to read, to write or to reset performance variables require the session argument. This requirement keeps the interface consistent and allows the use 15

1 of MPI_T_PVAR_ALL_HANDLES where appropriate. Further, this opens up additional
 2 performance optimizations for the implementation of handles. (*End of rationale.*)
 3

4 Example: Tool to Detect Receives with Long Unexpected Message Queues
 5

6 **Example 14.6**

7 The following example shows a sample tool to identify receive operations that occur
 8 during times with long message queues. This examples assumes that the MPI implementa-
 9 tion exports a variable with the name “MPI_T_UMQ_LENGTH” to represent the current length
 10 of the unexpected message queue. The tool is implemented as a PMPI tool using the MPI
 11 profiling interface.
 12

13 The tool consists of three parts: (1) the initialization (by intercepting the call to
 14 MPI_INIT), (2) the test for long unexpected message queues (by intercepting calls to
 15 MPI_RECV), and (3) the clean-up phase (by intercepting the call to MPI_FINALIZE). To
 16 capture all receives, the example would have to be extended to have similar wrappers for
 17 all receive operations.
 18

19 **Part 1 — Initialization:** During initialization, the tool searches for the variable and, once
 20 the right index is found, allocates a session and a handle for the variable with the found
 21 index, and starts the performance variable.
 22

```

23 #include <stdio.h>
24 #include <stdlib.h>
25 #include <string.h>
26 #include <assert.h>
27 #include <mpi.h>
28
29 /* Global variables for the tool */
30 static MPI_T_pvar_session session;
31 static MPI_T_pvar_handle handle;
32
33 int MPI_Init(int *argc, char ***argv ) {
34     int err, num, i, index, namelen, verbosity;
35     int var_class, bind, threadsup;
36     int readonly, continuous, atomic, count;
37     char name[18];
38     MPI_Comm comm;
39     MPI_Datatype datatype;
40     MPI_T_enum enumtype;
41
42     err=PMPI_Init(argc,argv);
43     if (err!=MPI_SUCCESS) return err;
44
45     err=PMPI_T_init_thread(MPI_THREAD_SINGLE,&threadsup);
46     if (err!=MPI_SUCCESS) return err;
47
48     err=PMPI_T_pvar_get_num(&num);

```

```

if (err!=MPI_SUCCESS) return err;      1
index=-1;                               2
i=0;                                     3
while ((i<num) && (index<0) && (err==MPI_SUCCESS)) { 4
    /* Pass a buffer that is at least one character longer than */ 5
    /* the name of the variable being searched for to avoid */ 6
    /* finding variables that have a name that has a prefix */ 7
    /* equal to the name of the variable being searched. */ 8
    namelen=18;                           9
    err=PMPI_T_pvar_get_info(i, name, &namelen, &verbosity, 10
        &var_class, &datatype, &enumtype, NULL, NULL, &bind, 11
        &readonly, &continuous, &atomic); 12
    if (strcmp(name,"MPI_T_UMQ_LENGTH")==0) index=i; 13
    i++; } 14
if (err!=MPI_SUCCESS) return err;      15
                                        16

/* this could be handled in a more flexible way for a generic tool */ 17
assert(index>=0);                       18
assert(var_class==MPI_T_PVAR_CLASS_LEVEL); 19
assert(datatype==MPI_INT);              20
assert(bind==MPI_T_BIND_MPI_COMM);     21
                                        22

/* Create a session */                  23
err=PMPI_T_pvar_session_create(&session); 24
if (err!=MPI_SUCCESS) return err;      25
                                        26

/* Get a handle and bind to MPI_COMM_WORLD */ 27
comm=MPI_COMM_WORLD;                   28
err=PMPI_T_pvar_handle_alloc(session, index, &comm, &handle, &count); 29
if (err!=MPI_SUCCESS) return err;      30
                                        31

/* this could be handled in a more flexible way for a generic tool */ 32
assert(count==1);                       33
                                        34

/* Start variable */                   35
err=PMPI_T_pvar_start(session, handle); 36
if (err!=MPI_SUCCESS) return err;      37
                                        38

return MPI_SUCCESS;                    39
}                                       40
                                        41

```

Part 2 — Testing the Queue Lengths During Receives: During every receive operation, the tool reads the unexpected queue length through the matching performance variable and compares it against a predefined threshold.

```
#define THRESHOLD 5
```

```
int MPI_Recv(void *buf, int count, MPI_Datatype datatype, int source,
```

```

1         int tag, MPI_Comm comm, MPI_Status *status)
2     {
3         int value, err;
4
5         if (comm==MPI_COMM_WORLD) {
6             err=PMPI_T_pvar_read(session, handle, &value);
7             if ((err==MPI_SUCCESS) && (value>THRESHOLD))
8                 {
9                     /* tool identified receive called with long UMQ */
10                    /* execute tool functionality, */
11                    /* e.g., gather and print call stack */
12                }
13        }
14
15        return PMPI_Recv(buf, count, datatype, source, tag, comm, status);
16    }
17

```

18 Part 3 — Termination: In the wrapper for MPI_FINALIZE, the MPI tool information inter-
19 face is finalized.

```

20
21 int MPI_Finalize(void)
22 {
23     int err;
24     err=PMPI_T_pvar_handle_free(session, &handle);
25     err=PMPI_T_pvar_session_free(&session);
26     err=PMPI_T_finalize();
27     return PMPI_Finalize();
28 }
29

```

30 14.3.8 Variable Categorization

31 MPI implementations can optionally group performance and control variables into categories
32 to express logical relationships between various variables. For example, an MPI implemen-
33 tation could group all control and performance variables that refer to message transfers in
34 the MPI implementation and thereby distinguish them from variables that refer to local
35 resources such as memory allocations or other interactions with the operating system.
36

37 Categories can also contain other categories to form a hierarchical grouping. Categories
38 can never include themselves, either directly or transitively within other included categories.
39 Expanding on the example above, this allows MPI to refine the grouping of variables referring
40 to message transfers into variables to control and to monitor message queues, message
41 matching activities and communication protocols. Each of these groups of variables would
42 be represented by a separate category and these categories would then be listed in a single
43 category representing variables for message transfers.

44 The category information may be queried in a fashion similar to the mechanism for
45 querying variable information. The MPI implementation exports a set of N categories via
46 the MPI tool information interface. If $N = 0$, then the MPI implementation does not export
47 any categories, otherwise the provided categories are indexed from 0 to $N - 1$. This index
48

number is used in subsequent calls to functions of the MPI tool information interface to identify the individual categories.

An MPI implementation is permitted to increase the number of categories during the execution of an MPI program when new categories become available through dynamic loading. However, MPI implementations are not allowed to change the index of a category or delete it once it has been added to the set.

Similarly, MPI implementations are allowed to add variables to categories, but they are not allowed to remove variables from categories or change the order in which they are returned.

Category Query Functions

The following function can be used to query the number of categories, N .

`MPI_T_CATEGORY_GET_NUM(num_cat)`

OUT	num_cat	current number of categories (integer)
-----	---------	--

```
int MPI_T_category_get_num(int *num_cat)
```

Individual category information can then be queried by calling the following function:

`MPI_T_CATEGORY_GET_INFO(cat_index, name, name_len, desc, desc_len, num_cvars, num_pvars, num_categories)`

IN	cat_index	index of the category to be queried (integer)
OUT	name	buffer to return the string containing the name of the category (string)
INOUT	name_len	length of the string and/or buffer for name (integer)
OUT	desc	buffer to return the string containing the description of the category (string)
INOUT	desc_len	length of the string and/or buffer for desc (integer)
OUT	num_cvars	number of control variables in the category (integer)
OUT	num_pvars	number of performance variables in the category (integer)
OUT	num_categories	number of categories contained in the category (integer)

```
int MPI_T_category_get_info(int cat_index, char *name, int *name_len,
                           char *desc, int *desc_len, int *num_cvars, int *num_pvars,
                           int *num_categories)
```

The arguments `name` and `name_len` are used to return the name of the category as described in Section 14.3.3.

The routine is required to return a name of at least length one. This name must be unique with respect to all other names for categories used by the MPI implementation.

1 If any OUT parameter to `MPI_T_CATEGORY_GET_INFO` is a NULL pointer, the im-
 2 plementation will ignore the parameter and not return a value for the parameter.

3 The arguments `desc` and `desc_len` are used to return the description of the category as
 4 described in Section 14.3.3.

5 Returning a description is optional. If an MPI implementation decides not to return a
 6 description, the first character for `desc` must be set to the null character and `desc_len` must
 7 be set to one at the return of this call.

8 The function returns the number of control variables, performance variables and other
 9 categories contained in the queried category in the arguments `num_cvars`, `num_pvars`, and
 10 `num_categories`, respectively.

11 If the name of a category is equivalent across connected MPI processes, then the re-
 12 turned description must be equivalent.

14 `MPI_T_CATEGORY_GET_INDEX(name, cat_index)`

16	IN	<code>name</code>	the name of the category (string)
17	OUT	<code>cat_index</code>	the index of the category (integer)

19
 20 `int MPI_T_category_get_index(const char *name, int *cat_index)`

21 `MPI_T_CATEGORY_GET_INDEX` is a function for retrieving the index of a category
 22 given a known category name. The `name` parameter is provided by the caller, and `cat_index`
 23 is returned by the MPI implementation. The `name` parameter is a string terminated with a
 24 null character.

25 This routine returns `MPI_SUCCESS` on success and returns `MPI_T_ERR_INVALID_NAME`
 26 if `name` does not match the name of any category provided by the implementation at the
 27 time of the call.

29 *Rationale.* This routine is provided to enable fast retrieval of a category index
 30 by a tool, assuming it knows the name of the category for which it is looking. The
 31 number of categories exposed by the implementation can change over time, so it is not
 32 possible for the tool to simply iterate over the list of categories once at initialization.
 33 Although using MPI implementation specific category names is not portable across
 34 MPI implementations, tool developers may choose to take this route for lower overhead
 35 at runtime because the tool will not have to iterate over the entire set of categories
 36 to find a specific one. (*End of rationale.*)

Category Member Query Functions

MPI_T_CATEGORY_GET_CVARS(*cat_index*, *len*, *indices*)

IN	<i>cat_index</i>	index of the category to be queried, in the range $[0, N-1]$ (integer)
IN	<i>len</i>	the length of the indices array (integer)
OUT	<i>indices</i>	an integer array of size <i>len</i> , indicating control variable indices (array of integers)

```
int MPI_T_category_get_cvars(int cat_index, int len, int indices[])
```

MPI_T_CATEGORY_GET_CVARS can be used to query which control variables are contained in a particular category. A category contains zero or more control variables.

MPI_T_CATEGORY_GET_PVARS(*cat_index*, *len*, *indices*)

IN	<i>cat_index</i>	index of the category to be queried, in the range $[0, N-1]$ (integer)
IN	<i>len</i>	the length of the indices array (integer)
OUT	<i>indices</i>	an integer array of size <i>len</i> , indicating performance variable indices (array of integers)

```
int MPI_T_category_get_pvars(int cat_index, int len, int indices[])
```

MPI_T_CATEGORY_GET_PVARS can be used to query which performance variables are contained in a particular category. A category contains zero or more performance variables.

MPI_T_CATEGORY_GET_CATEGORIES(*cat_index*, *len*, *indices*)

IN	<i>cat_index</i>	index of the category to be queried, in the range $[0, N-1]$ (integer)
IN	<i>len</i>	the length of the indices array (integer)
OUT	<i>indices</i>	an integer array of size <i>len</i> , indicating category indices (array of integers)

```
int MPI_T_category_get_categories(int cat_index, int len, int indices[])
```

MPI_T_CATEGORY_GET_CATEGORIES can be used to query which other categories are contained in a particular category. A category contains zero or more other categories.

As mentioned above, MPI implementations can grow the number of categories as well as the number of variables or other categories within a category. In order to allow users of the MPI tool information interface to check quickly whether new categories have been added or new variables or categories have been added to a category, MPI maintains a

1 virtual timestamp. This timestamp is monotonically increasing during the execution and is
 2 returned by the following function:

3
 4
 5 `MPI_T_CATEGORY_CHANGED(stamp)`

6 OUT stamp a virtual time stamp to indicate the last change to the
 7 categories (integer)

8
 9 `int MPI_T_category_changed(int *stamp)`
 10

11 If two subsequent calls to this routine return the same timestamp, it is guaranteed that
 12 the category information has not changed between the two calls. If the timestamp retrieved
 13 from the second call is higher, then some categories have been added or expanded.

14 *Advice to users.* The timestamp value is purely virtual and only intended to check
 15 for changes in the category information. It should not be used for any other purpose.
 16 (*End of advice to users.*)
 17

18 The index values returned in indices by `MPI_T_CATEGORY_GET_CVARS`,
 19 `MPI_T_CATEGORY_GET_PVARS` and `MPI_T_CATEGORY_GET_CATEGORIES` can be used
 20 as input to `MPI_T_CVAR_GET_INFO`, `MPI_T_PVAR_GET_INFO` and
 21 `MPI_T_CATEGORY_GET_INFO`, respectively.

22 The user is responsible for allocating the arrays passed into the functions
 23 `MPI_T_CATEGORY_GET_CVARS`, `MPI_T_CATEGORY_GET_PVARS` and
 24 `MPI_T_CATEGORY_GET_CATEGORIES`. Starting from array index 0, each function writes
 25 up to `len` elements into the array. If the category contains more than `len` elements, the
 26 function returns an arbitrary subset of size `len`. Otherwise, the entire set of elements is
 27 returned in the beginning entries of the array, and any remaining array entries are not
 28 modified.
 29

30 14.3.9 Return Codes for the MPI Tool Information Interface

31
 32 All functions defined as part of the MPI tool information interface return an integer error
 33 code (see Table 14.5) to indicate whether the function was completed successfully or was
 34 aborted. In the latter case the error code indicates the reason for not completing the routine.
 35 Such errors neither impact the execution of the MPI process nor invoke MPI error handlers.
 36 The MPI process continues executing regardless of the return code from the call. The MPI
 37 implementation is not required to check all user-provided parameters; if a user passes invalid
 38 parameter values to any routine the behavior of the implementation is undefined.

39 All error codes with the prefix `MPI_T_` must be unique values and cannot overlap with
 40 any other error codes or error classes returned by the MPI implementation. Further, they
 41 shall be treated as MPI error classes as defined in Section 8.4 and follow the same rules and
 42 restrictions. In particular, they must satisfy:

$$43 \quad 0 = \text{MPI_SUCCESS} < \text{MPI_T_ERR_XXX} \leq \text{MPI_ERR_LASTCODE}.$$

44
 45 *Rationale.* All MPI tool information interface functions must return error classes, be-
 46 cause applications cannot portably call `MPI_ERROR_CLASS` before MPI initialization
 47 to map an arbitrary error code to an error class. (*End of rationale.*)
 48

14.3.10 Profiling Interface

All requirements for the profiling interfaces, as described in Section 14.2, also apply to the MPI tool information interface. All rules, guidelines, and recommendations from Section 14.2 apply equally to calls defined as part of the MPI tool information interface.

1
2
3
4
5
6
7
8
9
10
11
12
13
14
15
16
17
18
19
20
21
22
23
24
25
26
27
28
29
30
31
32
33
34
35
36
37
38
39
40
41
42
43
44
45
46
47
48

Return Code	Description
Return Codes for All Functions in the MPI Tool Information Interface	
MPI_SUCCESS	Call completed successfully
MPI_T_ERR_INVALID	Invalid use of the interface or bad parameter values(s)
MPI_T_ERR_MEMORY	Out of memory
MPI_T_ERR_NOT_INITIALIZED	Interface not initialized
MPI_T_ERR_CANNOT_INIT	Interface not in the state to be initialized
Return Codes for Datatype Functions: MPI_T_ENUM_*	
MPI_T_ERR_INVALID_INDEX	The enumeration index is invalid
MPI_T_ERR_INVALID_ITEM	The item index queried is out of range (for MPI_T_ENUM_GET_ITEM only); This error code is deprecated in MPI-3.2 and superseded by MPI_T_ERR_INVALID_INDEX
Return Codes for Variable and Category Query Functions: MPI_T_*_GET_*	
MPI_T_ERR_INVALID_INDEX	The variable or category index is invalid
MPI_T_ERR_INVALID_NAME	The variable or category name is invalid
Return Codes for Handle Functions: MPI_T_*_{ALLOC FREE}	
MPI_T_ERR_INVALID_INDEX	The variable index is invalid
MPI_T_ERR_INVALID_HANDLE	The handle is invalid
MPI_T_ERR_OUT_OF_HANDLES	No more handles available
Return Codes for Session Functions: MPI_T_PVAR_SESSION_*	
MPI_T_ERR_OUT_OF_SESSIONS	No more sessions available
MPI_T_ERR_INVALID_SESSION	Session argument is not a valid session
Return Codes for Control Variable Access Functions:	
MPI_T_CVAR_READ, WRITE	
MPI_T_ERR_CVAR_SET_NOT_NOW	Variable cannot be set at this moment
MPI_T_ERR_CVAR_SET_NEVER	Variable cannot be set until end of execution
MPI_T_ERR_INVALID_HANDLE	The handle is invalid
Return Codes for Performance Variable Access and Control:	
MPI_T_PVAR_{START STOP READ WRITE RESET READREST}	
MPI_T_ERR_INVALID_HANDLE	The handle is invalid
MPI_T_ERR_INVALID_SESSION	Session argument is not a valid session
MPI_T_ERR_PVAR_NO_STARTSTOP	Variable cannot be started or stopped (for MPI_T_PVAR_START and MPI_T_PVAR_STOP)
MPI_T_ERR_PVAR_NO_WRITE	Variable cannot be written or reset (for MPI_T_PVAR_WRITE and MPI_T_PVAR_RESET)
MPI_T_ERR_PVAR_NO_ATOMIC	Variable cannot be read and written atomically (for MPI_T_PVAR_READRESET)
Return Codes for Category Functions: MPI_T_CATEGORY_*	
MPI_T_ERR_INVALID_INDEX	The category index is invalid

Table 14.5: Return codes used in functions of the MPI tool information interface

Chapter 15

Deprecated Interfaces

15.1 Deprecated since MPI-2.0

The following function is deprecated and is superseded by `MPI_COMM_CREATE_KEYVAL` in MPI-2.0. The language independent definition of the deprecated function is the same as that of the new function, except for the function name and a different behavior in the C/Fortran language interoperability, see Section 18.2.7. The language bindings are modified.

`MPI_KEYVAL_CREATE(copy_fn, delete_fn, keyval, extra_state)`

IN	<code>copy_fn</code>	Copy callback function for <code>keyval</code>
IN	<code>delete_fn</code>	Delete callback function for <code>keyval</code>
OUT	<code>keyval</code>	key value for future access (integer)
IN	<code>extra_state</code>	Extra state for callback functions

```
int MPI_Keyval_create(MPI_Copy_function *copy_fn,  
                    MPI_Delete_function *delete_fn, int *keyval,  
                    void* extra_state)
```

For this routine, an interface within the `mpi_f08` module was never defined.

```
MPI_KEYVAL_CREATE(COPY_FN, DELETE_FN, KEYVAL, EXTRA_STATE, IERROR)  
EXTERNAL COPY_FN, DELETE_FN  
INTEGER KEYVAL, EXTRA_STATE, IERROR
```

The `copy_fn` function is invoked when a communicator is duplicated by `MPI_COMM_DUP`. `copy_fn` should be of type `MPI_Copy_function`, which is defined as follows:

```
typedef int MPI_Copy_function(MPI_Comm oldcomm, int keyval,  
                             void *extra_state, void *attribute_val_in,  
                             void *attribute_val_out, int *flag)
```

A Fortran declaration for such a function is as follows:

For this routine, an interface within the `mpi_f08` module was never defined.

```

1  SUBROUTINE COPY_FUNCTION(OLDCOMM, KEYVAL, EXTRA_STATE, ATTRIBUTE_VAL_IN,
2      ATTRIBUTE_VAL_OUT, FLAG, IERR)
3      INTEGER OLDCOMM, KEYVAL, EXTRA_STATE, ATTRIBUTE_VAL_IN,
4      ATTRIBUTE_VAL_OUT, IERR
5      LOGICAL FLAG

```

6 `copy_fn` may be specified as `MPI_NULL_COPY_FN` or `MPI_DUP_FN` from either C or FORTRAN; `MPI_NULL_COPY_FN` is a function that does nothing other than returning `flag = 0` and `MPI_SUCCESS`. `MPI_DUP_FN` is a simple-minded copy function that sets `flag = 1`, returns the value of `attribute_val_in` in `attribute_val_out`, and returns `MPI_SUCCESS`. Note that `MPI_NULL_COPY_FN` and `MPI_DUP_FN` are also deprecated.

7 Analogous to `copy_fn` is a callback deletion function, defined as follows. The `delete_fn` function is invoked when a communicator is deleted by `MPI_COMM_FREE` or when a call is made explicitly to `MPI_ATTR_DELETE`. `delete_fn` should be of type `MPI_Delete_function`, which is defined as follows:

```

16  typedef int MPI_Delete_function(MPI_Comm comm, int keyval,
17      void *attribute_val, void *extra_state);
18

```

19 A Fortran declaration for such a function is as follows:
20 For this routine, an interface within the `mpi_f08` module was never defined.

```

22  SUBROUTINE DELETE_FUNCTION(COMM, KEYVAL, ATTRIBUTE_VAL, EXTRA_STATE, IERR)
23      INTEGER COMM, KEYVAL, ATTRIBUTE_VAL, EXTRA_STATE, IERR

```

24 `delete_fn` may be specified as `MPI_NULL_DELETE_FN` from either C or FORTRAN; `MPI_NULL_DELETE_FN` is a function that does nothing, other than returning `MPI_SUCCESS`. Note that `MPI_NULL_DELETE_FN` is also deprecated.

25 The following function is deprecated and is superseded by `MPI_COMM_FREE_KEYVAL` in MPI-2.0. The language independent definition of the deprecated function is the same as of the new function, except of the function name. The language bindings are modified.

```

32  MPI_KEYVAL_FREE(keyval)
33      INOUT    keyval                Frees the integer key value (integer)

```

```

36  int MPI_Keyval_free(int *keyval)

```

37 For this routine, an interface within the `mpi_f08` module was never defined.

```

39  MPI_KEYVAL_FREE(KEYVAL, IERROR)
40      INTEGER KEYVAL, IERROR

```

41 The following function is deprecated and is superseded by `MPI_COMM_SET_ATTR` in MPI-2.0. The language independent definition of the deprecated function is the same as of the new function, except of the function name. The language bindings are modified.

MPI_ATTR_PUT(comm, keyval, attribute_val) 1

INOUT	comm	communicator to which attribute will be attached (handle)	2
			3
IN	keyval	key value, as returned by MPI_KEYVAL_CREATE (integer)	4
			5
IN	attribute_val	attribute value	6
			7
			8

```
int MPI_Attr_put(MPI_Comm comm, int keyval, void* attribute_val)
```

For this routine, an interface within the `mpi_f08` module was never defined.

```
MPI_ATTR_PUT(COMM, KEYVAL, ATTRIBUTE_VAL, IERROR)
    INTEGER COMM, KEYVAL, ATTRIBUTE_VAL, IERROR
```

The following function is deprecated and is superseded by `MPI_COMM_GET_ATTR` in MPI-2.0. The language independent definition of the deprecated function is the same as of the new function, except of the function name. The language bindings are modified.

MPI_ATTR_GET(comm, keyval, attribute_val, flag)

IN	comm	communicator to which attribute is attached (handle)	21
IN	keyval	key value (integer)	22
OUT	attribute_val	attribute value, unless <code>flag = false</code>	23
			24
OUT	flag	true if an attribute value was extracted; false if no attribute is associated with the key	25
			26

```
int MPI_Attr_get(MPI_Comm comm, int keyval, void *attribute_val, int *flag)
```

For this routine, an interface within the `mpi_f08` module was never defined.

```
MPI_ATTR_GET(COMM, KEYVAL, ATTRIBUTE_VAL, FLAG, IERROR)
    INTEGER COMM, KEYVAL, ATTRIBUTE_VAL, IERROR
    LOGICAL FLAG
```

The following function is deprecated and is superseded by `MPI_COMM_DELETE_ATTR` in MPI-2.0. The language independent definition of the deprecated function is the same as of the new function, except of the function name. The language bindings are modified.

MPI_ATTR_DELETE(comm, keyval)

INOUT	comm	communicator to which attribute is attached (handle)	41
IN	keyval	The key value of the deleted attribute (integer)	42

```
int MPI_Attr_delete(MPI_Comm comm, int keyval)
```

For this routine, an interface within the `mpi_f08` module was never defined.

```
MPI_ATTR_DELETE(COMM, KEYVAL, IERROR)
```

1 INTEGER COMM, KEYVAL, IERROR
2
3

4 15.2 Deprecated since MPI-2.2

5
6 The entire set of C++ language bindings have been removed. See Chapter 16, [Removed Interfaces](#) for more information.
7

8 The following function typedefs have been deprecated and are superseded by new
9 names. Other than the typedef names, the function signatures are exactly the same; the
10 names were updated to match conventions of other function typedef names.

	Deprecated Name	New Name
	<u>MPI_Comm_errhandler_fn</u>	<u>MPI_Comm_errhandler_function</u>
	<u>MPI_File_errhandler_fn</u>	<u>MPI_File_errhandler_function</u>
	<u>MPI_Win_errhandler_fn</u>	<u>MPI_Win_errhandler_function</u>

16 15.3 Deprecated since MPI-3.2

17
18
19 Cancelling a send request by calling MPI_CANCEL has been deprecated and may be removed
20 in a future version of the MPI specification.

21 The following return class has been deprecated and is superseded by a new name.

	Deprecated Name	Replacement Name
	<u>MPI_T_ERR_INVALID_ITEM</u>	<u>MPI_T_ERR_INVALID_INDEX</u>

1
2
3
4
5
6
7
8
9
10
11
12
13
14
15
16
17
18
19
20
21
22
23
24
25
26
27
28
29
30
31
32
33
34
35
36
37
38
39
40
41
42
43
44
45
46
47
48

Chapter 16

Removed Interfaces

16.1 Removed MPI-1 Bindings

16.1.1 Overview

The following MPI-1 bindings were deprecated as of MPI-2 and are removed in MPI-3. They may be provided by an implementation for backwards compatibility, but are not required. Removal of these bindings affects all language-specific definitions thereof. Only the language-neutral bindings are listed when possible.

16.1.2 Removed MPI-1 Functions

Table 16.1 shows the removed MPI-1 functions and their replacements.

Removed	MPI-2 Replacement
MPI_ADDRESS	MPI_GET_ADDRESS
MPI_ERRHANDLER_CREATE	MPI_COMM_CREATE_ERRHANDLER
MPI_ERRHANDLER_GET	MPI_COMM_GET_ERRHANDLER
MPI_ERRHANDLER_SET	MPI_COMM_SET_ERRHANDLER
MPI_TYPE_EXTENT	MPI_TYPE_GET_EXTENT
MPI_TYPE_HINDEXED	MPI_TYPE_CREATE_HINDEXED
MPI_TYPE_HVECTOR	MPI_TYPE_CREATE_HVECTOR
MPI_TYPE_LB	MPI_TYPE_GET_EXTENT
MPI_TYPE_STRUCT	MPI_TYPE_CREATE_STRUCT
MPI_TYPE_UB	MPI_TYPE_GET_EXTENT

Table 16.1: Removed MPI-1 functions and their replacements

16.1.3 Removed MPI-1 Datatypes

Table 16.2 shows the removed MPI-1 datatypes and their replacements.

16.1.4 Removed MPI-1 Constants

Table 16.3 shows the removed MPI-1 constants. There are no MPI-2 replacements.

Removed	MPI-2 Replacement
MPI_LB	MPI_TYPE_CREATE_RESIZED
MPI_UB	MPI_TYPE_CREATE_RESIZED

Table 16.2: Removed MPI-1 datatypes and their replacements

Removed MPI-1 Constants
C type: <code>const int</code> (or unnamed <code>enum</code>)
Fortran type: <code>INTEGER</code>
MPI_COMBINER_HINDEXED_INTEGER
MPI_COMBINER_HVECTOR_INTEGER
MPI_COMBINER_STRUCT_INTEGER

Table 16.3: Removed MPI-1 constants

16.1.5 Removed MPI-1 Callback Prototypes

Table 16.4 shows the removed MPI-1 callback prototypes and their MPI-2 replacements.

Removed	MPI-2 Replacement
MPI_Handler_function	MPI_Comm_errhandler_function

Table 16.4: Removed MPI-1 callback prototypes and their replacements

16.2 C++ Bindings

The C++ bindings were deprecated as of MPI-2.2. The C++ bindings are removed in MPI-3.0. The namespace is still reserved, however, and bindings may only be provided by an implementation as described in the MPI-2.2 standard.

1
2
3
4
5
6
7
8
9
10
11
12
13
14
15
16
17
18
19
20
21
22
23
24
25
26
27
28
29
30
31
32
33
34
35
36
37
38
39
40
41
42
43
44
45
46
47
48

Chapter 17

Backward Incompatibilities

17.1 Backward Incompatible since MPI-3.2

The default communicator where errors are raised when not involving a communicator, window, or file was changed from `MPI_COMM_WORLD` to `MPI_COMM_SELF`.

1
2
3
4
5
6
7
8
9
10
11
12
13
14
15
16
17
18
19
20
21
22
23
24
25
26
27
28
29
30
31
32
33
34
35
36
37
38
39
40
41
42
43
44
45
46
47
48

1
2
3
4
5
6
7
8
9
10
11
12
13
14
15
16
17
18
19
20
21
22
23
24
25
26
27
28
29
30
31
32
33
34
35
36
37
38
39
40
41
42
43
44
45
46
47
48

Chapter 18

Language Bindings

18.1 Fortran Support

18.1.1 Overview

The Fortran MPI language bindings have been designed to be compatible with the Fortran 90 standard with additional features from Fortran 2003 and Fortran 2008 [41] + TS 29113 [42].

Rationale. Fortran 90 contains numerous features designed to make it a more “modern” language than Fortran 77. It seems natural that MPI should be able to take advantage of these new features with a set of bindings tailored to Fortran 90. In Fortran 2008 + TS 29113, the major new language features used are the `ASYNCHRONOUS` attribute to protect nonblocking MPI operations, and assumed-type and assumed-rank dummy arguments for choice buffer arguments. Further requirements for compiler support are listed in Section 18.1.7. (*End of rationale.*)

MPI defines three methods of Fortran support:

1. **USE mpi_f08:** This method is described in Section 18.1.2. It requires compile-time argument checking with unique MPI handle types and provides techniques to fully solve the optimization problems with nonblocking calls. This is the only Fortran support method that is consistent with the Fortran standard (Fortran 2008 + TS 29113 and later). This method is highly recommended for all MPI applications.
2. **USE mpi:** This method is described in Section 18.1.3 and requires compile-time argument checking. Handles are defined as `INTEGER`. This Fortran support method is inconsistent with the Fortran standard, and its use is therefore not recommended. It exists only for backwards compatibility.
3. **INCLUDE 'mpif.h':** This method is described in Section 18.1.4. The use of the include file `mpif.h` is strongly discouraged starting with MPI-3.0, because this method neither guarantees compile-time argument checking nor provides sufficient techniques to solve the optimization problems with nonblocking calls, and is therefore inconsistent with the Fortran standard. It exists only for backwards compatibility with legacy MPI applications.

Compliant MPI-3 implementations providing a Fortran interface must provide one or both of the following:

- The `USE mpi_f08` Fortran support method.
- The `USE mpi` and `INCLUDE 'mpif.h'` Fortran support methods.

Section 18.1.6 describes restrictions if the compiler does not support all the needed features.

Application subroutines and functions may use either one of the modules or the `mpif.h` include file. An implementation may require the use of one of the modules to prevent type mismatch errors.

Advice to users. Users are advised to utilize one of the MPI modules even if `mpif.h` enforces type checking on a particular system. Using a module provides several potential advantages over using an include file; the `mpi_f08` module offers the most robust and complete Fortran support. (*End of advice to users.*)

In a single application, it must be possible to link together routines which `USE mpi_f08`, `USE mpi`, and `INCLUDE 'mpif.h'`.

The LOGICAL compile-time constant `MPI_SUBARRAYS_SUPPORTED` is set to `.TRUE.` if all buffer choice arguments are defined in explicit interfaces with assumed-type and assumed-rank [42]; otherwise it is set to `.FALSE.` The LOGICAL compile-time constant `MPI_ASYNC_PROTECTS_NONBLOCKING` is set to `.TRUE.` if the `ASYNCHRONOUS` attribute was added to the choice buffer arguments of all nonblocking interfaces **and** the underlying Fortran compiler supports the `ASYNCHRONOUS` attribute for MPI communication (as part of TS 29113), otherwise it is set to `.FALSE.` These constants exist for each Fortran support method, but not in the C header file. The values may be different for each Fortran support method. All other constants and the integer values of handles must be the same for each Fortran support method.

Section 18.1.2 through 18.1.4 define the Fortran support methods. The Fortran interfaces of each MPI routine are shorthands. Section 18.1.5 defines the corresponding full interface specification together with the specific procedure names and implications for the profiling interface. Section 18.1.6 the implementation of the MPI routines for different versions of the Fortran standard. Section 18.1.7 summarizes major requirements for valid MPI-3.0 implementations with Fortran support. Section 18.1.8 and Section 18.1.9 describe additional functionality that is part of the Fortran support. `MPI_F_SYNC_REG` is needed for one of the methods to prevent register optimization problems. A set of functions provides additional support for Fortran intrinsic numeric types, including parameterized types: `MPI_SIZEOF`, `MPI_TYPE_MATCH_SIZE`, `MPI_TYPE_CREATE_F90_INTEGER`, `MPI_TYPE_CREATE_F90_REAL` and `MPI_TYPE_CREATE_F90_COMPLEX`. In the context of MPI, parameterized types are Fortran intrinsic types which are specified using `KIND` type parameters. Sections 18.1.10 through 18.1.19 give an overview and details on known problems when using Fortran together with MPI; Section 18.1.20 compares the Fortran problems with those in C.

18.1.2 Fortran Support Through the `mpi_f08` Module

An MPI implementation providing a Fortran interface must provide a module named `mpi_f08` that can be used in a Fortran program. Section 18.1.6 describes restrictions if the compiler does not support all the needed features. Within all MPI function specifications, the first

of the set of two Fortran routine interface specifications is provided by this module. This module must:

- Define all named MPI constants.
- Declare MPI functions that return a value.
- Provide explicit interfaces according to the Fortran routine interface specifications. This module therefore guarantees compile-time argument checking for all arguments which are not `TYPE(*)`, with the following exception:

Only one Fortran interface is defined for functions that are deprecated as of MPI-3.0. This interface must be provided as an explicit interface according to the rules defined for the `mpi` module, see Section 18.1.3.

Advice to users. It is strongly recommended that developers substitute calls to deprecated routines when upgrading from `mpif.h` or the `mpi` module to the `mpi_f08` module. (*End of advice to users.*)

- Define the derived type `MPI_Status`, and define all MPI handles with uniquely named handle types (instead of `INTEGER` handles, as in the `mpi` module). This is reflected in the first Fortran binding in each MPI function definition throughout this document (except for the deprecated routines).
- Overload the operators `.EQ.` and `.NE.` to allow the comparison of these MPI handles with `.EQ.`, `.NE.`, `==` and `/=`.
- Use the `ASYNCHRONOUS` attribute to protect the buffers of nonblocking operations, and set the `LOGICAL` compile-time constant `MPI_ASYNC_PROTECTS_NONBLOCKING` to `.TRUE.` if the underlying Fortran compiler supports the `ASYNCHRONOUS` attribute for MPI communication (as part of TS 29113). See Section 18.1.6 for older compiler versions.
- Set the `LOGICAL` compile-time constant `MPI_SUBARRAYS_SUPPORTED` to `.TRUE.` and declare choice buffers using the Fortran 2008 TS 29113 features assumed-type and assumed-rank, i.e., `TYPE(*)`, `DIMENSION(..)` in all nonblocking, split collective and persistent communication routines, if the underlying Fortran compiler supports it. With this, non-contiguous sub-arrays can be used as buffers in nonblocking routines.

Rationale. In all blocking routines, i.e., if the choice-buffer is not declared as `ASYNCHRONOUS`, the TS 29113 feature is not needed for the support of non-contiguous buffers because the compiler can pass the buffer by in-and-out-copy through a contiguous scratch array. (*End of rationale.*)

- Set the `MPI_SUBARRAYS_SUPPORTED` compile-time constant to `.FALSE.` and declare choice buffers with a compiler-dependent mechanism that overrides type checking if the underlying Fortran compiler does not support the Fortran 2008 TS 29113 assumed-type and assumed-rank notation. In this case, the use of non-contiguous sub-arrays as buffers in nonblocking calls may be invalid. See Section 18.1.6 for details.
- Declare each argument with an `INTENT` of `IN`, `OUT`, or `INOUT` as defined in this standard.

1 *Rationale.* For these definitions in the `mpi_f08` bindings, in most cases, `INTENT(IN)`
 2 is used if the C interface uses call-by-value. For all buffer arguments and for `OUT` and
 3 `INOUT` dummy arguments that allow one of the non-ordinary Fortran constants (see
 4 `MPI_BOTTOM`, etc. in Section 2.5.4) as input, an `INTENT` is not specified. (*End of*
 5 *rationale.*)

6
 7 *Advice to users.* If a dummy argument is declared with `INTENT(OUT)`, then the
 8 Fortran standard stipulates that the actual argument becomes undefined upon invo-
 9 cation of the MPI routine, i.e., it may be overwritten by some other values, e.g. zeros;
 10 according to [41], 12.5.2.4 Ordinary dummy variables, Paragraph 17: “If a dummy
 11 argument has `INTENT(OUT)`, the actual argument becomes undefined at the time
 12 the association is established, except [...]”. For example, if the dummy argument is
 13 an assumed-size array and the actual argument is a strided array, the call may be im-
 14 plemented with copy-in and copy-out of the argument. In the case of `INTENT(OUT)` the
 15 copy-in may be suppressed by the optimization and the routine starts execution using
 16 an array of undefined values. If the routine stores fewer elements into the dummy
 17 argument than is provided in the actual argument, then the remaining locations are
 18 overwritten with these undefined values. See also both advices to implementors in
 19 Section 18.1.3. (*End of advice to users.*)

- 20
- 21 • Declare all `ierror` output arguments as `OPTIONAL`, except for user-defined callback
 22 functions (e.g., `COMM_COPY_ATTR_FUNCTION`) and predefined callbacks (e.g.,
 23 `MPI_COMM_NULL_COPY_FN`).

24
 25 *Rationale.* For user-defined callback functions (e.g., `COMM_COPY_ATTR_FUNCTION`) and
 26 their predefined callbacks (e.g., `MPI_COMM_NULL_COPY_FN`), the `ierror` argument
 27 is not optional. The MPI library must always call these routines with an actual `ierror`
 28 argument. Therefore, these user-defined functions need not check whether the MPI
 29 library calls these routines with or without an actual `ierror` output argument. (*End of*
 30 *rationale.*)

31
 32 The MPI Fortran bindings in the `mpi_f08` module are designed based on the Fortran
 33 2008 standard [41] together with the Technical Specification “TS 29113 Further Interoper-
 34 ability with C” [42] of the ISO/IEC JTC1/SC22/WG5 (Fortran) working group.

35
 36 *Rationale.* The features in TS 29113 on further interoperability with C were decided
 37 on by ISO/IEC JTC1/SC22/WG5 and designed by PL22.3 (formerly J3) to support a
 38 higher level of integration between Fortran-specific features and C than was provided
 39 in the Fortran 2008 standard; part of this design is based on requirements from the
 40 MPI Forum to support MPI-3.0. According to [42], “an ISO/IEC TS is reviewed after
 41 three years in order to decide whether it will be confirmed for a further three years,
 42 revised to become an International Standard, or withdrawn. If the ISO/IEC TS is
 43 confirmed, it is reviewed again after a further three years, at which time it must either
 44 be transformed into an International Standard or be withdrawn.”

45 The TS 29113 contains the following language features that are needed for the MPI
 46 bindings in the `mpi_f08` module: assumed-type and assumed-rank. It is important
 47 that any possible actual argument can be used for such dummy arguments, e.g.,
 48 scalars, arrays, assumed-shape arrays, assumed-size arrays, allocatable arrays, and

with any element type, e.g., `REAL`, `CHARACTER*5`, `CHARACTER*(*)`, sequence derived types, or `BIND(C)` derived types. Especially for backward compatibility reasons, it is important that any possible actual argument in an implicit interface implementation of a choice buffer dummy argument (e.g., with `mpif.h` without argument-checking) can be used in an implementation with assumed-type and assumed-rank argument in an explicit interface (e.g., with the `mpi_f08` module).

A further feature useful for MPI is the extension of the semantics of the `ASYNCHRONOUS` attribute: In F2003 and F2008, this attribute could be used only to protect buffers of Fortran asynchronous I/O. With TS 29113, this attribute now also covers asynchronous communication occurring within library routines written in C.

The MPI Forum hereby wishes to acknowledge this important effort by the Fortran PL22.3 and WG5 committee. (*End of rationale.*)

18.1.3 Fortran Support Through the `mpi` Module

An MPI implementation providing a Fortran interface must provide a module named `mpi` that can be used in a Fortran program. Within all MPI function specifications, the second of the set of two Fortran routine interface specifications is provided by this module. This module must:

- Define all named MPI constants
- Declare MPI functions that return a value.
- Provide explicit interfaces according to the Fortran routine interface specifications. This module therefore guarantees compile-time argument checking and allows positional and keyword-based argument lists. If an implementation is paired with a compiler that either does not support `TYPE(*)`, `DIMENSION(..)` from TS 29113, or is otherwise unable to ignore the types of choice buffers, then the implementation must provide explicit interfaces only for MPI routines with no choice buffer arguments. See Section 18.1.6 for more details.
- Define all MPI handles as type `INTEGER`.
- Define the derived type `MPI_Status` and all named handle types that are used in the `mpi_f08` module. For these named handle types, overload the operators `.EQ.` and `.NE.` to allow handle comparison via the `.EQ.`, `.NE.`, `==` and `/=` operators.

Rationale. They are needed only when the application converts old-style `INTEGER` handles into new-style handles with a named type. (*End of rationale.*)
- A high quality MPI implementation may enhance the interface by using the `ASYNCHRONOUS` attribute in the same way as in the `mpi_f08` module if it is supported by the underlying compiler.
- Set the `LOGICAL` compile-time constant `MPI_ASYNC_PROTECTS_NONBLOCKING` to `.TRUE.` if the `ASYNCHRONOUS` attribute is used in all nonblocking interfaces **and** the underlying Fortran compiler supports the `ASYNCHRONOUS` attribute for MPI communication (as part of TS 29113), otherwise to `.FALSE..`

Advice to users. For an MPI implementation that fully supports nonblocking calls with the `ASYNCHRONOUS` attribute for choice buffers, an existing MPI-2.2 application may fail to compile even if it compiled and executed with expected results with an MPI-2.2 implementation. One reason may be that the application uses “contiguous” but not “simply contiguous” `ASYNCHRONOUS` arrays as actual arguments for choice buffers of nonblocking routines, e.g., by using subscript triplets with stride one or specifying `(1:n)` for a whole dimension instead of using `(:)`. This should be fixed to fulfill the Fortran constraints for `ASYNCHRONOUS` dummy arguments. This is not considered a violation of backward compatibility because existing applications can not use the `ASYNCHRONOUS` attribute to protect nonblocking calls. Another reason may be that the application does not conform either to MPI-2.2, or to MPI-3.0, or to the Fortran standard, typically because the program forces the compiler to perform copy-in/out for a choice buffer argument in a nonblocking MPI call. This is also not a violation of backward compatibility because the application itself is non-conforming. See Section 18.1.12 for more details. (*End of advice to users.*)

- A high quality MPI implementation may enhance the interface by using `TYPE(*)`, `DIMENSION(..)` choice buffer dummy arguments instead of using non-standardized extensions such as `!$PRAGMA IGNORE_TKR` or a set of overloaded functions as described by M. Hennecke in [29], if the compiler supports this TS 29113 language feature. See Section 18.1.6 for further details.
- Set the `LOGICAL` compile-time constant `MPI_SUBARRAYS_SUPPORTED` to `.TRUE.` if all choice buffer arguments in all nonblocking, split collective and persistent communication routines are declared with `TYPE(*)`, `DIMENSION(..)`, otherwise set it to `.FALSE..` When `MPI_SUBARRAYS_SUPPORTED` is defined as `.TRUE.`, non-contiguous sub-arrays can be used as buffers in nonblocking routines.
- Set the `MPI_SUBARRAYS_SUPPORTED` compile-time constant to `.FALSE.` and declare choice buffers with a compiler-dependent mechanism that overrides type checking if the underlying Fortran compiler does not support the TS 29113 assumed-type and assumed-rank features. In this case, the use of non-contiguous sub-arrays in non-blocking calls may be disallowed. See Section 18.1.6 for details.

An MPI implementation may provide other features in the `mpi` module that enhance the usability of MPI while maintaining adherence to the standard. For example, it may provide `INTENT` information in these interface blocks.

Advice to implementors. The appropriate `INTENT` may be different from what is given in the MPI language-neutral bindings. Implementations must choose `INTENT` so that the function adheres to the MPI standard, e.g., by defining the `INTENT` as provided in the `mpi_f08` bindings. (*End of advice to implementors.*)

Rationale. The intent given by the MPI generic interface is not precisely defined and does not in all cases correspond to the correct Fortran `INTENT`. For instance, receiving into a buffer specified by a datatype with absolute addresses may require associating `MPI_BOTTOM` with a dummy `OUT` argument. Moreover, “constants” such as `MPI_BOTTOM` and `MPI_STATUS_IGNORE` are not constants as defined by Fortran, but “special addresses” used in a nonstandard way. Finally, the MPI-1 generic intent

was changed in several places in MPI-2. For instance, `MPI_IN_PLACE` changes the intent of an `OUT` argument to be `INOUT`. (*End of rationale.*)

Advice to implementors. The Fortran 2008 standard illustrates in its Note 5.17 that “`INTENT(OUT)` means that the value of the argument after invoking the procedure is entirely the result of executing that procedure. If an argument should retain its value rather than being redefined, `INTENT(INOUT)` should be used rather than `INTENT(OUT)`, even if there is no explicit reference to the value of the dummy argument. Furthermore, `INTENT(INOUT)` is not equivalent to omitting the `INTENT` attribute, because `INTENT(INOUT)` always requires that the associated actual argument is definable.” Applications that include `mpif.h` may not expect that `INTENT(OUT)` is used. In particular, output array arguments are expected to keep their content as long as the MPI routine does not modify them. To keep this behavior, it is recommended that implementations not use `INTENT(OUT)` in the `mpi` module and the `mpif.h` include file, even though `INTENT(OUT)` is specified in an interface description of the `mpi_f08` module. (*End of advice to implementors.*)

18.1.4 Fortran Support Through the `mpif.h` Include File

The use of the `mpif.h` include file is strongly discouraged and may be deprecated in a future version of MPI.

An MPI implementation providing a Fortran interface must provide an include file named `mpif.h` that can be used in a Fortran program. Within all MPI function specifications, the second of the set of two Fortran routine interface specifications is supported by this include file. This include file must:

- Define all named MPI constants.
- Declare MPI functions that return a value.
- Define all handles as `INTEGER`.
- Be valid and equivalent for both fixed and free source form.

For each MPI routine, an implementation can choose to use an implicit or explicit interface for the second Fortran binding (in deprecated routines, the first one may be omitted).

- Set the `LOGICAL` compile-time constants `MPI_SUBARRAYS_SUPPORTED` and `MPI_ASYNC_PROTECTS_NONBLOCKING` according to the same rules as for the `mpi` module. In the case of implicit interfaces for choice buffer or nonblocking routines, the constants must be set to `.FALSE..`

Advice to users. Instead of using `mpif.h`, the use of the `mpi_f08` or `mpi` module is strongly encouraged for the following reasons:

- Most `mpif.h` implementations do not include compile-time argument checking.
- Therefore, many bugs in MPI applications remain undetected at compile-time, such as:
 - Missing `ierror` as last argument in most Fortran bindings.

- 1 – Declaration of a `status` as an `INTEGER` variable instead of an `INTEGER` array
- 2 with size `MPI_STATUS_SIZE`.
- 3 – Incorrect argument positions; e.g., interchanging the `count` and
- 4 `datatype` arguments.
- 5 – Passing incorrect MPI handles; e.g., passing a `datatype` instead of a commu-
- 6 nicator.
- 7
- 8 • The migration from `mpif.h` to the `mpi` module should be relatively straightforward
- 9 (i.e., substituting `include 'mpif.h'` after an `implicit` statement by `use`
- 10 `mpi` before that `implicit` statement) as long as the application syntax is correct.
- 11 • Migrating portable and correctly written applications to the `mpi` module is not
- 12 expected to be difficult. No compile or runtime problems should occur because
- 13 an `mpif.h` include file was always allowed to provide explicit Fortran interfaces.

14 (*End of advice to users.*)

15

16 *Rationale.* With MPI-3.0, the `mpif.h` include file was not deprecated in order to

17 retain strong backward compatibility. Internally, `mpif.h` and the `mpi` module may be

18 implemented so that essentially the same library implementation of the MPI routines

19 can be used. (*End of rationale.*)

20

21 18.1.5 Interface Specifications, Procedure Names, and the Profiling Interface

22

23 The Fortran interface specification of each MPI routine specifies the routine name that must

24 be called by the application program, and the names and types of the dummy arguments

25 together with additional attributes. The Fortran standard allows a given Fortran interface

26 to be implemented with several methods, e.g., within or outside of a module, with or without

27 `BIND(C)`, or the buffers with or without TS 29113. Such implementation decisions imply

28 different binary interfaces and different specific procedure names. The requirements for

29 several implementation schemes together with the rules for the specific procedure names

30 and its implications for the profiling interface are specified within this section, but not the

31 implementation details.

32

33 *Rationale.* This section was introduced in MPI-3.0 on Sep. 21, 2012. The major goals

34 for implementing the three Fortran support methods have been:

35

- 36 • Portable implementation of the wrappers from the MPI Fortran interfaces to the
 - 37 MPI routines in C.
 - 38 • Binary backward compatible implementation path when switching
 - 39 `MPI_SUBARRAYS_SUPPORTED` from `.FALSE.` to `.TRUE.`
 - 40 • The Fortran PMPI interface need not be backward compatible, but a method
 - 41 must be included that a tools layer can use to examine the MPI library about
 - 42 the specific procedure names and interfaces used.
 - 43 • No performance drawbacks.
 - 44 • Consistency between all three Fortran support methods.
 - 45 • Consistent with Fortran 2008 + TS 29113.
- 46
- 47
- 48

No.	Specific procedure name	Calling convention
1A	MPI_Isend_f08	Fortran interface and arguments, as in Annex A.3, except that in routines with a choice buffer dummy argument, this dummy argument is implemented with non-standard extensions like !\$PRAGMA IGNORE_TKR, which provides a call-by-reference argument without type, kind, and dimension checking.
1B	MPI_Isend_f08ts	Fortran interface and arguments, as in Annex A.3, but only for routines with one or more choice buffer dummy arguments; these dummy arguments are implemented with TYPE(*), DIMENSION(..).
2A	MPI_ISEND	Fortran interface and arguments, as in Annex A.4, except that in routines with a choice buffer dummy argument, this dummy argument is implemented with non-standard extensions like !\$PRAGMA IGNORE_TKR, which provides a call-by-reference argument without type, kind, and dimension checking.
2B	MPI_ISEND_FTS	Fortran interface and arguments, as in Annex A.4, but only for routines with one or more choice buffer dummy arguments; these dummy arguments are implemented with TYPE(*), DIMENSION(..).

Table 18.1: Specific Fortran procedure names and related calling conventions. MPI_ISEND is used as an example. For routines without choice buffers, only 1A and 2A apply.

The design expected that all dummy arguments in the MPI Fortran interfaces are interoperable with C according to Fortran 2008 + TS 29113. This expectation was not fulfilled. The LOGICAL arguments are not interoperable with C, mainly because the internal representations for .FALSE. and .TRUE. are compiler dependent. The provided interface was mainly based on BIND(C) interfaces and therefore inconsistent with Fortran. To be consistent with Fortran, the BIND(C) had to be removed from the callback procedure interfaces and the predefined callbacks, e.g., MPI_COMM_DUP_FN. Non-BIND(C) procedures are also not interoperable with C, and therefore the BIND(C) had to be removed from all routines with PROCEDURE arguments, e.g., from MPI_OP_CREATE.

Therefore, this section was rewritten as an erratum to MPI-3.0. (*End of rationale.*)

A Fortran call to an MPI routine shall result in a call to a procedure with one of the specific procedure names and calling conventions, as described in Table 18.1. Case is not significant in the names.

Note that for the deprecated routines in Section 15.1, which are reported only in Annex A.4, scheme 2A is utilized in the mpi module and mpif.h, and also in the mpi_f08 module.

To set MPI_SUBARRAYS_SUPPORTED to .TRUE. within a Fortran support method, it is required that all non-blocking and split-collective routines with buffer arguments are

1 implemented according to 1B and 2B, i.e., with `MPI_Xxxx_f08ts` in the `mpi_f08` module,
 2 and with `MPI_XXXX_FTS` in the `mpi` module and the `mpif.h` include file.

3 The `mpi` and `mpi_f08` modules and the `mpif.h` include file will each correspond to
 4 exactly one implementation scheme from Table 18.1. However, the MPI library may contain
 5 multiple implementation schemes from Table 18.1.

6 *Advice to implementors.* This may be desirable for backwards binary compatibility
 7 in the scope of a single MPI implementation, for example. (*End of advice to imple-*
 8 *mentors.*)

9
 10 *Rationale.* After a compiler provides the facilities from TS 29113, i.e., `TYPE(*)`,
 11 `DIMENSION(. .)`, it is possible to change the bindings within a Fortran support method
 12 to support subarrays without recompiling the complete application provided that the
 13 previous interfaces with their specific procedure names are still included in the li-
 14 brary. Of course, only recompiled routines can benefit from the added facilities.
 15 There is no binary compatibility conflict because each interface uses its own spe-
 16 cific procedure names and all interfaces use the same constants (except the value of
 17 `MPI_SUBARRAYS_SUPPORTED` and `MPI_ASYNC_PROTECTS_NONBLOCKING`) and type
 18 definitions. After a compiler also ensures that buffer arguments of nonblocking MPI
 19 operations can be protected through the `ASYNCHRONOUS` attribute, and the proce-
 20 dure declarations in the `mpi_f08` and `mpi` module and the `mpif.h` include file declare
 21 choice buffers with the `ASYNCHRONOUS` attribute, then the value of
 22 `MPI_ASYNC_PROTECTS_NONBLOCKING` can be switched to `.TRUE.` in the module def-
 23 inition and include file. (*End of rationale.*)

24
 25 *Advice to users.* Partial recompilation of user applications when upgrading MPI
 26 implementations is a highly complex and subtle topic. Users are strongly advised to
 27 consult their MPI implementation’s documentation to see exactly what is — and what
 28 is not — supported. (*End of advice to users.*)

29
 30 Within the `mpi_f08` and `mpi` modules and `mpif.h`, for all MPI procedures, a second
 31 procedure with the same calling conventions shall be supplied, except that the name is
 32 modified by prefixing with the letter “P”, e.g., `PMPI_Isend`. The specific procedure names
 33 for these `PMPI_Xxxx` procedures must be different from the specific procedure names for
 34 the `MPI_Xxxx` procedures and are not specified by this standard.

35 A user-written or middleware profiling routine should provide the same specific Fortran
 36 procedure names and calling conventions, and therefore can interpose itself as the MPI
 37 library routine. The profiling routine can internally call the matching
 38 `PMPI` routine with any of its existing bindings, except for routines that have callback routine
 39 dummy arguments, choice buffer arguments, or that are attribute caching routines (
 40 `MPI_{COMM|WIN|TYPE}_{SET|GET}_ATTR`). In this case, the profiling software should
 41 invoke the corresponding `PMPI` routine using the same Fortran support method as used in
 42 the calling application program, because the C, `mpi_f08` and `mpi` callback prototypes are
 43 different or the meaning of the choice buffer or `attribute_val` arguments are different.

44
 45 *Advice to users.* Although for each support method and MPI routine (e.g.,
 46 `MPI_ISEND` in `mpi_f08`), multiple routines may need to be provided to intercept
 47 the specific procedures in the MPI library (e.g., `MPI_Isend_f08` and `MPI_Isend_f08ts`),
 48 each profiling routine itself uses only one support method (e.g., `mpi_f08`) and calls

the real MPI routine through the one PMPI routine defined in this support method (i.e., `PMPI_Isend` in this example). (*End of advice to users.*)

Advice to implementors. If all of the following conditions are fulfilled:

- the handles in the `mpi_f08` module occupy one Fortran numerical storage unit (same as an `INTEGER` handle),
- the internal argument passing mechanism used to pass an actual `ierror` argument to a non-optional `ierror` dummy argument is binary compatible to passing an actual `ierror` argument to an `ierror` dummy argument that is declared as `OPTIONAL`,
- the internal argument passing mechanism for `ASYNCHRONOUS` and non-`ASYNCHRONOUS` arguments is the same,
- the internal routine call mechanism is the same for the Fortran and the C compilers for which the MPI library is compiled,
- the compiler does not provide TS 29113,

then the implementor may use the same internal routine implementations for all Fortran support methods but with several different specific procedure names. If the accompanying Fortran compiler supports TS 29113, then the new routines are needed only for routines with choice buffer arguments. (*End of advice to implementors.*)

Advice to implementors. In the Fortran support method `mpif.h`, compile-time argument checking can be also implemented for all routines. For `mpif.h`, the argument names are not specified through the MPI standard, i.e., only positional argument lists are defined, and not key-word based lists. Due to the rule that `mpif.h` must be valid for fixed and free source form, the subroutine declaration is restricted to one line with 72 characters. To keep the argument lists short, each argument name can be shortened to a minimum of one character. With this, the two longest subroutine declaration statements are

```
SUBROUTINE PMPI_Dist_graph_create_adjacent(a,b,c,d,e,f,g,h,i,j,k)
SUBROUTINE PMPI_Rget_accumulate(a,b,c,d,e,f,g,h,i,j,k,l,m,n)
```

with 71 and 66 characters. With buffers implemented with TS 29113, the specific procedure names have an additional postfix. The longest of such interface definitions is

```
INTERFACE PMPI_Rget_accumulate
SUBROUTINE PMPI_Rget_accumulate_fts(a,b,c,d,e,f,g,h,i,j,k,l,m,n)
```

with 70 characters. In principle, continuation lines would be possible in `mpif.h` (spaces in columns 73–131, & in column 132, and in column 6 of the continuation line) but this would not be valid if the source line length is extended with a compiler flag to 132 characters. Column 133 is also not available for the continuation character because lines longer than 132 characters are invalid with some compilers by default.

The longest specific procedure names are `PMPI_Dist_graph_create_adjacent_f08` and `PMPI_File_write_ordered_begin_f08ts` both with 35 characters in the `mpi_f08` module. For example, the interface specifications together with the specific procedure names can be implemented with

```

1  MODULE mpi_f08
2      TYPE, BIND(C) :: MPI_Comm
3      INTEGER :: MPI_VAL
4  END TYPE MPI_Comm
5      ...
6  INTERFACE MPI_Comm_rank ! (as defined in Chapter 6)
7      SUBROUTINE MPI_Comm_rank_f08(comm, rank, ierror)
8          IMPORT :: MPI_Comm
9          TYPE(MPI_Comm),      INTENT(IN)  :: comm
10         INTEGER,              INTENT(OUT) :: rank
11         INTEGER, OPTIONAL,    INTENT(OUT) :: ierror
12     END SUBROUTINE
13 END INTERFACE
14 END MODULE mpi_f08
15
16 MODULE mpi
17     INTERFACE MPI_Comm_rank ! (as defined in Chapter 6)
18         SUBROUTINE MPI_Comm_rank(comm, rank, ierror)
19             INTEGER, INTENT(IN)  :: comm ! The INTENT may be added although
20             INTEGER, INTENT(OUT) :: rank ! it is not defined in the
21             INTEGER, INTENT(OUT) :: ierror ! official routine definition.
22         END SUBROUTINE
23     END INTERFACE
24 END MODULE mpi

```

And if interfaces are provided in `mpif.h`, they might look like this (outside of any module and in fixed source format):

```

25
26 !23456789012345678901234567890123456789012345678901234567890123456789012
27     INTERFACE MPI_Comm_rank ! (as defined in Chapter 6)
28         SUBROUTINE MPI_Comm_rank(comm, rank, ierror)
29             INTEGER, INTENT(IN)  :: comm ! The argument names may be
30             INTEGER, INTENT(OUT) :: rank ! shortened so that the
31             INTEGER, INTENT(OUT) :: ierror ! subroutine line fits to the
32         END SUBROUTINE ! maximum of 72 characters.
33     END INTERFACE

```

(End of advice to implementors.)

Advice to users. The following is an example of how a user-written or middleware profiling routine can be implemented:

```

34
35
36
37
38 SUBROUTINE MPI_Isend_f08ts(buf,count,datatype,dest,tag,comm,request,ierror)
39     USE :: mpi_f08, my_noname => MPI_Isend_f08ts
40     TYPE(*), DIMENSION(..), ASYNCHRONOUS :: buf
41     INTEGER,          INTENT(IN)          :: count, dest, tag
42     TYPE(MPI_Datatype), INTENT(IN)        :: datatype
43     TYPE(MPI_Comm),   INTENT(IN)         :: comm
44     TYPE(MPI_Request), INTENT(OUT)       :: request
45     INTEGER, OPTIONAL, INTENT(OUT)      :: ierror
46     ! ... some code for the begin of profiling
47     call PMPI_Isend (buf, count, datatype, dest, tag, comm, request, ierror)
48     ! ... some code for the end of profiling
49 END SUBROUTINE MPI_Isend_f08ts

```

Note that this routine is used to intercept the existing specific procedure name `MPI_Isend_f08ts` in the MPI library. This routine must not be part of a module. This routine itself calls `PMPI_Isend`. The `USE` of the `mpi_f08` module is needed for definitions of handle types and the interface for `PMPI_Isend`. However, this module also contains an interface definition for the specific procedure name `MPI_Isend_f08ts` that conflicts with the definition of this profiling routine (i.e., the name is doubly defined). Therefore, the `USE` here specifically excludes the interface from the module by renaming the unused routine name in the `mpi_f08` module into “`my_noname`” in the scope of this routine. (*End of advice to users.*)

Advice to users. The PMPI interface allows intercepting MPI routines. For example, an additional `MPI_ISEND` profiling wrapper can be provided that is called by the application and internally calls `PMPI_ISEND`. There are two typical use cases: a profiling layer that is developed independently from the application and the MPI library, and profiling routines that are part of the application and have access to the application data. With MPI-3.0, new Fortran interfaces and implementation schemes were introduced that have several implications on how Fortran MPI routines are internally implemented and optimized. For profiling layers, these schemes imply that several internal interfaces with different specific procedure names may need to be intercepted, as shown in the example code above. Therefore, for wrapper routines that are part of a Fortran application, it may be more convenient to make the name shift within the application, i.e., to substitute the call to the MPI routine (e.g., `MPI_ISEND`) by a call to a user-written profiling wrapper with a new name (e.g., `X_MPI_ISEND`) and to call the Fortran `MPI_ISEND` from this wrapper, instead of using the PMPI interface. (*End of advice to users.*)

Advice to implementors. An implementation that provides a Fortran interface must provide a combination of MPI library and module or include file that uses the specific procedure names as described in Table 18.1 so that the MPI Fortran routines are interceptable as described above. (*End of advice to implementors.*)

18.1.6 MPI for Different Fortran Standard Versions

This section describes which Fortran interface functionality can be provided for different versions of the Fortran standard.

- *For Fortran 77* with some extensions:
 - MPI identifiers may be up to 30 characters (31 with the profiling interface).
 - MPI identifiers may contain underscores after the first character.
 - An MPI subroutine with a choice argument may be called with different argument types.
 - Although not required by the MPI standard, the `INCLUDE` statement should be available for including `mpif.h` into the user application source code.

Only MPI-1.1, MPI-1.2, and MPI-1.3 can be implemented. The use of absolute addresses from `MPI_ADDRESS` and `MPI_BOTTOM` may cause problems if an address does not fit into the memory space provided by an `INTEGER`. (In MPI-2.0 this problem is solved with `MPI_GET_ADDRESS`, but not for Fortran 77.)

1 • *For Fortran 90:*

2 The major additional features that are needed from Fortran 90 are:

- 3
- 4 – The `MODULE` and `INTERFACE` concept.
- 5 – The `KIND=` and `SELECTED_..._KIND` concept.
- 6 – Fortran derived `TYPE`s and the `SEQUENCE` attribute.
- 7 – The `OPTIONAL` attribute for dummy arguments.
- 8 – Cray pointers, which are a non-standard compiler extension, are needed for the
- 9 use of `MPI_ALLOC_MEM`.

10

11 With these features, MPI-1.1 – MPI-2.2 can be implemented without restrictions.

12 MPI-3.0 can be implemented with some restrictions. The Fortran support methods

13 are abbreviated with `S1` = the `mpi_f08` module, `S2` = the `mpi` module, and `S3` = the

14 `mpif.f` include file. If not stated otherwise, restrictions exist for each method which

15 prevent implementing the complete semantics of MPI-3.0.

- 16
- 17 – `MPI_SUBARRAYS_SUPPORTED` equals `.FALSE.`, i.e., subscript triplets and non-
- 18 contiguous subarrays cannot be used as buffers in nonblocking routines, RMA,
- 19 or split-collective I/O.
- 20
- 21 – `S1`, `S2`, and `S3` can be implemented, but for `S1`, only a preliminary implementa-
- 22 tion is possible.
- 23 – In this preliminary interface of `S1`, the following changes are necessary:
- 24 * `TYPE(*)`, `DIMENSION(...)` is substituted by non-standardized extensions
- 25 like `!$PRAGMA IGNORE_TKR`.
- 26 * The `ASYNCHRONOUS` attribute is omitted.
- 27 * `PROCEDURE(...)` callback declarations are substituted by `EXTERNAL`.
- 28
- 29 – The specific procedure names are specified in Section 18.1.5.
- 30
- 31 – Due to the rules specified in Section 18.1.5, choice buffer declarations should be
- 32 implemented only with non-standardized extensions like `!$PRAGMA IGNORE_TKR`
- 33 (as long as F2008+TS 29113 is not available).
- 34 In `S2` and `S3`: Without such extensions, routines with choice buffers should be
- 35 provided with an implicit interface, instead of overloading with a different MPI
- 36 function for each possible buffer type (as mentioned in Section 18.1.11). Such
- 37 overloading would also imply restrictions for passing Fortran derived types as
- 38 choice buffer, see also Section 18.1.15.
- 39 Only in `S1`: The implicit interfaces for routines with choice buffer arguments
- 40 imply that the `ierror` argument cannot be defined as `OPTIONAL`. For this reason,
- 41 it is recommended not to provide the `mpi_f08` module if such an extension is not
- 42 available.
- 43 – The `ASYNCHRONOUS` attribute can **not** be used in applications to protect buffers
- 44 in nonblocking MPI calls (`S1–S3`).
- 45 – The `TYPE(C_PTR)` binding of the `MPI_ALLOC_MEM` and `MPI_WIN_ALLOCATE`
- 46 routines is not available.
- 47
- 48

- In S1 and S2, the definition of the handle types (e.g., `TYPE(MPI_Comm)` and the status type `TYPE(MPI_Status)` must be modified: The `SEQUENCE` attribute must be used instead of `BIND(C)` (which is not available in Fortran 90/95). This restriction implies that the application must be fully recompiled if one switches to an MPI library for Fortran 2003 and later because the internal memory size of the handles may have changed. For this reason, an implementor may choose not to provide the `mpi_f08` module for Fortran 90 compilers. In this case, the `mpi_f08` handle types and all routines, constants and types related to `TYPE(MPI_Status)` (see Section 18.2.5) are also not available in the `mpi` module and `mpif.h`.
- *For Fortran 95:*
The quality of the MPI interface and the restrictions are the same as with Fortran 90.
- *For Fortran 2003:*
The major features that are needed from Fortran 2003 are:
 - Interoperability with C, i.e.,
 - * `BIND(C)` derived types.
 - * The `ISO_C_BINDING` intrinsic type `C_PTR` and routine `C_F_POINTER`.
 - The ability to define an `ABSTRACT INTERFACE` and to use it for `PROCEDURE` dummy arguments.
 - The ability to overload the operators `.EQ.` and `.NE.` to allow the comparison of derived types (used in MPI-3.0 for MPI handles).
 - The `ASYNCHRONOUS` attribute is available to protect Fortran asynchronous I/O. This feature is not yet used by MPI, but it is the basis for the enhancement for MPI communication in the TS 29113.

With these features (but still without the features of TS 29113), MPI-1.1 – MPI-2.2 can be implemented without restrictions, but with one enhancement:

- The user application can use `TYPE(C_PTR)` together with `MPI_ALLOC_MEM` as long as `MPI_ALLOC_MEM` is defined with an implicit interface because a `C_PTR` and an `INTEGER(KIND=MPI_ADDRESS_KIND)` argument must both map to a `void *` argument.

MPI-3.0 can be implemented with the following restrictions:

- `MPI_SUBARRAYS_SUPPORTED` equals `.FALSE.`
- For S1, only a preliminary implementation is possible. The following changes are necessary:
 - * `TYPE(*)`, `DIMENSION(..)` is substituted by non-standardized extensions like `!$PRAGMA IGNORE_TKR`.
- The specific procedure names are specified in Section 18.1.5.
- With S1, the `ASYNCHRONOUS` is required as specified in the second Fortran interfaces. With S2 and S3 the implementation can also add this attribute if explicit interfaces are used.

- 1 – The `ASYNCHRONOUS` Fortran attribute can be used in applications to *try to* protect
- 2 buffers in nonblocking MPI calls, but the protection can work only if the compiler
- 3 is able to protect asynchronous Fortran I/O and makes no difference between such
- 4 asynchronous Fortran I/O and MPI communication.
- 5 – The `TYPE(C_PTR)` binding of the `MPI_ALLOC_MEM`, `MPI_WIN_ALLOCATE`,
- 6 `MPI_WIN_ALLOCATE_SHARED`, and `MPI_WIN_SHARED_QUERY` routines can
- 7 be used only for Fortran types that are C compatible.
- 8 – The same restriction as for Fortran 90 applies if non-standardized extensions like
- 9 `!$PRAGMA IGNORE_TKR` are not available.

- 11 • For Fortran 2008 + TS 29113 and later and
- 12 For Fortran 2003 + TS 29113:

13 The major feature that are needed from TS 29113 are:

- 14 – `TYPE(*)`, `DIMENSION(..)` is available.
- 15 – The `ASYNCHRONOUS` attribute is extended to protect also nonblocking MPI com-
- 16 munication.
- 17 – The array dummy argument of the `ISO_C_BINDING` intrinsic `C_F_POINTER` is not
- 18 restricted to Fortran types for which a corresponding type in C exists.

20 Using these features, MPI-3.0 can be implemented without any restrictions.

- 21 – With S1, `MPI_SUBARRAYS_SUPPORTED` equals `.TRUE..` The `ASYNCHRONOUS` at-
- 22 tribute can be used to protect buffers in nonblocking MPI calls. The `TYPE(C_PTR)`
- 23 binding of the `MPI_ALLOC_MEM`, `MPI_WIN_ALLOCATE`,
- 24 `MPI_WIN_ALLOCATE_SHARED`, and `MPI_WIN_SHARED_QUERY` routines can
- 25 be used for any Fortran type.
- 26 – With S2 and S3, the value of `MPI_SUBARRAYS_SUPPORTED` is implementation
- 27 dependent. A high quality implementation will also provide
- 28 `MPI_SUBARRAYS_SUPPORTED==.TRUE.` and will use the
- 29 `ASYNCHRONOUS` attribute in the same way as in S1.
- 30 – If non-standardized extensions like `!$PRAGMA IGNORE_TKR` are not available then
- 31 S2 must be implemented with `TYPE(*)`, `DIMENSION(..)`.

33 *Advice to implementors.* If `MPI_SUBARRAYS_SUPPORTED==.FALSE.`, the choice

34 argument may be implemented with an explicit interface using compiler directives,

35 for example:

```

37   INTERFACE
38       SUBROUTINE MPI...(buf, ...)
39           !DEC$ ATTRIBUTES NO_ARG_CHECK :: buf
40           !$PRAGMA IGNORE_TKR buf
41           !DIR$ IGNORE_TKR buf
42           !IBM* IGNORE_TKR buf
43           REAL, DIMENSION(*) :: buf
44           ... ! declarations of the other arguments
45       END SUBROUTINE
46   END INTERFACE

```

47 (*End of advice to implementors.*)

18.1.7 Requirements on Fortran Compilers

MPI-3.0 (and later) compliant Fortran bindings are not only a property of the MPI library itself, but rather a property of an MPI library together with the Fortran compiler suite for which it is compiled.

Advice to users. Users must take appropriate steps to ensure that proper options are specified to compilers. MPI libraries must document these options. Some MPI libraries are shipped together with special compilation scripts (e.g., `mpif90`, `mpicc`) that set these options automatically. (*End of advice to users.*)

An MPI library together with the Fortran compiler suite is only compliant with MPI-3.0 (and later), as referred by `MPI_GET_VERSION`, if all the solutions described in Sections 18.1.11 through 18.1.19 work correctly. Based on this rule, major requirements for all three Fortran support methods (i.e., the `mpi_f08` and `mpi` modules, and `mpif.h`) are:

- The language features assumed-type and assumed-rank from Fortran 2008 TS 29113 [42] are available. This is required only for `mpi_f08`. As long as this requirement is not supported by the compiler, it is valid to build an MPI library that implements the `mpi_f08` module with `MPI_SUBARRAYS_SUPPORTED` set to `.FALSE..`
- “Simply contiguous” arrays and scalars must be passed to choice buffer dummy arguments of nonblocking routines with call by reference. This is needed only if one of the support methods does not use the `ASYNCHRONOUS` attribute. See Section 18.1.12 for more details.
- `SEQUENCE` and `BIND(C)` derived types are valid as actual arguments passed to choice buffer dummy arguments, and, in the case of `MPI_SUBARRAYS_SUPPORTED==.FALSE.`, they are passed with call by reference, and passed by descriptor in the case of `.TRUE..`
- All actual arguments that are allowed for a dummy argument in an implicitly defined and separately compiled Fortran routine with the given compiler (e.g., `CHARACTER(LEN=*)` strings and array of strings) must also be valid for choice buffer dummy arguments with all Fortran support methods.
- The array dummy argument of the `ISO_C_BINDING` intrinsic module procedure `C_F_POINTER` is not restricted to Fortran types for which a corresponding type in C exists.
- The Fortran compiler shall not provide `TYPE(*)` unless the `ASYNCHRONOUS` attribute protects MPI communication as described in TS 29113. Specifically, the TS 29113 must be implemented as a whole.

The following rules are required at least as long as the compiler does not provide the extension of the `ASYNCHRONOUS` attribute as part of TS 29113 and there still exists a Fortran support method with `MPI_ASYNC_PROTECTS_NONBLOCKING==.FALSE..` Observation of these rules by the MPI application developer is especially recommended for backward compatibility of existing applications that use the `mpi` module or the `mpif.h` include file. The rules are as follows:

- 1 • Separately compiled empty Fortran routines with implicit interfaces and separately
2 compiled empty C routines with BIND(C) Fortran interfaces (e.g., MPI_F_SYNC_REG
3 on page 680 and Section 18.1.8, and DD on page 681) solve the problems described in
4 Section 18.1.17.
- 5 • The problems with temporary data movement (described in detail in Section 18.1.18)
6 are solved as long as the application uses different sets of variables for the nonblocking
7 communication (or nonblocking or split collective I/O) and the computation when
8 overlapping communication and computation.
- 9 • Problems caused by automatic and permanent data movement (e.g., within a garbage
10 collection, see Section 18.1.19) are resolved **without** any further requirements on the
11 application program, neither on the usage of the buffers, nor on the declaration of
12 application routines that are involved in invoking MPI procedures.

13 All of these rules are valid for the `mpi_f08` and `mpi` modules and independently of whether
14 `mpif.h` uses explicit interfaces.

15 *Advice to implementors.* Some of these rules are already part of the Fortran 2003
16 standard, some of these requirements require the Fortran TS 29113 [42], and some of
17 these requirements for MPI-3.0 are beyond the scope of TS 29113. (*End of advice to
18 implementors.*)

19 18.1.8 Additional Support for Fortran Register-Memory-Synchronization

20 As described in Section 18.1.17, a dummy call may be necessary to tell the compiler that
21 registers are to be flushed for a given buffer or that accesses to a buffer may not be moved
22 across a given point in the execution sequence. Only a Fortran binding exists for this call.

23 MPI_F_SYNC_REG(buf)

24 INOUT buf initial address of buffer (choice)

25 MPI_F_sync_reg(buf)

26 TYPE(*), DIMENSION(..), ASYNCHRONOUS :: buf

27 MPI_F_SYNC_REG(buf)

28 <type> buf(*)

29 This routine has no executable statements. It must be compiled in the MPI library in
30 such a manner that a Fortran compiler cannot detect in the module that the routine has
31 an empty body. It is used only to force the compiler to flush a cached register value of a
32 variable or buffer back to memory (when necessary), or to invalidate the register value.

33 *Rationale.* This function is not available in other languages because it would not be
34 useful. This routine has no `ierror` return argument because there is no operation that
35 can fail. (*End of rationale.*)

36 *Advice to implementors.* This routine can be bound to a C routine to minimize
37 the risk that the Fortran compiler can learn that this routine is empty (and that
38 the call to this routine can be removed as part of an optimization). However, it is

explicitly allowed to implement this routine within the `mpi_f08` module according to the definition for the `mpi` module or `mpif.h` to circumvent the overhead of building the internal dope vector to handle the assumed-type, assumed-rank argument. (*End of advice to implementors.*)

Rationale. This routine is not defined with `TYPE(*)`, `DIMENSION(*)`, i.e., assumed size instead of assumed rank, because this would restrict the usability to “simply contiguous” arrays and would require overloading with another interface for scalar arguments. (*End of rationale.*)

Advice to users. If only a part of an array (e.g., defined by a subscript triplet) is used in a nonblocking routine, it is recommended to pass the whole array to `MPI_F_SYNC_REG` anyway to minimize the overhead of this no-operation call. Note that this routine need not be called if `MPI_ASYNC_PROTECTS_NONBLOCKING` is `.TRUE.` and the application fully uses the facilities of `ASYNCHRONOUS` arrays. (*End of advice to users.*)

18.1.9 Additional Support for Fortran Numeric Intrinsic Types

MPI provides a small number of named datatypes that correspond to named intrinsic types supported by C and Fortran. These include `MPI_INTEGER`, `MPI_REAL`, `MPI_INT`, `MPI_DOUBLE`, etc., as well as the optional types `MPI_REAL4`, `MPI_REAL8`, etc. There is a one-to-one correspondence between language declarations and MPI types.

Fortran (starting with Fortran 90) provides so-called `KIND`-parameterized types. These types are declared using an intrinsic type (one of `INTEGER`, `REAL`, `COMPLEX`, `LOGICAL`, and `CHARACTER`) with an optional integer `KIND` parameter that selects from among one or more variants. The specific meaning of different `KIND` values themselves are implementation dependent and not specified by the language. Fortran provides the `KIND` selection functions `selected_real_kind` for `REAL` and `COMPLEX` types, and `selected_int_kind` for `INTEGER` types that allow users to declare variables with a minimum precision or number of digits. These functions provide a portable way to declare `KIND`-parameterized `REAL`, `COMPLEX`, and `INTEGER` variables in Fortran. This scheme is backward compatible with Fortran 77. `REAL` and `INTEGER` Fortran variables have a default `KIND` if none is specified. Fortran `DOUBLE PRECISION` variables are of intrinsic type `REAL` with a non-default `KIND`. The following two declarations are equivalent:

```
double precision x
real(KIND(0.0d0)) x
```

MPI provides two orthogonal methods for handling communication buffers of numeric intrinsic types. The first method (see the following section) can be used when variables have been declared in a portable way — using default `KIND` or using `KIND` parameters obtained with the `selected_int_kind` or `selected_real_kind` functions. With this method, MPI automatically selects the correct data size (e.g., 4 or 8 bytes) and provides representation conversion in heterogeneous environments. The second method (see “Support for size-specific MPI Datatypes” on page 663) gives the user complete control over communication by exposing machine representations.

Parameterized Datatypes with Specified Precision and Exponent Range

MPI provides named datatypes corresponding to standard Fortran 77 numeric types: MPI_INTEGER, MPI_COMPLEX, MPI_REAL, MPI_DOUBLE_PRECISION and MPI_DOUBLE_COMPLEX. MPI automatically selects the correct data size and provides representation conversion in heterogeneous environments. The mechanism described in this section extends this model to support portable parameterized numeric types.

The model for supporting portable parameterized types is as follows. Real variables are declared (perhaps indirectly) using `selected_real_kind(p, r)` to determine the KIND parameter, where `p` is decimal digits of precision and `r` is an exponent range. Implicitly MPI maintains a two-dimensional array of predefined MPI datatypes `D(p, r)`. `D(p, r)` is defined for each value of `(p, r)` supported by the compiler, including pairs for which one value is unspecified. Attempting to access an element of the array with an index `(p, r)` not supported by the compiler is erroneous. MPI implicitly maintains a similar array of COMPLEX datatypes. For integers, there is a similar implicit array related to `selected_int_kind` and indexed by the requested number of digits `r`. Note that the predefined datatypes contained in these implicit arrays are not the same as the named MPI datatypes MPI_REAL, etc., but a new set.

Advice to implementors. The above description is for explanatory purposes only. It is not expected that implementations will have such internal arrays. (*End of advice to implementors.*)

Advice to users. `selected_real_kind()` maps a large number of `(p,r)` pairs to a much smaller number of KIND parameters supported by the compiler. KIND parameters are not specified by the language and are not portable. From the language point of view intrinsic types of the same base type and KIND parameter are of the same type. In order to allow interoperability in a heterogeneous environment, MPI is more stringent. The corresponding MPI datatypes match if and only if they have the same `(p,r)` value (REAL and COMPLEX) or `r` value (INTEGER). Thus MPI has many more datatypes than there are fundamental language types. (*End of advice to users.*)

```
MPI_TYPE_CREATE_F90_REAL(p, r, newtype)
```

IN	p	precision, in decimal digits (integer)
IN	r	decimal exponent range (integer)
OUT	newtype	the requested MPI datatype (handle)

```
int MPI_Type_create_f90_real(int p, int r, MPI_Datatype *newtype)
```

```
MPI_Type_create_f90_real(p, r, newtype, ierror)
    INTEGER, INTENT(IN) :: p, r
    TYPE(MPI_Datatype), INTENT(OUT) :: newtype
    INTEGER, OPTIONAL, INTENT(OUT) :: ierror
```

```
MPI_TYPE_CREATE_F90_REAL(P, R, NEWTYPE, IERROR)
    INTEGER P, R, NEWTYPE, IERROR
```

This function returns a predefined MPI datatype that matches a `REAL` variable of `KIND selected_real_kind(p, r)`. In the model described above it returns a handle for the element `D(p, r)`. Either `p` or `r` may be omitted from calls to `selected_real_kind(p, r)` (but not both). Analogously, either `p` or `r` may be set to `MPI_UNDEFINED`. In communication, an MPI datatype `A` returned by `MPI_TYPE_CREATE_F90_REAL` matches a datatype `B` if and only if `B` was returned by `MPI_TYPE_CREATE_F90_REAL` called with the same values for `p` and `r` or `B` is a duplicate of such a datatype. Restrictions on using the returned datatype with the “external32” data representation are given on page 663.

It is erroneous to supply values for `p` and `r` not supported by the compiler.

```
MPI_TYPE_CREATE_F90_COMPLEX(p, r, newtype)
```

IN	<code>p</code>	precision, in decimal digits (integer)
IN	<code>r</code>	decimal exponent range (integer)
OUT	<code>newtype</code>	the requested MPI datatype (handle)

```
int MPI_Type_create_f90_complex(int p, int r, MPI_Datatype *newtype)
```

```
MPI_Type_create_f90_complex(p, r, newtype, ierror)
  INTEGER, INTENT(IN) :: p, r
  TYPE(MPI_Datatype), INTENT(OUT) :: newtype
  INTEGER, OPTIONAL, INTENT(OUT) :: ierror
```

```
MPI_TYPE_CREATE_F90_COMPLEX(P, R, NEWTYPE, IERROR)
  INTEGER P, R, NEWTYPE, IERROR
```

This function returns a predefined MPI datatype that matches a `COMPLEX` variable of `KIND selected_real_kind(p, r)`. Either `p` or `r` may be omitted from calls to `selected_real_kind(p, r)` (but not both). Analogously, either `p` or `r` may be set to `MPI_UNDEFINED`. Matching rules for datatypes created by this function are analogous to the matching rules for datatypes created by `MPI_TYPE_CREATE_F90_REAL`. Restrictions on using the returned datatype with the “external32” data representation are given on page 663.

It is erroneous to supply values for `p` and `r` not supported by the compiler.

```
MPI_TYPE_CREATE_F90_INTEGER(r, newtype)
```

IN	<code>r</code>	decimal exponent range, i.e., number of decimal digits (integer)
OUT	<code>newtype</code>	the requested MPI datatype (handle)

```
int MPI_Type_create_f90_integer(int r, MPI_Datatype *newtype)
```

```
MPI_Type_create_f90_integer(r, newtype, ierror)
  INTEGER, INTENT(IN) :: r
  TYPE(MPI_Datatype), INTENT(OUT) :: newtype
  INTEGER, OPTIONAL, INTENT(OUT) :: ierror
```

```
MPI_TYPE_CREATE_F90_INTEGER(R, NEWTYPE, IERROR)
```

1 INTEGER R, NEWTYPE, IERROR

2
3 This function returns a predefined MPI datatype that matches a `INTEGER` variable of
4 `KIND selected_int_kind(r)`. Matching rules for datatypes created by this function are
5 analogous to the matching rules for datatypes created by `MPI_TYPE_CREATE_F90_REAL`.
6 Restrictions on using the returned datatype with the “external32” data representation are
7 given on page 663.

8 It is erroneous to supply a value for `r` that is not supported by the compiler.

9 Example:

```
10       integer        longtype, quadtype
11       integer, parameter :: long = selected_int_kind(15)
12       integer(long) ii(10)
13       real(selected_real_kind(30)) x(10)
14       call MPI_TYPE_CREATE_F90_INTEGER(15, longtype, ierror)
15       call MPI_TYPE_CREATE_F90_REAL(30, MPI_UNDEFINED, quadtype, ierror)
16       ...
17
18       call MPI_SEND(ii, 10, longtype, ...)
19       call MPI_SEND(x, 10, quadtype, ...)
```

21 *Advice to users.* The datatypes returned by the above functions are predefined
22 datatypes. They cannot be freed; they do not need to be committed; they can be
23 used with predefined reduction operations. There are two situations in which they
24 behave differently syntactically, but not semantically, from the MPI named predefined
25 datatypes.

- 26
- 27 1. `MPI_TYPE_GET_ENVELOPE` returns special combiners that allow a program to
28 retrieve the values of `p` and `r`.
- 29 2. Because the datatypes are not named, they cannot be used as compile-time
30 initializers or otherwise accessed before a call to one of the
31 `MPI_TYPE_CREATE_F90_XXX` routines.

32
33 If a variable was declared specifying a non-default `KIND` value that was not obtained
34 with `selected_real_kind()` or `selected_int_kind()`, the only way to obtain a
35 matching MPI datatype is to use the size-based mechanism described in the next
36 section.

37 (*End of advice to users.*)

38
39 *Advice to implementors.* An application may often repeat a call to
40 `MPI_TYPE_CREATE_F90_XXX` with the same combination of `(XXX,p,r)`. The appli-
41 cation is not allowed to free the returned predefined, unnamed datatype handles. To
42 prevent the creation of a potentially huge amount of handles, a high quality MPI imple-
43 mentation should return the same datatype handle for the same `(REAL/COMPLEX/
44 INTEGER,p,r)` combination. Checking for the combination `(p,r)` in the preceding call
45 to `MPI_TYPE_CREATE_F90_XXX` and using a hash table to find formerly generated
46 handles should limit the overhead of finding a previously generated datatype with
47 same combination of `(XXX,p,r)`. (*End of advice to implementors.*)

Rationale. The MPI_TYPE_CREATE_F90_REAL/COMPLEX/INTEGER interface needs as input the original range and precision values to be able to define useful and compiler-independent external (Section 13.5.2) or user-defined (Section 13.5.3) data representations, and in order to be able to perform automatic and efficient data conversions in a heterogeneous environment. (*End of rationale.*)

We now specify how the datatypes described in this section behave when used with the “external32” external data representation described in Section 13.5.2.

The external32 representation specifies data formats for integer and floating point values. Integer values are represented in two’s complement big-endian format. Floating point values are represented by one of three IEEE formats. These are the IEEE “Single,” “Double,” and “Double Extended” formats, requiring 4, 8, and 16 bytes of storage, respectively. For the IEEE “Double Extended” formats, MPI specifies a Format Width of 16 bytes, with 15 exponent bits, bias = +10383, 112 fraction bits, and an encoding analogous to the “Double” format.

The external32 representations of the datatypes returned by MPI_TYPE_CREATE_F90_REAL/COMPLEX/INTEGER are given by the following rules.

For MPI_TYPE_CREATE_F90_REAL:

```

if      (p > 33) or (r > 4931) then  external32 representation
                                     is undefined
else if (p > 15) or (r >  307) then  external32_size = 16
else if (p >  6) or (r >   37) then  external32_size =  8
else                                     external32_size =  4

```

For MPI_TYPE_CREATE_F90_COMPLEX: twice the size as for MPI_TYPE_CREATE_F90_REAL.

For MPI_TYPE_CREATE_F90_INTEGER:

```

if      (r > 38) then  external32 representation is undefined
else if (r > 18) then  external32_size = 16
else if (r >  9) then  external32_size =  8
else if (r >  4) then  external32_size =  4
else if (r >  2) then  external32_size =  2
else                                     external32_size =  1

```

If the external32 representation of a datatype is undefined, the result of using the datatype directly or indirectly (i.e., as part of another datatype or through a duplicated datatype) in operations that require the external32 representation is undefined. These operations include MPI_PACK_EXTERNAL, MPI_UNPACK_EXTERNAL, and many MPI_FILE functions, when the “external32” data representation is used. The ranges for which the external32 representation is undefined are reserved for future standardization.

Support for Size-specific MPI Datatypes

MPI provides named datatypes corresponding to optional Fortran 77 numeric types that contain explicit byte lengths — MPI_REAL4, MPI_INTEGER8, etc. This section describes a mechanism that generalizes this model to support all Fortran numeric intrinsic types.

We assume that for each **typeclass** (integer, real, complex) and each word size there is a unique machine representation. For every pair (**typeclass**, **n**) supported by a compiler,

MPI must provide a named size-specific datatype. The name of this datatype is of the form MPI_<TYPE>n in C and Fortran where <TYPE> is one of REAL, INTEGER and COMPLEX, and **n** is the length in bytes of the machine representation. This datatype locally matches all variables of type (**typeclass, n**) in Fortran. The list of names for such types includes:

```

MPI_REAL4
MPI_REAL8
MPI_REAL16
MPI_COMPLEX8
MPI_COMPLEX16
MPI_COMPLEX32
MPI_INTEGER1
MPI_INTEGER2
MPI_INTEGER4
MPI_INTEGER8
MPI_INTEGER16

```

One datatype is required for each representation supported by the Fortran compiler.

Rationale. Particularly for the longer floating-point types, C and Fortran may use different representations. For example, a Fortran compiler may define a 16-byte REAL type with 33 decimal digits of precision while a C compiler may define a 16-byte long double type that implements an 80-bit (10 byte) extended precision floating point value. Both of these types are 16 bytes long, but they are not interoperable. Thus, these types are defined by Fortran, even though C may define types of the same length. (*End of rationale.*)

To be backward compatible with the interpretation of these types in MPI-1, we assume that the nonstandard declarations REAL*n, INTEGER*n, always create a variable whose representation is of size **n**. These datatypes may also be used for variables declared with KIND=INT8/16/32/64 or KIND=REAL32/64/128, which are defined in the ISO_FORTRAN_ENV intrinsic module. Note that the MPI datatypes and the REAL*n, INTEGER*n declarations count bytes whereas the Fortran KIND values count bits. All these datatypes are predefined.

The following functions allow a user to obtain a size-specific MPI datatype for any intrinsic Fortran type.

```
MPI_SIZEOF(x, size)
```

IN	x	a Fortran variable of numeric intrinsic type (choice)
OUT	size	size of machine representation of that type (integer)

```

MPI_Sizeof(x, size, ierror)
  TYPE(*), DIMENSION(..) :: x
  INTEGER, INTENT(OUT) :: size
  INTEGER, OPTIONAL, INTENT(OUT) :: ierror

```

```

MPI_SIZEOF(X, SIZE, IERROR)
  <type> X
  INTEGER SIZE, IERROR

```

This function returns the size in bytes of the machine representation of the given variable. It is a generic Fortran routine and has a Fortran binding only.

Advice to users. This function is similar to the C *sizeof* operator but behaves slightly differently. If given an array argument, it returns the size of the base element, not the size of the whole array. (*End of advice to users.*)

Rationale. This function is not available in other languages because it would not be useful. (*End of rationale.*)

MPI_TYPE_MATCH_SIZE(typeclass, size, datatype)

IN	typeclass	generic type specifier (integer)
IN	size	size, in bytes, of representation (integer)
OUT	datatype	datatype with correct type, size (handle)

```
int MPI_Type_match_size(int typeclass, int size, MPI_Datatype *datatype)
```

```
MPI_Type_match_size(typeclass, size, datatype, ierror)
```

```
INTEGER, INTENT(IN) :: typeclass, size
TYPE(MPI_Datatype), INTENT(OUT) :: datatype
INTEGER, OPTIONAL, INTENT(OUT) :: ierror
```

```
MPI_TYPE_MATCH_SIZE(TYPECLASS, SIZE, DATATYPE, IERROR)
```

```
INTEGER TYPECLASS, SIZE, DATATYPE, IERROR
```

typeclass is one of MPI_TYPECLASS_REAL, MPI_TYPECLASS_INTEGER and MPI_TYPECLASS_COMPLEX, corresponding to the desired **typeclass**. The function returns an MPI datatype matching a local variable of type (**typeclass**, **size**).

This function returns a reference (handle) to one of the predefined named datatypes, not a duplicate. This type cannot be freed. MPI_TYPE_MATCH_SIZE can be used to obtain a size-specific type that matches a Fortran numeric intrinsic type by first calling MPI_SIZEOF in order to compute the variable size, and then calling MPI_TYPE_MATCH_SIZE to find a suitable datatype. In C, one can use the C function `sizeof()`, instead of MPI_SIZEOF. In addition, for variables of default kind the variable's size can be computed by a call to MPI_TYPE_GET_EXTENT, if the **typeclass** is known. It is erroneous to specify a size not supported by the compiler.

Rationale. This is a convenience function. Without it, it can be tedious to find the correct named type. See note to implementors below. (*End of rationale.*)

Advice to implementors. This function could be implemented as a series of tests.

```
int MPI_Type_match_size(int typeclass, int size, MPI_Datatype *rtype)
```

```
{
  switch(typeclass) {
    case MPI_TYPECLASS_REAL: switch(size) {
      case 4: *rtype = MPI_REAL4; return MPI_SUCCESS;
```

```

1         case 8: *rtype = MPI_REAL8; return MPI_SUCCESS;
2         default: error(...);
3     }
4     case MPI_TYPECLASS_INTEGER: switch(size) {
5         case 4: *rtype = MPI_INTEGER4; return MPI_SUCCESS;
6         case 8: *rtype = MPI_INTEGER8; return MPI_SUCCESS;
7         default: error(...);
8     }
9     ... etc. ...
10    }
11
12    return MPI_SUCCESS;
13 }

```

(*End of advice to implementors.*)

Communication With Size-specific Types

The usual type matching rules apply to size-specific datatypes: a value sent with datatype `MPI_<TYPE>n` can be received with this same datatype on another process. Most modern computers use 2's complement for integers and IEEE format for floating point. Thus, communication using these size-specific datatypes will not entail loss of precision or truncation errors.

Advice to users. Care is required when communicating in a heterogeneous environment. Consider the following code:

```

27 real(selected_real_kind(5)) x(100)
28 call MPI_SIZEOF(x, size, ierror)
29 call MPI_TYPE_MATCH_SIZE(MPI_TYPECLASS_REAL, size, xtype, ierror)
30 if (myrank .eq. 0) then
31     ... initialize x ...
32     call MPI_SEND(x, xtype, 100, 1, ...)
33 else if (myrank .eq. 1) then
34     call MPI_RECV(x, xtype, 100, 0, ...)
35 endif

```

This may not work in a heterogeneous environment if the value of `size` is not the same on process 1 and process 0. There should be no problem in a homogeneous environment. To communicate in a heterogeneous environment, there are at least four options. The first is to declare variables of default type and use the MPI datatypes for these types, e.g., declare a variable of type `REAL` and use `MPI_REAL`. The second is to use `selected_real_kind` or `selected_int_kind` and with the functions of the previous section. The third is to declare a variable that is known to be the same size on all architectures (e.g., `selected_real_kind(12)` on almost all compilers will result in an 8-byte representation). The fourth is to carefully check representation size before communication. This may require explicit conversion to a variable of size that can be communicated and handshaking between sender and receiver to agree on a size.

Note finally that using the “external32” representation for I/O requires explicit attention to the representation sizes. Consider the following code:

```

real(selected_real_kind(5)) x(100)
call MPI_SIZEOF(x, size, ierror)
call MPI_TYPE_MATCH_SIZE(MPI_TYPECLASS_REAL, size, xtype, ierror)

if (myrank .eq. 0) then
  call MPI_FILE_OPEN(MPI_COMM_SELF, 'foo',
                    MPI_MODE_CREATE+MPI_MODE_WRONLY,
                    MPI_INFO_NULL, fh, ierror)
  call MPI_FILE_SET_VIEW(fh, zero, xtype, xtype, 'external32',
                        MPI_INFO_NULL, ierror)
  call MPI_FILE_WRITE(fh, x, 100, xtype, status, ierror)
  call MPI_FILE_CLOSE(fh, ierror)
endif

call MPI_BARRIER(MPI_COMM_WORLD, ierror)

if (myrank .eq. 1) then
  call MPI_FILE_OPEN(MPI_COMM_SELF, 'foo', MPI_MODE_RDONLY,
                    MPI_INFO_NULL, fh, ierror)
  call MPI_FILE_SET_VIEW(fh, zero, xtype, xtype, 'external32',
                        MPI_INFO_NULL, ierror)
  call MPI_FILE_WRITE(fh, x, 100, xtype, status, ierror)
  call MPI_FILE_CLOSE(fh, ierror)
endif

```

If processes 0 and 1 are on different machines, this code may not work as expected if the size is different on the two machines. (*End of advice to users.*)

18.1.10 Problems With Fortran Bindings for MPI

This section discusses a number of problems that may arise when using MPI in a Fortran program. It is intended as advice to users, and clarifies how MPI interacts with Fortran. It is intended to clarify, not add to, this standard.

As noted in the original MPI specification, the interface violates the Fortran standard in several ways. While these may cause few problems for Fortran 77 programs, they become more significant for Fortran 90 programs, so that users must exercise care when using new Fortran 90 features. With Fortran 2008 and the new semantics defined in TS 29113, most violations are resolved, and this is hinted at in an addendum to each item. The violations were originally adopted and have been retained because they are important for the usability of MPI. The rest of this section describes the potential problems in detail.

The following MPI features are inconsistent with Fortran 90 and Fortran 77.

1. An MPI subroutine with a choice argument may be called with different argument types. When using the `mpi_f08` module together with a compiler that supports Fortran 2008 + TS 29113, this problem is resolved.

- 1 2. An MPI subroutine with an assumed-size dummy argument may be passed an actual
2 scalar argument. This is only solved for choice buffers through the use of
3 DIMENSION(...).
- 4
- 5 3. Nonblocking and split-collective MPI routines assume that actual arguments are passed
6 by address or descriptor and that arguments and the associated data are not copied
7 on entrance to or exit from the subroutine. This problem is solved with the use of the
8 ASYNCHRONOUS attribute.
- 9
- 10 4. An MPI implementation may read or modify user data (e.g., communication buffers
11 used by nonblocking communications) concurrently with a user program that is ex-
12 ecuting outside of MPI calls. This problem is resolved by relying on the extended
13 semantics of the ASYNCHRONOUS attribute as specified in TS 29113.
- 14
- 15 5. Several named “constants,” such as MPI_BOTTOM, MPI_IN_PLACE,
16 MPI_STATUS_IGNORE, MPI_STATUSES_IGNORE, MPI_ERRCODES_IGNORE,
17 MPI_UNWEIGHTED, MPI_WEIGHTS_EMPTY, MPI_ARGV_NULL, and MPI_ARGVS_NULL
18 are not ordinary Fortran constants and require a special implementation. See Sec-
19 tion 2.5.4 for more information.
- 20 6. The memory allocation routine MPI_ALLOC_MEM cannot be used from
21 Fortran 77/90/95 without a language extension (for example, Cray pointers) that
22 allows the allocated memory to be associated with a Fortran variable. Therefore,
23 address sized integers were used in MPI-2.0 – MPI-2.2. In Fortran 2003,
24 TYPE(C_PTR) entities were added, which allow a standard-conforming implementation
25 of the semantics of MPI_ALLOC_MEM. In MPI-3.0 and later, MPI_ALLOC_MEM has
26 an additional, overloaded interface to support this language feature. The use of Cray
27 pointers is deprecated. The mpi_f08 module only supports TYPE(C_PTR) pointers.

28 Additionally, MPI is inconsistent with Fortran 77 in a number of ways, as noted below.

- 29
- 30 • MPI identifiers exceed 6 characters.
- 31
- 32 • MPI identifiers may contain underscores after the first character.
- 33
- 34 • MPI requires an include file, `mpif.h`. On systems that do not support include files,
35 the implementation should specify the values of named constants.
- 36 • Many routines in MPI have KIND-parameterized integers (e.g., MPI_ADDRESS_KIND
37 and MPI_OFFSET_KIND) that hold address information. On systems that do not sup-
38 port Fortran 90-style parameterized types, `INTEGER*8` or `INTEGER` should be used
39 instead.

40 MPI-1 contained several routines that take address-sized information as input or return
41 address-sized information as output. In C such arguments were of type `MPI_Aint` and in
42 Fortran of type `INTEGER`. On machines where integers are smaller than addresses, these
43 routines can lose information. In MPI-2 the use of these functions has been deprecated and
44 they have been replaced by routines taking `INTEGER` arguments of `KIND=MPI_ADDRESS_KIND`.
45 A number of new MPI-2 functions also take `INTEGER` arguments of non-default `KIND`. See
46 Section 2.6 and Section 4.1.1 for more information.

47 Sections 18.1.11 through 18.1.19 describe several problems in detail which concern
48 the interaction of MPI and Fortran as well as their solutions. Some of these solutions

require special capabilities from the compilers. Major requirements are summarized in Section 18.1.7.

18.1.11 Problems Due to Strong Typing

All MPI functions with choice arguments associate actual arguments of different Fortran datatypes with the same dummy argument. This is not allowed by Fortran 77, and in Fortran 90, it is technically only allowed if the function is overloaded with a different function for each type (see also Section 18.1.6). In C, the use of `void*` formal arguments avoids these problems. Similar to C, with Fortran 2008 + TS 29113 (and later) together with the `mpi_f08` module, the problem is avoided by declaring choice arguments with `TYPE(*)`, `DIMENSION(..)`, i.e., as assumed-type and assumed-rank dummy arguments.

Using `INCLUDE 'mpif.h'`, the following code fragment is technically invalid and may generate a compile-time error.

```
integer i(5)
real    x(5)
...
call mpi_send(x, 5, MPI_REAL, ...)
call mpi_send(i, 5, MPI_INTEGER, ...)
```

In practice, it is rare for compilers to do more than issue a warning. When using either the `mpi_f08` or `mpi` module, the problem is usually resolved through the assumed-type and assumed-rank declarations of the dummy arguments, or with a compiler-dependent mechanism that overrides type checking for choice arguments.

It is also technically invalid in Fortran to pass a scalar actual argument to an array dummy argument that is not a choice buffer argument. Thus, when using the `mpi_f08` or `mpi` module, the following code fragment usually generates an error since the `dims` and `periods` arguments to `MPI_CART_CREATE` are declared as assumed size arrays `INTEGER :: DIMS(*)` and `LOGICAL :: PERIODS(*)`.

```
USE mpi_f08      ! or USE mpi
INTEGER size
CALL MPI_Cart_create( comm_old,1,size,.TRUE.,.TRUE.,comm_cart,ierror )
```

Although this is a non-conforming MPI call, compiler warnings are not expected (but may occur) when using `INCLUDE 'mpif.h'` and this include file does not use Fortran explicit interfaces.

18.1.12 Problems Due to Data Copying and Sequence Association with Subscript Triplets

Arrays with subscript **triplets** describe Fortran subarrays with or without strides, e.g.,

```
REAL a(100,100,100)
CALL MPI_Send( a(11:17, 12:99:3, 1:100), 7*30*100, MPI_REAL, ...)
```

The handling of subscript triplets depends on the value of the constant `MPI_SUBARRAYS_SUPPORTED`:

- If `MPI_SUBARRAYS_SUPPORTED` equals `.TRUE.:`

Choice buffer arguments are declared as `TYPE(*)`, `DIMENSION(..)`. For example, consider the following code fragment:

```

REAL s(100), r(100)
CALL MPI_Isend(s(1:100:5), 3, MPI_REAL, ..., rq, ierror)
CALL MPI_Wait(rq, status, ierror)
CALL MPI_Irecv(r(1:100:5), 3, MPI_REAL, ..., rq, ierror)
CALL MPI_Wait(rq, status, ierror)

```

In this case, the individual elements `s(1)`, `s(6)`, and `s(11)` are sent between the start of `MPI_ISEND` and the end of `MPI_WAIT` even though the compiled code will not copy `s(1:100:5)` to a real contiguous temporary scratch buffer. Instead, the compiled code will pass a descriptor to `MPI_ISEND` that allows MPI to operate directly on `s(1)`, `s(6)`, `s(11)`, ..., `s(96)`. The called `MPI_ISEND` routine will take only the first three of these elements due to the type signature “3, `MPI_REAL`”.

All nonblocking MPI functions (e.g., `MPI_ISEND`, `MPI_PUT`, `MPI_FILE_WRITE_ALL_BEGIN`) behave as if *the user-specified elements of choice buffers are copied to a contiguous scratch buffer in the MPI runtime environment*. All datatype descriptions (in the example above, “3, `MPI_REAL`”) read and store data from and to this virtual contiguous scratch buffer. Displacements in MPI derived datatypes are relative to the beginning of this virtual contiguous scratch buffer. Upon completion of a nonblocking receive operation (e.g., when `MPI_WAIT` on a corresponding `MPI_Request` returns), it is as if the received data has been copied from the virtual contiguous scratch buffer back to the non-contiguous application buffer. In the example above, `r(1)`, `r(6)`, and `r(11)` are guaranteed to be defined with the received data when `MPI_WAIT` returns.

Note that the above definition does not supercede restrictions about buffers used with non-blocking operations (e.g., those specified in Section 3.7.2).

Advice to implementors. The Fortran descriptor for `TYPE(*)`, `DIMENSION(..)` arguments contains enough information that, if desired, the MPI library can make a real contiguous copy of non-contiguous user buffers when the nonblocking operation is started, and release this buffer not before the nonblocking communication has completed (e.g., the `MPI_WAIT` routine). Efficient implementations may avoid such additional memory-to-memory data copying. (*End of advice to implementors.*)

Rationale. If `MPI_SUBARRAYS_SUPPORTED` equals `.TRUE.`, non-contiguous buffers are handled inside the MPI library instead of by the compiler through argument association conventions. Therefore, the scope of MPI library scratch buffers can be from the beginning of a nonblocking operation until the completion of the operation although beginning and completion are implemented in different routines. (*End of rationale.*)

- If `MPI_SUBARRAYS_SUPPORTED` equals `.FALSE.:`

In this case, the use of Fortran arrays with subscript triplets as actual choice buffer arguments in any nonblocking MPI operation (which also includes persistent request, and split collectives) may cause undefined behavior. They may, however, be used in blocking MPI operations.

Implicit in MPI is the idea of a contiguous chunk of memory accessible through a linear address space. MPI copies data to and from this memory. An MPI program specifies the location of data by providing memory addresses and offsets. In the C language, sequence association rules plus pointers provide all the necessary low-level structure.

In Fortran, array data is not necessarily stored contiguously. For example, the array section `A(1:N:2)` involves only the elements of `A` with indices 1, 3, 5, The same is true for a pointer array whose target is such a section. Most compilers ensure that an array that is a dummy argument is held in contiguous memory if it is declared with an explicit shape (e.g., `B(N)`) or is of assumed size (e.g., `B(*)`). If necessary, they do this by making a copy of the array into contiguous memory.¹

Because MPI dummy buffer arguments are assumed-size arrays if `MPI_SUBARRAYS_SUPPORTED` equals `.FALSE.`, this leads to a serious problem for a nonblocking call: the compiler copies the temporary array back on return but MPI continues to copy data to the memory that held it. For example, consider the following code fragment:

```
real a(100)
call MPI_IRecv(a(1:100:2), MPI_REAL, 50, ...)
```

Since the first dummy argument to `MPI_IRecv` is an assumed-size array (`<type> buf(*)`), the array section `a(1:100:2)` is copied to a temporary before being passed to `MPI_IRecv`, so that it is contiguous in memory. `MPI_IRecv` returns immediately, and data is copied from the temporary back into the array `a`. Sometime later, MPI may write to the address of the deallocated temporary. Copying is also a problem for `MPI_Isend` since the temporary array may be deallocated before the data has all been sent from it.

Most Fortran 90 compilers do not make a copy if the actual argument is the whole of an explicit-shape or assumed-size array or is a “simply contiguous” section such as `A(1:N)` of such an array. (“Simply contiguous” is defined in the next paragraph.) Also, many compilers treat allocatable arrays the same as they treat explicit-shape arrays in this regard (though we know of one that does not). However, the same is not true for assumed-shape and pointer arrays; since they may be discontinuous, copying is often done. It is this copying that causes problems for MPI as described in the previous paragraph.

According to the Fortran 2008 Standard, Section 6.5.4, a “simply contiguous” array section is

```
name ( [ :, ] ... [ <subscript> ] : [ <subscript> ] [ , <subscript> ] ... )
```

¹Technically, the Fortran standard is worded to allow non-contiguous storage of any array data, unless the dummy argument has the `CONTIGUOUS` attribute.

1 That is, there are zero or more dimensions that are selected in full, then one dimension
 2 selected without a stride, then zero or more dimensions that are selected with a simple
 3 subscript. The compiler can detect from analyzing the source code that the array is
 4 contiguous. Examples are

```
5
6     A(1:N), A(:,N), A(:,1:N,1), A(1:6,N), A(:, :, 1:N)
```

7
 8 Because of Fortran’s column-major ordering, where the first index varies fastest, a
 9 “simply contiguous” section of a contiguous array will also be contiguous.

10 The same problem can occur with a scalar argument. A compiler may make a copy of
 11 scalar dummy arguments within a called procedure when passed as an actual argument
 12 to a choice buffer routine. That this can cause a problem is illustrated by the example
 13

```
14
15     real :: a
16     call user1(a,rq)
17     call MPI_WAIT(rq,status,ierr)
18     write (*,*) a
19
20     subroutine user1(buf,request)
21     call MPI_Irecv(buf,...,request,...)
22     end
```

23
 24 If `a` is copied, `MPI_Irecv` will alter the copy when it completes the communication
 25 and will not alter `a` itself.

26 Note that copying will almost certainly occur for an argument that is a non-trivial
 27 expression (one with at least one operator or function call), a section that does not
 28 select a contiguous part of its parent (e.g., `A(1:n:2)`), a pointer whose target is such
 29 a section, or an assumed-shape array that is (directly or indirectly) associated with
 30 such a section.
 31

32 If a compiler option exists that inhibits copying of arguments, in either the calling or
 33 called procedure, this must be employed.

34 If a compiler makes copies in the calling procedure of arguments that are explicit-
 35 shape or assumed-size arrays, “simply contiguous” array sections of such arrays, or
 36 scalars, and if no compiler option exists to inhibit such copying, then the compiler
 37 cannot be used for applications that use `MPI_GET_ADDRESS`, or any nonblocking
 38 MPI routine. If a compiler copies scalar arguments in the called procedure and there
 39 is no compiler option to inhibit this, then this compiler cannot be used for applications
 40 that use memory references across subroutine calls as in the example above.
 41

42 18.1.13 Problems Due to Data Copying and Sequence Association with Vector Subscripts

43 Fortran arrays with **vector** subscripts describe subarrays containing a possibly irregular
 44 set of elements
 45

```
46
47     REAL a(100)
48     CALL MPI_Send( A((/7,9,23,81,82/)), 5, MPI_REAL, ...)
```

Fortran arrays with a vector subscript must not be used as actual choice buffer arguments in any nonblocking or split collective MPI operations. They may, however, be used in blocking MPI operations.

18.1.14 Special Constants

MPI requires a number of special “constants” that cannot be implemented as normal Fortran constants, e.g., `MPI_BOTTOM`. The complete list can be found in Section 2.5.4. In C, these are implemented as constant pointers, usually as `NULL` and are used where the function prototype calls for a pointer to a variable, not the variable itself.

In Fortran, using special values for the constants (e.g., by defining them through `parameter` statements) is not possible because an implementation cannot distinguish these values from valid data. Typically these constants are implemented as predefined static variables (e.g., a variable in an MPI-declared `COMMON` block), relying on the fact that the target compiler passes data by address. Inside the subroutine, the address of the actual choice buffer argument can be compared with the address of such a predefined static variable.

These special constants also cause an exception with the usage of Fortran `INTENT`: with `USE mpi_f08`, the attributes `INTENT(IN)`, `INTENT(OUT)`, and `INTENT(INOUT)` are used in the Fortran interface. In most cases, `INTENT(IN)` is used if the C interface uses call-by-value. For all buffer arguments and for dummy arguments that may be modified and allow one of these special constants as input, an `INTENT` is not specified.

18.1.15 Fortran Derived Types

MPI supports passing Fortran entities of `BIND(C)` and `SEQUENCE` derived types to choice dummy arguments, provided no type component has the `ALLOCATABLE` or `POINTER` attribute.

The following code fragment shows some possible ways to send scalars or arrays of interoperable derived type in Fortran. The example assumes that all data is passed by address.

```

type, BIND(C) :: mytype
  integer :: i
  real :: x
  double precision :: d
  logical :: l
end type mytype

type(mytype) :: foo, fooarr(5)
integer :: blocklen(4), type(4)
integer(KIND=MPI_ADDRESS_KIND) :: disp(4), base, lb, extent

call MPI_GET_ADDRESS(foo%i, disp(1), ierr)
call MPI_GET_ADDRESS(foo%x, disp(2), ierr)
call MPI_GET_ADDRESS(foo%d, disp(3), ierr)
call MPI_GET_ADDRESS(foo%l, disp(4), ierr)

base = disp(1)
disp(1) = disp(1) - base
disp(2) = disp(2) - base

```

```

1      disp(3) = disp(3) - base
2      disp(4) = disp(4) - base
3
4      blocklen(1) = 1
5      blocklen(2) = 1
6      blocklen(3) = 1
7      blocklen(4) = 1
8
9      type(1) = MPI_INTEGER
10     type(2) = MPI_REAL
11     type(3) = MPI_DOUBLE_PRECISION
12     type(4) = MPI_LOGICAL
13
14     call MPI_TYPE_CREATE_STRUCT(4, blocklen, disp, type, newtype, ierr)
15     call MPI_TYPE_COMMIT(newtype, ierr)
16
17     call MPI_SEND(foo%i, 1, newtype, dest, tag, comm, ierr)
18     ! or
19     call MPI_SEND(foo, 1, newtype, dest, tag, comm, ierr)
20     ! expects that base == address(foo%i) == address(foo)
21
22     call MPI_GET_ADDRESS(fooarr(1), disp(1), ierr)
23     call MPI_GET_ADDRESS(fooarr(2), disp(2), ierr)
24     extent = disp(2) - disp(1)
25     lb = 0
26     call MPI_TYPE_CREATE_RESIZED(newtype, lb, extent, newarrtype, ierr)
27     call MPI_TYPE_COMMIT(newarrtype, ierr)
28
29     call MPI_SEND(fooarr, 5, newarrtype, dest, tag, comm, ierr)
30

```

Using the derived type variable `foo` instead of its first basic type element `foo%i` may be impossible if the MPI library implements choice buffer arguments through overloading instead of using `TYPE(*)`, `DIMENSION(..)`, or through a non-standardized extension such as `!$PRAGMA IGNORE_TKR`; see Section 18.1.6.

To use a derived type in an array requires a correct extent of the datatype handle to take care of the alignment rules applied by the compiler. These alignment rules may imply that there are gaps between the components of a derived type, and also between the subsequent elements of an array of a derived type. The extent of an interoperable derived type (i.e., defined with `BIND(C)`) and a `SEQUENCE` derived type with the same content may be different because C and Fortran may apply different alignment rules. As recommended in the advice to users in Section 4.1.6, one should add an additional fifth structure element with one numerical storage unit at the end of this structure to force in most cases that the array of structures is contiguous. Even with such an additional element, one should keep this resizing due to the special alignment rules that can be used by the compiler for structures, as also mentioned in this advice.

Using the extended semantics defined in TS 29113, it is also possible to use entities or derived types without either the `BIND(C)` or the `SEQUENCE` attribute as choice buffer arguments; some additional constraints must be observed, e.g., no `ALLOCATABLE` or `POINTER`

type components may exist. In this case, the `base` address in the example must be changed to become the address of `foo` instead of `foo%i`, because the Fortran compiler may rearrange type components or add padding. Sending the structure `foo` should then also be performed by providing it (and not `foo%i`) as actual argument for `MPI_Send`.

18.1.16 Optimization Problems, an Overview

MPI provides operations that may be hidden from the user code and run concurrently with it, accessing the same memory as user code. Examples include the data transfer for an `MPI_IRECV`. The optimizer of a compiler will assume that it can recognize periods when a copy of a variable can be kept in a register without reloading from or storing to memory. When the user code is working with a register copy of some variable while the hidden operation reads or writes the memory copy, problems occur. These problems are independent of the Fortran support method; i.e., they occur with the `mpi_f08` module, the `mpi` module, and the `mpif.h` include file.

This section shows four problematic usage areas (the abbreviations in parentheses are used in the table below):

- Use of nonblocking routines or persistent requests (*Nonbl.*).
- Use of one-sided routines (*1-sided*).
- Use of MPI parallel file I/O split collective operations (*Split*).
- Use of `MPI_BOTTOM` together with absolute displacements in MPI datatypes, or relative displacements between two variables in such datatypes (*Bottom*).

The following compiler optimization strategies (valid for serial code) may cause problems in MPI applications:

- Code movement and register optimization problems; see Section 18.1.17.
- Temporary data movement and temporary memory modifications; see Section 18.1.18.
- Permanent data movement (e.g., through garbage collection); see Section 18.1.19.

Table 18.2 shows the only usage areas where these optimization problems may occur.

Optimization may cause a problem in following usage areas			
	Nonbl.	1-sided	Split	Bottom
Code movement and register optimization	yes	yes	no	yes
Temporary data movement	yes	yes	yes	no
Permanent data movement	yes	yes	yes	yes

Table 18.2: Occurrence of Fortran optimization problems in several usage areas

The solutions in the following sections are based on compromises:

- 1 • to minimize the burden for the application programmer, e.g., as shown in Sections
- 2 “Solutions” through “The (Poorly Performing) Fortran VOLATILE Attribute” on
- 3 pages 677–682,
- 4
- 5 • to minimize the drawbacks on compiler based optimization, and
- 6
- 7 • to minimize the requirements defined in Section 18.1.7.

18.1.17 Problems with Code Movement and Register Optimization

10 Nonblocking Operations

11 If a variable is local to a Fortran subroutine (i.e., not in a module or a `COMMON` block), the
 12 compiler will assume that it cannot be modified by a called subroutine unless it is an actual
 13 argument of the call. In the most common linkage convention, the subroutine is expected
 14 to save and restore certain registers. Thus, the optimizer will assume that a register which
 15 held a valid copy of such a variable before the call will still hold a valid copy on return.
 16

17 **Example 18.1** Fortran 90 register optimization — extreme.

19 Source	compiled as	or compiled as
20		
21 REAL :: buf, b1	REAL :: buf, b1	REAL :: buf, b1
22 call MPI_IRecv(buf,..req)	call MPI_IRecv(buf,..req)	call MPI_IRecv(buf,..req)
	register = buf	b1 = buf
23 call MPI_WAIT(req,..)	call MPI_WAIT(req,..)	call MPI_WAIT(req,..)
24 b1 = buf	b1 = register	
25		

26

27 Example 18.1 shows extreme, but allowed, possibilities. `MPI_WAIT` on a concurrent
 28 thread modifies `buf` between the invocation of `MPI_IRecv` and the completion of `MPI_WAIT`.
 29 But the compiler cannot see any possibility that `buf` can be changed after `MPI_IRecv` has
 30 returned, and may schedule the load of `buf` earlier than typed in the source. The compiler
 31 has no reason to avoid using a register to hold `buf` across the call to `MPI_WAIT`. It also may
 32 reorder the instructions as illustrated in the rightmost column.

33

34 **Example 18.2** Similar example with `MPI_ISEND`

36 Source	compiled as	with a possible MPI-internal execution sequence
37		
38 REAL :: buf, copy	REAL :: buf, copy	REAL :: buf, copy
39 buf = val	buf = val	buf = val
40 call MPI_ISEND(buf,..req)	call MPI_ISEND(buf,..req)	addr = &buf
41 copy = buf	copy = buf	copy = buf
	buf = val_overwrite	buf = val_overwrite
42 call MPI_WAIT(req,..)	call MPI_WAIT(req,..)	call send(*addr) ! within
		! MPI_WAIT
44 buf = val_overwrite		
45		

46

47 Due to valid compiler code movement optimizations in Example 18.2, the content of
 48 `buf` may already have been overwritten by the compiler when the content of `buf` is sent.

The code movement is permitted because the compiler cannot detect a possible access to `buf` in `MPI_WAIT` (or in a second thread between the start of `MPI_ISEND` and the end of `MPI_WAIT`).

Such register optimization is based on moving code; here, the access to `buf` was moved from after `MPI_WAIT` to before `MPI_WAIT`. Note that code movement may also occur across subroutine boundaries when subroutines or functions are inlined.

This register optimization/code movement problem for nonblocking operations does not occur with MPI parallel file I/O split collective operations, because in the `..._BEGIN` and `..._END` calls, the same buffer has to be provided as an actual argument. The register optimization / code movement problem for `MPI_BOTTOM` and derived MPI datatypes may occur in each blocking and nonblocking communication call, as well as in each parallel file I/O operation.

Persistent Operations

With persistent requests, the buffer argument is hidden from the `MPI_START` and `MPI_STARTALL` calls, i.e., the Fortran compiler may move buffer accesses across the `MPI_START` or `MPI_STARTALL` call, similar to the `MPI_WAIT` call as described in the Nonblocking Operations subsection in Section 18.1.17.

One-sided Communication

An example with instruction reordering due to register optimization can be found in Section 11.7.4.

MPI_BOTTOM and Combining Independent Variables in Datatypes

This section is only relevant if the MPI program uses a buffer argument to an `MPI_SEND`, `MPI_RECV`, etc., that hides the actual variables involved in the communication. `MPI_BOTTOM` with an `MPI_Datatype` containing *absolute addresses* is one example. Creating a datatype which uses one variable as an anchor and brings along others by using `MPI_GET_ADDRESS` to determine their offsets from the anchor is another. The anchor variable would be the only one referenced in the call. Also attention must be paid if MPI operations are used that run in parallel with the user's application.

Example 18.3 shows what Fortran compilers are allowed to do.

In Example 18.3, the compiler does not invalidate the register because it cannot see that `MPI_RECV` changes the value of `buf`. The access to `buf` is hidden by the use of `MPI_GET_ADDRESS` and `MPI_BOTTOM`.

In Example 18.4, several successive assignments to the same variable `buf` can be combined in a way such that only the last assignment is executed. "Successive" means that no interfering load access to this variable occurs between the assignments. The compiler cannot detect that the call to `MPI_SEND` statement is interfering because the load access to `buf` is hidden by the usage of `MPI_BOTTOM`.

Solutions

The following sections show in detail how the problems with code movement and register optimization can be portably solved. Application writers can partially or fully avoid these compiler optimization problems by using one or more of the special Fortran declarations

Example 18.3 Fortran 90 register optimization.

<pre> 1 2 3 This source ... 4 5 call MPI_GET_ADDRESS(buf,bufaddr, 6 ierror) 7 call MPI_TYPE_CREATE_STRUCT(1,1, 8 bufaddr, 9 MPI_REAL,type,ierror) 10 call MPI_TYPE_COMMIT(type,ierror) 11 val_old = buf 12 13 call MPI_RECV(MPI_BOTTOM,1,type,...) 14 val_new = buf </pre>	<pre> can be compiled as: call MPI_GET_ADDRESS(buf,...) call MPI_TYPE_CREATE_STRUCT(...) call MPI_TYPE_COMMIT(...) register = buf val_old = register call MPI_RECV(MPI_BOTTOM,...) val_new = register </pre>
--	--

Example 18.4 Similar example with MPI_SEND

<pre> 18 This source ... 19 20 ! buf contains val_old 21 buf = val_new 22 call MPI_SEND(MPI_BOTTOM,1,type,...) 23 ! with buf as a displacement in type 24 25 26 27 28 29 buf = val_overwrite </pre>	<pre> can be compiled as: ! buf contains val_old call MPI_SEND(...) ! i.e. val_old is sent ! ! buf=val_new is moved to here ! and detected as dead code ! and therefore removed ! buf = val_overwrite </pre>
---	--

with the send and receive buffers used in nonblocking operations, or in operations in which MPI_BOTTOM is used, or if datatype handles that combine several variables are used:

- Use of the Fortran `ASYNCHRONOUS` attribute.
- Use of the helper routine `MPI_F_SYNC_REG`, or an equivalent user-written dummy routine.
- Declare the buffer as a Fortran module variable or within a Fortran common block.
- Use of the Fortran `VOLATILE` attribute.

Each of these methods solves the problems of code movement and register optimization, but may incur various degrees of performance impact, and may not be usable in every application context. These methods may not be guaranteed by the Fortran standard, but they must be guaranteed by a MPI-3.0 (and later) compliant MPI library and associated compiler suite according to the requirements listed in Section 18.1.7. The performance impact of using `MPI_F_SYNC_REG` is expected to be low, that of using module variables or the `ASYNCHRONOUS` attribute is expected to be low to medium, and that of using the

VOLATILE attribute is expected to be high or very high. Note that there is one attribute that cannot be used for this purpose: the Fortran TARGET attribute does not solve code movement problems in MPI applications.

The Fortran ASYNCHRONOUS Attribute

Declaring an actual buffer argument with the ASYNCHRONOUS Fortran attribute in a scoping unit (or BLOCK) informs the compiler that any statement in the scoping unit may be executed while the buffer is affected by a pending asynchronous Fortran input/output operation (since Fortran 2003) or by an asynchronous communication (TS 29113 extension). Without the extensions specified in TS 29113, a Fortran compiler may totally ignore this attribute if the Fortran compiler implements asynchronous Fortran input/output operations with blocking I/O. The ASYNCHRONOUS attribute protects the buffer accesses from optimizations through code movements across routine calls, and the buffer itself from temporary and permanent data movements. If the choice buffer dummy argument of a nonblocking MPI routine is declared with ASYNCHRONOUS (which is mandatory for the mpi_f08 module, with allowable exceptions listed in Section 18.1.6), then the compiler has to guarantee call by reference and should report a compile-time error if call by reference is impossible, e.g., if vector subscripts are used. The MPI_ASYNC_PROTECTS_NONBLOCKING is set to .TRUE. if both the protection of the actual buffer argument through ASYNCHRONOUS according to the TS 29113 extension and the declaration of the dummy argument with ASYNCHRONOUS in the Fortran support method is guaranteed for all nonblocking routines, otherwise it is set to .FALSE..

The ASYNCHRONOUS attribute has some restrictions. Section 5.4.2 of the TS 29113 specifies:

“Asynchronous communication for a Fortran variable occurs through the action of procedures defined by means other than Fortran. It is initiated by execution of an asynchronous communication initiation procedure and completed by execution of an asynchronous communication completion procedure. Between the execution of the initiation and completion procedures, any variable of which any part is associated with any part of the asynchronous communication variable is a pending communication affector. Whether a procedure is an asynchronous communication initiation or completion procedure is processor dependent.

Asynchronous communication is either input communication or output communication. For input communication, a pending communication affector shall not be referenced, become defined, become undefined, become associated with a dummy argument that has the VALUE attribute, or have its pointer association status changed. For output communication, a pending communication affector shall not be redefined, become undefined, or have its pointer association status changed.”

In Example 18.5 Case (a) on page 685, the read accesses to **b** within `function(b(i-1), b(i), b(i+1))` cannot be moved by compiler optimizations to before the wait call because **b** was declared as ASYNCHRONOUS. Note that only the elements 0, 1, 100, and 101 of **b** are involved in asynchronous communication but by definition, the total variable **b** is the pending communication affector and is usable for input and output asynchronous communication between the MPI_I... routines and MPI_Waitall. Case (a) works fine because the read accesses to **b** occur after the communication has completed.

In Case (b), the read accesses to `b(1:100)` in the loop `i=2,99` are read accesses to a pending communication affector while input communication (i.e., the two `MPI_Irecv` calls) is pending. This is a contradiction to the rule that *for input communication, a pending communication affector shall not be referenced*. The problem can be solved by using separate variables for the halos and the inner array, or by splitting a common array into disjoint subarrays which are passed through different dummy arguments into a subroutine, as shown in Example 18.9.

If one does not overlap communication and computation on the same variable, then all optimization problems can be solved through the `ASYNCHRONOUS` attribute.

The problems with `MPI_BOTTOM`, as shown in Example 18.3 and Example 18.4, can also be solved by declaring the buffer `buf` with the `ASYNCHRONOUS` attribute.

In some MPI routines, a buffer dummy argument is defined as `ASYNCHRONOUS` to guarantee passing by reference, provided that the actual argument is also defined as `ASYNCHRONOUS`.

Calling `MPI_F_SYNC_REG`

The compiler may be prevented from moving a reference to a buffer across a call to an MPI subroutine by surrounding the call by calls to an external subroutine with the buffer as an actual argument. The MPI library provides the `MPI_F_SYNC_REG` routine for this purpose; see Section 18.1.8.

- The problems illustrated by the Examples 18.1 and 18.2 can be solved by calling `MPI_F_SYNC_REG(buf)` once immediately after `MPI_WAIT`.

Example 18.1

can be solved with

```
call MPI_IRecv(buf, ..req)
```

```
call MPI_WAIT(req, ..)
```

```
call MPI_F_SYNC_REG(buf)
```

```
b1 = buf
```

Example 18.2

can be solved with

```
buf = val
```

```
call MPI_ISEND(buf, ..req)
```

```
copy = buf
```

```
call MPI_WAIT(req, ..)
```

```
call MPI_F_SYNC_REG(buf)
```

```
buf = val_overwrite
```

The call to `MPI_F_SYNC_REG(buf)` prevents moving the last line before the `MPI_WAIT` call. Further calls to `MPI_F_SYNC_REG(buf)` are not needed because it is still correct if the additional read access `copy=buf` is moved below `MPI_WAIT` and before `buf=val_overwrite`.

- The problems illustrated by the Examples 18.3 and 18.4 can be solved with two additional `MPI_F_SYNC_REG(buf)` statements; one directly before `MPI_RECV/` `MPI_SEND`, and one directly after this communication operation.

Example 18.3

can be solved with

```
call MPI_F_SYNC_REG(buf)
```

```
call MPI_RECV(MPI_BOTTOM, ...)
```

```
call MPI_F_SYNC_REG(buf)
```

Example 18.4

can be solved with

```
call MPI_F_SYNC_REG(buf)
```

```
call MPI_SEND(MPI_BOTTOM, ...)
```

```
call MPI_F_SYNC_REG(buf)
```

The first call to `MPI_F_SYNC_REG(buf)` is needed to finish all load and store references to `buf` prior to `MPI_RECV/MPI_SEND`; the second call is needed to assure that any subsequent access to `buf` is not moved before `MPI_RECV/SEND`.

- In the example in Section 11.7.4, two asynchronous accesses must be protected: in Process 1, the access to `bbbb` must be protected similar to Example 18.1, i.e., a call to `MPI_F_SYNC_REG(bbbb)` is needed after the second `MPI_WIN_FENCE` to guarantee that further accesses to `bbbb` are not moved ahead of the call to `MPI_WIN_FENCE`. In Process 2, both calls to `MPI_WIN_FENCE` together act as a communication call with `MPI_BOTTOM` as the buffer. That is, before the first fence and after the second fence, a call to `MPI_F_SYNC_REG(buff)` is needed to guarantee that accesses to `buff` are not moved after or ahead of the calls to `MPI_WIN_FENCE`. Using `MPI_GET` instead of `MPI_PUT`, the same calls to `MPI_F_SYNC_REG` are necessary.

Source of Process 1

```
bbbb = 777

call MPI_WIN_FENCE
call MPI_PUT(bbbb
into buff of process 2)
```

```
call MPI_WIN_FENCE
call MPI_F_SYNC_REG(bbbb)
```

Source of Process 2

```
buff = 999
call MPI_F_SYNC_REG(buff)
call MPI_WIN_FENCE

call MPI_WIN_FENCE
call MPI_F_SYNC_REG(buff)
ccc = buff
```

- The temporary memory modification problem, i.e., Example 18.6, can **not** be solved with this method.

A User Defined Routine Instead of `MPI_F_SYNC_REG`

Instead of `MPI_F_SYNC_REG`, one can also use a user defined external subroutine, which is separately compiled:

```
subroutine DD(buf)
  integer buf
end
```

Note that if the intent is declared in an explicit interface for the external subroutine, it must be `OUT` or `INOUT`. The subroutine itself may have an empty body, but the compiler does not know this and has to assume that the buffer may be altered. For example, a call to `MPI_RECV` with `MPI_BOTTOM` as buffer might be replaced by

```
call DD(buf)
call MPI_RECV(MPI_BOTTOM, ...)
call DD(buf)
```

Such a user-defined routine was introduced in MPI-2.0 and is still included here to document such usage in existing application programs although new applications should prefer `MPI_F_SYNC_REG` or one of the other possibilities. In an existing application, calls to

1 such a user-written routine should be substituted by a call to `MPI_F_SYNC_REG` because
2 the user-written routine may not be implemented in accordance with the rules specified in
3 Section 18.1.7.

4 5 Module Variables and COMMON Blocks

6
7 An alternative to the previously mentioned methods is to put the buffer or variable into a
8 module or a common block and access it through a `USE` or `COMMON` statement in each scope
9 where it is referenced, defined or appears as an actual argument in a call to an MPI routine.
10 The compiler will then have to assume that the MPI procedure may alter the buffer or
11 variable, provided that the compiler cannot infer that the MPI procedure does not reference
12 the module or common block.

- 13 • This method solves problems of instruction reordering, code movement, and register
14 optimization related to nonblocking and one-sided communication, or related to the
15 usage of `MPI_BOTTOM` and derived datatype handles.
- 16
17 • Unfortunately, this method does **not** solve problems caused by asynchronous accesses
18 between the start and end of a nonblocking or one-sided communication. Specifically,
19 problems caused by temporary memory modifications are not solved.

20 21 The (Poorly Performing) Fortran VOLATILE Attribute

22
23 The `VOLATILE` attribute gives the buffer or variable the properties needed to avoid register
24 optimization or code movement problems, but it may inhibit optimization of any code
25 containing references or definitions of the buffer or variable. On many modern systems, the
26 performance impact will be large because not only register, but also cache optimizations
27 will not be applied. Therefore, use of the `VOLATILE` attribute to enforce correct execution
28 of MPI programs is discouraged.

29 30 The Fortran TARGET Attribute

31
32 The `TARGET` attribute does not solve the code movement problem because it is not specified
33 for the choice buffer dummy arguments of nonblocking routines. If the compiler detects that
34 the application program specifies the `TARGET` attribute for an actual buffer argument used
35 in the call to a nonblocking routine, the compiler may ignore this attribute if no pointer
36 reference to this buffer exists.

37 *Rationale.* The Fortran standardization body decided to extend the `ASYNCHRONOUS`
38 attribute within the TS 29113 to protect buffers in nonblocking calls from all kinds of
39 optimization, instead of extending the `TARGET` attribute. (*End of rationale.*)

40 41 18.1.18 Temporary Data Movement and Temporary Memory Modification

42
43 The compiler is allowed to temporarily modify data in memory. Normally, this problem
44 may occur only when overlapping communication and computation, as in Example 18.5,
45 Case (b) on page 685. Example 18.6 also shows a possibility that could be problematic.

46 In the compiler-generated, possible optimization in Example 18.7, `buf(100,100)` from
47 Example 18.6 is equivalenced with the 1-dimensional array `buf_1dim(10000)`. The nonblock-
48 ing receive may asynchronously receive the data in the boundary `buf(1,1:100)` while the fused

loop is temporarily using this part of the buffer. When the `tmp` data is written back to `buf`, the previous data of `buf(1,1:100)` is restored and the received data is lost. The principle behind this optimization is that the receive buffer data `buf(1,1:100)` was temporarily moved to `tmp`.

Example 18.8 shows a second possible optimization. The whole array is temporarily moved to `local_buf`.

When storing `local_buf` back to the original location `buf`, then this implies overwriting the section of `buf` that serves as a receive buffer in the nonblocking MPI call, i.e., this storing back of `local_buf` is therefore likely to interfere with asynchronously received data in `buf(1,1:100)`.

Note that this problem may also occur:

- With the local buffer at the origin process, between an RMA communication call and the ensuing synchronization call; see Chapter 11.
- With the window buffer at the target process between two ensuing RMA synchronization calls.
- With the local buffer in MPI parallel file I/O split collective operations between the `..._BEGIN` and `..._END` calls; see Section 13.4.5.

As already mentioned in subsection *The Fortran ASYNCHRONOUS attribute* on page 679 of Section 18.1.17, the `ASYNCHRONOUS` attribute can prevent compiler optimization with temporary data movement, but only if the receive buffer and the local references are separated into different variables, as shown in Example 18.9 and in Example 18.10.

Note also that the methods

- calling `MPI_F_SYNC_REG` (or such a user-defined routine),
- using module variables and `COMMON` blocks, and
- the `TARGET` attribute

cannot be used to prevent such temporary data movement. These methods influence compiler optimization when library routines are called. They cannot prevent the optimizations of the code fragments shown in Example 18.6 and 18.7.

Note also that compiler optimization with temporary data movement should **not** be prevented by declaring `buf` as `VOLATILE` because the `VOLATILE` implies that all accesses to any storage unit (word) of `buf` must be directly done in the main memory exactly in the sequence defined by the application program. The `VOLATILE` attribute prevents all register and cache optimizations. Therefore, `VOLATILE` may cause a huge performance degradation.

Instead of solving the problem, it is better to **prevent** the problem: when overlapping communication and computation, the nonblocking communication (or nonblocking or split collective I/O) and the computation should be executed **on different variables**, and the communication should be *protected* with the `ASYNCHRONOUS` attribute. In this case, the temporary memory modifications are done only on the variables used in the computation and cannot have any side effect on the data used in the nonblocking MPI operations.

Rationale. This is a strong restriction for application programs. To weaken this restriction, a new or modified asynchronous feature in the Fortran language would be necessary: an asynchronous attribute that can be used on parts of an array and

1 together with asynchronous operations outside the scope of Fortran. If such a feature
2 becomes available in a future edition of the Fortran standard, then this restriction
3 also may be weakened in a later version of the MPI standard. (*End of rationale.*)
4

5 In Example 18.9 (which is a solution for the problem shown in Example 18.5 and
6 in Example 18.10 (which is a solution for the problem shown in Example 18.8), the ar-
7 ray is split into inner and halo part and both disjoint parts are passed to a subroutine
8 `separated_sections`. This routine overlaps the receiving of the halo data and the calcu-
9 lations on the inner part of the array. In a second step, the whole array is used to do the
10 calculation on the elements where inner+halo is needed. Note that the halo and the inner
11 area are strided arrays. Those can be used in non-blocking communication only with a TS
12 29113 based MPI library.
13

14 18.1.19 Permanent Data Movement

15 A Fortran compiler may implement permanent data movement during the execution of a
16 Fortran program. This would require that pointers to such data are appropriately updated.
17 An implementation with automatic garbage collection is one use case. Such permanent data
18 movement is in conflict with MPI in several areas:
19

- 20 • MPI datatype handles with absolute addresses in combination with `MPI_BOTTOM`.
- 21
- 22 • All nonblocking MPI operations if the internally used pointers to the buffers are not
23 updated by the Fortran runtime, or if within an MPI process, the data movement is
24 executed in parallel with the MPI operation.
25

26 This problem can be also solved by using the `ASYNCHRONOUS` attribute for such buffers.
27 This MPI standard requires that the problems with permanent data movement do not
28 occur by imposing suitable restrictions on the MPI library together with the compiler used;
29 see Section 18.1.7.
30

31 18.1.20 Comparison with C

32 In C, subroutines which modify variables that are not in the argument list will not cause
33 register optimization problems. This is because taking pointers to storage objects by using
34 the `&` operator and later referencing the objects by indirection on the pointer is an integral
35 part of the language. A C compiler understands the implications, so that the problem should
36 not occur, in general. However, some compilers do offer optional aggressive optimization
37 levels which may not be safe. Problems due to temporary memory modifications can also
38 occur in C. As above, the best advice is to avoid the problem: use different variables for
39 buffers in nonblocking MPI operations and computation that is executed while a nonblocking
40 operation is pending.
41
42
43
44
45
46
47
48

Example 18.5 Protecting nonblocking communication with the `ASYNCHRONOUS` attribute.

```

USE mpi_f08
REAL, ASYNCHRONOUS :: b(0:101) ! elements 0 and 101 are halo cells
REAL :: bnew(0:101)           ! elements 1 and 100 are newly computed
TYPE(MPI_Request) :: req(4)
INTEGER :: left, right, i
CALL MPI_Cart_shift(...,left,right,...)
CALL MPI_Irecv(b( 0), ..., left, ..., req(1), ...)
CALL MPI_Irecv(b(101), ..., right, ..., req(2), ...)
CALL MPI_Isend(b( 1), ..., left, ..., req(3), ...)
CALL MPI_Isend(b(100), ..., right, ..., req(4), ...)

#ifdef WITHOUT_OVERLAPPING_COMMUNICATION_AND_COMPUTATION
! Case (a)
  CALL MPI_Waitall(4,req,...)
  DO i=1,100 ! compute all new local data
    bnew(i) = function(b(i-1), b(i), b(i+1))
  END DO
#endif

#ifdef WITH_OVERLAPPING_COMMUNICATION_AND_COMPUTATION
! Case (b)
  DO i=2,99 ! compute only elements for which halo data is not needed
    bnew(i) = function(b(i-1), b(i), b(i+1))
  END DO
  CALL MPI_Waitall(4,req,...)
  i=1 ! compute leftmost element
  bnew(i) = function(b(i-1), b(i), b(i+1))
  i=100 ! compute rightmost element
  bnew(i) = function(b(i-1), b(i), b(i+1))
#endif

```

Example 18.6 Overlapping Communication and Computation.

```

USE mpi_f08
REAL :: buf(100,100)
CALL MPI_Irecv(buf(1,1:100),...req,...)
DO j=1,100
  DO i=2,100
    buf(i,j)=....
  END DO
END DO
CALL MPI_Wait(req,...)

```

1
2
3
4
5
6
7
8
9
10
11
12
13
14
15
16
17
18
19
20
21
22
23
24
25
26
27
28
29
30
31
32
33
34
35
36
37
38
39
40
41
42
43
44
45
46
47
48

Example 18.7 The compiler may substitute the nested loops through loop fusion.

```
REAL :: buf(100,100), buf_1dim(10000)
EQUIVALENCE (buf(1,1), buf_1dim(1))
CALL MPI_Irecv(buf(1,1:100),...req,...)
tmp(1:100) = buf(1,1:100)
DO j=1,10000
  buf_1dim(h)=...
END DO
buf(1,1:100) = tmp(1:100)
CALL MPI_Wait(req,...)
```

Example 18.8 Another optimization is based on the usage of a separate memory storage area, e.g., in a GPU.

```
REAL :: buf(100,100), local_buf(100,100)
CALL MPI_Irecv(buf(1,1:100),...req,...)
local_buf = buf
DO j=1,100
  DO i=2,100
    local_buf(i,j)=....
  END DO
END DO
buf = local_buf ! may overwrite asynchronously received
                ! data in buf(1,1:100)
CALL MPI_Wait(req,...)
```

Example 18.9 Using separated variables for overlapping communication and computation to allow the protection of nonblocking communication with the ASYNCHRONOUS attribute.

```

USE mpi_f08
REAL :: b(0:101)      ! elements 0 and 101 are halo cells
REAL :: bnew(0:101)  ! elements 1 and 100 are newly computed
INTEGER :: i
CALL separated_sections(b(0), b(1:100), b(101), bnew(0:101))
i=1 ! compute leftmost element
  bnew(i) = function(b(i-1), b(i), b(i+1))
i=100 ! compute rightmost element
  bnew(i) = function(b(i-1), b(i), b(i+1))
END

SUBROUTINE separated_sections(b_lefthalo, b_inner, b_righthalo, bnew)
USE mpi_f08
REAL, ASYNCHRONOUS :: b_lefthalo(0:0), b_inner(1:100), b_righthalo(101:101)
REAL :: bnew(0:101) ! elements 1 and 100 are newly computed
TYPE(MPI_Request) :: req(4)
INTEGER :: left, right, i
CALL MPI_Cart_shift(...,left,right,...)
CALL MPI_Irecv(b_lefthalo ( 0), ..., left, ..., req(1), ...)
CALL MPI_Irecv(b_righthalo(101), ..., right, ..., req(2), ...)
! b_lefthalo and b_righthalo is written asynchronously.
! There is no other concurrent access to b_lefthalo and b_righthalo.
CALL MPI_Isend(b_inner( 1), ..., left, ..., req(3), ...)
CALL MPI_Isend(b_inner(100), ..., right, ..., req(4), ...)

DO i=2,99 ! compute only elements for which halo data is not needed
  bnew(i) = function(b_inner(i-1), b_inner(i), b_inner(i+1))
  ! b_inner is read and sent at the same time.
  ! This is allowed based on the rules for ASYNCHRONOUS.
END DO
CALL MPI_Waitall(4,req,...)
END SUBROUTINE

```

1
2
3
4
5
6
7
8
9
10
11
12
13
14
15
16
17
18
19
20
21
22
23
24
25
26
27
28
29
30
31
32
33
34
35
36
37
38
39
40
41
42
43
44
45
46
47
48

Example 18.10 Protecting GPU optimizations with the ASYNCHRONOUS attribute.

```
USE mpi_f08
REAL :: buf(100,100)
CALL separated_sections(buf(1:1,1:100), buf(2:100,1:100))
END

SUBROUTINE separated_sections(buf_halo, buf_inner)
REAL, ASYNCHRONOUS :: buf_halo(1:1,1:100)
REAL :: buf_inner(2:100,1:100)
REAL :: local_buf(2:100,100)

CALL MPI_Irecv(buf_halo(1,1:100),...req,...)
local_buf = buf_inner
DO j=1,100
  DO i=2,100
    local_buf(i,j)=....
  END DO
END DO
buf_inner = local_buf ! buf_halo is not touched!!!

CALL MPI_Wait(req,...)
```

18.2 Language Interoperability

18.2.1 Introduction

It is not uncommon for library developers to use one language to develop an application library that may be called by an application program written in a different language. MPI currently supports ISO (previously ANSI) C and Fortran bindings. It should be possible for applications in any of the supported languages to call MPI-related functions in another language.

Moreover, MPI allows the development of client-server code, with MPI communication used between a parallel client and a parallel server. It should be possible to code the server in one language and the clients in another language. To do so, communications should be possible between applications written in different languages.

There are several issues that need to be addressed in order to achieve interoperability.

Initialization We need to specify how the MPI environment is initialized for all languages.

Interlanguage passing of MPI opaque objects We need to specify how MPI object handles are passed between languages. We also need to specify what happens when an MPI object is accessed in one language, to retrieve information (e.g., attributes) set in another language.

Interlanguage communication We need to specify how messages sent in one language can be received in another language.

It is highly desirable that the solution for interlanguage interoperability be extensible to new languages, should MPI bindings be defined for such languages.

18.2.2 Assumptions

We assume that conventions exist for programs written in one language to call routines written in another language. These conventions specify how to link routines in different languages into one program, how to call functions in a different language, how to pass arguments between languages, and the correspondence between basic data types in different languages. In general, these conventions will be implementation dependent. Furthermore, not every basic datatype may have a matching type in other languages. For example, C character strings may not be compatible with Fortran CHARACTER variables. However, we assume that a Fortran INTEGER, as well as a (sequence associated) Fortran array of INTEGERS, can be passed to a C program. We also assume that Fortran and C have address-sized integers. This does not mean that the default-size integers are the same size as default-sized pointers, but only that there is some way to hold (and pass) a C address in a Fortran integer. It is also assumed that INTEGER(KIND=MPI_OFFSET_KIND) can be passed from Fortran to C as MPI_Offset.

18.2.3 Initialization

A call to MPI_INIT or MPI_INIT_THREAD, from any language, initializes MPI for execution in all languages.

Advice to users. Certain implementations use the (inout) argc, argv arguments of the C version of MPI_INIT in order to propagate values for argc and argv to all

1 executing processes. Use of the Fortran version of MPI_INIT to initialize MPI may
2 result in a loss of this ability. (*End of advice to users.*)

3
4 The function MPI_INITIALIZED returns the same answer in all languages.

5 The function MPI_FINALIZE finalizes the MPI environments for all languages.

6 The function MPI_FINALIZED returns the same answer in all languages.

7 The function MPI_ABORT kills processes, irrespective of the language used by the
8 caller or by the processes killed.

9 The MPI environment is initialized in the same manner for all languages by
10 MPI_INIT. E.g., MPI_COMM_WORLD carries the same information regardless of language:
11 same processes, same environmental attributes, same error handlers.

12 Information can be added to info objects in one language and retrieved in another.

13
14 *Advice to users.* The use of several languages in one MPI program may require the
15 use of special options at compile and/or link time. (*End of advice to users.*)

16
17 *Advice to implementors.* Implementations may selectively link language specific MPI
18 libraries only to codes that need them, so as not to increase the size of binaries for codes
19 that use only one language. The MPI initialization code need perform initialization for
20 a language only if that language library is loaded. (*End of advice to implementors.*)

21 22 18.2.4 Transfer of Handles

23 Handles are passed between Fortran and C by using an explicit C wrapper to convert Fortran
24 handles to C handles. There is no direct access to C handles in Fortran.

25 The type definition MPI_Fint is provided in C for an integer of the size that matches a
26 Fortran INTEGER; usually, MPI_Fint will be equivalent to int. With the Fortran mpi module
27 or the mpif.h include file, a Fortran handle is a Fortran INTEGER value that can be used in
28 the following conversion functions. With the Fortran mpi_f08 module, a Fortran handle is a
29 BIND(C) derived type that contains an INTEGER component named MPI_VAL. This INTEGER
30 value can be used in the following conversion functions.

31 The following functions are provided in C to convert from a Fortran communicator
32 handle (which is an integer) to a C communicator handle, and vice versa. See also Sec-
33 tion 2.6.4.

34 MPI_Comm MPI_Comm_f2c(MPI_Fint comm)

35
36 If comm is a valid Fortran handle to a communicator, then MPI_Comm_f2c returns a
37 valid C handle to that same communicator; if comm = MPI_COMM_NULL (Fortran value),
38 then MPI_Comm_f2c returns a null C handle; if comm is an invalid Fortran handle, then
39 MPI_Comm_f2c returns an invalid C handle.

40 MPI_Fint MPI_Comm_c2f(MPI_Comm comm)

41 The function MPI_Comm_c2f translates a C communicator handle into a Fortran handle
42 to the same communicator; it maps a null handle into a null handle and an invalid handle
43 into an invalid handle.

44 Similar functions are provided for the other types of opaque objects.

45 MPI_Datatype MPI_Type_f2c(MPI_Fint datatype)

46
47 MPI_Fint MPI_Type_c2f(MPI_Datatype datatype)

```

MPI_Group MPI_Group_f2c(MPI_Fint group)           1
MPI_Fint MPI_Group_c2f(MPI_Group group)          2
MPI_Request MPI_Request_f2c(MPI_Fint request)    3
MPI_Fint MPI_Request_c2f(MPI_Request request)    4
MPI_File MPI_File_f2c(MPI_Fint file)            5
MPI_Fint MPI_File_c2f(MPI_File file)            6
MPI_Win MPI_Win_f2c(MPI_Fint win)               7
MPI_Fint MPI_Win_c2f(MPI_Win win)              8
MPI_Op MPI_Op_f2c(MPI_Fint op)                 9
MPI_Fint MPI_Op_c2f(MPI_Op op)                10
MPI_Info MPI_Info_f2c(MPI_Fint info)           11
MPI_Fint MPI_Info_c2f(MPI_Info info)           12
MPI_Errhandler MPI_Errhandler_f2c(MPI_Fint errhandler) 13
MPI_Fint MPI_Errhandler_c2f(MPI_Errhandler errhandler) 14
MPI_Message MPI_Message_f2c(MPI_Fint message) 15
MPI_Fint MPI_Message_c2f(MPI_Message message) 16

```

Example 18.11 The example below illustrates how the Fortran MPI function `MPI_TYPE_COMMIT` can be implemented by wrapping the C MPI function `MPI_Type_commit` with a C wrapper to do handle conversions. In this example a Fortran-C interface is assumed where a Fortran function is all upper case when referred to from C and arguments are passed by addresses.

```

! FORTRAN PROCEDURE                               17
SUBROUTINE MPI_TYPE_COMMIT( DATATYPE, IERR)       18
INTEGER :: DATATYPE, IERR                        19
CALL MPI_X_TYPE_COMMIT(DATATYPE, IERR)           20
RETURN                                           21
END                                               22

/* C wrapper */                                  23

void MPI_X_TYPE_COMMIT( MPI_Fint *f_handle, MPI_Fint *ierr) 24
{
    MPI_Datatype datatype;                        25

    datatype = MPI_Type_f2c( *f_handle);         26
    *ierr = (MPI_Fint)MPI_Type_commit( &datatype); 27
    *f_handle = MPI_Type_c2f(datatype);          28
    return;                                       29
}

```

1 }
 2

3 The same approach can be used for all other MPI functions. The call to MPI_XXX_f2c
 4 (resp. MPI_XXX_c2f) can be omitted when the handle is an OUT (resp. IN) argument,
 5 rather than INOUT.

6
 7 *Rationale.* The design here provides a convenient solution for the prevalent case,
 8 where a C wrapper is used to allow Fortran code to call a C library, or C code to
 9 call a Fortran library. The use of C wrappers is much more likely than the use of
 10 Fortran wrappers, because it is much more likely that a variable of type INTEGER can
 11 be passed to C, than a C handle can be passed to Fortran.

12 Returning the converted value as a function value rather than through the argument
 13 list allows the generation of efficient inlined code when these functions are simple
 14 (e.g., the identity). The conversion function in the wrapper does not catch an invalid
 15 handle argument. Instead, an invalid handle is passed below to the library function,
 16 which, presumably, checks its input arguments. (*End of rationale.*)

17 18.2.5 Status

18
 19 The following two procedures are provided in C to convert from a Fortran (with the `mpi`
 20 module or `mpif.h`) status (which is an array of integers) to a C status (which is a structure),
 21 and vice versa. The conversion occurs on all the information in status, including that which
 22 is hidden. That is, no status information is lost in the conversion.

```
23 int MPI_Status_f2c(const MPI_Fint *f_status, MPI_Status *c_status)
```

24
 25 If `f_status` is a valid Fortran status, but not the Fortran value of `MPI_STATUS_IGNORE`
 26 or `MPI_STATUSES_IGNORE`, then `MPI_Status_f2c` returns in `c_status` a valid C status with
 27 the same content. If `f_status` is the Fortran value of `MPI_STATUS_IGNORE` or
 28 `MPI_STATUSES_IGNORE`, or if `f_status` is not a valid Fortran status, then the call is erroneous.

29 The C status has the same source, tag and error code values as the Fortran status,
 30 and returns the same answers when queried for count, elements, and cancellation. The
 31 conversion function may be called with a Fortran status argument that has an undefined
 32 error field, in which case the value of the error field in the C status argument is undefined.

33 Two global variables of type `MPI_Fint*`, `MPI_F_STATUS_IGNORE` and
 34 `MPI_F_STATUSES_IGNORE` are declared in `mpi.h`. They can be used to test, in C, whether
 35 `f_status` is the Fortran value of `MPI_STATUS_IGNORE` or `MPI_STATUSES_IGNORE` defined in
 36 the `mpi` module or `mpif.h`. These are global variables, not C constant expressions and
 37 cannot be used in places where C requires constant expressions. Their value is defined only
 38 between the calls to `MPI_INIT` and `MPI_FINALIZE` and should not be changed by user code.

39 To do the conversion in the other direction, we have the following:

```
40 int MPI_Status_c2f(const MPI_Status *c_status, MPI_Fint *f_status)
```

41
 42 This call converts a C status into a Fortran status, and has a behavior similar to
 43 `MPI_Status_f2c`. That is, the value of `c_status` must not be either `MPI_STATUS_IGNORE` or
 44 `MPI_STATUSES_IGNORE`.

45
 46 *Advice to users.* There exists no separate conversion function for arrays of statuses,
 47 since one can simply loop through the array, converting each status with the routines
 48 in Figure 18.1. (*End of advice to users.*)

Rationale. The handling of MPI_STATUS_IGNORE is required in order to layer libraries with only a C wrapper: if the Fortran call has passed MPI_STATUS_IGNORE, then the C wrapper must handle this correctly. Note that this constant need not have the same value in Fortran and C. If MPI_Status_f2c were to handle MPI_STATUS_IGNORE, then the type of its result would have to be MPI_Status**, which was considered an inferior solution. (*End of rationale.*)

Using the mpi_f08 Fortran module, a status is declared as TYPE(MPI_Status). The C type MPI_F08_status can be used to pass a Fortran TYPE(MPI_Status) argument into a C routine. Figure 18.1 illustrates all status conversion routines. Some are only available in C, some in both C and Fortran.

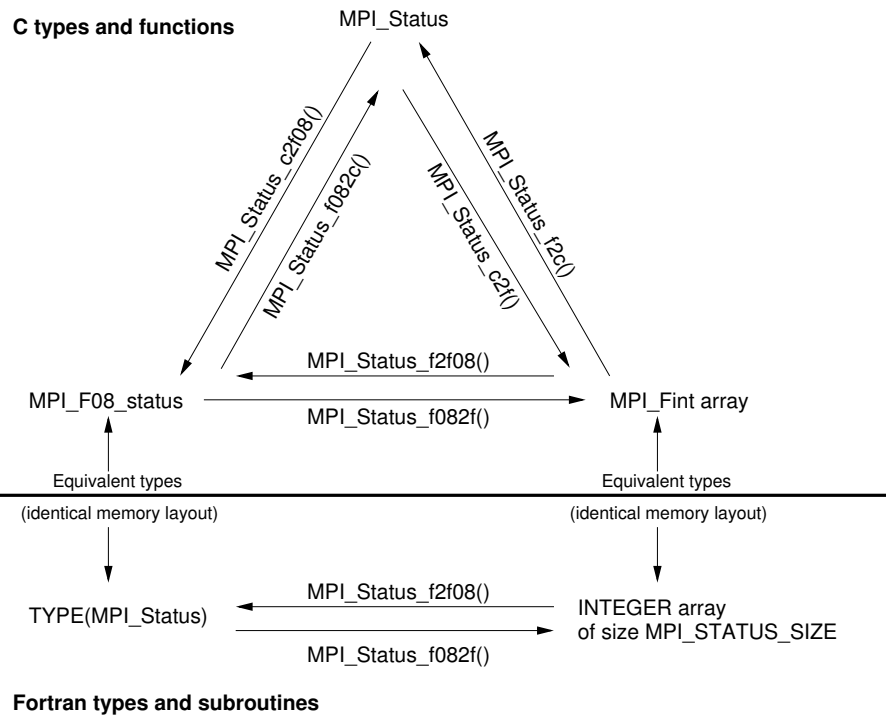

Figure 18.1: Status conversion routines

```
int MPI_Status_f082c(const MPI_F08_status *f08_status,
                    MPI_Status *c_status)
```

This C routine converts a Fortran mpi_f08 TYPE(MPI_Status) into a C MPI_Status.

```
int MPI_Status_c2f08(const MPI_Status *c_status,
                    MPI_F08_status *f08_status)
```

This C routine converts a C MPI_Status into a Fortran mpi_f08 TYPE(MPI_Status). Two global variables of type MPI_F08_status*, MPI_F08_STATUS_IGNORE and MPI_F08_STATUSES_IGNORE are declared in mpi.h. They can be used to test, in C, whether f_status is the Fortran value of MPI_STATUS_IGNORE or MPI_STATUSES_IGNORE defined in the mpi_f08 module. These are global variables, not C constant expressions and cannot be used in places where C requires constant expressions. Their value is defined only between the calls to MPI_INIT and MPI_FINALIZE and should not be changed by user code.

Conversion between the two Fortran versions of a status can be done with:

```

1      Conversion between the two Fortran versions of a status can be done with:
2
3
4      MPI_STATUS_F2F08(f_status, f08_status)
5          IN          f_status          status object declared as array
6          OUT          f08_status       status object declared as named type
7
8
9      int MPI_Status_f2f08(MPI_Fint *f_status, MPI_F08_status *f08_status)
10
11     MPI_Status_f2f08(f_status, f08_status, ierror)
12         INTEGER, INTENT(IN) :: f_status(MPI_STATUS_SIZE)
13         TYPE(MPI_Status), INTENT(OUT) :: f08_status
14         INTEGER, OPTIONAL, INTENT(OUT) :: ierror
15
16     MPI_STATUS_F2F08(F_STATUS, F08_STATUS, IERROR)
17         INTEGER :: F_STATUS(MPI_STATUS_SIZE)
18         TYPE(MPI_Status) :: F08_STATUS
19         INTEGER IERROR

```

This routine converts a Fortran INTEGER, DIMENSION(MPI_STATUS_SIZE) status array into a Fortran mpi_f08 TYPE(MPI_Status).

```

21
22
23     MPI_STATUS_F082F(f08_status, f_status)
24         IN          f08_status       status object declared as named type
25         OUT          f_status       status object declared as array
26
27
28     int MPI_Status_f082f(MPI_F08_status *f08_status, MPI_Fint *f_status)
29
30     MPI_Status_f082f(f08_status, f_status, ierror)
31         TYPE(MPI_Status), INTENT(IN) :: f08_status
32         INTEGER, INTENT(OUT) :: f_status(MPI_STATUS_SIZE)
33         INTEGER, OPTIONAL, INTENT(OUT) :: ierror
34
35     MPI_STATUS_F082F(F08_STATUS, F_STATUS, IERROR)
36         TYPE(MPI_Status) :: F08_STATUS
37         INTEGER :: F_STATUS(MPI_STATUS_SIZE)
38         INTEGER IERROR

```

This routine converts a Fortran mpi_f08 TYPE(MPI_Status) into a Fortran INTEGER, DIMENSION(MPI_STATUS_SIZE) status array.

18.2.6 MPI Opaque Objects

Unless said otherwise, opaque objects are “the same” in all languages: they carry the same information, and have the same meaning in both languages. The mechanism described in the previous section can be used to pass references to MPI objects from language to language. An object created in one language can be accessed, modified or freed in another language.

We examine below in more detail issues that arise for each type of MPI object.

Datatypes

Datatypes encode the same information in all languages. E.g., a datatype accessor like `MPI_TYPE_GET_EXTENT` will return the same information in all languages. If a datatype defined in one language is used for a communication call in another language, then the message sent will be identical to the message that would be sent from the first language: the same communication buffer is accessed, and the same representation conversion is performed, if needed. All predefined datatypes can be used in datatype constructors in any language. If a datatype is committed, it can be used for communication in any language.

The function `MPI_GET_ADDRESS` returns the same value in all languages. Note that we do not require that the constant `MPI_BOTTOM` have the same value in all languages (see Section 18.2.9).

Example 18.12

```

! FORTRAN CODE
REAL :: R(5)
INTEGER :: TYPE, IERR, AOBLN(1), AOTYPE(1)
INTEGER (KIND=MPI_ADDRESS_KIND) :: AODISP(1)

! create an absolute datatype for array R
AOBLN(1) = 5
CALL MPI_GET_ADDRESS( R, AODISP(1), IERR)
AOTYPE(1) = MPI_REAL
CALL MPI_TYPE_CREATE_STRUCT(1, AOBLN,AODISP,AOTYPE, TYPE, IERR)
CALL C_ROUTINE(TYPE)

/* C code */

void C_ROUTINE(MPI_Fint *ftype)
{
    int count = 5;
    int lens[2] = {1,1};
    MPI_Aint displs[2];
    MPI_Datatype types[2], newtype;

    /* create an absolute datatype for buffer that consists
    /* of count, followed by R(5)

    MPI_Get_address(&count, &displs[0]);
    displs[1] = 0;
    types[0] = MPI_INT;
    types[1] = MPI_Type_f2c(*ftype);
    MPI_Type_create_struct(2, lens, displs, types, &newtype);
    MPI_Type_commit(&newtype);

    MPI_Send(MPI_BOTTOM, 1, newtype, 1, 0, MPI_COMM_WORLD);
    /* the message sent contains an int count of 5, followed
    /* by the 5 REAL entries of the Fortran array R.

```

1 }
 2

3 *Advice to implementors.* The following implementation can be used: MPI addresses,
 4 as returned by `MPI_GET_ADDRESS`, will have the same value in all languages. One
 5 obvious choice is that MPI addresses be identical to regular addresses. The address
 6 is stored in the datatype, when datatypes with absolute addresses are constructed.
 7 When a send or receive operation is performed, then addresses stored in a datatype
 8 are interpreted as displacements that are all augmented by a base address. This base
 9 address is (the address of) `buf`, or zero, if `buf = MPI_BOTTOM`. Thus, if `MPI_BOTTOM`
 10 is zero then a send or receive call with `buf = MPI_BOTTOM` is implemented exactly
 11 as a call with a regular buffer argument: in both cases the base address is `buf`. On the
 12 other hand, if `MPI_BOTTOM` is not zero, then the implementation has to be slightly
 13 different. A test is performed to check whether `buf = MPI_BOTTOM`. If true, then the
 14 base address is zero, otherwise it is `buf`. In particular, if `MPI_BOTTOM` does not have
 15 the same value in Fortran and C, then an additional test for `buf = MPI_BOTTOM` is
 16 needed in at least one of the languages.

17 It may be desirable to use a value other than zero for `MPI_BOTTOM` even in C, so as
 18 to distinguish it from a NULL pointer. If `MPI_BOTTOM = c` then one can still avoid
 19 the test `buf = MPI_BOTTOM`, by using the displacement from `MPI_BOTTOM`, i.e., the
 20 regular address - `c`, as the MPI address returned by `MPI_GET_ADDRESS` and stored
 21 in absolute datatypes. (*End of advice to implementors.*)

22 Callback Functions

23
 24 MPI calls may associate callback functions with MPI objects: error handlers are associ-
 25 ated with communicators and files, attribute copy and delete functions are associated with
 26 attribute keys, reduce operations are associated with operation objects, etc. In a multilan-
 27 guage environment, a function passed in an MPI call in one language may be invoked by an
 28 MPI call in another language. MPI implementations must make sure that such invocation
 29 will use the calling convention of the language the function is bound to.
 30

31 *Advice to implementors.* Callback functions need to have a language tag. This
 32 tag is set when the callback function is passed in by the library function (which is
 33 presumably different for each language and language support method), and is used
 34 to generate the right calling sequence when the callback function is invoked. (*End of*
 35 *advice to implementors.*)

36 *Advice to users.* If a subroutine written in one language or Fortran support method
 37 wants to pass a callback routine including the predefined Fortran functions (e.g.,
 38 `MPI_COMM_NULL_COPY_FN`) to another application routine written in another lan-
 39 guage or Fortran support method, then it must be guaranteed that both routines use
 40 the callback interface definition that is defined for the argument when passing the
 41 callback to an MPI routine (e.g., `MPI_COMM_CREATE_KEYVAL`); see also the advice
 42 to users on page 291. (*End of advice to users.*)
 43

44 Error Handlers

45
 46 *Advice to implementors.* Error handlers, have, in C, a variable length argument list.
 47 It might be useful to provide to the handler information on the language environment
 48 where the error occurred. (*End of advice to implementors.*)

Reduce Operations

All predefined named and unnamed datatypes as listed in Section 5.9.2 can be used in the listed predefined operations independent of the programming language from which the MPI routine is called.

Advice to users. Reduce operations receive as one of their arguments the datatype of the operands. Thus, one can define “polymorphic” reduce operations that work for C and Fortran datatypes. (*End of advice to users.*)

18.2.7 Attributes

Attribute keys can be allocated in one language and freed in another. Similarly, attribute values can be set in one language and accessed in another. To achieve this, attribute keys will be allocated in an integer range that is valid all languages. The same holds true for system-defined attribute values (such as `MPI_TAG_UB`, `MPI_WTIME_IS_GLOBAL`, etc.).

Attribute keys declared in one language are associated with copy and delete functions in that language (the functions provided by the `MPI_{TYPE,COMM,WIN}_CREATE_KEYVAL` call). When a communicator is duplicated, for each attribute, the corresponding copy function is called, using the right calling convention for the language of that function; and similarly, for the delete callback function.

Advice to implementors. This requires that attributes be tagged either as “C” or “Fortran” and that the language tag be checked in order to use the right calling convention for the callback function. (*End of advice to implementors.*)

The attribute manipulation functions described in Section 6.7 defines attributes arguments to be of type `void*` in C, and of type `INTEGER`, in Fortran. On some systems, `INTEGER`s will have 32 bits, while C pointers will have 64 bits. This is a problem if communicator attributes are used to move information from a Fortran caller to a C callee, or vice-versa.

MPI behaves as if it stores, internally, address sized attributes. If Fortran `INTEGER`s are smaller, then the (deprecated) Fortran function `MPI_ATTR_GET` will return the least significant part of the attribute word; the (deprecated) Fortran function `MPI_ATTR_PUT` will set the least significant part of the attribute word, which will be sign extended to the entire word. (These two functions may be invoked explicitly by user code, or implicitly, by attribute copying callback functions.)

As for addresses, new functions are provided that manipulate Fortran address sized attributes, and have the same functionality as the old functions in C. These functions are described in Section 6.7. Users are encouraged to use these new functions.

MPI supports two types of attributes: address-valued (pointer) attributes, and integer-valued attributes. C attribute functions put and get address-valued attributes. Fortran attribute functions put and get integer-valued attributes. When an integer-valued attribute is accessed from C, then `MPI_XXX_get_attr` will return the address of (a pointer to) the integer-valued attribute, which is a pointer to `MPI_Aint` if the attribute was stored with Fortran `MPI_XXX_SET_ATTR`, and a pointer to `int` if it was stored with the deprecated Fortran `MPI_ATTR_PUT`. When an address-valued attribute is accessed from Fortran, then `MPI_XXX_GET_ATTR` will convert the address into an integer and return the result of this conversion. This conversion is lossless if new style attribute functions are used, and an integer of kind `MPI_ADDRESS_KIND` is returned. The conversion may cause truncation if

1 deprecated attribute functions are used. In C, the deprecated routines `MPI_Attr_put` and
 2 `MPI_Attr_get` behave identical to `MPI_Comm_set_attr` and `MPI_Comm_get_attr`.

4 **Example 18.13**

5 A. Setting an attribute value in C

```
6 int set_val = 3;
7 struct foo set_struct;
8
9 /* Set a value that is a pointer to an int */
10
11 MPI_Comm_set_attr(MPI_COMM_WORLD, keyval1, &set_val);
12 /* Set a value that is a pointer to a struct */
13 MPI_Comm_set_attr(MPI_COMM_WORLD, keyval2, &set_struct);
14 /* Set an integer value */
15 MPI_Comm_set_attr(MPI_COMM_WORLD, keyval3, (void *) 17);
16
```

17 B. Reading the attribute value in C

```
18
19 int flag, *get_val;
20 struct foo *get_struct;
21
22 /* Upon successful return, get_val == &set_val
23 (and therefore *get_val == 3) */
24 MPI_Comm_get_attr(MPI_COMM_WORLD, keyval1, &get_val, &flag);
25 /* Upon successful return, get_struct == &set_struct */
26 MPI_Comm_get_attr(MPI_COMM_WORLD, keyval2, &get_struct, &flag);
27 /* Upon successful return, get_val == (void*) 17 */
28 /* i.e., (MPI_Aint) get_val == 17 */
29 MPI_Comm_get_attr(MPI_COMM_WORLD, keyval3, &get_val, &flag);
30
```

31 C. Reading the attribute value with (deprecated) Fortran MPI-1 calls

```
32 LOGICAL FLAG
33 INTEGER IERR, GET_VAL, GET_STRUCT
34
35 ! Upon successful return, GET_VAL == &set_val, possibly truncated
36 CALL MPI_ATTR_GET(MPI_COMM_WORLD, KEYVAL1, GET_VAL, FLAG, IERR)
37 ! Upon successful return, GET_STRUCT == &set_struct, possibly truncated
38 CALL MPI_ATTR_GET(MPI_COMM_WORLD, KEYVAL2, GET_STRUCT, FLAG, IERR)
39 ! Upon successful return, GET_VAL == 17
40 CALL MPI_ATTR_GET(MPI_COMM_WORLD, KEYVAL3, GET_VAL, FLAG, IERR)
41
```

42 D. Reading the attribute value with Fortran MPI-2 calls

43
44
45
46
47
48

```

LOGICAL FLAG 1
INTEGER IERR 2
INTEGER (KIND=MPI_ADDRESS_KIND) GET_VAL, GET_STRUCT 3
4
! Upon successful return, GET_VAL == &set_val 5
CALL MPI_COMM_GET_ATTR(MPI_COMM_WORLD, KEYVAL1, GET_VAL, FLAG, IERR) 6
! Upon successful return, GET_STRUCT == &set_struct 7
CALL MPI_COMM_GET_ATTR(MPI_COMM_WORLD, KEYVAL2, GET_STRUCT, FLAG, IERR) 8
! Upon successful return, GET_VAL == 17 9
CALL MPI_COMM_GET_ATTR(MPI_COMM_WORLD, KEYVAL3, GET_VAL, FLAG, IERR) 10
11

```

Example 18.14 A. Setting an attribute value with the (deprecated) Fortran MPI-1 call

```

INTEGER IERR, VAL 14
VAL = 7 15
CALL MPI_ATTR_PUT(MPI_COMM_WORLD, KEYVAL, VAL, IERR) 16
17

```

B. Reading the attribute value in C

```

int flag; 20
int *value; 21
22
/* Upon successful return, value points to internal MPI storage and 23
   *value == (int) 7 */ 24
MPI_Comm_get_attr(MPI_COMM_WORLD, keyval, &value, &flag); 25
26

```

C. Reading the attribute value with (deprecated) Fortran MPI-1 calls

```

LOGICAL FLAG 29
INTEGER IERR, VALUE 30
31
! Upon successful return, VALUE == 7 32
CALL MPI_ATTR_GET(MPI_COMM_WORLD, KEYVAL, VALUE, FLAG, IERR) 33
34

```

D. Reading the attribute value with Fortran MPI-2 calls

```

LOGICAL FLAG 37
INTEGER IERR 38
INTEGER (KIND=MPI_ADDRESS_KIND) VALUE 39
40
! Upon successful return, VALUE == 7 (sign extended) 41
CALL MPI_COMM_GET_ATTR(MPI_COMM_WORLD, KEYVAL, VALUE, FLAG, IERR) 42
43

```

Example 18.15 A. Setting an attribute value via a Fortran MPI-2 call

```

1  INTEGER IERR
2  INTEGER(KIND=MPI_ADDRESS_KIND) VALUE1
3  INTEGER(KIND=MPI_ADDRESS_KIND) VALUE2
4  VALUE1 = 42
5  VALUE2 = INT(2, KIND=MPI_ADDRESS_KIND) ** 40
6
7  CALL MPI_COMM_SET_ATTR(MPI_COMM_WORLD, KEYVAL1, VALUE1, IERR)
8  CALL MPI_COMM_SET_ATTR(MPI_COMM_WORLD, KEYVAL2, VALUE2, IERR)
9

```

B. Reading the attribute value in C

```

11
12  int flag;
13  MPI_Aint *value1, *value2;
14
15  /* Upon successful return, value1 points to internal MPI storage and
16     *value1 == 42 */
17  MPI_Comm_get_attr(MPI_COMM_WORLD, keyval1, &value1, &flag);
18  /* Upon successful return, value2 points to internal MPI storage and
19     *value2 == 2^40 */
20  MPI_Comm_get_attr(MPI_COMM_WORLD, keyval2, &value2, &flag);
21

```

C. Reading the attribute value with (deprecated) Fortran MPI-1 calls

```

23
24  LOGICAL FLAG
25  INTEGER IERR, VALUE1, VALUE2
26
27  ! Upon successful return, VALUE1 == 42
28  CALL MPI_ATTR_GET(MPI_COMM_WORLD, KEYVAL1, VALUE1, FLAG, IERR)
29  ! Upon successful return, VALUE2 == 2^40, or 0 if truncation
30  ! needed (i.e., the least significant part of the attribute word)
31  CALL MPI_ATTR_GET(MPI_COMM_WORLD, KEYVAL2, VALUE2, FLAG, IERR)
32

```

D. Reading the attribute value with Fortran MPI-2 calls

```

34
35  LOGICAL FLAG
36  INTEGER IERR
37  INTEGER (KIND=MPI_ADDRESS_KIND) VALUE1, VALUE2
38
39  ! Upon successful return, VALUE1 == 42
40  CALL MPI_COMM_GET_ATTR(MPI_COMM_WORLD, KEYVAL1, VALUE1, FLAG, IERR)
41  ! Upon successful return, VALUE2 == 2^40
42  CALL MPI_COMM_GET_ATTR(MPI_COMM_WORLD, KEYVAL2, VALUE2, FLAG, IERR)
43

```

The predefined MPI attributes can be integer valued or address-valued. Predefined integer valued attributes, such as MPI_TAG_UB, behave as if they were put by a call to the deprecated Fortran routine MPI_ATTR_PUT, i.e., in Fortran, MPI_COMM_GET_ATTR(MPI_COMM_WORLD, MPI_TAG_UB, val, flag, ierr) will return in val the upper bound for tag value; in C, MPI_Comm_get_attr(MPI_COMM_WORLD,

MPI_TAG_UB, &p, &flag) will return in p a pointer to an int containing the upper bound for tag value.

Address-valued predefined attributes, such as MPI_WIN_BASE behave as if they were put by a C call, i.e., in Fortran, MPI_WIN_GET_ATTR(win, MPI_WIN_BASE, val, flag, ierror) will return in val the base address of the window, converted to an integer. In C, MPI_Win_get_attr(win, MPI_WIN_BASE, &p, &flag) will return in p a pointer to the window base, cast to (void *).

Rationale. The design is consistent with the behavior specified for predefined attributes, and ensures that no information is lost when attributes are passed from language to language. Because the language interoperability for predefined attributes was defined based on MPI_ATTR_PUT, this definition is kept for compatibility reasons although the routine itself is now deprecated. (*End of rationale.*)

Advice to implementors. Implementations should tag attributes either as (1) address attributes, (2) as INTEGER(KIND=MPI_ADDRESS_KIND) attributes or (3) as INTEGER attributes, according to whether they were set in (1) C (with MPI_Attr_put or MPI_XXX_set_attr), (2) in Fortran with MPI_XXX_SET_ATTR or (3) with the deprecated Fortran routine MPI_ATTR_PUT. Thus, the right choice can be made when the attribute is retrieved. (*End of advice to implementors.*)

18.2.8 Extra-State

Extra-state should not be modified by the copy or delete callback functions. (This is obvious from the C binding, but not obvious from the Fortran binding). However, these functions may update state that is indirectly accessed via extra-state. E.g., in C, extra-state can be a pointer to a data structure that is modified by the copy or callback functions; in Fortran, extra-state can be an index into an entry in a COMMON array that is modified by the copy or callback functions. In a multithreaded environment, users should be aware that distinct threads may invoke the same callback function concurrently: if this function modifies state associated with extra-state, then mutual exclusion code must be used to protect updates and accesses to the shared state.

18.2.9 Constants

MPI constants have the same value in all languages, unless specified otherwise. This does not apply to constant handles (MPI_INT, MPI_COMM_WORLD, MPI_ERRORS_RETURN, MPI_SUM, etc.) These handles need to be converted, as explained in Section 18.2.4. Constants that specify maximum lengths of strings (see Section A.1.1 for a listing) have a value one less in Fortran than C since in C the length includes the null terminating character. Thus, these constants represent the amount of space which must be allocated to hold the largest possible such string, rather than the maximum number of printable characters the string could contain.

Advice to users. This definition means that it is safe in C to allocate a buffer to receive a string using a declaration like

```
char name [MPI_MAX_OBJECT_NAME];
```

1 (*End of advice to users.*)

2
3 Also constant “addresses,” i.e., special values for reference arguments that are not han-
4 dles, such as MPI_BOTTOM or MPI_STATUS_IGNORE may have different values in different
5 languages.

6 *Rationale.* The current MPI standard specifies that MPI_BOTTOM can be used in
7 initialization expressions in C, but not in Fortran. Since Fortran does not normally
8 support call by value, then MPI_BOTTOM in Fortran must be the name of a predefined
9 static variable, e.g., a variable in an MPI declared COMMON block. On the other hand,
10 in C, it is natural to take MPI_BOTTOM = 0 (Caveat: Defining MPI_BOTTOM = 0
11 implies that NULL pointer cannot be distinguished from MPI_BOTTOM; it may be
12 that MPI_BOTTOM = 1 is better. See the advice to implementors in the *Datatypes*
13 subsection in Section 18.2.6) Requiring that the Fortran and C values be the same
14 will complicate the initialization process. (*End of rationale.*)

16 18.2.10 Interlanguage Communication

17
18 The type matching rules for communication in MPI are not changed: the datatype specifi-
19 cation for each item sent should match, in type signature, the datatype specification used to
20 receive this item (unless one of the types is MPI_PACKED). Also, the type of a message item
21 should match the type declaration for the corresponding communication buffer location,
22 unless the type is MPI_BYTE or MPI_PACKED. Interlanguage communication is allowed if it
23 complies with these rules.

24 **Example 18.16** In the example below, a Fortran array is sent from Fortran and received
25 in C.

```
27 ! FORTRAN CODE
28 SUBROUTINE MYEXAMPLE()
29 USE mpi_f08
30 REAL :: R(5)
31 INTEGER :: IERR, MYRANK, AOBLN(1)
32 TYPE(MPI_Datatype) :: TYPE, AOTYPE(1)
33 INTEGER (KIND=MPI_ADDRESS_KIND) :: AODISP(1)
34
35 ! create an absolute datatype for array R
36 AOBLN(1) = 5
37 CALL MPI_GET_ADDRESS( R, AODISP(1), IERR)
38 AOTYPE(1) = MPI_REAL
39 CALL MPI_TYPE_CREATE_STRUCT(1, AOBLN,AODISP,AOTYPE, TYPE, IERR)
40 CALL MPI_TYPE_COMMIT(TYPE, IERR)
41
42 CALL MPI_COMM_RANK( MPI_COMM_WORLD, MYRANK, IERR)
43 IF (MYRANK.EQ.0) THEN
44     CALL MPI_SEND( MPI_BOTTOM, 1, TYPE, 1, 0, MPI_COMM_WORLD, IERR)
45 ELSE
46     CALL C_ROUTINE(TYPE%MPI_VAL)
47 END IF
48 END SUBROUTINE
```



```
/* C code */
```

```
void C_ROUTINE(MPI_Fint *fhandle)
```

```
{
```

```
    MPI_Datatype type;
```

```
    MPI_Status status;
```

```
    type = MPI_Type_f2c(*fhandle);
```

```
    MPI_Recv( MPI_BOTTOM, 1, type, 0, 0, MPI_COMM_WORLD, &status);
```

```
}
```

MPI implementors may weaken these type matching rules, and allow messages to be sent with Fortran types and received with C types, and vice versa, when those types match. I.e., if the Fortran type `INTEGER` is identical to the C type `int`, then an MPI implementation may allow data to be sent with datatype `MPI_INTEGER` and be received with datatype `MPI_INT`. However, such code is not portable.

1
2
3
4
5
6
7
8
9
10
11
12
13
14
15
16
17
18
19
20
21
22
23
24
25
26
27
28
29
30
31
32
33
34
35
36
37
38
39
40
41
42
43
44
45
46
47
48

1
2
3
4
5
6
7
8
9
10
11
12
13
14
15
16
17
18
19
20
21
22
23
24
25
26
27
28
29
30
31
32
33
34
35
36
37
38
39
40
41
42
43
44
45
46
47
48

Annex A

Language Bindings Summary

In this section we summarize the specific bindings for C and Fortran. First we present the constants, type definitions, info values and keys. Then we present the routine prototypes separately for each binding. Listings are alphabetical within chapter.

A.1 Defined Values and Handles

A.1.1 Defined Constants

The C and Fortran names are listed below. Constants with the type `const int` may also be implemented as literal integer constants substituted by the preprocessor.

Error classes	
C type: <code>const int</code> (or unnamed <code>enum</code>)	
Fortran type: <code>INTEGER</code>	
<code>MPI_SUCCESS</code>	
<code>MPI_ERR_BUFFER</code>	
<code>MPI_ERR_COUNT</code>	
<code>MPI_ERR_TYPE</code>	
<code>MPI_ERR_TAG</code>	
<code>MPI_ERR_COMM</code>	
<code>MPI_ERR_RANK</code>	
<code>MPI_ERR_REQUEST</code>	
<code>MPI_ERR_ROOT</code>	
<code>MPI_ERR_GROUP</code>	
<code>MPI_ERR_OP</code>	
<code>MPI_ERR_TOPOLOGY</code>	
<code>MPI_ERR_DIMS</code>	
<code>MPI_ERR_ARG</code>	
<code>MPI_ERR_UNKNOWN</code>	
<code>MPI_ERR_TRUNCATE</code>	
<code>MPI_ERR_OTHER</code>	
<code>MPI_ERR_INTERN</code>	
<code>MPI_ERR_PENDING</code>	

(Continued on next page)

1	Error classes (continued)
2	C type: <code>const int</code> (or unnamed <code>enum</code>)
3	Fortran type: <code>INTEGER</code>
4	<hr/> MPI_ERR_IN_STATUS
5	MPI_ERR_ACCESS
6	MPI_ERR_AMODE
7	MPI_ERR_ASSERT
8	MPI_ERR_BAD_FILE
9	MPI_ERR_BASE
10	MPI_ERR_CONVERSION
11	MPI_ERR_DISP
12	MPI_ERR_DUP_DATAREP
13	MPI_ERR_FILE_EXISTS
14	MPI_ERR_FILE_IN_USE
15	MPI_ERR_FILE
16	MPI_ERR_INFO_KEY
17	MPI_ERR_INFO_NOKEY
18	MPI_ERR_INFO_VALUE
19	MPI_ERR_INFO
20	MPI_ERR_IO
21	MPI_ERR_KEYVAL
22	MPI_ERR_LOCKTYPE
23	MPI_ERR_NAME
24	MPI_ERR_NO_MEM
25	MPI_ERR_NOT_SAME
26	MPI_ERR_NO_SPACE
27	MPI_ERR_NO_SUCH_FILE
28	MPI_ERR_PORT
29	MPI_ERR_QUOTA
30	MPI_ERR_READ_ONLY
31	MPI_ERR_RMA_ATTACH
32	MPI_ERR_RMA_CONFLICT
33	MPI_ERR_RMA_RANGE
34	MPI_ERR_RMA_SHARED
35	MPI_ERR_RMA_SYNC
36	MPI_ERR_RMA_FLAVOR
37	MPI_ERR_SERVICE
38	MPI_ERR_SIZE
39	MPI_ERR_SPAWN
40	MPI_ERR_UNSUPPORTED_DATAREP
41	MPI_ERR_UNSUPPORTED_OPERATION
42	MPI_ERR_WIN

(Continued on next page)

43
44
45
46
47
48

Error classes (continued)

C type: `const int` (or unnamed `enum`)

Fortran type: `INTEGER`

MPI_T_ERR_CANNOT_INIT

MPI_T_ERR_NOT_INITIALIZED

MPI_T_ERR_MEMORY

MPI_T_ERR_INVALID

MPI_T_ERR_INVALID_INDEX

MPI_T_ERR_INVALID_ITEM (deprecated as of MPI-3.2)

MPI_T_ERR_INVALID_SESSION

MPI_T_ERR_INVALID_HANDLE

MPI_T_ERR_INVALID_NAME

MPI_T_ERR_OUT_OF_HANDLES

MPI_T_ERR_OUT_OF_SESSIONS

MPI_T_ERR_CVAR_SET_NOT_NOW

MPI_T_ERR_CVAR_SET_NEVER

MPI_T_ERR_PVAR_NO_WRITE

MPI_T_ERR_PVAR_NO_STARTSTOP

MPI_T_ERR_PVAR_NO_ATOMIC

MPI_ERR_LASTCODE

Buffer Address Constants

C type: `void * const`

Fortran type: (predefined memory location)¹

MPI_BOTTOM

MPI_IN_PLACE

¹ Note that in Fortran these constants are not usable for initialization expressions or assignment. See Section 2.5.4.

Assorted Constants

C type: `const int` (or unnamed `enum`)

Fortran type: `INTEGER`

MPI_PROC_NULL

MPI_ANY_SOURCE

MPI_ANY_TAG

MPI_UNDEFINED

MPI_BSEND_OVERHEAD

MPI_KEYVAL_INVALID

MPI_LOCK_EXCLUSIVE

MPI_LOCK_SHARED

MPI_ROOT

No Process Message Handle

C type: `MPI_Message`

Fortran type: `INTEGER` or `TYPE(MPI_Message)`

MPI_MESSAGE_NO_PROC

Fortran Support Method Specific Constants

Fortran type: LOGICAL

MPI_SUBARRAYS_SUPPORTED (Fortran only)

MPI_ASYNC_PROTECTS_NONBLOCKING (Fortran only)

Status size and reserved index values (Fortran only)

Fortran type: INTEGER

MPI_STATUS_SIZE

MPI_SOURCE

MPI_TAG

MPI_ERROR

Variable Address Size (Fortran only)

Fortran type: INTEGER

MPI_ADDRESS_KIND

MPI_COUNT_KIND

MPI_INTEGER_KIND

MPI_OFFSET_KIND

Error-handling specifiers

C type: MPI_Errhandler

Fortran type: INTEGER or TYPE(MPI_Errhandler)

MPI_ERRORS_ARE_FATAL

MPI_ERRORS_RETURN

Maximum Sizes for Strings

C type: const int (or unnamed enum)

Fortran type: INTEGER

MPI_MAX_DATAREP_STRING

MPI_MAX_ERROR_STRING

MPI_MAX_INFO_KEY

MPI_MAX_INFO_VAL

MPI_MAX_LIBRARY_VERSION_STRING

MPI_MAX_OBJECT_NAME

MPI_MAX_PORT_NAME

MPI_MAX_PROCESSOR_NAME

Named Predefined Datatypes	C types	
C type: MPI_Datatype		1
Fortran type: INTEGER		2
or TYPE(MPI_Datatype)		3
MPI_CHAR	char	4
	(treated as printable character)	5
MPI_SHORT	signed short int	6
MPI_INT	signed int	7
MPI_LONG	signed long	8
MPI_LONG_LONG_INT	signed long long	9
MPI_LONG_LONG (as a synonym)	signed long long	10
MPI_SIGNED_CHAR	signed char	11
	(treated as integral value)	12
MPI_UNSIGNED_CHAR	unsigned char	13
	(treated as integral value)	14
MPI_UNSIGNED_SHORT	unsigned short	15
MPI_UNSIGNED	unsigned int	16
MPI_UNSIGNED_LONG	unsigned long	17
MPI_UNSIGNED_LONG_LONG	unsigned long long	18
MPI_FLOAT	float	19
MPI_DOUBLE	double	20
MPI_LONG_DOUBLE	long double	21
MPI_WCHAR	wchar_t	22
	(defined in <stddef.h>)	23
	(treated as printable character)	24
MPI_C_BOOL	_Bool	25
MPI_INT8_T	int8_t	26
MPI_INT16_T	int16_t	27
MPI_INT32_T	int32_t	28
MPI_INT64_T	int64_t	29
MPI_UINT8_T	uint8_t	30
MPI_UINT16_T	uint16_t	31
MPI_UINT32_T	uint32_t	32
MPI_UINT64_T	uint64_t	33
MPI_AINT	MPI_Aint	34
MPI_COUNT	MPI_Count	35
MPI_OFFSET	MPI_Offset	36
MPI_C_COMPLEX	float _Complex	37
MPI_C_FLOAT_COMPLEX	float _Complex	38
MPI_C_DOUBLE_COMPLEX	double _Complex	39
MPI_C_LONG_DOUBLE_COMPLEX	long double _Complex	40
MPI_BYTE	(any C type)	41
MPI_PACKED	(any C type)	42

44

45

46

47

48

Named Predefined Datatypes	Fortran types
C type: MPI_Datatype Fortran type: INTEGER or TYPE(MPI_Datatype)	
MPI_INTEGER	INTEGER
MPI_REAL	REAL
MPI_DOUBLE_PRECISION	DOUBLE PRECISION
MPI_COMPLEX	COMPLEX
MPI_LOGICAL	LOGICAL
MPI_CHARACTER	CHARACTER(1)
MPI_AINT	INTEGER (KIND=MPI_ADDRESS_KIND)
MPI_COUNT	INTEGER (KIND=MPI_COUNT_KIND)
MPI_OFFSET	INTEGER (KIND=MPI_OFFSET_KIND)
MPI_BYTE	(any Fortran type)
MPI_PACKED	(any Fortran type)

Named Predefined Datatypes ¹	C++ types
C type: MPI_Datatype Fortran type: INTEGER or TYPE(MPI_Datatype)	
MPI_CXX_BOOL	bool
MPI_CXX_FLOAT_COMPLEX	std::complex<float>
MPI_CXX_DOUBLE_COMPLEX	std::complex<double>
MPI_CXX_LONG_DOUBLE_COMPLEX	std::complex<long double>

¹ If an accompanying C++ compiler is missing, then the MPI datatypes in this table are not defined.

Optional datatypes (Fortran)	Fortran types
C type: MPI_Datatype Fortran type: INTEGER or TYPE(MPI_Datatype)	
MPI_DOUBLE_COMPLEX	DOUBLE COMPLEX
MPI_INTEGER1	INTEGER*1
MPI_INTEGER2	INTEGER*2
MPI_INTEGER4	INTEGER*4
MPI_INTEGER8	INTEGER*8
MPI_INTEGER16	INTEGER*16
MPI_REAL2	REAL*2
MPI_REAL4	REAL*4
MPI_REAL8	REAL*8
MPI_REAL16	REAL*16
MPI_COMPLEX4	COMPLEX*4
MPI_COMPLEX8	COMPLEX*8
MPI_COMPLEX16	COMPLEX*16
MPI_COMPLEX32	COMPLEX*32

Datatypes for reduction functions (C)	1
C type: MPI_Datatype	2
Fortran type: INTEGER or TYPE(MPI_Datatype)	3
MPI_FLOAT_INT	4
MPI_DOUBLE_INT	5
MPI_LONG_INT	6
MPI_2INT	7
MPI_SHORT_INT	8
MPI_LONG_DOUBLE_INT	9
	10
Datatypes for reduction functions (Fortran)	11
C type: MPI_Datatype	12
Fortran type: INTEGER or TYPE(MPI_Datatype)	13
MPI_2REAL	14
MPI_2DOUBLE_PRECISION	15
MPI_2INTEGER	16
	17
Reserved communicators	18
C type: MPI_Comm	19
Fortran type: INTEGER or TYPE(MPI_Comm)	20
MPI_COMM_WORLD	21
MPI_COMM_SELF	22
	23
Communicator split type constants	24
C type: const int (or unnamed enum)	25
Fortran type: INTEGER	26
MPI_COMM_TYPE_SHARED	27
	28
Results of communicator and group comparisons	29
C type: const int (or unnamed enum)	30
Fortran type: INTEGER	31
MPI_IDENT	32
MPI_CONGRUENT	33
MPI_SIMILAR	34
MPI_UNEQUAL	35
	36
Estimates for MPI communication costs for Cartesian topology weights	37
C type: const double	38
Fortran type: DOUBLE PRECISION	39
MPI_COSTS_CONTIGUOUS	40
MPI_COSTS_STRIDED	41
MPI_COSTS_SCATTERED	42
	43
Environmental inquiry info key	44
C type: MPI_Info	45
Fortran type: INTEGER or TYPE(MPI_Info)	46
MPI_INFO_ENV	47
	48

#120

1	Environmental inquiry keys
2	C type: <code>const int</code> (or unnamed <code>enum</code>)
3	Fortran type: <code>INTEGER</code>
4	<hr/> MPI_TAG_UB
5	MPI_IO
6	MPI_HOST
7	MPI_WTIME_IS_GLOBAL
8	<hr/>
9	Collective Operations
10	C type: <code>MPI_Op</code>
11	Fortran type: <code>INTEGER</code> or <code>TYPE(MPI_Op)</code>
12	<hr/> MPI_MAX
13	MPI_MIN
14	MPI_SUM
15	MPI_PROD
16	MPI_MAXLOC
17	MPI_MINLOC
18	MPI_BAND
19	MPI_BOR
20	MPI_BXOR
21	MPI_LAND
22	MPI_LOR
23	MPI_LXOR
24	MPI_REPLACE
25	MPI_NO_OP
26	<hr/>
27	
28	
29	
30	
31	
32	
33	
34	
35	
36	
37	
38	
39	
40	
41	
42	
43	
44	
45	
46	
47	
48	

Null Handles		1
<hr/>		2
C/Fortran name		3
C type / Fortran type		4
<hr/>		5
MPI_GROUP_NULL		6
MPI_Group / INTEGER or TYPE(MPI_Group)		7
MPI_COMM_NULL		8
MPI_Comm / INTEGER or TYPE(MPI_Comm)		9
MPI_DATATYPE_NULL		10
MPI_Datatype / INTEGER or TYPE(MPI_Datatype)		11
MPI_REQUEST_NULL		12
MPI_Request / INTEGER or TYPE(MPI_Request)		13
MPI_OP_NULL		14
MPI_Op / INTEGER or TYPE(MPI_Op)		15
MPI_ERRHANDLER_NULL		16
MPI_Errhandler / INTEGER or TYPE(MPI_Errhandler)		17
MPI_FILE_NULL		18
MPI_File / INTEGER or TYPE(MPI_File)		19
MPI_INFO_NULL		20
MPI_Info / INTEGER or TYPE(MPI_Info)		21
MPI_WIN_NULL		22
MPI_Win / INTEGER or TYPE(MPI_Win)		23
MPI_MESSAGE_NULL		24
MPI_Message / INTEGER or TYPE(MPI_Message)		25
<hr/>		26
Empty group		27
<hr/>		28
C type: MPI_Group		29
Fortran type: INTEGER or TYPE(MPI_Group)		30
<hr/>		31
MPI_GROUP_EMPTY		32
<hr/>		33
Topologies		34
<hr/>		35
C type: const int (or unnamed enum)		36
Fortran type: INTEGER		37
<hr/>		38
MPI_GRAPH		39
MPI_CART		40
MPI_DIST_GRAPH		41
<hr/>		42
		43
		44
		45
		46
		47
		48

1
2
3
4
5
6
7
8
9
10
11
12
13
14
15
16
17
18
19
20
21
22
23
24
25
26
27
28
29
30
31
32
33
34
35
36
37
38
39
40
41
42
43
44
45
46
47
48

Predefined functions

C/Fortran name	C type	Fortran type with mpi module	Fortran type with mpi_f08 module
MPI_COMM_NULL_COPY_FN	MPI_Comm_copy_attr_function	/ COMM_COPY_ATTR_FUNCTION	/ PROCEDURE(MPI_Comm_copy_attr_function) ¹⁾
MPI_COMM_DUP_FN	MPI_Comm_copy_attr_function	/ COMM_COPY_ATTR_FUNCTION	/ PROCEDURE(MPI_Comm_copy_attr_function) ¹⁾
MPI_COMM_NULL_DELETE_FN	MPI_Comm_delete_attr_function	/ COMM_DELETE_ATTR_FUNCTION	/ PROCEDURE(MPI_Comm_delete_attr_function) ¹⁾
MPI_WIN_NULL_COPY_FN	MPI_Win_copy_attr_function	/ WIN_COPY_ATTR_FUNCTION	/ PROCEDURE(MPI_Win_copy_attr_function) ¹⁾
MPI_WIN_DUP_FN	MPI_Win_copy_attr_function	/ WIN_COPY_ATTR_FUNCTION	/ PROCEDURE(MPI_Win_copy_attr_function) ¹⁾
MPI_WIN_NULL_DELETE_FN	MPI_Win_delete_attr_function	/ WIN_DELETE_ATTR_FUNCTION	/ PROCEDURE(MPI_Win_delete_attr_function) ¹⁾
MPI_TYPE_NULL_COPY_FN	MPI_Type_copy_attr_function	/ TYPE_COPY_ATTR_FUNCTION	/ PROCEDURE(MPI_Type_copy_attr_function) ¹⁾
MPI_TYPE_DUP_FN	MPI_Type_copy_attr_function	/ TYPE_COPY_ATTR_FUNCTION	/ PROCEDURE(MPI_Type_copy_attr_function) ¹⁾
MPI_TYPE_NULL_DELETE_FN	MPI_Type_delete_attr_function	/ TYPE_DELETE_ATTR_FUNCTION	/ PROCEDURE(MPI_Type_delete_attr_function) ¹⁾
MPI_CONVERSION_FN_NULL	MPI_Datarep_conversion_function	/ DATAREP_CONVERSION_FUNCTION	/ PROCEDURE(MPI_Datarep_conversion_function) ¹⁾

¹⁾ See the advice to implementors (on page 290) and advice to users (on page 291) on the predefined Fortran functions MPI_COMM_NULL_COPY_FN, ... in Section 6.7.2.

Deprecated predefined functions

C/Fortran name	C type	Fortran type with mpi module
MPI_NULL_COPY_FN	MPI_Copy_function	/ COPY_FUNCTION
MPI_DUP_FN	MPI_Copy_function	/ COPY_FUNCTION
MPI_NULL_DELETE_FN	MPI_Delete_function	/ DELETE_FUNCTION

Predefined Attribute Keys	1
C type: <code>const int</code> (or unnamed <code>enum</code>)	2
Fortran type: <code>INTEGER</code>	3
<hr/>	
<code>MPI_APPNUM</code>	4
<code>MPI_LASTUSED</code>	5
<code>MPI_UNIVERSE_SIZE</code>	6
<code>MPI_WIN_BASE</code>	7
<code>MPI_WIN_DISP_UNIT</code>	8
<code>MPI_WIN_SIZE</code>	9
<code>MPI_WIN_CREATE_FLAVOR</code>	10
<code>MPI_WIN_MODEL</code>	11
<hr/>	12
MPI Window Create Flavors	13
C type: <code>const int</code> (or unnamed <code>enum</code>)	14
Fortran type: <code>INTEGER</code>	15
<hr/>	
<code>MPI_WIN_FLAVOR_CREATE</code>	16
<code>MPI_WIN_FLAVOR_ALLOCATE</code>	17
<code>MPI_WIN_FLAVOR_DYNAMIC</code>	18
<code>MPI_WIN_FLAVOR_SHARED</code>	19
<hr/>	20
MPI Window Models	21
C type: <code>const int</code> (or unnamed <code>enum</code>)	22
Fortran type: <code>INTEGER</code>	23
<hr/>	
<code>MPI_WIN_SEPARATE</code>	24
<code>MPI_WIN_UNIFIED</code>	25
<hr/>	26
Mode Constants	27
C type: <code>const int</code> (or unnamed <code>enum</code>)	28
Fortran type: <code>INTEGER</code>	29
<hr/>	
<code>MPI_MODE_APPEND</code>	30
<code>MPI_MODE_CREATE</code>	31
<code>MPI_MODE_DELETE_ON_CLOSE</code>	32
<code>MPI_MODE_EXCL</code>	33
<code>MPI_MODE_NOCHECK</code>	34
<code>MPI_MODE_NOPRECEDE</code>	35
<code>MPI_MODE_NOPUT</code>	36
<code>MPI_MODE_NOSTORE</code>	37
<code>MPI_MODE_NOSUCCEED</code>	38
<code>MPI_MODE_RDONLY</code>	39
<code>MPI_MODE_RDWR</code>	40
<code>MPI_MODE_SEQUENTIAL</code>	41
<code>MPI_MODE_UNIQUE_OPEN</code>	42
<code>MPI_MODE_WRONLY</code>	43
<hr/>	44
	45
	46
	47
	48

Datatype Decoding ConstantsC type: `const int` (or unnamed `enum`)Fortran type: `INTEGER`

MPI_COMBINER_CONTIGUOUS
 MPI_COMBINER_DARRAY
 MPI_COMBINER_DUP
 MPI_COMBINER_F90_COMPLEX
 MPI_COMBINER_F90_INTEGER
 MPI_COMBINER_F90_REAL
 MPI_COMBINER_HINDEXED
 MPI_COMBINER_HVECTOR
 MPI_COMBINER_INDEXED_BLOCK
 MPI_COMBINER_HINDEXED_BLOCK
 MPI_COMBINER_INDEXED
 MPI_COMBINER_NAMED
 MPI_COMBINER_RESIZED
 MPI_COMBINER_STRUCT
 MPI_COMBINER_SUBARRAY
 MPI_COMBINER_VECTOR

Threads ConstantsC type: `const int` (or unnamed `enum`)Fortran type: `INTEGER`

MPI_THREAD_FUNNELED
 MPI_THREAD_MULTIPLE
 MPI_THREAD_SERIALIZED
 MPI_THREAD_SINGLE

File Operation Constants, Part 1C type: `const MPI_Offset` (or unnamed `enum`)Fortran type: `INTEGER (KIND=MPI_OFFSET_KIND)`

MPI_DISPLACEMENT_CURRENT

File Operation Constants, Part 2C type: `const int` (or unnamed `enum`)Fortran type: `INTEGER`

MPI_DISTRIBUTE_BLOCK
 MPI_DISTRIBUTE_CYCLIC
 MPI_DISTRIBUTE_DFLT_DARG
 MPI_DISTRIBUTE_NONE
 MPI_ORDER_C
 MPI_ORDER_FORTRAN
 MPI_SEEK_CUR
 MPI_SEEK_END
 MPI_SEEK_SET

F90 Datatype Matching ConstantsC type: `const int` (or unnamed enum)Fortran type: `INTEGER``MPI_TYPECLASS_COMPLEX``MPI_TYPECLASS_INTEGER``MPI_TYPECLASS_REAL`**Constants Specifying Empty or Ignored Input**

C/Fortran name

C type / Fortran type¹`MPI_ARGVS_NULL``char***` / 2-dim. array of `CHARACTER*(*)``MPI_ARGV_NULL``char**` / array of `CHARACTER*(*)``MPI_ERRCODES_IGNORE``int*` / `INTEGER` array`MPI_STATUSES_IGNORE``MPI_Status*` / `INTEGER`, `DIMENSION(MPI_STATUS_SIZE,*)`or `TYPE(MPI_Status)`, `DIMENSION(*)``MPI_STATUS_IGNORE``MPI_Status*` / `INTEGER`, `DIMENSION(MPI_STATUS_SIZE)`or `TYPE(MPI_Status)``MPI_UNWEIGHTED``int*` / `INTEGER` array`MPI_WEIGHTS_EMPTY``int*` / `INTEGER` array`MPI_WEIGHTS_EQUAL``double*` / `DOUBLE PRECISION` array¹ Note that in Fortran these constants are not usable for initialization expressions or assignment. See Section 2.5.4.**C Constants Specifying Ignored Input (no Fortran)**C type: `MPI_Fint*` equivalent to Fortran`MPI_F_STATUSES_IGNORE` `MPI_STATUSES_IGNORE` in `mpi / mpif.h``MPI_F_STATUS_IGNORE` `MPI_STATUS_IGNORE` in `mpi / mpif.h`C type: `MPI_F08_status*` equivalent to Fortran`MPI_F08_STATUSES_IGNORE` `MPI_STATUSES_IGNORE` in `mpi_f08``MPI_F08_STATUS_IGNORE` `MPI_STATUS_IGNORE` in `mpi_f08`**C preprocessor Constants and Fortran Parameters**C type: C-preprocessor macro that expands to an `int` valueFortran type: `INTEGER``MPI_SUBVERSION``MPI_VERSION`

#120

Null handles used in the MPI tool information interface

MPI_T_ENUM_NULL
 MPI_T_enum
 MPI_T_CVAR_HANDLE_NULL
 MPI_T_cvar_handle
 MPI_T_PVAR_HANDLE_NULL
 MPI_T_pvar_handle
 MPI_T_PVAR_SESSION_NULL
 MPI_T_pvar_session

Verbosity Levels in the MPI tool information interface

C type: const int (or unnamed enum)

MPI_T_VERBOSITY_USER_BASIC
 MPI_T_VERBOSITY_USER_DETAIL
 MPI_T_VERBOSITY_USER_ALL
 MPI_T_VERBOSITY_TUNER_BASIC
 MPI_T_VERBOSITY_TUNER_DETAIL
 MPI_T_VERBOSITY_TUNER_ALL
 MPI_T_VERBOSITY_MPIDEV_BASIC
 MPI_T_VERBOSITY_MPIDEV_DETAIL
 MPI_T_VERBOSITY_MPIDEV_ALL

Constants to identify associations of variables in the MPI tool information interface

C type: const int (or unnamed enum)

MPI_T_BIND_NO_OBJECT
 MPI_T_BIND_MPI_COMM
 MPI_T_BIND_MPI_DATATYPE
 MPI_T_BIND_MPI_ERRHANDLER
 MPI_T_BIND_MPI_FILE
 MPI_T_BIND_MPI_GROUP
 MPI_T_BIND_MPI_OP
 MPI_T_BIND_MPI_REQUEST
 MPI_T_BIND_MPI_WIN
 MPI_T_BIND_MPI_MESSAGE
 MPI_T_BIND_MPI_INFO

Constants describing the scope of a control variable in the MPI tool information interface

C type: const int (or unnamed enum)

MPI_T_SCOPE_CONSTANT
 MPI_T_SCOPE_READONLY
 MPI_T_SCOPE_LOCAL
 MPI_T_SCOPE_GROUP
 MPI_T_SCOPE_GROUP_EQ
 MPI_T_SCOPE_ALL
 MPI_T_SCOPE_ALL_EQ

**Additional constants used
by the MPI tool information interface**

C type: MPI_T_pvar_handle

MPI_T_PVAR_ALL_HANDLES

**Performance variables classes used by the
MPI tool information interface**

C type: const int (or unnamed enum)

MPI_T_PVAR_CLASS_STATE

MPI_T_PVAR_CLASS_LEVEL

MPI_T_PVAR_CLASS_SIZE

MPI_T_PVAR_CLASS_PERCENTAGE

MPI_T_PVAR_CLASS_HIGHWATERMARK

MPI_T_PVAR_CLASS_LOWWATERMARK

MPI_T_PVAR_CLASS_COUNTER

MPI_T_PVAR_CLASS_AGGREGATE

MPI_T_PVAR_CLASS_TIMER

MPI_T_PVAR_CLASS_GENERIC

A.1.2 Types

The following are defined C type definitions, included in the file `mpi.h`.

```
/* C opaque types */
```

```
MPI_Aint
```

```
MPI_Count
```

```
MPI_Fint
```

```
MPI_Offset
```

```
MPI_Status
```

```
MPI_F08_status
```

```
/* C handles to assorted structures */
```

```
MPI_Comm
```

```
MPI_Datatype
```

```
MPI_Errhandler
```

```
MPI_File
```

```
MPI_Group
```

```
MPI_Info
```

```
MPI_Message
```

```
MPI_Op
```

```
MPI_Request
```

```
MPI_Win
```

```
/* Types for the MPI_T interface */
```

```
MPI_T_enum
```

```
MPI_T_cvar_handle
```

```
MPI_T_pvar_handle
```

```
MPI_T_pvar_session
```

1
2
3 The following are defined Fortran type definitions, included in the `mpi_f08` and `mpi`
4 modules.

5 ! Fortran opaque types in the `mpi_f08` and `mpi` modules
6 TYPE(MPI_Status)
7

8 ! Fortran handles in the `mpi_f08` and `mpi` modules

9 TYPE(MPI_Comm)
10 TYPE(MPI_Datatype)
11 TYPE(MPI_Errhandler)
12 TYPE(MPI_File)
13 TYPE(MPI_Group)
14 TYPE(MPI_Info)
15 TYPE(MPI_Message)
16 TYPE(MPI_Op)
17 TYPE(MPI_Request)
18 TYPE(MPI_Win)
19

20 A.1.3 Prototype Definitions

21 C Bindings

22 The following are defined C typedefs for user-defined functions, also included in the file
23 `mpi.h`.

24 /* prototypes for user-defined functions */
25 typedef void MPI_User_function(void *invec, void *inoutvec, int *len,
26 MPI_Datatype *datatype);
27
28 typedef int MPI_Comm_copy_attr_function(MPI_Comm oldcomm,
29 int comm_keyval, void *extra_state, void *attribute_val_in,
30 void *attribute_val_out, int *flag);
31 typedef int MPI_Comm_delete_attr_function(MPI_Comm comm,
32 int comm_keyval, void *attribute_val, void *extra_state);
33
34 typedef int MPI_Win_copy_attr_function(MPI_Win oldwin, int win_keyval,
35 void *extra_state, void *attribute_val_in,
36 void *attribute_val_out, int *flag);
37 typedef int MPI_Win_delete_attr_function(MPI_Win win, int win_keyval,
38 void *attribute_val, void *extra_state);
39
40 typedef int MPI_Type_copy_attr_function(MPI_Datatype oldtype,
41 int type_keyval, void *extra_state,
42 void *attribute_val_in, void *attribute_val_out, int *flag);
43 typedef int MPI_Type_delete_attr_function(MPI_Datatype datatype,
44 int type_keyval, void *attribute_val, void *extra_state);
45
46
47
48

```

typedef void MPI_Comm_errhandler_function(MPI_Comm *, int *, ...);      1
typedef void MPI_Win_errhandler_function(MPI_Win *, int *, ...);      2
typedef void MPI_File_errhandler_function(MPI_File *, int *, ...);    3
                                                                    4
typedef int MPI_Grequest_query_function(void *extra_state,            5
                                         MPI_Status *status);          6
typedef int MPI_Grequest_free_function(void *extra_state);           7
typedef int MPI_Grequest_cancel_function(void *extra_state, int complete); 8
                                                                    9
typedef int MPI_Datarep_extent_function(MPI_Datatype datatype,       10
                                         MPI_Aint *file_extent, void *extra_state); 11
typedef int MPI_Datarep_conversion_function(void *userbuf,          12
                                             MPI_Datatype datatype, int count, void *filebuf, 13
                                             MPI_Offset position, void *extra_state); 14
                                                                    15

```

Fortran 2008 Bindings with the mpi_f08 Module 16

The callback prototypes when using the Fortran mpi_f08 module are shown below: 17

The user-function argument to MPI_Op_create should be declared according to: 18

ABSTRACT INTERFACE 19

```

SUBROUTINE MPI_User_function(invec, inoutvec, len, datatype)        20
  USE, INTRINSIC :: ISO_C_BINDING, ONLY : C_PTR                    21
  TYPE(C_PTR), VALUE :: invec, inoutvec                            22
  INTEGER :: len                                                    23
  TYPE(MPI_Datatype) :: datatype                                   24
                                                                    25

```

The copy and delete function arguments to MPI_Comm_create_keyval should be declared according to: 26

ABSTRACT INTERFACE 27

```

SUBROUTINE MPI_Comm_copy_attr_function(oldcomm, comm_keyval, extra_state, 28
  attribute_val_in, attribute_val_out, flag, ierror)                29
  TYPE(MPI_Comm) :: oldcomm                                         30
  INTEGER :: comm_keyval, ierror                                     31
  INTEGER(KIND=MPI_ADDRESS_KIND) :: extra_state, attribute_val_in, 32
  attribute_val_out                                                 33
  LOGICAL :: flag                                                  34
                                                                    35

```

ABSTRACT INTERFACE 36

```

SUBROUTINE MPI_Comm_delete_attr_function(comm, comm_keyval,          37
  attribute_val, extra_state, ierror)                                38
  TYPE(MPI_Comm) :: comm                                           39
  INTEGER :: comm_keyval, ierror                                     40
  INTEGER(KIND=MPI_ADDRESS_KIND) :: attribute_val, extra_state     41
                                                                    42

```

The copy and delete function arguments to MPI_Win_create_keyval should be declared according to: 43

ABSTRACT INTERFACE 44

```

SUBROUTINE MPI_Win_copy_attr_function(oldwin, win_keyval, extra_state, 45
  attribute_val_in, attribute_val_out, flag, ierror)                46
                                                                    47

```

```

1     TYPE(MPI_Win) :: oldwin
2     INTEGER :: win_keyval, ierror
3     INTEGER(KIND=MPI_ADDRESS_KIND) :: extra_state, attribute_val_in,
4     attribute_val_out
5     LOGICAL :: flag

```

6 ABSTRACT INTERFACE

```

7     SUBROUTINE MPI_Win_delete_attr_function(win, win_keyval, attribute_val,
8     extra_state, ierror)
9         TYPE(MPI_Win) :: win
10        INTEGER :: win_keyval, ierror
11        INTEGER(KIND=MPI_ADDRESS_KIND) :: attribute_val, extra_state

```

13 The copy and delete function arguments to MPI_Type_create_keyval should be declared according to:

15 ABSTRACT INTERFACE

```

16     SUBROUTINE MPI_Type_copy_attr_function(oldtype, type_keyval, extra_state,
17     attribute_val_in, attribute_val_out, flag, ierror)
18         TYPE(MPI_Datatype) :: oldtype
19         INTEGER :: type_keyval, ierror
20         INTEGER(KIND=MPI_ADDRESS_KIND) :: extra_state, attribute_val_in,
21         attribute_val_out
22         LOGICAL :: flag

```

24 ABSTRACT INTERFACE

```

25     SUBROUTINE MPI_Type_delete_attr_function(datatype, type_keyval,
26     attribute_val, extra_state, ierror)
27         TYPE(MPI_Datatype) :: datatype
28         INTEGER :: type_keyval, ierror
29         INTEGER(KIND=MPI_ADDRESS_KIND) :: attribute_val, extra_state

```

30 The handler-function argument to MPI_Comm_create_errhandler should be declared like this:

32 ABSTRACT INTERFACE

```

33     SUBROUTINE MPI_Comm_errhandler_function(comm, error_code)
34         TYPE(MPI_Comm) :: comm
35         INTEGER :: error_code

```

36 The handler-function argument to MPI_Win_create_errhandler should be declared like this:

39 ABSTRACT INTERFACE

```

40     SUBROUTINE MPI_Win_errhandler_function(win, error_code)
41         TYPE(MPI_Win) :: win
42         INTEGER :: error_code

```

43 The handler-function argument to MPI_File_create_errhandler should be declared like this:

45 ABSTRACT INTERFACE

```

46     SUBROUTINE MPI_File_errhandler_function(file, error_code)
47         TYPE(MPI_File) :: file

```

48

```
INTEGER :: error_code
```

The query, free, and cancel function arguments to MPI_Grequest_start should be declared according to:

```
ABSTRACT INTERFACE
```

```
  SUBROUTINE MPI_Grequest_query_function(extra_state, status, ierror)
```

```
    TYPE(MPI_Status) :: status
```

```
    INTEGER :: ierror
```

```
    INTEGER(KIND=MPI_ADDRESS_KIND) :: extra_state
```

```
ABSTRACT INTERFACE
```

```
  SUBROUTINE MPI_Grequest_free_function(extra_state, ierror)
```

```
    INTEGER :: ierror
```

```
    INTEGER(KIND=MPI_ADDRESS_KIND) :: extra_state
```

```
ABSTRACT INTERFACE
```

```
  SUBROUTINE MPI_Grequest_cancel_function(extra_state, complete, ierror)
```

```
    INTEGER :: ierror
```

```
    INTEGER(KIND=MPI_ADDRESS_KIND) :: extra_state
```

```
    LOGICAL :: complete
```

The extent and conversion function arguments to MPI_Register_datarep should be declared according to:

```
ABSTRACT INTERFACE
```

```
  SUBROUTINE MPI_Datarep_extent_function(datatype, extent, extra_state,
    ierror)
```

```
    TYPE(MPI_Datatype) :: datatype
```

```
    INTEGER(KIND=MPI_ADDRESS_KIND) :: extent, extra_state
```

```
    INTEGER :: ierror
```

```
ABSTRACT INTERFACE
```

```
  SUBROUTINE MPI_Datarep_conversion_function(userbuf, datatype, count,
    filebuf, position, extra_state, ierror)
```

```
    USE, INTRINSIC :: ISO_C_BINDING, ONLY : C_PTR
```

```
    TYPE(C_PTR), VALUE :: userbuf, filebuf
```

```
    TYPE(MPI_Datatype) :: datatype
```

```
    INTEGER :: count, ierror
```

```
    INTEGER(KIND=MPI_OFFSET_KIND) :: position
```

```
    INTEGER(KIND=MPI_ADDRESS_KIND) :: extra_state
```

Fortran Bindings with mpif.h or the mpi Module

With the Fortran mpi module or mpif.h, here are examples of how each of the user-defined subroutines should be declared.

The user-function argument to MPI_OP_CREATE should be declared like this:

```
SUBROUTINE USER_FUNCTION(INVEC, INOUTVEC, LEN, DATATYPE)
```

```
  <type> INVEC(LEN), INOUTVEC(LEN)
```

```
  INTEGER LEN, DATATYPE
```

1 The copy and delete function arguments to MPI_COMM_CREATE_KEYVAL should be
2 declared like these:

```
3
4 SUBROUTINE COMM_COPY_ATTR_FUNCTION(OLDCOMM, COMM_KEYVAL, EXTRA_STATE,
5     ATTRIBUTE_VAL_IN, ATTRIBUTE_VAL_OUT, FLAG, IERROR)
6     INTEGER OLDCOMM, COMM_KEYVAL, IERROR
7     INTEGER(KIND=MPI_ADDRESS_KIND) EXTRA_STATE, ATTRIBUTE_VAL_IN,
8     ATTRIBUTE_VAL_OUT
9     LOGICAL FLAG
10
11 SUBROUTINE COMM_DELETE_ATTR_FUNCTION(COMM, COMM_KEYVAL, ATTRIBUTE_VAL,
12     EXTRA_STATE, IERROR)
13     INTEGER COMM, COMM_KEYVAL, IERROR
14     INTEGER(KIND=MPI_ADDRESS_KIND) ATTRIBUTE_VAL, EXTRA_STATE
```

15 The copy and delete function arguments to MPI_WIN_CREATE_KEYVAL should be
16 declared like these:

```
17
18 SUBROUTINE WIN_COPY_ATTR_FUNCTION(OLDWIN, WIN_KEYVAL, EXTRA_STATE,
19     ATTRIBUTE_VAL_IN, ATTRIBUTE_VAL_OUT, FLAG, IERROR)
20     INTEGER OLDWIN, WIN_KEYVAL, IERROR
21     INTEGER(KIND=MPI_ADDRESS_KIND) EXTRA_STATE, ATTRIBUTE_VAL_IN,
22     ATTRIBUTE_VAL_OUT
23     LOGICAL FLAG
24
25 SUBROUTINE WIN_DELETE_ATTR_FUNCTION(WIN, WIN_KEYVAL, ATTRIBUTE_VAL,
26     EXTRA_STATE, IERROR)
27     INTEGER WIN, WIN_KEYVAL, IERROR
28     INTEGER(KIND=MPI_ADDRESS_KIND) ATTRIBUTE_VAL, EXTRA_STATE
29
```

30 The copy and delete function arguments to MPI_TYPE_CREATE_KEYVAL should be
31 declared like these:

```
32
33 SUBROUTINE TYPE_COPY_ATTR_FUNCTION(OLDTYPE, TYPE_KEYVAL, EXTRA_STATE,
34     ATTRIBUTE_VAL_IN, ATTRIBUTE_VAL_OUT, FLAG, IERROR)
35     INTEGER OLDTYPE, TYPE_KEYVAL, IERROR
36     INTEGER(KIND=MPI_ADDRESS_KIND) EXTRA_STATE,
37     ATTRIBUTE_VAL_IN, ATTRIBUTE_VAL_OUT
38     LOGICAL FLAG
39
40 SUBROUTINE TYPE_DELETE_ATTR_FUNCTION(DATATYPE, TYPE_KEYVAL, ATTRIBUTE_VAL,
41     EXTRA_STATE, IERROR)
42     INTEGER DATATYPE, TYPE_KEYVAL, IERROR
43     INTEGER(KIND=MPI_ADDRESS_KIND) ATTRIBUTE_VAL, EXTRA_STATE
```

44 The handler-function argument to MPI_COMM_CREATE_ERRHANDLER should be de-
45 clared like this:

```
46
47 SUBROUTINE COMM_ERRHANDLER_FUNCTION(COMM, ERROR_CODE)
48     INTEGER COMM, ERROR_CODE
```

The handler-function argument to `MPI_WIN_CREATE_ERRHANDLER` should be declared like this:

```
SUBROUTINE WIN_ERRHANDLER_FUNCTION(WIN, ERROR_CODE)
    INTEGER WIN, ERROR_CODE
```

The handler-function argument to `MPI_FILE_CREATE_ERRHANDLER` should be declared like this:

```
SUBROUTINE FILE_ERRHANDLER_FUNCTION(FILE, ERROR_CODE)
    INTEGER FILE, ERROR_CODE
```

The query, free, and cancel function arguments to `MPI_GREQUEST_START` should be declared like these:

```
SUBROUTINE GREQUEST_QUERY_FUNCTION(EXTRA_STATE, STATUS, IERROR)
    INTEGER STATUS(MPI_STATUS_SIZE), IERROR
    INTEGER(KIND=MPI_ADDRESS_KIND) EXTRA_STATE
```

```
SUBROUTINE GREQUEST_FREE_FUNCTION(EXTRA_STATE, IERROR)
    INTEGER IERROR
    INTEGER(KIND=MPI_ADDRESS_KIND) EXTRA_STATE
```

```
SUBROUTINE GREQUEST_CANCEL_FUNCTION(EXTRA_STATE, COMPLETE, IERROR)
    INTEGER IERROR
    INTEGER(KIND=MPI_ADDRESS_KIND) EXTRA_STATE
    LOGICAL COMPLETE
```

The extent and conversion function arguments to `MPI_REGISTER_DATAREP` should be declared like these:

```
SUBROUTINE DATAREP_EXTENT_FUNCTION(DATATYPE, EXTENT, EXTRA_STATE, IERROR)
    INTEGER DATATYPE, IERROR
    INTEGER(KIND=MPI_ADDRESS_KIND) EXTENT, EXTRA_STATE
```

```
SUBROUTINE DATAREP_CONVERSION_FUNCTION(USERBUF, DATATYPE, COUNT, FILEBUF,
    POSITION, EXTRA_STATE, IERROR)
    <TYPE> USERBUF(*), FILEBUF(*)
    INTEGER COUNT, DATATYPE, IERROR
    INTEGER(KIND=MPI_OFFSET_KIND) POSITION
    INTEGER(KIND=MPI_ADDRESS_KIND) EXTRA_STATE
```

A.1.4 Deprecated Prototype Definitions

The following are defined C typedefs for deprecated user-defined functions, also included in the file `mpi.h`.

```
/* prototypes for user-defined functions */
typedef int MPI_Copy_function(MPI_Comm oldcomm, int keyval,
```

```

1         void *extra_state, void *attribute_val_in,
2         void *attribute_val_out, int *flag);
3     typedef int MPI_Delete_function(MPI_Comm comm, int keyval,
4         void *attribute_val, void *extra_state);
5

```

The following are deprecated Fortran user-defined callback subroutine prototypes. The deprecated copy and delete function arguments to MPI_KEYVAL_CREATE should be declared like these:

```

9
10    SUBROUTINE COPY_FUNCTION(OLDCOMM, KEYVAL, EXTRA_STATE,
11        ATTRIBUTE_VAL_IN, ATTRIBUTE_VAL_OUT, FLAG, IERR)
12        INTEGER OLDCOMM, KEYVAL, EXTRA_STATE, ATTRIBUTE_VAL_IN,
13            ATTRIBUTE_VAL_OUT, IERR
14        LOGICAL FLAG
15
16    SUBROUTINE DELETE_FUNCTION(COMM, KEYVAL, ATTRIBUTE_VAL, EXTRA_STATE, IERR)
17        INTEGER COMM, KEYVAL, ATTRIBUTE_VAL, EXTRA_STATE, IERR
18

```

A.1.5 Info Keys

The following info keys are reserved. They are strings.

```

21    access_style
22    accumulate_ops
23    accumulate_ordering
24    alloc_shared_noncontig
25    appnum
26    arch
27    cb_block_size
28    cb_buffer_size
29    cb_nodes
30    chunked_item
31    chunked_size
32    chunked
33    collective_buffering
34    file_perm
35    filename
36    file
37    host
38    io_node_list
39    ip_address
40    ip_port
41    ip_port
42    mpi_split_levels
43    nb_proc
44    no_locks
45    num_io_nodes
46    path
47    same_disp_unit
48    same_size

```

#120

soft	1
striping_factor	2
striping_unit	3
wdir	4

	5
	6

A.1.6 Info Values 7

The following info values are reserved. They are strings. 8

false	9
random	10
rar	11
raw	12
read_mostly	13
read_once	14
reverse_sequential	15
same_op	16
same_op_no_op	17
sequential	18
true	19
war	20
waw	21
write_mostly	22
write_once	23

	24
	25
	26
	27
	28
	29
	30
	31
	32
	33
	34
	35
	36
	37
	38
	39
	40
	41
	42
	43
	44
	45
	46
	47
	48

A.2 C Bindings

A.2.1 Point-to-Point Communication C Bindings

```
1  int MPI_Bsend(const void* buf, int count, MPI_Datatype datatype, int dest,
2      int tag, MPI_Comm comm)
3
4  int MPI_Bsend_init(const void* buf, int count, MPI_Datatype datatype,
5      int dest, int tag, MPI_Comm comm, MPI_Request *request)
6
7  int MPI_Buffer_attach(void* buffer, int size)
8
9  int MPI_Buffer_detach(void* buffer_addr, int* size)
10
11 int MPI_Cancel(MPI_Request *request)
12
13 int MPI_Get_count(const MPI_Status *status, MPI_Datatype datatype,
14     int *count)
15
16 int MPI_Ibsend(const void* buf, int count, MPI_Datatype datatype, int dest,
17     int tag, MPI_Comm comm, MPI_Request *request)
18
19 int MPI_Improbe(int source, int tag, MPI_Comm comm, int *flag,
20     MPI_Message *message, MPI_Status *status)
21
22 int MPI_Imrecv(void* buf, int count, MPI_Datatype datatype,
23     MPI_Message *message, MPI_Request *request)
24
25 int MPI_Iprobe(int source, int tag, MPI_Comm comm, int *flag,
26     MPI_Status *status)
27
28 int MPI_Irecv(void* buf, int count, MPI_Datatype datatype, int source,
29     int tag, MPI_Comm comm, MPI_Request *request)
30
31 int MPI_Irsend(const void* buf, int count, MPI_Datatype datatype, int dest,
32     int tag, MPI_Comm comm, MPI_Request *request)
33
34 int MPI_Isend(const void* buf, int count, MPI_Datatype datatype, int dest,
35     int tag, MPI_Comm comm, MPI_Request *request)
36
37 int MPI_Issend(const void* buf, int count, MPI_Datatype datatype, int dest,
38     int tag, MPI_Comm comm, MPI_Request *request)
39
40 int MPI_Mprobe(int source, int tag, MPI_Comm comm, MPI_Message *message,
41     MPI_Status *status)
42
43 int MPI_Mrecv(void* buf, int count, MPI_Datatype datatype,
44     MPI_Message *message, MPI_Status *status)
45
46 int MPI_Probe(int source, int tag, MPI_Comm comm, MPI_Status *status)
47
48 int MPI_Recv_init(void* buf, int count, MPI_Datatype datatype, int source,
49     int tag, MPI_Comm comm, MPI_Request *request)
50
51 int MPI_Recv(void* buf, int count, MPI_Datatype datatype, int source,
52     int tag, MPI_Comm comm, MPI_Status *status)
```

```
int MPI_Request_free(MPI_Request *request) 1
int MPI_Request_get_status(MPI_Request request, int *flag, 2
    MPI_Status *status) 3
int MPI_Rsend(const void* buf, int count, MPI_Datatype datatype, int dest, 4
    int tag, MPI_Comm comm) 5
int MPI_Rsend_init(const void* buf, int count, MPI_Datatype datatype, 6
    int dest, int tag, MPI_Comm comm, MPI_Request *request) 7
int MPI_Send(const void* buf, int count, MPI_Datatype datatype, int dest, 8
    int tag, MPI_Comm comm) 9
int MPI_Send_init(const void* buf, int count, MPI_Datatype datatype, 10
    int dest, int tag, MPI_Comm comm, MPI_Request *request) 11
int MPI_Sendrecv(const void *sendbuf, int sendcount, MPI_Datatype sendtype, 12
    int dest, int sendtag, void *recvbuf, int recvcount,
    MPI_Datatype recvtype, int source, int recvtag, MPI_Comm comm, 13
    MPI_Status *status) 14
int MPI_Sendrecv_replace(void* buf, int count, MPI_Datatype datatype, 15
    int dest, int sendtag, int source, int recvtag, MPI_Comm comm,
    MPI_Status *status) 16
int MPI_Ssend(const void* buf, int count, MPI_Datatype datatype, int dest, 17
    int tag, MPI_Comm comm) 18
int MPI_Ssend_init(const void* buf, int count, MPI_Datatype datatype, 19
    int dest, int tag, MPI_Comm comm, MPI_Request *request) 20
int MPI_Startall(int count, MPI_Request array_of_requests[]) 21
int MPI_Start(MPI_Request *request) 22
int MPI_Testall(int count, MPI_Request array_of_requests[], int *flag, 23
    MPI_Status array_of_statuses[]) 24
int MPI_Testany(int count, MPI_Request array_of_requests[], int *index, 25
    int *flag, MPI_Status *status) 26
int MPI_Test_cancelled(const MPI_Status *status, int *flag) 27
int MPI_Test(MPI_Request *request, int *flag, MPI_Status *status) 28
int MPI_Testsome(int incount, MPI_Request array_of_requests[], 29
    int *outcount, int array_of_indices[],
    MPI_Status array_of_statuses[]) 30
int MPI_Waitall(int count, MPI_Request array_of_requests[], 31
    MPI_Status array_of_statuses[]) 32
int MPI_Waitany(int count, MPI_Request array_of_requests[], int *index, 33
    MPI_Status *status) 34
    35
    36
    37
    38
    39
    40
    41
    42
    43
    44
    45
    46
    47
    48
```

```
1 int MPI_Wait(MPI_Request *request, MPI_Status *status)
2
3 int MPI_Waitsome(int incount, MPI_Request array_of_requests[],
4                 int *outcount, int array_of_indices[],
5                 MPI_Status array_of_statuses[])
6
7 A.2.2 Datatypes C Bindings
8
9 int MPI_Get_address(const void *location, MPI_Aint *address)
10
11 int MPI_Get_elements(const MPI_Status *status, MPI_Datatype datatype,
12                     int *count)
13
14 int MPI_Get_elements_x(const MPI_Status *status, MPI_Datatype datatype,
15                       MPI_Count *count)
16
17 int MPI_Pack(const void* inbuf, int incount, MPI_Datatype datatype,
18             void *outbuf, int outsize, int *position, MPI_Comm comm)
19
20 int MPI_Pack_external(const char datarep[], const void *inbuf, int incount,
21                     MPI_Datatype datatype, void *outbuf, MPI_Aint outsize,
22                     MPI_Aint *position)
23
24 int MPI_Pack_external_size(const char datarep[], int incount,
25                           MPI_Datatype datatype, MPI_Aint *size)
26
27 int MPI_Pack_size(int incount, MPI_Datatype datatype, MPI_Comm comm,
28                  int *size)
29
30 int MPI_Type_commit(MPI_Datatype *datatype)
31
32 int MPI_Type_contiguous(int count, MPI_Datatype oldtype,
33                       MPI_Datatype *newtype)
34
35 int MPI_Type_create_darray(int size, int rank, int ndims,
36                           const int array_of_gsizes[], const int array_of_distrib[],
37                           const int array_of_dargs[], const int array_of_psize[],
38                           int order, MPI_Datatype oldtype, MPI_Datatype *newtype)
39
40 int MPI_Type_create_hindexed_block(int count, int blocklength,
41                                   const MPI_Aint array_of_displacements[], MPI_Datatype oldtype,
42                                   MPI_Datatype *newtype)
43
44 int MPI_Type_create_hindexed(int count, const int array_of_blocklengths[],
45                             const MPI_Aint array_of_displacements[], MPI_Datatype oldtype,
46                             MPI_Datatype *newtype)
47
48 int MPI_Type_create_hvector(int count, int blocklength, MPI_Aint stride,
49                             MPI_Datatype oldtype, MPI_Datatype *newtype)
50
51 int MPI_Type_create_indexed_block(int count, int blocklength,
52                                  const int array_of_displacements[], MPI_Datatype oldtype,
53                                  MPI_Datatype *newtype)
```

```
int MPI_Type_create_resized(MPI_Datatype oldtype, MPI_Aint lb,      1
                           MPI_Aint extent, MPI_Datatype *newtype)  2
                                                                    3
int MPI_Type_create_struct(int count, const int array_of_blocklengths[],  4
                           const MPI_Aint array_of_displacements[],      5
                           const MPI_Datatype array_of_types[], MPI_Datatype *newtype)  6
                                                                    7
int MPI_Type_create_subarray(int ndims, const int array_of_sizes[],      8
                             const int array_of_subsizes[], const int array_of_starts[],  9
                             int order, MPI_Datatype oldtype, MPI_Datatype *newtype) 10
                                                                    11
int MPI_Type_dup(MPI_Datatype oldtype, MPI_Datatype *newtype)      12
                                                                    13
int MPI_Type_free(MPI_Datatype *datatype)                            14
                                                                    15
int MPI_Type_get_contents(MPI_Datatype datatype, int max_integers,      16
                           int max_addresses, int max_datatypes, int array_of_integers[], 17
                           MPI_Aint array_of_addresses[],              18
                           MPI_Datatype array_of_datatypes[])        19
                                                                    20
int MPI_Type_get_envelope(MPI_Datatype datatype, int *num_integers,      21
                           int *num_addresses, int *num_datatypes, int *combiner)      22
                                                                    23
int MPI_Type_get_extent(MPI_Datatype datatype, MPI_Aint *lb,          24
                           MPI_Aint *extent)                          25
                                                                    26
int MPI_Type_get_extent_x(MPI_Datatype datatype, MPI_Count *lb,        27
                           MPI_Count *extent)                         28
                                                                    29
int MPI_Type_get_true_extent(MPI_Datatype datatype, MPI_Aint *true_lb, 30
                              MPI_Aint *true_extent)                  31
                                                                    32
int MPI_Type_get_true_extent_x(MPI_Datatype datatype, MPI_Count *true_lb, 33
                              MPI_Count *true_extent)                  34
                                                                    35
int MPI_Type_indexed(int count, const int array_of_blocklengths[],      36
                           const int array_of_displacements[], MPI_Datatype oldtype,      37
                           MPI_Datatype *newtype)                     38
                                                                    39
int MPI_Type_size(MPI_Datatype datatype, int *size)                  40
                                                                    41
int MPI_Type_size_x(MPI_Datatype datatype, MPI_Count *size)          42
                                                                    43
int MPI_Type_vector(int count, int blocklength, int stride,           44
                           MPI_Datatype oldtype, MPI_Datatype *newtype) 45
                                                                    46
int MPI_Unpack(const void* inbuf, int insize, int *position, void *outbuf, 47
               int outcount, MPI_Datatype datatype, MPI_Comm comm)   48
                                                                    49
int MPI_Unpack_external(const char datarep[], const void *inbuf,       50
                           MPI_Aint insize, MPI_Aint *position, void *outbuf,         51
                           int outcount, MPI_Datatype datatype)      52
                                                                    53
MPI_Aint MPI_Aint_add(MPI_Aint base, MPI_Aint disp)                  54
                                                                    55
MPI_Aint MPI_Aint_diff(MPI_Aint addr1, MPI_Aint addr2)              56
```

A.2.3 Collective Communication C Bindings

```
1 int MPI_Allgather(const void* sendbuf, int sendcount,
2                 MPI_Datatype sendtype, void* recvbuf, int recvcount,
3                 MPI_Datatype recvtype, MPI_Comm comm)
4
5
6 int MPI_Allgather_init(const void* sendbuf, int sendcount,
7                       MPI_Datatype sendtype, void* recvbuf, int recvcount,
8                       MPI_Datatype recvtype, MPI_Comm comm, MPI_Info info,
9                       MPI_Request *request)
10
11 int MPI_Allgatherv(const void* sendbuf, int sendcount,
12                   MPI_Datatype sendtype, void* recvbuf, const int recvcounts[],
13                   const int displs[], MPI_Datatype recvtype, MPI_Comm comm)
14
15 int MPI_Allgatherv_init(const void* sendbuf, int sendcount,
16                         MPI_Datatype sendtype, void* recvbuf, const int recvcounts[],
17                         const int displs[], MPI_Datatype recvtype, MPI_Comm comm,
18                         MPI_Info info, MPI_Request* request)
19
20 int MPI_Allreduce(const void* sendbuf, void* recvbuf, int count,
21                  MPI_Datatype datatype, MPI_Op op, MPI_Comm comm)
22
23 int MPI_Allreduce_init(const void* sendbuf, void* recvbuf, int count,
24                       MPI_Datatype datatype, MPI_Op op, MPI_Comm comm,
25                       MPI_Info info, MPI_Request *request)
26
27 int MPI_Alltoall(const void* sendbuf, int sendcount, MPI_Datatype sendtype,
28                 void* recvbuf, int recvcount, MPI_Datatype recvtype,
29                 MPI_Comm comm)
30
31 int MPI_Alltoall_init(const void* sendbuf, int sendcount,
32                      MPI_Datatype sendtype, void* recvbuf, int recvcount,
33                      MPI_Datatype recvtype, MPI_Comm comm, MPI_Info info,
34                      MPI_Request *request)
35
36 int MPI_Alltoallv(const void* sendbuf, const int sendcounts[],
37                  const int sdispls[], MPI_Datatype sendtype, void* recvbuf,
38                  const int recvcounts[], const int rdispls[],
39                  MPI_Datatype recvtype, MPI_Comm comm)
40
41 int MPI_Alltoallv_init(const void* sendbuf, const int sendcounts[],
42                       const int sdispls[], MPI_Datatype sendtype, void* recvbuf,
43                       const int recvcounts[], const int rdispls[],
44                       MPI_Datatype recvtype, MPI_Comm comm, MPI_info info,
45                       MPI_Request *request)
46
47 int MPI_Alltoallw(const void* sendbuf, const int sendcounts[],
48                  const int sdispls[], const MPI_Datatype sendtypes[],
49                  void* recvbuf, const int recvcounts[], const int rdispls[],
50                  const MPI_Datatype recvtypes[], MPI_Comm comm)
51
52 int MPI_Alltoallw_init(const void* sendbuf, const int sendcounts[],
```

```
    const int sdispls[], const MPI_Datatype sendtypes[],      1
    void* recvbuf, const int recvcnts[], const int rdispls[],  2
    const MPI_Datatype recvtypes[], MPI_Comm comm, MPI_Info info,  3
    MPI_Request *request)                                     4
                                                            5
int MPI_Barrier_init(MPI_Comm comm, MPI_Info info, MPI_Request *request)  6
int MPI_Barrier(MPI_Comm comm)                               7
                                                            8
int MPI_Bcast_init(void* buffer, int count, MPI_Datatype datatype,  9
    int root, MPI_Comm comm, MPI_Info info, MPI_Request *request) 10
int MPI_Bcast(void* buffer, int count, MPI_Datatype datatype, int root, 11
    MPI_Comm comm)                                         12
                                                            13
int MPI_Exscan(const void* sendbuf, void* recvbuf, int count, 14
    MPI_Datatype datatype, MPI_Op op, MPI_Comm comm)      15
int MPI_Exscan_init(const void* sendbuf, void* recvbuf, int count, 16
    MPI_Datatype datatype, MPI_Op op, MPI_Comm comm,      17
    MPI_Info info, MPI_Request *request)                  18
                                                            19
int MPI_Gather(const void* sendbuf, int sendcount, MPI_Datatype sendtype, 20
    void* recvbuf, int recvcnt, MPI_Datatype recvtype, int root, 21
    MPI_Comm comm)                                       22
                                                            23
int MPI_Gather_init(const void* sendbuf, int sendcount,      24
    MPI_Datatype sendtype, void* recvbuf, int recvcnt,    25
    MPI_Datatype recvtype, int root, MPI_Comm comm, MPI_Info info, 26
    MPI_Request *request)                                 27
int MPI_Gatherv(const void* sendbuf, int sendcount, MPI_Datatype sendtype, 28
    void* recvbuf, const int recvcnts[], const int displs[], 29
    MPI_Datatype recvtype, int root, MPI_Comm comm)      30
                                                            31
int MPI_Gatherv_init(const void* sendbuf, int sendcount,    32
    MPI_Datatype sendtype, void* recvbuf, const int recvcnts[], 33
    const int displs[], MPI_Datatype recvtype, int root, 34
    MPI_Comm comm, MPI_Info info, MPI_Request *request) 35
int MPI_Iallgather(const void* sendbuf, int sendcount,      36
    MPI_Datatype sendtype, void* recvbuf, int recvcnt,    37
    MPI_Datatype recvtype, MPI_Comm comm, MPI_Request *request) 38
int MPI_Iallgatherv(const void* sendbuf, int sendcount,    39
    MPI_Datatype sendtype, void* recvbuf, const int recvcnts[], 40
    const int displs[], MPI_Datatype recvtype, MPI_Comm comm, 41
    MPI_Request* request)                                 42
                                                            43
int MPI_Iallreduce(const void* sendbuf, void* recvbuf, int count, 44
    MPI_Datatype datatype, MPI_Op op, MPI_Comm comm,      45
    MPI_Request *request)                                 46
int MPI_Ialltoall(const void* sendbuf, int sendcount,      47
    MPI_Datatype sendtype, void* recvbuf, const int recvcnts[], 48
    const int displs[], MPI_Datatype recvtype, MPI_Comm comm,
    MPI_Request* request)
```

```
1         MPI_Datatype sendtype, void* recvbuf, int recvcount,
2         MPI_Datatype recvtype, MPI_Comm comm, MPI_Request *request)
3
4     int MPI_Ialltoallv(const void* sendbuf, const int sendcounts[],
5         const int sdispls[], MPI_Datatype sendtype, void* recvbuf,
6         const int recvcounts[], const int rdispls[],
7         MPI_Datatype recvtype, MPI_Comm comm, MPI_Request *request)
8
9     int MPI_Ialltoallw(const void* sendbuf, const int sendcounts[],
10        const int sdispls[], const MPI_Datatype sendtypes[],
11        void* recvbuf, const int recvcounts[], const int rdispls[],
12        const MPI_Datatype recvtypes[], MPI_Comm comm,
13        MPI_Request *request)
14
15     int MPI_Ibcast(void* buffer, int count, MPI_Datatype datatype, int root,
16        MPI_Comm comm, MPI_Request *request)
17
18     int MPI_Iexscan(const void* sendbuf, void* recvbuf, int count,
19        MPI_Datatype datatype, MPI_Op op, MPI_Comm comm,
20        MPI_Request *request)
21
22     int MPI_Igather(const void* sendbuf, int sendcount, MPI_Datatype sendtype,
23        void* recvbuf, int recvcount, MPI_Datatype recvtype, int root,
24        MPI_Comm comm, MPI_Request *request)
25
26     int MPI_Igatherv(const void* sendbuf, int sendcount, MPI_Datatype sendtype,
27        void* recvbuf, const int recvcounts[], const int displs[],
28        MPI_Datatype recvtype, int root, MPI_Comm comm,
29        MPI_Request *request)
30
31     int MPI_Ireduce(const void* sendbuf, void* recvbuf, int count,
32        MPI_Datatype datatype, MPI_Op op, int root, MPI_Comm comm,
33        MPI_Request *request)
34
35     int MPI_Ireduce_scatter_block(const void* sendbuf, void* recvbuf,
36        int recvcount, MPI_Datatype datatype, MPI_Op op,
37        MPI_Comm comm, MPI_Request *request)
38
39     int MPI_Ireduce_scatter(const void* sendbuf, void* recvbuf,
40        const int recvcounts[], MPI_Datatype datatype, MPI_Op op,
41        MPI_Comm comm, MPI_Request *request)
42
43     int MPI_Iscan(const void* sendbuf, void* recvbuf, int count,
44        MPI_Datatype datatype, MPI_Op op, MPI_Comm comm,
45        MPI_Request *request)
46
47     int MPI_Iscatter(const void* sendbuf, int sendcount, MPI_Datatype sendtype,
48        void* recvbuf, int recvcount, MPI_Datatype recvtype, int root,
49        MPI_Comm comm, MPI_Request *request)
50
51     int MPI_Iscatterv(const void* sendbuf, const int sendcounts[],
52        const int displs[], MPI_Datatype sendtype, void* recvbuf,
```



```
        int recvcnt, MPI_Datatype recvtpe, int root, MPI_Comm comm, 1
        MPI_Request *request) 2
3
int MPI_Op_commutative(MPI_Op op, int *commute) 4
int MPI_Op_create(MPI_User_function* user_fn, int commute, MPI_Op* op) 5
int MPI_Op_free(MPI_Op *op) 6
int MPI_Reduce(const void* sendbuf, void* recvbuf, int count, 7
        MPI_Datatype datatype, MPI_Op op, int root, MPI_Comm comm) 8
int MPI_Reduce_init(const void* sendbuf, void* recvbuf, int count, 9
        MPI_Datatype datatype, MPI_Op op, int root, MPI_Comm comm, 10
        MPI_Info info, MPI_Request *request) 11
int MPI_Reduce_local(const void* inbuf, void* inoutbuf, int count, 12
        MPI_Datatype datatype, MPI_Op op) 13
int MPI_Reduce_scatter_block(const void* sendbuf, void* recvbuf, 14
        int recvcnt, MPI_Datatype datatype, MPI_Op op, 15
        MPI_Comm comm) 16
int MPI_Reduce_scatter_block_init(const void* sendbuf, void* recvbuf, 17
        int recvcnt, MPI_Datatype datatype, MPI_Op op, 18
        MPI_Comm comm, MPI_Info info, MPI_Request *request) 19
int MPI_Reduce_scatter(const void* sendbuf, void* recvbuf, 20
        const int recvcnts[], MPI_Datatype datatype, MPI_Op op, 21
        MPI_Comm comm) 22
int MPI_Reduce_scatter_init(const void* sendbuf, void* recvbuf, 23
        const int recvcnts[], MPI_Datatype datatype, MPI_Op op, 24
        MPI_Comm comm, MPI_Info info, MPI_Request *request) 25
int MPI_Scan(const void* sendbuf, void* recvbuf, int count, 26
        MPI_Datatype datatype, MPI_Op op, MPI_Comm comm) 27
int MPI_Scan_init(const void* sendbuf, void* recvbuf, int count, 28
        MPI_Datatype datatype, MPI_Op op, MPI_Comm comm, 29
        MPI_Info info, MPI_Request *request) 30
int MPI_Scatter(const void* sendbuf, int sendcount, MPI_Datatype sendtpe, 31
        void* recvbuf, int recvcnt, MPI_Datatype recvtpe, int root, 32
        MPI_Comm comm) 33
int MPI_Scatter_init(const void* sendbuf, int sendcount, 34
        MPI_Datatype sendtpe, void* recvbuf, int recvcnt, 35
        MPI_Datatype recvtpe, int root, MPI_Comm comm, MPI_Info info, 36
        MPI_Request *request) 37
int MPI_Scatterv(const void* sendbuf, const int sendcounts[], 38
        const int displs[], MPI_Datatype sendtpe, void* recvbuf, 39
        int recvcnt, MPI_Datatype recvtpe, int root, MPI_Comm comm) 40
41
42
43
44
45
46
47
48
```

```

1 int MPI_Scatterv_init(const void* sendbuf, const int sendcounts[],
2                     const int displs[], MPI_Datatype sendtype, void* recvbuf,
3                     int recvcnt, MPI_Datatype recvtype, int root, MPI_Comm comm,
4                     MPI_Info info, MPI_Request *request)
5
6

```

7 A.2.4 Groups, Contexts, Communicators, and Caching C Bindings

```

8 int MPI_Comm_compare(MPI_Comm comm1, MPI_Comm comm2, int *result)
9
10 int MPI_Comm_create_group(MPI_Comm comm, MPI_Group group, int tag,
11                          MPI_Comm *newcomm)
12
13 int MPI_Comm_create_keyval(MPI_Comm_copy_attr_function *comm_copy_attr_fn,
14                          MPI_Comm_delete_attr_function *comm_delete_attr_fn,
15                          int *comm_keyval, void *extra_state)
16
17 int MPI_Comm_create(MPI_Comm comm, MPI_Group group, MPI_Comm *newcomm)
18
19 int MPI_Comm_delete_attr(MPI_Comm comm, int comm_keyval)
20
21 int MPI_COMM_DUP_FN(MPI_Comm oldcomm, int comm_keyval, void *extra_state,
22                   void *attribute_val_in, void *attribute_val_out, int *flag)
23
24 int MPI_Comm_dup(MPI_Comm comm, MPI_Comm *newcomm)
25
26 int MPI_Comm_dup_with_info(MPI_Comm comm, MPI_Info info, MPI_Comm *newcomm)
27
28 int MPI_Comm_free_keyval(int *comm_keyval)
29
30 int MPI_Comm_free(MPI_Comm *comm)
31
32 int MPI_Comm_get_attr(MPI_Comm comm, int comm_keyval, void *attribute_val,
33                     int *flag)
34
35 int MPI_Comm_get_info(MPI_Comm comm, MPI_Info *info_used)
36
37 int MPI_Comm_get_name(MPI_Comm comm, char *comm_name, int *resultlen)
38
39 int MPI_Comm_group(MPI_Comm comm, MPI_Group *group)
40
41 int MPI_Comm_idup(MPI_Comm comm, MPI_Comm *newcomm, MPI_Request *request)
42
43 int MPI_Comm_idup_with_info(MPI_Comm comm, MPI_Info info,
44                          MPI_Comm *newcomm, MPI_Request *request)
45
46 int MPI_COMM_NULL_COPY_FN(MPI_Comm oldcomm, int comm_keyval,
47                          void *extra_state, void *attribute_val_in,
48                          void *attribute_val_out, int *flag)
49
50 int MPI_COMM_NULL_DELETE_FN(MPI_Comm comm, int comm_keyval,
51                             void *attribute_val, void *extra_state)
52
53 int MPI_Comm_rank(MPI_Comm comm, int *rank)
54
55 int MPI_Comm_remote_group(MPI_Comm comm, MPI_Group *group)
56
57 int MPI_Comm_remote_size(MPI_Comm comm, int *size)

```

```
int MPI_Comm_set_attr(MPI_Comm comm, int comm_keyval, void *attribute_val) 1
int MPI_Comm_set_info(MPI_Comm comm, MPI_Info info) 2
int MPI_Comm_set_name(MPI_Comm comm, const char *comm_name) 3
int MPI_Comm_size(MPI_Comm comm, int *size) 4
int MPI_Comm_split(MPI_Comm comm, int color, int key, MPI_Comm *newcomm) 5
int MPI_Comm_split_type(MPI_Comm comm, int split_type, int key, 6
    MPI_Info info, MPI_Comm *newcomm) 7
int MPI_Comm_test_inter(MPI_Comm comm, int *flag) 8
int MPI_Group_compare(MPI_Group group1, MPI_Group group2, int *result) 9
int MPI_Group_difference(MPI_Group group1, MPI_Group group2, 10
    MPI_Group *newgroup) 11
int MPI_Group_excl(MPI_Group group, int n, const int ranks[], 12
    MPI_Group *newgroup) 13
int MPI_Group_free(MPI_Group *group) 14
int MPI_Group_incl(MPI_Group group, int n, const int ranks[], 15
    MPI_Group *newgroup) 16
int MPI_Group_intersection(MPI_Group group1, MPI_Group group2, 17
    MPI_Group *newgroup) 18
int MPI_Group_range_excl(MPI_Group group, int n, int ranges[][3], 19
    MPI_Group *newgroup) 20
int MPI_Group_range_incl(MPI_Group group, int n, int ranges[][3], 21
    MPI_Group *newgroup) 22
int MPI_Group_rank(MPI_Group group, int *rank) 23
int MPI_Group_size(MPI_Group group, int *size) 24
int MPI_Group_translate_ranks(MPI_Group group1, int n, const int ranks1[], 25
    MPI_Group group2, int ranks2[]) 26
int MPI_Group_union(MPI_Group group1, MPI_Group group2, 27
    MPI_Group *newgroup) 28
int MPI_Intercomm_create(MPI_Comm local_comm, int local_leader, 29
    MPI_Comm peer_comm, int remote_leader, int tag, 30
    MPI_Comm *newintercomm) 31
int MPI_Intercomm_merge(MPI_Comm intercomm, int high, 32
    MPI_Comm *newintracomm) 33
int MPI_Type_create_keyval(MPI_Type_copy_attr_function *type_copy_attr_fn, 34
    MPI_Type_delete_attr_function *type_delete_attr_fn, 35
    int *type_keyval, void *extra_state) 36

```

```
1 int MPI_Type_delete_attr(MPI_Datatype datatype, int type_keyval)
2
3 int MPI_TYPE_DUP_FN(MPI_Datatype oldtype, int type_keyval,
4     void *extra_state, void *attribute_val_in,
5     void *attribute_val_out, int *flag)
6
7 int MPI_Type_free_keyval(int *type_keyval)
8
9 int MPI_Type_get_attr(MPI_Datatype datatype, int type_keyval,
10     void *attribute_val, int *flag)
11
12 int MPI_Type_get_name(MPI_Datatype datatype, char *type_name,
13     int *resultlen)
14
15 int MPI_TYPE_NULL_COPY_FN(MPI_Datatype oldtype, int type_keyval,
16     void *extra_state, void *attribute_val_in,
17     void *attribute_val_out, int *flag)
18
19 int MPI_Type_set_attr(MPI_Datatype datatype, int type_keyval,
20     void *attribute_val)
21
22 int MPI_Type_set_name(MPI_Datatype datatype, const char *type_name)
23
24 int MPI_Win_create_keyval(MPI_Win_copy_attr_function *win_copy_attr_fn,
25     MPI_Win_delete_attr_function *win_delete_attr_fn,
26     int *win_keyval, void *extra_state)
27
28 int MPI_Win_delete_attr(MPI_Win win, int win_keyval)
29
30 int MPI_WIN_DUP_FN(MPI_Win oldwin, int win_keyval, void *extra_state,
31     void *attribute_val_in, void *attribute_val_out, int *flag)
32
33 int MPI_Win_free_keyval(int *win_keyval)
34
35 int MPI_Win_get_attr(MPI_Win win, int win_keyval, void *attribute_val,
36     int *flag)
37
38 int MPI_Win_get_name(MPI_Win win, char *win_name, int *resultlen)
39
40 int MPI_WIN_NULL_COPY_FN(MPI_Win oldwin, int win_keyval, void *extra_state,
41     void *attribute_val_in, void *attribute_val_out, int *flag)
42
43 int MPI_WIN_NULL_DELETE_FN(MPI_Win win, int win_keyval,
44     void *attribute_val, void *extra_state)
45
46 int MPI_Win_set_attr(MPI_Win win, int win_keyval, void *attribute_val)
47
48 int MPI_Win_set_name(MPI_Win win, const char *win_name)
```

A.2.5 Process Topologies C Bindings

```
int MPI_Cart_coords(MPI_Comm comm, int rank, int maxdims, int coords[])
```

```
int MPI_Cart_create(MPI_Comm comm_old, int ndims, const int dims[],  
                   const int periods[], int reorder, MPI_Comm *comm_cart) 1  
                                                                              2  
                                                                              3  
int MPI_Cart_create_weighted(MPI_Comm comm_old, int ndims,  
                             const double dim_weights[], const int periods[],  
                             MPI_Info info, int dims[], MPI_Comm *comm_cart) 4  
                                                                              5  
                                                                              6  
int MPI_Cartdim_get(MPI_Comm comm, int *ndims) 7  
                                                                              8  
int MPI_Cart_get(MPI_Comm comm, int maxdims, int dims[], int periods[],  
                 int coords[]) 9  
                                                                              10  
int MPI_Cart_map(MPI_Comm comm, int ndims, const int dims[],  
                 const int periods[], int *newrank) 11  
                                                                              12  
                                                                              13  
int MPI_Cart_rank(MPI_Comm comm, const int coords[], int *rank) 14  
                                                                              15  
int MPI_Cart_shift(MPI_Comm comm, int direction, int disp,  
                  int *rank_source, int *rank_dest) 16  
                                                                              17  
int MPI_Cart_sub(MPI_Comm comm, const int remain_dims[], MPI_Comm *newcomm) 18  
                                                                              19  
int MPI_Dims_create(int nnodes, int ndims, int dims[]) 20  
                                                                              21  
int MPI_Dims_create_weighted(int nnodes, int ndims,  
                             const double dim_weights[], const int periods[],  
                             MPI_Info info, int dims[]) 22  
                                                                              23  
                                                                              24  
int MPI_Dist_graph_create_adjacent(MPI_Comm comm_old, int indegree,  
                                   const int sources[], const int sourceweights[], int outdegree,  
                                   const int destinations[], const int destweights[],  
                                   MPI_Info info, int reorder, MPI_Comm *comm_dist_graph) 25  
                                                                              26  
                                                                              27  
                                                                              28  
int MPI_Dist_graph_create(MPI_Comm comm_old, int n, const int sources[],  
                          const int degrees[], const int destinations[],  
                          const int weights[], MPI_Info info, int reorder,  
                          MPI_Comm *comm_dist_graph) 29  
                                                                              30  
                                                                              31  
                                                                              32  
int MPI_Dist_graph_neighbors_count(MPI_Comm comm, int *indegree,  
                                  int *outdegree, int *weighted) 33  
                                                                              34  
                                                                              35  
int MPI_Dist_graph_neighbors(MPI_Comm comm, int maxindegree, int sources[],  
                             int sourceweights[], int maxoutdegree, int destinations[],  
                             int destweights[]) 36  
                                                                              37  
                                                                              38  
                                                                              39  
int MPI_Graph_create(MPI_Comm comm_old, int nnodes, const int index[],  
                    const int edges[], int reorder, MPI_Comm *comm_graph) 40  
                                                                              41  
int MPI_Graphdims_get(MPI_Comm comm, int *nnodes, int *nedges) 42  
                                                                              43  
int MPI_Graph_get(MPI_Comm comm, int maxindex, int maxedges, int index[],  
                 int edges[]) 44  
                                                                              45  
int MPI_Graph_map(MPI_Comm comm, int nnodes, const int index[],  
                 const int edges[], int *newrank) 46  
                                                                              47  
                                                                              48
```

```
1 int MPI_Graph_neighbors_count(MPI_Comm comm, int rank, int *nneighbors)
2
3 int MPI_Graph_neighbors(MPI_Comm comm, int rank, int maxneighbors,
4     int neighbors[])
5
6 int MPI_Ineighbor_allgather(const void* sendbuf, int sendcount,
7     MPI_Datatype sendtype, void* recvbuf, int recvcount,
8     MPI_Datatype recvtype, MPI_Comm comm, MPI_Request *request)
9
10 int MPI_Ineighbor_allgatherv(const void* sendbuf, int sendcount,
11     MPI_Datatype sendtype, void* recvbuf, const int recvcounts[],
12     const int displs[], MPI_Datatype recvtype, MPI_Comm comm,
13     MPI_Request *request)
14
15 int MPI_Ineighbor_alltoall(const void* sendbuf, int sendcount,
16     MPI_Datatype sendtype, void* recvbuf, int recvcount,
17     MPI_Datatype recvtype, MPI_Comm comm, MPI_Request *request)
18
19 int MPI_Ineighbor_alltoallv(const void* sendbuf, const int sendcounts[],
20     const int sdispls[], MPI_Datatype sendtype, void* recvbuf,
21     const int recvcounts[], const int rdispls[],
22     MPI_Datatype recvtype, MPI_Comm comm, MPI_Request *request)
23
24 int MPI_Ineighbor_alltoallw(const void* sendbuf, const int sendcounts[],
25     const MPI_Aint sdispls[], const MPI_Datatype sendtypes[],
26     void* recvbuf, const int recvcounts[],
27     const MPI_Aint rdispls[], const MPI_Datatype recvtypes[],
28     MPI_Comm comm, MPI_Request *request)
29
30 int MPI_Neighbor_allgather(const void* sendbuf, int sendcount,
31     MPI_Datatype sendtype, void* recvbuf, int recvcount,
32     MPI_Datatype recvtype, MPI_Comm comm)
33
34 int MPI_Neighbor_allgather_init(const void* sendbuf, int sendcount,
35     MPI_Datatype sendtype, void* recvbuf, int recvcount,
36     MPI_Datatype recvtype, MPI_Comm comm, MPI_Info info,
37     MPI_Request *request)
38
39 int MPI_Neighbor_allgatherv(const void* sendbuf, int sendcount,
40     MPI_Datatype sendtype, void* recvbuf, const int recvcounts[],
41     const int displs[], MPI_Datatype recvtype, MPI_Comm comm)
42
43 int MPI_Neighbor_allgatherv_init(const void* sendbuf, int sendcount,
44     MPI_Datatype sendtype, void* recvbuf, const int recvcounts[],
45     const int displs[], MPI_Datatype recvtype, MPI_Comm comm,
46     MPI_Info info, MPI_Request *request)
47
48 int MPI_Neighbor_alltoall(const void* sendbuf, int sendcount,
49     MPI_Datatype sendtype, void* recvbuf, int recvcount,
50     MPI_Datatype recvtype, MPI_Comm comm)
51
52 int MPI_Neighbor_alltoall_init(const void* sendbuf, int sendcount,
53     MPI_Datatype sendtype, void* recvbuf, int recvcount,
```

```

        MPI_Datatype recvtype, MPI_Comm comm, MPI_Info info,
        MPI_Request *request)
1
2
3
int MPI_Neighbor_alltoallv(const void* sendbuf, const int sendcounts[],
4
5
6
7
8
9
10
11
12
13
14
15
16
17
18
19
20
21
22
23
24
25
26
27
28
29
30
31
32
33
34
35
36
37
38
39
40
41
42
43
44
45
46
47
48
        MPI_Datatype sendtype, void* recvbuf, const int recvcounts[],
        const int rdispls[], MPI_Datatype recvtype, MPI_Comm comm)

int MPI_Neighbor_alltoallv_init(const void* sendbuf,
        const int sendcounts[], const int sdispls[],
        MPI_Datatype sendtype, void* recvbuf, const int recvcounts[],
        const int rdispls[], MPI_Datatype recvtype, MPI_Comm comm,
        MPI_Info info, MPI_Request *request)

int MPI_Neighbor_alltoallw(const void* sendbuf, const int sendcounts[],
        const MPI_Aint sdispls[], const MPI_Datatype sendtypes[],
        void* recvbuf, const int recvcounts[],
        const MPI_Aint rdispls[], const MPI_Datatype recvtypes[],
        MPI_Comm comm)

int MPI_Neighbor_alltoallw_init(const void* sendbuf,
        const int sendcounts[], const MPI_Aint sdispls[],
        const MPI_Datatype sendtypes[], void* recvbuf,
        const int recvcounts[], const MPI_Aint rdispls[],
        const MPI_Datatype recvtypes[], MPI_Comm comm, MPI_Info info,
        MPI_Request *request)

int MPI_Topo_test(MPI_Comm comm, int *status)

```

A.2.6 MPI Environmental Management C Bindings

```

int MPI_Abort(MPI_Comm comm, int errorcode)
int MPI_Add_error_class(int *errorclass)
int MPI_Add_error_code(int errorclass, int *errorcode)
int MPI_Add_error_string(int errorcode, const char *string)
int MPI_Alloc_mem(MPI_Aint size, MPI_Info info, void *baseptr)
int MPI_Comm_call_errhandler(MPI_Comm comm, int errorcode)
int MPI_Comm_create_errhandler(MPI_Comm_errhandler_function
        *comm_errhandler_fn, MPI_Errhandler *errhandler)
int MPI_Comm_get_errhandler(MPI_Comm comm, MPI_Errhandler *errhandler)
int MPI_Comm_set_errhandler(MPI_Comm comm, MPI_Errhandler errhandler)
int MPI_Errhandler_free(MPI_Errhandler *errhandler)
int MPI_Error_class(int errorcode, int *errorclass)
int MPI_Error_string(int errorcode, char *string, int *resultlen)

```

```

1  int MPI_File_call_errhandler(MPI_File fh, int errorcode)
2
3  int MPI_File_create_errhandler(MPI_File_errhandler_function
4      *file_errhandler_fn, MPI_Errhandler *errhandler)
5
6  int MPI_File_get_errhandler(MPI_File file, MPI_Errhandler *errhandler)
7
8  int MPI_File_set_errhandler(MPI_File file, MPI_Errhandler errhandler)
9
10 int MPI_Finalized(int *flag)
11
12 int MPI_Finalize(void)
13
14 int MPI_Free_mem(void *base)
15
16 int MPI_Get_library_version(char *version, int *resultlen)
17
18 int MPI_Get_processor_name(char *name, int *resultlen)
19
20 int MPI_Get_version(int *version, int *subversion)
21
22 int MPI_Initialized(int *flag)
23
24 int MPI_Init(int *argc, char ***argv)
25
26 int MPI_Win_call_errhandler(MPI_Win win, int errorcode)
27
28 int MPI_Win_create_errhandler(MPI_Win_errhandler_function
29     *win_errhandler_fn, MPI_Errhandler *errhandler)
30
31 int MPI_Win_get_errhandler(MPI_Win win, MPI_Errhandler *errhandler)
32
33 int MPI_Win_set_errhandler(MPI_Win win, MPI_Errhandler errhandler)
34
35 double MPI_Wtick(void)
36
37 double MPI_Wtime(void)
38
39
40
41
42
43
44
45
46
47
48

```

A.2.7 The Info Object C Bindings

```

33 int MPI_Info_create(MPI_Info *info)
34
35 int MPI_Info_delete(MPI_Info info, const char *key)
36
37 int MPI_Info_dup(MPI_Info info, MPI_Info *newinfo)
38
39 int MPI_Info_free(MPI_Info *info)
40
41 int MPI_Info_get(MPI_Info info, const char *key, int valuelen, char *value,
42     int *flag)
43
44 int MPI_Info_get_nkeys(MPI_Info info, int *nkeys)
45
46 int MPI_Info_get_nthkey(MPI_Info info, int n, char *key)
47
48 int MPI_Info_get_valuelen(MPI_Info info, const char *key, int *valuelen,
49     int *flag)
50
51 int MPI_Info_set(MPI_Info info, const char *key, const char *value)

```

A.2.8 Process Creation and Management C Bindings

```

int MPI_Close_port(const char *port_name)
int MPI_Comm_accept(const char *port_name, MPI_Info info, int root,
                    MPI_Comm comm, MPI_Comm *newcomm)
int MPI_Comm_connect(const char *port_name, MPI_Info info, int root,
                    MPI_Comm comm, MPI_Comm *newcomm)
int MPI_Comm_disconnect(MPI_Comm *comm)
int MPI_Comm_get_parent(MPI_Comm *parent)
int MPI_Comm_join(int fd, MPI_Comm *intercomm)
int MPI_Comm_spawn(const char *command, char *argv[], int maxprocs,
                  MPI_Info info, int root, MPI_Comm comm, MPI_Comm *intercomm,
                  int array_of_errcodes[])
int MPI_Comm_spawn_multiple(int count, char *array_of_commands[],
                            char **array_of_argv[], const int array_of_maxprocs[],
                            const MPI_Info array_of_info[], int root, MPI_Comm comm,
                            MPI_Comm *intercomm, int array_of_errcodes[])
int MPI_Lookup_name(const char *service_name, MPI_Info info,
                  char *port_name)
int MPI_Open_port(MPI_Info info, char *port_name)
int MPI_Publish_name(const char *service_name, MPI_Info info,
                   const char *port_name)
int MPI_Unpublish_name(const char *service_name, MPI_Info info,
                     const char *port_name)

```

A.2.9 One-Sided Communications C Bindings

```

int MPI_Accumulate(const void *origin_addr, int origin_count,
                 MPI_Datatype origin_datatype, int target_rank,
                 MPI_Aint target_disp, int target_count,
                 MPI_Datatype target_datatype, MPI_Op op, MPI_Win win)
int MPI_Compare_and_swap(const void *origin_addr, const void *compare_addr,
                       void *result_addr, MPI_Datatype datatype, int target_rank,
                       MPI_Aint target_disp, MPI_Win win)
int MPI_Fetch_and_op(const void *origin_addr, void *result_addr,
                   MPI_Datatype datatype, int target_rank, MPI_Aint target_disp,
                   MPI_Op op, MPI_Win win)
int MPI_Get_accumulate(const void *origin_addr, int origin_count,
                     MPI_Datatype origin_datatype, void *result_addr,
                     int result_count, MPI_Datatype result_datatype,

```

```
1         int target_rank, MPI_Aint target_disp, int target_count,
2         MPI_Datatype target_datatype, MPI_Op op, MPI_Win win)
3
4     int MPI_Get(void *origin_addr, int origin_count,
5         MPI_Datatype origin_datatype, int target_rank,
6         MPI_Aint target_disp, int target_count,
7         MPI_Datatype target_datatype, MPI_Win win)
8
9     int MPI_Put(const void *origin_addr, int origin_count,
10        MPI_Datatype origin_datatype, int target_rank,
11        MPI_Aint target_disp, int target_count,
12        MPI_Datatype target_datatype, MPI_Win win)
13
14    int MPI_Raccumulate(const void *origin_addr, int origin_count,
15        MPI_Datatype origin_datatype, int target_rank,
16        MPI_Aint target_disp, int target_count,
17        MPI_Datatype target_datatype, MPI_Op op, MPI_Win win,
18        MPI_Request *request)
19
20    int MPI_Rget_accumulate(const void *origin_addr, int origin_count,
21        MPI_Datatype origin_datatype, void *result_addr,
22        int result_count, MPI_Datatype result_datatype,
23        int target_rank, MPI_Aint target_disp, int target_count,
24        MPI_Datatype target_datatype, MPI_Op op, MPI_Win win,
25        MPI_Request *request)
26
27    int MPI_Rget(void *origin_addr, int origin_count,
28        MPI_Datatype origin_datatype, int target_rank,
29        MPI_Aint target_disp, int target_count,
30        MPI_Datatype target_datatype, MPI_Win win,
31        MPI_Request *request)
32
33    int MPI_Rput(const void *origin_addr, int origin_count,
34        MPI_Datatype origin_datatype, int target_rank,
35        MPI_Aint target_disp, int target_count,
36        MPI_Datatype target_datatype, MPI_Win win,
37        MPI_Request *request)
38
39    int MPI_Win_allocate(MPI_Aint size, int disp_unit, MPI_Info info,
40        MPI_Comm comm, void *baseptr, MPI_Win *win)
41
42    int MPI_Win_allocate_shared(MPI_Aint size, int disp_unit, MPI_Info info,
43        MPI_Comm comm, void *baseptr, MPI_Win *win)
44
45    int MPI_Win_attach(MPI_Win win, void *base, MPI_Aint size)
46
47    int MPI_Win_complete(MPI_Win win)
48
49    int MPI_Win_create_dynamic(MPI_Info info, MPI_Comm comm, MPI_Win *win)
50
51    int MPI_Win_create(void *base, MPI_Aint size, int disp_unit, MPI_Info info,
52        MPI_Comm comm, MPI_Win *win)
53
54    int MPI_Win_detach(MPI_Win win, const void *base)
```

```
int MPI_Win_fence(int assert, MPI_Win win) 1
int MPI_Win_flush_all(MPI_Win win) 2
int MPI_Win_flush(int rank, MPI_Win win) 3
int MPI_Win_flush_local_all(MPI_Win win) 4
int MPI_Win_flush_local(int rank, MPI_Win win) 5
int MPI_Win_free(MPI_Win *win) 6
int MPI_Win_get_group(MPI_Win win, MPI_Group *group) 7
int MPI_Win_get_info(MPI_Win win, MPI_Info *info_used) 8
int MPI_Win_lock_all(int assert, MPI_Win win) 9
int MPI_Win_lock(int lock_type, int rank, int assert, MPI_Win win) 10
int MPI_Win_post(MPI_Group group, int assert, MPI_Win win) 11
int MPI_Win_set_info(MPI_Win win, MPI_Info info) 12
int MPI_Win_shared_query(MPI_Win win, int rank, MPI_Aint *size, 13
    int *disp_unit, void *baseptr) 14
int MPI_Win_start(MPI_Group group, int assert, MPI_Win win) 15
int MPI_Win_sync(MPI_Win win) 16
int MPI_Win_test(MPI_Win win, int *flag) 17
int MPI_Win_unlock_all(MPI_Win win) 18
int MPI_Win_unlock(int rank, MPI_Win win) 19
int MPI_Win_wait(MPI_Win win) 20
```

A.2.10 External Interfaces C Bindings

```
int MPI_Grequest_complete(MPI_Request request) 21
int MPI_Grequest_start(MPI_Grequest_query_function *query_fn, 22
    MPI_Grequest_free_function *free_fn, 23
    MPI_Grequest_cancel_function *cancel_fn, void *extra_state, 24
    MPI_Request *request) 25
int MPI_Init_thread(int *argc, char ***argv, int required, int *provided) 26
int MPI_Is_thread_main(int *flag) 27
int MPI_Query_thread(int *provided) 28
int MPI_Status_set_cancelled(MPI_Status *status, int flag) 29
int MPI_Status_set_elements(MPI_Status *status, MPI_Datatype datatype, 30
    int count) 31
```

```
1 int MPI_Status_set_elements_x(MPI_Status *status, MPI_Datatype datatype,
2                               MPI_Count count)
3
```

4 A.2.11 I/O C Bindings

```
6 int MPI_CONVERSION_FN_NULL(void *userbuf, MPI_Datatype datatype, int count,
7                               void *filebuf, MPI_Offset position, void *extra_state)
8
```

```
9 int MPI_File_close(MPI_File *fh)
```

```
10 int MPI_File_delete(const char *filename, MPI_Info info)
```

```
11 int MPI_File_get_amode(MPI_File fh, int *amode)
```

```
12 int MPI_File_get_atomicity(MPI_File fh, int *flag)
```

```
13 int MPI_File_get_byte_offset(MPI_File fh, MPI_Offset offset,
14                               MPI_Offset *disp)
```

```
15 int MPI_File_get_group(MPI_File fh, MPI_Group *group)
```

```
16 int MPI_File_get_info(MPI_File fh, MPI_Info *info_used)
```

```
17 int MPI_File_get_position(MPI_File fh, MPI_Offset *offset)
```

```
18 int MPI_File_get_position_shared(MPI_File fh, MPI_Offset *offset)
```

```
19 int MPI_File_get_size(MPI_File fh, MPI_Offset *size)
```

```
20 int MPI_File_get_type_extent(MPI_File fh, MPI_Datatype datatype,
21                               MPI_Aint *extent)
```

```
22 int MPI_File_get_view(MPI_File fh, MPI_Offset *disp, MPI_Datatype *etype,
23                               MPI_Datatype *filetype, char *datarep)
```

```
24 int MPI_File_iread_all(MPI_File fh, void *buf, int count,
25                               MPI_Datatype datatype, MPI_Request *request)
```

```
26 int MPI_File_iread_at_all(MPI_File fh, MPI_Offset offset, void *buf,
27                               int count, MPI_Datatype datatype, MPI_Request *request)
```

```
28 int MPI_File_iread_at(MPI_File fh, MPI_Offset offset, void *buf, int count,
29                               MPI_Datatype datatype, MPI_Request *request)
```

```
30 int MPI_File_iread(MPI_File fh, void *buf, int count,
31                               MPI_Datatype datatype, MPI_Request *request)
```

```
32 int MPI_File_iread_shared(MPI_File fh, void *buf, int count,
33                               MPI_Datatype datatype, MPI_Request *request)
```

```
34 int MPI_File_iwrite_all(MPI_File fh, const void *buf, int count,
35                               MPI_Datatype datatype, MPI_Request *request)
```

```
36 int MPI_File_iwrite_at_all(MPI_File fh, MPI_Offset offset, const void *buf,
37                               int count, MPI_Datatype datatype, MPI_Request *request)
```

```
int MPI_File_iread_at(MPI_File fh, MPI_Offset offset, const void *buf,      1
                    int count, MPI_Datatype datatype, MPI_Request *request)  2
int MPI_File_iread(MPI_File fh, const void *buf, int count,                3
                  MPI_Datatype datatype, MPI_Request *request)              4
int MPI_File_iread_shared(MPI_File fh, const void *buf, int count,          5
                          MPI_Datatype datatype, MPI_Request *request)      6
int MPI_File_irewrite(MPI_File fh, const void *buf, int count,              7
                     MPI_Datatype datatype, MPI_Request *request)           8
int MPI_File_irewrite_shared(MPI_File fh, const void *buf, int count,       9
                              MPI_Datatype datatype, MPI_Request *request)  10
int MPI_File_preallocate(MPI_File fh, MPI_Offset size)                     11
int MPI_File_read_all_begin(MPI_File fh, void *buf, int count,              12
                            MPI_Datatype datatype)                          13
int MPI_File_read_all_end(MPI_File fh, void *buf, MPI_Status *status)      14
int MPI_File_read_all(MPI_File fh, void *buf, int count,                   15
                      MPI_Datatype datatype, MPI_Status *status)           16
int MPI_File_read_at_all_begin(MPI_File fh, MPI_Offset offset, void *buf,   17
                               int count, MPI_Datatype datatype)           18
int MPI_File_read_at_all_end(MPI_File fh, void *buf, MPI_Status *status)   19
int MPI_File_read_at_all(MPI_File fh, MPI_Offset offset, void *buf,        20
                          int count, MPI_Datatype datatype, MPI_Status *status)  21
int MPI_File_read_at(MPI_File fh, MPI_Offset offset, void *buf, int count,  22
                    MPI_Datatype datatype, MPI_Status *status)             23
int MPI_File_read(MPI_File fh, void *buf, int count, MPI_Datatype datatype,  24
                  MPI_Status *status)                                       25
int MPI_File_read_ordered_begin(MPI_File fh, void *buf, int count,          26
                                MPI_Datatype datatype)                       27
int MPI_File_read_ordered_end(MPI_File fh, void *buf, MPI_Status *status)  28
int MPI_File_read_ordered(MPI_File fh, void *buf, int count,                29
                           MPI_Datatype datatype, MPI_Status *status)       30
int MPI_File_read_shared(MPI_File fh, void *buf, int count,                 31
                          MPI_Datatype datatype, MPI_Status *status)        32
int MPI_File_seek(MPI_File fh, MPI_Offset offset, int whence)               33
int MPI_File_seek_shared(MPI_File fh, MPI_Offset offset, int whence)        34
int MPI_File_set_atomicity(MPI_File fh, int flag)                           35
int MPI_File_set_info(MPI_File fh, MPI_Info info)                           36
int MPI_File_set_size(MPI_File fh, MPI_Offset size)                          37
int MPI_File_set_size(MPI_File fh, MPI_Offset size)                          38
int MPI_File_set_size(MPI_File fh, MPI_Offset size)                          39
int MPI_File_set_size(MPI_File fh, MPI_Offset size)                          40
int MPI_File_set_size(MPI_File fh, MPI_Offset size)                          41
int MPI_File_set_size(MPI_File fh, MPI_Offset size)                          42
int MPI_File_set_size(MPI_File fh, MPI_Offset size)                          43
int MPI_File_set_size(MPI_File fh, MPI_Offset size)                          44
int MPI_File_set_size(MPI_File fh, MPI_Offset size)                          45
int MPI_File_set_size(MPI_File fh, MPI_Offset size)                          46
int MPI_File_set_size(MPI_File fh, MPI_Offset size)                          47
int MPI_File_set_size(MPI_File fh, MPI_Offset size)                          48
```

```
1 int MPI_File_set_view(MPI_File fh, MPI_Offset disp, MPI_Datatype etype,
2     MPI_Datatype filetype, const char *datarep, MPI_Info info)
3
4 int MPI_File_sync(MPI_File fh)
5
6 int MPI_File_write_all_begin(MPI_File fh, const void *buf, int count,
7     MPI_Datatype datatype)
8
9 int MPI_File_write_all_end(MPI_File fh, const void *buf,
10     MPI_Status *status)
11
12 int MPI_File_write_all(MPI_File fh, const void *buf, int count,
13     MPI_Datatype datatype, MPI_Status *status)
14
15 int MPI_File_write_at_all_begin(MPI_File fh, MPI_Offset offset,
16     const void *buf, int count, MPI_Datatype datatype)
17
18 int MPI_File_write_at_all_end(MPI_File fh, const void *buf,
19     MPI_Status *status)
20
21 int MPI_File_write_at_all(MPI_File fh, MPI_Offset offset, const void *buf,
22     int count, MPI_Datatype datatype, MPI_Status *status)
23
24 int MPI_File_write_at(MPI_File fh, MPI_Offset offset, const void *buf,
25     int count, MPI_Datatype datatype, MPI_Status *status)
26
27 int MPI_File_write(MPI_File fh, const void *buf, int count,
28     MPI_Datatype datatype, MPI_Status *status)
29
30 int MPI_File_write_ordered_begin(MPI_File fh, const void *buf, int count,
31     MPI_Datatype datatype)
32
33 int MPI_File_write_ordered_end(MPI_File fh, const void *buf,
34     MPI_Status *status)
35
36 int MPI_File_write_ordered(MPI_File fh, const void *buf, int count,
37     MPI_Datatype datatype, MPI_Status *status)
38
39 int MPI_File_write_shared(MPI_File fh, const void *buf, int count,
40     MPI_Datatype datatype, MPI_Status *status)
41
42 int MPI_Register_datarep(const char *datarep,
43     MPI_Datarep_conversion_function *read_conversion_fn,
44     MPI_Datarep_conversion_function *write_conversion_fn,
45     MPI_Datarep_extent_function *dtype_file_extent_fn,
46     void *extra_state)
```

A.2.12 Language Bindings C Bindings

```
47 int MPI_Status_f082f(MPI_F08_status *f08_status, MPI_Fint *f_status)
48
49 int MPI_Status_f2f08(MPI_Fint *f_status, MPI_F08_status *f08_status)
50
51 int MPI_Type_create_f90_complex(int p, int r, MPI_Datatype *newtype)
```

```

int MPI_Type_create_f90_integer(int r, MPI_Datatype *newtype)           1
int MPI_Type_create_f90_real(int p, int r, MPI_Datatype *newtype)     2
int MPI_Type_match_size(int typeclass, int size, MPI_Datatype *datatype) 3
MPI_Fint MPI_Comm_c2f(MPI_Comm comm)                                  4
MPI_Comm MPI_Comm_f2c(MPI_Fint comm)                                  5
MPI_Fint MPI_Errhandler_c2f(MPI_Errhandler errhandler)              6
MPI_Errhandler MPI_Errhandler_f2c(MPI_Fint errhandler)              7
MPI_Fint MPI_File_c2f(MPI_File file)                                  8
MPI_File MPI_File_f2c(MPI_Fint file)                                  9
MPI_Fint MPI_Group_c2f(MPI_Group group)                               10
MPI_Group MPI_Group_f2c(MPI_Fint group)                              11
MPI_Fint MPI_Info_c2f(MPI_Info info)                                 12
MPI_Info MPI_Info_f2c(MPI_Fint info)                                 13
MPI_Fint MPI_Message_c2f(MPI_Message message)                       14
MPI_Message MPI_Message_f2c(MPI_Fint message)                       15
MPI_Fint MPI_Op_c2f(MPI_Op op)                                       16
MPI_Op MPI_Op_f2c(MPI_Fint op)                                       17
MPI_Fint MPI_Request_c2f(MPI_Request request)                         18
MPI_Request MPI_Request_f2c(MPI_Fint request)                        19
int MPI_Status_c2f08(const MPI_Status *c_status,                      20
                    MPI_F08_status *f08_status)                       21
int MPI_Status_c2f(const MPI_Status *c_status, MPI_Fint *f_status)    22
int MPI_Status_f082c(const MPI_F08_status *f08_status,                23
                    MPI_Status *c_status)                              24
int MPI_Status_f2c(const MPI_Fint *f_status, MPI_Status *c_status)    25
MPI_Fint MPI_Type_c2f(MPI_Datatype datatype)                          26
MPI_Datatype MPI_Type_f2c(MPI_Fint datatype)                          27
MPI_Fint MPI_Win_c2f(MPI_Win win)                                     28
MPI_Win MPI_Win_f2c(MPI_Fint win)                                     29

A.2.13 Tools / Profiling Interface C Bindings                          30
int MPI_Pcontrol(const int level, ...)                                  31

```

A.2.14 Tools / MPI Tool Information Interface C Bindings

```
1 int MPI_T_category_changed(int *stamp)
2
3 int MPI_T_category_get_categories(int cat_index, int len, int indices[])
4
5 int MPI_T_category_get_cvars(int cat_index, int len, int indices[])
6
7 int MPI_T_category_get_index(const char *name, int *cat_index)
8
9 int MPI_T_category_get_info(int cat_index, char *name, int *name_len,
10 char *desc, int *desc_len, int *num_cvars, int *num_pvars,
11 int *num_categories)
12
13 int MPI_T_category_get_num(int *num_cat)
14
15 int MPI_T_category_get_pvars(int cat_index, int len, int indices[])
16
17 int MPI_T_cvar_get_index(const char *name, int *cvar_index)
18
19 int MPI_T_cvar_get_info(int cvar_index, char *name, int *name_len,
20 int *verbosity, MPI_Datatype *datatype, MPI_T_enum *enumtype,
21 char *desc, int *desc_len, int *bind, int *scope)
22
23 int MPI_T_cvar_get_num(int *num_cvar)
24
25 int MPI_T_cvar_handle_alloc(int cvar_index, void *obj_handle,
26 MPI_T_cvar_handle *handle, int *count)
27
28 int MPI_T_cvar_handle_free(MPI_T_cvar_handle *handle)
29
30 int MPI_T_cvar_read(MPI_T_cvar_handle handle, void* buf)
31
32 int MPI_T_cvar_write(MPI_T_cvar_handle handle, const void* buf)
33
34 int MPI_T_enum_get_info(MPI_T_enum enumtype, int *num, char *name,
35 int *name_len)
36
37 int MPI_T_enum_get_item(MPI_T_enum enumtype, int index, int *value,
38 char *name, int *name_len)
39
40 int MPI_T_finalize(void)
41
42 int MPI_T_init_thread(int required, int *provided)
43
44 int MPI_T_pvar_get_index(const char *name, int var_class, int *pvar_index)
45
46 int MPI_T_pvar_get_info(int pvar_index, char *name, int *name_len,
47 int *verbosity, int *var_class, MPI_Datatype *datatype,
48 MPI_T_enum *enumtype, char *desc, int *desc_len, int *bind,
49 int *readonly, int *continuous, int *atomic)
50
51 int MPI_T_pvar_get_num(int *num_pvar)
52
53 int MPI_T_pvar_handle_alloc(MPI_T_pvar_session session, int pvar_index,
54 void *obj_handle, MPI_T_pvar_handle *handle, int *count)
```



```
int MPI_T_pvar_handle_free(MPI_T_pvar_session session,      1
                          MPI_T_pvar_handle *handle)      2
int MPI_T_pvar_read(MPI_T_pvar_session session, MPI_T_pvar_handle handle,  3
                   void* buf)                             4
int MPI_T_pvar_readreset(MPI_T_pvar_session session,       5
                        MPI_T_pvar_handle handle, void* buf) 6
int MPI_T_pvar_reset(MPI_T_pvar_session session, MPI_T_pvar_handle handle) 7
int MPI_T_pvar_session_create(MPI_T_pvar_session *session) 8
int MPI_T_pvar_session_free(MPI_T_pvar_session *session)  9
int MPI_T_pvar_start(MPI_T_pvar_session session, MPI_T_pvar_handle handle) 10
int MPI_T_pvar_stop(MPI_T_pvar_session session, MPI_T_pvar_handle handle) 11
int MPI_T_pvar_write(MPI_T_pvar_session session, MPI_T_pvar_handle handle, 12
                    const void* buf)                     13
                                                    14
                                                    15
                                                    16
                                                    17
                                                    18
                                                    19
```

A.2.15 Deprecated C Bindings

```
int MPI_Attr_delete(MPI_Comm comm, int keyval)            20
int MPI_Attr_get(MPI_Comm comm, int keyval, void *attribute_val, int *flag) 21
int MPI_Attr_put(MPI_Comm comm, int keyval, void* attribute_val)           22
int MPI_DUP_FN(MPI_Comm oldcomm, int keyval, void *extra_state,            23
               void *attribute_val_in, void *attribute_val_out, int *flag) 24
int MPI_Keyval_create(MPI_Copy_function *copy_fn,          25
                     MPI_Delete_function *delete_fn, int *keyval,          26
                     void* extra_state)                    27
int MPI_Keyval_free(int *keyval)                                         28
int MPI_NULL_COPY_FN(MPI_Comm oldcomm, int keyval, void *extra_state,      29
                    void *attribute_val_in, void *attribute_val_out, int *flag) 30
int MPI_NULL_DELETE_FN(MPI_Comm comm, int keyval, void *attribute_val,     31
                      void *extra_state)                                32
                                                    33
                                                    34
                                                    35
                                                    36
                                                    37
                                                    38
                                                    39
                                                    40
                                                    41
                                                    42
                                                    43
                                                    44
                                                    45
                                                    46
                                                    47
                                                    48
```

1 A.3 Fortran 2008 Bindings with the mpi_f08 Module

2 A.3.1 Point-to-Point Communication Fortran 2008 Bindings

3 MPI_Bsend(buf, count, datatype, dest, tag, comm, ierror)

4 TYPE(*), DIMENSION(..), INTENT(IN) :: buf
5 INTEGER, INTENT(IN) :: count, dest, tag
6 TYPE(MPI_Datatype), INTENT(IN) :: datatype
7 TYPE(MPI_Comm), INTENT(IN) :: comm
8 INTEGER, OPTIONAL, INTENT(OUT) :: ierror

9 MPI_Bsend_init(buf, count, datatype, dest, tag, comm, request, ierror)

10 TYPE(*), DIMENSION(..), INTENT(IN), ASYNCHRONOUS :: buf
11 INTEGER, INTENT(IN) :: count, dest, tag
12 TYPE(MPI_Datatype), INTENT(IN) :: datatype
13 TYPE(MPI_Comm), INTENT(IN) :: comm
14 TYPE(MPI_Request), INTENT(OUT) :: request
15 INTEGER, OPTIONAL, INTENT(OUT) :: ierror

16 MPI_Buffer_attach(buffer, size, ierror)

17 TYPE(*), DIMENSION(..), ASYNCHRONOUS :: buffer
18 INTEGER, INTENT(IN) :: size
19 INTEGER, OPTIONAL, INTENT(OUT) :: ierror

20 MPI_Buffer_detach(buffer_addr, size, ierror)

21 USE, INTRINSIC :: ISO_C_BINDING, ONLY : C_PTR
22 TYPE(C_PTR), INTENT(OUT) :: buffer_addr
23 INTEGER, INTENT(OUT) :: size
24 INTEGER, OPTIONAL, INTENT(OUT) :: ierror

25 MPI_Cancel(request, ierror)

26 TYPE(MPI_Request), INTENT(IN) :: request
27 INTEGER, OPTIONAL, INTENT(OUT) :: ierror

28 MPI_Get_count(status, datatype, count, ierror)

29 TYPE(MPI_Status), INTENT(IN) :: status
30 TYPE(MPI_Datatype), INTENT(IN) :: datatype
31 INTEGER, INTENT(OUT) :: count
32 INTEGER, OPTIONAL, INTENT(OUT) :: ierror

33 MPI_Ibsend(buf, count, datatype, dest, tag, comm, request, ierror)

34 TYPE(*), DIMENSION(..), INTENT(IN), ASYNCHRONOUS :: buf
35 INTEGER, INTENT(IN) :: count, dest, tag
36 TYPE(MPI_Datatype), INTENT(IN) :: datatype
37 TYPE(MPI_Comm), INTENT(IN) :: comm
38 TYPE(MPI_Request), INTENT(OUT) :: request
39 INTEGER, OPTIONAL, INTENT(OUT) :: ierror

40 MPI_Improbe(source, tag, comm, flag, message, status, ierror)

41 INTEGER, INTENT(IN) :: source, tag
42 TYPE(MPI_Comm), INTENT(IN) :: comm

```

LOGICAL, INTENT(OUT) :: flag                                1
TYPE(MPI_Message), INTENT(OUT) :: message                 2
TYPE(MPI_Status) :: status                                3
INTEGER, OPTIONAL, INTENT(OUT) :: ierror                 4
                                                            5
MPI_Imrecv(buf, count, datatype, message, request, ierror) 6
  TYPE(*), DIMENSION(..), ASYNCHRONOUS :: buf           7
  INTEGER, INTENT(IN) :: count                            8
  TYPE(MPI_Datatype), INTENT(IN) :: datatype             9
  TYPE(MPI_Message), INTENT(INOUT) :: message            10
  TYPE(MPI_Request), INTENT(OUT) :: request              11
  INTEGER, OPTIONAL, INTENT(OUT) :: ierror               12
                                                            13
MPI_Iprobe(source, tag, comm, flag, status, ierror)       14
  INTEGER, INTENT(IN) :: source, tag                     15
  TYPE(MPI_Comm), INTENT(IN) :: comm                     16
  LOGICAL, INTENT(OUT) :: flag                           17
  TYPE(MPI_Status) :: status                             18
  INTEGER, OPTIONAL, INTENT(OUT) :: ierror               19
                                                            20
MPI_Irecv(buf, count, datatype, source, tag, comm, request, ierror) 21
  TYPE(*), DIMENSION(..), ASYNCHRONOUS :: buf           22
  INTEGER, INTENT(IN) :: count, source, tag              23
  TYPE(MPI_Datatype), INTENT(IN) :: datatype             24
  TYPE(MPI_Comm), INTENT(IN) :: comm                    25
  TYPE(MPI_Request), INTENT(OUT) :: request              26
  INTEGER, OPTIONAL, INTENT(OUT) :: ierror               27
                                                            28
MPI_Irsend(buf, count, datatype, dest, tag, comm, request, ierror) 29
  TYPE(*), DIMENSION(..), INTENT(IN), ASYNCHRONOUS :: buf 30
  INTEGER, INTENT(IN) :: count, dest, tag                31
  TYPE(MPI_Datatype), INTENT(IN) :: datatype             32
  TYPE(MPI_Comm), INTENT(IN) :: comm                    33
  TYPE(MPI_Request), INTENT(OUT) :: request              34
  INTEGER, OPTIONAL, INTENT(OUT) :: ierror               35
                                                            36
MPI_Isend(buf, count, datatype, dest, tag, comm, request, ierror) 37
  TYPE(*), DIMENSION(..), INTENT(IN), ASYNCHRONOUS :: buf 38
  INTEGER, INTENT(IN) :: count, dest, tag                39
  TYPE(MPI_Datatype), INTENT(IN) :: datatype             40
  TYPE(MPI_Comm), INTENT(IN) :: comm                    41
  TYPE(MPI_Request), INTENT(OUT) :: request              42
  INTEGER, OPTIONAL, INTENT(OUT) :: ierror               43
                                                            44
MPI_Issend(buf, count, datatype, dest, tag, comm, request, ierror) 45
  TYPE(*), DIMENSION(..), INTENT(IN), ASYNCHRONOUS :: buf 46
  INTEGER, INTENT(IN) :: count, dest, tag                47
  TYPE(MPI_Datatype), INTENT(IN) :: datatype             48
  TYPE(MPI_Comm), INTENT(IN) :: comm                    49
  TYPE(MPI_Request), INTENT(OUT) :: request              50
  INTEGER, OPTIONAL, INTENT(OUT) :: ierror               51

```

```

1     INTEGER, OPTIONAL, INTENT(OUT) :: ierror
2
3     MPI_Mprobe(source, tag, comm, message, status, ierror)
4         INTEGER, INTENT(IN) :: source, tag
5         TYPE(MPI_Comm), INTENT(IN) :: comm
6         TYPE(MPI_Message), INTENT(OUT) :: message
7         TYPE(MPI_Status) :: status
8         INTEGER, OPTIONAL, INTENT(OUT) :: ierror
9
10    MPI_Mrecv(buf, count, datatype, message, status, ierror)
11        TYPE(*), DIMENSION(..) :: buf
12        INTEGER, INTENT(IN) :: count
13        TYPE(MPI_Datatype), INTENT(IN) :: datatype
14        TYPE(MPI_Message), INTENT(INOUT) :: message
15        TYPE(MPI_Status) :: status
16        INTEGER, OPTIONAL, INTENT(OUT) :: ierror
17
18    MPI_Probe(source, tag, comm, status, ierror)
19        INTEGER, INTENT(IN) :: source, tag
20        TYPE(MPI_Comm), INTENT(IN) :: comm
21        TYPE(MPI_Status) :: status
22        INTEGER, OPTIONAL, INTENT(OUT) :: ierror
23
24    MPI_Recv(buf, count, datatype, source, tag, comm, status, ierror)
25        TYPE(*), DIMENSION(..) :: buf
26        INTEGER, INTENT(IN) :: count, source, tag
27        TYPE(MPI_Datatype), INTENT(IN) :: datatype
28        TYPE(MPI_Comm), INTENT(IN) :: comm
29        TYPE(MPI_Status) :: status
30        INTEGER, OPTIONAL, INTENT(OUT) :: ierror
31
32    MPI_Recv_init(buf, count, datatype, source, tag, comm, request, ierror)
33        TYPE(*), DIMENSION(..), ASYNCHRONOUS :: buf
34        INTEGER, INTENT(IN) :: count, source, tag
35        TYPE(MPI_Datatype), INTENT(IN) :: datatype
36        TYPE(MPI_Comm), INTENT(IN) :: comm
37        TYPE(MPI_Request), INTENT(OUT) :: request
38        INTEGER, OPTIONAL, INTENT(OUT) :: ierror
39
40    MPI_Request_free(request, ierror)
41        TYPE(MPI_Request), INTENT(INOUT) :: request
42        INTEGER, OPTIONAL, INTENT(OUT) :: ierror
43
44    MPI_Request_get_status(request, flag, status, ierror)
45        TYPE(MPI_Request), INTENT(IN) :: request
46        LOGICAL, INTENT(OUT) :: flag
47        TYPE(MPI_Status) :: status
48        INTEGER, OPTIONAL, INTENT(OUT) :: ierror
49
50    MPI_Rsend(buf, count, datatype, dest, tag, comm, ierror)
51        TYPE(*), DIMENSION(..), INTENT(IN) :: buf

```

```

INTEGER, INTENT(IN) :: count, dest, tag                                1
TYPE(MPI_Datatype), INTENT(IN) :: datatype                            2
TYPE(MPI_Comm), INTENT(IN) :: comm                                    3
INTEGER, OPTIONAL, INTENT(OUT) :: ierror                             4
                                                                 5
MPI_Rsend_init(buf, count, datatype, dest, tag, comm, request, ierror) 6
  TYPE(*), DIMENSION(..), INTENT(IN), ASYNCHRONOUS :: buf           7
  INTEGER, INTENT(IN) :: count, dest, tag                             8
  TYPE(MPI_Datatype), INTENT(IN) :: datatype                          9
  TYPE(MPI_Comm), INTENT(IN) :: comm                                  10
  TYPE(MPI_Request), INTENT(OUT) :: request                           11
  INTEGER, OPTIONAL, INTENT(OUT) :: ierror                             12
                                                                 13
MPI_Send(buf, count, datatype, dest, tag, comm, ierror)              14
  TYPE(*), DIMENSION(..), INTENT(IN) :: buf                           15
  INTEGER, INTENT(IN) :: count, dest, tag                             16
  TYPE(MPI_Datatype), INTENT(IN) :: datatype                          17
  TYPE(MPI_Comm), INTENT(IN) :: comm                                  18
  INTEGER, OPTIONAL, INTENT(OUT) :: ierror                             19
                                                                 20
MPI_Send_init(buf, count, datatype, dest, tag, comm, request, ierror) 21
  TYPE(*), DIMENSION(..), INTENT(IN), ASYNCHRONOUS :: buf           22
  INTEGER, INTENT(IN) :: count, dest, tag                             23
  TYPE(MPI_Datatype), INTENT(IN) :: datatype                          24
  TYPE(MPI_Comm), INTENT(IN) :: comm                                  25
  TYPE(MPI_Request), INTENT(OUT) :: request                           26
  INTEGER, OPTIONAL, INTENT(OUT) :: ierror                             27
                                                                 28
MPI_Sendrecv_replace(buf, count, datatype, dest, sendtag, source, recvtag, 29
  comm, status, ierror)
  TYPE(*), DIMENSION(..) :: buf                                       30
  INTEGER, INTENT(IN) :: count, dest, sendtag, source, recvtag        31
  TYPE(MPI_Datatype), INTENT(IN) :: datatype                           32
  TYPE(MPI_Comm), INTENT(IN) :: comm                                    33
  TYPE(MPI_Status) :: status                                           34
  INTEGER, OPTIONAL, INTENT(OUT) :: ierror                             35
                                                                 36
MPI_Sendrecv(sendbuf, sendcount, sendtype, dest, sendtag, recvbuf, 37
  recvcount, recvtype, source, recvtag, comm, status, ierror)
  TYPE(*), DIMENSION(..), INTENT(IN) :: sendbuf                       38
  TYPE(*), DIMENSION(..) :: recvbuf                                    39
  INTEGER, INTENT(IN) :: sendcount, dest, sendtag, recvcount, source, 40
  recvtag
  TYPE(MPI_Datatype), INTENT(IN) :: sendtype, recvtype                 41
  TYPE(MPI_Comm), INTENT(IN) :: comm                                    42
  TYPE(MPI_Status) :: status                                           43
  INTEGER, OPTIONAL, INTENT(OUT) :: ierror                             44
                                                                 45
MPI_Ssend(buf, count, datatype, dest, tag, comm, ierror)            46
  TYPE(*), DIMENSION(..), INTENT(IN) :: buf                           47
                                                                 48

```

```

1     INTEGER, INTENT(IN) :: count, dest, tag
2     TYPE(MPI_Datatype), INTENT(IN) :: datatype
3     TYPE(MPI_Comm), INTENT(IN) :: comm
4     INTEGER, OPTIONAL, INTENT(OUT) :: ierror
5
6 MPI_Ssend_init(buf, count, datatype, dest, tag, comm, request, ierror)
7     TYPE(*), DIMENSION(..), INTENT(IN), ASYNCHRONOUS :: buf
8     INTEGER, INTENT(IN) :: count, dest, tag
9     TYPE(MPI_Datatype), INTENT(IN) :: datatype
10    TYPE(MPI_Comm), INTENT(IN) :: comm
11    TYPE(MPI_Request), INTENT(OUT) :: request
12    INTEGER, OPTIONAL, INTENT(OUT) :: ierror
13
14 MPI_Startall(count, array_of_requests, ierror)
15    INTEGER, INTENT(IN) :: count
16    TYPE(MPI_Request), INTENT(INOUT) :: array_of_requests(count)
17    INTEGER, OPTIONAL, INTENT(OUT) :: ierror
18
19 MPI_Start(request, ierror)
20    TYPE(MPI_Request), INTENT(INOUT) :: request
21    INTEGER, OPTIONAL, INTENT(OUT) :: ierror
22
23 MPI_Testall(count, array_of_requests, flag, array_of_statuses, ierror)
24    INTEGER, INTENT(IN) :: count
25    TYPE(MPI_Request), INTENT(INOUT) :: array_of_requests(count)
26    LOGICAL, INTENT(OUT) :: flag
27    TYPE(MPI_Status) :: array_of_statuses(*)
28    INTEGER, OPTIONAL, INTENT(OUT) :: ierror
29
30 MPI_Testany(count, array_of_requests, index, flag, status, ierror)
31    INTEGER, INTENT(IN) :: count
32    TYPE(MPI_Request), INTENT(INOUT) :: array_of_requests(count)
33    INTEGER, INTENT(OUT) :: index
34    LOGICAL, INTENT(OUT) :: flag
35    TYPE(MPI_Status) :: status
36    INTEGER, OPTIONAL, INTENT(OUT) :: ierror
37
38 MPI_Test_cancelled(status, flag, ierror)
39    TYPE(MPI_Status), INTENT(IN) :: status
40    LOGICAL, INTENT(OUT) :: flag
41    INTEGER, OPTIONAL, INTENT(OUT) :: ierror
42
43 MPI_Test(request, flag, status, ierror)
44    TYPE(MPI_Request), INTENT(INOUT) :: request
45    LOGICAL, INTENT(OUT) :: flag
46    TYPE(MPI_Status) :: status
47    INTEGER, OPTIONAL, INTENT(OUT) :: ierror
48
49 MPI_Testsome(incount, array_of_requests, outcount, array_of_indices,
50             array_of_statuses, ierror)
51    INTEGER, INTENT(IN) :: incount

```

```

TYPE(MPI_Request), INTENT(INOUT) :: array_of_requests(incount)      1
INTEGER, INTENT(OUT) :: outcount, array_of_indices(*)              2
TYPE(MPI_Status) :: array_of_statuses(*)                            3
INTEGER, OPTIONAL, INTENT(OUT) :: ierror                            4
                                                                    5
MPI_Waitall(count, array_of_requests, array_of_statuses, ierror)   6
  INTEGER, INTENT(IN) :: count                                      7
  TYPE(MPI_Request), INTENT(INOUT) :: array_of_requests(count)    8
  TYPE(MPI_Status) :: array_of_statuses(*)                          9
  INTEGER, OPTIONAL, INTENT(OUT) :: ierror                          10
                                                                    11
MPI_Waitany(count, array_of_requests, index, status, ierror)       12
  INTEGER, INTENT(IN) :: count                                      13
  TYPE(MPI_Request), INTENT(INOUT) :: array_of_requests(count)    14
  INTEGER, INTENT(OUT) :: index                                     15
  TYPE(MPI_Status) :: status                                       16
  INTEGER, OPTIONAL, INTENT(OUT) :: ierror                          17
                                                                    18
MPI_Wait(request, status, ierror)                                    19
  TYPE(MPI_Request), INTENT(INOUT) :: request                       20
  TYPE(MPI_Status) :: status                                       21
  INTEGER, OPTIONAL, INTENT(OUT) :: ierror                          22
                                                                    23
MPI_Waitsome(incount, array_of_requests, outcount, array_of_indices,
              array_of_statuses, ierror)                             24
  INTEGER, INTENT(IN) :: incount                                    25
  TYPE(MPI_Request), INTENT(INOUT) :: array_of_requests(incount)  26
  INTEGER, INTENT(OUT) :: outcount, array_of_indices(*)           27
  TYPE(MPI_Status) :: array_of_statuses(*)                          28
  INTEGER, OPTIONAL, INTENT(OUT) :: ierror                          29
                                                                    30
A.3.2 Datatypes Fortran 2008 Bindings                               31
                                                                    32
INTEGER(KIND=MPI_ADDRESS_KIND) MPI_Aint_add(base, disp)            33
  INTEGER(KIND=MPI_ADDRESS_KIND), INTENT(IN) :: base, disp        34
                                                                    35
INTEGER(KIND=MPI_ADDRESS_KIND) MPI_Aint_diff(addr1, addr2)        36
  INTEGER(KIND=MPI_ADDRESS_KIND), INTENT(IN) :: addr1, addr2      37
                                                                    38
MPI_Get_address(location, address, ierror)                          39
  TYPE(*), DIMENSION(..), ASYNCHRONOUS :: location                40
  INTEGER(KIND=MPI_ADDRESS_KIND), INTENT(OUT) :: address           41
  INTEGER, OPTIONAL, INTENT(OUT) :: ierror                          42
                                                                    43
MPI_Get_elements(status, datatype, count, ierror)                  44
  TYPE(MPI_Status), INTENT(IN) :: status                            45
  TYPE(MPI_Datatype), INTENT(IN) :: datatype                       46
  INTEGER, INTENT(OUT) :: count                                     47
  INTEGER, OPTIONAL, INTENT(OUT) :: ierror                          48
                                                                    49
MPI_Get_elements_x(status, datatype, count, ierror)                50
  TYPE(MPI_Status), INTENT(IN) :: status                            51
  TYPE(MPI_Datatype), INTENT(IN) :: datatype                       52
  INTEGER, INTENT(OUT) :: count                                     53
  INTEGER, OPTIONAL, INTENT(OUT) :: ierror                          54

```

```

1     TYPE(MPI_Status), INTENT(IN) :: status
2     TYPE(MPI_Datatype), INTENT(IN) :: datatype
3     INTEGER(KIND=MPI_COUNT_KIND), INTENT(OUT) :: count
4     INTEGER, OPTIONAL, INTENT(OUT) :: ierror
5
6 MPI_Pack_external(datarep, inbuf, incount, datatype, outbuf, outsize,
7     position, ierror)
8     CHARACTER(LEN=*), INTENT(IN) :: datarep
9     TYPE(*), DIMENSION(..), INTENT(IN) :: inbuf
10    TYPE(*), DIMENSION(..) :: outbuf
11    INTEGER, INTENT(IN) :: incount
12    TYPE(MPI_Datatype), INTENT(IN) :: datatype
13    INTEGER(KIND=MPI_ADDRESS_KIND), INTENT(IN) :: outsize
14    INTEGER(KIND=MPI_ADDRESS_KIND), INTENT(INOUT) :: position
15    INTEGER, OPTIONAL, INTENT(OUT) :: ierror
16
17 MPI_Pack_external_size(datarep, incount, datatype, size, ierror)
18    TYPE(MPI_Datatype), INTENT(IN) :: datatype
19    INTEGER, INTENT(IN) :: incount
20    CHARACTER(LEN=*), INTENT(IN) :: datarep
21    INTEGER(KIND=MPI_ADDRESS_KIND), INTENT(OUT) :: size
22    INTEGER, OPTIONAL, INTENT(OUT) :: ierror
23
24 MPI_Pack(inbuf, incount, datatype, outbuf, outsize, position, comm, ierror)
25    TYPE(*), DIMENSION(..), INTENT(IN) :: inbuf
26    TYPE(*), DIMENSION(..) :: outbuf
27    INTEGER, INTENT(IN) :: incount, outsize
28    TYPE(MPI_Datatype), INTENT(IN) :: datatype
29    INTEGER, INTENT(INOUT) :: position
30    TYPE(MPI_Comm), INTENT(IN) :: comm
31    INTEGER, OPTIONAL, INTENT(OUT) :: ierror
32
33 MPI_Pack_size(incount, datatype, comm, size, ierror)
34    INTEGER, INTENT(IN) :: incount
35    TYPE(MPI_Datatype), INTENT(IN) :: datatype
36    TYPE(MPI_Comm), INTENT(IN) :: comm
37    INTEGER, INTENT(OUT) :: size
38    INTEGER, OPTIONAL, INTENT(OUT) :: ierror
39
40 MPI_Type_commit(datatype, ierror)
41    TYPE(MPI_Datatype), INTENT(INOUT) :: datatype
42    INTEGER, OPTIONAL, INTENT(OUT) :: ierror
43
44 MPI_Type_contiguous(count, oldtype, newtype, ierror)
45    INTEGER, INTENT(IN) :: count
46    TYPE(MPI_Datatype), INTENT(IN) :: oldtype
47    TYPE(MPI_Datatype), INTENT(OUT) :: newtype
48    INTEGER, OPTIONAL, INTENT(OUT) :: ierror
49
50 MPI_Type_create_darray(size, rank, ndims, array_of_gsizes,
51     array_of_distribs, array_of_dargs, array_of_psize, order,

```



```

        oldtype, newtype, ierror)
1
INTEGER, INTENT(IN) :: size, rank, ndims, array_of_gsizes(ndims),
2
        array_of_distrib(ndims), array_of_dargs(ndims),
3
        array_of_psize(ndims), order
4
TYPE(MPI_Datatype), INTENT(IN) :: oldtype
5
TYPE(MPI_Datatype), INTENT(OUT) :: newtype
6
INTEGER, OPTIONAL, INTENT(OUT) :: ierror
7
MPI_Type_create_hindexed_block(count, blocklength, array_of_displacements,
8
        oldtype, newtype, ierror)
9
INTEGER, INTENT(IN) :: count, blocklength
10
INTEGER(KIND=MPI_ADDRESS_KIND), INTENT(IN) ::
11
        array_of_displacements(count)
12
TYPE(MPI_Datatype), INTENT(IN) :: oldtype
13
TYPE(MPI_Datatype), INTENT(OUT) :: newtype
14
INTEGER, OPTIONAL, INTENT(OUT) :: ierror
15
MPI_Type_create_hindexed(count, array_of_blocklengths,
16
        array_of_displacements, oldtype, newtype, ierror)
17
INTEGER, INTENT(IN) :: count, array_of_blocklengths(count)
18
INTEGER(KIND=MPI_ADDRESS_KIND), INTENT(IN) ::
19
        array_of_displacements(count)
20
TYPE(MPI_Datatype), INTENT(IN) :: oldtype
21
TYPE(MPI_Datatype), INTENT(OUT) :: newtype
22
INTEGER, OPTIONAL, INTENT(OUT) :: ierror
23
MPI_Type_create_hvector(count, blocklength, stride, oldtype, newtype,
24
        ierror)
25
INTEGER, INTENT(IN) :: count, blocklength
26
INTEGER(KIND=MPI_ADDRESS_KIND), INTENT(IN) :: stride
27
TYPE(MPI_Datatype), INTENT(IN) :: oldtype
28
TYPE(MPI_Datatype), INTENT(OUT) :: newtype
29
INTEGER, OPTIONAL, INTENT(OUT) :: ierror
30
MPI_Type_create_indexed_block(count, blocklength, array_of_displacements,
31
        oldtype, newtype, ierror)
32
INTEGER, INTENT(IN) :: count, blocklength,
33
        array_of_displacements(count)
34
TYPE(MPI_Datatype), INTENT(IN) :: oldtype
35
TYPE(MPI_Datatype), INTENT(OUT) :: newtype
36
INTEGER, OPTIONAL, INTENT(OUT) :: ierror
37
MPI_Type_create_resized(oldtype, lb, extent, newtype, ierror)
38
INTEGER(KIND=MPI_ADDRESS_KIND), INTENT(IN) :: lb, extent
39
TYPE(MPI_Datatype), INTENT(IN) :: oldtype
40
TYPE(MPI_Datatype), INTENT(OUT) :: newtype
41
INTEGER, OPTIONAL, INTENT(OUT) :: ierror
42
MPI_Type_create_struct(count, array_of_blocklengths,
43
        array_of_displacements, array_of_types, newtype, ierror)
44

```

```

1     INTEGER, INTENT(IN) :: count, array_of_blocklengths(count)
2     INTEGER(KIND=MPI_ADDRESS_KIND), INTENT(IN) ::
3         array_of_displacements(count)
4     TYPE(MPI_Datatype), INTENT(IN) :: array_of_types(count)
5     TYPE(MPI_Datatype), INTENT(OUT) :: newtype
6     INTEGER, OPTIONAL, INTENT(OUT) :: ierror
7
8     MPI_Type_create_subarray(ndims, array_of_sizes, array_of_subsizes,
9         array_of_starts, order, oldtype, newtype, ierror)
10    INTEGER, INTENT(IN) :: ndims, array_of_sizes(ndims),
11        array_of_subsizes(ndims), array_of_starts(ndims), order
12    TYPE(MPI_Datatype), INTENT(IN) :: oldtype
13    TYPE(MPI_Datatype), INTENT(OUT) :: newtype
14    INTEGER, OPTIONAL, INTENT(OUT) :: ierror
15
16    MPI_Type_dup(oldtype, newtype, ierror)
17    TYPE(MPI_Datatype), INTENT(IN) :: oldtype
18    TYPE(MPI_Datatype), INTENT(OUT) :: newtype
19    INTEGER, OPTIONAL, INTENT(OUT) :: ierror
20
21    MPI_Type_free(datatype, ierror)
22    TYPE(MPI_Datatype), INTENT(INOUT) :: datatype
23    INTEGER, OPTIONAL, INTENT(OUT) :: ierror
24
25    MPI_Type_get_contents(datatype, max_integers, max_addresses, max_datatypes,
26        array_of_integers, array_of_addresses, array_of_datatypes,
27        ierror)
28    TYPE(MPI_Datatype), INTENT(IN) :: datatype
29    INTEGER, INTENT(IN) :: max_integers, max_addresses, max_datatypes
30    INTEGER, INTENT(OUT) :: array_of_integers(max_integers)
31    INTEGER(KIND=MPI_ADDRESS_KIND), INTENT(OUT) ::
32        array_of_addresses(max_addresses)
33    TYPE(MPI_Datatype), INTENT(OUT) :: array_of_datatypes(max_datatypes)
34    INTEGER, OPTIONAL, INTENT(OUT) :: ierror
35
36    MPI_Type_get_envelope(datatype, num_integers, num_addresses, num_datatypes,
37        combiner, ierror)
38    TYPE(MPI_Datatype), INTENT(IN) :: datatype
39    INTEGER, INTENT(OUT) :: num_integers, num_addresses, num_datatypes,
40        combiner
41    INTEGER, OPTIONAL, INTENT(OUT) :: ierror
42
43    MPI_Type_get_extent(datatype, lb, extent, ierror)
44    TYPE(MPI_Datatype), INTENT(IN) :: datatype
45    INTEGER(KIND=MPI_ADDRESS_KIND), INTENT(OUT) :: lb, extent
46    INTEGER, OPTIONAL, INTENT(OUT) :: ierror
47
48    MPI_Type_get_extent_x(datatype, lb, extent, ierror)
49    TYPE(MPI_Datatype), INTENT(IN) :: datatype
50    INTEGER(KIND=MPI_COUNT_KIND), INTENT(OUT) :: lb, extent
51    INTEGER, OPTIONAL, INTENT(OUT) :: ierror

```

```

MPI_Type_get_true_extent(datatype, true_lb, true_extent, ierror)      1
    TYPE(MPI_Datatype), INTENT(IN) :: datatype                        2
    INTEGER(KIND=MPI_ADDRESS_KIND), INTENT(OUT) :: true_lb, true_extent 3
    INTEGER, OPTIONAL, INTENT(OUT) :: ierror                          4
                                                                    5
MPI_Type_get_true_extent_x(datatype, true_lb, true_extent, ierror)   6
    TYPE(MPI_Datatype), INTENT(IN) :: datatype                        7
    INTEGER(KIND=MPI_COUNT_KIND), INTENT(OUT) :: true_lb, true_extent 8
    INTEGER, OPTIONAL, INTENT(OUT) :: ierror                          9
                                                                    10
MPI_Type_indexed(count, array_of_blocklengths, array_of_displacements, 11
    oldtype, newtype, ierror)
    INTEGER, INTENT(IN) :: count, array_of_blocklengths(count),      12
    array_of_displacements(count)                                     13
    TYPE(MPI_Datatype), INTENT(IN) :: oldtype                         14
    TYPE(MPI_Datatype), INTENT(OUT) :: newtype                       15
    INTEGER, OPTIONAL, INTENT(OUT) :: ierror                         16
                                                                    17
MPI_Type_size(datatype, size, ierror)                                  18
    TYPE(MPI_Datatype), INTENT(IN) :: datatype                       19
    INTEGER, INTENT(OUT) :: size                                       20
    INTEGER, OPTIONAL, INTENT(OUT) :: ierror                         21
                                                                    22
MPI_Type_size_x(datatype, size, ierror)                                23
    TYPE(MPI_Datatype), INTENT(IN) :: datatype                       24
    INTEGER(KIND=MPI_COUNT_KIND), INTENT(OUT) :: size                 25
    INTEGER, OPTIONAL, INTENT(OUT) :: ierror                         26
                                                                    27
MPI_Type_vector(count, blocklength, stride, oldtype, newtype, ierror) 28
    INTEGER, INTENT(IN) :: count, blocklength, stride                 29
    TYPE(MPI_Datatype), INTENT(IN) :: oldtype                         30
    TYPE(MPI_Datatype), INTENT(OUT) :: newtype                       31
    INTEGER, OPTIONAL, INTENT(OUT) :: ierror                         32
                                                                    33
MPI_Unpack_external(datarep, inbuf, insize, position, outbuf, outcount, 34
    datatype, ierror)
    CHARACTER(LEN=*), INTENT(IN) :: datarep                           35
    TYPE(*), DIMENSION(..), INTENT(IN) :: inbuf                       36
    TYPE(*), DIMENSION(..) :: outbuf                                  37
    INTEGER(KIND=MPI_ADDRESS_KIND), INTENT(IN) :: insize              38
    INTEGER(KIND=MPI_ADDRESS_KIND), INTENT(INOUT) :: position         39
    INTEGER, INTENT(IN) :: outcount                                   40
    TYPE(MPI_Datatype), INTENT(IN) :: datatype                       41
    INTEGER, OPTIONAL, INTENT(OUT) :: ierror                          42
                                                                    43
MPI_Unpack(inbuf, insize, position, outbuf, outcount, datatype, comm, 44
    ierror)
    TYPE(*), DIMENSION(..), INTENT(IN) :: inbuf                       45
    TYPE(*), DIMENSION(..) :: outbuf                                  46
    INTEGER, INTENT(IN) :: insize, outcount                           47
    INTEGER, INTENT(INOUT) :: position                                48

```

```

1     TYPE(MPI_Datatype), INTENT(IN) :: datatype
2     TYPE(MPI_Comm), INTENT(IN) :: comm
3     INTEGER, OPTIONAL, INTENT(OUT) :: ierror

```

6 A.3.3 Collective Communication Fortran 2008 Bindings

```

7 MPI_Allgather_init(sendbuf, sendcount, sendtype, recvbuf, recvcount,
8     recvtype, comm, info, request, ierror)
9     TYPE(*), DIMENSION(..), INTENT(IN), ASYNCHRONOUS :: sendbuf
10    TYPE(*), DIMENSION(..), ASYNCHRONOUS :: recvbuf
11    INTEGER, INTENT(IN) :: sendcount, recvcount
12    TYPE(MPI_Datatype), INTENT(IN) :: sendtype, recvtype
13    TYPE(MPI_Comm), INTENT(IN) :: comm
14    TYPE(MPI_Info), INTENT(IN) :: info
15    TYPE(MPI_Request), INTENT(OUT) :: request
16    INTEGER, OPTIONAL, INTENT(OUT) :: ierror
17
18 MPI_Allgather(sendbuf, sendcount, sendtype, recvbuf, recvcount, recvtype,
19    comm, ierror)
20    TYPE(*), DIMENSION(..), INTENT(IN) :: sendbuf
21    TYPE(*), DIMENSION(..) :: recvbuf
22    INTEGER, INTENT(IN) :: sendcount, recvcount
23    TYPE(MPI_Datatype), INTENT(IN) :: sendtype, recvtype
24    TYPE(MPI_Comm), INTENT(IN) :: comm
25    INTEGER, OPTIONAL, INTENT(OUT) :: ierror
26
27 MPI_Allgatherv_init(sendbuf, sendcount, sendtype, recvbuf, recvcounts,
28    displs, recvtype, comm, info, request, ierror)
29    TYPE(*), DIMENSION(..), INTENT(IN), ASYNCHRONOUS :: sendbuf
30    TYPE(*), DIMENSION(..), ASYNCHRONOUS :: recvbuf
31    INTEGER, INTENT(IN) :: sendcount
32    INTEGER, INTENT(IN), ASYNCHRONOUS :: recvcounts(*), displs(*)
33    TYPE(MPI_Datatype), INTENT(IN) :: sendtype, recvtype
34    TYPE(MPI_Comm), INTENT(IN) :: comm
35    TYPE(MPI_Info), INTENT(IN) :: info
36    TYPE(MPI_Request), INTENT(OUT) :: request
37    INTEGER, OPTIONAL, INTENT(OUT) :: ierror
38
39 MPI_Allgatherv(sendbuf, sendcount, sendtype, recvbuf, recvcounts, displs,
40    recvtype, comm, ierror)
41    TYPE(*), DIMENSION(..), INTENT(IN) :: sendbuf
42    TYPE(*), DIMENSION(..) :: recvbuf
43    INTEGER, INTENT(IN) :: sendcount, recvcounts(*), displs(*)
44    TYPE(MPI_Datatype), INTENT(IN) :: sendtype, recvtype
45    TYPE(MPI_Comm), INTENT(IN) :: comm
46    INTEGER, OPTIONAL, INTENT(OUT) :: ierror
47
48 MPI_Allreduce_init(sendbuf, recvbuf, count, datatype, op, comm, info,
    request, ierror)

```

```

TYPE(*), DIMENSION(..), INTENT(IN), ASYNCHRONOUS :: sendbuf      1
TYPE(*), DIMENSION(..), ASYNCHRONOUS :: recvbuf                2
INTEGER, INTENT(IN) :: count                                    3
TYPE(MPI_Datatype), INTENT(IN) :: datatype                      4
TYPE(MPI_Op), INTENT(IN) :: op                                  5
TYPE(MPI_Comm), INTENT(IN) :: comm                              6
TYPE(MPI_Info), INTENT(IN) :: info                              7
TYPE(MPI_Request), INTENT(OUT) :: request                       8
INTEGER, OPTIONAL, INTENT(OUT) :: ierror                       9
                                                                10
MPI_Allreduce(sendbuf, recvbuf, count, datatype, op, comm, ierror) 11
TYPE(*), DIMENSION(..), INTENT(IN) :: sendbuf                  12
TYPE(*), DIMENSION(..) :: recvbuf                              13
INTEGER, INTENT(IN) :: count                                    14
TYPE(MPI_Datatype), INTENT(IN) :: datatype                      15
TYPE(MPI_Op), INTENT(IN) :: op                                  16
TYPE(MPI_Comm), INTENT(IN) :: comm                              17
INTEGER, OPTIONAL, INTENT(OUT) :: ierror                       18
                                                                19
MPI_Alltoall_init(sendbuf, sendcount, sendtype, recvbuf, recvcount, 20
                  recvtype, comm, info, request, ierror)
TYPE(*), DIMENSION(..), INTENT(IN), ASYNCHRONOUS :: sendbuf    21
TYPE(*), DIMENSION(..), ASYNCHRONOUS :: recvbuf                22
INTEGER, INTENT(IN) :: sendcount, recvcount                    23
TYPE(MPI_Datatype), INTENT(IN) :: sendtype, recvtype           24
TYPE(MPI_Comm), INTENT(IN) :: comm                              25
TYPE(MPI_Info), INTENT(IN) :: info                              26
TYPE(MPI_Request), INTENT(OUT) :: request                       27
INTEGER, OPTIONAL, INTENT(OUT) :: ierror                       28
                                                                29
MPI_Alltoall(sendbuf, sendcount, sendtype, recvbuf, recvcount, recvtype, 30
             comm, ierror)
TYPE(*), DIMENSION(..), INTENT(IN) :: sendbuf                  31
TYPE(*), DIMENSION(..) :: recvbuf                              32
INTEGER, INTENT(IN) :: sendcount, recvcount                    33
TYPE(MPI_Datatype), INTENT(IN) :: sendtype, recvtype           34
TYPE(MPI_Comm), INTENT(IN) :: comm                              35
INTEGER, OPTIONAL, INTENT(OUT) :: ierror                       36
                                                                37
MPI_Alltoallv_init(sendbuf, sendcounts, sdispls, sendtype, recvbuf, 38
                  recvcounts, rdispls, recvtype, comm, info, request, ierror) 39
TYPE(*), DIMENSION(..), INTENT(IN), ASYNCHRONOUS :: sendbuf    40
TYPE(*), DIMENSION(..), ASYNCHRONOUS :: recvbuf                41
INTEGER, INTENT(IN), ASYNCHRONOUS :: sendcounts(*), sdispls(*), 42
                  recvcounts(*), rdispls(*)                     43
TYPE(MPI_Datatype), INTENT(IN) :: sendtype, recvtype           44
TYPE(MPI_Comm), INTENT(IN) :: comm                              45
TYPE(MPI_Info), INTENT(IN) :: info                              46
TYPE(MPI_Request), INTENT(OUT) :: request                       47
                                                                48

```

```

1     INTEGER, OPTIONAL, INTENT(OUT) :: ierror
2
3     MPI_Alltoallv(sendbuf, sendcounts, sdispls, sendtype, recvbuf, recvcoun
4         rdispls, recvtype, comm, ierror)
5     TYPE(*), DIMENSION(..), INTENT(IN) :: sendbuf
6     TYPE(*), DIMENSION(..) :: recvbuf
7     INTEGER, INTENT(IN) :: sendcounts(*), sdispls(*), recvcoun
8         rdispls(*)
9     TYPE(MPI_Datatype), INTENT(IN) :: sendtype, recvtype
10    TYPE(MPI_Comm), INTENT(IN) :: comm
11    INTEGER, OPTIONAL, INTENT(OUT) :: ierror
12
13    MPI_Alltoallw_init(sendbuf, sendcounts, sdispls, sendtypes, recvbuf,
14        recvcoun
15        rdispls, recvtypes, comm, info, request, ierror)
16    TYPE(*), DIMENSION(..), INTENT(IN), ASYNCHRONOUS :: sendbuf
17    TYPE(*), DIMENSION(..), ASYNCHRONOUS :: recvbuf
18    INTEGER, INTENT(IN), ASYNCHRONOUS :: sendcounts(*), sdispls(*),
19        recvcoun
20        rdispls(*)
21    TYPE(MPI_Datatype), INTENT(IN), ASYNCHRONOUS :: sendtypes(*),
22        recvtypes(*)
23    TYPE(MPI_Comm), INTENT(IN) :: comm
24    TYPE(MPI_Info), INTENT(IN) :: info
25    TYPE(MPI_Request), INTENT(OUT) :: request
26    INTEGER, OPTIONAL, INTENT(OUT) :: ierror
27
28    MPI_Alltoallw(sendbuf, sendcounts, sdispls, sendtypes, recvbuf, recvcoun
29        rdispls, recvtypes, comm, ierror)
30    TYPE(*), DIMENSION(..), INTENT(IN) :: sendbuf
31    TYPE(*), DIMENSION(..) :: recvbuf
32    INTEGER, INTENT(IN) :: sendcounts(*), sdispls(*), recvcoun
33        rdispls(*)
34    TYPE(MPI_Datatype), INTENT(IN) :: sendtypes(*)
35    TYPE(MPI_Datatype), INTENT(IN) :: recvtypes(*)
36    TYPE(MPI_Comm), INTENT(IN) :: comm
37    INTEGER, OPTIONAL, INTENT(OUT) :: ierror
38
39    MPI_Barrier(comm, ierror)
40    TYPE(MPI_Comm), INTENT(IN) :: comm
41    INTEGER, OPTIONAL, INTENT(OUT) :: ierror
42
43    MPI_Barrier_init(comm, info, request, ierror)
44    TYPE(MPI_Comm), INTENT(IN) :: comm
45    TYPE(MPI_Info), INTENT(IN) :: info
46    TYPE(MPI_Request), INTENT(OUT) :: request
47    INTEGER, OPTIONAL, INTENT(OUT) :: ierror
48
49    MPI_Bcast(buffer, count, datatype, root, comm, ierror)
50    TYPE(*), DIMENSION(..) :: buffer
51    INTEGER, INTENT(IN) :: count, root
52    TYPE(MPI_Datatype), INTENT(IN) :: datatype

```

```

TYPE(MPI_Comm), INTENT(IN) :: comm
INTEGER, OPTIONAL, INTENT(OUT) :: ierror
MPI_Bcast_init(buffer, count, datatype, root, comm, info, request, ierror)
TYPE(*), DIMENSION(..), ASYNCHRONOUS :: buffer
INTEGER, INTENT(IN) :: count, root
TYPE(MPI_Datatype), INTENT(IN) :: datatype
TYPE(MPI_Comm), INTENT(IN) :: comm
TYPE(MPI_Info), INTENT(IN) :: info
TYPE(MPI_Request), INTENT(OUT) :: request
INTEGER, OPTIONAL, INTENT(OUT) :: ierror
MPI_Exscan_init(sendbuf, recvbuf, count, datatype, op, comm, info, request,
               ierror)
TYPE(*), DIMENSION(..), INTENT(IN), ASYNCHRONOUS :: sendbuf
TYPE(*), DIMENSION(..), ASYNCHRONOUS :: recvbuf
INTEGER, INTENT(IN) :: count
TYPE(MPI_Datatype), INTENT(IN) :: datatype
TYPE(MPI_Op), INTENT(IN) :: op
TYPE(MPI_Comm), INTENT(IN) :: comm
TYPE(MPI_Info), INTENT(IN) :: info
TYPE(MPI_Request), INTENT(OUT) :: request
INTEGER, OPTIONAL, INTENT(OUT) :: ierror
MPI_Exscan(sendbuf, recvbuf, count, datatype, op, comm, ierror)
TYPE(*), DIMENSION(..), INTENT(IN) :: sendbuf
TYPE(*), DIMENSION(..) :: recvbuf
INTEGER, INTENT(IN) :: count
TYPE(MPI_Datatype), INTENT(IN) :: datatype
TYPE(MPI_Op), INTENT(IN) :: op
TYPE(MPI_Comm), INTENT(IN) :: comm
INTEGER, OPTIONAL, INTENT(OUT) :: ierror
MPI_Gather_init(sendbuf, sendcount, sendtype, recvbuf, recvcount, recvtype,
               root, comm, info, request, ierror)
TYPE(*), DIMENSION(..), INTENT(IN), ASYNCHRONOUS :: sendbuf
TYPE(*), DIMENSION(..), ASYNCHRONOUS :: recvbuf
INTEGER, INTENT(IN) :: sendcount, recvcount, root
TYPE(MPI_Datatype), INTENT(IN) :: sendtype, recvtype
TYPE(MPI_Comm), INTENT(IN) :: comm
TYPE(MPI_Info), INTENT(IN) :: info
TYPE(MPI_Request), INTENT(OUT) :: request
INTEGER, OPTIONAL, INTENT(OUT) :: ierror
MPI_Gather(sendbuf, sendcount, sendtype, recvbuf, recvcount, recvtype,
           root, comm, ierror)
TYPE(*), DIMENSION(..), INTENT(IN) :: sendbuf
TYPE(*), DIMENSION(..) :: recvbuf
INTEGER, INTENT(IN) :: sendcount, recvcount, root
TYPE(MPI_Datatype), INTENT(IN) :: sendtype, recvtype

```

```

1     TYPE(MPI_Comm), INTENT(IN) :: comm
2     INTEGER, OPTIONAL, INTENT(OUT) :: ierror
3
4 MPI_Gatherv_init(sendbuf, sendcount, sendtype, recvbuf, recvcounts, displs,
5                 recvtype, root, comm, info, request, ierror)
6     TYPE(*), DIMENSION(..), INTENT(IN), ASYNCHRONOUS :: sendbuf
7     TYPE(*), DIMENSION(..), ASYNCHRONOUS :: recvbuf
8     INTEGER, INTENT(IN) :: sendcount, root
9     INTEGER, INTENT(IN), ASYNCHRONOUS :: recvcounts(*), displs(*)
10    TYPE(MPI_Datatype), INTENT(IN) :: sendtype, recvtype
11    TYPE(MPI_Comm), INTENT(IN) :: comm
12    TYPE(MPI_Info), INTENT(IN) :: info
13    TYPE(MPI_Request), INTENT(OUT) :: request
14    INTEGER, OPTIONAL, INTENT(OUT) :: ierror
15
16 MPI_Gatherv(sendbuf, sendcount, sendtype, recvbuf, recvcounts, displs,
17            recvtype, root, comm, ierror)
18    TYPE(*), DIMENSION(..), INTENT(IN) :: sendbuf
19    TYPE(*), DIMENSION(..) :: recvbuf
20    INTEGER, INTENT(IN) :: sendcount, recvcounts(*), displs(*), root
21    TYPE(MPI_Datatype), INTENT(IN) :: sendtype, recvtype
22    TYPE(MPI_Comm), INTENT(IN) :: comm
23    INTEGER, OPTIONAL, INTENT(OUT) :: ierror
24
25 MPI_Iallgather(sendbuf, sendcount, sendtype, recvbuf, recvcount, recvtype,
26              comm, request, ierror)
27    TYPE(*), DIMENSION(..), INTENT(IN), ASYNCHRONOUS :: sendbuf
28    TYPE(*), DIMENSION(..), ASYNCHRONOUS :: recvbuf
29    INTEGER, INTENT(IN) :: sendcount, recvcount
30    TYPE(MPI_Datatype), INTENT(IN) :: sendtype, recvtype
31    TYPE(MPI_Comm), INTENT(IN) :: comm
32    TYPE(MPI_Request), INTENT(OUT) :: request
33    INTEGER, OPTIONAL, INTENT(OUT) :: ierror
34
35 MPI_Iallgatherv(sendbuf, sendcount, sendtype, recvbuf, recvcounts, displs,
36                recvtype, comm, request, ierror)
37    TYPE(*), DIMENSION(..), INTENT(IN), ASYNCHRONOUS :: sendbuf
38    TYPE(*), DIMENSION(..), ASYNCHRONOUS :: recvbuf
39    INTEGER, INTENT(IN) :: sendcount
40    INTEGER, INTENT(IN), ASYNCHRONOUS :: recvcounts(*), displs(*)
41    TYPE(MPI_Datatype), INTENT(IN) :: sendtype, recvtype
42    TYPE(MPI_Comm), INTENT(IN) :: comm
43    TYPE(MPI_Request), INTENT(OUT) :: request
44    INTEGER, OPTIONAL, INTENT(OUT) :: ierror
45
46 MPI_Iallreduce(sendbuf, recvbuf, count, datatype, op, comm, request,
47               ierror)
48    TYPE(*), DIMENSION(..), INTENT(IN), ASYNCHRONOUS :: sendbuf
49    TYPE(*), DIMENSION(..), ASYNCHRONOUS :: recvbuf
50    INTEGER, INTENT(IN) :: count

```



```

TYPE(MPI_Datatype), INTENT(IN) :: datatype           1
TYPE(MPI_Op), INTENT(IN) :: op                       2
TYPE(MPI_Comm), INTENT(IN) :: comm                   3
TYPE(MPI_Request), INTENT(OUT) :: request            4
INTEGER, OPTIONAL, INTENT(OUT) :: ierror            5
                                                    6
MPI_Ialltoall(sendbuf, sendcount, sendtype, recvbuf, recvcount, recvttype,
              comm, request, ierror)                 7
TYPE(*), DIMENSION(..), INTENT(IN), ASYNCHRONOUS :: sendbuf  8
TYPE(*), DIMENSION(..), ASYNCHRONOUS :: recvbuf        9
INTEGER, INTENT(IN) :: sendcount, recvcount          10
TYPE(MPI_Datatype), INTENT(IN) :: sendtype, recvttype  11
TYPE(MPI_Comm), INTENT(IN) :: comm                   12
TYPE(MPI_Request), INTENT(OUT) :: request            13
INTEGER, OPTIONAL, INTENT(OUT) :: ierror            14
                                                    15
MPI_Ialltoallv(sendbuf, sendcounts, sdispls, sendtype, recvbuf, recvcounst,
              rdispls, recvttype, comm, request, ierror) 16
TYPE(*), DIMENSION(..), INTENT(IN), ASYNCHRONOUS :: sendbuf  17
TYPE(*), DIMENSION(..), ASYNCHRONOUS :: recvbuf        18
INTEGER, INTENT(IN), ASYNCHRONOUS :: sendcounts(*), sdispls(*), 19
              recvcounst(*), rdispls(*)                20
TYPE(MPI_Datatype), INTENT(IN) :: sendtype, recvttype  21
TYPE(MPI_Comm), INTENT(IN) :: comm                   22
TYPE(MPI_Request), INTENT(OUT) :: request            23
INTEGER, OPTIONAL, INTENT(OUT) :: ierror            24
                                                    25
MPI_Ialltoallw(sendbuf, sendcounts, sdispls, sendtypes, recvbuf,
              recvcounst, rdispls, recvtypes, comm, request, ierror) 26
TYPE(*), DIMENSION(..), INTENT(IN), ASYNCHRONOUS :: sendbuf  27
TYPE(*), DIMENSION(..), ASYNCHRONOUS :: recvbuf        28
INTEGER, INTENT(IN), ASYNCHRONOUS :: sendcounts(*), sdispls(*), 29
              recvcounst(*), rdispls(*)                30
TYPE(MPI_Datatype), INTENT(IN), ASYNCHRONOUS :: sendtypes(*), 31
              recvtypes(*)                             32
TYPE(MPI_Comm), INTENT(IN) :: comm                   33
TYPE(MPI_Request), INTENT(OUT) :: request            34
INTEGER, OPTIONAL, INTENT(OUT) :: ierror            35
                                                    36
MPI_Ibarrier(comm, request, ierror)                 37
TYPE(MPI_Comm), INTENT(IN) :: comm                   38
TYPE(MPI_Request), INTENT(OUT) :: request            39
INTEGER, OPTIONAL, INTENT(OUT) :: ierror            40
                                                    41
MPI_Ibcast(buffer, count, datatype, root, comm, request, ierror) 42
TYPE(*), DIMENSION(..), ASYNCHRONOUS :: buffer        43
INTEGER, INTENT(IN) :: count, root                   44
TYPE(MPI_Datatype), INTENT(IN) :: datatype           45
TYPE(MPI_Comm), INTENT(IN) :: comm                   46
TYPE(MPI_Request), INTENT(OUT) :: request            47
                                                    48

```

```

1     INTEGER, OPTIONAL, INTENT(OUT) :: ierror
2
3     MPI_Iexscan(sendbuf, recvbuf, count, datatype, op, comm, request, ierror)
4     TYPE(*), DIMENSION(..), INTENT(IN), ASYNCHRONOUS :: sendbuf
5     TYPE(*), DIMENSION(..), ASYNCHRONOUS :: recvbuf
6     INTEGER, INTENT(IN) :: count
7     TYPE(MPI_Datatype), INTENT(IN) :: datatype
8     TYPE(MPI_Op), INTENT(IN) :: op
9     TYPE(MPI_Comm), INTENT(IN) :: comm
10    TYPE(MPI_Request), INTENT(OUT) :: request
11    INTEGER, OPTIONAL, INTENT(OUT) :: ierror
12
13    MPI_Igather(sendbuf, sendcount, sendtype, recvbuf, recvcount, recvtype,
14               root, comm, request, ierror)
15    TYPE(*), DIMENSION(..), INTENT(IN), ASYNCHRONOUS :: sendbuf
16    TYPE(*), DIMENSION(..), ASYNCHRONOUS :: recvbuf
17    INTEGER, INTENT(IN) :: sendcount, recvcount, root
18    TYPE(MPI_Datatype), INTENT(IN) :: sendtype, recvtype
19    TYPE(MPI_Comm), INTENT(IN) :: comm
20    TYPE(MPI_Request), INTENT(OUT) :: request
21    INTEGER, OPTIONAL, INTENT(OUT) :: ierror
22
23    MPI_Igatherv(sendbuf, sendcount, sendtype, recvbuf, recvcounts, displs,
24               recvtype, root, comm, request, ierror)
25    TYPE(*), DIMENSION(..), INTENT(IN), ASYNCHRONOUS :: sendbuf
26    TYPE(*), DIMENSION(..), ASYNCHRONOUS :: recvbuf
27    INTEGER, INTENT(IN) :: sendcount, root
28    INTEGER, INTENT(IN), ASYNCHRONOUS :: recvcounts(*), displs(*)
29    TYPE(MPI_Datatype), INTENT(IN) :: sendtype, recvtype
30    TYPE(MPI_Comm), INTENT(IN) :: comm
31    TYPE(MPI_Request), INTENT(OUT) :: request
32    INTEGER, OPTIONAL, INTENT(OUT) :: ierror
33
34    MPI_Ireduce_scatter_block(sendbuf, recvbuf, recvcount, datatype, op, comm,
35                             request, ierror)
36    TYPE(*), DIMENSION(..), INTENT(IN), ASYNCHRONOUS :: sendbuf
37    TYPE(*), DIMENSION(..), ASYNCHRONOUS :: recvbuf
38    INTEGER, INTENT(IN) :: recvcount
39    TYPE(MPI_Datatype), INTENT(IN) :: datatype
40    TYPE(MPI_Op), INTENT(IN) :: op
41    TYPE(MPI_Comm), INTENT(IN) :: comm
42    TYPE(MPI_Request), INTENT(OUT) :: request
43    INTEGER, OPTIONAL, INTENT(OUT) :: ierror
44
45    MPI_Ireduce_scatter(sendbuf, recvbuf, recvcounts, datatype, op, comm,
46                       request, ierror)
47    TYPE(*), DIMENSION(..), INTENT(IN), ASYNCHRONOUS :: sendbuf
48    TYPE(*), DIMENSION(..), ASYNCHRONOUS :: recvbuf
49    INTEGER, INTENT(IN), ASYNCHRONOUS :: recvcounts(*)
50    TYPE(MPI_Datatype), INTENT(IN) :: datatype

```

```

TYPE(MPI_Op), INTENT(IN) :: op
TYPE(MPI_Comm), INTENT(IN) :: comm
TYPE(MPI_Request), INTENT(OUT) :: request
INTEGER, OPTIONAL, INTENT(OUT) :: ierror

MPI_Ireduce(sendbuf, recvbuf, count, datatype, op, root, comm, request,
            ierror)
TYPE(*), DIMENSION(..), INTENT(IN), ASYNCHRONOUS :: sendbuf
TYPE(*), DIMENSION(..), ASYNCHRONOUS :: recvbuf
INTEGER, INTENT(IN) :: count, root
TYPE(MPI_Datatype), INTENT(IN) :: datatype
TYPE(MPI_Op), INTENT(IN) :: op
TYPE(MPI_Comm), INTENT(IN) :: comm
TYPE(MPI_Request), INTENT(OUT) :: request
INTEGER, OPTIONAL, INTENT(OUT) :: ierror

MPI_Iscan(sendbuf, recvbuf, count, datatype, op, comm, request, ierror)
TYPE(*), DIMENSION(..), INTENT(IN), ASYNCHRONOUS :: sendbuf
TYPE(*), DIMENSION(..), ASYNCHRONOUS :: recvbuf
INTEGER, INTENT(IN) :: count
TYPE(MPI_Datatype), INTENT(IN) :: datatype
TYPE(MPI_Op), INTENT(IN) :: op
TYPE(MPI_Comm), INTENT(IN) :: comm
TYPE(MPI_Request), INTENT(OUT) :: request
INTEGER, OPTIONAL, INTENT(OUT) :: ierror

MPI_Iscatter(sendbuf, sendcount, sendtype, recvbuf, recvcount, recvtype,
            root, comm, request, ierror)
TYPE(*), DIMENSION(..), INTENT(IN), ASYNCHRONOUS :: sendbuf
TYPE(*), DIMENSION(..), ASYNCHRONOUS :: recvbuf
INTEGER, INTENT(IN) :: sendcount, recvcount, root
TYPE(MPI_Datatype), INTENT(IN) :: sendtype, recvtype
TYPE(MPI_Comm), INTENT(IN) :: comm
TYPE(MPI_Request), INTENT(OUT) :: request
INTEGER, OPTIONAL, INTENT(OUT) :: ierror

MPI_Iscatterv(sendbuf, sendcounts, displs, sendtype, recvbuf, recvcount,
            recvtype, root, comm, request, ierror)
TYPE(*), DIMENSION(..), INTENT(IN), ASYNCHRONOUS :: sendbuf
TYPE(*), DIMENSION(..), ASYNCHRONOUS :: recvbuf
INTEGER, INTENT(IN), ASYNCHRONOUS :: sendcounts(*), displs(*)
INTEGER, INTENT(IN) :: recvcount, root
TYPE(MPI_Datatype), INTENT(IN) :: sendtype, recvtype
TYPE(MPI_Comm), INTENT(IN) :: comm
TYPE(MPI_Request), INTENT(OUT) :: request
INTEGER, OPTIONAL, INTENT(OUT) :: ierror

MPI_Op_commutative(op, commute, ierror)
TYPE(MPI_Op), INTENT(IN) :: op
LOGICAL, INTENT(OUT) :: commute

```

```

1     INTEGER, OPTIONAL, INTENT(OUT) :: ierror
2
3     MPI_Op_create(user_fn, commute, op, ierror)
4     PROCEDURE(MPI_User_function) :: user_fn
5     LOGICAL, INTENT(IN) :: commute
6     TYPE(MPI_Op), INTENT(OUT) :: op
7     INTEGER, OPTIONAL, INTENT(OUT) :: ierror
8
9     MPI_Op_free(op, ierror)
10    TYPE(MPI_Op), INTENT(INOUT) :: op
11    INTEGER, OPTIONAL, INTENT(OUT) :: ierror
12
13    MPI_Reduce_init(sendbuf, recvbuf, count, datatype, op, root, comm, info,
14                   request, ierror)
15    TYPE(*), DIMENSION(..), INTENT(IN), ASYNCHRONOUS :: sendbuf
16    TYPE(*), DIMENSION(..), ASYNCHRONOUS :: recvbuf
17    INTEGER, INTENT(IN) :: count, root
18    TYPE(MPI_Datatype), INTENT(IN) :: datatype
19    TYPE(MPI_Op), INTENT(IN) :: op
20    TYPE(MPI_Comm), INTENT(IN) :: comm
21    TYPE(MPI_Info), INTENT(IN) :: info
22    TYPE(MPI_Request), INTENT(OUT) :: request
23    INTEGER, OPTIONAL, INTENT(OUT) :: ierror
24
25    MPI_Reduce_local(inbuf, inoutbuf, count, datatype, op, ierror)
26    TYPE(*), DIMENSION(..), INTENT(IN) :: inbuf
27    TYPE(*), DIMENSION(..) :: inoutbuf
28    INTEGER, INTENT(IN) :: count
29    TYPE(MPI_Datatype), INTENT(IN) :: datatype
30    TYPE(MPI_Op), INTENT(IN) :: op
31    INTEGER, OPTIONAL, INTENT(OUT) :: ierror
32
33    MPI_Reduce_scatter_block_init(sendbuf, recvbuf, recvcnt, datatype, op,
34                                 comm, info, request, ierror)
35    TYPE(*), DIMENSION(..), INTENT(IN), ASYNCHRONOUS :: sendbuf
36    TYPE(*), DIMENSION(..), ASYNCHRONOUS :: recvbuf
37    INTEGER, INTENT(IN) :: recvcnt
38    TYPE(MPI_Datatype), INTENT(IN) :: datatype
39    TYPE(MPI_Op), INTENT(IN) :: op
40    TYPE(MPI_Comm), INTENT(IN) :: comm
41    TYPE(MPI_Info), INTENT(IN) :: info
42    TYPE(MPI_Request), INTENT(OUT) :: request
43    INTEGER, OPTIONAL, INTENT(OUT) :: ierror
44
45    MPI_Reduce_scatter_block(sendbuf, recvbuf, recvcnt, datatype, op, comm,
46                             ierror)
47    TYPE(*), DIMENSION(..), INTENT(IN) :: sendbuf
48    TYPE(*), DIMENSION(..) :: recvbuf
49    INTEGER, INTENT(IN) :: recvcnt
50    TYPE(MPI_Datatype), INTENT(IN) :: datatype

```

```

TYPE(MPI_Op), INTENT(IN) :: op
TYPE(MPI_Comm), INTENT(IN) :: comm
INTEGER, OPTIONAL, INTENT(OUT) :: ierror
MPI_Reduce_scatter_init(sendbuf, recvbuf, recvcnts, datatype, op, comm,
    info, request, ierror)
TYPE(*), DIMENSION(..), INTENT(IN), ASYNCHRONOUS :: sendbuf
TYPE(*), DIMENSION(..), ASYNCHRONOUS :: recvbuf
INTEGER, INTENT(IN), ASYNCHRONOUS :: recvcnts(*)
TYPE(MPI_Datatype), INTENT(IN) :: datatype
TYPE(MPI_Op), INTENT(IN) :: op
TYPE(MPI_Comm), INTENT(IN) :: comm
TYPE(MPI_Info), INTENT(IN) :: info
TYPE(MPI_Request), INTENT(OUT) :: request
INTEGER, OPTIONAL, INTENT(OUT) :: ierror
MPI_Reduce_scatter(sendbuf, recvbuf, recvcnts, datatype, op, comm,
    ierror)
TYPE(*), DIMENSION(..), INTENT(IN) :: sendbuf
TYPE(*), DIMENSION(..) :: recvbuf
INTEGER, INTENT(IN) :: recvcnts(*)
TYPE(MPI_Datatype), INTENT(IN) :: datatype
TYPE(MPI_Op), INTENT(IN) :: op
TYPE(MPI_Comm), INTENT(IN) :: comm
INTEGER, OPTIONAL, INTENT(OUT) :: ierror
MPI_Reduce(sendbuf, recvbuf, count, datatype, op, root, comm, ierror)
TYPE(*), DIMENSION(..), INTENT(IN) :: sendbuf
TYPE(*), DIMENSION(..) :: recvbuf
INTEGER, INTENT(IN) :: count, root
TYPE(MPI_Datatype), INTENT(IN) :: datatype
TYPE(MPI_Op), INTENT(IN) :: op
TYPE(MPI_Comm), INTENT(IN) :: comm
INTEGER, OPTIONAL, INTENT(OUT) :: ierror
MPI_Scan_init(sendbuf, recvbuf, count, datatype, op, comm, info, request,
    ierror)
TYPE(*), DIMENSION(..), INTENT(IN), ASYNCHRONOUS :: sendbuf
TYPE(*), DIMENSION(..), ASYNCHRONOUS :: recvbuf
INTEGER, INTENT(IN) :: count
TYPE(MPI_Datatype), INTENT(IN) :: datatype
TYPE(MPI_Op), INTENT(IN) :: op
TYPE(MPI_Comm), INTENT(IN) :: comm
TYPE(MPI_Info), INTENT(IN) :: info
TYPE(MPI_Request), INTENT(OUT) :: request
INTEGER, OPTIONAL, INTENT(OUT) :: ierror
MPI_Scan(sendbuf, recvbuf, count, datatype, op, comm, ierror)
TYPE(*), DIMENSION(..), INTENT(IN) :: sendbuf
TYPE(*), DIMENSION(..) :: recvbuf

```

```

1     INTEGER, INTENT(IN) :: count
2     TYPE(MPI_Datatype), INTENT(IN) :: datatype
3     TYPE(MPI_Op), INTENT(IN) :: op
4     TYPE(MPI_Comm), INTENT(IN) :: comm
5     INTEGER, OPTIONAL, INTENT(OUT) :: ierror
6
7     MPI_Scatter_init(sendbuf, sendcount, sendtype, recvbuf, recvcount,
8         recvtype, root, comm, info, request, ierror)
9     TYPE(*), DIMENSION(..), INTENT(IN), ASYNCHRONOUS :: sendbuf
10    TYPE(*), DIMENSION(..), ASYNCHRONOUS :: recvbuf
11    INTEGER, INTENT(IN) :: sendcount, recvcount, root
12    TYPE(MPI_Datatype), INTENT(IN) :: sendtype, recvtype
13    TYPE(MPI_Comm), INTENT(IN) :: comm
14    TYPE(MPI_Info), INTENT(IN) :: info
15    TYPE(MPI_Request), INTENT(OUT) :: request
16    INTEGER, OPTIONAL, INTENT(OUT) :: ierror
17
18    MPI_Scatter(sendbuf, sendcount, sendtype, recvbuf, recvcount, recvtype,
19        root, comm, ierror)
20    TYPE(*), DIMENSION(..), INTENT(IN) :: sendbuf
21    TYPE(*), DIMENSION(..) :: recvbuf
22    INTEGER, INTENT(IN) :: sendcount, recvcount, root
23    TYPE(MPI_Datatype), INTENT(IN) :: sendtype, recvtype
24    TYPE(MPI_Comm), INTENT(IN) :: comm
25    INTEGER, OPTIONAL, INTENT(OUT) :: ierror
26
27    MPI_Scatterv_init(sendbuf, sendcounts, displs, sendtype, recvbuf,
28        recvcount, recvtype, root, comm, info, request, ierror)
29    TYPE(*), DIMENSION(..), INTENT(IN), ASYNCHRONOUS :: sendbuf
30    TYPE(*), DIMENSION(..), ASYNCHRONOUS :: recvbuf
31    INTEGER, INTENT(IN), ASYNCHRONOUS :: sendcounts(*), displs(*)
32    INTEGER, INTENT(IN) :: recvcount, root
33    TYPE(MPI_Datatype), INTENT(IN) :: sendtype, recvtype
34    TYPE(MPI_Comm), INTENT(IN) :: comm
35    TYPE(MPI_Info), INTENT(IN) :: info
36    TYPE(MPI_Request), INTENT(OUT) :: request
37    INTEGER, OPTIONAL, INTENT(OUT) :: ierror
38
39    MPI_Scatterv(sendbuf, sendcounts, displs, sendtype, recvbuf, recvcount,
40        recvtype, root, comm, ierror)
41    TYPE(*), DIMENSION(..), INTENT(IN) :: sendbuf
42    TYPE(*), DIMENSION(..) :: recvbuf
43    INTEGER, INTENT(IN) :: sendcounts(*), displs(*), recvcount, root
44    TYPE(MPI_Datatype), INTENT(IN) :: sendtype, recvtype
45    TYPE(MPI_Comm), INTENT(IN) :: comm
46    INTEGER, OPTIONAL, INTENT(OUT) :: ierror
47
48

```

A.3.4 Groups, Contexts, Communicators, and Caching Fortran 2008 Bindings

MPI_Comm_compare(comm1, comm2, result, ierror)	1
TYPE(MPI_Comm), INTENT(IN) :: comm1, comm2	2
INTEGER, INTENT(OUT) :: result	3
INTEGER, OPTIONAL, INTENT(OUT) :: ierror	4
MPI_Comm_create(comm, group, newcomm, ierror)	5
TYPE(MPI_Comm), INTENT(IN) :: comm	6
TYPE(MPI_Group), INTENT(IN) :: group	7
TYPE(MPI_Comm), INTENT(OUT) :: newcomm	8
INTEGER, OPTIONAL, INTENT(OUT) :: ierror	9
MPI_Comm_create_group(comm, group, tag, newcomm, ierror)	10
TYPE(MPI_Comm), INTENT(IN) :: comm	11
TYPE(MPI_Group), INTENT(IN) :: group	12
INTEGER, INTENT(IN) :: tag	13
TYPE(MPI_Comm), INTENT(OUT) :: newcomm	14
INTEGER, OPTIONAL, INTENT(OUT) :: ierror	15
MPI_Comm_create_keyval(comm_copy_attr_fn, comm_delete_attr_fn, comm_keyval,	16
extra_state, ierror)	17
PROCEDURE(MPI_Comm_copy_attr_function) :: comm_copy_attr_fn	18
PROCEDURE(MPI_Comm_delete_attr_function) :: comm_delete_attr_fn	19
INTEGER, INTENT(OUT) :: comm_keyval	20
INTEGER(KIND=MPI_ADDRESS_KIND), INTENT(IN) :: extra_state	21
INTEGER, OPTIONAL, INTENT(OUT) :: ierror	22
MPI_Comm_delete_attr(comm, comm_keyval, ierror)	23
TYPE(MPI_Comm), INTENT(IN) :: comm	24
INTEGER, INTENT(IN) :: comm_keyval	25
INTEGER, OPTIONAL, INTENT(OUT) :: ierror	26
MPI_Comm_dup(comm, newcomm, ierror)	27
TYPE(MPI_Comm), INTENT(IN) :: comm	28
TYPE(MPI_Comm), INTENT(OUT) :: newcomm	29
INTEGER, OPTIONAL, INTENT(OUT) :: ierror	30
MPI_COMM_DUP_FN(oldcomm, comm_keyval, extra_state, attribute_val_in,	31
attribute_val_out, flag, ierror)	32
TYPE(MPI_Comm) :: oldcomm	33
INTEGER :: comm_keyval	34
INTEGER(KIND=MPI_ADDRESS_KIND) :: extra_state, attribute_val_in	35
INTEGER(KIND=MPI_ADDRESS_KIND) :: attribute_val_out	36
LOGICAL :: flag	37
INTEGER :: ierror	38
MPI_Comm_dup_with_info(comm, info, newcomm, ierror)	39
TYPE(MPI_Comm), INTENT(IN) :: comm	40
TYPE(MPI_Info), INTENT(IN) :: info	41
TYPE(MPI_Comm), INTENT(OUT) :: newcomm	42
	43
	44
	45
	46
	47
	48

```

1     INTEGER, OPTIONAL, INTENT(OUT) :: ierror
2
3     MPI_Comm_free(comm, ierror)
4         TYPE(MPI_Comm), INTENT(INOUT) :: comm
5         INTEGER, OPTIONAL, INTENT(OUT) :: ierror
6
7     MPI_Comm_free_keyval(comm_keyval, ierror)
8         INTEGER, INTENT(INOUT) :: comm_keyval
9         INTEGER, OPTIONAL, INTENT(OUT) :: ierror
10
11    MPI_Comm_get_attr(comm, comm_keyval, attribute_val, flag, ierror)
12        TYPE(MPI_Comm), INTENT(IN) :: comm
13        INTEGER, INTENT(IN) :: comm_keyval
14        INTEGER(KIND=MPI_ADDRESS_KIND), INTENT(OUT) :: attribute_val
15        LOGICAL, INTENT(OUT) :: flag
16        INTEGER, OPTIONAL, INTENT(OUT) :: ierror
17
18    MPI_Comm_get_info(comm, info_used, ierror)
19        TYPE(MPI_Comm), INTENT(IN) :: comm
20        TYPE(MPI_Info), INTENT(OUT) :: info_used
21        INTEGER, OPTIONAL, INTENT(OUT) :: ierror
22
23    MPI_Comm_get_name(comm, comm_name, resultlen, ierror)
24        TYPE(MPI_Comm), INTENT(IN) :: comm
25        CHARACTER(LEN=MPI_MAX_OBJECT_NAME), INTENT(OUT) :: comm_name
26        INTEGER, INTENT(OUT) :: resultlen
27        INTEGER, OPTIONAL, INTENT(OUT) :: ierror
28
29    MPI_Comm_group(comm, group, ierror)
30        TYPE(MPI_Comm), INTENT(IN) :: comm
31        TYPE(MPI_Group), INTENT(OUT) :: group
32        INTEGER, OPTIONAL, INTENT(OUT) :: ierror
33
34    MPI_Comm_idup(comm, newcomm, request, ierror)
35        TYPE(MPI_Comm), INTENT(IN) :: comm
36        TYPE(MPI_Comm), INTENT(OUT), ASYNCHRONOUS :: newcomm
37        TYPE(MPI_Request), INTENT(OUT) :: request
38        INTEGER, OPTIONAL, INTENT(OUT) :: ierror
39
40    MPI_Comm_idup_with_info(comm, info, newcomm, request, ierror)
41        TYPE(MPI_Comm), INTENT(IN) :: comm
42        TYPE(MPI_Info), INTENT(IN) :: info
43        TYPE(MPI_Comm), INTENT(OUT), ASYNCHRONOUS :: newcomm
44        TYPE(MPI_Request), INTENT(OUT) :: request
45        INTEGER, OPTIONAL, INTENT(OUT) :: ierror
46
47    MPI_COMM_NULL_COPY_FN(oldcomm, comm_keyval, extra_state, attribute_val_in,
48        attribute_val_out, flag, ierror)
49        TYPE(MPI_Comm) :: oldcomm
50        INTEGER :: comm_keyval
51        INTEGER(KIND=MPI_ADDRESS_KIND) :: extra_state, attribute_val_in
52        INTEGER(KIND=MPI_ADDRESS_KIND) :: attribute_val_out

```



```

LOGICAL :: flag 1
INTEGER :: ierror 2
MPI_COMM_NULL_DELETE_FN(comm, comm_keyval, attribute_val, extra_state, 3
    ierror) 4
TYPE(MPI_Comm) :: comm 5
INTEGER :: comm_keyval 6
INTEGER(KIND=MPI_ADDRESS_KIND) :: attribute_val, extra_state 7
INTEGER :: ierror 8
MPI_Comm_rank(comm, rank, ierror) 9
TYPE(MPI_Comm), INTENT(IN) :: comm 10
INTEGER, INTENT(OUT) :: rank 11
INTEGER, OPTIONAL, INTENT(OUT) :: ierror 12
MPI_Comm_remote_group(comm, group, ierror) 13
TYPE(MPI_Comm), INTENT(IN) :: comm 14
TYPE(MPI_Group), INTENT(OUT) :: group 15
INTEGER, OPTIONAL, INTENT(OUT) :: ierror 16
MPI_Comm_remote_size(comm, size, ierror) 17
TYPE(MPI_Comm), INTENT(IN) :: comm 18
INTEGER, INTENT(OUT) :: size 19
INTEGER, OPTIONAL, INTENT(OUT) :: ierror 20
MPI_Comm_set_attr(comm, comm_keyval, attribute_val, ierror) 21
TYPE(MPI_Comm), INTENT(IN) :: comm 22
INTEGER, INTENT(IN) :: comm_keyval 23
INTEGER(KIND=MPI_ADDRESS_KIND), INTENT(IN) :: attribute_val 24
INTEGER, OPTIONAL, INTENT(OUT) :: ierror 25
MPI_Comm_set_info(comm, info, ierror) 26
TYPE(MPI_Comm), INTENT(IN) :: comm 27
TYPE(MPI_Info), INTENT(IN) :: info 28
INTEGER, OPTIONAL, INTENT(OUT) :: ierror 29
MPI_Comm_set_name(comm, comm_name, ierror) 30
TYPE(MPI_Comm), INTENT(IN) :: comm 31
CHARACTER(LEN=*), INTENT(IN) :: comm_name 32
INTEGER, OPTIONAL, INTENT(OUT) :: ierror 33
MPI_Comm_size(comm, size, ierror) 34
TYPE(MPI_Comm), INTENT(IN) :: comm 35
INTEGER, INTENT(OUT) :: size 36
INTEGER, OPTIONAL, INTENT(OUT) :: ierror 37
MPI_Comm_split(comm, color, key, newcomm, ierror) 38
TYPE(MPI_Comm), INTENT(IN) :: comm 39
INTEGER, INTENT(IN) :: color, key 40
TYPE(MPI_Comm), INTENT(OUT) :: newcomm 41
INTEGER, OPTIONAL, INTENT(OUT) :: ierror 42

```

```
1 MPI_Comm_split_type(comm, split_type, key, info, newcomm, ierror)
2     TYPE(MPI_Comm), INTENT(IN) :: comm
3     INTEGER, INTENT(IN) :: split_type, key
4     TYPE(MPI_Info), INTENT(IN) :: info
5     TYPE(MPI_Comm), INTENT(OUT) :: newcomm
6     INTEGER, OPTIONAL, INTENT(OUT) :: ierror
7
8 MPI_Comm_test_inter(comm, flag, ierror)
9     TYPE(MPI_Comm), INTENT(IN) :: comm
10    LOGICAL, INTENT(OUT) :: flag
11    INTEGER, OPTIONAL, INTENT(OUT) :: ierror
12
13 MPI_Group_compare(group1, group2, result, ierror)
14    TYPE(MPI_Group), INTENT(IN) :: group1, group2
15    INTEGER, INTENT(OUT) :: result
16    INTEGER, OPTIONAL, INTENT(OUT) :: ierror
17
18 MPI_Group_difference(group1, group2, newgroup, ierror)
19    TYPE(MPI_Group), INTENT(IN) :: group1, group2
20    TYPE(MPI_Group), INTENT(OUT) :: newgroup
21    INTEGER, OPTIONAL, INTENT(OUT) :: ierror
22
23 MPI_Group_excl(group, n, ranks, newgroup, ierror)
24    TYPE(MPI_Group), INTENT(IN) :: group
25    INTEGER, INTENT(IN) :: n, ranks(n)
26    TYPE(MPI_Group), INTENT(OUT) :: newgroup
27    INTEGER, OPTIONAL, INTENT(OUT) :: ierror
28
29 MPI_Group_free(group, ierror)
30    TYPE(MPI_Group), INTENT(INOUT) :: group
31    INTEGER, OPTIONAL, INTENT(OUT) :: ierror
32
33 MPI_Group_incl(group, n, ranks, newgroup, ierror)
34    TYPE(MPI_Group), INTENT(IN) :: group
35    INTEGER, INTENT(IN) :: n, ranks(n)
36    TYPE(MPI_Group), INTENT(OUT) :: newgroup
37    INTEGER, OPTIONAL, INTENT(OUT) :: ierror
38
39 MPI_Group_intersection(group1, group2, newgroup, ierror)
40    TYPE(MPI_Group), INTENT(IN) :: group1, group2
41    TYPE(MPI_Group), INTENT(OUT) :: newgroup
42    INTEGER, OPTIONAL, INTENT(OUT) :: ierror
43
44 MPI_Group_range_excl(group, n, ranges, newgroup, ierror)
45    TYPE(MPI_Group), INTENT(IN) :: group
46    INTEGER, INTENT(IN) :: n, ranges(3,n)
47    TYPE(MPI_Group), INTENT(OUT) :: newgroup
48    INTEGER, OPTIONAL, INTENT(OUT) :: ierror
49
50 MPI_Group_range_incl(group, n, ranges, newgroup, ierror)
51    TYPE(MPI_Group), INTENT(IN) :: group
52    INTEGER, INTENT(IN) :: n, ranges(3,n)
```

```

    TYPE(MPI_Group), INTENT(OUT) :: newgroup
    INTEGER, OPTIONAL, INTENT(OUT) :: ierror
MPI_Group_rank(group, rank, ierror)
    TYPE(MPI_Group), INTENT(IN) :: group
    INTEGER, INTENT(OUT) :: rank
    INTEGER, OPTIONAL, INTENT(OUT) :: ierror
MPI_Group_size(group, size, ierror)
    TYPE(MPI_Group), INTENT(IN) :: group
    INTEGER, INTENT(OUT) :: size
    INTEGER, OPTIONAL, INTENT(OUT) :: ierror
MPI_Group_translate_ranks(group1, n, ranks1, group2, ranks2, ierror)
    TYPE(MPI_Group), INTENT(IN) :: group1, group2
    INTEGER, INTENT(IN) :: n, ranks1(n)
    INTEGER, INTENT(OUT) :: ranks2(n)
    INTEGER, OPTIONAL, INTENT(OUT) :: ierror
MPI_Group_union(group1, group2, newgroup, ierror)
    TYPE(MPI_Group), INTENT(IN) :: group1, group2
    TYPE(MPI_Group), INTENT(OUT) :: newgroup
    INTEGER, OPTIONAL, INTENT(OUT) :: ierror
MPI_Intercomm_create(local_comm, local_leader, peer_comm, remote_leader,
    tag, newintercomm, ierror)
    TYPE(MPI_Comm), INTENT(IN) :: local_comm, peer_comm
    INTEGER, INTENT(IN) :: local_leader, remote_leader, tag
    TYPE(MPI_Comm), INTENT(OUT) :: newintercomm
    INTEGER, OPTIONAL, INTENT(OUT) :: ierror
MPI_Intercomm_merge(intercomm, high, newintracomm, ierror)
    TYPE(MPI_Comm), INTENT(IN) :: intercomm
    LOGICAL, INTENT(IN) :: high
    TYPE(MPI_Comm), INTENT(OUT) :: newintracomm
    INTEGER, OPTIONAL, INTENT(OUT) :: ierror
MPI_Type_create_keyval(type_copy_attr_fn, type_delete_attr_fn, type_keyval,
    extra_state, ierror)
    PROCEDURE(MPI_Type_copy_attr_function) :: type_copy_attr_fn
    PROCEDURE(MPI_Type_delete_attr_function) :: type_delete_attr_fn
    INTEGER, INTENT(OUT) :: type_keyval
    INTEGER(KIND=MPI_ADDRESS_KIND), INTENT(IN) :: extra_state
    INTEGER, OPTIONAL, INTENT(OUT) :: ierror
MPI_Type_delete_attr(datatype, type_keyval, ierror)
    TYPE(MPI_Datatype), INTENT(IN) :: datatype
    INTEGER, INTENT(IN) :: type_keyval
    INTEGER, OPTIONAL, INTENT(OUT) :: ierror
MPI_TYPE_DUP_FN(oldtype, type_keyval, extra_state, attribute_val_in,
    attribute_val_out, flag, ierror)

```

```

1     TYPE(MPI_Datatype) :: oldtype
2     INTEGER :: type_keyval
3     INTEGER(KIND=MPI_ADDRESS_KIND) :: extra_state, attribute_val_in
4     INTEGER(KIND=MPI_ADDRESS_KIND) :: attribute_val_out
5     LOGICAL :: flag
6     INTEGER :: ierror
7
8     MPI_Type_free_keyval(type_keyval, ierror)
9     INTEGER, INTENT(INOUT) :: type_keyval
10    INTEGER, OPTIONAL, INTENT(OUT) :: ierror
11
12    MPI_Type_get_attr(datatype, type_keyval, attribute_val, flag, ierror)
13    TYPE(MPI_Datatype), INTENT(IN) :: datatype
14    INTEGER, INTENT(IN) :: type_keyval
15    INTEGER(KIND=MPI_ADDRESS_KIND), INTENT(OUT) :: attribute_val
16    LOGICAL, INTENT(OUT) :: flag
17    INTEGER, OPTIONAL, INTENT(OUT) :: ierror
18
19    MPI_Type_get_name(datatype, type_name, resultlen, ierror)
20    TYPE(MPI_Datatype), INTENT(IN) :: datatype
21    CHARACTER(LEN=MPI_MAX_OBJECT_NAME), INTENT(OUT) :: type_name
22    INTEGER, INTENT(OUT) :: resultlen
23    INTEGER, OPTIONAL, INTENT(OUT) :: ierror
24
25    MPI_TYPE_NULL_COPY_FN(oldtype, type_keyval, extra_state, attribute_val_in,
26    attribute_val_out, flag, ierror)
27    TYPE(MPI_Datatype) :: oldtype
28    INTEGER :: type_keyval
29    INTEGER(KIND=MPI_ADDRESS_KIND) :: extra_state, attribute_val_in
30    INTEGER(KIND=MPI_ADDRESS_KIND) :: attribute_val_out
31    LOGICAL :: flag
32    INTEGER :: ierror
33
34    MPI_TYPE_NULL_DELETE_FN(datatype, type_keyval, attribute_val, extra_state,
35    ierror)
36    TYPE(MPI_Datatype) :: datatype
37    INTEGER :: type_keyval
38    INTEGER(KIND=MPI_ADDRESS_KIND) :: attribute_val, extra_state
39    INTEGER, INTENT(OUT) :: ierror
40
41    MPI_Type_set_attr(datatype, type_keyval, attribute_val, ierror)
42    TYPE(MPI_Datatype), INTENT(IN) :: datatype
43    INTEGER, INTENT(IN) :: type_keyval
44    INTEGER(KIND=MPI_ADDRESS_KIND), INTENT(IN) :: attribute_val
45    INTEGER, OPTIONAL, INTENT(OUT) :: ierror
46
47    MPI_Type_set_name(datatype, type_name, ierror)
48    TYPE(MPI_Datatype), INTENT(IN) :: datatype
49    CHARACTER(LEN=*), INTENT(IN) :: type_name
50    INTEGER, OPTIONAL, INTENT(OUT) :: ierror

```

```

MPI_Win_create_keyval(win_copy_attr_fn, win_delete_attr_fn, win_keyval,      1
                     extra_state, ierror)                                  2
    PROCEDURE(MPI_Win_copy_attr_function) :: win_copy_attr_fn             3
    PROCEDURE(MPI_Win_delete_attr_function) :: win_delete_attr_fn         4
    INTEGER, INTENT(OUT) :: win_keyval                                     5
    INTEGER(KIND=MPI_ADDRESS_KIND), INTENT(IN) :: extra_state             6
    INTEGER, OPTIONAL, INTENT(OUT) :: ierror                             7
                                                                           8
MPI_Win_delete_attr(win, win_keyval, ierror)                               9
    TYPE(MPI_Win), INTENT(IN) :: win                                     10
    INTEGER, INTENT(IN) :: win_keyval                                    11
    INTEGER, OPTIONAL, INTENT(OUT) :: ierror                             12
                                                                           13
MPI_WIN_DUP_FN(oldwin, win_keyval, extra_state, attribute_val_in,         14
               attribute_val_out, flag, ierror)                          15
    TYPE(MPI_Win) :: oldwin                                             16
    INTEGER :: win_keyval                                               17
    INTEGER(KIND=MPI_ADDRESS_KIND) :: extra_state, attribute_val_in     18
    INTEGER(KIND=MPI_ADDRESS_KIND) :: attribute_val_out                 19
    LOGICAL :: flag                                                    20
    INTEGER :: ierror                                                    21
                                                                           22
MPI_Win_free_keyval(win_keyval, ierror)                                   23
    INTEGER, INTENT(INOUT) :: win_keyval                                 24
    INTEGER, OPTIONAL, INTENT(OUT) :: ierror                             25
                                                                           26
MPI_Win_get_attr(win, win_keyval, attribute_val, flag, ierror)           27
    TYPE(MPI_Win), INTENT(IN) :: win                                     28
    INTEGER, INTENT(IN) :: win_keyval                                    29
    INTEGER(KIND=MPI_ADDRESS_KIND), INTENT(OUT) :: attribute_val        30
    LOGICAL, INTENT(OUT) :: flag                                        31
    INTEGER, OPTIONAL, INTENT(OUT) :: ierror                             32
                                                                           33
MPI_Win_get_name(win, win_name, resultlen, ierror)                       34
    TYPE(MPI_Win), INTENT(IN) :: win                                     35
    CHARACTER(LEN=MPI_MAX_OBJECT_NAME), INTENT(OUT) :: win_name        36
    INTEGER, INTENT(OUT) :: resultlen                                    37
    INTEGER, OPTIONAL, INTENT(OUT) :: ierror                             38
                                                                           39
MPI_WIN_NULL_COPY_FN(oldwin, win_keyval, extra_state, attribute_val_in,  40
                    attribute_val_out, flag, ierror)                    41
    TYPE(MPI_Win) :: oldwin                                             42
    INTEGER :: win_keyval                                               43
    INTEGER(KIND=MPI_ADDRESS_KIND) :: extra_state, attribute_val_in     44
    INTEGER(KIND=MPI_ADDRESS_KIND) :: attribute_val_out                 45
    LOGICAL :: flag                                                    46
    INTEGER :: ierror                                                    47
                                                                           48
MPI_WIN_NULL_DELETE_FN(win, win_keyval, attribute_val, extra_state, ierror)
    TYPE(MPI_Win) :: win
    INTEGER :: win_keyval

```

```

1      INTEGER(KIND=MPI_ADDRESS_KIND) :: attribute_val, extra_state
2      INTEGER :: ierror
3
4      MPI_Win_set_attr(win, win_keyval, attribute_val, ierror)
5      TYPE(MPI_Win), INTENT(IN) :: win
6      INTEGER, INTENT(IN) :: win_keyval
7      INTEGER(KIND=MPI_ADDRESS_KIND), INTENT(IN) :: attribute_val
8      INTEGER, OPTIONAL, INTENT(OUT) :: ierror
9
10     MPI_Win_set_name(win, win_name, ierror)
11     TYPE(MPI_Win), INTENT(IN) :: win
12     CHARACTER(LEN=*), INTENT(IN) :: win_name
13     INTEGER, OPTIONAL, INTENT(OUT) :: ierror
14
15     A.3.5 Process Topologies Fortran 2008 Bindings
16
17     MPI_Cart_coords(comm, rank, maxdims, coords, ierror)
18     TYPE(MPI_Comm), INTENT(IN) :: comm
19     INTEGER, INTENT(IN) :: rank, maxdims
20     INTEGER, INTENT(OUT) :: coords(maxdims)
21     INTEGER, OPTIONAL, INTENT(OUT) :: ierror
22
23     MPI_Cart_create(comm_old, ndims, dims, periods, reorder, comm_cart, ierror)
24     TYPE(MPI_Comm), INTENT(IN) :: comm_old
25     INTEGER, INTENT(IN) :: ndims, dims(ndims)
26     LOGICAL, INTENT(IN) :: periods(ndims), reorder
27     TYPE(MPI_Comm), INTENT(OUT) :: comm_cart
28     INTEGER, OPTIONAL, INTENT(OUT) :: ierror
29
30     MPI_Cart_create_weighted(comm_old, ndims, dim_weights, periods, info, dims,
31                             comm_cart, ierror)
32     TYPE(MPI_Comm), INTENT(IN) :: comm_old
33     INTEGER, INTENT(IN) :: ndims
34     DOUBLE PRECISION, INTENT(IN) :: dim_weights(ndims)
35     LOGICAL, INTENT(IN) :: periods(ndims)
36     TYPE(MPI_Info), INTENT(IN) :: info
37     INTEGER, INTENT(INOUT) :: dims(ndims)
38     TYPE(MPI_Comm), INTENT(OUT) :: comm_cart
39     INTEGER, OPTIONAL, INTENT(OUT) :: ierror
40
41     MPI_Cartdim_get(comm, ndims, ierror)
42     TYPE(MPI_Comm), INTENT(IN) :: comm
43     INTEGER, INTENT(OUT) :: ndims
44     INTEGER, OPTIONAL, INTENT(OUT) :: ierror
45
46     MPI_Cart_get(comm, maxdims, dims, periods, coords, ierror)
47     TYPE(MPI_Comm), INTENT(IN) :: comm
48     INTEGER, INTENT(IN) :: maxdims
49     INTEGER, INTENT(OUT) :: dims(maxdims), coords(maxdims)
50     LOGICAL, INTENT(OUT) :: periods(maxdims)

```

```

    INTEGER, OPTIONAL, INTENT(OUT) :: ierror
1
MPI_Cart_map(comm, ndims, dims, periods, newrank, ierror)
2
    TYPE(MPI_Comm), INTENT(IN) :: comm
3
    INTEGER, INTENT(IN) :: ndims, dims(ndims)
4
    LOGICAL, INTENT(IN) :: periods(ndims)
5
    INTEGER, INTENT(OUT) :: newrank
6
    INTEGER, OPTIONAL, INTENT(OUT) :: ierror
7
MPI_Cart_rank(comm, coords, rank, ierror)
8
    TYPE(MPI_Comm), INTENT(IN) :: comm
9
    INTEGER, INTENT(IN) :: coords(*)
10
    INTEGER, INTENT(OUT) :: rank
11
    INTEGER, OPTIONAL, INTENT(OUT) :: ierror
12
MPI_Cart_shift(comm, direction, disp, rank_source, rank_dest, ierror)
13
    TYPE(MPI_Comm), INTENT(IN) :: comm
14
    INTEGER, INTENT(IN) :: direction, disp
15
    INTEGER, INTENT(OUT) :: rank_source, rank_dest
16
    INTEGER, OPTIONAL, INTENT(OUT) :: ierror
17
MPI_Cart_sub(comm, remain_dims, newcomm, ierror)
18
    TYPE(MPI_Comm), INTENT(IN) :: comm
19
    LOGICAL, INTENT(IN) :: remain_dims(*)
20
    TYPE(MPI_Comm), INTENT(OUT) :: newcomm
21
    INTEGER, OPTIONAL, INTENT(OUT) :: ierror
22
MPI_Dims_create(nnodes, ndims, dims, ierror)
23
    INTEGER, INTENT(IN) :: nnodes, ndims
24
    INTEGER, INTENT(INOUT) :: dims(ndims)
25
    INTEGER, OPTIONAL, INTENT(OUT) :: ierror
26
MPI_Dims_create_weighted(nnodes, ndims, dim_weights, periods, info, dims,
27
    ierror)
28
    INTEGER, INTENT(IN) :: nnodes, ndims
29
    DOUBLE PRECISION, INTENT(IN) :: dim_weights(ndims)
30
    LOGICAL, INTENT(IN) :: periods(ndims)
31
    TYPE(MPI_Info), INTENT(IN) :: info
32
    INTEGER, INTENT(INOUT) :: dims(ndims)
33
    INTEGER, OPTIONAL, INTENT(OUT) :: ierror
34
MPI_Dist_graph_create_adjacent(comm_old, indegree, sources, sourceweights,
35
    outdegree, destinations, destweights, info, reorder,
36
    comm_dist_graph, ierror)
37
    TYPE(MPI_Comm), INTENT(IN) :: comm_old
38
    INTEGER, INTENT(IN) :: indegree, sources(indegree), outdegree,
39
    destinations(outdegree)
40
    INTEGER, INTENT(IN) :: sourceweights(*), destweights(*)
41
    TYPE(MPI_Info), INTENT(IN) :: info
42
    LOGICAL, INTENT(IN) :: reorder
43
    TYPE(MPI_Comm), INTENT(OUT) :: comm_dist_graph
44

```

```

1     INTEGER, OPTIONAL, INTENT(OUT) :: ierror
2
3     MPI_Dist_graph_create(comm_old, n, sources, degrees, destinations, weights,
4         info, reorder, comm_dist_graph, ierror)
5     TYPE(MPI_Comm), INTENT(IN) :: comm_old
6     INTEGER, INTENT(IN) :: n, sources(n), degrees(n), destinations(*)
7     INTEGER, INTENT(IN) :: weights(*)
8     TYPE(MPI_Info), INTENT(IN) :: info
9     LOGICAL, INTENT(IN) :: reorder
10    TYPE(MPI_Comm), INTENT(OUT) :: comm_dist_graph
11    INTEGER, OPTIONAL, INTENT(OUT) :: ierror
12
13    MPI_Dist_graph_neighbors(comm, maxindegree, sources, sourceweights,
14        maxoutdegree, destinations, destweights, ierror)
15    TYPE(MPI_Comm), INTENT(IN) :: comm
16    INTEGER, INTENT(IN) :: maxindegree, maxoutdegree
17    INTEGER, INTENT(OUT) :: sources(maxindegree),
18        destinations(maxoutdegree)
19    INTEGER :: sourceweights(*), destweights(*)
20    INTEGER, OPTIONAL, INTENT(OUT) :: ierror
21
22    MPI_Dist_graph_neighbors_count(comm, indegree, outdegree, weighted, ierror)
23    TYPE(MPI_Comm), INTENT(IN) :: comm
24    INTEGER, INTENT(OUT) :: indegree, outdegree
25    LOGICAL, INTENT(OUT) :: weighted
26    INTEGER, OPTIONAL, INTENT(OUT) :: ierror
27
28    MPI_Graph_create(comm_old, nnodes, index, edges, reorder, comm_graph,
29        ierror)
30    TYPE(MPI_Comm), INTENT(IN) :: comm_old
31    INTEGER, INTENT(IN) :: nnodes, index(nnodes), edges(*)
32    LOGICAL, INTENT(IN) :: reorder
33    TYPE(MPI_Comm), INTENT(OUT) :: comm_graph
34    INTEGER, OPTIONAL, INTENT(OUT) :: ierror
35
36    MPI_Graphdims_get(comm, nnodes, nedges, ierror)
37    TYPE(MPI_Comm), INTENT(IN) :: comm
38    INTEGER, INTENT(OUT) :: nnodes, nedges
39    INTEGER, OPTIONAL, INTENT(OUT) :: ierror
40
41    MPI_Graph_get(comm, maxindex, maxedges, index, edges, ierror)
42    TYPE(MPI_Comm), INTENT(IN) :: comm
43    INTEGER, INTENT(IN) :: maxindex, maxedges
44    INTEGER, INTENT(OUT) :: index(maxindex), edges(maxedges)
45    INTEGER, OPTIONAL, INTENT(OUT) :: ierror
46
47    MPI_Graph_map(comm, nnodes, index, edges, newrank, ierror)
48    TYPE(MPI_Comm), INTENT(IN) :: comm
49    INTEGER, INTENT(IN) :: nnodes, index(nnodes), edges(*)
50    INTEGER, INTENT(OUT) :: newrank
51    INTEGER, OPTIONAL, INTENT(OUT) :: ierror

```



```

MPI_Graph_neighbors(comm, rank, maxneighbors, neighbors, ierror)      1
  TYPE(MPI_Comm), INTENT(IN) :: comm                                2
  INTEGER, INTENT(IN) :: rank, maxneighbors                        3
  INTEGER, INTENT(OUT) :: neighbors(maxneighbors)                 4
  INTEGER, OPTIONAL, INTENT(OUT) :: ierror                         5
                                                                    6
MPI_Graph_neighbors_count(comm, rank, nneighbors, ierror)           7
  TYPE(MPI_Comm), INTENT(IN) :: comm                                8
  INTEGER, INTENT(IN) :: rank                                       9
  INTEGER, INTENT(OUT) :: nneighbors                               10
  INTEGER, OPTIONAL, INTENT(OUT) :: ierror                         11
                                                                    12
MPI_Ineighbor_allgather(sendbuf, sendcount, sendtype, recvbuf, recvcount,
  recvtype, comm, request, ierror)                                  13
  TYPE(*), DIMENSION(..), INTENT(IN), ASYNCHRONOUS :: sendbuf    14
  TYPE(*), DIMENSION(..), ASYNCHRONOUS :: recvbuf                 15
  INTEGER, INTENT(IN) :: sendcount, recvcount                     16
  TYPE(MPI_Datatype), INTENT(IN) :: sendtype, recvtype            17
  TYPE(MPI_Comm), INTENT(IN) :: comm                               18
  TYPE(MPI_Request), INTENT(OUT) :: request                       19
  INTEGER, OPTIONAL, INTENT(OUT) :: ierror                         20
                                                                    21
MPI_Ineighbor_allgatherv(sendbuf, sendcount, sendtype, recvbuf, recvcounts,
  displs, recvtype, comm, request, ierror)                          22
  TYPE(*), DIMENSION(..), INTENT(IN), ASYNCHRONOUS :: sendbuf    23
  TYPE(*), DIMENSION(..), ASYNCHRONOUS :: recvbuf                 24
  INTEGER, INTENT(IN) :: sendcount                                  25
  INTEGER, INTENT(IN), ASYNCHRONOUS :: recvcounts(*), displs(*)  26
  TYPE(MPI_Datatype), INTENT(IN) :: sendtype, recvtype            27
  TYPE(MPI_Comm), INTENT(IN) :: comm                               28
  TYPE(MPI_Request), INTENT(OUT) :: request                       29
  INTEGER, OPTIONAL, INTENT(OUT) :: ierror                         30
                                                                    31
MPI_Ineighbor_alltoall(sendbuf, sendcount, sendtype, recvbuf, recvcount,
  recvtype, comm, request, ierror)                                  32
  TYPE(*), DIMENSION(..), INTENT(IN), ASYNCHRONOUS :: sendbuf    33
  TYPE(*), DIMENSION(..), ASYNCHRONOUS :: recvbuf                 34
  INTEGER, INTENT(IN) :: sendcount, recvcount                     35
  TYPE(MPI_Datatype), INTENT(IN) :: sendtype, recvtype            36
  TYPE(MPI_Comm), INTENT(IN) :: comm                               37
  TYPE(MPI_Request), INTENT(OUT) :: request                       38
  INTEGER, OPTIONAL, INTENT(OUT) :: ierror                         39
                                                                    40
MPI_Ineighbor_alltoallv(sendbuf, sendcounts, sdispls, sendtype, recvbuf,
  recvcounts, rdispls, recvtype, comm, request, ierror)            41
  TYPE(*), DIMENSION(..), INTENT(IN), ASYNCHRONOUS :: sendbuf    42
  TYPE(*), DIMENSION(..), ASYNCHRONOUS :: recvbuf                 43
  INTEGER, INTENT(IN), ASYNCHRONOUS :: sendcounts(*), sdispls(*),  44
  recvcounts(*), rdispls(*)                                       45
  TYPE(MPI_Datatype), INTENT(IN) :: sendtype, recvtype            46
                                                                    47
MPI_Ineighbor_alltoallv(sendbuf, sendcounts, sdispls, sendtype, recvbuf,
  recvcounts, rdispls, recvtype, comm, request, ierror)            48
  TYPE(*), DIMENSION(..), INTENT(IN), ASYNCHRONOUS :: sendbuf    49
  TYPE(*), DIMENSION(..), ASYNCHRONOUS :: recvbuf                 50
  INTEGER, INTENT(IN), ASYNCHRONOUS :: sendcounts(*), sdispls(*),  51
  recvcounts(*), rdispls(*)                                       52
  TYPE(MPI_Datatype), INTENT(IN) :: sendtype, recvtype            53

```

```

1     TYPE(MPI_Comm), INTENT(IN) :: comm
2     TYPE(MPI_Request), INTENT(OUT) :: request
3     INTEGER, OPTIONAL, INTENT(OUT) :: ierror
4
5 MPI_Ineighbor_alltoallw(sendbuf, sendcounts, sdispls, sendtypes, recvbuf,
6     recvcounts, rdispls, recvtypes, comm, request, ierror)
7     TYPE(*), DIMENSION(..), INTENT(IN), ASYNCHRONOUS :: sendbuf
8     TYPE(*), DIMENSION(..), ASYNCHRONOUS :: recvbuf
9     INTEGER, INTENT(IN), ASYNCHRONOUS :: sendcounts(*), recvcounts(*)
10    INTEGER(KIND=MPI_ADDRESS_KIND), INTENT(IN), ASYNCHRONOUS ::
11        sdispls(*), rdispls(*)
12    TYPE(MPI_Datatype), INTENT(IN), ASYNCHRONOUS :: sendtypes(*),
13        recvtypes(*)
14    TYPE(MPI_Comm), INTENT(IN) :: comm
15    TYPE(MPI_Request), INTENT(OUT) :: request
16    INTEGER, OPTIONAL, INTENT(OUT) :: ierror
17
18 MPI_Neighbor_allgather_init(sendbuf, sendcount, sendtype, recvbuf,
19     recvcount, recvtype, comm, info, request, ierror)
20    TYPE(*), DIMENSION(..), INTENT(IN), ASYNCHRONOUS :: sendbuf
21    TYPE(*), DIMENSION(..), ASYNCHRONOUS :: recvbuf
22    INTEGER, INTENT(IN) :: sendcount, recvcount
23    TYPE(MPI_Datatype), INTENT(IN) :: sendtype, recvtype
24    TYPE(MPI_Comm), INTENT(IN) :: comm
25    TYPE(MPI_Info), INTENT(IN) :: info
26    TYPE(MPI_Request), INTENT(OUT) :: request
27    INTEGER, OPTIONAL, INTENT(OUT) :: ierror
28
29 MPI_Neighbor_allgather(sendbuf, sendcount, sendtype, recvbuf, recvcount,
30     recvtype, comm, ierror)
31    TYPE(*), DIMENSION(..), INTENT(IN) :: sendbuf
32    TYPE(*), DIMENSION(..) :: recvbuf
33    INTEGER, INTENT(IN) :: sendcount, recvcount
34    TYPE(MPI_Datatype), INTENT(IN) :: sendtype, recvtype
35    TYPE(MPI_Comm), INTENT(IN) :: comm
36    INTEGER, OPTIONAL, INTENT(OUT) :: ierror
37
38 MPI_Neighbor_allgatherv_init(sendbuf, sendcount, sendtype, recvbuf,
39     recvcounts, displs, recvtype, comm, info, request, ierror)
40    TYPE(*), DIMENSION(..), INTENT(IN), ASYNCHRONOUS :: sendbuf
41    TYPE(*), DIMENSION(..), ASYNCHRONOUS :: recvbuf
42    INTEGER, INTENT(IN) :: sendcount
43    INTEGER, INTENT(IN), ASYNCHRONOUS :: recvcounts(*), displs(*)
44    TYPE(MPI_Datatype), INTENT(IN) :: sendtype, recvtype
45    TYPE(MPI_Comm), INTENT(IN) :: comm
46    TYPE(MPI_Info), INTENT(IN) :: info
47    TYPE(MPI_Request), INTENT(OUT) :: request
48    INTEGER, OPTIONAL, INTENT(OUT) :: ierror
49
50 MPI_Neighbor_allgatherv(sendbuf, sendcount, sendtype, recvbuf, recvcounts,

```

```

        displs, recvtype, comm, ierror)
1
TYPE(*), DIMENSION(..), INTENT(IN) :: sendbuf
2
TYPE(*), DIMENSION(..) :: recvbuf
3
INTEGER, INTENT(IN) :: sendcount, recvcounts(*), displs(*)
4
TYPE(MPI_Datatype), INTENT(IN) :: sendtype, recvtype
5
TYPE(MPI_Comm), INTENT(IN) :: comm
6
INTEGER, OPTIONAL, INTENT(OUT) :: ierror
7
8
MPI_Neighbor_alltoall_init(sendbuf, sendcount, sendtype, recvbuf,
9
        recvcount, recvtype, comm, info, request, ierror)
10
TYPE(*), DIMENSION(..), INTENT(IN), ASYNCHRONOUS :: sendbuf
11
TYPE(*), DIMENSION(..), ASYNCHRONOUS :: recvbuf
12
INTEGER, INTENT(IN) :: sendcount, recvcount
13
TYPE(MPI_Datatype), INTENT(IN) :: sendtype, recvtype
14
TYPE(MPI_Comm), INTENT(IN) :: comm
15
TYPE(MPI_Info), INTENT(IN) :: info
16
TYPE(MPI_Request), INTENT(OUT) :: request
17
INTEGER, OPTIONAL, INTENT(OUT) :: ierror
18
19
MPI_Neighbor_alltoall(sendbuf, sendcount, sendtype, recvbuf, recvcount,
20
        recvtype, comm, ierror)
21
TYPE(*), DIMENSION(..), INTENT(IN) :: sendbuf
22
TYPE(*), DIMENSION(..) :: recvbuf
23
INTEGER, INTENT(IN) :: sendcount, recvcount
24
TYPE(MPI_Datatype), INTENT(IN) :: sendtype, recvtype
25
TYPE(MPI_Comm), INTENT(IN) :: comm
26
INTEGER, OPTIONAL, INTENT(OUT) :: ierror
27
28
MPI_Neighbor_alltoallv_init(sendbuf, sendcounts, sdispls, sendtype,
29
        recvbuf, recvcounts, rdispls, recvtype, comm, info, request,
30
        ierror)
31
TYPE(*), DIMENSION(..), INTENT(IN), ASYNCHRONOUS :: sendbuf
32
TYPE(*), DIMENSION(..), ASYNCHRONOUS :: recvbuf
33
INTEGER, INTENT(IN), ASYNCHRONOUS :: sendcounts(*), sdispls(*),
34
        recvcounts(*), rdispls(*)
35
TYPE(MPI_Datatype), INTENT(IN) :: sendtype, recvtype
36
TYPE(MPI_Comm), INTENT(IN) :: comm
37
TYPE(MPI_Info), INTENT(IN) :: info
38
TYPE(MPI_Request), INTENT(OUT) :: request
39
INTEGER, OPTIONAL, INTENT(OUT) :: ierror
40
41
MPI_Neighbor_alltoallv(sendbuf, sendcounts, sdispls, sendtype, recvbuf,
42
        recvcounts, rdispls, recvtype, comm, ierror)
43
TYPE(*), DIMENSION(..), INTENT(IN) :: sendbuf
44
TYPE(*), DIMENSION(..) :: recvbuf
45
INTEGER, INTENT(IN) :: sendcounts(*), sdispls(*), recvcounts(*),
46
        rdispls(*)
47
TYPE(MPI_Datatype), INTENT(IN) :: sendtype, recvtype
48
TYPE(MPI_Comm), INTENT(IN) :: comm

```

```

1     INTEGER, OPTIONAL, INTENT(OUT) :: ierror
2
3     MPI_Neighbor_alltoallw_init(sendbuf, sendcounts, sdispls, sendtypes,
4         recvbuf, recvcounts, rdispls, recvtypes, comm, info, request,
5         ierror)
6     TYPE(*), DIMENSION(..), INTENT(IN), ASYNCHRONOUS :: sendbuf
7     TYPE(*), DIMENSION(..), ASYNCHRONOUS :: recvbuf
8     INTEGER, INTENT(IN), ASYNCHRONOUS :: sendcounts(*), recvcounts(*)
9     INTEGER(KIND=MPI_ADDRESS_KIND), INTENT(IN), ASYNCHRONOUS ::
10        sdispls(*), rdispls(*)
11    TYPE(MPI_Datatype), INTENT(IN), ASYNCHRONOUS :: sendtypes(*),
12        recvtypes(*)
13    TYPE(MPI_Comm), INTENT(IN) :: comm
14    TYPE(MPI_Info), INTENT(IN) :: info
15    TYPE(MPI_Request), INTENT(OUT) :: request
16    INTEGER, OPTIONAL, INTENT(OUT) :: ierror
17
18    MPI_Neighbor_alltoallw(sendbuf, sendcounts, sdispls, sendtypes, recvbuf,
19        recvcounts, rdispls, recvtypes, comm, ierror)
20    TYPE(*), DIMENSION(..), INTENT(IN) :: sendbuf
21    TYPE(*), DIMENSION(..) :: recvbuf
22    INTEGER, INTENT(IN) :: sendcounts(*), recvcounts(*)
23    INTEGER(KIND=MPI_ADDRESS_KIND), INTENT(IN) :: sdispls(*), rdispls(*)
24    TYPE(MPI_Datatype), INTENT(IN) :: sendtypes(*), recvtypes(*)
25    TYPE(MPI_Comm), INTENT(IN) :: comm
26    INTEGER, OPTIONAL, INTENT(OUT) :: ierror
27
28    MPI_Topo_test(comm, status, ierror)
29    TYPE(MPI_Comm), INTENT(IN) :: comm
30    INTEGER, INTENT(OUT) :: status
31    INTEGER, OPTIONAL, INTENT(OUT) :: ierror
32
33    A.3.6 MPI Environmental Management Fortran 2008 Bindings
34
35    DOUBLE PRECISION MPI_Wtick()
36
37    DOUBLE PRECISION MPI_Wtime()
38
39    MPI_Abort(comm, errorcode, ierror)
40    TYPE(MPI_Comm), INTENT(IN) :: comm
41    INTEGER, INTENT(IN) :: errorcode
42    INTEGER, OPTIONAL, INTENT(OUT) :: ierror
43
44    MPI_Add_error_class(errorclass, ierror)
45    INTEGER, INTENT(OUT) :: errorclass
46    INTEGER, OPTIONAL, INTENT(OUT) :: ierror
47
48    MPI_Add_error_code(errorclass, errorcode, ierror)
49    INTEGER, INTENT(IN) :: errorclass
50    INTEGER, INTENT(OUT) :: errorcode
51    INTEGER, OPTIONAL, INTENT(OUT) :: ierror

```

```

MPI_Add_error_string(errorcode, string, ierror)           1
    INTEGER, INTENT(IN) :: errorcode                     2
    CHARACTER(LEN=*), INTENT(IN) :: string               3
    INTEGER, OPTIONAL, INTENT(OUT) :: ierror            4
                                                    5
MPI_Alloc_mem(size, info, baseptr, ierror)              6
    USE, INTRINSIC :: ISO_C_BINDING, ONLY : C_PTR       7
    INTEGER(KIND=MPI_ADDRESS_KIND), INTENT(IN) :: size  8
    TYPE(MPI_Info), INTENT(IN) :: info                  9
    TYPE(C_PTR), INTENT(OUT) :: baseptr                 10
    INTEGER, OPTIONAL, INTENT(OUT) :: ierror           11
                                                    12
MPI_Comm_call_errhandler(comm, errorcode, ierror)      13
    TYPE(MPI_Comm), INTENT(IN) :: comm                  14
    INTEGER, INTENT(IN) :: errorcode                   15
    INTEGER, OPTIONAL, INTENT(OUT) :: ierror           16
                                                    17
MPI_Comm_create_errhandler(comm_errhandler_fn, errhandler, ierror) 18
    PROCEDURE(MPI_Comm_errhandler_function) :: comm_errhandler_fn 19
    TYPE(MPI_Errhandler), INTENT(OUT) :: errhandler    20
    INTEGER, OPTIONAL, INTENT(OUT) :: ierror           21
                                                    22
MPI_Comm_get_errhandler(comm, errhandler, ierror)      23
    TYPE(MPI_Comm), INTENT(IN) :: comm                  24
    TYPE(MPI_Errhandler), INTENT(OUT) :: errhandler    25
    INTEGER, OPTIONAL, INTENT(OUT) :: ierror           26
                                                    27
MPI_Comm_set_errhandler(comm, errhandler, ierror)      28
    TYPE(MPI_Comm), INTENT(IN) :: comm                  29
    TYPE(MPI_Errhandler), INTENT(IN) :: errhandler     30
    INTEGER, OPTIONAL, INTENT(OUT) :: ierror           31
                                                    32
MPI_Errhandler_free(errhandler, ierror)                33
    TYPE(MPI_Errhandler), INTENT(INOUT) :: errhandler  34
    INTEGER, OPTIONAL, INTENT(OUT) :: ierror           35
                                                    36
MPI_Error_class(errorcode, errorclass, ierror)         37
    INTEGER, INTENT(IN) :: errorcode                   38
    INTEGER, INTENT(OUT) :: errorclass                 39
    INTEGER, OPTIONAL, INTENT(OUT) :: ierror           40
                                                    41
MPI_Error_string(errorcode, string, resultlen, ierror) 42
    INTEGER, INTENT(IN) :: errorcode                   43
    CHARACTER(LEN=MPI_MAX_ERROR_STRING), INTENT(OUT) :: string 44
    INTEGER, INTENT(OUT) :: resultlen                  45
    INTEGER, OPTIONAL, INTENT(OUT) :: ierror           46
                                                    47
MPI_File_call_errhandler(fh, errorcode, ierror)        48
    TYPE(MPI_File), INTENT(IN) :: fh                   49
    INTEGER, INTENT(IN) :: errorcode                   50
    INTEGER, OPTIONAL, INTENT(OUT) :: ierror           51

```

```
1 MPI_File_create_errhandler(file_errhandler_fn, errhandler, ierror)
2   PROCEDURE(MPI_File_errhandler_function) :: file_errhandler_fn
3   TYPE(MPI_Errhandler), INTENT(OUT) :: errhandler
4   INTEGER, OPTIONAL, INTENT(OUT) :: ierror
5
6 MPI_File_get_errhandler(file, errhandler, ierror)
7   TYPE(MPI_File), INTENT(IN) :: file
8   TYPE(MPI_Errhandler), INTENT(OUT) :: errhandler
9   INTEGER, OPTIONAL, INTENT(OUT) :: ierror
10
11 MPI_File_set_errhandler(file, errhandler, ierror)
12   TYPE(MPI_File), INTENT(IN) :: file
13   TYPE(MPI_Errhandler), INTENT(IN) :: errhandler
14   INTEGER, OPTIONAL, INTENT(OUT) :: ierror
15
16 MPI_Finalized(flag, ierror)
17   LOGICAL, INTENT(OUT) :: flag
18   INTEGER, OPTIONAL, INTENT(OUT) :: ierror
19
20 MPI_Finalize(ierror)
21   INTEGER, OPTIONAL, INTENT(OUT) :: ierror
22
23 MPI_Free_mem(base, ierror)
24   TYPE(*), DIMENSION(..), INTENT(IN), ASYNCHRONOUS :: base
25   INTEGER, OPTIONAL, INTENT(OUT) :: ierror
26
27 MPI_Get_library_version(version, resultlen, ierror)
28   CHARACTER(LEN=MPI_MAX_LIBRARY_VERSION_STRING), INTENT(OUT) :: version
29   INTEGER, INTENT(OUT) :: resultlen
30   INTEGER, OPTIONAL, INTENT(OUT) :: ierror
31
32 MPI_Get_processor_name(name, resultlen, ierror)
33   CHARACTER(LEN=MPI_MAX_PROCESSOR_NAME), INTENT(OUT) :: name
34   INTEGER, INTENT(OUT) :: resultlen
35   INTEGER, OPTIONAL, INTENT(OUT) :: ierror
36
37 MPI_Get_version(version, subversion, ierror)
38   INTEGER, INTENT(OUT) :: version, subversion
39   INTEGER, OPTIONAL, INTENT(OUT) :: ierror
40
41 MPI_Initialized(flag, ierror)
42   LOGICAL, INTENT(OUT) :: flag
43   INTEGER, OPTIONAL, INTENT(OUT) :: ierror
44
45 MPI_Init(ierror)
46   INTEGER, OPTIONAL, INTENT(OUT) :: ierror
47
48 MPI_Win_call_errhandler(win, errorcode, ierror)
49   TYPE(MPI_Win), INTENT(IN) :: win
50   INTEGER, INTENT(IN) :: errorcode
51   INTEGER, OPTIONAL, INTENT(OUT) :: ierror
52
53 MPI_Win_create_errhandler(win_errhandler_fn, errhandler, ierror)
```

```

PROCEDURE(MPI_Win_errhandler_function) :: win_errhandler_fn      1
TYPE(MPI_Errhandler), INTENT(OUT) :: errhandler                 2
INTEGER, OPTIONAL, INTENT(OUT) :: ierror                       3
                                                                4
MPI_Win_get_errhandler(win, errhandler, ierror)                 5
TYPE(MPI_Win), INTENT(IN) :: win                               6
TYPE(MPI_Errhandler), INTENT(OUT) :: errhandler                7
INTEGER, OPTIONAL, INTENT(OUT) :: ierror                       8
                                                                9
MPI_Win_set_errhandler(win, errhandler, ierror)                 10
TYPE(MPI_Win), INTENT(IN) :: win                               11
TYPE(MPI_Errhandler), INTENT(IN) :: errhandler                 12
INTEGER, OPTIONAL, INTENT(OUT) :: ierror                       13
                                                                14
A.3.7 The Info Object Fortran 2008 Bindings                    15
MPI_Info_create(info, ierror)                                    16
TYPE(MPI_Info), INTENT(OUT) :: info                             17
INTEGER, OPTIONAL, INTENT(OUT) :: ierror                       18
                                                                19
MPI_Info_delete(info, key, ierror)                               20
TYPE(MPI_Info), INTENT(IN) :: info                             21
CHARACTER(LEN=*), INTENT(IN) :: key                            22
INTEGER, OPTIONAL, INTENT(OUT) :: ierror                       23
                                                                24
MPI_Info_dup(info, newinfo, ierror)                             25
TYPE(MPI_Info), INTENT(IN) :: info                             26
TYPE(MPI_Info), INTENT(OUT) :: newinfo                         27
INTEGER, OPTIONAL, INTENT(OUT) :: ierror                       28
                                                                29
MPI_Info_free(info, ierror)                                      30
TYPE(MPI_Info), INTENT(INOUT) :: info                           31
INTEGER, OPTIONAL, INTENT(OUT) :: ierror                       32
                                                                33
MPI_Info_get(info, key, valuelen, value, flag, ierror)         34
TYPE(MPI_Info), INTENT(IN) :: info                             35
CHARACTER(LEN=*), INTENT(IN) :: key                            36
INTEGER, INTENT(IN) :: valuelen                               37
CHARACTER(LEN=valuelen), INTENT(OUT) :: value                 38
LOGICAL, INTENT(OUT) :: flag                                   39
INTEGER, OPTIONAL, INTENT(OUT) :: ierror                       40
                                                                41
MPI_Info_get_nkeys(info, nkeys, ierror)                         42
TYPE(MPI_Info), INTENT(IN) :: info                             43
INTEGER, INTENT(OUT) :: nkeys                                  44
INTEGER, OPTIONAL, INTENT(OUT) :: ierror                       45
                                                                46
MPI_Info_get_nthkey(info, n, key, ierror)                       47
TYPE(MPI_Info), INTENT(IN) :: info                             48
INTEGER, INTENT(IN) :: n                                       49
CHARACTER(LEN=*), INTENT(OUT) :: key                           50

```

```

1     INTEGER, OPTIONAL, INTENT(OUT) :: ierror
2
3     MPI_Info_get_valuelen(info, key, valuelen, flag, ierror)
4     TYPE(MPI_Info), INTENT(IN) :: info
5     CHARACTER(LEN=*), INTENT(IN) :: key
6     INTEGER, INTENT(OUT) :: valuelen
7     LOGICAL, INTENT(OUT) :: flag
8     INTEGER, OPTIONAL, INTENT(OUT) :: ierror
9
10    MPI_Info_set(info, key, value, ierror)
11    TYPE(MPI_Info), INTENT(IN) :: info
12    CHARACTER(LEN=*), INTENT(IN) :: key, value
13    INTEGER, OPTIONAL, INTENT(OUT) :: ierror
14
15    A.3.8 Process Creation and Management Fortran 2008 Bindings
16
17    MPI_Close_port(port_name, ierror)
18    CHARACTER(LEN=*), INTENT(IN) :: port_name
19    INTEGER, OPTIONAL, INTENT(OUT) :: ierror
20
21    MPI_Comm_accept(port_name, info, root, comm, newcomm, ierror)
22    CHARACTER(LEN=*), INTENT(IN) :: port_name
23    TYPE(MPI_Info), INTENT(IN) :: info
24    INTEGER, INTENT(IN) :: root
25    TYPE(MPI_Comm), INTENT(IN) :: comm
26    TYPE(MPI_Comm), INTENT(OUT) :: newcomm
27    INTEGER, OPTIONAL, INTENT(OUT) :: ierror
28
29    MPI_Comm_connect(port_name, info, root, comm, newcomm, ierror)
30    CHARACTER(LEN=*), INTENT(IN) :: port_name
31    TYPE(MPI_Info), INTENT(IN) :: info
32    INTEGER, INTENT(IN) :: root
33    TYPE(MPI_Comm), INTENT(IN) :: comm
34    TYPE(MPI_Comm), INTENT(OUT) :: newcomm
35    INTEGER, OPTIONAL, INTENT(OUT) :: ierror
36
37    MPI_Comm_disconnect(comm, ierror)
38    TYPE(MPI_Comm), INTENT(INOUT) :: comm
39    INTEGER, OPTIONAL, INTENT(OUT) :: ierror
40
41    MPI_Comm_get_parent(parent, ierror)
42    TYPE(MPI_Comm), INTENT(OUT) :: parent
43    INTEGER, OPTIONAL, INTENT(OUT) :: ierror
44
45    MPI_Comm_join(fd, intercomm, ierror)
46    INTEGER, INTENT(IN) :: fd
47    TYPE(MPI_Comm), INTENT(OUT) :: intercomm
48    INTEGER, OPTIONAL, INTENT(OUT) :: ierror
49
50    MPI_Comm_spawn(command, argv, maxprocs, info, root, comm, intercomm,
51    array_of_errcodes, ierror)

```



```

CHARACTER(LEN=*), INTENT(IN) :: command, argv(*)           1
INTEGER, INTENT(IN) :: maxprocs, root                     2
TYPE(MPI_Info), INTENT(IN) :: info                        3
TYPE(MPI_Comm), INTENT(IN) :: comm                       4
TYPE(MPI_Comm), INTENT(OUT) :: intercomm                 5
INTEGER :: array_of_errcodes(*)                          6
INTEGER, OPTIONAL, INTENT(OUT) :: ierror                 7
                                                           8
MPI_Comm_spawn_multiple(count, array_of_commands, array_of_argv,
                        array_of_maxprocs, array_of_info, root, comm, intercomm,
                        array_of_errcodes, ierror)        9
INTEGER, INTENT(IN) :: count, array_of_maxprocs(*), root 10
CHARACTER(LEN=*), INTENT(IN) :: array_of_commands(*)     11
CHARACTER(LEN=*), INTENT(IN) :: array_of_argv(count, *) 12
TYPE(MPI_Info), INTENT(IN) :: array_of_info(*)           13
TYPE(MPI_Comm), INTENT(IN) :: comm                       14
TYPE(MPI_Comm), INTENT(OUT) :: intercomm                 15
INTEGER :: array_of_errcodes(*)                          16
INTEGER, OPTIONAL, INTENT(OUT) :: ierror                 17
                                                           18
MPI_Lookup_name(service_name, info, port_name, ierror)   19
CHARACTER(LEN=*), INTENT(IN) :: service_name             20
TYPE(MPI_Info), INTENT(IN) :: info                       21
CHARACTER(LEN=MPI_MAX_PORT_NAME), INTENT(OUT) :: port_name 22
INTEGER, OPTIONAL, INTENT(OUT) :: ierror                 23
                                                           24
MPI_Open_port(info, port_name, ierror)                   25
TYPE(MPI_Info), INTENT(IN) :: info                       26
CHARACTER(LEN=MPI_MAX_PORT_NAME), INTENT(OUT) :: port_name 27
INTEGER, OPTIONAL, INTENT(OUT) :: ierror                 28
                                                           29
MPI_Publish_name(service_name, info, port_name, ierror) 30
TYPE(MPI_Info), INTENT(IN) :: info                       31
CHARACTER(LEN=*), INTENT(IN) :: service_name, port_name 32
INTEGER, OPTIONAL, INTENT(OUT) :: ierror                 33
                                                           34
MPI_Unpublish_name(service_name, info, port_name, ierror) 35
CHARACTER(LEN=*), INTENT(IN) :: service_name, port_name 36
TYPE(MPI_Info), INTENT(IN) :: info                       37
INTEGER, OPTIONAL, INTENT(OUT) :: ierror                 38
                                                           39
A.3.9 One-Sided Communications Fortran 2008 Bindings    40
MPI_Accumulate(origin_addr, origin_count, origin_datatype, target_rank,
               target_disp, target_count, target_datatype, op, win, ierror) 41
TYPE(*), DIMENSION(..), INTENT(IN), ASYNCHRONOUS :: origin_addr 42
INTEGER, INTENT(IN) :: origin_count, target_rank, target_count 43
TYPE(MPI_Datatype), INTENT(IN) :: origin_datatype, target_datatype 44
INTEGER(KIND=MPI_ADDRESS_KIND), INTENT(IN) :: target_disp 45
TYPE(MPI_Op), INTENT(IN) :: op                           46

```

```

1     TYPE(MPI_Win), INTENT(IN) :: win
2     INTEGER, OPTIONAL, INTENT(OUT) :: ierror
3
4     MPI_Compare_and_swap(origin_addr, compare_addr, result_addr, datatype,
5         target_rank, target_disp, win, ierror)
6     TYPE(*), DIMENSION(..), INTENT(IN), ASYNCHRONOUS :: origin_addr
7     TYPE(*), DIMENSION(..), INTENT(IN), ASYNCHRONOUS :: compare_addr
8     TYPE(*), DIMENSION(..), ASYNCHRONOUS :: result_addr
9     TYPE(MPI_Datatype), INTENT(IN) :: datatype
10    INTEGER, INTENT(IN) :: target_rank
11    INTEGER(KIND=MPI_ADDRESS_KIND), INTENT(IN) :: target_disp
12    TYPE(MPI_Win), INTENT(IN) :: win
13    INTEGER, OPTIONAL, INTENT(OUT) :: ierror
14
15    MPI_Fetch_and_op(origin_addr, result_addr, datatype, target_rank,
16        target_disp, op, win, ierror)
17    TYPE(*), DIMENSION(..), INTENT(IN), ASYNCHRONOUS :: origin_addr
18    TYPE(*), DIMENSION(..), ASYNCHRONOUS :: result_addr
19    TYPE(MPI_Datatype), INTENT(IN) :: datatype
20    INTEGER, INTENT(IN) :: target_rank
21    INTEGER(KIND=MPI_ADDRESS_KIND), INTENT(IN) :: target_disp
22    TYPE(MPI_Op), INTENT(IN) :: op
23    TYPE(MPI_Win), INTENT(IN) :: win
24    INTEGER, OPTIONAL, INTENT(OUT) :: ierror
25
26    MPI_Get_accumulate(origin_addr, origin_count, origin_datatype, result_addr,
27        result_count, result_datatype, target_rank, target_disp,
28        target_count, target_datatype, op, win, ierror)
29    TYPE(*), DIMENSION(..), INTENT(IN), ASYNCHRONOUS :: origin_addr
30    TYPE(*), DIMENSION(..), ASYNCHRONOUS :: result_addr
31    INTEGER, INTENT(IN) :: origin_count, result_count, target_rank,
32        target_count
33    TYPE(MPI_Datatype), INTENT(IN) :: origin_datatype, target_datatype,
34        result_datatype
35    INTEGER(KIND=MPI_ADDRESS_KIND), INTENT(IN) :: target_disp
36    TYPE(MPI_Op), INTENT(IN) :: op
37    TYPE(MPI_Win), INTENT(IN) :: win
38    INTEGER, OPTIONAL, INTENT(OUT) :: ierror
39
40    MPI_Get(origin_addr, origin_count, origin_datatype, target_rank,
41        target_disp, target_count, target_datatype, win, ierror)
42    TYPE(*), DIMENSION(..), ASYNCHRONOUS :: origin_addr
43    INTEGER, INTENT(IN) :: origin_count, target_rank, target_count
44    TYPE(MPI_Datatype), INTENT(IN) :: origin_datatype, target_datatype
45    INTEGER(KIND=MPI_ADDRESS_KIND), INTENT(IN) :: target_disp
46    TYPE(MPI_Win), INTENT(IN) :: win
47    INTEGER, OPTIONAL, INTENT(OUT) :: ierror
48
49    MPI_Put(origin_addr, origin_count, origin_datatype, target_rank,
50        target_disp, target_count, target_datatype, win, ierror)

```

```

TYPE(*), DIMENSION(..), INTENT(IN), ASYNCHRONOUS :: origin_addr      1
INTEGER, INTENT(IN) :: origin_count, target_rank, target_count      2
TYPE(MPI_Datatype), INTENT(IN) :: origin_datatype, target_datatype  3
INTEGER(KIND=MPI_ADDRESS_KIND), INTENT(IN) :: target_disp          4
TYPE(MPI_Win), INTENT(IN) :: win                                    5
INTEGER, OPTIONAL, INTENT(OUT) :: ierror                            6
                                                                    7
MPI_Raccumulate(origin_addr, origin_count, origin_datatype, target_rank,  8
                target_disp, target_count, target_datatype, op, win, request,  9
                ierror)                                           10
TYPE(*), DIMENSION(..), INTENT(IN), ASYNCHRONOUS :: origin_addr      11
INTEGER, INTENT(IN) :: origin_count, target_rank, target_count      12
TYPE(MPI_Datatype), INTENT(IN) :: origin_datatype, target_datatype  13
INTEGER(KIND=MPI_ADDRESS_KIND), INTENT(IN) :: target_disp          14
TYPE(MPI_Op), INTENT(IN) :: op                                       15
TYPE(MPI_Win), INTENT(IN) :: win                                       16
TYPE(MPI_Request), INTENT(OUT) :: request                             17
INTEGER, OPTIONAL, INTENT(OUT) :: ierror                            18
                                                                    19
MPI_Rget_accumulate(origin_addr, origin_count, origin_datatype,      20
                   result_addr, result_count, result_datatype, target_rank,  21
                   target_disp, target_count, target_datatype, op, win, request,  22
                   ierror)                                           23
TYPE(*), DIMENSION(..), INTENT(IN), ASYNCHRONOUS :: origin_addr      24
TYPE(*), DIMENSION(..), ASYNCHRONOUS :: result_addr                 25
INTEGER, INTENT(IN) :: origin_count, result_count, target_rank,      26
                   target_count                                       27
TYPE(MPI_Datatype), INTENT(IN) :: origin_datatype, target_datatype,  28
                   result_datatype                                   29
INTEGER(KIND=MPI_ADDRESS_KIND), INTENT(IN) :: target_disp          30
TYPE(MPI_Op), INTENT(IN) :: op                                       31
TYPE(MPI_Win), INTENT(IN) :: win                                       32
TYPE(MPI_Request), INTENT(OUT) :: request                             33
INTEGER, OPTIONAL, INTENT(OUT) :: ierror                            34
                                                                    35
MPI_Rget(origin_addr, origin_count, origin_datatype, target_rank,    36
          target_disp, target_count, target_datatype, win, request,  37
          ierror)                                                    38
TYPE(*), DIMENSION(..), ASYNCHRONOUS :: origin_addr                 39
INTEGER, INTENT(IN) :: origin_count, target_rank, target_count      40
TYPE(MPI_Datatype), INTENT(IN) :: origin_datatype, target_datatype  41
INTEGER(KIND=MPI_ADDRESS_KIND), INTENT(IN) :: target_disp          42
TYPE(MPI_Win), INTENT(IN) :: win                                       43
TYPE(MPI_Request), INTENT(OUT) :: request                             44
INTEGER, OPTIONAL, INTENT(OUT) :: ierror                            45
                                                                    46
MPI_Rput(origin_addr, origin_count, origin_datatype, target_rank,    47
          target_disp, target_count, target_datatype, win, request,  48
          ierror)

```

```

1     TYPE(*), DIMENSION(..), INTENT(IN), ASYNCHRONOUS :: origin_addr
2     INTEGER, INTENT(IN) :: origin_count, target_rank, target_count
3     TYPE(MPI_Datatype), INTENT(IN) :: origin_datatype, target_datatype
4     INTEGER(KIND=MPI_ADDRESS_KIND), INTENT(IN) :: target_disp
5     TYPE(MPI_Win), INTENT(IN) :: win
6     TYPE(MPI_Request), INTENT(OUT) :: request
7     INTEGER, OPTIONAL, INTENT(OUT) :: ierror
8
9     MPI_Win_allocate_shared(size, disp_unit, info, comm, baseptr, win, ierror)
10    USE, INTRINSIC :: ISO_C_BINDING, ONLY : C_PTR
11    INTEGER(KIND=MPI_ADDRESS_KIND), INTENT(IN) :: size
12    INTEGER, INTENT(IN) :: disp_unit
13    TYPE(MPI_Info), INTENT(IN) :: info
14    TYPE(MPI_Comm), INTENT(IN) :: comm
15    TYPE(C_PTR), INTENT(OUT) :: baseptr
16    TYPE(MPI_Win), INTENT(OUT) :: win
17    INTEGER, OPTIONAL, INTENT(OUT) :: ierror
18
19    MPI_Win_allocate(size, disp_unit, info, comm, baseptr, win, ierror)
20    USE, INTRINSIC :: ISO_C_BINDING, ONLY : C_PTR
21    INTEGER(KIND=MPI_ADDRESS_KIND), INTENT(IN) :: size
22    INTEGER, INTENT(IN) :: disp_unit
23    TYPE(MPI_Info), INTENT(IN) :: info
24    TYPE(MPI_Comm), INTENT(IN) :: comm
25    TYPE(C_PTR), INTENT(OUT) :: baseptr
26    TYPE(MPI_Win), INTENT(OUT) :: win
27    INTEGER, OPTIONAL, INTENT(OUT) :: ierror
28
29    MPI_Win_attach(win, base, size, ierror)
30    TYPE(MPI_Win), INTENT(IN) :: win
31    TYPE(*), DIMENSION(..), ASYNCHRONOUS :: base
32    INTEGER(KIND=MPI_ADDRESS_KIND), INTENT(IN) :: size
33    INTEGER, OPTIONAL, INTENT(OUT) :: ierror
34
35    MPI_Win_complete(win, ierror)
36    TYPE(MPI_Win), INTENT(IN) :: win
37    INTEGER, OPTIONAL, INTENT(OUT) :: ierror
38
39    MPI_Win_create(base, size, disp_unit, info, comm, win, ierror)
40    TYPE(*), DIMENSION(..), ASYNCHRONOUS :: base
41    INTEGER(KIND=MPI_ADDRESS_KIND), INTENT(IN) :: size
42    INTEGER, INTENT(IN) :: disp_unit
43    TYPE(MPI_Info), INTENT(IN) :: info
44    TYPE(MPI_Comm), INTENT(IN) :: comm
45    TYPE(MPI_Win), INTENT(OUT) :: win
46    INTEGER, OPTIONAL, INTENT(OUT) :: ierror
47
48    MPI_Win_create_dynamic(info, comm, win, ierror)
49    TYPE(MPI_Info), INTENT(IN) :: info
50    TYPE(MPI_Comm), INTENT(IN) :: comm

```

```

TYPE(MPI_Win), INTENT(OUT) :: win
INTEGER, OPTIONAL, INTENT(OUT) :: ierror
MPI_Win_detach(win, base, ierror)
TYPE(MPI_Win), INTENT(IN) :: win
TYPE(*), DIMENSION(..), ASYNCHRONOUS :: base
INTEGER, OPTIONAL, INTENT(OUT) :: ierror
MPI_Win_fence(assert, win, ierror)
INTEGER, INTENT(IN) :: assert
TYPE(MPI_Win), INTENT(IN) :: win
INTEGER, OPTIONAL, INTENT(OUT) :: ierror
MPI_Win_flush_all(win, ierror)
TYPE(MPI_Win), INTENT(IN) :: win
INTEGER, OPTIONAL, INTENT(OUT) :: ierror
MPI_Win_flush_local_all(win, ierror)
TYPE(MPI_Win), INTENT(IN) :: win
INTEGER, OPTIONAL, INTENT(OUT) :: ierror
MPI_Win_flush_local(rank, win, ierror)
INTEGER, INTENT(IN) :: rank
TYPE(MPI_Win), INTENT(IN) :: win
INTEGER, OPTIONAL, INTENT(OUT) :: ierror
MPI_Win_flush(rank, win, ierror)
INTEGER, INTENT(IN) :: rank
TYPE(MPI_Win), INTENT(IN) :: win
INTEGER, OPTIONAL, INTENT(OUT) :: ierror
MPI_Win_free(win, ierror)
TYPE(MPI_Win), INTENT(INOUT) :: win
INTEGER, OPTIONAL, INTENT(OUT) :: ierror
MPI_Win_get_group(win, group, ierror)
TYPE(MPI_Win), INTENT(IN) :: win
TYPE(MPI_Group), INTENT(OUT) :: group
INTEGER, OPTIONAL, INTENT(OUT) :: ierror
MPI_Win_get_info(win, info_used, ierror)
TYPE(MPI_Win), INTENT(IN) :: win
TYPE(MPI_Info), INTENT(OUT) :: info_used
INTEGER, OPTIONAL, INTENT(OUT) :: ierror
MPI_Win_lock_all(assert, win, ierror)
INTEGER, INTENT(IN) :: assert
TYPE(MPI_Win), INTENT(IN) :: win
INTEGER, OPTIONAL, INTENT(OUT) :: ierror
MPI_Win_lock(lock_type, rank, assert, win, ierror)
INTEGER, INTENT(IN) :: lock_type, rank, assert
TYPE(MPI_Win), INTENT(IN) :: win

```

```
1     INTEGER, OPTIONAL, INTENT(OUT) :: ierror
2
3     MPI_Win_post(group, assert, win, ierror)
4         TYPE(MPI_Group), INTENT(IN) :: group
5         INTEGER, INTENT(IN) :: assert
6         TYPE(MPI_Win), INTENT(IN) :: win
7         INTEGER, OPTIONAL, INTENT(OUT) :: ierror
8
9     MPI_Win_set_info(win, info, ierror)
10        TYPE(MPI_Win), INTENT(IN) :: win
11        TYPE(MPI_Info), INTENT(IN) :: info
12        INTEGER, OPTIONAL, INTENT(OUT) :: ierror
13
14    MPI_Win_shared_query(win, rank, size, disp_unit, baseptr, ierror)
15        USE, INTRINSIC :: ISO_C_BINDING, ONLY : C_PTR
16        TYPE(MPI_Win), INTENT(IN) :: win
17        INTEGER, INTENT(IN) :: rank
18        INTEGER(KIND=MPI_ADDRESS_KIND), INTENT(OUT) :: size
19        INTEGER, INTENT(OUT) :: disp_unit
20        TYPE(C_PTR), INTENT(OUT) :: baseptr
21        INTEGER, OPTIONAL, INTENT(OUT) :: ierror
22
23    MPI_Win_start(group, assert, win, ierror)
24        TYPE(MPI_Group), INTENT(IN) :: group
25        INTEGER, INTENT(IN) :: assert
26        TYPE(MPI_Win), INTENT(IN) :: win
27        INTEGER, OPTIONAL, INTENT(OUT) :: ierror
28
29    MPI_Win_sync(win, ierror)
30        TYPE(MPI_Win), INTENT(IN) :: win
31        INTEGER, OPTIONAL, INTENT(OUT) :: ierror
32
33    MPI_Win_test(win, flag, ierror)
34        TYPE(MPI_Win), INTENT(IN) :: win
35        LOGICAL, INTENT(OUT) :: flag
36        INTEGER, OPTIONAL, INTENT(OUT) :: ierror
37
38    MPI_Win_unlock_all(win, ierror)
39        TYPE(MPI_Win), INTENT(IN) :: win
40        INTEGER, OPTIONAL, INTENT(OUT) :: ierror
41
42    MPI_Win_unlock(rank, win, ierror)
43        INTEGER, INTENT(IN) :: rank
44        TYPE(MPI_Win), INTENT(IN) :: win
45        INTEGER, OPTIONAL, INTENT(OUT) :: ierror
46
47    MPI_Win_wait(win, ierror)
48        TYPE(MPI_Win), INTENT(IN) :: win
49        INTEGER, OPTIONAL, INTENT(OUT) :: ierror
```

A.3.10 External Interfaces Fortran 2008 Bindings

```

MPI_Grequest_complete(request, ierror)
  TYPE(MPI_Request), INTENT(IN) :: request
  INTEGER, OPTIONAL, INTENT(OUT) :: ierror

MPI_Grequest_start(query_fn, free_fn, cancel_fn, extra_state, request,
  ierror)
  PROCEDURE(MPI_Grequest_query_function) :: query_fn
  PROCEDURE(MPI_Grequest_free_function) :: free_fn
  PROCEDURE(MPI_Grequest_cancel_function) :: cancel_fn
  INTEGER(KIND=MPI_ADDRESS_KIND), INTENT(IN) :: extra_state
  TYPE(MPI_Request), INTENT(OUT) :: request
  INTEGER, OPTIONAL, INTENT(OUT) :: ierror

MPI_Init_thread(required, provided, ierror)
  INTEGER, INTENT(IN) :: required
  INTEGER, INTENT(OUT) :: provided
  INTEGER, OPTIONAL, INTENT(OUT) :: ierror

MPI_Is_thread_main(flag, ierror)
  LOGICAL, INTENT(OUT) :: flag
  INTEGER, OPTIONAL, INTENT(OUT) :: ierror

MPI_Query_thread(provided, ierror)
  INTEGER, INTENT(OUT) :: provided
  INTEGER, OPTIONAL, INTENT(OUT) :: ierror

MPI_Status_set_cancelled(status, flag, ierror)
  TYPE(MPI_Status), INTENT(INOUT) :: status
  LOGICAL, INTENT(IN) :: flag
  INTEGER, OPTIONAL, INTENT(OUT) :: ierror

MPI_Status_set_elements(status, datatype, count, ierror)
  TYPE(MPI_Status), INTENT(INOUT) :: status
  TYPE(MPI_Datatype), INTENT(IN) :: datatype
  INTEGER, INTENT(IN) :: count
  INTEGER, OPTIONAL, INTENT(OUT) :: ierror

MPI_Status_set_elements_x(status, datatype, count, ierror)
  TYPE(MPI_Status), INTENT(INOUT) :: status
  TYPE(MPI_Datatype), INTENT(IN) :: datatype
  INTEGER(KIND = MPI_COUNT_KIND), INTENT(IN) :: count
  INTEGER, OPTIONAL, INTENT(OUT) :: ierror

A.3.11 I/O Fortran 2008 Bindings

MPI_CONVERSION_FN_NULL(userbuf, datatype, count, filebuf, position,
  extra_state, ierror)
  USE, INTRINSIC :: ISO_C_BINDING, ONLY : C_PTR
  TYPE(C_PTR), VALUE :: userbuf, filebuf

```

```

1     TYPE(MPI_Datatype) :: datatype
2     INTEGER :: count, ierror
3     INTEGER(KIND=MPI_OFFSET_KIND) :: position
4     INTEGER(KIND=MPI_ADDRESS_KIND) :: extra_state
5
6     MPI_File_close(fh, ierror)
7         TYPE(MPI_File), INTENT(INOUT) :: fh
8         INTEGER, OPTIONAL, INTENT(OUT) :: ierror
9
10    MPI_File_delete(filename, info, ierror)
11        CHARACTER(LEN=*), INTENT(IN) :: filename
12        TYPE(MPI_Info), INTENT(IN) :: info
13        INTEGER, OPTIONAL, INTENT(OUT) :: ierror
14
15    MPI_File_get_amode(fh, amode, ierror)
16        TYPE(MPI_File), INTENT(IN) :: fh
17        INTEGER, INTENT(OUT) :: amode
18        INTEGER, OPTIONAL, INTENT(OUT) :: ierror
19
20    MPI_File_get_atomicity(fh, flag, ierror)
21        TYPE(MPI_File), INTENT(IN) :: fh
22        LOGICAL, INTENT(OUT) :: flag
23        INTEGER, OPTIONAL, INTENT(OUT) :: ierror
24
25    MPI_File_get_byte_offset(fh, offset, disp, ierror)
26        TYPE(MPI_File), INTENT(IN) :: fh
27        INTEGER(KIND=MPI_OFFSET_KIND), INTENT(IN) :: offset
28        INTEGER(KIND=MPI_OFFSET_KIND), INTENT(OUT) :: disp
29        INTEGER, OPTIONAL, INTENT(OUT) :: ierror
30
31    MPI_File_get_group(fh, group, ierror)
32        TYPE(MPI_File), INTENT(IN) :: fh
33        TYPE(MPI_Group), INTENT(OUT) :: group
34        INTEGER, OPTIONAL, INTENT(OUT) :: ierror
35
36    MPI_File_get_info(fh, info_used, ierror)
37        TYPE(MPI_File), INTENT(IN) :: fh
38        TYPE(MPI_Info), INTENT(OUT) :: info_used
39        INTEGER, OPTIONAL, INTENT(OUT) :: ierror
40
41    MPI_File_get_position(fh, offset, ierror)
42        TYPE(MPI_File), INTENT(IN) :: fh
43        INTEGER(KIND=MPI_OFFSET_KIND), INTENT(OUT) :: offset
44        INTEGER, OPTIONAL, INTENT(OUT) :: ierror
45
46    MPI_File_get_position_shared(fh, offset, ierror)
47        TYPE(MPI_File), INTENT(IN) :: fh
48        INTEGER(KIND=MPI_OFFSET_KIND), INTENT(OUT) :: offset
49        INTEGER, OPTIONAL, INTENT(OUT) :: ierror
50
51    MPI_File_get_size(fh, size, ierror)
52        TYPE(MPI_File), INTENT(IN) :: fh

```



```

    INTEGER(KIND=MPI_OFFSET_KIND), INTENT(OUT) :: size
    INTEGER, OPTIONAL, INTENT(OUT) :: ierror
MPI_File_get_type_extent(fh, datatype, extent, ierror)
    TYPE(MPI_File), INTENT(IN) :: fh
    TYPE(MPI_Datatype), INTENT(IN) :: datatype
    INTEGER(KIND=MPI_ADDRESS_KIND), INTENT(OUT) :: extent
    INTEGER, OPTIONAL, INTENT(OUT) :: ierror
MPI_File_get_view(fh, disp, etype, filetype, datarep, ierror)
    TYPE(MPI_File), INTENT(IN) :: fh
    INTEGER(KIND=MPI_OFFSET_KIND), INTENT(OUT) :: disp
    TYPE(MPI_Datatype), INTENT(OUT) :: etype, filetype
    CHARACTER(LEN=*), INTENT(OUT) :: datarep
    INTEGER, OPTIONAL, INTENT(OUT) :: ierror
MPI_File_iread_all(fh, buf, count, datatype, request, ierror)
    TYPE(MPI_File), INTENT(IN) :: fh
    TYPE(*), DIMENSION(..), ASYNCHRONOUS :: buf
    INTEGER, INTENT(IN) :: count
    TYPE(MPI_Datatype), INTENT(IN) :: datatype
    TYPE(MPI_Request), INTENT(OUT) :: request
    INTEGER, OPTIONAL, INTENT(OUT) :: ierror
MPI_File_iread_at_all(fh, offset, buf, count, datatype, request, ierror)
    TYPE(MPI_File), INTENT(IN) :: fh
    INTEGER(KIND=MPI_OFFSET_KIND), INTENT(IN) :: offset
    TYPE(*), DIMENSION(..), ASYNCHRONOUS :: buf
    INTEGER, INTENT(IN) :: count
    TYPE(MPI_Datatype), INTENT(IN) :: datatype
    TYPE(MPI_Request), INTENT(OUT) :: request
    INTEGER, OPTIONAL, INTENT(OUT) :: ierror
MPI_File_iread_at(fh, offset, buf, count, datatype, request, ierror)
    TYPE(MPI_File), INTENT(IN) :: fh
    INTEGER(KIND=MPI_OFFSET_KIND), INTENT(IN) :: offset
    TYPE(*), DIMENSION(..), ASYNCHRONOUS :: buf
    INTEGER, INTENT(IN) :: count
    TYPE(MPI_Datatype), INTENT(IN) :: datatype
    TYPE(MPI_Request), INTENT(OUT) :: request
    INTEGER, OPTIONAL, INTENT(OUT) :: ierror
MPI_File_iread(fh, buf, count, datatype, request, ierror)
    TYPE(MPI_File), INTENT(IN) :: fh
    TYPE(*), DIMENSION(..), ASYNCHRONOUS :: buf
    INTEGER, INTENT(IN) :: count
    TYPE(MPI_Datatype), INTENT(IN) :: datatype
    TYPE(MPI_Request), INTENT(OUT) :: request
    INTEGER, OPTIONAL, INTENT(OUT) :: ierror
MPI_File_iread_shared(fh, buf, count, datatype, request, ierror)

```

```

1     TYPE(MPI_File), INTENT(IN) :: fh
2     TYPE(*), DIMENSION(..), ASYNCHRONOUS :: buf
3     INTEGER, INTENT(IN) :: count
4     TYPE(MPI_Datatype), INTENT(IN) :: datatype
5     TYPE(MPI_Request), INTENT(OUT) :: request
6     INTEGER, OPTIONAL, INTENT(OUT) :: ierror
7
8 MPI_File_ fwrite_all(fh, buf, count, datatype, request, ierror)
9     TYPE(MPI_File), INTENT(IN) :: fh
10    TYPE(*), DIMENSION(..), INTENT(IN), ASYNCHRONOUS :: buf
11    INTEGER, INTENT(IN) :: count
12    TYPE(MPI_Datatype), INTENT(IN) :: datatype
13    TYPE(MPI_Request), INTENT(OUT) :: request
14    INTEGER, OPTIONAL, INTENT(OUT) :: ierror
15
16 MPI_File_ fwrite_at_all(fh, offset, buf, count, datatype, request, ierror)
17    TYPE(MPI_File), INTENT(IN) :: fh
18    INTEGER(KIND=MPI_OFFSET_KIND), INTENT(IN) :: offset
19    TYPE(*), DIMENSION(..), INTENT(IN), ASYNCHRONOUS :: buf
20    INTEGER, INTENT(IN) :: count
21    TYPE(MPI_Datatype), INTENT(IN) :: datatype
22    TYPE(MPI_Request), INTENT(OUT) :: request
23    INTEGER, OPTIONAL, INTENT(OUT) :: ierror
24
25 MPI_File_ fwrite_at(fh, offset, buf, count, datatype, request, ierror)
26    TYPE(MPI_File), INTENT(IN) :: fh
27    INTEGER(KIND=MPI_OFFSET_KIND), INTENT(IN) :: offset
28    TYPE(*), DIMENSION(..), INTENT(IN), ASYNCHRONOUS :: buf
29    INTEGER, INTENT(IN) :: count
30    TYPE(MPI_Datatype), INTENT(IN) :: datatype
31    TYPE(MPI_Request), INTENT(OUT) :: request
32    INTEGER, OPTIONAL, INTENT(OUT) :: ierror
33
34 MPI_File_ fwrite(fh, buf, count, datatype, request, ierror)
35    TYPE(MPI_File), INTENT(IN) :: fh
36    TYPE(*), DIMENSION(..), INTENT(IN), ASYNCHRONOUS :: buf
37    INTEGER, INTENT(IN) :: count
38    TYPE(MPI_Datatype), INTENT(IN) :: datatype
39    TYPE(MPI_Request), INTENT(OUT) :: request
40    INTEGER, OPTIONAL, INTENT(OUT) :: ierror
41
42 MPI_File_ fwrite_shared(fh, buf, count, datatype, request, ierror)
43    TYPE(MPI_File), INTENT(IN) :: fh
44    TYPE(*), DIMENSION(..), INTENT(IN), ASYNCHRONOUS :: buf
45    INTEGER, INTENT(IN) :: count
46    TYPE(MPI_Datatype), INTENT(IN) :: datatype
47    TYPE(MPI_Request), INTENT(OUT) :: request
48    INTEGER, OPTIONAL, INTENT(OUT) :: ierror
49
50 MPI_File_ fopen(comm, filename, amode, info, fh, ierror)

```

```

TYPE(MPI_Comm), INTENT(IN) :: comm
CHARACTER(LEN=*), INTENT(IN) :: filename
INTEGER, INTENT(IN) :: amode
TYPE(MPI_Info), INTENT(IN) :: info
TYPE(MPI_File), INTENT(OUT) :: fh
INTEGER, OPTIONAL, INTENT(OUT) :: ierror

MPI_File_preallocate(fh, size, ierror)
TYPE(MPI_File), INTENT(IN) :: fh
INTEGER(KIND=MPI_OFFSET_KIND), INTENT(IN) :: size
INTEGER, OPTIONAL, INTENT(OUT) :: ierror

MPI_File_read_all_begin(fh, buf, count, datatype, ierror)
TYPE(MPI_File), INTENT(IN) :: fh
TYPE(*), DIMENSION(..), ASYNCHRONOUS :: buf
INTEGER, INTENT(IN) :: count
TYPE(MPI_Datatype), INTENT(IN) :: datatype
INTEGER, OPTIONAL, INTENT(OUT) :: ierror

MPI_File_read_all_end(fh, buf, status, ierror)
TYPE(MPI_File), INTENT(IN) :: fh
TYPE(*), DIMENSION(..), ASYNCHRONOUS :: buf
TYPE(MPI_Status) :: status
INTEGER, OPTIONAL, INTENT(OUT) :: ierror

MPI_File_read_all(fh, buf, count, datatype, status, ierror)
TYPE(MPI_File), INTENT(IN) :: fh
TYPE(*), DIMENSION(..) :: buf
INTEGER, INTENT(IN) :: count
TYPE(MPI_Datatype), INTENT(IN) :: datatype
TYPE(MPI_Status) :: status
INTEGER, OPTIONAL, INTENT(OUT) :: ierror

MPI_File_read_at_all_begin(fh, offset, buf, count, datatype, ierror)
TYPE(MPI_File), INTENT(IN) :: fh
INTEGER(KIND=MPI_OFFSET_KIND), INTENT(IN) :: offset
TYPE(*), DIMENSION(..), ASYNCHRONOUS :: buf
INTEGER, INTENT(IN) :: count
TYPE(MPI_Datatype), INTENT(IN) :: datatype
INTEGER, OPTIONAL, INTENT(OUT) :: ierror

MPI_File_read_at_all_end(fh, buf, status, ierror)
TYPE(MPI_File), INTENT(IN) :: fh
TYPE(*), DIMENSION(..), ASYNCHRONOUS :: buf
TYPE(MPI_Status) :: status
INTEGER, OPTIONAL, INTENT(OUT) :: ierror

MPI_File_read_at_all(fh, offset, buf, count, datatype, status, ierror)
TYPE(MPI_File), INTENT(IN) :: fh
INTEGER(KIND=MPI_OFFSET_KIND), INTENT(IN) :: offset
TYPE(*), DIMENSION(..) :: buf

```

```

1     INTEGER, INTENT(IN) :: count
2     TYPE(MPI_Datatype), INTENT(IN) :: datatype
3     TYPE(MPI_Status) :: status
4     INTEGER, OPTIONAL, INTENT(OUT) :: ierror
5
6 MPI_File_read_at(fh, offset, buf, count, datatype, status, ierror)
7     TYPE(MPI_File), INTENT(IN) :: fh
8     INTEGER(KIND=MPI_OFFSET_KIND), INTENT(IN) :: offset
9     TYPE(*), DIMENSION(..) :: buf
10    INTEGER, INTENT(IN) :: count
11    TYPE(MPI_Datatype), INTENT(IN) :: datatype
12    TYPE(MPI_Status) :: status
13    INTEGER, OPTIONAL, INTENT(OUT) :: ierror
14
15 MPI_File_read(fh, buf, count, datatype, status, ierror)
16    TYPE(MPI_File), INTENT(IN) :: fh
17    TYPE(*), DIMENSION(..) :: buf
18    INTEGER, INTENT(IN) :: count
19    TYPE(MPI_Datatype), INTENT(IN) :: datatype
20    TYPE(MPI_Status) :: status
21    INTEGER, OPTIONAL, INTENT(OUT) :: ierror
22
23 MPI_File_read_ordered_begin(fh, buf, count, datatype, ierror)
24    TYPE(MPI_File), INTENT(IN) :: fh
25    TYPE(*), DIMENSION(..), ASYNCHRONOUS :: buf
26    INTEGER, INTENT(IN) :: count
27    TYPE(MPI_Datatype), INTENT(IN) :: datatype
28    INTEGER, OPTIONAL, INTENT(OUT) :: ierror
29
30 MPI_File_read_ordered_end(fh, buf, status, ierror)
31    TYPE(MPI_File), INTENT(IN) :: fh
32    TYPE(*), DIMENSION(..), ASYNCHRONOUS :: buf
33    TYPE(MPI_Status) :: status
34    INTEGER, OPTIONAL, INTENT(OUT) :: ierror
35
36 MPI_File_read_ordered(fh, buf, count, datatype, status, ierror)
37    TYPE(MPI_File), INTENT(IN) :: fh
38    TYPE(*), DIMENSION(..) :: buf
39    INTEGER, INTENT(IN) :: count
40    TYPE(MPI_Datatype), INTENT(IN) :: datatype
41    TYPE(MPI_Status) :: status
42    INTEGER, OPTIONAL, INTENT(OUT) :: ierror
43
44 MPI_File_read_shared(fh, buf, count, datatype, status, ierror)
45    TYPE(MPI_File), INTENT(IN) :: fh
46    TYPE(*), DIMENSION(..) :: buf
47    INTEGER, INTENT(IN) :: count
48    TYPE(MPI_Datatype), INTENT(IN) :: datatype
49    TYPE(MPI_Status) :: status
50    INTEGER, OPTIONAL, INTENT(OUT) :: ierror

```

```

MPI_File_seek(fh, offset, whence, ierror)           1
  TYPE(MPI_File), INTENT(IN) :: fh                 2
  INTEGER(KIND=MPI_OFFSET_KIND), INTENT(IN) :: offset 3
  INTEGER, INTENT(IN) :: whence                     4
  INTEGER, OPTIONAL, INTENT(OUT) :: ierror          5
                                                    6
MPI_File_seek_shared(fh, offset, whence, ierror)   7
  TYPE(MPI_File), INTENT(IN) :: fh                 8
  INTEGER(KIND=MPI_OFFSET_KIND), INTENT(IN) :: offset 9
  INTEGER, INTENT(IN) :: whence                    10
  INTEGER, OPTIONAL, INTENT(OUT) :: ierror          11
                                                    12
MPI_File_set_atomicity(fh, flag, ierror)           13
  TYPE(MPI_File), INTENT(IN) :: fh                 14
  LOGICAL, INTENT(IN) :: flag                      15
  INTEGER, OPTIONAL, INTENT(OUT) :: ierror          16
                                                    17
MPI_File_set_info(fh, info, ierror)                18
  TYPE(MPI_File), INTENT(IN) :: fh                 19
  TYPE(MPI_Info), INTENT(IN) :: info                20
  INTEGER, OPTIONAL, INTENT(OUT) :: ierror          21
                                                    22
MPI_File_set_size(fh, size, ierror)                23
  TYPE(MPI_File), INTENT(IN) :: fh                 24
  INTEGER(KIND=MPI_OFFSET_KIND), INTENT(IN) :: size 25
  INTEGER, OPTIONAL, INTENT(OUT) :: ierror          26
                                                    27
MPI_File_set_view(fh, disp, etype, filetype, datarep, info, ierror) 28
  TYPE(MPI_File), INTENT(IN) :: fh                 29
  INTEGER(KIND=MPI_OFFSET_KIND), INTENT(IN) :: disp 30
  TYPE(MPI_Datatype), INTENT(IN) :: etype, filetype 31
  CHARACTER(LEN=*), INTENT(IN) :: datarep           32
  TYPE(MPI_Info), INTENT(IN) :: info                33
  INTEGER, OPTIONAL, INTENT(OUT) :: ierror          34
                                                    35
MPI_File_sync(fh, ierror)                           36
  TYPE(MPI_File), INTENT(IN) :: fh                 37
  INTEGER, OPTIONAL, INTENT(OUT) :: ierror          38
                                                    39
MPI_File_write_all_begin(fh, buf, count, datatype, ierror) 40
  TYPE(MPI_File), INTENT(IN) :: fh                 41
  TYPE(*), DIMENSION(..), INTENT(IN), ASYNCHRONOUS :: buf 42
  INTEGER, INTENT(IN) :: count                     43
  TYPE(MPI_Datatype), INTENT(IN) :: datatype        44
  INTEGER, OPTIONAL, INTENT(OUT) :: ierror          45
                                                    46
MPI_File_write_all_end(fh, buf, status, ierror)     47
  TYPE(MPI_File), INTENT(IN) :: fh                 48
  TYPE(*), DIMENSION(..), INTENT(IN), ASYNCHRONOUS :: buf 49
  TYPE(MPI_Status) :: status                       50
  INTEGER, OPTIONAL, INTENT(OUT) :: ierror          51
                                                    52

```

```

1 MPI_File_write_all(fh, buf, count, datatype, status, ierror)
2     TYPE(MPI_File), INTENT(IN) :: fh
3     TYPE(*), DIMENSION(..), INTENT(IN) :: buf
4     INTEGER, INTENT(IN) :: count
5     TYPE(MPI_Datatype), INTENT(IN) :: datatype
6     TYPE(MPI_Status) :: status
7     INTEGER, OPTIONAL, INTENT(OUT) :: ierror
8
9 MPI_File_write_at_all_begin(fh, offset, buf, count, datatype, ierror)
10    TYPE(MPI_File), INTENT(IN) :: fh
11    INTEGER(KIND=MPI_OFFSET_KIND), INTENT(IN) :: offset
12    TYPE(*), DIMENSION(..), INTENT(IN), ASYNCHRONOUS :: buf
13    INTEGER, INTENT(IN) :: count
14    TYPE(MPI_Datatype), INTENT(IN) :: datatype
15    INTEGER, OPTIONAL, INTENT(OUT) :: ierror
16
17 MPI_File_write_at_all_end(fh, buf, status, ierror)
18    TYPE(MPI_File), INTENT(IN) :: fh
19    TYPE(*), DIMENSION(..), INTENT(IN), ASYNCHRONOUS :: buf
20    TYPE(MPI_Status) :: status
21    INTEGER, OPTIONAL, INTENT(OUT) :: ierror
22
23 MPI_File_write_at_all(fh, offset, buf, count, datatype, status, ierror)
24    TYPE(MPI_File), INTENT(IN) :: fh
25    INTEGER(KIND=MPI_OFFSET_KIND), INTENT(IN) :: offset
26    TYPE(*), DIMENSION(..), INTENT(IN) :: buf
27    INTEGER, INTENT(IN) :: count
28    TYPE(MPI_Datatype), INTENT(IN) :: datatype
29    TYPE(MPI_Status) :: status
30    INTEGER, OPTIONAL, INTENT(OUT) :: ierror
31
32 MPI_File_write_at(fh, offset, buf, count, datatype, status, ierror)
33    TYPE(MPI_File), INTENT(IN) :: fh
34    INTEGER(KIND=MPI_OFFSET_KIND), INTENT(IN) :: offset
35    TYPE(*), DIMENSION(..), INTENT(IN) :: buf
36    INTEGER, INTENT(IN) :: count
37    TYPE(MPI_Datatype), INTENT(IN) :: datatype
38    TYPE(MPI_Status) :: status
39    INTEGER, OPTIONAL, INTENT(OUT) :: ierror
40
41 MPI_File_write(fh, buf, count, datatype, status, ierror)
42    TYPE(MPI_File), INTENT(IN) :: fh
43    TYPE(*), DIMENSION(..), INTENT(IN) :: buf
44    INTEGER, INTENT(IN) :: count
45    TYPE(MPI_Datatype), INTENT(IN) :: datatype
46    TYPE(MPI_Status) :: status
47    INTEGER, OPTIONAL, INTENT(OUT) :: ierror
48
49 MPI_File_write_ordered_begin(fh, buf, count, datatype, ierror)
50    TYPE(MPI_File), INTENT(IN) :: fh

```

```

TYPE(*), DIMENSION(..), INTENT(IN), ASYNCHRONOUS :: buf           1
INTEGER, INTENT(IN) :: count                                     2
TYPE(MPI_Datatype), INTENT(IN) :: datatype                     3
INTEGER, OPTIONAL, INTENT(OUT) :: ierror                       4
                                                                5
MPI_File_write_ordered_end(fh, buf, status, ierror)            6
  TYPE(MPI_File), INTENT(IN) :: fh                             7
  TYPE(*), DIMENSION(..), INTENT(IN), ASYNCHRONOUS :: buf     8
  TYPE(MPI_Status) :: status                                   9
  INTEGER, OPTIONAL, INTENT(OUT) :: ierror                    10
                                                                11
MPI_File_write_ordered(fh, buf, count, datatype, status, ierror) 12
  TYPE(MPI_File), INTENT(IN) :: fh                             13
  TYPE(*), DIMENSION(..), INTENT(IN) :: buf                   14
  INTEGER, INTENT(IN) :: count                                 15
  TYPE(MPI_Datatype), INTENT(IN) :: datatype                  16
  TYPE(MPI_Status) :: status                                  17
  INTEGER, OPTIONAL, INTENT(OUT) :: ierror                    18
                                                                19
MPI_File_write_shared(fh, buf, count, datatype, status, ierror) 20
  TYPE(MPI_File), INTENT(IN) :: fh                             21
  TYPE(*), DIMENSION(..), INTENT(IN) :: buf                   22
  INTEGER, INTENT(IN) :: count                                 23
  TYPE(MPI_Datatype), INTENT(IN) :: datatype                  24
  TYPE(MPI_Status) :: status                                  25
  INTEGER, OPTIONAL, INTENT(OUT) :: ierror                    26
                                                                27
MPI_Register_datarep(datarep, read_conversion_fn, write_conversion_fn,
                    dtype_file_extent_fn, extra_state, ierror) 28
  CHARACTER(LEN=*), INTENT(IN) :: datarep                     29
  PROCEDURE(MPI_Datarep_conversion_function) :: read_conversion_fn 30
  PROCEDURE(MPI_Datarep_conversion_function) :: write_conversion_fn 31
  PROCEDURE(MPI_Datarep_extent_function) :: dtype_file_extent_fn 32
  INTEGER(KIND=MPI_ADDRESS_KIND), INTENT(IN) :: extra_state 33
  INTEGER, OPTIONAL, INTENT(OUT) :: ierror                    34
                                                                35

```

A.3.12 Language Bindings Fortran 2008 Bindings

```

MPI_F_sync_reg(buf)                                           36
  TYPE(*), DIMENSION(..), ASYNCHRONOUS :: buf                 37
                                                                38
MPI_Sizeof(x, size, ierror)                                    39
  TYPE(*), DIMENSION(..) :: x                                  40
  INTEGER, INTENT(OUT) :: size                                  41
  INTEGER, OPTIONAL, INTENT(OUT) :: ierror                     42
                                                                43
MPI_Status_f082f(f08_status, f_status, ierror)               44
  TYPE(MPI_Status), INTENT(IN) :: f08_status                   45
  INTEGER, INTENT(OUT) :: f_status(MPI_STATUS_SIZE)            46
  INTEGER, OPTIONAL, INTENT(OUT) :: ierror                     47
                                                                48

```

```
1 MPI_Status_f2f08(f_status, f08_status, ierror)
2     INTEGER, INTENT(IN) :: f_status(MPI_STATUS_SIZE)
3     TYPE(MPI_Status), INTENT(OUT) :: f08_status
4     INTEGER, OPTIONAL, INTENT(OUT) :: ierror
5
6 MPI_Type_create_f90_complex(p, r, newtype, ierror)
7     INTEGER, INTENT(IN) :: p, r
8     TYPE(MPI_Datatype), INTENT(OUT) :: newtype
9     INTEGER, OPTIONAL, INTENT(OUT) :: ierror
10
11 MPI_Type_create_f90_integer(r, newtype, ierror)
12     INTEGER, INTENT(IN) :: r
13     TYPE(MPI_Datatype), INTENT(OUT) :: newtype
14     INTEGER, OPTIONAL, INTENT(OUT) :: ierror
15
16 MPI_Type_create_f90_real(p, r, newtype, ierror)
17     INTEGER, INTENT(IN) :: p, r
18     TYPE(MPI_Datatype), INTENT(OUT) :: newtype
19     INTEGER, OPTIONAL, INTENT(OUT) :: ierror
20
21 MPI_Type_match_size(typeclass, size, datatype, ierror)
22     INTEGER, INTENT(IN) :: typeclass, size
23     TYPE(MPI_Datatype), INTENT(OUT) :: datatype
24     INTEGER, OPTIONAL, INTENT(OUT) :: ierror
```

A.3.13 Tools / Profiling Interface Fortran 2008 Bindings

```
25 MPI_Pcontrol(level)
26     INTEGER, INTENT(IN) :: level
27
28
29
30
31
32
33
34
35
36
37
38
39
40
41
42
43
44
45
46
47
48
```

A.4 Fortran Bindings with mpif.h or the mpi Module

A.4.1 Point-to-Point Communication Fortran Bindings

```

MPI_BSEND(BUF, COUNT, DATATYPE, DEST, TAG, COMM, IERROR)
  <type> BUF(*)
  INTEGER COUNT, DATATYPE, DEST, TAG, COMM, IERROR

MPI_BSEND_INIT(BUF, COUNT, DATATYPE, DEST, TAG, COMM, REQUEST, IERROR)
  <type> BUF(*)
  INTEGER COUNT, DATATYPE, DEST, TAG, COMM, REQUEST, IERROR

MPI_BUFFER_ATTACH(BUFFER, SIZE, IERROR)
  <type> BUFFER(*)
  INTEGER SIZE, IERROR

MPI_BUFFER_DETACH(BUFFER_ADDR, SIZE, IERROR)
  <type> BUFFER_ADDR(*)
  INTEGER SIZE, IERROR

MPI_CANCEL(REQUEST, IERROR)
  INTEGER REQUEST, IERROR

MPI_GET_COUNT(STATUS, DATATYPE, COUNT, IERROR)
  INTEGER STATUS(MPI_STATUS_SIZE), DATATYPE, COUNT, IERROR

MPI_IBSEND(BUF, COUNT, DATATYPE, DEST, TAG, COMM, REQUEST, IERROR)
  <type> BUF(*)
  INTEGER COUNT, DATATYPE, DEST, TAG, COMM, REQUEST, IERROR

MPI_IMPROBE(SOURCE, TAG, COMM, FLAG, MESSAGE, STATUS, IERROR)
  INTEGER SOURCE, TAG, COMM, MESSAGE, STATUS(MPI_STATUS_SIZE), IERROR
  LOGICAL FLAG

MPI_IMRECV(BUF, COUNT, DATATYPE, MESSAGE, REQUEST, IERROR)
  <type> BUF(*)
  INTEGER COUNT, DATATYPE, MESSAGE, REQUEST, IERROR

MPI_IPROBE(SOURCE, TAG, COMM, FLAG, STATUS, IERROR)
  LOGICAL FLAG
  INTEGER SOURCE, TAG, COMM, STATUS(MPI_STATUS_SIZE), IERROR

MPI_IRECV(BUF, COUNT, DATATYPE, SOURCE, TAG, COMM, REQUEST, IERROR)
  <type> BUF(*)
  INTEGER COUNT, DATATYPE, SOURCE, TAG, COMM, REQUEST, IERROR

MPI_IRSEND(BUF, COUNT, DATATYPE, DEST, TAG, COMM, REQUEST, IERROR)
  <type> BUF(*)
  INTEGER COUNT, DATATYPE, DEST, TAG, COMM, REQUEST, IERROR

MPI_ISEND(BUF, COUNT, DATATYPE, DEST, TAG, COMM, REQUEST, IERROR)
  <type> BUF(*)
  INTEGER COUNT, DATATYPE, DEST, TAG, COMM, REQUEST, IERROR

```

```
1 MPI_ISSEND(BUF, COUNT, DATATYPE, DEST, TAG, COMM, REQUEST, IERROR)
2   <type> BUF(*)
3   INTEGER COUNT, DATATYPE, DEST, TAG, COMM, REQUEST, IERROR
4
5 MPI_MPROBE(SOURCE, TAG, COMM, MESSAGE, STATUS, IERROR)
6   INTEGER SOURCE, TAG, COMM, MESSAGE, STATUS(MPI_STATUS_SIZE), IERROR
7
8 MPI_MRECV(BUF, COUNT, DATATYPE, MESSAGE, STATUS, IERROR)
9   <type> BUF(*)
10  INTEGER COUNT, DATATYPE, MESSAGE, STATUS(MPI_STATUS_SIZE), IERROR
11
12 MPI_PROBE(SOURCE, TAG, COMM, STATUS, IERROR)
13  INTEGER SOURCE, TAG, COMM, STATUS(MPI_STATUS_SIZE), IERROR
14
15 MPI_RECV(BUF, COUNT, DATATYPE, SOURCE, TAG, COMM, STATUS, IERROR)
16  <type> BUF(*)
17  INTEGER COUNT, DATATYPE, SOURCE, TAG, COMM, STATUS(MPI_STATUS_SIZE),
18  IERROR
19
20 MPI_RECV_INIT(BUF, COUNT, DATATYPE, SOURCE, TAG, COMM, REQUEST, IERROR)
21  <type> BUF(*)
22  INTEGER COUNT, DATATYPE, SOURCE, TAG, COMM, REQUEST, IERROR
23
24 MPI_REQUEST_FREE(REQUEST, IERROR)
25  INTEGER REQUEST, IERROR
26
27 MPI_REQUEST_GET_STATUS(REQUEST, FLAG, STATUS, IERROR)
28  INTEGER REQUEST, STATUS(MPI_STATUS_SIZE), IERROR
29  LOGICAL FLAG
30
31 MPI_RSEND(BUF, COUNT, DATATYPE, DEST, TAG, COMM, IERROR)
32  <type> BUF(*)
33  INTEGER COUNT, DATATYPE, DEST, TAG, COMM, IERROR
34
35 MPI_RSEND_INIT(BUF, COUNT, DATATYPE, DEST, TAG, COMM, REQUEST, IERROR)
36  <type> BUF(*)
37  INTEGER COUNT, DATATYPE, DEST, TAG, COMM, REQUEST, IERROR
38
39 MPI_SEND(BUF, COUNT, DATATYPE, DEST, TAG, COMM, IERROR)
40  <type> BUF(*)
41  INTEGER COUNT, DATATYPE, DEST, TAG, COMM, IERROR
42
43 MPI_SEND_INIT(BUF, COUNT, DATATYPE, DEST, TAG, COMM, REQUEST, IERROR)
44  <type> BUF(*)
45  INTEGER COUNT, DATATYPE, DEST, TAG, COMM, REQUEST, IERROR
46
47 MPI_SENDRECV_REPLACE(BUF, COUNT, DATATYPE, DEST, SENDTAG, SOURCE, RECVTAG,
48  COMM, STATUS, IERROR)
49  <type> BUF(*)
50  INTEGER COUNT, DATATYPE, DEST, SENDTAG, SOURCE, RECVTAG, COMM,
51  STATUS(MPI_STATUS_SIZE), IERROR
52
53 MPI_SENDRECV(SENDBUF, SENDCOUNT, SENDTYPE, DEST, SENDTAG, RECVBUF,
54  RECVCOUNT, RECVMODE, SOURCE, RECVTAG, COMM, STATUS, IERROR)
```

```
<type> SENDBUF(*), RECVBUF(*) 1
INTEGER SENDCOUNT, SENDTYPE, DEST, SENDTAG, RECVCOUNT, RECVMYPE, 2
SOURCE, RECVTAG, COMM, STATUS(MPI_STATUS_SIZE), IERROR 3
MPI_SSEND(BUF, COUNT, DATATYPE, DEST, TAG, COMM, IERROR) 4
<type> BUF(*) 5
INTEGER COUNT, DATATYPE, DEST, TAG, COMM, IERROR 6
MPI_SSEND_INIT(BUF, COUNT, DATATYPE, DEST, TAG, COMM, REQUEST, IERROR) 8
<type> BUF(*) 9
INTEGER COUNT, DATATYPE, DEST, TAG, COMM, REQUEST, IERROR 10
MPI_STARTALL(COUNT, ARRAY_OF_REQUESTS, IERROR) 11
INTEGER COUNT, ARRAY_OF_REQUESTS(*), IERROR 12
MPI_START(REQUEST, IERROR) 14
INTEGER REQUEST, IERROR 15
MPI_TESTALL(COUNT, ARRAY_OF_REQUESTS, FLAG, ARRAY_OF_STATUSES, IERROR) 17
LOGICAL FLAG 18
INTEGER COUNT, ARRAY_OF_REQUESTS(*), 19
ARRAY_OF_STATUSES(MPI_STATUS_SIZE,*), IERROR 20
MPI_TESTANY(COUNT, ARRAY_OF_REQUESTS, INDEX, FLAG, STATUS, IERROR) 21
LOGICAL FLAG 22
INTEGER COUNT, ARRAY_OF_REQUESTS(*), INDEX, STATUS(MPI_STATUS_SIZE), 23
IERROR 24
MPI_TEST_CANCELLED(STATUS, FLAG, IERROR) 26
LOGICAL FLAG 27
INTEGER STATUS(MPI_STATUS_SIZE), IERROR 28
MPI_TEST(REQUEST, FLAG, STATUS, IERROR) 29
LOGICAL FLAG 30
INTEGER REQUEST, STATUS(MPI_STATUS_SIZE), IERROR 31
MPI_TESTSOME(INCOUNT, ARRAY_OF_REQUESTS, OUTCOUNT, ARRAY_OF_INDICES, 33
ARRAY_OF_STATUSES, IERROR) 34
INTEGER INCOUNT, ARRAY_OF_REQUESTS(*), OUTCOUNT, ARRAY_OF_INDICES(*), 35
ARRAY_OF_STATUSES(MPI_STATUS_SIZE,*), IERROR 36
MPI_WAITALL(COUNT, ARRAY_OF_REQUESTS, ARRAY_OF_STATUSES, IERROR) 37
INTEGER COUNT, ARRAY_OF_REQUESTS(*) 38
INTEGER ARRAY_OF_STATUSES(MPI_STATUS_SIZE,*), IERROR 39
MPI_WAITANY(COUNT, ARRAY_OF_REQUESTS, INDEX, STATUS, IERROR) 41
INTEGER COUNT, ARRAY_OF_REQUESTS(*), INDEX, STATUS(MPI_STATUS_SIZE), 42
IERROR 43
MPI_WAIT(REQUEST, STATUS, IERROR) 44
INTEGER REQUEST, STATUS(MPI_STATUS_SIZE), IERROR 45
MPI_WAITSOME(INCOUNT, ARRAY_OF_REQUESTS, OUTCOUNT, ARRAY_OF_INDICES, 47
ARRAY_OF_STATUSES, IERROR) 48
```

```

1     INTEGER INCOUNT, ARRAY_OF_REQUESTS(*), OUTCOUNT, ARRAY_OF_INDICES(*),
2         ARRAY_OF_STATUSES(MPI_STATUS_SIZE,*), IERROR
3
4

```

A.4.2 Datatypes Fortran Bindings

```

6     INTEGER(KIND=MPI_ADDRESS_KIND) MPI_AINT_ADD(BASE, DISP)
7         INTEGER(KIND=MPI_ADDRESS_KIND) BASE, DISP
8
9     INTEGER(KIND=MPI_ADDRESS_KIND) MPI_AINT_DIFF(ADDR1, ADDR2)
10        INTEGER(KIND=MPI_ADDRESS_KIND) ADDR1, ADDR2
11
12    MPI_GET_ADDRESS(LOCATION, ADDRESS, IERROR)
13        <type> LOCATION(*)
14        INTEGER IERROR
15        INTEGER(KIND=MPI_ADDRESS_KIND) ADDRESS
16
17    MPI_GET_ELEMENTS(STATUS, DATATYPE, COUNT, IERROR)
18        INTEGER STATUS(MPI_STATUS_SIZE), DATATYPE, COUNT, IERROR
19
20    MPI_GET_ELEMENTS_X(STATUS, DATATYPE, COUNT, IERROR)
21        INTEGER STATUS(MPI_STATUS_SIZE), DATATYPE, IERROR
22        INTEGER(KIND=MPI_COUNT_KIND) COUNT
23
24    MPI_PACK_EXTERNAL(DATAREP, INBUF, INCOUNT, DATATYPE, OUTBUF, OUTSIZE,
25        POSITION, IERROR)
26        INTEGER INCOUNT, DATATYPE, IERROR
27        INTEGER(KIND=MPI_ADDRESS_KIND) OUTSIZE, POSITION
28        CHARACTER*(*) DATAREP
29        <type> INBUF(*), OUTBUF(*)
30
31    MPI_PACK_EXTERNAL_SIZE(DATAREP, INCOUNT, DATATYPE, SIZE, IERROR)
32        INTEGER INCOUNT, DATATYPE, IERROR
33        INTEGER(KIND=MPI_ADDRESS_KIND) SIZE
34        CHARACTER*(*) DATAREP
35
36    MPI_PACK(INBUF, INCOUNT, DATATYPE, OUTBUF, OUTSIZE, POSITION, COMM, IERROR)
37        <type> INBUF(*), OUTBUF(*)
38        INTEGER INCOUNT, DATATYPE, OUTSIZE, POSITION, COMM, IERROR
39
40    MPI_PACK_SIZE(INCOUNT, DATATYPE, COMM, SIZE, IERROR)
41        INTEGER INCOUNT, DATATYPE, COMM, SIZE, IERROR
42
43    MPI_TYPE_COMMIT(DATATYPE, IERROR)
44        INTEGER DATATYPE, IERROR
45
46    MPI_TYPE_CONTIGUOUS(COUNT, OLDTYPE, NEWTYPE, IERROR)
47        INTEGER COUNT, OLDTYPE, NEWTYPE, IERROR
48
49    MPI_TYPE_CREATE_DARRAY(SIZE, RANK, NDIMS, ARRAY_OF_GSIZES,
50        ARRAY_OF_DISTRIBS, ARRAY_OF_DARGS, ARRAY_OF_PSIZEs, ORDER,
51        OLDTYPE, NEWTYPE, IERROR)
52        INTEGER SIZE, RANK, NDIMS, ARRAY_OF_GSIZES(*), ARRAY_OF_DISTRIBS(*),
53        ARRAY_OF_DARGS(*), ARRAY_OF_PSIZEs(*), ORDER, OLDTYPE,

```

```

NEWTYPE, IERROR)
1
MPI_TYPE_CREATE_HINDEXED_BLOCK(COUNT, BLOCKLENGTH, ARRAY_OF_DISPLACEMENTS,
2
OLDTYPE, NEWTYPE, IERROR)
3
INTEGER COUNT, BLOCKLENGTH, OLDTYPE, NEWTYPE, IERROR
4
INTEGER(KIND=MPI_ADDRESS_KIND) ARRAY_OF_DISPLACEMENTS(*)
5
6
MPI_TYPE_CREATE_HINDEXED(COUNT, ARRAY_OF_BLOCKLENGTHS,
7
ARRAY_OF_DISPLACEMENTS, OLDTYPE, NEWTYPE, IERROR)
8
INTEGER COUNT, ARRAY_OF_BLOCKLENGTHS(*), OLDTYPE, NEWTYPE, IERROR
9
INTEGER(KIND=MPI_ADDRESS_KIND) ARRAY_OF_DISPLACEMENTS(*)
10
11
MPI_TYPE_CREATE_HVECTOR(COUNT, BLOCKLENGTH, STRIDE, OLDTYPE, NEWTYPE,
12
IERROR)
13
INTEGER COUNT, BLOCKLENGTH, OLDTYPE, NEWTYPE, IERROR
14
INTEGER(KIND=MPI_ADDRESS_KIND) STRIDE
15
16
MPI_TYPE_CREATE_INDEXED_BLOCK(COUNT, BLOCKLENGTH, ARRAY_OF_DISPLACEMENTS,
17
OLDTYPE, NEWTYPE, IERROR)
18
INTEGER COUNT, BLOCKLENGTH, ARRAY_OF_DISPLACEMENTS(*), OLDTYPE,
19
NEWTYPE, IERROR
20
21
MPI_TYPE_CREATE_RESIZED(OLDTYPE, LB, EXTENT, NEWTYPE, IERROR)
22
INTEGER OLDTYPE, NEWTYPE, IERROR
23
INTEGER(KIND=MPI_ADDRESS_KIND) LB, EXTENT
24
25
MPI_TYPE_CREATE_STRUCT(COUNT, ARRAY_OF_BLOCKLENGTHS,
26
ARRAY_OF_DISPLACEMENTS, ARRAY_OF_TYPES, NEWTYPE, IERROR)
27
INTEGER COUNT, ARRAY_OF_BLOCKLENGTHS(*), ARRAY_OF_TYPES(*), NEWTYPE,
28
IERROR
29
INTEGER(KIND=MPI_ADDRESS_KIND) ARRAY_OF_DISPLACEMENTS(*)
30
31
MPI_TYPE_CREATE_SUBARRAY(NDIMS, ARRAY_OF_SIZES, ARRAY_OF_SUBSIZES,
32
ARRAY_OF_STARTS, ORDER, OLDTYPE, NEWTYPE, IERROR)
33
INTEGER NDIMS, ARRAY_OF_SIZES(*), ARRAY_OF_SUBSIZES(*),
34
ARRAY_OF_STARTS(*), ORDER, OLDTYPE, NEWTYPE, IERROR
35
36
MPI_TYPE_DUP(OLDTYPE, NEWTYPE, IERROR)
37
INTEGER OLDTYPE, NEWTYPE, IERROR
38
39
MPI_TYPE_FREE(DATATYPE, IERROR)
40
INTEGER DATATYPE, IERROR
41
42
MPI_TYPE_GET_CONTENTS(DATATYPE, MAX_INTEGERS, MAX_ADDRESSES, MAX_DATATYPES,
43
ARRAY_OF_INTEGERS, ARRAY_OF_ADDRESSES, ARRAY_OF_DATATYPES,
44
IERROR)
45
INTEGER DATATYPE, MAX_INTEGERS, MAX_ADDRESSES, MAX_DATATYPES,
46
ARRAY_OF_INTEGERS(*), ARRAY_OF_DATATYPES(*), IERROR
47
INTEGER(KIND=MPI_ADDRESS_KIND) ARRAY_OF_ADDRESSES(*)
48
49
MPI_TYPE_GET_ENVELOPE(DATATYPE, NUM_INTEGERS, NUM_ADDRESSES, NUM_DATATYPES,
50
COMBINER, IERROR)
51
INTEGER DATATYPE, NUM_INTEGERS, NUM_ADDRESSES, NUM_DATATYPES, COMBINER,
52
IERROR)
53

```

```

1           IERROR
2
3 MPI_TYPE_GET_EXTENT(DATATYPE, LB, EXTENT, IERROR)
4     INTEGER DATATYPE, IERROR
5     INTEGER(KIND=MPI_ADDRESS_KIND) LB, EXTENT
6
7 MPI_TYPE_GET_EXTENT_X(DATATYPE, LB, EXTENT, IERROR)
8     INTEGER DATATYPE, IERROR
9     INTEGER(KIND=MPI_COUNT_KIND) LB, EXTENT
10
11 MPI_TYPE_GET_TRUE_EXTENT(DATATYPE, TRUE_LB, TRUE_EXTENT, IERROR)
12     INTEGER DATATYPE, IERROR
13     INTEGER(KIND=MPI_ADDRESS_KIND) TRUE_LB, TRUE_EXTENT
14
15 MPI_TYPE_GET_TRUE_EXTENT_X(DATATYPE, TRUE_LB, TRUE_EXTENT, IERROR)
16     INTEGER DATATYPE, IERROR
17     INTEGER(KIND=MPI_COUNT_KIND) TRUE_LB, TRUE_EXTENT
18
19 MPI_TYPE_INDEXED(COUNT, ARRAY_OF_BLOCKLENGTHS, ARRAY_OF_DISPLACEMENTS,
20     OLDTYPE, NEWTYPE, IERROR)
21     INTEGER COUNT, ARRAY_OF_BLOCKLENGTHS(*), ARRAY_OF_DISPLACEMENTS(*),
22     OLDTYPE, NEWTYPE, IERROR
23
24 MPI_TYPE_SIZE(DATATYPE, SIZE, IERROR)
25     INTEGER DATATYPE, SIZE, IERROR
26
27 MPI_TYPE_SIZE_X(DATATYPE, SIZE, IERROR)
28     INTEGER DATATYPE, IERROR
29     INTEGER(KIND=MPI_COUNT_KIND) SIZE
30
31 MPI_TYPE_VECTOR(COUNT, BLOCKLENGTH, STRIDE, OLDTYPE, NEWTYPE, IERROR)
32     INTEGER COUNT, BLOCKLENGTH, STRIDE, OLDTYPE, NEWTYPE, IERROR
33
34 MPI_UNPACK_EXTERNAL(DATAREP, INBUF, INSIZE, POSITION, OUTBUF, OUTCOUNT,
35     DATATYPE, IERROR)
36     INTEGER OUTCOUNT, DATATYPE, IERROR
37     INTEGER(KIND=MPI_ADDRESS_KIND) INSIZE, POSITION
38     CHARACTER*(*) DATAREP
39     <type> INBUF(*), OUTBUF(*)
40
41 MPI_UNPACK(INBUF, INSIZE, POSITION, OUTBUF, OUTCOUNT, DATATYPE, COMM,
42     IERROR)
43     <type> INBUF(*), OUTBUF(*)
44     INTEGER INSIZE, POSITION, OUTCOUNT, DATATYPE, COMM, IERROR
45
46 A.4.3 Collective Communication Fortran Bindings
47
48 MPI_ALLGATHER_INIT(SENDBUF, SENDCOUNT, SENDTYPE, RECVBUFF, RECVCOUNT,
49     RECVMODE, COMM, INFO, REQUEST, IERROR)
50     <type> SENDBUF(*), RECVBUFF(*)
51     INTEGER SENDCOUNT, SENDTYPE, RECVCOUNT, RECVMODE, COMM, INFO, REQUEST,
52     IERROR

```

```

MPI_ALLGATHER(SENDBUF, SENDCOUNT, SENDTYPE, RECVBUF, REVCOUNT, RECVTYPE,
              COMM, IERROR)
    <type> SENDBUF(*), RECVBUF(*)
    INTEGER SENDCOUNT, SENDTYPE, REVCOUNT, RECVTYPE, COMM, IERROR
MPI_ALLGATHERV_INIT(SENDBUF, SENDCOUNT, SENDTYPE, RECVBUF, REVCOUNTS,
                   DISPLS, RECVTYPE, COMM, INFO, REQUEST, IERROR)
    <type> SENDBUF(*), RECVBUF(*)
    INTEGER SENDCOUNT, SENDTYPE, REVCOUNTS(*), DISPLS(*), RECVTYPE, COMM,
    INFO, REQUEST, IERROR
MPI_ALLGATHERV(SENDBUF, SENDCOUNT, SENDTYPE, RECVBUF, REVCOUNTS, DISPLS,
              RECVTYPE, COMM, IERROR)
    <type> SENDBUF(*), RECVBUF(*)
    INTEGER SENDCOUNT, SENDTYPE, REVCOUNTS(*), DISPLS(*), RECVTYPE, COMM,
    IERROR
MPI_ALLREDUCE_INIT(SENDBUF, RECVBUF, COUNT, DATATYPE, OP, COMM, INFO,
                  REQUEST, IERROR)
    <type> SENDBUF(*), RECVBUF(*)
    INTEGER COUNT, DATATYPE, OP, COMM, INFO, REQUEST, IERROR
MPI_ALLREDUCE(SENDBUF, RECVBUF, COUNT, DATATYPE, OP, COMM, IERROR)
    <type> SENDBUF(*), RECVBUF(*)
    INTEGER COUNT, DATATYPE, OP, COMM, IERROR
MPI_ALLTOALL_INIT(SENDBUF, SENDCOUNT, SENDTYPE, RECVBUF, REVCOUNT,
                 RECVTYPE, COMM, INFO, REQUEST, IERROR)
    <type> SENDBUF(*), RECVBUF(*)
    INTEGER SENDCOUNT, SENDTYPE, REVCOUNT, RECVTYPE, COMM, INFO, REQUEST,
    IERROR
MPI_ALLTOALL(SENDBUF, SENDCOUNT, SENDTYPE, RECVBUF, REVCOUNT, RECVTYPE,
            COMM, IERROR)
    <type> SENDBUF(*), RECVBUF(*)
    INTEGER SENDCOUNT, SENDTYPE, REVCOUNT, RECVTYPE, COMM, IERROR
MPI_ALLTOALLV_INIT(SENDBUF, SENDCOUNTS, SDISPLS, SENDTYPE, RECVBUF,
                  REVCOUNTS, RDISPLS, RECVTYPE, COMM, INFO, REQUEST, IERROR)
    <type> SENDBUF(*), RECVBUF(*)
    INTEGER SENDCOUNTS(*), SDISPLS(*), SENDTYPE, REVCOUNTS(*), RDISPLS(*),
    RECVTYPE, COMM, INFO, REQUEST, IERROR
MPI_ALLTOALLV(SENDBUF, SENDCOUNTS, SDISPLS, SENDTYPE, RECVBUF, REVCOUNTS,
            RDISPLS, RECVTYPE, COMM, IERROR)
    <type> SENDBUF(*), RECVBUF(*)
    INTEGER SENDCOUNTS(*), SDISPLS(*), SENDTYPE, REVCOUNTS(*), RDISPLS(*),
    RECVTYPE, COMM, IERROR
MPI_ALLTOALLW_INIT(SENDBUF, SENDCOUNTS, SDISPLS, SENDTYPES, RECVBUF,
                  REVCOUNTS, RDISPLS, RECVTYPES, COMM, INFO, REQUEST, IERROR)
    <type> SENDBUF(*), RECVBUF(*)

```

```

1     INTEGER SENDCOUNTS(*), SDISPLS(*), SENDTYPES(*), RECVCOUNTS(*),
2         RDISPLS(*), RECVTYPES(*), COMM, INFO, REQUEST, IERROR
3
4     MPI_ALLTOALLW(SENDBUF, SENDCOUNTS, SDISPLS, SENDTYPES, RECVBUF, RECVCOUNTS,
5         RDISPLS, RECVTYPES, COMM, IERROR)
6     <type> SENDBUF(*), RECVBUF(*)
7     INTEGER SENDCOUNTS(*), SDISPLS(*), SENDTYPES(*), RECVCOUNTS(*),
8         RDISPLS(*), RECVTYPES(*), COMM, IERROR
9
10    MPI_BARRIER(COMM, IERROR)
11    INTEGER COMM, IERROR
12
13    MPI_BARRIER_INIT(COMM, INFO, REQUEST, IERROR)
14    INTEGER COMM, INFO, REQUEST, IERROR
15
16    MPI_BCAST(BUFFER, COUNT, DATATYPE, ROOT, COMM, IERROR)
17    <type> BUFFER(*)
18    INTEGER COUNT, DATATYPE, ROOT, COMM, IERROR
19
20    MPI_BCAST_INIT(BUFFER, COUNT, DATATYPE, ROOT, COMM, INFO, REQUEST, IERROR)
21    <type> BUFFER(*)
22    INTEGER COUNT, DATATYPE, ROOT, COMM, INFO, REQUEST, IERROR
23
24    MPI_EXSCAN_INIT(SENDBUF, RECVBUF, COUNT, DATATYPE, OP, COMM, INFO, REQUEST,
25        IERROR)
26    <type> SENDBUF(*), RECVBUF(*)
27    INTEGER COUNT, DATATYPE, OP, COMM, INFO, REQUEST, IERROR
28
29    MPI_EXSCAN(SENDBUF, RECVBUF, COUNT, DATATYPE, OP, COMM, IERROR)
30    <type> SENDBUF(*), RECVBUF(*)
31    INTEGER COUNT, DATATYPE, OP, COMM, IERROR
32
33    MPI_GATHER_INIT(SENDBUF, SENDCOUNT, SENDTYPE, RECVBUF, RECVCOUNT, RECVTYPE,
34        ROOT, COMM, INFO, REQUEST, IERROR)
35    <type> SENDBUF(*), RECVBUF(*)
36    INTEGER SENDCOUNT, SENDTYPE, RECVCOUNT, RECVTYPE, ROOT, COMM, INFO,
37        REQUEST, IERROR
38
39    MPI_GATHER(SENDBUF, SENDCOUNT, SENDTYPE, RECVBUF, RECVCOUNT, RECVTYPE,
40        ROOT, COMM, IERROR)
41    <type> SENDBUF(*), RECVBUF(*)
42    INTEGER SENDCOUNT, SENDTYPE, RECVCOUNT, RECVTYPE, ROOT, COMM, INFO,
43        REQUEST, IERROR
44
45    MPI_GATHERV_INIT(SENDBUF, SENDCOUNT, SENDTYPE, RECVBUF, RECVCOUNTS, DISPLS,
46        RECVTYPE, ROOT, COMM, INFO, REQUEST, IERROR)
47    <type> SENDBUF(*), RECVBUF(*)
48    INTEGER SENDCOUNT, SENDTYPE, RECVCOUNTS(*), DISPLS(*), RECVTYPE, ROOT,

```



```

COMM, IERROR 1
MPI_IALLGATHER(SENDBUF, SENDCOUNT, SENDTYPE, RECVBUF, REVCOUNT, RECVTYPE, 2
COMM, REQUEST, IERROR) 3
<type> SENDBUF(*), RECVBUF(*) 4
INTEGER SENDCOUNT, SENDTYPE, REVCOUNT, RECVTYPE, COMM, REQUEST, IERROR 5
MPI_IALLGATHERV(SENDBUF, SENDCOUNT, SENDTYPE, RECVBUF, REVCOUNTS, DISPLS, 6
RECVTYPE, COMM, REQUEST, IERROR) 7
<type> SENDBUF(*), RECVBUF(*) 8
INTEGER SENDCOUNT, SENDTYPE, REVCOUNTS(*), DISPLS(*), RECVTYPE, COMM, 9
REQUEST, IERROR 10
MPI_IALLREDUCE(SENDBUF, RECVBUF, COUNT, DATATYPE, OP, COMM, REQUEST, 11
IERROR) 12
<type> SENDBUF(*), RECVBUF(*) 13
INTEGER COUNT, DATATYPE, OP, COMM, REQUEST, IERROR 14
MPI_IALLTOALL(SENDBUF, SENDCOUNT, SENDTYPE, RECVBUF, REVCOUNT, RECVTYPE, 15
COMM, REQUEST, IERROR) 16
<type> SENDBUF(*), RECVBUF(*) 17
INTEGER SENDCOUNT, SENDTYPE, REVCOUNT, RECVTYPE, COMM, REQUEST, IERROR 18
MPI_IALLTOALLV(SENDBUF, SENDCOUNTS, SDISPLS, SENDTYPE, RECVBUF, REVCOUNTS, 19
RDISPLS, RECVTYPE, COMM, REQUEST, IERROR) 20
<type> SENDBUF(*), RECVBUF(*) 21
INTEGER SENDCOUNTS(*), SDISPLS(*), SENDTYPE, REVCOUNTS(*), RDISPLS(*), 22
RECVTYPE, COMM, REQUEST, IERROR 23
MPI_IALLTOALLW(SENDBUF, SENDCOUNTS, SDISPLS, SENDTYPES, RECVBUF, 24
REVCOUNTS, RDISPLS, RECVTYPES, COMM, REQUEST, IERROR) 25
<type> SENDBUF(*), RECVBUF(*) 26
INTEGER SENDCOUNTS(*), SDISPLS(*), SENDTYPES(*), REVCOUNTS(*), 27
RDISPLS(*), RECVTYPES(*), COMM, REQUEST, IERROR 28
MPI_IBARRIER(COMM, REQUEST, IERROR) 29
INTEGER COMM, REQUEST, IERROR 30
MPI_IBCAST(BUFFER, COUNT, DATATYPE, ROOT, COMM, REQUEST, IERROR) 31
<type> BUFFER(*) 32
INTEGER COUNT, DATATYPE, ROOT, COMM, REQUEST, IERROR 33
MPI_IEXSCAN(SENDBUF, RECVBUF, COUNT, DATATYPE, OP, COMM, REQUEST, IERROR) 34
<type> SENDBUF(*), RECVBUF(*) 35
INTEGER COUNT, DATATYPE, OP, COMM, REQUEST, IERROR 36
MPI_IGATHER(SENDBUF, SENDCOUNT, SENDTYPE, RECVBUF, REVCOUNT, RECVTYPE, 37
ROOT, COMM, REQUEST, IERROR) 38
<type> SENDBUF(*), RECVBUF(*) 39
INTEGER SENDCOUNT, SENDTYPE, REVCOUNT, RECVTYPE, ROOT, COMM, REQUEST, 40
IERROR 41
MPI_IGATHERV(SENDBUF, SENDCOUNT, SENDTYPE, RECVBUF, REVCOUNTS, DISPLS, 42

```

```

1         RECVTYPE, ROOT, COMM, REQUEST, IERROR)
2     <type> SENDBUF(*), RECVBUF(*)
3     INTEGER SENDCOUNT, SENDTYPE, RECVCOUNTS(*), DISPLS(*), RECVTYPE, ROOT,
4         COMM, REQUEST, IERROR
5
6     MPI_IREDUCE_SCATTER_BLOCK(SENDBUF, RECVBUF, RECVCOUNT, DATATYPE, OP, COMM,
7         REQUEST, IERROR)
8     <type> SENDBUF(*), RECVBUF(*)
9     INTEGER RECVCOUNT, DATATYPE, OP, COMM, REQUEST, IERROR
10
11    MPI_IREDUCE_SCATTER(SENDBUF, RECVBUF, RECVCOUNTS, DATATYPE, OP, COMM,
12        REQUEST, IERROR)
13    <type> SENDBUF(*), RECVBUF(*)
14    INTEGER RECVCOUNTS(*), DATATYPE, OP, COMM, REQUEST, IERROR
15
16    MPI_IREDUCE(SENDBUF, RECVBUF, COUNT, DATATYPE, OP, ROOT, COMM, REQUEST,
17        IERROR)
18    <type> SENDBUF(*), RECVBUF(*)
19    INTEGER COUNT, DATATYPE, OP, ROOT, COMM, REQUEST, IERROR
20
21    MPI_ISCAN(SENDBUF, RECVBUF, COUNT, DATATYPE, OP, COMM, REQUEST, IERROR)
22    <type> SENDBUF(*), RECVBUF(*)
23    INTEGER COUNT, DATATYPE, OP, COMM, REQUEST, IERROR
24
25    MPI_ISCATTER(SENDBUF, SENDCOUNT, SENDTYPE, RECVBUF, RECVCOUNT, RECVTYPE,
26        ROOT, COMM, REQUEST, IERROR)
27    <type> SENDBUF(*), RECVBUF(*)
28    INTEGER SENDCOUNT, SENDTYPE, RECVCOUNT, RECVTYPE, ROOT, COMM, REQUEST,
29        IERROR
30
31    MPI_ISCATTERV(SENDBUF, SENDCOUNTS, DISPLS, SENDTYPE, RECVBUF, RECVCOUNT,
32        RECVTYPE, ROOT, COMM, REQUEST, IERROR)
33    <type> SENDBUF(*), RECVBUF(*)
34    INTEGER SENDCOUNTS(*), DISPLS(*), SENDTYPE, RECVCOUNT, RECVTYPE, ROOT,
35        COMM, REQUEST, IERROR
36
37    MPI_OP_COMMUTATIVE(OP, COMMUTE, IERROR)
38    LOGICAL COMMUTE
39    INTEGER OP, IERROR
40
41    MPI_OP_CREATE( USER_FN, COMMUTE, OP, IERROR)
42    EXTERNAL USER_FN
43    LOGICAL COMMUTE
44    INTEGER OP, IERROR
45
46    MPI_OP_FREE(OP, IERROR)
47    INTEGER OP, IERROR
48
49    MPI_REDUCE_INIT(SENDBUF, RECVBUF, COUNT, DATATYPE, OP, ROOT, COMM, INFO,
50        REQUEST, IERROR)
51    <type> SENDBUF(*), RECVBUF(*)
52    INTEGER COUNT, DATATYPE, OP, ROOT, COMM, INFO, REQUEST, IERROR

```

```

MPI_REDUCE_LOCAL(INBUF, INOUTBUF, COUNT, DATATYPE, OP, IERROR)      1
  <type> INBUF(*), INOUTBUF(*)                                     2
  INTEGER COUNT, DATATYPE, OP, IERROR                             3
                                                                    4
MPI_REDUCE_SCATTER_BLOCK_INIT(SENDBUF, RECVBUF, RECVCOUNT, DATATYPE, OP,  5
  COMM, INFO, REQUEST, IERROR)                                    6
  <type> SENDBUF(*), RECVBUF(*)                                   7
  INTEGER RECVCOUNT, DATATYPE, OP, COMM, INFO, REQUEST, IERROR  8
                                                                    9
MPI_REDUCE_SCATTER_BLOCK(SENDBUF, RECVBUF, RECVCOUNT, DATATYPE, OP, COMM, 10
  IERROR)                                                         11
  <type> SENDBUF(*), RECVBUF(*)                                   12
  INTEGER RECVCOUNT, DATATYPE, OP, COMM, IERROR                 13
                                                                    14
MPI_REDUCE_SCATTER_INIT(SENDBUF, RECVBUF, RECVCOUNTS, DATATYPE, OP, COMM, 15
  INFO, REQUEST, IERROR)                                         16
  <type> SENDBUF(*), RECVBUF(*)                                   17
  INTEGER RECVCOUNTS(*), DATATYPE, OP, COMM, INFO, REQUEST, IERROR 18
                                                                    19
MPI_REDUCE_SCATTER(SENDBUF, RECVBUF, RECVCOUNTS, DATATYPE, OP, COMM, 20
  IERROR)                                                         21
  <type> SENDBUF(*), RECVBUF(*)                                   22
  INTEGER RECVCOUNTS(*), DATATYPE, OP, COMM, IERROR            23
                                                                    24
MPI_REDUCE(SENDBUF, RECVBUF, COUNT, DATATYPE, OP, ROOT, COMM, IERROR) 25
  <type> SENDBUF(*), RECVBUF(*)                                   26
  INTEGER COUNT, DATATYPE, OP, ROOT, COMM, IERROR              27
                                                                    28
MPI_SCAN_INIT(SENDBUF, RECVBUF, COUNT, DATATYPE, OP, COMM, INFO, REQUEST, 29
  IERROR)                                                         30
  <type> SENDBUF(*), RECVBUF(*)                                   31
  INTEGER COUNT, DATATYPE, OP, COMM, INFO, REQUEST, IERROR    32
                                                                    33
MPI_SCAN(SENDBUF, RECVBUF, COUNT, DATATYPE, OP, COMM, IERROR)      34
  <type> SENDBUF(*), RECVBUF(*)                                   35
  INTEGER COUNT, DATATYPE, OP, COMM, IERROR                    36
                                                                    37
MPI_SCATTER_INIT(SENDBUF, SENDCOUNT, SENDTYPE, RECVBUF, RECVCOUNT, 38
  RECVMODE, ROOT, COMM, INFO, REQUEST, IERROR)                  39
  <type> SENDBUF(*), RECVBUF(*)                                   40
  INTEGER SENDCOUNT, SENDTYPE, RECVCOUNT, RECVMODE, ROOT, COMM, INFO, 41
  REQUEST, IERROR                                               42
                                                                    43
MPI_SCATTER(SENDBUF, SENDCOUNT, SENDTYPE, RECVBUF, RECVCOUNT, RECVMODE, 44
  ROOT, COMM, IERROR)                                           45
  <type> SENDBUF(*), RECVBUF(*)                                   46
  INTEGER SENDCOUNT, SENDTYPE, RECVCOUNT, RECVMODE, ROOT, COMM, IERROR 47
                                                                    48
MPI_SCATTERV_INIT(SENDBUF, SENDCOUNTS, DISPLS, SENDTYPE, RECVBUF, 49
  RECVCOUNT, RECVMODE, ROOT, COMM, INFO, REQUEST, IERROR)      50
  <type> SENDBUF(*), RECVBUF(*)                                   51
  INTEGER SENDCOUNTS(*), DISPLS(*), SENDTYPE, RECVCOUNT, RECVMODE, ROOT, 52
  IERROR                                                         53

```

```

1           COMM, INFO, REQUEST, IERROR
2
3 MPI_SCATTERV(SENDBUF, SENDCOUNTS, DISPLS, SENDTYPE, RECVBUF, REVCOUNT,
4             RECVTYPE, ROOT, COMM, IERROR)
5     <type> SENDBUF(*), RECVBUF(*)
6     INTEGER SENDCOUNTS(*), DISPLS(*), SENDTYPE, REVCOUNT, RECVTYPE, ROOT,
7             COMM, IERROR
8
9
10          A.4.4 Groups, Contexts, Communicators, and Caching Fortran Bindings
11
12 MPI_COMM_COMPARE(COMM1, COMM2, RESULT, IERROR)
13     INTEGER COMM1, COMM2, RESULT, IERROR
14
15 MPI_COMM_CREATE(COMM, GROUP, NEWCOMM, IERROR)
16     INTEGER COMM, GROUP, NEWCOMM, IERROR
17
18 MPI_COMM_CREATE_GROUP(COMM, GROUP, TAG, NEWCOMM, IERROR)
19     INTEGER COMM, GROUP, TAG, NEWCOMM, IERROR
20
21 MPI_COMM_CREATE_KEYVAL(COMM_COPY_ATTR_FN, COMM_DELETE_ATTR_FN, COMM_KEYVAL,
22     EXTRA_STATE, IERROR)
23     EXTERNAL COMM_COPY_ATTR_FN, COMM_DELETE_ATTR_FN
24     INTEGER COMM_KEYVAL, IERROR
25     INTEGER(KIND=MPI_ADDRESS_KIND) EXTRA_STATE
26
27 MPI_COMM_DELETE_ATTR(COMM, COMM_KEYVAL, IERROR)
28     INTEGER COMM, COMM_KEYVAL, IERROR
29
30 MPI_COMM_DUP(COMM, NEWCOMM, IERROR)
31     INTEGER COMM, NEWCOMM, IERROR
32
33 MPI_COMM_DUP_FN(OLDCOMM, COMM_KEYVAL, EXTRA_STATE, ATTRIBUTE_VAL_IN,
34     ATTRIBUTE_VAL_OUT, FLAG, IERROR)
35     INTEGER OLDCOMM, COMM_KEYVAL, IERROR
36     INTEGER(KIND=MPI_ADDRESS_KIND) EXTRA_STATE, ATTRIBUTE_VAL_IN,
37     ATTRIBUTE_VAL_OUT
38     LOGICAL FLAG
39
40 MPI_COMM_DUP_WITH_INFO(COMM, INFO, NEWCOMM, IERROR)
41     INTEGER COMM, INFO, NEWCOMM, IERROR
42
43 MPI_COMM_FREE(COMM, IERROR)
44     INTEGER COMM, IERROR
45
46 MPI_COMM_FREE_KEYVAL(COMM_KEYVAL, IERROR)
47     INTEGER COMM_KEYVAL, IERROR
48
49 MPI_COMM_GET_ATTR(COMM, COMM_KEYVAL, ATTRIBUTE_VAL, FLAG, IERROR)
50     INTEGER COMM, COMM_KEYVAL, IERROR
51     INTEGER(KIND=MPI_ADDRESS_KIND) ATTRIBUTE_VAL
52     LOGICAL FLAG
53
54 MPI_COMM_GET_INFO(COMM, INFO_USED, IERROR)

```

INTEGER COMM, INFO_USED, IERROR	1
MPI_COMM_GET_NAME(COMM, COMM_NAME, RESULTLEN, IERROR)	2
INTEGER COMM, RESULTLEN, IERROR	3
CHARACTER*(*) COMM_NAME	4
	5
MPI_COMM_GROUP(COMM, GROUP, IERROR)	6
INTEGER COMM, GROUP, IERROR	7
	8
MPI_COMM_IDUP(COMM, NEWCOMM, REQUEST, IERROR)	9
INTEGER COMM, NEWCOMM, REQUEST, IERROR	10
	11
MPI_COMM_IDUP_WITH_INFO(COMM, INFO, NEWCOMM, REQUEST, IERROR)	12
INTEGER COMM, INFO, NEWCOMM, REQUEST, IERROR	13
	14
MPI_COMM_NULL_COPY_FN(OLDCOMM, COMM_KEYVAL, EXTRA_STATE, ATTRIBUTE_VAL_IN, ATTRIBUTE_VAL_OUT, FLAG, IERROR)	15
INTEGER OLDCOMM, COMM_KEYVAL, IERROR	16
INTEGER(KIND=MPI_ADDRESS_KIND) EXTRA_STATE, ATTRIBUTE_VAL_IN, ATTRIBUTE_VAL_OUT	17
LOGICAL FLAG	18
	19
MPI_COMM_NULL_DELETE_FN(COMM, COMM_KEYVAL, ATTRIBUTE_VAL, EXTRA_STATE, IERROR)	20
INTEGER COMM, COMM_KEYVAL, IERROR	21
INTEGER(KIND=MPI_ADDRESS_KIND) ATTRIBUTE_VAL, EXTRA_STATE	22
	23
MPI_COMM_RANK(COMM, RANK, IERROR)	24
INTEGER COMM, RANK, IERROR	25
	26
MPI_COMM_REMOTE_GROUP(COMM, GROUP, IERROR)	27
INTEGER COMM, GROUP, IERROR	28
	29
MPI_COMM_REMOTE_SIZE(COMM, SIZE, IERROR)	30
INTEGER COMM, SIZE, IERROR	31
	32
MPI_COMM_SET_ATTR(COMM, COMM_KEYVAL, ATTRIBUTE_VAL, IERROR)	33
INTEGER COMM, COMM_KEYVAL, IERROR	34
INTEGER(KIND=MPI_ADDRESS_KIND) ATTRIBUTE_VAL	35
	36
MPI_COMM_SET_INFO(COMM, INFO, IERROR)	37
INTEGER COMM, INFO, IERROR	38
	39
MPI_COMM_SET_NAME(COMM, COMM_NAME, IERROR)	40
INTEGER COMM, IERROR	41
CHARACTER*(*) COMM_NAME	42
	43
MPI_COMM_SIZE(COMM, SIZE, IERROR)	44
INTEGER COMM, SIZE, IERROR	45
	46
MPI_COMM_SPLIT(COMM, COLOR, KEY, NEWCOMM, IERROR)	47
INTEGER COMM, COLOR, KEY, NEWCOMM, IERROR	48
	49
MPI_COMM_SPLIT_TYPE(COMM, SPLIT_TYPE, KEY, INFO, NEWCOMM, IERROR)	50
INTEGER COMM, SPLIT_TYPE, KEY, INFO, NEWCOMM, IERROR	51

```

1 MPI_COMM_TEST_INTER(COMM, FLAG, IERROR)
2     INTEGER COMM, IERROR
3     LOGICAL FLAG
4
5 MPI_GROUP_COMPARE(GROUP1, GROUP2, RESULT, IERROR)
6     INTEGER GROUP1, GROUP2, RESULT, IERROR
7
8 MPI_GROUP_DIFFERENCE(GROUP1, GROUP2, NEWGROUP, IERROR)
9     INTEGER GROUP1, GROUP2, NEWGROUP, IERROR
10
11 MPI_GROUP_EXCL(GROUP, N, RANKS, NEWGROUP, IERROR)
12     INTEGER GROUP, N, RANKS(*), NEWGROUP, IERROR
13
14 MPI_GROUP_FREE(GROUP, IERROR)
15     INTEGER GROUP, IERROR
16
17 MPI_GROUP_INCL(GROUP, N, RANKS, NEWGROUP, IERROR)
18     INTEGER GROUP, N, RANKS(*), NEWGROUP, IERROR
19
20 MPI_GROUP_INTERSECTION(GROUP1, GROUP2, NEWGROUP, IERROR)
21     INTEGER GROUP1, GROUP2, NEWGROUP, IERROR
22
23 MPI_GROUP_RANGE_EXCL(GROUP, N, RANGES, NEWGROUP, IERROR)
24     INTEGER GROUP, N, RANGES(3,*), NEWGROUP, IERROR
25
26 MPI_GROUP_RANGE_INCL(GROUP, N, RANGES, NEWGROUP, IERROR)
27     INTEGER GROUP, N, RANGES(3,*), NEWGROUP, IERROR
28
29 MPI_GROUP_RANK(GROUP, RANK, IERROR)
30     INTEGER GROUP, RANK, IERROR
31
32 MPI_GROUP_SIZE(GROUP, SIZE, IERROR)
33     INTEGER GROUP, SIZE, IERROR
34
35 MPI_GROUP_TRANSLATE_RANKS(GROUP1, N, RANKS1, GROUP2, RANKS2, IERROR)
36     INTEGER GROUP1, N, RANKS1(*), GROUP2, RANKS2(*), IERROR
37
38 MPI_GROUP_UNION(GROUP1, GROUP2, NEWGROUP, IERROR)
39     INTEGER GROUP1, GROUP2, NEWGROUP, IERROR
40
41 MPI_INTERCOMM_CREATE(LOCAL_COMM, LOCAL_LEADER, PEER_COMM, REMOTE_LEADER,
42     TAG, NEWINTERCOMM, IERROR)
43     INTEGER LOCAL_COMM, LOCAL_LEADER, PEER_COMM, REMOTE_LEADER, TAG,
44     NEWINTERCOMM, IERROR
45
46 MPI_INTERCOMM_MERGE(INTERCOMM, HIGH, NEWINTRACOMM, IERROR)
47     INTEGER INTERCOMM, NEWINTRACOMM, IERROR
48     LOGICAL HIGH
49
50 MPI_TYPE_CREATE_KEYVAL(TYPE_COPY_ATTR_FN, TYPE_DELETE_ATTR_FN, TYPE_KEYVAL,
51     EXTRA_STATE, IERROR)
52     EXTERNAL TYPE_COPY_ATTR_FN, TYPE_DELETE_ATTR_FN
53     INTEGER TYPE_KEYVAL, IERROR
54     INTEGER(KIND=MPI_ADDRESS_KIND) EXTRA_STATE
55
56
57
58
59
60
61
62
63
64
65
66
67
68
69
70
71
72
73
74
75
76
77
78
79
80
81
82
83
84
85
86
87
88
89
90
91
92
93
94
95
96
97
98
99

```

```

MPI_TYPE_DELETE_ATTR(DATATYPE, TYPE_KEYVAL, IERROR)           1
    INTEGER DATATYPE, TYPE_KEYVAL, IERROR                     2
                                                                3
MPI_TYPE_DUP_FN(OLDTYPE, TYPE_KEYVAL, EXTRA_STATE, ATTRIBUTE_VAL_IN,
    ATTRIBUTE_VAL_OUT, FLAG, IERROR)                           4
    INTEGER OLDTYPE, TYPE_KEYVAL, IERROR                       5
    INTEGER(KIND=MPI_ADDRESS_KIND) EXTRA_STATE, ATTRIBUTE_VAL_IN,
    ATTRIBUTE_VAL_OUT                                         6
    LOGICAL FLAG                                              7
                                                                8
MPI_TYPE_FREE_KEYVAL(TYPE_KEYVAL, IERROR)                      9
    INTEGER TYPE_KEYVAL, IERROR                               10
                                                                11
MPI_TYPE_GET_ATTR(DATATYPE, TYPE_KEYVAL, ATTRIBUTE_VAL, FLAG, IERROR)
    INTEGER DATATYPE, TYPE_KEYVAL, IERROR                     12
    INTEGER(KIND=MPI_ADDRESS_KIND) ATTRIBUTE_VAL              13
    LOGICAL FLAG                                             14
                                                                15
MPI_TYPE_GET_NAME(DATATYPE, TYPE_NAME, RESULTLEN, IERROR)    16
    INTEGER DATATYPE, RESULTLEN, IERROR                      17
    CHARACTER*(*) TYPE_NAME                                  18
                                                                19
MPI_TYPE_NULL_COPY_FN(OLDTYPE, TYPE_KEYVAL, EXTRA_STATE, ATTRIBUTE_VAL_IN,
    ATTRIBUTE_VAL_OUT, FLAG, IERROR)                          20
    INTEGER OLDTYPE, TYPE_KEYVAL, IERROR                     21
    INTEGER(KIND=MPI_ADDRESS_KIND) EXTRA_STATE, ATTRIBUTE_VAL_IN,
    ATTRIBUTE_VAL_OUT                                         22
    LOGICAL FLAG                                             23
                                                                24
MPI_TYPE_NULL_DELETE_FN(DATATYPE, TYPE_KEYVAL, ATTRIBUTE_VAL, EXTRA_STATE,
    IERROR)                                                    25
    INTEGER DATATYPE, TYPE_KEYVAL, IERROR                    26
    INTEGER(KIND=MPI_ADDRESS_KIND) ATTRIBUTE_VAL, EXTRA_STATE
                                                                27
MPI_TYPE_SET_ATTR(DATATYPE, TYPE_KEYVAL, ATTRIBUTE_VAL, IERROR)
    INTEGER DATATYPE, TYPE_KEYVAL, IERROR                     28
    INTEGER(KIND=MPI_ADDRESS_KIND) ATTRIBUTE_VAL              29
                                                                30
MPI_TYPE_SET_NAME(DATATYPE, TYPE_NAME, IERROR)                31
    INTEGER DATATYPE, IERROR                                  32
    CHARACTER*(*) TYPE_NAME                                  33
                                                                34
MPI_WIN_CREATE_KEYVAL(WIN_COPY_ATTR_FN, WIN_DELETE_ATTR_FN, WIN_KEYVAL,
    EXTRA_STATE, IERROR)                                      35
    EXTERNAL WIN_COPY_ATTR_FN, WIN_DELETE_ATTR_FN            36
    INTEGER WIN_KEYVAL, IERROR                                37
    INTEGER(KIND=MPI_ADDRESS_KIND) EXTRA_STATE               38
                                                                39
MPI_WIN_DELETE_ATTR(WIN, WIN_KEYVAL, IERROR)                   40
    INTEGER WIN, WIN_KEYVAL, IERROR                           41
                                                                42
MPI_WIN_DUP_FN(OLDWIN, WIN_KEYVAL, EXTRA_STATE, ATTRIBUTE_VAL_IN,
    ATTRIBUTE_VAL_OUT, FLAG, IERROR)                           43
    INTEGER OLDWIN, WIN_KEYVAL, EXTRA_STATE, ATTRIBUTE_VAL_IN,
    ATTRIBUTE_VAL_OUT, FLAG, IERROR                           44
                                                                45

```

```

1      INTEGER OLDWIN, WIN_KEYVAL, IERROR
2      INTEGER(KIND=MPI_ADDRESS_KIND) EXTRA_STATE, ATTRIBUTE_VAL_IN,
3          ATTRIBUTE_VAL_OUT
4      LOGICAL FLAG
5
6      MPI_WIN_FREE_KEYVAL(WIN_KEYVAL, IERROR)
7          INTEGER WIN_KEYVAL, IERROR
8
9      MPI_WIN_GET_ATTR(WIN, WIN_KEYVAL, ATTRIBUTE_VAL, FLAG, IERROR)
10         INTEGER WIN, WIN_KEYVAL, IERROR
11         INTEGER(KIND=MPI_ADDRESS_KIND) ATTRIBUTE_VAL
12         LOGICAL FLAG
13
14     MPI_WIN_GET_NAME(WIN, WIN_NAME, RESULTLEN, IERROR)
15         INTEGER WIN, RESULTLEN, IERROR
16         CHARACTER*(*) WIN_NAME
17
18     MPI_WIN_NULL_COPY_FN(OLDWIN, WIN_KEYVAL, EXTRA_STATE, ATTRIBUTE_VAL_IN,
19         ATTRIBUTE_VAL_OUT, FLAG, IERROR)
20         INTEGER OLDWIN, WIN_KEYVAL, IERROR
21         INTEGER(KIND=MPI_ADDRESS_KIND) EXTRA_STATE, ATTRIBUTE_VAL_IN,
22         ATTRIBUTE_VAL_OUT
23         LOGICAL FLAG
24
25     MPI_WIN_NULL_DELETE_FN(WIN, WIN_KEYVAL, ATTRIBUTE_VAL, EXTRA_STATE, IERROR)
26         INTEGER WIN, WIN_KEYVAL, IERROR
27         INTEGER(KIND=MPI_ADDRESS_KIND) ATTRIBUTE_VAL, EXTRA_STATE
28
29     MPI_WIN_SET_ATTR(WIN, WIN_KEYVAL, ATTRIBUTE_VAL, IERROR)
30         INTEGER WIN, WIN_KEYVAL, IERROR
31         INTEGER(KIND=MPI_ADDRESS_KIND) ATTRIBUTE_VAL
32
33     MPI_WIN_SET_NAME(WIN, WIN_NAME, IERROR)
34         INTEGER WIN, IERROR
35         CHARACTER*(*) WIN_NAME
36
37 A.4.5 Process Topologies Fortran Bindings
38
39     MPI_CART_COORDS(COMM, RANK, MAXDIMS, COORDS, IERROR)
40         INTEGER COMM, RANK, MAXDIMS, COORDS(*), IERROR
41
42     MPI_CART_CREATE(COMM_OLD, NDIMS, DIMS, PERIODS, REORDER, COMM_CART, IERROR)
43         INTEGER COMM_OLD, NDIMS, DIMS(*), COMM_CART, IERROR
44         LOGICAL PERIODS(*), REORDER
45
46     MPI_CART_CREATE_WEIGHTED(COMM_OLD, NDIMS, DIM_WEIGHTS, PERIODS, INFO, DIMS,
47         COMM_CART, IERROR)
48         INTEGER COMM_OLD, NDIMS, INFO, DIMS(*), COMM_CART, IERROR
49         DOUBLE PRECISION DIM_WEIGHTS(*)
50         LOGICAL PERIODS(*)
51
52     MPI_CARTDIM_GET(COMM, NDIMS, IERROR)

```

INTEGER COMM, NDIMS, IERROR	1
MPI_CART_GET(COMM, MAXDIMS, DIMS, PERIODS, COORDS, IERROR)	2
INTEGER COMM, MAXDIMS, DIMS(*), COORDS(*), IERROR	3
LOGICAL PERIODS(*)	4
MPI_CART_MAP(COMM, NDIMS, DIMS, PERIODS, NEWRANK, IERROR)	5
INTEGER COMM, NDIMS, DIMS(*), NEWRANK, IERROR	6
LOGICAL PERIODS(*)	7
MPI_CART_RANK(COMM, COORDS, RANK, IERROR)	8
INTEGER COMM, COORDS(*), RANK, IERROR	9
MPI_CART_SHIFT(COMM, DIRECTION, DISP, RANK_SOURCE, RANK_DEST, IERROR)	10
INTEGER COMM, DIRECTION, DISP, RANK_SOURCE, RANK_DEST, IERROR	11
MPI_CART_SUB(COMM, REMAIN_DIMS, NEWCOMM, IERROR)	12
INTEGER COMM, NEWCOMM, IERROR	13
LOGICAL REMAIN_DIMS(*)	14
MPI_DIMS_CREATE(NNODES, NDIMS, DIMS, IERROR)	15
INTEGER NNODES, NDIMS, DIMS(*), IERROR	16
MPI_DIMS_CREATE_WEIGHTED(NNODES, NDIMS, DIM_WEIGHTS, PERIODS, INFO, DIMS, IERROR)	17
INTEGER NNODES, INFO, NDIMS, DIMS(*), IERROR	18
DOUBLE PRECISION DIM_WEIGHTS(*)	19
LOGICAL PERIODS(*)	20
MPI_DIST_GRAPH_CREATE_ADJACENT(COMM_OLD, INDEGREE, SOURCES, SOURCEWEIGHTS, OUTDEGREE, DESTINATIONS, DESTWEIGHTS, INFO, REORDER, COMM_DIST_GRAPH, IERROR)	21
INTEGER COMM_OLD, INDEGREE, SOURCES(*), SOURCEWEIGHTS(*), OUTDEGREE, DESTINATIONS(*), DESTWEIGHTS(*), INFO, COMM_DIST_GRAPH, IERROR	22
LOGICAL REORDER	23
MPI_DIST_GRAPH_CREATE(COMM_OLD, N, SOURCES, DEGREES, DESTINATIONS, WEIGHTS, INFO, REORDER, COMM_DIST_GRAPH, IERROR)	24
INTEGER COMM_OLD, N, SOURCES(*), DEGREES(*), DESTINATIONS(*), WEIGHTS(*), INFO, COMM_DIST_GRAPH, IERROR	25
LOGICAL REORDER	26
MPI_DIST_GRAPH_NEIGHBORS(COMM, MAXINDEGREE, SOURCES, SOURCEWEIGHTS, MAXOUTDEGREE, DESTINATIONS, DESTWEIGHTS, IERROR)	27
INTEGER COMM, MAXINDEGREE, SOURCES(*), SOURCEWEIGHTS(*), MAXOUTDEGREE, DESTINATIONS(*), DESTWEIGHTS(*), IERROR	28
MPI_DIST_GRAPH_NEIGHBORS_COUNT(COMM, INDEGREE, OUTDEGREE, WEIGHTED, IERROR)	29
INTEGER COMM, INDEGREE, OUTDEGREE, IERROR	30
LOGICAL WEIGHTED	31
MPI_GRAPH_CREATE(COMM_OLD, NNODES, INDEX, EDGES, REORDER, COMM_GRAPH,	32
	33
	34
	35
	36
	37
	38
	39
	40
	41
	42
	43
	44
	45
	46
	47
	48

```

1           IERROR)
2     INTEGER COMM_OLD, NNODES, INDEX(*), EDGES(*), COMM_GRAPH, IERROR
3     LOGICAL REORDER
4
5     MPI_GRAPHDIMS_GET(COMM, NNODES, NEDGES, IERROR)
6     INTEGER COMM, NNODES, NEDGES, IERROR
7
8     MPI_GRAPH_GET(COMM, MAXINDEX, MAXEDGES, INDEX, EDGES, IERROR)
9     INTEGER COMM, MAXINDEX, MAXEDGES, INDEX(*), EDGES(*), IERROR
10
11    MPI_GRAPH_MAP(COMM, NNODES, INDEX, EDGES, NEWRANK, IERROR)
12    INTEGER COMM, NNODES, INDEX(*), EDGES(*), NEWRANK, IERROR
13
14    MPI_GRAPH_NEIGHBORS(COMM, RANK, MAXNEIGHBORS, NEIGHBORS, IERROR)
15    INTEGER COMM, RANK, MAXNEIGHBORS, NEIGHBORS(*), IERROR
16
17    MPI_GRAPH_NEIGHBORS_COUNT(COMM, RANK, NNEIGHBORS, IERROR)
18    INTEGER COMM, RANK, NNEIGHBORS, IERROR
19
20    MPI_INEIGHBOR_ALLGATHER(SENDBUF, SENDCOUNT, SENDTYPE, RECVBUF, RECVCOUNT,
21    RECVTYPE, COMM, REQUEST, IERROR)
22    <type> SENDBUF(*), RECVBUF(*)
23    INTEGER SENDCOUNT, SENDTYPE, RECVCOUNT, RECVTYPE, COMM, REQUEST, IERROR
24
25    MPI_INEIGHBOR_ALLGATHERV(SENDBUF, SENDCOUNT, SENDTYPE, RECVBUF, RECVCOUNTS,
26    DISPLS, RECVTYPE, COMM, REQUEST, IERROR)
27    <type> SENDBUF(*), RECVBUF(*)
28    INTEGER SENDCOUNT, SENDTYPE, RECVCOUNTS(*), DISPLS(*), RECVTYPE, COMM,
29    REQUEST, IERROR
30
31    MPI_INEIGHBOR_ALLTOALL(SENDBUF, SENDCOUNT, SENDTYPE, RECVBUF, RECVCOUNT,
32    RECVTYPE, COMM, REQUEST, IERROR)
33    <type> SENDBUF(*), RECVBUF(*)
34    INTEGER SENDCOUNT, SENDTYPE, RECVCOUNT, RECVTYPE, COMM, REQUEST, IERROR
35
36    MPI_INEIGHBOR_ALLTOALLV(SENDBUF, SENDCOUNTS, SDISPLS, SENDTYPE, RECVBUF,
37    RECVCOUNTS, RDISPLS, RECVTYPE, COMM, REQUEST, IERROR)
38    <type> SENDBUF(*), RECVBUF(*)
39    INTEGER SENDCOUNTS(*), SDISPLS(*), SENDTYPE, RECVCOUNTS(*), RDISPLS(*),
40    RECVTYPE, COMM, REQUEST, IERROR
41
42    MPI_INEIGHBOR_ALLTOALLW(SENDBUF, SENDCOUNTS, SDISPLS, SENDTYPES, RECVBUF,
43    RECVCOUNTS, RDISPLS, RECVTYPES, COMM, REQUEST, IERROR)
44    <type> SENDBUF(*), RECVBUF(*)
45    INTEGER(KIND=MPI_ADDRESS_KIND) SDISPLS(*), RDISPLS(*)
46    INTEGER SENDCOUNTS(*), SENDTYPES(*), RECVCOUNTS(*), RECVTYPES(*), COMM,
47    REQUEST, IERROR
48
49    MPI_NEIGHBOR_ALLGATHER_INIT(SENDBUF, SENDCOUNT, SENDTYPE, RECVBUF,
50    RECVCOUNT, RECVTYPE, COMM, INFO, REQUEST, IERROR)
51    <type> SENDBUF(*), RECVBUF(*)
52    INTEGER SENDCOUNT, SENDTYPE, RECVCOUNT, RECVTYPE, COMM, INFO, REQUEST,
53    IERROR

```

```

MPI_NEIGHBOR_ALLGATHER(SENDBUF, SENDCOUNT, SENDTYPE, RECVBUF, RECVCOUNT,
    RECVTYPE, COMM, IERROR)
    <type> SENDBUF(*), RECVBUF(*)
    INTEGER SENDCOUNT, SENDTYPE, RECVCOUNT, RECVTYPE, COMM, IERROR
MPI_NEIGHBOR_ALLGATHERV_INIT(SENDBUF, SENDCOUNT, SENDTYPE, RECVBUF,
    RECVCOUNTS, DISPLS, RECVTYPE, COMM, INFO, REQUEST, IERROR)
    <type> SENDBUF(*), RECVBUF(*)
    INTEGER SENDCOUNT, SENDTYPE, RECVCOUNTS(*), DISPLS(*), RECVTYPE, COMM,
    INFO, REQUEST, IERROR
MPI_NEIGHBOR_ALLGATHERV(SENDBUF, SENDCOUNT, SENDTYPE, RECVBUF, RECVCOUNTS,
    DISPLS, RECVTYPE, COMM, IERROR)
    <type> SENDBUF(*), RECVBUF(*)
    INTEGER SENDCOUNT, SENDTYPE, RECVCOUNTS(*), DISPLS(*), RECVTYPE, COMM,
    IERROR
MPI_NEIGHBOR_ALLTOALL_INIT(SENDBUF, SENDCOUNT, SENDTYPE, RECVBUF,
    RECVCOUNT, RECVTYPE, COMM, INFO, REQUEST, IERROR)
    <type> SENDBUF(*), RECVBUF(*)
    INTEGER SENDCOUNT, SENDTYPE, RECVCOUNT, RECVTYPE, COMM, INFO, REQUEST,
    IERROR
MPI_NEIGHBOR_ALLTOALL(SENDBUF, SENDCOUNT, SENDTYPE, RECVBUF, RECVCOUNT,
    RECVTYPE, COMM, IERROR)
    <type> SENDBUF(*), RECVBUF(*)
    INTEGER SENDCOUNT, SENDTYPE, RECVCOUNT, RECVTYPE, COMM, IERROR
MPI_NEIGHBOR_ALLTOALLV_INIT(SENDBUF, SENDCOUNTS, SDISPLS, SENDTYPE,
    RECVBUF, RECVCOUNTS, RDISPLS, RECVTYPE, COMM, INFO, REQUEST,
    IERROR)
    <type> SENDBUF(*), RECVBUF(*)
    INTEGER SENDCOUNTS(*), SDISPLS(*), SENDTYPE, RECVCOUNTS(*), RDISPLS(*),
    RECVTYPE, COMM, INFO, REQUEST, IERROR
MPI_NEIGHBOR_ALLTOALLV(SENDBUF, SENDCOUNTS, SDISPLS, SENDTYPE, RECVBUF,
    RECVCOUNTS, RDISPLS, RECVTYPE, COMM, IERROR)
    <type> SENDBUF(*), RECVBUF(*)
    INTEGER SENDCOUNTS(*), SDISPLS(*), SENDTYPE, RECVCOUNTS(*), RDISPLS(*),
    RECVTYPE, COMM, IERROR
MPI_NEIGHBOR_ALLTOALLW_INIT(SENDBUF, SENDCOUNTS, SDISPLS, SENDTYPES,
    RECVBUF, RECVCOUNTS, RDISPLS, RECVTYPES, COMM, INFO, REQUEST,
    IERROR)
    <type> SENDBUF(*), RECVBUF(*)
    INTEGER(KIND=MPI_ADDRESS_KIND) SDISPLS(*), RDISPLS(*)
    INTEGER SENDCOUNTS(*), SENDTYPES(*), RECVCOUNTS(*), RECVTYPES(*), COMM,
    INFO, REQUEST, IERROR
MPI_NEIGHBOR_ALLTOALLW(SENDBUF, SENDCOUNTS, SDISPLS, SENDTYPES, RECVBUF,
    RECVCOUNTS, RDISPLS, RECVTYPES, COMM, IERROR)

```

```

1      <type> SENDBUF(*), RECVBUF(*)
2      INTEGER(KIND=MPI_ADDRESS_KIND) SDISPLS(*), RDISPLS(*)
3      INTEGER SENDCOUNTS(*), SENDTYPES(*), RECVCOUNTS(*), RECVTYPES(*), COMM,
4          IERROR
5
6      MPI_TOPO_TEST(COMM, STATUS, IERROR)
7          INTEGER COMM, STATUS, IERROR
8

```

A.4.6 MPI Environmental Management Fortran Bindings

```

9
10
11     DOUBLE PRECISION MPI_WTICK()
12
13     DOUBLE PRECISION MPI_WTIME()
14
15     MPI_ABORT(COMM, ERRORCODE, IERROR)
16         INTEGER COMM, ERRORCODE, IERROR
17
18     MPI_ADD_ERROR_CLASS(ERRORCLASS, IERROR)
19         INTEGER ERRORCLASS, IERROR
20
21     MPI_ADD_ERROR_CODE(ERRORCLASS, ERRORCODE, IERROR)
22         INTEGER ERRORCLASS, ERRORCODE, IERROR
23
24     MPI_ADD_ERROR_STRING(ERRORCODE, STRING, IERROR)
25         INTEGER ERRORCODE, IERROR
26         CHARACTER*(*) STRING
27
28     MPI_ALLOC_MEM(SIZE, INFO, BASEPTR, IERROR)
29         INTEGER INFO, IERROR
30         INTEGER(KIND=MPI_ADDRESS_KIND) SIZE, BASEPTR
31
32     If the Fortran compiler provides TYPE(C_PTR), then overloaded by:
33
34     INTERFACE MPI_ALLOC_MEM
35         SUBROUTINE MPI_ALLOC_MEM(SIZE, INFO, BASEPTR, IERROR)
36             IMPORT :: MPI_ADDRESS_KIND
37             INTEGER :: INFO, IERROR
38             INTEGER(KIND=MPI_ADDRESS_KIND) :: SIZE, BASEPTR
39         END SUBROUTINE
40
41         SUBROUTINE MPI_ALLOC_MEM_CPTR(SIZE, INFO, BASEPTR, IERROR)
42             USE, INTRINSIC :: ISO_C_BINDING, ONLY : C_PTR
43             IMPORT :: MPI_ADDRESS_KIND
44             INTEGER :: INFO, IERROR
45             INTEGER(KIND=MPI_ADDRESS_KIND) :: SIZE
46             TYPE(C_PTR) :: BASEPTR
47         END SUBROUTINE
48     END INTERFACE
49
50     MPI_COMM_CALL_ERRHANDLER(COMM, ERRORCODE, IERROR)
51         INTEGER COMM, ERRORCODE, IERROR
52
53     MPI_COMM_CREATE_ERRHANDLER(COMM_ERRHANDLER_FN, ERRHANDLER, IERROR)
54         EXTERNAL COMM_ERRHANDLER_FN
55

```

INTEGER ERRHANDLER, IERROR	1
MPI_COMM_GET_ERRHANDLER(COMM, ERRHANDLER, IERROR)	2
INTEGER COMM, ERRHANDLER, IERROR	3
MPI_COMM_SET_ERRHANDLER(COMM, ERRHANDLER, IERROR)	4
INTEGER COMM, ERRHANDLER, IERROR	5
MPI_ERRHANDLER_FREE(ERRHANDLER, IERROR)	6
INTEGER ERRHANDLER, IERROR	7
MPI_ERROR_CLASS(ERRORCODE, ERRORCLASS, IERROR)	8
INTEGER ERRORCODE, ERRORCLASS, IERROR	9
MPI_ERROR_STRING(ERRORCODE, STRING, RESULTLEN, IERROR)	10
INTEGER ERRORCODE, RESULTLEN, IERROR	11
CHARACTER*(*) STRING	12
MPI_FILE_CALL_ERRHANDLER(FH, ERRORCODE, IERROR)	13
INTEGER FH, ERRORCODE, IERROR	14
MPI_FILE_CREATE_ERRHANDLER(FILE_ERRHANDLER_FN, ERRHANDLER, IERROR)	15
EXTERNAL FILE_ERRHANDLER_FN	16
INTEGER ERRHANDLER, IERROR	17
MPI_FILE_GET_ERRHANDLER(FILE, ERRHANDLER, IERROR)	18
INTEGER FILE, ERRHANDLER, IERROR	19
MPI_FILE_SET_ERRHANDLER(FILE, ERRHANDLER, IERROR)	20
INTEGER FILE, ERRHANDLER, IERROR	21
MPI_FINALIZED(FLAG, IERROR)	22
LOGICAL FLAG	23
INTEGER IERROR	24
MPI_FINALIZE(IERROR)	25
INTEGER IERROR	26
MPI_FREE_MEM(BASE, IERROR)	27
<type> BASE(*)	28
INTEGER IERROR	29
MPI_GET_LIBRARY_VERSION(VERSION, RESULTLEN, IERROR)	30
CHARACTER*(*) VERSION	31
INTEGER RESULTLEN, IERROR	32
MPI_GET_PROCESSOR_NAME(NAME, RESULTLEN, IERROR)	33
CHARACTER*(*) NAME	34
INTEGER RESULTLEN, IERROR	35
MPI_GET_VERSION(VERSION, SUBVERSION, IERROR)	36
INTEGER VERSION, SUBVERSION, IERROR	37
MPI_INITIALIZED(FLAG, IERROR)	38
LOGICAL FLAG	39
	40
	41
	42
	43
	44
	45
	46
	47
	48

```
1     INTEGER IERROR
2
3     MPI_INIT(IERROR)
4         INTEGER IERROR
5
6     MPI_WIN_CALL_ERRHANDLER(WIN, ERRORCODE, IERROR)
7         INTEGER WIN, ERRORCODE, IERROR
8
9     MPI_WIN_CREATE_ERRHANDLER(WIN_ERRHANDLER_FN, ERRHANDLER, IERROR)
10        EXTERNAL WIN_ERRHANDLER_FN
11        INTEGER ERRHANDLER, IERROR
12
13    MPI_WIN_GET_ERRHANDLER(WIN, ERRHANDLER, IERROR)
14        INTEGER WIN, ERRHANDLER, IERROR
15
16    MPI_WIN_SET_ERRHANDLER(WIN, ERRHANDLER, IERROR)
17        INTEGER WIN, ERRHANDLER, IERROR
```

17 A.4.7 The Info Object Fortran Bindings

```
18
19    MPI_INFO_CREATE(INFO, IERROR)
20        INTEGER INFO, IERROR
21
22    MPI_INFO_DELETE(INFO, KEY, IERROR)
23        INTEGER INFO, IERROR
24        CHARACTER*(*) KEY
25
26    MPI_INFO_DUP(INFO, NEWINFO, IERROR)
27        INTEGER INFO, NEWINFO, IERROR
28
29    MPI_INFO_FREE(INFO, IERROR)
30        INTEGER INFO, IERROR
31
32    MPI_INFO_GET(INFO, KEY, VALUELEN, VALUE, FLAG, IERROR)
33        INTEGER INFO, VALUELEN, IERROR
34        CHARACTER*(*) KEY, VALUE
35        LOGICAL FLAG
36
37    MPI_INFO_GET_NKEYS(INFO, NKEYS, IERROR)
38        INTEGER INFO, NKEYS, IERROR
39
40    MPI_INFO_GET_NTHKEY(INFO, N, KEY, IERROR)
41        INTEGER INFO, N, IERROR
42        CHARACTER*(*) KEY
43
44    MPI_INFO_GET_VALUELEN(INFO, KEY, VALUELEN, FLAG, IERROR)
45        INTEGER INFO, VALUELEN, IERROR
46        LOGICAL FLAG
47        CHARACTER*(*) KEY
48
49    MPI_INFO_SET(INFO, KEY, VALUE, IERROR)
50        INTEGER INFO, IERROR
51        CHARACTER*(*) KEY, VALUE
```

A.4.8 Process Creation and Management Fortran Bindings

MPI_CLOSE_PORT(PORT_NAME, IERROR)	1
CHARACTER*(*) PORT_NAME	2
INTEGER IERROR	3
MPI_COMM_ACCEPT(PORT_NAME, INFO, ROOT, COMM, NEWCOMM, IERROR)	4
CHARACTER*(*) PORT_NAME	5
INTEGER INFO, ROOT, COMM, NEWCOMM, IERROR	6
MPI_COMM_CONNECT(PORT_NAME, INFO, ROOT, COMM, NEWCOMM, IERROR)	7
CHARACTER*(*) PORT_NAME	8
INTEGER INFO, ROOT, COMM, NEWCOMM, IERROR	9
MPI_COMM_DISCONNECT(COMM, IERROR)	10
INTEGER COMM, IERROR	11
MPI_COMM_GET_PARENT(PARENT, IERROR)	12
INTEGER PARENT, IERROR	13
MPI_COMM_JOIN(FD, INTERCOMM, IERROR)	14
INTEGER FD, INTERCOMM, IERROR	15
MPI_COMM_SPAWN(COMMAND, ARGV, MAXPROCS, INFO, ROOT, COMM, INTERCOMM, ARRAY_OF_ERRCODES, IERROR)	16
CHARACTER*(*) COMMAND, ARGV(*)	17
INTEGER INFO, MAXPROCS, ROOT, COMM, INTERCOMM, ARRAY_OF_ERRCODES(*), IERROR	18
MPI_COMM_SPAWN_MULTIPLE(COUNT, ARRAY_OF_COMMANDS, ARRAY_OF_ARGV, ARRAY_OF_MAXPROCS, ARRAY_OF_INFO, ROOT, COMM, INTERCOMM, ARRAY_OF_ERRCODES, IERROR)	19
INTEGER COUNT, ARRAY_OF_INFO(*), ARRAY_OF_MAXPROCS(*), ROOT, COMM, INTERCOMM, ARRAY_OF_ERRCODES(*), IERROR	20
CHARACTER*(*) ARRAY_OF_COMMANDS(*), ARRAY_OF_ARGV(COUNT, *)	21
MPI_LOOKUP_NAME(SERVICE_NAME, INFO, PORT_NAME, IERROR)	22
CHARACTER*(*) SERVICE_NAME, PORT_NAME	23
INTEGER INFO, IERROR	24
MPI_OPEN_PORT(INFO, PORT_NAME, IERROR)	25
CHARACTER*(*) PORT_NAME	26
INTEGER INFO, IERROR	27
MPI_PUBLISH_NAME(SERVICE_NAME, INFO, PORT_NAME, IERROR)	28
INTEGER INFO, IERROR	29
CHARACTER*(*) SERVICE_NAME, PORT_NAME	30
MPI_UNPUBLISH_NAME(SERVICE_NAME, INFO, PORT_NAME, IERROR)	31
INTEGER INFO, IERROR	32
CHARACTER*(*) SERVICE_NAME, PORT_NAME	33

A.4.9 One-Sided Communications Fortran Bindings

```

1  MPI_ACCUMULATE(ORIGIN_ADDR, ORIGIN_COUNT, ORIGIN_DATATYPE, TARGET_RANK,
2  TARGET_DISP, TARGET_COUNT, TARGET_DATATYPE, OP, WIN, IERROR)
3  <type> ORIGIN_ADDR(*)
4  INTEGER(KIND=MPI_ADDRESS_KIND) TARGET_DISP
5  INTEGER ORIGIN_COUNT, ORIGIN_DATATYPE, TARGET_RANK, TARGET_COUNT,
6  TARGET_DATATYPE, OP, WIN, IERROR
7
8  MPI_COMPARE_AND_SWAP(ORIGIN_ADDR, COMPARE_ADDR, RESULT_ADDR, DATATYPE,
9  TARGET_RANK, TARGET_DISP, WIN, IERROR)
10 <type> ORIGIN_ADDR(*), COMPARE_ADDR(*), RESULT_ADDR(*)
11 INTEGER(KIND=MPI_ADDRESS_KIND) TARGET_DISP
12 INTEGER DATATYPE, TARGET_RANK, WIN, IERROR
13
14 MPI_FETCH_AND_OP(ORIGIN_ADDR, RESULT_ADDR, DATATYPE, TARGET_RANK,
15 TARGET_DISP, OP, WIN, IERROR)
16 <type> ORIGIN_ADDR(*), RESULT_ADDR(*)
17 INTEGER(KIND=MPI_ADDRESS_KIND) TARGET_DISP
18 INTEGER DATATYPE, TARGET_RANK, OP, WIN, IERROR
19
20 MPI_GET_ACCUMULATE(ORIGIN_ADDR, ORIGIN_COUNT, ORIGIN_DATATYPE, RESULT_ADDR,
21 RESULT_COUNT, RESULT_DATATYPE, TARGET_RANK, TARGET_DISP,
22 TARGET_COUNT, TARGET_DATATYPE, OP, WIN, IERROR)
23 <type> ORIGIN_ADDR(*), RESULT_ADDR(*)
24 INTEGER(KIND=MPI_ADDRESS_KIND) TARGET_DISP
25 INTEGER ORIGIN_COUNT, ORIGIN_DATATYPE, RESULT_COUNT, RESULT_DATATYPE,
26 TARGET_RANK, TARGET_COUNT, TARGET_DATATYPE, OP, WIN, IERROR
27
28 MPI_GET(ORIGIN_ADDR, ORIGIN_COUNT, ORIGIN_DATATYPE, TARGET_RANK,
29 TARGET_DISP, TARGET_COUNT, TARGET_DATATYPE, WIN, IERROR)
30 <type> ORIGIN_ADDR(*)
31 INTEGER(KIND=MPI_ADDRESS_KIND) TARGET_DISP
32 INTEGER ORIGIN_COUNT, ORIGIN_DATATYPE, TARGET_RANK, TARGET_COUNT,
33 TARGET_DATATYPE, WIN, IERROR
34
35 MPI_PUT(ORIGIN_ADDR, ORIGIN_COUNT, ORIGIN_DATATYPE, TARGET_RANK,
36 TARGET_DISP, TARGET_COUNT, TARGET_DATATYPE, WIN, IERROR)
37 <type> ORIGIN_ADDR(*)
38 INTEGER(KIND=MPI_ADDRESS_KIND) TARGET_DISP
39 INTEGER ORIGIN_COUNT, ORIGIN_DATATYPE, TARGET_RANK, TARGET_COUNT,
40 TARGET_DATATYPE, WIN, IERROR
41
42 MPI_RACCUMULATE(ORIGIN_ADDR, ORIGIN_COUNT, ORIGIN_DATATYPE, TARGET_RANK,
43 TARGET_DISP, TARGET_COUNT, TARGET_DATATYPE, OP, WIN, REQUEST,
44 IERROR)
45 <type> ORIGIN_ADDR(*)
46 INTEGER(KIND=MPI_ADDRESS_KIND) TARGET_DISP
47 INTEGER ORIGIN_COUNT, ORIGIN_DATATYPE, TARGET_RANK, TARGET_COUNT,
48 TARGET_DATATYPE, OP, WIN, REQUEST, IERROR

```



```

MPI_RGET_ACCUMULATE(ORIGIN_ADDR, ORIGIN_COUNT, ORIGIN_DATATYPE,      1
                    RESULT_ADDR, RESULT_COUNT, RESULT_DATATYPE, TARGET_RANK,  2
                    TARGET_DISP, TARGET_COUNT, TARGET_DATATYPE, OP, WIN, REQUEST,  3
                    IERROR)                                                4
    <type> ORIGIN_ADDR(*), RESULT_ADDR(*)                                  5
    INTEGER(KIND=MPI_ADDRESS_KIND) TARGET_DISP                            6
    INTEGER ORIGIN_COUNT, ORIGIN_DATATYPE, RESULT_COUNT, RESULT_DATATYPE,  7
            TARGET_RANK, TARGET_COUNT, TARGET_DATATYPE, OP, WIN, REQUEST,  8
    IERROR                                                                    9
MPI_RGET(ORIGIN_ADDR, ORIGIN_COUNT, ORIGIN_DATATYPE, TARGET_RANK,    10
         TARGET_DISP, TARGET_COUNT, TARGET_DATATYPE, WIN, REQUEST,    11
         IERROR)                                                         12
    <type> ORIGIN_ADDR(*)                                                13
    INTEGER(KIND=MPI_ADDRESS_KIND) TARGET_DISP                            14
    INTEGER ORIGIN_COUNT, ORIGIN_DATATYPE, TARGET_RANK, TARGET_COUNT,    15
            TARGET_DATATYPE, WIN, REQUEST, IERROR                        16
MPI_RPUT(ORIGIN_ADDR, ORIGIN_COUNT, ORIGIN_DATATYPE, TARGET_RANK,    17
         TARGET_DISP, TARGET_COUNT, TARGET_DATATYPE, WIN, REQUEST,    18
         IERROR)                                                         19
    <type> ORIGIN_ADDR(*)                                                20
    INTEGER(KIND=MPI_ADDRESS_KIND) TARGET_DISP                            21
    INTEGER ORIGIN_COUNT, ORIGIN_DATATYPE, TARGET_RANK, TARGET_COUNT,    22
            TARGET_DATATYPE, WIN, REQUEST, IERROR                        23
MPI_WIN_ALLOCATE_SHARED(SIZE, DISP_UNIT, INFO, COMM, BASEPTR, WIN, IERROR)  24
    INTEGER DISP_UNIT, INFO, COMM, WIN, IERROR                            25
    INTEGER(KIND=MPI_ADDRESS_KIND) SIZE, BASEPTR                          26
If the Fortran compiler provides TYPE(C_PTR), then overloaded by:      27
INTERFACE MPI_WIN_ALLOCATE_SHARED                                        28
    SUBROUTINE MPI_WIN_ALLOCATE_SHARED(SIZE, DISP_UNIT, INFO, COMM, &    29
        BASEPTR, WIN, IERROR)                                           30
        IMPORT :: MPI_ADDRESS_KIND                                        31
        INTEGER :: DISP_UNIT, INFO, COMM, WIN, IERROR                  32
        INTEGER(KIND=MPI_ADDRESS_KIND) :: SIZE, BASEPTR                33
    END SUBROUTINE                                                       34
    SUBROUTINE MPI_WIN_ALLOCATE_SHARED_CPTR(SIZE, DISP_UNIT, INFO, COMM, &  35
        BASEPTR, WIN, IERROR)                                           36
        USE, INTRINSIC :: ISO_C_BINDING, ONLY : C_PTR                  37
        IMPORT :: MPI_ADDRESS_KIND                                        38
        INTEGER :: DISP_UNIT, INFO, COMM, WIN, IERROR                  39
        INTEGER(KIND=MPI_ADDRESS_KIND) :: SIZE                          40
        TYPE(C_PTR) :: BASEPTR                                          41
    END SUBROUTINE                                                       42
END INTERFACE                                                            43
MPI_WIN_ALLOCATE(SIZE, DISP_UNIT, INFO, COMM, BASEPTR, WIN, IERROR)    44
    INTEGER DISP_UNIT, INFO, COMM, WIN, IERROR                            45

```

```

1      INTEGER(KIND=MPI_ADDRESS_KIND) SIZE, BASEPTR
2      If the Fortran compiler provides TYPE(C_PTR), then overloaded by:
3
4      INTERFACE MPI_WIN_ALLOCATE
5          SUBROUTINE MPI_WIN_ALLOCATE(SIZE, DISP_UNIT, INFO, COMM, BASEPTR, &
6              WIN, IERROR)
7              IMPORT :: MPI_ADDRESS_KIND
8              INTEGER :: DISP_UNIT, INFO, COMM, WIN, IERROR
9              INTEGER(KIND=MPI_ADDRESS_KIND) :: SIZE, BASEPTR
10             END SUBROUTINE
11             SUBROUTINE MPI_WIN_ALLOCATE_CPTR(SIZE, DISP_UNIT, INFO, COMM, BASEPTR, &
12                 WIN, IERROR)
13                 USE, INTRINSIC :: ISO_C_BINDING, ONLY : C_PTR
14                 IMPORT :: MPI_ADDRESS_KIND
15                 INTEGER :: DISP_UNIT, INFO, COMM, WIN, IERROR
16                 INTEGER(KIND=MPI_ADDRESS_KIND) :: SIZE
17                 TYPE(C_PTR) :: BASEPTR
18             END SUBROUTINE
19         END INTERFACE
20
21     MPI_WIN_ATTACH(WIN, BASE, SIZE, IERROR)
22     INTEGER WIN, IERROR
23     <type> BASE(*)
24     INTEGER (KIND=MPI_ADDRESS_KIND) SIZE
25
26     MPI_WIN_COMPLETE(WIN, IERROR)
27     INTEGER WIN, IERROR
28
29     MPI_WIN_CREATE(BASE, SIZE, DISP_UNIT, INFO, COMM, WIN, IERROR)
30     <type> BASE(*)
31     INTEGER(KIND=MPI_ADDRESS_KIND) SIZE
32     INTEGER DISP_UNIT, INFO, COMM, WIN, IERROR
33
34     MPI_WIN_CREATE_DYNAMIC(INFO, COMM, WIN, IERROR)
35     INTEGER INFO, COMM, WIN, IERROR
36
37     MPI_WIN_DETACH(WIN, BASE, IERROR)
38     INTEGER WIN, IERROR
39     <type> BASE(*)
40
41     MPI_WIN_FENCE(ASSERT, WIN, IERROR)
42     INTEGER ASSERT, WIN, IERROR
43
44     MPI_WIN_FLUSH_ALL(WIN, IERROR)
45     INTEGER WIN, IERROR
46
47     MPI_WIN_FLUSH_LOCAL_ALL(WIN, IERROR)
48     INTEGER WIN, IERROR
49
50     MPI_WIN_FLUSH_LOCAL(RANK, WIN, IERROR)
51     INTEGER RANK, WIN, IERROR
52
53     MPI_WIN_FLUSH(RANK, WIN, IERROR)

```

```

    INTEGER RANK, WIN, IERROR                                1
MPI_WIN_FREE(WIN, IERROR)                                  2
    INTEGER WIN, IERROR                                     3
MPI_WIN_GET_GROUP(WIN, GROUP, IERROR)                     4
    INTEGER WIN, GROUP, IERROR                             5
MPI_WIN_GET_INFO(WIN, INFO_USED, IERROR)                  6
    INTEGER WIN, INFO_USED, IERROR                         7
MPI_WIN_LOCK_ALL(ASSERT, WIN, IERROR)                    8
    INTEGER ASSERT, WIN, IERROR                            9
MPI_WIN_LOCK(LOCK_TYPE, RANK, ASSERT, WIN, IERROR)       10
    INTEGER LOCK_TYPE, RANK, ASSERT, WIN, IERROR          11
MPI_WIN_POST(GROUP, ASSERT, WIN, IERROR)                 12
    INTEGER GROUP, ASSERT, WIN, IERROR                    13
MPI_WIN_SET_INFO(WIN, INFO, IERROR)                      14
    INTEGER WIN, INFO, IERROR                             15
MPI_WIN_SHARED_QUERY(WIN, RANK, SIZE, DISP_UNIT, BASEPTR, IERROR) 16
    INTEGER WIN, RANK, DISP_UNIT, IERROR                  17
    INTEGER (KIND=MPI_ADDRESS_KIND) SIZE, BASEPTR         18
If the Fortran compiler provides TYPE(C_PTR), then overloaded by: 19
INTERFACE MPI_WIN_SHARED_QUERY                             20
  SUBROUTINE MPI_WIN_SHARED_QUERY(WIN, RANK, SIZE, DISP_UNIT, & 21
    BASEPTR, IERROR)                                     22
    IMPORT :: MPI_ADDRESS_KIND                           23
    INTEGER :: WIN, RANK, DISP_UNIT, IERROR              24
    INTEGER(KIND=MPI_ADDRESS_KIND) :: SIZE, BASEPTR     25
  END SUBROUTINE
  SUBROUTINE MPI_WIN_SHARED_QUERY_CPTR(WIN, RANK, SIZE, DISP_UNIT, & 26
    BASEPTR, IERROR)                                    27
    USE, INTRINSIC :: ISO_C_BINDING, ONLY : C_PTR      28
    IMPORT :: MPI_ADDRESS_KIND                           29
    INTEGER :: WIN, RANK, DISP_UNIT, IERROR              30
    INTEGER(KIND=MPI_ADDRESS_KIND) :: SIZE              31
    TYPE(C_PTR) :: BASEPTR                              32
  END SUBROUTINE
END INTERFACE                                             33
MPI_WIN_START(GROUP, ASSERT, WIN, IERROR)                34
    INTEGER GROUP, ASSERT, WIN, IERROR                   35
MPI_WIN_SYNC(WIN, IERROR)                                 36
    INTEGER WIN, IERROR                                   37
MPI_WIN_TEST(WIN, FLAG, IERROR)                           38
    INTEGER WIN, IERROR                                   39
    LOGICAL FLAG                                         40

```

1 MPI_WIN_UNLOCK_ALL(WIN, IERROR)
2 INTEGER WIN, IERROR

3
4 MPI_WIN_UNLOCK(RANK, WIN, IERROR)
5 INTEGER RANK, WIN, IERROR

6 MPI_WIN_WAIT(WIN, IERROR)
7 INTEGER WIN, IERROR

10 A.4.10 External Interfaces Fortran Bindings

11 MPI_GREQUEST_COMPLETE(REQUEST, IERROR)
12 INTEGER REQUEST, IERROR

13
14 MPI_GREQUEST_START(QUERY_FN, FREE_FN, CANCEL_FN, EXTRA_STATE, REQUEST,
15 IERROR)
16 INTEGER REQUEST, IERROR
17 EXTERNAL QUERY_FN, FREE_FN, CANCEL_FN
18 INTEGER (KIND=MPI_ADDRESS_KIND) EXTRA_STATE

19 MPI_INIT_THREAD(REQUIRED, PROVIDED, IERROR)
20 INTEGER REQUIRED, PROVIDED, IERROR

21
22 MPI_IS_THREAD_MAIN(FLAG, IERROR)
23 LOGICAL FLAG
24 INTEGER IERROR

25 MPI_QUERY_THREAD(PROVIDED, IERROR)
26 INTEGER PROVIDED, IERROR

27
28 MPI_STATUS_SET_CANCELLED(STATUS, FLAG, IERROR)
29 INTEGER STATUS(MPI_STATUS_SIZE), IERROR
30 LOGICAL FLAG

31 MPI_STATUS_SET_ELEMENTS(STATUS, DATATYPE, COUNT, IERROR)
32 INTEGER STATUS(MPI_STATUS_SIZE), DATATYPE, COUNT, IERROR

33
34 MPI_STATUS_SET_ELEMENTS_X(STATUS, DATATYPE, COUNT, IERROR)
35 INTEGER STATUS(MPI_STATUS_SIZE), DATATYPE, IERROR
36 INTEGER (KIND=MPI_COUNT_KIND) COUNT

38 A.4.11 I/O Fortran Bindings

39
40 MPI_CONVERSION_FN_NULL(USERBUF, DATATYPE, COUNT, FILEBUF, POSITION,
41 EXTRA_STATE, IERROR)
42 <TYPE> USERBUF(*), FILEBUF(*)
43 INTEGER COUNT, DATATYPE, IERROR
44 INTEGER (KIND=MPI_OFFSET_KIND) POSITION
45 INTEGER (KIND=MPI_ADDRESS_KIND) EXTRA_STATE

46
47 MPI_FILE_CLOSE(FH, IERROR)
48 INTEGER FH, IERROR

MPI_FILE_DELETE(FILENAME, INFO, IERROR)	1
CHARACTER*(*) FILENAME	2
INTEGER INFO, IERROR	3
	4
MPI_FILE_GET_AMODE(FH, AMODE, IERROR)	5
INTEGER FH, AMODE, IERROR	6
	7
MPI_FILE_GET_ATOMICITY(FH, FLAG, IERROR)	8
INTEGER FH, IERROR	9
LOGICAL FLAG	10
	11
MPI_FILE_GET_BYTE_OFFSET(FH, OFFSET, DISP, IERROR)	12
INTEGER FH, IERROR	13
INTEGER(KIND=MPI_OFFSET_KIND) OFFSET, DISP	14
	15
MPI_FILE_GET_GROUP(FH, GROUP, IERROR)	16
INTEGER FH, GROUP, IERROR	17
	18
MPI_FILE_GET_INFO(FH, INFO_USED, IERROR)	19
INTEGER FH, INFO_USED, IERROR	20
	21
MPI_FILE_GET_POSITION(FH, OFFSET, IERROR)	22
INTEGER FH, IERROR	23
INTEGER(KIND=MPI_OFFSET_KIND) OFFSET	24
	25
MPI_FILE_GET_POSITION_SHARED(FH, OFFSET, IERROR)	26
INTEGER FH, IERROR	27
INTEGER(KIND=MPI_OFFSET_KIND) OFFSET	28
	29
MPI_FILE_GET_SIZE(FH, SIZE, IERROR)	30
INTEGER FH, IERROR	31
INTEGER(KIND=MPI_OFFSET_KIND) SIZE	32
	33
MPI_FILE_GET_TYPE_EXTENT(FH, DATATYPE, EXTENT, IERROR)	34
INTEGER FH, DATATYPE, IERROR	35
INTEGER(KIND=MPI_ADDRESS_KIND) EXTENT	36
	37
MPI_FILE_GET_VIEW(FH, DISP, ETYPE, FILETYPE, DATAREP, IERROR)	38
INTEGER FH, ETYPE, FILETYPE, IERROR	39
CHARACTER*(*) DATAREP	40
INTEGER(KIND=MPI_OFFSET_KIND) DISP	41
	42
MPI_FILE_IREAD_ALL(FH, BUF, COUNT, DATATYPE, REQUEST, IERROR)	43
<type> BUF(*)	44
INTEGER FH, COUNT, DATATYPE, REQUEST, IERROR	45
	46
MPI_FILE_IREAD_AT_ALL(FH, OFFSET, BUF, COUNT, DATATYPE, REQUEST, IERROR)	47
<type> BUF(*)	48
INTEGER FH, COUNT, DATATYPE, REQUEST, IERROR	
INTEGER(KIND=MPI_OFFSET_KIND) OFFSET	
MPI_FILE_IREAD_AT(FH, OFFSET, BUF, COUNT, DATATYPE, REQUEST, IERROR)	
<type> BUF(*)	
INTEGER FH, COUNT, DATATYPE, REQUEST, IERROR	
INTEGER(KIND=MPI_OFFSET_KIND) OFFSET	

```

1      INTEGER(KIND=MPI_OFFSET_KIND) OFFSET
2
3      MPI_FILE_IREAD(FH, BUF, COUNT, DATATYPE, REQUEST, IERROR)
4          <type> BUF(*)
5          INTEGER FH, COUNT, DATATYPE, REQUEST, IERROR
6
7      MPI_FILE_IREAD_SHARED(FH, BUF, COUNT, DATATYPE, REQUEST, IERROR)
8          <type> BUF(*)
9          INTEGER FH, COUNT, DATATYPE, REQUEST, IERROR
10
11     MPI_FILE_IWRITE_ALL(FH, BUF, COUNT, DATATYPE, REQUEST, IERROR)
12         <type> BUF(*)
13         INTEGER FH, COUNT, DATATYPE, REQUEST, IERROR
14
15     MPI_FILE_IWRITE_AT_ALL(FH, OFFSET, BUF, COUNT, DATATYPE, REQUEST, IERROR)
16         <type> BUF(*)
17         INTEGER FH, COUNT, DATATYPE, REQUEST, IERROR
18         INTEGER(KIND=MPI_OFFSET_KIND) OFFSET
19
20     MPI_FILE_IWRITE_AT(FH, OFFSET, BUF, COUNT, DATATYPE, REQUEST, IERROR)
21         <type> BUF(*)
22         INTEGER FH, COUNT, DATATYPE, REQUEST, IERROR
23         INTEGER(KIND=MPI_OFFSET_KIND) OFFSET
24
25     MPI_FILE_IWRITE(FH, BUF, COUNT, DATATYPE, REQUEST, IERROR)
26         <type> BUF(*)
27         INTEGER FH, COUNT, DATATYPE, REQUEST, IERROR
28
29     MPI_FILE_IWRITE_SHARED(FH, BUF, COUNT, DATATYPE, REQUEST, IERROR)
30         <type> BUF(*)
31         INTEGER FH, COUNT, DATATYPE, REQUEST, IERROR
32
33     MPI_FILE_OPEN(COMM, FILENAME, AMODE, INFO, FH, IERROR)
34         CHARACTER*(*) FILENAME
35         INTEGER COMM, AMODE, INFO, FH, IERROR
36
37     MPI_FILE_PREALLOCATE(FH, SIZE, IERROR)
38         INTEGER FH, IERROR
39         INTEGER(KIND=MPI_OFFSET_KIND) SIZE
40
41     MPI_FILE_READ_ALL_BEGIN(FH, BUF, COUNT, DATATYPE, IERROR)
42         <type> BUF(*)
43         INTEGER FH, COUNT, DATATYPE, IERROR
44
45     MPI_FILE_READ_ALL_END(FH, BUF, STATUS, IERROR)
46         <type> BUF(*)
47         INTEGER FH, STATUS(MPI_STATUS_SIZE), IERROR
48
49     MPI_FILE_READ_ALL(FH, BUF, COUNT, DATATYPE, STATUS, IERROR)
50         <type> BUF(*)
51         INTEGER FH, COUNT, DATATYPE, STATUS(MPI_STATUS_SIZE), IERROR
52
53     MPI_FILE_READ_AT_ALL_BEGIN(FH, OFFSET, BUF, COUNT, DATATYPE, IERROR)
54         <type> BUF(*)

```

INTEGER FH, COUNT, DATATYPE, IERROR	1
INTEGER(KIND=MPI_OFFSET_KIND) OFFSET	2
	3
MPI_FILE_READ_AT_ALL_END(FH, BUF, STATUS, IERROR)	4
<type> BUF(*)	5
INTEGER FH, STATUS(MPI_STATUS_SIZE), IERROR	6
	7
MPI_FILE_READ_AT_ALL(FH, OFFSET, BUF, COUNT, DATATYPE, STATUS, IERROR)	8
<type> BUF(*)	9
INTEGER FH, COUNT, DATATYPE, STATUS(MPI_STATUS_SIZE), IERROR	10
INTEGER(KIND=MPI_OFFSET_KIND) OFFSET	11
	12
MPI_FILE_READ_AT(FH, OFFSET, BUF, COUNT, DATATYPE, STATUS, IERROR)	13
<type> BUF(*)	14
INTEGER FH, COUNT, DATATYPE, STATUS(MPI_STATUS_SIZE), IERROR	15
INTEGER(KIND=MPI_OFFSET_KIND) OFFSET	16
	17
MPI_FILE_READ(FH, BUF, COUNT, DATATYPE, STATUS, IERROR)	18
<type> BUF(*)	19
INTEGER FH, COUNT, DATATYPE, STATUS(MPI_STATUS_SIZE), IERROR	20
	21
MPI_FILE_READ_ORDERED_BEGIN(FH, BUF, COUNT, DATATYPE, IERROR)	22
<type> BUF(*)	23
INTEGER FH, COUNT, DATATYPE, IERROR	24
	25
MPI_FILE_READ_ORDERED_END(FH, BUF, STATUS, IERROR)	26
<type> BUF(*)	27
INTEGER FH, STATUS(MPI_STATUS_SIZE), IERROR	28
	29
MPI_FILE_READ_ORDERED(FH, BUF, COUNT, DATATYPE, STATUS, IERROR)	30
<type> BUF(*)	31
INTEGER FH, COUNT, DATATYPE, STATUS(MPI_STATUS_SIZE), IERROR	32
	33
MPI_FILE_READ_SHARED(FH, BUF, COUNT, DATATYPE, STATUS, IERROR)	34
<type> BUF(*)	35
INTEGER FH, COUNT, DATATYPE, STATUS(MPI_STATUS_SIZE), IERROR	36
	37
MPI_FILE_SEEK(FH, OFFSET, WHENCE, IERROR)	38
INTEGER FH, WHENCE, IERROR	39
INTEGER(KIND=MPI_OFFSET_KIND) OFFSET	40
	41
MPI_FILE_SEEK_SHARED(FH, OFFSET, WHENCE, IERROR)	42
INTEGER FH, WHENCE, IERROR	43
INTEGER(KIND=MPI_OFFSET_KIND) OFFSET	44
	45
MPI_FILE_SET_ATOMICITY(FH, FLAG, IERROR)	46
INTEGER FH, IERROR	47
LOGICAL FLAG	48
MPI_FILE_SET_INFO(FH, INFO, IERROR)	
INTEGER FH, INFO, IERROR	
MPI_FILE_SET_SIZE(FH, SIZE, IERROR)	
INTEGER FH, IERROR	

```

1      INTEGER(KIND=MPI_OFFSET_KIND) SIZE
2
3      MPI_FILE_SET_VIEW(FH, DISP, ETYPE, FILETYPE, DATAREP, INFO, IERROR)
4          INTEGER FH, ETYPE, FILETYPE, INFO, IERROR
5          CHARACTER*(*) DATAREP
6          INTEGER(KIND=MPI_OFFSET_KIND) DISP
7
8      MPI_FILE_SYNC(FH, IERROR)
9          INTEGER FH, IERROR
10
11     MPI_FILE_WRITE_ALL_BEGIN(FH, BUF, COUNT, DATATYPE, IERROR)
12         <type> BUF(*)
13         INTEGER FH, COUNT, DATATYPE, IERROR
14
15     MPI_FILE_WRITE_ALL_END(FH, BUF, STATUS, IERROR)
16         <type> BUF(*)
17         INTEGER FH, STATUS(MPI_STATUS_SIZE), IERROR
18
19     MPI_FILE_WRITE_ALL(FH, BUF, COUNT, DATATYPE, STATUS, IERROR)
20         <type> BUF(*)
21         INTEGER FH, COUNT, DATATYPE, STATUS(MPI_STATUS_SIZE), IERROR
22
23     MPI_FILE_WRITE_AT_ALL_BEGIN(FH, OFFSET, BUF, COUNT, DATATYPE, IERROR)
24         <type> BUF(*)
25         INTEGER FH, COUNT, DATATYPE, IERROR
26         INTEGER(KIND=MPI_OFFSET_KIND) OFFSET
27
28     MPI_FILE_WRITE_AT_ALL_END(FH, BUF, STATUS, IERROR)
29         <type> BUF(*)
30         INTEGER FH, STATUS(MPI_STATUS_SIZE), IERROR
31         INTEGER(KIND=MPI_OFFSET_KIND) OFFSET
32
33     MPI_FILE_WRITE_AT_ALL(FH, OFFSET, BUF, COUNT, DATATYPE, STATUS, IERROR)
34         <type> BUF(*)
35         INTEGER FH, COUNT, DATATYPE, STATUS(MPI_STATUS_SIZE), IERROR
36         INTEGER(KIND=MPI_OFFSET_KIND) OFFSET
37
38     MPI_FILE_WRITE_AT(FH, OFFSET, BUF, COUNT, DATATYPE, STATUS, IERROR)
39         <type> BUF(*)
40         INTEGER FH, COUNT, DATATYPE, STATUS(MPI_STATUS_SIZE), IERROR
41         INTEGER(KIND=MPI_OFFSET_KIND) OFFSET
42
43     MPI_FILE_WRITE(FH, BUF, COUNT, DATATYPE, STATUS, IERROR)
44         <type> BUF(*)
45         INTEGER FH, COUNT, DATATYPE, STATUS(MPI_STATUS_SIZE), IERROR
46
47     MPI_FILE_WRITE_ORDERED_BEGIN(FH, BUF, COUNT, DATATYPE, IERROR)
48         <type> BUF(*)
49         INTEGER FH, COUNT, DATATYPE, IERROR
50
51     MPI_FILE_WRITE_ORDERED_END(FH, BUF, STATUS, IERROR)
52         <type> BUF(*)
53         INTEGER FH, STATUS(MPI_STATUS_SIZE), IERROR
54
55     MPI_FILE_WRITE_ORDERED(FH, BUF, COUNT, DATATYPE, STATUS, IERROR)

```



```

    <type> BUF(*)
    INTEGER FH, COUNT, DATATYPE, STATUS(MPI_STATUS_SIZE), IERROR
MPI_FILE_WRITE_SHARED(FH, BUF, COUNT, DATATYPE, STATUS, IERROR)
    <type> BUF(*)
    INTEGER FH, COUNT, DATATYPE, STATUS(MPI_STATUS_SIZE), IERROR
MPI_REGISTER_DATAREP(DATAREP, READ_CONVERSION_FN, WRITE_CONVERSION_FN,
    DTYPE_FILE_EXTENT_FN, EXTRA_STATE, IERROR)
    CHARACTER*(*) DATAREP
    EXTERNAL READ_CONVERSION_FN, WRITE_CONVERSION_FN, DTYPE_FILE_EXTENT_FN
    INTEGER(KIND=MPI_ADDRESS_KIND) EXTRA_STATE
    INTEGER IERROR

```

A.4.12 Language Bindings Fortran Bindings

```

MPI_F_SYNC_REG(buf)
    <type> buf(*)
MPI_SIZEOF(X, SIZE, IERROR)
    <type> X
    INTEGER SIZE, IERROR
MPI_STATUS_F082F(F08_STATUS, F_STATUS, IERROR)
    TYPE(MPI_Status) :: F08_STATUS
    INTEGER :: F_STATUS(MPI_STATUS_SIZE)
    INTEGER IERROR
MPI_STATUS_F2F08(F_STATUS, F08_STATUS, IERROR)
    INTEGER :: F_STATUS(MPI_STATUS_SIZE)
    TYPE(MPI_Status) :: F08_STATUS
    INTEGER IERROR
MPI_TYPE_CREATE_F90_COMPLEX(P, R, NEWTYPE, IERROR)
    INTEGER P, R, NEWTYPE, IERROR
MPI_TYPE_CREATE_F90_INTEGER(R, NEWTYPE, IERROR)
    INTEGER R, NEWTYPE, IERROR
MPI_TYPE_CREATE_F90_REAL(P, R, NEWTYPE, IERROR)
    INTEGER P, R, NEWTYPE, IERROR
MPI_TYPE_MATCH_SIZE(TYPECLASS, SIZE, DATATYPE, IERROR)
    INTEGER TYPECLASS, SIZE, DATATYPE, IERROR

```

A.4.13 Tools / Profiling Interface Fortran Bindings

```

MPI_PCONTROL(LEVEL)
    INTEGER LEVEL

```

1 A.4.14 Deprecated Fortran Bindings

2 MPI_ATTR_DELETE(COMM, KEYVAL, IERROR)

3 INTEGER COMM, KEYVAL, IERROR

4
5 MPI_ATTR_GET(COMM, KEYVAL, ATTRIBUTE_VAL, FLAG, IERROR)

6 INTEGER COMM, KEYVAL, ATTRIBUTE_VAL, IERROR

7 LOGICAL FLAG

8
9 MPI_ATTR_PUT(COMM, KEYVAL, ATTRIBUTE_VAL, IERROR)

10 INTEGER COMM, KEYVAL, ATTRIBUTE_VAL, IERROR

11 MPI_DUP_FN(OLDCOMM, KEYVAL, EXTRA_STATE, ATTRIBUTE_VAL_IN,

12 ATTRIBUTE_VAL_OUT, FLAG, IERR)

13 INTEGER OLDCOMM, KEYVAL, EXTRA_STATE, ATTRIBUTE_VAL_IN,

14 ATTRIBUTE_VAL_OUT, IERR

15 LOGICAL FLAG

16
17 MPI_KEYVAL_CREATE(COPY_FN, DELETE_FN, KEYVAL, EXTRA_STATE, IERROR)

18 EXTERNAL COPY_FN, DELETE_FN

19 INTEGER KEYVAL, EXTRA_STATE, IERROR

20 MPI_KEYVAL_FREE(KEYVAL, IERROR)

21 INTEGER KEYVAL, IERROR

22
23 MPI_NULL_COPY_FN(OLDCOMM, KEYVAL, EXTRA_STATE, ATTRIBUTE_VAL_IN,

24 ATTRIBUTE_VAL_OUT, FLAG, IERR)

25 INTEGER OLDCOMM, KEYVAL, EXTRA_STATE, ATTRIBUTE_VAL_IN,

26 ATTRIBUTE_VAL_OUT, IERR

27 LOGICAL FLAG

28
29 MPI_NULL_DELETE_FN(COMM, KEYVAL, ATTRIBUTE_VAL, EXTRA_STATE, IERROR)

30 INTEGER COMM, KEYVAL, ATTRIBUTE_VAL, EXTRA_STATE, IERROR

31 SUBROUTINE COPY_FUNCTION(OLDCOMM, KEYVAL, EXTRA_STATE, ATTRIBUTE_VAL_IN,

32 ATTRIBUTE_VAL_OUT, FLAG, IERR)

33 INTEGER OLDCOMM, KEYVAL, EXTRA_STATE, ATTRIBUTE_VAL_IN,

34 ATTRIBUTE_VAL_OUT, IERR

35 LOGICAL FLAG

36
37 SUBROUTINE DELETE_FUNCTION(COMM, KEYVAL, ATTRIBUTE_VAL, EXTRA_STATE, IERR)

38 INTEGER COMM, KEYVAL, ATTRIBUTE_VAL, EXTRA_STATE, IERR

39

40

41

42

43

44

45

46

47

48

1
2
3
4
5
6
7
8
9
10
11
12
13
14
15
16
17
18
19
20
21
22
23
24
25
26
27
28
29
30
31
32
33
34
35
36
37
38
39
40
41
42
43
44
45
46
47
48

Annex B

Change-Log

Annex B.1 summarizes changes from the previous version of the MPI standard to the version presented by this document. Only significant changes (i.e., clarifications and new features) that might either require implementation effort in the MPI libraries or change the understanding of MPI from a user’s perspective are presented. Editorial modifications, formatting, typo corrections and minor clarifications are not shown. If not otherwise noted, the section and page references refer to the locations of the change or new functionality in this version of the standard. Changes in Annexes B.2–B.5 were already introduced in the corresponding sections in previous versions of this standard.

B.1 Changes from Version 3.1 to Version 3.2

B.1.1 Changes in MPI-3.2

1. Section 3.8.4 on page 73.
Cancelling a send request by calling MPI_CANCEL has been deprecated and may be removed in a future version of the MPI specification.
2. Sections 3.7.3, 3.9, 5.13, 7.8, and 7.9 on pages 54, 75, 217, 357, and 362.
Persistent collective communication and persistent neighborhood communication are added to the standard.
3. Section 6.4.2 on page 257, and MPI-3.1 Section 6.4.2 on page 237.
The functions MPI_COMM_DUP and MPI_COMM_IDUP were updated to no longer propagate info hints.
This change may affect backward compatibility.
4. Sections 6.4.4, 11.2.7, and 13.2.8 on pages 269, 449, and 534, and MPI-3.1 Sections 6.4.4, 11.2.7, and 13.2.8 on pages 248, 415, and 500.
The definition of info hints was updated to allow applications to provide assertions regarding their usage of MPI objects and operations.
5. Section 6.4.4 on page 269.
The new info hints mpi_assert_no_any_tag, mpi_assert_no_any_source, mpi_assert_exact_length, and mpi_assert_allow_overtaking were added for use with communicators.

- 1 6. Section 6.4.2 on page 257.
2 The MPI_COMM_IDUP_WITH_INFO function was added.
- 3
- 4 7. Sections 6.4.4, 11.2.7, and 13.2.8 on pages 269, 449, and 534.
5 The semantics of the MPI_COMM_SET_INFO, MPI_COMM_GET_INFO,
6 MPI_WIN_SET_INFO, MPI_WIN_GET_INFO, MPI_FILE_SET_INFO, and
7 MPI_FILE_GET_INFO were clarified.
- 8
- 9 8. Section 14.3.9 and Table 14.5 on pages 630 and 632.
10 MPI_T_ERR_INVALID_ITEM is deprecated. MPI routines should return
11 MPI_T_ERR_INVALID_INDEX instead of MPI_T_ERR_INVALID_ITEM.
- 12
- 13 9. Section 7.5.
14 MPI_DIMS_CREATE is now guaranteed to return MPI_SUCCESS if the number of di-
15 mensions passed to the routine is set to 0 and the number of nodes is set to 1.
- 16
- 17 10. Sections 2.8, 8.3, 8.5, and 8.7 on pages 20, 374, 382, and 389.
18 MPI calls that are not related to any objects are considered to be attached to the
19 communicator MPI_COMM_SELF instead of MPI_COMM_WORLD. The definition of
20 MPI_ERRORS_ARE_FATAL was clarified to cover all connected processes, and a new
21 error handler, MPI_ERRORS_ABORT, was created to limit the scope of aborting.
- 22
- 23 11. Sections 7.4, 7.5.1 and 7.5.2 on pages 311, 313 and 318.
24 New application grid and hardware aware Cartesian virtual topology creation routine
25 MPI_CART_CREATE_WEIGHTED, together with appropriate new convenience func-
26 tion MPI_DIMS_CREATE_WEIGHTED; and the new constant MPI_WEIGHTED_EQUAL,
27 MPI_COSTS_CONTIGUOUS, MPI_COSTS_STRIDED, MPI_COSTS_SCATTERED, and re-
28 served info key mpi_split_levels.
- 29
- 30 12. Sections 8.3 and 8.4 on pages 374 and 382.
31 Clarified definition of errors to say that MPI should continue whenever possible and
32 allow the user to recover from errors.
- 33
- 34 13. Section 12.3 on page 517
35 The mpi_f08 binding incorrectly had the dummy parameter flag in the MPI F08
36 binding for MPI_SET_STATUS_CANCELLED marked as INTENT(OUT). It has been
37 fixed to be INTENT(IN).

#120

37 B.2 Changes from Version 3.0 to Version 3.1

38 B.2.1 Fixes to Errata in Previous Versions of MPI

- 39 1. Chapters 3–18, Annex A.3 on page 752, and Example 5.21 on page 189, and MPI-3.0
40 Chapters 3-17, Annex A.3 on page 707, and Example 5.21 on page 187.
41 Within the mpi_f08 Fortran support method, BIND(C) was removed from all
42 SUBROUTINE, FUNCTION, and ABSTRACT INTERFACE definitions.
- 43
- 44 2. Section 3.2.5 on page 32, and MPI-3.0 Section 3.2.5 on page 30.
45 The three public fields MPI_SOURCE, MPI_TAG, and MPI_ERROR of the Fortran derived
46 type TYPE(MPI_Status) must be of type INTEGER.
47
48

3. Section 3.8.2 on page 70, and MPI-3.0 Section 3.8.2 on page 67. 1
 The flag arguments of the Fortran interfaces of MPI_IMPROBE were originally incorrectly defined as INTEGER (instead as LOGICAL). 2
4. Section 6.4.2 on page 257, and MPI-3.0 Section 6.4.2 on page 237. 3
 In the `mpi_f08` binding of MPI_COMM_IDUP, the output argument `newcomm` is declared as ASYNCHRONOUS. 4
5. Section 6.4.4 on page 269, and MPI-3.0 Section 6.4.4 on page 248. 5
 In the `mpi_f08` binding of MPI_COMM_SET_INFO, the intent of `comm` is IN, and the optional output argument `iererror` was missing. 6
6. Section 7.6 on page 341, and MPI-3.0 Sections 7.6, on pages 314. 7
 In the case of virtual general graph topologies (created with MPI_CART_CREATE), the use of neighborhood collective communication is restricted to adjacency matrices with the number of edges between any two processes is defined to be the same for both processes (i.e., with a symmetric adjacency matrix). 8
7. Section 8.1.1 on page 367, and MPI-3.0 Section 8.1.1 on page 335. 9
 In the `mpi_f08` binding of MPI_GET_LIBRARY_VERSION, a typo in the `resultlen` argument was corrected. 10
8. Sections 8.2 (MPI_ALLOC_MEM and MPI_ALLOC_MEM_CPTR), 11
 11.2.2 (MPI_WIN_ALLOCATE and MPI_WIN_ALLOCATE_CPTR), 12
 11.2.3 (MPI_WIN_ALLOCATE_SHARED and MPI_WIN_ALLOCATE_SHARED_CPTR), 13
 11.2.3 (MPI_WIN_SHARED_QUERY and MPI_WIN_SHARED_QUERY_CPTR), 14
 14.2.1 and 14.2.7 (Profiling interface), and corresponding sections in MPI-3.0. 15
 The linker name concept was substituted by defining specific procedure names. 16
9. Section 11.2.1 on page 437, and MPI-3.0 Section 11.2.2 on page 407. 17
 The `same_size` info key can be used with all window flavors, and requires that all processes in the process group of the communicator have provided this info key with the same value. 18
10. Section 11.3.4 on page 457, and MPI-3.0 Section 11.3.4 on page 424. 19
 Origin buffer arguments to MPI_GET_ACCUMULATE are ignored when the MPI_NO_OP operation is used. 20
11. Section 11.3.4 on page 457, and MPI-3.0 Section 11.3.4 on page 424. 21
 Clarify the roles of origin, result, and target communication parameters in MPI_GET_ACCUMULATE. 22
12. Section 14.3 on page 601, and MPI-3.0 Section 14.3 on page 561 23
 New paragraph and advice to users clarifying intent of variable names in the tools information interface. 24
13. Section 14.3.3 on page 603, and MPI-3.0 Section 14.3.3 on page 563. 25
 New paragraph clarifying variable name equivalence in the tools information interface. 26
14. Sections 14.3.6, 14.3.7, and 14.3.8 on pages 607, 614, and 626, and 27
 MPI-3.0 Sections 14.3.6, 14.3.7, and 14.3.8 on pages 567, 573, and 584. 28
 In functions MPI_T_CVAR_GET_INFO, MPI_T_PVAR_GET_INFO, and 29

1 MPI_T_CATEGORY_GET_INFO, clarification of parameters that must be identical for
 2 equivalent control variable / performance variable / category names across connected
 3 processes.

- 4
- 5 15. Section 14.3.7 on page 614, and MPI-3.0 Section 14.3.7 on page 573.
 6 Clarify return code of MPI_T_PVAR_{START,STOP,RESET} routines.
- 7
- 8 16. Section 14.3.7 on page 614, and MPI-3.0 Section 14.3.7 on page 579, line 7.
 9 Clarify the return code when bad handle is passed to an MPI_T_PVAR_* routine.
- 10
- 11 17. Section 18.1.4 on page 647, and MPI-3.0 Section 17.1.4 on page 603.
 12 The advice to implementors at the end of the section was rewritten and moved into
 13 the following section.
- 14
- 15 18. Section 18.1.5 on page 648, and MPI-3.0 Section 17.1.5 on page 605.
 16 The section was fully rewritten. The linker name concept was substituted by defining
 17 specific procedure names.
- 18
- 19 19. Section 18.1.6 on page 653, and MPI-3.0 Section 17.1.6 on page 611.
 20 The requirements on BIND(C) procedure interfaces were removed.
- 21
- 22 20. Annexes A.2, A.3, and A.4 on pages 728, 752, and 807, and
 23 MPI-3.0 Annexes A.2, A.3, and A.4 on pages 685, 707, and 756.
 24 The predefined callback MPI_CONVERSION_FN_NULL was added to all three an-
 25 nexes.
- 26
- 27 21. Annex A.3.4 on page 773, and MPI-3.0 Annex A.3.4 on page 724.
 28 In the mpi_f08 binding of
 29 MPI_{COMM|TYPE|WIN}_{DUP|NULL_COPY|NULL_DELETE}_FN, all INTENT(...) information was removed.

30 B.2.2 Changes in MPI-3.1

- 31
- 32 1. Sections 2.6.4 and 4.1.5 on pages 19 and 103.
 33 The use of the intrinsic operators “+” and “-” for absolute addresses is substituted
 34 by MPI_AINT_ADD and MPI_AINT_DIFF. In C, they can be implemented as macros.
- 35
- 36 2. Sections 8.1.1, 8.7, and 12.4 on pages 367, 389, and 518.
 37 The routines MPI_INITIALIZED, MPI_FINALIZED, MPI_QUERY_THREAD,
 38 MPI_IS_THREAD_MAIN, MPI_GET_VERSION, and MPI_GET_LIBRARY_VERSION
 39 are callable from threads without restriction (in the sense of MPI_THREAD_MULTIPLE),
 40 irrespective of the actual level of thread support provided, in the case where the im-
 41 plementation supports threads.
- 42
- 43 3. Section 11.2.1 on page 437.
 44 The same_disp_unit info key was added for use in RMA window creation routines.
- 45
- 46 4. Sections 13.4.2 and 13.4.3 on pages 543 and 548.
 47 Added MPI_FILE_IREAD_AT_ALL, MPI_FILE_IWRITE_AT_ALL,
 48 MPI_FILE_IREAD_ALL, and MPI_FILE_IWRITE_ALL

5. Sections 14.3.6, 14.3.7, and 14.3.8 on pages 607, 614, and 626. Clarified that NULL parameters can be provided in MPI_T_{CVAR|PVAR|CATEGORY}_GET_INFO routines.
6. Sections 14.3.6, 14.3.7, 14.3.8, and 14.3.9 on pages 607, 614, 626, and 630. New routines MPI_T_CVAR_GET_INDEX, MPI_T_PVAR_GET_INDEX, MPI_T_CATEGORY_GET_INDEX, were added to support retrieving indices of variables and categories. The error codes MPI_T_ERR_INVALID and MPI_T_ERR_INVALID_NAME were added to indicate invalid uses of the interface.

B.3 Changes from Version 2.2 to Version 3.0

B.3.1 Fixes to Errata in Previous Versions of MPI

1. Sections 2.6.2 and 2.6.3 on pages 18 and 19, and MPI-2.2 Section 2.6.2 on page 17, lines 41-42, Section 2.6.3 on page 18, lines 15-16, and Section 2.6.4 on page 18, lines 40-41. This is an MPI-2 erratum: The scope for the reserved prefix MPI_ and the C++ namespace MPI is now any name as originally intended in MPI-1.
2. Sections 3.2.2, 5.9.2, 13.5.2 Table 13.2, and Annex A.1.1 on pages 27, 178, 574, and 705, and MPI-2.2 Sections 3.2.2, 5.9.2, 13.5.2 Table 13.2, 16.1.16 Table 16.1, and Annex A.1.1 on pages 27, 164, 433, 472 and 513. This is an MPI-2.2 erratum: New named predefined datatypes MPI_CXX_BOOL, MPI_CXX_FLOAT_COMPLEX, MPI_CXX_DOUBLE_COMPLEX, and MPI_CXX_LONG_DOUBLE_COMPLEX were added in C and Fortran corresponding to the C++ types bool, std::complex<float>, std::complex<double>, and std::complex<long double>. These datatypes also correspond to the deprecated C++ predefined datatypes MPI::BOOL, MPI::COMPLEX, MPI::DOUBLE_COMPLEX, and MPI::LONG_DOUBLE_COMPLEX, which were removed in MPI-3.0. The non-standard C++ types Complex<...> were substituted by the standard types std::complex<...>.
3. Sections 5.9.2 on pages 178 and MPI-2.2 Section 5.9.2, page 165, line 47. This is an MPI-2.2 erratum: MPI_C_COMPLEX was added to the “Complex” reduction group.
4. Section 7.5.5 on page 330, and MPI-2.2, Section 7.5.5 on page 257, C++ interface on page 264, line 3. This is an MPI-2.2 erratum: The argument rank was removed and in/outdegree are now defined as int& indegree and int& outdegree in the C++ interface of MPI_DIST_GRAPH_NEIGHBORS_COUNT.
5. Section 13.5.2, Table 13.2 on page 574, and MPI-2.2, Section 13.5.3, Table 13.2 on page 433. This was an MPI-2.2 erratum: The MPI_C_BOOL “external32” representation is corrected to a 1-byte size.
6. MPI-2.2 Section 16.1.16 on page 471, line 45. This is an MPI-2.2 erratum: The constant MPI::_LONG_LONG should be MPI::LONG_LONG.

- 1 7. Annex [A.1.1](#) on page [705](#), Table “Optional datatypes (Fortran),” and
 2 MPI-2.2, Annex [A.1.1](#), Table on page 517, lines 34, and 37-41.
 3 This is an MPI-2.2 erratum: The C++ datatype handles MPI::`INTEGER16`,
 4 MPI::`REAL16`, MPI::`F_COMPLEX4`, MPI::`F_COMPLEX8`, MPI::`F_COMPLEX16`,
 5 MPI::`F_COMPLEX32` were added to the table.

7 B.3.2 Changes in MPI-3.0

- 8
 9 1. Section [2.6.1](#) on page [18](#), Section [16.2](#) on page [638](#) and all other chapters.
 10 The C++ bindings were removed from the standard. See errata in Section [B.3.1](#) on
 11 page [845](#) for the latest changes to the MPI C++ binding defined in MPI-2.2.
 12 This change may affect backward compatibility.
- 13
 14 2. Section [2.6.1](#) on page [18](#), Section [15.1](#) on page [633](#) and Section [16.1](#) on page [637](#).
 15 The deprecated functions `MPI_TYPE_HVECTOR`, `MPI_TYPE_HINDEXED`,
 16 `MPI_TYPE_STRUCT`, `MPI_ADDRESS`, `MPI_TYPE_EXTENT`, `MPI_TYPE_LB`,
 17 `MPI_TYPE_UB`, `MPI_ERRHANDLER_CREATE` (and its callback function prototype
 18 `MPI_Handler_function`), `MPI_ERRHANDLER_SET`, `MPI_ERRHANDLER_GET`, the dep-
 19 recated special datatype handles `MPI_LB`, `MPI_UB`, and the constants
 20 `MPI_COMBINER_HINDEXED_INTEGER`, `MPI_COMBINER_HVECTOR_INTEGER`,
 21 `MPI_COMBINER_STRUCT_INTEGER` were removed from the standard.
 22 This change may affect backward compatibility.
- 23
 24 3. Section [2.3](#) on page [10](#).
 25 Clarified parameter usage for IN parameters. C bindings are now const-correct where
 26 backward compatibility is preserved.
- 27
 28 4. Section [2.5.4](#) on page [15](#) and Section [7.5.4](#) on page [323](#).
 29 The recommended C implementation value for `MPI_UNWEIGHTED` changed from `NULL`
 30 to `non-NULL`. An additional weight array constant (`MPI_WEIGHTS_EMPTY`) was in-
 31 troduced.
- 32
 33 5. Section [2.5.4](#) on page [15](#) and Section [8.1.1](#) on page [367](#).
 34 Added the new routine `MPI_GET_LIBRARY_VERSION` to query library specific ver-
 35 sions, and the new constant `MPI_MAX_LIBRARY_VERSION_STRING`.
- 36
 37 6. Sections [2.5.8](#), [3.2.2](#), [3.3](#), [5.9.2](#), on pages [17](#), [27](#), [29](#), [178](#), Sections [4.1](#), [4.1.7](#), [4.1.8](#),
 38 [4.1.11](#), [12.3](#) on pages [85](#), [108](#), [110](#), [113](#), [516](#), and Annex [A.1.1](#) on page [705](#).
 39 New inquiry functions, `MPI_TYPE_SIZE_X`, `MPI_TYPE_GET_EXTENT_X`,
 40 `MPI_TYPE_GET_TRUE_EXTENT_X`, and `MPI_GET_ELEMENTS_X`, return their re-
 41 sults as an `MPI_Count` value, which is a new type large enough to represent ele-
 42 ment counts in memory, file views, etc. A new function,
 43 `MPI_STATUS_SET_ELEMENTS_X`, modifies the opaque part of an `MPI_Status` object
 44 so that a call to `MPI_GET_ELEMENTS_X` returns the provided `MPI_Count` value (in
 45 Fortran, `INTEGER (KIND=MPI_COUNT_KIND)`). The corresponding predefined datatype
 46 is `MPI_COUNT`.
- 47
 48 7. Chapter [3](#) on page [25](#) until Chapter [18](#) on page [641](#).
 In the C language bindings, the array-arguments’ interfaces were modified to consis-
 tently use use `[]` instead of `*`.

Exceptions are `MPI_INIT`, which continues to use `char ***argv` (correct because of subtle rules regarding the use of the `&` operator with `char *argv[]`), and `MPI_INIT_THREAD`, which is changed to be consistent with `MPI_INIT`.

8. Sections [3.2.5](#), [4.1.5](#), [4.1.11](#), [4.2](#) on pages [32](#), [103](#), [113](#), [134](#).
The functions `MPI_GET_COUNT` and `MPI_GET_ELEMENTS` were defined to set the `count` argument to `MPI_UNDEFINED` when that argument would overflow. The functions `MPI_PACK_SIZE` and `MPI_TYPE_SIZE` were defined to set the `size` argument to `MPI_UNDEFINED` when that argument would overflow. In all other MPI-2.2 routines, the type and semantics of the count arguments remain unchanged, i.e., `int` or `INTEGER`.
9. Section [3.2.6](#) on page [34](#), and Section [3.8](#) on page [66](#).
`MPI_STATUS_IGNORE` can be also used in `MPI_IPROBE`, `MPI_PROBE`, `MPI_IMPROBE`, and `MPI_MPROBE`.
10. Section [3.8](#) on page [66](#) and Section [3.11](#) on page [82](#).
The use of `MPI_PROC_NULL` in probe operations was clarified. A special predefined message `MPI_MESSAGE_NO_PROC` was defined for the use of matching probe (i.e., the new `MPI_MPROBE` and `MPI_IMPROBE`) with `MPI_PROC_NULL`.
11. Sections [3.8.2](#), [3.8.3](#), [18.2.4](#), [A.1.1](#) on pages [70](#), [72](#), [690](#), [705](#).
Like `MPI_PROBE` and `MPI_IPROBE`, the new `MPI_MPROBE` and `MPI_IMPROBE` operations allow incoming messages to be queried without actually receiving them, except that `MPI_MPROBE` and `MPI_IMPROBE` provide a mechanism to receive the specific message with the new routines `MPI_MRECV` and `MPI_IMRECV` regardless of other intervening probe or receive operations. The opaque object `MPI_Message`, the null handle `MPI_MESSAGE_NULL`, and the conversion functions `MPI_Message_c2f` and `MPI_Message_f2c` were defined.
12. Section [4.1.2](#) on page [87](#) and Section [4.1.13](#) on page [118](#).
The routine `MPI_TYPE_CREATE_HINDEXED_BLOCK` and constant `MPI_COMBINER_HINDEXED_BLOCK` were added.
13. Chapter [5](#) on page [143](#) and Section [5.12](#) on page [199](#).
Added nonblocking interfaces to all collective operations.
14. Sections [6.4.2](#), [6.4.4](#), [11.2.7](#), on pages [257](#), [269](#), [449](#).
The new routines `MPI_COMM_DUP_WITH_INFO`, `MPI_COMM_SET_INFO`, `MPI_COMM_GET_INFO`, `MPI_WIN_SET_INFO`, and `MPI_WIN_GET_INFO` were added. The routine `MPI_COMM_DUP` must also duplicate info hints.
15. Section [6.4.2](#) on page [257](#).
Added `MPI_COMM_IDUP`.
16. Section [6.4.2](#) on page [257](#).
Added the new communicator construction routine `MPI_COMM_CREATE_GROUP`, which is invoked only by the processes in the group of the new communicator being constructed.

- 1 17. Section [6.4.2](#) on page [257](#).
2 Added the `MPI_COMM_SPLIT_TYPE` routine and the communicator split type con-
3 stant `MPI_COMM_TYPE_SHARED`.
4
- 5 18. Section [6.6.2](#) on page [281](#).
6 In MPI-2.2, communication involved in an `MPI_INTERCOMM_CREATE` operation
7 could interfere with point-to-point communication on the parent communicator with
8 the same tag or `MPI_ANY_TAG`. This interference has been removed in MPI-3.0.
9
- 10 19. Section [6.8](#) on page [302](#).
11 Section 6.8 on page 238. The constant `MPI_MAX_OBJECT_NAME` also applies for type
12 and window names.
13
- 14 20. Section [7.5.8](#) on page [339](#).
15 `MPI_CART_MAP` can also be used for a zero-dimensional topologies.
16
- 17 21. Section [7.6](#) on page [341](#) and Section [7.7](#) on page [351](#).
18 The following neighborhood collective communication routines were added to sup-
19 port sparse communication on virtual topology grids: `MPI_NEIGHBOR_ALLGATHER`,
20 `MPI_NEIGHBOR_ALLGATHERV`, `MPI_NEIGHBOR_ALLTOALL`,
21 `MPI_NEIGHBOR_ALLTOALLV`, `MPI_NEIGHBOR_ALLTOALLW` and the nonblocking
22 variants `MPI_INEIGHBOR_ALLGATHER`, `MPI_INEIGHBOR_ALLGATHERV`,
23 `MPI_INEIGHBOR_ALLTOALL`, `MPI_INEIGHBOR_ALLTOALLV`, and
24 `MPI_INEIGHBOR_ALLTOALLW`. The displacement arguments in
25 `MPI_NEIGHBOR_ALLTOALLW` and `MPI_INEIGHBOR_ALLTOALLW` were defined as
26 address size integers. In `MPI_DIST_GRAPH_NEIGHBORS`, an ordering rule was added
27 for communicators created with `MPI_DIST_GRAPH_CREATE_ADJACENT`.
28
- 29 22. Section [8.7](#) on page [389](#) and Section [12.4.3](#) on page [521](#).
30 The use of `MPI_INIT`, `MPI_INIT_THREAD` and `MPI_FINALIZE` was clarified. After
31 MPI is initialized, the application can access information about the execution envi-
32 ronment by querying the new predefined info object `MPI_INFO_ENV`.
33
- 34 23. Section [8.7](#) on page [389](#).
35 Allow calls to `MPI_T` routines before `MPI_INIT` and after `MPI_FINALIZE`.
36
- 37 24. Chapter [11](#) on page [435](#).
38 Substantial revision of the entire One-sided chapter, with new routines for window
39 creation, additional synchronization methods in passive target communication, new
40 one-sided communication routines, a new memory model, and other changes.
41
- 42 25. Section [14.3](#) on page [601](#).
43 A new MPI Tool Information Interface was added.
44 The following changes are related to the Fortran language support.
45
- 46 26. Section [2.3](#) on page [10](#), and Sections [18.1.1](#), [18.1.2](#), [18.1.7](#) on pages [641](#), [642](#), and [657](#).
47 The new `mpi_08` Fortran module was introduced.
48
- 49 27. Section [2.5.1](#) on page [12](#), and Sections [18.1.2](#), [18.1.3](#), [18.1.7](#) on pages [642](#), [645](#), and [657](#).
50 Handles to opaque objects were defined as named types within the `mpi_08` Fortran

module. The operators `.EQ.`, `.NE.`, `==`, and `/=` were overloaded to allow the comparison of these handles. The handle types and the overloaded operators are also available through the `mpi` Fortran module.

28. Sections 2.5.4, 2.5.5 on pages 15, 16, Sections 18.1.1, 18.1.10, 18.1.11, 18.1.12, 18.1.13 on pages 641, 667, 669, 669, 672, and Sections 18.1.2, 18.1.3, 18.1.7 on pages 642, 645, 657.

Within the `mpi_08` Fortran module, choice buffers were defined as assumed-type and assumed-rank according to Fortran 2008 TS 29113 [42], and the compile-time constant `MPI_SUBARRAYS_SUPPORTED` was set to `.TRUE.`. With this, Fortran subscript triplets can be used in nonblocking MPI operations; vector subscripts are not supported in nonblocking operations. If the compiler does not support this Fortran TR 29113 feature, the constant is set to `.FALSE.`.

29. Section 2.6.2 on page 18, Section 18.1.2 on page 642, and Section 18.1.7 on page 657. The `ierror` dummy arguments are `OPTIONAL` within the `mpi_08` Fortran module.

30. Section 3.2.5 on page 32, Sections 18.1.2, 18.1.3, 18.1.7, on pages 642, 645, 657, and Section 18.2.5 on page 692.

Within the `mpi_08` Fortran module, the status was defined as `TYPE(MPI_Status)`. Additionally, within both the `mpi` and the `mpi_f08` modules, the constants `MPI_STATUS_SIZE`, `MPI_SOURCE`, `MPI_TAG`, `MPI_ERROR`, and `TYPE(MPI_Status)` are defined. New conversion routines were added: `MPI_STATUS_F2F08`, `MPI_STATUS_F082F`, `MPI_Status_c2f08`, and `MPI_Status_f082c`. In `mpi.h`, the new type `MPI_F08_status`, and the external variables `MPI_F08_STATUS_IGNORE` and `MPI_F08_STATUSES_IGNORE` were added.

31. Section 3.6 on page 46.

In Fortran with the `mpi` module or `mpif.h`, the type of the `buffer_addr` argument of `MPI_BUFFER_DETACH` is incorrectly defined and the argument is therefore unused.

32. Section 4.1 on page 85, Section 4.1.6 on page 106, and Section 18.1.15 on page 673.

The Fortran alignments of basic datatypes within Fortran derived types are implementation dependent; therefore it is recommended to use the `BIND(C)` attribute for derived types in MPI communication buffers. If an array of structures (in C/C++) or derived types (in Fortran) is to be used in MPI communication buffers, it is recommended that the user creates a portable datatype handle and additionally applies `MPI_TYPE_CREATE_RESIZED` to this datatype handle.

33. Sections 4.1.10, 5.9.5, 5.9.7, 6.7.4, 6.8, 8.3.1, 8.3.2, 8.3.3, 15.1, 18.1.9 on pages 113, 185, 191, 296, 302, 376, 378, 379, 633, and 659. In some routines, the dummy argument names were changed because they were identical to the Fortran keywords `TYPE` and `FUNCTION`. The new dummy argument names must be used because the `mpi` and `mpi_08` modules guarantee keyword-based actual argument lists. The argument name type was changed in `MPI_TYPE_DUP`, the Fortran `USER_FUNCTION` of `MPI_OP_CREATE`, `MPI_TYPE_SET_ATTR`, `MPI_TYPE_GET_ATTR`, `MPI_TYPE_DELETE_ATTR`, `MPI_TYPE_SET_NAME`, `MPI_TYPE_GET_NAME`, `MPI_TYPE_MATCH_SIZE`, the callback prototype definition `MPI_Type_delete_attr_function`, and the predefined callback function `MPI_TYPE_NULL_DELETE_FN`; function was changed in `MPI_OP_CREATE`,

1 MPI_COMM_CREATE_ERRHANDLER, MPI_WIN_CREATE_ERRHANDLER,
2 MPI_FILE_CREATE_ERRHANDLER, and MPI_ERRHANDLER_CREATE. For consis-
3 tency reasons, INOUBUF was changed to INOUTBUF in MPI_REDUCE_LOCAL, and
4 intracomm to newintracomm in MPI_INTERCOMM_MERGE.

5
6 34. Section 6.7.2 on page 288.

7 It was clarified that in Fortran, the flag values returned by a `comm_copy_attr_fn`
8 callback, including `MPI_COMM_NULL_COPY_FN` and `MPI_COMM_DUP_FN`, are
9 `.FALSE.` and `.TRUE.`; see `MPI_COMM_CREATE_KEYVAL`.

10
11 35. Section 8.2 on page 371.

12 With the `mpi` and `mpi_f08` Fortran modules, `MPI_ALLOC_MEM` now also supports
13 `TYPE(C_PTR)` C-pointers instead of only returning an address-sized integer that may
14 be usable together with a non-standard Cray-pointer.

15
16 36. Section 18.1.15 on page 673, and Section 18.1.7 on page 657.

17 Fortran `SEQUENCE` and `BIND(C)` derived application types can now be used as buffers
18 in MPI operations.

19
20 37. Section 18.1.16 on page 675 to Section 18.1.19 on page 684, Section 18.1.7 on page 657,
21 and Section 18.1.8 on page 658.

22 The sections about Fortran optimization problems and their solutions were partially
23 rewritten and new methods are added, e.g., the use of the `ASYNCHRONOUS` attribute.
24 The constant `MPI_ASYNC_PROTECTS_NONBLOCKING` tells whether the semantics of
25 the `ASYNCHRONOUS` attribute is extended to protect nonblocking operations. The For-
26 tran routine `MPI_F_SYNC_REG` is added. MPI-3.0 compliance for an MPI library
27 together with a Fortran compiler is defined in Section 18.1.7.

28
29 38. Section 18.1.2 on page 642.

30 Within the `mpi_08` Fortran module, dummy arguments are now declared with
31 `INTENT=IN`, `OUT`, or `INOUT` as defined in the `mpi_08` interfaces.

32
33 39. Section 18.1.3 on page 645, and Section 18.1.7 on page 657.

34 The existing `mpi` Fortran module must implement compile-time argument checking.

35
36 40. Section 18.1.4 on page 647.

37 The use of the `mpif.h` Fortran include file is now strongly discouraged.

38
39 41. Section A.1.1, Table “*Predefined functions*” on page 713, Section A.1.3 on page 720,
40 and Section A.3.4 on page 773.

41 Within the new `mpi_f08` module, all callback prototype definitions are now defined
42 with explicit interfaces `PROCEDURE(MPI_...)` that have the `BIND(C)` attribute; user-
43 written callbacks must be modified if the `mpi_f08` module is used.

44
45 42. Section A.1.3 on page 720.

46 In some routines, the Fortran callback prototype names were changed from `..._FN` to
47 `..._FUNCTION` to be consistent with the other language bindings.

B.4 Changes from Version 2.1 to Version 2.2

1. Section 2.5.4 on page 15.
It is now guaranteed that predefined named constant handles (as other constants) can be used in initialization expressions or assignments, i.e., also before the call to MPI_INIT.
2. Section 2.6 on page 17, and Section 16.2 on page 638.
The C++ language bindings have been deprecated and may be removed in a future version of the MPI specification.
3. Section 3.2.2 on page 27.
MPI_CHAR for printable characters is now defined for C type char (instead of signed char). This change should not have any impact on applications nor on MPI libraries (except some comment lines), because printable characters could and can be stored in any of the C types char, signed char, and unsigned char, and MPI_CHAR is not allowed for predefined reduction operations.
4. Section 3.2.2 on page 27.
MPI_(U)INT{8,16,32,64}_T, MPI_AINT, MPI_OFFSET, MPI_C_BOOL, MPI_C_COMPLEX, MPI_C_FLOAT_COMPLEX, MPI_C_DOUBLE_COMPLEX, and MPI_C_LONG_DOUBLE_COMPLEX are now valid predefined MPI datatypes.
5. Section 3.4 on page 39, Section 3.7.2 on page 50, Section 3.9 on page 75, and Section 5.1 on page 143.
The read access restriction on the send buffer for blocking, non blocking and collective API has been lifted. It is permitted to access for read the send buffer while the operation is in progress.
6. Section 3.7 on page 49.
The Advice to users for IBSEND and IRSEND was slightly changed.
7. Section 3.7.3 on page 54.
The advice to free an active request was removed in the Advice to users for MPI_REQUEST_FREE.
8. Section 3.7.6 on page 66.
MPI_REQUEST_GET_STATUS changed to permit inactive or null requests as input.
9. Section 5.8 on page 170.
“In place” option is added to MPI_ALLTOALL, MPI_ALLTOALLV, and MPI_ALLTOALLW for intracommunicators.
10. Section 5.9.2 on page 178.
Predefined parameterized datatypes (e.g., returned by MPI_TYPE_CREATE_F90_REAL) and optional named predefined datatypes (e.g. MPI_REAL8) have been added to the list of valid datatypes in reduction operations.
11. Section 5.9.2 on page 178.
MPI_(U)INT{8,16,32,64}_T are all considered C integer types for the purposes of the predefined reduction operators. MPI_AINT and MPI_OFFSET are considered Fortran

1 integer types. MPI_C_BOOL is considered a Logical type.

2 MPI_C_COMPLEX, MPI_C_FLOAT_COMPLEX, MPI_C_DOUBLE_COMPLEX, and
3 MPI_C_LONG_DOUBLE_COMPLEX are considered Complex types.

- 4
5 12. Section 5.9.7 on page 191.

6 The local routines MPI_REDUCE_LOCAL and MPI_OP_COMMUTATIVE have been
7 added.

- 8
9 13. Section 5.10.1 on page 193.

10 The collective function MPI_REDUCE_SCATTER_BLOCK is added to the MPI stan-
11 dard.

- 12
13 14. Section 5.11.2 on page 196.

14 Added in place argument to MPI_EXSCAN.

- 15
16 15. Section 6.4.2 on page 257, and Section 6.6 on page 278.

17 Implementations that did not implement MPI_COMM_CREATE on intercommuni-
18 cators will need to add that functionality. As the standard described the behav-
19 ior of this operation on intercommunicators, it is believed that most implementa-
20 tions already provide this functionality. Note also that the C++ binding for both
21 MPI_COMM_CREATE and MPI_COMM_SPLIT explicitly allow Intercomms.

- 22
23 16. Section 6.4.2 on page 257.

24 MPI_COMM_CREATE is extended to allow several disjoint subgroups as input if comm
25 is an intracommunicator. If comm is an intercommunicator it was clarified that all
26 processes in the same local group of comm must specify the same value for group.

- 27
28 17. Section 7.5.4 on page 323.

29 New functions for a scalable distributed graph topology interface has been added.
30 In this section, the functions MPI_DIST_GRAPH_CREATE_ADJACENT and
31 MPI_DIST_GRAPH_CREATE, the constants MPI_UNWEIGHTED, and the derived C++
32 class Distgraphcomm were added.

- 33
34 18. Section 7.5.5 on page 330.

35 For the scalable distributed graph topology interface, the functions
36 MPI_DIST_GRAPH_NEIGHBORS_COUNT and MPI_DIST_GRAPH_NEIGHBORS and
37 the constant MPI_DIST_GRAPH were added.

- 38
39 19. Section 7.5.5 on page 330.

40 Remove ambiguity regarding duplicated neighbors with MPI_GRAPH_NEIGHBORS
41 and MPI_GRAPH_NEIGHBORS_COUNT.

- 42
43 20. Section 8.1.1 on page 367.

44 The subversion number changed from 1 to 2.

- 45
46 21. Section 8.3 on page 374, Section 15.2 on page 636, and Annex A.1.3 on page 720.

47 Changed function pointer typedef names MPI_{Comm,File,Win}_errhandler_fn to
48 MPI_{Comm,File,Win}_errhandler_function. Deprecated old “_fn” names.

- 49
50 22. Section 8.7.1 on page 395.

51 Attribute deletion callbacks on MPI_COMM_SELF are now called in LIFO order. Imple-
52 mentors must now also register all implementation-internal attribute deletion callbacks
53 on MPI_COMM_SELF before returning from MPI_INIT/MPI_INIT_THREAD.

23. Section [11.3.4](#) on page [457](#).
The restriction added in MPI 2.1 that the operation MPI_REPLACE in MPI_ACCUMULATE can be used only with predefined datatypes has been removed. MPI_REPLACE can now be used even with derived datatypes, as it was in MPI 2.0. Also, a clarification has been made that MPI_REPLACE can be used only in MPI_ACCUMULATE, not in collective operations that do reductions, such as MPI_REDUCE and others.
24. Section [12.2](#) on page [509](#).
Add “*” to the query_fn, free_fn, and cancel_fn arguments to the C++ binding for MPI::Grequest::Start() for consistency with the rest of MPI functions that take function pointer arguments.
25. Section [13.5.2](#) on page [572](#), and Table [13.2](#) on page [574](#).
MPI_(U)INT{8,16,32,64}_T, MPI_AINT, MPI_OFFSET, MPI_C_COMPLEX, MPI_C_FLOAT_COMPLEX, MPI_C_DOUBLE_COMPLEX, MPI_C_LONG_DOUBLE_COMPLEX, and MPI_C_BOOL are added as predefined datatypes in the external32 representation.
26. Section [18.2.7](#) on page [697](#).
The description was modified that it only describes how an MPI implementation behaves, but not how MPI stores attributes internally. The erroneous MPI-2.1 Example 16.17 was replaced with three new examples [18.13](#), [18.14](#), and [18.15](#) on pages [698-699](#) explicitly detailing cross-language attribute behavior. Implementations that matched the behavior of the old example will need to be updated.
27. Annex [A.1.1](#) on page [705](#).
Removed type MPI::Fint (compare MPI_Fint in Section [A.1.2](#) on page [719](#)).
28. Annex [A.1.1](#) on page [705](#). Table *Named Predefined Datatypes*.
Added MPI_(U)INT{8,16,32,64}_T, MPI_AINT, MPI_OFFSET, MPI_C_BOOL, MPI_C_FLOAT_COMPLEX, MPI_C_COMPLEX, MPI_C_DOUBLE_COMPLEX, and MPI_C_LONG_DOUBLE_COMPLEX are added as predefined datatypes.

B.5 Changes from Version 2.0 to Version 2.1

1. Section [3.2.2](#) on page [27](#), and Annex [A.1](#) on page [705](#).
In addition, the MPI_LONG_LONG should be added as an optional type; it is a synonym for MPI_LONG_LONG_INT.
2. Section [3.2.2](#) on page [27](#), and Annex [A.1](#) on page [705](#).
MPI_LONG_LONG_INT, MPI_LONG_LONG (as synonym), MPI_UNSIGNED_LONG_LONG, MPI_SIGNED_CHAR, and MPI_WCHAR are moved from optional to official and they are therefore defined for all three language bindings.
3. Section [3.2.5](#) on page [32](#).
MPI_GET_COUNT with zero-length datatypes: The value returned as the count argument of MPI_GET_COUNT for a datatype of length zero where zero bytes have been transferred is zero. If the number of bytes transferred is greater than zero, MPI_UNDEFINED is returned.

- 1 4. Section 4.1 on page 85.
2 General rule about derived datatypes: Most datatype constructors have replication
3 count or block length arguments. Allowed values are non-negative integers. If the
4 value is zero, no elements are generated in the type map and there is no effect on
5 datatype bounds or extent.
6
- 7 5. Section 4.3 on page 140.
8 MPI_BYTE should be used to send and receive data that is packed using
9 MPI_PACK_EXTERNAL.
10
- 11 6. Section 5.9.6 on page 189.
12 If comm is an intercommunicator in MPI_ALLREDUCE, then both groups should pro-
13 vide count and datatype arguments that specify the same type signature (i.e., it is not
14 necessary that both groups provide the same count value).
15
- 16 7. Section 6.3.1 on page 248.
17 MPI_GROUP_TRANSLATE_RANKS and MPI_PROC_NULL: MPI_PROC_NULL is a valid
18 rank for input to MPI_GROUP_TRANSLATE_RANKS, which returns MPI_PROC_NULL
19 as the translated rank.
20
- 21 8. Section 6.7 on page 286.
22 About the attribute caching functions:
23 *Advice to implementors.* High-quality implementations should raise an er-
24 ror when a keyval that was created by a call to MPI_XXX_CREATE_KEYVAL
25 is used with an object of the wrong type with a call to
26 MPI_YYY_GET_ATTR, MPI_YYY_SET_ATTR, MPI_YYY_DELETE_ATTR, or
27 MPI_YYY_FREE_KEYVAL. To do so, it is necessary to maintain, with each key-
28 val, information on the type of the associated user function. (*End of advice to*
29 *implementors.*)
30
- 31 9. Section 6.8 on page 302.
32 In MPI_COMM_GET_NAME: In C, a null character is additionally stored at
33 name[resultlen]. resultlen cannot be larger than MPI_MAX_OBJECT_NAME-1. In For-
34 tran, name is padded on the right with blank characters. resultlen cannot be larger
35 than MPI_MAX_OBJECT_NAME.
36
- 37 10. Section 7.4 on page 311.
38 About MPI_GRAPH_CREATE and MPI_CART_CREATE: All input arguments must
39 have identical values on all processes of the group of comm_old.
40
- 41 11. Section 7.5.1 on page 313.
42 In MPI_CART_CREATE: If ndims is zero then a zero-dimensional Cartesian topology
43 is created. The call is erroneous if it specifies a grid that is larger than the group size
44 or if ndims is negative.
45
- 46 12. Section 7.5.3 on page 321.
47 In MPI_GRAPH_CREATE: If the graph is empty, i.e., nnodes == 0, then
48 MPI_COMM_NULL is returned in all processes.

13. Section 7.5.3 on page 321. 1
 In MPI_GRAPH_CREATE: A single process is allowed to be defined multiple times 2
 in the list of neighbors of a process (i.e., there may be multiple edges between two 3
 processes). A process is also allowed to be a neighbor to itself (i.e., a self loop in the 4
 graph). The adjacency matrix is allowed to be non-symmetric. 5
6
Advice to users. Performance implications of using multiple edges or a non- 7
 symmetric adjacency matrix are not defined. The definition of a node-neighbor 8
 edge does not imply a direction of the communication. (*End of advice to users.*) 9
14. Section 7.5.5 on page 330. 10
 In MPI_CARTDIM_GET and MPI_CART_GET: If comm is associated with a zero- 11
 dimensional Cartesian topology, MPI_CARTDIM_GET returns ndims=0 and 12
 MPI_CART_GET will keep all output arguments unchanged. 13
14
15. Section 7.5.5 on page 330. 15
 In MPI_CART_RANK: If comm is associated with a zero-dimensional Cartesian topol- 16
 ogy, coord is not significant and 0 is returned in rank. 17
18
16. Section 7.5.5 on page 330. 19
 In MPI_CART_COORDS: If comm is associated with a zero-dimensional Cartesian 20
 topology, coords will be unchanged. 21
22
17. Section 7.5.6 on page 337. 23
 In MPI_CART_SHIFT: It is erroneous to call MPI_CART_SHIFT with a direction that 24
 is either negative or greater than or equal to the number of dimensions in the Cartesian 25
 communicator. This implies that it is erroneous to call MPI_CART_SHIFT with a 26
 comm that is associated with a zero-dimensional Cartesian topology. 27
18. Section 7.5.7 on page 339. 28
 In MPI_CART_SUB: If all entries in remain_dims are false or comm is already associ- 29
 ated with a zero-dimensional Cartesian topology then newcomm is associated with a 30
 zero-dimensional Cartesian topology. 31
32
- 18.1. Section 8.1.1 on page 367. 33
 The subversion number changed from 0 to 1. 34
35
19. Section 8.1.2 on page 368. 36
 In MPI_GET_PROCESSOR_NAME: In C, a null character is additionally stored at 37
 name[resultlen]. resultlen cannot be larger then MPI_MAX_PROCESSOR_NAME-1. In 38
 Fortran, name is padded on the right with blank characters. resultlen cannot be larger 39
 then MPI_MAX_PROCESSOR_NAME. 40
20. Section 8.3 on page 374. 41
 MPI_{COMM,WIN,FILE}_GET_ERRHANDLER behave as if a new error handler object 42
 is created. That is, once the error handler is no longer needed, 43
 MPI_ERRHANDLER_FREE should be called with the error handler returned from 44
 MPI_ERRHANDLER_GET or MPI_{COMM,WIN,FILE}_GET_ERRHANDLER to mark 45
 the error handler for deallocation. This provides behavior similar to that of 46
 MPI_COMM_GROUP and MPI_GROUP_FREE. 47
48

- 1 21. Section 8.7 on page 389, see explanations to MPI_FINALIZE.
2 MPI_FINALIZE is collective over all connected processes. If no processes were spawned,
3 accepted or connected then this means over MPI_COMM_WORLD; otherwise it is col-
4 lective over the union of all processes that have been and continue to be connected,
5 as explained in Section 10.5.4 on page 431.
6
- 7 22. Section 8.7 on page 389.
8 About MPI_ABORT:
9 *Advice to users.* Whether the errorcode is returned from the executable or from
10 the MPI process startup mechanism (e.g., mpiexec), is an aspect of quality of the
11 MPI library but not mandatory. (*End of advice to users.*)
12
13 *Advice to implementors.* Where possible, a high-quality implementation will try
14 to return the errorcode from the MPI process startup mechanism (e.g. mpiexec
15 or singleton init). (*End of advice to implementors.*)
16
- 17 23. Section 9 on page 399.
18 An implementation must support info objects as caches for arbitrary (key, value)
19 pairs, regardless of whether it recognizes the key. Each function that takes hints in
20 the form of an MPI_Info must be prepared to ignore any key it does not recognize. This
21 description of info objects does not attempt to define how a particular function should
22 react if it recognizes a key but not the associated value. MPI_INFO_GET_NKEYS,
23 MPI_INFO_GET_NTHKEY, MPI_INFO_GET_VALUELEN, and MPI_INFO_GET must
24 retain all (key,value) pairs so that layered functionality can also use the Info object.
25
- 26 24. Section 11.3 on page 451.
27 MPI_PROC_NULL is a valid target rank in the MPI RMA calls MPI_ACCUMULATE,
28 MPI_GET, and MPI_PUT. The effect is the same as for MPI_PROC_NULL in MPI point-
29 to-point communication. See also item 25 in this list.
30
- 31 25. Section 11.3 on page 451.
32 After any RMA operation with rank MPI_PROC_NULL, it is still necessary to finish
33 the RMA epoch with the synchronization method that started the epoch. See also
34 item 24 in this list.
35
- 36 26. Section 11.3.4 on page 457.
37 MPI_REPLACE in MPI_ACCUMULATE, like the other predefined operations, is defined
38 only for the predefined MPI datatypes.
39
- 40 27. Section 13.2.8 on page 534.
41 About MPI_FILE_SET_VIEW and MPI_FILE_SET_INFO: When an info object that
42 specifies a subset of valid hints is passed to MPI_FILE_SET_VIEW or
43 MPI_FILE_SET_INFO, there will be no effect on previously set or defaulted hints that
44 the info does not specify.
45
- 46 28. Section 13.2.8 on page 534.
47 About MPI_FILE_GET_INFO: If no hint exists for the file associated with fh, a handle
48 to a newly created info object is returned that contains no key/value pair.

29. Section 13.3 on page 538. 1
If a file does not have the mode `MPI_MODE_SEQUENTIAL`, then 2
`MPI_DISPLACEMENT_CURRENT` is invalid as `disp` in `MPI_FILE_SET_VIEW`. 3
4
30. Section 13.5.2 on page 572. 5
The bias of 16 byte doubles was defined with 10383. The correct value is 16383. 6
7
31. MPI-2.2, Section 16.1.4 (Section was removed in MPI-3.0). 8
In the example in this section, the buffer should be declared as `const void* buf`. 9
10
32. Section 18.1.9 on page 659. 11
About `MPI_TYPE_CREATE_F90_XXX`: 12
Advice to implementors. An application may often repeat a call to 13
`MPI_TYPE_CREATE_F90_XXX` with the same combination of `(XXX,p,r)`. The 14
application is not allowed to free the returned predefined, unnamed datatype 15
handles. To prevent the creation of a potentially huge amount of handles, the 16
MPI implementation should return the same datatype handle for the same (17
`REAL/COMPLEX/INTEGER,p,r`) combination. Checking for the combination (18
`p,r`) in the preceding call to `MPI_TYPE_CREATE_F90_XXX` and using a hash- 19
table to find formerly generated handles should limit the overhead of finding 20
a previously generated datatype with same combination of `(XXX,p,r)`. (*End of 21
advice to implementors.*) 22
33. Section A.1.1 on page 705. 23
`MPI_BOTTOM` is defined as `void * const MPI::BOTTOM`. 24
25
26
27
28
29
30
31
32
33
34
35
36
37
38
39
40
41
42
43
44
45
46
47
48

- 1
- 2
- 3
- 4
- 5
- 6
- 7
- 8
- 9
- 10
- 11
- 12
- 13
- 14
- 15
- 16
- 17
- 18
- 19
- 20
- 21
- 22
- 23
- 24
- 25
- 26
- 27
- 28
- 29
- 30
- 31
- 32
- 33
- 34
- 35
- 36
- 37
- 38
- 39
- 40
- 41
- 42
- 43
- 44
- 45
- 46
- 47
- 48

1
2
3
4
5
6
7
8
9
10
11
12
13
14
15
16
17
18
19
20
21
22
23
24
25
26
27
28
29
30
31
32
33
34
35
36
37
38
39
40
41
42
43
44
45
46
47
48

Bibliography

- [1] V. Bala and S. Kipnis. Process groups: a mechanism for the coordination of and communication among processes in the Venus collective communication library. Technical report, IBM T. J. Watson Research Center, October 1992. Preprint. [1.2](#)
- [2] V. Bala, S. Kipnis, L. Rudolph, and Marc Snir. Designing efficient, scalable, and portable collective communication libraries. Technical report, IBM T. J. Watson Research Center, October 1992. Preprint. [1.2](#)
- [3] Purushotham V. Bangalore, Nathan E. Doss, and Anthony Skjellum. MPI++: Issues and Features. In *OOO-SKI '94*, page in press, 1994. [6.1](#)
- [4] A. Beguelin, J. Dongarra, A. Geist, R. Manchek, and V. Sunderam. Visualization and debugging in a heterogeneous environment. *IEEE Computer*, 26(6):88–95, June 1993. [1.2](#)
- [5] Luc Bomans and Rolf Hempel. The Argonne/GMD macros in FORTRAN for portable parallel programming and their implementation on the Intel iPSC/2. *Parallel Computing*, 15:119–132, 1990. [1.2](#)
- [6] Dan Bonachea and Jason Duell. Problems with using MPI 1.1 and 2.0 as compilation targets for parallel language implementations. *IJHPCN*, 1(1/2/3):91–99, 2004. [11.7](#)
- [7] Rajesh Bordawekar, Juan Miguel del Rosario, and Alok Choudhary. Design and evaluation of primitives for parallel I/O. In *Proceedings of Supercomputing '93*, pages 452–461, 1993. [13.1](#)
- [8] R. Butler and E. Lusk. User’s guide to the p4 programming system. Technical Report TM-ANL-92/17, Argonne National Laboratory, 1992. [1.2](#)
- [9] Ralph Butler and Ewing Lusk. Monitors, messages, and clusters: The p4 parallel programming system. *Parallel Computing*, 20(4):547–564, April 1994. Also Argonne National Laboratory Mathematics and Computer Science Division preprint P362-0493. [1.2](#)
- [10] Robin Calkin, Rolf Hempel, Hans-Christian Hoppe, and Peter Wypior. Portable programming with the PARMACS message-passing library. *Parallel Computing*, 20(4):615–632, April 1994. [1.2](#)
- [11] S. Chittor and R. J. Enbody. Performance evaluation of mesh-connected wormhole-routed networks for interprocessor communication in multicomputers. In *Proceedings of the 1990 Supercomputing Conference*, pages 647–656, 1990. [7.1](#)

- [12] S. Chittor and R. J. Enbody. Predicting the effect of mapping on the communication performance of large multicomputers. In *Proceedings of the 1991 International Conference on Parallel Processing, vol. II (Software)*, pages II-1 – II-4, 1991. 7.1
- [13] Parasoftware Corporation. Express version 1.0: A communication environment for parallel computers, 1988. 1.2
- [14] Yiannis Cotronis, Anthony Danalis, Dimitrios S. Nikolopoulos, and Jack Dongarra, editors. *Recent Advances in the Message Passing Interface - 18th European MPI Users' Group Meeting, EuroMPI 2011, Santorini, Greece, September 18-21, 2011. Proceedings*, volume 6960 of *Lecture Notes in Computer Science*. Springer, 2011. 17, 37
- [15] William D. Gropp. Using node and socket information to implement MPI Cartesian topologies. *Parallel Computing*, 85, 01 2019. 7.5.1
- [16] Juan Miguel del Rosario, Rajesh Bordawekar, and Alok Choudhary. Improved parallel I/O via a two-phase run-time access strategy. In *IPPS '93 Workshop on Input/Output in Parallel Computer Systems*, pages 56–70, 1993. Also published in *Computer Architecture News* 21(5), December 1993, pages 31–38. 13.1
- [17] James Dinan, Sriram Krishnamoorthy, Pavan Balaji, Jeff R. Hammond, Manojkumar Krishnan, Vinod Tipparaju, and Abhinav Vishnu. Noncollective communicator creation in MPI. In Cotronis et al. [14], pages 282–291. 6.4.2
- [18] J. Dongarra, A. Geist, R. Manchek, and V. Sunderam. Integrated PVM framework supports heterogeneous network computing. *Computers in Physics*, 7(2):166–75, April 1993. 1.2
- [19] J. J. Dongarra, R. Hempel, A. J. G. Hey, and D. W. Walker. A proposal for a user-level, message passing interface in a distributed memory environment. Technical Report TM-12231, Oak Ridge National Laboratory, February 1993. 1.2
- [20] Edinburgh Parallel Computing Centre, University of Edinburgh. *CHIMP Concepts*, June 1991. 1.2
- [21] Edinburgh Parallel Computing Centre, University of Edinburgh. *CHIMP Version 1.0 Interface*, May 1992. 1.2
- [22] D. Feitelson. Communicators: Object-based multiparty interactions for parallel programming. Technical Report 91-12, Dept. Computer Science, The Hebrew University of Jerusalem, November 1991. 6.1.2
- [23] Message Passing Interface Forum. MPI: A Message-Passing Interface standard. *The International Journal of Supercomputer Applications and High Performance Computing*, 8, 1994. 1.3
- [24] Message Passing Interface Forum. MPI: A Message-Passing Interface standard (version 1.1). Technical report, 1995. <http://www.mpi-forum.org>. 1.3
- [25] Al Geist, Adam Beguelin, Jack Dongarra, Weicheng Jiang, Bob Manchek, and Vaidy Sunderam. *PVM: Parallel Virtual Machine—A User's Guide and Tutorial for Network Parallel Computing*. MIT Press, 1994. 10.1

- [26] G. A. Geist, M. T. Heath, B. W. Peyton, and P. H. Worley. PICL: A portable instrumented communications library, C reference manual. Technical Report TM-11130, Oak Ridge National Laboratory, Oak Ridge, TN, July 1990. [1.2](#)
- [27] D. Gregor, T. Hoefler, B. Barrett, and A. Lumsdaine. Fixing probe for multi-threaded MPI applications. Technical Report 674, Indiana University, Jan. 2009. [3.8.2](#)
- [28] William D. Gropp and Barry Smith. Chameleon parallel programming tools users manual. Technical Report ANL-93/23, Argonne National Laboratory, March 1993. [1.2](#)
- [29] Michael Hennecke. A Fortran 90 interface to MPI version 1.1. Technical Report Internal Report 63/96, Rechenzentrum, Universität Karlsruhe, D-76128 Karlsruhe, Germany, June 1996. Available via world wide web from http://www.uni-karlsruhe.de/~Michael.Hennecke/Publications/#MPI_F90. [18.1.3](#)
- [30] T. Hoefler, G. Bronevetsky, B. Barrett, B. R. de Supinski, and A. Lumsdaine. Efficient MPI support for advanced hybrid programming models. In *Recent Advances in the Message Passing Interface (EuroMPI'10)*, volume LNCS 6305, pages 50–61. Springer, Sep. 2010. [3.8.1](#), [3.8.2](#)
- [31] T. Hoefler, P. Gottschling, A. Lumsdaine, and W. Rehm. Optimizing a conjugate gradient solver with non-blocking collective operations. *Elsevier Journal of Parallel Computing (PARCO)*, 33(9):624–633, Sep. 2007. [5.12](#)
- [32] T. Hoefler, F. Lorenzen, and A. Lumsdaine. Sparse non-blocking collectives in quantum mechanical calculations. In *Recent Advances in Parallel Virtual Machine and Message Passing Interface, 15th European PVM/MPI Users' Group Meeting*, volume LNCS 5205, pages 55–63. Springer, Sep. 2008. [7.6](#)
- [33] T. Hoefler and A. Lumsdaine. Message progression in parallel computing — to thread or not to thread? In *Proceedings of the 2008 IEEE International Conference on Cluster Computing*. IEEE Computer Society, Oct. 2008. [5.12](#)
- [34] T. Hoefler, A. Lumsdaine, and W. Rehm. Implementation and performance analysis of non-blocking collective operations for MPI. In *Proceedings of the 2007 International Conference on High Performance Computing, Networking, Storage and Analysis, SC07*. IEEE Computer Society/ACM, Nov. 2007. [5.12](#)
- [35] T. Hoefler, M. Schellmann, S. Gortlatch, and A. Lumsdaine. Communication optimization for medical image reconstruction algorithms. In *Recent Advances in Parallel Virtual Machine and Message Passing Interface, 15th European PVM/MPI Users' Group Meeting*, volume LNCS 5205, pages 75–83. Springer, Sep. 2008. [5.12](#)
- [36] T. Hoefler and J. L. Traeff. Sparse collective operations for MPI. In *Proceedings of the 23rd IEEE International Parallel & Distributed Processing Symposium, HIPS'09 Workshop*, May 2009. [7.6](#)
- [37] Torsten Hoefler and Marc Snir. Writing parallel libraries with MPI — common practice, issues, and extensions. In Cotronis et al. [[14](#)], pages 345–355. [6.4.2](#)
- [38] Institute of Electrical and Electronics Engineers, New York. *IEEE Standard for Binary Floating-Point Arithmetic, ANSI/IEEE Standard 754-1985*, 1985. [13.5.2](#)

- 1 [39] International Organization for Standardization, Geneva, ISO 8859-1:1987. *Information*
2 *processing — 8-bit single-byte coded graphic character sets — Part 1: Latin alphabet*
3 *No. 1*, 1987. [13.5.2](#)
- 4
5 [40] International Organization for Standardization, Geneva, ISO/IEC 9945-1:1996(E). *In-*
6 *formation technology — Portable Operating System Interface (POSIX) — Part 1: Sys-*
7 *tem Application Program Interface (API) [C Language]*, December 1996. [12.4](#), [13.2.1](#)
- 8
9 [41] International Organization for Standardization, Geneva, ISO/IEC 1539-1:2010. *In-*
10 *formation technology — Programming languages — Fortran — Part 1: Base language*,
11 November 2010. [18.1.1](#), [18.1.2](#)
- 12 [42] International Organization for Standardization, ISO/IEC/SC22/WG5
13 (Fortran), Geneva, TS 29113. *TS on further interoperability with C*,
14 2012. <http://www.nag.co.uk/sc22wg5/>, successfully balloted DTS at
15 <ftp://ftp.nag.co.uk/sc22wg5/N1901-N1950/N1917.pdf>. [18.1.1](#), [18.1.1](#), [18.1.2](#), [18.1.7](#),
16 [28](#)
- 17
18 [43] Charles H. Koelbel, David B. Loveman, Robert S. Schreiber, Guy L. Steele Jr., and
19 Mary E. Zosel. *The High Performance Fortran Handbook*. MIT Press, 1993. [4.1.4](#)
- 20 [44] David Kotz. Disk-directed I/O for MIMD multiprocessors. In *Proceedings of the 1994*
21 *Symposium on Operating Systems Design and Implementation*, pages 61–74, November
22 1994. Updated as Dartmouth TR PCS-TR94-226 on November 8, 1994. [13.1](#)
- 23
24 [45] O. Krämer and H. Mühlenbein. Mapping strategies in message-based multiprocessor
25 systems. *Parallel Computing*, 9:213–225, 1989. [7.1](#)
- 26
27 [46] S. J. Lefflet, R. S. Fabry, W. N. Joy, P. Lapsley, S. Miller, and C. Torek. An advanced
28 4.4BSD interprocess communication tutorial, Unix programmer’s supplementary docu-
29 ments (PSD) 21. Technical report, Computer Systems Research Group, Department of
30 Electrical Engineering and Computer Science, University of California, Berkeley, 1993.
31 Also available at <http://www.netbsd.org/Documentation/lite2/psd/>. [10.5.5](#)
- 32 [47] nCUBE Corporation. *nCUBE 2 Programmers Guide, r2.0*, December 1990. [1.2](#)
- 33
34 [48] Christoph Niethammer and Rolf Rabenseifner. An MPI interface for application and
35 hardware aware Cartesian topology optimization. In *Proceedings of the 26th European*
36 *MPI Users’ Group Meeting (EuroMPI 2019), September 11-13, 2019, Zürich, Switzer-*
37 *land*. ACM, New York, NY, USA, 9 pages. [7.5.2](#)
- 38
39 [49] Bill Nitzberg. Performance of the iPSC/860 Concurrent File System. Technical Report
40 RND-92-020, NAS Systems Division, NASA Ames, December 1992. [13.1](#)
- 41
42 [50] William J. Nitzberg. *Collective Parallel I/O*. PhD thesis, Department of Computer
43 and Information Science, University of Oregon, December 1995. [13.1](#)
- 44
45 [51] *4.4BSD Programmer’s Supplementary Documents (PSD)*. O’Reilly and Associates,
46 1994. [10.5.5](#)
- 47
48 [52] Paul Pierce. The NX/2 operating system. In *Proceedings of the Third Conference on*
Hypercube Concurrent Computers and Applications, pages 384–390. ACM Press, 1988.
[1.2](#)

#120

- [53] Martin Schulz and Bronis R. de Supinski. P^NMPI tools: A whole lot greater than the sum of their parts. In *ACM/IEEE Supercomputing Conference (SC)*, pages 1–10. ACM, 2007. [14.2.8](#)
- [54] K. E. Seamons, Y. Chen, P. Jones, J. Jozwiak, and M. Winslett. Server-directed collective I/O in Panda. In *Proceedings of Supercomputing '95*, December 1995. [13.1](#)
- [55] A. Skjellum and A. Leung. Zipcode: a portable multicomputer communication library atop the reactive kernel. In D. W. Walker and Q. F. Stout, editors, *Proceedings of the Fifth Distributed Memory Concurrent Computing Conference*, pages 767–776. IEEE Press, 1990. [1.2](#), [6.1.2](#)
- [56] A. Skjellum, S. Smith, C. Still, A. Leung, and M. Morari. The Zipcode message passing system. Technical report, Lawrence Livermore National Laboratory, September 1992. [1.2](#)
- [57] Anthony Skjellum, Nathan E. Doss, and Purushotham V. Bangalore. Writing Libraries in MPI. In Anthony Skjellum and Donna S. Reese, editors, *Proceedings of the Scalable Parallel Libraries Conference*, pages 166–173. IEEE Computer Society Press, October 1993. [6.1](#)
- [58] Anthony Skjellum, Nathan E. Doss, and Kishore Viswanathan. Inter-communicator extensions to MPI in the MPIX (MPI eXtension) Library. Technical Report MSU-940722, Mississippi State University — Dept. of Computer Science, April 1994. <http://www.erc.msstate.edu/mpi/mpix.html>. [5.2.2](#)
- [59] Anthony Skjellum, Steven G. Smith, Nathan E. Doss, Alvin P. Leung, and Manfred Morari. The Design and Evolution of Zipcode. *Parallel Computing*, 20(4):565–596, April 1994. [6.1.2](#), [6.5.6](#)
- [60] Rajeev Thakur and Alok Choudhary. An extended two-phase method for accessing sections of out-of-core arrays. *Scientific Programming*, 5(4):301–317, Winter 1996. [13.1](#)
- [61] Jesper Larsson Träff and Felix Donatus Lübbe. Specification guideline violations by MPI_Dims_Create. In *EuroMPI '15, Proceedings of the 22nd European MPI Users Group Meeting*, pages 19.1–19.2. ACM, 2015. [7.5.2](#)
- [62] *The Unicode Standard, Version 2.0*. Addison-Wesley, 1996. ISBN 0-201-48345-9. [13.5.2](#)
- [63] D. Walker. Standards for message passing in a distributed memory environment. Technical Report TM-12147, Oak Ridge National Laboratory, August 1992. [1.2](#)

#120

General Index

This index lists mainly terms of the MPI specification. The underlined page numbers refer to the definitions or parts of the definition of the terms. Bold face numbers mark section titles.

- absolute addresses, [16](#), [103](#), [677](#)
- access epoch, [471](#)
- action
 - in function names, [10](#)
- active, [54](#), [307](#)
- active target communication, [470](#)
- addresses, [117](#)
 - absolute, [16](#), [103](#), [677](#)
 - correct use, [117](#)
 - relative displacement, [16](#), [103](#)
- all-reduce, [189](#)
 - nonblocking, [213](#)
 - persistent, [230](#)
- all-to-all, [170](#)
 - nonblocking, [209](#)
 - persistent, [226](#)
- array arguments, [14](#)
- assertions, [484](#)
- ASYNCHRONOUS
 - Fortran attribute, [679](#)
- attribute, [245](#), [286](#), [697](#)
 - caching, [244](#)
- backward incompatibilities, [639](#)
- barrier synchronization, [149](#)
 - nonblocking, [201](#)
 - persistent, [219](#)
- blocking, [11](#), [39](#), [42](#), [541](#)
 - I/O, [542](#)
- bounds of datatypes, [108](#)
- broadcast, [150](#)
 - nonblocking, [202](#)
 - persistent, [219](#)
- buffer allocation, [46](#)
- buffered, [39](#), [49](#), [50](#)
 - nonblocking, [49](#)
- buffered send, [42](#)
- C
 - language binding, [19](#)
- caching, [243](#), [244](#), [286](#)
- callback functions
 - language interoperability, [696](#)
 - prototype definitions, [720](#)
 - deprecated, [725](#)
- cancel, [23](#), [55](#), [66](#), [73](#), [393](#), [636](#), [841](#), [842](#)
- canonical pack and unpack, [140](#)
- Cartesian
 - topology, [311](#), [313](#)
- change-log, [841](#)
- choice, [16](#)
- class
 - in function names, [10](#)
- clock synchronization, [370](#)
- collective, [11](#), [541](#)
- collective communication, [143](#)
 - correctness, [234](#)
 - file data access operations, [559](#)
 - neighborhood, [341](#)
 - nonblocking, [199](#)
- commit, [111](#)
- COMMON blocks, [682](#)
- communication, [435](#)
 - collective, [143](#)
 - modes, [39](#)
 - one-sided, [435](#)
 - point-to-point, [25](#)
 - RMA, [435](#)
- communicator, [29](#), [243](#), [244](#)
- completes
 - operation, [11](#)
- completion, [54](#)
 - multiple, [59](#)
- connected, [431](#)
- constants, [15](#), [701](#), [705](#)
- context, [243](#), [244](#), [246](#)
- control variables
 - tools interface, [607](#)
- conversion, [37](#)
- counts, [17](#)
- create
 - in function names, [10](#)
- data, [27](#)

- data conversion, [37](#)
- datatypes, [85](#), [695](#)
- delete
 - in function names, [10](#)
- deprecated interfaces, [18](#), [633](#)
- derived datatype, [12](#), [85](#), [673](#)
- disconnected, [431](#)
- displacement, [525](#), [538](#)
- distributed graph
 - topology, [311](#), [323](#)
- dynamically attached memory, [444](#)
- elementary datatype, [525](#), [539](#)
- empty, [54](#)
- end of file, [527](#)
- envelope, [25](#), [29](#)
- environmental inquiries, [368](#)
- equivalent datatypes, [12](#)
- error handling, [20](#), [374](#)
 - error codes and classes, [382](#)
 - error handlers, [376](#), [382](#), [696](#)
 - I/O, [589](#)
 - one-sided communication, [486](#)
 - program error, [20](#)
 - resource error, [20](#)
- establishing communication, [419](#)
- etype, [525](#), [539](#)
- exception, [374](#)
- exclusive scan
 - nonblocking, [217](#)
 - persistent, [234](#)
- explicit offsets, [541](#), [543](#)
- exposure epoch, [471](#)
- extent of datatypes, [86](#), [107](#), [108](#)
 - true extent, [110](#)
- external32
 - file data representation, [570](#)
- extra-state, [701](#)
- fairness, [44](#), [64](#)
- file, [525](#)
 - data access, [541](#)
 - collective operations, [559](#)
 - explicit offsets, [543](#)
 - individual file pointers, [548](#)
 - seek, [560](#)
 - shared file pointers, [556](#)
 - split collective, [562](#)
 - end of file, [527](#)
 - filetype, [526](#)
 - handle, [527](#)
 - interoperability, [568](#)
 - manipulation, [527](#)
 - offset, [17](#), [526](#)
 - pointer, [527](#)
 - size, [527](#)
 - view, [525](#), [526](#), [538](#)
- file size, [584](#)
- finished, [395](#)
- Fortran
 - language binding, [18](#), [641](#)
- Fortran support, [641](#)
- gather, [151](#)
 - nonblocking, [203](#)
 - persistent, [220](#)
- gather-to-all, [167](#)
 - nonblocking, [207](#)
 - persistent, [224](#)
- general datatype, [85](#)
- generalized requests, [509](#), [509](#)
- get
 - in function names, [10](#)
- graph
 - topology, [311](#), [321](#)
- group, [243](#), [244](#), [246](#), [279](#)
- group objects, [246](#)
- handles, [12](#), [690](#)
- host rank, [369](#)
- immediate, [50](#)
- inactive, [54](#)
- inclusive scan, [195](#)
 - nonblocking, [216](#)
 - persistent, [233](#)
- independent, [431](#)
- individual file pointers, [541](#), [548](#)
- info object, [399](#)
 - file info, [534](#)
 - keys, [726](#)
 - values, [727](#)
- initiation, [50](#)
- inter-communication, [245](#), [278](#)
- inter-communicator, [245](#), [278](#)
 - collective operations, [147](#), [148](#)
- interlanguage communication, [702](#)
- internal
 - file data representation, [570](#)
- interoperability, [568](#)
- intra-communication, [245](#), [278](#)
- intra-communicator, [244](#), [278](#)
 - collective operations, [146](#)
- intra-communicator objects, [247](#)
- I/O, [525](#)
- IO rank, [369](#)
- is
 - in function names, [10](#)

- 1 language binding, [17](#), [641](#)
- 2 interoperability, [689](#)
- 3 summary, [705](#)
- 4 lb_marker, [97](#), [98](#), [101](#), [107](#), [107](#), [111](#)
- 5 erased, [110](#)
- 6 local, [11](#), [39](#)
- 7 local group, [258](#)
- 8 loosely synchronous model, [306](#)
- 9 lower bound, [107](#)
- 10 lower-bound markers, [106](#)
- 11 macros, [19](#)
- 12 main thread, [519](#)
- 13 matched receives, [72](#)
- 14 matching
- 15 type, [35](#), [114](#), [583](#)
- 16 matching probe, [70](#)
- 17 memory
- 18 allocation, [371](#)
- 19 system, [12](#)
- 20 memory model, [436](#), [469](#)
- 21 separate, [436](#), [442](#)
- 22 unified, [436](#), [442](#)
- 23 message, [25](#)
- 24 data, [27](#)
- 25 envelope, [29](#)
- 26 modes, [39](#)
- 27 module variables, [682](#)
- 28 mpi module
- 29 Fortran support, [645](#)
- 30 mpi_f08 module
- 31 Fortran support, [642](#)
- 32 mpiexec, [390](#), [395](#), [396](#)
- 33 mpif.h include file
- 34 Fortran support, [647](#)
- 35 mpirun, [396](#)
- 36 multiple completions, [59](#)
- 37 named datatype, [12](#)
- 38 names, [419](#)
- 39 name publishing, [424](#)
- 40 naming objects, [302](#)
- 41 native
- 42 file data representation, [569](#)
- 43 neighborhood collective communication, [341](#)
- 44 nonblocking, [352](#)
- 45 non-local, [11](#), [39](#), [40](#)
- 46 nonblocking, [11](#), [49](#), [451](#), [541](#)
- 47 communication, [49](#)
- 48 completion, [54](#)
- Fortran problems, [676](#)
- I/O, [542](#)
- initiation, [50](#)
- request objects, [50](#)
- null handle, [54](#)
- null processes, [82](#)
- offset, [17](#), [526](#)
- one-sided communication, [435](#)
- Fortran problems, [677](#)
- opaque objects, [12](#), [694](#)
- operation completes, [11](#)
- origin, [436](#)
- pack, [134](#)
- canonical, [140](#)
- packing unit, [136](#)
- parallel procedure, [307](#)
- passive target communication, [470](#)
- performance variables
- tools interface, [614](#)
- persistent communication requests, [57](#), [75](#)
- collective persistent, [217](#), [357](#)
- Fortran problems, [677](#)
- PMPI_, [595](#)
- point-to-point communication, [25](#)
- portable datatype, [12](#)
- ports, [419](#)
- predefined datatype, [12](#)
- predefined reduction operations, [178](#)
- private window copy, [469](#)
- probe, [67](#)
- probe, matching, [70](#)
- process creation, [405](#)
- process group, [29](#)
- processes, [19](#)
- processor name, [370](#)
- profiling interface, [595](#)
- program error, [20](#)
- prototype definitions, [720](#)
- deprecated, [725](#)
- public window copy, [469](#)
- rank, [246](#)
- ready, [40](#), [49](#), [50](#)
- nonblocking, [49](#)
- ready send, [42](#)
- receive, [25](#), [26](#), [30](#)
- buffer, [26](#)
- complete, [49](#)
- context, [279](#)
- start call, [49](#)
- reduce, [176](#)
- nonblocking, [212](#)
- persistent, [229](#)
- reduce-scatter, [192](#)
- nonblocking, [214](#), [215](#)
- persistent, [231](#), [232](#)
- reduction operations, [175](#), [697](#)

- predefined, [178](#)
- process-local, [191](#)
- scan, [195](#)
- user-defined, [185](#)
- related, [136](#)
- relative displacement, [16](#), [103](#)
- remote group, [258](#)
- Remote Memory Access, *see* RMA
- removed interfaces, [18](#), [637](#)
- request complete
 - I/O, [542](#)
- request objects, [50](#)
- resource error, [20](#)
- RMA, [435](#)
 - communication calls, [451](#)
 - request-based, [464](#)
 - memory model, [469](#)
 - synchronization calls, [470](#)
- scan, [195](#)
 - inclusive, [195](#)
- scatter, [161](#)
 - nonblocking, [205](#)
 - persistent, [222](#)
- seek, [560](#)
- semantics
 - file consistency, [578](#)
 - nonblocking communications, [58](#)
 - point-to-point communication, [42](#)
- semantics and correctness
 - one-sided communication, [487](#)
- send, [25](#), [26](#)
 - buffer, [25](#)
 - complete, [49](#)
 - context, [279](#)
 - start, [49](#)
- send-receive, [80](#)
- separate memory model, [436](#), [442](#), [469](#)
- sequential storage, [117](#)
- Set
 - in function names, [10](#)
- shared file pointers, [541](#), [556](#)
- shared memory allocation, [441](#)
- signals, [22](#)
- singleton init, [430](#)
- size changing
 - I/O, [584](#)
- source, [279](#)
- split collective, [541](#), [562](#)
- standard, [39](#), [49](#)
 - nonblocking, [49](#)
- standard send, [42](#)
- starting processes, [406](#), [408](#)
- startup, [389](#)
 - portable, [396](#)
- state, [14](#)
- status, [32](#), [692](#)
 - associating information, [516](#)
 - ignore, [34](#)
 - test, [66](#)
- strong synchronization, [473](#)
- synchronization, [435](#), [451](#)
- synchronization calls
 - RMA, [470](#)
- synchronous, [39](#), [49](#), [50](#), [54](#)
 - nonblocking, [49](#)
- synchronous send, [42](#)
- system memory, [12](#)
- tag values, [369](#)
- target, [436](#)
- thread compliant, [518](#), [522](#)
- threads, [518](#)
- timers and synchronization, [388](#)
- tool information interface, [601](#)
- tool support, [595](#)
- topologies, [309](#)
- topology
 - Cartesian, [311](#), [313](#)
 - distributed graph, [311](#), [323](#)
 - graph, [311](#), [321](#)
 - virtual, [310](#)
- true extent of datatypes, [110](#)
- type map, [86](#)
- type matching, [35](#), [114](#)
- type signature, [86](#)
- types, [719](#)
- ub_marker, [97](#), [98](#), [101](#), [102](#), [107](#), [107](#), [111](#)
 - erased, [110](#)
- unified memory model, [436](#), [442](#), [469](#)
- universe size, [429](#)
- unnamed datatype, [12](#)
- unpack, [134](#)
 - canonical, [140](#)
- upper bound, [107](#)
- upper-bound markers, [106](#)
- user functions at process termination, [395](#)
- user-defined data representations, [573](#)
- user-defined reduction operations, [185](#)
- verbosity levels
 - tools interface, [602](#)
- version inquiries, [367](#)
- view, [525](#), [526](#), [538](#)
- virtual topology, [244](#), [245](#), [310](#)
- weak synchronization, [473](#)
- window

1 allocation, [439](#)
2 creation, [437](#)
3 dynamically attached memory, [444](#)
4 shared memory allocation, [441](#)

5
6
7
8
9
10
11
12
13
14
15
16
17
18
19
20
21
22
23
24
25
26
27
28
29
30
31
32
33
34
35
36
37
38
39
40
41
42
43
44
45
46
47
48

Examples Index

This index lists code examples throughout the text. Some examples are referred to by content; others are listed by the major MPI function that they are demonstrating. MPI functions listed in all capital letter are Fortran examples; MPI functions listed in mixed case are C examples.

- ASYNCHRONOUS, [503](#), [685](#), [687](#)
- Attributes between languages, [698](#)
- Basic tool using performance variables in the MPI tool information interface, [624](#)
- C/Fortran handle conversion, [691](#)
- Cartesian virtual topologies, [362](#)
- Client-server code, [65](#)
 - with blocking probe, [68](#)
 - with blocking probe, wrong, [69](#)
- Datatype
 - 3D array, [125](#)
 - absolute addresses, [130](#)
 - array of structures, [127](#)
 - elaborate example, [137](#), [139](#)
 - matching type, [114](#)
 - matrix transpose, [126](#)
 - union, [131](#)
- Datatypes
 - matching, [35](#)
 - not matching, [36](#)
 - untyped, [36](#)
- Deadlock
 - if not buffered, [45](#)
 - with MPI_Bcast, [234](#), [235](#)
 - wrong message exchange, [45](#)
- False matching of collective operations, [238](#)
- Fortran 90 copying and sequence problem, [669](#), [671](#), [672](#)
- Fortran 90 derived types, [673](#)
- Fortran 90 heterogeneous communication, [666](#), [667](#)
- Fortran 90 invalid KIND, [662](#)
- Fortran 90 MPI_TYPE_MATCH_SIZE implementation, [665](#)
- Fortran 90 overlapping communication and computation, [685](#), [686](#), [688](#)
- Fortran 90 register optimization, [676](#), [678](#)
- Independence of nonblocking operations, [241](#)
- Intercommunicator, [262](#), [266](#)
- Interlanguage communication, [702](#)
- Intertwined matching pairs, [43](#)
- Message exchange, [44](#)
- Mixing blocking and nonblocking collective operations, [237](#)
- Mixing collective and point-to-point requests, [240](#)
- MPI_ACCUMULATE, [459](#)
- MPI_Accumulate, [501](#), [504](#)
- MPI_Aint, [127](#)
- MPI_Aint_add, [504](#)
- MPI_Allgather, [169](#)
- MPI_ALLOC_MEM, [373](#)
- MPI_Alloc_mem, [373](#), [504](#)
- MPI_ALLREDUCE, [190](#)
- MPI_Alltoall, [239](#)
- MPI_ASYNC_PROTECTS_NONBLOCKING, [503](#)
- MPI_Barrier, [393](#), [491–494](#), [500–502](#)
- MPI_Bcast, [151](#), [234–238](#)
- MPI_BSEND, [43](#)
- MPI_Buffer_attach, [47](#), [392](#)
- MPI_Buffer_detach, [47](#)
- MPI_BYTE, [36](#)
- MPI_Cancel, [393](#)
- MPI_CART_COORDS, [338](#)
- MPI_CART_GET, [362](#)
- MPI_CART_RANK, [338](#)
- MPI_CART_SHIFT, [338](#), [362](#)
- MPI_CART_SUB, [339](#)
- MPI_CHARACTER, [37](#)
- MPI_Comm_create, [262](#), [272](#), [273](#), [276](#)
- MPI_Comm_create_keyval, [300](#)
- MPI_Comm_dup, [275](#)
- MPI_Comm_get_attr, [300](#)
- MPI_Comm_group, [262](#), [276](#), [300](#)
- MPI_Comm_remote_size, [266](#)
- MPI_Comm_set_attr, [300](#)

- 1 MPI_COMM_SPAWN, 410
 2 MPI_Comm_spawn, 410
 3 MPI_COMM_SPAWN_MULTIPLE, 416
 4 MPI_Comm_spawn_multiple, 416
 5 MPI_Comm_split, 266, 283, 285
 6 MPI_Compare_and_swap, 502, 504
 7 MPI_DIMS_CREATE, 319, 362
 8 MPI_DIST_GRAPH_CREATE, 328
 9 MPI_Dist_graph_create, 329
 10 MPI_DIST_GRAPH_CREATE_ADJACENT,
 11 328
 12 MPI_F_sync_reg, 503
 13 MPI_FILE_CLOSE, 549, 552
 14 MPI_FILE_GET_AMODE, 533
 15 MPI_FILE_IREAD, 552
 16 MPI_FILE_OPEN, 549, 552
 17 MPI_FILE_READ, 549
 18 MPI_FILE_SET_ATOMICITY, 585
 19 MPI_FILE_SET_VIEW, 549, 552
 20 MPI_FILE_SYNC, 585
 21 MPI_Finalize, 392, 393
 22 MPI_FREE_MEM, 373
 23 MPI_Free_mem, 504
 24 MPI_Gather, 139, 154, 155, 159
 25 MPI_Gatherv, 139, 156–159
 26 MPI_GET, 455, 456
 27 MPI_Get, 491, 493, 499, 500
 28 MPI_Get_accumulate, 501, 504
 29 MPI_GET_ADDRESS, 104, 673, 674, 695
 30 MPI_Get_address, 127, 130, 131, 137
 31 MPI_GET_COUNT, 116
 32 MPI_GET_ELEMENTS, 116
 33 MPI_GRAPH_CREATE, 322, 334, 335
 34 MPI_GRAPH_NEIGHBORS, 334
 35 MPI_GRAPH_NEIGHBORS_COUNT, 334
 36 MPI_Grequest_complete, 514
 37 MPI_Grequest_start, 514
 38 MPI_Group_excl, 272
 39 MPI_Group_free, 262, 272, 273
 40 MPI_Group_incl, 262, 273, 276
 41 MPI_Iallreduce, 240
 42 MPI_Ialltoall, 239
 43 MPI_Ibarrier, 237–240
 44 MPI_Ibcast, 202, 240, 241
 45 MPI_INFO_ENV, 391
 46 MPI_Intercomm_create, 283, 285
 47 MPI_Iprobe, 393
 48 MPI_Irecv, 56–58, 65
 MPI_Irecv, 240
 MPI_ISEND, 56–58, 65
 MPI_Op_create, 188, 189, 197
 MPI_Pack, 137, 139
 MPI_Pack_size, 139
 MPI_PROBE, 68, 69
 MPI_Put, 476, 482, 492, 494, 498, 499
 MPI_RECV, 35–37, 43–45, 58, 68, 69, 114
 MPI_Recv, 239
 MPI_REDUCE, 179, 180, 183
 MPI_Reduce, 183, 184, 188, 189
 MPI_REQUEST_FREE, 57
 MPI_Request_free, 392
 MPI_Rget, 503
 MPI_Rput, 503
 MPI_Scan, 197
 MPI_Scatter, 164
 MPI_Scatterv, 164, 165
 MPI_SEND, 35–37, 44, 45, 58, 68, 69, 114
 MPI_Send, 127, 130, 131, 137, 239, 240
 MPI_SENDRECV, 125, 126
 MPI_SENDRECV_REPLACE, 338
 MPI_SSEND, 43, 58
 MPI_Test_cancelled, 393
 MPI_TYPE_COMMIT, 112, 125, 126, 455,
 673, 674
 MPI_Type_commit, 127, 130, 131, 137,
 155–159, 165, 197
 MPI_TYPE_CONTIGUOUS, 88, 107, 114, 116
 MPI_Type_contiguous, 155
 MPI_TYPE_CREATE_DARRAY, 103
 MPI_TYPE_CREATE_HVECTOR, 125, 126
 MPI_Type_create_hvector, 127, 130
 MPI_TYPE_CREATE_INDEXED_BLOCK,
 455
 MPI_TYPE_CREATE_RESIZED, 673, 674
 MPI_TYPE_CREATE_STRUCT, 95, 107,
 126, 673, 674
 MPI_Type_create_struct, 127, 130, 131, 137,
 158, 159, 197
 MPI_TYPE_CREATE_SUBARRAY, 593
 MPI_TYPE_EXTENT, 455
 MPI_TYPE_FREE, 455
 MPI_Type_get_contents, 132
 MPI_Type_get_envelope, 132
 MPI_TYPE_GET_EXTENT, 125, 126, 456,
 459
 MPI_Type_get_extent, 127
 MPI_TYPE_INDEXED, 91, 125
 MPI_Type_indexed, 127, 130
 MPI_TYPE_VECTOR, 88, 89, 125, 126
 MPI_Type_vector, 156, 157, 159, 165
 MPI_Unpack, 137, 139
 MPI_User_function, 189
 MPI_WAIT, 56–58, 65, 552
 MPI_Wait, 237–240
 MPI_Waitall, 240, 503
 MPI_WAITANY, 65
 MPI_Waitany, 503
 MPI_WAIT SOME, 65

MPI_Win_attach, 504	1
MPI_Win_complete, 476 , 493 , 494 , 499 , 500	2
MPI_WIN_CREATE, 455 , 456 , 459	3
MPI_Win_create_dynamic, 504	4
MPI_Win_detach, 504	5
MPI_WIN_FENCE, 455 , 456 , 459	6
MPI_Win_fence, 498 , 499	7
MPI_Win_flush, 492 , 501 , 502 , 504	8
MPI_Win_flush_all, 501	9
MPI_Win_flush_local, 491	9
MPI_WIN_FREE, 456 , 459	10
MPI_Win_lock, 482 , 491 – 494	11
MPI_Win_lock_all, 503 , 504	12
MPI_Win_post, 493 , 494 , 499 , 500	13
MPI_Win_start, 476 , 493 , 494 , 499 , 500	14
MPI_Win_sync, 491 , 492 , 501 , 502	15
shared memory windows, 503	16
MPI_Win_unlock, 482 , 491 – 494	17
MPI_Win_unlock_all, 503 , 504	17
MPI_Win_wait, 493 , 494 , 499 , 500	18
mpiexec, 391 , 397 , 398	19
Neighborhood collective communication, 362	20
No Matching of Blocking and Nonblocking collective operations, 239	21
Non-deterministic program with MPI_Bcast, 236	22
Non-overtaking messages, 43	23
Nonblocking operations, 56 , 57	24
message ordering, 58	25
progress, 58	26
Overlapping Communicators, 240	27
Pipelining nonblocking collective operations, 240	28
Profiling interface, 598	29
Progression of nonblocking collective operations, 239	30
Reading the value of a control variable in the MPI tool information interface, 613	31
Shared memory windows MPI_Win_sync, 503	32
Threads and MPI, 519	33
Topologies, 362	34
Typemap, 87 – 89 , 91 , 95 , 103	35
Using MPI_T_CVAR_GET_INFO to list all names of control variables., 610	36
Virtual topologies, 362	37
	38
	39
	40
	41
	42
	43
	44
	45
	46
	47
	48

MPI Constant and Predefined Handle Index

This index lists predefined MPI constants and handles.

MPI::_LONG_LONG, 845
MPI::BOOL, 845
MPI::COMPLEX, 845
MPI::DOUBLE_COMPLEX, 845
MPI::F_COMPLEX16, 846
MPI::F_COMPLEX32, 846
MPI::F_COMPLEX4, 846
MPI::F_COMPLEX8, 846
MPI::INTEGER16, 846
MPI::LONG_DOUBLE_COMPLEX, 845
MPI::LONG_LONG, 845
MPI::REAL16, 846
MPI_2DOUBLE_PRECISION, 182, 711
MPI_2INT, 182, 711
MPI_2INTEGER, 182, 711
MPI_2REAL, 182, 711
MPI_ADDRESS_KIND, 15, 16, 16, 28, 287, 668, 697, 708
MPI_AINT, 27, 29, 179, 445, 709, 710, 851, 853
MPI_ANY_SOURCE, 30, 31, 43, 53, 54, 67–71, 78, 81, 82, 269, 308, 369, 707
MPI_ANY_TAG, 15, 30, 31, 33, 53, 54, 67–73, 78, 81–83, 269, 707, 848
MPI_APPNUM, 430, 431, 715
MPI_ARGV_NULL, 16, 410, 411, 668, 717
MPI_ARGVS_NULL, 16, 415, 668, 717
MPI_ASYNC_PROTECTS_NONBLOCKING, 15, 503, 642, 643, 645, 647, 650, 657, 659, 679, 708, 850
MPI_BAND, 178, 179, 712
MPI_BOR, 178, 179, 712
MPI_BOTTOM, 10, 15, 16, 34, 103, 117, 118, 147, 315, 325, 327, 412, 445, 449, 644, 646, 653, 668, 673, 675, 677, 678, 680–682, 684, 695, 696, 702, 707, 857
MPI_BSEND_OVERHEAD, 48, 707
MPI_BXOR, 178, 179, 712
MPI_BYTE, 27, 28, 35, 36, 38, 140, 179, 526, 570, 583, 702, 709, 710, 854
MPI_C_BOOL, 28, 179, 709, 845, 851–853
MPI_C_COMPLEX, 28, 179, 709, 845, 851–853
MPI_C_DOUBLE_COMPLEX, 28, 179, 709, 851–853
MPI_C_FLOAT_COMPLEX, 179, 709, 851–853
MPI_C_LONG_DOUBLE_COMPLEX, 28, 179, 709, 851–853
MPI_CART, 330, 713
MPI_CHAR, 28, 38, 95, 180, 181, 605, 606, 709, 851
MPI_CHARACTER, 27, 36–38, 180, 181, 710
MPI_COMBINER_CONTIGUOUS, 119, 122, 716
MPI_COMBINER_DARRAY, 119, 124, 716
MPI_COMBINER_DUP, 119, 122, 716
MPI_COMBINER_F90_COMPLEX, 119, 124, 716
MPI_COMBINER_F90_INTEGER, 119, 124, 716
MPI_COMBINER_F90_REAL, 119, 124, 716
MPI_COMBINER_HINDEXED, 23, 119, 123, 716
MPI_COMBINER_HINDEXED_BLOCK, 119, 123, 716, 847
MPI_COMBINER_HINDEXED_INTEGER, 23, 638, 846
MPI_COMBINER_HVECTOR, 23, 119, 123, 716
MPI_COMBINER_HVECTOR_INTEGER, 23, 638, 846
MPI_COMBINER_INDEXED, 119, 123, 716
MPI_COMBINER_INDEXED_BLOCK, 119, 123, 716
MPI_COMBINER_NAMED, 119, 122, 716
MPI_COMBINER_RESIZED, 119, 125, 716
MPI_COMBINER_STRUCT, 23, 119, 123, 716
MPI_COMBINER_STRUCT_INTEGER, 23, 638, 846

MPI_COMBINER_SUBARRAY, 119, 124, 716	MPI_DOUBLE_COMPLEX, 27, 179, 572, 660,	1
MPI_COMBINER_VECTOR, 119, 122, 716	710	2
MPI_COMM_DUP_FN, 23, 290, 714, 850	MPI_DOUBLE_INT, 182, 183, 711	3
MPI_COMM_NULL, 247, 261, 262, 264–266,	MPI_DOUBLE_PRECISION, 27, 178, 660,	4
268, 304, 313, 315, 321, 413, 432–434,	710	5
713, 854	MPI_DUP_FN, 23, 290, 634, 714	6
MPI_COMM_NULL_COPY_FN, 23, 290, 644,	MPI_ERR_ACCESS, 384, 531, 590, 706	7
696, 714, 850	MPI_ERR_AMODE, 384, 529, 590, 706	8
MPI_COMM_NULL_DELETE_FN, 23, 290,	MPI_ERR_ARG, 383, 705	9
714	MPI_ERR_ASSERT, 383, 486, 706	10
MPI_COMM_PARENT, 304	MPI_ERR_BAD_FILE, 384, 590, 706	11
MPI_COMM_SELF, 20, 247, 264, 270, 287,	MPI_ERR_BASE, 372, 383, 486, 706	12
304, 374, 375, 395, 432, 528, 639, 711,	MPI_ERR_BUFFER, 383, 705	13
842, 852	MPI_ERR_COMM, 383, 705	14
MPI_COMM_TYPE_HW_SUBDOMAIN,	MPI_ERR_CONVERSION, 384, 578, 590, 706	15
316, 317	MPI_ERR_COUNT, 383, 705	16
MPI_COMM_TYPE_SHARED, 268, 316, 317,	MPI_ERR_DIMS, 383, 705	17
711, 848	MPI_ERR_DISP, 383, 486, 706	18
MPI_COMM_WORLD, 15, 21, 29, 30,	MPI_ERR_DUP_DATAREP, 384, 575, 590,	19
247–249, 256, 257, 270, 273, 282, 304,	706	20
318, 368–370, 375, 377, 385, 392–396,	MPI_ERR_FILE, 384, 590, 706	21
405, 406, 408, 409, 413, 415, 429–432,	MPI_ERR_FILE_EXISTS, 384, 590, 706	22
522, 569, 589, 612, 620, 639, 690, 701,	MPI_ERR_FILE_IN_USE, 384, 531, 590, 706	23
711, 842, 856	MPI_ERR_GROUP, 383, 705	24
MPI_COMPLEX, 27, 179, 572, 660, 710	MPI_ERR_IN_STATUS, 32, 34, 55, 61, 63,	25
MPI_COMPLEX16, 179, 710	376, 383, 513, 543, 706	26
MPI_COMPLEX32, 179, 710	MPI_ERR_INFO, 383, 706	27
MPI_COMPLEX4, 179, 710	MPI_ERR_INFO_KEY, 383, 400, 706	28
MPI_COMPLEX8, 179, 710	MPI_ERR_INFO_NOKEY, 383, 401, 706	29
MPI_CONGRUENT, 257, 280, 711	MPI_ERR_INFO_VALUE, 383, 400, 706	30
MPI_CONVERSION_FN_NULL, 577, 714	MPI_ERR_INTERN, 375, 383, 705	31
MPI_COSTS_CONTIGUOUS, 316, 711, 842	MPI_ERR_IO, 384, 590, 706	32
MPI_COSTS_SCATTERED, 316, 711, 842	MPI_ERR_KEYVAL, 300, 383, 706	33
MPI_COSTS_STRIDED, 316, 711, 842	MPI_ERR_LASTCODE, 382, 384, 385, 387,	34
MPI_COUNT, 27, 29, 179, 605, 709, 710, 846	630, 707	35
MPI_COUNT_KIND, 15, 28, 708	MPI_ERR_LOCKTYPE, 383, 486, 706	36
MPI_CXX_BOOL, 29, 179, 710, 845	MPI_ERR_NAME, 383, 426, 706	37
MPI_CXX_DOUBLE_COMPLEX, 29, 179,	MPI_ERR_NO_MEM, 372, 383, 706	38
710, 845	MPI_ERR_NO_SPACE, 384, 590, 706	39
MPI_CXX_FLOAT_COMPLEX, 29, 179, 710,	MPI_ERR_NO_SUCH_FILE, 384, 530, 590,	40
845	706	41
MPI_CXX_LONG_DOUBLE_COMPLEX, 29,	MPI_ERR_NOT_SAME, 384, 590, 706	42
179, 710, 845	MPI_ERR_OP, 383, 486, 705	43
MPI_DATATYPE_NULL, 113, 713	MPI_ERR_OTHER, 382, 383, 705	44
MPI_DISPLACEMENT_CURRENT, 538,	MPI_ERR_PENDING, 61, 383, 705	45
539, 716, 857	MPI_ERR_PORT, 383, 423, 706	46
MPI_DIST_GRAPH, 330, 713, 852	MPI_ERR_QUOTA, 384, 590, 706	47
MPI_DISTRIBUTE_BLOCK, 100, 716	MPI_ERR_RANK, 383, 486, 705	48
MPI_DISTRIBUTE_CYCLIC, 100, 716	MPI_ERR_READ_ONLY, 384, 590, 706	
MPI_DISTRIBUTE_DFLT_DARG, 100, 716	MPI_ERR_REQUEST, 383, 705	
MPI_DISTRIBUTE_NONE, 100, 716	MPI_ERR_RMA_ATTACH, 384, 486, 706	
MPI_DOUBLE, 28, 178, 605, 614–616, 659,	MPI_ERR_RMA_CONFLICT, 383, 486, 706	
709	MPI_ERR_RMA_FLAVOR, 384, 443, 486, 706	
	MPI_ERR_RMA_RANGE, 384, 486, 706	

#120

1 MPI_ERR_RMA_SHARED, 384, 486, 706
2 MPI_ERR_RMA_SYNC, 383, 486, 706
3 MPI_ERR_ROOT, 383, 705
4 MPI_ERR_SERVICE, 383, 425, 706
5 MPI_ERR_SIZE, 383, 486, 706
6 MPI_ERR_SPAWN, 383, 411, 412, 706
7 MPI_ERR_TAG, 383, 705
8 MPI_ERR_TOPOLOGY, 383, 705
9 MPI_ERR_TRUNCATE, 383, 705
10 MPI_ERR_TYPE, 383, 705
11 MPI_ERR_UNKNOWN, 382, 383, 705
12 MPI_ERR_UNSUPPORTED_DATAREP, 384,
13 590, 706
14 MPI_ERR_UNSUPPORTED_OPERATION,
15 384, 590, 706
16 MPI_ERR_WIN, 383, 486, 706
17 MPI_ERRCODES_IGNORE, 16, 412, 668, 717
18 MPI_ERRHANDLER_NULL, 381, 713
19 MPI_ERROR, 32, 55, 199, 464, 708, 842, 849
20 MPI_ERRORS_ABORT, 374, 842
21 MPI_ERRORS_ARE_FATAL, 374, 375, 387,
22 486, 589, 708, 842
23 MPI_ERRORS_RETURN, 374, 375, 388, 394,
24 589, 701, 708
25 MPI_F08_STATUS_IGNORE, 693, 717, 849
26 MPI_F08_STATUSES_IGNORE, 693, 717, 849
27 MPI_F_STATUS_IGNORE, 692, 717
28 MPI_F_STATUSES_IGNORE, 692, 717
29 MPI_FILE_NULL, 530, 589, 713
30 MPI_FLOAT, 28, 95, 176, 178, 571, 709
31 MPI_FLOAT_INT, 12, 182, 183, 711
32 MPI_GRAPH, 330, 713
33 MPI_GROUP_EMPTY, 246, 252, 261, 262,
34 264, 713
35 MPI_GROUP_NULL, 246, 255, 713
36 MPI_HOST, 369, 712
37 MPI_IDENT, 249, 257, 711
38 MPI_IN_PLACE, 16, 146, 173, 647, 668, 707
39 MPI_INFO, 218
40 MPI_INFO_ENV, 390, 391, 711, 848
41 MPI_INFO_NULL, 328, 404, 412, 421, 529,
42 530, 540, 713
43 MPI_INT, 12, 28, 86, 178, 571, 572, 605, 606,
44 609, 614, 618, 659, 701, 703, 709
45 MPI_INT16_T, 28, 178, 709, 851, 853
46 MPI_INT32_T, 28, 178, 709, 851, 853
47 MPI_INT64_T, 28, 178, 709, 851, 853
48 MPI_INT8_T, 28, 178, 709, 851, 853
MPI_INTEGER, 27, 35, 178, 659, 660, 703,
710
MPI_INTEGER1, 27, 178, 710
MPI_INTEGER16, 178, 710
MPI_INTEGER2, 27, 178, 572, 710
MPI_INTEGER4, 27, 178, 710
MPI_INTEGERS, 178, 663, 710
MPI_INTEGER_KIND, 15, 708
MPI_IO, 369, 712
MPI_KEYVAL_INVALID, 290–292, 707
MPI_LAND, 178, 179, 712
MPI_LASTUSED_CODE, 385, 386, 715
MPI_LB, 23, 638, 846
MPI_LOCK_EXCLUSIVE, 479, 707
MPI_LOCK_SHARED, 479, 480, 707
MPI_LOGICAL, 27, 179, 710
MPI_LONG, 28, 178, 709
MPI_LONG_DOUBLE, 28, 178, 709
MPI_LONG_DOUBLE_INT, 182, 711
MPI_LONG_INT, 182, 183, 711
MPI_LONG_LONG, 28, 178, 709, 853
MPI_LONG_LONG_INT, 28, 178, 709, 853
MPI_LOR, 178, 179, 712
MPI_LXOR, 178, 179, 712
MPI_MAX, 176, 178, 179, 197, 712
MPI_MAX_DATAREP_STRING, 15, 540,
575, 708
MPI_MAX_ERROR_STRING, 15, 381, 386,
708
MPI_MAX_INFO_KEY, 15, 383, 399, 402, 708
MPI_MAX_INFO_VAL, 15, 383, 399, 708
MPI_MAX_LIBRARY_VERSION_STRING,
15, 368, 708, 846
MPI_MAX_OBJECT_NAME, 15, 303–305,
708, 848, 854
MPI_MAX_PORT_NAME, 15, 421, 708
MPI_MAX_PROCESSOR_NAME, 15, 370,
371, 708, 855
MPI_MAXLOC, 178, 181, 182, 185, 712
MPI_MESSAGE_NO_PROC, 71–73, 707, 847
MPI_MESSAGE_NULL, 71–73, 713, 847
MPI_MIN, 178, 179, 712
MPI_MINLOC, 178, 181, 182, 185, 712
MPI_MODE_APPEND, 528, 529, 715
MPI_MODE_CREATE, 528, 529, 537, 715
MPI_MODE_DELETE_ON_CLOSE, 528–530,
715
MPI_MODE_EXCL, 528, 529, 715
MPI_MODE_NOCHECK, 480, 484, 485, 715
MPI_MODE_NOPRECEDE, 475, 484, 485,
715
MPI_MODE_NOPUT, 484, 485, 715
MPI_MODE_NOSTORE, 484, 485, 715
MPI_MODE_NOSUCCEED, 484, 485, 715
MPI_MODE_RDONLY, 528, 529, 534, 715
MPI_MODE_RDWR, 528, 529, 715
MPI_MODE_SEQUENTIAL, 528, 529, 531,
532, 538, 543, 549, 560, 581, 715, 857
MPI_MODE_UNIQUE_OPEN, 528, 529, 715
MPI_MODE_WRONLY, 528, 529, 715

MPI_NO_OP, 438, 461, 462, 712, 843	
MPI_NULL_COPY_FN, 23, 290, 634, 714	
MPI_NULL_DELETE_FN, 23, 290, 634, 714	
MPI_OFFSET, 27, 179, 709, 710, 851, 853	
MPI_OFFSET_KIND, 15, 17, 28, 583, 668, 708	
MPI_OP_NULL, 188, 713	
MPI_ORDER_C, 15, 97, 100, 101, 716	
MPI_ORDER_FORTRAN, 15, 97, 100, 716	
MPI_PACKED, 12, 27, 28, 35, 134, 136, 140, 573, 702, 709, 710	
MPI_PROC_NULL, 26, 29, 31, 32, 67, 71–73, 82, 83, 148, 150, 152, 154, 162, 164, 177, 249, 338, 342, 369, 443, 452, 707, 847, 854, 856	
MPI_PROD, 178, 179, 712	
MPI_REAL, 27, 35, 178, 572, 659, 660, 666, 710	
MPI_REAL16, 179, 710	
MPI_REAL2, 27, 179, 710	
MPI_REAL4, 27, 179, 659, 663, 710	
MPI_REAL8, 27, 179, 659, 710, 851	
MPI_REPLACE, 459–462, 502, 712, 853, 856	
MPI_REQUEST_NULL, 54–57, 60–63, 512, 713	
MPI_ROOT, 148, 707	
MPI_SEEK_CUR, 555, 561, 716	
MPI_SEEK_END, 555, 561, 716	
MPI_SEEK_SET, 555, 561, 716	
MPI_SHORT, 28, 178, 709	
MPI_SHORT_INT, 182, 711	
MPI_SIGNED_CHAR, 28, 178, 180, 181, 709, 853	
MPI_SIMILAR, 249, 257, 280, 711	
MPI_SOURCE, 32, 200, 708, 842, 849	
MPI_STATUS_IGNORE, 10, 15, 34, 511, 543, 646, 668, 692, 693, 702, 717, 847	
MPI_STATUS_SIZE, 15, 32, 648, 708, 849	
MPI_STATUSES_IGNORE, 14, 15, 34, 511, 513, 668, 692, 693, 717	
MPI_SUBARRAYS_SUPPORTED, 15, 642, 643, 646–650, 654–657, 669–671, 708, 849	
MPI_SUBVERSION, 15, 368, 717	
MPI_SUCCESS, 18, 19, 54, 61, 63, 289, 290, 292–295, 297, 298, 319, 321, 382, 383, 387, 388, 412, 578, 601, 610, 618, 621, 623, 628, 630, 632, 634, 705, 842	
MPI_SUM, 178, 179, 458, 701, 712	
MPI_T_BIND_MPI_COMM, 603, 718	
MPI_T_BIND_MPI_DATATYPE, 603, 718	
MPI_T_BIND_MPI_ERRHANDLER, 603, 718	
MPI_T_BIND_MPI_FILE, 603, 718	
MPI_T_BIND_MPI_GROUP, 603, 718	
MPI_T_BIND_MPI_INFO, 603, 718	1
MPI_T_BIND_MPI_MESSAGE, 603, 718	2
MPI_T_BIND_MPI_OP, 603, 718	3
MPI_T_BIND_MPI_REQUEST, 603, 718	4
MPI_T_BIND_MPI_WIN, 603, 718	5
MPI_T_BIND_NO_OBJECT, 603, 609, 611, 618, 620, 718	6
MPI_T_CVAR_HANDLE_NULL, 612, 718	7
MPI_T_CVAR_READ, WRITE, 632	8
MPI_T_ENUM_NULL, 609, 618, 718	9
MPI_T_ERR_XXX, 630	10
MPI_T_ERR_CANNOT_INIT, 632, 707	11
MPI_T_ERR_CVAR_SET_NEVER, 613, 632, 707	12
MPI_T_ERR_CVAR_SET_NOT_NOW, 613, 632, 707	13
MPI_T_ERR_INVALID, 632, 707, 845	14
MPI_T_ERR_INVALID_HANDLE, 620, 632, 707	15
MPI_T_ERR_INVALID_INDEX, 23, 632, 636, 707, 842	16
MPI_T_ERR_INVALID_ITEM, 23, 632, 636, 707, 842	17
MPI_T_ERR_INVALID_NAME, 610, 618, 628, 632, 707, 845	18
MPI_T_ERR_INVALID_SESSION, 632, 707	19
MPI_T_ERR_MEMORY, 632, 707	20
MPI_T_ERR_NOT_INITIALIZED, 632, 707	21
MPI_T_ERR_OUT_OF_HANDLES, 632, 707	22
MPI_T_ERR_OUT_OF_SESSIONS, 632, 707	23
MPI_T_ERR_PVAR_NO_ATOMIC, 623, 632, 707	24
MPI_T_ERR_PVAR_NO_STARTSTOP, 621, 632, 707	25
MPI_T_ERR_PVAR_NO_WRITE, 622, 623, 632, 707	26
MPI_T_PVAR_ALL_HANDLES, 621–624, 719	27
MPI_T_PVAR_CLASS_AGGREGATE, 615, 616, 719	28
MPI_T_PVAR_CLASS_COUNTER, 615, 719	29
MPI_T_PVAR_CLASS_GENERIC, 616, 719	30
MPI_T_PVAR_CLASS_HIGHWATERMARK, 615, 719	31
MPI_T_PVAR_CLASS_LEVEL, 614, 719	32
MPI_T_PVAR_CLASS_LOWWATERMARK, 615, 719	33
MPI_T_PVAR_CLASS_PERCENTAGE, 615, 719	34
MPI_T_PVAR_CLASS_SIZE, 614, 719	35
MPI_T_PVAR_CLASS_STATE, 614, 719	36
MPI_T_PVAR_CLASS_TIMER, 616, 719	37
MPI_T_PVAR_HANDLE_NULL, 621, 718	38
MPI_T_PVAR_SESSION_NULL, 619, 718	39
MPI_T_SCOPE_ALL, 609, 718	40
	41
	42
	43
	44
	45
	46
	47
	48

1 MPI_T_SCOPE_ALL_EQ, 609, 613, 718
 2 MPI_T_SCOPE_CONSTANT, 609, 718
 3 MPI_T_SCOPE_GROUP, 609, 718
 4 MPI_T_SCOPE_GROUP_EQ, 609, 613, 718
 5 MPI_T_SCOPE_LOCAL, 609, 718
 6 MPI_T_SCOPE_READONLY, 609, 718
 7 MPI_T_VERBOSITY_MPIDEV_ALL, 602,
 718
 8 MPI_T_VERBOSITY_MPIDEV_BASIC, 602,
 718
 9 MPI_T_VERBOSITY_MPIDEV_DETAIL,
 10 602, 718
 11 MPI_T_VERBOSITY_TUNER_ALL, 602, 718
 12 MPI_T_VERBOSITY_TUNER_BASIC, 602,
 718
 13 MPI_T_VERBOSITY_TUNER_DETAIL, 602,
 718
 14 MPI_T_VERBOSITY_USER_ALL, 602, 718
 15 MPI_T_VERBOSITY_USER_BASIC, 602,
 718
 16 MPI_T_VERBOSITY_USER_DETAIL, 602,
 718
 17 MPI_TAG, 32, 200, 708, 842, 849
 18 MPI_TAG_UB, 29, 369, 697, 700, 712
 19 MPI_THREAD_FUNNELED, 522, 716
 20 MPI_THREAD_MULTIPLE, 522, 524, 716,
 844
 21 MPI_THREAD_SERIALIZED, 522, 716
 22 MPI_THREAD_SINGLE, 522, 523, 716
 23 MPI_TYPE_DUP_FN, 297, 714
 24 MPI_TYPE_NULL_COPY_FN, 297, 714
 25 MPI_TYPE_NULL_DELETE_FN, 297, 714,
 849
 26 MPI_TYPECLASS_COMPLEX, 665, 717
 27 MPI_TYPECLASS_INTEGER, 665, 717
 28 MPI_TYPECLASS_REAL, 665, 717
 29 MPI_UB, 4, 23, 638, 846
 30 MPI_UINT16_T, 28, 178, 709, 851, 853
 31 MPI_UINT32_T, 28, 178, 709, 851, 853
 32 MPI_UINT64_T, 28, 178, 709, 851, 853
 33 MPI_UINT8_T, 28, 178, 709, 851, 853
 34 MPI_UNDEFINED, 33, 60, 61, 63, 64, 106,
 109, 111, 116, 137, 248, 249, 265, 266,
 330, 340, 341, 661, 707, 847, 853
 35 MPI_UNEQUAL, 249, 257, 280, 711
 36 MPI_UNIVERSE_SIZE, 408, 429, 430, 715
 37 MPI_UNSIGNED, 28, 178, 605, 614–616, 709
 38 MPI_UNSIGNED_CHAR, 28, 178, 180, 181,
 709
 39 MPI_UNSIGNED_LONG, 28, 178, 605,
 614–616, 709
 40 MPI_UNSIGNED_LONG_LONG, 28, 178,
 605, 614–616, 709, 853
 41 MPI_UNSIGNED_SHORT, 28, 178, 709
 42 MPI_UNWEIGHTED, 16, 325, 327, 328, 336,
 337, 668, 717, 846, 852
 43 MPI_VAL, 12, 690
 44 MPI_VERSION, 15, 368, 717
 45 MPI_WCHAR, 28, 180, 181, 305, 572, 709, 853
 46 MPI_WEIGHTED_EQUAL, 842
 47 MPI_WEIGHTS_EMPTY, 16, 325, 327, 668,
 717, 846
 48 MPI_WEIGHTS_EQUAL, 16, 314, 315, 717

#120

1
2
3
4
5
6
7
8
9
10
11
12
13
14
15
16
17
18
19
20
21
22
23
24
25
26
27
28
29
30
31
32
33
34
35
36
37
38
39
40
41
42
43
44
45
46
47
48

MPI Declarations Index

This index refers to declarations needed in C, such as address kind integers, handles, etc. The underlined page numbers is the “main” reference (sometimes there are more than one when key concepts are discussed in multiple areas).

- MPI_Aint, 16, 16, 17, 27, 87, 87, 89, 92, 95,
103–105, 108–110, 120, 141, 142, 437,
439, 441, 444, 445, 452, 454, 458, 460,
462–466, 468, 571, 575, 668, 697, 719
- MPI_Comm, 12, 26, 250, 255–260, 263, 264,
267, 268, 270, 280–283, 288, 291–293,
711, 713, 719, 720
- MPI_Count, 17, 17, 27, 719, 846
- MPI_Datatype, 87, 677, 709–711, 713, 719, 720
- MPI_ERR_..., 382
- MPI_Errhandler, 376, 377–381, 691, 708, 713,
719, 720
- MPI_F08_status, 693, 717, 719, 849
- MPI_File, 379, 380, 388, 527, 529, 531–533,
535, 538, 540, 544–555, 557–561,
563–568, 571, 580, 581, 691, 713, 719,
720
- MPI_Fint, 690, 690, 717, 719, 853
- MPI_Group, 248, 248, 249–255, 260, 281, 449,
475, 477, 533, 690, 691, 713, 719, 720
- MPI_Info, 371, 399, 399, 400–403, 408, 411,
414, 420, 422–426, 450, 527, 530, 535,
538, 691, 711, 713, 719, 720, 856
- MPI_Message, 70, 691, 707, 713, 719, 720, 847
- MPI_Offset, 17, 17, 27, 531, 532, 538, 540,
544–548, 554, 555, 561, 563, 564, 575,
583, 583, 689, 719
- MPI_Op, 176, 185, 188, 190–197, 212–217,
229–234, 458, 460, 462, 466, 468, 691,
712, 713, 719, 720
- MPI_Request, 51–53, 55, 56, 57, 59–64, 66, 73,
76–79, 510, 513, 546–548, 552–554,
558, 670, 691, 713, 719, 720
- MPI_Status, 30, 32–34, 55, 56, 59–64, 66–68,
70–72, 74, 81, 82, 115, 511, 516, 517,
544, 545, 549–551, 557, 559, 560,
564–568, 645, 692–694, 717, 719, 720,
842, 846, 849
- MPI_T_cvar_handle, 611, 611, 612, 718
- MPI_T_enum, 606, 606, 607, 608, 617, 718
- MPI_T_ERR_XXX, 630
- MPI_T_pvar_handle, 619, 619, 620–623, 718
- MPI_T_pvar_session, 619, 619, 620–623, 718
- MPI_Win, 294–296, 305, 306, 378, 379, 387,
437, 439, 441, 444, 447, 449, 450, 452,
454, 458, 460, 462–466, 468, 474–484,
691, 713, 719, 720

MPI Callback Function Prototype Index

This index lists the C typedef names for callback routines, such as those used with attribute caching or user-defined reduction operations. Fortran example prototypes are given near the text of the C name.

MPI_Comm_copy_attr_function, [18](#), [23](#), [289](#),
[644](#), [714](#), [720](#)
MPI_Comm_delete_attr_function, [23](#), [289](#),
[714](#), [720](#)
MPI_Comm_errhandler_fn, [636](#), [852](#)
MPI_Comm_errhandler_function, [23](#), [376](#), [636](#),
[638](#), [721](#), [852](#)
MPI_Copy_function, [23](#), [633](#), [714](#), [725](#)
MPI_Datarep_conversion_function, [576](#), [714](#),
[721](#)
MPI_Datarep_extent_function, [575](#), [721](#)
MPI_Delete_function, [23](#), [634](#), [714](#), [726](#)
MPI_File_errhandler_fn, [636](#), [852](#)
MPI_File_errhandler_function, [379](#), [636](#), [721](#),
[852](#)
MPI_Grequest_cancel_function, [512](#), [721](#)
MPI_Grequest_free_function, [511](#), [721](#)
MPI_Grequest_query_function, [511](#), [721](#)
MPI_Handler_function, [23](#), [638](#), [846](#)
MPI_Type_copy_attr_function, [297](#), [714](#), [720](#)
MPI_Type_delete_attr_function, [297](#), [714](#),
[720](#), [849](#)
MPI_User_function, [186](#), [189](#), [720](#)
MPI_Win_copy_attr_function, [294](#), [714](#), [720](#)
MPI_Win_delete_attr_function, [294](#), [714](#), [720](#)
MPI_Win_errhandler_fn, [636](#), [852](#)
MPI_Win_errhandler_function, [378](#), [636](#), [721](#),
[852](#)

MPI Function Index

The underlined page numbers refer to the function definitions.

MPI_SET_STATUS_CANCELLED, [842](#)
MPI_ABORT, [186](#), [374](#), [391](#), [394](#), [432](#), [605](#),
[690](#), [856](#)
MPI_ACCUMULATE, [435](#), [451](#), [458](#), [459](#), [461](#),
[467](#), [471](#), [495](#), [501](#), [502](#), [853](#), [856](#)
MPI_ADD_ERROR_CLASS, [385](#), [385](#)
MPI_ADD_ERROR_CODE, [386](#)
MPI_ADD_ERROR_STRING, [386](#), [386](#), [387](#)
MPI_ADDRESS, [23](#), [637](#), [653](#), [846](#)
MPI_AINT_ADD, [19](#), [103–105](#), [105](#), [445](#), [844](#)
MPI_AINT_DIFF, [19](#), [103–105](#), [105](#), [445](#), [844](#)
MPI_ALLGATHER, [143](#), [147](#), [148](#), [167](#), [167](#),
[168–170](#), [207](#)
MPI_ALLGATHER_INIT, [224](#)
MPI_ALLGATHERV, [143](#), [147](#), [148](#), [168](#), [169](#),
[208](#)
MPI_ALLGATHERV_INIT, [225](#)
MPI_ALLOC_MEM, [371](#), [372](#), [373](#), [383](#),
[439–443](#), [446](#), [453](#), [482](#), [654–656](#), [668](#),
[843](#), [850](#)
MPI_ALLOC_MEM_CPTR, [372](#), [843](#)
MPI_ALLREDUCE, [143](#), [146–148](#), [178](#), [185](#),
[190](#), [190](#), [213](#), [854](#)
MPI_ALLREDUCE_INIT, [230](#)
MPI_ALLTOALL, [143](#), [147](#), [148](#), [170](#), [170](#),
[171–173](#), [209](#), [851](#)
MPI_ALLTOALL_INIT, [226](#)
MPI_ALLTOALLV, [143](#), [147](#), [148](#), [172](#), [172](#),
[173](#), [175](#), [210](#), [851](#)
MPI_ALLTOALLV_INIT, [227](#)
MPI_ALLTOALLW, [143](#), [147](#), [148](#), [174](#), [175](#),
[212](#), [851](#)
MPI_ALLTOALLW_INIT, [228](#)
MPI_ATTR_DELETE, [23](#), [300](#), [634](#), [635](#)
MPI_ATTR_GET, [23](#), [300](#), [635](#), [697](#), [698](#)
MPI_ATTR_PUT, [23](#), [300](#), [635](#), [697](#), [698](#), [700](#),
[701](#)
MPI_BARRIER, [143](#), [147](#), [149](#), [149](#), [150](#), [201](#),
[492](#), [493](#), [585](#)
MPI_BARRIER_INIT, [219](#)
MPI_BCAST, [143](#), [147](#), [150](#), [150](#), [151](#), [177](#),
[202](#), [238](#)
MPI_BCAST_INIT, [219](#)
MPI_BSEND, [40](#), [48](#)
MPI_BSEND_INIT, [76](#), [79](#)
MPI_BUFFER_ATTACH, [46](#), [55](#)
MPI_BUFFER_DETACH, [47](#), [849](#)
MPI_CANCEL, [23](#), [43](#), [55](#), [66](#), [73](#), [73](#), [74](#), [75](#),
[200](#), [218](#), [393](#), [464](#), [509](#), [512](#), [513](#), [636](#),
[841](#)
MPI_CART_COORDS, [312](#), [333](#), [333](#), [855](#)
MPI_CART_CREATE, [279](#), [311–313](#), [313](#),
[319–321](#), [331](#), [339](#), [340](#), [342](#), [669](#), [843](#),
[854](#)
MPI_CART_CREATE_WEIGHTED, [311](#),
[312](#), [314](#), [314](#), [316](#), [318](#), [320](#), [842](#)
MPI_CART_GET, [312](#), [331](#), [332](#), [855](#)
MPI_CART_MAP, [312](#), [340](#), [340](#), [848](#)
MPI_CART_RANK, [312](#), [332](#), [332](#), [855](#)
MPI_CART_SHIFT, [312](#), [337](#), [338](#), [338](#), [341](#),
[855](#)
MPI_CART_SUB, [312](#), [339](#), [339](#), [340](#), [855](#)
MPI_CARTDIM_GET, [312](#), [331](#), [331](#), [855](#)
MPI_CLOSE_PORT, [421](#), [421](#), [425](#)
MPI_COMM_ACCEPT, [420](#), [422](#), [422](#), [423](#),
[430](#), [431](#)
MPI_COMM_C2F, [690](#)
MPI_COMM_CALL_ERRHANDLER, [387](#),
[388](#)
MPI_COMM_COMPARE, [257](#), [280](#)
MPI_COMM_CONNECT, [383](#), [423](#), [423](#), [430](#),
[431](#)
MPI_COMM_CREATE, [255](#), [257](#), [260](#),
[261–266](#), [311](#), [852](#)
MPI_COMM_CREATE_ERRHANDLER, [23](#),
[375](#), [376](#), [377](#), [637](#), [722](#), [724](#), [850](#)
MPI_COMM_CREATE_GROUP, [257](#), [263](#),
[263](#), [264](#), [265](#), [847](#)
MPI_COMM_CREATE_KEYVAL, [23](#), [287](#),
[288](#), [290](#), [300](#), [633](#), [696](#), [697](#), [721](#), [724](#),
[850](#), [854](#)
MPI_COMM_DELETE_ATTR, [23](#), [287](#),
[290–292](#), [293](#), [300](#), [635](#)

1
2
3
4
5
6
7
8
9
10
11
12
13
14
15
16
17
18
19
20
21
22
23
24
25
26
27
28
29
30
31
32
33
34
35
36
37
38
39
40
41
42
43
44
45
46
47
48

#120

- 1 MPI_COMM_DISCONNECT, 300, 413, 431,
2 432, 432
- 3 MPI_COMM_DUP, 250, 255, 257, 258, 258,
4 259, 261, 281, 283, 287, 289, 293, 300,
5 307, 633, 841, 847
- 6 MPI_COMM_DUP_FN, 23, 290, 290, 291,
7 649, 714, 844, 850
- 8 MPI_COMM_DUP_WITH_INFO, 257, 258,
9 259, 260, 269, 847
- 10 MPI_COMM_F2C, 690
- 11 MPI_COMM_FREE, 255, 258, 268, 281, 283,
12 290, 291, 293, 300, 392, 395, 413, 431,
13 432, 634
- 14 MPI_COMM_FREE_KEYVAL, 23, 287, 291,
15 300, 634
- 16 MPI_COMM_GET_ATTR, 23, 287, 292, 292,
17 300, 368, 635, 650, 697, 698, 700
- 18 MPI_COMM_GET_ERRHANDLER, 23, 375,
19 377, 637, 855
- 20 MPI_COMM_GET_INFO, 269, 270, 270, 271,
21 842, 847
- 22 MPI_COMM_GET_NAME, 303, 303, 304, 854
- 23 MPI_COMM_GET_PARENT, 304, 375, 409,
24 412, 412, 413
- 25 MPI_COMM_GROUP, 14, 248, 250, 250, 255,
26 256, 280, 375, 855
- 27 MPI_COMM_IDUP, 255, 257, 259, 259, 260,
28 278, 287, 289, 293, 300, 841, 843, 847
- 29 MPI_COMM_IDUP_WITH_INFO, 257, 260,
30 260, 269, 842
- 31 MPI_COMM_JOIN, 433, 433, 434
- 32 MPI_COMM_NULL_COPY_FN, 23, 290, 290,
33 291, 644, 696, 714, 844, 850
- 34 MPI_COMM_NULL_DELETE_FN, 23, 290,
35 290, 291, 714, 844
- 36 MPI_COMM_RANK, 256, 256, 280, 651
- 37 MPI_COMM_RANK_F08, 651
- 38 MPI_COMM_REMOTE_GROUP, 281
- 39 MPI_COMM_REMOTE_SIZE, 281, 281
- 40 MPI_COMM_SET_ATTR, 23, 287, 290, 291,
41 300, 634, 650, 697, 698, 701
- 42 MPI_COMM_SET_ERRHANDLER, 23, 375,
43 377, 637
- 44 MPI_COMM_SET_INFO, 218, 269, 270, 270,
45 842, 843, 847
- 46 MPI_COMM_SET_NAME, 302, 302, 303
- 47 MPI_COMM_SIZE, 255, 256, 280
- 48 MPI_COMM_SPAWN, 390, 397, 406–408, 408,
409, 411–413, 415–417, 429–431
- MPI_COMM_SPAWN_MULTIPLE, 391, 397,
406, 407, 412, 414, 415, 430, 431
- MPI_COMM_SPLIT, 257, 261, 264, 265, 266,
307, 312, 313, 315, 321, 339–341, 852
- MPI_COMM_SPLIT_TYPE, 267, 269,
316–318, 848
- MPI_COMM_TEST_INTER, 279, 280
- MPI_COMM_WORLD, 523
- MPI_COMPARE_AND_SWAP, 435, 451, 463,
501
- MPI_CONVERSION_FN_NULL, 577, 714,
844
- MPI_CWIN_GET_ATTR, 650
- MPI_DIMS_CREATE, 311, 318, 319, 319, 842
- MPI_DIMS_CREATE_WEIGHTED, 311, 312,
318, 320, 320, 321, 842
- MPI_DIST_GRAPH_CREATE, 269, 311, 323,
326, 326, 327–329, 337, 342, 852
- MPI_DIST_GRAPH_CREATE_ADJACENT,
269, 311, 323, 324, 325, 328, 337, 341,
848, 852
- MPI_DIST_GRAPH_NEIGHBORS, 312, 335,
336, 337, 342, 848, 852
- MPI_DIST_GRAPH_NEIGHBORS_COUNT,
312, 335, 336, 337, 845, 852
- MPI_DUP_FN, 23, 290, 634, 714
- MPI_ERRHANDLER_C2F, 691
- MPI_ERRHANDLER_CREATE, 23, 637, 846,
850
- MPI_ERRHANDLER_F2C, 691
- MPI_ERRHANDLER_FREE, 375, 381, 392,
855
- MPI_ERRHANDLER_GET, 23, 637, 846, 855
- MPI_ERRHANDLER_SET, 23, 637, 846
- MPI_ERROR_CLASS, 382, 382, 630
- MPI_ERROR_STRING, 381, 381, 382, 385,
387
- MPI_EXSCAN, 144, 147, 178, 185, 196, 197,
217, 852
- MPI_EXSCAN_INIT, 234
- MPI_F_SYNC_REG, 104, 503, 642, 658, 658,
659, 678, 680–683, 850
- MPI_FETCH_AND_OP, 435, 451, 459, 461,
462
- MPI_FILE_C2F, 691
- MPI_FILE_CALL_ERRHANDLER, 388, 388
- MPI_FILE_CLOSE, 432, 527, 528, 529, 530
- MPI_FILE_CREATE_ERRHANDLER, 375,
379, 380, 722, 725, 850
- MPI_FILE_DELETE, 529, 530, 530, 534, 537,
589
- MPI_FILE_F2C, 691
- MPI_FILE_GET_AMODE, 533, 533
- MPI_FILE_GET_ATOMICITY, 581, 581
- MPI_FILE_GET_BYTE_OFFSET, 549, 555,
555, 556, 562
- MPI_FILE_GET_ERRHANDLER, 375, 380,
589, 855

#120

MPI_FILE_GET_GROUP, 533 , 533	MPI_FILE_SET_ATOMICITY, 529 , 579 , 580 , 580	1
MPI_FILE_GET_INFO, 534 , 535 , 535 , 536 , 537 , 842 , 856	MPI_FILE_SET_ERRHANDLER, 375 , 380 , 589	2
MPI_FILE_GET_POSITION, 555 , 555	MPI_FILE_SET_INFO, 534 , 535 , 535 , 537 , 842 , 856	3
MPI_FILE_GET_POSITION_SHARED, 560 , 561 , 561 , 581	MPI_FILE_SET_SIZE, 531 , 531 , 532 , 579 , 582 , 584	4
MPI_FILE_GET_SIZE, 532 , 533 , 584	MPI_FILE_SET_VIEW, 98 , 384 , 528 , 534 , 535 , 537 , 538 , 538 , 539 , 540 , 555 , 562 , 569 , 575 , 583 , 590 , 856 , 857	5
MPI_FILE_GET_TYPE_EXTENT, 571 , 571 , 577	MPI_FILE_SYNC, 530 , 541 , 578–581 , 581 , 587	6
MPI_FILE_GET_VIEW, 540 , 540	MPI_FILE_WRITE, 541 , 551 , 551 , 552 , 554 , 583	7
MPI_FILE_IXXX, 542	MPI_FILE_WRITE_ALL, 541 , 551 , 552 , 554	8
MPI_FILE_IREAD, 541 , 552 , 552 , 562 , 579	MPI_FILE_WRITE_ALL_BEGIN, 541 , 566 , 670 , 683	9
MPI_FILE_IREAD_ALL, 541 , 553 , 553 , 844	MPI_FILE_WRITE_ALL_END, 541 , 566 , 683	10
MPI_FILE_IREAD_AT, 541 , 546 , 546	MPI_FILE_WRITE_AT, 541 , 545 , 545 , 546 , 548	11
MPI_FILE_IREAD_AT_ALL, 541 , 547 , 547 , 844	MPI_FILE_WRITE_AT_ALL, 541 , 545 , 546 , 548	12
MPI_FILE_IREAD_SHARED, 541 , 558 , 558	MPI_FILE_WRITE_AT_ALL_BEGIN, 541 , 564 , 683	13
MPI_FILE_IWRITE, 541 , 553 , 554	MPI_FILE_WRITE_AT_ALL_END, 541 , 565 , 683	14
MPI_FILE_IWRITE_ALL, 541 , 554 , 554 , 844	MPI_FILE_WRITE_ORDERED, 541 , 559 , 560 , 560	15
MPI_FILE_IWRITE_AT, 541 , 547 , 548	MPI_FILE_WRITE_ORDERED_BEGIN, 541 , 568 , 683	16
MPI_FILE_IWRITE_AT_ALL, 541 , 548 , 548 , 844	MPI_FILE_WRITE_ORDERED_END, 541 , 568 , 683	17
MPI_FILE_IWRITE_SHARED, 541 , 558 , 559	MPI_FILE_WRITE_SHARED, 541 , 542 , 557 , 558–560	18
MPI_FILE_OPEN, 384 , 520 , 527 , 527 , 528 , 529 , 534 , 537 , 539 , 556 , 583 , 584 , 589 , 590	MPI_FINALIZE, 15 , 21 , 368 , 369 , 391 , 391 , 392–396 , 432 , 519 , 528 , 601 , 611 , 624 , 626 , 690 , 692 , 693 , 848 , 856	19
MPI_FILE_PREALLOCATE, 531 , 532 , 532 , 579 , 584	MPI_FINALIZED, 390 , 393 , 395 , 395 , 396 , 518 , 524 , 690 , 844	20
MPI_FILE_READ, 541 , 549 , 549 , 550 , 552 , 583 , 584	MPI_FREE_MEM, 372 , 372 , 373 , 383 , 440 , 441	21
MPI_FILE_READ_ALL, 541 , 550 , 550 , 553 , 562 , 563	MPI_GATHER, 143 , 146–148 , 151 , 153 , 154 , 161 , 162 , 167 , 177 , 203	22
MPI_FILE_READ_ALL_BEGIN, 541 , 562 , 563 , 565 , 579 , 683	MPI_GATHER_INIT, 220	23
MPI_FILE_READ_ALL_END, 541 , 562 , 563 , 565 , 579 , 683	MPI_GATHERV, 143 , 147 , 148 , 153 , 153 , 154 , 155 , 163 , 169 , 204	24
MPI_FILE_READ_AT, 541 , 544 , 544 , 545 , 546	MPI_GATHERV_INIT, 221	25
MPI_FILE_READ_AT_ALL, 541 , 544 , 545 , 547	MPI_GET, 435 , 451 , 454 , 455 , 461 , 466 , 471 , 491 , 494 , 503 , 681 , 856	26
MPI_FILE_READ_AT_ALL_BEGIN, 541 , 563 , 683	MPI_GET_ACCUMULATE, 435 , 451 , 459 , 460 , 461 , 462 , 469 , 495 , 501 , 843	27
MPI_FILE_READ_AT_ALL_END, 541 , 564 , 683	MPI_GET_ADDRESS, 23 , 87 , 103 , 104 , 104 , 105 , 117 , 445 , 637 , 653 , 672 , 677 , 695 , 696	28
MPI_FILE_READ_ORDERED, 541 , 559 , 560		29
MPI_FILE_READ_ORDERED_BEGIN, 541 , 567 , 683		30
MPI_FILE_READ_ORDERED_END, 541 , 567 , 683		31
MPI_FILE_READ_SHARED, 541 , 557 , 557 , 558 , 560		32
MPI_FILE_SEEK, 554 , 555		33
MPI_FILE_SEEK_SHARED, 560 , 561 , 561 , 562 , 581		34

- 1 MPI_GET_COUNT, [33](#), [33](#), [34](#), [54](#), [116](#), [464](#),
2 [517](#), [543](#), [847](#), [853](#)
- 3 MPI_GET_ELEMENTS, [54](#), [115](#), [115](#), [116](#),
4 [517](#), [518](#), [543](#), [847](#)
- 5 MPI_GET_ELEMENTS_X, [54](#), [115](#), [115](#), [116](#),
6 [517](#), [543](#), [846](#)
- 7 MPI_GET_LIBRARY_VERSION, [368](#), [368](#),
8 [390](#), [393](#), [518](#), [843](#), [844](#), [846](#)
- 9 MPI_GET_PROCESSOR_NAME, [370](#), [370](#),
10 [371](#), [855](#)
- 11 MPI_GET_VERSION, [367](#), [368](#), [390](#), [393](#), [518](#),
12 [524](#), [657](#), [844](#)
- 13 MPI_GRAPH_CREATE, [311](#), [312](#), [321](#), [321](#),
14 [323](#), [328](#), [330](#), [331](#), [334](#), [341](#), [342](#), [854](#),
15 [855](#)
- 16 MPI_GRAPH_GET, [312](#), [330](#), [331](#), [331](#)
- 17 MPI_GRAPH_MAP, [312](#), [341](#), [341](#)
- 18 MPI_GRAPH_NEIGHBORS, [312](#), [334](#), [334](#),
19 [335](#), [342](#), [852](#)
- 20 MPI_GRAPH_NEIGHBORS_COUNT, [312](#),
21 [333](#), [334](#), [335](#), [852](#)
- 22 MPI_GRAPHDIMS_GET, [312](#), [330](#), [330](#), [331](#)
- 23 MPI_GREQUEST_COMPLETE, [510](#)–[513](#), [513](#)
- 24 MPI_GREQUEST_START, [510](#), [511](#), [723](#), [725](#),
25 [853](#)
- 26 MPI_GROUP_C2F, [691](#)
- 27 MPI_GROUP_COMPARE, [249](#), [252](#)
- 28 MPI_GROUP_DIFFERENCE, [251](#)
- 29 MPI_GROUP_EXCL, [252](#), [253](#), [254](#)
- 30 MPI_GROUP_F2C, [691](#)
- 31 MPI_GROUP_FREE, [255](#), [255](#), [256](#), [375](#), [392](#),
32 [855](#)
- 33 MPI_GROUP_INCL, [252](#), [252](#), [254](#)
- 34 MPI_GROUP_INTERSECTION, [251](#)
- 35 MPI_GROUP_RANGE_EXCL, [254](#), [254](#)
- 36 MPI_GROUP_RANGE_INCL, [253](#), [254](#)
- 37 MPI_GROUP_RANK, [248](#), [256](#)
- 38 MPI_GROUP_SIZE, [248](#), [256](#)
- 39 MPI_GROUP_TRANSLATE_RANKS, [249](#),
40 [249](#), [854](#)
- 41 MPI_GROUP_UNION, [250](#)
- 42 MPI_IALLGATHER, [143](#), [147](#), [148](#), [207](#)
- 43 MPI_IALLGATHERV, [143](#), [147](#), [148](#), [208](#)
- 44 MPI_IALLREDUCE, [143](#), [147](#), [148](#), [213](#)
- 45 MPI_IALLTOALL, [143](#), [147](#), [148](#), [209](#)
- 46 MPI_IALLTOALLV, [143](#), [147](#), [148](#), [210](#)
- 47 MPI_IALLTOALLW, [143](#), [147](#), [148](#), [211](#)
- 48 MPI_IBARRIER, [143](#), [147](#), [199](#), [201](#), [201](#), [238](#)
- MPI_IBCAST, [143](#), [147](#), [202](#), [202](#), [242](#)
- MPI_IBSEND, [51](#), [55](#), [79](#)
- MPI_IXSCAN, [144](#), [147](#), [217](#)
- MPI_IGATHER, [143](#), [147](#), [148](#), [203](#)
- MPI_IGATHERV, [143](#), [147](#), [148](#), [204](#)
- MPI_IMPROBE, [66](#), [69](#), [70](#), [70](#), [71](#), [73](#), [520](#),
[843](#), [847](#)
- MPI_IMRECV, [69](#)–[73](#), [73](#), [847](#)
- MPI_INEIGHBOR_ALLGATHER, [312](#), [352](#),
[848](#)
- MPI_INEIGHBOR_ALLGATHERV, [312](#), [353](#),
[848](#)
- MPI_INEIGHBOR_ALLTOALL, [312](#), [354](#), [848](#)
- MPI_INEIGHBOR_ALLTOALLV, [312](#), [355](#),
[848](#)
- MPI_INEIGHBOR_ALLTOALLW, [312](#), [356](#),
[848](#)
- MPI_INFO_C2F, [691](#)
- MPI_INFO_CREATE, [400](#), [400](#)
- MPI_INFO_DELETE, [383](#), [401](#), [401](#), [403](#)
- MPI_INFO_DUP, [403](#), [403](#)
- MPI_INFO_F2C, [691](#)
- MPI_INFO_FREE, [271](#), [392](#), [403](#), [451](#), [536](#)
- MPI_INFO_GET, [399](#), [401](#), [856](#)
- MPI_INFO_GET_NKEYS, [399](#), [402](#), [402](#), [403](#),
[856](#)
- MPI_INFO_GET_NTHKEY, [399](#), [403](#), [856](#)
- MPI_INFO_GET_VALUELEN, [399](#), [402](#), [856](#)
- MPI_INFO_SET, [400](#), [400](#), [401](#), [403](#)
- MPI_INIT, [15](#), [21](#), [247](#), [368](#), [369](#), [389](#), [389](#),
[390](#), [393](#)–[396](#), [409](#)–[411](#), [413](#), [429](#), [430](#),
[521](#), [522](#), [524](#), [601](#), [604](#), [611](#), [624](#), [689](#),
[690](#), [692](#), [693](#), [847](#), [848](#), [851](#), [852](#)
- MPI_INIT_THREAD, [247](#), [390](#), [395](#), [521](#),
[522](#)–[524](#), [601](#), [604](#), [611](#), [689](#), [847](#), [848](#),
[852](#)
- MPI_INITIALIZED, [390](#), [393](#), [394](#), [394](#), [395](#),
[396](#), [518](#), [524](#), [690](#), [844](#)
- MPI_INTERCOMM_CREATE, [257](#), [264](#), [281](#),
[282](#), [282](#), [283](#), [848](#)
- MPI_INTERCOMM_MERGE, [257](#), [264](#), [278](#),
[281](#)–[283](#), [283](#), [850](#)
- MPI_IProbe, [33](#), [66](#), [67](#), [67](#), [68](#)–[71](#), [73](#), [520](#),
[847](#)
- MPI_Irecv, [53](#), [73](#), [671](#), [672](#), [675](#), [676](#)
- MPI_IREDUCE, [143](#), [147](#), [148](#), [212](#), [213](#)
- MPI_IREDUCE_SCATTER, [143](#), [147](#), [148](#),
[215](#)
- MPI_IREDUCE_SCATTER_BLOCK, [143](#),
[147](#), [148](#), [214](#)
- MPI_IRSEND, [53](#)
- MPI_IS_THREAD_MAIN, [518](#), [522](#), [524](#), [844](#)
- MPI_ISCAN, [144](#), [147](#), [216](#)
- MPI_ISCATTER, [143](#), [147](#), [148](#), [205](#)
- MPI_ISCATTERV, [143](#), [147](#), [148](#), [206](#)
- MPI_ISEND, [51](#), [79](#), [649](#), [650](#), [653](#), [670](#), [671](#),
[676](#), [677](#)
- MPI_ISSEND, [52](#)
- MPI_KEYVAL_CREATE, [23](#), [633](#), [635](#), [726](#)

MPI_KEYVAL_FREE, 23 , 300 , 634	213, 458 , 459 , 461 , 462 , 853	1
MPI_LOOKUP_NAME, 383 , 420 , 424 , 426 , 426	MPI_REDUCE_INIT, 229	2
MPI_MESSAGE_C2F, 691 , 847	MPI_REDUCE_LOCAL, 177 , 178 , 185 , 191 , 850 , 852	3
MPI_MESSAGE_F2C, 691 , 847	MPI_REDUCE_SCATTER, 143 , 147 , 148 , 178 , 185 , 194 , 194 , 195 , 215	4
MPI_MPROBE, 66 , 69–71 , 71 , 73 , 520 , 847	MPI_REDUCE_SCATTER_BLOCK, 143 , 147 , 148 , 178 , 185 , 193 , 193 , 194 , 214 , 852	5
MPI_MRECV, 69–72 , 72 , 73 , 847	MPI_REDUCE_SCATTER_BLOCK_INIT, 231	6
MPI_NEIGHBOR_ALLGATHER, 312 , 343 , 344 , 346 , 352 , 848	MPI_REDUCE_SCATTER_INIT, 232	7
MPI_NEIGHBOR_ALLGATHER_INIT, 357	MPI_REGISTER_DATAREP, 384 , 573 , 575–577 , 590 , 723 , 725	8
MPI_NEIGHBOR_ALLGATHERV, 312 , 345 , 353 , 848	MPI_REQUEST_C2F, 691	9
MPI_NEIGHBOR_ALLGATHERV_INIT, 358	MPI_REQUEST_F2C, 691	10
MPI_NEIGHBOR_ALLTOALL, 312 , 346 , 347 , 354 , 848	MPI_REQUEST_FREE, 57 , 57 , 74 , 79 , 200 , 218 , 391 , 392 , 464 , 512 , 513 , 851	11
MPI_NEIGHBOR_ALLTOALL_INIT, 359	MPI_REQUEST_GET_STATUS, 34 , 66 , 66 , 511 , 851	12
MPI_NEIGHBOR_ALLTOALLV, 312 , 348 , 355 , 848	MPI_RGET, 435 , 451 , 465 , 466	13
MPI_NEIGHBOR_ALLTOALLV_INIT, 360	MPI_RGET_ACCUMULATE, 435 , 451 , 459 , 461 , 468 , 469	14
MPI_NEIGHBOR_ALLTOALLV_INIT, 360	MPI_RPUT, 435 , 451 , 464 , 465	15
MPI_NEIGHBOR_ALLTOALLW, 312 , 349 , 350 , 357 , 848	MPI_RSEND, 41	16
MPI_NEIGHBOR_ALLTOALLW_INIT, 361	MPI_RSEND_INIT, 77	17
MPI_NULL_COPY_FN, 18 , 23 , 290 , 634 , 714	MPI_SCAN, 144 , 147 , 178 , 185 , 195 , 196 , 197 , 216	18
MPI_NULL_DELETE_FN, 23 , 290 , 634 , 714	MPI_SCAN_INIT, 233	19
MPI_OP_C2F, 691	MPI_SCATTER, 143 , 147 , 148 , 161 , 161 , 163 , 164 , 193 , 205	20
MPI_OP_COMMUTATIVE, 192 , 852	MPI_SCATTER_INIT, 222	21
MPI_OP_CREATE, 185 , 185 , 187 , 649 , 721 , 723 , 849	MPI_SCATTERV, 143 , 147 , 148 , 163 , 163 , 164 , 195 , 206	22
MPI_OP_F2C, 691	MPI_SCATTERV_INIT, 223	23
MPI_OP_FREE, 188 , 392	MPI_SEND, 25 , 26 , 27 , 34 , 36 , 86 , 113 , 114 , 134 , 239 , 528 , 585 , 598 , 677 , 678 , 680 , 681	24
MPI_OPEN_PORT, 420 , 420 , 422 , 423 , 425 , 426	MPI_SEND_INIT, 76 , 79	25
MPI_PACK, 48 , 134 , 137 , 140 , 573 , 576	MPI_SENDRECV, 81 , 337	26
MPI_PACK_EXTERNAL, 8 , 140 , 141 , 663 , 854	MPI_SENDRECV_REPLACE, 82	27
MPI_PACK_EXTERNAL_SIZE, 142	MPI_SIZEOF, 642 , 664 , 665	28
MPI_PACK_SIZE, 48 , 137 , 137 , 847	MPI_SSEND, 41	29
MPI_PCONTROL, 596 , 597 , 597	MPI_SSEND_INIT, 77	30
MPI_PROBE, 31 , 33 , 34 , 66–68 , 68 , 69–71 , 73 , 520 , 847	MPI_START, 78 , 79 , 79 , 80 , 218 , 677	31
MPI_PUBLISH_NAME, 420 , 424 , 424 , 425 , 426	MPI_STARTALL, 79 , 79 , 218 , 677	32
MPI_PUT, 435 , 451 , 452 , 454 , 458 , 459 , 465 , 471 , 476 , 486 , 488 , 492 , 494 , 503 , 670 , 681 , 856	MPI_STATUS_C2F, 692	33
MPI_QUERY_THREAD, 518 , 523 , 524 , 844	MPI_STATUS_C2F08, 693 , 849	34
MPI_RACCUMULATE, 435 , 451 , 459 , 461 , 466 , 467	MPI_STATUS_F082C, 693 , 849	35
MPI_RECV, 26 , 30 , 32–34 , 67 , 69 , 70 , 86 , 114 , 115 , 135 , 144 , 152 , 239 , 518 , 585 , 624 , 677 , 680 , 681	MPI_STATUS_F082F, 694 , 849	36
MPI_RECV_INIT, 78 , 78	MPI_STATUS_F2C, 692	37
MPI_REDUCE, 143 , 147 , 148 , 176 , 176 , 177 , 178 , 185–187 , 190 , 193 , 195–197 , 212 , 213 , 458 , 459 , 461 , 462 , 853	MPI_STATUS_F2F08, 694 , 849	38
	MPI_STATUS_SET_CANCELLED, 517	39
	MPI_STATUS_SET_ELEMENTS, 516 , 517	40
		41
		42
		43
		44
		45
		46
		47
		48

- 1 MPI_STATUS_SET_ELEMENTS_X, [517](#),
2 [517](#), [846](#)
- 3 MPI_T_CATEGORY_CHANGED, [630](#)
- 4 MPI_T_CATEGORY_GET_CATEGORIES,
5 [629](#), [629](#), [630](#), [632](#)
- 6 MPI_T_CATEGORY_GET_CVARS, [629](#), [629](#),
7 [630](#), [632](#)
- 8 MPI_T_CATEGORY_GET_INDEX, [628](#), [628](#),
9 [632](#), [845](#)
- 10 MPI_T_CATEGORY_GET_INFO, [627](#), [628](#),
11 [630](#), [632](#), [844](#), [845](#)
- 12 MPI_T_CATEGORY_GET_NUM, [627](#)
- 13 MPI_T_CATEGORY_GET_PVARS, [629](#), [629](#),
14 [630](#), [632](#)
- 15 MPI_T_CVAR_GET_INDEX, [610](#), [610](#), [632](#),
16 [845](#)
- 17 MPI_T_CVAR_GET_INFO, [606](#), [608](#), [608](#),
18 [609](#), [611–613](#), [630](#), [632](#), [843](#), [845](#)
- 19 MPI_T_CVAR_GET_NUM, [608](#), [612](#)
- 20 MPI_T_CVAR_HANDLE_ALLOC, [606](#), [611](#),
21 [612](#), [613](#), [632](#)
- 22 MPI_T_CVAR_HANDLE_FREE, [612](#), [612](#),
23 [632](#)
- 24 MPI_T_CVAR_READ, [612](#)
- 25 MPI_T_CVAR_WRITE, [612](#)
- 26 MPI_T_ENUM_GET_INFO, [606](#), [606](#), [632](#)
- 27 MPI_T_ENUM_GET_ITEM, [606](#), [607](#), [632](#)
- 28 MPI_T_FINALIZE, [605](#), [605](#)
- 29 MPI_T_INIT_THREAD, [604](#), [604](#), [605](#)
- 30 MPI_T_PVAR_GET_INDEX, [618](#), [618](#), [632](#),
31 [845](#)
- 32 MPI_T_PVAR_GET_INFO, [606](#), [616](#), [617](#),
33 [617](#), [620](#), [622](#), [623](#), [630](#), [632](#), [843](#), [845](#)
- 34 MPI_T_PVAR_GET_NUM, [616](#), [620](#)
- 35 MPI_T_PVAR_HANDLE_ALLOC, [606](#), [620](#),
36 [620](#), [622](#), [632](#)
- 37 MPI_T_PVAR_HANDLE_FREE, [620](#), [621](#),
38 [632](#), [844](#)
- 39 MPI_T_PVAR_READ, [622](#), [622](#), [623](#), [632](#), [844](#)
- 40 MPI_T_PVAR_READRESET, [618](#), [623](#), [623](#),
41 [632](#), [844](#)
- 42 MPI_T_PVAR_RESET, [623](#), [623](#), [632](#), [844](#)
- 43 MPI_T_PVAR_SESSION_CREATE, [619](#), [632](#)
- 44 MPI_T_PVAR_SESSION_FREE, [619](#), [632](#)
- 45 MPI_T_PVAR_START, [621](#), [632](#), [844](#)
- 46 MPI_T_PVAR_STOP, [621](#), [632](#), [844](#)
- 47 MPI_T_PVAR_WRITE, [622](#), [622](#), [632](#), [844](#)
- 48 MPI_TEST, [34](#), [54](#), [56](#), [56](#), [57](#), [59](#), [61](#), [74](#), [79](#),
[218](#), [391](#), [513](#), [542](#), [543](#)
- MPI_TEST_CANCELLED, [54–56](#), [74](#), [75](#), [511](#),
[518](#), [543](#)
- MPI_TESTALL, [59](#), [62](#), [62](#), [511–513](#), [516](#), [519](#)
- MPI_TESTANY, [59](#), [60](#), [61](#), [64](#), [511–513](#), [516](#),
[519](#)
- MPI_TESTSOME, [59](#), [64](#), [64](#), [65](#), [511–513](#),
[516](#), [519](#)
- MPI_TOPO_TEST, [312](#), [330](#), [330](#)
- MPI_TYPE_C2F, [690](#)
- MPI_TYPE_COMMIT, [112](#), [112](#), [691](#)
- MPI_TYPE_CONTIGUOUS, [12](#), [87](#), [87](#), [89](#),
[107](#), [119](#), [526](#), [571](#)
- MPI_TYPE_CREATE_DARRAY, [12](#), [33](#), [99](#),
[99](#), [119](#)
- MPI_TYPE_CREATE_F90_COMPLEX, [12](#),
[119](#), [121](#), [179](#), [573](#), [642](#), [661](#), [663](#)
- MPI_TYPE_CREATE_F90_INTEGER, [12](#),
[119](#), [121](#), [178](#), [573](#), [642](#), [661](#), [663](#)
- MPI_TYPE_CREATE_F90_REAL, [12](#), [119](#),
[121](#), [179](#), [573](#), [642](#), [660](#), [661–663](#), [851](#)
- MPI_TYPE_CREATE_HINDEXED, [12](#), [23](#),
[87](#), [92](#), [92](#), [94](#), [96](#), [119](#), [637](#)
- MPI_TYPE_CREATE_HINDEXED_BLOCK,
[12](#), [87](#), [94](#), [94](#), [119](#), [847](#)
- MPI_TYPE_CREATE_HVECTOR, [12](#), [23](#),
[87](#), [89](#), [89](#), [119](#), [637](#)
- MPI_TYPE_CREATE_INDEXED_BLOCK,
[12](#), [93](#), [94](#), [119](#)
- MPI_TYPE_CREATE_KEYVAL, [287](#), [297](#),
[300](#), [697](#), [722](#), [724](#), [854](#)
- MPI_TYPE_CREATE_RESIZED, [23](#), [87](#), [107](#),
[109](#), [110](#), [119](#), [571](#), [638](#), [849](#)
- MPI_TYPE_CREATE_STRUCT, [12](#), [23](#), [87](#),
[94](#), [95](#), [95](#), [96](#), [107](#), [119](#), [175](#), [637](#)
- MPI_TYPE_CREATE_SUBARRAY, [12](#), [15](#),
[96](#), [98](#), [100](#), [119](#), [316](#)
- MPI_TYPE_DELETE_ATTR, [287](#), [299](#), [300](#),
[849](#)
- MPI_TYPE_DUP, [12](#), [113](#), [113](#), [119](#), [849](#)
- MPI_TYPE_DUP_FN, [297](#), [297](#), [714](#), [844](#)
- MPI_TYPE_EXTENT, [23](#), [637](#), [846](#)
- MPI_TYPE_F2C, [690](#)
- MPI_TYPE_FREE, [112](#), [121](#), [298](#), [392](#)
- MPI_TYPE_FREE_KEYVAL, [287](#), [298](#), [300](#)
- MPI_TYPE_GET_ATTR, [287](#), [299](#), [300](#), [650](#),
[697](#), [849](#)
- MPI_TYPE_GET_CONTENTS, [118](#), [119](#),
[120](#), [121](#), [122](#)
- MPI_TYPE_GET_ENVELOPE, [118](#), [118](#),
[120](#), [121](#), [662](#)
- MPI_TYPE_GET_EXTENT, [23](#), [108](#), [111](#),
[637](#), [665](#), [695](#)
- MPI_TYPE_GET_EXTENT_X, [109](#), [846](#)
- MPI_TYPE_GET_NAME, [305](#), [849](#)
- MPI_TYPE_GET_TRUE_EXTENT, [110](#), [110](#)
- MPI_TYPE_GET_TRUE_EXTENT_X, [110](#),
[111](#), [846](#)
- MPI_TYPE_HINDEXED, [23](#), [637](#), [846](#)
- MPI_TYPE_HVECTOR, [23](#), [637](#), [846](#)

MPI_TYPE_INDEXED, 12 , 90 , 91 , 91 , 92 , 93 , 119	MPI_WIN_FENCE, 447 , 455 , 471 , 474 , 475 , 484 , 485 , 487 , 488 , 491 , 496 , 681	1
MPI_TYPE_LB, 23 , 637 , 846	MPI_WIN_FLUSH, 442 , 464 , 465 , 482 , 483 , 487 , 501 , 502	2
MPI_TYPE_MATCH_SIZE, 642 , 665 , 665 , 849	MPI_WIN_FLUSH_ALL, 464 , 465 , 483 , 487	3
MPI_TYPE_NULL_COPY_FN, 297 , 297 , 714 , 844	MPI_WIN_FLUSH_LOCAL, 464 , 483 , 487	4
MPI_TYPE_NULL_DELETE_FN, 297 , 714 , 844 , 849	MPI_WIN_FLUSH_LOCAL_ALL, 464 , 483 , 484 , 487	5
MPI_TYPE_SET_ATTR, 287 , 299 , 300 , 650 , 697 , 701 , 849	MPI_WIN_FREE, 295 , 392 , 432 , 447 , 447 , 448	6
MPI_TYPE_SET_NAME, 305 , 849	MPI_WIN_FREE_KEYVAL, 287 , 295 , 300	7
MPI_TYPE_SIZE, 106 , 106 , 598 , 847	MPI_WIN_GET_ATTR, 287 , 296 , 300 , 448 , 697 , 701	8
MPI_TYPE_SIZE_X, 106 , 106 , 846	MPI_WIN_GET_ERRHANDLER, 375 , 379 , 855	9
MPI_TYPE_STRUCT, 23 , 637 , 846	MPI_WIN_GET_GROUP, 449 , 449	10
MPI_TYPE_UB, 23 , 637 , 846	MPI_WIN_GET_INFO, 449 , 450 , 450 , 451 , 842 , 847	11
MPI_TYPE_VECTOR, 12 , 88 , 88 , 89 , 92 , 119	MPI_WIN_GET_NAME, 306	12
MPI_UNPACK, 135 , 135 , 136 , 140 , 576	MPI_WIN_LOCK, 438 , 447 , 472 , 479 , 480 – 482 , 484 , 485 , 487 , 491 – 493	13
MPI_UNPACK_EXTERNAL, 8 , 141 , 663	MPI_WIN_LOCK_ALL, 438 , 472 , 480 , 480 , 481 , 484 , 485 , 487 , 493 , 501	14
MPI_UNPUBLISH_NAME, 383 , 425 , 425	MPI_WIN_NULL_COPY_FN, 294 , 294 , 714 , 844	15
MPI_WAIT, 32 , 34 , 54 , 55 , 55 , 56 – 58 , 60 , 61 , 74 , 79 , 199 , 218 , 239 , 391 , 509 , 513 , 520 , 542 , 543 , 562 , 579 , 580 , 670 , 676 , 677 , 680	MPI_WIN_NULL_DELETE_FN, 294 , 714 , 844	16
MPI_WAITALL, 59 , 61 , 61 , 62 , 200 , 240 , 464 , 511 – 513 , 516 , 519 , 520	MPI_WIN_POST, 447 , 471 , 476 , 477 , 477 , 478 , 479 , 481 , 484 , 485 , 487 , 494 , 496	17
MPI_WAITANY, 43 , 59 , 59 , 60 , 64 , 511 – 513 , 516 , 519 , 520	MPI_WIN_SET_ATTR, 287 , 295 , 300 , 448 , 650 , 697 , 701	18
MPI_WAITSOME, 59 , 63 , 63 , 64 , 65 , 511 – 513 , 516 , 519 , 520	MPI_WIN_SET_ERRHANDLER, 375 , 378	19
MPI_WIN_ALLOCATE, 436 , 439 , 440 , 442 , 447 , 449 , 453 , 482 , 654 , 656 , 843	MPI_WIN_SET_INFO, 449 , 450 , 450 , 842 , 847	20
MPI_WIN_ALLOCATE_CPTR, 440 , 843	MPI_WIN_SET_NAME, 305	21
MPI_WIN_ALLOCATE_SHARED, 436 , 441 , 441 , 443 , 447 , 449 , 656 , 843	MPI_WIN_SHARED_QUERY, 441 , 443 , 656 , 843	22
MPI_WIN_ALLOCATE_SHARED_CPTR, 442 , 843	MPI_WIN_SHARED_QUERY_CPTR, 444 , 843	23
MPI_WIN_ATTACH, 444 , 445 , 445 , 446 , 447 , 482	MPI_WIN_START, 447 , 471 , 475 , 476 , 477 , 479 , 484 , 485 , 494 , 501	24
MPI_WIN_C2F, 691	MPI_WIN_SYNC, 484 , 484 , 487 , 489 , 490 , 493 , 501 – 503	25
MPI_WIN_CALL_ERRHANDLER, 387 , 388	MPI_WIN_TEST, 478 , 478	26
MPI_WIN_COMPLETE, 447 , 471 , 476 , 476 , 477 – 479 , 487 , 493	MPI_WIN_UNLOCK, 447 , 465 , 472 , 480 , 482 , 487 , 491 , 492	27
MPI_WIN_CREATE, 436 , 437 , 439 , 440 , 442 , 445 – 447 , 449 , 486 , 520	MPI_WIN_UNLOCK_ALL, 465 , 472 , 480 , 481 , 487 , 491 , 501	28
MPI_WIN_CREATE_DYNAMIC, 384 , 436 , 444 , 444 , 445 – 447 , 449 , 486	MPI_WIN_WAIT, 447 , 471 , 477 , 477 , 478 , 479 , 481 , 487 , 491 , 493 , 494	29
MPI_WIN_CREATE_ERRHANDLER, 375 , 378 , 379 , 722 , 725 , 850	MPI_WTICK, 19 , 389 , 389	30
MPI_WIN_CREATE_KEYVAL, 287 , 293 , 300 , 697 , 721 , 724 , 854	MPI_WTIME, 19 , 370 , 388 , 389 , 598 , 616	31
MPI_WIN_DELETE_ATTR, 287 , 296 , 300	mpexec, 390 , 395 , 396 , 396 , 522	32
MPI_WIN_DETACH, 444 , 446 , 446 , 447	mpirun, 396	33
MPI_WIN_DUP_FN, 294 , 294 , 714 , 844	PMPI_, 595 , 650	34
MPI_WIN_F2C, 691		35
		36
		37
		38
		39
		40
		41
		42
		43
		44
		45
		46
		47
		48

1 PMPI_AINT_ADD, 19
2 PMPI_AINT_DIFF, 19
3 PMPI_ISEND, 650, 653
4 PMPI_WTICK, 19
5 PMPI_WTIME, 19
6
7
8
9
10
11
12
13
14
15
16
17
18
19
20
21
22
23
24
25
26
27
28
29
30
31
32
33
34
35
36
37
38
39
40
41
42
43
44
45
46
47
48