

# MPI: A Message-Passing Interface Standard

Version 4.0

(Draft)

Unofficial, for comment only

Message Passing Interface Forum

April 17, 2020

1 This document describes the 2019 Draft Specification of the Message-Passing Interface  
2 (MPI) standard, intended for comment. It is not an official version of the standard. The  
3 MPI standard includes point-to-point message-passing, collective communications, group  
4 and communicator concepts, process topologies, environmental management, process cre-  
5 ation and management, one-sided communications, extended collective operations, external  
6 interfaces, I/O, some miscellaneous topics, and a profiling interface. Language bindings for  
7 C and Fortran are defined.

8 Historically, the evolution of the standards is from MPI-1.0 (May 5, 1994) to MPI-1.1  
9 (June 12, 1995) to MPI-1.2 (July 18, 1997), with several clarifications and additions and  
10 published as part of the MPI-2 document, to MPI-2.0 (July 18, 1997), with new functionality,  
11 to MPI-1.3 (May 30, 2008), combining for historical reasons the documents 1.1 and 1.2  
12 and some errata documents to one combined document, and to MPI-2.1 (June 23, 2008),  
13 combining the previous documents. Version MPI-2.2 (September 4, 2009) added additional  
14 clarifications and seven new routines. Version MPI-3.0 (September 21, 2012) is an extension  
15 of MPI-2.2. Version MPI-3.1 (June 4, 2015) adds clarifications and minor extensions to  
16 MPI-3.0.

17  
18 **Comments.** Please send comments on MPI to the MPI Forum as follows:

- 19  
20 1. Subscribe to <http://lists.mpi-forum.org/mailman/listinfo.cgi/mpi-comments>
- 21  
22 2. Send your comment to: [mpi-comments@mpi-forum.org](mailto:mpi-comments@mpi-forum.org), together with the URL of  
23 the version of the MPI standard and the page and line numbers on which you are  
24 commenting.

25 Your comment will be forwarded to MPI Forum committee members for consideration.  
26 Messages sent from an unsubscribed e-mail address will not be considered.

27  
28  
29  
30  
31  
32  
33  
34  
35  
36  
37  
38  
39  
40  
41  
42  
43  
44  
45 ©1993, 1994, 1995, 1996, 1997, 2008, 2009, 2012, 2015, 2019 University of Tennessee,  
46 Knoxville, Tennessee. Permission to copy without fee all or part of this material is granted,  
47 provided the University of Tennessee copyright notice and the title of this document appear,  
48 and notice is given that copying is by permission of the University of Tennessee.

2019 Draft Specification, November, 2019. This document contains a draft of the MPI specification as of the date of publication. It has not been adopted as an official MPI specification, and is provided for comment only. This document includes a number of new features that will be present in the final MPI-4.0 document. The largest changes are the addition of persistent collectives, application info assertions, and improvements to the definitions of error handling. In addition, there are a number of smaller improvements and corrections.

Version 3.1: June 4, 2015. This document contains mostly corrections and clarifications to the MPI-3.0 document. The largest change is a correction to the Fortran bindings introduced in MPI-3.0. Additionally, new functions added include routines to manipulate `MPI_Aint` values in a portable manner, nonblocking collective I/O routines, and routines to get the index value by name for `MPI_T` performance and control variables.

Version 3.0: September 21, 2012. Coincident with the development of MPI-2.2, the MPI Forum began discussions of a major extension to MPI. This document contains the MPI-3 Standard. This draft version of the MPI-3 standard contains significant extensions to MPI functionality, including nonblocking collectives, new one-sided communication operations, and Fortran 2008 bindings. Unlike MPI-2.2, this standard is considered a major update to the MPI standard. As with previous versions, new features have been adopted only when there were compelling needs for the users. Some features, however, may have more than a minor impact on existing MPI implementations.

Version 2.2: September 4, 2009. This document contains mostly corrections and clarifications to the MPI-2.1 document. A few extensions have been added; however all correct MPI-2.1 programs are correct MPI-2.2 programs. New features were adopted only when there were compelling needs for users, open source implementations, and minor impact on existing MPI implementations.

Version 2.1: June 23, 2008. This document combines the previous documents MPI-1.3 (May 30, 2008) and MPI-2.0 (July 18, 1997). Certain parts of MPI-2.0, such as some sections of Chapter 4, Miscellany, and Chapter 7, Extended Collective Operations, have been merged into the Chapters of MPI-1.3. Additional errata and clarifications collected by the MPI Forum are also included in this document.

Version 1.3: May 30, 2008. This document combines the previous documents MPI-1.1 (June 12, 1995) and the MPI-1.2 Chapter in MPI-2 (July 18, 1997). Additional errata collected by the MPI Forum referring to MPI-1.1 and MPI-1.2 are also included in this document.

Version 2.0: July 18, 1997. Beginning after the release of MPI-1.1, the MPI Forum began meeting to consider corrections and extensions. MPI-2 has been focused on process creation and management, one-sided communications, extended collective communications, external interfaces and parallel I/O. A miscellany chapter discusses items that do not fit elsewhere, in particular language interoperability.

1 Version 1.2: July 18, 1997. The MPI-2 Forum introduced MPI-1.2 as Chapter 3 in the  
2 standard “MPI-2: Extensions to the Message-Passing Interface”, July 18, 1997. This section  
3 contains clarifications and minor corrections to Version 1.1 of the MPI Standard. The only  
4 new function in MPI-1.2 is one for identifying to which version of the MPI Standard the  
5 implementation conforms. There are small differences between MPI-1 and MPI-1.1. There  
6 are very few differences between MPI-1.1 and MPI-1.2, but large differences between MPI-1.2  
7 and MPI-2.  
8

9 Version 1.1: June, 1995. Beginning in March, 1995, the Message-Passing Interface Forum  
10 reconvened to correct errors and make clarifications in the MPI document of May 5, 1994,  
11 referred to below as Version 1.0. These discussions resulted in Version 1.1. The changes  
12 from Version 1.0 are minor. A version of this document with all changes marked is available.  
13

14 Version 1.0: May, 1994. The Message-Passing Interface Forum (MPIF), with participation  
15 from over 40 organizations, has been meeting since January 1993 to discuss and define a set  
16 of library interface standards for message passing. MPIF is not sanctioned or supported by  
17 any official standards organization.

18 The goal of the Message-Passing Interface, simply stated, is to develop a widely used  
19 standard for writing message-passing programs. As such the interface should establish a  
20 practical, portable, efficient, and flexible standard for message-passing.

21 This is the final report, Version 1.0, of the Message-Passing Interface Forum. This  
22 document contains all the technical features proposed for the interface. This copy of the  
23 draft was processed by L<sup>A</sup>T<sub>E</sub>X on May 5, 1994.  
24  
25  
26  
27  
28  
29  
30  
31  
32  
33  
34  
35  
36  
37  
38  
39  
40  
41  
42  
43  
44  
45  
46  
47  
48

# Contents

<b>List of Figures</b>	<b>xviii</b>
<b>List of Tables</b>	<b>xx</b>
<b>Acknowledgments</b>	<b>xxii</b>
<b>1 Introduction to MPI</b>	<b>1</b>
1.1 Overview and Goals	1
1.2 Background of MPI-1.0	2
1.3 Background of MPI-1.1, MPI-1.2, and MPI-2.0	2
1.4 Background of MPI-1.3 and MPI-2.1	3
1.5 Background of MPI-2.2	4
1.6 Background of MPI-3.0	4
1.7 Background of MPI-3.1	4
1.8 Background of 2019 Draft Specification	5
1.9 Who Should Use This Standard?	5
1.10 What Platforms Are Targets for Implementation?	5
1.11 What Is Included in the Standard?	5
1.12 What Is Not Included in the Standard?	6
1.13 Organization of This Document	6
<b>2 MPI Terms and Conventions</b>	<b>9</b>
2.1 Document Notation	9
2.2 Naming Conventions	9
2.3 Procedure Specification	10
2.4 Semantic Terms	11
2.5 Data Types	12
2.5.1 Opaque Objects	12
2.5.2 Array Arguments	14
2.5.3 State	14
2.5.4 Named Constants	15
2.5.5 Choice	16
2.5.6 Absolute Addresses and Relative Address Displacements	16
2.5.7 File Offsets	16
2.5.8 Counts	17
2.6 Language Binding	17
2.6.1 Deprecated and Removed Interfaces	17
2.6.2 Fortran Binding Issues	18

2.6.3	C Binding Issues . . . . .	18
2.6.4	Functions and Macros . . . . .	20
2.7	Processes . . . . .	20
2.8	Error Handling . . . . .	20
2.9	Implementation Issues . . . . .	22
2.9.1	Independence of Basic Runtime Routines . . . . .	22
2.9.2	Interaction with Signals . . . . .	22
2.10	Examples . . . . .	23
<b>3</b>	<b>Point-to-Point Communication</b> . . . . .	<b>25</b>
3.1	Introduction . . . . .	25
3.2	Blocking Send and Receive Operations . . . . .	26
3.2.1	Blocking Send . . . . .	26
3.2.2	Message Data . . . . .	27
3.2.3	Message Envelope . . . . .	29
3.2.4	Blocking Receive . . . . .	30
3.2.5	Return Status . . . . .	32
3.2.6	Passing MPI_STATUS_IGNORE for Status . . . . .	34
3.3	Data Type Matching and Data Conversion . . . . .	35
3.3.1	Type Matching Rules . . . . .	35
Type MPI_CHARACTER . . . . .	37	
3.3.2	Data Conversion . . . . .	38
3.4	Communication Modes . . . . .	39
3.5	Semantics of Point-to-Point Communication . . . . .	43
3.6	Buffer Allocation and Usage . . . . .	47
3.6.1	Model Implementation of Buffered Mode . . . . .	49
3.7	Nonblocking Communication . . . . .	49
3.7.1	Communication Request Objects . . . . .	51
3.7.2	Communication Initiation . . . . .	51
3.7.3	Communication Completion . . . . .	55
3.7.4	Semantics of Nonblocking Communications . . . . .	59
3.7.5	Multiple Completions . . . . .	60
3.7.6	Non-Destructive Test of status . . . . .	67
3.8	Probe and Cancel . . . . .	68
3.8.1	Probe . . . . .	68
3.8.2	Matching Probe . . . . .	71
3.8.3	Matched Receives . . . . .	73
3.8.4	Cancel . . . . .	75
3.9	Persistent Communication Requests . . . . .	77
3.10	Send-Receive . . . . .	83
3.11	Null Processes . . . . .	85
<b>4</b>	<b>Datatypes</b> . . . . .	<b>87</b>
4.1	Derived Datatypes . . . . .	87
4.1.1	Type Constructors with Explicit Addresses . . . . .	89
4.1.2	Datatype Constructors . . . . .	89
4.1.3	Subarray Datatype Constructor . . . . .	99
4.1.4	Distributed Array Datatype Constructor . . . . .	101

4.1.5	Address and Size Functions	106
4.1.6	Lower-Bound and Upper-Bound Markers	110
4.1.7	Extent and Bounds of Datatypes	112
4.1.8	True Extent of Datatypes	114
4.1.9	Commit and Free	115
4.1.10	Duplicating a Datatype	117
4.1.11	Use of General Datatypes in Communication	117
4.1.12	Correct Use of Addresses	121
4.1.13	Decoding a Datatype	122
4.1.14	Examples	129
4.2	Pack and Unpack	138
4.3	Canonical MPI_PACK and MPI_UNPACK	144
<b>5</b>	<b>Collective Communication</b>	<b>149</b>
5.1	Introduction and Overview	149
5.2	Communicator Argument	152
5.2.1	Specifics for Intracommunicator Collective Operations	152
5.2.2	Applying Collective Operations to Intercommunicators	153
5.2.3	Specifics for Intercommunicator Collective Operations	154
5.3	Barrier Synchronization	155
5.4	Broadcast	156
5.4.1	Example using MPI_BCAST	157
5.5	Gather	157
5.5.1	Examples using MPI_GATHER, MPI_GATHERV	160
5.6	Scatter	167
5.6.1	Examples using MPI_SCATTER, MPI_SCATTERV	170
5.7	Gather-to-all	173
5.7.1	Example using MPI_ALLGATHER	175
5.8	All-to-All Scatter/Gather	176
5.9	Global Reduction Operations	181
5.9.1	Reduce	182
5.9.2	Predefined Reduction Operations	184
5.9.3	Signed Characters and Reductions	186
5.9.4	MINLOC and MAXLOC	187
5.9.5	User-Defined Reduction Operations	191
	Example of User-Defined Reduce	194
5.9.6	All-Reduce	195
5.9.7	Process-Local Reduction	197
5.10	Reduce-Scatter	198
5.10.1	MPI_REDUCE_SCATTER_BLOCK	199
5.10.2	MPI_REDUCE_SCATTER	200
5.11	Scan	202
5.11.1	Inclusive Scan	202
5.11.2	Exclusive Scan	203
5.11.3	Example using MPI_SCAN	204
5.12	Nonblocking Collective Operations	205
5.12.1	Nonblocking Barrier Synchronization	207
5.12.2	Nonblocking Broadcast	208

Example using MPI_IBCAST	209
5.12.3 Nonblocking Gather	209
5.12.4 Nonblocking Scatter	211
5.12.5 Nonblocking Gather-to-all	213
5.12.6 Nonblocking All-to-All Scatter/Gather	215
5.12.7 Nonblocking Reduce	218
5.12.8 Nonblocking All-Reduce	219
5.12.9 Nonblocking Reduce-Scatter with Equal Blocks	220
5.12.10 Nonblocking Reduce-Scatter	221
5.12.11 Nonblocking Inclusive Scan	222
5.12.12 Nonblocking Exclusive Scan	223
5.13 Persistent Collective Operations	223
5.13.1 Persistent Barrier Synchronization	225
5.13.2 Persistent Broadcast	225
5.13.3 Persistent Gather	226
5.13.4 Persistent Scatter	229
5.13.5 Persistent Gather-to-all	231
5.13.6 Persistent All-to-All Scatter/Gather	233
5.13.7 Persistent Reduce	236
5.13.8 Persistent All-Reduce	237
5.13.9 Persistent Reduce-Scatter with Equal Blocks	238
5.13.10 Persistent Reduce-Scatter	239
5.13.11 Persistent Inclusive Scan	240
5.13.12 Persistent Exclusive Scan	241
5.14 Correctness	241
<b>6 Groups, Contexts, Communicators, and Caching</b>	<b>251</b>
6.1 Introduction	251
6.1.1 Features Needed to Support Libraries	251
6.1.2 MPI's Support for Libraries	252
6.2 Basic Concepts	254
6.2.1 Groups	254
6.2.2 Contexts	254
6.2.3 Intra-Communicators	255
6.2.4 Predefined Intra-Communicators	255
6.3 Group Management	256
6.3.1 Group Accessors	256
6.3.2 Group Constructors	258
6.3.3 Group Destructors	264
6.4 Communicator Management	265
6.4.1 Communicator Accessors	265
6.4.2 Communicator Constructors	267
6.4.3 Communicator Destructors	280
6.4.4 Communicator Info	281
6.5 Motivating Examples	283
6.5.1 Current Practice #1	283
6.5.2 Current Practice #2	284
6.5.3 (Approximate) Current Practice #3	285



6.5.4	Example #4	286
6.5.5	Library Example #1	286
6.5.6	Library Example #2	288
6.6	Inter-Communication	290
6.6.1	Inter-Communicator Accessors	292
6.6.2	Inter-Communicator Operations	294
6.6.3	Inter-Communication Examples	298
	Example 1: Three-Group “Pipeline”	298
	Example 2: Three-Group “Ring”	299
6.7	Caching	300
6.7.1	Functionality	301
6.7.2	Communicators	302
6.7.3	Windows	308
6.7.4	Datatypes	311
6.7.5	Error Class for Invalid Keyval	315
6.7.6	Attributes Example	315
6.8	Naming Objects	317
6.9	Formalizing the Loosely Synchronous Model	321
6.9.1	Basic Statements	322
6.9.2	Models of Execution	322
	Static Communicator Allocation	322
	Dynamic Communicator Allocation	322
	The General Case	323
<b>7</b>	<b>Process Topologies</b>	<b>325</b>
7.1	Introduction	325
7.2	Virtual Topologies	326
7.3	Embedding in MPI	326
7.4	Overview of the Functions	326
7.5	Topology Constructors	328
7.5.1	Cartesian Constructor	328
7.5.2	Cartesian Convenience Function: MPI_DIMS_CREATE	329
7.5.3	Graph Constructor	330
7.5.4	Distributed Graph Constructor	332
7.5.5	Topology Inquiry Functions	339
7.5.6	Cartesian Shift Coordinates	347
7.5.7	Partitioning of Cartesian Structures	349
7.5.8	Low-Level Topology Functions	349
7.6	Neighborhood Collective Communication	351
7.6.1	Neighborhood Gather	352
7.6.2	Neighbor Alltoall	356
7.7	Nonblocking Neighborhood Communication	361
7.7.1	Nonblocking Neighborhood Gather	362
7.7.2	Nonblocking Neighborhood Alltoall	364
7.8	Persistent Neighborhood Communication	367
7.8.1	Persistent Neighborhood Gather	367
7.8.2	Persistent Neighborhood Alltoall	369
7.9	An Application Example	373

<b>8 MPI Environmental Management</b>	<b>379</b>
8.1 Implementation Information	379
8.1.1 Version Inquiries	379
8.1.2 Environmental Inquiries	381
Tag Values	381
Host Rank	381
IO Rank	382
Clock Synchronization	382
Inquire Processor Name	382
8.2 Memory Allocation	383
8.3 Error Handling	386
8.3.1 Error Handlers for Communicators	389
8.3.2 Error Handlers for Windows	391
8.3.3 Error Handlers for Files	393
8.3.4 Error Handlers for Sessions	394
8.3.5 Freeing Errorhandlers and Retrieving Error Strings	396
8.4 Error Codes and Classes	397
8.5 Error Classes, Error Codes, and Error Handlers	398
8.6 Timers and Synchronization	405
<b>9 The Info Object</b>	<b>407</b>
<b>10 Process Initialization, Creation, and Management</b>	<b>415</b>
10.1 Introduction	415
10.2 The World Model	416
10.2.1 Starting MPI Processes	416
10.2.2 Finalizing MPI	422
10.2.3 Determining Whether MPI Has Been Initialized When Using the World Model	425
10.2.4 Allowing User Functions at MPI Finalization	426
10.3 The Sessions Model	427
10.3.1 Session Creation and Destruction Methods	429
10.3.2 Processes Sets	430
10.3.3 Runtime Query Functions	431
10.3.4 Sessions Model Examples	434
10.4 Common Elements of Both Process Models	440
10.4.1 MPI Functionality that is Always Available	440
10.4.2 Aborting MPI Processes	441
10.5 Portable MPI Process Startup	442
10.6 MPI and Threads	444
10.6.1 General	444
10.6.2 Clarifications	445
10.7 The Dynamic Process Model	447
10.7.1 Starting Processes	448
10.7.2 The Runtime Environment	448
10.8 Process Manager Interface	449
10.8.1 Processes in MPI	449
10.8.2 Starting Processes and Establishing Communication	449

10.8.3	Starting Multiple Executables and Establishing Communication . . .	454
10.8.4	Reserved Keys . . . . .	457
10.8.5	Spawn Example . . . . .	458
	Manager-worker Example Using <code>MPI_COMM_SPAWN</code> . . . . .	458
10.9	Establishing Communication . . . . .	460
10.9.1	Names, Addresses, Ports, and All That . . . . .	460
10.9.2	Server Routines . . . . .	461
10.9.3	Client Routines . . . . .	464
10.9.4	Name Publishing . . . . .	465
10.9.5	Reserved Key Values . . . . .	468
10.9.6	Client/Server Examples . . . . .	468
	Simplest Example — Completely Portable. . . . .	468
	Ocean/Atmosphere — Relies on Name Publishing . . . . .	468
	Simple Client-Server Example . . . . .	469
10.10	Other Functionality . . . . .	470
10.10.1	Universe Size . . . . .	470
10.10.2	Singleton MPI Initialization . . . . .	471
10.10.3	<code>MPI_APPNUM</code> . . . . .	472
10.10.4	Releasing Connections . . . . .	473
10.10.5	Another Way to Establish MPI Communication . . . . .	474
<b>11</b>	<b>One-Sided Communications</b> . . . . .	<b>477</b>
11.1	Introduction . . . . .	477
11.2	Initialization . . . . .	478
11.2.1	Window Creation . . . . .	479
11.2.2	Window That Allocates Memory . . . . .	481
11.2.3	Window That Allocates Shared Memory . . . . .	483
11.2.4	Window of Dynamically Attached Memory . . . . .	486
11.2.5	Window Destruction . . . . .	490
11.2.6	Window Attributes . . . . .	490
11.2.7	Window Info . . . . .	492
11.3	Communication Calls . . . . .	494
11.3.1	Put . . . . .	495
11.3.2	Get . . . . .	497
11.3.3	Examples for Communication Calls . . . . .	498
11.3.4	Accumulate Functions . . . . .	500
	Accumulate Function . . . . .	501
	Get Accumulate Function . . . . .	503
	Fetch and Op Function . . . . .	505
	Compare and Swap Function . . . . .	506
11.3.5	Request-based RMA Communication Operations . . . . .	507
11.4	Memory Model . . . . .	512
11.5	Synchronization Calls . . . . .	514
11.5.1	Fence . . . . .	516
11.5.2	General Active Target Synchronization . . . . .	519
11.5.3	Lock . . . . .	523
11.5.4	Flush and Sync . . . . .	526
11.5.5	Assertions . . . . .	528

11.5.6	Miscellaneous Clarifications . . . . .	530
11.6	Error Handling . . . . .	530
11.6.1	Error Handlers . . . . .	530
11.6.2	Error Classes . . . . .	530
11.7	Semantics and Correctness . . . . .	530
11.7.1	Atomicity . . . . .	539
11.7.2	Ordering . . . . .	539
11.7.3	Progress . . . . .	540
11.7.4	Registers and Compiler Optimizations . . . . .	542
11.8	Examples . . . . .	543
<b>12</b>	<b>External Interfaces</b> . . . . .	<b>553</b>
12.1	Introduction . . . . .	553
12.2	Generalized Requests . . . . .	553
12.2.1	Examples . . . . .	558
12.3	Associating Information with Status . . . . .	560
<b>13</b>	<b>I/O</b> . . . . .	<b>563</b>
13.1	Introduction . . . . .	563
13.1.1	Definitions . . . . .	563
13.2	File Manipulation . . . . .	565
13.2.1	Opening a File . . . . .	565
13.2.2	Closing a File . . . . .	568
13.2.3	Deleting a File . . . . .	568
13.2.4	Resizing a File . . . . .	569
13.2.5	Preallocating Space for a File . . . . .	570
13.2.6	Querying the Size of a File . . . . .	571
13.2.7	Querying File Parameters . . . . .	571
13.2.8	File Info . . . . .	573
Reserved File Hints . . . . .	574	
13.3	File Views . . . . .	576
13.4	Data Access . . . . .	579
13.4.1	Data Access Routines . . . . .	579
Positioning . . . . .	580	
Synchronism . . . . .	580	
Coordination . . . . .	581	
Data Access Conventions . . . . .	581	
13.4.2	Data Access with Explicit Offsets . . . . .	582
13.4.3	Data Access with Individual File Pointers . . . . .	587
13.4.4	Data Access with Shared File Pointers . . . . .	595
Noncollective Operations . . . . .	596	
Collective Operations . . . . .	598	
Seek . . . . .	600	
13.4.5	Split Collective Data Access Routines . . . . .	602
13.5	File Interoperability . . . . .	609
13.5.1	Datatypes for File Interoperability . . . . .	611
13.5.2	External Data Representation: “external32” . . . . .	613
13.5.3	User-Defined Data Representations . . . . .	616

Extent Callback . . . . .	617
Datarep Conversion Functions . . . . .	617
13.5.4 Matching Data Representations . . . . .	619
13.6 Consistency and Semantics . . . . .	620
13.6.1 File Consistency . . . . .	620
13.6.2 Random Access vs. Sequential Files . . . . .	623
13.6.3 Progress . . . . .	624
13.6.4 Collective File Operations . . . . .	624
13.6.5 Nonblocking Collective File Operations . . . . .	624
13.6.6 Type Matching . . . . .	625
13.6.7 Miscellaneous Clarifications . . . . .	625
13.6.8 MPI_Offset Type . . . . .	625
13.6.9 Logical vs. Physical File Layout . . . . .	625
13.6.10 File Size . . . . .	626
13.6.11 Examples . . . . .	626
Asynchronous I/O . . . . .	629
13.7 I/O Error Handling . . . . .	630
13.8 I/O Error Classes . . . . .	631
13.9 Examples . . . . .	631
13.9.1 Double Buffering with Split Collective I/O . . . . .	631
13.9.2 Subarray Filetype Constructor . . . . .	634
<b>14 Tool Support</b> . . . . .	<b>637</b>
14.1 Introduction . . . . .	637
14.2 Profiling Interface . . . . .	637
14.2.1 Requirements . . . . .	637
14.2.2 Discussion . . . . .	638
14.2.3 Logic of the Design . . . . .	638
14.2.4 Miscellaneous Control of Profiling . . . . .	639
14.2.5 Profiler Implementation Example . . . . .	640
14.2.6 MPI Library Implementation Example . . . . .	640
Systems with Weak Symbols . . . . .	640
Systems without Weak Symbols . . . . .	641
14.2.7 Complications . . . . .	641
Multiple Counting . . . . .	641
Linker Oddities . . . . .	642
Fortran Support Methods . . . . .	642
14.2.8 Multiple Levels of Interception . . . . .	642
14.3 The MPI Tool Information Interface . . . . .	643
14.3.1 Verbosity Levels . . . . .	644
14.3.2 Binding MPI Tool Information Interface Variables to MPI Objects . . . . .	644
14.3.3 Convention for Returning Strings . . . . .	645
14.3.4 Initialization and Finalization . . . . .	646
14.3.5 Datatype System . . . . .	647
14.3.6 Control Variables . . . . .	650
Control Variable Query Functions . . . . .	650
Example: Printing All Control Variables . . . . .	653
Handle Allocation and Deallocation . . . . .	654

Control Variable Access Functions . . . . .	655
Example: Reading the Value of a Control Variable . . . . .	656
14.3.7 Performance Variables . . . . .	657
Performance Variable Classes . . . . .	657
Performance Variable Query Functions . . . . .	659
Performance Experiment Sessions . . . . .	662
Handle Allocation and Deallocation . . . . .	662
Starting and Stopping of Performance Variables . . . . .	664
Performance Variable Access Functions . . . . .	665
Example: Tool to Detect Receives with Long Unexpected Message Queues . . . . .	667
14.3.8 Events . . . . .	669
Event Sources . . . . .	669
Callback Safety Requirements . . . . .	671
Event Type Query Functions . . . . .	673
Handle Allocation and Deallocation . . . . .	676
Handling Dropped Events . . . . .	680
Reading Event Data . . . . .	682
Reading Event Meta Data . . . . .	683
14.3.9 Variable Categorization . . . . .	684
Category Query Functions . . . . .	685
Category Member Query Functions . . . . .	687
14.3.10 Return Codes for the MPI Tool Information Interface . . . . .	689
14.3.11 Profiling Interface . . . . .	690
<b>15 Deprecated Interfaces</b> . . . . .	<b>693</b>
15.1 Deprecated since MPI-2.0 . . . . .	693
15.2 Deprecated since MPI-2.2 . . . . .	696
15.3 Deprecated since MPI-3.2 . . . . .	696
15.4 Deprecated since MPI-4.0 . . . . .	696
<b>16 Removed Interfaces</b> . . . . .	<b>699</b>
16.1 Removed MPI-1 Bindings . . . . .	699
16.1.1 Overview . . . . .	699
16.1.2 Removed MPI-1 Functions . . . . .	699
16.1.3 Removed MPI-1 Datatypes . . . . .	699
16.1.4 Removed MPI-1 Constants . . . . .	699
16.1.5 Removed MPI-1 Callback Prototypes . . . . .	700
16.2 C++ Bindings . . . . .	700
<b>17 Backward Incompatibilities</b> . . . . .	<b>701</b>
17.1 Backward Incompatible since MPI-3.2 . . . . .	701
<b>18 Language Bindings</b> . . . . .	<b>703</b>
18.1 Fortran Support . . . . .	703
18.1.1 Overview . . . . .	703
18.1.2 Fortran Support Through the <code>mpi_f08</code> Module . . . . .	704
18.1.3 Fortran Support Through the <code>mpi</code> Module . . . . .	707

18.1.4	Fortran Support Through the <code>mpif.h</code> Include File	709
18.1.5	Interface Specifications, Procedure Names, and the Profiling Interface	710
18.1.6	MPI for Different Fortran Standard Versions	715
18.1.7	Requirements on Fortran Compilers	719
18.1.8	Additional Support for Fortran Register-Memory-Synchronization	720
18.1.9	Additional Support for Fortran Numeric Intrinsic Types	721
	Parameterized Datatypes with Specified Precision and Exponent Range	722
	Support for Size-specific MPI Datatypes	726
	Communication With Size-specific Types	728
18.1.10	Problems With Fortran Bindings for MPI	729
18.1.11	Problems Due to Strong Typing	731
18.1.12	Problems Due to Data Copying and Sequence Association with Subscript Triplets	731
18.1.13	Problems Due to Data Copying and Sequence Association with Vector Subscripts	734
18.1.14	Special Constants	735
18.1.15	Fortran Derived Types	735
18.1.16	Optimization Problems, an Overview	737
18.1.17	Problems with Code Movement and Register Optimization	738
	Nonblocking Operations	738
	Persistent Operations	739
	One-sided Communication	739
	MPI_BOTTOM and Combining Independent Variables in Datatypes	739
	Solutions	740
	The Fortran ASYNCHRONOUS Attribute	740
	Calling MPI_F_SYNC_REG	742
	A User Defined Routine Instead of MPI_F_SYNC_REG	743
	Module Variables and COMMON Blocks	743
	The (Poorly Performing) Fortran VOLATILE Attribute	744
	The Fortran TARGET Attribute	744
18.1.18	Temporary Data Movement and Temporary Memory Modification	744
18.1.19	Permanent Data Movement	746
18.1.20	Comparison with C	746
18.2	Language Interoperability	751
18.2.1	Introduction	751
18.2.2	Assumptions	751
18.2.3	Initialization	751
18.2.4	Transfer of Handles	752
18.2.5	Status	754
18.2.6	MPI Opaque Objects	757
	Datatypes	757
	Callback Functions	758
	Error Handlers	759
	Reduce Operations	759
18.2.7	Attributes	759
18.2.8	Extra-State	763
18.2.9	Constants	763
18.2.10	Interlanguage Communication	764

<b>A</b>	<b>Language Bindings Summary</b>	<b>767</b>
A.1	Defined Values and Handles	767
A.1.1	Defined Constants	767
A.1.2	Types	781
A.1.3	Prototype Definitions	782
C Bindings		782
Fortran 2008 Bindings with the <code>mpi_f08</code> Module		783
Fortran Bindings with <code>mpif.h</code> or the <code>mpi</code> Module		786
A.1.4	Deprecated Prototype Definitions	788
A.1.5	Info Keys	789
A.1.6	Info Values	790
A.2	C Bindings	791
A.2.1	Point-to-Point Communication C Bindings	791
A.2.2	Datatypes C Bindings	793
A.2.3	Collective Communication C Bindings	795
A.2.4	Groups, Contexts, Communicators, and Caching C Bindings	799
A.2.5	Process Topologies C Bindings	802
A.2.6	MPI Environmental Management C Bindings	804
A.2.7	The Info Object C Bindings	805
A.2.8	Process Creation and Management C Bindings	806
A.2.9	One-Sided Communications C Bindings	807
A.2.10	External Interfaces C Bindings	809
A.2.11	I/O C Bindings	809
A.2.12	Language Bindings C Bindings	812
A.2.13	Tools / Profiling Interface C Bindings	813
A.2.14	Tools / MPI Tool Information Interface C Bindings	813
A.2.15	Deprecated C Bindings	816
A.3	Fortran 2008 Bindings with the <code>mpi_f08</code> Module	817
A.3.1	Point-to-Point Communication Fortran 2008 Bindings	817
A.3.2	Datatypes Fortran 2008 Bindings	822
A.3.3	Collective Communication Fortran 2008 Bindings	827
A.3.4	Groups, Contexts, Communicators, and Caching Fortran 2008 Bindings	838
A.3.5	Process Topologies Fortran 2008 Bindings	845
A.3.6	MPI Environmental Management Fortran 2008 Bindings	851
A.3.7	The Info Object Fortran 2008 Bindings	854
A.3.8	Process Creation and Management Fortran 2008 Bindings	855
A.3.9	One-Sided Communications Fortran 2008 Bindings	858
A.3.10	External Interfaces Fortran 2008 Bindings	863
A.3.11	I/O Fortran 2008 Bindings	864
A.3.12	Language Bindings Fortran 2008 Bindings	872
A.3.13	Tools / Profiling Interface Fortran 2008 Bindings	872
A.3.14	Deprecated Fortran 2008 Bindings	872
A.4	Fortran Bindings with <code>mpif.h</code> or the <code>mpi</code> Module	874
A.4.1	Point-to-Point Communication Fortran Bindings	874
A.4.2	Datatypes Fortran Bindings	877
A.4.3	Collective Communication Fortran Bindings	879
A.4.4	Groups, Contexts, Communicators, and Caching Fortran Bindings	885
A.4.5	Process Topologies Fortran Bindings	890



A.4.6	MPI Environmental Management Fortran Bindings . . . . .	893
A.4.7	The Info Object Fortran Bindings . . . . .	895
A.4.8	Process Creation and Management Fortran Bindings . . . . .	896
A.4.9	One-Sided Communications Fortran Bindings . . . . .	898
A.4.10	External Interfaces Fortran Bindings . . . . .	902
A.4.11	I/O Fortran Bindings . . . . .	902
A.4.12	Language Bindings Fortran Bindings . . . . .	907
A.4.13	Tools / Profiling Interface Fortran Bindings . . . . .	907
A.4.14	Deprecated Fortran Bindings . . . . .	907
<b>B</b>	<b>Change-Log</b>	<b>909</b>
B.1	Changes from Version 3.2 to Version 4.0 . . . . .	909
B.1.1	Changes in MPI-4.0 . . . . .	909
B.2	Changes from Version 3.1 to Version 3.2 . . . . .	909
B.2.1	Changes in MPI-3.2 . . . . .	909
B.3	Changes from Version 3.0 to Version 3.1 . . . . .	911
B.3.1	Fixes to Errata in Previous Versions of MPI . . . . .	911
B.3.2	Changes in MPI-3.1 . . . . .	913
B.4	Changes from Version 2.2 to Version 3.0 . . . . .	913
B.4.1	Fixes to Errata in Previous Versions of MPI . . . . .	913
B.4.2	Changes in MPI-3.0 . . . . .	914
B.5	Changes from Version 2.1 to Version 2.2 . . . . .	919
B.6	Changes from Version 2.0 to Version 2.1 . . . . .	922
	<b>Bibliography</b>	<b>927</b>
	<b>General Index</b>	<b>933</b>
	<b>Examples Index</b>	<b>938</b>
	<b>MPI Constant and Predefined Handle Index</b>	<b>941</b>
	<b>MPI Declarations Index</b>	<b>946</b>
	<b>MPI Callback Function Prototype Index</b>	<b>947</b>
	<b>MPI Function Index</b>	<b>948</b>

# List of Figures

5.1	Collective communications, an overview . . . . .	151
5.2	Intercommunicator allgather . . . . .	154
5.3	Intercommunicator reduce-scatter . . . . .	155
5.4	Gather example . . . . .	161
5.5	Gatherv example with strides . . . . .	162
5.6	Gatherv example, 2-dimensional . . . . .	163
5.7	Gatherv example, 2-dimensional, subarrays with different sizes . . . . .	164
5.8	Gatherv example, 2-dimensional, subarrays with different sizes and strides . . . . .	166
5.9	Scatter example . . . . .	171
5.10	Scatterv example with strides . . . . .	171
5.11	Scatterv example with different strides and counts . . . . .	172
5.12	Race conditions with point-to-point and collective communications . . . . .	244
5.13	Overlapping Communicators Example . . . . .	248
6.1	Intercommunicator creation using <code>MPI_COMM_CREATE</code> . . . . .	273
6.2	Intercommunicator construction with <code>MPI_COMM_SPLIT</code> . . . . .	277
6.3	Three-group pipeline . . . . .	298
6.4	Three-group ring . . . . .	299
7.1	Neighborhood gather communication example. . . . .	354
7.2	Set-up of process structure for two-dimensional parallel Poisson solver. . . . .	374
7.3	Communication routine with local data copying and sparse neighborhood all-to-all. . . . .	375
7.4	Communication routine with sparse neighborhood all-to-all-w and without local data copying. . . . .	376
7.5	Two-dimensional parallel Poisson solver with persistent sparse neighborhood all-to-all-w and without local data copying. . . . .	377
10.1	Session handle to communicator . . . . .	428
10.2	Process set examples . . . . .	431
11.1	Schematic description of the public/private window operations in the <code>MPI_WIN_SEPARATE</code> memory model for two overlapping windows. . . . .	513
11.2	Active target communication . . . . .	516
11.3	Active target communication, with weak synchronization . . . . .	517
11.4	Passive target communication . . . . .	518
11.5	Active target communication with several processes . . . . .	521
11.6	Symmetric communication . . . . .	541
11.7	Deadlock situation . . . . .	541

11.8 No deadlock . . . . .	541
13.1 Etypes and filetypes . . . . .	564
13.2 Partitioning a file among parallel processes . . . . .	564
13.3 Displacements . . . . .	577
13.4 Example array file layout . . . . .	634
13.5 Example local array filetype for process 1 . . . . .	634
18.1 Status conversion routines . . . . .	755

DRAFT

# List of Tables

2.1	Deprecated and Removed constructs . . . . .	19
3.1	Predefined MPI datatypes corresponding to Fortran datatypes . . . . .	27
3.2	Predefined MPI datatypes corresponding to C datatypes . . . . .	28
3.3	Predefined MPI datatypes corresponding to both C and Fortran datatypes . . . . .	29
3.4	Predefined MPI datatypes corresponding to C++ datatypes . . . . .	29
4.1	combiner values returned from MPI_TYPE_GET_ENVELOPE . . . . .	123
6.1	MPI_COMM_* Function Behavior (in Inter-Communication Mode) . . . . .	293
8.1	Error classes (Part 1) . . . . .	399
8.2	Error classes (Part 2) . . . . .	400
10.1	List of MPI Functions that can be called at any time within an MPI program, including prior to MPI initialization and following MPI finalization . . . . .	440
11.1	C types of attribute value argument to MPI_WIN_GET_ATTR and MPI_WIN_SET_ATTR. . . . .	491
11.2	Error classes in one-sided communication routines . . . . .	531
13.1	Data access routines . . . . .	579
13.2	“external32” sizes of predefined datatypes . . . . .	614
13.3	“external32” sizes of optional datatypes . . . . .	615
13.4	“external32” sizes of C++ datatypes . . . . .	615
13.5	I/O Error Classes . . . . .	632
14.1	MPI tool information interface verbosity levels . . . . .	645
14.2	Constants to identify associations of variables . . . . .	645
14.3	MPI datatypes that can be used by the MPI tool information interface . . . . .	648
14.4	Scopes for control variables . . . . .	652
14.5	Hierarchy of safety requirement levels for event callback routines. . . . .	672
14.6	List of MPI functions that when called from within a callback function may not return MPI_T_ERR_NOT_ACCESSIBLE. . . . .	673
14.7	Return codes used in functions of the MPI tool information interface . . . . .	691
16.1	Removed MPI-1 functions and their replacements . . . . .	699
16.2	Removed MPI-1 datatypes and their replacements . . . . .	700
16.3	Removed MPI-1 constants . . . . .	700
16.4	Removed MPI-1 callback prototypes and their replacements . . . . .	700

18.1 Specific Fortran procedure names and related calling conventions . . . . . 711  
18.2 Occurrence of Fortran optimization problems . . . . . 737

1  
2  
3  
4  
5  
6  
7  
8  
9  
10  
11  
12  
13  
14  
15  
16  
17  
18  
19  
20  
21  
22  
23  
24  
25  
26  
27  
28  
29  
30  
31  
32  
33  
34  
35  
36  
37  
38  
39  
40  
41  
42  
43  
44  
45  
46  
47  
48

DRAFT

# Acknowledgments

This document is the product of a number of distinct efforts in four distinct phases: one for each of MPI-1, MPI-2, MPI-3, and MPI-4. This section describes these in historical order, starting with MPI-1. Some efforts, particularly parts of MPI-2, had distinct groups of individuals associated with them, and these efforts are detailed separately.

This document represents the work of many people who have served on the MPI Forum. The meetings have been attended by dozens of people from many parts of the world. It is the hard and dedicated work of this group that has led to the MPI standard.

The technical development was carried out by subgroups, whose work was reviewed by the full committee. During the period of development of the Message-Passing Interface (MPI), many people helped with this effort.

Those who served as primary coordinators in MPI-1.0 and MPI-1.1 are:

- Jack Dongarra, David Walker, Conveners and Meeting Chairs
- Ewing Lusk, Bob Knighten, Minutes
- Marc Snir, William Gropp, Ewing Lusk, Point-to-Point Communication
- Al Geist, Marc Snir, Steve Otto, Collective Communication
- Steve Otto, Editor
- Rolf Hempel, Process Topologies
- Ewing Lusk, Language Binding
- William Gropp, Environmental Management
- James Cownie, Profiling
- Tony Skjellum, Lyndon Clarke, Marc Snir, Richard Littlefield, Mark Sears, Groups, Contexts, and Communicators
- Steven Huss-Lederman, Initial Implementation Subset

The following list includes some of the active participants in the MPI-1.0 and MPI-1.1 process not mentioned above.

Ed Anderson	Robert Babb	Joe Baron	Eric Barszcz	1
Scott Berryman	Rob Bjornson	Nathan Doss	Anne Elster	2
Jim Feeney	Vince Fernando	Sam Fineberg	Jon Flower	3
Daniel Frye	Ian Glendinning	Adam Greenberg	Robert Harrison	4
Leslie Hart	Tom Haupt	Don Heller	Tom Henderson	5
Alex Ho	C.T. Howard Ho	Gary Howell	John Kapenga	6
James Kohl	Susan Krauss	Bob Leary	Arthur Maccabe	7
Peter Madams	Alan Mainwaring	Oliver McBryan	Phil McKinley	8
Charles Mosher	Dan Nessett	Peter Pacheco	Howard Palmer	9
Paul Pierce	Sanjay Ranka	Peter Rigsbee	Arch Robison	10
Erich Schikuta	Ambuj Singh	Alan Sussman	Robert Tomlinson	11
Robert G. Voigt	Dennis Weeks	Stephen Wheat	Steve Zenith	12

The University of Tennessee and Oak Ridge National Laboratory made the draft available by anonymous FTP mail servers and were instrumental in distributing the document.

The work on the MPI-1 standard was supported in part by ARPA and NSF under grant ASC-9310330, the National Science Foundation Science and Technology Center Cooperative Agreement No. CCR-8809615, and by the Commission of the European Community through Esprit project P6643 (PPPE).

#### MPI-1.2 and MPI-2.0:

Those who served as primary coordinators in MPI-1.2 and MPI-2.0 are:

- Ewing Lusk, Convener and Meeting Chair
- Steve Huss-Lederman, Editor
- Ewing Lusk, Miscellany
- Bill Saphir, Process Creation and Management
- Marc Snir, One-Sided Communications
- Bill Gropp and Anthony Skjellum, Extended Collective Operations
- Steve Huss-Lederman, External Interfaces
- Bill Nitzberg, I/O
- Andrew Lumsdaine, Bill Saphir, and Jeff Squyres, Language Bindings
- Anthony Skjellum and Arkady Kanevsky, Real-Time

The following list includes some of the active participants who attended MPI-2 Forum meetings and are not mentioned above.

1	Greg Astfalk	Robert Babb	Ed Benson	Rajesh Bordawekar
2	Pete Bradley	Peter Brennan	Ron Brightwell	Maciej Brodowicz
3	Eric Brunner	Greg Burns	Margaret Cahir	Pang Chen
4	Ying Chen	Albert Cheng	Yong Cho	Joel Clark
5	Lyndon Clarke	Laurie Costello	Dennis Cottel	Jim Cownie
6	Zhenqian Cui	Suresh Damodaran-Kamal		Raja Daoud
7	Judith Devaney	David DiNucci	Doug Doefler	Jack Dongarra
8	Terry Dontje	Nathan Doss	Anne Elster	Mark Fallon
9	Karl Feind	Sam Fineberg	Craig Fischberg	Stephen Fleischman
10	Ian Foster	Hubertus Franke	Richard Frost	Al Geist
11	Robert George	David Greenberg	John Hagedorn	Kei Harada
12	Leslie Hart	Shane Hebert	Rolf Hempel	Tom Henderson
13	Alex Ho	Hans-Christian Hoppe	Joefon Jann	Terry Jones
14	Karl Kesselman	Koichi Konishi	Susan Kraus	Steve Kubica
15	Steve Landherr	Mario Lauria	Mark Law	Juan Leon
16	Lloyd Lewins	Ziyang Lu	Bob Madahar	Peter Madams
17	John May	Oliver McBryan	Brian McCandless	Tyce McLarty
18	Thom McMahon	Harish Nag	Nick Nevin	Jarek Nieplocha
19	Ron Oldfield	Peter Ossadnik	Steve Otto	Peter Pacheco
20	Yoonho Park	Perry Partow	Pratap Pattnaik	Elsie Pierce
21	Paul Pierce	Heidi Poxon	Jean-Pierre Prost	Boris Protopopov
22	James Pruyve	Rolf Rabenseifner	Joe Rieken	Peter Rigsbee
23	Tom Robey	Anna Rounbehler	Nobutoshi Sagawa	Arindam Saha
24	Eric Salo	Darren Sanders	Eric Sharakan	Andrew Sherman
25	Fred Shirley	Lance Shuler	A. Gordon Smith	Ian Stockdale
26	David Taylor	Stephen Taylor	Greg Tensa	Rajeev Thakur
27	Marydell Tholburn	Dick Treumann	Simon Tsang	Manuel Ujaldon
28	David Walker	Jerrell Watts	Klaus Wolf	Parkson Wong
29	Dave Wright			

30  
31 The MPI Forum also acknowledges and appreciates the valuable input from people via  
32 e-mail and in person.

33 The following institutions supported the MPI-2 effort through time and travel support  
34 for the people listed above.

- 35 Argonne National Laboratory
- 36 Bolt, Beranek, and Newman
- 37 California Institute of Technology
- 38 Center for Computing Sciences
- 39 Convex Computer Corporation
- 40 Cray Research
- 41 Digital Equipment Corporation
- 42 Dolphin Interconnect Solutions, Inc.
- 43 Edinburgh Parallel Computing Centre
- 44 General Electric Company
- 45 German National Research Center for Information Technology
- 46 Hewlett-Packard
- 47 Hitachi
- 48 Hughes Aircraft Company



Intel Corporation	1
International Business Machines	2
Khoral Research	3
Lawrence Livermore National Laboratory	4
Los Alamos National Laboratory	5
MPI Software Technology, Inc.	6
Mississippi State University	7
NEC Corporation	8
National Aeronautics and Space Administration	9
National Energy Research Scientific Computing Center	10
National Institute of Standards and Technology	11
National Oceanic and Atmospheric Administration	12
Oak Ridge National Laboratory	13
The Ohio State University	14
PALLAS GmbH	15
Pacific Northwest National Laboratory	16
Pratt & Whitney	17
San Diego Supercomputer Center	18
Sanders, A Lockheed-Martin Company	19
Sandia National Laboratories	20
Schlumberger	21
Scientific Computing Associates, Inc.	22
Silicon Graphics Incorporated	23
Sky Computers	24
Sun Microsystems Computer Corporation	25
Syracuse University	26
The MITRE Corporation	27
Thinking Machines Corporation	28
United States Navy	29
University of Colorado	30
University of Denver	31
University of Houston	32
University of Illinois	33
University of Maryland	34
University of Notre Dame	35
University of San Francisco	36
University of Stuttgart Computing Center	37
University of Wisconsin	38

MPI-2 operated on a very tight budget (in reality, it had no budget when the first meeting was announced). Many institutions helped the MPI-2 effort by supporting the efforts and travel of the members of the MPI Forum. Direct support was given by NSF and DARPA under NSF contract CDA-9115428 for travel by U.S. academic participants and Esprit under project HPC Standards (21111) for European participants.

1 MPI-1.3 and MPI-2.1:

2 The editors and organizers of the combined documents have been:

- 3
- 4 • Richard Graham, Convener and Meeting Chair
  - 5
  - 6 • Jack Dongarra, Steering Committee
  - 7
  - 8 • Al Geist, Steering Committee
  - 9
  - 10 • Bill Gropp, Steering Committee
  - 11
  - 12 • Rainer Keller, Merge of MPI-1.3
  - 13
  - 14 • Andrew Lumsdaine, Steering Committee
  - 15
  - 16 • Ewing Lusk, Steering Committee, MPI-1.1-Errata (Oct. 12, 1998) MPI-2.1-Errata
  - 17 Ballots 1, 2 (May 15, 2002)
  - 18
  - 19 • Rolf Rabenseifner, Steering Committee, Merge of MPI-2.1 and MPI-2.1-Errata Ballots
  - 20 3, 4 (2008)

21 All chapters have been revisited to achieve a consistent MPI-2.1 text. Those who served  
22 as authors for the necessary modifications are:

- 23 • Bill Gropp, Front matter, Introduction, and Bibliography
- 24
- 25 • Richard Graham, Point-to-Point Communication
- 26
- 27 • Adam Moody, Collective Communication
- 28
- 29 • Richard Treumann, Groups, Contexts, and Communicators
- 30
- 31 • Jesper Larsson Träff, Process Topologies, Info-Object, and One-Sided Communica-
- 32 tions
- 33
- 34 • George Bosilca, Environmental Management
- 35
- 36 • David Solt, Process Creation and Management
- 37
- 38 • Bronis R. de Supinski, External Interfaces, and Profiling
- 39
- 40 • Rajeev Thakur, I/O
- 41
- 42 • Jeffrey M. Squyres, Language Bindings and MPI-2.1 Secretary
- 43
- 44 • Rolf Rabenseifner, Deprecated Functions and Annex Change-Log
- 45
- 46 • Alexander Supalov and Denis Nagorny, Annex Language Bindings

47 The following list includes some of the active participants who attended MPI-2 Forum  
48 meetings and in the e-mail discussions of the errata items and are not mentioned above.

Pavan Balaji	Purushotham V. Bangalore	Brian Barrett	1
Richard Barrett	Christian Bell	Robert Blackmore	2
Gil Bloch	Ron Brightwell	Jeffrey Brown	3
Darius Buntinas	Jonathan Carter	Nathan DeBardeleben	4
Terry Dontje	Gabor Dozsa	Edric Ellis	5
Karl Feind	Edgar Gabriel	Patrick Geoffray	6
David Gingold	Dave Goodell	Erez Haba	7
Robert Harrison	Thomas Herauld	Steve Hodson	8
Torsten Hoefler	Joshua Hursey	Yann Kalemkarian	9
Matthew Koop	Quincey Koziol	Sameer Kumar	10
Miron Livny	Kannan Narasimhan	Mark Pagel	11
Avneesh Pant	Steve Poole	Howard Pritchard	12
Craig Rasmussen	Hubert Ritzdorf	Rob Ross	13
Tony Skjellum	Brian Smith	Vinod Tipparaju	14
Jesper Larsson Träff	Keith Underwood		15

The MPI Forum also acknowledges and appreciates the valuable input from people via e-mail and in person.

The following institutions supported the MPI-2 effort through time and travel support for the people listed above.

Argonne National Laboratory	21
Bull	22
Cisco Systems, Inc.	23
Cray Inc.	24
The HDF Group	25
Hewlett-Packard	26
IBM T.J. Watson Research	27
Indiana University	28
Institut National de Recherche en Informatique et Automatique (Inria)	29
Intel Corporation	30
Lawrence Berkeley National Laboratory	31
Lawrence Livermore National Laboratory	32
Los Alamos National Laboratory	33
Mathworks	34
Mellanox Technologies	35
Microsoft	36
Myricom	37
NEC Laboratories Europe, NEC Europe Ltd.	38
Oak Ridge National Laboratory	39
The Ohio State University	40
Pacific Northwest National Laboratory	41
QLogic Corporation	42
Sandia National Laboratories	43
SiCortex	44
Silicon Graphics Incorporated	45
Sun Microsystems, Inc.	46
University of Alabama at Birmingham	47
University of Houston	48

1 University of Illinois at Urbana-Champaign  
2 University of Stuttgart, High Performance Computing Center Stuttgart (HLRS)  
3 University of Tennessee, Knoxville  
4 University of Wisconsin

5  
6 Funding for the MPI Forum meetings was partially supported by award #CCF-0816909  
7 from the National Science Foundation. In addition, the HDF Group provided travel support  
8 for one U.S. academic.

9  
10 **MPI-2.2:**

11 All chapters have been revisited to achieve a consistent MPI-2.2 text. Those who served as  
12 authors for the necessary modifications are:

- 13  
14 • William Gropp, Front matter, Introduction, and Bibliography; MPI-2.2 chair.
- 15  
16 • Richard Graham, Point-to-Point Communication and Datatypes
- 17  
18 • Adam Moody, Collective Communication
- 19  
20 • Torsten Hoefler, Collective Communication and Process Topologies
- 21  
22 • Richard Treumann, Groups, Contexts, and Communicators
- 23  
24 • Jesper Larsson Träff, Process Topologies, Info-Object and One-Sided Communications
- 25  
26 • George Bosilca, Datatypes and Environmental Management
- 27  
28 • David Solt, Process Creation and Management
- 29  
30 • Bronis R. de Supinski, External Interfaces, and Profiling
- 31  
32 • Rajeev Thakur, I/O
- 33  
34 • Jeffrey M. Squyres, Language Bindings and MPI-2.2 Secretary
- 35  
36 • Rolf Rabenseifner, Deprecated Functions, Annex Change-Log, and Annex Language Bindings
- 37  
38 • Alexander Supalov, Annex Language Bindings

39  
40  
41  
42  
43  
44  
45  
46  
47  
48  
The following list includes some of the active participants who attended MPI-2 Forum meetings and in the e-mail discussions of the errata items and are not mentioned above.

Pavan Balaji	Purushotham V. Bangalore	Brian Barrett	1
Richard Barrett	Christian Bell	Robert Blackmore	2
Gil Bloch	Ron Brightwell	Greg Bronevetsky	3
Jeff Brown	Darius Buntinas	Jonathan Carter	4
Nathan DeBardeleben	Terry Dontje	Gabor Dozsa	5
Edric Ellis	Karl Feind	Edgar Gabriel	6
Patrick Geoffray	Johann George	David Gingold	7
David Goodell	Erez Haba	Robert Harrison	8
Thomas Herault	Marc-André Hermanns	Steve Hodson	9
Joshua Hursey	Yutaka Ishikawa	Bin Jia	10
Hideyuki Jitsumoto	Terry Jones	Yann Kalemkarian	11
Ranier Keller	Matthew Koop	Quincey Koziol	12
Manojkumar Krishnan	Sameer Kumar	Miron Livny	13
Andrew Lumsdaine	Miao Luo	Ewing Lusk	14
Timothy I. Mattox	Kannan Narasimhan	Mark Pagel	15
Avneesh Pant	Steve Poole	Howard Pritchard	16
Craig Rasmussen	Hubert Ritzdorf	Rob Ross	17
Martin Schulz	Pavel Shamis	Galen Shipman	18
Christian Siebert	Anthony Skjellum	Brian Smith	19
Naoki Sueyasu	Vinod Tipparaju	Keith Underwood	20
Rolf Vandevaart	Abhinav Vishnu	Weikuan Yu	21

The MPI Forum also acknowledges and appreciates the valuable input from people via e-mail and in person. 23

The following institutions supported the MPI-2.2 effort through time and travel support for the people listed above. 24

Argonne National Laboratory	27
Auburn University	28
Bull	29
Cisco Systems, Inc.	30
Cray Inc.	31
Forschungszentrum Jülich	32
Fujitsu	33
The HDF Group	34
Hewlett-Packard	35
International Business Machines	36
Indiana University	37
Institut National de Recherche en Informatique et Automatique (Inria)	38
Institute for Advanced Science & Engineering Corporation	39
Intel Corporation	40
Lawrence Berkeley National Laboratory	41
Lawrence Livermore National Laboratory	42
Los Alamos National Laboratory	43
Mathworks	44
Mellanox Technologies	45
Microsoft	46
Myricom	47
NEC Corporation	48

1 Oak Ridge National Laboratory  
2 The Ohio State University  
3 Pacific Northwest National Laboratory  
4 QLogic Corporation  
5 RunTime Computing Solutions, LLC  
6 Sandia National Laboratories  
7 SiCortex, Inc.  
8 Silicon Graphics Inc.  
9 Sun Microsystems, Inc.  
10 Tokyo Institute of Technology  
11 University of Alabama at Birmingham  
12 University of Houston  
13 University of Illinois at Urbana-Champaign  
14 University of Stuttgart, High Performance Computing Center Stuttgart (HLRS)  
15 University of Tennessee, Knoxville  
16 University of Tokyo  
17 University of Wisconsin

18 Funding for the MPI Forum meetings was partially supported by awards #CCF-0816909  
19 and #CCF-1144042 from the National Science Foundation. In addition, the HDF Group  
20 provided travel support for one U.S. academic.  
21

## 22 MPI-3.0:

23 MPI-3.0 is a significant effort to extend and modernize the MPI Standard.  
24 The editors and organizers of the MPI-3.0 have been:

- 25 • William Gropp, Steering committee, Front matter, Introduction, Groups, Contexts,  
26 and Communicators, One-Sided Communications, and Bibliography
- 27 • Richard Graham, Steering committee, Point-to-Point Communication, Meeting Con-  
28 vener, and MPI-3.0 chair
- 29 • Torsten Hoefler, Collective Communication, One-Sided Communications, and Process  
30 Topologies
- 31 • George Bosilca, Datatypes and Environmental Management
- 32 • David Solt, Process Creation and Management
- 33 • Bronis R. de Supinski, External Interfaces and Tool Support
- 34 • Rajeev Thakur, I/O and One-Sided Communications
- 35 • Darius Buntinas, Info Object
- 36 • Jeffrey M. Squyres, Language Bindings and MPI-3.0 Secretary
- 37 • Rolf Rabenseifner, Steering committee, Terms and Definitions, and Fortran Bindings,  
38 Deprecated Functions, Annex Change-Log, and Annex Language Bindings
- 39 • Craig Rasmussen, Fortran Bindings

The following list includes some of the active participants who attended MPI-3 Forum meetings or participated in the e-mail discussions and who are not mentioned above.

Tatsuya Abe	Tomoya Adachi	Sadaf Alam
Reinhold Bader	Pavan Balaji	Purushotham V. Bangalore
Brian Barrett	Richard Barrett	Robert Blackmore
Aurelien Bouteiller	Ron Brightwell	Greg Bronevetsky
Jed Brown	Darius Buntinas	Devendar Bureddy
Arno Candel	George Carr	Mohamad Chaarawi
Raghunath Raja Chandrasekar	James Dinan	Terry Dontje
Edgar Gabriel	Balazs Gerofi	Brice Goglin
David Goodell	Manjunath Gorentla	Erez Haba
Jeff Hammond	Thomas Herault	Marc-André Hermanns
Jennifer Herrett-Skjellum	Nathan Hjelm	Atsushi Hori
Joshua Hursey	Marty Itzkowitz	Yutaka Ishikawa
Nysal Jan	Bin Jia	Hideyuki Jitsumoto
Yann Kalemkarian	Krishna Kandalla	Takahiro Kawashima
Chulho Kim	Dries Kimpe	Christof Klausecker
Alice Koniges	Quincey Koziol	Dieter Kranzlmuller
Manojkumar Krishnan	Sameer Kumar	Eric Lantz
Jay Lofstead	Bill Long	Andrew Lumsdaine
Miao Luo	Ewing Lusk	Adam Moody
Nick M. Maclaren	Amith Mamidala	Guillaume Mercier
Scott McMillan	Douglas Miller	Kathryn Mohror
Tim Murray	Tomotake Nakamura	Takeshi Nanri
Steve Oyanagi	Mark Pagel	Swann Perarnau
Sreeram Potluri	Howard Pritchard	Rolf Riesen
Hubert Ritzdorf	Kuninobu Sasaki	Timo Schneider
Martin Schulz	Gilad Shainer	Christian Siebert
Anthony Skjellum	Brian Smith	Marc Snir
Raffaele Giuseppe Solca	Shinji Sumimoto	Alexander Supalov
Sayantan Sur	Masamichi Takagi	Fabian Tillier
Vinod Tipparaju	Jesper Larsson Träff	Richard Treumann
Keith Underwood	Rolf Vandevaart	Anh Vo
Abhinav Vishnu	Min Xie	Enqiang Zhou

The MPI Forum also acknowledges and appreciates the valuable input from people via e-mail and in person.

The MPI Forum also thanks those that provided feedback during the public comment period. In particular, the Forum would like to thank Jeremiah Wilcock for providing detailed comments on the entire draft standard.

The following institutions supported the MPI-3 effort through time and travel support for the people listed above.

Argonne National Laboratory  
Bull  
Cisco Systems, Inc.  
Cray Inc.  
CSCS

1 ETH Zurich  
2 Fujitsu Ltd.  
3 German Research School for Simulation Sciences  
4 The HDF Group  
5 Hewlett-Packard  
6 International Business Machines  
7 IBM India Private Ltd  
8 Indiana University  
9 Institut National de Recherche en Informatique et Automatique (Inria)  
10 Institute for Advanced Science & Engineering Corporation  
11 Intel Corporation  
12 Lawrence Berkeley National Laboratory  
13 Lawrence Livermore National Laboratory  
14 Los Alamos National Laboratory  
15 Mellanox Technologies, Inc.  
16 Microsoft Corporation  
17 NEC Corporation  
18 National Oceanic and Atmospheric Administration, Global Systems Division  
19 NVIDIA Corporation  
20 Oak Ridge National Laboratory  
21 The Ohio State University  
22 Oracle America  
23 Platform Computing  
24 RIKEN AICS  
25 RunTime Computing Solutions, LLC  
26 Sandia National Laboratories  
27 Technical University of Chemnitz  
28 Tokyo Institute of Technology  
29 University of Alabama at Birmingham  
30 University of Chicago  
31 University of Houston  
32 University of Illinois at Urbana-Champaign  
33 University of Stuttgart, High Performance Computing Center Stuttgart (HLRS)  
34 University of Tennessee, Knoxville  
35 University of Tokyo

36 Funding for the MPI Forum meetings was partially supported by awards #CCF-0816909  
37 and #CCF-1144042 from the National Science Foundation. In addition, the HDF Group  
38 and Sandia National Laboratories provided travel support for one U.S. academic each.  
39

#### 40 MPI-3.1:

41 MPI-3.1 is a minor update to the MPI Standard.  
42 The editors and organizers of the MPI-3.1 have been:

- 43 • Martin Schulz, MPI-3.1 chair
- 44 • William Gropp, Steering committee, Front matter, Introduction, One-Sided Commu-  
45 nications, and Bibliography; Overall editor



- Rolf Rabenseifner, Steering committee, Terms and Definitions, and Fortran Bindings, Deprecated Functions, Annex Change-Log, and Annex Language Bindings
- Richard L. Graham, Steering committee, Meeting Convener
- Jeffrey M. Squyres, Language Bindings and MPI-3.1 Secretary
- Daniel Holmes, Point-to-Point Communication
- George Bosilca, Datatypes and Environmental Management
- Torsten Hoefler, Collective Communication and Process Topologies
- Pavan Balaji, Groups, Contexts, and Communicators, and External Interfaces
- Jeff Hammond, The Info Object
- David Solt, Process Creation and Management
- Quincey Koziol, I/O
- Kathryn Mohror, Tool Support
- Rajeev Thakur, One-Sided Communications

The following list includes some of the active participants who attended MPI Forum meetings or participated in the e-mail discussions.

Charles Archer	Pavan Balaji	Purushotham V. Bangalore
Brian Barrett	Wesley Bland	Michael Blocksome
George Bosilca	Aurelien Bouteiller	Devendar Bureddy
Yohann Burette	Mohamad Chaarawi	Alexey Cheptsov
James Dinan	Dmitry Durnov	Thomas Francois
Edgar Gabriel	Todd Gamblin	Balazs Gerofi
Paddy Gillies	David Goodell	Manjunath Gorentla Venkata
Richard L. Graham	Ryan E. Grant	William Gropp
Khaled Hamidouche	Jeff Hammond	Amin Hassani
Marc-André Hermanns	Nathan Hjelm	Torsten Hoefler
Daniel Holmes	Atsushi Hori	Yutaka Ishikawa
Hideyuki Jitsumoto	Jithin Jose	Krishna Kandalla
Christos Kavouklis	Takahiro Kawashima	Chulho Kim
Michael Knobloch	Alice Koniges	Quincey Koziol
Sameer Kumar	Joshua Ladd	Ignacio Laguna
Huiwei Lu	Guillaume Mercier	Kathryn Mohror
Adam Moody	Tomotake Nakamura	Takeshi Nanri
Steve Oyanagi	Antonio J. Pëna	Sreeram Potluri
Howard Pritchard	Rolf Rabenseifner	Nicholas Radcliffe
Ken Raffenetti	Raghunath Raja	Craig Rasmussen
Davide Rossetti	Kento Sato	Martin Schulz
Sangmin Seo	Christian Siebert	Anthony Skjellum
Brian Smith	David Solt	Jeffrey M. Squyres

1 Hari Subramoni Shinji Sumimoto Alexander Supalov  
2 Bronis R. de Supinski Sayantan Sur Masamichi Takagi  
3 Keita Teranishi Rajeev Thakur Fabian Tillier  
4 Yuichi Tsujita Geoffroy Vallée Rolf vandeVaart  
5 Akshay Venkatesh Jerome Vienne Venkat Vishwanath  
6 Anh Vo Huseyin S. Yildiz Junchao Zhang  
7 Xin Zhao

8  
9 The MPI Forum also acknowledges and appreciates the valuable input from people via  
10 e-mail and in person.

11 The following institutions supported the MPI-3.1 effort through time and travel support  
12 for the people listed above.

13 Argonne National Laboratory  
14 Auburn University  
15 Cisco Systems, Inc.  
16 Cray  
17 EPCC, The University of Edinburgh  
18 ETH Zurich  
19 Forschungszentrum Jülich  
20 Fujitsu  
21 German Research School for Simulation Sciences  
22 The HDF Group  
23 International Business Machines  
24 Institut National de Recherche en Informatique et Automatique (Inria)  
25 Intel Corporation  
26 Jülich Aachen Research Alliance, High-Performance Computing (JARA-HPC)  
27 Kyushu University  
28 Lawrence Berkeley National Laboratory  
29 Lawrence Livermore National Laboratory  
30 Lenovo  
31 Los Alamos National Laboratory  
32 Mellanox Technologies, Inc.  
33 Microsoft Corporation  
34 NEC Corporation  
35 NVIDIA Corporation  
36 Oak Ridge National Laboratory  
37 The Ohio State University  
38 RIKEN AICS  
39 Sandia National Laboratories  
40 Texas Advanced Computing Center  
41 Tokyo Institute of Technology  
42 University of Alabama at Birmingham  
43 University of Houston  
44 University of Illinois at Urbana-Champaign  
45 University of Oregon  
46 University of Stuttgart, High Performance Computing Center Stuttgart (HLRS)  
47 University of Tennessee, Knoxville  
48 University of Tokyo

## MPI-4.0:

MPI-4.0 is a major update to the MPI Standard.

The editors and organizers of the MPI-4.0 have been:

- Martin Schulz, MPI-4.0 chair, Info Object
- Wesley Bland, MPI-4.0 Secretary
- William Gropp, Steering committee, Front matter, Introduction, One-Sided Communications, and Bibliography; Overall editor
- Rolf Rabenseifner, Steering committee, Terms and Conventions, Deprecated Functions, Removed Interfaces, Annex Change-Log, and Annex Language Bindings
- Daniel Holmes, Point-to-Point Communication, Sessions
- George Bosilca, Datatypes and Environmental Management
- Torsten Hoeffler, Collective Communication and Process Topologies
- Pavan Balaji, Groups, Contexts, and Communicators, and External Interfaces
- Howard Pritchard, Process Creation and Management
- Anthony Skjellum, I/O
- Kathryn Mohror, Tools
- Puri Bangalore, Language Bindings

As part of the development of MPI-4.0, a number of working groups were established. In some cases, the work for these groups overlapped with multiple chapters. The following describes the major working groups and the leaders of those groups:

**Collective Communication, Topology, Communicators** Torsten Hoeffler, Andrew Lumsdaine, and Anthony Skjellum

**Fault Tolerance** Wesley Bland, Aurélien Bouteiller, and Richard Graham

**Hardware-Topologies** Guillaume Mercier

**Hybrid** Pavan Balaji and Jim Dinan

**Large Counts** Jeff Hammond

**Persistence** Anthony Skjellum

**Point to Point Communication** Richard Graham and Dan Holmes

**Remote Memory Access** William Gropp and Rajeev Thakur

**Semantic Terms** Rolf Rabenseifner and Purushotham Bangalore

**Sessions** Daniel Holmes

**Tools** Kathryn Mohror and Marc-André Hermanns

1 The following list includes some of the active participants who attended MPI Forum  
2 meetings or participated in the e-mail discussions.

3  
4  
5 Julien Adam Abdelhalim Amer Charles Archer  
6 Ammar Ahmad Awan Pavan Balaji Marc Gamell Balmana  
7 Purushotham Bangalore Mohammadreza Bayatpour Jean-Baptiste Besnard  
8 Claudia Blaas-Schenner Wesley Bland Gil Bloch  
9 George Bosilca Aurelien Bouteiller Ben Bratu  
10 Alexander Calvert Nicholas Chaimov Sourav Chakraborty  
11 Steffen Christgau Ching-Hsiang Chu Mikhail Chuvelev  
12 James Clark Carsten Clauss Giuseppe Congiu  
13 Brandon Cook James Custer Anna Daly  
14 Hoang-Vu Dang James Dinan Matthew Dosanjh  
15 Murali Emani Christian Engelmann Noah Evans  
16 Ana Gainaru Esthela Gallardo Balazs Gerofi  
17 Salvatore Di Girolamo Brice Goglin Richard Graham  
18 Ryan Grant Stanley Graves William Gropp  
19 Siegmar Gross Taylor Groves Yanfei Guo  
20 Khaled Hamidouche Jeff Hammond Marc-André Hermanns  
21 Nathan Hjelm Torsten Hoefler Daniel Holmes  
22 Atsushi Hori Josh Hursey Ilya Ivanov  
23 Julien Jaeger Emmanuel Jeannot Sylvain Jeaugey  
24 Jithin Jose Krishna Kandalla Takahiro Kawashima  
25 Chulho Kim Michael Knobloch Alice Koniges  
26 Sameer Kumar Kim Kyunghun Ignacio Laguna  
27 Stefan Lankes Tonglin Li Xioyi Lu  
28 Kavitha Madhu Alexey Malhanov Ryan Marshall  
29 William Marts Guillaume Mercier Kathryn Mohror  
30 Takeshi Nanri Thomas Naughton Takafumi Nose  
31 Lena Oden Steve Oyanagi Guillaume Papauré  
32 Ivy Peng Ignacio Laguna Peralta Antonio Peña  
33 Simon Pickartz Artem Polyakov Sreeram Potluri  
34 Howard Pritchard Martina Prugger Marc Pérache  
35 Rolf Rabenseifner Nicholas Radcliffe Ken Raffenetti  
36 Craig Rasmussen Soren Rasmussen Hubert Ritzdorf  
37 Sergio Rivas-Gomez Davide Rossetti Martin Ruefenacht  
38 Amit Ruhela Joseph Schuchart Martin Schulz  
39 Sangmin Seo Sameh Sharkawi Sameer Shende  
40 Min Si Anthony Skjellum Brian Smith  
41 David Solt Jeff Squyres Srinivas Sridharan  
42 Hari Subramoni Nawrin Sultana Shinji Sumimoto  
43 Sayantan Sur Hugo Taboada Keita Teranishi  
44 Rajeev Thakur Keith Underwood Isaias Alberto Compres Urena  
45 Geoffroy Vallee Manjunath Gorentla Venkata Akshay Venkatesh  
46  
47  
48

Jerome Vienne Anh Vo Justin Wozniak  
Junchao Zhang Dong Zhong Hui Zhou

1  
2  
3  
4  
5  
6  
7  
8  
9  
10  
11  
12  
13  
14  
15  
16  
17  
18  
19  
20  
21  
22  
23  
24  
25  
26  
27  
28  
29  
30  
31  
32  
33  
34  
35  
36  
37  
38  
39  
40  
41  
42  
43  
44  
45  
46  
47  
48

The MPI Forum also acknowledges and appreciates the valuable input from people via e-mail and in person.

The following institutions supported the MPI-4.0 effort through time and travel support for the people listed above.

- ATOS/BULL
- Argonne National Laboratory
- Arm
- Auburn University
- Barcelona Supercomputing Center
- CEA
- Cisco Systems Inc.
- Cray Inc.
- EPCC, The University Of Edinburgh
- ETH Zrich
- Forschungszentrum Jülich
- Fujitsu
- Fulda University of Applied Sciences
- German Research School for Simulation Sciences
- Hewlett Packard Enterprise
- International Business Machines
- Institut National de Recherche en Informatique et Automatique (Inria)
- Intel Corporation
- Jülich Aachen Research Alliance, High-Performance Computing (JARA-HPC)
- Jülich Supercomputing Center
- KTH Royal Institute Of Technology
- Kyushu University
- Lawrence Berkeley National Laboratory
- Lawrence Livermore National Laboratory
- Lenovo
- Los Alamos National Laboratory
- Mellanox Technologies, Inc.
- Microsoft Corporation
- NEC Corporation
- NVIDIA Corporation
- Oak Ridge National Laboratory
- PAR-TEC
- Paratools, Inc.
- RIKEN AICS (R-CCS as of 2017)
- RWTH Aachen University
- Rutgers University
- Sandia National Laboratories
- Silicon Graphics, Inc.
- VSC Research Center, TU Wien

1 Technical University Of Munich  
2 The HDF Group  
3 The Ohio State University  
4 Texas Advanced Computing Center  
5 Tokyo Institute of Technology  
6 University of Alabama at Birmingham  
7 University of Houston  
8 University of Illinois at Urbana-Champaign and the National Center for Supercomputing Applications  
9  
10 University of Innsbruck  
11 University of Oregon  
12 University of Pottsdam  
13 University of Stuttgart, High Performance Computing Center Stuttgart (HLRS)  
14 University of Tennessee, Chattanooga  
15 University of Tennessee, Knoxville  
16 University of Texas at El Paso  
17 University of Tokyo



18  
19  
20  
21  
22  
23  
24  
25  
26  
27  
28  
29  
30  
31  
32  
33  
34  
35  
36  
37  
38  
39  
40  
41  
42  
43  
44  
45  
46  
47  
48

1  
2  
3  
4  
5  
6  
7  
8  
9  
10  
11  
12  
13  
14  
15  
16  
17  
18  
19  
20  
21  
22  
23  
24  
25  
26  
27  
28  
29  
30  
31  
32  
33  
34  
35  
36  
37  
38  
39  
40  
41  
42  
43  
44  
45  
46  
47  
48

# Chapter 1

## Introduction to MPI

### 1.1 Overview and Goals

MPI (Message-Passing Interface) is a *message-passing library interface specification*. All parts of this definition are significant. MPI addresses primarily the message-passing parallel programming model, in which data is moved from the address space of one process to that of another process through cooperative operations on each process. Extensions to the “classical” message-passing model are provided in collective operations, remote-memory access operations, dynamic process creation, and parallel I/O. MPI is a *specification*, not an implementation; there are multiple implementations of MPI. This specification is for a *library interface*; MPI is not a language, and all MPI operations are expressed as functions, subroutines, or methods, according to the appropriate language bindings which, for C and Fortran, are part of the MPI standard. The standard has been defined through an open process by a community of parallel computing vendors, computer scientists, and application developers. The next few sections provide an overview of the history of MPI’s development.

The main advantages of establishing a message-passing standard are portability and ease of use. In a distributed memory communication environment in which the higher level routines and/or abstractions are built upon lower level message-passing routines the benefits of standardization are particularly apparent. Furthermore, the definition of a message-passing standard, such as that proposed here, provides vendors with a clearly defined base set of routines that they can implement efficiently, or in some cases for which they can provide hardware support, thereby enhancing scalability.

The goal of the Message-Passing Interface simply stated is to develop a widely used standard for writing message-passing programs. As such the interface should establish a practical, portable, efficient, and flexible standard for message passing.

A complete list of goals follows.

- Design an application programming interface (not necessarily for compilers or a system implementation library).
- Allow efficient communication: Avoid memory-to-memory copying, allow overlap of computation and communication, and offload to communication co-processors, where available.
- Allow for implementations that can be used in a heterogeneous environment.
- Allow convenient C and Fortran bindings for the interface.

- 1 • Assume a reliable communication interface: the user need not cope with commu-  
2 cation failures. Such failures are dealt with by the underlying communication subsystem.
- 3
- 4 • Define an interface that can be implemented on many vendor’s platforms, with no  
5 significant changes in the underlying communication and system software.
- 6
- 7 • Semantics of the interface should be language independent.
- 8
- 9 • The interface should be designed to allow for thread safety.

## 10 1.2 Background of MPI-1.0

12 MPI sought to make use of the most attractive features of a number of existing message-  
13 passing systems, rather than selecting one of them and adopting it as the standard. Thus,  
14 MPI was strongly influenced by work at the IBM T. J. Watson Research Center [2, 3], Intel’s  
15 NX/2 [53], Express [14], nCUBE’s Vertex [49], p4 [9, 10], and PARMACS [6, 11]. Other  
16 important contributions have come from Zipcode [56, 57], Chimp [20, 21], PVM [5, 18],  
17 Chameleon [28], and PICL [26].

18 The MPI standardization effort involved about 60 people from 40 organizations mainly  
19 from the United States and Europe. Most of the major vendors of concurrent computers  
20 were involved in MPI, along with researchers from universities, government laboratories, and  
21 industry. The standardization process began with the Workshop on Standards for Message-  
22 Passing in a Distributed Memory Environment, sponsored by the Center for Research on  
23 Parallel Computing, held April 29–30, 1992, in Williamsburg, Virginia [64]. At this work-  
24 shop the basic features essential to a standard message-passing interface were discussed,  
25 and a working group established to continue the standardization process.

26 A preliminary draft proposal, known as MPI-1, was put forward by Dongarra, Hempel,  
27 Hey, and Walker in November 1992, and a revised version was completed in February  
28 1993 [19]. MPI-1 embodied the main features that were identified at the Williamsburg  
29 workshop as being necessary in a message passing standard. Since MPI-1 was primarily  
30 intended to promote discussion and “get the ball rolling,” it focused mainly on point-to-point  
31 communications. MPI-1 brought to the forefront a number of important standardization  
32 issues, but did not include any collective communication routines and was not thread-safe.

33 In November 1992, a meeting of the MPI working group was held in Minneapolis, at  
34 which it was decided to place the standardization process on a more formal footing, and to  
35 generally adopt the procedures and organization of the High Performance Fortran Forum.  
36 Subcommittees were formed for the major component areas of the standard, and an email  
37 discussion service established for each. In addition, the goal of producing a draft MPI  
38 standard by the Fall of 1993 was set. To achieve this goal the MPI working group met every  
39 6 weeks for two days throughout the first 9 months of 1993, and presented the draft MPI  
40 standard at the Supercomputing 93 conference in November 1993. These meetings and the  
41 email discussion together constituted the MPI Forum, membership of which has been open  
42 to all members of the high performance computing community.

## 44 1.3 Background of MPI-1.1, MPI-1.2, and MPI-2.0

46 Beginning in March 1995, the MPI Forum began meeting to consider corrections and exten-  
47 sions to the original MPI Standard document [23]. The first product of these deliberations  
48



was Version 1.1 of the MPI specification, released in June of 1995 [24] (see <http://www.mpi-forum.org> for official MPI document releases). At that time, effort focused in five areas.

1. Further corrections and clarifications for the MPI-1.1 document.
2. Additions to MPI-1.1 that do not significantly change its types of functionality (new datatype constructors, language interoperability, etc.).
3. Completely new types of functionality (dynamic processes, one-sided communication, parallel I/O, etc.) that are what everyone thinks of as “MPI-2 functionality.”
4. Bindings for Fortran 90 and C++. MPI-2 specifies C++ bindings for both MPI-1 and MPI-2 functions, and extensions to the Fortran 77 binding of MPI-1 and MPI-2 to handle Fortran 90 issues.
5. Discussions of areas in which the MPI process and framework seem likely to be useful, but where more discussion and experience are needed before standardization (e.g., zero-copy semantics on shared-memory machines, real-time specifications).

Corrections and clarifications (items of type 1 in the above list) were collected in Chapter 3 of the MPI-2 document: “Version 1.2 of MPI.” That chapter also contains the function for identifying the version number. Additions to MPI-1.1 (items of types 2, 3, and 4 in the above list) are in the remaining chapters of the MPI-2 document, and constitute the specification for MPI-2. Items of type 5 in the above list have been moved to a separate document, the “MPI Journal of Development” (JOD), and are not part of the MPI-2 Standard.

This structure makes it easy for users and implementors to understand what level of MPI compliance a given implementation has:

- MPI-1 compliance will mean compliance with MPI-1.3. This is a useful level of compliance. It means that the implementation conforms to the clarifications of MPI-1.1 function behavior given in Chapter 3 of the MPI-2 document. Some implementations may require changes to be MPI-1 compliant.
- MPI-2 compliance will mean compliance with all of MPI-2.1.
- The MPI Journal of Development is not part of the MPI Standard.

It is to be emphasized that forward compatibility is preserved. That is, a valid MPI-1.1 program is both a valid MPI-1.3 program and a valid MPI-2.1 program, and a valid MPI-1.3 program is a valid MPI-2.1 program.

## 1.4 Background of MPI-1.3 and MPI-2.1

After the release of MPI-2.0, the MPI Forum kept working on errata and clarifications for both standard documents (MPI-1.1 and MPI-2.0). The short document “Errata for MPI-1.1” was released October 12, 1998. On July 5, 2001, a first ballot of errata and clarifications for MPI-2.0 was released, and a second ballot was voted on May 22, 2002. Both votes were done electronically. Both ballots were combined into one document: “Errata for MPI-2,” May 15, 2002. This errata process was then interrupted, but the Forum and its e-mail reflectors kept working on new requests for clarification.

1 Restarting regular work of the MPI Forum was initiated in three meetings, at Eu-  
2 roPVM/MPI'06 in Bonn, at EuroPVM/MPI'07 in Paris, and at SC'07 in Reno. In De-  
3 cember 2007, a steering committee started the organization of new MPI Forum meetings at  
4 regular 8-weeks intervals. At the January 14–16, 2008 meeting in Chicago, the MPI Forum  
5 decided to combine the existing and future MPI documents to one document for each ver-  
6 sion of the MPI standard. For technical and historical reasons, this series was started with  
7 MPI-1.3. Additional Ballots 3 and 4 solved old questions from the errata list started in 1995  
8 up to new questions from the last years. After all documents (MPI-1.1, MPI-2, Errata for  
9 MPI-1.1 (Oct. 12, 1998), and MPI-2.1 Ballots 1–4) were combined into one draft document,  
10 for each chapter, a chapter author and review team were defined. They cleaned up the  
11 document to achieve a consistent MPI-2.1 document. The final MPI-2.1 standard document  
12 was finished in June 2008, and finally released with a second vote in September 2008 in  
13 the meeting at Dublin, just before EuroPVM/MPI'08. The major work of the current MPI  
14 Forum is the preparation of MPI-3.

## 15 16 1.5 Background of MPI-2.2

17  
18 MPI-2.2 is a minor update to the MPI-2.1 standard. This version addresses additional errors  
19 and ambiguities that were not corrected in the MPI-2.1 standard as well as a small number  
20 of extensions to MPI-2.1 that met the following criteria:

- 21  
22 • Any correct MPI-2.1 program is a correct MPI-2.2 program.
- 23  
24 • Any extension must have significant benefit for users.
- 25  
26 • Any extension must not require significant implementation effort. To that end, all  
27 such changes are accompanied by an open source implementation.

28 The discussions of MPI-2.2 proceeded concurrently with the MPI-3 discussions; in some  
29 cases, extensions were proposed for MPI-2.2 but were later moved to MPI-3.

## 30 31 1.6 Background of MPI-3.0

32  
33 MPI-3.0 is a major update to the MPI standard. The updates include the extension of  
34 collective operations to include nonblocking versions, extensions to the one-sided operations,  
35 and a new Fortran 2008 binding. In addition, the deprecated C++ bindings have been  
36 removed, as well as many of the deprecated routines and MPI objects (such as the MPI\_UB  
37 datatype).

## 38 39 1.7 Background of MPI-3.1

40  
41 MPI-3.1 is a minor update to the MPI standard. Most of the updates are corrections  
42 and clarifications to the standard, especially for the Fortran bindings. New functions added  
43 include routines to manipulate MPI\_Aint values in a portable manner, nonblocking collective  
44 I/O routines, and routines to get the index value by name for MPI\_T performance and  
45 control variables. A general index was also added.

## 1.8 Background of 2019 Draft Specification

The 2019 draft specification is expected to become the MPI-4.0 specification once all features have been merged. MPI-4.0 is a major update to the MPI standard. This update includes a number of new features which will be present in the final MPI-4.0 document. The largest changes are the addition of persistent collectives, application info assertions, and improvements to the definitions of error handling. In addition, there are a number of smaller improvements and corrections.

## 1.9 Who Should Use This Standard?

This standard is intended for use by all those who want to write portable message-passing programs in Fortran and C (and access the C bindings from C++). This includes individual application programmers, developers of software designed to run on parallel machines, and creators of environments and tools. In order to be attractive to this wide audience, the standard must provide a simple, easy-to-use interface for the basic user while not semantically precluding the high-performance message-passing operations available on advanced machines.

## 1.10 What Platforms Are Targets for Implementation?

The attractiveness of the message-passing paradigm at least partially stems from its wide portability. Programs expressed this way may run on distributed-memory multiprocessors, networks of workstations, and combinations of all of these. In addition, shared-memory implementations, including those for multi-core processors and hybrid architectures, are possible. The paradigm will not be made obsolete by architectures combining the shared- and distributed-memory views, or by increases in network speeds. It thus should be both possible and useful to implement this standard on a great variety of machines, including those “machines” consisting of collections of other machines, parallel or not, connected by a communication network.

The interface is suitable for use by fully general MIMD programs, as well as those written in the more restricted style of SPMD. MPI provides many features intended to improve performance on scalable parallel computers with specialized interprocessor communication hardware. Thus, we expect that native, high-performance implementations of MPI will be provided on such machines. At the same time, implementations of MPI on top of standard Unix interprocessor communication protocols will provide portability to workstation clusters and heterogenous networks of workstations.

## 1.11 What Is Included in the Standard?

The standard includes:

- Point-to-point communication,
- Datatypes,
- Collective operations,

- 1 • Process groups,
- 2
- 3 • Communication contexts,
- 4
- 5 • Process topologies,
- 6
- 7 • Environmental management and inquiry,
- 8
- 9 • The Info object,
- 10
- 11 • Process creation and management,
- 12
- 13 • One-sided communication,
- 14
- 15 • External interfaces,
- 16
- 17 • Parallel file I/O,
- 18
- 19 • Language bindings for Fortran and C,
- 20
- 21 • Tool support.

## 22 1.12 What Is Not Included in the Standard?

23 The standard does not specify:

- 24 • Operations that require more operating system support than is currently standard;  
25 for example, interrupt-driven receives, remote execution, or active messages,
- 26 • Program construction tools,
- 27
- 28 • Debugging facilities.

29 There are many features that have been considered and not included in this standard.  
30 This happened for a number of reasons, one of which is the time constraint that was self-  
31 imposed in finishing the standard. Features that are not included can always be offered as  
32 extensions by specific implementations. Perhaps future versions of MPI will address some  
33 of these issues.  
34

## 35 1.13 Organization of This Document

36 The following is a list of the remaining chapters in this document, along with a brief  
37 description of each.

- 38 • Chapter 2, [MPI Terms and Conventions](#), explains notational terms and conventions  
39 used throughout the MPI document.
- 40
- 41 • Chapter 3, [Point-to-Point Communication](#), defines the basic, pairwise communication  
42 subset of MPI. *Send* and *receive* are found here, along with many associated functions  
43 designed to make basic communication powerful and efficient.
- 44
- 45 • Chapter 4, [Datatypes](#), defines a method to describe any data layout, e.g., an array of  
46 structures in the memory, which can be used as message send or receive buffer.
- 47
- 48

- Chapter 5, [Collective Communication](#), defines process-group collective communication operations. Well known examples of this are barrier and broadcast over a group of processes (not necessarily all the processes). With MPI-2, the semantics of collective communication was extended to include intercommunicators. It also adds two new collective operations. MPI-3 adds nonblocking collective operations.
- Chapter 6, [Groups, Contexts, Communicators, and Caching](#), shows how groups of processes are formed and manipulated, how unique communication contexts are obtained, and how the two are bound together into a *communicator*.
- Chapter 7, [Process Topologies](#), explains a set of utility functions meant to assist in the mapping of process groups (a linearly ordered set) to richer topological structures such as multi-dimensional grids.
- Chapter 8, [MPI Environmental Management](#), explains how the programmer can manage and make inquiries of the current MPI environment. These functions are needed for the writing of correct, robust programs, and are especially important for the construction of highly-portable message-passing programs.
- Chapter 9, [The Info Object](#), defines an opaque object, that is used as input in several MPI routines.
- Chapter 10, [Process Initialization, Creation, and Management](#), defines routines that allow for creation of processes.
- Chapter 11, [One-Sided Communications](#), defines communication routines that can be completed by a single process. These include shared-memory operations (put/get) and remote accumulate operations.
- Chapter 12, [External Interfaces](#), defines routines designed to allow developers to layer on top of MPI. This includes generalized requests, routines that decode MPI opaque objects, and threads.
- Chapter 13, [I/O](#), defines MPI support for parallel I/O.
- Chapter 14, [Tool Support](#), covers interfaces that allow debuggers, performance analyzers, and other tools to obtain data about the operation of MPI processes. This chapter includes Section 14.2 ([Profiling Interface](#)), which was a chapter in previous versions of MPI.
- Chapter 15, [Deprecated Interfaces](#), describes routines that are kept for reference. However usage of these functions is discouraged, as they may be deleted in future versions of the standard.
- Chapter 16, [Removed Interfaces](#), describes routines and constructs that have been removed from MPI. Some of these were deprecated in MPI-2, and the MPI Forum decided to remove these from the MPI-3 standard. Others of these were deprecated in MPI-3, and the MPI Forum decided to remove these from the MPI-4 standard.
- Chapter 17, [Backward Incompatibilities](#), describes incompatibilities with previous versions of MPI.

- Chapter 18, [Language Bindings](#), discusses Fortran issues, and describes language interoperability aspects between C and Fortran.

The Appendices are:

- Annex A, [Language Bindings Summary](#), gives specific syntax in C and Fortran, for all MPI functions, constants, and types.
- Annex B, [Change-Log](#), summarizes some changes since the previous version of the standard.
- Several Index pages show the locations of examples, constants and predefined handles, callback routine prototypes, and all MPI functions.

MPI provides various interfaces to facilitate interoperability of distinct MPI implementations. Among these are the canonical data representation for MPI I/O and for `MPI_PACK_EXTERNAL` and `MPI_UNPACK_EXTERNAL`. The definition of an actual binding of these interfaces that will enable interoperability is outside the scope of this document.

A separate document consists of ideas that were discussed in the MPI Forum during the MPI-2 development and deemed to have value, but are not included in the MPI Standard. They are part of the “Journal of Development” (JOD), lest good ideas be lost and in order to provide a starting point for further work. The chapters in the JOD are

- Chapter 2, [Spawning Independent Processes](#), includes some elements of dynamic process management, in particular management of processes with which the spawning processes do not intend to communicate, that the Forum discussed at length but ultimately decided not to include in the MPI Standard.
- Chapter 3, [Threads and MPI](#), describes some of the expected interaction between an MPI implementation and a thread library in a multi-threaded environment.
- Chapter 4, [Communicator ID](#), describes an approach to providing identifiers for communicators.
- Chapter 5, [Miscellany](#), discusses Miscellaneous topics in the MPI JOD, in particular single-copy routines for use in shared-memory environments and new datatype constructors.
- Chapter 6, [Toward a Full Fortran 90 Interface](#), describes an approach to providing a more elaborate Fortran 90 interface.
- Chapter 7, [Split Collective Communication](#), describes a specification for certain non-blocking collective operations.
- Chapter 8, [Real-Time MPI](#), discusses MPI support for real time processing.

1  
2  
3  
4  
5  
6  
7  
8  
9  
10  
11  
12  
13  
14  
15  
16  
17  
18  
19  
20  
21  
22  
23  
24  
25  
26  
27  
28  
29  
30  
31  
32  
33  
34  
35  
36  
37  
38  
39  
40  
41  
42  
43  
44  
45  
46  
47  
48

## Chapter 2

# MPI Terms and Conventions

This chapter explains notational terms and conventions used throughout the MPI document, some of the choices that have been made, and the rationale behind those choices.

### 2.1 Document Notation

*Rationale.* Throughout this document, the rationale for the design choices made in the interface specification is set off in this format. Some readers may wish to skip these sections, while readers interested in interface design may want to read them carefully. (*End of rationale.*)

*Advice to users.* Throughout this document, material aimed at users and that illustrates usage is set off in this format. Some readers may wish to skip these sections, while readers interested in programming in MPI may want to read them carefully. (*End of advice to users.*)

*Advice to implementors.* Throughout this document, material that is primarily commentary to implementors is set off in this format. Some readers may wish to skip these sections, while readers interested in MPI implementations may want to read them carefully. (*End of advice to implementors.*)

### 2.2 Naming Conventions

In many cases MPI names for C functions are of the form `MPI_Class_action_subset`. This convention originated with MPI-1. Since MPI-2 an attempt has been made to standardize the names of MPI functions according to the following rules.

1. In C, all routines associated with a particular type of MPI object should be of the form `MPI_Class_action_subset` or, if no subset exists, of the form `MPI_Class_action`. In Fortran, all routines associated with a particular type of MPI object should be of the form `MPI_CLASS_ACTION_SUBSET` or, if no subset exists, of the form `MPI_CLASS_ACTION`.
2. If the routine is not associated with a class, the name should be of the form `MPI_Action_subset` in C and `MPI_ACTION_SUBSET` in Fortran.

- 1       3. The names of certain actions have been standardized. In particular, **Create** creates  
 2       a new object, **Get** retrieves information about an object, **Set** sets this information,  
 3       **Delete** deletes information, **Is** asks whether or not an object has a certain property.

4  
 5       C and Fortran names for some MPI functions (that were defined during the MPI-1  
 6       process) violate these rules in several cases. The most common exceptions are the omission  
 7       of the **Class** name from the routine and the omission of the **Action** where one can be  
 8       inferred.

9       MPI identifiers are limited to 30 characters (31 with the profiling interface). This is  
 10      done to avoid exceeding the limit on some compilation systems.

## 12   2.3 Procedure Specification

13  
 14      MPI procedures are specified using a language-independent notation. The arguments of  
 15      procedure calls are marked as IN, OUT, or INOUT. The meanings of these are:

- 16      • IN: the call may use the input value but does not update the argument from the  
 17        perspective of the caller at any time during the call's execution,
- 18      • OUT: the call may update the argument but does not use its input value,
- 19      • INOUT: the call may both use and update the argument.

20  
 21      There is one special case — if an argument is a handle to an opaque object (these  
 22      terms are defined in Section 2.5.1), and the object is updated by the procedure call, then  
 23      the argument is marked INOUT or OUT. It is marked this way even though the handle itself  
 24      is not modified — we use the INOUT or OUT attribute to denote that what the handle  
 25      references is updated.

26  
 27      *Rationale.* The definition of MPI tries to avoid, to the largest possible extent, the use  
 28      of INOUT arguments, because such use is error-prone, especially for scalar arguments.  
 29      (*End of rationale.*)

30  
 31      MPI's use of IN, OUT, and INOUT is intended to indicate to the user how an argument  
 32      is to be used, but does not provide a rigorous classification that can be translated directly  
 33      into all language bindings (e.g., **INTENT** in Fortran 90 bindings or **const** in C bindings).  
 34      For instance, the “constant” **MPI\_BOTTOM** can usually be passed to OUT buffer arguments.  
 35      Similarly, **MPI\_STATUS\_IGNORE** can be passed as the OUT status argument.

36      A common occurrence for MPI functions is an argument that is used as IN by some pro-  
 37      cesses and OUT by other processes. Such an argument is, syntactically, an INOUT argument  
 38      and is marked as such, although, semantically, it is not used in one call both for input and  
 39      for output on a single process.

40      Another frequent situation arises when an argument value is needed only by a subset  
 41      of the processes. When an argument is not significant at a process then an arbitrary value  
 42      can be passed as an argument.

43      Unless specified otherwise, an argument of type OUT or type INOUT cannot be aliased  
 44      with any other argument passed to an MPI procedure. An example of argument aliasing in  
 45      C appears below. If we define a C procedure like this,



```
void copyIntBuffer(int *pin, int *pout, int len)
{
    int i;
    for (i=0; i<len; ++i) *pout++ = *pin++;
}
```

then a call to it in the following code fragment has aliased arguments.

```
int a[10];
copyIntBuffer(a, a+3, 7);
```

Although the C language allows this, such usage of MPI procedures is forbidden unless otherwise specified. Note that Fortran prohibits aliasing of arguments.

All MPI functions are first specified in the language-independent notation. Immediately below this, language dependent bindings follow:

- The ISO C version of the function.
- The Fortran version used with `USE mpi_f08`.
- The Fortran version of the same function used with `USE mpi` or `INCLUDE 'mpif.h'`.

An exception is Section 14.3 “The MPI Tool Information Interface”, which only provides ISO C interfaces.

“Fortran” in this document refers to Fortran 90 and higher; see Section 2.6.

## 2.4 Semantic Terms

When discussing MPI procedures the following semantic terms are used.

**nonblocking** A procedure is nonblocking if it may return before the associated operation completes, and before the user is allowed to reuse resources (such as buffers) specified in the call. The word complete is used with respect to operations and any associated requests and/or communications. An **operation completes** when the user is allowed to reuse resources, and any output buffers have been updated.

**blocking** A procedure is blocking if return from the procedure indicates the user is allowed to reuse resources specified in the call.

**local** A procedure is local if completion of the procedure depends only on the local executing process.

**non-local** A procedure is non-local if completion of the operation may require the execution of some MPI procedure on another process. Such an operation may require communication occurring with another user process.

**collective** A procedure is collective if all processes in a process group need to invoke the procedure. A collective call may or may not be synchronizing. Collective calls over the same communicator must be executed in the same order by all members of the process group.

1 **predefined** A predefined datatype is a datatype with a predefined (constant) name (such  
2 as `MPI_INT`, `MPI_FLOAT_INT`, or `MPI_PACKED`) or a datatype constructed with  
3 `MPI_TYPE_CREATE_F90_INTEGER`, `MPI_TYPE_CREATE_F90_REAL`, or  
4 `MPI_TYPE_CREATE_F90_COMPLEX`. The former are **named** whereas the latter are  
5 **unnamed**.

6  
7 **derived** A derived datatype is any datatype that is not predefined.

8  
9 **portable** A datatype is portable if it is a predefined datatype, or it is derived from  
10 a portable datatype using only the type constructors `MPI_TYPE_CONTIGUOUS`,  
11 `MPI_TYPE_VECTOR`, `MPI_TYPE_INDEXED`,  
12 `MPI_TYPE_CREATE_INDEXED_BLOCK`, `MPI_TYPE_CREATE_SUBARRAY`,  
13 `MPI_TYPE_DUP`, and `MPI_TYPE_CREATE_DARRAY`. Such a datatype is portable  
14 because all displacements in the datatype are in terms of extents of one predefined  
15 datatype. Therefore, if such a datatype fits a data layout in one memory, it will  
16 fit the corresponding data layout in another memory, if the same declarations were  
17 used, even if the two systems have different architectures. On the other hand, if a  
18 datatype was constructed using `MPI_TYPE_CREATE_HINDEXED`,  
19 `MPI_TYPE_CREATE_HINDEXED_BLOCK`, `MPI_TYPE_CREATE_HVECTOR` or  
20 `MPI_TYPE_CREATE_STRUCT`, then the datatype contains explicit byte displacements  
21 (e.g., providing padding to meet alignment restrictions). These displacements  
22 are unlikely to be chosen correctly if they fit data layout on one memory, but are  
23 used for data layouts on another process, running on a processor with a different  
24 architecture.

25 **equivalent** Two datatypes are equivalent if they appear to have been created with the same  
26 sequence of calls (and arguments) and thus have the same typemap. Two equivalent  
27 datatypes do not necessarily have the same cached attributes or the same names.

## 29 2.5 Data Types

### 30 2.5.1 Opaque Objects

31  
32  
33 MPI manages **system memory** that is used for buffering messages and for storing internal  
34 representations of various MPI objects such as groups, communicators, datatypes, etc. This  
35 memory is not directly accessible to the user, and objects stored there are **opaque**: their  
36 size and shape is not visible to the user. Opaque objects are accessed via **handles**, which  
37 exist in user space. MPI procedures that operate on opaque objects are passed handle  
38 arguments to access these objects. In addition to their use by MPI calls for object access,  
39 handles can participate in assignments and comparisons.

40 In Fortran with `USE mpi` or `INCLUDE 'mpif.h'`, all handles have type `INTEGER`. In  
41 Fortran with `USE mpi_f08`, and in C, a different handle type is defined for each category of  
42 objects. With Fortran `USE mpi_f08`, the handles are defined as Fortran `BIND(C)` derived  
43 types that consist of only one element `INTEGER :: MPI_VAL`. The internal handle value is  
44 identical to the Fortran `INTEGER` value used in the `mpi` module and `mpif.h`. The operators  
45 `.EQ.`, `.NE.`, `==` and `/=` are overloaded to allow the comparison of these handles. The type  
46 names are identical to the names in C, except that they are not case sensitive. For example:

```

TYPE, BIND(C) :: MPI_Comm
  INTEGER      :: MPI_VAL
END TYPE MPI_Comm

```

The C types must support the use of the assignment and equality operators.

*Advice to implementors.* In Fortran, the handle can be an index into a table of opaque objects in a system table; in C it can be such an index or a pointer to the object. (*End of advice to implementors.*)

*Rationale.* Since the Fortran integer values are equivalent, applications can easily convert MPI handles between all three supported Fortran methods. For example, an integer communicator handle `COMM` can be converted directly into an exactly equivalent `mpi_f08` communicator handle named `comm_f08` by `comm_f08%MPI_VAL=COMM`, and vice versa. The use of the `INTEGER` defined handles and the `BIND(C)` derived type handles is different: Fortran 2003 (and later) define that `BIND(C)` derived types can be used within user defined common blocks, but it is up to the rules of the companion C compiler how many numerical storage units are used for these `BIND(C)` derived type handles. Most compilers use one unit for both, the `INTEGER` handles and the handles defined as `BIND(C)` derived types. (*End of rationale.*)

*Advice to users.* If a user wants to substitute `mpif.h` or the `mpi` module by the `mpi_f08` module and the application program stores a handle in a Fortran common block then it is necessary to change the Fortran support method in all application routines that use this common block, because the number of numerical storage units of such a handle can be different in the two modules. (*End of advice to users.*)

Opaque objects are allocated and deallocated by calls that are specific to each object type. These are listed in the sections where the objects are described. The calls accept a handle argument of matching type. In an allocate call this is an OUT argument that returns a valid reference to the object. In a call to deallocate this is an INOUT argument which returns with an “invalid handle” value. MPI provides an “invalid handle” constant for each object type. Comparisons to this constant are used to test for validity of the handle.

A call to a deallocate routine invalidates the handle and marks the object for deallocation. The object is not accessible to the user after the call. However, MPI need not deallocate the object immediately. Any operation pending (at the time of the deallocate) that involves this object will complete normally; the object will be deallocated afterwards.

An opaque object and its handle are significant only at the process where the object was created and cannot be transferred to another process.

MPI provides certain predefined opaque objects and predefined, static handles to these objects. The user must not free such objects.

*Rationale.* This design hides the internal representation used for MPI data structures, thus allowing similar calls in C and Fortran. It also avoids conflicts with the typing rules in these languages, and easily allows future extensions of functionality. The mechanism for opaque objects used here loosely follows the POSIX Fortran binding standard.

The explicit separation of handles in user space and objects in system space allows space-reclaiming and deallocation calls to be made at appropriate points in the user

1 program. If the opaque objects were in user space, one would have to be very careful  
2 not to go out of scope before any pending operation requiring that object completed.  
3 The specified design allows an object to be marked for deallocation, the user program  
4 can then go out of scope, and the object itself still persists until any pending operations  
5 are complete.

6 The requirement that handles support assignment/comparison is made since such op-  
7 erations are common. This restricts the domain of possible implementations. The  
8 alternative in C would have been to allow handles to have been an arbitrary, opaque  
9 type. This would force the introduction of routines to do assignment and compar-  
10 ison, adding complexity, and was therefore ruled out. In Fortran, the handles are  
11 defined such that assignment and comparison are available through the operators of  
12 the language or overloaded versions of these operators. (*End of rationale.*)

13  
14 *Advice to users.* A user may accidentally create a dangling reference by assigning to a  
15 handle the value of another handle, and then deallocating the object associated with  
16 these handles. Conversely, if a handle variable is deallocated before the associated  
17 object is freed, then the object becomes inaccessible (this may occur, for example, if  
18 the handle is a local variable within a subroutine, and the subroutine is exited before  
19 the associated object is deallocated). It is the user's responsibility to avoid adding or  
20 deleting references to opaque objects, except as a result of MPI calls that allocate or  
21 deallocate such objects. (*End of advice to users.*)

22  
23 *Advice to implementors.* The intended semantics of opaque objects is that opaque  
24 objects are separate from one another; each call to allocate such an object copies  
25 all the information required for the object. Implementations may avoid excessive  
26 copying by substituting referencing for copying. For example, a derived datatype  
27 may contain references to its components, rather than copies of its components; a  
28 call to `MPI_COMM_GROUP` may return a reference to the group associated with the  
29 communicator, rather than a copy of this group. In such cases, the implementation  
30 must maintain reference counts, and allocate and deallocate objects in such a way that  
31 the visible effect is as if the objects were copied. (*End of advice to implementors.*)

## 32 33 2.5.2 Array Arguments

34  
35 An MPI call may need an argument that is an array of opaque objects, or an array of  
36 handles. The array-of-handles is a regular array with entries that are handles to objects  
37 of the same type in consecutive locations in the array. Whenever such an array is used,  
38 an additional `len` argument is required to indicate the number of valid entries (unless this  
39 number can be derived otherwise). The valid entries are at the beginning of the array;  
40 `len` indicates how many of them there are, and need not be the size of the entire array.  
41 The same approach is followed for other array arguments. In some cases NULL handles are  
42 considered valid entries. When a NULL argument is desired for an array of statuses, one  
43 uses `MPI_STATUSES_IGNORE`.

## 44 45 2.5.3 State

46  
47 MPI procedures use at various places arguments with *state* types. The values of such a data  
48 type are all identified by names, and no operation is defined on them. For example, the

MPI\_TYPE\_CREATE\_SUBARRAY routine has a state argument order with values MPI\_ORDER\_C and MPI\_ORDER\_FORTRAN.

#### 2.5.4 Named Constants

MPI procedures sometimes assign a special meaning to a special value of a basic type argument; e.g., `tag` is an integer-valued argument of point-to-point communication operations, with a special wild-card value, `MPI_ANY_TAG`. Such arguments will have a range of regular values, which is a proper subrange of the range of values of the corresponding basic type; special values (such as `MPI_ANY_TAG`) will be outside the regular range. The range of regular values, such as `tag`, can be queried using environmental inquiry functions, see Chapter 8. The range of other values, such as `source`, depends on values given by other MPI routines (in the case of `source` it is the communicator size).

MPI also provides predefined named constant handles, such as `MPI_COMM_WORLD`.

All named constants, with the exceptions noted below for Fortran, can be used in initialization expressions or assignments, but not necessarily in array declarations or as labels in C `switch` or Fortran `select/case` statements. This implies named constants to be link-time but not necessarily compile-time constants. The named constants listed below are required to be compile-time constants in both C and Fortran. These constants do not change values during execution. Opaque objects accessed by constant handles are defined and do not change value between MPI initialization (`MPI_INIT`) and MPI completion (`MPI_FINALIZE`). The handles themselves are constants and can be also used in initialization expressions or assignments.

The constants that are required to be compile-time constants (and can thus be used for array length declarations and labels in C `switch` and Fortran `case/select` statements) are:

`MPI_MAX_PROCESSOR_NAME`  
`MPI_MAX_LIBRARY_VERSION_STRING`  
`MPI_MAX_ERROR_STRING`  
`MPI_MAX_DATAREP_STRING`  
`MPI_MAX_INFO_KEY`  
`MPI_MAX_INFO_VAL`  
`MPI_MAX_OBJECT_NAME`  
`MPI_MAX_PORT_NAME`  
`MPI_VERSION`  
`MPI_SUBVERSION`  
`MPI_STATUS_SIZE` (Fortran only)  
`MPI_ADDRESS_KIND` (Fortran only)  
`MPI_COUNT_KIND` (Fortran only)  
`MPI_INTEGER_KIND` (Fortran only)  
`MPI_OFFSET_KIND` (Fortran only)  
`MPI_SUBARRAYS_SUPPORTED` (Fortran only)  
`MPI_ASYNC_PROTECTS_NONBLOCKING` (Fortran only)

The constants that cannot be used in initialization expressions or assignments in Fortran are as follows:

`MPI_BOTTOM`  
`MPI_STATUS_IGNORE`  
`MPI_STATUSES_IGNORE`

```

1  MPI_ERRCODES_IGNORE
2  MPI_IN_PLACE
3  MPI_ARGV_NULL
4  MPI_ARGVS_NULL
5  MPI_UNWEIGHTED
6  MPI_WEIGHTS_EMPTY

```

*Advice to implementors.* In Fortran the implementation of these special constants may require the use of language constructs that are outside the Fortran standard. Using special values for the constants (e.g., by defining them through `PARAMETER` statements) is not possible because an implementation cannot distinguish these values from valid data. Typically, these constants are implemented as predefined static variables (e.g., a variable in an MPI-declared `COMMON` block), relying on the fact that the target compiler passes data by address. Inside the subroutine, this address can be extracted by some mechanism outside the Fortran standard (e.g., by Fortran extensions or by implementing the function in C). (*End of advice to implementors.*)

### 2.5.5 Choice

MPI functions sometimes use arguments with a *choice* (or union) data type. Distinct calls to the same routine may pass by reference actual arguments of different types. The mechanism for providing such arguments will differ from language to language. For Fortran with the include file `mpif.h` or the `mpi` module, the document uses `<type>` to represent a choice variable; with the Fortran `mpi_f08` module, such arguments are declared with the Fortran 2008 + TS 29113 syntax `TYPE(*), DIMENSION(..)`; for C, we use `void*`.

*Advice to implementors.* Implementors can freely choose how to implement choice arguments in the `mpi` module, e.g., with a non-standard compiler-dependent method that has the quality of the call mechanism in the implicit Fortran interfaces, or with the method defined for the `mpi_f08` module. See details in Section 18.1.1. (*End of advice to implementors.*)

### 2.5.6 Absolute Addresses and Relative Address Displacements

Some MPI procedures use *address* arguments that represent an *absolute address* in the calling program, or *relative displacement* arguments that represent differences of two absolute addresses. The datatype of such arguments is `MPI_Aint` in C and `INTEGER (KIND=MPI_ADDRESS_KIND)` in Fortran. These types must have the same width and encode address values in the same manner such that address values in one language may be passed directly to another language without conversion. There is the MPI constant `MPI_BOTTOM` to indicate the start of the address range. For retrieving absolute addresses or any calculation with absolute addresses, one should use the routines and functions provided in Section 4.1.5. Section 4.1.12 provides additional rules for the correct use of absolute addresses. For expressions with relative displacements or other usage without absolute addresses, intrinsic operators (e.g., `+`, `-`, `*`) can be used.

### 2.5.7 File Offsets

For I/O there is a need to give the size, displacement, and offset into a file. These quantities can easily be larger than 32 bits which can be the default size of a Fortran integer. To

overcome this, these quantities are declared to be `INTEGER (KIND=MPI_OFFSET_KIND)` in Fortran. In C one uses `MPI_Offset`. These types must have the same width and encode address values in the same manner such that offset values in one language may be passed directly to another language without conversion.

### 2.5.8 Counts

As described above, MPI defines types (e.g., `MPI_Aint`) to address locations within memory and other types (e.g., `MPI_Offset`) to address locations within files. In addition, some MPI procedures use *count* arguments that represent a number of MPI datatypes on which to operate. Furthermore, *timestamps* in the context of the MPI Tool Information Interface are a count of clock ticks elapsed since some time in the past. At times, one needs a single type that can be used to address locations within either memory or files as well as express *count* values, and that type is `MPI_Count` in C and `INTEGER (KIND=MPI_COUNT_KIND)` in Fortran. These types must have the same width and encode values in the same manner such that count values in one language may be passed directly to another language without conversion. The size of the `MPI_Count` type is determined by the MPI implementation with the restriction that it must be minimally capable of encoding any value that may be stored in a variable of type `int`, `MPI_Aint`, or `MPI_Offset` in C and of type `INTEGER`, `INTEGER (KIND=MPI_ADDRESS_KIND)`, or `INTEGER (KIND=MPI_OFFSET_KIND)` in Fortran.

*Rationale.* Count values logically need to be large enough to encode any value used for expressing element counts, type maps in memory, type maps in file views, etc. For backward compatibility reasons, many MPI routines still use `int` in C and `INTEGER` in Fortran as the type of count arguments. (*End of rationale.*)

## 2.6 Language Binding

This section defines the rules for MPI language binding in general and for Fortran, and ISO C, in particular. (Note that ANSI C has been replaced by ISO C.) Defined here are various object representations, as well as the naming conventions used for expressing this standard. The actual calling sequences are defined elsewhere.

MPI bindings are for Fortran 90 or later, though they were originally designed to be usable in Fortran 77 environments. With the `mpi_f08` module, two new Fortran features, *assumed type* and *assumed rank*, are also required, see Section 2.5.5.

Since the word `PARAMETER` is a keyword in the Fortran language, we use the word “argument” to denote the arguments to a subroutine. These are normally referred to as parameters in C, however, we expect that C programmers will understand the word “argument” (which has no specific meaning in C), thus allowing us to avoid unnecessary confusion for Fortran programmers.

Since Fortran is case insensitive, linkers may use either lower case or upper case when resolving Fortran names. Users of case sensitive languages should avoid any prefix of the form “MPI\_” and “PMPI\_”, where any of the letters are either upper or lower case.

### 2.6.1 Deprecated and Removed Interfaces

A number of chapters refer to deprecated or replaced MPI constructs. These are constructs that continue to be part of the MPI standard, as documented in Chapter 15, but that users

1 are recommended not to continue using, since better solutions were provided with newer  
2 versions of MPI. For example, the Fortran binding for MPI-1 functions that have address  
3 arguments uses `INTEGER`. This is not consistent with the C binding, and causes problems on  
4 machines with 32 bit `INTEGER`s and 64 bit addresses. In MPI-2, these functions were given  
5 new names with new bindings for the address arguments. The use of the old functions was  
6 declared as deprecated. For consistency, here and in a few other cases, new C functions are  
7 also provided, even though the new functions are equivalent to the old functions. The old  
8 names are deprecated.

9 Some of the deprecated constructs are now removed, as documented in Chapter 16.  
10 They may still be provided by an implementation for backwards compatibility, but are not  
11 required.

12 Table 2.1 shows a list of all of the deprecated and removed constructs. Note that some  
13 C typedefs and Fortran subroutine names are included in this list; they are the types of  
14 callback functions.

## 16 2.6.2 Fortran Binding Issues

17 Originally, MPI-1.1 provided bindings for Fortran 77. These bindings are retained, but they  
18 are now interpreted in the context of the Fortran 90 standard. MPI can still be used with  
19 most Fortran 77 compilers, as noted below. When the term “Fortran” is used it means  
20 Fortran 90 or later; it means Fortran 2008 + TS 29113 and later if the `mpi_f08` module is  
21 used.  
22

23 All MPI names have an `MPI_` prefix, and all characters are capitals. Programs must  
24 not declare names, e.g., for variables, subroutines, functions, parameters, derived types,  
25 abstract interfaces, or modules, beginning with the prefix `MPI_`. To avoid conflicting with  
26 the profiling interface, programs must also avoid subroutines and functions with the prefix  
27 `PMPI_`. This is mandated to avoid possible name collisions.

28 All MPI Fortran subroutines have a return code in the last argument. With `USE`  
29 `mpi_f08`, this last argument is declared as `OPTIONAL`, except for user-defined callback func-  
30 tions (e.g., `COMM_COPY_ATTR_FUNCTION`) and their predefined callbacks (e.g.,  
31 `MPI_NULL_COPY_FN`). A few MPI operations which are functions do not have the return  
32 code argument. The return code value for successful completion is `MPI_SUCCESS`. Other  
33 error codes are implementation dependent; see the error codes in Chapter 8 and Annex A.

34 Constants representing the maximum length of a string are one smaller in Fortran than  
35 in C as discussed in Section 18.2.9.

36 Handles are represented in Fortran as `INTEGER`s, or as a `BIND(C)` derived type with the  
37 `mpi_f08` module; see Section 2.5.1. Binary-valued variables are of type `LOGICAL`.

38 Array arguments are indexed from one.

39 The older MPI Fortran bindings (`mpif.h` and `use mpi`) are inconsistent with the For-  
40 tran standard in several respects. These inconsistencies, such as register optimization prob-  
41 lems, have implications for user codes that are discussed in detail in Section 18.1.16.

## 43 2.6.3 C Binding Issues

44 We use the ISO C declaration format. All MPI names have an `MPI_` prefix, defined constants  
45 are in all capital letters, and defined types and functions have one capital letter after  
46 the prefix. Programs must not declare names (identifiers), e.g., for variables, functions,  
47 constants, types, or macros, beginning with any prefix of the form `MPI_`, where any of the  
48



Deprecated or removed construct	deprecated since	removed since	Replacement	
MPI_ADDRESS	MPI-2.0	MPI-3.0	MPI_GET_ADDRESS	1
MPI_TYPE_HINDEXED	MPI-2.0	MPI-3.0	MPI_TYPE_CREATE_HINDEXED	2
MPI_TYPE_HVECTOR	MPI-2.0	MPI-3.0	MPI_TYPE_CREATE_HVECTOR	3
MPI_TYPE_STRUCT	MPI-2.0	MPI-3.0	MPI_TYPE_CREATE_STRUCT	4
MPI_TYPE_EXTENT	MPI-2.0	MPI-3.0	MPI_TYPE_GET_EXTENT	5
MPI_TYPE_UB	MPI-2.0	MPI-3.0	MPI_TYPE_GET_EXTENT	6
MPI_TYPE_LB	MPI-2.0	MPI-3.0	MPI_TYPE_GET_EXTENT	7
MPI_LB <sup>1</sup>	MPI-2.0	MPI-3.0	MPI_TYPE_CREATE_RESIZED	8
MPI_UB <sup>1</sup>	MPI-2.0	MPI-3.0	MPI_TYPE_CREATE_RESIZED	9
MPI_ERRHANDLER_CREATE	MPI-2.0	MPI-3.0	MPI_COMM_CREATE_ERRHANDLER	10
MPI_ERRHANDLER_GET	MPI-2.0	MPI-3.0	MPI_COMM_GET_ERRHANDLER	11
MPI_ERRHANDLER_SET	MPI-2.0	MPI-3.0	MPI_COMM_SET_ERRHANDLER	12
MPI_Handler_function <sup>2</sup>	MPI-2.0	MPI-3.0	MPI_Comm_errhandler_function <sup>2</sup>	13
MPI_KEYVAL_CREATE	MPI-2.0		MPI_COMM_CREATE_KEYVAL	14
MPI_KEYVAL_FREE	MPI-2.0		MPI_COMM_FREE_KEYVAL	15
MPI_DUP_FN <sup>3</sup>	MPI-2.0		MPI_COMM_DUP_FN <sup>3</sup>	16
MPI_NULL_COPY_FN <sup>3</sup>	MPI-2.0		MPI_COMM_NULL_COPY_FN <sup>3</sup>	17
MPI_NULL_DELETE_FN <sup>3</sup>	MPI-2.0		MPI_COMM_NULL_DELETE_FN <sup>3</sup>	18
MPI_Copy_function <sup>2</sup>	MPI-2.0		MPI_Comm_copy_attr_function <sup>2</sup>	19
COPY_FUNCTION <sup>3</sup>	MPI-2.0		COMM_COPY_ATTR_FUNCTION <sup>3</sup>	20
MPI_Delete_function <sup>2</sup>	MPI-2.0		MPI_Comm_delete_attr_function <sup>2</sup>	21
DELETE_FUNCTION <sup>3</sup>	MPI-2.0		COMM_DELETE_ATTR_FUNCTION <sup>3</sup>	22
MPI_ATTR_DELETE	MPI-2.0		MPI_COMM_DELETE_ATTR	23
MPI_ATTR_GET	MPI-2.0		MPI_COMM_GET_ATTR	24
MPI_ATTR_PUT	MPI-2.0		MPI_COMM_SET_ATTR	25
MPI_COMBINER_HVECTOR_INTEGER <sup>4</sup>	-	MPI-3.0	MPI_COMBINER_HVECTOR <sup>4</sup>	26
MPI_COMBINER_HINDEXED_INTEGER <sup>4</sup>	-	MPI-3.0	MPI_COMBINER_HINDEXED <sup>4</sup>	27
MPI_COMBINER_STRUCT_INTEGER <sup>4</sup>	-	MPI-3.0	MPI_COMBINER_STRUCT <sup>4</sup>	28
MPI::...	MPI-2.2	MPI-3.0	C language binding	29
MPI_CANCEL for send requests	MPI-3.2		no direct replacement	30
MPI_INFO_GET	MPI-4.0		MPI_INFO_GET_STRING	31
MPI_INFO_GET_VALUELEN	MPI-4.0		MPI_INFO_GET_STRING	32
MPI_T_ERR_INVALID_ITEM	MPI-3.2		MPI_T_ERR_INVALID_INDEX	33
MPI_SIZEOF	MPI-4.0		storage_size() <sup>5</sup>	34
<sup>1</sup> Predefined datatype.				35
<sup>2</sup> Callback prototype definition.				36
<sup>3</sup> Predefined callback routine.				37
<sup>4</sup> Constant.				38
<sup>5</sup> Fortran intrinsic. It returns the size in bits instead of bytes.				39
Other entries are regular MPI routines.				40

Table 2.1: Deprecated and Removed constructs

letters are either upper or lower case. To support the profiling interface, programs must not declare functions with names beginning with any prefix of the form `PMPI_`, where any of the letters are either upper or lower case.

The definition of named constants, function prototypes, and type definitions must be supplied in an include file `mpi.h`.

Almost all C functions return an error code. The successful return code will be `MPI_SUCCESS`, but failure return codes are implementation dependent.

Type declarations are provided for handles to each category of opaque objects.

Array arguments are indexed from zero.

1 Logical flags are integers with value 0 meaning “false” and a non-zero value meaning  
2 “true.”

3 Choice arguments are pointers of type `void*`.

#### 5 2.6.4 Functions and Macros

6 An implementation is allowed to implement `MPI_WTIME`, `PMPI_WTIME`, `MPI_WTICK`,  
7 `PMPI_WTICK`, `MPI_AINT_ADD`, `PMPI_AINT_ADD`, `MPI_AINT_DIFF`, `PMPI_AINT_DIFF`,  
8 and the handle-conversion functions (`MPI_Group_f2c`, etc.) in Section 18.2.4, and no others,  
9 as macros in C.

11 *Advice to implementors.* Implementors should document which routines are imple-  
12 mented as macros. (*End of advice to implementors.*)

14 *Advice to users.* If these routines are implemented as macros, they will not work  
15 with the MPI profiling interface. (*End of advice to users.*)

### 18 2.7 Processes

19 An MPI program consists of autonomous processes, executing their own code, in an MIMD  
20 style. The codes executed by each process need not be identical. The processes communicate  
21 via calls to MPI communication primitives. Typically, each process executes in its own  
22 address space, although shared-memory implementations of MPI are possible.

24 This document specifies the behavior of a parallel program assuming that only MPI  
25 calls are used. The interaction of an MPI program with other possible means of commu-  
26 nication, I/O, and process management is not specified. Unless otherwise stated in the  
27 specification of the standard, MPI places no requirements on the result of its interaction  
28 with external mechanisms that provide similar or equivalent functionality. This includes,  
29 but is not limited to, interactions with external mechanisms for process control, shared and  
30 remote memory access, file system access and control, interprocess communication, process  
31 signaling, and terminal I/O. High quality implementations should strive to make the results  
32 of such interactions intuitive to users, and attempt to document restrictions where deemed  
33 necessary.

35 *Advice to implementors.* Implementations that support such additional mechanisms  
36 for functionality supported within MPI are expected to document how these interact  
37 with MPI. (*End of advice to implementors.*)

38 The interaction of MPI and threads is defined in Section 10.6.

### 41 2.8 Error Handling

42 MPI provides the user with reliable message transmission. A message sent is always re-  
43 ceived correctly, and the user does not need to check for transmission errors, time-outs,  
44 or other error conditions. In other words, MPI does not provide mechanisms for dealing  
45 with **transmission failures** in the communication system. If the MPI implementation is  
46 built on an unreliable underlying mechanism, then it is the job of the implementor of the  
47 MPI subsystem to insulate the user from this unreliability, and to reflect only unrecoverable  
48

transmission failures. Whenever possible, such failures will be reflected as errors in the relevant communication call.

Similarly, MPI itself provides no mechanisms for handling MPI **process failures**, that is, when an MPI process unexpectedly and permanently stops communicating (e.g., a software or hardware crash results in an MPI process terminating unexpectedly).

Of course, MPI programs may still be erroneous. A **program error** can occur when an MPI call is made with an incorrect argument (non-existing destination in a send operation, buffer too small in a receive operation, etc.). This type of error would occur in any implementation. In addition, a **resource error** may occur when a program exceeds the amount of available system resources (number of pending messages, system buffers, etc.). The occurrence of this type of error depends on the amount of available resources in the system and the resource allocation mechanism used; this may differ from system to system. A high-quality implementation will provide generous limits on the important resources so as to alleviate the portability problem this represents.

In C and Fortran, almost all MPI calls return a code that indicates successful completion of the operation. Whenever possible, MPI calls return an error code if an error occurred during the call. By default, an error detected during the execution of the MPI library causes the parallel computation to abort, except for file operations. However, MPI provides mechanisms for users to change this default and to handle recoverable errors. The user may specify that no error is fatal, and handle error codes returned by MPI calls by himself or herself. Also, the user may provide his or her own error-handling routines, which will be invoked whenever an MPI call returns abnormally. The MPI error handling facilities are described in Section 8.3.

Several factors limit the ability of MPI calls to return with meaningful error codes when an error occurs. MPI may not be able to detect some errors; other errors may be too expensive to detect in normal execution mode; finally some errors may be “catastrophic” and may prevent MPI from returning control to the caller. On the other hand, some errors may be detected after the associated operation has completed; some errors may not have a communicator, window, or file on which an error may be raised. In such cases, these errors will be raised on the communicator `MPI_COMM_SELF`. When `MPI_COMM_SELF` is not initialized (i.e., before `MPI_INIT` / `MPI_INIT_THREAD` or after `MPI_FINALIZE`) the error raises the **initial error handler** (set during the launch operation, see 10.8.4).

An example of such a case arises because of the nature of asynchronous communications: MPI calls may initiate operations that continue asynchronously after the call returned. Thus, the operation may return with a code indicating successful completion, yet later cause an error exception to be raised. If there is a subsequent call that relates to the same operation (e.g., a call that verifies that an asynchronous operation has completed) then the error argument associated with this call will be used to indicate the nature of the error. In a few cases, the error may occur after all calls that relate to the operation have completed, so that no error value can be used to indicate the nature of the error (e.g., an error on the receiver in a send with the ready mode).

This document does not specify the state of a computation after an erroneous MPI call has occurred. The desired behavior is that a relevant error code be returned, and the effect of the error be localized to the greatest possible extent. E.g., it is highly desirable that an erroneous receive call will not cause any part of the receiver’s memory to be overwritten, beyond the area specified for receiving the message.

Implementations may go beyond this document in supporting in a meaningful manner MPI calls that are defined here to be erroneous. For example, MPI specifies strict type

1 matching rules between matching send and receive operations: it is erroneous to send a  
2 floating point variable and receive an integer. Implementations may go beyond these type  
3 matching rules, and provide automatic type conversion in such situations. It will be helpful  
4 to generate warnings for such non-conforming behavior.

5 MPI defines a way for users to create new error codes as defined in Section 8.5.

## 7 8 2.9 Implementation Issues

9 There are a number of areas where an MPI implementation may interact with the operating  
10 environment and system. While MPI does not mandate that any services (such as signal  
11 handling) be provided, it does strongly suggest the behavior to be provided if those services  
12 are available. This is an important point in achieving portability across platforms that  
13 provide the same set of services.

### 15 2.9.1 Independence of Basic Runtime Routines

16 MPI programs require that library routines that are part of the basic language environment  
17 (such as `write` in Fortran and `printf` and `malloc` in ISO C) and are executed after  
18 `MPI_INIT` and before `MPI_FINALIZE` operate independently and that their *completion* is  
19 independent of the action of other processes in an MPI program.

20 Note that this in no way prevents the creation of library routines that provide parallel  
21 services whose operation is collective. However, the following program is expected to com-  
22 plete in an ISO C environment regardless of the size of `MPI_COMM_WORLD` (assuming that  
23 `printf` is available at the executing nodes).

```
24 int rank;  
25 MPI_Init((void *)0, (void *)0);  
26 MPI_Comm_rank(MPI_COMM_WORLD, &rank);  
27 if (rank == 0) printf("Starting program\n");  
28 MPI_Finalize();
```

29 The corresponding Fortran programs are also expected to complete.

30 An example of what is *not* required is any particular ordering of the action of these  
31 routines when called by several tasks. For example, MPI makes neither requirements nor  
32 recommendations for the output from the following program (again assuming that I/O is  
33 available at the executing nodes).

```
34 MPI_Comm_rank(MPI_COMM_WORLD, &rank);  
35 printf("Output from task rank %d\n", rank);
```

36 In addition, calls that fail because of resource exhaustion or other error are not con-  
37 sidered a violation of the requirements here (however, they are required to complete, just  
38 not to complete successfully).

### 41 2.9.2 Interaction with Signals

42 MPI does not specify the interaction of processes with signals and does not require that MPI  
43 be signal safe. The implementation may reserve some signals for its own use. It is required  
44 that the implementation document which signals it uses, and it is strongly recommended

that it not use `SIGALRM`, `SIGFPE`, or `SIGIO`. Implementations may also prohibit the use of MPI calls from within signal handlers.

In multithreaded environments, users can avoid conflicts between signals and the MPI library by catching signals only on threads that do not execute MPI calls. High quality single-threaded implementations will be signal safe: an MPI call suspended by a signal will resume and complete normally after the signal is handled.

## 2.10 Examples

The examples in this document are for illustration purposes only. They are not intended to specify the standard. Furthermore, the examples have not been carefully checked or verified.

DRAFT

1  
2  
3  
4  
5  
6  
7  
8  
9  
10  
11  
12  
13  
14  
15  
16  
17  
18  
19  
20  
21  
22  
23  
24  
25  
26  
27  
28  
29  
30  
31  
32  
33  
34  
35  
36  
37  
38  
39  
40  
41  
42  
43  
44  
45  
46  
47  
48

DRAFT

## Chapter 3

# Point-to-Point Communication

### 3.1 Introduction

Sending and receiving of messages by processes is the basic MPI communication mechanism. The basic point-to-point communication operations are **send** and **receive**. Their use is illustrated in the example below.

```
#include "mpi.h"
int main(int argc, char *argv[])
{
    char message[20];
    int myrank;
    MPI_Status status;
    MPI_Init(&argc, &argv);
    MPI_Comm_rank(MPI_COMM_WORLD, &myrank);
    if (myrank == 0) /* code for process zero */
    {
        strcpy(message, "Hello, there");
        MPI_Send(message, strlen(message)+1, MPI_CHAR, 1, 99, MPI_COMM_WORLD);
    }
    else if (myrank == 1) /* code for process one */
    {
        MPI_Recv(message, 20, MPI_CHAR, 0, 99, MPI_COMM_WORLD, &status);
        printf("received :%s:\n", message);
    }
    MPI_Finalize();
    return 0;
}
```

In this example, process zero (`myrank = 0`) sends a message to process one using the **send** operation `MPI_SEND`. The operation specifies a **send buffer** in the sender memory from which the message data is taken. In the example above, the send buffer consists of the storage containing the variable `message` in the memory of process zero. The location, size and type of the send buffer are specified by the first three parameters of the send operation. The message sent will contain the 13 characters of this variable. In addition, the send operation associates an **envelope** with the message. This envelope specifies the

1 message destination and contains distinguishing information that can be used by the **receive**  
 2 operation to select a particular message. The last three parameters of the send operation,  
 3 along with the rank of the sender, specify the envelope for the message sent. Process one  
 4 (**myrank** = 1) receives this message with the **receive** operation **MPI\_RECV**. The message to  
 5 be received is selected according to the value of its envelope, and the message data is stored  
 6 into the **receive buffer**. In the example above, the receive buffer consists of the storage  
 7 containing the string **message** in the memory of process one. The first three parameters  
 8 of the receive operation specify the location, size and type of the receive buffer. The next  
 9 three parameters are used for selecting the incoming message. The last parameter is used  
 10 to return information on the message just received.

11 The next sections describe the blocking send and receive operations. We discuss send,  
 12 receive, blocking communication semantics, type matching requirements, type conversion in  
 13 heterogeneous environments, and more general communication modes. Nonblocking com-  
 14 munication is addressed next, followed by probing and canceling a message, channel-like  
 15 constructs and send-receive operations, ending with a description of the “dummy” process,  
 16 **MPI\_PROC\_NULL**.

## 18 3.2 Blocking Send and Receive Operations

### 20 3.2.1 Blocking Send

22 The syntax of the blocking send operation is given below.

24 **MPI\_SEND**(buf, count, datatype, dest, tag, comm)

26	IN	buf	initial address of send buffer (choice)
27	IN	count	number of elements in send buffer (non-negative inte- 28 ger)
29	IN	datatype	datatype of each send buffer element (handle)
30	IN	dest	rank of destination (integer)
31	IN	tag	message tag (integer)
32	IN	comm	communicator (handle)
33			
34			

#### 36 C binding

37 **int MPI\_Send**(const void \*buf, int count, MPI\_Datatype datatype, int dest,  
 38 int tag, MPI\_Comm comm)

#### 39 Fortran 2008 binding

40 **MPI\_Send**(buf, count, datatype, dest, tag, comm, ierror)  
 41 TYPE(\*), DIMENSION(..), INTENT(IN) :: buf  
 42 INTEGER, INTENT(IN) :: count, dest, tag  
 43 TYPE(MPI\_Datatype), INTENT(IN) :: datatype  
 44 TYPE(MPI\_Comm), INTENT(IN) :: comm  
 45 INTEGER, OPTIONAL, INTENT(OUT) :: ierror

#### 47 Fortran binding

48 **MPI\_SEND**(BUF, COUNT, DATATYPE, DEST, TAG, COMM, IERROR)



```
<type> BUF(*)
INTEGER COUNT, DATATYPE, DEST, TAG, COMM, IERROR
```

The blocking semantics of this call are described in Section 3.4.

### 3.2.2 Message Data

The send buffer specified by the MPI\_SEND operation consists of `count` successive entries of the type indicated by `datatype`, starting with the entry at address `buf`. Note that we specify the message length in terms of number of *elements*, not number of *bytes*. The former is machine independent and closer to the application level.

The data part of the message consists of a sequence of `count` values, each of the type indicated by `datatype`. `count` may be zero, in which case the data part of the message is empty. The basic datatypes that can be specified for message data values correspond to the basic datatypes of the host language. Possible values of this argument for Fortran and the corresponding Fortran types are listed in Table 3.1.

MPI datatype	Fortran datatype
MPI_INTEGER	INTEGER
MPI_REAL	REAL
MPI_DOUBLE_PRECISION	DOUBLE PRECISION
MPI_COMPLEX	COMPLEX
MPI_LOGICAL	LOGICAL
MPI_CHARACTER	CHARACTER(1)
MPI_BYTE	
MPI_PACKED	

Table 3.1: Predefined MPI datatypes corresponding to Fortran datatypes

Possible values for this argument for C and the corresponding C types are listed in Table 3.2.

The datatypes MPI\_BYTE and MPI\_PACKED do not correspond to a Fortran or C datatype. A value of type MPI\_BYTE consists of a byte (8 binary digits). A byte is uninterpreted and is different from a character. Different machines may have different representations for characters, or may use more than one byte to represent characters. On the other hand, a byte has the same binary value on all machines. The use of the type MPI\_PACKED is explained in Section 4.2.

MPI requires support of these datatypes, which match the basic datatypes of Fortran and ISO C. Additional MPI datatypes should be provided if the host language has additional data types: MPI\_DOUBLE\_COMPLEX for double precision complex in Fortran declared to be of type DOUBLE COMPLEX; MPI\_REAL2, MPI\_REAL4, and MPI\_REAL8 for Fortran reals, declared to be of type REAL\*2, REAL\*4 and REAL\*8, respectively; MPI\_INTEGER1, MPI\_INTEGER2, and MPI\_INTEGER4 for Fortran integers, declared to be of type INTEGER\*1, INTEGER\*2, and INTEGER\*4, respectively; etc.

*Rationale.* One goal of the design is to allow for MPI to be implemented as a library, with no need for additional preprocessing or compilation. Thus, one cannot assume that a communication call has information on the datatype of variables in the communication buffer; this information must be supplied by an explicit argument.

MPI datatype	C datatype
MPI_CHAR	char (treated as printable character)
MPI_SHORT	signed short int
MPI_INT	signed int
MPI_LONG	signed long int
MPI_LONG_LONG_INT	signed long long int
MPI_LONG_LONG (as a synonym)	signed long long int
MPI_SIGNED_CHAR	signed char (treated as integral value)
MPI_UNSIGNED_CHAR	unsigned char (treated as integral value)
MPI_UNSIGNED_SHORT	unsigned short int
MPI_UNSIGNED	unsigned int
MPI_UNSIGNED_LONG	unsigned long int
MPI_UNSIGNED_LONG_LONG	unsigned long long int
MPI_FLOAT	float
MPI_DOUBLE	double
MPI_LONG_DOUBLE	long double
MPI_WCHAR	wchar_t (defined in <stddef.h> (treated as printable character)
MPI_C_BOOL	_Bool
MPI_INT8_T	int8_t
MPI_INT16_T	int16_t
MPI_INT32_T	int32_t
MPI_INT64_T	int64_t
MPI_UINT8_T	uint8_t
MPI_UINT16_T	uint16_t
MPI_UINT32_T	uint32_t
MPI_UINT64_T	uint64_t
MPI_C_COMPLEX	float _Complex
MPI_C_FLOAT_COMPLEX (as a synonym)	float _Complex
MPI_C_DOUBLE_COMPLEX	double _Complex
MPI_C_LONG_DOUBLE_COMPLEX	long double _Complex
MPI_BYTE	
MPI_PACKED	

Table 3.2: Predefined MPI datatypes corresponding to C datatypes

The need for such datatype information will become clear in Section 3.3.2. (*End of rationale.*)

The datatypes MPI\_AINT, MPI\_OFFSET, and MPI\_COUNT correspond to the MPI-defined C types MPI\_Aint, MPI\_Offset, and MPI\_Count and their Fortran equivalents INTEGER (KIND=MPI\_ADDRESS\_KIND), INTEGER (KIND=MPI\_OFFSET\_KIND), and INTEGER (KIND=MPI\_COUNT\_KIND). This is described in Table 3.3. All predefined datatype handles

MPI datatype	C datatype	Fortran datatype
MPI_AINT	MPI_Aint	INTEGER (KIND=MPI_ADDRESS_KIND)
MPI_OFFSET	MPI_Offset	INTEGER (KIND=MPI_OFFSET_KIND)
MPI_COUNT	MPI_Count	INTEGER (KIND=MPI_COUNT_KIND)

Table 3.3: Predefined MPI datatypes corresponding to both C and Fortran datatypes

are available in all language bindings. See Sections 18.2.6 and 18.2.10 on page 757 and 764 for information on interlanguage communication with these types.

If there is an accompanying C++ compiler then the datatypes in Table 3.4 are also supported in C and Fortran.

MPI datatype	C++ datatype
MPI_CXX_BOOL	bool
MPI_CXX_FLOAT_COMPLEX	std::complex<float>
MPI_CXX_DOUBLE_COMPLEX	std::complex<double>
MPI_CXX_LONG_DOUBLE_COMPLEX	std::complex<long double>

Table 3.4: Predefined MPI datatypes corresponding to C++ datatypes

### 3.2.3 Message Envelope

In addition to the data part, messages carry information that can be used to distinguish messages and selectively receive them. This information consists of a fixed number of fields, which we collectively call the **message envelope**. These fields are

source  
destination  
tag  
communicator

The message source is implicitly determined by the identity of the message sender. The other fields are specified by arguments in the send operation.

The message destination is specified by the `dest` argument.

The integer-valued message tag is specified by the `tag` argument. This integer can be used by the program to distinguish different types of messages. The range of valid tag values is  $0, \dots, UB$ , where the value of `UB` is implementation dependent. It can be found by querying the value of the attribute `MPI_TAG_UB`, as described in Chapter 8. MPI requires that `UB` be no less than 32767.

The `comm` argument specifies the **communicator** that is used for the send operation. Communicators are explained in Chapter 6; below is a brief summary of their usage.

A communicator specifies the communication context for a communication operation. Each communication context provides a separate “communication universe”: messages are always received within the context they were sent, and messages sent in different contexts do not interfere.

The communicator also specifies the set of processes that share this communication context. This **process group** is ordered and processes are identified by their rank within

1 this group. Thus, the range of valid values for `dest` is  $0, \dots, n-1 \cup \{\text{MPI\_PROC\_NULL}\}$ , where  
 2  $n$  is the number of processes in the group. (If the communicator is an inter-communicator,  
 3 then destinations are identified by their rank in the remote group. See Chapter 6.)

4 When using the World Model (see Section 10.1), a predefined communicator  
 5 `MPI_COMM_WORLD` is provided by MPI. It allows communication with all processes that  
 6 are accessible after MPI initialization and processes are identified by their rank in the group  
 7 of `MPI_COMM_WORLD`.  
 8

9 *Advice to users.* Users that are comfortable with the notion of a flat name space  
 10 for processes, and a single communication context, as offered by most existing com-  
 11 munication libraries, need only use the World Model for MPI initialization, and the  
 12 predefined variable `MPI_COMM_WORLD` as the `comm` argument. This will allow com-  
 13 munication with all the processes available at initialization time.

14 Users may define new communicators, as explained in Chapter 6. Communicators  
 15 provide an important encapsulation mechanism for libraries and modules. They allow  
 16 modules to have their own disjoint communication universe and their own process  
 17 numbering scheme. (*End of advice to users.*)  
 18

19 *Advice to implementors.* The message envelope would normally be encoded by a  
 20 fixed-length message header. However, the actual encoding is implementation depen-  
 21 dent. Some of the information (e.g., source or destination) may be implicit, and need  
 22 not be explicitly carried by messages. Also, processes may be identified by relative  
 23 ranks, or absolute ids, etc. (*End of advice to implementors.*)  
 24

### 25 3.2.4 Blocking Receive

26 The syntax of the blocking receive operation is given below.  
 27

28  
 29 `MPI_RECV(buf, count, datatype, source, tag, comm, status)`

30			
31	OUT	<code>buf</code>	initial address of receive buffer (choice)
32	IN	<code>count</code>	number of elements in receive buffer (non-negative in- 33 teger)
34	IN	<code>datatype</code>	datatype of each receive buffer element (handle)
35	IN	<code>source</code>	rank of source or <code>MPI_ANY_SOURCE</code> (integer)
36	IN	<code>tag</code>	message tag or <code>MPI_ANY_TAG</code> (integer)
37	IN	<code>comm</code>	communicator (handle)
38	OUT	<code>status</code>	status object (Status)
39			
40			

### 41 C binding

42  
 43 `int MPI_Recv(void *buf, int count, MPI_Datatype datatype, int source,`  
 44 `int tag, MPI_Comm comm, MPI_Status *status)`

### 45 Fortran 2008 binding

46  
 47 `MPI_Recv(buf, count, datatype, source, tag, comm, status, ierror)`  
 48 `TYPE(*), DIMENSION(..) :: buf`

```

INTEGER, INTENT(IN) :: count, source, tag
TYPE(MPI_Datatype), INTENT(IN) :: datatype
TYPE(MPI_Comm), INTENT(IN) :: comm
TYPE(MPI_Status) :: status
INTEGER, OPTIONAL, INTENT(OUT) :: ierror

```

### Fortran binding

```

MPI_RECV(BUF, COUNT, DATATYPE, SOURCE, TAG, COMM, STATUS, IERROR)
  <type> BUF(*)
  INTEGER COUNT, DATATYPE, SOURCE, TAG, COMM, STATUS(MPI_STATUS_SIZE),
  IERROR

```

The blocking semantics of this call are described in Section 3.4.

The receive buffer consists of the storage containing `count` consecutive elements of the type specified by `datatype`, starting at address `buf`. The length of the received message must be less than or equal to the length of the receive buffer. An overflow error occurs if all incoming data does not fit, without truncation, into the receive buffer.

If a message that is shorter than the receive buffer arrives, then only those locations corresponding to the (shorter) message are modified.

*Advice to users.* The `MPI_PROBE` function described in Section 3.8 can be used to receive messages of unknown length. (*End of advice to users.*)

*Advice to implementors.* Even though no specific behavior is mandated by MPI for erroneous programs, the recommended handling of overflow situations is to return in `status` information about the source and tag of the incoming message. The receive operation will return an error code. A quality implementation will also ensure that no memory that is outside the receive buffer will ever be overwritten.

In the case of a message shorter than the receive buffer, MPI is quite strict in that it allows no modification of the other locations. A more lenient statement would allow for some optimizations but this is not allowed. The implementation must be ready to end a copy into the receiver memory exactly at the end of the receive buffer, even if it is an odd address. (*End of advice to implementors.*)

The selection of a message by a receive operation is governed by the value of the message envelope. A message can be received by a receive operation if its envelope matches the `source`, `tag` and `comm` values specified by the receive operation. The receiver may specify a wildcard `MPI_ANY_SOURCE` value for `source`, and/or a wildcard `MPI_ANY_TAG` value for `tag`, indicating that any source and/or tag are acceptable. It cannot specify a wildcard value for `comm`. Thus, a message can be received by a receive operation only if it is addressed to the receiving process, has a matching communicator, has matching source unless `source = MPI_ANY_SOURCE` in the pattern, and has a matching tag unless `tag = MPI_ANY_TAG` in the pattern.

The message tag is specified by the `tag` argument of the receive operation. The argument `source`, if different from `MPI_ANY_SOURCE`, is specified as a rank within the process group associated with that same communicator (remote process group, for intercommunicators). Thus, the range of valid values for the `source` argument is  $\{0, \dots, n - 1\} \cup \{\text{MPI\_ANY\_SOURCE}\} \cup \{\text{MPI\_PROC\_NULL}\}$ , where  $n$  is the number of processes in this group.

1 Note the asymmetry between send and receive operations: A receive operation may  
 2 accept messages from an arbitrary sender, on the other hand, a send operation must specify  
 3 a unique receiver. This matches a “push” communication mechanism, where data transfer  
 4 is effected by the sender (rather than a “pull” mechanism, where data transfer is effected  
 5 by the receiver).

6 Source = destination is allowed, that is, a process can send a message to itself. (How-  
 7 ever, it is unsafe to do so with the blocking send and receive operations described above,  
 8 since this may lead to deadlock. See Section 3.5.)

9 *Advice to implementors.* Message context and other communicator information can  
 10 be implemented as an additional tag field. It differs from the regular message tag  
 11 in that wild card matching is not allowed on this field, and that value setting for  
 12 this field is controlled by communicator manipulation functions. (*End of advice to*  
 13 *implementors.*)

14 The use of `dest = MPI_PROC_NULL` or `source = MPI_PROC_NULL` to define a “dummy”  
 15 destination or source in any send or receive call is described in Section 3.11.

### 18 3.2.5 Return Status

19 The source or tag of a received message may not be known if wildcard values were used  
 20 in the receive operation. Also, if multiple requests are completed by a single MPI function  
 21 (see Section 3.7.5), a distinct error code may need to be returned for each request. The  
 22 information is returned by the `status` argument of `MPI_RECV`. The type of `status` is MPI-  
 23 defined. Status variables need to be explicitly allocated by the user, that is, they are not  
 24 system objects.

25 In C, `status` is a structure that contains three fields named `MPI_SOURCE`, `MPI_TAG`,  
 26 and `MPI_ERROR`; the structure may contain additional fields. Thus,  
 27 `status.MPI_SOURCE`, `status.MPI_TAG` and `status.MPI_ERROR` contain the source, tag, and  
 28 error code, respectively, of the received message.

29 In Fortran with `USE mpi` or `INCLUDE 'mpif.h'`, `status` is an array of `INTEGER`s of size  
 30 `MPI_STATUS_SIZE`. The constants `MPI_SOURCE`, `MPI_TAG` and `MPI_ERROR` are the indices  
 31 of the entries that store the source, tag and error fields. Thus, `status(MPI_SOURCE)`,  
 32 `status(MPI_TAG)` and `status(MPI_ERROR)` contain, respectively, the source, tag and error  
 33 code of the received message.

34 With Fortran `USE mpi_f08`, `status` is defined as the Fortran `BIND(C)` derived type  
 35 `TYPE(MPI_Status)` containing three public `INTEGER` fields named `MPI_SOURCE`, `MPI_TAG`,  
 36 and `MPI_ERROR`. `TYPE(MPI_Status)` may contain additional, implementation-specific fields.  
 37 Thus, `status%MPI_SOURCE`, `status%MPI_TAG` and `status%MPI_ERROR` contain the source,  
 38 tag, and error code of a received message respectively. Additionally, within both the `mpi`  
 39 and the `mpi_f08` modules, the constants `MPI_STATUS_SIZE`, `MPI_SOURCE`, `MPI_TAG`,  
 40 `MPI_ERROR`, and `TYPE(MPI_Status)` are defined to allow conversion between both status  
 41 representations. Conversion routines are provided in Section 18.2.5.

42 *Rationale.* The Fortran `TYPE(MPI_Status)` is defined as a `BIND(C)` derived type so  
 43 that it can be used at any location where the status integer array representation can  
 44 be used, e.g., in user defined common blocks. (*End of rationale.*)

45 *Rationale.* It is allowed to have the same name (e.g., `MPI_SOURCE`) defined as a  
 46 constant (e.g., Fortran parameter) and as a field of a derived type. (*End of rationale.*)

In general, message-passing calls do not modify the value of the error code field of status variables. This field may be updated only by the functions in Section 3.7.5 which return multiple statuses. The field is updated if and only if such function returns with an error code of MPI\_ERR\_IN\_STATUS.

*Rationale.* The error field in status is not needed for calls that return only one status, such as MPI\_WAIT, since that would only duplicate the information returned by the function itself. The current design avoids the additional overhead of setting it, in such cases. The field is needed for calls that return multiple statuses, since each request may have had a different failure. (*End of rationale.*)

The status argument also returns information on the length of the message received. However, this information is not directly available as a field of the status variable and a call to MPI\_GET\_COUNT is required to “decode” this information.

MPI\_GET\_COUNT(status, datatype, count)

IN	status	return status of receive operation (Status)
IN	datatype	datatype of each receive buffer entry (handle)
OUT	count	number of received entries (integer)

#### C binding

```
int MPI_Get_count(const MPI_Status *status, MPI_Datatype datatype,
                 int *count)
```

#### Fortran 2008 binding

```
MPI_Get_count(status, datatype, count, ierror)
  TYPE(MPI_Status), INTENT(IN) :: status
  TYPE(MPI_Datatype), INTENT(IN) :: datatype
  INTEGER, INTENT(OUT) :: count
  INTEGER, OPTIONAL, INTENT(OUT) :: ierror
```

#### Fortran binding

```
MPI_GET_COUNT(STATUS, DATATYPE, COUNT, IERROR)
  INTEGER STATUS(MPI_STATUS_SIZE), DATATYPE, COUNT, IERROR
```

Returns the number of entries received. (Again, we count *entries*, each of type *datatype*, not *bytes*.) The *datatype* argument should match the argument provided by the receive call that set the status variable. If the number of entries received exceeds the limits of the *count* parameter, then MPI\_GET\_COUNT sets the value of *count* to MPI\_UNDEFINED. There are other situations where the value of *count* can be set to MPI\_UNDEFINED; see Section 4.1.11.

*Rationale.* Some message-passing libraries use INOUT *count*, *tag* and *source* arguments, thus using them both to specify the selection criteria for incoming messages and return the actual envelope values of the received message. The use of a separate status argument prevents errors that are often attached with INOUT argument (e.g., using the MPI\_ANY\_TAG constant as the tag in a receive). Some libraries use calls that refer implicitly to the “last message received.” This is not thread safe.

1 The `datatype` argument is passed to `MPI_GET_COUNT` so as to improve performance.  
 2 A message might be received without counting the number of elements it contains,  
 3 and the count value is often not needed. Also, this allows the same function to be  
 4 used after a call to `MPI_PROBE` or `MPI_IPROBE`. With a status from `MPI_PROBE`  
 5 or `MPI_IPROBE`, the same datatypes are allowed as in a call to `MPI_RECV` to receive  
 6 this message. (*End of rationale.*)  
 7

8 The value returned as the `count` argument of `MPI_GET_COUNT` for a datatype of length  
 9 zero where zero bytes have been transferred is zero. If the number of bytes transferred is  
 10 greater than zero, `MPI_UNDEFINED` is returned.  
 11

12 *Rationale.* Zero-length datatypes may be created in a number of cases. An important  
 13 case is `MPI_TYPE_CREATE_DARRAY`, where the definition of the particular darray  
 14 results in an empty block on some MPI process. Programs written in an SPMD style  
 15 will not check for this special case and may want to use `MPI_GET_COUNT` to check  
 16 the status. (*End of rationale.*)  
 17

18 *Advice to users.* The buffer size required for the receive can be affected by data con-  
 19 versions and by the stride of the receive datatype. In most cases, the safest approach  
 20 is to use the same datatype with `MPI_GET_COUNT` and the receive. (*End of advice*  
 21 *to users.*)  
 22

23 All send and receive operations use the `buf`, `count`, `datatype`, `source`, `dest`, `tag`, `comm`,  
 24 and `status` arguments in the same way as the blocking `MPI_SEND` and `MPI_RECV` operations  
 25 described in this section.  
 26

### 27 3.2.6 Passing `MPI_STATUS_IGNORE` for Status

28 Every call to `MPI_RECV` includes a `status` argument, wherein the system can return details  
 29 about the message received. There are also a number of other MPI calls where `status`  
 30 is returned. An object of type `MPI_Status` is not an MPI opaque object; its structure  
 31 is declared in `mpi.h` and `mpif.h`, and it exists in the user's program. In many cases,  
 32 application programs are constructed so that it is unnecessary for them to examine the  
 33 `status` fields. In these cases, it is a waste for the user to allocate a status object, and it is  
 34 particularly wasteful for the MPI implementation to fill in fields in this object.  
 35

36 To cope with this problem, there are two predefined constants, `MPI_STATUS_IGNORE`  
 37 and `MPI_STATUSES_IGNORE`, which when passed to a receive, probe, wait, or test function,  
 38 inform the implementation that the status fields are not to be filled in. Note that  
 39 `MPI_STATUS_IGNORE` is not a special type of `MPI_Status` object; rather, it is a special  
 40 value for the argument. In C one would expect it to be `NULL`, not the address of a special  
 41 `MPI_Status`.  
 42

43 `MPI_STATUS_IGNORE`, and the array version `MPI_STATUSES_IGNORE`, can be used every-  
 44 where a status argument is passed to a receive, wait, or test function. `MPI_STATUS_IGNORE`  
 45 cannot be used when status is an IN argument. Note that in Fortran `MPI_STATUS_IGNORE`  
 46 and `MPI_STATUSES_IGNORE` are objects like `MPI_BOTTOM` (not usable for initialization or  
 47 assignment). See Section 2.5.4.  
 48

49 In general, this optimization can apply to all functions for which `status` or an array of  
 50 statuses is an OUT argument. Note that this converts `status` into an INOUT argument. The  
 51 functions that can be passed `MPI_STATUS_IGNORE` are all the various forms of `MPI_RECV`,



MPI\_PROBE, MPI\_TEST, and MPI\_WAIT, as well as MPI\_REQUEST\_GET\_STATUS. When an array is passed, as in the MPI\_{TEST|WAIT}{ALL|SOME} functions, a separate constant, MPI\_STATUSES\_IGNORE, is passed for the array argument. It is possible for an MPI function to return MPI\_ERR\_IN\_STATUS even when MPI\_STATUS\_IGNORE or MPI\_STATUSES\_IGNORE has been passed to that function.

MPI\_STATUS\_IGNORE and MPI\_STATUSES\_IGNORE are not required to have the same values in C and Fortran.

It is not allowed to have some of the statuses in an array of statuses for MPI\_{TEST|WAIT}{ALL|SOME} functions set to MPI\_STATUS\_IGNORE; one either specifies ignoring *all* of the statuses in such a call with MPI\_STATUSES\_IGNORE, or *none* of them by passing normal statuses in all positions in the array of statuses.

## 3.3 Data Type Matching and Data Conversion

### 3.3.1 Type Matching Rules

One can think of message transfer as consisting of the following three phases.

1. Data is pulled out of the send buffer and a message is assembled.
2. A message is transferred from sender to receiver.
3. Data is pulled from the incoming message and disassembled into the receive buffer.

Type matching has to be observed at each of these three phases: The type of each variable in the sender buffer has to match the type specified for that entry by the send operation; the type specified by the send operation has to match the type specified by the receive operation; and the type of each variable in the receive buffer has to match the type specified for that entry by the receive operation. A program that fails to observe these three rules is erroneous.

To define type matching more precisely, we need to deal with two issues: matching of types of the host language with types specified in communication operations; and matching of types at sender and receiver.

The types of a send and receive match (phase two) if both operations use identical names. That is, MPI\_INTEGER matches MPI\_INTEGER, MPI\_REAL matches MPI\_REAL, and so on. There is one exception to this rule, discussed in Section 4.2: the type MPI\_PACKED can match any other type.

The type of a variable in a host program matches the type specified in the communication operation if the datatype name used by that operation corresponds to the basic type of the host program variable. For example, an entry with type name MPI\_INTEGER matches a Fortran variable of type INTEGER. A table giving this correspondence for Fortran and C appears in Section 3.2.2. There are two exceptions to this last rule: an entry with type name MPI\_BYTE or MPI\_PACKED can be used to match any byte of storage (on a byte-addressable machine), irrespective of the datatype of the variable that contains this byte. The type MPI\_PACKED is used to send data that has been explicitly packed, or receive data that will be explicitly unpacked, see Section 4.2. The type MPI\_BYTE allows one to transfer the binary value of a byte in memory unchanged.

To summarize, the type matching rules fall into the three categories below.

- 1     • Communication of typed values (e.g., with datatype different from `MPI_BYTE`), where
- 2       the datatypes of the corresponding entries in the sender program, in the send call, in
- 3       the receive call and in the receiver program must all match.
- 4
- 5     • Communication of untyped values (e.g., of datatype `MPI_BYTE`), where both sender
- 6       and receiver use the datatype `MPI_BYTE`. In this case, there are no requirements on
- 7       the types of the corresponding entries in the sender and the receiver programs, nor is
- 8       it required that they be the same.
- 9
- 10    • Communication involving packed data, where `MPI_PACKED` is used.

11     The following examples illustrate the first two cases.

12

13    **Example 3.1** Sender and receiver specify matching types.

```
14  CALL MPI_COMM_RANK(comm, rank, ierr)
15  IF (rank .EQ. 0) THEN
16      CALL MPI_SEND(a(1), 10, MPI_REAL, 1, tag, comm, ierr)
17  ELSE IF (rank .EQ. 1) THEN
18      CALL MPI_RECV(b(1), 15, MPI_REAL, 0, tag, comm, status, ierr)
19  END IF
20
```

21     This code is correct if both `a` and `b` are real arrays of size  $\geq 10$ . (In Fortran, it might be

22     correct to use this code even if `a` or `b` have size  $< 10$ : e.g., when `a(1)` can be equivalenced

23     to an array with ten reals.)

24

25    **Example 3.2** Sender and receiver do not specify matching types.

```
26  CALL MPI_COMM_RANK(comm, rank, ierr)
27  IF (rank .EQ. 0) THEN
28      CALL MPI_SEND(a(1), 10, MPI_REAL, 1, tag, comm, ierr)
29  ELSE IF (rank .EQ. 1) THEN
30      CALL MPI_RECV(b(1), 40, MPI_BYTE, 0, tag, comm, status, ierr)
31  END IF
32
```

33

34     This code is erroneous, since sender and receiver do not provide matching datatype

35     arguments.

36

37    **Example 3.3** Sender and receiver specify communication of untyped values.

```
38  CALL MPI_COMM_RANK(comm, rank, ierr)
39  IF (rank .EQ. 0) THEN
40      CALL MPI_SEND(a(1), 40, MPI_BYTE, 1, tag, comm, ierr)
41  ELSE IF (rank .EQ. 1) THEN
42      CALL MPI_RECV(b(1), 60, MPI_BYTE, 0, tag, comm, status, ierr)
43  END IF
44
```

45     This code is correct, irrespective of the type and size of `a` and `b` (unless this results in

46     an out of bounds memory access).

*Advice to users.* If a buffer of type `MPI_BYTE` is passed as an argument to `MPI_SEND`, then MPI will send the data stored at contiguous locations, starting from the address indicated by the `buf` argument. This may have unexpected results when the data layout is not as a casual user would expect it to be. For example, some Fortran compilers implement variables of type `CHARACTER` as a structure that contains the character length and a pointer to the actual string. In such an environment, sending and receiving a Fortran `CHARACTER` variable using the `MPI_BYTE` type will not have the anticipated result of transferring the character string. For this reason, the user is advised to use typed communications whenever possible. (*End of advice to users.*)

#### Type `MPI_CHARACTER`

The type `MPI_CHARACTER` matches one character of a Fortran variable of type `CHARACTER`, rather than the entire character string stored in the variable. Fortran variables of type `CHARACTER` or substrings are transferred as if they were arrays of characters. This is illustrated in the example below.

#### Example 3.4 Transfer of Fortran `CHARACTER`s.

```
CHARACTER*10 a
CHARACTER*10 b

CALL MPI_COMM_RANK(comm, rank, ierr)
IF (rank .EQ. 0) THEN
  CALL MPI_SEND(a, 5, MPI_CHARACTER, 1, tag, comm, ierr)
ELSE IF (rank .EQ. 1) THEN
  CALL MPI_RECV(b(6:10), 5, MPI_CHARACTER, 0, tag, comm, status, ierr)
END IF
```

The last five characters of string `b` at process 1 are replaced by the first five characters of string `a` at process 0.

*Rationale.* The alternative choice would be for `MPI_CHARACTER` to match a character of arbitrary length. This runs into problems.

A Fortran character variable is a constant length string, with no special termination symbol. There is no fixed convention on how to represent characters, and how to store their length. Some compilers pass a character argument to a routine as a pair of arguments, one holding the address of the string and the other holding the length of string. Consider the case of an MPI communication call that is passed a communication buffer with type defined by a derived datatype (Section 4.1). If this communicator buffer contains variables of type `CHARACTER` then the information on their length will not be passed to the MPI routine.

This problem forces us to provide explicit information on character length with the MPI call. One could add a length parameter to the type `MPI_CHARACTER`, but this does not add much convenience and the same functionality can be achieved by defining a suitable derived datatype. (*End of rationale.*)

*Advice to implementors.* Some compilers pass Fortran `CHARACTER` arguments as a structure with a length and a pointer to the actual string. In such an environment,

1 the MPI call needs to dereference the pointer in order to reach the string. (*End of*  
2 *advice to implementors.*)  
3

### 4 3.3.2 Data Conversion

5  
6 One of the goals of MPI is to support parallel computations across heterogeneous environ-  
7 ments. Communication in a heterogeneous environment may require data conversions. We  
8 use the following terminology.

9 **type conversion** changes the datatype of a value, e.g., by rounding a `REAL` to an `INTEGER`.

10  
11 **representation conversion** changes the binary representation of a value, e.g., from Hex  
12 floating point to IEEE floating point.  
13

14 The type matching rules imply that MPI communication never entails type conversion.  
15 On the other hand, MPI requires that a representation conversion be performed when a  
16 typed value is transferred across environments that use different representations for the  
17 datatype of this value. MPI does not specify rules for representation conversion. Such  
18 conversion is expected to preserve integer, logical and character values, and to convert a  
19 floating point value to the nearest value that can be represented on the target system.

20 Overflow and underflow exceptions may occur during floating point conversions. Con-  
21 version of integers or characters may also lead to exceptions when a value that can be  
22 represented in one system cannot be represented in the other system. An exception occur-  
23 ring during representation conversion results in a failure of the communication. An error  
24 occurs either in the send operation, or the receive operation, or both.

25 If a value sent in a message is untyped (i.e., of type `MPI_BYTE`), then the binary  
26 representation of the byte stored at the receiver is identical to the binary representation  
27 of the byte loaded at the sender. This holds true, whether sender and receiver run in the  
28 same or in distinct environments. No representation conversion is required. (Note that  
29 representation conversion may occur when values of type `MPI_CHARACTER` or `MPI_CHAR`  
30 are transferred, for example, from an EBCDIC encoding to an ASCII encoding.)

31 No conversion need occur when an MPI program executes in a homogeneous system,  
32 where all processes run in the same environment.

33 Consider the three examples, 3.1–3.3. The first program is correct, assuming that `a` and  
34 `b` are `REAL` arrays of size  $\geq 10$ . If the sender and receiver execute in different environments,  
35 then the real values that are fetched from the send buffer will be converted to the  
36 representation for reals on the receiver site before they are stored in the receive buffer.  
37 While the number of real elements fetched from the send buffer equal the number of real  
38 elements stored in the receive buffer, the number of bytes stored need not equal the number  
39 of bytes loaded. For example, the sender may use a four byte representation and the receiver  
40 an eight byte representation for reals.

41 The second program is erroneous, and its behavior is undefined.

42 The third program is correct. The exact same sequence of forty bytes that were loaded  
43 from the send buffer will be stored in the receive buffer, even if sender and receiver run in  
44 a different environment. The message sent has exactly the same length (in bytes) and the  
45 same binary representation as the message received. If `a` and `b` are of different types, or if  
46 they are of the same type but different data representations are used, then the bits stored  
47 in the receive buffer may encode values that are different from the values they encoded in  
48 the send buffer.

Data representation conversion also applies to the envelope of a message: source, destination and tag are all integers that may need to be converted.

*Advice to implementors.* The current definition does not require messages to carry data type information. Both sender and receiver provide complete data type information. In a heterogeneous environment, one can either use a machine independent encoding such as XDR, or have the receiver convert from the sender representation to its own, or even have the sender do the conversion.

Additional type information might be added to messages in order to allow the system to detect mismatches between datatype at sender and receiver. This might be particularly useful in a slower but safer debug mode. (*End of advice to implementors.*)

MPI requires support for inter-language communication, i.e., if messages are sent by a C or C++ process and received by a Fortran process, or vice-versa. The behavior is defined in Section 18.2.

### 3.4 Communication Modes

The send call described in Section 3.2.1 is **blocking**: it does not return until the message data and envelope have been safely stored away so that the sender is free to modify the send buffer. The message might be copied directly into the matching receive buffer, or it might be copied into a temporary system buffer.

Message buffering decouples the send and receive operations. A blocking send can complete as soon as the message was buffered, even if no matching receive has been executed by the receiver. On the other hand, message buffering can be expensive, as it entails additional memory-to-memory copying, and it requires the allocation of memory for buffering. MPI offers the choice of several communication modes that allow one to control the choice of the communication protocol.

The send call described in Section 3.2.1 uses the **standard** communication mode. In this mode, it is up to MPI to decide whether outgoing messages will be buffered. MPI may buffer outgoing messages. In such a case, the send call may complete before a matching receive is invoked. On the other hand, buffer space may be unavailable, or MPI may choose not to buffer outgoing messages, for performance reasons. In this case, the send call will not complete until a matching receive has been posted, and the data has been moved to the receiver.

Thus, a send in standard mode can be started whether or not a matching receive has been posted. It may complete before a matching receive is posted. The standard mode send is *non-local*: successful completion of the send operation may depend on the occurrence of a matching receive.

*Rationale.* The reluctance of MPI to mandate whether standard sends are buffering or not stems from the desire to achieve portable programs. Since any system will run out of buffer resources as message sizes are increased, and some implementations may want to provide little buffering, MPI takes the position that correct (and therefore, portable) programs do not rely on system buffering in standard mode. Buffering may improve the performance of a correct program, but it doesn't affect the result of the program. If the user wishes to guarantee a certain amount of buffering, the user-provided buffer system of Section 3.6 should be used, along with the buffered-mode send. (*End of rationale.*)

1 There are three additional communication modes.

2 A **buffered** mode send operation can be started whether or not a matching receive  
 3 has been posted. It may complete before a matching receive is posted. However, unlike the  
 4 standard send, this operation is *local*, and its completion does not depend on the occurrence  
 5 of a matching receive. Thus, if a send is executed and no matching receive is posted, then  
 6 MPI must buffer the outgoing message, so as to allow the send call to complete. An error will  
 7 occur if there is insufficient buffer space. The amount of available buffer space is controlled  
 8 by the user — see Section 3.6. Buffer allocation by the user may be required for the buffered  
 9 mode to be effective.

10 A send that uses the **synchronous** mode can be started whether or not a matching  
 11 receive was posted. However, the send will complete successfully only if a matching receive is  
 12 posted, and the receive operation has started to receive the message sent by the synchronous  
 13 send. Thus, the completion of a synchronous send not only indicates that the send buffer  
 14 can be reused, but it also indicates that the receiver has reached a certain point in its  
 15 execution, namely that it has started executing the matching receive. If both sends and  
 16 receives are blocking operations then the use of the synchronous mode provides synchronous  
 17 communication semantics: a communication does not complete at either end before both  
 18 processes rendezvous at the communication. A send executed in this mode is *non-local*.

19 A send that uses the **ready** communication mode may be started *only* if the matching  
 20 receive is already posted. Otherwise, the operation is erroneous and its outcome is unde-  
 21 fined. On some systems, this allows the removal of a hand-shake operation that is otherwise  
 22 required and results in improved performance. The completion of the send operation does  
 23 not depend on the status of a matching receive, and merely indicates that the send buffer  
 24 can be reused. A send operation that uses the ready mode has the same semantics as a  
 25 standard send operation, or a synchronous send operation; it is merely that the sender  
 26 provides additional information to the system (namely that a matching receive is already  
 27 posted), that can save some overhead. In a correct program, therefore, a ready send could  
 28 be replaced by a standard send with no effect on the behavior of the program other than  
 29 performance.

30 Three additional send functions are provided for the three additional communication  
 31 modes. The communication mode is indicated by a one letter prefix: B for buffered, S for  
 32 synchronous, and R for ready.

33  
 34  
 35 MPI\_BSEND(buf, count, datatype, dest, tag, comm)

36	IN	buf	initial address of send buffer (choice)
37	IN	count	number of elements in send buffer (non-negative inte- 38 ger)
39	IN	datatype	datatype of each send buffer element (handle)
40	IN	dest	rank of destination (integer)
41	IN	tag	message tag (integer)
42	IN	comm	communicator (handle)
43			
44			

#### 45 C binding

46  
 47 int MPI\_Bsend(const void \*buf, int count, MPI\_Datatype datatype, int dest,  
 48 int tag, MPI\_Comm comm)

**Fortran 2008 binding**

```

MPI_Bsend(buf, count, datatype, dest, tag, comm, ierror)
    TYPE(*), DIMENSION(..), INTENT(IN) :: buf
    INTEGER, INTENT(IN) :: count, dest, tag
    TYPE(MPI_Datatype), INTENT(IN) :: datatype
    TYPE(MPI_Comm), INTENT(IN) :: comm
    INTEGER, OPTIONAL, INTENT(OUT) :: ierror

```

**Fortran binding**

```

MPI_BSEND(BUF, COUNT, DATATYPE, DEST, TAG, COMM, IERROR)
    <type> BUF(*)
    INTEGER COUNT, DATATYPE, DEST, TAG, COMM, IERROR

```

Send in buffered mode.

```

MPI_SSEND(buf, count, datatype, dest, tag, comm)

```

IN	buf	initial address of send buffer (choice)
IN	count	number of elements in send buffer (non-negative integer)
IN	datatype	datatype of each send buffer element (handle)
IN	dest	rank of destination (integer)
IN	tag	message tag (integer)
IN	comm	communicator (handle)

**C binding**

```

int MPI_Ssend(const void *buf, int count, MPI_Datatype datatype, int dest,
             int tag, MPI_Comm comm)

```

**Fortran 2008 binding**

```

MPI_Ssend(buf, count, datatype, dest, tag, comm, ierror)
    TYPE(*), DIMENSION(..), INTENT(IN) :: buf
    INTEGER, INTENT(IN) :: count, dest, tag
    TYPE(MPI_Datatype), INTENT(IN) :: datatype
    TYPE(MPI_Comm), INTENT(IN) :: comm
    INTEGER, OPTIONAL, INTENT(OUT) :: ierror

```

**Fortran binding**

```

MPI_SSEND(BUF, COUNT, DATATYPE, DEST, TAG, COMM, IERROR)
    <type> BUF(*)
    INTEGER COUNT, DATATYPE, DEST, TAG, COMM, IERROR

```

Send in synchronous mode.

```

1 MPI_RSEND(buf, count, datatype, dest, tag, comm)
2     IN      buf                initial address of send buffer (choice)
3
4     IN      count              number of elements in send buffer (non-negative integer)
5
6     IN      datatype           datatype of each send buffer element (handle)
7
8     IN      dest               rank of destination (integer)
9
10    IN      tag                 message tag (integer)
11
12    IN      comm                communicator (handle)

```

### C binding

```

13 int MPI_Rsend(const void *buf, int count, MPI_Datatype datatype, int dest,
14              int tag, MPI_Comm comm)
15

```

### Fortran 2008 binding

```

16 MPI_Rsend(buf, count, datatype, dest, tag, comm, ierror)
17     TYPE(*), DIMENSION(..), INTENT(IN) :: buf
18     INTEGER, INTENT(IN) :: count, dest, tag
19     TYPE(MPI_Datatype), INTENT(IN) :: datatype
20     TYPE(MPI_Comm), INTENT(IN) :: comm
21     INTEGER, OPTIONAL, INTENT(OUT) :: ierror
22

```

### Fortran binding

```

23 MPI_RSEND(BUF, COUNT, DATATYPE, DEST, TAG, COMM, IERROR)
24     <type> BUF(*)
25     INTEGER COUNT, DATATYPE, DEST, TAG, COMM, IERROR
26
27

```

Send in ready mode.

There is only one receive operation, but it matches any of the send modes. The receive operation described in the last section is *blocking*: it returns only after the receive buffer contains the newly received message. A receive can complete before the matching send has completed (of course, it can complete only after the matching send has started).

In a multithreaded implementation of MPI, the system may de-schedule a thread that is blocked on a send or receive operation, and schedule another thread for execution in the same address space. In such a case it is the user's responsibility not to modify a communication buffer until the communication completes. Otherwise, the outcome of the computation is undefined.

*Advice to implementors.* Since a synchronous send cannot complete before a matching receive is posted, one will not normally buffer messages sent by such an operation.

It is recommended to choose buffering over blocking the sender, whenever possible, for standard sends. The programmer can signal his or her preference for blocking the sender until a matching receive occurs by using the synchronous send mode.

A possible communication protocol for the various communication modes is outlined below.

*ready send*: The message is sent as soon as possible.



*synchronous send*: The sender sends a request-to-send message. The receiver stores this request. When a matching receive is posted, the receiver sends back a permission-to-send message, and the sender now sends the message.

*standard send*: First protocol may be used for short messages, and second protocol for long messages.

*buffered send*: The sender copies the message into a buffer and then sends it with a nonblocking send (using the same protocol as for standard send).

Additional control messages might be needed for flow control and error recovery. Of course, there are many other possible protocols.

Ready send can be implemented as a standard send. In this case there will be no performance advantage (or disadvantage) for the use of ready send.

A standard send can be implemented as a synchronous send. In such a case, no data buffering is needed. However, users may expect some buffering.

In a multithreaded environment, the execution of a blocking communication should block only the executing thread, allowing the thread scheduler to de-schedule this thread and schedule another thread for execution. (*End of advice to implementors.*)

### 3.5 Semantics of Point-to-Point Communication

A valid MPI implementation guarantees certain general properties of point-to-point communication, which are described in this section.

**Order** Messages are *non-overtaking*: If a sender sends two messages in succession to the same destination, and both match the same receive, then this operation cannot receive the second message if the first one is still pending. If a receiver posts two receives in succession, and both match the same message, then the second receive operation cannot be satisfied by this message, if the first one is still pending. This requirement facilitates matching of sends to receives. It guarantees that message-passing code is deterministic, if processes are single-threaded and the wildcard `MPI_ANY_SOURCE` is not used in receives. (Some of the calls described later, such as `MPI_CANCEL` or `MPI_WAITANY`, are additional sources of nondeterminism.)

If a process has a single thread of execution, then any two communications executed by this process are ordered. On the other hand, if the process is multithreaded, then the semantics of thread execution may not define a relative order between two send operations executed by two distinct threads. The operations are logically concurrent, even if one physically precedes the other. In such a case, the two messages sent can be received in any order. Similarly, if two receive operations that are logically concurrent receive two successively sent messages, then the two messages can match the two receives in either order.

**Example 3.5** An example of non-overtaking messages.

```

1 CALL MPI_COMM_RANK(comm, rank, ierr)
2 IF (rank .EQ. 0) THEN
3     CALL MPI_BSEND(buf1, count, MPI_REAL, 1, tag, comm, ierr)
4     CALL MPI_BSEND(buf2, count, MPI_REAL, 1, tag, comm, ierr)
5 ELSE IF (rank .EQ. 1) THEN
6     CALL MPI_RECV(buf1, count, MPI_REAL, 0, MPI_ANY_TAG, comm, status, ierr)
7     CALL MPI_RECV(buf2, count, MPI_REAL, 0, tag, comm, status, ierr)
8 END IF

```

The message sent by the first send must be received by the first receive, and the message sent by the second send must be received by the second receive.

**Progress** If a pair of matching send and receives have been initiated on two processes, then at least one of these two operations will complete, independently of other actions in the system: the send operation will complete, unless the receive is satisfied by another message, and completes; the receive operation will complete, unless the message sent is consumed by another matching receive that was posted at the same destination process.

**Example 3.6** An example of two, intertwined matching pairs.

```

20 CALL MPI_COMM_RANK(comm, rank, ierr)
21 IF (rank .EQ. 0) THEN
22     CALL MPI_BSEND(buf1, count, MPI_REAL, 1, tag1, comm, ierr)
23     CALL MPI_SSEND(buf2, count, MPI_REAL, 1, tag2, comm, ierr)
24 ELSE IF (rank .EQ. 1) THEN
25     CALL MPI_RECV(buf1, count, MPI_REAL, 0, tag2, comm, status, ierr)
26     CALL MPI_RECV(buf2, count, MPI_REAL, 0, tag1, comm, status, ierr)
27 END IF

```

Both processes invoke their first communication call. Since the first send of process zero uses the buffered mode, it must complete, irrespective of the state of process one. Since no matching receive is posted, the message will be copied into buffer space. (If insufficient buffer space is available, then the program will fail.) The second send is then invoked. At that point, a matching pair of send and receive operation is enabled, and both operations must complete. Process one next invokes its second receive call, which will be satisfied by the buffered message. Note that process one received the messages in the reverse order they were sent.

**Fairness** MPI makes no guarantee of *fairness* in the handling of communication. Suppose that a send is posted. Then it is possible that the destination process repeatedly posts a receive that matches this send, yet the message is never received, because it is each time overtaken by another message, sent from another source. Similarly, suppose that a receive was posted by a multithreaded process. Then it is possible that messages that match this receive are repeatedly received, yet the receive is never satisfied, because it is overtaken by other receives posted at this node (by other executing threads). It is the programmer's responsibility to prevent starvation in such situations.

Resource limitations Any pending communication operation consumes system resources that are limited. Errors may occur when lack of resources prevent the execution of an MPI call. A quality implementation will use a (small) fixed amount of resources for each pending send in the ready or synchronous mode and for each pending receive. However, buffer space may be consumed to store messages sent in standard mode, and must be consumed to store messages sent in buffered mode, when no matching receive is available. The amount of space available for buffering will be much smaller than program data memory on many systems. Then, it will be easy to write programs that overrun available buffer space.

MPI allows the user to provide buffer memory for messages sent in the buffered mode. Furthermore, MPI specifies a detailed operational model for the use of this buffer. An MPI implementation is required to do no worse than implied by this model. This allows users to avoid buffer overflows when they use buffered sends. Buffer allocation and use is described in Section 3.6.

A buffered send operation that cannot complete because of a lack of buffer space is erroneous. When such a situation is detected, an error is signaled that may cause the program to terminate abnormally. On the other hand, a standard send operation that cannot complete because of lack of buffer space will merely block, waiting for buffer space to become available or for a matching receive to be posted. This behavior is preferable in many situations. Consider a situation where a producer repeatedly produces new values and sends them to a consumer. Assume that the producer produces new values faster than the consumer can consume them. If buffered sends are used, then a buffer overflow will result. Additional synchronization has to be added to the program so as to prevent this from occurring. If standard sends are used, then the producer will be automatically throttled, as its send operations will block when buffer space is unavailable.

In some situations, a lack of buffer space leads to deadlock situations. This is illustrated by the examples below.

**Example 3.7** An exchange of messages.

```
CALL MPI_COMM_RANK(comm, rank, ierr)
IF (rank .EQ. 0) THEN
  CALL MPI_SEND(sendbuf, count, MPI_REAL, 1, tag, comm, ierr)
  CALL MPI_RECV(recvbuf, count, MPI_REAL, 1, tag, comm, status, ierr)
ELSE IF (rank .EQ. 1) THEN
  CALL MPI_RECV(recvbuf, count, MPI_REAL, 0, tag, comm, status, ierr)
  CALL MPI_SEND(sendbuf, count, MPI_REAL, 0, tag, comm, ierr)
END IF
```

This program will succeed even if no buffer space for data is available. The standard send operation can be replaced, in this example, with a synchronous send.

**Example 3.8** An errant attempt to exchange messages.

```
CALL MPI_COMM_RANK(comm, rank, ierr)
IF (rank .EQ. 0) THEN
  CALL MPI_RECV(recvbuf, count, MPI_REAL, 1, tag, comm, status, ierr)
  CALL MPI_SEND(sendbuf, count, MPI_REAL, 1, tag, comm, ierr)
ELSE IF (rank .EQ. 1) THEN
  CALL MPI_RECV(recvbuf, count, MPI_REAL, 0, tag, comm, status, ierr)
```

```

1 CALL MPI_SEND(sendbuf, count, MPI_REAL, 0, tag, comm, ierr)
2 END IF

```

The receive operation of the first process must complete before its send, and can complete only if the matching send of the second processor is executed. The receive operation of the second process must complete before its send and can complete only if the matching send of the first process is executed. This program will always deadlock. The same holds for any other send mode.

**Example 3.9** An exchange that relies on buffering.

```

9 CALL MPI_COMM_RANK(comm, rank, ierr)
10
11 CALL MPI_COMM_RANK(comm, rank, ierr)
12 IF (rank .EQ. 0) THEN
13 CALL MPI_SEND(sendbuf, count, MPI_REAL, 1, tag, comm, ierr)
14 CALL MPI_RECV(recvbuf, count, MPI_REAL, 1, tag, comm, status, ierr)
15 ELSE IF (rank .EQ. 1) THEN
16 CALL MPI_SEND(sendbuf, count, MPI_REAL, 0, tag, comm, ierr)
17 CALL MPI_RECV(recvbuf, count, MPI_REAL, 0, tag, comm, status, ierr)
18 END IF

```

The message sent by each process has to be copied out before the send operation returns and the receive operation starts. For the program to complete, it is necessary that at least one of the two messages sent be buffered. Thus, this program can succeed only if the communication system can buffer at least `count` words of data.

*Advice to users.* When standard send operations are used, then a deadlock situation may occur where both processes are blocked because buffer space is not available. The same will certainly happen, if the synchronous mode is used. If the buffered mode is used, and not enough buffer space is available, then the program will not complete either. However, rather than a deadlock situation, we shall have a buffer overflow error.

A program is “safe” if no message buffering is required for the program to complete. One can replace all sends in such program with synchronous sends, and the program will still run correctly. This conservative programming style provides the best portability, since program completion does not depend on the amount of buffer space available or on the communication protocol used.

Many programmers prefer to have more leeway and opt to use the “unsafe” programming style shown in Example 3.9. In such cases, the use of standard sends is likely to provide the best compromise between performance and robustness: quality implementations will provide sufficient buffering so that “common practice” programs will not deadlock. The buffered send mode can be used for programs that require more buffering, or in situations where the programmer wants more control. This mode might also be used for debugging purposes, as buffer overflow conditions are easier to diagnose than deadlock conditions.

Nonblocking message-passing operations, as described in Section 3.7, can be used to avoid the need for buffering outgoing messages. This prevents deadlocks due to lack of buffer space, and improves performance, by allowing overlap of computation and communication, and avoiding the overheads of allocating buffers and copying messages into buffers. (*End of advice to users.*)

## 3.6 Buffer Allocation and Usage

A user may specify a buffer to be used for buffering messages sent in buffered mode. Buffering is done by the sender.

`MPI_BUFFER_ATTACH(buffer, size)`

IN	buffer	initial buffer address (choice)
IN	size	buffer size, in bytes (non-negative integer)

### C binding

```
int MPI_Buffer_attach(void *buffer, int size)
```

### Fortran 2008 binding

```
MPI_Buffer_attach(buffer, size, ierror)
    TYPE(*), DIMENSION(..), ASYNCHRONOUS :: buffer
    INTEGER, INTENT(IN) :: size
    INTEGER, OPTIONAL, INTENT(OUT) :: ierror
```

### Fortran binding

```
MPI_BUFFER_ATTACH(BUFFER, SIZE, IERROR)
    <type> BUFFER(*)
    INTEGER SIZE, IERROR
```

Provides to MPI a buffer in the user's memory to be used for buffering outgoing messages. The buffer is used only by messages sent in buffered mode. Only one buffer can be attached to a process at a time. In C, `buffer` is the starting address of a memory region. In Fortran, one can pass the first element of a memory region or a whole array, which must be 'simply contiguous' (for 'simply contiguous,' see also Section 18.1.12).

`MPI_BUFFER_DETACH(buffer_addr, size)`

OUT	buffer_addr	initial buffer address (choice)
OUT	size	buffer size, in bytes (non-negative integer)

### C binding

```
int MPI_Buffer_detach(void *buffer_addr, int *size)
```

### Fortran 2008 binding

```
MPI_Buffer_detach(buffer_addr, size, ierror)
    USE, INTRINSIC :: ISO_C_BINDING, ONLY : C_PTR
    TYPE(C_PTR), INTENT(OUT) :: buffer_addr
    INTEGER, INTENT(OUT) :: size
    INTEGER, OPTIONAL, INTENT(OUT) :: ierror
```

### Fortran binding

```
MPI_BUFFER_DETACH(BUFFER_ADDR, SIZE, IERROR)
    <type> BUFFER_ADDR(*)
    INTEGER SIZE, IERROR
```

1 Detach the buffer currently associated with MPI. The call returns the address and the  
 2 size of the detached buffer. This operation will block until all messages currently in the  
 3 buffer have been transmitted. Upon return of this function, the user may reuse or deallocate  
 4 the space taken by the buffer.

5  
 6 **Example 3.10** Calls to attach and detach buffers.

```
7
8 #define BUFFSIZE 10000
9 int size;
10 char *buff;
11 MPI_Buffer_attach(malloc(BUFFSIZE), BUFFSIZE);
12 /* a buffer of 10000 bytes can now be used by MPI_Bsend */
13 MPI_Buffer_detach(&buff, &size);
14 /* Buffer size reduced to zero */
15 MPI_Buffer_attach(buff, size);
16 /* Buffer of 10000 bytes available again */
```

17 *Advice to users.* Even though the C functions `MPI_Buffer_attach` and  
 18 `MPI_Buffer_detach` both have a first argument of type `void*`, these arguments are  
 19 used differently: A pointer to the buffer is passed to `MPI_Buffer_attach`; the address  
 20 of the pointer is passed to `MPI_Buffer_detach`, so that this call can return the pointer  
 21 value. In Fortran with the `mpi` module or `mpif.h`, the type of the `buffer_addr` argument  
 22 is wrongly defined and the argument is therefore unused. In Fortran with the `mpi_f08`  
 23 module, the address of the buffer is returned as `TYPE(C_PTR)`, see also Example 8.1  
 24 about the use of `C_PTR` pointers. (*End of advice to users.*)

25  
 26 *Rationale.* Both arguments are defined to be of type `void*` (rather than `void*` and  
 27 `void**`, respectively), so as to avoid complex type casts. E.g., in the last example,  
 28 `&buff`, which is of type `char**`, can be passed as argument to `MPI_Buffer_detach`  
 29 without type casting. If the formal parameter had type `void**` then we would need  
 30 a type cast before and after the call. (*End of rationale.*)

31  
 32 The statements made in this section describe the behavior of MPI for buffered-mode  
 33 sends. When no buffer is currently associated, MPI behaves as if a zero-sized buffer is  
 34 associated with the process.

35 MPI must provide as much buffering for outgoing messages *as if* outgoing message  
 36 data were buffered by the sending process, in the specified buffer space, using a circular,  
 37 contiguous-space allocation policy. We outline below a model implementation that defines  
 38 this policy. MPI may provide more buffering, and may use a better buffer allocation algo-  
 39 rithm than described below. On the other hand, MPI may signal an error whenever the  
 40 simple buffering allocator described below would run out of space. In particular, if no buffer  
 41 is explicitly associated with the process, then any buffered send may cause an error.

42 MPI does not provide mechanisms for querying or controlling buffering done by standard  
 43 mode sends. It is expected that vendors will provide such information for their implemen-  
 44 tations.

45  
 46 *Rationale.* There is a wide spectrum of possible implementations of buffered com-  
 47 munication: buffering can be done at sender, at receiver, or both; buffers can be  
 48 dedicated to one sender-receiver pair, or be shared by all communications; buffering

can be done in real or in virtual memory; it can use dedicated memory, or memory shared by other processes; buffer space may be allocated statically or be changed dynamically; etc. It does not seem feasible to provide a portable mechanism for querying or controlling buffering that would be compatible with all these choices, yet provide meaningful information. (*End of rationale.*)

### 3.6.1 Model Implementation of Buffered Mode

The model implementation uses the packing and unpacking functions described in Section 4.2 and the nonblocking communication functions described in Section 3.7.

We assume that a circular queue of pending message entries (PME) is maintained. Each entry contains a communication request handle that identifies a pending nonblocking send, a pointer to the next entry and the packed message data. The entries are stored in successive locations in the buffer. Free space is available between the queue tail and the queue head.

A buffered send call results in the execution of the following code.

- Traverse sequentially the PME queue from head towards the tail, deleting all entries for communications that have completed, up to the first entry with an uncompleted request; update queue head to point to that entry.
- Compute the number,  $n$ , of bytes needed to store an entry for the new message. An upper bound on  $n$  can be computed as follows: A call to the function `MPI_PACK_SIZE(count, datatype, comm, size)`, with the `count`, `datatype` and `comm` arguments used in the `MPI_BSEND` call, returns an upper bound on the amount of space needed to buffer the message data (see Section 4.2). The MPI constant `MPI_BSEND_OVERHEAD` provides an upper bound on the additional space consumed by the entry (e.g., for pointers or envelope information).
- Find the next contiguous empty space of  $n$  bytes in buffer (space following queue tail, or space at start of buffer if queue tail is too close to end of buffer). If space is not found then raise buffer overflow error.
- Append to end of PME queue in contiguous space the new entry that contains request handle, next pointer and packed message data; `MPI_PACK` is used to pack data.
- Post nonblocking send (standard mode) for packed data.
- Return

## 3.7 Nonblocking Communication

One can improve performance on many systems by overlapping communication and computation. This is especially true on systems where communication can be executed autonomously by an intelligent communication controller. Light-weight threads are one mechanism for achieving such overlap. An alternative mechanism that often leads to better performance is to use **nonblocking communication**. A nonblocking **send start** call initiates the send operation, but does not complete it. The send start call can return before the message was copied out of the send buffer. A separate **send complete** call is needed to complete the communication, i.e., to verify that the data has been copied out of the send

1 buffer. With suitable hardware, the transfer of data out of the sender memory may proceed  
2 concurrently with computations done at the sender after the send was initiated and before it  
3 completed. Similarly, a nonblocking **receive start call** initiates the receive operation, but  
4 does not complete it. The call can return before a message is stored into the receive buffer.  
5 A separate **receive complete** call is needed to complete the receive operation and verify  
6 that the data has been received into the receive buffer. With suitable hardware, the transfer  
7 of data into the receiver memory may proceed concurrently with computations done after  
8 the receive was initiated and before it completed. The use of nonblocking receives may also  
9 avoid system buffering and memory-to-memory copying, as information is provided early  
10 on the location of the receive buffer.

11 Nonblocking send start calls can use the same four modes as blocking sends: *standard*,  
12 *buffered*, *synchronous* and *ready*. These carry the same meaning. Sends of all modes, *ready*  
13 excepted, can be started whether a matching receive has been posted or not; a nonblocking  
14 **ready** send can be started only if a matching receive is posted. In all cases, the send start  
15 call is local: it returns immediately, irrespective of the status of other processes. If the call  
16 causes some system resource to be exhausted, then it will fail and return an error code.  
17 Quality implementations of MPI should ensure that this happens only in “pathological”  
18 cases. That is, an MPI implementation should be able to support a large number of pending  
19 nonblocking operations.

20 The send-complete call returns when data has been copied out of the send buffer. It  
21 may carry additional meaning, depending on the send mode.

22 If the send mode is **synchronous**, then the send can complete only if a matching receive  
23 has started. That is, a receive has been posted, and has been matched with the send. In  
24 this case, the send-complete call is non-local. Note that a synchronous, nonblocking send  
25 may complete, if matched by a nonblocking receive, before the receive complete call occurs.  
26 (It can complete as soon as the sender “knows” the transfer will complete, but before the  
27 receiver “knows” the transfer will complete.)

28 If the send mode is **buffered** then the message must be buffered if there is no pending  
29 receive. In this case, the send-complete call is local, and must succeed irrespective of the  
30 status of a matching receive.

31 If the send mode is **standard** then the send-complete call may return before a matching  
32 receive is posted, if the message is buffered. On the other hand, the receive-complete may  
33 not complete until a matching receive is posted, and the message was copied into the receive  
34 buffer.

35 Nonblocking sends can be matched with blocking receives, and vice-versa.

36  
37 *Advice to users.* The completion of a send operation may be delayed, for standard  
38 mode, and must be delayed, for synchronous mode, until a matching receive is posted.  
39 The use of nonblocking sends in these two cases allows the sender to proceed ahead  
40 of the receiver, so that the computation is more tolerant of fluctuations in the speeds  
41 of the two processes.

42 Nonblocking sends in the buffered and ready modes have a more limited impact, e.g.,  
43 the blocking version of buffered send is capable of completing regardless of when a  
44 matching receive call is made. However, separating the start from the completion  
45 of these sends still gives some opportunity for optimization within the MPI library.  
46 For example, starting a buffered send gives an implementation more flexibility in  
47 determining if and how the message is buffered. There are also advantages for both  
48



nonblocking buffered and ready modes when data copying can be done concurrently with computation.

The message-passing model implies that communication is initiated by the sender. The communication will generally have lower overhead if a receive is already posted when the sender initiates the communication (data can be moved directly to the receive buffer, and there is no need to queue a pending send request). However, a receive operation can complete only after the matching send has occurred. The use of nonblocking receives allows one to achieve lower communication overheads without blocking the receiver while it waits for the send. (*End of advice to users.*)

### 3.7.1 Communication Request Objects

Nonblocking communications use opaque **request** objects to identify communication operations and match the operation that initiates the communication with the operation that terminates it. These are system objects that are accessed via a handle. A request object identifies various properties of a communication operation, such as the send mode, the communication buffer that is associated with it, its context, the tag and destination arguments to be used for a send, or the tag and source arguments to be used for a receive. In addition, this object stores information about the status of the pending communication operation.

### 3.7.2 Communication Initiation

We use the same naming conventions as for blocking communication: a prefix of B, S, or R is used for **buffered**, **synchronous** or **ready** mode. In addition a prefix of I (for **immediate**) indicates that the call is nonblocking.

`MPI_ISEND(buf, count, datatype, dest, tag, comm, request)`

IN	<code>buf</code>	initial address of send buffer (choice)
IN	<code>count</code>	number of elements in send buffer (non-negative integer)
IN	<code>datatype</code>	datatype of each send buffer element (handle)
IN	<code>dest</code>	rank of destination (integer)
IN	<code>tag</code>	message tag (integer)
IN	<code>comm</code>	communicator (handle)
OUT	<code>request</code>	communication request (handle)

#### C binding

```
int MPI_Isend(const void *buf, int count, MPI_Datatype datatype, int dest,
             int tag, MPI_Comm comm, MPI_Request *request)
```

#### Fortran 2008 binding

```
MPI_Isend(buf, count, datatype, dest, tag, comm, request, ierror)
  TYPE(*), DIMENSION(..), INTENT(IN), ASYNCHRONOUS :: buf
  INTEGER, INTENT(IN) :: count, dest, tag
  TYPE(MPI_Datatype), INTENT(IN) :: datatype
```

```

1     TYPE(MPI_Comm), INTENT(IN) :: comm
2     TYPE(MPI_Request), INTENT(OUT) :: request
3     INTEGER, OPTIONAL, INTENT(OUT) :: ierror

```

#### Fortran binding

```

6 MPI_ISEND(BUF, COUNT, DATATYPE, DEST, TAG, COMM, REQUEST, IERROR)
7     <type> BUF(*)
8     INTEGER COUNT, DATATYPE, DEST, TAG, COMM, REQUEST, IERROR

```

9 Start a standard mode, nonblocking send.

```

11 MPI_IBSEND(buf, count, datatype, dest, tag, comm, request)
12
13 IN     buf                initial address of send buffer (choice)
14 IN     count              number of elements in send buffer (non-negative inte-
15                                     ger)
16
17 IN     datatype           datatype of each send buffer element (handle)
18 IN     dest               rank of destination (integer)
19 IN     tag                message tag (integer)
20 IN     comm               communicator (handle)
21 IN     request            communication request (handle)
22 OUT
23

```

#### C binding

```

25 int MPI_Ibsend(const void *buf, int count, MPI_Datatype datatype, int dest,
26               int tag, MPI_Comm comm, MPI_Request *request)
27

```

#### Fortran 2008 binding

```

29 MPI_Ibsend(buf, count, datatype, dest, tag, comm, request, ierror)
30     TYPE(*), DIMENSION(..), INTENT(IN), ASYNCHRONOUS :: buf
31     INTEGER, INTENT(IN) :: count, dest, tag
32     TYPE(MPI_Datatype), INTENT(IN) :: datatype
33     TYPE(MPI_Comm), INTENT(IN) :: comm
34     TYPE(MPI_Request), INTENT(OUT) :: request
35     INTEGER, OPTIONAL, INTENT(OUT) :: ierror

```

#### Fortran binding

```

37 MPI_IBSEND(BUF, COUNT, DATATYPE, DEST, TAG, COMM, REQUEST, IERROR)
38     <type> BUF(*)
39     INTEGER COUNT, DATATYPE, DEST, TAG, COMM, REQUEST, IERROR

```

41 Start a buffered mode, nonblocking send.

```

42
43
44
45
46
47
48

```

MPI_ISSEND(buf, count, datatype, dest, tag, comm, request)			1
IN	buf	initial address of send buffer (choice)	2
IN	count	number of elements in send buffer (non-negative integer)	3
			4
			5
IN	datatype	datatype of each send buffer element (handle)	6
IN	dest	rank of destination (integer)	7
IN	tag	message tag (integer)	8
IN	comm	communicator (handle)	9
IN	comm	communicator (handle)	10
OUT	request	communication request (handle)	11
			12

**C binding**

```
int MPI_Issend(const void *buf, int count, MPI_Datatype datatype, int dest,
              int tag, MPI_Comm comm, MPI_Request *request)
```

**Fortran 2008 binding**

```
MPI_Issend(buf, count, datatype, dest, tag, comm, request, ierror)
  TYPE(*), DIMENSION(..), INTENT(IN), ASYNCHRONOUS :: buf
  INTEGER, INTENT(IN) :: count, dest, tag
  TYPE(MPI_Datatype), INTENT(IN) :: datatype
  TYPE(MPI_Comm), INTENT(IN) :: comm
  TYPE(MPI_Request), INTENT(OUT) :: request
  INTEGER, OPTIONAL, INTENT(OUT) :: ierror
```

**Fortran binding**

```
MPI_ISSEND(BUF, COUNT, DATATYPE, DEST, TAG, COMM, REQUEST, IERROR)
  <type> BUF(*)
  INTEGER COUNT, DATATYPE, DEST, TAG, COMM, REQUEST, IERROR
```

Start a synchronous mode, nonblocking send.

```
MPI_IRSEND(buf, count, datatype, dest, tag, comm, request)
```

IN	buf	initial address of send buffer (choice)	34
IN	count	number of elements in send buffer (non-negative integer)	35
			36
			37
IN	datatype	datatype of each send buffer element (handle)	38
IN	dest	rank of destination (integer)	39
IN	tag	message tag (integer)	40
IN	comm	communicator (handle)	41
IN	comm	communicator (handle)	42
OUT	request	communication request (handle)	43
			44

**C binding**

```
int MPI_Irsend(const void *buf, int count, MPI_Datatype datatype, int dest,
              int tag, MPI_Comm comm, MPI_Request *request)
```

**Fortran 2008 binding**

```

1 MPI_Irsend(buf, count, datatype, dest, tag, comm, request, ierror)
2     TYPE(*), DIMENSION(..), INTENT(IN), ASYNCHRONOUS :: buf
3     INTEGER, INTENT(IN) :: count, dest, tag
4     TYPE(MPI_Datatype), INTENT(IN) :: datatype
5     TYPE(MPI_Comm), INTENT(IN) :: comm
6     TYPE(MPI_Request), INTENT(OUT) :: request
7     INTEGER, OPTIONAL, INTENT(OUT) :: ierror

```

**Fortran binding**

```

10 MPI_IRSEND(BUF, COUNT, DATATYPE, DEST, TAG, COMM, REQUEST, IERROR)
11     <type> BUF(*)
12     INTEGER COUNT, DATATYPE, DEST, TAG, COMM, REQUEST, IERROR

```

14 Start a ready mode nonblocking send.

```

17 MPI_Irecv(buf, count, datatype, source, tag, comm, request)

```

18	OUT	buf	initial address of receive buffer (choice)
19	IN	count	number of elements in receive buffer (non-negative integer)
20			
21	IN	datatype	datatype of each receive buffer element (handle)
22	IN	source	rank of source or MPI_ANY_SOURCE (integer)
23	IN	tag	message tag or MPI_ANY_TAG (integer)
24	IN	comm	communicator (handle)
25	OUT	request	communication request (handle)
26			
27			
28			

**C binding**

```

30 int MPI_Irecv(void *buf, int count, MPI_Datatype datatype, int source,
31             int tag, MPI_Comm comm, MPI_Request *request)

```

**Fortran 2008 binding**

```

34 MPI_Irecv(buf, count, datatype, source, tag, comm, request, ierror)
35     TYPE(*), DIMENSION(..), ASYNCHRONOUS :: buf
36     INTEGER, INTENT(IN) :: count, source, tag
37     TYPE(MPI_Datatype), INTENT(IN) :: datatype
38     TYPE(MPI_Comm), INTENT(IN) :: comm
39     TYPE(MPI_Request), INTENT(OUT) :: request
40     INTEGER, OPTIONAL, INTENT(OUT) :: ierror

```

**Fortran binding**

```

42 MPI_Irecv(BUF, COUNT, DATATYPE, SOURCE, TAG, COMM, REQUEST, IERROR)
43     <type> BUF(*)
44     INTEGER COUNT, DATATYPE, SOURCE, TAG, COMM, REQUEST, IERROR

```

46 Start a nonblocking receive.

47 These calls allocate a communication request object and associate it with the request  
48 handle (the argument request). The request can be used later to query the status of the

communication or wait for its completion.

A nonblocking send call indicates that the system may start copying data out of the send buffer. The sender should not modify any part of the send buffer after a nonblocking send operation is called, until the send completes.

A nonblocking receive call indicates that the system may start writing data into the receive buffer. The receiver should not access any part of the receive buffer after a nonblocking receive operation is called, until the receive completes.

*Advice to users.* To prevent problems with the argument copying and register optimization done by Fortran compilers, please note the hints in Sections 18.1.10–18.1.20. (*End of advice to users.*)

### 3.7.3 Communication Completion

The functions `MPI_WAIT` and `MPI_TEST` are used to complete a nonblocking communication. The completion of a send operation indicates that the sender is now free to update the locations in the send buffer (the send operation itself leaves the content of the send buffer unchanged). It does not indicate that the message has been received, rather, it may have been buffered by the communication subsystem. However, if a **synchronous** mode send was used, the completion of the send operation indicates that a matching receive was initiated, and that the message will eventually be received by this matching receive.

The completion of a receive operation indicates that the receive buffer contains the received message, the receiver is now free to access it, and that the status object is set. It does not indicate that the matching send operation has completed (but indicates, of course, that the send was initiated).

We shall use the following terminology: A **null handle** is a handle with value `MPI_REQUEST_NULL`. A persistent request and the handle to it are **inactive** if the request is not associated with any ongoing communication (see Section 3.9). A handle is **active** if it is neither null nor inactive. An **empty** status is a status which is set to return `tag = MPI_ANY_TAG`, `source = MPI_ANY_SOURCE`, `error = MPI_SUCCESS`, and is also internally configured so that calls to `MPI_GET_COUNT`, `MPI_GET_ELEMENTS`, and `MPI_GET_ELEMENTS_X` return `count = 0` and `MPI_TEST_CANCELLED` returns false. We set a status variable to empty when the value returned by it is not significant. Status is set in this way so as to prevent errors due to accesses of stale information.

The fields in a status object returned by a call to `MPI_WAIT`, `MPI_TEST`, or any of the other derived functions (`MPI_{TEST|WAIT}{ALL|SOME|ANY}`), where the request corresponds to a send call, are undefined, with two exceptions: The error status field will contain valid information if the wait or test call returned with `MPI_ERR_IN_STATUS`; and the returned status can be queried by the call `MPI_TEST_CANCELLED`.

Error codes belonging to the error class `MPI_ERR_IN_STATUS` should be returned only by the MPI completion functions that take arrays of `MPI_Status`. For the functions that take a single `MPI_Status` argument, the error code is returned by the function, and the value of the `MPI_ERROR` field in the `MPI_Status` argument is undefined (see 3.2.5).

```

1 MPI_WAIT(request, status)
2     INOUT    request                request (handle)
3
4     OUT     status                  status object (Status)

```

### C binding

```

7 int MPI_Wait(MPI_Request *request, MPI_Status *status)

```

### Fortran 2008 binding

```

9 MPI_Wait(request, status, ierror)
10     TYPE(MPI_Request), INTENT(INOUT) :: request
11     TYPE(MPI_Status) :: status
12     INTEGER, OPTIONAL, INTENT(OUT) :: ierror

```

### Fortran binding

```

15 MPI_WAIT(REQUEST, STATUS, IERROR)
16     INTEGER REQUEST, STATUS(MPI_STATUS_SIZE), IERROR

```

A call to `MPI_WAIT` returns when the operation identified by `request` is complete. If the request is an active persistent request, it is marked inactive. Any other type of request is deallocated and the request handle is set to `MPI_REQUEST_NULL`. `MPI_WAIT` is a non-local operation.

The call returns, in `status`, information on the completed operation. The content of the status object for a receive operation can be accessed as described in Section 3.2.5. The status object for a send operation may be queried by a call to `MPI_TEST_CANCELLED` (see Section 3.8).

One is allowed to call `MPI_WAIT` with a null or inactive request argument. In this case the operation returns immediately with empty `status`.

*Advice to users.* Successful return of `MPI_WAIT` after a `MPI_IBSEND` implies that the user send buffer can be reused — i.e., data has been sent out or copied into a buffer attached with `MPI_BUFFER_ATTACH`. Note that, at this point, we can no longer cancel the send (see Section 3.8). If a matching receive is never posted, then the buffer cannot be freed. This runs somewhat counter to the stated goal of `MPI_CANCEL` (always being able to free program space that was committed to the communication subsystem). (*End of advice to users.*)

*Advice to implementors.* In a multithreaded environment, a call to `MPI_WAIT` should block only the calling thread, allowing the thread scheduler to schedule another thread for execution. (*End of advice to implementors.*)

```

41 MPI_TEST(request, flag, status)
42
43     INOUT    request                communication request (handle)
44
45     OUT     flag                    true if operation completed (logical)
46
47     OUT     status                  status object (Status)

```

### C binding

```
int MPI_Test(MPI_Request *request, int *flag, MPI_Status *status)
```

#### Fortran 2008 binding

```
MPI_Test(request, flag, status, ierror)
  TYPE(MPI_Request), INTENT(INOUT) :: request
  LOGICAL, INTENT(OUT) :: flag
  TYPE(MPI_Status) :: status
  INTEGER, OPTIONAL, INTENT(OUT) :: ierror
```

#### Fortran binding

```
MPI_TEST(REQUEST, FLAG, STATUS, IERROR)
  INTEGER REQUEST, STATUS(MPI_STATUS_SIZE), IERROR
  LOGICAL FLAG
```

A call to `MPI_TEST` returns `flag = true` if the operation identified by `request` is complete. In such a case, the status object is set to contain information on the completed operation. If the request is an active persistent request, it is marked as inactive. Any other type of request is deallocated and the request handle is set to `MPI_REQUEST_NULL`. The call returns `flag = false` if the operation identified by `request` is not complete. In this case, the value of the status object is undefined. `MPI_TEST` is a local operation.

The return status object for a receive operation carries information that can be accessed as described in Section 3.2.5. The status object for a send operation carries information that can be accessed by a call to `MPI_TEST_CANCELLED` (see Section 3.8).

One is allowed to call `MPI_TEST` with a null or inactive `request` argument. In such a case the operation returns with `flag = true` and empty `status`.

The functions `MPI_WAIT` and `MPI_TEST` can be used to complete both sends and receives.

*Advice to users.* The use of the nonblocking `MPI_TEST` call allows the user to schedule alternative activities within a single thread of execution. An event-driven thread scheduler can be emulated with periodic calls to `MPI_TEST`. (*End of advice to users.*)

#### Example 3.11 Simple usage of nonblocking operations and `MPI_WAIT`.

```
CALL MPI_COMM_RANK(comm, rank, ierr)
IF (rank .EQ. 0) THEN
  CALL MPI_ISEND(a(1), 10, MPI_REAL, 1, tag, comm, request, ierr)
  **** do some computation to mask latency ****
  CALL MPI_WAIT(request, status, ierr)
ELSE IF (rank .EQ. 1) THEN
  CALL MPI_IRECV(a(1), 15, MPI_REAL, 0, tag, comm, request, ierr)
  **** do some computation to mask latency ****
  CALL MPI_WAIT(request, status, ierr)
END IF
```

A request object can be deallocated by using the following operation.

```

1 MPI_REQUEST_FREE(request)
2     INOUT    request                communication request (handle)
3

```

### C binding

```

4
5 int MPI_Request_free(MPI_Request *request)
6

```

### Fortran 2008 binding

```

7
8 MPI_Request_free(request, ierror)
9     TYPE(MPI_Request), INTENT(INOUT) :: request
10    INTEGER, OPTIONAL, INTENT(OUT) :: ierror
11

```

### Fortran binding

```

12 MPI_REQUEST_FREE(REQUEST, IERROR)
13     INTEGER REQUEST, IERROR
14

```

MPI\_REQUEST\_FREE is a local operation that marks the request object for deallocation and sets request to MPI\_REQUEST\_NULL. Ongoing communication, if any, that is associated with the request will be allowed to complete. The request will be deallocated only after its completion. Classes of operations described later in the standard, such as nonblocking collective and persistent collective (see Chapters 5 and 7), also use request objects. In the case of nonblocking collective operations and persistent collective operations, it is erroneous to call MPI\_REQUEST\_FREE unless the request is inactive.

*Rationale.* For point-to-point operations, the MPI\_REQUEST\_FREE mechanism is provided for reasons of performance and convenience on the sending side. (*End of rationale.*)

*Advice to users.* Once a request is freed by a call to MPI\_REQUEST\_FREE, it is not possible to check for the successful completion of the associated communication with calls to MPI\_WAIT or MPI\_TEST. Also, if an error occurs subsequently during the communication, an error code cannot be returned to the user — such an error must be treated as fatal. An active receive request should never be freed as the receiver will have no way to verify that the receive has completed and the receive buffer can be reused. (*End of advice to users.*)

**Example 3.12** An example using MPI\_REQUEST\_FREE.

```

35
36 CALL MPI_COMM_RANK(MPI_COMM_WORLD, rank, ierr)
37
38 IF (rank .EQ. 0) THEN
39     DO i=1,n
40         CALL MPI_ISEND(outval, 1, MPI_REAL, 1, 0, MPI_COMM_WORLD, req, ierr)
41         CALL MPI_REQUEST_FREE(req, ierr)
42         CALL MPI_IRECV(inval, 1, MPI_REAL, 1, 0, MPI_COMM_WORLD, req, ierr)
43         CALL MPI_WAIT(req, status, ierr)
44     END DO
45 ELSE IF (rank .EQ. 1) THEN
46     CALL MPI_IRECV(inval, 1, MPI_REAL, 0, 0, MPI_COMM_WORLD, req, ierr)
47     CALL MPI_WAIT(req, status, ierr)
48

```



```

DO I=1,n-1
  CALL MPI_ISEND(outval, 1, MPI_REAL, 0, 0, MPI_COMM_WORLD, req, ierr)
  CALL MPI_REQUEST_FREE(req, ierr)
  CALL MPI_Irecv(ival, 1, MPI_REAL, 0, 0, MPI_COMM_WORLD, req, ierr)
  CALL MPI_WAIT(req, status, ierr)
END DO
CALL MPI_ISEND(outval, 1, MPI_REAL, 0, 0, MPI_COMM_WORLD, req, ierr)
CALL MPI_WAIT(req, status, ierr)
END IF

```

### 3.7.4 Semantics of Nonblocking Communications

The semantics of nonblocking communication is defined by suitably extending the definitions in Section 3.5.

**Order** Nonblocking communication operations are ordered according to the execution order of the calls that initiate the communication. The non-overtaking requirement of Section 3.5 is extended to nonblocking communication, with this definition of order being used.

**Example 3.13** Message ordering for nonblocking operations.

```

CALL MPI_COMM_RANK(comm, rank, ierr)
IF (RANK .EQ. 0) THEN
  CALL MPI_ISEND(a, 1, MPI_REAL, 1, 0, comm, r1, ierr)
  CALL MPI_ISEND(b, 1, MPI_REAL, 1, 0, comm, r2, ierr)
ELSE IF (rank .EQ. 1) THEN
  CALL MPI_Irecv(a, 1, MPI_REAL, 0, MPI_ANY_TAG, comm, r1, ierr)
  CALL MPI_Irecv(b, 1, MPI_REAL, 0, 0, comm, r2, ierr)
END IF
CALL MPI_WAIT(r1, status, ierr)
CALL MPI_WAIT(r2, status, ierr)

```

The first send of process zero will match the first receive of process one, even if both messages are sent before process one executes either receive.

**Progress** A call to `MPI_WAIT` that completes a receive will eventually terminate and return if a matching send has been started, unless the send is satisfied by another receive. In particular, if the matching send is nonblocking, then the receive should complete even if no call is executed by the sender to complete the send. Similarly, a call to `MPI_WAIT` that completes a send will eventually return if a matching receive has been started, unless the receive is satisfied by another send, and even if no call is executed to complete the receive.

**Example 3.14** An illustration of progress semantics.

```

1 CALL MPI_COMM_RANK(comm, rank, ierr)
2 IF (RANK .EQ. 0) THEN
3     CALL MPI_SSEND(a, 1, MPI_REAL, 1, 0, comm, ierr)
4     CALL MPI_SEND(b, 1, MPI_REAL, 1, 1, comm, ierr)
5 ELSE IF (rank .EQ. 1) THEN
6     CALL MPI_IRecv(a, 1, MPI_REAL, 0, 0, comm, r, ierr)
7     CALL MPI_RECV(b, 1, MPI_REAL, 0, 1, comm, status, ierr)
8     CALL MPI_WAIT(r, status, ierr)
9 END IF

```

This code should not deadlock in a correct MPI implementation. The first synchronous send of process zero must complete after process one posts the matching (nonblocking) receive even if process one has not yet reached the completing wait call. Thus, process zero will continue and execute the second send, allowing process one to complete execution.

If an `MPI_TEST` that completes a receive is repeatedly called with the same arguments, and a matching send has been started, then the call will eventually return `flag = true`, unless the send is satisfied by another receive. If an `MPI_TEST` that completes a send is repeatedly called with the same arguments, and a matching receive has been started, then the call will eventually return `flag = true`, unless the receive is satisfied by another send.

### 3.7.5 Multiple Completions

It is convenient to be able to wait for the completion of any, some, or all the operations in a list, rather than having to wait for a specific message. A call to `MPI_WAITANY` or `MPI_TESTANY` can be used to wait for the completion of one out of several operations. A call to `MPI_WAITALL` or `MPI_TESTALL` can be used to wait for all pending operations in a list. A call to `MPI_WAIT SOME` or `MPI_TEST SOME` can be used to complete all enabled operations in a list.

`MPI_WAITANY(count, array_of_requests, index, status)`

IN	count	list length (non-negative integer)
INOUT	array_of_requests	array of requests (array of handles)
OUT	index	index of handle for operation that completed (integer)
OUT	status	status object (Status)

#### C binding

```

int MPI_Waitany(int count, MPI_Request array_of_requests[], int *index,
               MPI_Status *status)

```

#### Fortran 2008 binding

```

MPI_Waitany(count, array_of_requests, index, status, ierror)
    INTEGER, INTENT(IN) :: count
    TYPE(MPI_Request), INTENT(INOUT) :: array_of_requests(count)
    INTEGER, INTENT(OUT) :: index
    TYPE(MPI_Status) :: status
    INTEGER, OPTIONAL, INTENT(OUT) :: ierror

```

**Fortran binding**

```
MPI_WAITANY(COUNT, ARRAY_OF_REQUESTS, INDEX, STATUS, IERROR)
    INTEGER COUNT, ARRAY_OF_REQUESTS(*), INDEX, STATUS(MPI_STATUS_SIZE),
    IERROR
```

Blocks until one of the operations associated with the active requests in the array has completed. If more than one operation is enabled and can terminate, one is arbitrarily chosen. Returns in `index` the index of that request in the array and returns in `status` the status of the completing operation. (The array is indexed from zero in C, and from one in Fortran.) If the request is an active persistent request, it is marked inactive. Any other type of request is deallocated and the request handle is set to `MPI_REQUEST_NULL`.

The `array_of_requests` list may contain null or inactive handles. If the list contains no active handles (list has length zero or all entries are null or inactive), then the call returns immediately with `index = MPI_UNDEFINED`, and an empty `status`.

The execution of `MPI_WAITANY(count, array_of_requests, index, status)` has the same effect as the execution of `MPI_WAIT(&array_of_requests[i], status)`, where `i` is the value returned by `index` (unless the value of `index` is `MPI_UNDEFINED`). `MPI_WAITANY` with an array containing one active entry is equivalent to `MPI_WAIT`.

```
MPI_TESTANY(count, array_of_requests, index, flag, status)
```

IN	count	list length (non-negative integer)
INOUT	array_of_requests	array of requests (array of handles)
OUT	index	index of operation that completed or <code>MPI_UNDEFINED</code> if none completed (integer)
OUT	flag	true if one of the operations is complete (logical)
OUT	status	status object (Status)

**C binding**

```
int MPI_Testany(int count, MPI_Request array_of_requests[], int *index,
    int *flag, MPI_Status *status)
```

**Fortran 2008 binding**

```
MPI_Testany(count, array_of_requests, index, flag, status, ierror)
    INTEGER, INTENT(IN) :: count
    TYPE(MPI_Request), INTENT(INOUT) :: array_of_requests(count)
    INTEGER, INTENT(OUT) :: index
    LOGICAL, INTENT(OUT) :: flag
    TYPE(MPI_Status) :: status
    INTEGER, OPTIONAL, INTENT(OUT) :: ierror
```

**Fortran binding**

```
MPI_TESTANY(COUNT, ARRAY_OF_REQUESTS, INDEX, FLAG, STATUS, IERROR)
    INTEGER COUNT, ARRAY_OF_REQUESTS(*), INDEX, STATUS(MPI_STATUS_SIZE),
    IERROR
    LOGICAL FLAG
```

Tests for completion of either one or none of the operations associated with active

handles. In the former case, it returns `flag = true`, returns in `index` the index of this request in the array, and returns in `status` the status of that operation. If the request is an active persistent request, it is marked as inactive. Any other type of request is deallocated and the handle is set to `MPI_REQUEST_NULL`. (The array is indexed from zero in C, and from one in Fortran.) In the latter case (no operation completed), it returns `flag = false`, returns a value of `MPI_UNDEFINED` in `index` and `status` is undefined.

The array may contain null or inactive handles. If the array contains no active handles then the call returns immediately with `flag = true`, `index = MPI_UNDEFINED`, and an empty `status`.

If the array of requests contains active handles then the execution of `MPI_TESTANY(count, array_of_requests, index, status)` has the same effect as the execution of `MPI_TEST(&array_of_requests[i], flag, status)`, for  $i=0, 1, \dots, \text{count}-1$ , in some arbitrary order, until one call returns `flag = true`, or all fail. In the former case, `index` is set to the last value of  $i$ , and in the latter case, it is set to `MPI_UNDEFINED`. `MPI_TESTANY` with an array containing one active entry is equivalent to `MPI_TEST`.

`MPI_WAITALL(count, array_of_requests, array_of_statuses)`

IN	count	lists length (non-negative integer)
INOUT	array_of_requests	array of requests (array of handles)
OUT	array_of_statuses	array of status objects (array of Status)

### C binding

```
int MPI_Waitall(int count, MPI_Request array_of_requests[],
               MPI_Status array_of_statuses[])
```

### Fortran 2008 binding

```
MPI_Waitall(count, array_of_requests, array_of_statuses, ierror)
  INTEGER, INTENT(IN) :: count
  TYPE(MPI_Request), INTENT(INOUT) :: array_of_requests(count)
  TYPE(MPI_Status) :: array_of_statuses(*)
  INTEGER, OPTIONAL, INTENT(OUT) :: ierror
```

### Fortran binding

```
MPI_WAITALL(COUNT, ARRAY_OF_REQUESTS, ARRAY_OF_STATUSES, IERROR)
  INTEGER COUNT, ARRAY_OF_REQUESTS(*),
  ARRAY_OF_STATUSES(MPI_STATUS_SIZE, *), IERROR
```

Blocks until all communication operations associated with active handles in the list complete, and return the status of all these operations (this includes the case where no handle in the list is active). Both arrays have the same number of valid entries. The  $i$ -th entry in `array_of_statuses` is set to the return status of the  $i$ -th operation. Active persistent requests are marked inactive. Requests of any other type are deallocated and the corresponding handles in the array are set to `MPI_REQUEST_NULL`. The list may contain null or inactive handles. The call sets to empty the status of each such entry.

The error-free execution of `MPI_WAITALL(count, array_of_requests, array_of_statuses)` has the same effect as the execution of

MPI\_WAIT(&array\_of\_request[i], &array\_of\_statuses[i]), for  $i=0, \dots, \text{count}-1$ , in some arbitrary order. MPI\_WAITALL with an array of length one is equivalent to MPI\_WAIT.

When one or more of the communications completed by a call to MPI\_WAITALL fail, it is desirable to return specific information on each communication. The function MPI\_WAITALL will return in such case the error code MPI\_ERR\_IN\_STATUS and will set the error field of each status to a specific error code. This code will be MPI\_SUCCESS, if the specific communication completed; it will be another specific error code, if it failed; or it can be MPI\_ERR\_PENDING if it has neither failed nor completed. The function MPI\_WAITALL will return MPI\_SUCCESS if no request had an error, or will return another error code if it failed for other reasons (such as invalid arguments). In such cases, it will not update the error fields of the statuses.

*Rationale.* This design streamlines error handling in the application. The application code need only test the (single) function result to determine if an error has occurred. It needs to check each individual status only when an error occurred. (*End of rationale.*)

MPI\_TESTALL(count, array\_of\_requests, flag, array\_of\_statuses)

IN	count	lists length (non-negative integer)
INOUT	array_of_requests	array of requests (array of handles)
OUT	flag	(logical)
OUT	array_of_statuses	array of status objects (array of Status)

### C binding

```
int MPI_Testall(int count, MPI_Request array_of_requests[], int *flag,
               MPI_Status array_of_statuses[])
```

### Fortran 2008 binding

```
MPI_Testall(count, array_of_requests, flag, array_of_statuses, ierror)
  INTEGER, INTENT(IN) :: count
  TYPE(MPI_Request), INTENT(INOUT) :: array_of_requests(count)
  LOGICAL, INTENT(OUT) :: flag
  TYPE(MPI_Status) :: array_of_statuses(*)
  INTEGER, OPTIONAL, INTENT(OUT) :: ierror
```

### Fortran binding

```
MPI_TESTALL(COUNT, ARRAY_OF_REQUESTS, FLAG, ARRAY_OF_STATUSES, IERROR)
  INTEGER COUNT, ARRAY_OF_REQUESTS(*),
  ARRAY_OF_STATUSES(MPI_STATUS_SIZE, *), IERROR
  LOGICAL FLAG
```

Returns `flag = true` if all communications associated with active handles in the array have completed (this includes the case where no handle in the list is active). In this case, each status entry that corresponds to an active request is set to the status of the corresponding operation. Active persistent requests are marked inactive. Requests of any other type are deallocated and the corresponding handles in the array are set to `MPI_REQUEST_NULL`. Each status entry that corresponds to a null or inactive handle is set to empty.

1 Otherwise, `flag = false` is returned, no request is modified and the values of the status  
 2 entries are undefined. This is a local operation.

3 Errors that occurred during the execution of `MPI_TESTALL` are handled in the same  
 4 manner as errors in `MPI_WAITALL`.

5  
 6  
 7 `MPI_WAITSSOME`(`incount`, `array_of_requests`, `outcount`, `array_of_indices`, `array_of_statuses`)

8  
 9 IN `incount` length of `array_of_requests` (non-negative integer)  
 10 INOUT `array_of_requests` array of requests (array of handles)  
 11 OUT `outcount` number of completed requests (integer)  
 12 OUT `array_of_indices` array of indices of operations that completed (array of  
 13 integers)  
 14  
 15 OUT `array_of_statuses` array of status objects for operations that completed  
 16 (array of `Status`)  
 17

### 18 C binding

19 `int MPI_Waitssome(int incount, MPI_Request array_of_requests[],`  
 20 `int *outcount, int array_of_indices[],`  
 21 `MPI_Status array_of_statuses[])`  
 22

### 23 Fortran 2008 binding

24 `MPI_Waitssome(incount, array_of_requests, outcount, array_of_indices,`  
 25 `array_of_statuses, ierror)`  
 26 `INTEGER, INTENT(IN) :: incount`  
 27 `TYPE(MPI_Request), INTENT(INOUT) :: array_of_requests(incount)`  
 28 `INTEGER, INTENT(OUT) :: outcount, array_of_indices(*)`  
 29 `TYPE(MPI_Status) :: array_of_statuses(*)`  
 30 `INTEGER, OPTIONAL, INTENT(OUT) :: ierror`  
 31

### 32 Fortran binding

33 `MPI_WAITSSOME(INCOUNT, ARRAY_OF_REQUESTS, OUTCOUNT, ARRAY_OF_INDICES,`  
 34 `ARRAY_OF_STATUSES, IERROR)`  
 35 `INTEGER INCOUNT, ARRAY_OF_REQUESTS(*), OUTCOUNT, ARRAY_OF_INDICES(*),`  
 36 `ARRAY_OF_STATUSES(MPI_STATUS_SIZE, *), IERROR`

37 Waits until at least one of the operations associated with active handles in the list have  
 38 completed. Returns in `outcount` the number of requests from the list `array_of_requests` that  
 39 have completed. Returns in the first `outcount` locations of the array `array_of_indices` the  
 40 indices of these operations (index within the array `array_of_requests`; the array is indexed  
 41 from zero in C and from one in Fortran). Returns in the first `outcount` locations of the  
 42 array `array_of_status` the status for these completed operations. Completed active persistent  
 43 requests are marked as inactive. Any other type or request that completed is deallocated,  
 44 and the associated handle is set to `MPI_REQUEST_NULL`.

45 If the list contains no active handles, then the call returns immediately with `outcount`  
 46 = `MPI_UNDEFINED`.

47 When one or more of the communications completed by `MPI_WAITSSOME` fails, then  
 48 it is desirable to return specific information on each communication. The arguments

outcount, array\_of\_indices and array\_of\_statuses will be adjusted to indicate completion of all communications that have succeeded or failed. The call will return the error code MPI\_ERR\_IN\_STATUS and the error field of each status returned will be set to indicate success or to indicate the specific error that occurred. The call will return MPI\_SUCCESS if no request resulted in an error, and will return another error code if it failed for other reasons (such as invalid arguments). In such cases, it will not update the error fields of the statuses.

MPI\_TESTSOME(incount, array\_of\_requests, outcount, array\_of\_indices, array\_of\_statuses)

IN	incount	length of array_of_requests (non-negative integer)
INOUT	array_of_requests	array of requests (array of handles)
OUT	outcount	number of completed requests (integer)
OUT	array_of_indices	array of indices of operations that completed (array of integers)
OUT	array_of_statuses	array of status objects for operations that completed (array of Status)

### C binding

```
int MPI_Testsome(int incount, MPI_Request array_of_requests[],
                int *outcount, int array_of_indices[],
                MPI_Status array_of_statuses[])
```

### Fortran 2008 binding

```
MPI_Testsome(incount, array_of_requests, outcount, array_of_indices,
             array_of_statuses, ierror)
    INTEGER, INTENT(IN) :: incount
    TYPE(MPI_Request), INTENT(INOUT) :: array_of_requests(incount)
    INTEGER, INTENT(OUT) :: outcount, array_of_indices(*)
    TYPE(MPI_Status) :: array_of_statuses(*)
    INTEGER, OPTIONAL, INTENT(OUT) :: ierror
```

### Fortran binding

```
MPI_TESTSOME(INCOUNT, ARRAY_OF_REQUESTS, OUTCOUNT, ARRAY_OF_INDICES,
             ARRAY_OF_STATUSES, IERROR)
    INTEGER INCOUNT, ARRAY_OF_REQUESTS(*), OUTCOUNT, ARRAY_OF_INDICES(*),
    ARRAY_OF_STATUSES(MPI_STATUS_SIZE, *), IERROR
```

Behaves like MPI\_WAITSSOME, except that it returns immediately. If no operation has completed it returns outcount = 0. If there is no active handle in the list it returns outcount = MPI\_UNDEFINED.

MPI\_TESTSOME is a local operation, which returns immediately, whereas MPI\_WAITSSOME will block until a communication completes, if it was passed a list that contains at least one active handle. Both calls fulfill a **fairness** requirement: If a request for a receive repeatedly appears in a list of requests passed to MPI\_WAITSSOME or MPI\_TESTSOME, and a matching send has been posted, then the receive will eventually succeed, unless the send is satisfied by another receive; and similarly for send requests.

1 Errors that occur during the execution of MPI\_TEST SOME are handled as for  
2 MPI\_WAIT SOME.

3  
4 *Advice to users.* The use of MPI\_TEST SOME is likely to be more efficient than the use  
5 of MPI\_TEST ANY. The former returns information on all completed communications,  
6 with the latter, a new call is required for each communication that completes.

7 A server with multiple clients can use MPI\_WAIT SOME so as not to starve any client.  
8 Clients send messages to the server with service requests. The server calls  
9 MPI\_WAIT SOME with one receive request for each client, and then handles all receives  
10 that completed. If a call to MPI\_WAIT ANY is used instead, then one client could starve  
11 while requests from another client always sneak in first. (*End of advice to users.*)

12  
13 *Advice to implementors.* MPI\_TEST SOME should complete as many pending com-  
14 munications as possible. (*End of advice to implementors.*)

15  
16 **Example 3.15** Client-server code (starvation can occur).

```
17
18 CALL MPI_COMM_SIZE(comm, size, ierr)
19 CALL MPI_COMM_RANK(comm, rank, ierr)
20 IF (rank .GT. 0) THEN          ! client code
21   DO WHILE(.TRUE.)
22     CALL MPI_ISEND(a, n, MPI_REAL, 0, tag, comm, request, ierr)
23     CALL MPI_WAIT(request, status, ierr)
24   END DO
25 ELSE                          ! rank=0 -- server code
26   DO i=1,size-1
27     CALL MPI_IRecv(a(1,i), n, MPI_REAL, i, tag, &
28                  comm, request_list(i), ierr)
29   END DO
30   DO WHILE(.TRUE.)
31     CALL MPI_WAITANY(size-1, request_list, index, status, ierr)
32     CALL DO_SERVICE(a(1,index)) ! handle one message
33     CALL MPI_IRecv(a(1, index), n, MPI_REAL, index, tag, &
34                  comm, request_list(index), ierr)
35   END DO
36 END IF
```

37  
38 **Example 3.16** Same code, using MPI\_WAIT SOME.

```
39
40 CALL MPI_COMM_SIZE(comm, size, ierr)
41 CALL MPI_COMM_RANK(comm, rank, ierr)
42 IF (rank .GT. 0) THEN          ! client code
43   DO WHILE(.TRUE.)
44     CALL MPI_ISEND(a, n, MPI_REAL, 0, tag, comm, request, ierr)
45     CALL MPI_WAIT(request, status, ierr)
46   END DO
47 ELSE                          ! rank=0 -- server code
48   DO i=1,size-1
```



```

CALL MPI_Irecv(a(1,i), n, MPI_REAL, i, tag, &
               comm, request_list(i), ierr)
END DO
DO WHILE(.TRUE.)
CALL MPI_WAITsome(size, request_list, numdone, &
                  indices, statuses, ierr)
DO i=1,numdone
CALL DO_SERVICE(a(1, indices(i)))
CALL MPI_Irecv(a(1, indices(i)), n, MPI_REAL, 0, tag, &
               comm, request_list(indices(i)), ierr)
END DO
END DO
END IF

```

### 3.7.6 Non-Destructive Test of status

This call is useful for accessing the information associated with a request, without freeing the request (in case the user is expected to access it later). It allows one to layer libraries more conveniently, since multiple layers of software may access the same completed request and extract from it the status information.

**MPI\_REQUEST\_GET\_STATUS(request, flag, status)**

IN	request	request (handle)
OUT	flag	boolean flag, same as from MPI_TEST (logical)
OUT	status	status object if flag is true (Status)

#### C binding

```
int MPI_Request_get_status(MPI_Request request, int *flag,
                           MPI_Status *status)
```

#### Fortran 2008 binding

```
MPI_Request_get_status(request, flag, status, ierror)
TYPE(MPI_Request), INTENT(IN) :: request
LOGICAL, INTENT(OUT) :: flag
TYPE(MPI_Status) :: status
INTEGER, OPTIONAL, INTENT(OUT) :: ierror
```

#### Fortran binding

```
MPI_REQUEST_GET_STATUS(REQUEST, FLAG, STATUS, IERROR)
INTEGER REQUEST, STATUS(MPI_STATUS_SIZE), IERROR
LOGICAL FLAG
```

Sets `flag = true` if the operation is complete, and, if so, returns in `status` the request status. However, unlike `test` or `wait`, it does not deallocate or inactivate the request; a subsequent call to `test`, `wait` or `free` should be executed with that request. It sets `flag = false` if the operation is not complete.

One is allowed to call `MPI_REQUEST_GET_STATUS` with a null or inactive request argument. In such a case the operation returns with `flag = true` and empty `status`.

## 3.8 Probe and Cancel

The `MPI_PROBE`, `MPI_IPROBE`, `MPI_MPROBE`, and `MPI_IMPROBE` operations allow incoming messages to be checked for, without actually receiving them. The user can then decide how to receive them, based on the information returned by the probe (basically, the information returned by `status`). In particular, the user may allocate memory for the receive buffer, according to the length of the probed message.

The `MPI_CANCEL` operation allows pending communications to be cancelled. This is required for cleanup. Posting a send or a receive ties up user resources (send or receive buffers), and a **cancel** may be needed to free these resources gracefully.

Cancelling a send request by calling `MPI_CANCEL` is deprecated.

### 3.8.1 Probe

`MPI_IPROBE(source, tag, comm, flag, status)`

IN	source	rank of source or <code>MPI_ANY_SOURCE</code> (integer)
IN	tag	message tag or <code>MPI_ANY_TAG</code> (integer)
IN	comm	communicator (handle)
OUT	flag	(logical)
OUT	status	status object ( <code>Status</code> )

#### C binding

```
int MPI_Iprobe(int source, int tag, MPI_Comm comm, int *flag,
              MPI_Status *status)
```

#### Fortran 2008 binding

```
MPI_Iprobe(source, tag, comm, flag, status, ierror)
  INTEGER, INTENT(IN) :: source, tag
  TYPE(MPI_Comm), INTENT(IN) :: comm
  LOGICAL, INTENT(OUT) :: flag
  TYPE(MPI_Status) :: status
  INTEGER, OPTIONAL, INTENT(OUT) :: ierror
```

#### Fortran binding

```
MPI_IPROBE(SOURCE, TAG, COMM, FLAG, STATUS, IERROR)
  INTEGER SOURCE, TAG, COMM, STATUS(MPI_STATUS_SIZE), IERROR
  LOGICAL FLAG
```

`MPI_IPROBE(source, tag, comm, flag, status)` returns `flag = true` if there is a message that can be received and that matches the pattern specified by the arguments `source`, `tag`, and `comm`. The call matches the same message that would have been received by a call to `MPI_RECV(..., source, tag, comm, status)` executed at the same point in the program, and returns in `status` the same value that would have been returned by `MPI_RECV()`. Otherwise, the call returns `flag = false`, and leaves `status` undefined.

If `MPI_IPROBE` returns `flag = true`, then the content of the status object can be subsequently accessed as described in Section 3.2.5 to find the source, tag and length of the

probed message.

A subsequent receive executed with the same communicator, and the source and tag returned in status by `MPI_IPROBE` will receive the message that was matched by the probe, if no other intervening receive occurs after the probe, and the send is not successfully cancelled before the receive. If the receiving process is multithreaded, it is the user's responsibility to ensure that the last condition holds.

The `source` argument of `MPI_PROBE` can be `MPI_ANY_SOURCE`, and the `tag` argument can be `MPI_ANY_TAG`, so that one can probe for messages from an arbitrary source and/or with an arbitrary tag. However, a specific communication context must be provided with the `comm` argument.

It is not necessary to receive a message immediately after it has been probed for, and the same message may be probed for several times before it is received.

A probe with `MPI_PROC_NULL` as source returns `flag = true`, and the status object returns `source = MPI_PROC_NULL`, `tag = MPI_ANY_TAG`, and `count = 0`; see Section 3.11.

`MPI_PROBE(source, tag, comm, status)`

IN	<code>source</code>	rank of source or <code>MPI_ANY_SOURCE</code> (integer)
IN	<code>tag</code>	message tag or <code>MPI_ANY_TAG</code> (integer)
IN	<code>comm</code>	communicator (handle)
OUT	<code>status</code>	status object ( <code>Status</code> )

### C binding

```
int MPI_Probe(int source, int tag, MPI_Comm comm, MPI_Status *status)
```

### Fortran 2008 binding

```
MPI_Probe(source, tag, comm, status, ierror)
  INTEGER, INTENT(IN) :: source, tag
  TYPE(MPI_Comm), INTENT(IN) :: comm
  TYPE(MPI_Status) :: status
  INTEGER, OPTIONAL, INTENT(OUT) :: ierror
```

### Fortran binding

```
MPI_PROBE(SOURCE, TAG, COMM, STATUS, IERROR)
  INTEGER SOURCE, TAG, COMM, STATUS(MPI_STATUS_SIZE), IERROR
```

`MPI_PROBE` behaves like `MPI_IPROBE` except that it is a blocking call that returns only after a matching message has been found.

The MPI implementation of `MPI_PROBE` and `MPI_IPROBE` needs to guarantee progress: if a call to `MPI_PROBE` has been issued by a process, and a send that matches the probe has been initiated by some process, then the call to `MPI_PROBE` will return, unless the message is received by another concurrent receive operation (that is executed by another thread at the probing process). Similarly, if a process busy waits with `MPI_IPROBE` and a matching message has been issued, then the call to `MPI_IPROBE` will eventually return `flag = true` unless the message is received by another concurrent receive operation or matched by a concurrent matched probe.

**Example 3.17** Use blocking probe to wait for an incoming message.

```

1  CALL MPI_COMM_RANK(comm, rank, ierr)
2  IF (rank .EQ. 0) THEN
3      CALL MPI_SEND(i, 1, MPI_INTEGER, 2, 0, comm, ierr)
4  ELSE IF (rank .EQ. 1) THEN
5      CALL MPI_SEND(x, 1, MPI_REAL, 2, 0, comm, ierr)
6  ELSE IF (rank .EQ. 2) THEN
7      DO i=1,2
8          CALL MPI_PROBE(MPI_ANY_SOURCE, 0, &
9                          comm, status, ierr)
10         IF (status(MPI_SOURCE) .EQ. 0) THEN
11             100    CALL MPI_RECV(i, 1, MPI_INTEGER, 0, 0, comm, status, ierr)
12         ELSE
13             200    CALL MPI_RECV(x, 1, MPI_REAL, 1, 0, comm, status, ierr)
14         END IF
15     END DO
16 END IF

```

Each message is received with the right type.

**Example 3.18** A similar program to the previous example, but now it has a problem.

```

21  CALL MPI_COMM_RANK(comm, rank, ierr)
22  IF (rank .EQ. 0) THEN
23      CALL MPI_SEND(i, 1, MPI_INTEGER, 2, 0, comm, ierr)
24  ELSE IF (rank .EQ. 1) THEN
25      CALL MPI_SEND(x, 1, MPI_REAL, 2, 0, comm, ierr)
26  ELSE IF (rank .EQ. 2) THEN
27      DO i=1,2
28          CALL MPI_PROBE(MPI_ANY_SOURCE, 0, &
29                          comm, status, ierr)
30         IF (status(MPI_SOURCE) .EQ. 0) THEN
31             100    CALL MPI_RECV(i, 1, MPI_INTEGER, MPI_ANY_SOURCE, &
32                          0, comm, status, ierr)
33         ELSE
34             200    CALL MPI_RECV(x, 1, MPI_REAL, MPI_ANY_SOURCE, &
35                          0, comm, status, ierr)
36         END IF
37     END DO
38 END IF

```

In Example 3.18, the two receive calls in statements labeled 100 and 200 in Example 3.17 are slightly modified, using `MPI_ANY_SOURCE` as the source argument. The program is now incorrect: the receive operation may receive a message that is distinct from the message probed by the preceding call to `MPI_PROBE`.

*Advice to users.* In a multithreaded MPI program, `MPI_PROBE` and `MPI_IPROBE` might need special care. If a thread probes for a message and then immediately posts a matching receive, the receive may match a message other than that found by the probe since another thread could concurrently receive that original

message [30]. MPI\_MPROBE and MPI\_IMPROBE solve this problem by matching the incoming message so that it may only be received with MPI\_MRECV or MPI\_IMRECV on the corresponding message handle. (*End of advice to users.*)

*Advice to implementors.* A call to MPI\_PROBE(source, tag, comm, status) will match the message that would have been received by a call to MPI\_RECV(..., source, tag, comm, status) executed at the same point. Suppose that this message has source *s*, tag *t* and communicator *c*. If the tag argument in the probe call has value MPI\_ANY\_TAG then the message probed will be the earliest pending message from source *s* with communicator *c* and any tag; in any case, the message probed will be the earliest pending message from source *s* with tag *t* and communicator *c* (this is the message that would have been received, so as to preserve message order). This message continues as the earliest pending message from source *s* with tag *t* and communicator *c*, until it is received. A receive operation subsequent to the probe that uses the same communicator as the probe and uses the tag and source values returned by the probe, must receive this message, unless it has already been received by another receive operation. (*End of advice to implementors.*)

### 3.8.2 Matching Probe

The function MPI\_PROBE checks for incoming messages without receiving them. Since the list of incoming messages is global among the threads of each MPI process, it can be hard to use this functionality in threaded environments [30, 27].

Like MPI\_PROBE and MPI\_Iprobe, the MPI\_MPROBE and MPI\_IMPROBE operations allow incoming messages to be queried without actually receiving them, except that MPI\_MPROBE and MPI\_IMPROBE provide a mechanism to receive the specific message that was matched regardless of other intervening probe or receive operations. This gives the application an opportunity to decide how to receive the message, based on the information returned by the probe. In particular, the user may allocate memory for the receive buffer, according to the length of the probed message.

MPI\_IMPROBE(source, tag, comm, flag, message, status)

IN	source	rank of source or MPI_ANY_SOURCE (integer)
IN	tag	message tag or MPI_ANY_TAG (integer)
IN	comm	communicator (handle)
OUT	flag	flag (logical)
OUT	message	returned message (handle)
OUT	status	status object (Status)

#### C binding

```
int MPI_Iprobe(int source, int tag, MPI_Comm comm, int *flag,
               MPI_Message *message, MPI_Status *status)
```

#### Fortran 2008 binding

```
MPI_Iprobe(source, tag, comm, flag, message, status, ierror)
INTEGER, INTENT(IN) :: source, tag
```

```

1     TYPE(MPI_Comm), INTENT(IN) :: comm
2     LOGICAL, INTENT(OUT) :: flag
3     TYPE(MPI_Message), INTENT(OUT) :: message
4     TYPE(MPI_Status) :: status
5     INTEGER, OPTIONAL, INTENT(OUT) :: ierror

```

### Fortran binding

```

7 MPI_IMPROBE(SOURCE, TAG, COMM, FLAG, MESSAGE, STATUS, IERROR)
8     INTEGER SOURCE, TAG, COMM, MESSAGE, STATUS(MPI_STATUS_SIZE), IERROR
9     LOGICAL FLAG

```

MPI\_IMPROBE(source, tag, comm, flag, message, status) returns flag = true if there is a message that can be received and that matches the pattern specified by the arguments source, tag, and comm. The call matches the same message that would have been received by a call to MPI\_RECV(..., source, tag, comm, status) executed at the same point in the program and returns in status the same value that would have been returned by MPI\_RECV. In addition, it returns in message a handle to the matched message. Otherwise, the call returns flag = false, and leaves status and message undefined.

A matched receive (MPI\_MRECV or MPI\_IMRECV) executed with the message handle will receive the message that was matched by the probe. Unlike MPI\_IPROBE, no other probe or receive operation may match the message returned by MPI\_IMPROBE. Each message returned by MPI\_IMPROBE must be received with either MPI\_MRECV or MPI\_IMRECV.

The source argument of MPI\_IMPROBE can be MPI\_ANY\_SOURCE, and the tag argument can be MPI\_ANY\_TAG, so that one can probe for messages from an arbitrary source and/or with an arbitrary tag. However, a specific communication context must be provided with the comm argument.

A synchronous send operation that is matched with MPI\_IMPROBE or MPI\_MPROBE will complete successfully only if both a matching receive is posted with MPI\_MRECV or MPI\_IMRECV, and the receive operation has started to receive the message sent by the synchronous send.

There is a special predefined message: MPI\_MESSAGE\_NO\_PROC, which is a message which has MPI\_PROC\_NULL as its source process. The predefined constant MPI\_MESSAGE\_NULL is the value used for invalid message handles.

A matching probe with source = MPI\_PROC\_NULL returns flag = true, message = MPI\_MESSAGE\_NO\_PROC, and the status object returns source = MPI\_PROC\_NULL, tag = MPI\_ANY\_TAG, and count = 0; see Section 3.11. It is not necessary to call MPI\_MRECV or MPI\_IMRECV with MPI\_MESSAGE\_NO\_PROC, but it is not erroneous to do so.

*Rationale.* MPI\_MESSAGE\_NO\_PROC was chosen instead of MPI\_MESSAGE\_PROC\_NULL to avoid possible confusion as another null handle constant. (*End of rationale.*)

MPI\_MPROBE(source, tag, comm, message, status) 1

IN	source	rank of source or MPI_ANY_SOURCE (integer) <span style="float: right;">2</span>
IN	tag	message tag or MPI_ANY_TAG (integer) <span style="float: right;">3</span>
IN	comm	communicator (handle) <span style="float: right;">4</span>
OUT	message	returned message (handle) <span style="float: right;">5</span>
OUT	status	status object (Status) <span style="float: right;">6</span>

### C binding 7

```
int MPI_Mprobe(int source, int tag, MPI_Comm comm, MPI_Message *message,
               MPI_Status *status) 8
```

### Fortran 2008 binding 9

```
MPI_Mprobe(source, tag, comm, message, status, ierror) 10
```

```
  INTEGER, INTENT(IN) :: source, tag
  TYPE(MPI_Comm), INTENT(IN) :: comm
  TYPE(MPI_Message), INTENT(OUT) :: message
  TYPE(MPI_Status) :: status
  INTEGER, OPTIONAL, INTENT(OUT) :: ierror 11-15
```

### Fortran binding 16

```
MPI_MPROBE(SOURCE, TAG, COMM, MESSAGE, STATUS, IERROR) 17
  INTEGER SOURCE, TAG, COMM, MESSAGE, STATUS(MPI_STATUS_SIZE), IERROR 18
```

MPI\_MPROBE behaves like MPI\_IMPROBE except that it is a blocking call that returns only after a matching message has been found. 19

The implementation of MPI\_MPROBE and MPI\_IMPROBE needs to guarantee progress in the same way as in the case of MPI\_PROBE and MPI\_IPROBE. 20

### 3.8.3 Matched Receives 21

The functions MPI\_MRECV and MPI\_IMRECV receive messages that have been previously matched by a matching probe (Section 3.8.2). 22

MPI\_MRECV(buf, count, datatype, message, status) 23

OUT	buf	initial address of receive buffer (choice) <span style="float: right;">24</span>
IN	count	number of elements in receive buffer (non-negative integer) <span style="float: right;">25</span>
IN	datatype	datatype of each receive buffer element (handle) <span style="float: right;">26</span>
INOUT	message	message (handle) <span style="float: right;">27</span>
OUT	status	status object (Status) <span style="float: right;">28</span>

### C binding 29

```
int MPI_Mrecv(void *buf, int count, MPI_Datatype datatype,
              MPI_Message *message, MPI_Status *status) 30
```

### Fortran 2008 binding 31

```

1 MPI_Mrecv(buf, count, datatype, message, status, ierror)
2     TYPE(*), DIMENSION(..) :: buf
3     INTEGER, INTENT(IN) :: count
4     TYPE(MPI_Datatype), INTENT(IN) :: datatype
5     TYPE(MPI_Message), INTENT(INOUT) :: message
6     TYPE(MPI_Status) :: status
7     INTEGER, OPTIONAL, INTENT(OUT) :: ierror

```

### Fortran binding

```

9 MPI_MRECV(BUF, COUNT, DATATYPE, MESSAGE, STATUS, IERROR)
10     <type> BUF(*)
11     INTEGER COUNT, DATATYPE, MESSAGE, STATUS(MPI_STATUS_SIZE), IERROR

```

This call receives a message matched by a matching probe operation (Section 3.8.2).

The receive buffer consists of the storage containing `count` consecutive elements of the type specified by `datatype`, starting at address `buf`. The length of the received message must be less than or equal to the length of the receive buffer. An overflow error occurs if all incoming data does not fit, without truncation, into the receive buffer.

If the message is shorter than the receive buffer, then only those locations corresponding to the (shorter) message are modified.

On return from this function, the message handle is set to `MPI_MESSAGE_NULL`. All errors that occur during the execution of this operation are handled according to the error handler set for the communicator used in the matching probe call that produced the message handle.

If `MPI_MRECV` is called with `MPI_MESSAGE_NO_PROC` as the message argument, the call returns immediately with the status object set to `source = MPI_PROC_NULL`, `tag = MPI_ANY_TAG`, and `count = 0`, as if a receive from `MPI_PROC_NULL` was issued (see Section 3.11). A call to `MPI_MRECV` with `MPI_MESSAGE_NULL` is erroneous.

```

30 MPI_IMRECV(buf, count, datatype, message, request)

```

OUT	<code>buf</code>	initial address of receive buffer (choice)
IN	<code>count</code>	number of elements in receive buffer (non-negative integer)
IN	<code>datatype</code>	datatype of each receive buffer element (handle)
INOUT	<code>message</code>	message (handle)
OUT	<code>request</code>	communication request (handle)

### C binding

```

40 int MPI_Imrecv(void *buf, int count, MPI_Datatype datatype,
41               MPI_Message *message, MPI_Request *request)

```

### Fortran 2008 binding

```

44 MPI_Imrecv(buf, count, datatype, message, request, ierror)
45     TYPE(*), DIMENSION(..), ASYNCHRONOUS :: buf
46     INTEGER, INTENT(IN) :: count
47     TYPE(MPI_Datatype), INTENT(IN) :: datatype
48     TYPE(MPI_Message), INTENT(INOUT) :: message

```



```

TYPE(MPI_Request), INTENT(OUT) :: request
INTEGER, OPTIONAL, INTENT(OUT) :: ierror

```

**Fortran binding**

```

MPI_IMRECV(BUF, COUNT, DATATYPE, MESSAGE, REQUEST, IERROR)
  <type> BUF(*)
  INTEGER COUNT, DATATYPE, MESSAGE, REQUEST, IERROR

```

MPI\_IMRECV is the nonblocking variant of MPI\_MRECV and starts a nonblocking receive of a matched message. Completion semantics are similar to MPI\_IRECV as described in Section 3.7.2. On return from this function, the message handle is set to MPI\_MESSAGE\_NULL.

If MPI\_IMRECV is called with MPI\_MESSAGE\_NO\_PROC as the message argument, the call returns immediately with a request object which, when completed, will yield a status object set to source = MPI\_PROC\_NULL, tag = MPI\_ANY\_TAG, and count = 0, as if a receive from MPI\_PROC\_NULL was issued (see Section 3.11). A call to MPI\_IMRECV with MPI\_MESSAGE\_NULL is erroneous.

*Advice to implementors.* If reception of a matched message is started with MPI\_IMRECV, then it is possible to cancel the returned request with MPI\_CANCEL. If MPI\_CANCEL succeeds, the matched message must be found by a subsequent message probe (MPI\_PROBE, MPI\_Iprobe, MPI\_Mprobe, or MPI\_Improbe), received by a subsequent receive operation or cancelled by the sender. See Section 3.8.4 for details about MPI\_CANCEL. The cancellation of operations initiated with MPI\_IMRECV may fail. (*End of advice to implementors.*)

**3.8.4 Cancel**

```

MPI_CANCEL(request)
  IN      request      communication request (handle)

```

**C binding**

```

int MPI_Cancel(MPI_Request *request)

```

**Fortran 2008 binding**

```

MPI_Cancel(request, ierror)
  TYPE(MPI_Request), INTENT(IN) :: request
  INTEGER, OPTIONAL, INTENT(OUT) :: ierror

```

**Fortran binding**

```

MPI_CANCEL(REQUEST, IERROR)
  INTEGER REQUEST, IERROR

```

A call to MPI\_CANCEL marks for cancellation a pending, nonblocking communication operation (send or receive). Cancelling a send request by calling MPI\_CANCEL is deprecated. The cancel call is local. It returns immediately, possibly before the communication is actually cancelled. It is still necessary to call MPI\_REQUEST\_FREE, MPI\_WAIT or MPI\_TEST (or any of the derived operations) with the cancelled request as argument after

the call to `MPI_CANCEL`. If a communication is marked for cancellation, then a `MPI_WAIT` call for that communication is guaranteed to return, irrespective of the activities of other processes (i.e., `MPI_WAIT` behaves as a local function); similarly if `MPI_TEST` is repeatedly called in a busy wait loop for a cancelled communication, then `MPI_TEST` will eventually be successful.

`MPI_CANCEL` can be used to cancel a communication that uses a persistent request (see Section 3.9), in the same way it is used for nonpersistent requests. Cancelling a persistent send request by calling `MPI_CANCEL` is deprecated. A successful cancellation cancels the active communication, but not the request itself. After the call to `MPI_CANCEL` and the subsequent call to `MPI_WAIT` or `MPI_TEST`, the request becomes inactive and can be activated for a new communication.

The successful cancellation of a buffered send frees the buffer space occupied by the pending message. Cancelling a buffered send request by calling `MPI_CANCEL` is deprecated.

Either the cancellation succeeds, or the communication succeeds, but not both. If a send is marked for cancellation, which is deprecated, then it must be the case that either the send completes normally, in which case the message sent was received at the destination process, or that the send is successfully cancelled, in which case no part of the message was received at the destination. Then, any matching receive has to be satisfied by another send. If a receive is marked for cancellation, then it must be the case that either the receive completes normally, or that the receive is successfully cancelled, in which case no part of the receive buffer is altered. Then, any matching send has to be satisfied by another receive.

If the operation has been cancelled, then information to that effect will be returned in the status argument of the operation that completes the communication.

*Rationale.* Although the IN request handle parameter should not need to be passed by reference, the C binding has listed the argument type as `MPI_Request*` since MPI-1.0. This function signature therefore cannot be changed without breaking existing MPI applications. (*End of rationale.*)

`MPI_TEST_CANCELLED(status, flag)`

IN	status	status object (Status)
OUT	flag	(logical)

### C binding

```
int MPI_Test_cancelled(const MPI_Status *status, int *flag)
```

### Fortran 2008 binding

```
MPI_Test_cancelled(status, flag, ierror)
    TYPE(MPI_Status), INTENT(IN) :: status
    LOGICAL, INTENT(OUT) :: flag
    INTEGER, OPTIONAL, INTENT(OUT) :: ierror
```

### Fortran binding

```
MPI_TEST_CANCELLED(STATUS, FLAG, IERROR)
    INTEGER STATUS(MPI_STATUS_SIZE), IERROR
    LOGICAL FLAG
```

Returns `flag = true` if the communication associated with the status object was cancelled successfully. In such a case, all other fields of `status` (such as `count` or `tag`) are undefined. Returns `flag = false`, otherwise. If a receive operation might be cancelled then one should call `MPI_TEST_CANCELLED` first, to check whether the operation was cancelled, before checking on the other fields of the return status.

*Advice to users.* Cancel can be an expensive operation that should be used only exceptionally. (*End of advice to users.*)

*Advice to implementors.* If a send operation uses an “eager” protocol (data is transferred to the receiver before a matching receive is posted), then the cancellation of this send may require communication with the intended receiver in order to free allocated buffers. On some systems this may require an interrupt to the intended receiver. Note that, while communication may be needed to implement `MPI_CANCEL`, this is still a local operation, since its completion does not depend on the code executed by other processes. If processing is required on another process, this should be transparent to the application (hence the need for an interrupt and an interrupt handler). (*End of advice to implementors.*)

### 3.9 Persistent Communication Requests

Often a communication with the same argument list (with the exception of the buffer contents) is repeatedly executed within the inner loop of a parallel computation. In such a situation, it may be possible to optimize the communication by binding the list of communication arguments to a **persistent** communication request once and, then, repeatedly using the request to initiate and complete operations. In the case of point-to-point communication, the persistent request thus created can be thought of as a communication port or a “half-channel.” It does not provide the full functionality of a conventional channel, since there is no binding of the send port to the receive port. This construct allows reduction of the overhead for communication between the process and communication controller, but not of the overhead for communication between one communication controller and another. It is not necessary that messages sent with a persistent point-to-point request be received by a receive operation using a persistent point-to-point request, or vice versa.

There are also collective communication persistent operations defined in Section 5.13 and Section 7.8. The remainder of this section covers the point-to-point persistent initialization operations and the start routines, which are used for both point-to-point and collective persistent communication.

A persistent point-to-point communication request is created using one of the five following calls. These point-to-point persistent calls involve no communication.

```

1 MPI_SEND_INIT(buf, count, datatype, dest, tag, comm, request)
2     IN      buf                initial address of send buffer (choice)
3
4     IN      count              number of elements sent (non-negative integer)
5
6     IN      datatype           type of each element (handle)
7
8     IN      dest               rank of destination (integer)
9
10    IN      tag                 message tag (integer)
11
12    IN      comm                communicator (handle)
13
14    OUT     request             communication request (handle)

```

**C binding**

```

15 int MPI_Send_init(const void *buf, int count, MPI_Datatype datatype,
16                  int dest, int tag, MPI_Comm comm, MPI_Request *request)

```

**Fortran 2008 binding**

```

17 MPI_Send_init(buf, count, datatype, dest, tag, comm, request, ierror)
18     TYPE(*), DIMENSION(..), INTENT(IN), ASYNCHRONOUS :: buf
19     INTEGER, INTENT(IN) :: count, dest, tag
20     TYPE(MPI_Datatype), INTENT(IN) :: datatype
21     TYPE(MPI_Comm), INTENT(IN) :: comm
22     TYPE(MPI_Request), INTENT(OUT) :: request
23     INTEGER, OPTIONAL, INTENT(OUT) :: ierror

```

**Fortran binding**

```

24 MPI_SEND_INIT(BUF, COUNT, DATATYPE, DEST, TAG, COMM, REQUEST, IERROR)
25     <type> BUF(*)
26     INTEGER COUNT, DATATYPE, DEST, TAG, COMM, REQUEST, IERROR

```

Creates a persistent communication request for a standard mode send operation, and binds to it all the arguments of a send operation.

```

31
32
33 MPI_BSEND_INIT(buf, count, datatype, dest, tag, comm, request)
34     IN      buf                initial address of send buffer (choice)
35
36     IN      count              number of elements sent (non-negative integer)
37
38     IN      datatype           type of each element (handle)
39
40     IN      dest               rank of destination (integer)
41
42     IN      tag                 message tag (integer)
43
44     IN      comm                communicator (handle)
45
46     OUT     request             communication request (handle)

```

**C binding**

```

47 int MPI_Bsend_init(const void *buf, int count, MPI_Datatype datatype,
48                  int dest, int tag, MPI_Comm comm, MPI_Request *request)

```

**Fortran 2008 binding**

```

MPI_Bsend_init(buf, count, datatype, dest, tag, comm, request, ierror)
    TYPE(*), DIMENSION(..), INTENT(IN), ASYNCHRONOUS :: buf
    INTEGER, INTENT(IN) :: count, dest, tag
    TYPE(MPI_Datatype), INTENT(IN) :: datatype
    TYPE(MPI_Comm), INTENT(IN) :: comm
    TYPE(MPI_Request), INTENT(OUT) :: request
    INTEGER, OPTIONAL, INTENT(OUT) :: ierror

```

**Fortran binding**

```

MPI_BSEND_INIT(BUF, COUNT, DATATYPE, DEST, TAG, COMM, REQUEST, IERROR)
    <type> BUF(*)
    INTEGER COUNT, DATATYPE, DEST, TAG, COMM, REQUEST, IERROR

```

Creates a persistent communication request for a buffered mode send.

```

MPI_SSEND_INIT(buf, count, datatype, dest, tag, comm, request)

```

IN	buf	initial address of send buffer (choice)
IN	count	number of elements sent (non-negative integer)
IN	datatype	type of each element (handle)
IN	dest	rank of destination (integer)
IN	tag	message tag (integer)
IN	comm	communicator (handle)
OUT	request	communication request (handle)

**C binding**

```

int MPI_Ssend_init(const void *buf, int count, MPI_Datatype datatype,
    int dest, int tag, MPI_Comm comm, MPI_Request *request)

```

**Fortran 2008 binding**

```

MPI_Ssend_init(buf, count, datatype, dest, tag, comm, request, ierror)
    TYPE(*), DIMENSION(..), INTENT(IN), ASYNCHRONOUS :: buf
    INTEGER, INTENT(IN) :: count, dest, tag
    TYPE(MPI_Datatype), INTENT(IN) :: datatype
    TYPE(MPI_Comm), INTENT(IN) :: comm
    TYPE(MPI_Request), INTENT(OUT) :: request
    INTEGER, OPTIONAL, INTENT(OUT) :: ierror

```

**Fortran binding**

```

MPI_SSEND_INIT(BUF, COUNT, DATATYPE, DEST, TAG, COMM, REQUEST, IERROR)
    <type> BUF(*)
    INTEGER COUNT, DATATYPE, DEST, TAG, COMM, REQUEST, IERROR

```

Creates a persistent communication object for a synchronous mode send operation.

```

1 MPI_RSEND_INIT(buf, count, datatype, dest, tag, comm, request)
2     IN      buf                initial address of send buffer (choice)
3
4     IN      count              number of elements sent (non-negative integer)
5
6     IN      datatype           type of each element (handle)
7
8     IN      dest               rank of destination (integer)
9
10    IN      tag                 message tag (integer)
11
12    IN      comm                communicator (handle)
13
14    OUT     request             communication request (handle)
15
16 C binding
17 int MPI_Rsend_init(const void *buf, int count, MPI_Datatype datatype,
18                   int dest, int tag, MPI_Comm comm, MPI_Request *request)
19
20 Fortran 2008 binding
21 MPI_Rsend_init(buf, count, datatype, dest, tag, comm, request, ierror)
22     TYPE(*), DIMENSION(..), INTENT(IN), ASYNCHRONOUS :: buf
23     INTEGER, INTENT(IN) :: count, dest, tag
24     TYPE(MPI_Datatype), INTENT(IN) :: datatype
25     TYPE(MPI_Comm), INTENT(IN) :: comm
26     TYPE(MPI_Request), INTENT(OUT) :: request
27     INTEGER, OPTIONAL, INTENT(OUT) :: ierror
28
29 Fortran binding
30 MPI_RSEND_INIT(BUF, COUNT, DATATYPE, DEST, TAG, COMM, REQUEST, IERROR)
31     <type> BUF(*)
32     INTEGER COUNT, DATATYPE, DEST, TAG, COMM, REQUEST, IERROR
33
34     Creates a persistent communication object for a ready mode send operation.
35
36 MPI_RECV_INIT(buf, count, datatype, source, tag, comm, request)
37     OUT     buf                initial address of receive buffer (choice)
38
39     IN      count              number of elements received (non-negative integer)
40
41     IN      datatype           type of each element (handle)
42
43     IN      source             rank of source or MPI_ANY_SOURCE (integer)
44
45     IN      tag                 message tag or MPI_ANY_TAG (integer)
46
47     IN      comm                communicator (handle)
48
49     OUT     request             communication request (handle)
50
51 C binding
52 int MPI_Recv_init(void *buf, int count, MPI_Datatype datatype, int source,
53                  int tag, MPI_Comm comm, MPI_Request *request)
54
55 Fortran 2008 binding
56 MPI_Recv_init(buf, count, datatype, source, tag, comm, request, ierror)

```

```

TYPE(*), DIMENSION(..), ASYNCHRONOUS :: buf
INTEGER, INTENT(IN) :: count, source, tag
TYPE(MPI_Datatype), INTENT(IN) :: datatype
TYPE(MPI_Comm), INTENT(IN) :: comm
TYPE(MPI_Request), INTENT(OUT) :: request
INTEGER, OPTIONAL, INTENT(OUT) :: ierror

```

**Fortran binding**

```

MPI_RECV_INIT(BUF, COUNT, DATATYPE, SOURCE, TAG, COMM, REQUEST, IERROR)
  <type> BUF(*)
  INTEGER COUNT, DATATYPE, SOURCE, TAG, COMM, REQUEST, IERROR

```

Creates a persistent communication request for a receive operation. The argument `buf` is marked as `OUT` because the user gives permission to write on the receive buffer by passing the argument to `MPI_RECV_INIT`.

A persistent communication request is inactive after it was created — no active communication is attached to the request.

A communication (send or receive) that uses a persistent request is initiated by the function `MPI_START`.

```

MPI_START(request)

```

```

  INOUT  request          communication request (handle)

```

**C binding**

```

int MPI_Start(MPI_Request *request)

```

**Fortran 2008 binding**

```

MPI_Start(request, ierror)
  TYPE(MPI_Request), INTENT(INOUT) :: request
  INTEGER, OPTIONAL, INTENT(OUT) :: ierror

```

**Fortran binding**

```

MPI_START(REQUEST, IERROR)
  INTEGER REQUEST, IERROR

```

The argument, `request`, is a handle returned by one of the previous five calls. The associated request should be inactive. The request becomes active once the call is made.

If the request is for a send with ready mode, then a matching receive should be posted before the call is made. The communication buffer should not be modified after the call, and until the operation completes.

The call is local, with similar semantics to the nonblocking communication operations described in Section 3.7. That is, a call to `MPI_START` with a request created by `MPI_SEND_INIT` starts a communication in the same manner as a call to `MPI_ISEND`; a call to `MPI_START` with a request created by `MPI_BSEND_INIT` starts a communication in the same manner as a call to `MPI_IBSEND`; and so on.

```
1 MPI_STARTALL(count, array_of_requests)
```

```
2     IN          count          list length (non-negative integer)
```

```
3     INOUT      array_of_requests  array of requests (array of handles)
```

### 6 C binding

```
7 int MPI_Startall(int count, MPI_Request array_of_requests[])
```

### 9 Fortran 2008 binding

```
10 MPI_Startall(count, array_of_requests, ierror)
```

```
11     INTEGER, INTENT(IN) :: count
```

```
12     TYPE(MPI_Request), INTENT(INOUT) :: array_of_requests(count)
```

```
13     INTEGER, OPTIONAL, INTENT(OUT) :: ierror
```

### 14 Fortran binding

```
15 MPI_STARTALL(COUNT, ARRAY_OF_REQUESTS, IERROR)
```

```
16     INTEGER COUNT, ARRAY_OF_REQUESTS(*), IERROR
```

17 Start all communications associated with requests in `array_of_requests`. A call to  
18 `MPI_STARTALL(count, array_of_requests)` has the same effect as calls to  
19 `MPI_START (&array_of_requests[i])`, executed for  $i=0, \dots, \text{count}-1$ , in some arbitrary order.

20 A communication started with a call to `MPI_START` or `MPI_STARTALL` is completed  
21 by a call to `MPI_WAIT`, `MPI_TEST`, or one of the derived functions described in Sec-  
22 tion 3.7.5. The request becomes inactive after successful completion of such call. The re-  
23 quest is not deallocated and it can be activated anew by an `MPI_START` or `MPI_STARTALL`  
24 call.

25 A persistent request is deallocated by a call to `MPI_REQUEST_FREE` (Section 3.7.3).

26 The call to `MPI_REQUEST_FREE` can occur at any point in the program after the per-  
27 sistent request was created. However, the request will be deallocated only after it becomes  
28 inactive. Active receive requests should not be freed. Otherwise, it will not be possible to  
29 check that the receive has completed. Collective operation requests (defined in Section 5.12  
30 and Section 7.7 for nonblocking collective operations, and Section 5.13 and Section 7.8 for  
31 persistent collective operations) must not be freed while active. It is preferable, in general,  
32 to free requests when they are inactive. If this rule is followed, then the functions described  
33 in this section will be invoked in a sequence of the form,

```
35     Create (Start Complete)* Free
```

36 where `*` indicates zero or more repetitions. If the same communication object is used in  
37 several concurrent threads, it is the user's responsibility to coordinate calls so that the  
38 correct sequence is obeyed.

39 A send operation initiated with `MPI_START` can be matched with any receive operation  
40 and, likewise, a receive operation initiated with `MPI_START` can receive messages generated  
41 by any send operation.

42  
43  
44 *Advice to users.* To prevent problems with the argument copying and register  
45 optimization done by Fortran compilers, please note the hints in Sections 18.1.10–  
46 18.1.20. (*End of advice to users.*)



## 3.10 Send-Receive

The **send-receive** operations combine in one call the sending of a message to one destination and the receiving of another message, from another process. The two (source and destination) are possibly the same. A send-receive operation is very useful for executing a shift operation across a chain of processes. If blocking sends and receives are used for such a shift, then one needs to order the sends and receives correctly (for example, even processes send, then receive, odd processes receive first, then send) so as to prevent cyclic dependencies that may lead to deadlock. When a send-receive operation is used, the communication subsystem takes care of these issues. The send-receive operation can be used in conjunction with the functions described in Chapter 7 in order to perform shifts on various logical topologies. Also, a send-receive operation is useful for implementing remote procedure calls.

A message sent by a send-receive operation can be received by a regular receive operation or probed by a probe operation; a send-receive operation can receive a message sent by a regular send operation.

**MPI\_SENDRECV**(sendbuf, sendcount, sendtype, dest, sendtag, recvbuf, recvcount, recvtype, source, recvtag, comm, status)

IN	sendbuf	initial address of send buffer (choice)
IN	sendcount	number of elements in send buffer (non-negative integer)
IN	sendtype	type of elements in send buffer (handle)
IN	dest	rank of destination (integer)
IN	sendtag	send tag (integer)
OUT	recvbuf	initial address of receive buffer (choice)
IN	recvcount	number of elements in receive buffer (non-negative integer)
IN	recvtype	type of elements receive buffer element (handle)
IN	source	rank of source or MPI_ANY_SOURCE (integer)
IN	recvtag	receive tag or MPI_ANY_TAG (integer)
IN	comm	communicator (handle)
OUT	status	status object (Status)

### C binding

```
int MPI_Sendrecv(const void *sendbuf, int sendcount, MPI_Datatype sendtype,
                int dest, int sendtag, void *recvbuf, int recvcount,
                MPI_Datatype recvtype, int source, int recvtag, MPI_Comm comm,
                MPI_Status *status)
```

### Fortran 2008 binding

```
MPI_Sendrecv(sendbuf, sendcount, sendtype, dest, sendtag, recvbuf,
             recvcount, recvtype, source, recvtag, comm, status, ierror)
TYPE(*), DIMENSION(..), INTENT(IN) :: sendbuf
```

```

1     INTEGER, INTENT(IN) :: sendcount, dest, sendtag, recvcount, source,
2     recvtag
3     TYPE(MPI_Datatype), INTENT(IN) :: sendtype, recvttype
4     TYPE(*), DIMENSION(..) :: recvbuf
5     TYPE(MPI_Comm), INTENT(IN) :: comm
6     TYPE(MPI_Status) :: status
7     INTEGER, OPTIONAL, INTENT(OUT) :: ierror

```

### Fortran binding

```

9     MPI_SENDRECV(SENDBUF, SENDCOUNT, SENDTYPE, DEST, SENDTAG, RECVBUF,
10     RECVCOUNT, RECVTTYPE, SOURCE, RECVTAG, COMM, STATUS, IERROR)
11     <type> SENDBUF(*), RECVBUF(*)
12     INTEGER SENDCOUNT, SENDTYPE, DEST, SENDTAG, RECVCOUNT, RECVTTYPE,
13     SOURCE, RECVTAG, COMM, STATUS(MPI_STATUS_SIZE), IERROR

```

Execute a blocking send and receive operation. Both send and receive use the same communicator, but possibly different tags. The send buffer and receive buffers must be disjoint, and may have different lengths and datatypes.

The semantics of a send-receive operation is what would be obtained if the caller forked two concurrent threads, one to execute the send, and one to execute the receive, followed by a join of these two threads.

```

23     MPI_SENDRECV_REPLACE(buf, count, datatype, dest, sendtag, source, recvtag, comm, status)

```

25	INOUT	buf	initial address of send and receive buffer (choice)
26	IN	count	number of elements in send and receive buffer (non-negative integer)
27			
28			
29	IN	datatype	type of elements in send and receive buffer (handle)
30	IN	dest	rank of destination (integer)
31	IN	sendtag	send message tag (integer)
32	IN	source	rank of source or MPI_ANY_SOURCE (integer)
33	IN	recvtag	receive message tag or MPI_ANY_TAG (integer)
34	IN	comm	communicator (handle)
35	OUT	status	status object (Status)
36			
37			
38			

### C binding

```

40     int MPI_Sendrecv_replace(void *buf, int count, MPI_Datatype datatype,
41     int dest, int sendtag, int source, int recvtag, MPI_Comm comm,
42     MPI_Status *status)

```

### Fortran 2008 binding

```

44     MPI_Sendrecv_replace(buf, count, datatype, dest, sendtag, source, recvtag,
45     comm, status, ierror)
46     TYPE(*), DIMENSION(..) :: buf
47     INTEGER, INTENT(IN) :: count, dest, sendtag, source, recvtag
48

```

```

TYPE(MPI_Datatype), INTENT(IN) :: datatype
TYPE(MPI_Comm), INTENT(IN) :: comm
TYPE(MPI_Status) :: status
INTEGER, OPTIONAL, INTENT(OUT) :: ierror

```

### Fortran binding

```

MPI_SENDRECV_REPLACE(BUF, COUNT, DATATYPE, DEST, SENDTAG, SOURCE, RECVTAG,
                    COMM, STATUS, IERROR)
<type> BUF(*)
INTEGER COUNT, DATATYPE, DEST, SENDTAG, SOURCE, RECVTAG, COMM,
STATUS(MPI_STATUS_SIZE), IERROR

```

Execute a blocking send and receive. The same buffer is used both for the send and for the receive, so that the message sent is replaced by the message received.

*Advice to implementors.* Additional intermediate buffering is needed for the “replace” variant. (*End of advice to implementors.*)

## 3.11 Null Processes

In many instances, it is convenient to specify a “dummy” source or destination for communication. This simplifies the code that is needed for dealing with boundaries, for example, in the case of a non-circular shift done with calls to send-receive.

The special value `MPI_PROC_NULL` can be used instead of a rank wherever a source or a destination argument is required in a call. A communication with process `MPI_PROC_NULL` has no effect. A send to `MPI_PROC_NULL` succeeds and returns as soon as possible. A receive from `MPI_PROC_NULL` succeeds and returns as soon as possible with no modifications to the receive buffer. When a receive with `source = MPI_PROC_NULL` is executed then the status object returns `source = MPI_PROC_NULL`, `tag = MPI_ANY_TAG` and `count = 0`. A probe or matching probe with `source = MPI_PROC_NULL` succeeds and returns as soon as possible, and the status object returns `source = MPI_PROC_NULL`, `tag = MPI_ANY_TAG` and `count = 0`. A matching probe (cf. Section 3.8.2) with `source = MPI_PROC_NULL` returns `flag = true`, `message = MPI_MESSAGE_NO_PROC`, and the status object returns `source = MPI_PROC_NULL`, `tag = MPI_ANY_TAG`, and `count = 0`.

1  
2  
3  
4  
5  
6  
7  
8  
9  
10  
11  
12  
13  
14  
15  
16  
17  
18  
19  
20  
21  
22  
23  
24  
25  
26  
27  
28  
29  
30  
31  
32  
33  
34  
35  
36  
37  
38  
39  
40  
41  
42  
43  
44  
45  
46  
47  
48

DRAFT

1  
2  
3  
4  
5  
6  
7  
8  
9  
10  
11  
12  
13  
14  
15  
16  
17  
18  
19  
20  
21  
22  
23  
24  
25  
26  
27  
28  
29  
30  
31  
32  
33  
34  
35  
36  
37  
38  
39  
40  
41  
42  
43  
44  
45  
46  
47  
48

# Chapter 4

## Datatypes

Basic datatypes were introduced in Section 3.2.2 and in Section 3.3. In this chapter, this model is extended to describe any data layout. We consider general datatypes that allow one to transfer efficiently heterogeneous and noncontiguous data. We conclude with the description of calls for explicit packing and unpacking of messages.

### 4.1 Derived Datatypes

Up to here, all point to point communications have involved only buffers containing a sequence of identical basic datatypes. This is too constraining on two accounts. One often wants to pass messages that contain values with different datatypes (e.g., an integer count, followed by a sequence of real numbers); and one often wants to send noncontiguous data (e.g., a sub-block of a matrix). One solution is to pack noncontiguous data into a contiguous buffer at the sender site and unpack it at the receiver site. This has the disadvantage of requiring additional memory-to-memory copy operations at both sites, even when the communication subsystem has scatter-gather capabilities. Instead, MPI provides mechanisms to specify more general, mixed, and noncontiguous communication buffers. It is up to the implementation to decide whether data should be first packed in a contiguous buffer before being transmitted, or whether it can be collected directly from where it resides.

The general mechanisms provided here allow one to transfer directly, without copying, objects of various shapes and sizes. It is not assumed that the MPI library is cognizant of the objects declared in the host language. Thus, if one wants to transfer a structure, or an array section, it will be necessary to provide in MPI a definition of a communication buffer that mimics the definition of the structure or array section in question. These facilities can be used by library designers to define communication functions that can transfer objects defined in the host language — by decoding their definitions as available in a symbol table or a dope vector. Such higher-level communication functions are not part of MPI.

More general communication buffers are specified by replacing the basic datatypes that have been used so far with derived datatypes that are constructed from basic datatypes using the constructors described in this section. These methods of constructing derived datatypes can be applied recursively.

A **general datatype** is an opaque object that specifies two things:

- A sequence of basic datatypes
- A sequence of integer (byte) displacements

The displacements are not required to be positive, distinct, or in increasing order. Therefore, the order of items need not coincide with their order in store, and an item may appear more than once. We call such a pair of sequences (or sequence of pairs) a **type map**. The sequence of basic datatypes (displacements ignored) is the **type signature** of the datatype.

Let

$$Typemap = \{(type_0, disp_0), \dots, (type_{n-1}, disp_{n-1})\},$$

be such a type map, where  $type_i$  are basic types, and  $disp_i$  are displacements. Let

$$Typesig = \{type_0, \dots, type_{n-1}\}$$

be the associated type signature. This type map, together with a base address `buf`, specifies a communication buffer: the communication buffer that consists of  $n$  entries, where the  $i$ -th entry is at address `buf + dispi` and has type  $type_i$ . A message assembled from such a communication buffer will consist of  $n$  values, of the types defined by  $Typesig$ .

Most datatype constructors have replication count or block length arguments. Allowed values are non-negative integers. If the value is zero, no elements are generated in the type map and there is no effect on datatype bounds or extent.

We can use a handle to a general datatype as an argument in a send or receive operation, instead of a basic datatype argument. The operation `MPI_SEND(buf, 1, datatype, ...)` will use the send buffer defined by the base address `buf` and the general datatype associated with `datatype`; it will generate a message with the type signature determined by the `datatype` argument. `MPI_RECV(buf, 1, datatype, ...)` will use the receive buffer defined by the base address `buf` and the general datatype associated with `datatype`.

General datatypes can be used in all send and receive operations. We discuss, in Section 4.1.11, the case where the second argument `count` has value  $> 1$ .

The basic datatypes presented in Section 3.2.2 are particular cases of a general datatype, and are predefined. Thus, `MPI_INT` is a predefined handle to a datatype with type map  $\{(int, 0)\}$ , with one entry of type `int` and displacement zero. The other basic datatypes are similar.

The **extent** of a datatype is defined to be the span from the first byte to the last byte occupied by entries in this datatype, rounded up to satisfy alignment requirements. That is, if

$$Typemap = \{(type_0, disp_0), \dots, (type_{n-1}, disp_{n-1})\},$$

then

$$\begin{aligned} lb(Typemap) &= \min_j disp_j, \\ ub(Typemap) &= \max_j (disp_j + sizeof(type_j)) + \epsilon, \text{ and} \\ extent(Typemap) &= ub(Typemap) - lb(Typemap). \end{aligned} \tag{4.1}$$

If  $type_j$  requires alignment to a byte address that is a multiple of  $k_j$ , then  $\epsilon$  is the least non-negative increment needed to round  $extent(Typemap)$  to the next multiple of  $\max_j k_j$ . In Fortran, it is implementation dependent whether the MPI implementation computes the alignments  $k_j$  according to the alignments used by the compiler in common blocks, SEQUENCE derived types, BIND(C) derived types, or derived types that are neither SEQUENCE nor BIND(C). The complete definition of **extent** is given by Equation 4.1 Section 4.1.

**Example 4.1** Assume that  $Type = \{(double, 0), (char, 8)\}$  (a `double` at displacement zero, followed by a `char` at displacement eight). Assume, furthermore, that doubles have to be strictly aligned at addresses that are multiples of eight. Then, the extent of this datatype is 16 (9 rounded to the next multiple of 8). A datatype that consists of a character immediately followed by a double will also have an extent of 16.

*Rationale.* The definition of extent is motivated by the assumption that the amount of padding added at the end of each structure in an array of structures is the least needed to fulfill alignment constraints. More explicit control of the extent is provided in Section 4.1.6. Such explicit control is needed in cases where the assumption does not hold, for example, where union types are used. In Fortran, structures can be expressed with several language features, e.g., common blocks, `SEQUENCE` derived types, or `BIND(C)` derived types. The compiler may use different alignments, and therefore, it is recommended to use `MPI_TYPE_CREATE_RESIZED` for arrays of structures if an alignment may cause an alignment-gap at the end of a structure as described in Section 4.1.6 and in Section 18.1.15. (*End of rationale.*)

#### 4.1.1 Type Constructors with Explicit Addresses

In Fortran, the functions `MPI_TYPE_CREATE_HVECTOR`, `MPI_TYPE_CREATE_HINDEXED`, `MPI_TYPE_CREATE_HINDEXED_BLOCK`, `MPI_TYPE_CREATE_STRUCT`, and `MPI_GET_ADDRESS` accept arguments of type `INTEGER(KIND=MPI_ADDRESS_KIND)`, wherever arguments of type `MPI_Aint` are used in C. On Fortran 77 systems that do not support the Fortran 90 `KIND` notation, and where addresses are 64 bits whereas default `INTEGER`s are 32 bits, these arguments will be of type `INTEGER*8`.

#### 4.1.2 Datatype Constructors

**Contiguous** The simplest datatype constructor is `MPI_TYPE_CONTIGUOUS` which allows replication of a datatype into contiguous locations.

`MPI_TYPE_CONTIGUOUS(count, oldtype, newtype)`

IN	count	replication count (non-negative integer)
IN	oldtype	old datatype (handle)
OUT	newtype	new datatype (handle)

#### C binding

```
int MPI_Type_contiguous(int count, MPI_Datatype oldtype,
                       MPI_Datatype *newtype)
```

#### Fortran 2008 binding

```
MPI_Type_contiguous(count, oldtype, newtype, ierror)
  INTEGER, INTENT(IN) :: count
  TYPE(MPI_Datatype), INTENT(IN) :: oldtype
  TYPE(MPI_Datatype), INTENT(OUT) :: newtype
  INTEGER, OPTIONAL, INTENT(OUT) :: ierror
```

**Fortran binding**

```

MPI_TYPE_CONTIGUOUS(COUNT, OLDTYPE, NEWTYPE, IERROR)
    INTEGER COUNT, OLDTYPE, NEWTYPE, IERROR

```

`newtype` is the datatype obtained by concatenating `count` copies of `oldtype`. Concatenation is defined using *extent* as the size of the concatenated copies.

**Example 4.2** Let `oldtype` have type map  $\{(\text{double}, 0), (\text{char}, 8)\}$ , with extent 16, and let `count` = 3. The type map of the datatype returned by `newtype` is

$$\{(\text{double}, 0), (\text{char}, 8), (\text{double}, 16), (\text{char}, 24), (\text{double}, 32), (\text{char}, 40)\};$$

i.e., alternating `double` and `char` elements, with displacements 0, 8, 16, 24, 32, 40.

In general, assume that the type map of `oldtype` is

$$\{(type_0, disp_0), \dots, (type_{n-1}, disp_{n-1})\},$$

with extent *ex*. Then `newtype` has a type map with `count` · *n* entries defined by:

$$\{(type_0, disp_0), \dots, (type_{n-1}, disp_{n-1}), (type_0, disp_0 + ex), \dots, (type_{n-1}, disp_{n-1} + ex), \\ \dots, (type_0, disp_0 + ex \cdot (\text{count} - 1)), \dots, (type_{n-1}, disp_{n-1} + ex \cdot (\text{count} - 1))\}.$$

**Vector** The function `MPI_TYPE_VECTOR` is a more general constructor that allows replication of a datatype into locations that consist of equally spaced blocks. Each block is obtained by concatenating the same number of copies of the old datatype. The spacing between blocks is a multiple of the extent of the old datatype.

```

MPI_TYPE_VECTOR(count, blocklength, stride, oldtype, newtype)

```

IN	count	number of blocks (non-negative integer)
IN	blocklength	number of elements in each block (non-negative integer)
IN	stride	number of elements between start of each block (integer)
IN	oldtype	old datatype (handle)
OUT	newtype	new datatype (handle)

**C binding**

```

int MPI_Type_vector(int count, int blocklength, int stride,
    MPI_Datatype oldtype, MPI_Datatype *newtype)

```

**Fortran 2008 binding**

```

MPI_Type_vector(count, blocklength, stride, oldtype, newtype, ierror)
    INTEGER, INTENT(IN) :: count, blocklength, stride
    TYPE(MPI_Datatype), INTENT(IN) :: oldtype
    TYPE(MPI_Datatype), INTENT(OUT) :: newtype
    INTEGER, OPTIONAL, INTENT(OUT) :: ierror

```



**Fortran binding**

```
MPI_TYPE_VECTOR(COUNT, BLOCKLENGTH, STRIDE, OLDTYPE, NEWTYPE, IERROR)
    INTEGER COUNT, BLOCKLENGTH, STRIDE, OLDTYPE, NEWTYPE, IERROR
```

**Example 4.3** Assume, again, that `oldtype` has type map  $\{(double, 0), (char, 8)\}$ , with extent 16. A call to `MPI_TYPE_VECTOR(2, 3, 4, oldtype, newtype)` will create the datatype with type map,

$$\{(double, 0), (char, 8), (double, 16), (char, 24), (double, 32), (char, 40), \\ (double, 64), (char, 72), (double, 80), (char, 88), (double, 96), (char, 104)\}.$$

That is, two blocks with three copies each of the old type, with a stride of 4 elements ( $4 \cdot 16$  bytes) between the the start of each block.

**Example 4.4** A call to `MPI_TYPE_VECTOR(3, 1, -2, oldtype, newtype)` will create the datatype,

$$\{(double, 0), (char, 8), (double, -32), (char, -24), (double, -64), (char, -56)\}.$$

In general, assume that `oldtype` has type map,

$$\{(type_0, disp_0), \dots, (type_{n-1}, disp_{n-1})\},$$

with extent  $ex$ . Let  $bl$  be the blocklength. The newly created datatype has a type map with  $count \cdot bl \cdot n$  entries:

$$\{(type_0, disp_0), \dots, (type_{n-1}, disp_{n-1}), \\ (type_0, disp_0 + ex), \dots, (type_{n-1}, disp_{n-1} + ex), \dots, \\ (type_0, disp_0 + (bl - 1) \cdot ex), \dots, (type_{n-1}, disp_{n-1} + (bl - 1) \cdot ex), \\ (type_0, disp_0 + stride \cdot ex), \dots, (type_{n-1}, disp_{n-1} + stride \cdot ex), \dots, \\ (type_0, disp_0 + (stride + bl - 1) \cdot ex), \dots, (type_{n-1}, disp_{n-1} + (stride + bl - 1) \cdot ex), \dots, \\ (type_0, disp_0 + stride \cdot (count - 1) \cdot ex), \dots, \\ (type_{n-1}, disp_{n-1} + stride \cdot (count - 1) \cdot ex), \dots, \\ (type_0, disp_0 + (stride \cdot (count - 1) + bl - 1) \cdot ex), \dots, \\ (type_{n-1}, disp_{n-1} + (stride \cdot (count - 1) + bl - 1) \cdot ex)\}.$$

A call to `MPI_TYPE_CONTIGUOUS(count, oldtype, newtype)` is equivalent to a call to `MPI_TYPE_VECTOR(count, 1, 1, oldtype, newtype)`, or to a call to `MPI_TYPE_VECTOR(1, count, n, oldtype, newtype)`,  $n$  arbitrary.

Hvector The function `MPI_TYPE_CREATE_HVECTOR` is identical to `MPI_TYPE_VECTOR`, except that `stride` is given in bytes, rather than in elements. The use for both types of vector constructors is illustrated in Section 4.1.14. (H stands for “heterogeneous”).

`MPI_TYPE_CREATE_HVECTOR(count, blocklength, stride, oldtype, newtype)`

IN	count	number of blocks (non-negative integer)
IN	blocklength	number of elements in each block (non-negative integer)
IN	stride	number of bytes between start of each block (integer)
IN	oldtype	old datatype (handle)
OUT	newtype	new datatype (handle)

### C binding

```
int MPI_Type_create_hvector(int count, int blocklength, MPI_Aint stride,
                           MPI_Datatype oldtype, MPI_Datatype *newtype)
```

### Fortran 2008 binding

```
MPI_Type_create_hvector(count, blocklength, stride, oldtype, newtype,
                        ierror)
    INTEGER, INTENT(IN) :: count, blocklength
    INTEGER(KIND=MPI_ADDRESS_KIND), INTENT(IN) :: stride
    TYPE(MPI_Datatype), INTENT(IN) :: oldtype
    TYPE(MPI_Datatype), INTENT(OUT) :: newtype
    INTEGER, OPTIONAL, INTENT(OUT) :: ierror
```

### Fortran binding

```
MPI_TYPE_CREATE_HVECTOR(COUNT, BLOCKLENGTH, STRIDE, OLDTYPE, NEWTYPE,
                        IERROR)
    INTEGER COUNT, BLOCKLENGTH, OLDTYPE, NEWTYPE, IERROR
    INTEGER(KIND=MPI_ADDRESS_KIND) STRIDE
```

Assume that `oldtype` has type map,

$$\{(type_0, disp_0), \dots, (type_{n-1}, disp_{n-1})\},$$

with extent  $ex$ . Let  $bl$  be the blocklength. The newly created datatype has a type map with  $count \cdot bl \cdot n$  entries:

$$\begin{aligned} &\{(type_0, disp_0), \dots, (type_{n-1}, disp_{n-1}), \\ &(type_0, disp_0 + ex), \dots, (type_{n-1}, disp_{n-1} + ex), \dots, \\ &(type_0, disp_0 + (bl - 1) \cdot ex), \dots, (type_{n-1}, disp_{n-1} + (bl - 1) \cdot ex), \\ &(type_0, disp_0 + stride), \dots, (type_{n-1}, disp_{n-1} + stride), \dots, \\ &(type_0, disp_0 + stride + (bl - 1) \cdot ex), \dots, \end{aligned}$$

$$\begin{aligned}
 & (type_{n-1}, disp_{n-1} + stride + (bl - 1) \cdot ex), \dots, \\
 & (type_0, disp_0 + stride \cdot (count - 1)), \dots, (type_{n-1}, disp_{n-1} + stride \cdot (count - 1)), \dots, \\
 & (type_0, disp_0 + stride \cdot (count - 1) + (bl - 1) \cdot ex), \dots, \\
 & (type_{n-1}, disp_{n-1} + stride \cdot (count - 1) + (bl - 1) \cdot ex)\}.
 \end{aligned}$$

**Indexed** The function `MPI_TYPE_INDEXED` allows replication of an old datatype into a sequence of blocks (each block is a concatenation of the old datatype), where each block can contain a different number of copies and have a different displacement. All block displacements are multiples of the old type extent.

`MPI_TYPE_INDEXED(count, array_of_blocklengths, array_of_displacements, oldtype, newtype)`

IN	count	number of blocks – also number of entries in <code>array_of_displacements</code> and <code>array_of_blocklengths</code> (non-negative integer)
IN	array_of_blocklengths	number of elements per block (array of non-negative integers)
IN	array_of_displacements	displacement for each block, in multiples of <code>oldtype</code> (array of integers)
IN	oldtype	old datatype (handle)
OUT	newtype	new datatype (handle)

#### C binding

```
int MPI_Type_indexed(int count, const int array_of_blocklengths[],
                    const int array_of_displacements[], MPI_Datatype oldtype,
                    MPI_Datatype *newtype)
```

#### Fortran 2008 binding

```
MPI_Type_indexed(count, array_of_blocklengths, array_of_displacements,
                 oldtype, newtype, ierror)
    INTEGER, INTENT(IN) :: count, array_of_blocklengths(count),
array_of_displacements(count)
    TYPE(MPI_Datatype), INTENT(IN) :: oldtype
    TYPE(MPI_Datatype), INTENT(OUT) :: newtype
    INTEGER, OPTIONAL, INTENT(OUT) :: ierror
```

#### Fortran binding

```
MPI_TYPE_INDEXED(COUNT, ARRAY_OF_BLOCKLENGTHS, ARRAY_OF_DISPLACEMENTS,
                 OLDTYPE, NEWTYPE, IERROR)
    INTEGER COUNT, ARRAY_OF_BLOCKLENGTHS(*), ARRAY_OF_DISPLACEMENTS(*),
    OLDTYPE, NEWTYPE, IERROR
```

**Example 4.5** Let `oldtype` have type map  $\{(\text{double}, 0), (\text{char}, 8)\}$ , with extent 16. Let  $B = (3, 1)$  and let  $D = (4, 0)$ . A call to `MPI_TYPE_INDEXED(2, B, D, oldtype, newtype)` returns a datatype with type map,

$$\{(\text{double}, 64), (\text{char}, 72), (\text{double}, 80), (\text{char}, 88), (\text{double}, 96), (\text{char}, 104), (\text{double}, 0), (\text{char}, 8)\}.$$

That is, three copies of the old type starting at displacement 64, and one copy starting at displacement 0.

In general, assume that `oldtype` has type map,

$$\{(type_0, disp_0), \dots, (type_{n-1}, disp_{n-1})\},$$

with extent  $ex$ . Let  $B$  be the `array_of_blocklengths` argument and  $D$  be the `array_of_displacements` argument. The newly created datatype has  $n \cdot \sum_{i=0}^{\text{count}-1} B[i]$  entries:

$$\begin{aligned} &\{(type_0, disp_0 + D[0] \cdot ex), \dots, (type_{n-1}, disp_{n-1} + D[0] \cdot ex), \dots, \\ &(type_0, disp_0 + (D[0] + B[0] - 1) \cdot ex), \dots, \\ &(type_{n-1}, disp_{n-1} + (D[0] + B[0] - 1) \cdot ex), \dots, \\ &(type_0, disp_0 + D[\text{count}-1] \cdot ex), \dots, (type_{n-1}, disp_{n-1} + D[\text{count}-1] \cdot ex), \dots, \\ &(type_0, disp_0 + (D[\text{count}-1] + B[\text{count}-1] - 1) \cdot ex), \dots, \\ &(type_{n-1}, disp_{n-1} + (D[\text{count}-1] + B[\text{count}-1] - 1) \cdot ex)\}. \end{aligned}$$

A call to `MPI_TYPE_VECTOR(count, blocklength, stride, oldtype, newtype)` is equivalent to a call to `MPI_TYPE_INDEXED(count, B, D, oldtype, newtype)` where

$$D[j] = j \cdot \text{stride}, \quad j = 0, \dots, \text{count} - 1,$$

and

$$B[j] = \text{blocklength}, \quad j = 0, \dots, \text{count} - 1.$$

**Hindexed** The function `MPI_TYPE_CREATE_HINDEXED` is identical to `MPI_TYPE_INDEXED`, except that block displacements in `array_of_displacements` are specified in bytes, rather than in multiples of the `oldtype` extent.

`MPI_TYPE_CREATE_HINDEXED(count, array_of_blocklengths, array_of_displacements, oldtype, newtype)`

IN	count	number of blocks – also number of entries in <code>array_of_displacements</code> and <code>array_of_blocklengths</code> (non-negative integer)
IN	array_of_blocklengths	number of elements in each block (array of non-negative integers)
IN	array_of_displacements	byte displacement of each block (array of integers)
IN	oldtype	old datatype (handle)
OUT	newtype	new datatype (handle)

**C binding**

```
int MPI_Type_create_hindexed(int count, const int array_of_blocklengths[],
                             const MPI_Aint array_of_displacements[], MPI_Datatype oldtype,
                             MPI_Datatype *newtype)
```

**Fortran 2008 binding**

```
MPI_Type_create_hindexed(count, array_of_blocklengths,
                          array_of_displacements, oldtype, newtype, ierror)
  INTEGER, INTENT(IN) :: count, array_of_blocklengths(count)
  INTEGER(KIND=MPI_ADDRESS_KIND), INTENT(IN) ::
array_of_displacements(count)
  TYPE(MPI_Datatype), INTENT(IN) :: oldtype
  TYPE(MPI_Datatype), INTENT(OUT) :: newtype
  INTEGER, OPTIONAL, INTENT(OUT) :: ierror
```

**Fortran binding**

```
MPI_TYPE_CREATE_HINDEXED(COUNT, ARRAY_OF_BLOCKLENGTHS,
                          ARRAY_OF_DISPLACEMENTS, OLDTYPE, NEWTYPE, IERROR)
  INTEGER COUNT, ARRAY_OF_BLOCKLENGTHS(*), OLDTYPE, NEWTYPE, IERROR
  INTEGER(KIND=MPI_ADDRESS_KIND) ARRAY_OF_DISPLACEMENTS(*)
```

Assume that `oldtype` has type map,

$$\{(type_0, disp_0), \dots, (type_{n-1}, disp_{n-1})\},$$

with extent  $ex$ . Let  $B$  be the `array_of_blocklengths` argument and  $D$  be the `array_of_displacements` argument. The newly created datatype has a type map with  $n \cdot \sum_{i=0}^{count-1} B[i]$  entries:

$$\{(type_0, disp_0 + D[0]), \dots, (type_{n-1}, disp_{n-1} + D[0]), \dots,$$

$$(type_0, disp_0 + D[0] + (B[0] - 1) \cdot ex), \dots,$$

$$(type_{n-1}, disp_{n-1} + D[0] + (B[0] - 1) \cdot ex), \dots,$$

$$(type_0, disp_0 + D[count-1]), \dots, (type_{n-1}, disp_{n-1} + D[count-1]), \dots,$$

$$(type_0, disp_0 + D[count-1] + (B[count-1] - 1) \cdot ex), \dots,$$

$$(type_{n-1}, disp_{n-1} + D[count-1] + (B[count-1] - 1) \cdot ex)\}.$$

**Indexed\_block** This function is the same as `MPI_TYPE_INDEXED` except that the block-length is the same for all blocks. There are many codes using indirect addressing arising from unstructured grids where the blocksize is always 1 (gather/scatter). The following convenience function allows for constant blocksize and arbitrary displacements.

```

1 MPI_TYPE_CREATE_INDEXED_BLOCK(count, blocklength, array_of_displacements, oldtype,
2     newtype)
3     IN     count           length of array of displacements (non-negative integer)
4     IN     blocklength     size of block (non-negative integer)
5     IN     array_of_displacements array of displacements (array of integers)
6     IN     oldtype         old datatype (handle)
7     OUT    newtype         new datatype (handle)

```

**C binding**

```

12 int MPI_Type_create_indexed_block(int count, int blocklength,
13     const int array_of_displacements[], MPI_Datatype oldtype,
14     MPI_Datatype *newtype)

```

**Fortran 2008 binding**

```

16 MPI_Type_create_indexed_block(count, blocklength, array_of_displacements,
17     oldtype, newtype, ierror)
18     INTEGER, INTENT(IN) :: count, blocklength,
19     array_of_displacements(count)
20     TYPE(MPI_Datatype), INTENT(IN) :: oldtype
21     TYPE(MPI_Datatype), INTENT(OUT) :: newtype
22     INTEGER, OPTIONAL, INTENT(OUT) :: ierror

```

**Fortran binding**

```

25 MPI_TYPE_CREATE_INDEXED_BLOCK(COUNT, BLOCKLENGTH, ARRAY_OF_DISPLACEMENTS,
26     OLDTYPE, NEWTYPE, IERROR)
27     INTEGER COUNT, BLOCKLENGTH, ARRAY_OF_DISPLACEMENTS(*), OLDTYPE,
28     NEWTYPE, IERROR

```

Hindexed\_block The function MPI\_TYPE\_CREATE\_HINDEXED\_BLOCK is identical to MPI\_TYPE\_CREATE\_INDEXED\_BLOCK, except that block displacements in array\_of\_displacements are specified in bytes, rather than in multiples of the oldtype extent.

```

35 MPI_TYPE_CREATE_HINDEXED_BLOCK(count, blocklength, array_of_displacements, oldtype,
36     newtype)
37     IN     count           length of array of displacements (non-negative integer)
38     IN     blocklength     size of block (non-negative integer)
39     IN     array_of_displacements byte displacement of each block (array of integers)
40     IN     oldtype         old datatype (handle)
41     OUT    newtype         new datatype (handle)

```

**C binding**

```

46 int MPI_Type_create_hindexed_block(int count, int blocklength,
47     const MPI_Aint array_of_displacements[], MPI_Datatype oldtype,
48     MPI_Datatype *newtype)

```

**Fortran 2008 binding**

```

MPI_Type_create_hindexed_block(count, blocklength, array_of_displacements,
                               oldtype, newtype, ierror)
    INTEGER, INTENT(IN) :: count, blocklength
    INTEGER(KIND=MPI_ADDRESS_KIND), INTENT(IN) ::
array_of_displacements(count)
    TYPE(MPI_Datatype), INTENT(IN) :: oldtype
    TYPE(MPI_Datatype), INTENT(OUT) :: newtype
    INTEGER, OPTIONAL, INTENT(OUT) :: ierror

```

**Fortran binding**

```

MPI_TYPE_CREATE_HINDEXED_BLOCK(COUNT, BLOCKLENGTH, ARRAY_OF_DISPLACEMENTS,
                                OLDDTYPE, NEWTYPE, IERROR)
    INTEGER COUNT, BLOCKLENGTH, OLDDTYPE, NEWTYPE, IERROR
    INTEGER(KIND=MPI_ADDRESS_KIND) ARRAY_OF_DISPLACEMENTS(*)

```

Struct `MPI_TYPE_CREATE_STRUCT` is the most general type constructor. It further generalizes `MPI_TYPE_CREATE_HINDEXED` in that it allows each block to consist of replications of different datatypes.

```

MPI_TYPE_CREATE_STRUCT(count, array_of_blocklengths, array_of_displacements, array_of_types,
                       newtype)

```

IN	count	number of blocks also number of entries in arrays array_of_types, array_of_displacements, and array_of_blocklengths (non-negative integer)
IN	array_of_blocklengths	number of elements in each block (array of non-negative integers)
IN	array_of_displacements	byte displacement of each block (array of integers)
IN	array_of_types	types of elements in each block (array of handles)
OUT	newtype	new datatype (handle)

**C binding**

```

int MPI_Type_create_struct(int count, const int array_of_blocklengths[],
                           const MPI_Aint array_of_displacements[],
                           const MPI_Datatype array_of_types[], MPI_Datatype *newtype)

```

**Fortran 2008 binding**

```

MPI_Type_create_struct(count, array_of_blocklengths,
                       array_of_displacements, array_of_types, newtype, ierror)
    INTEGER, INTENT(IN) :: count, array_of_blocklengths(count)
    INTEGER(KIND=MPI_ADDRESS_KIND), INTENT(IN) ::
array_of_displacements(count)
    TYPE(MPI_Datatype), INTENT(IN) :: array_of_types(count)
    TYPE(MPI_Datatype), INTENT(OUT) :: newtype
    INTEGER, OPTIONAL, INTENT(OUT) :: ierror

```

**Fortran binding**

```

1 MPI_TYPE_CREATE_STRUCT(COUNT, ARRAY_OF_BLOCKLENGTHS,
2     ARRAY_OF_DISPLACEMENTS, ARRAY_OF_TYPES, NEWTYPE, IERROR)
3     INTEGER COUNT, ARRAY_OF_BLOCKLENGTHS(*), ARRAY_OF_TYPES(*), NEWTYPE,
4     IERROR
5     INTEGER(KIND=MPI_ADDRESS_KIND) ARRAY_OF_DISPLACEMENTS(*)
6
7
8

```

**Example 4.6** Let `type1` have type map,

$$\{(\text{double}, 0), (\text{char}, 8)\},$$

with extent 16. Let  $B = (2, 1, 3)$ ,  $D = (0, 16, 26)$ , and  $T = (\text{MPI\_FLOAT}, \text{type1}, \text{MPI\_CHAR})$ . Then a call to `MPI_TYPE_CREATE_STRUCT(3, B, D, T, newtype)` returns a datatype with type map,

$$\{(\text{float}, 0), (\text{float}, 4), (\text{double}, 16), (\text{char}, 24), (\text{char}, 26), (\text{char}, 27), (\text{char}, 28)\}.$$

That is, two copies of `MPI_FLOAT` starting at 0, followed by one copy of `type1` starting at 16, followed by three copies of `MPI_CHAR`, starting at 26. (We assume that a float occupies four bytes.)

In general, let  $T$  be the `array_of_types` argument, where  $T[i]$  is a handle to,

$$\text{typemap}_i = \{(type_0^i, disp_0^i), \dots, (type_{n_i-1}^i, disp_{n_i-1}^i)\},$$

with extent  $ex_i$ . Let  $B$  be the `array_of_blocklength` argument and  $D$  be the `array_of_displacements` argument. Let  $c$  be the `count` argument. Then the newly created datatype has a type map with  $\sum_{i=0}^{c-1} B[i] \cdot n_i$  entries:

$$\begin{aligned}
& \{(type_0^0, disp_0^0 + D[0]), \dots, (type_{n_0}^0, disp_{n_0}^0 + D[0]), \dots, \\
& (type_0^0, disp_0^0 + D[0] + (B[0] - 1) \cdot ex_0), \dots, (type_{n_0}^0, disp_{n_0}^0 + D[0] + (B[0]-1) \cdot ex_0), \dots, \\
& (type_0^{c-1}, disp_0^{c-1} + D[c-1]), \dots, (type_{n_{c-1}-1}^{c-1}, disp_{n_{c-1}-1}^{c-1} + D[c-1]), \dots, \\
& (type_0^{c-1}, disp_0^{c-1} + D[c-1] + (B[c-1] - 1) \cdot ex_{c-1}), \dots, \\
& (type_{n_{c-1}-1}^{c-1}, disp_{n_{c-1}-1}^{c-1} + D[c-1] + (B[c-1]-1) \cdot ex_{c-1})\}.
\end{aligned}$$

A call to `MPI_TYPE_CREATE_HINDEXED(count, B, D, oldtype, newtype)` is equivalent to a call to `MPI_TYPE_CREATE_STRUCT(count, B, D, T, newtype)`, where each entry of  $T$  is equal to `oldtype`.



## 4.1.3 Subarray Datatype Constructor

```
MPI_TYPE_CREATE_SUBARRAY(ndims, array_of_sizes, array_of_subsizes, array_of_starts,
                          order, oldtype, newtype)
```

IN	ndims	number of array dimensions (positive integer)
IN	array_of_sizes	number of elements of type <code>oldtype</code> in each dimension of the full array (array of positive integers)
IN	array_of_subsizes	number of elements of type <code>oldtype</code> in each dimension of the subarray (array of positive integers)
IN	array_of_starts	starting coordinates of the subarray in each dimension (array of non-negative integers)
IN	order	array storage order flag (state)
IN	oldtype	old datatype (handle)
OUT	newtype	new datatype (handle)

**C binding**

```
int MPI_Type_create_subarray(int ndims, const int array_of_sizes[],
                             const int array_of_subsizes[], const int array_of_starts[],
                             int order, MPI_Datatype oldtype, MPI_Datatype *newtype)
```

**Fortran 2008 binding**

```
MPI_Type_create_subarray(ndims, array_of_sizes, array_of_subsizes,
                          array_of_starts, order, oldtype, newtype, ierror)
    INTEGER, INTENT(IN) :: ndims, array_of_sizes(ndims),
    array_of_subsizes(ndims), array_of_starts(ndims), order
    TYPE(MPI_Datatype), INTENT(IN) :: oldtype
    TYPE(MPI_Datatype), INTENT(OUT) :: newtype
    INTEGER, OPTIONAL, INTENT(OUT) :: ierror
```

**Fortran binding**

```
MPI_TYPE_CREATE_SUBARRAY(NDIMS, ARRAY_OF_SIZES, ARRAY_OF_SUBSIZES,
                          ARRAY_OF_STARTS, ORDER, OLDDTYPE, NEWTYPE, IERROR)
    INTEGER NDIMS, ARRAY_OF_SIZES(*), ARRAY_OF_SUBSIZES(*),
    ARRAY_OF_STARTS(*), ORDER, OLDDTYPE, NEWTYPE, IERROR
```

The subarray type constructor creates an MPI datatype describing an  $n$ -dimensional subarray of an  $n$ -dimensional array. The subarray may be situated anywhere within the full array, and may be of any nonzero size up to the size of the larger array as long as it is confined within this array. This type constructor facilitates creating filetypes to access arrays distributed in blocks among processes to a single file that contains the global array, see MPI I/O, especially Section 13.1.1.

This type constructor can handle arrays with an arbitrary number of dimensions and works for both C and Fortran ordered matrices (i.e., row-major or column-major). Note that a C program may use Fortran order and a Fortran program may use C order.

The `ndims` parameter specifies the number of dimensions in the full data array and gives the number of elements in `array_of_sizes`, `array_of_subsizes`, and `array_of_starts`.

The number of elements of type `oldtype` in each dimension of the  $n$ -dimensional array and the requested subarray are specified by `array_of_sizes` and `array_of_subsizes`, respectively. For any dimension  $i$ , it is erroneous to specify `array_of_subsizes[i] < 1` or `array_of_subsizes[i] > array_of_sizes[i]`.

The `array_of_starts` contains the starting coordinates of each dimension of the subarray. Arrays are assumed to be indexed starting from zero. For any dimension  $i$ , it is erroneous to specify `array_of_starts[i] < 0` or `array_of_starts[i] > (array_of_sizes[i] - array_of_subsizes[i])`.

*Advice to users.* In a Fortran program with arrays indexed starting from 1, if the starting coordinate of a particular dimension of the subarray is  $n$ , then the entry in `array_of_starts` for that dimension is  $n-1$ . (*End of advice to users.*)

The `order` argument specifies the storage order for the subarray as well as the full array. It must be set to one of the following:

**MPI\_ORDER\_C** The ordering used by C arrays, (i.e., row-major order)

**MPI\_ORDER\_FORTRAN** The ordering used by Fortran arrays, (i.e., column-major order)

A  $ndims$ -dimensional subarray (`newtype`) with no extra padding can be defined by the function `Subarray()` as follows:

$$\begin{aligned} \text{newtype} = & \text{Subarray}(ndims, \{size_0, size_1, \dots, size_{ndims-1}\}, \\ & \{subsize_0, subsize_1, \dots, subsize_{ndims-1}\}, \\ & \{start_0, start_1, \dots, start_{ndims-1}\}, \text{oldtype}) \end{aligned}$$

Let the typemap of `oldtype` have the form:

$$\{(type_0, disp_0), (type_1, disp_1), \dots, (type_{n-1}, disp_{n-1})\}$$

where  $type_i$  is a predefined MPI datatype, and let  $ex$  be the extent of `oldtype`. Then we define the `Subarray()` function recursively using the following three equations. Equation 4.2 defines the base step. Equation 4.3 defines the recursion step when `order = MPI_ORDER_FORTRAN`, and Equation 4.4 defines the recursion step when `order = MPI_ORDER_C`. These equations use the conceptual datatypes `lb_marker` and `ub_marker`; see Section 4.1.6 for details.

$$\begin{aligned} & \text{Subarray}(1, \{size_0\}, \{subsize_0\}, \{start_0\}, \\ & \quad \{(type_0, disp_0), (type_1, disp_1), \dots, (type_{n-1}, disp_{n-1})\}) \\ & = \{(\text{lb\_marker}, 0), \\ & \quad (type_0, disp_0 + start_0 \times ex), \dots, (type_{n-1}, disp_{n-1} + start_0 \times ex), \\ & \quad (type_0, disp_0 + (start_0 + 1) \times ex), \dots, (type_{n-1}, \\ & \quad \quad disp_{n-1} + (start_0 + 1) \times ex), \dots \\ & \quad (type_0, disp_0 + (start_0 + subsize_0 - 1) \times ex), \dots, \\ & \quad \quad (type_{n-1}, disp_{n-1} + (start_0 + subsize_0 - 1) \times ex), \\ & \quad (\text{ub\_marker}, size_0 \times ex)\} \end{aligned} \tag{4.2}$$

$$\text{Subarray}(ndims, \{size_0, size_1, \dots, size_{ndims-1}\}, \tag{4.3}$$

$$\begin{aligned}
& \{subsize_0, subsize_1, \dots, subsize_{ndims-1}\}, \\
& \{start_0, start_1, \dots, start_{ndims-1}\}, oldtype) \\
= & \text{Subarray}(ndims - 1, \{size_1, size_2, \dots, size_{ndims-1}\}, \\
& \{subsize_1, subsize_2, \dots, subsize_{ndims-1}\}, \\
& \{start_1, start_2, \dots, start_{ndims-1}\}, \\
& \text{Subarray}(1, \{size_0\}, \{subsize_0\}, \{start_0\}, oldtype)) \\
& \text{Subarray}(ndims, \{size_0, size_1, \dots, size_{ndims-1}\}, \\
& \{subsize_0, subsize_1, \dots, subsize_{ndims-1}\}, \\
& \{start_0, start_1, \dots, start_{ndims-1}\}, oldtype) \\
= & \text{Subarray}(ndims - 1, \{size_0, size_1, \dots, size_{ndims-2}\}, \\
& \{subsize_0, subsize_1, \dots, subsize_{ndims-2}\}, \\
& \{start_0, start_1, \dots, start_{ndims-2}\}, \\
& \text{Subarray}(1, \{size_{ndims-1}\}, \{subsize_{ndims-1}\}, \{start_{ndims-1}\}, oldtype))
\end{aligned} \tag{4.4}$$

For an example use of `MPI_TYPE_CREATE_SUBARRAY` in the context of I/O see Section 13.9.2.

#### 4.1.4 Distributed Array Datatype Constructor

The distributed array type constructor supports HPF-like [44] data distributions. However, unlike in HPF, the storage order may be specified for C arrays as well as for Fortran arrays.

*Advice to users.* One can create an HPF-like file view using this type constructor as follows. Complementary filetypes are created by having every process of a group call this constructor with identical arguments (with the exception of rank which should be set appropriately). These filetypes (along with identical `disp` and `etype`) are then used to define the view (via `MPI_FILE_SET_VIEW`), see MPI I/O, especially Section 13.1.1 and Section 13.3. Using this view, a collective data access operation (with identical offsets) will yield an HPF-like distribution pattern. (*End of advice to users.*)

```

1 MPI_TYPE_CREATE_DARRAY(size, rank, ndims, array_of_gsizes, array_of_distrib, array_of_dargs,
2   array_of_psizes, order, oldtype, newtype)
3
4   IN      size                size of process group (positive integer)
5
6   IN      rank                rank in process group (non-negative integer)
7
8   IN      ndims               number of array dimensions as well as process grid
9   dimensions (positive integer)
10
11  IN      array_of_gsizes      number of elements of type oldtype in each dimension
12  of global array (array of positive integers)
13
14  IN      array_of_distrib      distribution of array in each dimension (array of states)
15
16  IN      array_of_dargs        distribution argument in each dimension (array of positive
17  integers)
18
19  IN      array_of_psizes       size of process grid in each dimension (array of positive
20  integers)
21
22  IN      order                array storage order flag (state)
23
24  IN      oldtype               old datatype (handle)
25
26  OUT     newtype               new datatype (handle)

```

**C binding**

```

22 int MPI_Type_create_darray(int size, int rank, int ndims,
23   const int array_of_gsizes[], const int array_of_distrib[],
24   const int array_of_dargs[], const int array_of_psizes[],
25   int order, MPI_Datatype oldtype, MPI_Datatype *newtype)

```

**Fortran 2008 binding**

```

28 MPI_Type_create_darray(size, rank, ndims, array_of_gsizes,
29   array_of_distrib, array_of_dargs, array_of_psizes, order,
30   oldtype, newtype, ierror)
31   INTEGER, INTENT(IN) :: size, rank, ndims, array_of_gsizes(ndims),
32   array_of_distrib(ndims), array_of_dargs(ndims),
33   array_of_psizes(ndims), order
34   TYPE(MPI_Datatype), INTENT(IN) :: oldtype
35   TYPE(MPI_Datatype), INTENT(OUT) :: newtype
36   INTEGER, OPTIONAL, INTENT(OUT) :: ierror

```

**Fortran binding**

```

38 MPI_TYPE_CREATE_DARRAY(SIZE, RANK, NDIMS, ARRAY_OF_GSIZES,
39   ARRAY_OF_DISTRIBS, ARRAY_OF_DARGS, ARRAY_OF_PSIZEs, ORDER,
40   OLDTYPE, NEWTYPE, IERROR)
41   INTEGER SIZE, RANK, NDIMS, ARRAY_OF_GSIZES(*), ARRAY_OF_DISTRIBS(*),
42   ARRAY_OF_DARGS(*), ARRAY_OF_PSIZEs(*), ORDER, OLDTYPE, NEWTYPE, IERROR

```

MPI\_TYPE\_CREATE\_DARRAY can be used to generate the datatypes corresponding to the distribution of an *ndims*-dimensional array of *oldtype* elements onto an *ndims*-dimensional grid of logical processes. Unused dimensions of *array\_of\_psize*s should be set to 1. (See Example 4.7.) For a call to MPI\_TYPE\_CREATE\_DARRAY to be correct, the equation  $\prod_{i=0}^{ndims-1} array\_of\_psizes[i] = size$  must be satisfied. The ordering of processes

in the process grid is assumed to be row-major, as in the case of virtual Cartesian process topologies.

*Advice to users.* For both Fortran and C arrays, the ordering of processes in the process grid is assumed to be row-major. This is consistent with the ordering used in virtual Cartesian process topologies in MPI. To create such virtual process topologies, or to find the coordinates of a process in the process grid, etc., users may use the corresponding process topology functions, see Chapter 7. (*End of advice to users.*)

Each dimension of the array can be distributed in one of three ways:

- MPI\_DISTRIBUTE\_BLOCK - Block distribution
- MPI\_DISTRIBUTE\_CYCLIC - Cyclic distribution
- MPI\_DISTRIBUTE\_NONE - Dimension not distributed.

The constant MPI\_DISTRIBUTE\_DFLT\_DARG specifies a default distribution argument. The distribution argument for a dimension that is not distributed is ignored. For any dimension  $i$  in which the distribution is MPI\_DISTRIBUTE\_BLOCK, it is erroneous to specify  $\text{array\_of\_dargs}[i] * \text{array\_of\_psizes}[i] < \text{array\_of\_gsizes}[i]$ .

For example, the HPF layout `ARRAY(CYCLIC(15))` corresponds to MPI\_DISTRIBUTE\_CYCLIC with a distribution argument of 15, and the HPF layout `ARRAY(BLOCK)` corresponds to MPI\_DISTRIBUTE\_BLOCK with a distribution argument of MPI\_DISTRIBUTE\_DFLT\_DARG.

The `order` argument is used as in MPI\_TYPE\_CREATE\_SUBARRAY to specify the storage order. Therefore, arrays described by this type constructor may be stored in Fortran (column-major) or C (row-major) order. Valid values for `order` are MPI\_ORDER\_FORTRAN and MPI\_ORDER\_C.

This routine creates a new MPI datatype with a typemap defined in terms of a function called “cyclic()” (see below).

Without loss of generality, it suffices to define the typemap for the MPI\_DISTRIBUTE\_CYCLIC case where MPI\_DISTRIBUTE\_DFLT\_DARG is not used.

MPI\_DISTRIBUTE\_BLOCK and MPI\_DISTRIBUTE\_NONE can be reduced to the MPI\_DISTRIBUTE\_CYCLIC case for dimension  $i$  as follows.

MPI\_DISTRIBUTE\_BLOCK with  $\text{array\_of\_dargs}[i]$  equal to MPI\_DISTRIBUTE\_DFLT\_DARG is equivalent to MPI\_DISTRIBUTE\_CYCLIC with  $\text{array\_of\_dargs}[i]$  set to

$$(\text{array\_of\_gsizes}[i] + \text{array\_of\_psizes}[i] - 1) / \text{array\_of\_psizes}[i].$$

If  $\text{array\_of\_dargs}[i]$  is not MPI\_DISTRIBUTE\_DFLT\_DARG, then MPI\_DISTRIBUTE\_BLOCK and MPI\_DISTRIBUTE\_CYCLIC are equivalent.

MPI\_DISTRIBUTE\_NONE is equivalent to MPI\_DISTRIBUTE\_CYCLIC with  $\text{array\_of\_dargs}[i]$  set to  $\text{array\_of\_gsizes}[i]$ .

Finally, MPI\_DISTRIBUTE\_CYCLIC with  $\text{array\_of\_dargs}[i]$  equal to MPI\_DISTRIBUTE\_DFLT\_DARG is equivalent to MPI\_DISTRIBUTE\_CYCLIC with  $\text{array\_of\_dargs}[i]$  set to 1.

For MPI\_ORDER\_FORTRAN, an `ndims`-dimensional distributed array (`newtype`) is defined by the following code fragment:

```

1   oldtypes[0] = oldtype;
2   for (i = 0; i < ndims; i++) {
3       oldtypes[i+1] = cyclic(array_of_dargs[i],
4                             array_of_gsizes[i],
5                             r[i],
6                             array_of_psize[i],
7                             oldtypes[i]);
8   }
9   newtype = oldtypes[ndims];

```

For MPI\_ORDER\_C, the code is:

```

12  oldtypes[0] = oldtype;
13  for (i = 0; i < ndims; i++) {
14      oldtypes[i + 1] = cyclic(array_of_dargs[ndims - i - 1],
15                              array_of_gsizes[ndims - i - 1],
16                              r[ndims - i - 1],
17                              array_of_psize[ndims - i - 1],
18                              oldtypes[i]);
19  }
20  newtype = oldtypes[ndims];

```

where  $r[i]$  is the position of the process (with rank `rank`) in the process grid at dimension  $i$ . The values of  $r[i]$  are given by the following code fragment:

```

26  t_rank = rank;
27  t_size = 1;
28  for (i = 0; i < ndims; i++)
29      t_size *= array_of_psize[i];
30  for (i = 0; i < ndims; i++) {
31      t_size = t_size / array_of_psize[i];
32      r[i] = t_rank / t_size;
33      t_rank = t_rank % t_size;
34  }

```

Let the typemap of `oldtype` have the form:

```

38  {(type0, disp0), (type1, disp1), ..., (typen-1, dispn-1)}

```

where  $type_i$  is a predefined MPI datatype, and let  $ex$  be the extent of `oldtype`. The following function uses the conceptual datatypes `lb_marker` and `ub_marker`, see Section 4.1.6 for details.

Given the above, the function `cyclic()` is defined as follows:

```

44  cyclic(darg, gsize, r, psize, oldtype)
45  = {(lb_marker, 0),
46     (type0, disp0 + r × darg × ex), ...,
47     (typen-1, dispn-1 + r × darg × ex),

```

```

(type0, disp0 + (r × darg + 1) × ex), ..., 1
      (typen-1, dispn-1 + (r × darg + 1) × ex), 2
... 3
(type0, disp0 + ((r + 1) × darg - 1) × ex), ..., 4
      (typen-1, dispn-1 + ((r + 1) × darg - 1) × ex), 5
... 6
      (type0, disp0 + r × darg × ex + psize × darg × ex), ..., 7
      (typen-1, dispn-1 + r × darg × ex + psize × darg × ex), 8
      (type0, disp0 + (r × darg + 1) × ex + psize × darg × ex), ..., 9
      (typen-1, dispn-1 + (r × darg + 1) × ex + psize × darg × ex), 10
... 11
      (type0, disp0 + ((r + 1) × darg - 1) × ex + psize × darg × ex), ..., 12
      (typen-1, dispn-1 + ((r + 1) × darg - 1) × ex + psize × darg × ex), 13
      ⋮ 14
      (type0, disp0 + r × darg × ex + psize × darg × ex × (count - 1)), ..., 15
      (typen-1, dispn-1 + r × darg × ex + psize × darg × ex × (count - 1)), 16
      (type0, disp0 + (r × darg + 1) × ex + psize × darg × ex × (count - 1)), ..., 17
      (typen-1, dispn-1 + (r × darg + 1) × ex 18
      + psize × darg × ex × (count - 1)), 19
... 20
      (type0, disp0 + (r × darg + darglast - 1) × ex 21
      + psize × darg × ex × (count - 1)), ..., 22
      (typen-1, dispn-1 + (r × darg + darglast - 1) × ex 23
      + psize × darg × ex × (count - 1)), 24
      (ub_marker, gsize * ex) 25
} 26

```

where *count* is defined by this code fragment:

```

nblocks = (gsize + (darg - 1)) / darg; 34
count = nblocks / psize; 35
left_over = nblocks - count * psize; 36
if (r < left_over) 37
    count = count + 1; 38

```

Here, *nblocks* is the number of blocks that must be distributed among the processors. Finally, *darg<sub>last</sub>* is defined by this code fragment:

```

if ((num_in_last_cyclic = gsize % (psize * darg)) == 0) 42
    darg_last = darg; 43
else { 44
    darg_last = num_in_last_cyclic - darg * r; 45
    if (darg_last > darg) 46
        darg_last = darg; 47
    if (darg_last <= 0) 48

```

```

1         darg_last = darg;
2     }
3
4

```

**Example 4.7** Consider generating the filetypes corresponding to the HPF distribution:

```

6         <oldtype> FILEARRAY(100, 200, 300)
7     !HPF$ PROCESSORS PROCESSES(2, 3)
8     !HPF$ DISTRIBUTE FILEARRAY(CYCLIC(10), *, BLOCK) ONTO PROCESSES
9

```

This can be achieved by the following Fortran code, assuming there will be six processes attached to the run:

```

12     ndims = 3
13     array_of_gsizes(1) = 100
14     array_of_distribs(1) = MPI_DISTRIBUTE_CYCLIC
15     array_of_dargs(1) = 10
16     array_of_gsizes(2) = 200
17     array_of_distribs(2) = MPI_DISTRIBUTE_NONE
18     array_of_dargs(2) = 0
19     array_of_gsizes(3) = 300
20     array_of_distribs(3) = MPI_DISTRIBUTE_BLOCK
21     array_of_dargs(3) = MPI_DISTRIBUTE_DFLT_DARG
22     array_of_psize(1) = 2
23     array_of_psize(2) = 1
24     array_of_psize(3) = 3
25     call MPI_COMM_SIZE(MPI_COMM_WORLD, size, ierr)
26     call MPI_COMM_RANK(MPI_COMM_WORLD, rank, ierr)
27     call MPI_TYPE_CREATE_DARRAY(size, rank, ndims, array_of_gsizes, &
28         array_of_distribs, array_of_dargs, array_of_psize, &
29         MPI_ORDER_FORTRAN, oldtype, newtype, ierr)
30
31

```

#### 4.1.5 Address and Size Functions

The displacements in a general datatype are relative to some initial buffer address. **Absolute addresses** can be substituted for these displacements: we treat them as displacements relative to “address zero,” the start of the address space. This initial address zero is indicated by the constant `MPI_BOTTOM`. Thus, a datatype can specify the absolute address of the entries in the communication buffer, in which case the `buf` argument is passed the value `MPI_BOTTOM`. Note that in Fortran `MPI_BOTTOM` is not usable for initialization or assignment, see Section 2.5.4.

The address of a location in memory can be found by invoking the function `MPI_GET_ADDRESS`. The **relative displacement** between two absolute addresses can be calculated with the function `MPI_AINT_DIFF`. A new absolute address as sum of an absolute base address and a relative displacement can be calculated with the function `MPI_AINT_ADD`. To ensure portability, arithmetic on absolute addresses should not be performed with the intrinsic operators “-” and “+”. See also Sections 2.5.6 and 4.1.12 on pages 16 and 121.



*Rationale.* Address sized integer values, i.e., MPI\_Aint or INTEGER(KIND=MPI\_ADDRESS\_KIND) values, are signed integers, while absolute addresses are unsigned quantities. Direct arithmetic on addresses stored in address sized signed variables can cause overflows, resulting in undefined behavior. (*End of rationale.*)

MPI\_GET\_ADDRESS(location, address)

IN	location	location in caller memory (choice)
OUT	address	address of location (integer)

### C binding

```
int MPI_Get_address(const void *location, MPI_Aint *address)
```

### Fortran 2008 binding

```
MPI_Get_address(location, address, ierror)
  TYPE(*), DIMENSION(..), ASYNCHRONOUS :: location
  INTEGER(KIND=MPI_ADDRESS_KIND), INTENT(OUT) :: address
  INTEGER, OPTIONAL, INTENT(OUT) :: ierror
```

### Fortran binding

```
MPI_GET_ADDRESS(LOCATION, ADDRESS, IERROR)
  <type> LOCATION(*)
  INTEGER(KIND=MPI_ADDRESS_KIND) ADDRESS
  INTEGER IERROR
```

Returns the (byte) address of location.

*Rationale.* In the mpi\_f08 module, the location argument is not defined with INTENT(IN) because existing applications may use MPI\_GET\_ADDRESS as a substitute for MPI\_F\_SYNC\_REG, which was not defined before MPI-3.0. (*End of rationale.*)

**Example 4.8** Using MPI\_GET\_ADDRESS for an array.

```
REAL A(100,100)
INTEGER(KIND=MPI_ADDRESS_KIND) I1, I2, DIFF
CALL MPI_GET_ADDRESS(A(1,1), I1, IERROR)
CALL MPI_GET_ADDRESS(A(10,10), I2, IERROR)
DIFF = MPI_AINT_DIFF(I2, I1)
! The value of DIFF is 909*sizeofreal; the values of I1 and I2 are
! implementation dependent.
```

*Advice to users.* C users may be tempted to avoid the usage of MPI\_GET\_ADDRESS and rely on the availability of the address operator &. Note, however, that & cast-expression is a pointer, not an address. ISO C does not require that the value of a pointer (or the pointer cast to int) be the absolute address of the object pointed at — although this is commonly the case. Furthermore, referencing may not have a unique definition on machines with a segmented address space. The

1 use of `MPI_GET_ADDRESS` to “reference” C variables guarantees portability to such  
 2 machines as well. (*End of advice to users.*)

3  
 4 *Advice to users.* To prevent problems with the argument copying and register  
 5 optimization done by Fortran compilers, please note the hints in Sections [18.1.10](#)–  
 6 [18.1.20](#). (*End of advice to users.*)

7  
 8 To ensure portability, arithmetic on MPI addresses must be performed using the  
 9 `MPI_AINT_ADD` and `MPI_AINT_DIFF` functions.

10  
 11 `MPI_AINT_ADD(base, disp)`

12  
 13 IN base base address (integer)

14 IN disp displacement (integer)

15  
 16 **C binding**

17 `MPI_Aint MPI_Aint_add(MPI_Aint base, MPI_Aint disp)`

18  
 19 **Fortran 2008 binding**

20 `INTEGER(KIND=MPI_ADDRESS_KIND) MPI_Aint_add(base, disp)`  
 21 `INTEGER(KIND=MPI_ADDRESS_KIND), INTENT(IN) :: base, disp`

22  
 23 **Fortran binding**

24 `INTEGER(KIND=MPI_ADDRESS_KIND) MPI_AINT_ADD(BASE, DISP)`  
 25 `INTEGER(KIND=MPI_ADDRESS_KIND) BASE, DISP`

26 `MPI_AINT_ADD` produces a new `MPI_Aint` value that is equivalent to the sum of  
 27 the `base` and `disp` arguments, where `base` represents a base address returned by a call to  
 28 `MPI_GET_ADDRESS` and `disp` represents a signed integer displacement. The resulting ad-  
 29 dress is valid only at the process that generated `base`, and it must correspond to a location  
 30 in the same object referenced by `base`, as described in Section [4.1.12](#). The addition is per-  
 31 formed in a manner that results in the correct `MPI_Aint` representation of the output address,  
 32 as if the process that originally produced `base` had called:

33  
 34 `MPI_Get_address((char *) base + disp, &result);`

35  
 36  
 37 `MPI_AINT_DIFF(addr1, addr2)`

38 IN addr1 minuend address (integer)

39 IN addr2 subtrahend address (integer)

40  
 41  
 42 **C binding**

43 `MPI_Aint MPI_Aint_diff(MPI_Aint addr1, MPI_Aint addr2)`

44  
 45 **Fortran 2008 binding**

46 `INTEGER(KIND=MPI_ADDRESS_KIND) MPI_Aint_diff(addr1, addr2)`  
 47 `INTEGER(KIND=MPI_ADDRESS_KIND), INTENT(IN) :: addr1, addr2`

48 **Fortran binding**

```

INTEGER(KIND=MPI_ADDRESS_KIND) MPI_AINT_DIFF(ADDR1, ADDR2)
      INTEGER(KIND=MPI_ADDRESS_KIND) ADDR1, ADDR2

```

MPI\_AINT\_DIFF produces a new MPI\_Aint value that is equivalent to the difference between `addr1` and `addr2` arguments, where `addr1` and `addr2` represent addresses returned by calls to `MPI_GET_ADDRESS`. The resulting address is valid only at the process that generated `addr1` and `addr2`, and `addr1` and `addr2` must correspond to locations in the same object in the same process, as described in Section 4.1.12. The difference is calculated in a manner that results in the signed difference from `addr1` to `addr2`, as if the process that originally produced the addresses had called `(char *) addr1 - (char *) addr2` on the addresses initially passed to `MPI_GET_ADDRESS`.

The following auxiliary functions provide useful information on derived datatypes.

```

MPI_TYPE_SIZE(datatype, size)

```

```

IN      datatype          datatype (handle)
OUT     size              datatype size (integer)

```

#### C binding

```

int MPI_Type_size(MPI_Datatype datatype, int *size)

```

#### Fortran 2008 binding

```

MPI_Type_size(datatype, size, ierror)
      TYPE(MPI_Datatype), INTENT(IN) :: datatype
      INTEGER, INTENT(OUT) :: size
      INTEGER, OPTIONAL, INTENT(OUT) :: ierror

```

#### Fortran binding

```

MPI_TYPE_SIZE(DATATYPE, SIZE, IERROR)
      INTEGER DATATYPE, SIZE, IERROR

```

```

MPI_TYPE_SIZE_X(datatype, size)

```

```

IN      datatype          datatype (handle)
OUT     size              datatype size (integer)

```

#### C binding

```

int MPI_Type_size_x(MPI_Datatype datatype, MPI_Count *size)

```

#### Fortran 2008 binding

```

MPI_Type_size_x(datatype, size, ierror)
      TYPE(MPI_Datatype), INTENT(IN) :: datatype
      INTEGER(KIND=MPI_COUNT_KIND), INTENT(OUT) :: size
      INTEGER, OPTIONAL, INTENT(OUT) :: ierror

```

#### Fortran binding

```

MPI_TYPE_SIZE_X(DATATYPE, SIZE, IERROR)
      INTEGER DATATYPE, IERROR

```

1           INTEGER(KIND=MPI\_COUNT\_KIND) SIZE

2           MPI\_TYPE\_SIZE and MPI\_TYPE\_SIZE\_X set the value of `size` to the total size, in  
3 bytes, of the entries in the type signature associated with `datatype`; i.e., the total size of the  
4 data in a message that would be created with this datatype. Entries that occur multiple  
5 times in the datatype are counted with their multiplicity. For both functions, if the OUT  
6 parameter cannot express the value to be returned (e.g., if the parameter is too small to  
7 hold the output value), it is set to MPI\_UNDEFINED.  
8

#### 9           4.1.6 Lower-Bound and Upper-Bound Markers

11 It is often convenient to define explicitly the lower bound and upper bound of a type map,  
12 and override the definition given on page 110. This allows one to define a datatype that has  
13 “holes” at its beginning or its end, or a datatype with entries that extend above the upper  
14 bound or below the lower bound. Examples of such usage are provided in Section 4.1.14.  
15 Also, the user may want to override the alignment rules that are used to compute upper  
16 bounds and extents. E.g., a C compiler may allow the user to override default alignment  
17 rules for some of the structures within a program. The user has to specify explicitly the  
18 bounds of the datatypes that match these structures.

19           To achieve this, we add two additional conceptual datatypes, `lb_marker` and  
20 `ub_marker`, that represent the lower bound and upper bound of a datatype. These con-  
21 ceptual datatypes occupy no space ( $extent(\text{lb\_marker}) = extent(\text{ub\_marker}) = 0$ ). They do  
22 not affect the size or count of a datatype, and do not affect the content of a message created  
23 with this datatype. However, they do affect the definition of the extent of a datatype and,  
24 therefore, affect the outcome of a replication of this datatype by a datatype constructor.  
25

26 **Example 4.9** A call to `MPI_TYPE_CREATE_RESIZED(MPI_INT, -3, 9, type1)` creates a  
27 new datatype that has an extent of 9 (from -3 to 5, 5 included), and contains an integer  
28 at displacement 0. This is the datatype defined by the typemap  $\{(\text{lb\_marker}, -3), (\text{int}, 0),$   
29  $(\text{ub\_marker}, 6)\}$ . If this type is replicated twice by a call to `MPI_TYPE_CONTIGUOUS(2,`  
30 `type1, type2)` then the newly created type can be described by the typemap  $\{(\text{lb\_marker},$   
31  $-3), (\text{int}, 0), (\text{int}, 9), (\text{ub\_marker}, 15)\}$ . (An entry of type `ub_marker` can be deleted if there  
32 is another entry of type `ub_marker` with a higher displacement; an entry of type `lb_marker`  
33 can be deleted if there is another entry of type `lb_marker` with a lower displacement.)  
34

35           In general, if

$$36 \quad \text{Typemap} = \{(type_0, disp_0), \dots, (type_{n-1}, disp_{n-1})\},$$

37 then the **lower bound** of `Typemap` is defined to be

$$39 \quad lb(\text{Typemap}) = \begin{cases} \min_j disp_j & \text{if no entry has type} \\ \min_j \{disp_j \text{ such that } type_j = \text{lb\_marker}\} & \text{lb\_marker} \\ & \text{otherwise} \end{cases}$$

42 Similarly, the **upper bound** of `Typemap` is defined to be

$$44 \quad ub(\text{Typemap}) = \begin{cases} \max_j (disp_j + sizeof(type_j)) + \epsilon & \text{if no entry has type} \\ \max_j \{disp_j \text{ such that } type_j = \text{ub\_marker}\} & \text{ub\_marker} \\ & \text{otherwise} \end{cases}$$

47 Then

$$48 \quad extent(\text{Typemap}) = ub(\text{Typemap}) - lb(\text{Typemap})$$

If  $type_i$  requires alignment to a byte address that is a multiple of  $k_i$ , then  $\epsilon$  is the least non-negative increment needed to round  $extent(Typemap)$  to the next multiple of  $\max_i k_i$ . In Fortran, it is implementation dependent whether the MPI implementation computes the alignments  $k_i$  according to the alignments used by the compiler in common blocks, SEQUENCE derived types, BIND(C) derived types, or derived types that are neither SEQUENCE nor BIND(C).

The formal definitions given for the various datatype constructors apply now, with the amended definition of **extent**.

*Rationale.* Before Fortran 2003, MPI\_TYPE\_CREATE\_STRUCT could be applied to Fortran common blocks and SEQUENCE derived types. With Fortran 2003, this list was extended by BIND(C) derived types and MPI implementors have implemented the alignments  $k_i$  differently, i.e., some based on the alignments used in SEQUENCE derived types, and others according to BIND(C) derived types. (*End of rationale.*)

*Advice to implementors.* In Fortran, it is generally recommended to use BIND(C) derived types instead of common blocks or SEQUENCE derived types. Therefore it is recommended to calculate the alignments  $k_i$  based on BIND(C) derived types. (*End of advice to implementors.*)

*Advice to users.* Structures combining different basic datatypes should be defined so that there will be no gaps based on alignment rules. If such a datatype is used to create an array of structures, users should also avoid an alignment-gap at the end of the structure. In MPI communication, the content of such gaps would not be communicated into the receiver's buffer. For example, such an alignment-gap may occur between an odd number of floats or REALs before a double or DOUBLE PRECISION data. Such gaps may be added explicitly to both the structure and the MPI derived datatype handle because the communication of a contiguous derived datatype may be significantly faster than the communication of one that is non-contiguous because of such alignment-gaps.

Example: Instead of

```

TYPE, BIND(C) :: my_data
  REAL, DIMENSION(3) :: x
  ! there may be a gap of the size of one REAL
  ! if the alignment of a DOUBLE PRECISION is
  ! two times the size of a REAL
  DOUBLE PRECISION :: p
END TYPE

```

one should define

```

TYPE, BIND(C) :: my_data
  REAL, DIMENSION(3) :: x
  REAL :: gap1
  DOUBLE PRECISION :: p
END TYPE

```

and also include `gap1` in the matching MPI derived datatype. It is required that all processes in a communication add the same gaps, i.e., defined with the same basic datatype. Both the original and the modified structures are portable, but may have different performance implications for the communication and memory accesses during computation on systems with different alignment values.

In principle, a compiler may define an additional alignment rule for structures, e.g., to use at least 4 or 8 byte alignment, although the content may have a  $max_i k_i$  alignment less than this structure alignment. To maintain portability, users should always resize structure derived datatype handles if used in an array of structures, see the Example in Section 18.1.15. (*End of advice to users.*)

#### 4.1.7 Extent and Bounds of Datatypes

`MPI_TYPE_GET_EXTENT(datatype, lb, extent)`

IN	datatype	datatype to get information on (handle)
OUT	lb	lower bound of datatype (integer)
OUT	extent	extent of datatype (integer)

##### C binding

```
int MPI_Type_get_extent(MPI_Datatype datatype, MPI_Aint *lb,
    MPI_Aint *extent)
```

##### Fortran 2008 binding

```
MPI_Type_get_extent(datatype, lb, extent, ierror)
    TYPE(MPI_Datatype), INTENT(IN) :: datatype
    INTEGER(KIND=MPI_ADDRESS_KIND), INTENT(OUT) :: lb, extent
    INTEGER, OPTIONAL, INTENT(OUT) :: ierror
```

##### Fortran binding

```
MPI_TYPE_GET_EXTENT(DATATYPE, LB, EXTENT, IERROR)
    INTEGER DATATYPE, IERROR
    INTEGER(KIND=MPI_ADDRESS_KIND) LB, EXTENT
```

`MPI_TYPE_GET_EXTENT_X(datatype, lb, extent)`

IN	datatype	datatype to get information on (handle)
OUT	lb	lower bound of datatype (integer)
OUT	extent	extent of datatype (integer)

##### C binding

```
int MPI_Type_get_extent_x(MPI_Datatype datatype, MPI_Count *lb,
    MPI_Count *extent)
```

##### Fortran 2008 binding

```
MPI_Type_get_extent_x(datatype, lb, extent, ierror)
```

```

TYPE(MPI_Datatype), INTENT(IN) :: datatype
INTEGER(KIND=MPI_COUNT_KIND), INTENT(OUT) :: lb, extent
INTEGER, OPTIONAL, INTENT(OUT) :: ierror

```

**Fortran binding**

```

MPI_TYPE_GET_EXTENT_X(DATATYPE, LB, EXTENT, IERROR)
  INTEGER DATATYPE, IERROR
  INTEGER(KIND=MPI_COUNT_KIND) LB, EXTENT

```

Returns the lower bound and the extent of `datatype` (as defined in Equation 4.1).

For both functions, if either `OUT` parameter cannot express the value to be returned (e.g., if the parameter is too small to hold the output value), it is set to `MPI_UNDEFINED`.

MPI allows one to change the extent of a datatype, using lower bound and upper bound markers. This provides control over the stride of successive datatypes that are replicated by datatype constructors, or are replicated by the `count` argument in a send or receive call.

```

MPI_TYPE_CREATE_RESIZED(oldtype, lb, extent, newtype)

```

IN	<code>oldtype</code>	input datatype (handle)
IN	<code>lb</code>	new lower bound of datatype (integer)
IN	<code>extent</code>	new extent of datatype (integer)
OUT	<code>newtype</code>	output datatype (handle)

**C binding**

```

int MPI_Type_create_resized(MPI_Datatype oldtype, MPI_Aint lb,
  MPI_Aint extent, MPI_Datatype *newtype)

```

**Fortran 2008 binding**

```

MPI_Type_create_resized(oldtype, lb, extent, newtype, ierror)
  TYPE(MPI_Datatype), INTENT(IN) :: oldtype
  INTEGER(KIND=MPI_ADDRESS_KIND), INTENT(IN) :: lb, extent
  TYPE(MPI_Datatype), INTENT(OUT) :: newtype
  INTEGER, OPTIONAL, INTENT(OUT) :: ierror

```

**Fortran binding**

```

MPI_TYPE_CREATE_RESIZED(OLDTYPE, LB, EXTENT, NEWTYPE, IERROR)
  INTEGER OLDTYPE, NEWTYPE, IERROR
  INTEGER(KIND=MPI_ADDRESS_KIND) LB, EXTENT

```

Returns in `newtype` a handle to a new datatype that is identical to `oldtype`, except that the lower bound of this new datatype is set to be `lb`, and its upper bound is set to be `lb + extent`. Any previous `lb` and `ub` markers are erased, and a new pair of lower bound and upper bound markers are put in the positions indicated by the `lb` and `extent` arguments. This affects the behavior of the datatype when used in communication operations, with `count > 1`, and when used in the construction of new derived datatypes.

### 4.1.8 True Extent of Datatypes

Suppose we implement gather (see also Section 5.5) as a spanning tree implemented on top of point-to-point routines. Since the receive buffer is only valid on the root process, one will need to allocate some temporary space for receiving data on intermediate nodes. However, the datatype extent cannot be used as an estimate of the amount of space that needs to be allocated, if the user has modified the extent, for example by using `MPI_TYPE_CREATE_RESIZED`. The functions `MPI_TYPE_GET_TRUE_EXTENT` and `MPI_TYPE_GET_TRUE_EXTENT_X` are provided which return the true extent of the datatype.

`MPI_TYPE_GET_TRUE_EXTENT(datatype, true_lb, true_extent)`

IN	datatype	datatype to get information on (handle)
OUT	true_lb	true lower bound of datatype (integer)
OUT	true_extent	true size of datatype (integer)

#### C binding

```
int MPI_Type_get_true_extent(MPI_Datatype datatype, MPI_Aint *true_lb,
                             MPI_Aint *true_extent)
```

#### Fortran 2008 binding

```
MPI_Type_get_true_extent(datatype, true_lb, true_extent, ierror)
  TYPE(MPI_Datatype), INTENT(IN) :: datatype
  INTEGER(KIND=MPI_ADDRESS_KIND), INTENT(OUT) :: true_lb, true_extent
  INTEGER, OPTIONAL, INTENT(OUT) :: ierror
```

#### Fortran binding

```
MPI_TYPE_GET_TRUE_EXTENT(DATATYPE, TRUE_LB, TRUE_EXTENT, IERROR)
  INTEGER DATATYPE, IERROR
  INTEGER(KIND=MPI_ADDRESS_KIND) TRUE_LB, TRUE_EXTENT
```

`MPI_TYPE_GET_TRUE_EXTENT_X(datatype, true_lb, true_extent)`

IN	datatype	datatype to get information on (handle)
OUT	true_lb	true lower bound of datatype (integer)
OUT	true_extent	true size of datatype (integer)

#### C binding

```
int MPI_Type_get_true_extent_x(MPI_Datatype datatype, MPI_Count *true_lb,
                               MPI_Count *true_extent)
```

#### Fortran 2008 binding

```
MPI_Type_get_true_extent_x(datatype, true_lb, true_extent, ierror)
  TYPE(MPI_Datatype), INTENT(IN) :: datatype
  INTEGER(KIND=MPI_COUNT_KIND), INTENT(OUT) :: true_lb, true_extent
  INTEGER, OPTIONAL, INTENT(OUT) :: ierror
```



**Fortran binding**

```
MPI_TYPE_GET_TRUE_EXTENT_X(DATATYPE, TRUE_LB, TRUE_EXTENT, IERROR)
    INTEGER DATATYPE, IERROR
    INTEGER(KIND=MPI_COUNT_KIND) TRUE_LB, TRUE_EXTENT
```

`true_lb` returns the offset of the lowest unit of store which is addressed by the datatype, i.e., the lower bound of the corresponding typemap, ignoring explicit lower bound markers. `true_extent` returns the true size of the datatype, i.e., the extent of the corresponding typemap, ignoring explicit lower bound and upper bound markers, and performing no rounding for alignment. If the typemap associated with `datatype` is

$$Typemap = \{(type_0, disp_0), \dots, (type_{n-1}, disp_{n-1})\}$$

Then

$$true\_lb(Typemap) = \min_j \{disp_j : type_j \neq lb\_marker, ub\_marker\},$$

$$true\_ub(Typemap) = \max_j \{disp_j + sizeof(type_j) : type_j \neq lb\_marker, ub\_marker\},$$

and

$$true\_extent(Typemap) = true\_ub(Typemap) - true\_lb(Typemap).$$

(Readers should compare this with the definitions in Section 4.1.6 and Section 4.1.7, which describe the function `MPI_TYPE_GET_EXTENT`.)

The `true_extent` is the minimum number of bytes of memory necessary to hold a datatype, uncompressed.

For both functions, if either OUT parameter cannot express the value to be returned (e.g., if the parameter is too small to hold the output value), it is set to `MPI_UNDEFINED`.

**4.1.9 Commit and Free**

A datatype object has to be **committed** before it can be used in a communication. As an argument in datatype constructors, uncommitted and also committed datatypes can be used. There is no need to commit basic datatypes. They are “pre-committed.”

```
MPI_TYPE_COMMIT(datatype)
```

```
    INOUT    datatype                datatype that is committed (handle)
```

**C binding**

```
int MPI_Type_commit(MPI_Datatype *datatype)
```

**Fortran 2008 binding**

```
MPI_Type_commit(datatype, ierror)
    TYPE(MPI_Datatype), INTENT(INOUT) :: datatype
    INTEGER, OPTIONAL, INTENT(OUT) :: ierror
```

**Fortran binding**

```
MPI_TYPE_COMMIT(DATATYPE, IERROR)
    INTEGER DATATYPE, IERROR
```

1 The commit operation commits the datatype, that is, the formal description of a com-  
 2 munication buffer, not the content of that buffer. Thus, after a datatype has been commit-  
 3 ted, it can be repeatedly reused to communicate the changing content of a buffer or, indeed,  
 4 the content of different buffers, with different starting addresses.

5  
 6 *Advice to implementors.* The system may “compile” at commit time an internal  
 7 representation for the datatype that facilitates communication, e.g., change from a  
 8 compacted representation to a flat representation of the datatype, and select the most  
 9 convenient transfer mechanism. (*End of advice to implementors.*)

10  
 11 MPI\_TYPE\_COMMIT will accept a committed datatype; in this case, it is equivalent  
 12 to a no-op.

13 **Example 4.10** The following code fragment gives examples of using MPI\_TYPE\_COMMIT.

```
14
15 INTEGER type1, type2
16 CALL MPI_TYPE_CONTIGUOUS(5, MPI_REAL, type1, ierr)
17     ! new type object created
18 CALL MPI_TYPE_COMMIT(type1, ierr)
19     ! now type1 can be used for communication
20 type2 = type1
21     ! type2 can be used for communication
22     ! (it is a handle to same object as type1)
23 CALL MPI_TYPE_VECTOR(3, 5, 4, MPI_REAL, type1, ierr)
24     ! new uncommitted type object created
25 CALL MPI_TYPE_COMMIT(type1, ierr)
26     ! now type1 can be used anew for communication
```

```
27
28
29 MPI_TYPE_FREE(datatype)
30
31     INOUT    datatype          datatype that is freed (handle)
```

### 32 C binding

```
33
34 int MPI_Type_free(MPI_Datatype *datatype)
```

### 35 Fortran 2008 binding

```
36 MPI_Type_free(datatype, ierror)
37     TYPE(MPI_Datatype), INTENT(INOUT) :: datatype
38     INTEGER, OPTIONAL, INTENT(OUT) :: ierror
```

### 39 Fortran binding

```
40 MPI_TYPE_FREE(DATATYPE, IERROR)
41     INTEGER DATATYPE, IERROR
```

42  
 43  
 44 Marks the datatype object associated with `datatype` for deallocation and sets `datatype`  
 45 to `MPI_DATATYPE_NULL`. Any communication that is currently using this datatype will  
 46 complete normally. Freeing a datatype does not affect any other datatype that was built  
 47 from the freed datatype. The system behaves as if input datatype arguments to derived  
 48 datatype constructors are passed by value.

*Advice to implementors.* The implementation may keep a reference count of active communications that use the datatype, in order to decide when to free it. Also, one may implement constructors of derived datatypes so that they keep pointers to their datatype arguments, rather than copying them. In this case, one needs to keep track of active datatype definition references in order to know when a datatype object can be freed. (*End of advice to implementors.*)

#### 4.1.10 Duplicating a Datatype

`MPI_TYPE_DUP(oldtype, newtype)`

IN	oldtype	datatype (handle)
OUT	newtype	copy of oldtype (handle)

##### C binding

```
int MPI_Type_dup(MPI_Datatype oldtype, MPI_Datatype *newtype)
```

##### Fortran 2008 binding

```
MPI_Type_dup(oldtype, newtype, ierror)
    TYPE(MPI_Datatype), INTENT(IN) :: oldtype
    TYPE(MPI_Datatype), INTENT(OUT) :: newtype
    INTEGER, OPTIONAL, INTENT(OUT) :: ierror
```

##### Fortran binding

```
MPI_TYPE_DUP(OLDTYPE, NEWTYPE, IERROR)
    INTEGER OLDTYPE, NEWTYPE, IERROR
```

`MPI_TYPE_DUP` is a type constructor which duplicates the existing `oldtype` with associated key values. For each key value, the respective copy callback function determines the attribute value associated with this key in the new communicator; one particular action that a copy callback may take is to delete the attribute from the new datatype. Returns in `newtype` a new datatype with exactly the same properties as `oldtype` and any copied cached information, see Section 6.7.4. The new datatype has identical upper bound and lower bound and yields the same net result when fully decoded with the functions in Section 4.1.13. The `newtype` has the same committed state as the old `oldtype`.

#### 4.1.11 Use of General Datatypes in Communication

Handles to derived datatypes can be passed to a communication call wherever a datatype argument is required. A call of the form `MPI_SEND(buf, count, datatype, ...)`, where `count > 1`, is interpreted as if the call was passed a new datatype which is the concatenation of `count` copies of `datatype`. Thus, `MPI_SEND(buf, count, datatype, dest, tag, comm)` is equivalent to,

```
MPI_TYPE_CONTIGUOUS(count, datatype, newtype)
MPI_TYPE_COMMIT(newtype)
MPI_SEND(buf, 1, newtype, dest, tag, comm)
MPI_TYPE_FREE(newtype).
```

1 Similar statements apply to all other communication functions that have a count and  
2 datatype argument.

3 Suppose that a send operation `MPI_SEND(buf, count, datatype, dest, tag, comm)` is  
4 executed, where `datatype` has type map,

$$5 \quad \{(type_0, disp_0), \dots, (type_{n-1}, disp_{n-1})\},$$

7 and extent *extent*. (Explicit lower bound and upper bound markers are not listed in the  
8 type map, but they affect the value of *extent*.) The send operation sends  $n \cdot \text{count}$  entries,  
9 where entry  $i \cdot n + j$  is at location  $addr_{i,j} = \text{buf} + \text{extent} \cdot i + disp_j$  and has type  $type_j$ , for  
10  $i = 0, \dots, \text{count} - 1$  and  $j = 0, \dots, n - 1$ . These entries need not be contiguous, nor distinct;  
11 their order can be arbitrary.

12 The variable stored at address  $addr_{i,j}$  in the calling program should be of a type that  
13 matches  $type_j$ , where type matching is defined as in Section 3.3.1. The message sent contains  
14  $n \cdot \text{count}$  entries, where entry  $i \cdot n + j$  has type  $type_j$ .

15 Similarly, suppose that a receive operation `MPI_RECV(buf, count, datatype, source, tag,  
16 comm, status)` is executed, where `datatype` has type map,

$$17 \quad \{(type_0, disp_0), \dots, (type_{n-1}, disp_{n-1})\},$$

19 with extent *extent*. (Again, explicit lower bound and upper bound markers are not listed in  
20 the type map, but they affect the value of *extent*.) This receive operation receives  $n \cdot \text{count}$   
21 entries, where entry  $i \cdot n + j$  is at location  $\text{buf} + \text{extent} \cdot i + disp_j$  and has type  $type_j$ . If the  
22 incoming message consists of  $k$  elements, then we must have  $k \leq n \cdot \text{count}$ ; the  $i \cdot n + j$ -th  
23 element of the message should have a type that matches  $type_j$ .

24 **Type matching** is defined according to the type signature of the corresponding  
25 datatypes, that is, the sequence of basic type components. Type matching does not depend  
26 on some aspects of the datatype definition, such as the displacements (layout in memory)  
27 or the intermediate types used.

29 **Example 4.11** This example shows that type matching is defined in terms of the basic  
30 types that a derived type consists of.

```
31 ...
32 ...
33 CALL MPI_TYPE_CONTIGUOUS(2, MPI_REAL, type2, ...)
34 CALL MPI_TYPE_CONTIGUOUS(4, MPI_REAL, type4, ...)
35 CALL MPI_TYPE_CONTIGUOUS(2, type2, type22, ...)
36 ...
37 CALL MPI_SEND(a, 4, MPI_REAL, ...)
38 CALL MPI_SEND(a, 2, type2, ...)
39 CALL MPI_SEND(a, 1, type22, ...)
40 CALL MPI_SEND(a, 1, type4, ...)
41 ...
42 CALL MPI_RECV(a, 4, MPI_REAL, ...)
43 CALL MPI_RECV(a, 2, type2, ...)
44 CALL MPI_RECV(a, 1, type22, ...)
45 CALL MPI_RECV(a, 1, type4, ...)
46
```

47 Each of the sends matches any of the receives.

A datatype may specify overlapping entries. The use of such a datatype in a receive operation is erroneous. (This is erroneous even if the actual message received is short enough not to write any entry more than once.)

Suppose that `MPI_RECV(buf, count, datatype, dest, tag, comm, status)` is executed, where `datatype` has type map,

$$\{(type_0, disp_0), \dots, (type_{n-1}, disp_{n-1})\}.$$

The received message need not fill all the receive buffer, nor does it need to fill a number of locations which is a multiple of  $n$ . Any number,  $k$ , of basic elements can be received, where  $0 \leq k \leq count \cdot n$ . The number of basic elements received can be retrieved from `status` using the query functions `MPI_GET_ELEMENTS` or `MPI_GET_ELEMENTS_X`.

`MPI_TYPE_GET_ELEMENTS(status, datatype, count)`

IN	<code>status</code>	return status of receive operation (Status)
IN	<code>datatype</code>	datatype used by receive operation (handle)
OUT	<code>count</code>	number of received basic elements (integer)

#### C binding

```
int MPI_Type_get_elements(MPI_Status *status, MPI_Datatype datatype,
                          int *count)
```

#### Fortran 2008 binding

```
MPI_Type_get_elements(status, datatype, count, ierror)
  TYPE(MPI_Status), INTENT(IN) :: status
  TYPE(MPI_Datatype), INTENT(IN) :: datatype
  INTEGER, INTENT(OUT) :: count
  INTEGER, OPTIONAL, INTENT(OUT) :: ierror
```

#### Fortran binding

```
MPI_TYPE_GET_ELEMENTS(STATUS, DATATYPE, COUNT, IERROR)
  INTEGER STATUS(MPI_STATUS_SIZE), DATATYPE, COUNT, IERROR
```

`MPI_TYPE_GET_ELEMENTS_X(status, datatype, count)`

IN	<code>status</code>	return status of receive operation (Status)
IN	<code>datatype</code>	datatype used by receive operation (handle)
OUT	<code>count</code>	number of received basic elements (integer)

#### C binding

```
int MPI_Type_get_elements_x(MPI_Status *status, MPI_Datatype datatype,
                            MPI_Count *count)
```

#### Fortran 2008 binding

```
MPI_Type_get_elements_x(status, datatype, count, ierror)
  TYPE(MPI_Status), INTENT(IN) :: status
  TYPE(MPI_Datatype), INTENT(IN) :: datatype
```

```

1      INTEGER(KIND=MPI_COUNT_KIND), INTENT(OUT) :: count
2      INTEGER, OPTIONAL, INTENT(OUT) :: ierror

```

### Fortran binding

```

4      MPI_TYPE_GET_ELEMENTS_X(STATUS, DATATYPE, COUNT, IERROR)
5      INTEGER STATUS(MPI_STATUS_SIZE), DATATYPE, IERROR
6      INTEGER(KIND=MPI_COUNT_KIND) COUNT

```

The datatype argument should match the argument provided by the receive call that set the status variable. For both functions, if the OUT parameter cannot express the value to be returned (e.g., if the parameter is too small to hold the output value), it is set to MPI\_UNDEFINED.

The previously defined function MPI\_GET\_COUNT (Section 3.2.5), has a different behavior. It returns the number of “top-level entries” received, i.e. the number of “copies” of type datatype. In the previous example, MPI\_GET\_COUNT may return any integer value  $k$ , where  $0 \leq k \leq \text{count}$ . If MPI\_GET\_COUNT returns  $k$ , then the number of basic elements received (and the value returned by MPI\_GET\_ELEMENTS or MPI\_GET\_ELEMENTS\_X) is  $n \cdot k$ . If the number of basic elements received is not a multiple of  $n$ , that is, if the receive operation has not received an integral number of datatype “copies,” then MPI\_GET\_COUNT sets the value of count to MPI\_UNDEFINED.

#### Example 4.12 Usage of MPI\_GET\_COUNT and MPI\_GET\_ELEMENTS.

```

23      ...
24      CALL MPI_TYPE_CONTIGUOUS(2, MPI_REAL, Type2, ierr)
25      CALL MPI_TYPE_COMMIT(Type2, ierr)
26      ...
27      CALL MPI_COMM_RANK(comm, rank, ierr)
28      IF (rank.EQ.0) THEN
29          CALL MPI_SEND(a, 2, MPI_REAL, 1, 0, comm, ierr)
30          CALL MPI_SEND(a, 3, MPI_REAL, 1, 0, comm, ierr)
31      ELSE IF (rank.EQ.1) THEN
32          CALL MPI_RECV(a, 2, Type2, 0, 0, comm, stat, ierr)
33          CALL MPI_GET_COUNT(stat, Type2, i, ierr)      ! returns i=1
34          CALL MPI_GET_ELEMENTS(stat, Type2, i, ierr)  ! returns i=2
35          CALL MPI_RECV(a, 2, Type2, 0, 0, comm, stat, ierr)
36          CALL MPI_GET_COUNT(stat, Type2, i, ierr)    ! returns i=MPI_UNDEFINED
37          CALL MPI_GET_ELEMENTS(stat, Type2, i, ierr) ! returns i=3
38      END IF

```

The functions MPI\_GET\_ELEMENTS and MPI\_GET\_ELEMENTS\_X can also be used after a probe to find the number of elements in the probed message. Note that the MPI\_GET\_COUNT, MPI\_GET\_ELEMENTS, and MPI\_GET\_ELEMENTS\_X return the same values when they are used with basic datatypes as long as the limits of their respective count arguments are not exceeded.

*Rationale.* The extension given to the definition of MPI\_GET\_COUNT seems natural: one would expect this function to return the value of the count argument, when the receive buffer is filled. Sometimes datatype represents a basic unit of data one wants to transfer, for example, a record in an array of records (structures). One should be

able to find out how many components were received without bothering to divide by the number of elements in each component. However, on other occasions, `datatype` is used to define a complex layout of data in the receiver memory, and does not represent a basic unit of data for transfers. In such cases, one needs to use the function `MPI_GET_ELEMENTS` or `MPI_GET_ELEMENTS_X`. (*End of rationale.*)

*Advice to implementors.* The definition implies that a receive cannot change the value of storage outside the entries defined to compose the communication buffer. In particular, the definition implies that padding space in a structure should not be modified when such a structure is copied from one process to another. This would prevent the obvious optimization of copying the structure, together with the padding, as one contiguous block. The implementation is free to do this optimization when it does not impact the outcome of the computation. The user can “force” this optimization by explicitly including padding as part of the message. (*End of advice to implementors.*)

#### 4.1.12 Correct Use of Addresses

Successively declared variables in C or Fortran are not necessarily stored at contiguous locations. Thus, care must be exercised that displacements do not cross from one variable to another. Also, in machines with a segmented address space, addresses are not unique and address arithmetic has some peculiar properties. Thus, the use of **addresses**, that is, displacements relative to the start address `MPI_BOTTOM`, has to be restricted.

Variables belong to the same **sequential storage** if they belong to the same array, to the same `COMMON` block in Fortran, or to the same structure in C. Valid addresses are defined recursively as follows:

1. The function `MPI_GET_ADDRESS` returns a valid address, when passed as argument a variable of the calling program.
2. The `buf` argument of a communication function evaluates to a valid address, when passed as argument a variable of the calling program.
3. If `v` is a valid address, and `i` is an integer, then `v+i` is a valid address, provided `v` and `v+i` are in the same sequential storage.

A correct program uses only valid addresses to identify the locations of entries in communication buffers. Furthermore, if `u` and `v` are two valid addresses, then the (integer) difference `u - v` can be computed only if both `u` and `v` are in the same sequential storage. No other arithmetic operations can be meaningfully Aexecuted on addresses.

The rules above impose no constraints on the use of derived datatypes, as long as they are used to define a communication buffer that is wholly contained within the same sequential storage. However, the construction of a communication buffer that contains variables that are not within the same sequential storage must obey certain restrictions. Basically, a communication buffer with variables that are not within the same sequential storage can be used only by specifying in the communication call `buf = MPI_BOTTOM`, `count = 1`, and using a `datatype` argument where all displacements are valid (absolute) addresses.

*Advice to users.* It is not expected that MPI implementations will be able to detect erroneous, “out of bound” displacements — unless those overflow the user address space — since the MPI call may not know the extent of the arrays and records in the host program. (*End of advice to users.*)

*Advice to implementors.* There is no need to distinguish (absolute) addresses and (relative) displacements on a machine with contiguous address space: `MPI_BOTTOM` is zero, and both addresses and displacements are integers. On machines where the distinction is required, addresses are recognized as expressions that involve `MPI_BOTTOM`. (*End of advice to implementors.*)

#### 4.1.13 Decoding a Datatype

MPI datatype objects allow users to specify an arbitrary layout of data in memory. There are several cases where accessing the layout information in opaque datatype objects would be useful. The opaque datatype object has found a number of uses outside MPI. Furthermore, a number of tools wish to display internal information about a datatype. To achieve this, datatype decoding functions are provided. The two functions in this section are used together to decode datatypes to recreate the calling sequence used in their initial definition. These can be used to allow a user to determine the type map and type signature of a datatype.

`MPI_TYPE_GET_ENVELOPE(datatype, num_integers, num_addresses, num_datatypes, combiner)`

IN	datatype	datatype to access (handle)
OUT	num_integers	number of input integers used in call constructing combiner (non-negative integer)
OUT	num_addresses	number of input addresses used in call constructing combiner (non-negative integer)
OUT	num_datatypes	number of input datatypes used in call constructing combiner (non-negative integer)
OUT	combiner	combiner (state)

#### C binding

```
int MPI_Type_get_envelope(MPI_Datatype datatype, int *num_integers,
                          int *num_addresses, int *num_datatypes, int *combiner)
```

#### Fortran 2008 binding

```
MPI_Type_get_envelope(datatype, num_integers, num_addresses, num_datatypes,
                      combiner, ierror)
    TYPE(MPI_Datatype), INTENT(IN) :: datatype
    INTEGER, INTENT(OUT) :: num_integers, num_addresses, num_datatypes,
    combiner
    INTEGER, OPTIONAL, INTENT(OUT) :: ierror
```

#### Fortran binding

```
MPI_TYPE_GET_ENVELOPE(DATATYPE, NUM_INTEGERS, NUM_ADDRESSES, NUM_DATATYPES,
                      COMBINER, IERROR)
    INTEGER DATATYPE, NUM_INTEGERS, NUM_ADDRESSES, NUM_DATATYPES,
    COMBINER, IERROR
```



For the given datatype, `MPI_TYPE_GET_ENVELOPE` returns information on the number and type of input arguments used in the call that created the datatype. The number-of-arguments values returned can be used to provide sufficiently large arrays in the decoding routine `MPI_TYPE_GET_CONTENTS`. This call and the meaning of the returned values is described below. The combiner reflects the MPI datatype constructor call that was used in creating datatype.

*Rationale.* By requiring that the combiner reflect the constructor used in the creation of the datatype, the decoded information can be used to effectively recreate the calling sequence used in the original creation. This is the most useful information and was felt to be reasonable even though it constrains implementations to remember the original constructor sequence even if the internal representation is different.

The decoded information keeps track of datatype duplications. This is important as one needs to distinguish between a predefined datatype and a dup of a predefined datatype. The former is a constant object that cannot be freed, while the latter is a derived datatype that can be freed. (*End of rationale.*)

The list in Table 4.1 has the values that can be returned in combiner on the left and the call associated with them on the right.

<code>MPI_COMBINER_NAMED</code>	a named predefined datatype
<code>MPI_COMBINER_DUP</code>	<code>MPI_TYPE_DUP</code>
<code>MPI_COMBINER_CONTIGUOUS</code>	<code>MPI_TYPE_CONTIGUOUS</code>
<code>MPI_COMBINER_VECTOR</code>	<code>MPI_TYPE_VECTOR</code>
<code>MPI_COMBINER_HVECTOR</code>	<code>MPI_TYPE_CREATE_HVECTOR</code>
<code>MPI_COMBINER_INDEXED</code>	<code>MPI_TYPE_INDEXED</code>
<code>MPI_COMBINER_HINDEXED</code>	<code>MPI_TYPE_CREATE_HINDEXED</code>
<code>MPI_COMBINER_INDEXED_BLOCK</code>	<code>MPI_TYPE_CREATE_INDEXED_BLOCK</code>
<code>MPI_COMBINER_HINDEXED_BLOCK</code>	<code>MPI_TYPE_CREATE_HINDEXED_BLOCK</code>
<code>MPI_COMBINER_STRUCT</code>	<code>MPI_TYPE_CREATE_STRUCT</code>
<code>MPI_COMBINER_SUBARRAY</code>	<code>MPI_TYPE_CREATE_SUBARRAY</code>
<code>MPI_COMBINER_DARRAY</code>	<code>MPI_TYPE_CREATE_DARRAY</code>
<code>MPI_COMBINER_F90_REAL</code>	<code>MPI_TYPE_CREATE_F90_REAL</code>
<code>MPI_COMBINER_F90_COMPLEX</code>	<code>MPI_TYPE_CREATE_F90_COMPLEX</code>
<code>MPI_COMBINER_F90_INTEGER</code>	<code>MPI_TYPE_CREATE_F90_INTEGER</code>
<code>MPI_COMBINER_RESIZED</code>	<code>MPI_TYPE_CREATE_RESIZED</code>

Table 4.1: combiner values returned from `MPI_TYPE_GET_ENVELOPE`

If combiner is `MPI_COMBINER_NAMED` then datatype is a named predefined datatype.

The actual arguments used in the creation call for a datatype can be obtained using `MPI_TYPE_GET_CONTENTS`.

```

1 MPI_TYPE_GET_CONTENTS(datatype, max_integers, max_addresses, max_datatypes, array_of_integers,
2   array_of_addresses, array_of_datatypes)

```

3	IN	datatype	datatype to access (handle)
4			
5	IN	max_integers	number of elements in array_of_integers (non-negative integer)
6			
7	IN	max_addresses	number of elements in array_of_addresses (non-negative integer)
8			
9	IN	max_datatypes	number of elements in array_of_datatypes (non-negative integer)
10			
11			
12	OUT	array_of_integers	contains integer arguments used in constructing datatype (array of integers)
13			
14	OUT	array_of_addresses	contains address arguments used in constructing datatype (array of integers)
15			
16	OUT	array_of_datatypes	contains datatype arguments used in constructing datatype (array of handles)
17			
18			

### C binding

```

19
20
21 int MPI_Type_get_contents(MPI_Datatype datatype, int max_integers,
22   int max_addresses, int max_datatypes, int array_of_integers[],
23   MPI_Aint array_of_addresses[],
24   MPI_Datatype array_of_datatypes[])

```

### Fortran 2008 binding

```

25
26 MPI_Type_get_contents(datatype, max_integers, max_addresses, max_datatypes,
27   array_of_integers, array_of_addresses, array_of_datatypes,
28   ierror)
29   TYPE(MPI_Datatype), INTENT(IN) :: datatype
30   INTEGER, INTENT(IN) :: max_integers, max_addresses, max_datatypes
31   INTEGER, INTENT(OUT) :: array_of_integers(max_integers)
32   INTEGER(KIND=MPI_ADDRESS_KIND), INTENT(OUT) ::
33   array_of_addresses(max_addresses)
34   TYPE(MPI_Datatype), INTENT(OUT) :: array_of_datatypes(max_datatypes)
35   INTEGER, OPTIONAL, INTENT(OUT) :: ierror

```

### Fortran binding

```

36
37 MPI_TYPE_GET_CONTENTS(DATATYPE, MAX_INTEGERS, MAX_ADDRESSES, MAX_DATATYPES,
38   ARRAY_OF_INTEGERS, ARRAY_OF_ADDRESSES, ARRAY_OF_DATATYPES,
39   IERROR)
40   INTEGER DATATYPE, MAX_INTEGERS, MAX_ADDRESSES, MAX_DATATYPES,
41   ARRAY_OF_INTEGERS(*), ARRAY_OF_DATATYPES(*), IERROR
42   INTEGER(KIND=MPI_ADDRESS_KIND) ARRAY_OF_ADDRESSES(*)

```

44 datatype must be a predefined unnamed or a derived datatype; the call is erroneous if  
 45 datatype is a predefined named datatype.

46 The values given for max\_integers, max\_addresses, and max\_datatypes must be at least as  
 47 large as the value returned in num\_integers, num\_addresses, and num\_datatypes, respectively,  
 48 in the call MPI\_TYPE\_GET\_ENVELOPE for the same datatype argument.

*Rationale.* The arguments `max_integers`, `max_addresses`, and `max_datatypes` allow for error checking in the call. (*End of rationale.*)

The datatypes returned in `array_of_datatypes` are handles to datatype objects that are equivalent to the datatypes used in the original construction call. If these were derived datatypes, then the returned datatypes are new datatype objects, and the user is responsible for freeing these datatypes with `MPI_TYPE_FREE`. If these were predefined datatypes, then the returned datatype is equal to that (constant) predefined datatype and cannot be freed.

The committed state of returned derived datatypes is undefined, i.e., the datatypes may or may not be committed. Furthermore, the content of attributes of returned datatypes is undefined.

Note that `MPI_TYPE_GET_CONTENTS` can be invoked with a datatype argument that was constructed using `MPI_TYPE_CREATE_F90_REAL`, `MPI_TYPE_CREATE_F90_INTEGER`, or `MPI_TYPE_CREATE_F90_COMPLEX` (an unnamed predefined datatype). In such a case, an empty `array_of_datatypes` is returned.

*Rationale.* The definition of datatype equivalence implies that equivalent predefined datatypes are equal. By requiring the same handle for named predefined datatypes, it is possible to use the `==` or `.EQ.` comparison operator to determine the datatype involved. (*End of rationale.*)

*Advice to implementors.* The datatypes returned in `array_of_datatypes` must appear to the user as if each is an equivalent copy of the datatype used in the type constructor call. Whether this is done by creating a new datatype or via another mechanism such as a reference count mechanism is up to the implementation as long as the semantics are preserved. (*End of advice to implementors.*)

*Rationale.* The committed state and attributes of the returned datatype is deliberately left vague. The datatype used in the original construction may have been modified since its use in the constructor call. Attributes can be added, removed, or modified as well as having the datatype committed. The semantics given allow for a reference count implementation without having to track these changes. (*End of rationale.*)

In the deprecated datatype constructor calls, the address arguments in Fortran are of type `INTEGER`. In the preferred calls, the address arguments are of type `INTEGER(KIND=MPI_ADDRESS_KIND)`. The call `MPI_TYPE_GET_CONTENTS` returns all addresses in an argument of type `INTEGER(KIND=MPI_ADDRESS_KIND)`. This is true even if the deprecated calls were used. Thus, the location of values returned can be thought of as being returned by the C bindings. It can also be determined by examining the preferred calls for datatype constructors for the deprecated calls that involve addresses.

*Rationale.* By having all address arguments returned in the `array_of_addresses` argument, the result from a C and Fortran decoding of a datatype gives the result in the same argument. It is assumed that an integer of type `INTEGER(KIND=MPI_ADDRESS_KIND)` will be at least as large as the `INTEGER` argument used in datatype construction with the old MPI-1 calls so no loss of information will occur. (*End of rationale.*)

The following defines what values are placed in each entry of the returned arrays depending on the datatype constructor used for `datatype`. It also specifies the size of the arrays needed which is the values returned by `MPI_TYPE_GET_ENVELOPE`. In Fortran, the following calls were made:

```

1  PARAMETER (LARGE = 1000)
2  INTEGER TYPE, NI, NA, ND, COMBINER, I(LARGE), D(LARGE), IERROR
3  INTEGER (KIND=MPI_ADDRESS_KIND) A(LARGE)
4  ! CONSTRUCT DATATYPE TYPE (NOT SHOWN)
5  CALL MPI_TYPE_GET_ENVELOPE(TYPE, NI, NA, ND, COMBINER, IERROR)
6  IF ((NI .GT. LARGE) .OR. (NA .GT. LARGE) .OR. (ND .GT. LARGE)) THEN
7      WRITE (*, *) "NI, NA, OR ND = ", NI, NA, ND, &
8      " RETURNED BY MPI_TYPE_GET_ENVELOPE IS LARGER THAN LARGE = ", LARGE
9      CALL MPI_ABORT(MPI_COMM_WORLD, 99, IERROR)
10 ENDIF
11 CALL MPI_TYPE_GET_CONTENTS(TYPE, NI, NA, ND, I, A, D, IERROR)

```

or in C the analogous calls of:

```

19 #define LARGE 1000
20 int ni, na, nd, combiner, i[LARGE];
21 MPI_Aint a[LARGE];
22 MPI_Datatype type, d[LARGE];
23 /* construct datatype type (not shown) */
24 MPI_Type_get_envelope(type, &ni, &na, &nd, &combiner);
25 if ((ni > LARGE) || (na > LARGE) || (nd > LARGE)) {
26     fprintf(stderr, "ni, na, or nd = %d %d %d returned by ", ni, na, nd);
27     fprintf(stderr, "MPI_Type_get_envelope is larger than LARGE = %d\n",
28             LARGE);
29     MPI_Abort(MPI_COMM_WORLD, 99);
30 };
31 MPI_Type_get_contents(type, ni, na, nd, i, a, d);

```

In the descriptions that follow, the lower case name of arguments is used.

If combiner is `MPI_COMBINER_NAMED` then it is erroneous to call `MPI_TYPE_GET_CONTENTS`.

If combiner is `MPI_COMBINER_DUP` then

Constructor argument	C	Fortran location
<code>oldtype</code>	<code>d[0]</code>	<code>D(1)</code>

and `ni = 0`, `na = 0`, `nd = 1`.

If combiner is `MPI_COMBINER_CONTIGUOUS` then

Constructor argument	C	Fortran location
<code>count</code>	<code>i[0]</code>	<code>I(1)</code>
<code>oldtype</code>	<code>d[0]</code>	<code>D(1)</code>

and `ni = 1`, `na = 0`, `nd = 1`.

If combiner is `MPI_COMBINER_VECTOR` then

Constructor argument	C	Fortran location
count	i[0]	I(1)
blocklength	i[1]	I(2)
stride	i[2]	I(3)
oldtype	d[0]	D(1)

and ni = 3, na = 0, nd = 1.

If combiner is MPI\_COMBINER\_HVECTOR then

Constructor argument	C	Fortran location
count	i[0]	I(1)
blocklength	i[1]	I(2)
stride	a[0]	A(1)
oldtype	d[0]	D(1)

and ni = 2, na = 1, nd = 1.

If combiner is MPI\_COMBINER\_INDEXED then

Constructor argument	C	Fortran location
count	i[0]	I(1)
array_of_blocklengths	i[1] to i[i[0]]	I(2) to I(I(1)+1)
array_of_displacements	i[i[0]+1] to i[2*i[0]]	I(I(1)+2) to I(2*I(1)+1)
oldtype	d[0]	D(1)

and ni = 2\*count+1, na = 0, nd = 1.

If combiner is MPI\_COMBINER\_HINDEXED then

Constructor argument	C	Fortran location
count	i[0]	I(1)
array_of_blocklengths	i[1] to i[i[0]]	I(2) to I(I(1)+1)
array_of_displacements	a[0] to a[i[0]-1]	A(1) to A(I(1))
oldtype	d[0]	D(1)

and ni = count+1, na = count, nd = 1.

If combiner is MPI\_COMBINER\_INDEXED\_BLOCK then

Constructor argument	C	Fortran location
count	i[0]	I(1)
blocklength	i[1]	I(2)
array_of_displacements	i[2] to i[i[0]+1]	I(3) to I(I(1)+2)
oldtype	d[0]	D(1)

and ni = count+2, na = 0, nd = 1.

If combiner is MPI\_COMBINER\_HINDEXED\_BLOCK then

Constructor argument	C	Fortran location
count	i[0]	I(1)
blocklength	i[1]	I(2)
array_of_displacements	a[0] to a[i[0]-1]	A(1) to A(I(1))
oldtype	d[0]	D(1)

1 and  $ni = 2$ ,  $na = count$ ,  $nd = 1$ .

2 If combiner is `MPI_COMBINER_STRUCT` then

Constructor argument	C	Fortran location
count	$i[0]$	I(1)
array_of_blocklengths	$i[1]$ to $i[i[0]]$	I(2) to I(I(1)+1)
array_of_displacements	$a[0]$ to $a[i[0]-1]$	A(1) to A(I(1))
array_of_types	$d[0]$ to $d[i[0]-1]$	D(1) to D(I(1))

9 and  $ni = count+1$ ,  $na = count$ ,  $nd = count$ .

10 If combiner is `MPI_COMBINER_SUBARRAY` then

Constructor argument	C	Fortran location
ndims	$i[0]$	I(1)
array_of_sizes	$i[1]$ to $i[i[0]]$	I(2) to I(I(1)+1)
array_of_subsizes	$i[i[0]+1]$ to $i[2*i[0]]$	I(I(1)+2) to I(2*I(1)+1)
array_of_starts	$i[2*i[0]+1]$ to $i[3*i[0]]$	I(2*I(1)+2) to I(3*I(1)+1)
order	$i[3*i[0]+1]$	I(3*I(1)+2)
oldtype	$d[0]$	D(1)

19 and  $ni = 3*ndims+2$ ,  $na = 0$ ,  $nd = 1$ .

20 If combiner is `MPI_COMBINER_DARRAY` then

Constructor argument	C	Fortran location
size	$i[0]$	I(1)
rank	$i[1]$	I(2)
ndims	$i[2]$	I(3)
array_of_gsizes	$i[3]$ to $i[i[2]+2]$	I(4) to I(I(3)+3)
array_of_distribs	$i[i[2]+3]$ to $i[2*i[2]+2]$	I(I(3)+4) to I(2*I(3)+3)
array_of_dargs	$i[2*i[2]+3]$ to $i[3*i[2]+2]$	I(2*I(3)+4) to I(3*I(3)+3)
array_of_psizes	$i[3*i[2]+3]$ to $i[4*i[2]+2]$	I(3*I(3)+4) to I(4*I(3)+3)
order	$i[4*i[2]+3]$	I(4*I(3)+4)
oldtype	$d[0]$	D(1)

33 and  $ni = 4*ndims+4$ ,  $na = 0$ ,  $nd = 1$ .

34 If combiner is `MPI_COMBINER_F90_REAL` then

Constructor argument	C	Fortran location
p	$i[0]$	I(1)
r	$i[1]$	I(2)

37 and  $ni = 2$ ,  $na = 0$ ,  $nd = 0$ .

38 If combiner is `MPI_COMBINER_F90_COMPLEX` then

Constructor argument	C	Fortran location
p	$i[0]$	I(1)
r	$i[1]$	I(2)

41 and  $ni = 2$ ,  $na = 0$ ,  $nd = 0$ .

42 If combiner is `MPI_COMBINER_F90_INTEGER` then

Constructor argument	C	Fortran location
r	i[0]	I(1)

and ni = 1, na = 0, nd = 0.

If combiner is MPI\_COMBINER\_RESIZED then

Constructor argument	C	Fortran location
lb	a[0]	A(1)
extent	a[1]	A(2)
oldtype	d[0]	D(1)

and ni = 0, na = 2, nd = 1.

#### 4.1.14 Examples

The following examples illustrate the use of derived datatypes.

**Example 4.13** Send and receive a section of a 3D array.

```

REAL a(100,100,100), e(9,9,9)
INTEGER oneslice, twoslice, threeslice, myrank, ierr
INTEGER (KIND=MPI_ADDRESS_KIND) lb, sizeofreal
INTEGER status(MPI_STATUS_SIZE)

! extract the section a(1:17:2, 3:11, 2:10)
! and store it in e(:, :, :).

CALL MPI_COMM_RANK(MPI_COMM_WORLD, myrank, ierr)

CALL MPI_TYPE_GET_EXTENT(MPI_REAL, lb, sizeofreal, ierr)

! create datatype for a 1D section
CALL MPI_TYPE_VECTOR(9, 1, 2, MPI_REAL, oneslice, ierr)

! create datatype for a 2D section
CALL MPI_TYPE_CREATE_HVECTOR(9, 1, 100*sizeofreal, oneslice, &
                             twoslice, ierr)

! create datatype for the entire section
CALL MPI_TYPE_CREATE_HVECTOR(9, 1, 100*100*sizeofreal, twoslice, &
                             threeslice, ierr)

CALL MPI_TYPE_COMMIT(threeslice, ierr)
CALL MPI_SENDRECV(a(1,3,2), 1, threeslice, myrank, 0, e, 9*9*9, &
                  MPI_REAL, myrank, 0, MPI_COMM_WORLD, status, ierr)

```

**Example 4.14** Copy the (strictly) lower triangular part of a matrix.

```

1  REAL a(100,100), b(100,100)
2  INTEGER disp(100), blocklen(100), ltype, myrank, ierr
3  INTEGER status(MPI_STATUS_SIZE)
4
5  ! copy lower triangular part of array a
6  ! onto lower triangular part of array b
7
8  CALL MPI_COMM_RANK(MPI_COMM_WORLD, myrank, ierr)
9
10 ! compute start and size of each column
11 DO i=1,100
12     disp(i) = 100*(i-1) + i
13     blocklen(i) = 100-i
14 END DO
15
16 ! create datatype for lower triangular part
17 CALL MPI_TYPE_INDEXED(100, blocklen, disp, MPI_REAL, ltype, ierr)
18
19 CALL MPI_TYPE_COMMIT(ltype, ierr)
20 CALL MPI_SENDRECV(a, 1, ltype, myrank, 0, b, 1, &
21                 ltype, myrank, 0, MPI_COMM_WORLD, status, ierr)
22

```

**Example 4.15** Transpose a matrix.

```

24 REAL a(100,100), b(100,100)
25 INTEGER row, xpose, myrank, ierr
26 INTEGER (KIND=MPI_ADDRESS_KIND) lb, sizeofreal
27 INTEGER status(MPI_STATUS_SIZE)
28
29 ! transpose matrix a onto b
30
31 CALL MPI_COMM_RANK(MPI_COMM_WORLD, myrank, ierr)
32
33 CALL MPI_TYPE_GET_EXTENT(MPI_REAL, lb, sizeofreal, ierr)
34
35 ! create datatype for one row
36 CALL MPI_TYPE_VECTOR(100, 1, 100, MPI_REAL, row, ierr)
37
38 ! create datatype for matrix in row-major order
39 CALL MPI_TYPE_CREATE_HVECTOR(100, 1, sizeofreal, row, xpose, ierr)
40
41 CALL MPI_TYPE_COMMIT(xpose, ierr)
42
43 ! send matrix in row-major order and receive in column major order
44 CALL MPI_SENDRECV(a, 1, xpose, myrank, 0, b, 100*100, &
45                 MPI_REAL, myrank, 0, MPI_COMM_WORLD, status, ierr)
46

```

**Example 4.16** Another approach to the transpose problem:



```

REAL a(100,100), b(100,100)
INTEGER row, row1
INTEGER (KIND=MPI_ADDRESS_KIND) disp(2), lb, sizeofreal
INTEGER myrank, ierr
INTEGER status(MPI_STATUS_SIZE)

CALL MPI_COMM_RANK(MPI_COMM_WORLD, myrank, ierr)

! transpose matrix a onto b

CALL MPI_TYPE_GET_EXTENT(MPI_REAL, lb, sizeofreal, ierr)

! create datatype for one row
CALL MPI_TYPE_VECTOR(100, 1, 100, MPI_REAL, row, ierr)

! create datatype for one row, with the extent of one real number
lb = 0
CALL MPI_TYPE_CREATE_RESIZED(row, lb, sizeofreal, row1, ierr)

CALL MPI_TYPE_COMMIT(row1, ierr)

! send 100 rows and receive in column major order
CALL MPI_SENDRECV(a, 100, row1, myrank, 0, b, 100*100, &
                  MPI_REAL, myrank, 0, MPI_COMM_WORLD, status, ierr)

```

**Example 4.17** We manipulate an array of structures.

```

struct Partstruct
{
    int    type; /* particle type */
    double d[6]; /* particle coordinates */
    char   b[7]; /* some additional information */
};

struct Partstruct    particle[1000];

int    i, dest, tag;
MPI_Comm    comm;

/* build datatype describing structure */

MPI_Datatype Particlestruct, Particletype;
MPI_Datatype type[3] = {MPI_INT, MPI_DOUBLE, MPI_CHAR};
int    blocklen[3] = {1, 6, 7};
MPI_Aint    disp[3];
MPI_Aint    base, lb, sizeofentry;

```

```

1
2  /* compute displacements of structure components */
3
4  MPI_Get_address(particle, disp);
5  MPI_Get_address(particle[0].d, disp+1);
6  MPI_Get_address(particle[0].b, disp+2);
7  base = disp[0];
8  for (i=0; i < 3; i++) disp[i] = MPI_Aint_diff(disp[i], base);
9
10 MPI_Type_create_struct(3, blocklen, disp, type, &Particlestruct);
11
12     /* If compiler does padding in mysterious ways,
13     the following may be safer */
14
15 /* compute extent of the structure */
16
17 MPI_Get_address(particle+1, &sizeofentry);
18 sizeofentry = MPI_Aint_diff(sizeofentry, base);
19
20 /* build datatype describing structure */
21
22 MPI_Type_create_resized(Particlestruct, 0, sizeofentry, &Particletype);
23
24
25     /* 4.1:
26     send the entire array */
27
28 MPI_Type_commit(&Particletype);
29 MPI_Send(particle, 1000, Particletype, dest, tag, comm);
30
31
32     /* 4.2:
33     send only the entries of type zero particles,
34     preceded by the number of such entries */
35
36 MPI_Datatype Zparticles; /* datatype describing all particles
37                          with type zero (needs to be recomputed
38                          if types change) */
39 MPI_Datatype Ztype;
40
41 int          zdisp[1000];
42 int          zblock[1000], j, k;
43 int          zzblock[2] = {1,1};
44 MPI_Aint     zzdisp[2];
45 MPI_Datatype zztype[2];
46
47 /* compute displacements of type zero particles */
48 j = 0;

```

```

for (i=0; i < 1000; i++)
    if (particle[i].type == 0)
        {
            zdisp[j] = i;
            zblock[j] = 1;
            j++;
        }

/* create datatype for type zero particles */
MPI_Type_indexed(j, zblock, zdisp, Particletype, &Zparticles);

/* prepend particle count */
MPI_Get_address(&j, zzdisp);
MPI_Get_address(particle, zzdisp+1);
zztype[0] = MPI_INT;
zztype[1] = Zparticles;
MPI_Type_create_struct(2, zzblock, zzdisp, zztype, &Ztype);

MPI_Type_commit(&Ztype);
MPI_Send(MPI_BOTTOM, 1, Ztype, dest, tag, comm);

/* A probably more efficient way of defining Zparticles */

/* consecutive particles with index zero are handled as one block */
j=0;
for (i=0; i < 1000; i++)
    if (particle[i].type == 0)
        {
            for (k=i+1; (k < 1000)&&(particle[k].type == 0); k++);
            zdisp[j] = i;
            zblock[j] = k-i;
            j++;
            i = k;
        }
MPI_Type_indexed(j, zblock, zdisp, Particletype, &Zparticles);

/* 4.3:
    send the first two coordinates of all entries */

MPI_Datatype Allpairs; /* datatype for all pairs of coordinates */

MPI_Type_get_extent(Particletype, &lb, &sizeofentry);

/* sizeofentry can also be computed by subtracting the address
    of particle[0] from the address of particle[1] */

```

```

1 MPI_Type_create_hvector(1000, 2, sizeofentry, MPI_DOUBLE, &Allpairs);
2 MPI_Type_commit(&Allpairs);
3 MPI_Send(particle[0].d, 1, Allpairs, dest, tag, comm);
4
5     /* an alternative solution to 4.3 */
6
7 MPI_Datatype Twodouble;
8
9 MPI_Type_contiguous(2, MPI_DOUBLE, &Twodouble);
10
11 MPI_Datatype Onepair;    /* datatype for one pair of coordinates, with
12                          the extent of one particle entry */
13
14 MPI_Type_create_resized(Twodouble, 0, sizeofentry, &Onepair );
15 MPI_Type_commit(&Onepair);
16 MPI_Send(particle[0].d, 1000, Onepair, dest, tag, comm);
17
18
19

```

20 **Example 4.18** The same manipulations as in the previous example, but use absolute  
21 addresses in datatypes.

```

22 struct Partstruct
23 {
24     int    type;
25     double d[6];
26     char   b[7];
27 };
28
29
30 struct Partstruct particle[1000];
31
32     /* build datatype describing first array entry */
33
34 MPI_Datatype Particletype;
35 MPI_Datatype type[3] = {MPI_INT, MPI_DOUBLE, MPI_CHAR};
36 int         block[3] = {1, 6, 7};
37 MPI_Aint    disp[3];
38
39 MPI_Get_address(particle, disp);
40 MPI_Get_address(particle[0].d, disp+1);
41 MPI_Get_address(particle[0].b, disp+2);
42 MPI_Type_create_struct(3, block, disp, type, &Particletype);
43
44 /* Particletype describes first array entry -- using absolute
45    addresses */
46
47     /* 5.1:
48    send the entire array */

```

```

MPI_Type_commit(&Particletype);
MPI_Send(MPI_BOTTOM, 1000, Particletype, dest, tag, comm);

        /* 5.2:
        send the entries of type zero,
        preceded by the number of such entries */

MPI_Datatype Zparticles, Ztype;

int      zdisp[1000];
int      zblock[1000], i, j, k;
int      zzblock[2] = {1,1};
MPI_Datatype zztype[2];
MPI_Aint zzdisp[2];

j=0;
for (i=0; i < 1000; i++)
    if (particle[i].type == 0)
        {
            for (k=i+1; (k < 1000)&&(particle[k].type == 0); k++);
            zdisp[j] = i;
            zblock[j] = k-i;
            j++;
            i = k;
        }
MPI_Type_indexed(j, zblock, zdisp, Particletype, &Zparticles);
/* Zparticles describe particles with type zero, using
   their absolute addresses*/

/* prepend particle count */
MPI_Get_address(&j, zzdisp);
zzdisp[1] = (MPI_Aint)0;
zztype[0] = MPI_INT;
zztype[1] = Zparticles;
MPI_Type_create_struct(2, zzblock, zzdisp, zztype, &Ztype);

MPI_Type_commit(&Ztype);
MPI_Send(MPI_BOTTOM, 1, Ztype, dest, tag, comm);

```

**Example 4.19** Handling of unions.

```

union {
    int    ival;
    float  fval;
}

```

```

1      } u[1000];
2
3      int    utype;
4
5      /* All entries of u have identical type; variable
6         utype keeps track of their current type */
7
8      MPI_Datatype  mpi_utype[2];
9      MPI_Aint      i, extent;
10
11     /* compute an MPI datatype for each possible union type;
12        assume values are left-aligned in union storage. */
13
14     MPI_Get_address(u, &i);
15     MPI_Get_address(u+1, &extent);
16     extent = MPI_Aint_diff(extent, i);
17
18     MPI_Type_create_resized(MPI_INT, 0, extent, &mpi_utype[0]);
19
20     MPI_Type_create_resized(MPI_FLOAT, 0, extent, &mpi_utype[1]);
21
22     for(i=0; i<2; i++) MPI_Type_commit(&mpi_utype[i]);
23
24     /* actual communication */
25
26     MPI_Send(u, 1000, mpi_utype[utype], dest, tag, comm);
27
28

```

**Example 4.20** This example shows how a datatype can be decoded. The routine `printdatatype` prints out the elements of the datatype. Note the use of `MPI_Type_free` for datatypes that are not predefined.

```

32     /*
33        Example of decoding a datatype.
34
35        Returns 0 if the datatype is predefined, 1 otherwise
36        */
37     #include <stdio.h>
38     #include <stdlib.h>
39     #include "mpi.h"
40     int printdatatype(MPI_Datatype datatype)
41     {
42         int *array_of_ints;
43         MPI_Aint *array_of_adds;
44         MPI_Datatype *array_of_dtypes;
45         int num_ints, num_adds, num_dtypes, combiner;
46         int i;
47
48         MPI_Type_get_envelope(datatype,

```

```

                                &num_ints, &num_adds, &num_dtypes, &combiner); 1
switch (combiner) { 2
case MPI_COMBINER_NAMED: 3
    printf("Datatype is named:"); 4
    /* To print the specific type, we can match against the 5
       predefined forms. We can NOT use a switch statement here 6
       We could also use MPI_TYPE_GET_NAME if we preferred to use 7
       names that the user may have changed. 8
    */ 9
    if (datatype == MPI_INT) printf("MPI_INT\n"); 10
    else if (datatype == MPI_DOUBLE) printf("MPI_DOUBLE\n"); 11
    ... else test for other types ... 12
    return 0; 13
    break; 14
case MPI_COMBINER_STRUCT: 15
case MPI_COMBINER_STRUCT_INTEGER: 16
    printf("Datatype is struct containing"); 17
    array_of_ints = (int *)malloc(num_ints * sizeof(int)); 18
    array_of_adds = 19
        (MPI_Aint *) malloc(num_adds * sizeof(MPI_Aint)); 20
    array_of_dtypes = (MPI_Datatype *) 21
        malloc(num_dtypes * sizeof(MPI_Datatype)); 22
    MPI_Type_get_contents(datatype, num_ints, num_adds, num_dtypes, 23
        array_of_ints, array_of_adds, array_of_dtypes); 24
    printf(" %d datatypes:\n", array_of_ints[0]); 25
    for (i=0; i<array_of_ints[0]; i++) { 26
        printf("blocklength %d, displacement %ld, type:\n", 27
            array_of_ints[i+1], (long)array_of_adds[i]); 28
        if (printdatatype(array_of_dtypes[i])) { 29
            /* Note that we free the type ONLY if it 30
               is not predefined */ 31
            MPI_Type_free(&array_of_dtypes[i]); 32
        } 33
    } 34
    free(array_of_ints); 35
    free(array_of_adds); 36
    free(array_of_dtypes); 37
    break; 38
    ... other combiner values ... 39
default: 40
    printf("Unrecognized combiner type\n"); 41
} 42
return 1; 43
} 44
} 45
} 46
} 47
} 48

```

## 4.2 Pack and Unpack

Some existing communication libraries provide pack/unpack functions for sending noncontiguous data. In these, the user explicitly packs data into a contiguous buffer before sending it, and unpacks it from a contiguous buffer after receiving it. Derived datatypes, which are described in Section 4.1, allow one, in most cases, to avoid explicit packing and unpacking. The user specifies the layout of the data to be sent or received, and the communication library directly accesses a noncontiguous buffer. The pack/unpack routines are provided for compatibility with previous libraries. Also, they provide some functionality that is not otherwise available in MPI. For instance, a message can be received in several parts, where the receive operation done on a later part may depend on the content of a former part. Another use is that outgoing messages may be explicitly buffered in user supplied space, thus overriding the system buffering policy. Finally, the availability of pack and unpack operations facilitates the development of additional communication libraries layered on top of MPI.

**MPI\_PACK**(inbuf, incount, datatype, outbuf, outsize, position, comm)

IN	inbuf	input buffer start (choice)
IN	incount	number of input data items (non-negative integer)
IN	datatype	datatype of each input data item (handle)
OUT	outbuf	output buffer start (choice)
IN	outsize	output buffer size, in bytes (non-negative integer)
INOUT	position	current position in buffer, in bytes (integer)
IN	comm	communicator for packed message (handle)

### C binding

```
int MPI_Pack(const void *inbuf, int incount, MPI_Datatype datatype,
            void *outbuf, int outsize, int *position, MPI_Comm comm)
```

### Fortran 2008 binding

```
MPI_Pack(inbuf, incount, datatype, outbuf, outsize, position, comm, ierror)
  TYPE(*), DIMENSION(..), INTENT(IN) :: inbuf
  INTEGER, INTENT(IN) :: incount, outsize
  TYPE(MPI_Datatype), INTENT(IN) :: datatype
  TYPE(*), DIMENSION(..) :: outbuf
  INTEGER, INTENT(INOUT) :: position
  TYPE(MPI_Comm), INTENT(IN) :: comm
  INTEGER, OPTIONAL, INTENT(OUT) :: ierror
```

### Fortran binding

```
MPI_PACK(INBUF, INCOUNT, DATATYPE, OUTBUF, OUTSIZE, POSITION, COMM, IERROR)
  <type> INBUF(*), OUTBUF(*)
  INTEGER INCOUNT, DATATYPE, OUTSIZE, POSITION, COMM, IERROR
```

Packs the message in the send buffer specified by inbuf, incount, datatype into the buffer space specified by outbuf and outsize. The input buffer can be any communication buffer



allowed in MPI\_SEND. The output buffer is a contiguous storage area containing `outsize` bytes, starting at the address `outbuf` (length is counted in *bytes*, not elements, as if it were a communication buffer for a message of type MPI\_PACKED).

The input value of `position` is the first location in the output buffer to be used for packing. `position` is incremented by the size of the packed message, and the output value of `position` is the first location in the output buffer following the locations occupied by the packed message. The `comm` argument is the communicator that will be subsequently used for sending the packed message.

MPI\_UNPACK(`inbuf`, `insize`, `position`, `outbuf`, `outcount`, `datatype`, `comm`)

IN	<code>inbuf</code>	input buffer start (choice)
IN	<code>insize</code>	size of input buffer, in bytes (non-negative integer)
INOUT	<code>position</code>	current position in bytes (integer)
OUT	<code>outbuf</code>	output buffer start (choice)
IN	<code>outcount</code>	number of items to be unpacked (integer)
IN	<code>datatype</code>	datatype of each output data item (handle)
IN	<code>comm</code>	communicator for packed message (handle)

#### C binding

```
int MPI_Unpack(const void *inbuf, int insize, int *position, void *outbuf,
              int outcount, MPI_Datatype datatype, MPI_Comm comm)
```

#### Fortran 2008 binding

```
MPI_Unpack(inbuf, insize, position, outbuf, outcount, datatype, comm,
           ierror)
  TYPE(*), DIMENSION(..), INTENT(IN) :: inbuf
  INTEGER, INTENT(IN) :: insize, outcount
  INTEGER, INTENT(INOUT) :: position
  TYPE(*), DIMENSION(..) :: outbuf
  TYPE(MPI_Datatype), INTENT(IN) :: datatype
  TYPE(MPI_Comm), INTENT(IN) :: comm
  INTEGER, OPTIONAL, INTENT(OUT) :: ierror
```

#### Fortran binding

```
MPI_UNPACK(INBUF, INSIZE, POSITION, OUTBUF, OUTCOUNT, DATATYPE, COMM,
           IERROR)
  <type> INBUF(*), OUTBUF(*)
  INTEGER INSIZE, POSITION, OUTCOUNT, DATATYPE, COMM, IERROR
```

Unpacks a message into the receive buffer specified by `outbuf`, `outcount`, `datatype` from the buffer space specified by `inbuf` and `insize`. The output buffer can be any communication buffer allowed in MPI\_RECV. The input buffer is a contiguous storage area containing `insize` bytes, starting at address `inbuf`. The input value of `position` is the first location in the input buffer occupied by the packed message. `position` is incremented by the size of the packed message, so that the output value of `position` is the first location in the input buffer after

1 the locations occupied by the message that was unpacked. `comm` is the communicator used  
2 to receive the packed message.

3  
4 *Advice to users.* Note the difference between `MPI_RECV` and `MPI_UNPACK`: in  
5 `MPI_RECV`, the `count` argument specifies the maximum number of items that can  
6 be received. The actual number of items received is determined by the length of  
7 the incoming message. In `MPI_UNPACK`, the `count` argument specifies the actual  
8 number of items that are unpacked; the “size” of the corresponding message is the  
9 increment in `position`. The reason for this change is that the “incoming message size”  
10 is not predetermined since the user decides how much to unpack; nor is it easy to  
11 determine the “message size” from the number of items to be unpacked. In fact, in a  
12 heterogeneous system, this number may not be determined *a priori*. (*End of advice*  
13 *to users.*)

14  
15 To understand the behavior of `pack` and `unpack`, it is convenient to think of the data  
16 part of a message as being the sequence obtained by concatenating the successive values sent  
17 in that message. The `pack` operation stores this sequence in the buffer space, as if sending  
18 the message to that buffer. The `unpack` operation retrieves this sequence from buffer space,  
19 as if receiving a message from that buffer. (It is helpful to think of internal Fortran files or  
20 `sscanf` in C, for a similar function.)

21 Several messages can be successively packed into one **packing unit**. This is effected  
22 by several successive **related** calls to `MPI_PACK`, where the first call provides `position = 0`,  
23 and each successive call inputs the value of `position` that was output by the previous call,  
24 and the same values for `outbuf`, `outcount` and `comm`. This packing unit now contains the  
25 equivalent information that would have been stored in a message by one `send` call with a  
26 send buffer that is the “concatenation” of the individual send buffers.

27 A packing unit can be sent using type `MPI_PACKED`. Any point to point or collective  
28 communication function can be used to move the sequence of bytes that forms the packing  
29 unit from one process to another. This packing unit can now be received using any receive  
30 operation, with any datatype: the type matching rules are relaxed for messages sent with  
31 type `MPI_PACKED`.

32 A message sent with any type (including `MPI_PACKED`) can be received using the type  
33 `MPI_PACKED`. Such a message can then be unpacked by calls to `MPI_UNPACK`.

34 A packing unit (or a message created by a regular, “typed” `send`) can be unpacked into  
35 several successive messages. This is effected by several successive related calls to  
36 `MPI_UNPACK`, where the first call provides `position = 0`, and each successive call inputs the  
37 value of `position` that was output by the previous call, and the same values for `inbuf`, `insize`  
38 and `comm`.

39 The concatenation of two packing units is not necessarily a packing unit; nor is a  
40 substring of a packing unit necessarily a packing unit. Thus, one cannot concatenate two  
41 packing units and then unpack the result as one packing unit; nor can one unpack a substring  
42 of a packing unit as a separate packing unit. Each packing unit, that was created by a related  
43 sequence of `pack` calls, or by a regular `send`, must be unpacked as a unit, by a sequence of  
44 related `unpack` calls.

45 *Rationale.* The restriction on “atomic” packing and unpacking of packing units  
46 allows the implementation to add at the head of packing units additional information,  
47 such as a description of the sender architecture (to be used for type conversion, in a  
48 heterogeneous environment) (*End of rationale.*)

The following call allows the user to find out how much space is needed to pack a message and, thus, manage space allocation for buffers.

`MPI_PACK_SIZE`(`incount`, `datatype`, `comm`, `size`)

IN	<code>incount</code>	count argument to packing call (non-negative integer)
IN	<code>datatype</code>	datatype argument to packing call (handle)
IN	<code>comm</code>	communicator argument to packing call (handle)
OUT	<code>size</code>	upper bound on size of packed message, in bytes (non-negative integer)

### C binding

```
int MPI_Pack_size(int incount, MPI_Datatype datatype, MPI_Comm comm,
                 int *size)
```

### Fortran 2008 binding

```
MPI_Pack_size(incount, datatype, comm, size, ierror)
  INTEGER, INTENT(IN) :: incount
  TYPE(MPI_Datatype), INTENT(IN) :: datatype
  TYPE(MPI_Comm), INTENT(IN) :: comm
  INTEGER, INTENT(OUT) :: size
  INTEGER, OPTIONAL, INTENT(OUT) :: ierror
```

### Fortran binding

```
MPI_PACK_SIZE(INCOUNTO, DATATYPE, COMM, SIZE, IERROR)
  INTEGER INCOUNTO, DATATYPE, COMM, SIZE, IERROR
```

A call to `MPI_PACK_SIZE`(`incount`, `datatype`, `comm`, `size`) returns in `size` an upper bound on the increment in position that is effected by a call to `MPI_PACK`(`inbuf`, `incount`, `datatype`, `outbuf`, `outcount`, `position`, `comm`). If the packed size of the datatype cannot be expressed by the `size` parameter, then `MPI_PACK_SIZE` sets the value of `size` to `MPI_UNDEFINED`.

*Rationale.* The call returns an upper bound, rather than an exact bound, since the exact amount of space needed to pack the message may depend on the context (e.g., first message packed in a packing unit may take more space). (*End of rationale.*)

**Example 4.21** An example using `MPI_PACK`.

```
int      position, i, j, a[2];
char     buff[1000];

MPI_Comm_rank(MPI_COMM_WORLD, &myrank);
if (myrank == 0)
{
    /* SENDER CODE */

    position = 0;
    MPI_Pack(&i, 1, MPI_INT, buff, 1000, &position, MPI_COMM_WORLD);
```

```

1     MPI_Pack(&j, 1, MPI_INT, buff, 1000, &position, MPI_COMM_WORLD);
2     MPI_Send(buff, position, MPI_PACKED, 1, 0, MPI_COMM_WORLD);
3 }
4 else /* RECEIVER CODE */
5     MPI_Recv(a, 2, MPI_INT, 0, 0, MPI_COMM_WORLD, MPI_STATUS_IGNORE);
6
7
8

```

**Example 4.22** An elaborate example.

```

9     int    position, i;
10    float  a[1000];
11    char   buff[1000];
12
13    MPI_Comm_rank(MPI_COMM_WORLD, &myrank);
14    if (myrank == 0)
15    {
16        /* SENDER CODE */
17
18        int len[2];
19        MPI_Aint disp[2];
20        MPI_Datatype type[2], newtype;
21
22        /* build datatype for i followed by a[0]...a[i-1] */
23
24        len[0] = 1;
25        len[1] = i;
26        MPI_Get_address(&i, disp);
27        MPI_Get_address(a, disp+1);
28        type[0] = MPI_INT;
29        type[1] = MPI_FLOAT;
30        MPI_Type_create_struct(2, len, disp, type, &newtype);
31        MPI_Type_commit(&newtype);
32
33        /* Pack i followed by a[0]...a[i-1]*/
34
35        position = 0;
36        MPI_Pack(MPI_BOTTOM, 1, newtype, buff, 1000, &position, MPI_COMM_WORLD);
37
38        /* Send */
39
40        MPI_Send(buff, position, MPI_PACKED, 1, 0,
41                MPI_COMM_WORLD);
42
43        /* *****
44         One can replace the last three lines with
45         MPI_Send(MPI_BOTTOM, 1, newtype, 1, 0, MPI_COMM_WORLD);
46         ***** */
47    }
48    else if (myrank == 1)

```

```

{
    /* RECEIVER CODE */

    MPI_Status status;

    /* Receive */

    MPI_Recv(buff, 1000, MPI_PACKED, 0, 0, MPI_COMM_WORLD, &status);

    /* Unpack i */

    position = 0;
    MPI_Unpack(buff, 1000, &position, &i, 1, MPI_INT, MPI_COMM_WORLD);

    /* Unpack a[0]...a[i-1] */
    MPI_Unpack(buff, 1000, &position, a, i, MPI_FLOAT, MPI_COMM_WORLD);
}

```

**Example 4.23** Each process sends a count, followed by count characters to the root; the root concatenates all characters into one string.

```

int count, gsize, counts[64], totalcount, k1, k2, k,
    displs[64], position, concat_pos;
char chr[100], *lbuf, *rbuf, *cbuf;

MPI_Comm_size(comm, &gsize);
MPI_Comm_rank(comm, &myrank);

    /* allocate local pack buffer */
MPI_Pack_size(1, MPI_INT, comm, &k1);
MPI_Pack_size(count, MPI_CHAR, comm, &k2);
k = k1+k2;
lbuf = (char *)malloc(k);

    /* pack count, followed by count characters */
position = 0;
MPI_Pack(&count, 1, MPI_INT, lbuf, k, &position, comm);
MPI_Pack(chr, count, MPI_CHAR, lbuf, k, &position, comm);

if (myrank != root) {
    /* gather at root sizes of all packed messages */
    MPI_Gather(&position, 1, MPI_INT, NULL, 0,
        MPI_DATATYPE_NULL, root, comm);

    /* gather at root packed messages */
    MPI_Gatherv(lbuf, position, MPI_PACKED, NULL,
        NULL, NULL, MPI_DATATYPE_NULL, root, comm);
}

```

```

1  } else { /* root code */
2      /* gather sizes of all packed messages */
3      MPI_Gather(&position, 1, MPI_INT, counts, 1,
4                MPI_INT, root, comm);
5
6      /* gather all packed messages */
7      displs[0] = 0;
8      for (i=1; i < gsize; i++)
9          displs[i] = displs[i-1] + counts[i-1];
10     totalcount = displs[gsiz-1] + counts[gsiz-1];
11     rbuf = (char *)malloc(totalcount);
12     cbuf = (char *)malloc(totalcount);
13     MPI_Gatherv(lbuf, position, MPI_PACKED, rbuf,
14                counts, displs, MPI_PACKED, root, comm);
15
16     /* unpack all messages and concatenate strings */
17     concat_pos = 0;
18     for (i=0; i < gsize; i++) {
19         position = 0;
20         MPI_Unpack(rbuf+displs[i], totalcount-displs[i],
21                  &position, &count, 1, MPI_INT, comm);
22         MPI_Unpack(rbuf+displs[i], totalcount-displs[i],
23                  &position, cbuf+concat_pos, count, MPI_CHAR, comm);
24         concat_pos += count;
25     }
26     cbuf[concat_pos] = '\0';
27 }
28
29
30

```

### 4.3 Canonical MPI\_PACK and MPI\_UNPACK

These functions read/write data to/from the buffer in the “external32” data format specified in Section 13.5.2, and calculate the size needed for packing. Their first arguments specify the data format, for future extensibility, but currently the only valid value of the `datarep` argument is “external32.”

*Advice to users.* These functions could be used, for example, to send typed data in a portable format from one MPI implementation to another. (*End of advice to users.*)

The buffer will contain exactly the packed data, without headers. `MPI_BYTE` should be used to send and receive data that is packed using `MPI_PACK_EXTERNAL`.

*Rationale.* `MPI_PACK_EXTERNAL` specifies that there is no header on the message and further specifies the exact format of the data. Since `MPI_PACK` may (and is allowed to) use a header, the datatype `MPI_PACKED` cannot be used for data packed with `MPI_PACK_EXTERNAL`. (*End of rationale.*)

MPI_PACK_EXTERNAL(datarep, inbuf, incount, datatype, outbuf, outsize, position)			1
IN	datarep	data representation (string)	2
IN	inbuf	input buffer start (choice)	3
IN	incount	number of input data items (integer)	4
IN	datatype	datatype of each input data item (handle)	5
OUT	outbuf	output buffer start (choice)	6
IN	outsize	output buffer size, in bytes (integer)	7
INOUT	position	current position in buffer, in bytes (integer)	8

**C binding**

```

int MPI_Pack_external(const char datarep[], const void *inbuf, int incount,
                    MPI_Datatype datatype, void *outbuf, MPI_Aint outsize,
                    MPI_Aint *position)

```

**Fortran 2008 binding**

```

MPI_Pack_external(datarep, inbuf, incount, datatype, outbuf, outsize,
                position, ierror)
CHARACTER(LEN=*) INTENT(IN) :: datarep
TYPE(*), DIMENSION(..), INTENT(IN) :: inbuf
INTEGER, INTENT(IN) :: incount
TYPE(MPI_Datatype), INTENT(IN) :: datatype
TYPE(*), DIMENSION(..) :: outbuf
INTEGER(KIND=MPI_ADDRESS_KIND), INTENT(IN) :: outsize
INTEGER(KIND=MPI_ADDRESS_KIND), INTENT(INOUT) :: position
INTEGER, OPTIONAL, INTENT(OUT) :: ierror

```

**Fortran binding**

```

MPI_PACK_EXTERNAL(DATAREP, INBUF, INCOUNT, DATATYPE, OUTBUF, OUTSIZE,
                POSITION, IERROR)
CHARACTER*(*) DATAREP
<type> INBUF(*), OUTBUF(*)
INTEGER INCOUNT, DATATYPE, IERROR
INTEGER(KIND=MPI_ADDRESS_KIND) OUTSIZE, POSITION

```

```

1 MPI_UNPACK_EXTERNAL(datarep, inbuf, insize, position, outbuf, outcount, datatype)
2     IN      datarep          data representation (string)
3
4     IN      inbuf           input buffer start (choice)
5
6     IN      insize          input buffer size, in bytes (integer)
7
8     INOUT   position        current position in buffer, in bytes (integer)
9
10    OUT     outbuf          output buffer start (choice)
11
12    IN      outcount        number of output data items (integer)
13
14    IN      datatype        datatype of output data item (handle)

```

**C binding**

```

15 int MPI_Unpack_external(const char datarep[], const void *inbuf,
16                        MPI_Aint insize, MPI_Aint *position, void *outbuf,
17                        int outcount, MPI_Datatype datatype)

```

**Fortran 2008 binding**

```

18 MPI_Unpack_external(datarep, inbuf, insize, position, outbuf, outcount,
19                    datatype, ierror)
20     CHARACTER(LEN=*), INTENT(IN) :: datarep
21     TYPE(*), DIMENSION(..), INTENT(IN) :: inbuf
22     INTEGER(KIND=MPI_ADDRESS_KIND), INTENT(IN) :: insize
23     INTEGER(KIND=MPI_ADDRESS_KIND), INTENT(INOUT) :: position
24     TYPE(*), DIMENSION(..) :: outbuf
25     INTEGER, INTENT(IN) :: outcount
26     TYPE(MPI_Datatype), INTENT(IN) :: datatype
27     INTEGER, OPTIONAL, INTENT(OUT) :: ierror

```

**Fortran binding**

```

28
29 MPI_UNPACK_EXTERNAL(DATAREP, INBUF, INSIZE, POSITION, OUTBUF, OUTCOUNT,
30                    DATATYPE, IERROR)
31     CHARACTER*(*) DATAREP
32     <type> INBUF(*), OUTBUF(*)
33     INTEGER(KIND=MPI_ADDRESS_KIND) INSIZE, POSITION
34     INTEGER OUTCOUNT, DATATYPE, IERROR

```

```

35
36
37
38 MPI_PACK_EXTERNAL_SIZE(datarep, incount, datatype, size)

```

```

39     IN      datarep          data representation (string)
40
41     IN      incount          number of input data items (integer)
42
43     IN      datatype        datatype of each input data item (handle)
44
45     OUT     size            output buffer size, in bytes (integer)

```

**C binding**

```

46 int MPI_Pack_external_size(const char datarep[], int incount,
47                           MPI_Datatype datatype, MPI_Aint *size)
48

```



**Fortran 2008 binding**

```
MPI_Pack_external_size(datarep, incount, datatype, size, ierror)
  CHARACTER(LEN=*), INTENT(IN) :: datarep
  INTEGER, INTENT(IN) :: incount
  TYPE(MPI_Datatype), INTENT(IN) :: datatype
  INTEGER(KIND=MPI_ADDRESS_KIND), INTENT(OUT) :: size
  INTEGER, OPTIONAL, INTENT(OUT) :: ierror
```

**Fortran binding**

```
MPI_PACK_EXTERNAL_SIZE(DATAREP, INCOUNT, DATATYPE, SIZE, IERROR)
  CHARACTER*(*) DATAREP
  INTEGER INCOUNT, DATATYPE, IERROR
  INTEGER(KIND=MPI_ADDRESS_KIND) SIZE
```

DRAFT

1  
2  
3  
4  
5  
6  
7  
8  
9  
10  
11  
12  
13  
14  
15  
16  
17  
18  
19  
20  
21  
22  
23  
24  
25  
26  
27  
28  
29  
30  
31  
32  
33  
34  
35  
36  
37  
38  
39  
40  
41  
42  
43  
44  
45  
46  
47  
48

DRAFT

1  
2  
3  
4  
5  
6  
7  
8  
9  
10  
11  
12  
13  
14  
15  
16  
17  
18  
19  
20  
21  
22  
23  
24  
25  
26  
27  
28  
29  
30  
31  
32  
33  
34  
35  
36  
37  
38  
39  
40  
41  
42  
43  
44  
45  
46  
47  
48

## Chapter 5

# Collective Communication

### 5.1 Introduction and Overview

Collective communication is defined as communication that involves a group or groups of processes. The functions of this type provided by MPI are the following:

- `MPI_BARRIER`, `MPI_IBARRIER`: Barrier synchronization across all members of a group (Section 5.3 and Section 5.12.1).
- `MPI_BCAST`, `MPI_IBCAST`: Broadcast from one member to all members of a group (Section 5.4 and Section 5.12.2). This is shown as “broadcast” in Figure 5.1.
- `MPI_GATHER`, `MPI_IGATHER`, `MPI_GATHERV`, `MPI_IGATHERV`: Gather data from all members of a group to one member (Section 5.5 and Section 5.12.3). This is shown as “gather” in Figure 5.1.
- `MPI_SCATTER`, `MPI_ISCATTER`, `MPI_SCATTERV`, `MPI_ISCATTERV`: Scatter data from one member to all members of a group (Section 5.6 and Section 5.12.4). This is shown as “scatter” in Figure 5.1.
- `MPI_ALLGATHER`, `MPI_IALLGATHER`, `MPI_ALLGATHERV`, `MPI_IALLGATHERV`: A variation on Gather where all members of a group receive the result (Section 5.7 and Section 5.12.5). This is shown as “allgather” in Figure 5.1.
- `MPI_ALLTOALL`, `MPI_IALLTOALL`, `MPI_ALLTOALLV`, `MPI_IALLTOALLV`, `MPI_ALLTOALLW`, `MPI_IALLTOALLW`: Scatter/Gather data from all members to all members of a group (also called complete exchange) (Section 5.8 and Section 5.12.6). This is shown as “complete exchange” in Figure 5.1.
- `MPI_ALLREDUCE`, `MPI_IALLREDUCE`, `MPI_REDUCE`, `MPI_IREDUCE`: Global reduction operations such as sum, max, min, or user-defined functions, where the result is returned to all members of a group (Section 5.9.6 and Section 5.12.8) and a variation where the result is returned to only one member (Section 5.9 and Section 5.12.7).
- `MPI_REDUCE_SCATTER_BLOCK`, `MPI_IREDUCE_SCATTER_BLOCK`, `MPI_REDUCE_SCATTER`, `MPI_IREDUCE_SCATTER`: A combined reduction and scatter operation (Section 5.10, Section 5.12.9, and Section 5.12.10).

- `MPI_SCAN`, `MPI_ISCAN`, `MPI_EXSCAN`, `MPI_IEXSCAN`: Scan across all members of a group (also called prefix) (Section 5.11, Section 5.11.2, Section 5.12.11, and Section 5.12.12).

One of the key arguments in a call to a collective routine is a communicator that defines the group or groups of participating processes and provides a context for the operation. This is discussed further in Section 5.2. The syntax and semantics of the collective operations are defined to be consistent with the syntax and semantics of the point-to-point operations. Thus, general datatypes are allowed and must match between sending and receiving processes as specified in Chapter 4. Several collective routines such as broadcast and gather have a single originating or receiving process. Such a process is called the *root*. Some arguments in the collective functions are specified as “significant only at root,” and are ignored for all participants except the root. The reader is referred to Chapter 4 for information concerning communication buffers, general datatypes and type matching rules, and to Chapter 6 for information on how to define groups and create communicators.

The type-matching conditions for the collective operations are more strict than the corresponding conditions between sender and receiver in point-to-point. Namely, for collective operations, the amount of data sent must exactly match the amount of data specified by the receiver. Different type maps (the layout in memory, see Section 4.1) between sender and receiver are still allowed.

Collective operations can (but are not required to) complete as soon as the caller’s participation in the collective communication is finished. A blocking operation is complete as soon as the call returns. A nonblocking (immediate) call requires a separate completion call (cf. Section 3.7). The completion of a collective operation indicates that the caller is free to modify locations in the communication buffer. It does not indicate that other processes in the group have completed or even started the operation (unless otherwise implied by the description of the operation). Thus, a collective communication operation may, or may not, have the effect of synchronizing all calling processes. This statement excludes, of course, the barrier operation.

Collective communication calls may use the same communicators as point-to-point communication; MPI guarantees that messages generated on behalf of collective communication calls will not be confused with messages generated by point-to-point communication. The collective operations do not have a message tag argument. A more detailed discussion of correct use of collective routines is found in Section 5.14.

*Rationale.* The equal-data restriction (on type matching) was made so as to avoid the complexity of providing a facility analogous to the status argument of `MPI_RECV` for discovering the amount of data sent. Some of the collective routines would require an array of status values.

The statements about synchronization are made so as to allow a variety of implementations of the collective functions.

*(End of rationale.)*

*Advice to users.* It is dangerous to rely on synchronization side-effects of the collective operations for program correctness. For example, even though a particular implementation may provide a broadcast routine with a side-effect of synchronization, the standard does not require this, and a program that relies on this will not be portable.

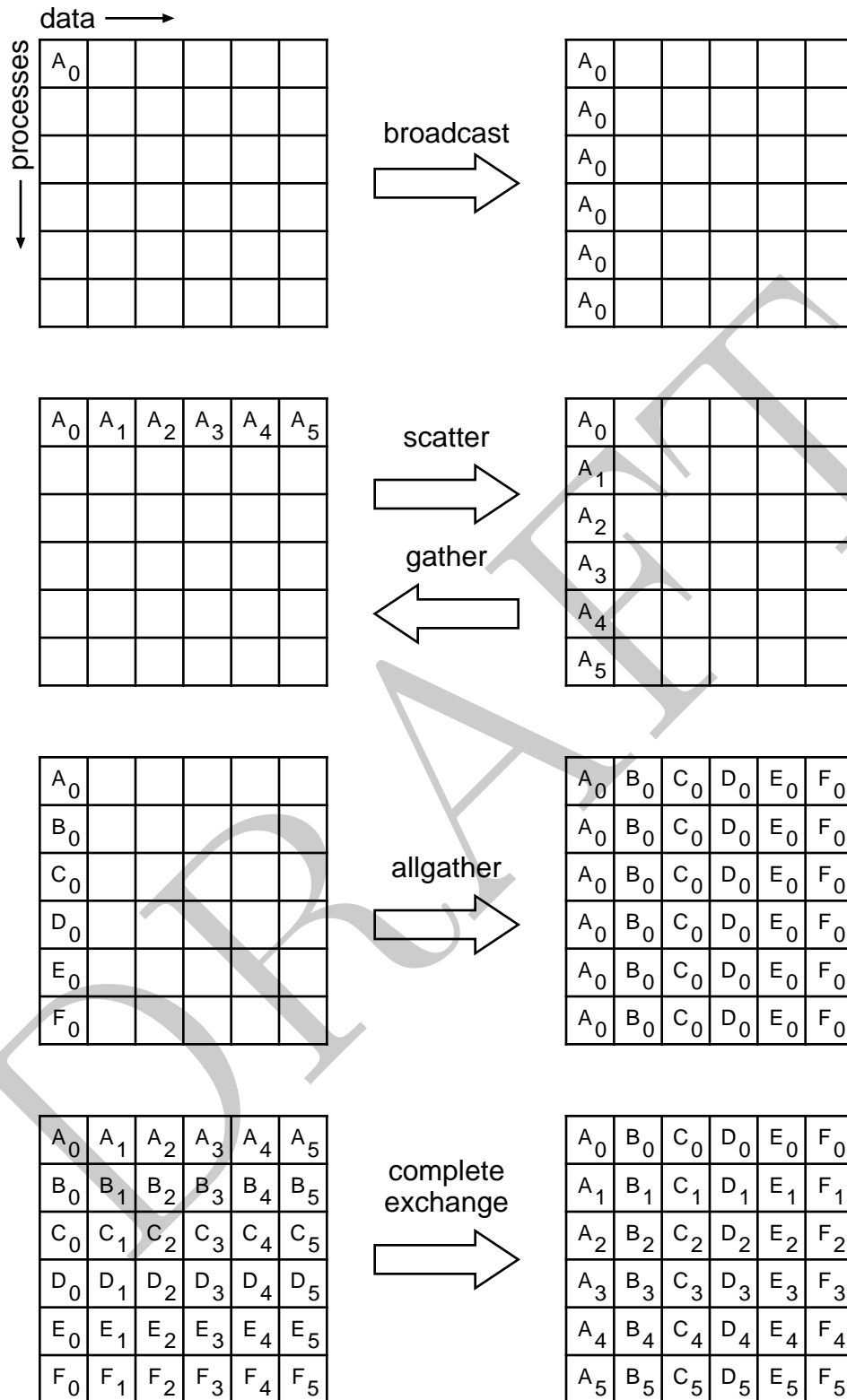

Figure 5.1: Collective move functions illustrated for a group of six processes. In each case, each row of boxes represents data locations in one process. Thus, in the broadcast, initially just the first process contains the data  $A_0$ , but after the broadcast all processes contain it.

1 On the other hand, a correct, portable program must allow for the fact that a collective  
2 call *may* be synchronizing. Though one cannot rely on any synchronization side-effect,  
3 one must program so as to allow it. These issues are discussed further in Section 5.14.  
4 (*End of advice to users.*)

5  
6 *Advice to implementors.* While vendors may write optimized collective routines  
7 matched to their architectures, a complete library of the collective communication  
8 routines can be written entirely using the MPI point-to-point communication func-  
9 tions and a few auxiliary functions. If implementing on top of point-to-point, a hidden,  
10 special communicator might be created for the collective operation so as to avoid inter-  
11 ference with any on-going point-to-point communication at the time of the collective  
12 call. This is discussed further in Section 5.14. (*End of advice to implementors.*)

13 Many of the descriptions of the collective routines provide illustrations in terms of  
14 blocking MPI point-to-point routines. These are intended solely to indicate what data is  
15 sent or received by what process. Many of these examples are *not* correct MPI programs;  
16 for purposes of simplicity, they often assume infinite buffering.

## 18 5.2 Communicator Argument

19  
20 The key concept of the collective functions is to have a group or groups of participating  
21 processes. The routines do not have group identifiers as explicit arguments. Instead, there  
22 is a communicator argument. Groups and communicators are discussed in full detail in  
23 Chapter 6. For the purposes of this chapter, it is sufficient to know that there are two types  
24 of communicators: *intra-communicators* and *inter-communicators*. An intracommunicator  
25 can be thought of as an identifier for a single group of processes linked with a context. An  
26 intercommunicator identifies two distinct groups of processes linked with a context.

### 28 5.2.1 Specifics for Intracommunicator Collective Operations

29  
30 All processes in the group identified by the intracommunicator must call the collective  
31 routine.

32 In many cases, collective communication can occur “in place” for intracommunicators,  
33 with the output buffer being identical to the input buffer. This is specified by providing  
34 a special argument value, `MPI_IN_PLACE`, instead of the send buffer or the receive buffer  
35 argument, depending on the operation performed.

36  
37 *Rationale.* The “in place” operations are provided to reduce unnecessary memory  
38 motion by both the MPI implementation and by the user. Note that while the simple  
39 check of testing whether the send and receive buffers have the same address will  
40 work for some cases (e.g., `MPI_ALLREDUCE`), they are inadequate in others (e.g.,  
41 `MPI_GATHER`, with root not equal to zero). Further, Fortran explicitly prohibits  
42 aliasing of arguments; the approach of using a special value to denote “in place”  
43 operation eliminates that difficulty. (*End of rationale.*)

44  
45 *Advice to users.* By allowing the “in place” option, the receive buffer in many of the  
46 collective calls becomes a send-and-receive buffer. For this reason, a Fortran binding  
47 that includes `INTENT` must mark these as `INOUT`, not `OUT`.

48 Note that `MPI_IN_PLACE` is a special kind of value; it has the same restrictions on its  
use that `MPI_BOTTOM` has. (*End of advice to users.*)

### 5.2.2 Applying Collective Operations to Intercommunicators

To understand how collective operations apply to intercommunicators, we can view most MPI intracommunicator collective operations as fitting one of the following categories (see, for instance, [59]):

**All-To-All** All processes contribute to the result. All processes receive the result.

- MPI\_ALLGATHER, MPI\_IALLGATHER, MPI\_ALLGATHERV, MPI\_IALLGATHERV
- MPI\_ALLTOALL, MPI\_IALLTOALL, MPI\_ALLTOALLV, MPI\_IALLTOALLV, MPI\_ALLTOALLW, MPI\_IALLTOALLW
- MPI\_ALLREDUCE, MPI\_IALLREDUCE, MPI\_REDUCE\_SCATTER\_BLOCK, MPI\_IREDUCE\_SCATTER\_BLOCK, MPI\_REDUCE\_SCATTER, MPI\_IREDUCE\_SCATTER
- MPI\_BARRIER, MPI\_IBARRIER

**All-To-One** All processes contribute to the result. One process receives the result.

- MPI\_GATHER, MPI\_IGATHER, MPI\_GATHERV, MPI\_IGATHERV
- MPI\_REDUCE, MPI\_IREDUCE

**One-To-All** One process contributes to the result. All processes receive the result.

- MPI\_BCAST, MPI\_IBCAST
- MPI\_SCATTER, MPI\_ISCATTER, MPI\_SCATTERV, MPI\_ISCATTERV

**Other** Collective operations that do not fit into one of the above categories.

- MPI\_SCAN, MPI\_ISCAN, MPI\_EXSCAN, MPI\_IEXSCAN

The data movement patterns of MPI\_SCAN, MPI\_ISCAN, MPI\_EXSCAN, and MPI\_IEXSCAN do not fit this taxonomy.

The application of collective communication to intercommunicators is best described in terms of two groups. For example, an all-to-all MPI\_ALLGATHER operation can be described as collecting data from all members of one group with the result appearing in all members of the other group (see Figure 5.2). As another example, a one-to-all MPI\_BCAST operation sends data from one member of one group to all members of the other group. Collective computation operations such as MPI\_REDUCE\_SCATTER have a similar interpretation (see Figure 5.3). For intracommunicators, these two groups are the same. For intercommunicators, these two groups are distinct. For the all-to-all operations, each such operation is described in two phases, so that it has a symmetric, full-duplex behavior.

The following collective operations also apply to intercommunicators:

- MPI\_BARRIER, MPI\_IBARRIER
- MPI\_BCAST, MPI\_IBCAST
- MPI\_GATHER, MPI\_IGATHER, MPI\_GATHERV, MPI\_IGATHERV,
- MPI\_SCATTER, MPI\_ISCATTER, MPI\_SCATTERV, MPI\_ISCATTERV,

- 1 • MPI\_ALLGATHER, MPI\_IALLGATHER, MPI\_ALLGATHERV, MPI\_IALLGATHERV,
- 2 • MPI\_ALLTOALL, MPI\_IALLTOALL, MPI\_ALLTOALLV, MPI\_IALLTOALLV,
- 3 MPI\_ALLTOALLW, MPI\_IALLTOALLW,
- 4
- 5 • MPI\_ALLREDUCE, MPI\_IALLREDUCE, MPI\_REDUCE, MPI\_IREDUCE,
- 6
- 7 • MPI\_REDUCE\_SCATTER\_BLOCK, MPI\_IREDUCE\_SCATTER\_BLOCK,
- 8 MPI\_REDUCE\_SCATTER, MPI\_IREDUCE\_SCATTER.
- 9

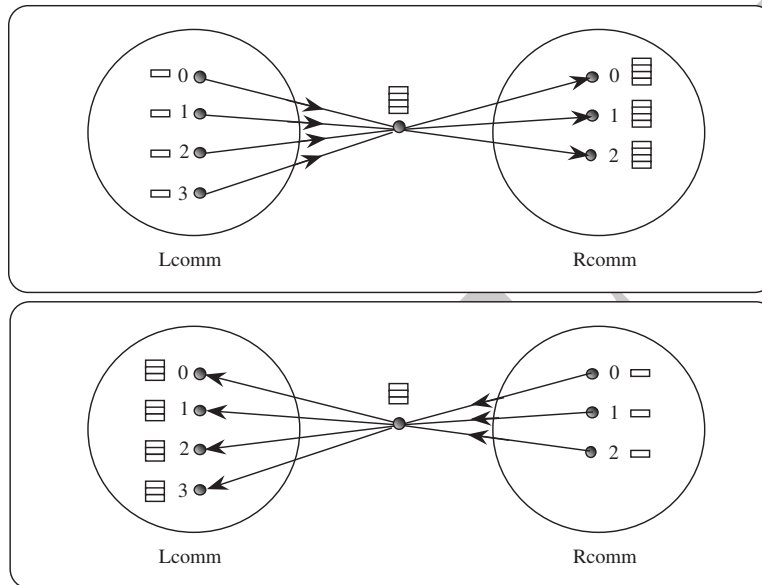

27 Figure 5.2: Intercommunicator allgather. The focus of data to one process is represented,  
 28 not mandated by the semantics. The two phases do allgathers in both directions.

### 31 5.2.3 Specifics for Intercommunicator Collective Operations

32 All processes in both groups identified by the intercommunicator must call the collective  
 33 routine.

34 Note that the “in place” option for intracommunicators does not apply to intercom-  
 35 municators since in the intercommunicator case there is no communication from a process  
 36 to itself.

37 For intercommunicator collective communication, if the operation is in the All-To-One  
 38 or One-To-All categories, then the transfer is unidirectional. The direction of the transfer  
 39 is indicated by a special value of the root argument. In this case, for the group containing the  
 40 root process, all processes in the group must call the routine using a special argument for  
 41 the root. For this, the root process uses the special root value MPI\_ROOT; all other processes  
 42 in the same group as the root use MPI\_PROC\_NULL. All processes in the other group (the  
 43 group that is the remote group relative to the root process) must call the collective routine  
 44 and provide the rank of the root. If the operation is in the All-To-All category, then the  
 45 transfer is bidirectional.

46  
 47 *Rationale.* Operations in the All-To-One and One-To-All categories are unidirectional  
 48 by nature, and there is a clear way of specifying direction. Operations in the All-To-All



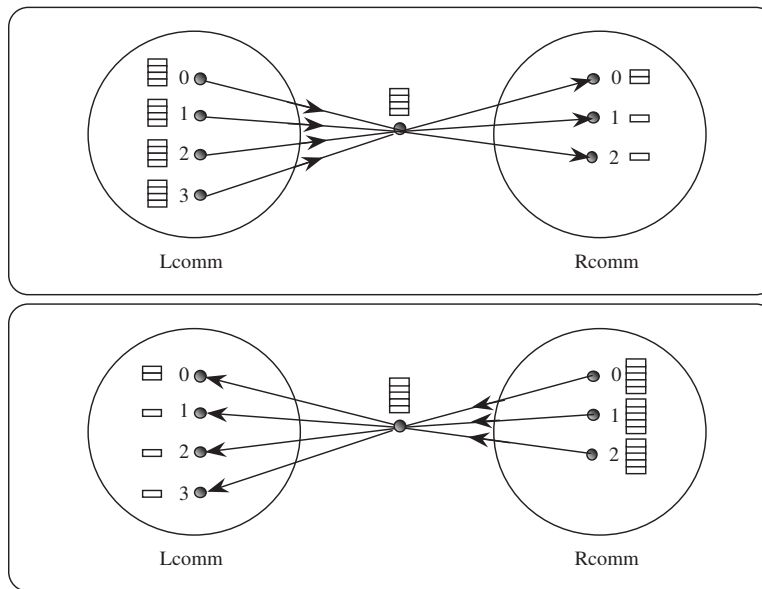

Figure 5.3: Intercommunicator reduce-scatter. The focus of data to one process is represented, not mandated by the semantics. The two phases do reduce-scatters in both directions.

category will often occur as part of an exchange, where it makes sense to communicate in both directions at once. (*End of rationale.*)

### 5.3 Barrier Synchronization

`MPI_BARRIER(comm)`

IN `comm` communicator (handle)

#### C binding

```
int MPI_Barrier(MPI_Comm comm)
```

#### Fortran 2008 binding

```
MPI_Barrier(comm, ierror)
  TYPE(MPI_Comm), INTENT(IN) :: comm
  INTEGER, OPTIONAL, INTENT(OUT) :: ierror
```

#### Fortran binding

```
MPI_BARRIER(COMM, IERROR)
  INTEGER COMM, IERROR
```

If `comm` is an intracommunicator, `MPI_BARRIER` blocks the caller until all group members have called it. The call returns at any process only after all group members have entered the call.

If `comm` is an intercommunicator, `MPI_BARRIER` involves two groups. The call returns at processes in one group (group A) of the intercommunicator only after all members of the

1 other group (group B) have entered the call (and vice versa). A process may return from  
 2 the call before all processes in its own group have entered the call.

## 3 4 5 5.4 Broadcast

6  
7  
8 MPI\_BCAST(buffer, count, datatype, root, comm)

9	INOUT	buffer	starting address of buffer (choice)
10			
11	IN	count	number of entries in buffer (non-negative integer)
12	IN	datatype	data type of buffer (handle)
13			
14	IN	root	rank of broadcast root (integer)
15	IN	comm	communicator (handle)

### 16 17 C binding

18 int MPI\_Bcast(void \*buffer, int count, MPI\_Datatype datatype, int root,  
 19 MPI\_Comm comm)

### 20 21 Fortran 2008 binding

22 MPI\_Bcast(buffer, count, datatype, root, comm, ierror)  
 23 TYPE(\*), DIMENSION(..) :: buffer  
 24 INTEGER, INTENT(IN) :: count, root  
 25 TYPE(MPI\_Datatype), INTENT(IN) :: datatype  
 26 TYPE(MPI\_Comm), INTENT(IN) :: comm  
 27 INTEGER, OPTIONAL, INTENT(OUT) :: ierror

### 28 29 Fortran binding

30 MPI\_BCAST(BUFFER, COUNT, DATATYPE, ROOT, COMM, IERROR)  
 31 <type> BUFFER(\*)  
 32 INTEGER COUNT, DATATYPE, ROOT, COMM, IERROR

33 If comm is an intracommunicator, MPI\_BCAST broadcasts a message from the process  
 34 with rank root to all processes of the group, itself included. It is called by all members of  
 35 the group using the same arguments for comm and root. On return, the content of root's  
 36 buffer is copied to all other processes.

37 General, derived datatypes are allowed for datatype. The type signature of count,  
 38 datatype on any process must be equal to the type signature of count, datatype at the root.  
 39 This implies that the amount of data sent must be equal to the amount received, pairwise  
 40 between each process and the root. MPI\_BCAST and all other data-movement collective  
 41 routines make this restriction. Distinct type maps between sender and receiver are still  
 42 allowed.

43 The “in place” option is not meaningful here.

44 If comm is an intercommunicator, then the call involves all processes in the intercom-  
 45 municator, but with one group (group A) defining the root process. All processes in the  
 46 other group (group B) pass the same value in argument root, which is the rank of the root  
 47 in group A. The root passes the value MPI\_ROOT in root. All other processes in group A  
 48 pass the value MPI\_PROC\_NULL in root. Data is broadcast from the root to all processes

in group B. The buffer arguments of the processes in group B must be consistent with the buffer argument of the root.

#### 5.4.1 Example using MPI\_BCAST

The examples in this section use intracommunicators.

**Example 5.1** Broadcast 100 ints from process 0 to every process in the group.

```
MPI_Comm comm;
int array[100];
int root=0;
...
MPI_Bcast(array, 100, MPI_INT, root, comm);
```

As in many of our example code fragments, we assume that some of the variables (such as `comm` in the above) have been assigned appropriate values.

## 5.5 Gather

`MPI_GATHER(sendbuf, sendcount, sendtype, recvbuf, recvcount, recvtype, root, comm)`

IN	<code>sendbuf</code>	starting address of send buffer (choice)
IN	<code>sendcount</code>	number of elements in send buffer (non-negative integer)
IN	<code>sendtype</code>	data type of send buffer elements (handle)
OUT	<code>recvbuf</code>	address of receive buffer (choice, significant only at root)
IN	<code>recvcount</code>	number of elements for any single receive (non-negative integer, significant only at root)
IN	<code>recvtype</code>	data type of recv buffer elements (handle, significant only at root)
IN	<code>root</code>	rank of receiving process (integer)
IN	<code>comm</code>	communicator (handle)

#### C binding

```
int MPI_Gather(const void *sendbuf, int sendcount, MPI_Datatype sendtype,
              void *recvbuf, int recvcount, MPI_Datatype recvtype, int root,
              MPI_Comm comm)
```

#### Fortran 2008 binding

```
MPI_Gather(sendbuf, sendcount, sendtype, recvbuf, recvcount, recvtype,
           root, comm, ierror)
TYPE(*), DIMENSION(..), INTENT(IN) :: sendbuf
INTEGER, INTENT(IN) :: sendcount, recvcount, root
```

```

1     TYPE(MPI_Datatype), INTENT(IN) :: sendtype, recvtype
2     TYPE(*), DIMENSION(..) :: recvbuf
3     TYPE(MPI_Comm), INTENT(IN) :: comm
4     INTEGER, OPTIONAL, INTENT(OUT) :: ierror

```

### Fortran binding

```

6 MPI_GATHER(SENDBUF, SENDCOUNT, SENDTYPE, RECVBUF, REVCOUNT, RECVTYPE,
7           ROOT, COMM, IERROR)
8     <type> SENDBUF(*), RECVBUF(*)
9     INTEGER SENDCOUNT, SENDTYPE, REVCOUNT, RECVTYPE, ROOT, COMM, IERROR

```

If `comm` is an intracommunicator, each process (root process included) sends the contents of its send buffer to the root process. The root process receives the messages and stores them in rank order. The outcome is *as if* each of the  $n$  processes in the group (including the root process) had executed a call to

```
MPI_Send(sendbuf, sendcount, sendtype, root , ...),
```

and the root had executed  $n$  calls to

```
MPI_Recv(recvbuf+i·recvcount·extent(recvtype), recvcount, recvtype, i,...),
```

where `extent(recvtype)` is the type extent obtained from a call to `MPI_Type_get_extent`.

An alternative description is that the  $n$  messages sent by the processes in the group are concatenated in rank order, and the resulting message is received by the root as if by a call to `MPI_RECV(recvbuf, recvcount·n, recvtype, ...)`.

The receive buffer is ignored for all non-root processes.

General, derived datatypes are allowed for both `sendtype` and `recvtype`. The type signature of `sendcount`, `sendtype` on each process must be equal to the type signature of `recvcount`, `recvtype` at the root. This implies that the amount of data sent must be equal to the amount of data received, pairwise between each process and the root. Distinct type maps between sender and receiver are still allowed.

All arguments to the function are significant on process `root`, while on other processes, only arguments `sendbuf`, `sendcount`, `sendtype`, `root`, and `comm` are significant. The arguments `root` and `comm` must have identical values on all processes.

The specification of counts and types should not cause any location on the root to be written more than once. Such a call is erroneous.

Note that the `recvcount` argument at the root indicates the number of items it receives from *each* process, not the total number of items it receives.

The “in place” option for intracommunicators is specified by passing `MPI_IN_PLACE` as the value of `sendbuf` at the root. In such a case, `sendcount` and `sendtype` are ignored, and the contribution of the root to the gathered vector is assumed to be already in the correct place in the receive buffer.

If `comm` is an intercommunicator, then the call involves all processes in the intercommunicator, but with one group (group A) defining the root process. All processes in the other group (group B) pass the same value in argument `root`, which is the rank of the root in group A. The root passes the value `MPI_ROOT` in `root`. All other processes in group A pass the value `MPI_PROC_NULL` in `root`. Data is gathered from all processes in group B to the root. The send buffer arguments of the processes in group B must be consistent with

the receive buffer argument of the root.

`MPI_GATHERV(sendbuf, sendcount, sendtype, recvbuf, recvcunts, displs, recvtype, root, comm)`

IN	sendbuf	starting address of send buffer (choice)	6
IN	sendcount	number of elements in send buffer (non-negative integer)	7
IN	sendtype	data type of send buffer elements (handle)	9
OUT	recvbuf	address of receive buffer (choice, significant only at root)	11
IN	recvcunts	non-negative integer array (of length group size) containing the number of elements that are received from each process (significant only at root)	13
IN	displs	integer array (of length group size). Entry <i>i</i> specifies the displacement relative to <code>recvbuf</code> at which to place the incoming data from process <i>i</i> (significant only at root)	16
IN	recvtype	data type of recv buffer elements (handle, significant only at root)	21
IN	root	rank of receiving process (integer)	23
IN	comm	communicator (handle)	25

### C binding

```
int MPI_Gatherv(const void *sendbuf, int sendcount, MPI_Datatype sendtype,
               void *recvbuf, const int recvcunts[], const int displs[],
               MPI_Datatype recvtype, int root, MPI_Comm comm)
```

### Fortran 2008 binding

```
MPI_Gatherv(sendbuf, sendcount, sendtype, recvbuf, recvcunts, displs,
            recvtype, root, comm, ierror)
    TYPE(*), DIMENSION(..), INTENT(IN) :: sendbuf
    INTEGER, INTENT(IN) :: sendcount, recvcunts(*), displs(*), root
    TYPE(MPI_Datatype), INTENT(IN) :: sendtype, recvtype
    TYPE(*), DIMENSION(..) :: recvbuf
    TYPE(MPI_Comm), INTENT(IN) :: comm
    INTEGER, OPTIONAL, INTENT(OUT) :: ierror
```

### Fortran binding

```
MPI_GATHERV(SENDBUF, SENDCOUNT, SENDTYPE, RECVBUF, RECVCOUNTS, DISPLS,
            RECVTYPE, ROOT, COMM, IERROR)
    <type> SENDBUF(*), RECVBUF(*)
    INTEGER SENDCOUNT, SENDTYPE, RECVCOUNTS(*), DISPLS(*), RECVTYPE, ROOT,
    COMM, IERROR
```

`MPI_GATHERV` extends the functionality of `MPI_GATHER` by allowing a varying count

of data from each process, since `recvcounts` is now an array. It also allows more flexibility as to where the data is placed on the root, by providing the new argument, `displs`.

If `comm` is an intracommunicator, the outcome is *as if* each process, including the root process, sends a message to the root,

```
MPI_Send(sendbuf, sendcount, sendtype, root, ...),
```

and the root executes `n` receives,

```
MPI_Recv(recvbuf+displs[j]-extent(recvtype), recvcounts[j], recvtype, i, ...).
```

The data received from process `j` is placed into `recvbuf` of the root process beginning at offset `displs[j]` elements (in terms of the `recvtype`).

The receive buffer is ignored for all non-root processes.

The type signature implied by `sendcount`, `sendtype` on process `i` must be equal to the type signature implied by `recvcounts[i]`, `recvtype` at the root. This implies that the amount of data sent must be equal to the amount of data received, pairwise between each process and the root. Distinct type maps between sender and receiver are still allowed, as illustrated in Example 5.6.

All arguments to the function are significant on process `root`, while on other processes, only arguments `sendbuf`, `sendcount`, `sendtype`, `root`, and `comm` are significant. The arguments `root` and `comm` must have identical values on all processes.

The specification of counts, types, and displacements should not cause any location on the root to be written more than once. Such a call is erroneous.

The “in place” option for intracommunicators is specified by passing `MPI_IN_PLACE` as the value of `sendbuf` at the root. In such a case, `sendcount` and `sendtype` are ignored, and the contribution of the root to the gathered vector is assumed to be already in the correct place in the receive buffer.

If `comm` is an intercommunicator, then the call involves all processes in the intercommunicator, but with one group (group A) defining the root process. All processes in the other group (group B) pass the same value in argument `root`, which is the rank of the root in group A. The root passes the value `MPI_ROOT` in `root`. All other processes in group A pass the value `MPI_PROC_NULL` in `root`. Data is gathered from all processes in group B to the root. The send buffer arguments of the processes in group B must be consistent with the receive buffer argument of the root.

### 5.5.1 Examples using `MPI_GATHER`, `MPI_GATHERV`

The examples in this section use intracommunicators.

**Example 5.2** Gather 100 ints from every process in group to root. See Figure 5.4.

```
MPI_Comm comm;
int gsize, sendarray[100];
int root, *rbuf;
...
MPI_Comm_size(comm, &gsize);
rbuf = (int *)malloc(gsize*100*sizeof(int));
MPI_Gather(sendarray, 100, MPI_INT, rbuf, 100, MPI_INT, root, comm);
```

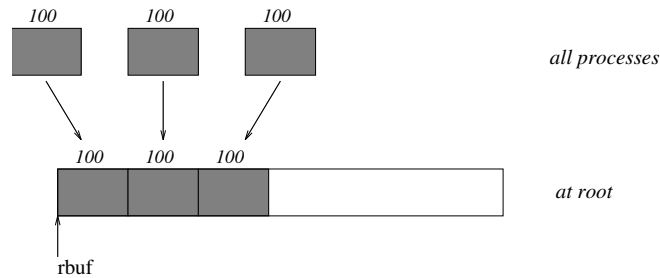

Figure 5.4: The root process gathers 100 ints from each process in the group.

**Example 5.3** Previous example modified — only the root allocates memory for the receive buffer.

```

MPI_Comm comm;
int gsize, sendarray[100];
int root, myrank, *rbuf;
...
MPI_Comm_rank(comm, &myrank);
if (myrank == root) {
    MPI_Comm_size(comm, &gsize);
    rbuf = (int *)malloc(gsize*100*sizeof(int));
}
MPI_Gather(sendarray, 100, MPI_INT, rbuf, 100, MPI_INT, root, comm);

```

**Example 5.4** Do the same as the previous example, but use a derived datatype. Note that the type cannot be the entire set of `gsize*100` ints since type matching is defined pairwise between the root and each process in the gather.

```

MPI_Comm comm;
int gsize, sendarray[100];
int root, *rbuf;
MPI_Datatype rtype;
...
MPI_Comm_size(comm, &gsize);
MPI_Type_contiguous(100, MPI_INT, &rtype);
MPI_Type_commit(&rtype);
rbuf = (int *)malloc(gsize*100*sizeof(int));
MPI_Gather(sendarray, 100, MPI_INT, rbuf, 1, rtype, root, comm);

```

**Example 5.5** Now have each process send 100 ints to root, but place each set (of 100) `stride` ints apart at receiving end. Use `MPI_GATHERV` and the `displs` argument to achieve this effect. Assume `stride`  $\geq$  100. See Figure 5.5.

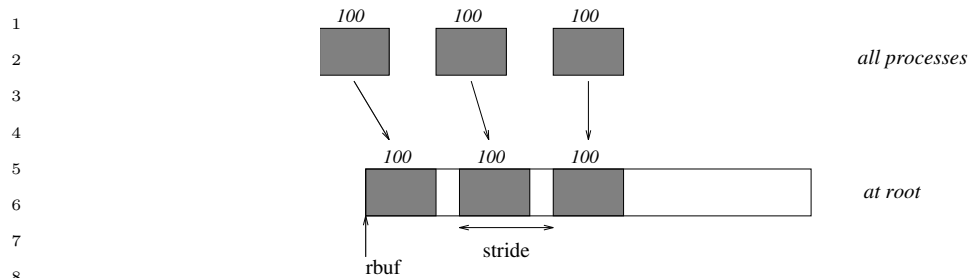

Figure 5.5: The root process gathers 100 ints from each process in the group, each set is placed *stride* ints apart.

```

13 MPI_Comm comm;
14 int gsize, sendarray[100];
15 int root, *rbuf, stride;
16 int *displs, i, *rcounts;
17
18 ...
19
20 MPI_Comm_size(comm, &gsize);
21 rbuf = (int *)malloc(gsize*stride*sizeof(int));
22 displs = (int *)malloc(gsize*sizeof(int));
23 rcounts = (int *)malloc(gsize*sizeof(int));
24 for (i=0; i<gsize; ++i) {
25     displs[i] = i*stride;
26     rcounts[i] = 100;
27 }
28 MPI_Gatherv(sendarray, 100, MPI_INT, rbuf, rcounts, displs, MPI_INT,
29             root, comm);

```

Note that the program is erroneous if *stride* < 100.

**Example 5.6** Same as Example 5.5 on the receiving side, but send the 100 ints from the 0th column of a 100×150 int array, in C. See Figure 5.6.

```

35 MPI_Comm comm;
36 int gsize, sendarray[100][150];
37 int root, *rbuf, stride;
38 MPI_Datatype stype;
39 int *displs, i, *rcounts;
40
41 ...
42
43 MPI_Comm_size(comm, &gsize);
44 rbuf = (int *)malloc(gsize*stride*sizeof(int));
45 displs = (int *)malloc(gsize*sizeof(int));
46 rcounts = (int *)malloc(gsize*sizeof(int));
47 for (i=0; i<gsize; ++i) {
48     displs[i] = i*stride;

```



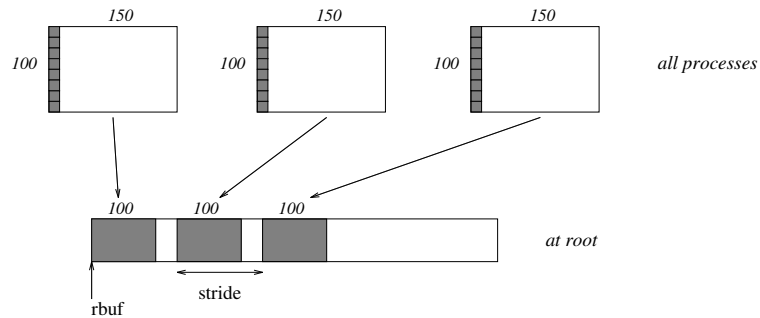

Figure 5.6: The root process gathers column 0 of a 100×150 C array, and each set is placed `stride` ints apart.

```

    rcounts[i] = 100;
}
/* Create datatype for 1 column of array
*/
MPI_Type_vector(100, 1, 150, MPI_INT, &stype);
MPI_Type_commit(&stype);
MPI_Gatherv(sendarray, 1, stype, rbuf, rcounts, displs, MPI_INT,
            root, comm);

```

**Example 5.7** Process  $i$  sends  $(100-i)$  ints from the  $i$ -th column of a  $100 \times 150$  int array, in C. It is received into a buffer with `stride`, as in the previous two examples. See Figure 5.7.

```

MPI_Comm comm;
int gsize, sendarray[100][150], *sptr;
int root, *rbuf, stride, myrank;
MPI_Datatype stype;
int *displs, i, *rcounts;
...
MPI_Comm_size(comm, &gsize);
MPI_Comm_rank(comm, &myrank);
rbuf = (int *)malloc(gsize*stride*sizeof(int));
displs = (int *)malloc(gsize*sizeof(int));
rcounts = (int *)malloc(gsize*sizeof(int));
for (i=0; i<gsize; ++i) {
    displs[i] = i*stride;
    rcounts[i] = 100-i;    /* note change from previous example */
}
/* Create datatype for the column we are sending
*/
MPI_Type_vector(100-myrank, 1, 150, MPI_INT, &stype);
MPI_Type_commit(&stype);
/* sptr is the address of start of "myrank" column

```

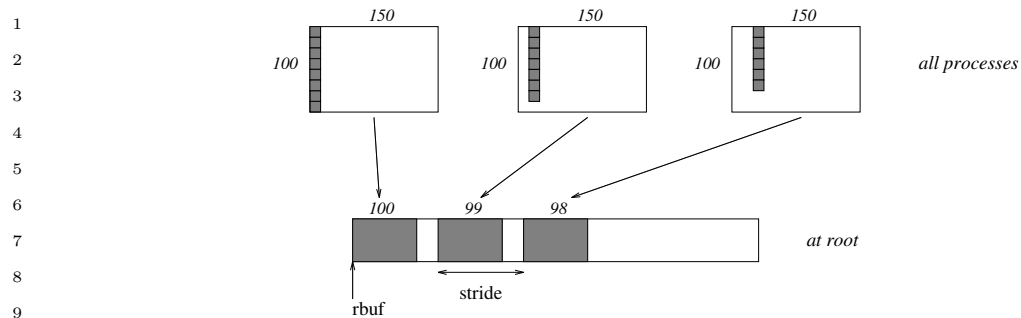

Figure 5.7: The root process gathers  $100-i$  ints from column  $i$  of a  $100 \times 150$  C-array, and each set is placed `stride` ints apart.

```

14     */
15     sptr = &sendarray[0][myrank];
16     MPI_Gatherv(sptr, 1, stype, rbuf, rcounts, displs, MPI_INT,
17               root, comm);

```

Note that a different amount of data is received from each process.

**Example 5.8** Same as Example 5.7, but done in a different way at the sending end. We create a datatype that causes the correct striding at the sending end so that we read a column of a C array. A similar thing was done in Example 4.16, Section 4.1.14.

```

24     MPI_Comm comm;
25     int gsize, sendarray[100][150], *sptr;
26     int root, *rbuf, stride, myrank;
27     MPI_Datatype stype;
28     int *displs, i, *rcounts;
29
30     ...
31
32     MPI_Comm_size(comm, &gsize);
33     MPI_Comm_rank(comm, &myrank);
34     rbuf = (int *)malloc(gsize*stride*sizeof(int));
35     displs = (int *)malloc(gsize*sizeof(int));
36     rcounts = (int *)malloc(gsize*sizeof(int));
37     for (i=0; i<gsize; ++i) {
38         displs[i] = i*stride;
39         rcounts[i] = 100-i;
40     }
41     /* Create datatype for one int, with extent of entire row
42     */
43     MPI_Type_create_resized(MPI_INT, 0, 150*sizeof(int), &stype);
44     MPI_Type_commit(&stype);
45     sptr = &sendarray[0][myrank];
46     MPI_Gatherv(sptr, 100-myrank, stype, rbuf, rcounts, displs, MPI_INT,
47               root, comm);
48

```

**Example 5.9** Same as Example 5.7 at sending side, but at receiving side we make the stride between received blocks vary from block to block. See Figure 5.8.

```

MPI_Comm comm;
int gsize, sendarray[100][150], *sptr;
int root, *rbuf, *stride, myrank, bufsize;
MPI_Datatype stype;
int *displs, i, *rcounts, offset;

...

MPI_Comm_size(comm, &gsize);
MPI_Comm_rank(comm, &myrank);

stride = (int *)malloc(gsize*sizeof(int));
...
/* stride[i] for i = 0 to gsize-1 is set somehow
*/

/* set up displs and rcounts vectors first
*/
displs = (int *)malloc(gsize*sizeof(int));
rcounts = (int *)malloc(gsize*sizeof(int));
offset = 0;
for (i=0; i<gsize; ++i) {
    displs[i] = offset;
    offset += stride[i];
    rcounts[i] = 100-i;
}
/* the required buffer size for rbuf is now easily obtained
*/
bufsize = displs[gsize-1]+rcounts[gsize-1];
rbuf = (int *)malloc(bufsize*sizeof(int));
/* Create datatype for the column we are sending
*/
MPI_Type_vector(100-myrank, 1, 150, MPI_INT, &stype);
MPI_Type_commit(&stype);
sptr = &sendarray[0][myrank];
MPI_Gatherv(sptr, 1, stype, rbuf, rcounts, displs, MPI_INT,
            root, comm);

```

**Example 5.10** Process  $i$  sends  $\text{num}$  ints from the  $i$ -th column of a  $100 \times 150$  int array, in C. The complicating factor is that the various values of  $\text{num}$  are not known to  $\text{root}$ , so a separate gather must first be run to find these out. The data is placed contiguously at the receiving end.

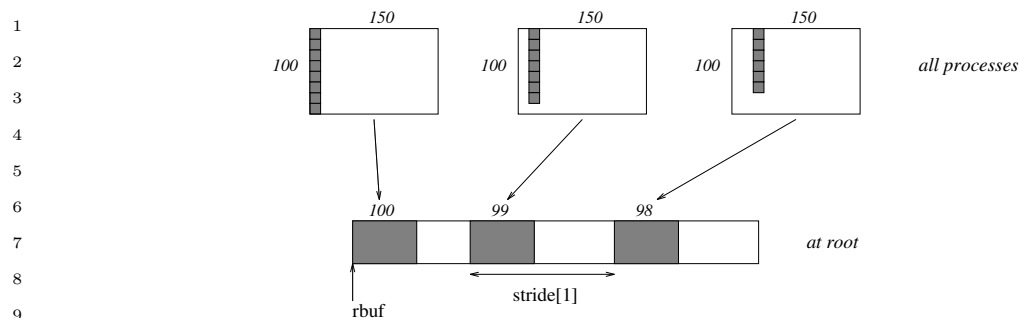

Figure 5.8: The root process gathers  $100-i$  ints from column  $i$  of a  $100 \times 150$  C-array, and each set is placed  $\text{stride}[i]$  ints apart (a varying stride).

```

14 MPI_Comm comm;
15 int gsize, sendarray[100][150], *sptr;
16 int root, *rbuf, myrank;
17 MPI_Datatype stype;
18 int *displs, i, *rcounts, num;
19
20 ...
21
22 MPI_Comm_size(comm, &gsize);
23 MPI_Comm_rank(comm, &myrank);
24
25 /* First, gather nums to root
26  */
27 rcounts = (int *)malloc(gsize*sizeof(int));
28 MPI_Gather(&num, 1, MPI_INT, rcounts, 1, MPI_INT, root, comm);
29 /* root now has correct rcounts, using these we set displs[] so
30  * that data is placed contiguously (or concatenated) at receive end
31  */
32 displs = (int *)malloc(gsize*sizeof(int));
33 displs[0] = 0;
34 for (i=1; i<gsize; ++i) {
35     displs[i] = displs[i-1]+rcounts[i-1];
36 }
37 /* And, create receive buffer
38  */
39 rbuf = (int *)malloc(gsize*(displs[gsize-1]+rcounts[gsize-1])
40                               *sizeof(int));
41 /* Create datatype for one int, with extent of entire row
42  */
43 MPI_Type_create_resized(MPI_INT, 0, 150*sizeof(int), &stype);
44 MPI_Type_commit(&stype);
45 sptr = &sendarray[0][myrank];
46 MPI_Gatherv(sptr, num, stype, rbuf, rcounts, displs, MPI_INT,
47             root, comm);
48

```

## 5.6 Scatter

`MPI_SCATTER(sendbuf, sendcount, sendtype, recvbuf, recvcount, recvtype, root, comm)`

IN	sendbuf	address of send buffer (choice, significant only at root)
IN	sendcount	number of elements sent to each process (non-negative integer, significant only at root)
IN	sendtype	data type of send buffer elements (handle, significant only at root)
OUT	recvbuf	address of receive buffer (choice)
IN	recvcount	number of elements in receive buffer (non-negative integer)
IN	recvtype	data type of receive buffer elements (handle)
IN	root	rank of sending process (integer)
IN	comm	communicator (handle)

**C binding**

```
int MPI_Scatter(const void *sendbuf, int sendcount, MPI_Datatype sendtype,
               void *recvbuf, int recvcount, MPI_Datatype recvtype, int root,
               MPI_Comm comm)
```

**Fortran 2008 binding**

```
MPI_Scatter(sendbuf, sendcount, sendtype, recvbuf, recvcount, recvtype,
            root, comm, ierror)
    TYPE(*), DIMENSION(..), INTENT(IN) :: sendbuf
    INTEGER, INTENT(IN) :: sendcount, recvcount, root
    TYPE(MPI_Datatype), INTENT(IN) :: sendtype, recvtype
    TYPE(*), DIMENSION(..) :: recvbuf
    TYPE(MPI_Comm), INTENT(IN) :: comm
    INTEGER, OPTIONAL, INTENT(OUT) :: ierror
```

**Fortran binding**

```
MPI_SCATTER(SENDBUF, SENDCOUNT, SENDTYPE, RECVBUF, RECVCOUNT, RECVTYPE,
            ROOT, COMM, IERROR)
    <type> SENDBUF(*), RECVBUF(*)
    INTEGER SENDCOUNT, SENDTYPE, RECVCOUNT, RECVTYPE, ROOT, COMM, IERROR
```

`MPI_SCATTER` is the inverse operation to `MPI_GATHER`.

If `comm` is an intracommunicator, the outcome is *as if* the root executed `n` send operations,

```
MPI_Send(sendbuf+i·sendcount·extent(sendtype), sendcount, sendtype, i,...),
```

and each process executed a receive,

```
MPI_Recv(recvbuf, recvcount, recvtype, i,...).
```

1 An alternative description is that the root sends a message with `MPI_Send(sendbuf,`  
2 `sendcount=n, sendtype, ...)`. This message is split into  $n$  equal segments, the  $i$ -th segment is  
3 sent to the  $i$ -th process in the group, and each process receives this message as above.

4 The send buffer is ignored for all non-root processes.

5 The type signature associated with `sendcount`, `sendtype` at the root must be equal to  
6 the type signature associated with `recvcount`, `recvtype` at all processes (however, the type  
7 maps may be different). This implies that the amount of data sent must be equal to the  
8 amount of data received, pairwise between each process and the root. Distinct type maps  
9 between sender and receiver are still allowed.

10 All arguments to the function are significant on process `root`, while on other processes,  
11 only arguments `recvbuf`, `recvcount`, `recvtype`, `root`, and `comm` are significant. The arguments  
12 `root` and `comm` must have identical values on all processes.

13 The specification of counts and types should not cause any location on the root to be  
14 read more than once.

15  
16 *Rationale.* Though not needed, the last restriction is imposed so as to achieve  
17 symmetry with `MPI_GATHER`, where the corresponding restriction (a multiple-write  
18 restriction) is necessary. (*End of rationale.*)

19  
20 The “in place” option for intracommunicators is specified by passing `MPI_IN_PLACE` as  
21 the value of `recvbuf` at the root. In such a case, `recvcount` and `recvtype` are ignored, and  
22 `root` “sends” no data to itself. The scattered vector is still assumed to contain  $n$  segments,  
23 where  $n$  is the group size; the `root`-th segment, which `root` should “send to itself,” is not  
24 moved.

25 If `comm` is an intercommunicator, then the call involves all processes in the intercom-  
26 municator, but with one group (group A) defining the root process. All processes in the  
27 other group (group B) pass the same value in argument `root`, which is the rank of the root  
28 in group A. The root passes the value `MPI_ROOT` in `root`. All other processes in group A  
29 pass the value `MPI_PROC_NULL` in `root`. Data is scattered from the root to all processes in  
30 group B. The receive buffer arguments of the processes in group B must be consistent with  
31 the send buffer argument of the root.

	MPI_SCATTERV(sendbuf, sendcounts, displs, sendtype, recvbuf, recvcount, recvtpe, root, comm)		1
			2
IN	sendbuf	address of send buffer (choice, significant only at root)	3
			4
IN	sendcounts	non-negative integer array (of length group size) specifying the number of elements to send to each rank	5
			6
IN	displs	integer array (of length group size). Entry i specifies the displacement (relative to sendbuf) from which to take the outgoing data to process i	7
			8
IN	sendtype	data type of send buffer elements (handle)	10
OUT	recvbuf	address of receive buffer (choice)	11
			12
IN	recvcount	number of elements in receive buffer (non-negative integer)	13
			14
IN	recvtpe	data type of receive buffer elements (handle)	15
			16
IN	root	rank of sending process (integer)	17
			18
IN	comm	communicator (handle)	19

**C binding**

```
int MPI_Scatterv(const void *sendbuf, const int sendcounts[],
                const int displs[], MPI_Datatype sendtype, void *recvbuf,
                int recvcount, MPI_Datatype recvtpe, int root, MPI_Comm comm)
```

**Fortran 2008 binding**

```
MPI_Scatterv(sendbuf, sendcounts, displs, sendtype, recvbuf, recvcount,
             recvtpe, root, comm, ierror)
TYPE(*), DIMENSION(..), INTENT(IN) :: sendbuf
INTEGER, INTENT(IN) :: sendcounts(*), displs(*), recvcount, root
TYPE(MPI_Datatype), INTENT(IN) :: sendtype, recvtpe
TYPE(*), DIMENSION(..) :: recvbuf
TYPE(MPI_Comm), INTENT(IN) :: comm
INTEGER, OPTIONAL, INTENT(OUT) :: ierror
```

**Fortran binding**

```
MPI_SCATTERV(SENDBUF, SENDCOUNTS, DISPLS, SENDTYPE, RECVBUF, RECVCOUNT,
             RECVTYPE, ROOT, COMM, IERROR)
<type> SENDBUF(*), RECVBUF(*)
INTEGER SENDCOUNTS(*), DISPLS(*), SENDTYPE, RECVCOUNT, RECVTYPE, ROOT,
COMM, IERROR
```

MPI\_SCATTERV is the inverse operation to MPI\_GATHERV.

MPI\_SCATTERV extends the functionality of MPI\_SCATTER by allowing a varying count of data to be sent to each process, since `sendcounts` is now an array. It also allows more flexibility as to where the data is taken from on the root, by providing an additional argument, `displs`.

If `comm` is an intracommunicator, the outcome is as if the root executed `n` send operations,

```
1 MPI_Send(sendbuf+displs[i]·extent(sendtype), sendcounts[i], sendtype, i,...),
```

2  
3 and each process executed a receive,

```
4  
5 MPI_Recv(recvbuf, recvcount, recvtype, i,...).
```

6  
7 The send buffer is ignored for all non-root processes.

8 The type signature implied by `sendcount[i]`, `sendtype` at the root must be equal to the  
9 type signature implied by `recvcount`, `recvtype` at process `i` (however, the type maps may be  
10 different). This implies that the amount of data sent must be equal to the amount of data  
11 received, pairwise between each process and the root. Distinct type maps between sender  
12 and receiver are still allowed.

13 All arguments to the function are significant on process `root`, while on other processes,  
14 only arguments `recvbuf`, `recvcount`, `recvtype`, `root`, and `comm` are significant. The arguments  
15 `root` and `comm` must have identical values on all processes.

16 The specification of counts, types, and displacements should not cause any location on  
17 the root to be read more than once.

18 The “in place” option for intracommunicators is specified by passing `MPI_IN_PLACE` as  
19 the value of `recvbuf` at the root. In such a case, `recvcount` and `recvtype` are ignored, and  
20 root “sends” no data to itself. The scattered vector is still assumed to contain  $n$  segments,  
21 where  $n$  is the group size; the  $root$ -th segment, which root should “send to itself,” is not  
22 moved.

23 If `comm` is an intercommunicator, then the call involves all processes in the intercom-  
24 municator, but with one group (group A) defining the root process. All processes in the  
25 other group (group B) pass the same value in argument `root`, which is the rank of the root  
26 in group A. The root passes the value `MPI_ROOT` in `root`. All other processes in group A  
27 pass the value `MPI_PROC_NULL` in `root`. Data is scattered from the root to all processes in  
28 group B. The receive buffer arguments of the processes in group B must be consistent with  
29 the send buffer argument of the root.

### 30 31 5.6.1 Examples using `MPI_SCATTER`, `MPI_SCATTERV`

32 The examples in this section use intracommunicators.

33  
34 **Example 5.11** The reverse of Example 5.2. Scatter sets of 100 `ints` from the root to each  
35 process in the group. See Figure 5.9.

```
36 MPI_Comm comm;  
37 int gsize,*sendbuf;  
38 int root, rbuf[100];  
39 ...  
40 MPI_Comm_size(comm, &gsize);  
41 sendbuf = (int *)malloc(gsize*100*sizeof(int));  
42 ...  
43 MPI_Scatter(sendbuf, 100, MPI_INT, rbuf, 100, MPI_INT, root, comm);  
44
```

45  
46 **Example 5.12** The reverse of Example 5.5. The root process scatters sets of 100 `ints` to  
47 the other processes, but the sets of 100 are *stride ints* apart in the sending buffer. Requires  
48 use of `MPI_SCATTERV`. Assume  $stride \geq 100$ . See Figure 5.10.



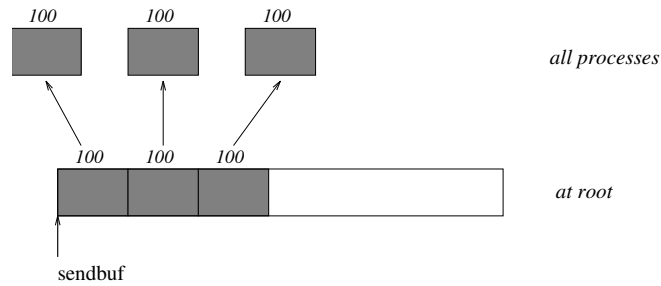

Figure 5.9: The root process scatters sets of 100 ints to each process in the group.

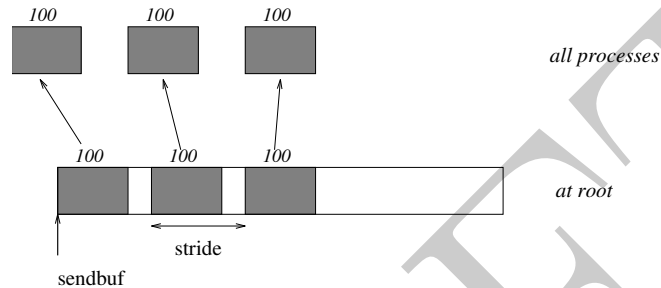

Figure 5.10: The root process scatters sets of 100 ints, moving by `stride` ints from `send` to `send` in the scatter.

```

MPI_Comm comm;
int gsize,*sendbuf;
int root, rbuf[100], i, *displs, *scounts;

...

MPI_Comm_size(comm, &gsize);
sendbuf = (int *)malloc(gsize*stride*sizeof(int));
...
displs = (int *)malloc(gsize*sizeof(int));
scounts = (int *)malloc(gsize*sizeof(int));
for (i=0; i<gsize; ++i) {
    displs[i] = i*stride;
    scounts[i] = 100;
}
MPI_Scatterv(sendbuf, scounts, displs, MPI_INT, rbuf, 100, MPI_INT,
            root, comm);

```

**Example 5.13** The reverse of Example 5.9. We have a varying stride between blocks at sending (root) side, at the receiving side we receive into the  $i$ -th column of a  $100 \times 150$  C array. See Figure 5.11.

```

MPI_Comm comm;
int gsize,recvarray[100][150],*rptr;
int root, *sendbuf, myrank, *stride;

```

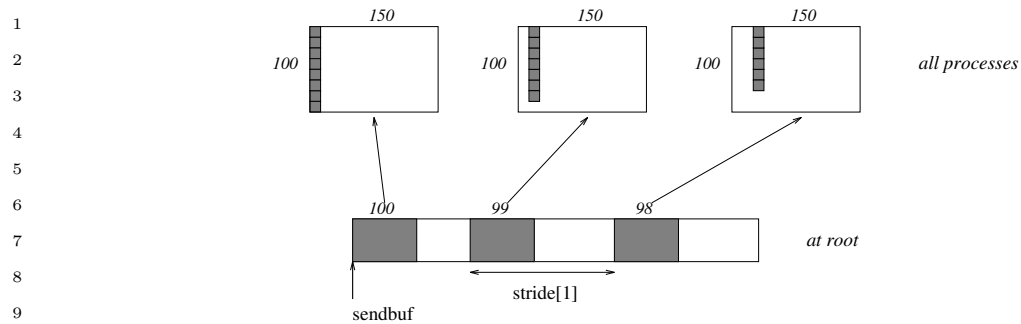

Figure 5.11: The root scatters blocks of  $100-i$  ints into column  $i$  of a  $100 \times 150$  C array. At the sending side, the blocks are  $\text{stride}[i]$  ints apart.

```

14 MPI_Datatype rtype;
15 int i, *displs, *counts, offset;
16 ...
17 MPI_Comm_size(comm, &gsize);
18 MPI_Comm_rank(comm, &myrank);
19
20 stride = (int *)malloc(gsize*sizeof(int));
21 ...
22 /* stride[i] for i = 0 to gsize-1 is set somehow
23  * sendbuf comes from elsewhere
24  */
25 ...
26 displs = (int *)malloc(gsize*sizeof(int));
27 counts = (int *)malloc(gsize*sizeof(int));
28 offset = 0;
29 for (i=0; i<gsize; ++i) {
30     displs[i] = offset;
31     offset += stride[i];
32     counts[i] = 100 - i;
33 }
34 /* Create datatype for the column we are receiving
35  */
36 MPI_Type_vector(100-myrank, 1, 150, MPI_INT, &rtype);
37 MPI_Type_commit(&rtype);
38 rptr = &recvarray[0][myrank];
39 MPI_Scatterv(sendbuf, counts, displs, MPI_INT, rptr, 1, rtype,
40             root, comm);

```

## 5.7 Gather-to-all

MPI_ALLGATHER(sendbuf, sendcount, sendtype, recvbuf, recvcount, recvtype, comm)			1
IN	sendbuf	starting address of send buffer (choice)	2
IN	sendcount	number of elements in send buffer (non-negative integer)	3
IN	sendtype	data type of send buffer elements (handle)	4
OUT	recvbuf	address of receive buffer (choice)	5
IN	recvcount	number of elements received from any process (non-negative integer)	6
IN	recvtype	data type of receive buffer elements (handle)	7
IN	comm	communicator (handle)	8

**C binding**

```
int MPI_Allgather(const void *sendbuf, int sendcount,
                 MPI_Datatype sendtype, void *recvbuf, int recvcount,
                 MPI_Datatype recvtype, MPI_Comm comm)
```

**Fortran 2008 binding**

```
MPI_Allgather(sendbuf, sendcount, sendtype, recvbuf, recvcount, recvtype,
              comm, ierror)
    TYPE(*), DIMENSION(..), INTENT(IN) :: sendbuf
    INTEGER, INTENT(IN) :: sendcount, recvcount
    TYPE(MPI_Datatype), INTENT(IN) :: sendtype, recvtype
    TYPE(*), DIMENSION(..) :: recvbuf
    TYPE(MPI_Comm), INTENT(IN) :: comm
    INTEGER, OPTIONAL, INTENT(OUT) :: ierror
```

**Fortran binding**

```
MPI_ALLGATHER(SENDBUF, SENDCOUNT, SENDTYPE, RECVBUF, REVCOUNT, RECVTYPE,
              COMM, IERROR)
    <type> SENDBUF(*), RECVBUF(*)
    INTEGER SENDCOUNT, SENDTYPE, REVCOUNT, RECVTYPE, COMM, IERROR
```

MPI\_ALLGATHER can be thought of as MPI\_GATHER, but where all processes receive the result, instead of just the root. The block of data sent from the j-th process is received by every process and placed in the j-th block of the buffer recvbuf.

The type signature associated with sendcount, sendtype, at a process must be equal to the type signature associated with recvcount, recvtype at any other process.

If comm is an intracommunicator, the outcome of a call to MPI\_ALLGATHER(...) is as if all processes executed n calls to

```
MPI_Gather(sendbuf, sendcount, sendtype, recvbuf, recvcount,
           recvtype, root, comm)
```

1 for `root = 0, ..., n-1`. The rules for correct usage of `MPI_ALLGATHER` are easily found  
 2 from the corresponding rules for `MPI_GATHER`.

3 The “in place” option for intracommunicators is specified by passing the value  
 4 `MPI_IN_PLACE` to the argument `sendbuf` at all processes. `sendcount` and `sendtype` are ignored.  
 5 Then the input data of each process is assumed to be in the area where that process would  
 6 receive its own contribution to the receive buffer.

7 If `comm` is an intercommunicator, then each process of one group (group A) contributes  
 8 `sendcount` data items; these data are concatenated and the result is stored at each process  
 9 in the other group (group B). Conversely the concatenation of the contributions of the  
 10 processes in group B is stored at each process in group A. The send buffer arguments in  
 11 group A must be consistent with the receive buffer arguments in group B, and vice versa.  
 12

13 *Advice to users.* The communication pattern of `MPI_ALLGATHER` executed on an  
 14 intercommunication domain need not be symmetric. The number of items sent by  
 15 processes in group A (as specified by the arguments `sendcount`, `sendtype` in group A  
 16 and the arguments `recvcount`, `recvtype` in group B), need not equal the number of  
 17 items sent by processes in group B (as specified by the arguments `sendcount`, `sendtype`  
 18 in group B and the arguments `recvcount`, `recvtype` in group A). In particular, one can  
 19 move data in only one direction by specifying `sendcount = 0` for the communication  
 20 in the reverse direction. (*End of advice to users.*)  
 21  
 22

23 `MPI_ALLGATHERV(sendbuf, sendcount, sendtype, recvbuf, recvcounts, displs, recvtype, comm)`  
 24

25			
26	IN	<code>sendbuf</code>	starting address of send buffer (choice)
27	IN	<code>sendcount</code>	number of elements in send buffer (non-negative integer)
28			
29	IN	<code>sendtype</code>	data type of send buffer elements (handle)
30			
31	OUT	<code>recvbuf</code>	address of receive buffer (choice)
32	IN	<code>recvcounts</code>	non-negative integer array (of length group size) containing the number of elements that are received from each process
33			
34			
35	IN	<code>displs</code>	integer array (of length group size). Entry <i>i</i> specifies the displacement (relative to <code>recvbuf</code> ) at which to place the incoming data from process <i>i</i>
36			
37			
38			
39	IN	<code>recvtype</code>	data type of receive buffer elements (handle)
40	IN	<code>comm</code>	communicator (handle)
41			

#### 42 C binding

```
43 int MPI_Allgatherv(const void *sendbuf, int sendcount,
44                 MPI_Datatype sendtype, void *recvbuf, const int recvcounts[],
45                 const int displs[], MPI_Datatype recvtype, MPI_Comm comm)
```

#### 47 Fortran 2008 binding

48

```

MPI_Allgatherv(sendbuf, sendcount, sendtype, recvbuf, recvcounts, displs,
               recvtype, comm, ierror)
    TYPE(*), DIMENSION(..), INTENT(IN) :: sendbuf
    INTEGER, INTENT(IN) :: sendcount, recvcounts(*), displs(*)
    TYPE(MPI_Datatype), INTENT(IN) :: sendtype, recvtype
    TYPE(*), DIMENSION(..) :: recvbuf
    TYPE(MPI_Comm), INTENT(IN) :: comm
    INTEGER, OPTIONAL, INTENT(OUT) :: ierror

```

### Fortran binding

```

MPI_ALLGATHERV(SENDBUF, SENDCOUNT, SENDTYPE, RECVBUF, RECVCOUNTS, DISPLS,
               RECVTYPE, COMM, IERROR)
    <type> SENDBUF(*), RECVBUF(*)
    INTEGER SENDCOUNT, SENDTYPE, RECVCOUNTS(*), DISPLS(*), RECVTYPE, COMM,
    IERROR

```

MPI\_ALLGATHERV can be thought of as MPI\_GATHERV, but where all processes receive the result, instead of just the root. The block of data sent from the  $j$ -th process is received by every process and placed in the  $j$ -th block of the buffer `recvbuf`. These blocks need not all be the same size.

The type signature associated with `sendcount`, `sendtype`, at process  $j$  must be equal to the type signature associated with `recvcounts[j]`, `recvtype` at any other process.

If `comm` is an intracommunicator, the outcome is as if all processes executed calls to

```

MPI_Gatherv(sendbuf, sendcount, sendtype, recvbuf, recvcounts, displs,
            recvtype, root, comm),

```

for `root = 0, ..., n-1`. The rules for correct usage of MPI\_ALLGATHERV are easily found from the corresponding rules for MPI\_GATHERV.

The “in place” option for intracommunicators is specified by passing the value `MPI_IN_PLACE` to the argument `sendbuf` at all processes. In such a case, `sendcount` and `sendtype` are ignored, and the input data of each process is assumed to be in the area where that process would receive its own contribution to the receive buffer.

If `comm` is an intercommunicator, then each process of one group (group A) contributes `sendcount` data items; these data are concatenated and the result is stored at each process in the other group (group B). Conversely the concatenation of the contributions of the processes in group B is stored at each process in group A. The send buffer arguments in group A must be consistent with the receive buffer arguments in group B, and vice versa.

#### 5.7.1 Example using MPI\_ALLGATHER

The example in this section uses intracommunicators.

**Example 5.14** The all-gather version of Example 5.2. Using MPI\_ALLGATHER, we will gather 100 ints from every process in the group to every process.

```

1     MPI_Comm comm;
2     int gsize, sendarray[100];
3     int *rbuf;
4     ...
5     MPI_Comm_size(comm, &gsize);
6     rbuf = (int *)malloc(gsize*100*sizeof(int));
7     MPI_Allgather(sendarray, 100, MPI_INT, rbuf, 100, MPI_INT, comm);
8

```

After the call, every process has the group-wide concatenation of the sets of data.

## 5.8 All-to-All Scatter/Gather

```

15 MPI_ALLTOALL(sendbuf, sendcount, sendtype, recvbuf, recvcoun, recvtype, comm)
16
17     IN      sendbuf      starting address of send buffer (choice)
18     IN      sendcount   number of elements sent to each process (non-negative
19                          integer)
20     IN      sendtype    data type of send buffer elements (handle)
21     OUT     recvbuf     address of receive buffer (choice)
22     IN      recvcoun    number of elements received from any process (non-
23                          negative integer)
24     IN      recvtype    data type of receive buffer elements (handle)
25     IN      comm        communicator (handle)
26
27

```

### C binding

```

29 int MPI_Alltoall(const void *sendbuf, int sendcount, MPI_Datatype sendtype,
30                void *recvbuf, int recvcoun, MPI_Datatype recvtype,
31                MPI_Comm comm)
32

```

### Fortran 2008 binding

```

34 MPI_Alltoall(sendbuf, sendcount, sendtype, recvbuf, recvcoun, recvtype,
35             comm, ierror)
36     TYPE(*), DIMENSION(..), INTENT(IN) :: sendbuf
37     INTEGER, INTENT(IN) :: sendcount, recvcoun
38     TYPE(MPI_Datatype), INTENT(IN) :: sendtype, recvtype
39     TYPE(*), DIMENSION(..) :: recvbuf
40     TYPE(MPI_Comm), INTENT(IN) :: comm
41     INTEGER, OPTIONAL, INTENT(OUT) :: ierror
42

```

### Fortran binding

```

44 MPI_ALLTOALL(SENDBUF, SENDCOUNT, SENDTYPE, RECVBUF, RECVCOUNT, RECVTYPE,
45             COMM, IERROR)
46     <type> SENDBUF(*), RECVBUF(*)
47     INTEGER SENDCOUNT, SENDTYPE, RECVCOUNT, RECVTYPE, COMM, IERROR
48

```

MPI\_ALLTOALL is an extension of MPI\_ALLGATHER to the case where each process sends distinct data to each of the receivers. The  $j$ -th block sent from process  $i$  is received by process  $j$  and is placed in the  $i$ -th block of `recvbuf`.

The type signature associated with `sendcount`, `sendtype`, at a process must be equal to the type signature associated with `recvcount`, `recvtype` at any other process. This implies that the amount of data sent must be equal to the amount of data received, pairwise between every pair of processes. As usual, however, the type maps may be different.

If `comm` is an intracommunicator, the outcome is as if each process executed a send to each process (itself included) with a call to,

```
MPI_Send(sendbuf+i·sendcount·extent(sendtype),sendcount,sendtype,i, ...),
```

and a receive from every other process with a call to,

```
MPI_Recv(recvbuf+i·recvcount·extent(recvtype),recvcount,recvtype,i,...).
```

All arguments on all processes are significant. The argument `comm` must have identical values on all processes.

The “in place” option for intracommunicators is specified by passing `MPI_IN_PLACE` to the argument `sendbuf` at *all* processes. In such a case, `sendcount` and `sendtype` are ignored. The data to be sent is taken from the `recvbuf` and replaced by the received data. Data sent and received must have the same type map as specified by `recvcount` and `recvtype`.

*Rationale.* For large MPI\_ALLTOALL instances, allocating both send and receive buffers may consume too much memory. The “in place” option effectively halves the application memory consumption and is useful in situations where the data to be sent will not be used by the sending process after the MPI\_ALLTOALL exchange (e.g., in parallel Fast Fourier Transforms). (*End of rationale.*)

*Advice to implementors.* Users may opt to use the “in place” option in order to conserve memory. Quality MPI implementations should thus strive to minimize system buffering. (*End of advice to implementors.*)

If `comm` is an intercommunicator, then the outcome is as if each process in group A sends a message to each process in group B, and vice versa. The  $j$ -th send buffer of process  $i$  in group A should be consistent with the  $i$ -th receive buffer of process  $j$  in group B, and vice versa.

*Advice to users.* When a complete exchange is executed on an intercommunication domain, then the number of data items sent from processes in group A to processes in group B need not equal the number of items sent in the reverse direction. In particular, one can have unidirectional communication by specifying `sendcount = 0` in the reverse direction. (*End of advice to users.*)

```

1 MPI_ALLTOALLV(sendbuf, sendcounts, sdispls, sendtype, recvbuf, recvcounts, rdispls, recvtype,
2             comm)
3
4     IN      sendbuf      starting address of send buffer (choice)
5
6     IN      sendcounts   non-negative integer array (of length group size) spec-
7                             ifying the number of elements to send to each rank
8
9     IN      sdispls      integer array (of length group size). Entry j specifies
10                             the displacement (relative to sendbuf) from which to
11                             take the outgoing data destined for process j
12
13     IN      sendtype     data type of send buffer elements (handle)
14
15     OUT     recvbuf      address of receive buffer (choice)
16
17     IN      recvcounts   non-negative integer array (of length group size) spec-
18                             ifying the number of elements that can be received
19                             from each rank
20
21     IN      rdispls      integer array (of length group size). Entry i specifies
22                             the displacement (relative to recvbuf) at which to place
23                             the incoming data from process i
24
25     IN      recvtype     data type of receive buffer elements (handle)
26
27     IN      comm         communicator (handle)

```

**C binding**

```

24 int MPI_Alltoallv(const void *sendbuf, const int sendcounts[],
25                 const int sdispls[], MPI_Datatype sendtype, void *recvbuf,
26                 const int recvcounts[], const int rdispls[],
27                 MPI_Datatype recvtype, MPI_Comm comm)

```

**Fortran 2008 binding**

```

29 MPI_Alltoallv(sendbuf, sendcounts, sdispls, sendtype, recvbuf, recvcounts,
30             rdispls, recvtype, comm, ierror)
31
32     TYPE(*), DIMENSION(..), INTENT(IN) :: sendbuf
33     INTEGER, INTENT(IN) :: sendcounts(*), sdispls(*), recvcounts(*),
34     rdispls(*)
35     TYPE(MPI_Datatype), INTENT(IN) :: sendtype, recvtype
36     TYPE(*), DIMENSION(..) :: recvbuf
37     TYPE(MPI_Comm), INTENT(IN) :: comm
38     INTEGER, OPTIONAL, INTENT(OUT) :: ierror

```

**Fortran binding**

```

39 MPI_ALLTOALLV(SENDBUF, SENDCOUNTS, SDISPLS, SENDTYPE, RECVBUF, RECVCOUNTS,
40             RDISPLS, RECVTYPE, COMM, IERROR)
41
42     <type> SENDBUF(*), RECVBUF(*)
43     INTEGER SENDCOUNTS(*), SDISPLS(*), SENDTYPE, RECVCOUNTS(*),
44     RDISPLS(*), RECVTYPE, COMM, IERROR

```

MPI\_ALLTOALLV adds flexibility to MPI\_ALLTOALL in that the location of data for the send is specified by sdispls and the location of the placement of the data on the receive side is specified by rdispls.



If `comm` is an intracommunicator, then the  $j$ -th block sent from process  $i$  is received by process  $j$  and is placed in the  $i$ -th block of `recvbuf`. These blocks need not all have the same size.

The type signature associated with `sendcounts[j]`, `sendtype` at process  $i$  must be equal to the type signature associated with `recvcounts[i]`, `recvtype` at process  $j$ . This implies that the amount of data sent must be equal to the amount of data received, pairwise between every pair of processes. Distinct type maps between sender and receiver are still allowed.

The outcome is as if each process sent a message to every other process with,

```
MPI_Send(sendbuf+sdispls[i]·extent(sendtype),sendcounts[i],sendtype,i,...),
```

and received a message from every other process with a call to

```
MPI_Recv(recvbuf+rdispls[i]·extent(recvtype),recvcounts[i],recvtype,i,...).
```

All arguments on all processes are significant. The argument `comm` must have identical values on all processes.

The “in place” option for intracommunicators is specified by passing `MPI_IN_PLACE` to the argument `sendbuf` at *all* processes. In such a case, `sendcounts`, `sdispls` and `sendtype` are ignored. The data to be sent is taken from the `recvbuf` and replaced by the received data. Data sent and received must have the same type map as specified by the `recvcounts` array and the `recvtype`, and is taken from the locations of the receive buffer specified by `rdispls`.

*Advice to users.* Specifying the “in place” option (which must be given on all processes) implies that the same amount and type of data is sent and received between any two processes in the group of the communicator. Different pairs of processes can exchange different amounts of data. Users must ensure that `recvcounts[j]` and `recvtype` on process  $i$  match `recvcounts[i]` and `recvtype` on process  $j$ . This symmetric exchange can be useful in applications where the data to be sent will not be used by the sending process after the `MPI_ALLTOALLV` exchange. (*End of advice to users.*)

If `comm` is an intercommunicator, then the outcome is as if each process in group A sends a message to each process in group B, and vice versa. The  $j$ -th send buffer of process  $i$  in group A should be consistent with the  $i$ -th receive buffer of process  $j$  in group B, and vice versa.

*Rationale.* The definitions of `MPI_ALLTOALL` and `MPI_ALLTOALLV` give as much flexibility as one would achieve by specifying  $n$  independent, point-to-point communications, with two exceptions: all messages use the same datatype, and messages are scattered from (or gathered to) sequential storage. (*End of rationale.*)

*Advice to implementors.* Although the discussion of collective communication in terms of point-to-point operation implies that each message is transferred directly from sender to receiver, implementations may use a tree communication pattern. Messages can be forwarded by intermediate nodes where they are split (for scatter) or concatenated (for gather), if this is more efficient. (*End of advice to implementors.*)

1	MPI_ALLTOALLW(sendbuf, sendcounts, sdispls, sendtypes, recvbuf, recvcoun- 2 3		
4	IN	sendbuf	starting address of send buffer (choice)
5	IN	sendcounts	non-negative integer array (of length group size) spec- 6 7
8	IN	sdispls	integer array (of length group size). Entry j specifies 9 10
11	IN	sendtypes	array of datatypes (of length group size). Entry j spec- 12 13
14	OUT	recvbuf	address of receive buffer (choice)
15	IN	recvcoun- 16	non-negative integer array (of length group size) spec- 17 18
19	IN	rdispls	integer array (of length group size). Entry i specifies 20 21
22	IN	recvtypes	array of datatypes (of length group size). Entry i spec- 23 24
25	IN	comm	communicator (handle)

**C binding**

```

30 int MPI_Alltoallw(const void *sendbuf, const int sendcounts[],
31                 const int sdispls[], const MPI_Datatype sendtypes[],
32                 void *recvbuf, const int recvcoun-[], const int rdispls[],
33                 const MPI_Datatype recvtypes[], MPI_Comm comm)
34 
```

**Fortran 2008 binding**

```

35 MPI_Alltoallw(sendbuf, sendcounts, sdispls, sendtypes, recvbuf, recvcoun-  
36                 rdispls, recvtypes, comm, ierror)
37     TYPE(*), DIMENSION(..), INTENT(IN) :: sendbuf
38     INTEGER, INTENT(IN) :: sendcounts(*), sdispls(*), recvcoun-(*),
39     rdispls(*)
40     TYPE(MPI_Datatype), INTENT(IN) :: sendtypes(*), recvtypes(*)
41     TYPE(*), DIMENSION(..) :: recvbuf
42     TYPE(MPI_Comm), INTENT(IN) :: comm
43     INTEGER, OPTIONAL, INTENT(OUT) :: ierror
44 
```

**Fortran binding**

```

45 MPI_ALLTOALLW(SENDBUF, SENDCOUNTS, SDISPLS, SENDTYPES, RECVBUF, RECVCOUNTS,  
46                 RDISPLS, RECVTYPES, COMM, IERROR)
47 
```

```

<type> SENDBUF(*), RECVBUF(*)
INTEGER SENDCOUNTS(*), SDISPLS(*), SENDTYPES(*), RECVCOUNTS(*),
RDISPLS(*), RECVTYPES(*), COMM, IERROR

```

MPI\_ALLTOALLW is the most general form of complete exchange. Like MPI\_TYPE\_CREATE\_STRUCT, the most general type constructor, MPI\_ALLTOALLW allows separate specification of count, displacement and datatype. In addition, to allow maximum flexibility, the displacement of blocks within the send and receive buffers is specified in bytes.

If `comm` is an intracommunicator, then the  $j$ -th block sent from process  $i$  is received by process  $j$  and is placed in the  $i$ -th block of `recvbuf`. These blocks need not all have the same size.

The type signature associated with `sendcounts[j]`, `sendtypes[j]` at process  $i$  must be equal to the type signature associated with `recvcounts[i]`, `recvtypes[i]` at process  $j$ . This implies that the amount of data sent must be equal to the amount of data received, pairwise between every pair of processes. Distinct type maps between sender and receiver are still allowed.

The outcome is as if each process sent a message to every other process with

```
MPI_Send(sendbuf+sdispls[i],sendcounts[i],sendtypes[i],i,...),
```

and received a message from every other process with a call to

```
MPI_Recv(recvbuf+rdispls[i],recvcounts[i],recvtypes[i],i,...).
```

All arguments on all processes are significant. The argument `comm` must describe the same communicator on all processes.

Like for MPI\_ALLTOALLV, the “in place” option for intracommunicators is specified by passing MPI\_IN\_PLACE to the argument `sendbuf` at *all* processes. In such a case, `sendcounts`, `sdispls` and `sendtypes` are ignored. The data to be sent is taken from the `recvbuf` and replaced by the received data. Data sent and received must have the same type map as specified by the `recvcounts` and `recvtypes` arrays, and is taken from the locations of the receive buffer specified by `rdispls`.

If `comm` is an intercommunicator, then the outcome is as if each process in group A sends a message to each process in group B, and vice versa. The  $j$ -th send buffer of process  $i$  in group A should be consistent with the  $i$ -th receive buffer of process  $j$  in group B, and vice versa.

*Rationale.* The MPI\_ALLTOALLW function generalizes several MPI functions by carefully selecting the input arguments. For example, by making all but one process have `sendcounts[i] = 0`, this achieves an MPI\_SCATTERW function. (*End of rationale.*)

## 5.9 Global Reduction Operations

The functions in this section perform a global reduce operation (for example sum, maximum, and logical and) across all members of a group. The reduction operation can be either one of a predefined list of operations, or a user-defined operation. The global reduction functions come in several flavors: a reduce that returns the result of the reduction to one member of a group, an all-reduce that returns this result to all members of a group, and two scan (parallel

1 prefix) operations. In addition, a reduce-scatter operation combines the functionality of a  
 2 reduce and of a scatter operation.

### 4 5.9.1 Reduce

7 **MPI\_REDUCE**(sendbuf, recvbuf, count, datatype, op, root, comm)

9	IN	sendbuf	address of send buffer (choice)
10	OUT	recvbuf	address of receive buffer (choice, significant only at 11 root)
12	IN	count	number of elements in send buffer (non-negative inte- 13 ger)
14	IN	datatype	data type of elements of send buffer (handle)
15	IN	op	reduce operation (handle)
16	IN	root	rank of root process (integer)
17	IN	comm	communicator (handle)

#### 21 C binding

22 `int MPI_Reduce(const void *sendbuf, void *recvbuf, int count,`  
 23 `MPI_Datatype datatype, MPI_Op op, int root, MPI_Comm comm)`

#### 24 Fortran 2008 binding

25 `MPI_Reduce(sendbuf, recvbuf, count, datatype, op, root, comm, ierror)`  
 26 `TYPE(*), DIMENSION(..), INTENT(IN) :: sendbuf`  
 27 `TYPE(*), DIMENSION(..) :: recvbuf`  
 28 `INTEGER, INTENT(IN) :: count, root`  
 29 `TYPE(MPI_Datatype), INTENT(IN) :: datatype`  
 30 `TYPE(MPI_Op), INTENT(IN) :: op`  
 31 `TYPE(MPI_Comm), INTENT(IN) :: comm`  
 32 `INTEGER, OPTIONAL, INTENT(OUT) :: ierror`

#### 34 Fortran binding

35 `MPI_REDUCE(SENDBUF, RECVBUF, COUNT, DATATYPE, OP, ROOT, COMM, IERROR)`  
 36 `<type> SENDBUF(*), RECVBUF(*)`  
 37 `INTEGER COUNT, DATATYPE, OP, ROOT, COMM, IERROR`

38  
 39 If `comm` is an intracommunicator, `MPI_REDUCE` combines the elements provided in the  
 40 input buffer of each process in the group, using the operation `op`, and returns the combined  
 41 value in the output buffer of the process with rank `root`. The input buffer is defined by  
 42 the arguments `sendbuf`, `count` and `datatype`; the output buffer is defined by the arguments  
 43 `recvbuf`, `count` and `datatype`; both have the same number of elements, with the same type.  
 44 The routine is called by all group members using the same arguments for `count`, `datatype`, `op`,  
 45 `root` and `comm`. Thus, all processes provide input buffers of the same length, with elements  
 46 of the same type as the output buffer at the root. Each process can provide one element, or a  
 47 sequence of elements, in which case the combine operation is executed element-wise on each  
 48 entry of the sequence. For example, if the operation is `MPI_MAX` and the send buffer contains

two elements that are floating point numbers (`count = 2` and `datatype = MPI_FLOAT`), then `recvbuf(1) = global max(sendbuf(1))` and `recvbuf(2) = global max(sendbuf(2))`.

Section 5.9.2, lists the set of predefined operations provided by MPI. That section also enumerates the datatypes to which each operation can be applied.

In addition, users may define their own operations that can be overloaded to operate on several datatypes, either basic or derived. This is further explained in Section 5.9.5.

The operation `op` is always assumed to be associative. All predefined operations are also assumed to be commutative. Users may define operations that are assumed to be associative, but not commutative. The “canonical” evaluation order of a reduction is determined by the ranks of the processes in the group. However, the implementation can take advantage of associativity, or associativity and commutativity in order to change the order of evaluation. This may change the result of the reduction for operations that are not strictly associative and commutative, such as floating point addition.

*Advice to implementors.* It is strongly recommended that `MPI_REDUCE` be implemented so that the same result be obtained whenever the function is applied on the same arguments, appearing in the same order. Note that this may prevent optimizations that take advantage of the physical location of ranks. (*End of advice to implementors.*)

*Advice to users.* Some applications may not be able to ignore the non-associative nature of floating-point operations or may use user-defined operations (see Section 5.9.5) that require a special reduction order and cannot be treated as associative. Such applications should enforce the order of evaluation explicitly. For example, in the case of operations that require a strict left-to-right (or right-to-left) evaluation order, this could be done by gathering all operands at a single process (e.g., with `MPI_GATHER`), applying the reduction operation in the desired order (e.g., with `MPI_REDUCE_LOCAL`), and if needed, broadcast or scatter the result to the other processes (e.g., with `MPI_BCAST`). (*End of advice to users.*)

The `datatype` argument of `MPI_REDUCE` must be compatible with `op`. Predefined operators work only with the MPI types listed in Section 5.9.2 and Section 5.9.4. Furthermore, the `datatype` and `op` given for predefined operators must be the same on all processes.

Note that it is possible for users to supply different user-defined operations to `MPI_REDUCE` in each process. MPI does not define which operations are used on which operands in this case. User-defined operators may operate on general, derived datatypes. In this case, each argument that the reduce operation is applied to is one element described by such a datatype, which may contain several basic values. This is further explained in Section 5.9.5.

*Advice to users.* Users should make no assumptions about how `MPI_REDUCE` is implemented. It is safest to ensure that the same function is passed to `MPI_REDUCE` by each process. (*End of advice to users.*)

Overlapping datatypes are permitted in “send” buffers. Overlapping datatypes in “receive” buffers are erroneous and may give unpredictable results.

The “in place” option for intracommunicators is specified by passing the value `MPI_IN_PLACE` to the argument `sendbuf` at the root. In such a case, the input data is taken at the root from the receive buffer, where it will be replaced by the output data.

If `comm` is an intercommunicator, then the call involves all processes in the intercommunicator, but with one group (group A) defining the root process. All processes in the other group (group B) pass the same value in argument `root`, which is the rank of the root in group A. The root passes the value `MPI_ROOT` in `root`. All other processes in group A pass the value `MPI_PROC_NULL` in `root`. Only send buffer arguments are significant in group B and only receive buffer arguments are significant at the root.

## 5.9.2 Predefined Reduction Operations

The following predefined operations are supplied for `MPI_REDUCE` and related functions `MPI_ALLREDUCE`, `MPI_REDUCE_SCATTER_BLOCK`, `MPI_REDUCE_SCATTER`, `MPI_SCAN`, `MPI_EXSCAN`, all nonblocking variants of those (see Section 5.12), and `MPI_REDUCE_LOCAL`. These operations are invoked by placing the following in `op`.

Name	Meaning
<code>MPI_MAX</code>	maximum
<code>MPI_MIN</code>	minimum
<code>MPI_SUM</code>	sum
<code>MPI_PROD</code>	product
<code>MPI_LAND</code>	logical and
<code>MPI_BAND</code>	bit-wise and
<code>MPI_LOR</code>	logical or
<code>MPI BOR</code>	bit-wise or
<code>MPI_LXOR</code>	logical exclusive or (xor)
<code>MPI_BXOR</code>	bit-wise exclusive or (xor)
<code>MPI_MAXLOC</code>	max value and location
<code>MPI_MINLOC</code>	min value and location

The two operations `MPI_MINLOC` and `MPI_MAXLOC` are discussed separately in Section 5.9.4. For the other predefined operations, we enumerate below the allowed combinations of `op` and `datatype` arguments. First, define groups of MPI basic datatypes in the following way.

C integer:	<code>MPI_INT</code> , <code>MPI_LONG</code> , <code>MPI_SHORT</code> , <code>MPI_UNSIGNED_SHORT</code> , <code>MPI_UNSIGNED</code> , <code>MPI_UNSIGNED_LONG</code> , <code>MPI_LONG_LONG_INT</code> , <code>MPI_LONG_LONG</code> (as synonym), <code>MPI_UNSIGNED_LONG_LONG</code> , <code>MPI_SIGNED_CHAR</code> , <code>MPI_UNSIGNED_CHAR</code> , <code>MPI_INT8_T</code> , <code>MPI_INT16_T</code> , <code>MPI_INT32_T</code> , <code>MPI_INT64_T</code> , <code>MPI_UINT8_T</code> , <code>MPI_UINT16_T</code> , <code>MPI_UINT32_T</code> , and <code>MPI_UINT64_T</code>
Fortran integer:	<code>MPI_INTEGER</code> and handles returned from

	MPI_TYPE_CREATE_F90_INTEGER	1
	and, if available, MPI_INTEGER1,	2
	MPI_INTEGER2, MPI_INTEGER4,	3
	MPI_INTEGER8, and MPI_INTEGER16	4
Floating point:	MPI_FLOAT, MPI_DOUBLE, MPI_REAL,	5
	MPI_DOUBLE_PRECISION,	6
	MPI_LONG_DOUBLE,	7
	and handles returned from	8
	MPI_TYPE_CREATE_F90_REAL	9
	and, if available, MPI_REAL2,	10
	MPI_REAL4, MPI_REAL8, and MPI_REAL16	11
Logical:	MPI_LOGICAL, MPI_C_BOOL,	12
	and MPI_CXX_BOOL	13
Complex:	MPI_COMPLEX, MPI_C_COMPLEX,	14
	MPI_C_FLOAT_COMPLEX (as synonym),	15
	MPI_C_DOUBLE_COMPLEX,	16
	MPI_C_LONG_DOUBLE_COMPLEX,	17
	MPI_CXX_FLOAT_COMPLEX,	18
	MPI_CXX_DOUBLE_COMPLEX,	19
	MPI_CXX_LONG_DOUBLE_COMPLEX,	20
	and handles returned from	21
	MPI_TYPE_CREATE_F90_COMPLEX	22
	and, if available, MPI_DOUBLE_COMPLEX,	23
	MPI_COMPLEX4, MPI_COMPLEX8,	24
	MPI_COMPLEX16, and MPI_COMPLEX32	25
Byte:	MPI_BYTE	26
Multi-language types:	MPI_AINT, MPI_OFFSET, and MPI_COUNT	27

Now, the valid datatypes for each operation are specified below.

Op	Allowed Types	
MPI_MAX, MPI_MIN	C integer, Fortran integer, Floating point, Multi-language types	32
MPI_SUM, MPI_PROD	C integer, Fortran integer, Floating point, Complex, Multi-language types	34
MPI_LAND, MPI_LOR, MPI_LXOR	C integer, Logical	36
MPI_BAND, MPI_BOR, MPI_BXOR	C integer, Fortran integer, Byte, Multi-language types	37

These operations together with all listed datatypes are valid in all supported programming languages, see also Reduce Operations on page 757 in Section 18.2.6.

The following examples use intracommunicators.

**Example 5.15** A routine that computes the dot product of two vectors that are distributed across a group of processes and returns the answer at node zero.

```

1  SUBROUTINE PAR_BLAS1(m, a, b, c, comm)
2  REAL a(m), b(m)      ! local slice of array
3  REAL c               ! result (at node zero)
4  REAL sum
5  INTEGER m, comm, i, ierr
6
7  ! local sum
8  sum = 0.0
9  DO i = 1, m
10     sum = sum + a(i)*b(i)
11 END DO
12
13 ! global sum
14 CALL MPI_REDUCE(sum, c, 1, MPI_REAL, MPI_SUM, 0, comm, ierr)
15 RETURN
16 END

```

19 **Example 5.16** A routine that computes the product of a vector and an array that are  
20 distributed across a group of processes and returns the answer at node zero.

```

21 SUBROUTINE PAR_BLAS2(m, n, a, b, c, comm)
22 REAL a(m), b(m,n)    ! local slice of array
23 REAL c(n)            ! result
24 REAL sum(n)
25 INTEGER n, comm, i, j, ierr
26
27 ! local sum
28 DO j=1,n
29     sum(j) = 0.0
30     DO i=1,m
31         sum(j) = sum(j) + a(i)*b(i,j)
32     END DO
33 END DO
34
35 ! global sum
36 CALL MPI_REDUCE(sum, c, n, MPI_REAL, MPI_SUM, 0, comm, ierr)
37
38 ! return result at node zero (and garbage at the other nodes)
39 RETURN
40 END

```

### 43 5.9.3 Signed Characters and Reductions

44 The types `MPI_SIGNED_CHAR` and `MPI_UNSIGNED_CHAR` can be used in reduction opera-  
45 tions. `MPI_CHAR`, `MPI_WCHAR`, and `MPI_CHARACTER` (which represent printable charac-  
46 ters) cannot be used in reduction operations. In a heterogeneous environment, `MPI_CHAR`,  
47 `MPI_WCHAR`, and `MPI_CHARACTER` will be translated so as to preserve the printable  
48



character, whereas `MPI_SIGNED_CHAR` and `MPI_UNSIGNED_CHAR` will be translated so as to preserve the integer value.

*Advice to users.* The types `MPI_CHAR`, `MPI_WCHAR`, and `MPI_CHARACTER` are intended for characters, and so will be translated to preserve the printable representation, rather than the integer value, if sent between machines with different character codes. The types `MPI_SIGNED_CHAR` and `MPI_UNSIGNED_CHAR` should be used in C if the integer value should be preserved. (*End of advice to users.*)

#### 5.9.4 MINLOC and MAXLOC

The operator `MPI_MINLOC` is used to compute a global minimum and also an index attached to the minimum value. `MPI_MAXLOC` similarly computes a global maximum and index. One application of these is to compute a global minimum (maximum) and the rank of the process containing this value.

The operation that defines `MPI_MAXLOC` is:

$$\begin{pmatrix} u \\ i \end{pmatrix} \circ \begin{pmatrix} v \\ j \end{pmatrix} = \begin{pmatrix} w \\ k \end{pmatrix}$$

where

$$w = \max(u, v)$$

and

$$k = \begin{cases} i & \text{if } u > v \\ \min(i, j) & \text{if } u = v \\ j & \text{if } u < v \end{cases}$$

`MPI_MINLOC` is defined similarly:

$$\begin{pmatrix} u \\ i \end{pmatrix} \circ \begin{pmatrix} v \\ j \end{pmatrix} = \begin{pmatrix} w \\ k \end{pmatrix}$$

where

$$w = \min(u, v)$$

and

$$k = \begin{cases} i & \text{if } u < v \\ \min(i, j) & \text{if } u = v \\ j & \text{if } u > v \end{cases}$$

Both operations are associative and commutative. Note that if `MPI_MAXLOC` is applied to reduce a sequence of pairs  $(u_0, 0), (u_1, 1), \dots, (u_{n-1}, n-1)$ , then the value returned is  $(u, r)$ , where  $u = \max_i u_i$  and  $r$  is the index of the first global maximum in the sequence. Thus, if each process supplies a value and its rank within the group, then a reduce operation with `op = MPI_MAXLOC` will return the maximum value and the rank of the first process with that value. Similarly, `MPI_MINLOC` can be used to return a minimum and its index. More generally, `MPI_MINLOC` computes a *lexicographic minimum*, where elements are ordered

1 according to the first component of each pair, and ties are resolved according to the second  
 2 component.

3 The reduce operation is defined to operate on arguments that consist of a pair: value  
 4 and index. For both Fortran and C, types are provided to describe the pair. The potentially  
 5 mixed-type nature of such arguments is a problem in Fortran. The problem is circumvented,  
 6 for Fortran, by having the MPI-provided type consist of a pair of the same type as value,  
 7 and coercing the index to this type also. In C, the MPI-provided pair type has distinct  
 8 types and the index is an `int`.

9 In order to use `MPI_MINLOC` and `MPI_MAXLOC` in a reduce operation, one must provide  
 10 a `datatype` argument that represents a pair (value and index). MPI provides nine such  
 11 predefined datatypes. The operations `MPI_MAXLOC` and `MPI_MINLOC` can be used with  
 12 each of the following datatypes.

13  
 14 Fortran:

15 Name	Description
16 <code>MPI_2REAL</code>	pair of <code>REAL</code> s
17 <code>MPI_2DOUBLE_PRECISION</code>	pair of <code>DOUBLE PRECISION</code> variables
18 <code>MPI_2INTEGER</code>	pair of <code>INTEGER</code> s

19  
 20  
 21 C:

22 Name	Description
23 <code>MPI_FLOAT_INT</code>	float and <code>int</code>
24 <code>MPI_DOUBLE_INT</code>	double and <code>int</code>
25 <code>MPI_LONG_INT</code>	long and <code>int</code>
26 <code>MPI_2INT</code>	pair of <code>int</code>
27 <code>MPI_SHORT_INT</code>	short and <code>int</code>
28 <code>MPI_LONG_DOUBLE_INT</code>	long double and <code>int</code>

29 The datatype `MPI_2REAL` is *as if* defined by the following (see Section 4.1).  
 30

```
31 MPI_Type_contiguous(2, MPI_REAL, MPI_2REAL);
```

32  
 33 Similar statements apply for `MPI_2INTEGER`, `MPI_2DOUBLE_PRECISION`, and `MPI_2INT`.

34 The datatype `MPI_SHORT_INT` is *as if* defined by the following sequence of instructions.

```
35  

  36 struct mystruct {  

  37     short val;  

  38     int rank;  

  39 };  

  40 type[0] = MPI_SHORT;  

  41 type[1] = MPI_INT;  

  42 disp[0] = 0;  

  43 disp[1] = offsetof(struct mystruct, rank);  

  44 block[0] = 1;  

  45 block[1] = 1;  

  46 MPI_Type_create_struct(2, block, disp, type, MPI_SHORT_INT);
```

Similar statements apply for MPI\_FLOAT\_INT, MPI\_LONG\_INT and MPI\_DOUBLE\_INT.

The following examples use intracommunicators.

**Example 5.17** Each process has an array of 30 doubles, in C. For each of the 30 locations, compute the value and rank of the process containing the largest value.

```

...
/* each process has an array of 30 double: ain[30]
*/
double ain[30], aout[30];
int ind[30];
struct {
    double val;
    int rank;
} in[30], out[30];
int i, myrank, root;

MPI_Comm_rank(comm, &myrank);
for (i=0; i<30; ++i) {
    in[i].val = ain[i];
    in[i].rank = myrank;
}
MPI_Reduce(in, out, 30, MPI_DOUBLE_INT, MPI_MAXLOC, root, comm);
/* At this point, the answer resides on process root
*/
if (myrank == root) {
    /* read ranks out
    */
    for (i=0; i<30; ++i) {
        aout[i] = out[i].val;
        ind[i] = out[i].rank;
    }
}

```

**Example 5.18** Same example, in Fortran.

```

...
! each process has an array of 30 double: ain(30)

DOUBLE PRECISION ain(30), aout(30)
INTEGER ind(30)
DOUBLE PRECISION in(2,30), out(2,30)
INTEGER i, myrank, root, ierr

CALL MPI_COMM_RANK(comm, myrank, ierr)
DO i=1,30
    in(1,i) = ain(i)
    in(2,i) = myrank    ! myrank is coerced to a double

```

```

1  END DO
2
3  CALL MPI_REDUCE(in, out, 30, MPI_2DOUBLE_PRECISION, MPI_MAXLOC, root,&
4             comm, ierr)
5  ! At this point, the answer resides on process root
6
7  IF (myrank .EQ. root) THEN
8      ! read ranks out
9      DO i=1,30
10         aout(i) = out(1,i)
11         ind(i) = out(2,i) ! rank is coerced back to an integer
12     END DO
13 END IF

```

**Example 5.19** Each process has a non-empty array of values. Find the minimum global value, the rank of the process that holds it and its index on this process.

```

18 #define LEN 1000
19
20 float val[LEN];          /* local array of values */
21 int count;              /* local number of values */
22 int myrank, minrank, minindex;
23 float minval;
24
25 struct {
26     float value;
27     int index;
28 } in, out;
29
30     /* local minloc */
31 in.value = val[0];
32 in.index = 0;
33 for (i=1; i < count; i++)
34     if (in.value > val[i]) {
35         in.value = val[i];
36         in.index = i;
37     }
38
39     /* global minloc */
40 MPI_Comm_rank(comm, &myrank);
41 in.index = myrank*LEN + in.index;
42 MPI_Reduce(&in, &out, 1, MPI_FLOAT_INT, MPI_MINLOC, root, comm);
43     /* At this point, the answer resides on process root
44     */
45 if (myrank == root) {
46     /* read answer out
47     */
48

```

```

    minval = out.value;
    minrank = out.index / LEN;
    minindex = out.index % LEN;
}

```

*Rationale.* The definition of MPI\_MINLOC and MPI\_MAXLOC given here has the advantage that it does not require any special-case handling of these two operations: they are handled like any other reduce operation. A programmer can provide his or her own definition of MPI\_MAXLOC and MPI\_MINLOC, if so desired. The disadvantage is that values and indices have to be first interleaved, and that indices and values have to be coerced to the same type, in Fortran. (*End of rationale.*)

### 5.9.5 User-Defined Reduction Operations

MPI\_OP\_CREATE(user\_fn, commute, op)

IN	user_fn	user defined function (function)
IN	commute	true if commutative; false otherwise.
OUT	op	operation (handle)

#### C binding

```
int MPI_Op_create(MPI_User_function *user_fn, int commute, MPI_Op *op)
```

#### Fortran 2008 binding

```

MPI_Op_create(user_fn, commute, op, ierror)
  PROCEDURE(MPI_User_function) :: user_fn
  LOGICAL, INTENT(IN) :: commute
  TYPE(MPI_Op), INTENT(OUT) :: op
  INTEGER, OPTIONAL, INTENT(OUT) :: ierror

```

#### Fortran binding

```

MPI_OP_CREATE(USER_FN, COMMUTE, OP, IERROR)
  EXTERNAL USER_FN
  LOGICAL COMMUTE
  INTEGER OP, IERROR

```

MPI\_OP\_CREATE binds a user-defined reduction operation to an `op` handle that can subsequently be used in `MPI_REDUCE`, `MPI_ALLREDUCE`, `MPI_REDUCE_SCATTER_BLOCK`, `MPI_REDUCE_SCATTER`, `MPI_SCAN`, `MPI_EXSCAN`, all nonblocking variants of those (see Section 5.12), and `MPI_REDUCE_LOCAL`. The user-defined operation is assumed to be associative. If `commute = true`, then the operation should be both commutative and associative. If `commute = false`, then the order of operands is fixed and is defined to be in ascending, process rank order, beginning with process zero. The order of evaluation can be changed, taking advantage of the associativity of the operation. If `commute = true` then the order of evaluation can be changed, taking advantage of commutativity and associativity.

The argument `user_fn` is the user-defined function, which must have the following four arguments: `invec`, `inoutvec`, `len`, and `datatype`.

1       The ISO C prototype for the function is the following.  
 2       typedef void MPI\_User\_function(void \*invec, void \*inoutvec, int \*len,  
 3                                   MPI\_Datatype \*datatype);

4       The Fortran declarations of the user-defined function `user_fn` appear below.

```
5       ABSTRACT INTERFACE
6       SUBROUTINE MPI_User_function(invec, inoutvec, len, datatype)
7           USE, INTRINSIC :: ISO_C_BINDING, ONLY : C_PTR
8           TYPE(C_PTR), VALUE :: invec, inoutvec
9           INTEGER :: len
10          TYPE(MPI_Datatype) :: datatype
11
12       SUBROUTINE USER_FUNCTION(INVEC, INOUTVEC, LEN, DATATYPE)
13          <type> INVEC(LEN), INOUTVEC(LEN)
14          INTEGER LEN, DATATYPE
```

15       The `datatype` argument is a handle to the data type that was passed into the call to `MPI_REDUCE`. The user reduce function should be written such that the following holds: Let `u[0], ..., u[len-1]` be the `len` elements in the communication buffer described by the arguments `invec`, `len` and `datatype` when the function is invoked; let `v[0], ..., v[len-1]` be `len` elements in the communication buffer described by the arguments `inoutvec`, `len` and `datatype` when the function is invoked; let `w[0], ..., w[len-1]` be `len` elements in the communication buffer described by the arguments `inoutvec`, `len` and `datatype` when the function returns; then  $w[i] = u[i] \circ v[i]$ , for  $i=0, \dots, len-1$ , where  $\circ$  is the reduce operation that the function computes.

16       Informally, we can think of `invec` and `inoutvec` as arrays of `len` elements that `user_fn` is combining. The result of the reduction over-writes values in `inoutvec`, hence the name. Each invocation of the function results in the pointwise evaluation of the reduce operator on `len` elements: i.e., the function returns in `inoutvec[i]` the value  $invec[i] \circ inoutvec[i]$ , for  $i=0, \dots, count-1$ , where  $\circ$  is the combining operation computed by the function.

17       *Rationale.* The `len` argument allows `MPI_REDUCE` to avoid calling the function for each element in the input buffer. Rather, the system can choose to apply the function to chunks of input. In C, it is passed in as a reference for reasons of compatibility with Fortran.

18       By internally comparing the value of the `datatype` argument to known, global handles, it is possible to overload the use of a single user-defined function for several, different data types. (*End of rationale.*)

19       General datatypes may be passed to the user function. However, use of datatypes that are not contiguous is likely to lead to inefficiencies.

20       No MPI communication function may be called inside the user function. `MPI_ABORT` may be called inside the function in case of an error.

21       *Advice to users.* Suppose one defines a library of user-defined reduce functions that are overloaded: the `datatype` argument is used to select the right execution path at each invocation, according to the types of the operands. The user-defined reduce function cannot “decode” the `datatype` argument that it is passed, and cannot identify, by itself, the correspondence between the `datatype` handles and the `datatype` they represent.

This correspondence was established when the datatypes were created. Before the library is used, a library initialization preamble must be executed. This preamble code will define the datatypes that are used by the library, and store handles to these datatypes in global, static variables that are shared by the user code and the library code.

The Fortran version of `MPI_REDUCE` will invoke a user-defined reduce function using the Fortran calling conventions and will pass a Fortran-type datatype argument; the C version will use C calling convention and the C representation of a datatype handle. Users who plan to mix languages should define their reduction functions accordingly. (*End of advice to users.*)

*Advice to implementors.* We outline below a naive and inefficient implementation of `MPI_REDUCE` not supporting the “in place” option.

```

MPI_Comm_size(comm, &groupsize);
MPI_Comm_rank(comm, &rank);
if (rank > 0) {
    MPI_Recv(tempbuf, count, datatype, rank-1,...);
    User_reduce(tempbuf, sendbuf, count, datatype);
}
if (rank < groupsize-1) {
    MPI_Send(sendbuf, count, datatype, rank+1, ...);
}
/* answer now resides in process groupsize-1 ... now send to root
*/
if (rank == root) {
    MPI_Irecv(recvbuf, count, datatype, groupsize-1,..., &req);
}
if (rank == groupsize-1) {
    MPI_Send(sendbuf, count, datatype, root, ...);
}
if (rank == root) {
    MPI_Wait(&req, &status);
}

```

The reduction computation proceeds, sequentially, from process 0 to process `groupsize-1`. This order is chosen so as to respect the order of a possibly non-commutative operator defined by the function `User_reduce()`. A more efficient implementation is achieved by taking advantage of associativity and using a logarithmic tree reduction. Commutativity can be used to advantage, for those cases in which the `commute` argument to `MPI_OP_CREATE` is true. Also, the amount of temporary buffer required can be reduced, and communication can be pipelined with computation, by transferring and reducing the elements in chunks of size `len < count`.

The predefined reduce operations can be implemented as a library of user-defined operations. However, better performance might be achieved if `MPI_REDUCE` handles these functions as a special case. (*End of advice to implementors.*)

```

1 MPI_OP_FREE(op)
2     INOUT    op                operation (handle)
3

```

#### C binding

```

4
5 int MPI_Op_free(MPI_Op *op)
6

```

#### Fortran 2008 binding

```

7 MPI_Op_free(op, ierror)
8     TYPE(MPI_Op), INTENT(INOUT) :: op
9     INTEGER, OPTIONAL, INTENT(OUT) :: ierror
10

```

#### Fortran binding

```

11 MPI_OP_FREE(OP, IERROR)
12     INTEGER OP, IERROR
13

```

Marks a user-defined reduction operation for deallocation and sets `op` to `MPI_OP_NULL`.

#### Example of User-Defined Reduce

It is time for an example of user-defined reduction. The example in this section uses an intracommunicator.

**Example 5.20** Compute the product of an array of complex numbers, in C.

```

23 typedef struct {
24     double real,imag;
25 } Complex;
26
27 /* the user-defined function
28 */
29 void myProd(void *inP, void *inoutP, int *len, MPI_Datatype *dptr)
30 {
31     int i;
32     Complex c;
33     Complex *in = (Complex *)inP, *inout = (Complex *)inoutP;
34
35     for (i=0; i< *len; ++i) {
36         c.real = inout->real*in->real -
37             inout->imag*in->imag;
38         c.imag = inout->real*in->imag +
39             inout->imag*in->real;
40         *inout = c;
41         in++; inout++;
42     }
43 }
44
45 /* and, to call it...
46 */
47 ...
48

```



```

1
2  /* each process has an array of 100 Complexes
3  */
4  Complex a[100], answer[100];
5  MPI_Op myOp;
6  MPI_Datatype ctype;
7
8  /* explain to MPI how type Complex is defined
9  */
10 MPI_Type_contiguous(2, MPI_DOUBLE, &ctype);
11 MPI_Type_commit(&ctype);
12 /* create the complex-product user-op
13 */
14 MPI_Op_create(myProd, 1, &myOp);
15
16 MPI_Reduce(a, answer, 100, ctype, myOp, root, comm);
17
18 /* At this point, the answer, which consists of 100 Complexes,
19  * resides on process root
20 */
21
22

```

**Example 5.21** How to use the `mpi_f08` interface of the Fortran `MPI_User_function`.

```

23
24 subroutine my_user_function(invec, inoutvec, len, type)  bind(c)
25   use, intrinsic :: iso_c_binding, only : c_ptr, c_f_pointer
26   use mpi_f08
27   type(c_ptr), value :: invec, inoutvec
28   integer :: len
29   type(MPI_Datatype) :: type
30   real, pointer :: invec_r(:), inoutvec_r(:)
31   if (type%MPI_VAL == MPI_REAL%MPI_VAL) then
32     call c_f_pointer(invec, invec_r, (/ len /))
33     call c_f_pointer(inoutvec, inoutvec_r, (/ len /))
34     inoutvec_r = invec_r + inoutvec_r
35   end if
36 end subroutine
37
38

```

### 5.9.6 All-Reduce

MPI includes a variant of the reduce operations where the result is returned to all processes in a group. MPI requires that all processes from the same group participating in these operations receive identical results.

```

1 MPI_ALLREDUCE(sendbuf, recvbuf, count, datatype, op, comm)
2     IN      sendbuf      starting address of send buffer (choice)
3
4     OUT     recvbuf      starting address of receive buffer (choice)
5
6     IN      count        number of elements in send buffer (non-negative integer)
7
8     IN      datatype     data type of elements of send buffer (handle)
9
10    IN      op           operation (handle)
11
12    IN      comm         communicator (handle)

```

### C binding

```

13 int MPI_Allreduce(const void *sendbuf, void *recvbuf, int count,
14                 MPI_Datatype datatype, MPI_Op op, MPI_Comm comm)

```

### Fortran 2008 binding

```

16 MPI_Allreduce(sendbuf, recvbuf, count, datatype, op, comm, ierror)
17     TYPE(*), DIMENSION(..), INTENT(IN) :: sendbuf
18     TYPE(*), DIMENSION(..) :: recvbuf
19     INTEGER, INTENT(IN) :: count
20     TYPE(MPI_Datatype), INTENT(IN) :: datatype
21     TYPE(MPI_Op), INTENT(IN) :: op
22     TYPE(MPI_Comm), INTENT(IN) :: comm
23     INTEGER, OPTIONAL, INTENT(OUT) :: ierror

```

### Fortran binding

```

26 MPI_ALLREDUCE(SENDBUF, RECVBUF, COUNT, DATATYPE, OP, COMM, IERROR)
27     <type> SENDBUF(*), RECVBUF(*)
28     INTEGER COUNT, DATATYPE, OP, COMM, IERROR

```

If `comm` is an intracommunicator, `MPI_ALLREDUCE` behaves the same as `MPI_REDUCE` except that the result appears in the receive buffer of all the group members.

*Advice to implementors.* The all-reduce operations can be implemented as a reduce, followed by a broadcast. However, a direct implementation can lead to better performance. (*End of advice to implementors.*)

The “in place” option for intracommunicators is specified by passing the value `MPI_IN_PLACE` to the argument `sendbuf` at all processes. In this case, the input data is taken at each process from the receive buffer, where it will be replaced by the output data.

If `comm` is an intercommunicator, then the result of the reduction of the data provided by processes in group A is stored at each process in group B, and vice versa. Both groups should provide `count` and `datatype` arguments that specify the same type signature.

The following example uses an intracommunicator.

**Example 5.22** A routine that computes the product of a vector and an array that are distributed across a group of processes and returns the answer at all nodes (see also Example 5.16).

```

SUBROUTINE PAR_BLAS2(m, n, a, b, c, comm) 1
REAL a(m), b(m,n) ! local slice of array 2
REAL c(n) ! result 3
REAL sum(n) 4
INTEGER n, comm, i, j, ierr 5

! local sum 7
DO j=1,n 8
  sum(j) = 0.0 9
  DO i=1,m 10
    sum(j) = sum(j) + a(i)*b(i,j) 11
  END DO 12
END DO 13

! global sum 15
CALL MPI_ALLREDUCE(sum, c, n, MPI_REAL, MPI_SUM, comm, ierr) 16

! return result at all nodes 18
RETURN 19
END 20

```

### 5.9.7 Process-Local Reduction

The functions in this section are of importance to library implementors who may want to implement special reduction patterns that are otherwise not easily covered by the standard MPI operations.

The following function applies a reduction operator to local arguments.

```

MPI_REDUCE_LOCAL(inbuf, inoutbuf, count, datatype, op) 29

```

IN	inbuf	input buffer (choice)	31
INOUT	inoutbuf	combined input and output buffer (choice)	32
IN	count	number of elements in inbuf and inoutbuf buffers (non-negative integer)	33-34
IN	datatype	data type of elements of inbuf and inoutbuf buffers (handle)	35-37
IN	op	operation (handle)	38-39

#### C binding

```

int MPI_Reduce_local(const void *inbuf, void *inoutbuf, int count,
                    MPI_Datatype datatype, MPI_Op op)

```

#### Fortran 2008 binding

```

MPI_Reduce_local(inbuf, inoutbuf, count, datatype, op, ierror) 45
  TYPE(*), DIMENSION(..), INTENT(IN) :: inbuf 46
  TYPE(*), DIMENSION(..) :: inoutbuf 47
  INTEGER, INTENT(IN) :: count 48

```

```

1     TYPE(MPI_Datatype), INTENT(IN) :: datatype
2     TYPE(MPI_Op), INTENT(IN) :: op
3     INTEGER, OPTIONAL, INTENT(OUT) :: ierror

```

#### Fortran binding

```

5 MPI_REDUCE_LOCAL(INBUF, INOUTBUF, COUNT, DATATYPE, OP, IERROR)
6     <type> INBUF(*), INOUTBUF(*)
7     INTEGER COUNT, DATATYPE, OP, IERROR
8

```

9 The function applies the operation given by `op` element-wise to the elements of `inbuf` and `inoutbuf` with the result stored element-wise in `inoutbuf`, as explained for user-defined operations in Section 5.9.5. Both `inbuf` and `inoutbuf` (input as well as result) have the same number of elements given by `count` and the same datatype given by `datatype`. The `MPI_IN_PLACE` option is not allowed.

14 Reduction operations can be queried for their commutativity.

```

16 MPI_OP_COMMUTATIVE(op, commute)

```

18	IN	op	operation (handle)
19	OUT	commute	true if op is commutative, false otherwise (logical)

#### C binding

```

22 int MPI_Op_commutative(MPI_Op op, int *commute)

```

#### Fortran 2008 binding

```

24 MPI_Op_commutative(op, commute, ierror)
25     TYPE(MPI_Op), INTENT(IN) :: op
26     LOGICAL, INTENT(OUT) :: commute
27     INTEGER, OPTIONAL, INTENT(OUT) :: ierror
28

```

#### Fortran binding

```

30 MPI_OP_COMMUTATIVE(OP, COMMUTE, IERROR)
31     INTEGER OP, IERROR
32     LOGICAL COMMUTE
33

```

## 5.10 Reduce-Scatter

37 MPI includes variants of the reduce operations where the result is scattered to all processes in a group on return. One variant scatters equal-sized blocks to all processes, while another variant scatters blocks that may vary in size for each process.

## 5.10.1 MPI\_REDUCE\_SCATTER\_BLOCK

MPI\_REDUCE\_SCATTER\_BLOCK(sendbuf, recvbuf, recvcnt, datatype, op, comm)

IN	sendbuf	starting address of send buffer (choice)
OUT	recvbuf	starting address of receive buffer (choice)
IN	recvcnt	element count per block (non-negative integer)
IN	datatype	data type of elements of send and receive buffers (handle)
IN	op	operation (handle)
IN	comm	communicator (handle)

**C binding**

```
int MPI_Reduce_scatter_block(const void *sendbuf, void *recvbuf,
    int recvcnt, MPI_Datatype datatype, MPI_Op op,
    MPI_Comm comm)
```

**Fortran 2008 binding**

```
MPI_Reduce_scatter_block(sendbuf, recvbuf, recvcnt, datatype, op, comm,
    ierror)
    TYPE(*), DIMENSION(..), INTENT(IN) :: sendbuf
    TYPE(*), DIMENSION(..) :: recvbuf
    INTEGER, INTENT(IN) :: recvcnt
    TYPE(MPI_Datatype), INTENT(IN) :: datatype
    TYPE(MPI_Op), INTENT(IN) :: op
    TYPE(MPI_Comm), INTENT(IN) :: comm
    INTEGER, OPTIONAL, INTENT(OUT) :: ierror
```

**Fortran binding**

```
MPI_REDUCE_SCATTER_BLOCK(SENDBUF, RECVBUF, RECVCOUNT, DATATYPE, OP, COMM,
    IERROR)
    <type> SENDBUF(*), RECVBUF(*)
    INTEGER REVCOUNT, DATATYPE, OP, COMM, IERROR
```

If `comm` is an intracommunicator, `MPI_REDUCE_SCATTER_BLOCK` first performs a global, element-wise reduction on vectors of `count = n*recvcnt` elements in the send buffers defined by `sendbuf`, `count` and `datatype`, using the operation `op`, where `n` is the number of processes in the group of `comm`. The routine is called by all group members using the same arguments for `recvcnt`, `datatype`, `op` and `comm`. The resulting vector is treated as `n` consecutive blocks of `recvcnt` elements that are scattered to the processes of the group. The `i`-th block is sent to process `i` and stored in the receive buffer defined by `recvbuf`, `recvcnt`, and `datatype`.

*Advice to implementors.* The `MPI_REDUCE_SCATTER_BLOCK` routine is functionally equivalent to: an `MPI_REDUCE` collective operation with `count` equal to `recvcnt*n`, followed by an `MPI_SCATTER` with `sendcount` equal to `recvcnt`. However, a direct implementation may run faster. (*End of advice to implementors.*)

The “in place” option for intracommunicators is specified by passing `MPI_IN_PLACE` in the `sendbuf` argument on *all* processes. In this case, the input data is taken from the receive buffer.

If `comm` is an intercommunicator, then the result of the reduction of the data provided by processes in one group (group A) is scattered among processes in the other group (group B) and vice versa. Within each group, all processes provide the same value for the `recvcount` argument, and provide input vectors of `count = n*recvcount` elements stored in the send buffers, where `n` is the size of the group. The number of elements `count` must be the same for the two groups. The resulting vector from the other group is scattered in blocks of `recvcount` elements among the processes in the group.

*Rationale.* The last restriction is needed so that the length of the send buffer of one group can be determined by the local `recvcount` argument of the other group. Otherwise, a communication is needed to figure out how many elements are reduced. (*End of rationale.*)

### 5.10.2 MPI\_REDUCE\_SCATTER

`MPI_REDUCE_SCATTER` extends the functionality of `MPI_REDUCE_SCATTER_BLOCK` such that the scattered blocks can vary in size. Block sizes are determined by the `recvcounts` array, such that the *i*-th block contains `recvcounts[i]` elements.

`MPI_REDUCE_SCATTER(sendbuf, recvbuf, recvcounts, datatype, op, comm)`

IN	<code>sendbuf</code>	starting address of send buffer (choice)
OUT	<code>recvbuf</code>	starting address of receive buffer (choice)
IN	<code>recvcounts</code>	non-negative integer array (of length group size) specifying the number of elements of the result distributed to each process.
IN	<code>datatype</code>	data type of elements of send and receive buffers (handle)
IN	<code>op</code>	operation (handle)
IN	<code>comm</code>	communicator (handle)

#### C binding

```
int MPI_Reduce_scatter(const void *sendbuf, void *recvbuf,
                      const int recvcounts[], MPI_Datatype datatype, MPI_Op op,
                      MPI_Comm comm)
```

#### Fortran 2008 binding

```
MPI_Reduce_scatter(sendbuf, recvbuf, recvcounts, datatype, op, comm,
                  ierror)
    TYPE(*), DIMENSION(..), INTENT(IN) :: sendbuf
    TYPE(*), DIMENSION(..) :: recvbuf
    INTEGER, INTENT(IN) :: recvcounts(*)
    TYPE(MPI_Datatype), INTENT(IN) :: datatype
    TYPE(MPI_Op), INTENT(IN) :: op
```

```

TYPE(MPI_Comm), INTENT(IN) :: comm
INTEGER, OPTIONAL, INTENT(OUT) :: ierror

```

**Fortran binding**

```

MPI_REDUCE_SCATTER(SENDBUF, RECVBUFF, RECVCOUNTS, DATATYPE, OP, COMM,
                  IERROR)
<type> SENDBUF(*), RECVBUFF(*)
INTEGER RECVCOUNTS(*), DATATYPE, OP, COMM, IERROR

```

If `comm` is an intracommunicator, `MPI_REDUCE_SCATTER` first performs a global, element-wise reduction on vectors of `count = \sum_{i=0}^{n-1} recvcounts[i]` elements in the send buffers defined by `sendbuf`, `count` and `datatype`, using the operation `op`, where `n` is the number of processes in the group of `comm`. The routine is called by all group members using the same arguments for `recvcounts`, `datatype`, `op` and `comm`. The resulting vector is treated as `n` consecutive blocks where the number of elements of the `i`-th block is `recvcounts[i]`. The blocks are scattered to the processes of the group. The `i`-th block is sent to process `i` and stored in the receive buffer defined by `recvbuf`, `recvcounts[i]` and `datatype`.

*Advice to implementors.* The `MPI_REDUCE_SCATTER` routine is functionally equivalent to: an `MPI_REDUCE` collective operation with `count` equal to the sum of `recvcounts[i]` followed by `MPI_SCATTERV` with `sendcounts` equal to `recvcounts`. However, a direct implementation may run faster. (*End of advice to implementors.*)

The “in place” option for intracommunicators is specified by passing `MPI_IN_PLACE` in the `sendbuf` argument. In this case, the input data is taken from the receive buffer. It is not required to specify the “in place” option on all processes, since the processes for which `recvcounts[i] == 0` may not have allocated a receive buffer.

If `comm` is an intercommunicator, then the result of the reduction of the data provided by processes in one group (group A) is scattered among processes in the other group (group B), and vice versa. Within each group, all processes provide the same `recvcounts` argument, and provide input vectors of `count = \sum_{i=0}^{n-1} recvcounts[i]` elements stored in the send buffers, where `n` is the size of the group. The resulting vector from the other group is scattered in blocks of `recvcounts[i]` elements among the processes in the group. The number of elements count must be the same for the two groups.

*Rationale.* The last restriction is needed so that the length of the send buffer can be determined by the sum of the local `recvcounts` entries. Otherwise, a communication is needed to figure out how many elements are reduced. (*End of rationale.*)

## 5.11 Scan

### 5.11.1 Inclusive Scan

`MPI_SCAN(sendbuf, recvbuf, count, datatype, op, comm)`

IN	<code>sendbuf</code>	starting address of send buffer (choice)
OUT	<code>recvbuf</code>	starting address of receive buffer (choice)
IN	<code>count</code>	number of elements in input buffer (non-negative integer)
IN	<code>datatype</code>	data type of elements of input buffer (handle)
IN	<code>op</code>	operation (handle)
IN	<code>comm</code>	communicator (handle)

#### C binding

```
int MPI_Scan(const void *sendbuf, void *recvbuf, int count,
            MPI_Datatype datatype, MPI_Op op, MPI_Comm comm)
```

#### Fortran 2008 binding

```
MPI_Scan(sendbuf, recvbuf, count, datatype, op, comm, ierror)
    TYPE(*), DIMENSION(..), INTENT(IN) :: sendbuf
    TYPE(*), DIMENSION(..) :: recvbuf
    INTEGER, INTENT(IN) :: count
    TYPE(MPI_Datatype), INTENT(IN) :: datatype
    TYPE(MPI_Op), INTENT(IN) :: op
    TYPE(MPI_Comm), INTENT(IN) :: comm
    INTEGER, OPTIONAL, INTENT(OUT) :: ierror
```

#### Fortran binding

```
MPI_SCAN(SENDBUF, RECVBUF, COUNT, DATATYPE, OP, COMM, IERROR)
    <type> SENDBUF(*), RECVBUF(*)
    INTEGER COUNT, DATATYPE, OP, COMM, IERROR
```

If `comm` is an intracommunicator, `MPI_SCAN` is used to perform a prefix reduction on data distributed across the group. The operation returns, in the receive buffer of the process with rank `i`, the reduction of the values in the send buffers of processes with ranks `0, ..., i` (inclusive). The routine is called by all group members using the same arguments for `count`, `datatype`, `op` and `comm`, except that for user-defined operations, the same rules apply as for `MPI_REDUCE`. The type of operations supported, their semantics, and the constraints on send and receive buffers are as for `MPI_REDUCE`.

The “in place” option for intracommunicators is specified by passing `MPI_IN_PLACE` in the `sendbuf` argument. In this case, the input data is taken from the receive buffer, and replaced by the output data.

This operation is invalid for intercommunicators.



## 5.11.2 Exclusive Scan

MPI\_EXSCAN(sendbuf, recvbuf, count, datatype, op, comm)

IN	sendbuf	starting address of send buffer (choice)
OUT	recvbuf	starting address of receive buffer (choice)
IN	count	number of elements in input buffer (non-negative integer)
IN	datatype	data type of elements of input buffer (handle)
IN	op	operation (handle)
IN	comm	intracommunicator (handle)

**C binding**

```
int MPI_Exscan(const void *sendbuf, void *recvbuf, int count,
               MPI_Datatype datatype, MPI_Op op, MPI_Comm comm)
```

**Fortran 2008 binding**

```
MPI_Exscan(sendbuf, recvbuf, count, datatype, op, comm, ierror)
    TYPE(*), DIMENSION(..), INTENT(IN) :: sendbuf
    TYPE(*), DIMENSION(..) :: recvbuf
    INTEGER, INTENT(IN) :: count
    TYPE(MPI_Datatype), INTENT(IN) :: datatype
    TYPE(MPI_Op), INTENT(IN) :: op
    TYPE(MPI_Comm), INTENT(IN) :: comm
    INTEGER, OPTIONAL, INTENT(OUT) :: ierror
```

**Fortran binding**

```
MPI_EXSCAN(SENDBUF, RECVBUF, COUNT, DATATYPE, OP, COMM, IERROR)
    <type> SENDBUF(*), RECVBUF(*)
    INTEGER COUNT, DATATYPE, OP, COMM, IERROR
```

If `comm` is an intracommunicator, `MPI_EXSCAN` is used to perform a prefix reduction on data distributed across the group. The value in `recvbuf` on the process with rank 0 is undefined, and `recvbuf` is not significant on process 0. The value in `recvbuf` on the process with rank 1 is defined as the value in `sendbuf` on the process with rank 0. For processes with rank  $i > 1$ , the operation returns, in the receive buffer of the process with rank  $i$ , the reduction of the values in the send buffers of processes with ranks  $0, \dots, i-1$  (inclusive). The routine is called by all group members using the same arguments for `count`, `datatype`, `op` and `comm`, except that for user-defined operations, the same rules apply as for `MPI_REDUCE`. The type of operations supported, their semantics, and the constraints on send and receive buffers, are as for `MPI_REDUCE`.

The “in place” option for intracommunicators is specified by passing `MPI_IN_PLACE` in the `sendbuf` argument. In this case, the input data is taken from the receive buffer, and replaced by the output data. The receive buffer on rank 0 is not changed by this operation.

This operation is invalid for intercommunicators.

*Rationale.* The exclusive scan is more general than the inclusive scan. Any inclusive scan operation can be achieved by using the exclusive scan and then locally combining the local contribution. Note that for non-invertable operations such as MPI\_MAX, the exclusive scan cannot be computed with the inclusive scan. (*End of rationale.*)

### 5.11.3 Example using MPI\_SCAN

The example in this section uses an intracommunicator.

**Example 5.23** This example uses a user-defined operation to produce a *segmented scan*. A segmented scan takes, as input, a set of values and a set of logicals, and the logicals delineate the various segments of the scan. For example:

<i>values</i>	$v_1$	$v_2$	$v_3$	$v_4$	$v_5$	$v_6$	$v_7$	$v_8$
<i>logicals</i>	0	0	1	1	1	0	0	1
<i>result</i>	$v_1$	$v_1 + v_2$	$v_3$	$v_3 + v_4$	$v_3 + v_4 + v_5$	$v_6$	$v_6 + v_7$	$v_8$

The operator that produces this effect is

$$\begin{pmatrix} u \\ i \end{pmatrix} \circ \begin{pmatrix} v \\ j \end{pmatrix} = \begin{pmatrix} w \\ j \end{pmatrix},$$

where

$$w = \begin{cases} u + v & \text{if } i = j \\ v & \text{if } i \neq j \end{cases}.$$

Note that this is a non-commutative operator. C code that implements it is given below.

```

typedef struct {
    double val;
    int log;
} SegScanPair;

/* the user-defined function
*/
void segScan(SegScanPair *in, SegScanPair *inout, int *len,
             MPI_Datatype *dptr)
{
    int i;
    SegScanPair c;

    for (i=0; i< *len; ++i) {
        if (in->log == inout->log)
            c.val = in->val + inout->val;
        else
            c.val = inout->val;
        c.log = inout->log;
        *inout = c;
    }
}

```

```

        in++; inout++;
    }
}

```

Note that the `inout` argument to the user-defined function corresponds to the right-hand operand of the operator. When using this operator, we must be careful to specify that it is non-commutative, as in the following.

```

int i,base;
SegScanPair a, answer;
MPI_Op      myOp;
MPI_Datatype type[2] = {MPI_DOUBLE, MPI_INT};
MPI_Aint     disp[2];
int         blocklen[2] = { 1, 1};
MPI_Datatype sspair;

/* explain to MPI how type SegScanPair is defined
 */
MPI_Get_address(&a, disp);
MPI_Get_address(&a.log, disp+1);
base = disp[0];
for (i=0; i<2; ++i) disp[i] -= base;
MPI_Type_create_struct(2, blocklen, disp, type, &sspair);
MPI_Type_commit(&sspair);
/* create the segmented-scan user-op
 */
MPI_Op_create(segScan, 0, &myOp);
...
MPI_Scan(&a, &answer, 1, sspair, myOp, comm);

```

## 5.12 Nonblocking Collective Operations

As described in Section 3.7, performance of many applications can be improved by overlapping communication and computation, and many systems enable this. Nonblocking collective operations combine the potential benefits of nonblocking point-to-point operations, to exploit overlap and to avoid synchronization, with the optimized implementation and message scheduling provided by collective operations [31, 35]. One way of doing this would be to perform a blocking collective operation in a separate thread. An alternative mechanism that often leads to better performance (e.g., avoids context switching, scheduler overheads, and thread management) is to use nonblocking collective communication [33].

The nonblocking collective communication model is similar to the model used for nonblocking point-to-point communication. A nonblocking call initiates a collective operation, which must be completed in a separate completion call. Once initiated, the operation may progress independently of any computation or other communication at participating processes. In this manner, nonblocking collective operations can mitigate possible synchronizing effects of collective operations by running them in the “background.” In addition to enabling communication-computation overlap, nonblocking collective operations can perform collective operations on overlapping communicators, which would lead to deadlocks

1 with blocking operations. Their semantic advantages can also be useful in combination with  
2 point-to-point communication.

3 As in the nonblocking point-to-point case, all calls are local and return immediately,  
4 irrespective of the status of other processes. The call initiates the operation, which indicates  
5 that the system may start to copy data out of the send buffer and into the receive buffer.  
6 Once initiated, all associated send buffers and buffers associated with input arguments (such  
7 as arrays of counts, displacements, or datatypes in the vector versions of the collectives)  
8 should not be modified, and all associated receive buffers should not be accessed, until the  
9 collective operation completes. The call returns a request handle, which must be passed to  
10 a completion call.

11 All completion calls (e.g., `MPI_WAIT`) described in Section 3.7.3 are supported for  
12 nonblocking collective operations. Similarly to the blocking case, nonblocking collective  
13 operations are considered to be complete when the local part of the operation is finished,  
14 i.e., for the caller, the semantics of the operation are guaranteed and all buffers can be  
15 safely accessed and modified. Completion does not indicate that other processes have  
16 completed or even started the operation (unless otherwise implied by the description of  
17 the operation). Completion of a particular nonblocking collective operation also does not  
18 indicate completion of any other posted nonblocking collective (or send-receive) operations,  
19 whether they are posted before or after the completed operation.

20  
21 *Advice to users.* Users should be aware that implementations are allowed, but  
22 not required (with exception of `MPI_IBARRIER`), to synchronize processes during the  
23 completion of a nonblocking collective operation. (*End of advice to users.*)

24  
25 Upon returning from a completion call in which a nonblocking collective operation  
26 completes, the `MPI_ERROR` field in the associated status object is set appropriately, see  
27 Section 3.2.5 on page 32. The values of the `MPI_SOURCE` and `MPI_TAG` fields are unde-  
28 fined. It is valid to mix different request types (i.e., any combination of collective requests,  
29 I/O requests, generalized requests, or point-to-point requests) in functions that enable mul-  
30 tiple completions (e.g., `MPI_WAITALL`). It is erroneous to call `MPI_REQUEST_FREE` or  
31 `MPI_CANCEL` for a request associated with a nonblocking collective operation. Nonblock-  
32 ing collective requests created using the APIs described in this section are not persistent.  
33 However, persistent collective requests can be created using persistent collective operations  
34 described in Sections 5.13 and 7.8.

35  
36 *Rationale.* Freeing an active nonblocking collective request could cause similar  
37 problems as discussed for point-to-point requests (see Section 3.7.3). Cancelling a  
38 request is not supported because the semantics of this operation are not well-defined.  
39 (*End of rationale.*)

40  
41 Multiple nonblocking collective operations can be outstanding on a single communi-  
42 cator. If the nonblocking call causes some system resource to be exhausted, then it will  
43 fail and generate an MPI exception. Quality implementations of MPI should ensure that  
44 this happens only in pathological cases. That is, an MPI implementation should be able to  
45 support a large number of pending nonblocking operations.

46 Unlike point-to-point operations, nonblocking collective operations do not match with  
47 blocking collective operations, and collective operations do not have a tag argument. All  
48 processes must call collective operations (blocking and nonblocking) in the same order  
per communicator. In particular, once a process calls a collective operation, all other

processes in the communicator must eventually call the same collective operation, and no other collective operation with the same communicator in between. This is consistent with the ordering rules for blocking collective operations in threaded environments.

*Rationale.* Matching blocking and nonblocking collective operations is not allowed because the implementation might use different communication algorithms for the two cases. Blocking collective operations may be optimized for minimal time to completion, while nonblocking collective operations may balance time to completion with CPU overhead and asynchronous progression.

The use of tags for collective operations can prevent certain hardware optimizations. (*End of rationale.*)

*Advice to users.* If program semantics require matching blocking and nonblocking collective operations, then a nonblocking collective operation can be initiated and immediately completed with a blocking wait to emulate blocking behavior. (*End of advice to users.*)

In terms of data movement, each nonblocking collective operation has the same effect as its blocking counterpart for intracommunicators and intercommunicators after completion. Likewise, upon completion, nonblocking collective reduction operations have the same effect as their blocking counterparts, and the same restrictions and recommendations on reduction orders apply.

The use of the “in place” option is allowed exactly as described for the corresponding blocking collective operations. When using the “in place” option, message buffers function as both send and receive buffers. Such buffers should not be modified or accessed until the operation completes.

Progression rules for nonblocking collective operations are similar to progression of nonblocking point-to-point operations, refer to Section 3.7.4.

*Advice to implementors.* Nonblocking collective operations can be implemented with local execution schedules [34] using nonblocking point-to-point communication and a reserved tag-space. (*End of advice to implementors.*)

### 5.12.1 Nonblocking Barrier Synchronization

`MPI_IBARRIER(comm, request)`

IN	<code>comm</code>	communicator (handle)
OUT	<code>request</code>	communication request (handle)

#### C binding

```
int MPI_Ibarrier(MPI_Comm comm, MPI_Request *request)
```

#### Fortran 2008 binding

```
MPI_Ibarrier(comm, request, ierror)
  TYPE(MPI_Comm), INTENT(IN) :: comm
  TYPE(MPI_Request), INTENT(OUT) :: request
```

```
1     INTEGER, OPTIONAL, INTENT(OUT) :: ierror
```

### Fortran binding

```
3 MPI_IBARRIER(COMM, REQUEST, IERROR)
4     INTEGER COMM, REQUEST, IERROR
```

6 MPI\_IBARRIER is a nonblocking version of MPI\_BARRIER. By calling MPI\_IBARRIER, a process notifies that it has reached the barrier. The call returns immediately, independent of whether other processes have called MPI\_IBARRIER. The usual barrier semantics are enforced at the corresponding completion operation (test or wait), which in the intra-communicator case will complete only after all other processes in the communicator have called MPI\_IBARRIER. In the intercommunicator case, it will complete when all processes in the remote group have called MPI\_IBARRIER.

14 *Advice to users.* A nonblocking barrier can be used to hide latency. Moving independent computations between the MPI\_IBARRIER and the subsequent completion call can overlap the barrier latency and therefore shorten possible waiting times. The semantic properties are also useful when mixing collective operations and point-to-point messages. (*End of advice to users.*)

## 5.12.2 Nonblocking Broadcast

```
23 MPI_IBCAST(buffer, count, datatype, root, comm, request)
```

24	INOUT	buffer	starting address of buffer (choice)
25	IN	count	number of entries in buffer (non-negative integer)
26	IN	datatype	data type of buffer (handle)
27	IN	root	rank of broadcast root (integer)
28	IN	comm	communicator (handle)
29	OUT	request	communication request (handle)

### C binding

```
34 int MPI_Ibcast(void *buffer, int count, MPI_Datatype datatype, int root,
35 MPI_Comm comm, MPI_Request *request)
```

### Fortran 2008 binding

```
38 MPI_Ibcast(buffer, count, datatype, root, comm, request, ierror)
39     TYPE(*), DIMENSION(..), ASYNCHRONOUS :: buffer
40     INTEGER, INTENT(IN) :: count, root
41     TYPE(MPI_Datatype), INTENT(IN) :: datatype
42     TYPE(MPI_Comm), INTENT(IN) :: comm
43     TYPE(MPI_Request), INTENT(OUT) :: request
44     INTEGER, OPTIONAL, INTENT(OUT) :: ierror
```

### Fortran binding

```
46 MPI_IBCAST(BUFFER, COUNT, DATATYPE, ROOT, COMM, REQUEST, IERROR)
47     <type> BUFFER(*)
```

INTEGER COUNT, DATATYPE, ROOT, COMM, REQUEST, IERROR

This call starts a nonblocking variant of MPI\_BCAST (see Section 5.4).

#### Example using MPI\_IBCAST

The example in this section uses an intracommunicator.

**Example 5.24** Start a broadcast of 100 ints from process 0 to every process in the group, perform some computation on independent data, and then complete the outstanding broadcast operation.

```
MPI_Comm comm;
int array1[100], array2[100];
int root=0;
MPI_Request req;
...
MPI_Ibcast(array1, 100, MPI_INT, root, comm, &req);
compute(array2, 100);
MPI_Wait(&req, MPI_STATUS_IGNORE);
```

#### 5.12.3 Nonblocking Gather

MPI\_IGATHER(sendbuf, sendcount, sendtype, recvbuf, recvcount, recvtype, root, comm, request)

IN	sendbuf	starting address of send buffer (choice)
IN	sendcount	number of elements in send buffer (non-negative integer)
IN	sendtype	data type of send buffer elements (handle)
OUT	recvbuf	address of receive buffer (choice, significant only at root)
IN	recvcount	number of elements for any single receive (non-negative integer, significant only at root)
IN	recvtype	data type of recv buffer elements (handle, significant only at root)
IN	root	rank of receiving process (integer)
IN	comm	communicator (handle)
OUT	request	communication request (handle)

#### C binding

```
int MPI_Igather(const void *sendbuf, int sendcount, MPI_Datatype sendtype,
               void *recvbuf, int recvcount, MPI_Datatype recvtype, int root,
               MPI_Comm comm, MPI_Request *request)
```

#### Fortran 2008 binding

```

1 MPI_Igather(sendbuf, sendcount, sendtype, recvbuf, recvcount, recvtype,
2             root, comm, request, ierror)
3     TYPE(*), DIMENSION(..), INTENT(IN), ASYNCHRONOUS :: sendbuf
4     INTEGER, INTENT(IN) :: sendcount, recvcount, root
5     TYPE(MPI_Datatype), INTENT(IN) :: sendtype, recvtype
6     TYPE(*), DIMENSION(..), ASYNCHRONOUS :: recvbuf
7     TYPE(MPI_Comm), INTENT(IN) :: comm
8     TYPE(MPI_Request), INTENT(OUT) :: request
9     INTEGER, OPTIONAL, INTENT(OUT) :: ierror

```

### Fortran binding

```

11 MPI_IGATHER(SENDBUF, SENDCOUNT, SENDTYPE, RECVBUF, RECVCOUNT, RECVTYPE,
12            ROOT, COMM, REQUEST, IERROR)
13     <type> SENDBUF(*), RECVBUF(*)
14     INTEGER SENDCOUNT, SENDTYPE, RECVCOUNT, RECVTYPE, ROOT, COMM, REQUEST,
15     IERROR

```

This call starts a nonblocking variant of MPI\_GATHER (see Section 5.5).

```

19 MPI_IGATHERV(sendbuf, sendcount, sendtype, recvbuf, recvcounts, displs, recvtype, root, comm,
20             request)

```

22	IN	sendbuf	starting address of send buffer (choice)
23	IN	sendcount	number of elements in send buffer (non-negative integer)
24			
25			
26	IN	sendtype	data type of send buffer elements (handle)
27	OUT	recvbuf	address of receive buffer (choice, significant only at root)
28			
29	IN	recvcounts	non-negative integer array (of length group size) containing the number of elements that are received from each process (significant only at root)
30			
31			
32	IN	displs	integer array (of length group size). Entry <i>i</i> specifies the displacement relative to <i>recvbuf</i> at which to place the incoming data from process <i>i</i> (significant only at root)
33			
34			
35			
36			
37	IN	recvtype	data type of recv buffer elements (handle, significant only at root)
38			
39	IN	root	rank of receiving process (integer)
40			
41	IN	comm	communicator (handle)
42	OUT	request	communication request (handle)

### C binding

```

44 int MPI_Igatherv(const void *sendbuf, int sendcount, MPI_Datatype sendtype,
45                void *recvbuf, const int recvcounts[], const int displs[],
46                MPI_Datatype recvtype, int root, MPI_Comm comm,
47                MPI_Request *request)
48

```



**Fortran 2008 binding**

```

MPI_Igatherv(sendbuf, sendcount, sendtype, recvbuf, recvcoun1ts, displs,2
              recvtype, root, comm, request, ierror)3
  TYPE(*), DIMENSION(..), INTENT(IN), ASYNCHRONOUS :: sendbuf4
  INTEGER, INTENT(IN) :: sendcount, displs(*), root5
  TYPE(MPI_Datatype), INTENT(IN) :: sendtype, recvtype6
  TYPE(*), DIMENSION(..), ASYNCHRONOUS :: recvbuf7
  INTEGER, INTENT(IN), ASYNCHRONOUS :: recvcoun8ts(*)
  TYPE(MPI_Comm), INTENT(IN) :: comm9
  TYPE(MPI_Request), INTENT(OUT) :: request10
  INTEGER, OPTIONAL, INTENT(OUT) :: ierror11

```

**Fortran binding**

```

MPI_IGATHERV(SENDBUF, SENDCOUNT, SENDTYPE, RECVBUF, RECVCOUNTS, DISPLS,13
             RECVTYPE, ROOT, COMM, REQUEST, IERROR)14
  <type> SENDBUF(*), RECVBUF(*)15
  INTEGER SENDCOUNT, SENDTYPE, RECVCOUNTS(*), DISPLS(*), RECVTYPE, ROOT,16
  COMM, REQUEST, IERROR17

```

This call starts a nonblocking variant of `MPI_GATHERV` (see Section 5.5).

## 5.12.4 Nonblocking Scatter

```

MPI_ISCATTER(sendbuf, sendcount, sendtype, recvbuf, recvcoun24t, recvtype, root, comm, request)25

```

IN	sendbuf	address of send buffer (choice, significant only at root)	<sup>27</sup>
IN	sendcount	number of elements sent to each process (non-negative integer, significant only at root)	<sup>28</sup>
IN	sendtype	data type of send buffer elements (handle, significant only at root)	<sup>29</sup>
OUT	recvbuf	address of receive buffer (choice)	<sup>30</sup>
IN	recvcoun <sup>31</sup> t	number of elements in receive buffer (non-negative integer)	<sup>32</sup>
IN	recvtype	data type of receive buffer elements (handle)	<sup>33</sup>
IN	root	rank of sending process (integer)	<sup>34</sup>
IN	comm	communicator (handle)	<sup>35</sup>
OUT	request	communication request (handle)	<sup>36</sup>

**C binding**

```

int MPI_Iscatter(const void *sendbuf, int sendcount, MPI_Datatype sendtype,43
                void *recvbuf, int recvcoun44t, MPI_Datatype recvtype, int root,45
                MPI_Comm comm, MPI_Request *request)46

```

**Fortran 2008 binding**

```

1 MPI_Isscatter(sendbuf, sendcount, sendtype, recvbuf, recvcount, recvtype,
2               root, comm, request, ierror)
3     TYPE(*), DIMENSION(..), INTENT(IN), ASYNCHRONOUS :: sendbuf
4     INTEGER, INTENT(IN) :: sendcount, recvcount, root
5     TYPE(MPI_Datatype), INTENT(IN) :: sendtype, recvtype
6     TYPE(*), DIMENSION(..), ASYNCHRONOUS :: recvbuf
7     TYPE(MPI_Comm), INTENT(IN) :: comm
8     TYPE(MPI_Request), INTENT(OUT) :: request
9     INTEGER, OPTIONAL, INTENT(OUT) :: ierror

```

### Fortran binding

```

10 MPI_ISCATTER(SENDBUF, SENDCOUNT, SENDTYPE, RECVBUF, RECVCOUNT, RECVTYPE,
11             ROOT, COMM, REQUEST, IERROR)
12     <type> SENDBUF(*), RECVBUF(*)
13     INTEGER SENDCOUNT, SENDTYPE, RECVCOUNT, RECVTYPE, ROOT, COMM, REQUEST,
14     IERROR

```

This call starts a nonblocking variant of `MPI_SCATTER` (see Section 5.6).

```

15 MPI_ISCATTERV(sendbuf, sendcounts, displs, sendtype, recvbuf, recvcount, recvtype, root,
16             comm, request)

```

17	IN	sendbuf	address of send buffer (choice, significant only at root)
18	IN	sendcounts	non-negative integer array (of length group size) specifying the number of elements to send to each rank
19	IN	displs	integer array (of length group size). Entry <i>i</i> specifies the displacement (relative to <code>sendbuf</code> ) from which to take the outgoing data to process <i>i</i>
20	IN	sendtype	data type of send buffer elements (handle)
21	OUT	recvbuf	address of receive buffer (choice)
22	IN	recvcount	number of elements in receive buffer (non-negative integer)
23	IN	recvtype	data type of receive buffer elements (handle)
24	IN	root	rank of sending process (integer)
25	IN	comm	communicator (handle)
26	OUT	request	communication request (handle)

### C binding

```

27 int MPI_Isscatterv(const void *sendbuf, const int sendcounts[],
28                 const int displs[], MPI_Datatype sendtype, void *recvbuf,
29                 int recvcount, MPI_Datatype recvtype, int root, MPI_Comm comm,
30                 MPI_Request *request)

```

### Fortran 2008 binding

```

31 MPI_Isscatterv(sendbuf, sendcounts, displs, sendtype, recvbuf, recvcount,
32             recvtype, root, comm, request, ierror)

```

```

TYPE(*), DIMENSION(..), INTENT(IN), ASYNCHRONOUS :: sendbuf
INTEGER, INTENT(IN), ASYNCHRONOUS :: sendcounts(*)
INTEGER, INTENT(IN) :: displs(*), recvcount, root
TYPE(MPI_Datatype), INTENT(IN) :: sendtype, recvtype
TYPE(*), DIMENSION(..), ASYNCHRONOUS :: recvbuf
TYPE(MPI_Comm), INTENT(IN) :: comm
TYPE(MPI_Request), INTENT(OUT) :: request
INTEGER, OPTIONAL, INTENT(OUT) :: ierror

```

**Fortran binding**

```

MPI_ISCATTERV(SENDBUF, SENDCOUNTS, DISPLS, SENDTYPE, RECVBUF, RECVCOUNT,
              RECVTYPE, ROOT, COMM, REQUEST, IERROR)
<type> SENDBUF(*), RECVBUF(*)
INTEGER SENDCOUNTS(*), DISPLS(*), SENDTYPE, RECVCOUNT, RECVTYPE, ROOT,
COMM, REQUEST, IERROR

```

This call starts a nonblocking variant of MPI\_SCATTERV (see Section 5.6).

## 5.12.5 Nonblocking Gather-to-all

```

MPI_IALLGATHER(sendbuf, sendcount, sendtype, recvbuf, recvcount, recvtype, comm, request)

```

IN	sendbuf	starting address of send buffer (choice)
IN	sendcount	number of elements in send buffer (non-negative integer)
IN	sendtype	data type of send buffer elements (handle)
OUT	recvbuf	address of receive buffer (choice)
IN	recvcount	number of elements received from any process (non-negative integer)
IN	recvtype	data type of receive buffer elements (handle)
IN	comm	communicator (handle)
OUT	request	communication request (handle)

**C binding**

```

int MPI_Iallgather(const void *sendbuf, int sendcount,
                  MPI_Datatype sendtype, void *recvbuf, int recvcount,
                  MPI_Datatype recvtype, MPI_Comm comm, MPI_Request *request)

```

**Fortran 2008 binding**

```

MPI_Iallgather(sendbuf, sendcount, sendtype, recvbuf, recvcount, recvtype,
              comm, request, ierror)
TYPE(*), DIMENSION(..), INTENT(IN), ASYNCHRONOUS :: sendbuf
INTEGER, INTENT(IN) :: sendcount, recvcount
TYPE(MPI_Datatype), INTENT(IN) :: sendtype, recvtype
TYPE(*), DIMENSION(..), ASYNCHRONOUS :: recvbuf

```

```

1     TYPE(MPI_Comm), INTENT(IN) :: comm
2     TYPE(MPI_Request), INTENT(OUT) :: request
3     INTEGER, OPTIONAL, INTENT(OUT) :: ierror

```

#### Fortran binding

```

6 MPI_IALLGATHER(SENDBUF, SENDCOUNT, SENDTYPE, RECVBUF, REVCOUNT, RECVTYPE,
7               COMM, REQUEST, IERROR)
8     <type> SENDBUF(*), RECVBUF(*)
9     INTEGER SENDCOUNT, SENDTYPE, REVCOUNT, RECVTYPE, COMM, REQUEST,
10    IERROR

```

This call starts a nonblocking variant of MPI\_ALLGATHER (see Section 5.7).

```

14 MPI_IALLGATHERV(sendbuf, sendcount, sendtype, recvbuf, recvcnts, displs, recvtype, comm,
15                request)

```

16	IN	sendbuf	starting address of send buffer (choice)
17	IN	sendcount	number of elements in send buffer (non-negative integer)
18			ger)
19			
20	IN	sendtype	data type of send buffer elements (handle)
21	OUT	recvbuf	address of receive buffer (choice)
22	IN	recvcnts	non-negative integer array (of length group size) containing the number of elements that are received from each process
23			
24			
25			
26	IN	displs	integer array (of length group size). Entry i specifies the displacement (relative to recvbuf) at which to place the incoming data from process i
27			
28			
29	IN	recvtype	data type of receive buffer elements (handle)
30	IN	comm	communicator (handle)
31			
32	OUT	request	communication request (handle)
33			

#### C binding

```

35 int MPI_Iallgatherv(const void *sendbuf, int sendcount,
36                   MPI_Datatype sendtype, void *recvbuf, const int recvcnts[],
37                   const int displs[], MPI_Datatype recvtype, MPI_Comm comm,
38                   MPI_Request *request)

```

#### Fortran 2008 binding

```

40 MPI_Iallgatherv(sendbuf, sendcount, sendtype, recvbuf, recvcnts, displs,
41                recvtype, comm, request, ierror)
42     TYPE(*), DIMENSION(..), INTENT(IN), ASYNCHRONOUS :: sendbuf
43     INTEGER, INTENT(IN) :: sendcount
44     TYPE(MPI_Datatype), INTENT(IN) :: sendtype, recvtype
45     TYPE(*), DIMENSION(..), ASYNCHRONOUS :: recvbuf
46     INTEGER, INTENT(IN), ASYNCHRONOUS :: recvcnts(*), displs(*)
47     TYPE(MPI_Comm), INTENT(IN) :: comm
48

```

```

TYPE(MPI_Request), INTENT(OUT) :: request
INTEGER, OPTIONAL, INTENT(OUT) :: ierror

```

**Fortran binding**

```

MPI_IALLGATHERV(SENDBUF, SENDCOUNT, SENDTYPE, RECVBUF, RECVCOUNTS, DISPLS,
                RECVTYPE, COMM, REQUEST, IERROR)
<type> SENDBUF(*), RECVBUF(*)
INTEGER SENDCOUNT, SENDTYPE, RECVCOUNTS(*), DISPLS(*), RECVTYPE, COMM,
REQUEST, IERROR

```

This call starts a nonblocking variant of MPI\_ALLGATHERV (see Section 5.7).

## 5.12.6 Nonblocking All-to-All Scatter/Gather

```

MPI_IALLTOALL(sendbuf, sendcount, sendtype, recvbuf, recvcount, recvtype, comm, request)

```

IN	sendbuf	starting address of send buffer (choice)
IN	sendcount	number of elements sent to each process (non-negative integer)
IN	sendtype	data type of send buffer elements (handle)
OUT	recvbuf	address of receive buffer (choice)
IN	recvcount	number of elements received from any process (non-negative integer)
IN	recvtype	data type of receive buffer elements (handle)
IN	comm	communicator (handle)
OUT	request	communication request (handle)

**C binding**

```

int MPI_Ialltoall(const void *sendbuf, int sendcount,
                 MPI_Datatype sendtype, void *recvbuf, int recvcount,
                 MPI_Datatype recvtype, MPI_Comm comm, MPI_Request *request)

```

**Fortran 2008 binding**

```

MPI_Ialltoall(sendbuf, sendcount, sendtype, recvbuf, recvcount, recvtype,
              comm, request, ierror)
TYPE(*), DIMENSION(..), INTENT(IN), ASYNCHRONOUS :: sendbuf
INTEGER, INTENT(IN) :: sendcount, recvcount
TYPE(MPI_Datatype), INTENT(IN) :: sendtype, recvtype
TYPE(*), DIMENSION(..), ASYNCHRONOUS :: recvbuf
TYPE(MPI_Comm), INTENT(IN) :: comm
TYPE(MPI_Request), INTENT(OUT) :: request
INTEGER, OPTIONAL, INTENT(OUT) :: ierror

```

**Fortran binding**

```

MPI_IALLTOALL(SENDBUF, SENDCOUNT, SENDTYPE, RECVBUF, RECVCOUNT, RECVTYPE,
              COMM, REQUEST, IERROR)

```

```

1     <type> SENDBUF(*), RECVBUF(*)
2     INTEGER SENDCOUNT, SENDTYPE, RECVCOUNT, RECVTYPE, COMM, REQUEST,
3     IERROR

```

This call starts a nonblocking variant of MPI\_ALLTOALL (see Section 5.8).

```

7 MPI_IALLTOALLV(sendbuf, sendcounts, sdispls, sendtype, recvbuf, recvcounts, rdispls, recvtype,
8               comm, request)

```

9			
10	IN	sendbuf	starting address of send buffer (choice)
11	IN	sendcounts	non-negative integer array (of length group size) specifying the number of elements to send to each rank
12			
13	IN	sdispls	integer array (of length group size). Entry j specifies the displacement (relative to sendbuf) from which to take the outgoing data destined for process j
14			
15			
16			
17	IN	sendtype	data type of send buffer elements (handle)
18	OUT	recvbuf	address of receive buffer (choice)
19	IN	recvcounts	non-negative integer array (of length group size) specifying the number of elements that can be received from each rank
20			
21			
22			
23	IN	rdispls	integer array (of length group size). Entry i specifies the displacement (relative to recvbuf) at which to place the incoming data from process i
24			
25			
26	IN	recvtype	data type of receive buffer elements (handle)
27	IN	comm	communicator (handle)
28			
29	OUT	request	communication request (handle)

### C binding

```

32 int MPI_Ialltoallv(const void *sendbuf, const int sendcounts[],
33                  const int sdispls[], MPI_Datatype sendtype, void *recvbuf,
34                  const int recvcounts[], const int rdispls[],
35                  MPI_Datatype recvtype, MPI_Comm comm, MPI_Request *request)

```

### Fortran 2008 binding

```

37 MPI_Ialltoallv(sendbuf, sendcounts, sdispls, sendtype, recvbuf, recvcounts,
38               rdispls, recvtype, comm, request, ierror)
39     TYPE(*), DIMENSION(..), INTENT(IN), ASYNCHRONOUS :: sendbuf
40     INTEGER, INTENT(IN), ASYNCHRONOUS :: sendcounts(*), sdispls(*),
41     recvcounts(*), rdispls(*)
42     TYPE(MPI_Datatype), INTENT(IN) :: sendtype, recvtype
43     TYPE(*), DIMENSION(..), ASYNCHRONOUS :: recvbuf
44     TYPE(MPI_Comm), INTENT(IN) :: comm
45     TYPE(MPI_Request), INTENT(OUT) :: request
46     INTEGER, OPTIONAL, INTENT(OUT) :: ierror

```

### Fortran binding

```

MPI_IALLTOALLV(SENDBUF, SENDCOUNTS, SDISPLS, SENDTYPE, RECVBUF, RECVCOUNTS,
               RDISPLS, RECVTYPE, COMM, REQUEST, IERROR)
    <type> SENDBUF(*), RECVBUF(*)
    INTEGER SENDCOUNTS(*), SDISPLS(*), SENDTYPE, RECVCOUNTS(*),
    RDISPLS(*), RECVTYPE, COMM, REQUEST, IERROR

```

This call starts a nonblocking variant of MPI\_ALLTOALLV (see Section 5.8).

```

MPI_IALLTOALLW(sendbuf, sendcounts, sdispls, sendtypes, recvbuf, recvcoun-
               t, rdispls, recvtypes,
               comm, request)

```

IN	sendbuf	starting address of send buffer (choice)
IN	sendcounts	integer array (of length group size) specifying the number of elements to send to each rank (array of non-negative integers)
IN	sdispls	integer array (of length group size). Entry j specifies the displacement in bytes (relative to sendbuf) from which to take the outgoing data destined for process j (array of integers)
IN	sendtypes	array of datatypes (of length group size). Entry j specifies the type of data to send to process j (array of handles)
OUT	recvbuf	address of receive buffer (choice)
IN	recvcoun- t	integer array (of length group size) specifying the number of elements that can be received from each rank (array of non-negative integers)
IN	rdispls	integer array (of length group size). Entry i specifies the displacement in bytes (relative to recvbuf) at which to place the incoming data from process i (array of integers)
IN	recvtypes	array of datatypes (of length group size). Entry i specifies the type of data received from process i (array of handles)
IN	comm	communicator (handle)
OUT	request	communication request (handle)

### C binding

```

int MPI_Ialltoallw(const void *sendbuf, const int sendcounts[],
                  const int sdispls[], const MPI_Datatype sendtypes[],
                  void *recvbuf, const int recvcoun-
                  t[], const int rdispls[],
                  const MPI_Datatype recvtypes[], MPI_Comm comm,
                  MPI_Request *request)

```

### Fortran 2008 binding

```

MPI_Ialltoallw(sendbuf, sendcounts, sdispls, sendtypes, recvbuf,
               recvcoun-
               t, rdispls, recvtypes, comm, request, ierror)

```

```

1     TYPE(*), DIMENSION(..), INTENT(IN), ASYNCHRONOUS :: sendbuf
2     INTEGER, INTENT(IN), ASYNCHRONOUS :: sendcounts(*), sdispls(*),
3     recvcounts(*), rdispls(*)
4     TYPE(MPI_Datatype), INTENT(IN), ASYNCHRONOUS :: sendtypes(*),
5     recvtypes(*)
6     TYPE(*), DIMENSION(..), ASYNCHRONOUS :: recvbuf
7     TYPE(MPI_Comm), INTENT(IN) :: comm
8     TYPE(MPI_Request), INTENT(OUT) :: request
9     INTEGER, OPTIONAL, INTENT(OUT) :: ierror

```

### Fortran binding

```

11 MPI_IALLTOALLW(SENDBUF, SENDCOUNTS, SDISPLS, SENDTYPES, RECVBUF,
12               RECVCOUNTS, RDISPLS, RECVTYPES, COMM, REQUEST, IERROR)
13     <type> SENDBUF(*), RECVBUF(*)
14     INTEGER SENDCOUNTS(*), SDISPLS(*), SENDTYPES(*), RECVCOUNTS(*),
15     RDISPLS(*), RECVTYPES(*), COMM, REQUEST, IERROR

```

17 This call starts a nonblocking variant of MPI\_ALLTOALLW (see Section 5.8).

### 5.12.7 Nonblocking Reduce

```

22 MPI_IREDUCE(sendbuf, recvbuf, count, datatype, op, root, comm, request)

```

24	IN	sendbuf	address of send buffer (choice)
25	OUT	recvbuf	address of receive buffer (choice, significant only at root)
27	IN	count	number of elements in send buffer (non-negative integer)
30	IN	datatype	data type of elements of send buffer (handle)
31	IN	op	reduce operation (handle)
32	IN	root	rank of root process (integer)
33	IN	comm	communicator (handle)
34	IN	comm	communicator (handle)
35	OUT	request	communication request (handle)

### C binding

```

38 int MPI_Ireduce(const void *sendbuf, void *recvbuf, int count,
39               MPI_Datatype datatype, MPI_Op op, int root, MPI_Comm comm,
40               MPI_Request *request)

```

### Fortran 2008 binding

```

43 MPI_Ireduce(sendbuf, recvbuf, count, datatype, op, root, comm, request,
44             ierror)
45     TYPE(*), DIMENSION(..), INTENT(IN), ASYNCHRONOUS :: sendbuf
46     TYPE(*), DIMENSION(..), ASYNCHRONOUS :: recvbuf
47     INTEGER, INTENT(IN) :: count, root
48     TYPE(MPI_Datatype), INTENT(IN) :: datatype

```



```

TYPE(MPI_Op), INTENT(IN) :: op
TYPE(MPI_Comm), INTENT(IN) :: comm
TYPE(MPI_Request), INTENT(OUT) :: request
INTEGER, OPTIONAL, INTENT(OUT) :: ierror

```

**Fortran binding**

```

MPI_IREDUCE(SENDBUF, RECVBUF, COUNT, DATATYPE, OP, ROOT, COMM, REQUEST,
            IERROR)

```

```

<type> SENDBUF(*), RECVBUF(*)

```

```

INTEGER COUNT, DATATYPE, OP, ROOT, COMM, REQUEST, IERROR

```

This call starts a nonblocking variant of MPI\_REDUCE (see Section 5.9.1).

*Advice to implementors.* The implementation is explicitly allowed to use different algorithms for blocking and nonblocking reduction operations that might change the order of evaluation of the operations. However, as for MPI\_REDUCE, it is strongly recommended that MPI\_IREDUCE be implemented so that the same result be obtained whenever the function is applied on the same arguments, appearing in the same order. Note that this may prevent optimizations that take advantage of the physical location of processes. (*End of advice to implementors.*)

*Advice to users.* For operations which are not truly associative, the result delivered upon completion of the nonblocking reduction may not exactly equal the result delivered by the blocking reduction, even when specifying the same arguments in the same order. (*End of advice to users.*)

## 5.12.8 Nonblocking All-Reduce

```

MPI_IALLREDUCE(sendbuf, recvbuf, count, datatype, op, comm, request)

```

IN	sendbuf	starting address of send buffer (choice)
OUT	recvbuf	starting address of receive buffer (choice)
IN	count	number of elements in send buffer (non-negative integer)
IN	datatype	data type of elements of send buffer (handle)
IN	op	operation (handle)
IN	comm	communicator (handle)
OUT	request	communication request (handle)

**C binding**

```

int MPI_Iallreduce(const void *sendbuf, void *recvbuf, int count,
                  MPI_Datatype datatype, MPI_Op op, MPI_Comm comm,
                  MPI_Request *request)

```

**Fortran 2008 binding**

```

MPI_Iallreduce(sendbuf, recvbuf, count, datatype, op, comm, request,
              ierror)

```

```

1  TYPE(*), DIMENSION(..), INTENT(IN), ASYNCHRONOUS :: sendbuf
2  TYPE(*), DIMENSION(..), ASYNCHRONOUS :: recvbuf
3  INTEGER, INTENT(IN) :: count
4  TYPE(MPI_Datatype), INTENT(IN) :: datatype
5  TYPE(MPI_Op), INTENT(IN) :: op
6  TYPE(MPI_Comm), INTENT(IN) :: comm
7  TYPE(MPI_Request), INTENT(OUT) :: request
8  INTEGER, OPTIONAL, INTENT(OUT) :: ierror

```

### Fortran binding

```

10 MPI_IALLREDUCE(SENDBUF, RECVBUF, COUNT, DATATYPE, OP, COMM, REQUEST,
11              IERROR)
12     <type> SENDBUF(*), RECVBUF(*)
13     INTEGER COUNT, DATATYPE, OP, COMM, REQUEST, IERROR

```

This call starts a nonblocking variant of MPI\_ALLREDUCE (see Section 5.9.6).

### 5.12.9 Nonblocking Reduce-Scatter with Equal Blocks

```

20 MPI_IREDUCE_SCATTER_BLOCK(sendbuf, recvbuf, recvcnt, datatype, op, comm, request)

```

23	IN	sendbuf	starting address of send buffer (choice)
24	OUT	recvbuf	starting address of receive buffer (choice)
25	IN	recvcnt	element count per block (non-negative integer)
26	IN	datatype	data type of elements of send and receive buffers (handle)
27	IN	op	operation (handle)
28	IN	comm	communicator (handle)
29	OUT	request	communication request (handle)

### C binding

```

34 int MPI_Ireduce_scatter_block(const void *sendbuf, void *recvbuf,
35                             int recvcnt, MPI_Datatype datatype, MPI_Op op,
36                             MPI_Comm comm, MPI_Request *request)

```

### Fortran 2008 binding

```

39 MPI_Ireduce_scatter_block(sendbuf, recvbuf, recvcnt, datatype, op, comm,
40                          request, ierror)
41     TYPE(*), DIMENSION(..), INTENT(IN), ASYNCHRONOUS :: sendbuf
42     TYPE(*), DIMENSION(..), ASYNCHRONOUS :: recvbuf
43     INTEGER, INTENT(IN) :: recvcnt
44     TYPE(MPI_Datatype), INTENT(IN) :: datatype
45     TYPE(MPI_Op), INTENT(IN) :: op
46     TYPE(MPI_Comm), INTENT(IN) :: comm
47     TYPE(MPI_Request), INTENT(OUT) :: request

```

```
INTEGER, OPTIONAL, INTENT(OUT) :: ierror
```

**Fortran binding**

```
MPI_IREDUCE_SCATTER_BLOCK(SENDBUF, RECVBUF, RECVCOUNT, DATATYPE, OP, COMM,  
    REQUEST, IERROR)
```

```
<type> SENDBUF(*), RECVBUF(*)
```

```
INTEGER RECVCOUNT, DATATYPE, OP, COMM, REQUEST, IERROR
```

This call starts a nonblocking variant of MPI\_REDUCE\_SCATTER\_BLOCK (see Section 5.10.1).

## 5.12.10 Nonblocking Reduce-Scatter

```
MPI_IREDUCE_SCATTER(sendbuf, recvbuf, recvcnts, datatype, op, comm, request)
```

IN	sendbuf	starting address of send buffer (choice)
OUT	recvbuf	starting address of receive buffer (choice)
IN	recvcnts	non-negative integer array specifying the number of elements in result distributed to each process. This array must be identical on all calling processes.
IN	datatype	data type of elements of input buffer (handle)
IN	op	operation (handle)
IN	comm	communicator (handle)
OUT	request	communication request (handle)

**C binding**

```
int MPI_Ireduce_scatter(const void *sendbuf, void *recvbuf,  
    const int recvcnts[], MPI_Datatype datatype, MPI_Op op,  
    MPI_Comm comm, MPI_Request *request)
```

**Fortran 2008 binding**

```
MPI_Ireduce_scatter(sendbuf, recvbuf, recvcnts, datatype, op, comm,  
    request, ierror)
```

```
TYPE(*), DIMENSION(..), INTENT(IN), ASYNCHRONOUS :: sendbuf
```

```
TYPE(*), DIMENSION(..), ASYNCHRONOUS :: recvbuf
```

```
INTEGER, INTENT(IN), ASYNCHRONOUS :: recvcnts(*)
```

```
TYPE(MPI_Datatype), INTENT(IN) :: datatype
```

```
TYPE(MPI_Op), INTENT(IN) :: op
```

```
TYPE(MPI_Comm), INTENT(IN) :: comm
```

```
TYPE(MPI_Request), INTENT(OUT) :: request
```

```
INTEGER, OPTIONAL, INTENT(OUT) :: ierror
```

**Fortran binding**

```
MPI_IREDUCE_SCATTER(SENDBUF, RECVBUF, RECVCOUNTS, DATATYPE, OP, COMM,  
    REQUEST, IERROR)
```

```
<type> SENDBUF(*), RECVBUF(*)
```

```
INTEGER RECVCOUNTS(*), DATATYPE, OP, COMM, REQUEST, IERROR
```

This call starts a nonblocking variant of MPI\_REDUCE\_SCATTER (see Section 5.10.2).

### 5.12.11 Nonblocking Inclusive Scan

MPI\_ISCAN(sendbuf, recvbuf, count, datatype, op, comm, request)

IN	sendbuf	starting address of send buffer (choice)
OUT	recvbuf	starting address of receive buffer (choice)
IN	count	number of elements in input buffer (non-negative integer)
IN	datatype	data type of elements of input buffer (handle)
IN	op	operation (handle)
IN	comm	communicator (handle)
OUT	request	communication request (handle)

#### C binding

```
int MPI_Iscan(const void *sendbuf, void *recvbuf, int count,
             MPI_Datatype datatype, MPI_Op op, MPI_Comm comm,
             MPI_Request *request)
```

#### Fortran 2008 binding

```
MPI_Iscan(sendbuf, recvbuf, count, datatype, op, comm, request, ierror)
    TYPE(*), DIMENSION(..), INTENT(IN), ASYNCHRONOUS :: sendbuf
    TYPE(*), DIMENSION(..), ASYNCHRONOUS :: recvbuf
    INTEGER, INTENT(IN) :: count
    TYPE(MPI_Datatype), INTENT(IN) :: datatype
    TYPE(MPI_Op), INTENT(IN) :: op
    TYPE(MPI_Comm), INTENT(IN) :: comm
    TYPE(MPI_Request), INTENT(OUT) :: request
    INTEGER, OPTIONAL, INTENT(OUT) :: ierror
```

#### Fortran binding

```
MPI_ISCAN(SENDBUF, RECVBUF, COUNT, DATATYPE, OP, COMM, REQUEST, IERROR)
    <type> SENDBUF(*), RECVBUF(*)
    INTEGER COUNT, DATATYPE, OP, COMM, REQUEST, IERROR
```

This call starts a nonblocking variant of MPI\_SCAN (see Section 5.11).

## 5.12.12 Nonblocking Exclusive Scan

MPI\_IEXSCAN(sendbuf, recvbuf, count, datatype, op, comm, request)

IN	sendbuf	starting address of send buffer (choice)
OUT	recvbuf	starting address of receive buffer (choice)
IN	count	number of elements in input buffer (non-negative integer)
IN	datatype	data type of elements of input buffer (handle)
IN	op	operation (handle)
IN	comm	intra-communicator (handle)
OUT	request	communication request (handle)

**C binding**

```
int MPI_Iexscan(const void *sendbuf, void *recvbuf, int count,
               MPI_Datatype datatype, MPI_Op op, MPI_Comm comm,
               MPI_Request *request)
```

**Fortran 2008 binding**

```
MPI_Iexscan(sendbuf, recvbuf, count, datatype, op, comm, request, ierror)
  TYPE(*), DIMENSION(..), INTENT(IN), ASYNCHRONOUS :: sendbuf
  TYPE(*), DIMENSION(..), ASYNCHRONOUS :: recvbuf
  INTEGER, INTENT(IN) :: count
  TYPE(MPI_Datatype), INTENT(IN) :: datatype
  TYPE(MPI_Op), INTENT(IN) :: op
  TYPE(MPI_Comm), INTENT(IN) :: comm
  TYPE(MPI_Request), INTENT(OUT) :: request
  INTEGER, OPTIONAL, INTENT(OUT) :: ierror
```

**Fortran binding**

```
MPI_IEXSCAN(SENDBUF, RECVBUF, COUNT, DATATYPE, OP, COMM, REQUEST, IERROR)
  <type> SENDBUF(*), RECVBUF(*)
  INTEGER COUNT, DATATYPE, OP, COMM, REQUEST, IERROR
```

This call starts a nonblocking variant of MPI\_EXSCAN (see Section 5.11.2).

## 5.13 Persistent Collective Operations

Many parallel computation algorithms involve repetitively executing a collective communication operation with the same arguments each time. As with persistent point-to-point operations (see Section 3.9), persistent collective operations allow the MPI programmer to specify operations that will be reused frequently (with fixed arguments). MPI can be designed to select a more efficient way to perform the collective operation based on the parameters specified when the operation is initialized. This “planned-transfer” approach [48, 38] can offer significant performance benefits for programs with repetitive communication patterns.

1 In terms of data movement, each persistent collective operation has the same effect as  
2 its blocking and nonblocking counterparts for intracommunicators and intercommunicators  
3 after completion. Likewise, upon completion, persistent collective reduction operations  
4 perform the same operation as their blocking and nonblocking counterparts, and the same  
5 restrictions and recommendations on reduction orders apply (see also Section 5.9.1).

6 Initialization calls for MPI persistent collective operations are non-local and follow all  
7 the existing rules for collective operations, in particular ordering; programs that do not  
8 conform to these restrictions are erroneous. After initialization, all arrays associated with  
9 input arguments (such as arrays of counts, displacements, and datatypes in the vector  
10 versions of the collectives) must not be modified until the corresponding persistent request  
11 is freed with `MPI_REQUEST_FREE`.

12 The `request` argument is an output argument that can be used zero or more times with  
13 `MPI_START` or `MPI_STARTALL` in order to start the collective operation. The `request` is  
14 initially inactive after the initialization call. Once initialized, persistent collective operations  
15 can be started in any order and the order can differ among processes in the communicator.  
16

17 *Rationale.* All ordering requirements that an implementation may need to match  
18 up collective operations across the communicator are achieved through the ordering  
19 requirements of the initialization functions. This enables out-of-order starts for the  
20 persistent operations, and particularly supports their use in `MPI_STARTALL`. (*End of*  
21 *rationale.*)

22 *Advice to implementors.* An MPI implementation should do no worse than duplicat-  
23 ing the communicator during the initialization function, caching the input arguments,  
24 and calling the appropriate nonblocking collective function, using the cached argu-  
25 ments, during `MPI_START`. High-quality implementations should be able to amortize  
26 setup costs and further optimize by taking advantage of early-binding, such as effi-  
27 cient and effective pre-allocation of certain resources and algorithm selection. (*End*  
28 *of advice to implementors.*)  
29

30  
31 A request must be inactive when it is started. Starting the operation makes the request  
32 active. Once any process starts a persistent collective operation, it must complete that  
33 operation and all other processes in the communicator must eventually start (and complete)  
34 the same persistent collective operation. Persistent collective operations cannot be matched  
35 with blocking or nonblocking collective operations. Completion of a persistent collective  
36 operation makes the corresponding request inactive. After starting a persistent collective  
37 operation, all associated send buffers must not be modified and all associated receive buffers  
38 must not be accessed until the corresponding persistent request is completed.

39 Completing a persistent collective request, for example using `MPI_TEST` or  
40 `MPI_WAIT`, makes it inactive, but does not free the request. This is the same behavior as  
41 for persistent point-to-point requests. Inactive persistent collective requests can be freed  
42 using `MPI_REQUEST_FREE`. It is erroneous to free an active persistent collective request.  
43 Persistent collective operations cannot be canceled; it is erroneous to use `MPI_CANCEL` on  
44 a persistent collective request.

45 For every nonblocking collective communication operation in MPI, there is a corre-  
46 sponding persistent collective operation with the analogous API signature.

47 The collective persistent API signatures include an `MPI_INFO` object in order to support  
48 optimization hints and other information that may be non-standard. Persistent collective

operations may be optimized during communicator creation or by the initialization operation of an individual persistent collective. Note that communicator-scoped hints should be provided using `MPI_COMM_SET_INFO` while, for operation-scoped hints, they are supplied to the persistent collective communication initialization functions using the `info` argument.

### 5.13.1 Persistent Barrier Synchronization

`MPI_BARRIER_INIT(comm, info, request)`

IN	<code>comm</code>	communicator (handle)
IN	<code>info</code>	info argument (handle)
OUT	<code>request</code>	communication request (handle)

#### C binding

```
int MPI_Barrier_init(MPI_Comm comm, MPI_Info info, MPI_Request *request)
```

#### Fortran 2008 binding

```
MPI_Barrier_init(comm, info, request, ierror)
    TYPE(MPI_Comm), INTENT(IN) :: comm
    TYPE(MPI_Info), INTENT(IN) :: info
    TYPE(MPI_Request), INTENT(OUT) :: request
    INTEGER, OPTIONAL, INTENT(OUT) :: ierror
```

#### Fortran binding

```
MPI_BARRIER_INIT(COMM, INFO, REQUEST, IERROR)
    INTEGER COMM, INFO, REQUEST, IERROR
```

Creates a persistent collective communication request for the barrier operation.

### 5.13.2 Persistent Broadcast

`MPI_BCAST_INIT(buffer, count, datatype, root, comm, info, request)`

INOUT	<code>buffer</code>	starting address of buffer (choice)
IN	<code>count</code>	number of entries in buffer (non-negative integer)
IN	<code>datatype</code>	data type of buffer (handle)
IN	<code>root</code>	rank of broadcast root (integer)
IN	<code>comm</code>	communicator (handle)
IN	<code>info</code>	info argument (handle)
OUT	<code>request</code>	communication request (handle)

#### C binding

```
int MPI_Bcast_init(void *buffer, int count, MPI_Datatype datatype,
    int root, MPI_Comm comm, MPI_Info info, MPI_Request *request)
```

**Fortran 2008 binding**

```

MPI_Bcast_init(buffer, count, datatype, root, comm, info, request, ierror)
    TYPE(*), DIMENSION(..), ASYNCHRONOUS :: buffer
    INTEGER, INTENT(IN) :: count, root
    TYPE(MPI_Datatype), INTENT(IN) :: datatype
    TYPE(MPI_Comm), INTENT(IN) :: comm
    TYPE(MPI_Info), INTENT(IN) :: info
    TYPE(MPI_Request), INTENT(OUT) :: request
    INTEGER, OPTIONAL, INTENT(OUT) :: ierror

```

**Fortran binding**

```

MPI_BCAST_INIT(BUFFER, COUNT, DATATYPE, ROOT, COMM, INFO, REQUEST, IERROR)
    <type> BUFFER(*)
    INTEGER COUNT, DATATYPE, ROOT, COMM, INFO, REQUEST, IERROR

```

Creates a persistent collective communication request for the broadcast operation.

**5.13.3 Persistent Gather**

```

MPI_GATHER_INIT(sendbuf, sendcount, sendtype, recvbuf, recvcount, recvtype, root, comm,
    info, request)

```

IN	sendbuf	starting address of send buffer (choice)
IN	sendcount	number of elements in send buffer (non-negative integer)
IN	sendtype	data type of send buffer elements (handle)
OUT	recvbuf	address of receive buffer (choice, significant only at root)
IN	recvcount	number of elements for any single receive (non-negative integer, significant only at root)
IN	recvtype	data type of recv buffer elements (handle, significant only at root)
IN	root	rank of receiving process (integer)
IN	comm	communicator (handle)
IN	info	info argument (handle)
OUT	request	communication request (handle)

**C binding**

```

int MPI_Gather_init(const void *sendbuf, int sendcount,
    MPI_Datatype sendtype, void *recvbuf, int recvcount,
    MPI_Datatype recvtype, int root, MPI_Comm comm, MPI_Info info,
    MPI_Request *request)

```

**Fortran 2008 binding**



```

MPI_Gather_init(sendbuf, sendcount, sendtype, recvbuf, recvcnt, recvtype,
               root, comm, info, request, ierror)
    TYPE(*), DIMENSION(..), INTENT(IN), ASYNCHRONOUS :: sendbuf
    INTEGER, INTENT(IN) :: sendcount, recvcnt, root
    TYPE(MPI_Datatype), INTENT(IN) :: sendtype, recvtype
    TYPE(*), DIMENSION(..), ASYNCHRONOUS :: recvbuf
    TYPE(MPI_Comm), INTENT(IN) :: comm
    TYPE(MPI_Info), INTENT(IN) :: info
    TYPE(MPI_Request), INTENT(OUT) :: request
    INTEGER, OPTIONAL, INTENT(OUT) :: ierror

```

**Fortran binding**

```

MPI_GATHER_INIT(SENDBUF, SENDCOUNT, SENDTYPE, RECVBUF, RECVCOUNT, RECVTYPE,
               ROOT, COMM, INFO, REQUEST, IERROR)
    <type> SENDBUF(*), RECVBUF(*)
    INTEGER SENDCOUNT, SENDTYPE, RECVCOUNT, RECVTYPE, ROOT, COMM, INFO,
    REQUEST, IERROR

```

Creates a persistent collective communication request for the gather operation.

```

MPI_GATHERV_INIT(sendbuf, sendcount, sendtype, recvbuf, recvcnts, displs, recvtype, root,
                comm, info, request)

```

IN	sendbuf	starting address of send buffer (choice)
IN	sendcount	number of elements in send buffer (non-negative integer)
IN	sendtype	data type of send buffer elements (handle)
OUT	recvbuf	address of receive buffer (choice, significant only at root)
IN	recvcnts	non-negative integer array (of length group size) containing the number of elements that are received from each process (significant only at root)
IN	displs	integer array (of length group size). Entry <i>i</i> specifies the displacement relative to <code>recvbuf</code> at which to place the incoming data from process <i>i</i> (significant only at root)
IN	recvtype	data type of recv buffer elements (handle, significant only at root)
IN	root	rank of receiving process (integer)
IN	comm	communicator (handle)
IN	info	info argument (handle)
OUT	request	communication request (handle)

**C binding**

```

1 int MPI_Gatherv_init(const void *sendbuf, int sendcount,
2     MPI_Datatype sendtype, void *recvbuf, const int recvcnts[],
3     const int displs[], MPI_Datatype recvtype, int root,
4     MPI_Comm comm, MPI_Info info, MPI_Request *request)

```

### Fortran 2008 binding

```

6 MPI_Gatherv_init(sendbuf, sendcount, sendtype, recvbuf, recvcnts, displs,
7     recvtype, root, comm, info, request, ierror)
8     TYPE(*), DIMENSION(..), INTENT(IN), ASYNCHRONOUS :: sendbuf
9     INTEGER, INTENT(IN) :: sendcount, root
10    TYPE(MPI_Datatype), INTENT(IN) :: sendtype, recvtype
11    TYPE(*), DIMENSION(..), ASYNCHRONOUS :: recvbuf
12    INTEGER, INTENT(IN), ASYNCHRONOUS :: recvcnts(*), displs(*)
13    TYPE(MPI_Comm), INTENT(IN) :: comm
14    TYPE(MPI_Info), INTENT(IN) :: info
15    TYPE(MPI_Request), INTENT(OUT) :: request
16    INTEGER, OPTIONAL, INTENT(OUT) :: ierror

```

### Fortran binding

```

18 MPI_GATHERV_INIT(SENDBUF, SENDCOUNT, SENDTYPE, RECVBUF, RECVCOUNTS, DISPLS,
19     RECVTYPE, ROOT, COMM, INFO, REQUEST, IERROR)
20     <type> SENDBUF(*), RECVBUF(*)
21     INTEGER SENDCOUNT, SENDTYPE, RECVCOUNTS(*), DISPLS(*), RECVTYPE, ROOT,
22     COMM, INFO, REQUEST, IERROR

```

Creates a persistent collective communication request for the gatherv operation.

48

## 5.13.4 Persistent Scatter

MPI\_SCATTER\_INIT(sendbuf, sendcount, sendtype, recvbuf, recvcount, recvtype, root, comm, info, request)

IN	sendbuf	address of send buffer (choice, significant only at root)
IN	sendcount	number of elements sent to each process (non-negative integer, significant only at root)
IN	sendtype	data type of send buffer elements (handle, significant only at root)
OUT	recvbuf	address of receive buffer (choice)
IN	recvcount	number of elements in receive buffer (non-negative integer)
IN	recvtype	data type of receive buffer elements (handle)
IN	root	rank of sending process (integer)
IN	comm	communicator (handle)
IN	info	info argument (handle)
OUT	request	communication request (handle)

**C binding**

```
int MPI_Scatter_init(const void *sendbuf, int sendcount,
                    MPI_Datatype sendtype, void *recvbuf, int recvcount,
                    MPI_Datatype recvtype, int root, MPI_Comm comm, MPI_Info info,
                    MPI_Request *request)
```

**Fortran 2008 binding**

```
MPI_Scatter_init(sendbuf, sendcount, sendtype, recvbuf, recvcount,
                 recvtype, root, comm, info, request, ierror)
TYPE(*), DIMENSION(..), INTENT(IN), ASYNCHRONOUS :: sendbuf
INTEGER, INTENT(IN) :: sendcount, recvcount, root
TYPE(MPI_Datatype), INTENT(IN) :: sendtype, recvtype
TYPE(*), DIMENSION(..), ASYNCHRONOUS :: recvbuf
TYPE(MPI_Comm), INTENT(IN) :: comm
TYPE(MPI_Info), INTENT(IN) :: info
TYPE(MPI_Request), INTENT(OUT) :: request
INTEGER, OPTIONAL, INTENT(OUT) :: ierror
```

**Fortran binding**

```
MPI_SCATTER_INIT(SENDBUF, SENDCOUNT, SENDTYPE, RECVBUF, RECVCOUNT,
                 RECVTYPE, ROOT, COMM, INFO, REQUEST, IERROR)
<type> SENDBUF(*), RECVBUF(*)
INTEGER SENDCOUNT, SENDTYPE, RECVCOUNT, RECVTYPE, ROOT, COMM, INFO,
REQUEST, IERROR
```

Creates a persistent collective communication request for the scatter operation.

```

1 MPI_SCATTERV_INIT(sendbuf, sendcounts, displs, sendtype, recvbuf, recvcoun, recvtype,
2     root, comm, info, request)
3
4     IN     sendbuf     address of send buffer (choice, significant only at root)
5
6     IN     sendcounts  non-negative integer array (of length group size) spec-
7     ifying the number of elements to send to each rank
8
9     IN     displs     integer array (of length group size). Entry i specifies
10    the displacement (relative to sendbuf) from which to
11    take the outgoing data to process i
12
13    IN     sendtype    data type of send buffer elements (handle)
14
15    OUT    recvbuf     address of receive buffer (choice)
16
17    IN     recvcoun    number of elements in receive buffer (non-negative in-
18    teger)
19
20    IN     recvtype    data type of receive buffer elements (handle)
21
22    IN     root        rank of sending process (integer)
23
24    IN     comm        communicator (handle)
25
26    IN     info        info argument (handle)
27
28    OUT    request     communication request (handle)

```

**C binding**

```

29 int MPI_Scatterv_init(const void *sendbuf, const int sendcounts[],
30     const int displs[], MPI_Datatype sendtype, void *recvbuf,
31     int recvcoun, MPI_Datatype recvtype, int root, MPI_Comm comm,
32     MPI_Info info, MPI_Request *request)

```

**Fortran 2008 binding**

```

33 MPI_Scatterv_init(sendbuf, sendcounts, displs, sendtype, recvbuf,
34     recvcoun, recvtype, root, comm, info, request, ierror)
35
36     TYPE(*), DIMENSION(..), INTENT(IN), ASYNCHRONOUS :: sendbuf
37     INTEGER, INTENT(IN), ASYNCHRONOUS :: sendcounts(*), displs(*)
38     TYPE(MPI_Datatype), INTENT(IN) :: sendtype, recvtype
39     TYPE(*), DIMENSION(..), ASYNCHRONOUS :: recvbuf
40     INTEGER, INTENT(IN) :: recvcoun, root
41     TYPE(MPI_Comm), INTENT(IN) :: comm
42     TYPE(MPI_Info), INTENT(IN) :: info
43     TYPE(MPI_Request), INTENT(OUT) :: request
44     INTEGER, OPTIONAL, INTENT(OUT) :: ierror

```

**Fortran binding**

```

45 MPI_SCATTERV_INIT(SENDBUF, SENDCOUNTS, DISPLS, SENDTYPE, RECVBUF,
46     RECVCOUNT, RECVTYPE, ROOT, COMM, INFO, REQUEST, IERROR)
47
48     <type> SENDBUF(*), RECVBUF(*)
49     INTEGER SENDCOUNTS(*), DISPLS(*), SENDTYPE, RECVCOUNT, RECVTYPE, ROOT,
50     COMM, INFO, REQUEST, IERROR

```

Creates a persistent collective communication request for the scatterv operation.

## 5.13.5 Persistent Gather-to-all

MPI\_ALLGATHER\_INIT(sendbuf, sendcount, sendtype, recvbuf, recvcount, recvtype, comm, info, request)

IN	sendbuf	starting address of send buffer (choice)
IN	sendcount	number of elements in send buffer (non-negative integer)
IN	sendtype	data type of send buffer elements (handle)
OUT	recvbuf	address of receive buffer (choice)
IN	recvcount	number of elements received from any process (non-negative integer)
IN	recvtype	data type of receive buffer elements (handle)
IN	comm	communicator (handle)
IN	info	info argument (handle)
OUT	request	communication request (handle)

**C binding**

```
int MPI_Allgather_init(const void *sendbuf, int sendcount,
    MPI_Datatype sendtype, void *recvbuf, int recvcount,
    MPI_Datatype recvtype, MPI_Comm comm, MPI_Info info,
    MPI_Request *request)
```

**Fortran 2008 binding**

```
MPI_Allgather_init(sendbuf, sendcount, sendtype, recvbuf, recvcount,
    recvtype, comm, info, request, ierror)
    TYPE(*), DIMENSION(..), INTENT(IN), ASYNCHRONOUS :: sendbuf
    INTEGER, INTENT(IN) :: sendcount, recvcount
    TYPE(MPI_Datatype), INTENT(IN) :: sendtype, recvtype
    TYPE(*), DIMENSION(..), ASYNCHRONOUS :: recvbuf
    TYPE(MPI_Comm), INTENT(IN) :: comm
    TYPE(MPI_Info), INTENT(IN) :: info
    TYPE(MPI_Request), INTENT(OUT) :: request
    INTEGER, OPTIONAL, INTENT(OUT) :: ierror
```

**Fortran binding**

```
MPI_ALLGATHER_INIT(SENDBUF, SENDCOUNT, SENDTYPE, RECVBUF, RECVCOUNT,
    RECVTYPE, COMM, INFO, REQUEST, IERROR)
    <type> SENDBUF(*), RECVBUF(*)
    INTEGER SENDCOUNT, SENDTYPE, REVCOUNT, RECVTYPE, COMM, INFO, REQUEST,
    IERROR
```

Creates a persistent collective communication request for the allgather operation.

```

1 MPI_ALLGATHERV_INIT(sendbuf, sendcount, sendtype, recvbuf, recvcoun
2     comm, info, request)
3
4     IN     sendbuf     starting address of send buffer (choice)
5
6     IN     sendcount   number of elements in send buffer (non-negative inte-
7
8     IN     sendtype    data type of send buffer elements (handle)
9
10    OUT    recvbuf     address of receive buffer (choice)
11
12    IN     recvcoun
13           ts         non-negative integer array (of length group size) con-
14
15           taining the number of elements that are received from
16
17           each process
18
19    IN     displs      integer array (of length group size). Entry i specifies
20
21           the displacement (relative to recvbuf) at which to place
22
23           the incoming data from process i
24
25    IN     recvtype    data type of receive buffer elements (handle)
26
27    IN     comm        communicator (handle)
28
29    IN     info        info argument (handle)
30
31    OUT    request     communication request (handle)

```

**C binding**

```

23 int MPI_Allgatherv_init(const void *sendbuf, int sendcount,
24     MPI_Datatype sendtype, void *recvbuf, const int recvcoun
25     ts[],
26     const int displs[], MPI_Datatype recvtype, MPI_Comm comm,
27     MPI_Info info, MPI_Request *request)

```

**Fortran 2008 binding**

```

28 MPI_Allgatherv_init(sendbuf, sendcount, sendtype, recvbuf, recvcoun
29     ts,
30     displs, recvtype, comm, info, request, ierror)
31     TYPE(*), DIMENSION(..), INTENT(IN), ASYNCHRONOUS :: sendbuf
32     INTEGER, INTENT(IN) :: sendcount
33     TYPE(MPI_Datatype), INTENT(IN) :: sendtype, recvtype
34     TYPE(*), DIMENSION(..), ASYNCHRONOUS :: recvbuf
35     INTEGER, INTENT(IN), ASYNCHRONOUS :: recvcoun
36     ts(*), displs(*)
37     TYPE(MPI_Comm), INTENT(IN) :: comm
38     TYPE(MPI_Info), INTENT(IN) :: info
39     TYPE(MPI_Request), INTENT(OUT) :: request
40     INTEGER, OPTIONAL, INTENT(OUT) :: ierror

```

**Fortran binding**

```

41 MPI_ALLGATHERV_INIT(SENDBUF, SENDCOUNT, SENDTYPE, RECVBUF, RECVCOUNTS,
42     DISPLS, RECVTYPE, COMM, INFO, REQUEST, IERROR)
43     <type> SENDBUF(*), RECVBUF(*)
44     INTEGER SENDCOUNT, SENDTYPE, REVCOUNTS(*), DISPLS(*), RECVTYPE, COMM,
45     INFO, REQUEST, IERROR

```

Creates a persistent collective communication request for the allgatherv operation.

## 5.13.6 Persistent All-to-All Scatter/Gather

MPI\_ALLTOALL\_INIT(sendbuf, sendcount, sendtype, recvbuf, recvcnt, recvtype, comm, info, request)

IN	sendbuf	starting address of send buffer (choice)	1
IN	sendcount	number of elements sent to each process (non-negative integer)	2
IN	sendtype	data type of send buffer elements (handle)	3
OUT	recvbuf	address of receive buffer (choice)	4
IN	recvcnt	number of elements received from any process (non-negative integer)	5
IN	recvtype	data type of receive buffer elements (handle)	6
IN	comm	communicator (handle)	7
IN	info	info argument (handle)	8
OUT	request	communication request (handle)	9

**C binding**

```
int MPI_Alltoall_init(const void *sendbuf, int sendcount,
                    MPI_Datatype sendtype, void *recvbuf, int recvcnt,
                    MPI_Datatype recvtype, MPI_Comm comm, MPI_Info info,
                    MPI_Request *request)
```

**Fortran 2008 binding**

```
MPI_Alltoall_init(sendbuf, sendcount, sendtype, recvbuf, recvcnt,
                 recvtype, comm, info, request, ierror)
    TYPE(*), DIMENSION(..), INTENT(IN), ASYNCHRONOUS :: sendbuf
    INTEGER, INTENT(IN) :: sendcount, recvcnt
    TYPE(MPI_Datatype), INTENT(IN) :: sendtype, recvtype
    TYPE(*), DIMENSION(..), ASYNCHRONOUS :: recvbuf
    TYPE(MPI_Comm), INTENT(IN) :: comm
    TYPE(MPI_Info), INTENT(IN) :: info
    TYPE(MPI_Request), INTENT(OUT) :: request
    INTEGER, OPTIONAL, INTENT(OUT) :: ierror
```

**Fortran binding**

```
MPI_ALLTOALL_INIT(SENDBUF, SENDCOUNT, SENDTYPE, RECVBUF, RECVCOUNT,
                 RECVTYPE, COMM, INFO, REQUEST, IERROR)
    <type> SENDBUF(*), RECVBUF(*)
    INTEGER SENDCOUNT, SENDTYPE, REVCOUNT, RECVTYPE, COMM, INFO, REQUEST,
    IERROR
```

Creates a persistent collective communication request for the alltoall operation.

```

1 MPI_ALLTOALLV_INIT(sendbuf, sendcounts, sdispls, sendtype, recvbuf, recvcoun
2     recvtype, comm, info, request)
3
4     IN     sendbuf     starting address of send buffer (choice)
5
6     IN     sendcounts  non-negative integer array (of length group size) spec-
7     ifying the number of elements to send to each rank
8
9     IN     sdispls     Integer array (of length group size). Entry j specifies
10    the displacement (relative to sendbuf) from which to
11    take the outgoing data destined for process j
12
13    IN     sendtype    data type of send buffer elements (handle)
14
15    OUT    recvbuf     address of receive buffer (choice)
16
17    IN     recvcoun
18    ts              non-negative integer array (of length group size) spec-
19    ifying the number of elements that can be received
20    from each rank
21
22    IN     rdispls     integer array (of length group size). Entry i specifies
23    the displacement (relative to recvbuf) at which to place
24    the incoming data from process i
25
26    IN     recvtype    data type of receive buffer elements (handle)
27
28    IN     comm        communicator (handle)
29
30    IN     info        info argument (handle)
31
32    OUT    request     communication request (handle)

```

**C binding**

```

27 int MPI_Alltoallv_init(const void *sendbuf, const int sendcounts[],
28     const int sdispls[], MPI_Datatype sendtype, void *recvbuf,
29     const int recvcoun
30     ts[], const int rdispls[],
31     MPI_Datatype recvtype, MPI_Comm comm, MPI_Info info,
32     MPI_Request *request)

```

**Fortran 2008 binding**

```

33 MPI_Alltoallv_init(sendbuf, sendcounts, sdispls, sendtype, recvbuf,
34     recvcoun
35     ts, rdispls, recvtype, comm, info, request, ierror)
36     TYPE(*), DIMENSION(..), INTENT(IN), ASYNCHRONOUS :: sendbuf
37     INTEGER, INTENT(IN), ASYNCHRONOUS :: sendcounts(*), sdispls(*),
38     recvcoun
39     ts(*), rdispls(*)
40     TYPE(MPI_Datatype), INTENT(IN) :: sendtype, recvtype
41     TYPE(*), DIMENSION(..), ASYNCHRONOUS :: recvbuf
42     TYPE(MPI_Comm), INTENT(IN) :: comm
43     TYPE(MPI_Info), INTENT(IN) :: info
44     TYPE(MPI_Request), INTENT(OUT) :: request
45     INTEGER, OPTIONAL, INTENT(OUT) :: ierror

```

**Fortran binding**

```

46 MPI_ALLTOALLV_INIT(SENDBUF, SENDCOUNTS, SDISPLS, SENDTYPE, RECVBUF,
47     RECVCOUNTS, RDISPLS, RECVTYPE, COMM, INFO, REQUEST, IERROR)
48     <type> SENDBUF(*), RECVBUF(*)

```



```

    INTEGER SENDCOUNTS(*), SDISPLS(*), SENDTYPE, RECVCOUNTS(*),
    RDISPLS(*), RECVTYPE, COMM, INFO, REQUEST, IERROR

```

Creates a persistent collective communication request for the alltoallv operation.

```

MPI_ALLTOALLW_INIT(sendbuf, sendcounts, sdispls, sendtypes, recvbuf, recvcounts, rdispls,
    recvtypes, comm, info, request)

```

IN	sendbuf	starting address of send buffer (choice)
IN	sendcounts	integer array (of length group size) specifying the number of elements to send to each rank (array of non-negative integers)
IN	sdispls	integer array (of length group size). Entry j specifies the displacement in bytes (relative to sendbuf) from which to take the outgoing data destined for process j (array of integers)
IN	sendtypes	Array of datatypes (of length group size). Entry j specifies the type of data to send to process j (array of handles)
OUT	recvbuf	address of receive buffer (choice)
IN	recvcounts	integer array (of length group size) specifying the number of elements that can be received from each rank (array of non-negative integers)
IN	rdispls	integer array (of length group size). Entry i specifies the displacement in bytes (relative to recvbuf) at which to place the incoming data from process i (array of integers)
IN	recvtypes	array of datatypes (of length group size). Entry i specifies the type of data received from process i (array of handles)
IN	comm	communicator (handle)
IN	info	info argument (handle)
OUT	request	communication request (handle)

### C binding

```

int MPI_Alltoallw_init(const void *sendbuf, const int sendcounts[],
    const int sdispls[], const MPI_Datatype sendtypes[],
    void *recvbuf, const int recvcounts[], const int rdispls[],
    const MPI_Datatype recvtypes[], MPI_Comm comm, MPI_Info info,
    MPI_Request *request)

```

### Fortran 2008 binding

```

MPI_Alltoallw_init(sendbuf, sendcounts, sdispls, sendtypes, recvbuf,
    recvcounts, rdispls, recvtypes, comm, info, request, ierror)
    TYPE(*), DIMENSION(..), INTENT(IN), ASYNCHRONOUS :: sendbuf

```

```

1     INTEGER, INTENT(IN), ASYNCHRONOUS :: sendcounts(*), sdispls(*),
2     recvcounts(*), rdispls(*)
3     TYPE(MPI_Datatype), INTENT(IN), ASYNCHRONOUS :: sendtypes(*),
4     recvtypes(*)
5     TYPE(*), DIMENSION(..), ASYNCHRONOUS :: recvbuf
6     TYPE(MPI_Comm), INTENT(IN) :: comm
7     TYPE(MPI_Info), INTENT(IN) :: info
8     TYPE(MPI_Request), INTENT(OUT) :: request
9     INTEGER, OPTIONAL, INTENT(OUT) :: ierror

```

### Fortran binding

```

11 MPI_ALLTOALLW_INIT(SENDBUF, SENDCOUNTS, SDISPLS, SENDTYPES, RECVBUF,
12     RECVCOUNTS, RDISPLS, RECVTYPES, COMM, INFO, REQUEST, IERROR)
13     <type> SENDBUF(*), RECVBUF(*)
14     INTEGER SENDCOUNTS(*), SDISPLS(*), SENDTYPES(*), RECVCOUNTS(*),
15     RDISPLS(*), RECVTYPES(*), COMM, INFO, REQUEST, IERROR

```

Creates a persistent collective communication request for the alltoallw operation.

### 5.13.7 Persistent Reduce

```

22 MPI_REDUCE_INIT(sendbuf, recvbuf, count, datatype, op, root, comm, info, request)
23
24 IN     sendbuf           address of send buffer (choice)
25 OUT    recvbuf           address of receive buffer (choice, significant only at
26                                root)
27 IN     count             number of elements in send buffer (non-negative inte-
28                                ger)
29 IN     datatype          data type of elements of send buffer (handle)
30 IN     op                 reduce operation (handle)
31 IN     root              rank of root process (integer)
32 IN     comm              communicator (handle)
33 IN     info              info argument (handle)
34 IN     request           communication request (handle)

```

### C binding

```

39 int MPI_Reduce_init(const void *sendbuf, void *recvbuf, int count,
40     MPI_Datatype datatype, MPI_Op op, int root, MPI_Comm comm,
41     MPI_Info info, MPI_Request *request)

```

### Fortran 2008 binding

```

44 MPI_Reduce_init(sendbuf, recvbuf, count, datatype, op, root, comm, info,
45     request, ierror)
46     TYPE(*), DIMENSION(..), INTENT(IN), ASYNCHRONOUS :: sendbuf
47     TYPE(*), DIMENSION(..), ASYNCHRONOUS :: recvbuf
48     INTEGER, INTENT(IN) :: count, root

```

```

TYPE(MPI_Datatype), INTENT(IN) :: datatype
TYPE(MPI_Op), INTENT(IN) :: op
TYPE(MPI_Comm), INTENT(IN) :: comm
TYPE(MPI_Info), INTENT(IN) :: info
TYPE(MPI_Request), INTENT(OUT) :: request
INTEGER, OPTIONAL, INTENT(OUT) :: ierror

```

**Fortran binding**

```

MPI_REDUCE_INIT(SENDBUF, RECVBUF, COUNT, DATATYPE, OP, ROOT, COMM, INFO,
               REQUEST, IERROR)
<type> SENDBUF(*), RECVBUF(*)
INTEGER COUNT, DATATYPE, OP, ROOT, COMM, INFO, REQUEST, IERROR

```

Creates a persistent collective communication request for the reduce operation.

## 5.13.8 Persistent All-Reduce

```

MPI_ALLREDUCE_INIT(sendbuf, recvbuf, count, datatype, op, comm, info, request)

```

IN	sendbuf	starting address of send buffer (choice)
OUT	recvbuf	starting address of receive buffer (choice)
IN	count	number of elements in send buffer (non-negative integer)
IN	datatype	data type of elements of send buffer (handle)
IN	op	operation (handle)
IN	comm	communicator (handle)
IN	info	info argument (handle)
OUT	request	communication request (handle)

**C binding**

```

int MPI_Allreduce_init(const void *sendbuf, void *recvbuf, int count,
                      MPI_Datatype datatype, MPI_Op op, MPI_Comm comm,
                      MPI_Info info, MPI_Request *request)

```

**Fortran 2008 binding**

```

MPI_Allreduce_init(sendbuf, recvbuf, count, datatype, op, comm, info,
                  request, ierror)
TYPE(*), DIMENSION(..), INTENT(IN), ASYNCHRONOUS :: sendbuf
TYPE(*), DIMENSION(..), ASYNCHRONOUS :: recvbuf
INTEGER, INTENT(IN) :: count
TYPE(MPI_Datatype), INTENT(IN) :: datatype
TYPE(MPI_Op), INTENT(IN) :: op
TYPE(MPI_Comm), INTENT(IN) :: comm
TYPE(MPI_Info), INTENT(IN) :: info
TYPE(MPI_Request), INTENT(OUT) :: request
INTEGER, OPTIONAL, INTENT(OUT) :: ierror

```

**Fortran binding**

```

MPI_ALLREDUCE_INIT(SENDBUF, RECVBUF, COUNT, DATATYPE, OP, COMM, INFO,
    REQUEST, IERROR)
    <type> SENDBUF(*), RECVBUF(*)
    INTEGER COUNT, DATATYPE, OP, COMM, INFO, REQUEST, IERROR

```

Creates a persistent collective communication request for the allreduce operation.

**5.13.9 Persistent Reduce-Scatter with Equal Blocks**

```

MPI_REDUCE_SCATTER_BLOCK_INIT(sendbuf, recvbuf, recvcnt, datatype, op, comm, info,
    request)

```

IN	sendbuf	starting address of send buffer (choice)
OUT	recvbuf	starting address of receive buffer (choice)
IN	recvcnt	element count per block (non-negative integer)
IN	datatype	data type of elements of send and receive buffers (handle)
IN	op	operation (handle)
IN	comm	communicator (handle)
IN	info	info argument (handle)
OUT	request	communication request (handle)

**C binding**

```

int MPI_Reduce_scatter_block_init(const void *sendbuf, void *recvbuf,
    int recvcnt, MPI_Datatype datatype, MPI_Op op,
    MPI_Comm comm, MPI_Info info, MPI_Request *request)

```

**Fortran 2008 binding**

```

MPI_Reduce_scatter_block_init(sendbuf, recvbuf, recvcnt, datatype, op,
    comm, info, request, ierror)
    TYPE(*), DIMENSION(..), INTENT(IN), ASYNCHRONOUS :: sendbuf
    TYPE(*), DIMENSION(..), ASYNCHRONOUS :: recvbuf
    INTEGER, INTENT(IN) :: recvcnt
    TYPE(MPI_Datatype), INTENT(IN) :: datatype
    TYPE(MPI_Op), INTENT(IN) :: op
    TYPE(MPI_Comm), INTENT(IN) :: comm
    TYPE(MPI_Info), INTENT(IN) :: info
    TYPE(MPI_Request), INTENT(OUT) :: request
    INTEGER, OPTIONAL, INTENT(OUT) :: ierror

```

**Fortran binding**

```

MPI_REDUCE_SCATTER_BLOCK_INIT(SENDBUF, RECVBUF, RECVCOUNT, DATATYPE, OP,
    COMM, INFO, REQUEST, IERROR)
    <type> SENDBUF(*), RECVBUF(*)
    INTEGER RECVCOUNT, DATATYPE, OP, COMM, INFO, REQUEST, IERROR

```

Creates a persistent collective communication request for the reduce-scatter with equal blocks operation.

#### 5.13.10 Persistent Reduce-Scatter

`MPI_REDUCE_SCATTER_INIT(sendbuf, recvbuf, recvcnts, datatype, op, comm, info, request)`

IN	sendbuf	starting address of send buffer (choice)
OUT	recvbuf	starting address of receive buffer (choice)
IN	recvcnts	non-negative integer array specifying the number of elements in result distributed to each process. This array must be identical on all calling processes.
IN	datatype	data type of elements of input buffer (handle)
IN	op	operation (handle)
IN	comm	communicator (handle)
IN	info	info argument (handle)
OUT	request	communication request (handle)

#### C binding

```
int MPI_Reduce_scatter_init(const void *sendbuf, void *recvbuf,
                           const int recvcnts[], MPI_Datatype datatype, MPI_Op op,
                           MPI_Comm comm, MPI_Info info, MPI_Request *request)
```

#### Fortran 2008 binding

```
MPI_Reduce_scatter_init(sendbuf, recvbuf, recvcnts, datatype, op, comm,
                        info, request, ierror)
TYPE(*), DIMENSION(..), INTENT(IN), ASYNCHRONOUS :: sendbuf
TYPE(*), DIMENSION(..), ASYNCHRONOUS :: recvbuf
INTEGER, INTENT(IN), ASYNCHRONOUS :: recvcnts(*)
TYPE(MPI_Datatype), INTENT(IN) :: datatype
TYPE(MPI_Op), INTENT(IN) :: op
TYPE(MPI_Comm), INTENT(IN) :: comm
TYPE(MPI_Info), INTENT(IN) :: info
TYPE(MPI_Request), INTENT(OUT) :: request
INTEGER, OPTIONAL, INTENT(OUT) :: ierror
```

#### Fortran binding

```
MPI_REDUCE_SCATTER_INIT(SENDBUF, RECVBUF, RECVCOUNTS, DATATYPE, OP, COMM,
                        INFO, REQUEST, IERROR)
<type> SENDBUF(*), RECVBUF(*)
INTEGER RECVCOUNTS(*), DATATYPE, OP, COMM, INFO, REQUEST, IERROR
```

Creates a persistent collective communication request for the reduce-scatter operation.

## 5.13.11 Persistent Inclusive Scan

```

1 MPI_SCAN_INIT(sendbuf, recvbuf, count, datatype, op, comm, info, request)
2
3
4

```

5	IN	sendbuf	starting address of send buffer (choice)
6			
7	OUT	recvbuf	starting address of receive buffer (choice)
8	IN	count	number of elements in input buffer (non-negative integer)
9			
10	IN	datatype	data type of elements of input buffer (handle)
11	IN	op	operation (handle)
12	IN	comm	communicator (handle)
13	IN	info	info argument (handle)
14	OUT	request	communication request (handle)
15			
16			
17			

**C binding**

```

18
19 int MPI_Scan_init(const void *sendbuf, void *recvbuf, int count,
20                 MPI_Datatype datatype, MPI_Op op, MPI_Comm comm,
21                 MPI_Info info, MPI_Request *request)
22

```

**Fortran 2008 binding**

```

23 MPI_Scan_init(sendbuf, recvbuf, count, datatype, op, comm, info, request,
24             ierror)
25     TYPE(*), DIMENSION(..), INTENT(IN), ASYNCHRONOUS :: sendbuf
26     TYPE(*), DIMENSION(..), ASYNCHRONOUS :: recvbuf
27     INTEGER, INTENT(IN) :: count
28     TYPE(MPI_Datatype), INTENT(IN) :: datatype
29     TYPE(MPI_Op), INTENT(IN) :: op
30     TYPE(MPI_Comm), INTENT(IN) :: comm
31     TYPE(MPI_Info), INTENT(IN) :: info
32     TYPE(MPI_Request), INTENT(OUT) :: request
33     INTEGER, OPTIONAL, INTENT(OUT) :: ierror
34

```

**Fortran binding**

```

35 MPI_SCAN_INIT(SENDBUF, RECVBUF, COUNT, DATATYPE, OP, COMM, INFO, REQUEST,
36             IERROR)
37     <type> SENDBUF(*), RECVBUF(*)
38     INTEGER COUNT, DATATYPE, OP, COMM, INFO, REQUEST, IERROR
39

```

Creates a persistent collective communication request for the inclusive scan operation.

## 5.13.12 Persistent Exclusive Scan

`MPI_EXSCAN_INIT`(sendbuf, recvbuf, count, datatype, op, comm, info, request)

IN	sendbuf	starting address of send buffer (choice)
OUT	recvbuf	starting address of receive buffer (choice)
IN	count	number of elements in input buffer (non-negative integer)
IN	datatype	data type of elements of input buffer (handle)
IN	op	operation (handle)
IN	comm	intracommunicator (handle)
IN	info	info argument (handle)
OUT	request	communication request (handle)

**C binding**

```
int MPI_Exscan_init(const void *sendbuf, void *recvbuf, int count,
                   MPI_Datatype datatype, MPI_Op op, MPI_Comm comm,
                   MPI_Info info, MPI_Request *request)
```

**Fortran 2008 binding**

```
MPI_Exscan_init(sendbuf, recvbuf, count, datatype, op, comm, info, request,
                ierror)
    TYPE(*), DIMENSION(..), INTENT(IN), ASYNCHRONOUS :: sendbuf
    TYPE(*), DIMENSION(..), ASYNCHRONOUS :: recvbuf
    INTEGER, INTENT(IN) :: count
    TYPE(MPI_Datatype), INTENT(IN) :: datatype
    TYPE(MPI_Op), INTENT(IN) :: op
    TYPE(MPI_Comm), INTENT(IN) :: comm
    TYPE(MPI_Info), INTENT(IN) :: info
    TYPE(MPI_Request), INTENT(OUT) :: request
    INTEGER, OPTIONAL, INTENT(OUT) :: ierror
```

**Fortran binding**

```
MPI_EXSCAN_INIT(SENDBUF, RECVBUF, COUNT, DATATYPE, OP, COMM, INFO, REQUEST,
                IERROR)
    <type> SENDBUF(*), RECVBUF(*)
    INTEGER COUNT, DATATYPE, OP, COMM, INFO, REQUEST, IERROR
```

Creates a persistent collective communication request for the exclusive scan operation.

## 5.14 Correctness

A correct, portable program must invoke collective communications so that deadlock will not occur, whether collective communications are synchronizing or not. The following examples illustrate dangerous use of collective routines on intracommunicators.

1 **Example 5.25** The following is erroneous.

```
2
3 switch(rank) {
4     case 0:
5         MPI_Bcast(buf1, count, type, 0, comm);
6         MPI_Bcast(buf2, count, type, 1, comm);
7         break;
8     case 1:
9         MPI_Bcast(buf2, count, type, 1, comm);
10        MPI_Bcast(buf1, count, type, 0, comm);
11        break;
12 }
13
```

14 We assume that the group of `comm` is  $\{0,1\}$ . Two processes execute two broadcast  
15 operations in reverse order. If the operation is synchronizing then a deadlock will occur.

16 Collective operations must be executed in the same order at all members of the com-  
17 munication group.

18 **Example 5.26** The following is erroneous.

```
19
20 switch(rank) {
21     case 0:
22         MPI_Bcast(buf1, count, type, 0, comm0);
23         MPI_Bcast(buf2, count, type, 2, comm2);
24         break;
25     case 1:
26         MPI_Bcast(buf1, count, type, 1, comm1);
27         MPI_Bcast(buf2, count, type, 0, comm0);
28         break;
29     case 2:
30         MPI_Bcast(buf1, count, type, 2, comm2);
31         MPI_Bcast(buf2, count, type, 1, comm1);
32         break;
33 }
34
```

35 Assume that the group of `comm0` is  $\{0,1\}$ , of `comm1` is  $\{1, 2\}$  and of `comm2` is  $\{2,0\}$ . If  
36 the broadcast is a synchronizing operation, then there is a cyclic dependency: the broadcast  
37 in `comm2` completes only after the broadcast in `comm0`; the broadcast in `comm0` completes  
38 only after the broadcast in `comm1`; and the broadcast in `comm1` completes only after the  
39 broadcast in `comm2`. Thus, the code will deadlock.

40 Collective operations must be executed in an order so that no cyclic dependencies occur.  
41 Nonblocking collective operations can alleviate this issue.

42 **Example 5.27** The following is erroneous.

43  
44  
45  
46  
47  
48



```

switch(rank) {
  case 0:
    MPI_Bcast(buf1, count, type, 0, comm);
    MPI_Send(buf2, count, type, 1, tag, comm);
    break;
  case 1:
    MPI_Recv(buf2, count, type, 0, tag, comm, status);
    MPI_Bcast(buf1, count, type, 0, comm);
    break;
}

```

Process zero executes a broadcast, followed by a blocking send operation. Process one first executes a blocking receive that matches the send, followed by broadcast call that matches the broadcast of process zero. This program may deadlock. The broadcast call on process zero *may* block until process one executes the matching broadcast call, so that the send is not executed. Process one will definitely block on the receive and so, in this case, never executes the broadcast.

The relative order of execution of collective operations and point-to-point operations should be such, so that even if the collective operations and the point-to-point operations are synchronizing, no deadlock will occur.

**Example 5.28** An unsafe, non-deterministic program.

```

switch(rank) {
  case 0:
    MPI_Bcast(buf1, count, type, 0, comm);
    MPI_Send(buf2, count, type, 1, tag, comm);
    break;
  case 1:
    MPI_Recv(buf2, count, type, MPI_ANY_SOURCE, tag, comm, status);
    MPI_Bcast(buf1, count, type, 0, comm);
    MPI_Recv(buf2, count, type, MPI_ANY_SOURCE, tag, comm, status);
    break;
  case 2:
    MPI_Send(buf2, count, type, 1, tag, comm);
    MPI_Bcast(buf1, count, type, 0, comm);
    break;
}

```

All three processes participate in a broadcast. Process 0 sends a message to process 1 after the broadcast, and process 2 sends a message to process 1 before the broadcast. Process 1 receives before and after the broadcast, with a wildcard source argument.

Two possible executions of this program, with different matchings of sends and receives, are illustrated in Figure 5.12. Note that the second execution has the peculiar effect that a send executed after the broadcast is received at another node before the broadcast. This example illustrates the fact that one should not rely on collective communication functions to have particular synchronization effects. A program that works correctly only when the first execution occurs (only when broadcast is synchronizing) is erroneous.

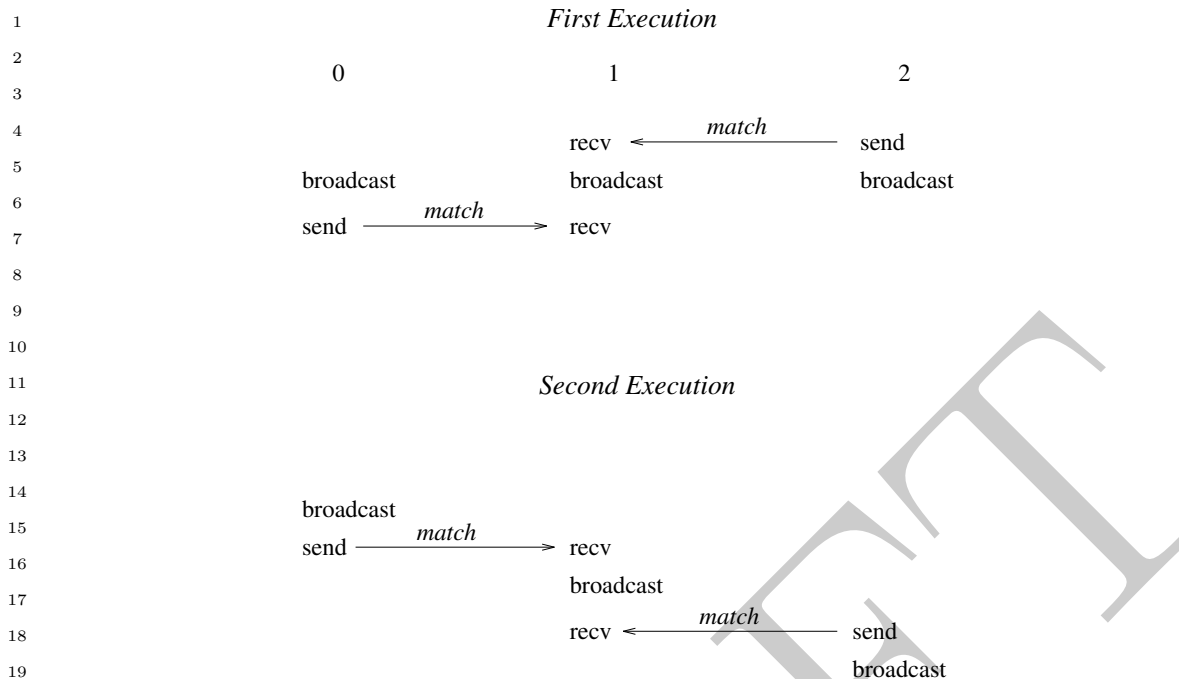

Figure 5.12: A race condition causes non-deterministic matching of sends and receives. One cannot rely on synchronization from a broadcast to make the program deterministic.

Finally, in multithreaded implementations, one can have more than one, concurrently executing, collective communication call at a process. In these situations, it is the user’s responsibility to ensure that the same communicator is not used concurrently by two different collective communication calls at the same process.

*Advice to implementors.* Assume that broadcast is implemented using point-to-point MPI communication. Suppose the following two rules are followed.

1. All receives specify their source explicitly (no wildcards).
2. Each process sends all messages that pertain to one collective call before sending any message that pertain to a subsequent collective call.

Then, messages belonging to successive broadcasts cannot be confused, as the order of point-to-point messages is preserved.

It is the implementor’s responsibility to ensure that point-to-point messages are not confused with collective messages. One way to accomplish this is, whenever a communicator is created, to also create a “hidden communicator” for collective communication. One could achieve a similar effect more cheaply, for example, by using a hidden tag or context bit to indicate whether the communicator is used for point-to-point or collective communication. (*End of advice to implementors.*)

**Example 5.29** Blocking and nonblocking collective operations can be interleaved, i.e., a blocking collective operation can be posted even if there is a nonblocking collective operation outstanding.

```
MPI_Request req;
MPI_Ibarrier(comm, &req);
MPI_Bcast(buf1, count, type, 0, comm);
MPI_Wait(&req, MPI_STATUS_IGNORE);
```

Each process starts a nonblocking barrier operation, participates in a blocking broadcast and then waits until every other process started the barrier operation. This effectively turns the broadcast into a synchronizing broadcast with possible communication/communication overlap (MPI\_Bcast is allowed, but not required to synchronize).

**Example 5.30** The starting order of collective operations on a particular communicator defines their matching. The following example shows an erroneous matching of different collective operations on the same communicator.

```
MPI_Request req;
switch(rank) {
  case 0:
    /* erroneous matching */
    MPI_Ibarrier(comm, &req);
    MPI_Bcast(buf1, count, type, 0, comm);
    MPI_Wait(&req, MPI_STATUS_IGNORE);
    break;
  case 1:
    /* erroneous matching */
    MPI_Bcast(buf1, count, type, 0, comm);
    MPI_Ibarrier(comm, &req);
    MPI_Wait(&req, MPI_STATUS_IGNORE);
    break;
}
```

This ordering would match MPI\_Ibarrier on rank 0 with MPI\_Bcast on rank 1 which is erroneous and the program behavior is undefined. However, if such an order is required, the user must create different duplicate communicators and perform the operations on them. If started with two processes, the following program would be correct:

```
MPI_Request req;
MPI_Comm dupcomm;
MPI_Comm_dup(comm, &dupcomm);
switch(rank) {
  case 0:
    MPI_Ibarrier(comm, &req);
    MPI_Bcast(buf1, count, type, 0, dupcomm);
    MPI_Wait(&req, MPI_STATUS_IGNORE);
    break;
  case 1:
    MPI_Bcast(buf1, count, type, 0, dupcomm);
    MPI_Ibarrier(comm, &req);
    MPI_Wait(&req, MPI_STATUS_IGNORE);
```

```

1         break;
2     }
3

```

*Advice to users.* The use of different communicators offers some flexibility regarding the matching of nonblocking collective operations. In this sense, communicators could be used as an equivalent to tags. However, communicator construction might induce overheads so that this should be used carefully. (*End of advice to users.*)

**Example 5.31** Nonblocking collective operations can rely on the same progression rules as nonblocking point-to-point messages. Thus, if started with two processes, the following program is a valid MPI program and is guaranteed to terminate:

```

13 MPI_Request req;
14
15 switch(rank) {
16     case 0:
17         MPI_Ibarrier(comm, &req);
18         MPI_Wait(&req, MPI_STATUS_IGNORE);
19         MPI_Send(buf, count, dtype, 1, tag, comm);
20         break;
21     case 1:
22         MPI_Ibarrier(comm, &req);
23         MPI_Recv(buf, count, dtype, 0, tag, comm, MPI_STATUS_IGNORE);
24         MPI_Wait(&req, MPI_STATUS_IGNORE);
25         break;
26 }
27

```

The MPI library must progress the barrier in the MPI\_Recv call. Thus, the MPI\_Wait call in rank 0 will eventually complete, which enables the matching MPI\_Send so all calls eventually return.

**Example 5.32** Blocking and nonblocking collective operations do not match. The following example is erroneous.

```

35 MPI_Request req;
36
37 switch(rank) {
38     case 0:
39         /* erroneous false matching of Alltoall and Ialltoall */
40         MPI_Ialltoall(sbuf, scnt, stype, rbuf, rcnt, rtype, comm, &req);
41         MPI_Wait(&req, MPI_STATUS_IGNORE);
42         break;
43     case 1:
44         /* erroneous false matching of Alltoall and Ialltoall */
45         MPI_Alltoall(sbuf, scnt, stype, rbuf, rcnt, rtype, comm);
46         break;
47 }
48

```

**Example 5.33** Collective and point-to-point requests can be mixed in functions that enable multiple completions. If started with two processes, the following program is valid.

```
MPI_Request reqs[2];

switch(rank) {
    case 0:
        MPI_Ibarrier(comm, &reqs[0]);
        MPI_Send(buf, count, dtype, 1, tag, comm);
        MPI_Wait(&reqs[0], MPI_STATUS_IGNORE);
        break;
    case 1:
        MPI_Irecv(buf, count, dtype, 0, tag, comm, &reqs[0]);
        MPI_Ibarrier(comm, &reqs[1]);
        MPI_Waitall(2, reqs, MPI_STATUSES_IGNORE);
        break;
}
```

The MPI\_Waitall call returns only after the barrier and the receive completed.

**Example 5.34** Multiple nonblocking collective operations can be outstanding on a single communicator and match in order.

```
MPI_Request reqs[3];

compute(buf1);
MPI_Ibcast(buf1, count, type, 0, comm, &reqs[0]);
compute(buf2);
MPI_Ibcast(buf2, count, type, 0, comm, &reqs[1]);
compute(buf3);
MPI_Ibcast(buf3, count, type, 0, comm, &reqs[2]);
MPI_Waitall(3, reqs, MPI_STATUSES_IGNORE);
```

*Advice to users.* Pipelining and double-buffering techniques can efficiently be used to overlap computation and communication. However, having too many outstanding requests might have a negative impact on performance. (*End of advice to users.*)

*Advice to implementors.* The use of pipelining may generate many outstanding requests. A high-quality hardware-supported implementation with limited resources should be able to fall back to a software implementation if its resources are exhausted. In this way, the implementation could limit the number of outstanding requests only by the available memory. (*End of advice to implementors.*)

**Example 5.35** Nonblocking collective operations can also be used to enable simultaneous collective operations on multiple overlapping communicators (see Figure 5.13). The following example is started with three processes and three communicators. The first communicator `comm1` includes ranks 0 and 1, `comm2` includes ranks 1 and 2, and `comm3` spans ranks 0 and 2. It is not possible to perform a blocking collective operation on all communicators because there exists no deadlock-free order to invoke them. However, nonblocking collective operations can easily be used to achieve this task.

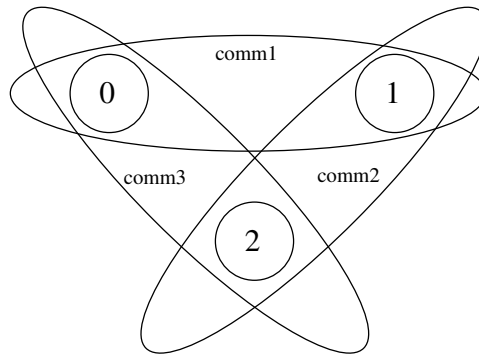

Figure 5.13: Example with overlapping communicators.

```

14 MPI_Request reqs[2];
15
16 switch(rank) {
17     case 0:
18         MPI_Iallreduce(sbuf1, rbuf1, count, dtype, MPI_SUM, comm1, &reqs[0]);
19         MPI_Iallreduce(sbuf3, rbuf3, count, dtype, MPI_SUM, comm3, &reqs[1]);
20         break;
21     case 1:
22         MPI_Iallreduce(sbuf1, rbuf1, count, dtype, MPI_SUM, comm1, &reqs[0]);
23         MPI_Iallreduce(sbuf2, rbuf2, count, dtype, MPI_SUM, comm2, &reqs[1]);
24         break;
25     case 2:
26         MPI_Iallreduce(sbuf2, rbuf2, count, dtype, MPI_SUM, comm2, &reqs[0]);
27         MPI_Iallreduce(sbuf3, rbuf3, count, dtype, MPI_SUM, comm3, &reqs[1]);
28         break;
29 }
30 MPI_Waitall(2, reqs, MPI_STATUSES_IGNORE);

```

*Advice to users.* This method can be useful if overlapping neighboring regions (halo or ghost zones) are used in collective operations. The sequence of the two calls in each process is irrelevant because the two nonblocking operations are performed on different communicators. (*End of advice to users.*)

**Example 5.36** The progress of multiple outstanding nonblocking collective operations is completely independent.

```

40 MPI_Request reqs[2];
41
42 compute(buf1);
43 MPI_Ibcast(buf1, count, type, 0, comm, &reqs[0]);
44 compute(buf2);
45 MPI_Ibcast(buf2, count, type, 0, comm, &reqs[1]);
46 MPI_Wait(&reqs[1], MPI_STATUS_IGNORE);
47 /* nothing is known about the status of the first bcast here */
48 MPI_Wait(&reqs[0], MPI_STATUS_IGNORE);

```

Finishing the second MPI\_IBCAST is completely independent of the first one. This means that it is not guaranteed that the first broadcast operation is finished or even started after the second one is completed via `reqs[1]`.

DRAFT

1  
2  
3  
4  
5  
6  
7  
8  
9  
10  
11  
12  
13  
14  
15  
16  
17  
18  
19  
20  
21  
22  
23  
24  
25  
26  
27  
28  
29  
30  
31  
32  
33  
34  
35  
36  
37  
38  
39  
40  
41  
42  
43  
44  
45  
46  
47  
48

1  
2  
3  
4  
5  
6  
7  
8  
9  
10  
11  
12  
13  
14  
15  
16  
17  
18  
19  
20  
21  
22  
23  
24  
25  
26  
27  
28  
29  
30  
31  
32  
33  
34  
35  
36  
37  
38  
39  
40  
41  
42  
43  
44  
45  
46  
47  
48

DRAFT



1  
2  
3  
4  
5  
6  
7  
8  
9  
10  
11  
12  
13  
14  
15  
16  
17  
18  
19  
20  
21  
22  
23  
24  
25  
26  
27  
28  
29  
30  
31  
32  
33  
34  
35  
36  
37  
38  
39  
40  
41  
42  
43  
44  
45  
46  
47  
48

## Chapter 6

# Groups, Contexts, Communicators, and Caching

### 6.1 Introduction

This chapter introduces MPI features that support the development of parallel libraries. Parallel libraries are needed to encapsulate the distracting complications inherent in parallel implementations of key algorithms. They help to ensure consistent correctness of such procedures, and provide a “higher level” of portability than MPI itself can provide. As such, libraries prevent each programmer from repeating the work of defining consistent data structures, data layouts, and methods that implement key algorithms (such as matrix operations). Since the best libraries come with several variations on parallel systems (different data layouts, different strategies depending on the size of the system or problem, or type of floating point), this too needs to be hidden from the user.

We refer the reader to [58] and [4] for further information on writing libraries in MPI, using the features described in this chapter.

#### 6.1.1 Features Needed to Support Libraries

The key features needed to support the creation of robust parallel libraries are as follows:

- Safe communication space, that guarantees that libraries can communicate as they need to, without conflicting with communication extraneous to the library,
- Group scope for collective operations, that allow libraries to avoid unnecessarily synchronizing uninvolved processes (potentially running unrelated code),
- Abstract process naming to allow libraries to describe their communication in terms suitable to their own data structures and algorithms,
- The ability to “adorn” a set of communicating processes with additional user-defined attributes, such as extra collective operations. This mechanism should provide a means for the user or library writer effectively to extend a message-passing notation.

In addition, a unified mechanism or object is needed for conveniently denoting communication context, the group of communicating processes, to house abstract process naming, and to store adornments.

## 6.1.2 MPI's Support for Libraries

The corresponding concepts that MPI provides, specifically to support robust libraries, are as follows:

- **Contexts** of communication,
- **Groups** of processes,
- **Virtual topologies**,
- **Attribute caching**,
- **Communicators**.

**Communicators** (see [22, 56, 60]) encapsulate all of these ideas in order to provide the appropriate scope for all communication operations in MPI. Communicators are divided into two kinds: intra-communicators for operations within a single group of processes and inter-communicators for operations between two groups of processes.

**Caching.** Communicators (see below) provide a “caching” mechanism that allows one to associate new attributes with communicators, on par with MPI built-in features. This can be used by advanced users to adorn communicators further, and by MPI to implement some communicator functions. For example, the virtual-topology functions described in Chapter 7 are likely to be supported this way.

**Groups.** Groups define an ordered collection of processes, each with a rank, and it is this group that defines the low-level names for inter-process communication (ranks are used for sending and receiving). Thus, groups define a scope for process names in point-to-point communication. In addition, groups define the scope of collective operations. Groups may be manipulated separately from communicators in MPI, but only communicators can be used in communication operations.

**Intra-communicators.** The most commonly used means for message passing in MPI is via intra-communicators. Intra-communicators contain an instance of a group, contexts of communication for both point-to-point and collective communication, and the ability to include virtual topology and other attributes. These features work as follows:

- **Contexts** provide the ability to have separate safe “universes” of message-passing in MPI. A context is akin to an additional tag that differentiates messages. The system manages this differentiation process. The use of separate communication contexts by distinct libraries (or distinct library invocations) insulates communication internal to the library execution from external communication. This allows the invocation of the library even if there are pending communications on “other” communicators, and avoids the need to synchronize entry or exit into library code. Pending point-to-point communications are also guaranteed not to interfere with collective communications within a single communicator.
- **Groups** define the participants in the communication (see above) of a communicator.

- A **virtual topology** defines a special mapping of the ranks in a group to and from a topology. Special constructors for communicators are defined in Chapter 7 to provide this feature. Intra-communicators as described in this chapter do not have topologies.
- **Attributes** define the local information that the user or library has added to a communicator for later reference.

*Advice to users.* The practice in many communication libraries is that there is a unique, predefined communication universe that includes all processes available when the parallel program is initiated; the processes are assigned consecutive ranks. Participants in a point-to-point communication are identified by their rank; a collective communication (such as broadcast) always involves all processes. When using the World Model (Section 10.2), this practice can be followed in MPI by using the predefined communicator `MPI_COMM_WORLD`. *Users who are satisfied with this practice can plug in `MPI_COMM_WORLD` wherever a communicator argument is required, and can consequently disregard the rest of this chapter. (End of advice to users.)*

**Inter-communicators.** The discussion has dealt so far with **intra-communication**: communication within a group. MPI also supports **inter-communication**: communication between two non-overlapping groups. When an application is built by composing several parallel modules, it is convenient to allow one module to communicate with another using local ranks for addressing within the second module. This is especially convenient in a client-server computing paradigm, where either client or server are parallel. The support of inter-communication also provides a mechanism for the extension of MPI to a dynamic model where not all processes are preallocated at initialization time. In such a situation, it becomes necessary to support communication across “universes.” Inter-communication is supported by objects called **inter-communicators**. These objects bind two groups together with communication contexts shared by both groups. For inter-communicators, these features work as follows:

- Contexts provide the ability to have a separate safe “universe” of message-passing between the two groups. A send in the local group is always a receive in the remote group, and vice versa. The system manages this differentiation process. The use of separate communication contexts by distinct libraries (or distinct library invocations) insulates communication internal to the library execution from external communication. This allows the invocation of the library even if there are pending communications on “other” communicators, and avoids the need to synchronize entry or exit into library code.
- A local and remote group specify the recipients and destinations for an inter-communicator.
- Virtual topology is undefined for an inter-communicator.
- As before, attributes cache defines the local information that the user or library has added to a communicator for later reference.

MPI provides mechanisms for creating and manipulating inter-communicators. They are used for point-to-point and collective communication in an related manner to intra-communicators. Users who do not need inter-communication in their applications can safely

1 ignore this extension. Users who require inter-communication between overlapping groups  
 2 must layer this capability on top of MPI.  
 3

## 4 6.2 Basic Concepts 5

6 In this section, we turn to a more formal definition of the concepts introduced above.  
 7

### 8 6.2.1 Groups 9

10 A **group** is an ordered set of process identifiers (henceforth processes); processes are imple-  
 11 mentation-dependent objects. Each process in a group is associated with an integer **rank**.  
 12 Ranks are contiguous and start from zero. Groups are represented by opaque **group ob-**  
 13 **jects**, and hence cannot be directly transferred from one process to another. A group is  
 14 used within a communicator to describe the participants in a communication “universe”  
 15 and to rank such participants (thus giving them unique names within that “universe” of  
 16 communication).

17 There is a special pre-defined group: `MPI_GROUP_EMPTY`, which is a group with no  
 18 members. The predefined constant `MPI_GROUP_NULL` is the value used for invalid group  
 19 handles.  
 20

21 *Advice to users.* `MPI_GROUP_EMPTY`, which is a valid handle to an empty group,  
 22 should not be confused with `MPI_GROUP_NULL`, which in turn is an invalid handle.  
 23 The former may be used as an argument to group operations; the latter, which is  
 24 returned when a group is freed, is not a valid argument. (*End of advice to users.*)  
 25

26 *Advice to implementors.* A group may be represented by a virtual-to-real process-  
 27 address-translation table. Each communicator object (see below) would have a pointer  
 28 to such a table.

29 Simple implementations of MPI will enumerate groups, such as in a table. However,  
 30 more advanced data structures make sense in order to improve scalability and memory  
 31 usage with large numbers of processes. Such implementations are possible with MPI.  
 32 (*End of advice to implementors.*)  
 33

### 34 6.2.2 Contexts 35

36 A **context** is a property of communicators (defined next) that allows partitioning of the  
 37 communication space. A message sent in one context cannot be received in another context.  
 38 Furthermore, where permitted, collective operations are independent of pending point-to-  
 39 point operations. Contexts are not explicit MPI objects; they appear only as part of the  
 40 realization of communicators (below).  
 41

42 *Advice to implementors.* Distinct communicators in the same process have distinct  
 43 contexts. A context is essentially a system-managed tag (or tags) needed to make  
 44 a communicator safe for point-to-point and MPI-defined collective communication.  
 45 Safety means that collective and point-to-point communication within one commu-  
 46 nicator do not interfere, and that communication over distinct communicators don’t  
 47 interfere.  
 48

A possible implementation for a context is as a supplemental tag attached to messages on send and matched on receive. Each intra-communicator stores the value of its two tags (one for point-to-point and one for collective communication). Communicator-generating functions use a collective communication to agree on a new group-wide unique context.

Analogously, in inter-communication, two context tags are stored per communicator, one used by group A to send and group B to receive, and a second used by group B to send and for group A to receive.

Since contexts are not explicit objects, other implementations are also possible. (*End of advice to implementors.*)

### 6.2.3 Intra-Communicators

Intra-communicators bring together the concepts of group and context. To support implementation-specific optimizations, and application topologies (defined in the next chapter, Chapter 7), communicators may also “cache” additional information (see Section 6.7). MPI communication operations reference communicators to determine the scope and the “communication universe” in which a point-to-point or collective operation is to operate.

Each communicator contains a group of valid participants; this group always includes the local process. The source and destination of a message is identified by process rank within that group.

For collective communication, the intra-communicator specifies the set of processes that participate in the collective operation (and their order, when significant). Thus, the communicator restricts the “spatial” scope of communication, and provides machine-independent process addressing through ranks.

Intra-communicators are represented by opaque **intra-communicator objects**, and hence cannot be directly transferred from one process to another.

### 6.2.4 Predefined Intra-Communicators

When using the World Model for MPI initialization, an initial intra-communicator `MPI_COMM_WORLD` of all processes the local process can communicate with after initialization (itself included) is defined once `MPI_INIT` or `MPI_INIT_THREAD` has been called. In addition, the communicator `MPI_COMM_SELF` is provided, which includes only the process itself. When using the Sessions Model (Section 10.3) for initialization of MPI resources, `MPI_COMM_WORLD` and `MPI_COMM_SELF` are not valid for use as a communicator. See the discussion concerning use of MPI named constants in 2.5.4 for valid uses of `MPI_COMM_WORLD` and `MPI_COMM_SELF` prior to initialization of MPI.

The predefined constant `MPI_COMM_NULL` is the value used for invalid communicator handles.

In a static-process-model implementation of MPI, all processes that participate in the computation are available after MPI is initialized. For this case, `MPI_COMM_WORLD` is a communicator of all processes available for the computation; this communicator has the same value in all processes. In an implementation of MPI where processes can dynamically join an MPI execution, it may be the case that a process starts an MPI computation without having access to all other processes. In such situations, `MPI_COMM_WORLD` is a communicator incorporating all processes with which the joining process can immediately

1 communicate. Therefore, MPI\_COMM\_WORLD may simultaneously represent disjoint groups  
2 in different processes.

3 All MPI implementations are required to provide the MPI\_COMM\_WORLD communi-  
4 cator. It cannot be deallocated during the life of a process. The group corresponding to  
5 this communicator does not appear as a pre-defined constant, but it may be accessed using  
6 MPI\_COMM\_GROUP (see below). MPI does not specify the correspondence between the  
7 process rank in MPI\_COMM\_WORLD and its (machine-dependent) absolute address. Neither  
8 does MPI specify the function of the host process, if any. Other implementation-dependent,  
9 predefined communicators may also be provided.

## 11 6.3 Group Management

13 This section describes the manipulation of process groups in MPI. These operations are  
14 local and their execution does not require interprocess communication.

### 16 6.3.1 Group Accessors

19 MPI\_GROUP\_SIZE(group, size)

21	IN	group	group (handle)
22	OUT	size	number of processes in the group (integer)

#### 24 C binding

25 int MPI\_Group\_size(MPI\_Group group, int \*size)

#### 27 Fortran 2008 binding

28 MPI\_Group\_size(group, size, ierror)  
29 TYPE(MPI\_Group), INTENT(IN) :: group  
30 INTEGER, INTENT(OUT) :: size  
31 INTEGER, OPTIONAL, INTENT(OUT) :: ierror

#### 32 Fortran binding

33 MPI\_GROUP\_SIZE(GROUP, SIZE, IERROR)  
34 INTEGER GROUP, SIZE, IERROR

37 MPI\_GROUP\_RANK(group, rank)

39	IN	group	group (handle)
40	OUT	rank	rank of the calling process in group, or
41			MPI_UNDEFINED if the process is not a member (in-
42			teger)

#### 45 C binding

46 int MPI\_Group\_rank(MPI\_Group group, int \*rank)

#### 47 Fortran 2008 binding

```

MPI_Group_rank(group, rank, ierror) 1
    TYPE(MPI_Group), INTENT(IN) :: group 2
    INTEGER, INTENT(OUT) :: rank 3
    INTEGER, OPTIONAL, INTENT(OUT) :: ierror 4

```

**Fortran binding**

```

MPI_GROUP_RANK(GROUP, RANK, IERROR) 6
    INTEGER GROUP, RANK, IERROR 7

```

```

MPI_GROUP_TRANSLATE_RANKS(group1, n, ranks1, group2, ranks2) 11

```

```

IN      group1          group1 (handle) 12
IN      n               number of ranks in ranks1 and ranks2 arrays (integer) 13
IN      ranks1          array of zero or more valid ranks in group1 14
IN      group2          group2 (handle) 15
OUT     ranks2          array of corresponding ranks in group2, 16
                        MPI_UNDEFINED when no correspondence exists. 17

```

**C binding**

```

int MPI_Group_translate_ranks(MPI_Group group1, int n, const int ranks1[], 21
                             MPI_Group group2, int ranks2[]) 22

```

**Fortran 2008 binding**

```

MPI_Group_translate_ranks(group1, n, ranks1, group2, ranks2, ierror) 25
    TYPE(MPI_Group), INTENT(IN) :: group1, group2 26
    INTEGER, INTENT(IN) :: n, ranks1(n) 27
    INTEGER, INTENT(OUT) :: ranks2(n) 28
    INTEGER, OPTIONAL, INTENT(OUT) :: ierror 29

```

**Fortran binding**

```

MPI_GROUP_TRANSLATE_RANKS(GROUP1, N, RANKS1, GROUP2, RANKS2, IERROR) 31
    INTEGER GROUP1, N, RANKS1(*), GROUP2, RANKS2(*), IERROR 32

```

This function is important for determining the relative numbering of the same processes in two different groups. For instance, if one knows the ranks of certain processes in the group of MPI\_COMM\_WORLD, one might want to know their ranks in a subset of that group.

MPI\_PROC\_NULL is a valid rank for input to MPI\_GROUP\_TRANSLATE\_RANKS, which returns MPI\_PROC\_NULL as the translated rank.

```

MPI_GROUP_COMPARE(group1, group2, result) 41

```

```

IN      group1          first group (handle) 42
IN      group2          second group (handle) 43
OUT     result          result (integer) 44

```

**C binding**

```

int MPI_Group_compare(MPI_Group group1, MPI_Group group2, int *result) 47

```

**Fortran 2008 binding**

```

MPI_Group_compare(group1, group2, result, ierror)
    TYPE(MPI_Group), INTENT(IN) :: group1, group2
    INTEGER, INTENT(OUT) :: result
    INTEGER, OPTIONAL, INTENT(OUT) :: ierror

```

**Fortran binding**

```

MPI_GROUP_COMPARE(GROUP1, GROUP2, RESULT, IERROR)
    INTEGER GROUP1, GROUP2, RESULT, IERROR

```

MPI\_IDENT results if the group members and group order is exactly the same in both groups. This happens for instance if `group1` and `group2` are the same handle. MPI\_SIMILAR results if the group members are the same but the order is different. MPI\_UNEQUAL results otherwise.

**6.3.2 Group Constructors**

MPI provides two approaches to constructing groups. In the first approach, MPI procedures are provided to subset and superset existing groups. These constructors construct new groups from existing groups. In the second approach, a group is created using a session handle and associated process set. This second approach is available when using the Sessions Model. With both approaches, these are local operations, and distinct groups may be defined on different processes; a process may also define a group that does not include itself. Consistent definitions are required when groups are used as arguments in communicator-building functions. When using the World Model for initializing MPI, the base group, upon which all other groups are defined, is the group associated with the initial communicator MPI\_COMM\_WORLD (accessible through the function MPI\_COMM\_GROUP).

*Rationale.* In what follows, there is no group duplication function analogous to MPI\_COMM\_DUP, defined later in this chapter. There is no need for a group duplicator. A group, once created, can have several references to it by making copies of the handle. The following constructors address the need for subsets and supersets of existing groups. (*End of rationale.*)

*Advice to implementors.* Each group constructor behaves as if it returned a new group object. When this new group is a copy of an existing group, then one can avoid creating such new objects, using a reference-count mechanism. (*End of advice to implementors.*)

```

MPI_COMM_GROUP(comm, group)

```

IN	comm	communicator (handle)
OUT	group	group corresponding to comm (handle)

**C binding**

```

int MPI_Comm_group(MPI_Comm comm, MPI_Group *group)

```

**Fortran 2008 binding**

```

MPI_Comm_group(comm, group, ierror)

```



```

TYPE(MPI_Comm), INTENT(IN) :: comm
TYPE(MPI_Group), INTENT(OUT) :: group
INTEGER, OPTIONAL, INTENT(OUT) :: ierror

```

**Fortran binding**

```

MPI_COMM_GROUP(COMM, GROUP, IERROR)
    INTEGER COMM, GROUP, IERROR

```

MPI\_COMM\_GROUP returns in group a handle to the group of comm.

```

MPI_GROUP_UNION(group1, group2, newgroup)

```

```

IN      group1          first group (handle)
IN      group2          second group (handle)
OUT     newgroup        union group (handle)

```

**C binding**

```

int MPI_Group_union(MPI_Group group1, MPI_Group group2,
    MPI_Group *newgroup)

```

**Fortran 2008 binding**

```

MPI_Group_union(group1, group2, newgroup, ierror)
    TYPE(MPI_Group), INTENT(IN) :: group1, group2
    TYPE(MPI_Group), INTENT(OUT) :: newgroup
    INTEGER, OPTIONAL, INTENT(OUT) :: ierror

```

**Fortran binding**

```

MPI_GROUP_UNION(GROUP1, GROUP2, NEWGROUP, IERROR)
    INTEGER GROUP1, GROUP2, NEWGROUP, IERROR

```

```

MPI_GROUP_INTERSECTION(group1, group2, newgroup)

```

```

IN      group1          first group (handle)
IN      group2          second group (handle)
OUT     newgroup        intersection group (handle)

```

**C binding**

```

int MPI_Group_intersection(MPI_Group group1, MPI_Group group2,
    MPI_Group *newgroup)

```

**Fortran 2008 binding**

```

MPI_Group_intersection(group1, group2, newgroup, ierror)
    TYPE(MPI_Group), INTENT(IN) :: group1, group2
    TYPE(MPI_Group), INTENT(OUT) :: newgroup
    INTEGER, OPTIONAL, INTENT(OUT) :: ierror

```

**Fortran binding**

```

MPI_GROUP_INTERSECTION(GROUP1, GROUP2, NEWGROUP, IERROR)

```

1 INTEGER GROUP1, GROUP2, NEWGROUP, IERROR

2

3

4 MPI\_GROUP\_DIFFERENCE(group1, group2, newgroup)

5

6 IN group1 first group (handle)

7 IN group2 second group (handle)

8 OUT newgroup difference group (handle)

9

### 10 C binding

11 int MPI\_Group\_difference(MPI\_Group group1, MPI\_Group group2,  
12 MPI\_Group \*newgroup)

13

### 14 Fortran 2008 binding

15 MPI\_Group\_difference(group1, group2, newgroup, ierror)

16 TYPE(MPI\_Group), INTENT(IN) :: group1, group2

17 TYPE(MPI\_Group), INTENT(OUT) :: newgroup

18 INTEGER, OPTIONAL, INTENT(OUT) :: ierror

19

### 20 Fortran binding

21 MPI\_GROUP\_DIFFERENCE(GROUP1, GROUP2, NEWGROUP, IERROR)

22 INTEGER GROUP1, GROUP2, NEWGROUP, IERROR

23

24 The set-like operations are defined as follows:

25

26 **union** All elements of the first group (group1), followed by all elements of second group (group2) not in the first group.

27

28 **intersect** all elements of the first group that are also in the second group, ordered as in the first group.

29

30 **difference** all elements of the first group that are not in the second group, ordered as in the first group.

31

32 Note that for these operations the order of processes in the output group is determined primarily by order in the first group (if possible) and then, if necessary, by order in the second group. Neither union nor intersection are commutative, but both are associative.

33

34 The new group can be empty, that is, equal to MPI\_GROUP\_EMPTY.

35

36

37

38 MPI\_GROUP\_INCL(group, n, ranks, newgroup)

39

40 IN group group (handle)

41

42 IN n number of elements in array ranks (and size of newgroup) (integer)

43

44 IN ranks ranks of processes in group to appear in newgroup (array of integers)

45

46 OUT newgroup new group derived from above, in the order defined by ranks (handle)

47

48

### 49 C binding

```
int MPI_Group_incl(MPI_Group group, int n, const int ranks[],
                  MPI_Group *newgroup)
```

**Fortran 2008 binding**

```
MPI_Group_incl(group, n, ranks, newgroup, ierror)
  TYPE(MPI_Group), INTENT(IN) :: group
  INTEGER, INTENT(IN) :: n, ranks(n)
  TYPE(MPI_Group), INTENT(OUT) :: newgroup
  INTEGER, OPTIONAL, INTENT(OUT) :: ierror
```

**Fortran binding**

```
MPI_GROUP_INCL(GROUP, N, RANKS, NEWGROUP, IERROR)
  INTEGER GROUP, N, RANKS(*), NEWGROUP, IERROR
```

The function `MPI_GROUP_INCL` creates a group `newgroup` that consists of the `n` processes in `group` with ranks `ranks[0], ..., ranks[n-1]`; the process with rank `i` in `newgroup` is the process with rank `ranks[i]` in `group`. Each of the `n` elements of `ranks` must be a valid rank in `group` and all elements must be distinct, or else the program is erroneous. If `n = 0`, then `newgroup` is `MPI_GROUP_EMPTY`. This function can, for instance, be used to reorder the elements of a group. See also `MPI_GROUP_COMPARE`.

```
MPI_GROUP_EXCL(group, n, ranks, newgroup)
```

IN	group	group (handle)
IN	n	number of elements in array ranks (integer)
IN	ranks	array of integer ranks of processes in group not to appear in newgroup
OUT	newgroup	new group derived from above, preserving the order defined by group (handle)

**C binding**

```
int MPI_Group_excl(MPI_Group group, int n, const int ranks[],
                  MPI_Group *newgroup)
```

**Fortran 2008 binding**

```
MPI_Group_excl(group, n, ranks, newgroup, ierror)
  TYPE(MPI_Group), INTENT(IN) :: group
  INTEGER, INTENT(IN) :: n, ranks(n)
  TYPE(MPI_Group), INTENT(OUT) :: newgroup
  INTEGER, OPTIONAL, INTENT(OUT) :: ierror
```

**Fortran binding**

```
MPI_GROUP_EXCL(GROUP, N, RANKS, NEWGROUP, IERROR)
  INTEGER GROUP, N, RANKS(*), NEWGROUP, IERROR
```

The function `MPI_GROUP_EXCL` creates a group of processes `newgroup` that is obtained by deleting from `group` those processes with ranks `ranks[0], ..., ranks[n-1]`. The ordering of processes in `newgroup` is identical to the ordering in `group`. Each of the `n` elements of `ranks`

1 must be a valid rank in `group` and all elements must be distinct; otherwise, the program is  
 2 erroneous. If `n = 0`, then `newgroup` is identical to `group`.

3  
 4  
 5 `MPI_GROUP_RANGE_INCL(group, n, ranges, newgroup)`

6	IN	<code>group</code>	<code>group</code> (handle)
7	IN	<code>n</code>	number of triplets in array <code>ranges</code> (integer)
8			
9	IN	<code>ranges</code>	a one-dimensional array of integer triplets, of the form 10 (first rank, last rank, stride) indicating ranks in <code>group</code> 11 of processes to be included in <code>newgroup</code>
12	OUT	<code>newgroup</code>	new group derived from above, in the order defined by 13 <code>ranges</code> (handle)

### 15 C binding

```
16 int MPI_Group_range_incl(MPI_Group group, int n, int ranges[][3],
17 MPI_Group *newgroup)
18
```

### 19 Fortran 2008 binding

```
20 MPI_Group_range_incl(group, n, ranges, newgroup, ierror)
21 TYPE(MPI_Group), INTENT(IN) :: group
22 INTEGER, INTENT(IN) :: n, ranges(3, n)
23 TYPE(MPI_Group), INTENT(OUT) :: newgroup
24 INTEGER, OPTIONAL, INTENT(OUT) :: ierror
25
```

### 25 Fortran binding

```
26 MPI_GROUP_RANGE_INCL(GROUP, N, RANGES, NEWGROUP, IERROR)
27 INTEGER GROUP, N, RANGES(3, *), NEWGROUP, IERROR
28
```

29 If `ranges` consists of the triplets

30  $(first_1, last_1, stride_1), \dots, (first_n, last_n, stride_n)$

31 then `newgroup` consists of the sequence of processes in `group` with ranks

32  
 33  
 34  $first_1, first_1 + stride_1, \dots, first_1 + \left\lfloor \frac{last_1 - first_1}{stride_1} \right\rfloor stride_1, \dots,$

35  
 36  
 37  $first_n, first_n + stride_n, \dots, first_n + \left\lfloor \frac{last_n - first_n}{stride_n} \right\rfloor stride_n.$

38  
 39 Each computed rank must be a valid rank in `group` and all computed ranks must be  
 40 distinct, or else the program is erroneous. Note that we may have  $first_i > last_i$ , and  $stride_i$   
 41 may be negative, but cannot be zero.

42 The functionality of this routine is specified to be equivalent to expanding the array  
 43 of `ranges` to an array of the included ranks and passing the resulting array of ranks and  
 44 other arguments to `MPI_GROUP_INCL`. A call to `MPI_GROUP_INCL` is equivalent to a call  
 45 to `MPI_GROUP_RANGE_INCL` with each rank `i` in `ranks` replaced by the triplet `(i,i,1)` in the  
 46 argument `ranges`.  
 47  
 48

MPI\_GROUP\_RANGE\_EXCL(group, n, ranges, newgroup)

IN	group	group (handle)	1 2 3
IN	n	number of triplets in array <code>ranges</code> (integer)	4
IN	ranges	a one-dimensional array of integer triplets, of the form (first rank, last rank, stride) indicating ranks in <code>group</code> of processes to be excluded from the output group <code>newgroup</code> (array of integers)	5 6 7 8 9
OUT	newgroup	new group derived from above, preserving the order in <code>group</code> (handle)	10 11

### C binding

```
int MPI_Group_range_excl(MPI_Group group, int n, int ranges[][3],
                        MPI_Group *newgroup)
```

### Fortran 2008 binding

```
MPI_Group_range_excl(group, n, ranges, newgroup, ierror)
  TYPE(MPI_Group), INTENT(IN) :: group
  INTEGER, INTENT(IN) :: n, ranges(3, n)
  TYPE(MPI_Group), INTENT(OUT) :: newgroup
  INTEGER, OPTIONAL, INTENT(OUT) :: ierror
```

### Fortran binding

```
MPI_GROUP_RANGE_EXCL(GROUP, N, RANGES, NEWGROUP, IERROR)
  INTEGER GROUP, N, RANGES(3, *), NEWGROUP, IERROR
```

Each computed rank must be a valid rank in `group` and all computed ranks must be distinct, or else the program is erroneous.

The functionality of this routine is specified to be equivalent to expanding the array of `ranges` to an array of the excluded ranks and passing the resulting array of ranks and other arguments to `MPI_GROUP_EXCL`. A call to `MPI_GROUP_EXCL` is equivalent to a call to `MPI_GROUP_RANGE_EXCL` with each rank `i` in `ranks` replaced by the triplet `(i,i,1)` in the argument `ranges`.

*Advice to users.* The range operations do not explicitly enumerate ranks, and therefore are more scalable if implemented efficiently. Hence, we recommend MPI programmers to use them whenever possible, as high-quality implementations will take advantage of this fact. (*End of advice to users.*)

*Advice to implementors.* The range operations should be implemented, if possible, without enumerating the group members, in order to obtain better scalability (time and space). (*End of advice to implementors.*)

```

1 MPI_GROUP_FROM_SESSION_PSET(session, pset_name, newgroup)
2     IN      session          session (handle)
3
4     IN      pset_name        name of process set to use to create the new group
5                               (string)
6
7     OUT     newgroup         new group derived from supplied session and process
8                               set (handle)

```

**C binding**

```

10 int MPI_Group_from_session_pset(MPI_Session session, const char *pset_name,
11                               MPI_Group *newgroup)
12

```

**Fortran 2008 binding**

```

14 MPI_Group_from_session_pset(session, pset_name, newgroup, ierror)
15     TYPE(MPI_Session), INTENT(IN) :: session
16     CHARACTER(LEN=*), INTENT(IN) :: pset_name
17     TYPE(MPI_Group), INTENT(OUT) :: newgroup
18     INTEGER, OPTIONAL, INTENT(OUT) :: ierror

```

**Fortran binding**

```

20 MPI_GROUP_FROM_SESSION_PSET(SESSION, PSET_NAME, NEWGROUP, IERROR)
21     INTEGER SESSION, NEWGROUP, IERROR
22     CHARACTER*(*) PSET_NAME

```

The function `MPI_GROUP_FROM_SESSION_PSET` creates a group `newgroup` using the provided session handle and process set. The process set name must be one returned from an invocation of `MPI_SESSION_GET_NTH_PSET` using the supplied session handle. If the `pset_name` does not exist, `MPI_GROUP_NULL` will be returned in the `newgroup` argument. As with other group constructors, `MPI_GROUP_FROM_SESSION_PSET` is a local function. See section 10.3 for more information on sessions and process sets.

**6.3.3 Group Destructors**

```

34 MPI_GROUP_FREE(group)
35
36     INOUT  group            group (handle)

```

**C binding**

```

39 int MPI_Group_free(MPI_Group *group)

```

**Fortran 2008 binding**

```

41 MPI_Group_free(group, ierror)
42     TYPE(MPI_Group), INTENT(INOUT) :: group
43     INTEGER, OPTIONAL, INTENT(OUT) :: ierror

```

**Fortran binding**

```

46 MPI_GROUP_FREE(GROUP, IERROR)
47     INTEGER GROUP, IERROR

```

This operation marks a group object for deallocation. The handle `group` is set to `MPI_GROUP_NULL` by the call. Any on-going operation using this group will complete normally.

*Advice to implementors.* One can keep a reference count that is incremented for each call to `MPI_COMM_GROUP`, `MPI_COMM_CREATE`, `MPI_COMM_DUP`, and `MPI_COMM_IDUP`, and decremented for each call to `MPI_GROUP_FREE` or `MPI_COMM_FREE`; the group object is ultimately deallocated when the reference count drops to zero. (*End of advice to implementors.*)

## 6.4 Communicator Management

This section describes the manipulation of communicators in MPI. Operations that access communicators are local and their execution does not require interprocess communication. Operations that create communicators are collective and may require interprocess communication.

*Advice to implementors.* High-quality implementations should amortize the overheads associated with the creation of communicators (for the same group, or subsets thereof) over several calls, by allocating multiple contexts with one collective communication. (*End of advice to implementors.*)

### 6.4.1 Communicator Accessors

The following are all local operations.

`MPI_COMM_SIZE(comm, size)`

IN	<code>comm</code>	communicator (handle)
OUT	<code>size</code>	number of processes in the group of <code>comm</code> (integer)

#### C binding

```
int MPI_Comm_size(MPI_Comm comm, int *size)
```

#### Fortran 2008 binding

```
MPI_Comm_size(comm, size, ierror)
    TYPE(MPI_Comm), INTENT(IN) :: comm
    INTEGER, INTENT(OUT) :: size
    INTEGER, OPTIONAL, INTENT(OUT) :: ierror
```

#### Fortran binding

```
MPI_COMM_SIZE(COMM, SIZE, IERROR)
    INTEGER COMM, SIZE, IERROR
```

*Rationale.* This function is equivalent to accessing the communicator's group with `MPI_COMM_GROUP` (see above), computing the size using `MPI_GROUP_SIZE`, and then freeing the temporary group via `MPI_GROUP_FREE`. However, this function is so commonly used that this shortcut was introduced. (*End of rationale.*)

*Advice to users.* This function indicates the number of processes involved in a communicator. For `MPI_COMM_WORLD`, it indicates the total number of processes available unless the number of processes has been changed by using the functions described in Chapter 10; note that the number of processes in `MPI_COMM_WORLD` does not change during the life of an MPI program.

This call is often used with the next call to determine the amount of concurrency available for a specific library or program. The following call, `MPI_COMM_RANK` indicates the rank of the process that calls it in the range from 0, . . . , `size-1`, where `size` is the return value of `MPI_COMM_SIZE`. (*End of advice to users.*)

`MPI_COMM_RANK(comm, rank)`

IN	<code>comm</code>	communicator (handle)
OUT	<code>rank</code>	rank of the calling process in group of <code>comm</code> (integer)

### C binding

```
int MPI_Comm_rank(MPI_Comm comm, int *rank)
```

### Fortran 2008 binding

```
MPI_Comm_rank(comm, rank, ierror)
  TYPE(MPI_Comm), INTENT(IN) :: comm
  INTEGER, INTENT(OUT) :: rank
  INTEGER, OPTIONAL, INTENT(OUT) :: ierror
```

### Fortran binding

```
MPI_COMM_RANK(COMM, RANK, IERROR)
  INTEGER COMM, RANK, IERROR
```

*Rationale.* This function is equivalent to accessing the communicator's group with `MPI_COMM_GROUP` (see above), computing the rank using `MPI_GROUP_RANK`, and then freeing the temporary group via `MPI_GROUP_FREE`. However, this function is so commonly used that this shortcut was introduced. (*End of rationale.*)

*Advice to users.* This function gives the rank of the process in the particular communicator's group. It is useful, as noted above, in conjunction with `MPI_COMM_SIZE`.

Many programs will be written with the master-slave model, where one process (such as the rank-zero process) will play a supervisory role, and the other processes will serve as compute nodes. In this framework, the two preceding calls are useful for determining the roles of the various processes of a communicator. (*End of advice to users.*)



MPI\_COMM\_COMPARE(comm1, comm2, result)

IN	comm1	first communicator (handle)
IN	comm2	second communicator (handle)
OUT	result	result (integer)

#### C binding

```
int MPI_Comm_compare(MPI_Comm comm1, MPI_Comm comm2, int *result)
```

#### Fortran 2008 binding

```
MPI_Comm_compare(comm1, comm2, result, ierror)
  TYPE(MPI_Comm), INTENT(IN) :: comm1, comm2
  INTEGER, INTENT(OUT) :: result
  INTEGER, OPTIONAL, INTENT(OUT) :: ierror
```

#### Fortran binding

```
MPI_COMM_COMPARE(COMM1, COMM2, RESULT, IERROR)
  INTEGER COMM1, COMM2, RESULT, IERROR
```

MPI\_IDENT results if and only if comm1 and comm2 are handles for the same object (identical groups and same contexts). MPI\_CONGRUENT results if the underlying groups are identical in constituents and rank order; these communicators differ only by context. MPI\_SIMILAR results if the group members of both communicators are the same but the rank order differs. MPI\_UNEQUAL results otherwise.

### 6.4.2 Communicator Constructors

The following are collective functions that are invoked by all processes in the group or groups associated with comm, with the exception of MPI\_COMM\_CREATE\_GROUP, MPI\_COMM\_CREATE\_FROM\_GROUP, and MPI\_INTERCOMM\_CREATE\_FROM\_GROUPS. MPI\_COMM\_CREATE\_GROUP and MPI\_COMM\_CREATE\_FROM\_GROUP are invoked only by the processes in the group of the new communicator being constructed. MPI\_INTERCOMM\_CREATE\_FROM\_GROUPS is invoked by all the processes in the local and remote groups of the new communicator being constructed. See the discussion below for the definition of local and remote groups.

*Rationale.* Note that, when using the World Model, there is a chicken-and-egg aspect to MPI in that a communicator is needed to create a new communicator. In the World Model, the base communicator for all MPI communicators is predefined outside of MPI, and is MPI\_COMM\_WORLD. The World Model was arrived at after considerable debate, and was chosen to increase “safety” of programs written in MPI. (End of rationale.)

This chapter presents the following communicator construction routines: MPI\_COMM\_CREATE, MPI\_COMM\_DUP, MPI\_COMM\_IDUP, MPI\_COMM\_DUP\_WITH\_INFO, MPI\_COMM\_IDUP\_WITH\_INFO and MPI\_COMM\_SPLIT can be used to create both intracommunicators and intercommunicators; MPI\_COMM\_CREATE\_GROUP, MPI\_COMM\_CREATE\_FROM\_GROUP, and MPI\_INTERCOMM\_MERGE (see Section 6.6.2) can be used to create intracommunicators;

1 MPI\_INTERCOMM\_CREATE and MPI\_INTERCOMM\_CREATE\_FROM\_GROUPS (see Sec-  
 2 tion 6.6.2) can be used to create intercommunicators.

3 An intracommunicator involves a single group while an intercommunicator involves  
 4 two groups. Where the following discussions address intercommunicator semantics, the  
 5 two groups in an intercommunicator are called the *left* and *right* groups. A process in an  
 6 intercommunicator is a member of either the left or the right group. From the point of view  
 7 of that process, the group that the process is a member of is called the *local group*; the  
 8 other group (relative to that process) is the *remote group*. The left and right group labels  
 9 give us a way to describe the two groups in an intercommunicator that is not relative to  
 10 any particular process (as the local and remote groups are).  
 11

12  
 13 MPI\_COMM\_DUP(comm, newcomm)

14 IN comm communicator (handle)  
 15 OUT newcomm copy of comm (handle)  
 16

### 17 C binding

18 int MPI\_Comm\_dup(MPI\_Comm comm, MPI\_Comm \*newcomm)  
 19

### 20 Fortran 2008 binding

21 MPI\_Comm\_dup(comm, newcomm, ierror)  
 22 TYPE(MPI\_Comm), INTENT(IN) :: comm  
 23 TYPE(MPI\_Comm), INTENT(OUT) :: newcomm  
 24 INTEGER, OPTIONAL, INTENT(OUT) :: ierror  
 25

### 26 Fortran binding

27 MPI\_COMM\_DUP(COMM, NEWCOMM, IERROR)  
 28 INTEGER COMM, NEWCOMM, IERROR  
 29

30 MPI\_COMM\_DUP duplicates the existing communicator `comm` with associated key  
 31 values and topology information. For each key value, the respective copy callback function  
 32 determines the attribute value associated with this key in the new communicator; one  
 33 particular action that a copy callback may take is to delete the attribute from the new  
 34 communicator. MPI\_COMM\_DUP returns in `newcomm` a new communicator with the same  
 35 group or groups, same topology, and any copied cached information, but a new context (see  
 36 Section 6.7.1).

37 *Advice to users.* This operation is used to provide a parallel library with a duplicate  
 38 communication space that has the same properties as the original communicator. This  
 39 includes any attributes (see below) and topologies (see Chapter 7). This call is valid  
 40 even if there are pending point-to-point communications involving the communicator  
 41 `comm`. A typical call might involve a MPI\_COMM\_DUP at the beginning of the  
 42 parallel call, and an MPI\_COMM\_FREE of that duplicated communicator at the end  
 43 of the call. Other models of communicator management are also possible.

44 This call applies to both intra- and inter-communicators. (*End of advice to users.*)

45  
 46 *Advice to implementors.* One need not actually copy the group information, but only  
 47 add a new reference and increment the reference count. Copy on write can be used  
 48 for the cached information. (*End of advice to implementors.*)

MPI\_COMM\_DUP\_WITH\_INFO(comm, info, newcomm) 1

IN	comm	communicator (handle)	2
IN	info	info object (handle)	3
OUT	newcomm	copy of comm (handle)	4

#### C binding

```
int MPI_Comm_dup_with_info(MPI_Comm comm, MPI_Info info, MPI_Comm *newcomm) 5
```

#### Fortran 2008 binding

```
MPI_Comm_dup_with_info(comm, info, newcomm, ierror) 6
  TYPE(MPI_Comm), INTENT(IN) :: comm 7
  TYPE(MPI_Info), INTENT(IN) :: info 8
  TYPE(MPI_Comm), INTENT(OUT) :: newcomm 9
  INTEGER, OPTIONAL, INTENT(OUT) :: ierror 10
```

#### Fortran binding

```
MPI_COMM_DUP_WITH_INFO(COMM, INFO, NEWCOMM, IERROR) 11
  INTEGER COMM, INFO, NEWCOMM, IERROR 12
```

MPI\_COMM\_DUP\_WITH\_INFO behaves exactly as MPI\_COMM\_DUP except that the hints provided by the argument info are associated with the output communicator newcomm. 13

*Rationale.* It is expected that some hints will only be valid at communicator creation time. However, for legacy reasons, most communicator creation calls do not provide an info argument. One may associate info hints with a duplicate of any communicator at creation time through a call to MPI\_COMM\_DUP\_WITH\_INFO. (*End of rationale.*) 14

MPI\_COMM\_IDUP(comm, newcomm, request) 15

IN	comm	communicator (handle)	16
OUT	newcomm	copy of comm (handle)	17
OUT	request	communication request (handle)	18

#### C binding

```
int MPI_Comm_idup(MPI_Comm comm, MPI_Comm *newcomm, MPI_Request *request) 19
```

#### Fortran 2008 binding

```
MPI_Comm_idup(comm, newcomm, request, ierror) 20
  TYPE(MPI_Comm), INTENT(IN) :: comm 21
  TYPE(MPI_Comm), INTENT(OUT), ASYNCHRONOUS :: newcomm 22
  TYPE(MPI_Request), INTENT(OUT) :: request 23
  INTEGER, OPTIONAL, INTENT(OUT) :: ierror 24
```

#### Fortran binding

```
MPI_COMM_IDUP(COMM, NEWCOMM, REQUEST, IERROR) 25
  INTEGER COMM, NEWCOMM, REQUEST, IERROR 26
```

1 MPI\_COMM\_IDUP is a nonblocking variant of MPI\_COMM\_DUP. With the exception  
 2 of its nonblocking behavior, the semantics of MPI\_COMM\_IDUP are as if MPI\_COMM\_DUP  
 3 was executed at the time that MPI\_COMM\_IDUP is called. For example, attributes changed  
 4 after MPI\_COMM\_IDUP will not be copied to the new communicator. All restrictions and  
 5 assumptions for nonblocking collective operations (see Section 5.12) apply to  
 6 MPI\_COMM\_IDUP and the returned request.

7 It is erroneous to use the communicator `newcomm` as an input argument to other MPI  
 8 functions before the MPI\_COMM\_IDUP operation completes.

9  
 10  
 11 MPI\_COMM\_IDUP\_WITH\_INFO(comm, info, newcomm, request)

12	IN	comm	communicator (handle)
13	IN	info	info object (handle)
14	OUT	newcomm	copy of comm (handle)
15	OUT	request	communication request (handle)

### 18 C binding

19 int MPI\_Comm\_idup\_with\_info(MPI\_Comm comm, MPI\_Info info,  
 20 MPI\_Comm \*newcomm, MPI\_Request \*request)

### 22 Fortran 2008 binding

23 MPI\_Comm\_idup\_with\_info(comm, info, newcomm, request, ierror)  
 24 TYPE(MPI\_Comm), INTENT(IN) :: comm  
 25 TYPE(MPI\_Info), INTENT(IN) :: info  
 26 TYPE(MPI\_Comm), INTENT(OUT), ASYNCHRONOUS :: newcomm  
 27 TYPE(MPI\_Request), INTENT(OUT) :: request  
 28 INTEGER, OPTIONAL, INTENT(OUT) :: ierror

### 29 Fortran binding

30 MPI\_COMM\_IDUP\_WITH\_INFO(COMM, INFO, NEWCOMM, REQUEST, IERROR)  
 31 INTEGER COMM, INFO, NEWCOMM, REQUEST, IERROR

32  
 33 MPI\_COMM\_IDUP\_WITH\_INFO is a nonblocking variant of  
 34 MPI\_COMM\_DUP\_WITH\_INFO. With the exception of its nonblocking behavior, the se-  
 35 mantics of MPI\_COMM\_IDUP\_WITH\_INFO are as if MPI\_COMM\_DUP\_WITH\_INFO was  
 36 executed at the time that MPI\_COMM\_IDUP\_WITH\_INFO is called. For example, attributes  
 37 or info hints changed after MPI\_COMM\_IDUP\_WITH\_INFO will not be copied to the new  
 38 communicator. All restrictions and assumptions for nonblocking collective operations (see  
 39 Section 5.12) apply to MPI\_COMM\_IDUP\_WITH\_INFO and the returned request.

40 It is erroneous to use the communicator `newcomm` as an input argument to other MPI  
 41 functions before the MPI\_COMM\_IDUP\_WITH\_INFO operation completes.

42  
 43 *Rationale.* The MPI\_COMM\_IDUP and MPI\_COMM\_IDUP\_WITH\_INFO functions  
 44 are crucial for the development of purely nonblocking libraries (see [37]). (*End of*  
 45 *rationale.*)

```

MPI_COMM_CREATE(comm, group, newcomm)
    IN      comm      communicator (handle)
    IN      group     group, which is a subset of the group of comm (handle)
    OUT     newcomm   new communicator (handle)

```

**C binding**

```
int MPI_Comm_create(MPI_Comm comm, MPI_Group group, MPI_Comm *newcomm)
```

**Fortran 2008 binding**

```

MPI_Comm_create(comm, group, newcomm, ierror)
    TYPE(MPI_Comm), INTENT(IN) :: comm
    TYPE(MPI_Group), INTENT(IN) :: group
    TYPE(MPI_Comm), INTENT(OUT) :: newcomm
    INTEGER, OPTIONAL, INTENT(OUT) :: ierror

```

**Fortran binding**

```

MPI_COMM_CREATE(COMM, GROUP, NEWCOMM, IERROR)
    INTEGER COMM, GROUP, NEWCOMM, IERROR

```

If `comm` is an intracommunicator, this function returns a new communicator `newcomm` with communication group defined by the `group` argument. No cached information propagates from `comm` to `newcomm`. Each process must call `MPI_COMM_CREATE` with a `group` argument that is a subgroup of the `group` associated with `comm`; this could be `MPI_GROUP_EMPTY`. The processes may specify different values for the `group` argument. If a process calls with a non-empty `group` then all processes in that `group` must call the function with the same `group` as argument, that is the same processes in the same order. Otherwise, the call is erroneous. This implies that the set of groups specified across the processes must be disjoint. If the calling process is a member of the group given as `group` argument, then `newcomm` is a communicator with `group` as its associated group. In the case that a process calls with a `group` to which it does not belong, e.g., `MPI_GROUP_EMPTY`, then `MPI_COMM_NULL` is returned as `newcomm`. The function is collective and must be called by all processes in the group of `comm`.

*Rationale.* The interface supports the original mechanism from MPI-1.1, which required the same `group` in all processes of `comm`. It was extended in MPI-2.2 to allow the use of disjoint subgroups in order to allow implementations to eliminate unnecessary communication that `MPI_COMM_SPLIT` would incur when the user already knows the membership of the disjoint subgroups. (*End of rationale.*)

*Rationale.* The requirement that the entire group of `comm` participate in the call stems from the following considerations:

- It allows the implementation to layer `MPI_COMM_CREATE` on top of regular collective communications.
- It provides additional safety, in particular in the case where partially overlapping groups are used to create new communicators.
- It permits implementations to sometimes avoid communication related to context creation.

1 (*End of rationale.*)

2  
3 *Advice to users.* MPI\_COMM\_CREATE provides a means to subset a group of pro-  
4 cesses for the purpose of separate MIMD computation, with separate communication  
5 space. newcomm, which emerges from MPI\_COMM\_CREATE, can be used in subse-  
6 quent calls to MPI\_COMM\_CREATE (or other communicator constructors) to further  
7 subdivide a computation into parallel sub-computations. A more general service is  
8 provided by MPI\_COMM\_SPLIT, below. (*End of advice to users.*)

9  
10 *Advice to implementors.* When calling MPI\_COMM\_DUP, all processes call with the  
11 same group (the group associated with the communicator). When calling  
12 MPI\_COMM\_CREATE, the processes provide the same group or disjoint subgroups.  
13 For both calls, it is theoretically possible to agree on a group-wide unique context  
14 with no communication. However, local execution of these functions requires use  
15 of a larger context name space and reduces error checking. Implementations may  
16 strike various compromises between these conflicting goals, such as bulk allocation of  
17 multiple contexts in one collective operation.

18 Important: If new communicators are created without synchronizing the processes  
19 involved then the communication system must be able to cope with messages arriving  
20 in a context that has not yet been allocated at the receiving process. (*End of advice*  
21 *to implementors.*)

22  
23 If comm is an intercommunicator, then the output communicator is also an intercommu-  
24 nicator where the local group consists only of those processes contained in group (see Fig-  
25 ure 6.1). The group argument should only contain those processes in the local group of  
26 the input intercommunicator that are to be a part of newcomm. All processes in the same  
27 local group of comm must specify the same value for group, i.e., the same members in the  
28 same order. If either group does not specify at least one process in the local group of the  
29 intercommunicator, or if the calling process is not included in the group, MPI\_COMM\_NULL  
30 is returned.

31  
32 *Rationale.* In the case where either the left or right group is empty, a null communi-  
33 cator is returned instead of an intercommunicator with MPI\_GROUP\_EMPTY because  
34 the side with the empty group must return MPI\_COMM\_NULL. (*End of rationale.*)

35  
36 **Example 6.1** The following example illustrates how the first node in the left side of an  
37 intercommunicator could be joined with all members on the right side of an intercommu-  
38 nicator to form a new intercommunicator.

```
39
40 MPI_Comm inter_comm, new_inter_comm;
41 MPI_Group local_group, group;
42 int rank = 0; /* rank on left side to include in
43                new inter-comm */
44
45 /* Construct the original intercommunicator: "inter_comm" */
46 ...
47
48 /* Construct the group of processes to be in new
```

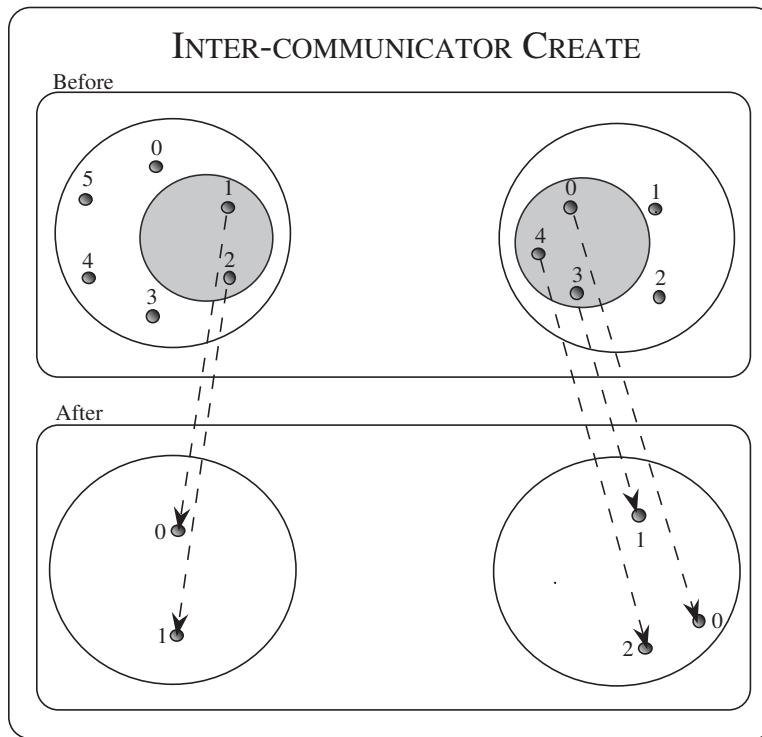

Figure 6.1: Intercommunicator creation using `MPI_COMM_CREATE` extended to intercommunicators. The input groups are those in the grey circle.

```

intercommunicator */
if (/* I'm on the left side of the intercommunicator */) {
    MPI_Comm_group(inter_comm, &local_group);
    MPI_Group_incl(local_group, 1, &rank, &group);
    MPI_Group_free(&local_group);
}
else
    MPI_Comm_group(inter_comm, &group);

MPI_Comm_create(inter_comm, group, &new_inter_comm);
MPI_Group_free(&group);

```

`MPI_COMM_CREATE_GROUP(comm, group, tag, newcomm)`

IN	<code>comm</code>	intracommunicator (handle)
IN	<code>group</code>	group, which is a subset of the group of <code>comm</code> (handle)
IN	<code>tag</code>	tag (integer)
OUT	<code>newcomm</code>	new communicator (handle)

### C binding

```

int MPI_Comm_create_group(MPI_Comm comm, MPI_Group group, int tag,
    MPI_Comm *newcomm)

```

**Fortran 2008 binding**

```

1 MPI_Comm_create_group(comm, group, tag, newcomm, ierror)
2     TYPE(MPI_Comm), INTENT(IN) :: comm
3     TYPE(MPI_Group), INTENT(IN) :: group
4     INTEGER, INTENT(IN) :: tag
5     TYPE(MPI_Comm), INTENT(OUT) :: newcomm
6     INTEGER, OPTIONAL, INTENT(OUT) :: ierror

```

**Fortran binding**

```

9 MPI_COMM_CREATE_GROUP(COMM, GROUP, TAG, NEWCOMM, IERROR)
10     INTEGER COMM, GROUP, TAG, NEWCOMM, IERROR

```

MPI\_COMM\_CREATE\_GROUP is similar to MPI\_COMM\_CREATE; however, MPI\_COMM\_CREATE must be called by all processes in the group of `comm`, whereas MPI\_COMM\_CREATE\_GROUP must be called by all processes in `group`, which is a subgroup of the group of `comm`. In addition, MPI\_COMM\_CREATE\_GROUP requires that `comm` is an intracommunicator. MPI\_COMM\_CREATE\_GROUP returns a new intracommunicator, `newcomm`, for which the `group` argument defines the communication group. No cached information propagates from `comm` to `newcomm`. Each process must provide a `group` argument that is a subgroup of the group associated with `comm`; this could be MPI\_GROUP\_EMPTY. If a non-empty group is specified, then all processes in that group must call the function, and each of these processes must provide the same arguments, including a `group` that contains the same members with the same ordering. Otherwise the call is erroneous. If the calling process is a member of the group given as the `group` argument, then `newcomm` is a communicator with `group` as its associated group. If the calling process is not a member of `group`, e.g., `group` is MPI\_GROUP\_EMPTY, then the call is a local operation and MPI\_COMM\_NULL is returned as `newcomm`.

*Rationale.* Functionality similar to MPI\_COMM\_CREATE\_GROUP can be implemented through repeated MPI\_INTERCOMM\_CREATE and MPI\_INTERCOMM\_MERGE calls that start with the MPI\_COMM\_SELF communicators at each process in `group` and build up an intracommunicator with `group` [17]. Such an algorithm requires the creation of many intermediate communicators; MPI\_COMM\_CREATE\_GROUP can provide a more efficient implementation that avoids this overhead. (*End of rationale.*)

*Advice to users.* An intercommunicator can be created collectively over processes in the union of the local and remote groups by creating the local communicator using MPI\_COMM\_CREATE\_GROUP and using that communicator as the local communicator argument to MPI\_INTERCOMM\_CREATE. (*End of advice to users.*)

The `tag` argument does not conflict with tags used in point-to-point communication and is not permitted to be a wildcard. If multiple threads at a given process perform concurrent MPI\_COMM\_CREATE\_GROUP operations, the user must distinguish these operations by providing different `tag` or `comm` arguments.

*Advice to users.* MPI\_COMM\_CREATE may provide lower overhead than MPI\_COMM\_CREATE\_GROUP because it can take advantage of collective communication on `comm` when constructing `newcomm`. (*End of advice to users.*)



MPI\_COMM\_SPLIT(comm, color, key, newcomm)

IN	comm	communicator (handle)
IN	color	control of subset assignment (integer)
IN	key	control of rank assignment (integer)
OUT	newcomm	new communicator (handle)

### C binding

```
int MPI_Comm_split(MPI_Comm comm, int color, int key, MPI_Comm *newcomm)
```

### Fortran 2008 binding

```
MPI_Comm_split(comm, color, key, newcomm, ierror)
  TYPE(MPI_Comm), INTENT(IN) :: comm
  INTEGER, INTENT(IN) :: color, key
  TYPE(MPI_Comm), INTENT(OUT) :: newcomm
  INTEGER, OPTIONAL, INTENT(OUT) :: ierror
```

### Fortran binding

```
MPI_COMM_SPLIT(COMM, COLOR, KEY, NEWCOMM, IERROR)
  INTEGER COMM, COLOR, KEY, NEWCOMM, IERROR
```

This function partitions the group associated with `comm` into disjoint subgroups, one for each value of `color`. Each subgroup contains all processes of the same color. Within each subgroup, the processes are ranked in the order defined by the value of the argument `key`, with ties broken according to their rank in the old group. A new communicator is created for each subgroup and returned in `newcomm`. A process may supply the color value `MPI_UNDEFINED`, in which case `newcomm` returns `MPI_COMM_NULL`. This is a collective call, but each process is permitted to provide different values for `color` and `key`.

With an intracommunicator `comm`, a call to `MPI_COMM_CREATE(comm, group, newcomm)` is equivalent to a call to `MPI_COMM_SPLIT(comm, color, key, newcomm)`, where processes that are members of their `group` argument provide `color = number of the group` (based on a unique numbering of all disjoint groups) and `key = rank in group`, and all processes that are not members of their `group` argument provide `color = MPI_UNDEFINED`.

The value of `color` must be non-negative or `MPI_UNDEFINED`.

*Advice to users.* This is an extremely powerful mechanism for dividing a single communicating group of processes into  $k$  subgroups, with  $k$  chosen implicitly by the user (by the number of colors asserted over all the processes). Each resulting communicator will be non-overlapping. Such a division could be useful for defining a hierarchy of computations, such as for multigrid, or linear algebra. For intracommunicators, `MPI_COMM_SPLIT` provides similar capability as `MPI_COMM_CREATE` to split a communicating group into disjoint subgroups. `MPI_COMM_SPLIT` is useful when some processes do not have complete information of the other members in their group, but all processes know (the color of) the group to which they belong. In this case, the MPI implementation discovers the other group members via communication. `MPI_COMM_CREATE` is useful when all processes have complete information of the members of their group. In this case, MPI can avoid the extra communication required to discover group membership. `MPI_COMM_CREATE_GROUP` is useful when all pro-

cesses in a given group have complete information of the members of their group and synchronization with processes outside the group can be avoided.

Multiple calls to `MPI_COMM_SPLIT` can be used to overcome the requirement that any call have no overlap of the resulting communicators (each process is of only one color per call). In this way, multiple overlapping communication structures can be created. Creative use of the color and key in such splitting operations is encouraged.

Note that, for a fixed color, the keys need not be unique. It is `MPI_COMM_SPLIT`'s responsibility to sort processes in ascending order according to this key, and to break ties in a consistent way. If all the keys are specified in the same way, then all the processes in a given color will have the relative rank order as they did in their parent group.

Essentially, making the key value zero for all processes of a given color means that one does not really care about the rank-order of the processes in the new communicator. (*End of advice to users.*)

*Rationale.* color is restricted to be non-negative, so as not to conflict with the value assigned to `MPI_UNDEFINED`. (*End of rationale.*)

The result of `MPI_COMM_SPLIT` on an intercommunicator is that those processes on the left with the same color as those processes on the right combine to create a new intercommunicator. The key argument describes the relative rank of processes on each side of the intercommunicator (see Figure 6.2). For those colors that are specified only on one side of the intercommunicator, `MPI_COMM_NULL` is returned. `MPI_COMM_NULL` is also returned to those processes that specify `MPI_UNDEFINED` as the color.

*Advice to users.* For intercommunicators, `MPI_COMM_SPLIT` is more general than `MPI_COMM_CREATE`. A single call to `MPI_COMM_SPLIT` can create a set of disjoint intercommunicators, while a call to `MPI_COMM_CREATE` creates only one. (*End of advice to users.*)

**Example 6.2** (Parallel client-server model). The following client code illustrates how clients on the left side of an intercommunicator could be assigned to a single server from a pool of servers on the right side of an intercommunicator.

```

35     /* Client code */
36     MPI_Comm  multiple_server_comm;
37     MPI_Comm  single_server_comm;
38     int       color, rank, num_servers;
39
40     /* Create intercommunicator with clients and servers:
41        multiple_server_comm */
42     ...
43
44     /* Find out the number of servers available */
45     MPI_Comm_remote_size(multiple_server_comm, &num_servers);
46
47     /* Determine my color */
48     MPI_Comm_rank(multiple_server_comm, &rank);

```

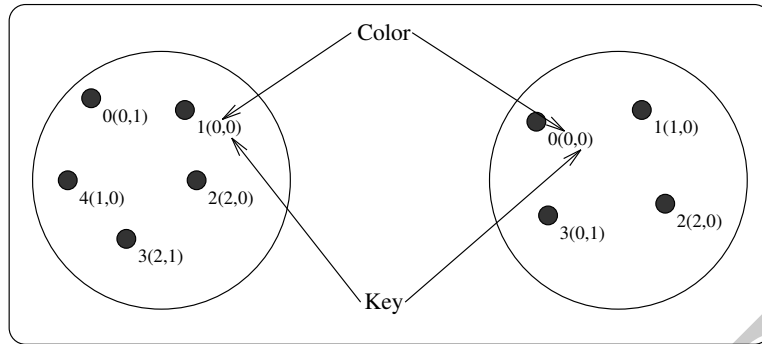

Input Intercommunicator (comm)

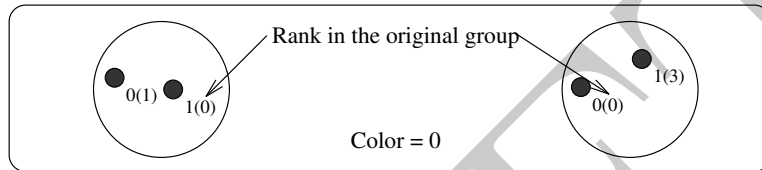

Color = 0

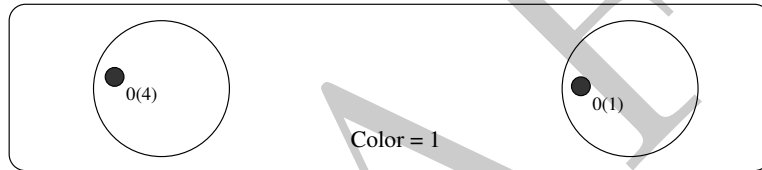

Color = 1

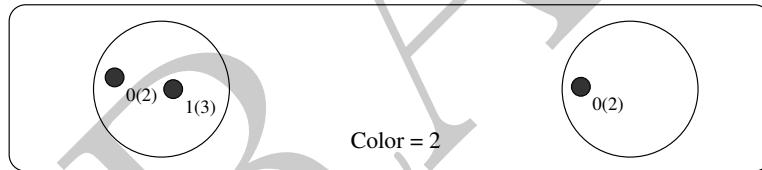

Color = 2

Disjoint output communicators (newcomm)  
(one per color)

Figure 6.2: Intercommunicator construction achieved by splitting an existing intercommunicator with MPI\_COMM\_SPLIT extended to intercommunicators.

1  
2  
3  
4  
5  
6  
7  
8  
9  
10  
11  
12  
13  
14  
15  
16  
17  
18  
19  
20  
21  
22  
23  
24  
25  
26  
27  
28  
29  
30  
31  
32  
33  
34  
35  
36  
37  
38  
39  
40  
41  
42  
43  
44  
45  
46  
47  
48

```

1     color = rank % num_servers;
2
3     /* Split the intercommunicator */
4     MPI_Comm_split(multiple_server_comm, color, rank,
5                   &single_server_comm);
6

```

The following is the corresponding server code:

```

8     /* Server code */
9     MPI_Comm multiple_client_comm;
10    MPI_Comm single_server_comm;
11    int rank;
12
13    /* Create intercommunicator with clients and servers:
14       multiple_client_comm */
15    ...
16
17    /* Split the intercommunicator for a single server per group
18       of clients */
19    MPI_Comm_rank(multiple_client_comm, &rank);
20    MPI_Comm_split(multiple_client_comm, rank, 0,
21                  &single_server_comm);
22
23
24

```

**MPI\_COMM\_SPLIT\_TYPE(comm, split\_type, key, info, newcomm)**

26	IN	comm	communicator (handle)
27	IN	split_type	type of processes to be grouped together (integer)
28	IN	key	control of rank assignment (integer)
29	IN	info	info argument (handle)
30	IN	info	info argument (handle)
31	OUT	newcomm	new communicator (handle)
32			

### C binding

```

34 int MPI_Comm_split_type(MPI_Comm comm, int split_type, int key,
35                         MPI_Info info, MPI_Comm *newcomm)
36

```

### Fortran 2008 binding

```

38 MPI_Comm_split_type(comm, split_type, key, info, newcomm, ierror)
39     TYPE(MPI_Comm), INTENT(IN) :: comm
40     INTEGER, INTENT(IN) :: split_type, key
41     TYPE(MPI_Info), INTENT(IN) :: info
42     TYPE(MPI_Comm), INTENT(OUT) :: newcomm
43     INTEGER, OPTIONAL, INTENT(OUT) :: ierror
44

```

### Fortran binding

```

45 MPI_COMM_SPLIT_TYPE(COMM, SPLIT_TYPE, KEY, INFO, NEWCOMM, IERROR)
46     INTEGER COMM, SPLIT_TYPE, KEY, INFO, NEWCOMM, IERROR
47
48

```

This function partitions the group associated with `comm` into disjoint subgroups, based on the type specified by `split_type`. Each subgroup contains all processes of the same type. Within each subgroup, the processes are ranked in the order defined by the value of the argument `key`, with ties broken according to their rank in the old group. A new communicator is created for each subgroup and returned in `newcomm`. This is a collective call; all processes must provide the same `split_type`, but each process is permitted to provide different values for `key`. An exception to this rule is that a process may supply the type value `MPI_UNDEFINED`, in which case `newcomm` returns `MPI_COMM_NULL`.

The following type is predefined by MPI:

`MPI_COMM_TYPE_SHARED` — this type splits the communicator into subcommunicators, each of which can create a shared memory region.

*Advice to implementors.* Implementations can define their own types, or use the `info` argument, to assist in creating communicators that help expose platform-specific information to the application. (*End of advice to implementors.*)

`MPI_COMM_CREATE_FROM_GROUP(group, stringtag, info, errhandler, newcomm)`

IN	<code>group</code>	group (handle)
IN	<code>stringtag</code>	unique identifier for this operation (string)
IN	<code>info</code>	info object (handle)
IN	<code>errhandler</code>	error handler to be attached to new intra-communicator (handle)
OUT	<code>newcomm</code>	new communicator (handle)

#### C binding

```
int MPI_Comm_create_from_group(MPI_Group group, const char *stringtag,
                               MPI_Info info, MPI_Errhandler errhandler, MPI_Comm *newcomm)
```

#### Fortran 2008 binding

```
MPI_Comm_create_from_group(group, stringtag, info, errhandler, newcomm,
                           ierror)
    TYPE(MPI_Group), INTENT(IN) :: group
    CHARACTER(LEN=*), INTENT(IN) :: stringtag
    TYPE(MPI_Info), INTENT(IN) :: info
    TYPE(MPI_Errhandler), INTENT(IN) :: errhandler
    TYPE(MPI_Comm), INTENT(OUT) :: newcomm
    INTEGER, OPTIONAL, INTENT(OUT) :: ierror
```

#### Fortran binding

```
MPI_COMM_CREATE_FROM_GROUP(GROUP, STRINGTAG, INFO, ERRHANDLER, NEWCOMM,
                            IERROR)
    INTEGER GROUP, INFO, ERRHANDLER, NEWCOMM, IERROR
    CHARACTER*(*) STRINGTAG
```

`MPI_COMM_CREATE_FROM_GROUP` is similar to `MPI_COMM_CREATE_GROUP`, except that the set of MPI processes involved in the creation of the new intracommunicator

is specified by a `group` argument, rather than the group associated with a pre-existing communicator. If a non-empty `group` is specified, then all MPI processes in that group must call the function and each of these MPI processes must provide the same arguments, including a group that contains the same members with the same ordering, and identical `stringtag` value. In the event that `MPI_GROUP_EMPTY` is supplied as the `group` argument, then the call is a local operation and `MPI_COMM_NULL` is returned as `newcomm`. The `stringtag` argument is analogous to the `tag` used for `MPI_COMM_CREATE_GROUP`. If multiple threads at a given MPI process perform concurrent `MPI_COMM_CREATE_FROM_GROUP` operations, the user must distinguish these operations by providing different `stringtag` arguments. The `stringtag` shall not exceed `MPI_MAX_FROM_GROUP_TAG` characters in length. For C, this includes space for a null terminating character. The `errhandler` argument specifies an error handler to be attached to the new intracommunicator. This error handler will also be invoked if the `MPI_COMM_CREATE_FROM_GROUP` function encounters an error. The `info` argument provides hints and assertions, possibly MPI implementation dependent, which indicate desired characteristics and guide communicator creation.

*Advice to users.* The `stringtag` argument is used to distinguish concurrent communicator construction operations issued by different entities. As such, it is important to ensure that this argument is unique for each concurrent call to `MPI_COMM_CREATE_FROM_GROUP`. Reverse domain name notation convention [1] is one approach to constructing unique `stringtag` arguments. See also example 10.8. (*End of advice to users.*)

### 6.4.3 Communicator Destructors

`MPI_COMM_FREE(comm)`

INOUT `comm` communicator to be destroyed (handle)

#### C binding

```
int MPI_Comm_free(MPI_Comm *comm)
```

#### Fortran 2008 binding

```
MPI_Comm_free(comm, ierror)
    TYPE(MPI_Comm), INTENT(INOUT) :: comm
    INTEGER, OPTIONAL, INTENT(OUT) :: ierror
```

#### Fortran binding

```
MPI_COMM_FREE(COMM, IERROR)
    INTEGER COMM, IERROR
```

This collective operation marks the communication object for deallocation. The `handle` is set to `MPI_COMM_NULL`. Any pending operations that use this communicator will complete normally; the object is actually deallocated only if there are no other active references to it. This call applies to intra- and inter-communicators. The delete callback functions for all cached attributes (see Section 6.7) are called in arbitrary order.

*Advice to implementors.* Though collective, it is anticipated that this operation will normally be implemented to be local, though a debugging version of an MPI library

might choose to synchronize. (*End of advice to implementors.*)

#### 6.4.4 Communicator Info

Hints specified via info (see Chapter 9) allow a user to provide information to direct optimization. Providing hints may enable an implementation to deliver increased performance or minimize use of system resources. An implementation is free to ignore all hints; however, applications must comply with any info hints they provide that are used by the MPI implementation (i.e., are returned by a call to `MPI_COMM_GET_INFO`) and that place a restriction on the behavior of the application. Hints are specified on a per communicator basis, in `MPI_COMM_DUP_WITH_INFO`, `MPI_COMM_IDUP_WITH_INFO`, `MPI_COMM_SET_INFO`, `MPI_COMM_SPLIT_TYPE`, `MPI_DIST_GRAPH_CREATE`, and `MPI_DIST_GRAPH_CREATE_ADJACENT`, via the opaque info object. When an info object that specifies a subset of valid hints is passed to `MPI_COMM_SET_INFO`, there will be no effect on previously set or defaulted hints that the info does not specify.

*Advice to implementors.* It may happen that a program is coded with hints for one system, and later executes on another system that does not support these hints. In general, unsupported hints should simply be ignored. Needless to say, no hint can be mandatory. However, for each hint used by a specific implementation, a default value must be provided when the user does not specify a value for this hint. (*End of advice to implementors.*)

Info hints are not propagated by MPI from one communicator to another. The following info keys are valid for all communicators.

`mpi_assert_no_any_tag` (**boolean, default: false**): If set to true, then the implementation may assume that the process will not use the `MPI_ANY_TAG` wildcard on the given communicator.

`mpi_assert_no_any_source` (**boolean, default: false**): If set to true, then the implementation may assume that the process will not use the `MPI_ANY_SOURCE` wildcard on the given communicator.

`mpi_assert_exact_length` (**boolean, default: false**): If set to true, then the implementation may assume that the lengths of messages received by the process are equal to the lengths of the corresponding receive buffers, for point-to-point communication operations on the given communicator.

`mpi_assert_allow_overtaking` (**boolean, default: false**): If set to true, then the implementation may assume that point-to-point communications on the given communicator do not rely on the non-overtaking rule specified in Section 3.5. In other words, the application asserts that send operations are not required to be matched at the receiver in the order in which the send operations were posted by the sender, and receive operations are not required to be matched in the order in which they were posted by the receiver.

*Advice to users.* Use of the `mpi_assert_allow_overtaking` info key can result in nondeterminism in the message matching order. (*End of advice to users.*)

1 *Advice to users.* Some optimizations may only be possible when all processes in the  
 2 group of the communicator provide a given info key with the same value. (*End of*  
 3 *advice to users.*)  
 4

5  
 6  
 7 MPI\_COMM\_SET\_INFO(comm, info)

8 INOUT comm communicator (handle)  
 9 IN info info object (handle)  
 10

### 11 C binding

12 int MPI\_Comm\_set\_info(MPI\_Comm comm, MPI\_Info info)  
 13

### 14 Fortran 2008 binding

15 MPI\_Comm\_set\_info(comm, info, ierror)  
 16 TYPE(MPI\_Comm), INTENT(IN) :: comm  
 17 TYPE(MPI\_Info), INTENT(IN) :: info  
 18 INTEGER, OPTIONAL, INTENT(OUT) :: ierror  
 19

### 20 Fortran binding

21 MPI\_COMM\_SET\_INFO(COMM, INFO, IERROR)  
 22 INTEGER COMM, INFO, IERROR  
 23

24 MPI\_COMM\_SET\_INFO updates the hints of the communicator associated with `comm`  
 25 using the hints provided in `info`. This operation has no effect on previously set or defaulted  
 26 hints that are not specified by `info`. It also has no effect on previously set or defaulted  
 27 hints that are specified by `info`, but are ignored by the MPI implementation in this call to  
 28 MPI\_COMM\_SET\_INFO. MPI\_COMM\_SET\_INFO is a collective routine. The `info` object  
 29 may be different on each process, but any `info` entries that an implementation requires to  
 30 be the same on all processes must appear with the same value in each process's `info` object.

31 *Advice to users.* Some `info` items that an implementation can use when it creates  
 32 a communicator cannot easily be changed once the communicator has been created.  
 33 Thus, an implementation may ignore hints issued in this call that it would have  
 34 accepted in a creation call. An implementation may also be unable to update certain  
 35 `info` hints in a call to MPI\_COMM\_SET\_INFO. MPI\_COMM\_GET\_INFO can be used to  
 36 determine whether updates to existing `info` hints were ignored by the implementation.  
 37 (*End of advice to users.*)  
 38

39 *Advice to users.* Setting `info` hints on the predefined communicators  
 40 MPI\_COMM\_WORLD and MPI\_COMM\_SELF may have unintended effects, as changes to  
 41 these global objects may affect all components of the application, including libraries  
 42 and tools. Users must ensure that all components of the application that use a given  
 43 communicator, including libraries and tools, can comply with any `info` hints associated  
 44 with that communicator. (*End of advice to users.*)  
 45  
 46  
 47  
 48



```

MPI_COMM_GET_INFO(comm, info_used)
    IN      comm      communicator object (handle)
    OUT    info_used  new info object (handle)

```

**C binding**

```
int MPI_Comm_get_info(MPI_Comm comm, MPI_Info *info_used)
```

**Fortran 2008 binding**

```

MPI_Comm_get_info(comm, info_used, ierror)
    TYPE(MPI_Comm), INTENT(IN) :: comm
    TYPE(MPI_Info), INTENT(OUT) :: info_used
    INTEGER, OPTIONAL, INTENT(OUT) :: ierror

```

**Fortran binding**

```

MPI_COMM_GET_INFO(COMM, INFO_USED, IERROR)
    INTEGER COMM, INFO_USED, IERROR

```

MPI\_COMM\_GET\_INFO returns a new info object containing the hints of the communicator associated with `comm`. The current setting of all hints related to this communicator is returned in `info_used`. An MPI implementation is required to return all hints that are supported by the implementation and have default values specified; any user-supplied hints that were not ignored by the implementation; and any additional hints that were set by the implementation. If no such hints exist, a handle to a newly created info object is returned that contains no key/value pair. The user is responsible for freeing `info_used` via `MPI_INFO_FREE`.

## 6.5 Motivating Examples

### 6.5.1 Current Practice #1

Example #1a:

```

int main(int argc, char *argv[])
{
    int me, size;
    ...
    MPI_Init(&argc, &argv);
    MPI_Comm_rank(MPI_COMM_WORLD, &me);
    MPI_Comm_size(MPI_COMM_WORLD, &size);

    (void)printf("Process %d size %d\n", me, size);
    ...
    MPI_Finalize();
    return 0;
}

```

Example #1a is a do-nothing program that initializes itself, and refers to the “all” communicator, and prints a message. It terminates itself too. This example does not imply that MPI supports `printf`-like communication itself.

Example #1b (supposing that `size` is even):

```

1  int main(int argc, char *argv[])
2  {
3      int me, size;
4      int SOME_TAG = 0;
5      ...
6      MPI_Init(&argc, &argv);
7
8      MPI_Comm_rank(MPI_COMM_WORLD, &me); /* local */
9      MPI_Comm_size(MPI_COMM_WORLD, &size); /* local */
10
11     if((me % 2) == 0)
12     {
13         /* send unless highest-numbered process */
14         if((me + 1) < size)
15             MPI_Send(..., me + 1, SOME_TAG, MPI_COMM_WORLD);
16     }
17     else
18         MPI_Recv(..., me - 1, SOME_TAG, MPI_COMM_WORLD, &status);
19
20     ...
21     MPI_Finalize();
22     return 0;
23 }

```

Example #1b schematically illustrates message exchanges between “even” and “odd” processes in the “all” communicator.

### 6.5.2 Current Practice #2

```

29  int main(int argc, char *argv[])
30  {
31      int me, count;
32      void *data;
33      ...
34
35      MPI_Init(&argc, &argv);
36      MPI_Comm_rank(MPI_COMM_WORLD, &me);
37
38      if(me == 0)
39      {
40          /* get input, create buffer ‘‘data’’ */
41          ...
42      }
43
44      MPI_Bcast(data, count, MPI_BYTE, 0, MPI_COMM_WORLD);
45
46      ...
47      MPI_Finalize();
48      return 0;

```

```
}
1
```

This example illustrates the use of a collective communication.

### 6.5.3 (Approximate) Current Practice #3

```

2
3
4
5
6
7
8
9
10
11
12
13
14
15
16
17
18
19
20
21
22
23
24
25
26
27
28
29
30
31
32
33
34
35
36
37
38
39
40
41
42
43
44
45
46
47
48
int main(int argc, char *argv[])
{
    int me, count, count2;
    void *send_buf, *recv_buf, *send_buf2, *recv_buf2;
    MPI_Group group_world, grprem;
    MPI_Comm commslave;
    static int ranks[] = {0};
    ...
    MPI_Init(&argc, &argv);
    MPI_Comm_group(MPI_COMM_WORLD, &group_world);
    MPI_Comm_rank(MPI_COMM_WORLD, &me); /* local */

    MPI_Group_excl(group_world, 1, ranks, &grprem); /* local */
    MPI_Comm_create(MPI_COMM_WORLD, grprem, &commslave);

    if(me != 0)
    {
        /* compute on slave */
        ...
        MPI_Reduce(send_buf,recv_buf,count, MPI_INT, MPI_SUM, 1, commslave);
        ...
        MPI_Comm_free(&commslave);
    }
    /* zero falls through immediately to this reduce, others do later... */
    MPI_Reduce(send_buf2, recv_buf2, count2,
               MPI_INT, MPI_SUM, 0, MPI_COMM_WORLD);

    MPI_Group_free(&group_world);
    MPI_Group_free(&grprem);
    MPI_Finalize();
    return 0;
}

```

This example illustrates how a group consisting of all but the zeroth process of the “all” group is created, and then how a communicator is formed (`commslave`) for that new group. The new communicator is used in a collective call, and all processes execute a collective call in the `MPI_COMM_WORLD` context. This example illustrates how the two communicators (that inherently possess distinct contexts) protect communication. That is, communication in `MPI_COMM_WORLD` is insulated from communication in `commslave`, and vice versa.

In summary, “group safety” is achieved via communicators because distinct contexts within communicators are enforced to be unique on any process.

## 1      6.5.4 Example #4

2      The following example is meant to illustrate “safety” between point-to-point and collective  
 3      communication. MPI guarantees that a single communicator can do safe point-to-point and  
 4      collective communication.  
 5

```

6      #define TAG_ARBITRARY 12345
7      #define SOME_COUNT     50
8
9      int main(int argc, char *argv[])
10     {
11        int me;
12        MPI_Request request[2];
13        MPI_Status status[2];
14        MPI_Group group_world, subgroup;
15        int ranks[] = {2, 4, 6, 8};
16        MPI_Comm the_comm;
17        ...
18        MPI_Init(&argc, &argv);
19        MPI_Comm_group(MPI_COMM_WORLD, &group_world);
20
21        MPI_Group_incl(group_world, 4, ranks, &subgroup); /* local */
22        MPI_Group_rank(subgroup, &me);                   /* local */
23
24        MPI_Comm_create(MPI_COMM_WORLD, subgroup, &the_comm);
25
26        if(me != MPI_UNDEFINED)
27        {
28            MPI_Irecv(buff1, count, MPI_DOUBLE, MPI_ANY_SOURCE, TAG_ARBITRARY,
29                      the_comm, request);
30            MPI_Isend(buff2, count, MPI_DOUBLE, (me+1)%4, TAG_ARBITRARY,
31                      the_comm, request+1);
32            for(i = 0; i < SOME_COUNT; i++)
33                MPI_Reduce(..., the_comm);
34            MPI_Waitall(2, request, status);
35
36            MPI_Comm_free(&the_comm);
37        }
38
39        MPI_Group_free(&group_world);
40        MPI_Group_free(&subgroup);
41        MPI_Finalize();
42        return 0;
43     }
44
```

## 45      6.5.5 Library Example #1

46      The main program:

```

47      int main(int argc, char *argv[])
48
```

```

{
  int done = 0;
  user_lib_t *libh_a, *libh_b;
  void *dataset1, *dataset2;
  ...
  MPI_Init(&argc, &argv);
  ...
  init_user_lib(MPI_COMM_WORLD, &libh_a);
  init_user_lib(MPI_COMM_WORLD, &libh_b);
  ...
  user_start_op(libh_a, dataset1);
  user_start_op(libh_b, dataset2);
  ...
  while(!done)
  {
    /* work */
    ...
    MPI_Reduce(..., MPI_COMM_WORLD);
    ...
    /* see if done */
    ...
  }
  user_end_op(libh_a);
  user_end_op(libh_b);

  uninit_user_lib(libh_a);
  uninit_user_lib(libh_b);
  MPI_Finalize();
  return 0;
}

```

The user library initialization code:

```

void init_user_lib(MPI_Comm comm, user_lib_t **handle)
{
  user_lib_t *save;

  user_lib_initsave(&save); /* local */
  MPI_Comm_dup(comm, &(save->comm));

  /* other inits */
  ...

  *handle = save;
}

```

User start-up code:

```

void user_start_op(user_lib_t *handle, void *data)

```

```

1  {
2  MPI_Irecv( ..., handle->comm, &(handle->irecv_handle) );
3  MPI_Isend( ..., handle->comm, &(handle->isend_handle) );
4  }

```

5  
6 User communication clean-up code:

```

7  void user_end_op(user_lib_t *handle)
8  {
9  MPI_Status status;
10 MPI_Wait(&handle->isend_handle, &status);
11 MPI_Wait(&handle->irecv_handle, &status);
12 }

```

13  
14 User object clean-up code:

```

15 void uninit_user_lib(user_lib_t *handle)
16 {
17 MPI_Comm_free(&(handle->comm));
18 free(handle);
19 }
20 }

```

## 21 22 6.5.6 Library Example #2

23 The main program:

```

24
25 int main(int argc, char *argv[])
26 {
27     int ma, mb;
28     MPI_Group group_world, group_a, group_b;
29     MPI_Comm comm_a, comm_b;
30
31     static int list_a[] = {0, 1};
32     #if defined(EXAMPLE_2B) || defined(EXAMPLE_2C)
33     static int list_b[] = {0, 2, 3};
34     #else /* EXAMPLE_2A */
35     static int list_b[] = {0, 2};
36     #endif
37     int size_list_a = sizeof(list_a)/sizeof(int);
38     int size_list_b = sizeof(list_b)/sizeof(int);
39
40     ...
41     MPI_Init(&argc, &argv);
42     MPI_Comm_group(MPI_COMM_WORLD, &group_world);
43
44     MPI_Group_incl(group_world, size_list_a, list_a, &group_a);
45     MPI_Group_incl(group_world, size_list_b, list_b, &group_b);
46
47     MPI_Comm_create(MPI_COMM_WORLD, group_a, &comm_a);
48     MPI_Comm_create(MPI_COMM_WORLD, group_b, &comm_b);

```

```

1
2   if(comm_a != MPI_COMM_NULL)
3       MPI_Comm_rank(comm_a, &ma);
4   if(comm_b != MPI_COMM_NULL)
5       MPI_Comm_rank(comm_b, &mb);
6
7   if(comm_a != MPI_COMM_NULL)
8       lib_call(comm_a);
9
10  if(comm_b != MPI_COMM_NULL)
11  {
12      lib_call(comm_b);
13      lib_call(comm_b);
14  }
15
16  if(comm_a != MPI_COMM_NULL)
17      MPI_Comm_free(&comm_a);
18  if(comm_b != MPI_COMM_NULL)
19      MPI_Comm_free(&comm_b);
20  MPI_Group_free(&group_a);
21  MPI_Group_free(&group_b);
22  MPI_Group_free(&group_world);
23  MPI_Finalize();
24  return 0;
25  }

```

The library:

```

26
27
28 void lib_call(MPI_Comm comm)
29 {
30     int me, done = 0;
31     MPI_Status status;
32     MPI_Comm_rank(comm, &me);
33     if(me == 0)
34         while(!done)
35         {
36             MPI_Recv(..., MPI_ANY_SOURCE, MPI_ANY_TAG, comm, &status);
37             ...
38         }
39     else
40     {
41         /* work */
42         MPI_Send(..., 0, ARBITRARY_TAG, comm);
43         ...
44     }
45 #ifdef EXAMPLE_2C
46     /* include (resp, exclude) for safety (resp, no safety): */
47     MPI_Barrier(comm);
48 #endif

```

1        }

2  
3 The above example is really three examples, depending on whether or not one includes rank  
4 3 in `list_b`, and whether or not a `synchronize` is included in `lib_call`. This example illustrates  
5 that, despite contexts, subsequent calls to `lib_call` with the same context need not be safe  
6 from one another (colloquially, “back-masking”). Safety is realized if the `MPI_Barrier`  
7 is added. What this demonstrates is that libraries have to be written carefully, even with  
8 contexts. When rank 3 is excluded, then the `synchronize` is not needed to get safety from  
9 back-masking.

10 Algorithms like “reduce” and “allreduce” have strong enough source selectivity prop-  
11 erties so that they are inherently okay (no back-masking), provided that MPI provides basic  
12 guarantees. So are multiple calls to a typical tree-broadcast algorithm with the same root  
13 or different roots (see [60]). Here we rely on two guarantees of MPI: pairwise ordering of  
14 messages between processes in the same context, and source selectivity — deleting either  
15 feature removes the guarantee that back-masking cannot be required.

16 Algorithms that try to do non-deterministic broadcasts or other calls that include wild-  
17 card operations will not generally have the good properties of the deterministic implemen-  
18 tations of “reduce,” “allreduce,” and “broadcast.” Such algorithms would have to utilize  
19 the monotonically increasing tags (within a communicator scope) to keep things straight.

20 All of the foregoing is a supposition of “collective calls” implemented with point-to-  
21 point operations. MPI implementations may or may not implement collective calls using  
22 point-to-point operations. These algorithms are used to illustrate the issues of correctness  
23 and safety, independent of how MPI implements its collective calls. See also Section 6.9.

## 24 6.6 Inter-Communication

25  
26  
27 This section introduces the concept of inter-communication and describes the portions of  
28 MPI that support it. It describes support for writing programs that contain user-level  
29 servers.

30 All communication described thus far has involved communication between processes  
31 that are members of the same group. This type of communication is called “**intra-com-**  
32 **munication**” and the communicator used is called an “**intra-communicator**,” as we have  
33 noted earlier in the chapter.

34 In modular and multi-disciplinary applications, different process groups execute distinct  
35 modules and processes within different modules communicate with one another in a pipeline  
36 or a more general module graph. In these applications, the most natural way for a process  
37 to specify a target process is by the rank of the target process within the target group. In  
38 applications that contain internal user-level servers, each server may be a process group that  
39 provides services to one or more clients, and each client may be a process group that uses the  
40 services of one or more servers. It is again most natural to specify the target process by rank  
41 within the target group in these applications. This type of communication is called “**inter-**  
42 **communication**” and the communicator used is called an “**inter-communicator**,” as  
43 introduced earlier.

44 An **inter-communication** is a point-to-point communication between processes in  
45 different groups. The group containing a process that initiates an inter-communication  
46 operation is called the “local group,” that is, the sender in a send and the receiver in a  
47 receive. The group containing the target process is called the “remote group,” that is,  
48 the receiver in a send and the sender in a receive. As in intra-communication, the target



process is specified using a (communicator, rank) pair. Unlike intra-communication, the rank is relative to a second, remote group.

All inter-communicator constructors are blocking except for `MPI_COMM_IDUP` and require that the local and remote groups be disjoint.

*Advice to users.* The groups must be disjoint for several reasons. Primarily, this is the intent of the intercommunicators — to provide a communicator for communication between disjoint groups. This is reflected in the definition of `MPI_INTERCOMM_MERGE`, which allows the user to control the ranking of the processes in the created intracommunicator; this ranking makes little sense if the groups are not disjoint. In addition, the natural extension of collective operations to intercommunicators makes the most sense when the groups are disjoint. (*End of advice to users.*)

Here is a summary of the properties of inter-communication and inter-communicators:

- The syntax of point-to-point and collective communication is the same for both inter- and intra-communication. The same communicator can be used both for send and for receive operations.
- A target process is addressed by its rank in the remote group, both for sends and for receives.
- Communications using an inter-communicator are guaranteed not to conflict with any communications that use a different communicator.
- A communicator will provide either intra- or inter-communication, never both.

The routine `MPI_COMM_TEST_INTER` may be used to determine if a communicator is an inter- or intra-communicator. Inter-communicators can be used as arguments to some of the other communicator access routines. Inter-communicators cannot be used as input to some of the constructor routines for intra-communicators (for instance, `MPI_CART_CREATE`).

*Advice to implementors.* For the purpose of point-to-point communication, communicators can be represented in each process by a tuple consisting of:

**group**  
**send\_context**  
**receive\_context**  
**source**

For inter-communicators, *group* describes the remote group, and *source* is the rank of the process in the local group. For intra-communicators, *group* is the communicator group (remote=local), *source* is the rank of the process in this group, and *send context* and *receive context* are identical. A group can be represented by a rank-to-absolute-address translation table.

The inter-communicator cannot be discussed sensibly without considering processes in both the local and remote groups. Imagine a process **P** in group  $\mathcal{P}$ , which has an inter-communicator  $\mathbf{C}_{\mathcal{P}}$ , and a process **Q** in group  $\mathcal{Q}$ , which has an inter-communicator  $\mathbf{C}_{\mathcal{Q}}$ . Then

- 1 •  $C_P$ .group describes the group  $Q$  and  $C_Q$ .group describes the group  $P$ .
- 2 •  $C_P$ .send\_context =  $C_Q$ .receive\_context and the context is unique in  $Q$ ;
- 3 •  $C_P$ .receive\_context =  $C_Q$ .send\_context and this context is unique in  $P$ .
- 4 •  $C_P$ .source is rank of  $P$  in  $P$  and  $C_Q$ .source is rank of  $Q$  in  $Q$ .

6 Assume that  $P$  sends a message to  $Q$  using the inter-communicator. Then  $P$  uses  
 7 the **group** table to find the absolute address of  $Q$ ; **source** and **send\_context** are  
 8 appended to the message.

9 Assume that  $Q$  posts a receive with an explicit source argument using the inter-  
 10 communicator. Then  $Q$  matches **receive\_context** to the message context and source  
 11 argument to the message source.

12 The same algorithm is appropriate for intra-communicators as well.

13 In order to support inter-communicator accessors and constructors, it is necessary to  
 14 supplement this model with additional structures, that store information about the  
 15 local communication group, and additional safe contexts. (*End of advice to imple-*  
 16 *mentors.*)

### 19 6.6.1 Inter-Communicator Accessors

22 MPI\_COMM\_TEST\_INTER(comm, flag)

24 IN	comm	communicator (handle)
25 OUT	flag	(logical)

#### 27 C binding

28 int MPI\_Comm\_test\_inter(MPI\_Comm comm, int \*flag)

#### 30 Fortran 2008 binding

```

31 MPI_Comm_test_inter(comm, flag, ierror)
32     TYPE(MPI_Comm), INTENT(IN) :: comm
33     LOGICAL, INTENT(OUT) :: flag
34     INTEGER, OPTIONAL, INTENT(OUT) :: ierror
  
```

#### 36 Fortran binding

```

37 MPI_COMM_TEST_INTER(COMM, FLAG, IERROR)
38     INTEGER COMM, IERROR
39     LOGICAL FLAG
  
```

40 This local routine allows the calling process to determine if a communicator is an inter-  
 41 communicator or an intra-communicator. It returns true if it is an inter-communicator,  
 42 otherwise false.

43 When an inter-communicator is used as an input argument to the communicator ac-  
 44 cessors described above under intra-communication, the following table describes behavior.  
 45 Furthermore, the operation MPI\_COMM\_COMPARE is valid for inter-communicators. Both  
 46 communicators must be either intra- or inter-communicators, or else MPI\_UNEQUAL results.  
 47 Both corresponding local and remote groups must compare correctly to get the results  
 48

MPI_COMM_SIZE	returns the size of the local group.	1
MPI_COMM_GROUP	returns the local group.	2
MPI_COMM_RANK	returns the rank in the local group	3

Table 6.1: MPI\_COMM\_\* Function Behavior (in Inter-Communication Mode)

MPI\_CONGRUENT or MPI\_SIMILAR. In particular, it is possible for MPI\_SIMILAR to result because either the local or remote groups were similar but not identical.

The following accessors provide consistent access to the remote group of an inter-communicator. The following are all local operations.

MPI\_COMM\_REMOTE\_SIZE(comm, size)

IN	comm	inter-communicator (handle)
OUT	size	number of processes in the remote group of comm (integer)

#### C binding

```
int MPI_Comm_remote_size(MPI_Comm comm, int *size)
```

#### Fortran 2008 binding

```
MPI_Comm_remote_size(comm, size, ierror)
  TYPE(MPI_Comm), INTENT(IN) :: comm
  INTEGER, INTENT(OUT) :: size
  INTEGER, OPTIONAL, INTENT(OUT) :: ierror
```

#### Fortran binding

```
MPI_COMM_REMOTE_SIZE(COMM, SIZE, IERROR)
  INTEGER COMM, SIZE, IERROR
```

MPI\_COMM\_REMOTE\_GROUP(comm, group)

IN	comm	inter-communicator (handle)
OUT	group	remote group corresponding to comm (handle)

#### C binding

```
int MPI_Comm_remote_group(MPI_Comm comm, MPI_Group *group)
```

#### Fortran 2008 binding

```
MPI_Comm_remote_group(comm, group, ierror)
  TYPE(MPI_Comm), INTENT(IN) :: comm
  TYPE(MPI_Group), INTENT(OUT) :: group
  INTEGER, OPTIONAL, INTENT(OUT) :: ierror
```

#### Fortran binding

```
MPI_COMM_REMOTE_GROUP(COMM, GROUP, IERROR)
  INTEGER COMM, GROUP, IERROR
```

1       *Rationale.* Symmetric access to both the local and remote groups of an inter-  
2 communicator is important, so this function, as well as `MPI_COMM_REMOTE_SIZE`  
3 have been provided. (*End of rationale.*)  
4

## 5 6.6.2 Inter-Communicator Operations

6 This section introduces five blocking inter-communicator operations.  
7 `MPI_INTERCOMM_CREATE` is used to bind two intra-communicators into an inter-  
8 communicator; the function `MPI_INTERCOMM_CREATE_FROM_GROUPS` constructs an inter-  
9 communicator from two previously defined disjoint groups; the function  
10 `MPI_INTERCOMM_MERGE` creates an intra-communicator by merging the local and remote  
11 groups of an inter-communicator. The functions `MPI_COMM_DUP` and `MPI_COMM_FREE`,  
12 introduced previously, duplicate and free an inter-communicator, respectively.  
13

14 Overlap of local and remote groups that are bound into an inter-communicator is  
15 prohibited. If there is overlap, then the program is erroneous and is likely to deadlock. (If  
16 a process is multithreaded, and MPI calls block only a thread, rather than a process, then  
17 “dual membership” can be supported. It is then the user’s responsibility to make sure that  
18 calls on behalf of the two “roles” of a process are executed by two independent threads.)

19 The function `MPI_INTERCOMM_CREATE` can be used to create an inter-communicator  
20 from two existing intra-communicators, in the following situation: At least one selected  
21 member from each group (the “group leader”) has the ability to communicate with the  
22 selected member from the other group; that is, a “peer” communicator exists to which both  
23 leaders belong, and each leader knows the rank of the other leader in this peer communicator.  
24 Furthermore, members of each group know the rank of their leader.

25 Construction of an inter-communicator from two intra-communicators requires separate  
26 collective operations in the local group and in the remote group, as well as a point-to-point  
27 communication between a process in the local group and a process in the remote group.

28 When using the World Model, the `MPI_COMM_WORLD` communicator (or preferably a  
29 dedicated duplicate thereof) can be this peer communicator. For applications that have used  
30 the Sessions Model, `spawn`, or `join` it may be necessary to first create an intracommunicator  
31 to be used as peer.

32 The application topology functions described in Chapter 7 do not apply to inter-  
33 communicators. Users that require this capability should utilize  
34 `MPI_INTERCOMM_MERGE` to build an intra-communicator, then apply the graph or cartesi-  
35 an topology capabilities to that intra-communicator, creating an appropriate topology-  
36 oriented intra-communicator. Alternatively, it may be reasonable to devise one’s own ap-  
37 plication topology mechanisms for this case, without loss of generality.  
38  
39  
40  
41  
42  
43  
44  
45  
46  
47  
48

MPI\_INTERCOMM\_CREATE(local\_comm, local\_leader, peer\_comm, remote\_leader, tag, newintercomm)

			2
			3
IN	local_comm	local intra-communicator (handle)	4
IN	local_leader	rank of local group leader in local_comm (integer)	5
IN	peer_comm	“peer” communicator; significant only at the local_leader (handle)	6 7
IN	remote_leader	rank of remote group leader in peer_comm; significant only at the local_leader (integer)	8 9
IN	tag	tag (integer)	10 11
OUT	newintercomm	new inter-communicator (handle)	12 13

### C binding

```
int MPI_Intercomm_create(MPI_Comm local_comm, int local_leader,
                        MPI_Comm peer_comm, int remote_leader, int tag,
                        MPI_Comm *newintercomm)
```

### Fortran 2008 binding

```
MPI_Intercomm_create(local_comm, local_leader, peer_comm, remote_leader,
                    tag, newintercomm, ierror)
    TYPE(MPI_Comm), INTENT(IN) :: local_comm, peer_comm
    INTEGER, INTENT(IN) :: local_leader, remote_leader, tag
    TYPE(MPI_Comm), INTENT(OUT) :: newintercomm
    INTEGER, OPTIONAL, INTENT(OUT) :: ierror
```

### Fortran binding

```
MPI_INTERCOMM_CREATE(LOCAL_COMM, LOCAL_LEADER, PEER_COMM, REMOTE_LEADER,
                    TAG, NEWINTERCOMM, IERROR)
    INTEGER LOCAL_COMM, LOCAL_LEADER, PEER_COMM, REMOTE_LEADER, TAG,
    NEWINTERCOMM, IERROR
```

This call creates an inter-communicator. It is collective over the union of the local and remote groups. MPI processes should provide identical local\_comm and local\_leader arguments within each group. Wildcards are not permitted for remote\_leader, local\_leader, and tag.

```

1 MPI_INTERCOMM_CREATE_FROM_GROUPS(local_group, local_leader, remote_group, remote_leader,
2     stringtag, info, errhandler, newintercomm)
3
4     IN     local_group           local group (handle)
5     IN     local_leader         rank of local group leader in local_group (integer)
6     IN     remote_group        remote group, significant only at local_leader (handle)
7     IN     remote_leader       rank of remote group leader in remote_group, signifi-
8     cant only at local_leader (integer)
9
10    IN     stringtag           unique identifier for this operation (string)
11    IN     info                info object (handle)
12    IN     errhandler          error handler to be attached to new inter-communicator
13                                (handle)
14
15    OUT    newintercomm        new inter-communicator (handle)
16

```

**C binding**

```

17
18 int MPI_Intercomm_create_from_groups(MPI_Group local_group,
19     int local_leader, MPI_Group remote_group, int remote_leader,
20     const char *stringtag, MPI_Info info,
21     MPI_Errhandler errhandler, MPI_Comm *newintercomm)
22

```

**Fortran 2008 binding**

```

23
24 MPI_Intercomm_create_from_groups(local_group, local_leader, remote_group,
25     remote_leader, stringtag, info, errhandler, newintercomm,
26     ierror)
27     TYPE(MPI_Group), INTENT(IN) :: local_group, remote_group
28     INTEGER, INTENT(IN) :: local_leader, remote_leader
29     CHARACTER(LEN=*), INTENT(IN) :: stringtag
30     TYPE(MPI_Info), INTENT(IN) :: info
31     TYPE(MPI_Errhandler), INTENT(IN) :: errhandler
32     TYPE(MPI_Comm), INTENT(OUT) :: newintercomm
33     INTEGER, OPTIONAL, INTENT(OUT) :: ierror
34

```

**Fortran binding**

```

35 MPI_INTERCOMM_CREATE_FROM_GROUPS(LOCAL_GROUP, LOCAL_LEADER, REMOTE_GROUP,
36     REMOTE_LEADER, STRINGTAG, INFO, ERRHANDLER, NEWINTERCOMM,
37     IERROR)
38     INTEGER LOCAL_GROUP, LOCAL_LEADER, REMOTE_GROUP, REMOTE_LEADER, INFO,
39     ERRHANDLER, NEWINTERCOMM, IERROR
40     CHARACTER*(*) STRINGTAG
41

```

42 This call creates an inter-communicator. Unlike `MPI_Intercomm_create`, this function uses
43 as input previously defined, disjoint local and remote groups. The calling MPI process
44 must be a member of the local group. The call is collective over the union of the local
45 and remote groups. All involved MPI processes shall provide an identical value for the
46 `stringtag` argument. Within each group, all MPI processes shall provide identical `local_group`,
47 `local_leader` arguments. Wildcards are not permitted for the `remote_leader` or `local_leader`
48 arguments. The `stringtag` argument serves the same purpose as the `stringtag` used in the

MPI\_COMM\_CREATE\_FROM\_GROUP function; it differentiates concurrent calls in a multi-threaded environment. The `stringtag` shall not exceed `MPI_MAX_FROM_GROUP_STRINGTAG` characters in length. For C, this includes space for a null terminating character. In the event that `MPI_GROUP_EMPTY` is supplied as the `local_group` or `remote_group` or both, then the call is a local operation and `MPI_COMM_NULL` is returned as the `newintercomm`.

`MPI_INTERCOMM_MERGE(intercomm, high, newintracomm)`

IN	<code>intercomm</code>	Inter-Communicator (handle)
IN	<code>high</code>	(logical)
OUT	<code>newintracomm</code>	new intra-communicator (handle)

### C binding

```
int MPI_Intercomm_merge(MPI_Comm intercomm, int high,
                        MPI_Comm *newintracomm)
```

### Fortran 2008 binding

```
MPI_Intercomm_merge(intercomm, high, newintracomm, ierror)
    TYPE(MPI_Comm), INTENT(IN) :: intercomm
    LOGICAL, INTENT(IN) :: high
    TYPE(MPI_Comm), INTENT(OUT) :: newintracomm
    INTEGER, OPTIONAL, INTENT(OUT) :: ierror
```

### Fortran binding

```
MPI_INTERCOMM_MERGE(INTERCOMM, HIGH, NEWINTRACOMM, IERROR)
    INTEGER INTERCOMM, NEWINTRACOMM, IERROR
    LOGICAL HIGH
```

This function creates an intra-communicator from the union of the two groups that are associated with `intercomm`. All processes should provide the same `high` value within each of the two groups. If processes in one group provided the value `high = false` and processes in the other group provided the value `high = true` then the union orders the “low” group before the “high” group. If all processes provided the same `high` argument then the order of the union is arbitrary. This call is blocking and collective within the union of the two groups.

The error handler on the new intercommunicator in each process is inherited from the communicator that contributes the local group. Note that this can result in different processes in the same communicator having different error handlers.

*Advice to implementors.* The implementation of `MPI_INTERCOMM_MERGE`, `MPI_COMM_FREE`, and `MPI_COMM_DUP` are similar to the implementation of `MPI_INTERCOMM_CREATE`, except that contexts private to the input inter-communicator are used for communication between group leaders rather than contexts inside a bridge communicator. (*End of advice to implementors.*)

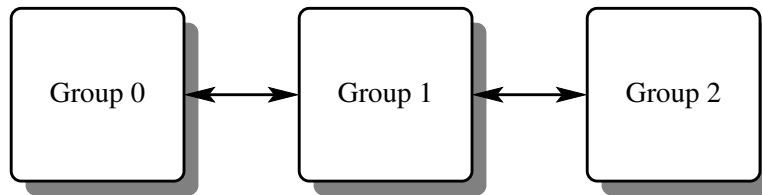

Figure 6.3: Three-group pipeline

### 6.6.3 Inter-Communication Examples

#### Example 1: Three-Group “Pipeline”

Groups 0 and 1 communicate. Groups 1 and 2 communicate. Therefore, group 0 requires one inter-communicator, group 1 requires two inter-communicators, and group 2 requires 1 inter-communicator.

```

17 int main(int argc, char *argv[])
18 {
19     MPI_Comm    myComm;        /* intra-communicator of local sub-group */
20     MPI_Comm    myFirstComm;   /* inter-communicator */
21     MPI_Comm    mySecondComm; /* second inter-communicator (group 1 only) */
22     int membershipKey;
23     int rank;
24
25     MPI_Init(&argc, &argv);
26     MPI_Comm_rank(MPI_COMM_WORLD, &rank);
27
28     /* User code must generate membershipKey in the range [0, 1, 2] */
29     membershipKey = rank % 3;
30
31     /* Build intra-communicator for local sub-group */
32     MPI_Comm_split(MPI_COMM_WORLD, membershipKey, rank, &myComm);
33
34     /* Build inter-communicators. Tags are hard-coded. */
35     if (membershipKey == 0)
36     {
37         /* Group 0 communicates with group 1. */
38         MPI_Intercomm_create(myComm, 0, MPI_COMM_WORLD, 1,
39                             1, &myFirstComm);
40     }
41     else if (membershipKey == 1)
42     {
43         /* Group 1 communicates with groups 0 and 2. */
44         MPI_Intercomm_create(myComm, 0, MPI_COMM_WORLD, 0,
45                             1, &myFirstComm);
46         MPI_Intercomm_create(myComm, 0, MPI_COMM_WORLD, 2,
47                             12, &mySecondComm);
48     }
49     else if (membershipKey == 2)
50     {
51         /* Group 2 communicates with group 1. */
  
```



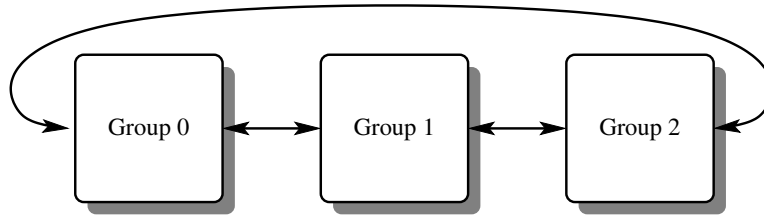

Figure 6.4: Three-group ring

```

MPI_Intercomm_create(myComm, 0, MPI_COMM_WORLD, 1,
                    12, &myFirstComm);
}

/* Do work ... */

switch(membershipKey) /* free communicators appropriately */
{
case 1:
    MPI_Comm_free(&mySecondComm);
case 0:
case 2:
    MPI_Comm_free(&myFirstComm);
    break;
}

MPI_Finalize();
return 0;
}

```

#### Example 2: Three-Group “Ring”

Groups 0 and 1 communicate. Groups 1 and 2 communicate. Groups 0 and 2 communicate. Therefore, each requires two inter-communicators.

```

int main(int argc, char *argv[])
{
    MPI_Comm myComm; /* intra-communicator of local sub-group */
    MPI_Comm myFirstComm; /* inter-communicators */
    MPI_Comm mySecondComm;
    int membershipKey;
    int rank;

    MPI_Init(&argc, &argv);
    MPI_Comm_rank(MPI_COMM_WORLD, &rank);
    ...

    /* User code must generate membershipKey in the range [0, 1, 2] */
    membershipKey = rank % 3;
}

```

```

1
2  /* Build intra-communicator for local sub-group */
3  MPI_Comm_split(MPI_COMM_WORLD, membershipKey, rank, &myComm);
4
5  /* Build inter-communicators.  Tags are hard-coded. */
6  if (membershipKey == 0)
7  {
8      /* Group 0 communicates with groups 1 and 2. */
9      MPI_Intercomm_create(myComm, 0, MPI_COMM_WORLD, 1,
10                          1, &myFirstComm);
11     MPI_Intercomm_create(myComm, 0, MPI_COMM_WORLD, 2,
12                          2, &mySecondComm);
13 }
14 else if (membershipKey == 1)
15 {
16     /* Group 1 communicates with groups 0 and 2. */
17     MPI_Intercomm_create(myComm, 0, MPI_COMM_WORLD, 0,
18                         1, &myFirstComm);
19     MPI_Intercomm_create(myComm, 0, MPI_COMM_WORLD, 2,
20                         12, &mySecondComm);
21 }
22 else if (membershipKey == 2)
23 {
24     /* Group 2 communicates with groups 0 and 1. */
25     MPI_Intercomm_create(myComm, 0, MPI_COMM_WORLD, 0,
26                         2, &myFirstComm);
27     MPI_Intercomm_create(myComm, 0, MPI_COMM_WORLD, 1,
28                         12, &mySecondComm);
29 }
30
31 /* Do some work ... */
32
33 /* Then free communicators before terminating... */
34 MPI_Comm_free(&myFirstComm);
35 MPI_Comm_free(&mySecondComm);
36 MPI_Comm_free(&myComm);
37 MPI_Finalize();
38 return 0;
39 }

```

## 6.7 Caching

MPI provides a “caching” facility that allows an application to attach arbitrary pieces of information, called **attributes**, to three kinds of MPI objects, communicators, windows, and datatypes. More precisely, the caching facility allows a portable library to do the following:

- pass information between calls by associating it with an MPI intra- or inter-communicator, window, or datatype,
- quickly retrieve that information, and

- be guaranteed that out-of-date information is never retrieved, even if the object is freed and its handle subsequently reused by MPI.

The caching capabilities, in some form, are required by built-in MPI routines such as collective communication and application topology. Defining an interface to these capabilities as part of the MPI standard is valuable because it permits routines like collective communication and application topologies to be implemented as portable code, and also because it makes MPI more extensible by allowing user-written routines to use standard MPI calling sequences.

*Advice to users.* The communicator `MPI_COMM_SELF` is a suitable choice for posting process-local attributes, via this attribute-caching mechanism. (*End of advice to users.*)

*Rationale.* In one extreme one can allow caching on all opaque handles. The other extreme is to only allow it on communicators. Caching has a cost associated with it and should only be allowed when it is clearly needed and the increased cost is modest. This is the reason that windows and datatypes were added but not other handles. (*End of rationale.*)

One difficulty is the potential for size differences between Fortran integers and C pointers. For this reason, the Fortran versions of these routines use integers of kind `MPI_ADDRESS_KIND`.

*Advice to implementors.* High-quality implementations should raise an error when a keyval that was created by a call to `MPI_XXX_CREATE_KEYVAL` is used with an object of the wrong type with a call to `MPI_YYY_GET_ATTR`, `MPI_YYY_SET_ATTR`, `MPI_YYY_DELETE_ATTR`, or `MPI_YYY_FREE_KEYVAL`. To do so, it is necessary to maintain, with each keyval, information on the type of the associated user function. (*End of advice to implementors.*)

### 6.7.1 Functionality

Attributes can be attached to communicators, windows, and datatypes. Attributes are local to the process and specific to the communicator to which they are attached. Attributes are not propagated by MPI from one communicator to another except when the communicator is duplicated using `MPI_COMM_DUP` or `MPI_COMM_IDUP` (and even then the application must give specific permission through callback functions for the attribute to be copied).

*Advice to users.* Attributes in C are of type `void*`. Typically, such an attribute will be a pointer to a structure that contains further information, or a handle to an MPI object. In Fortran, attributes are of type `INTEGER`. Such attribute can be a handle to an MPI object, or just an integer-valued attribute. (*End of advice to users.*)

*Advice to implementors.* Attributes are scalar values, equal in size to, or larger than a C-language pointer. Attributes can always hold an MPI handle. (*End of advice to implementors.*)

The caching interface defined here requires that attributes be stored by MPI opaquely within a communicator, window, or datatype. Accessor functions include the following:

- 1 • obtain a key value (used to identify an attribute); the user specifies “callback” func-
- 2 tions by which MPI informs the application when the communicator is destroyed or
- 3 copied.
- 4
- 5 • store and retrieve the value of an attribute;

6 *Advice to implementors.* Caching and callback functions are only called synchronously,  
 7 in response to explicit application requests. This avoids problems that result from re-  
 8 peated crossings between user and system space. (This synchronous calling rule is a  
 9 general property of MPI.)

10 The choice of key values is under control of MPI. This allows MPI to optimize its  
 11 implementation of attribute sets. It also avoids conflict between independent modules  
 12 caching information on the same communicators.

13 A much smaller interface, consisting of just a callback facility, would allow the entire  
 14 caching facility to be implemented by portable code. However, with the minimal call-  
 15 back interface, some form of table searching is implied by the need to handle arbitrary  
 16 communicators. In contrast, the more complete interface defined here permits rapid  
 17 access to attributes through the use of pointers in communicators (to find the attribute  
 18 table) and cleverly chosen key values (to retrieve individual attributes). In light of the  
 19 efficiency “hit” inherent in the minimal interface, the more complete interface defined  
 20 here is seen to be superior. (*End of advice to implementors.*)

21 MPI provides the following services related to caching. They are all process local.

## 22 6.7.2 Communicators

23 Functions for caching on communicators are:

24 `MPI_COMM_CREATE_KEYVAL(comm_copy_attr_fn, comm_delete_attr_fn, comm_keyval, extra_state)`

25	IN	<code>comm_copy_attr_fn</code>	copy callback function for <code>comm_keyval</code> (function)
26	IN	<code>comm_delete_attr_fn</code>	delete callback function for <code>comm_keyval</code> (function)
27	OUT	<code>comm_keyval</code>	key value for future access (integer)
28	IN	<code>extra_state</code>	extra state for callback function

### 29 C binding

```
30 int MPI_Comm_create_keyval(MPI_Comm_copy_attr_function *comm_copy_attr_fn,
31 MPI_Comm_delete_attr_function *comm_delete_attr_fn,
32 int *comm_keyval, void *extra_state)
```

### 33 Fortran 2008 binding

```
34 MPI_Comm_create_keyval(comm_copy_attr_fn, comm_delete_attr_fn, comm_keyval,
35 extra_state, ierror)
36 PROCEDURE(MPI_Comm_copy_attr_function), INTENT(IN) ::
37 comm_copy_attr_fn
38 PROCEDURE(MPI_Comm_delete_attr_function), INTENT(IN) ::
39 comm_delete_attr_fn
```

```

INTEGER, INTENT(OUT) :: comm_keyval
INTEGER(KIND=MPI_ADDRESS_KIND), INTENT(IN) :: extra_state
INTEGER, OPTIONAL, INTENT(OUT) :: ierror

```

**Fortran binding**

```

MPI_COMM_CREATE_KEYVAL(COMM_COPY_ATTR_FN, COMM_DELETE_ATTR_FN, COMM_KEYVAL,
    EXTRA_STATE, IERROR)
EXTERNAL COMM_COPY_ATTR_FN, COMM_DELETE_ATTR_FN
INTEGER COMM_KEYVAL, IERROR
INTEGER(KIND=MPI_ADDRESS_KIND) EXTRA_STATE

```

Generates a new attribute key. Keys are locally unique in a process, and opaque to user, though they are explicitly stored in integers. Once allocated, the key value can be used to associate attributes and access them on any locally defined communicator.

The C callback functions are:

```

typedef int MPI_Comm_copy_attr_function(MPI_Comm oldcomm, int comm_keyval,
    void *extra_state, void *attribute_val_in,
    void *attribute_val_out, int *flag);

```

and

```

typedef int MPI_Comm_delete_attr_function(MPI_Comm comm, int comm_keyval,
    void *attribute_val, void *extra_state);

```

which are the same as the MPI-1.1 calls but with a new name. The old names are deprecated. With the `mpi_f08` module, the Fortran callback functions are:

```

ABSTRACT INTERFACE
  SUBROUTINE MPI_Comm_copy_attr_function(oldcomm, comm_keyval, extra_state,
    attribute_val_in, attribute_val_out, flag, ierror)
    TYPE(MPI_Comm) :: oldcomm
    INTEGER :: comm_keyval, ierror
    INTEGER(KIND=MPI_ADDRESS_KIND) :: extra_state, attribute_val_in,
    attribute_val_out
    LOGICAL :: flag

```

and

```

ABSTRACT INTERFACE
  SUBROUTINE MPI_Comm_delete_attr_function(comm, comm_keyval,
    attribute_val, extra_state, ierror)
    TYPE(MPI_Comm) :: comm
    INTEGER :: comm_keyval, ierror
    INTEGER(KIND=MPI_ADDRESS_KIND) :: attribute_val, extra_state

```

With the `mpi` module and `mpif.h`, the Fortran callback functions are:

```

SUBROUTINE COMM_COPY_ATTR_FUNCTION(OLDCOMM, COMM_KEYVAL, EXTRA_STATE,
    ATTRIBUTE_VAL_IN, ATTRIBUTE_VAL_OUT, FLAG, IERROR)
  INTEGER OLDCOMM, COMM_KEYVAL, IERROR
  INTEGER(KIND=MPI_ADDRESS_KIND) EXTRA_STATE, ATTRIBUTE_VAL_IN,
  ATTRIBUTE_VAL_OUT
  LOGICAL FLAG

```

and

```

1 SUBROUTINE COMM_DELETE_ATTR_FUNCTION(COMM, COMM_KEYVAL, ATTRIBUTE_VAL,
2     EXTRA_STATE, IERROR)
3     INTEGER COMM, COMM_KEYVAL, IERROR
4     INTEGER(KIND=MPI_ADDRESS_KIND) ATTRIBUTE_VAL, EXTRA_STATE

```

The `comm_copy_attr_fn` function is invoked when a communicator is duplicated by `MPI_COMM_DUP` or `MPI_COMM_IDUP`. `comm_copy_attr_fn` should be of type `MPI_Comm_copy_attr_function`. The copy callback function is invoked for each key value in `oldcomm` in arbitrary order. Each call to the copy callback is made with a key value and its corresponding attribute. If it returns `flag = 0` or `.FALSE.`, then the attribute is deleted in the duplicated communicator. Otherwise (`flag = 1` or `.TRUE.`), the new attribute value is set to the value returned in `attribute_val_out`. The function returns `MPI_SUCCESS` on success and an error code on failure (in which case `MPI_COMM_DUP` or `MPI_COMM_IDUP` will fail).

The argument `comm_copy_attr_fn` may be specified as `MPI_COMM_NULL_COPY_FN` or `MPI_COMM_DUP_FN` from either C or Fortran. `MPI_COMM_NULL_COPY_FN` is a function that does nothing other than returning `flag = 0` or `.FALSE.` (depending on whether the keyval was created with a C or Fortran binding to `MPI_COMM_CREATE_KEYVAL`) and `MPI_SUCCESS`. `MPI_COMM_DUP_FN` is a simple-minded copy function that sets `flag = 1` or `.TRUE.`, returns the value of `attribute_val_in` in `attribute_val_out`, and returns `MPI_SUCCESS`. These replace the MPI-1 predefined callbacks `MPI_NULL_COPY_FN` and `MPI_DUP_FN`, whose use is deprecated.

*Advice to users.* Even though both formal arguments `attribute_val_in` and `attribute_val_out` are of type `void*`, their usage differs. The C copy function is passed by MPI in `attribute_val_in` the *value* of the attribute, and in `attribute_val_out` the *address* of the attribute, so as to allow the function to return the (new) attribute value. The use of type `void*` for both is to avoid messy type casts.

A valid copy function is one that completely duplicates the information by making a full duplicate copy of the data structures implied by an attribute; another might just make another reference to that data structure, while using a reference-count mechanism. Other types of attributes might not copy at all (they might be specific to `oldcomm` only). (*End of advice to users.*)

*Advice to implementors.* A C interface should be assumed for copy and delete functions associated with key values created in C; a Fortran calling interface should be assumed for key values created in Fortran. (*End of advice to implementors.*)

Analogous to `comm_copy_attr_fn` is a callback deletion function, defined as follows. The `comm_delete_attr_fn` function is invoked when a communicator is deleted by `MPI_COMM_FREE` or when a call is made explicitly to `MPI_COMM_DELETE_ATTR`. `comm_delete_attr_fn` should be of type `MPI_Comm_delete_attr_function`.

This function is called by `MPI_COMM_FREE`, `MPI_COMM_DELETE_ATTR`, and `MPI_COMM_SET_ATTR` to do whatever is needed to remove an attribute. The function returns `MPI_SUCCESS` on success and an error code on failure (in which case `MPI_COMM_FREE` will fail).

The argument `comm_delete_attr_fn` may be specified as `MPI_COMM_NULL_DELETE_FN` from either C or Fortran. `MPI_COMM_NULL_DELETE_FN` is a function that does nothing, other than returning

MPI\_SUCCESS. MPI\_COMM\_NULL\_DELETE\_FN replaces MPI\_NULL\_DELETE\_FN, whose use is deprecated.

If an attribute copy function or attribute delete function returns other than MPI\_SUCCESS, then the call that caused it to be invoked (for example, MPI\_COMM\_FREE), is erroneous.

The special key value MPI\_KEYVAL\_INVALID is never returned by MPI\_COMM\_CREATE\_KEYVAL. Therefore, it can be used for static initialization of key values.

*Advice to implementors.* The predefined Fortran functions MPI\_COMM\_NULL\_COPY\_FN, MPI\_COMM\_DUP\_FN, and MPI\_COMM\_NULL\_DELETE\_FN are defined in the mpi module (and mpif.h) and the mpi\_f08 module with the same name, but with different interfaces. Each function can coexist twice with the same name in the same MPI library, one routine as an implicit interface outside of the mpi module, i.e., declared as EXTERNAL, and the other routine within mpi\_f08 declared with CONTAINS. These routines have different link names, which are also different to the link names used for the routines used in C. (*End of advice to implementors.*)

*Advice to users.* Callbacks, including the predefined Fortran functions MPI\_COMM\_NULL\_COPY\_FN, MPI\_COMM\_DUP\_FN, and MPI\_COMM\_NULL\_DELETE\_FN should not be passed from one application routine that uses the mpi\_f08 module to another application routine that uses the mpi module or mpif.h, and vice versa; see also the advice to users on page 758. (*End of advice to users.*)

MPI\_COMM\_FREE\_KEYVAL(comm\_keyval)  
 INOUT comm\_keyval key value (integer)

### C binding

```
int MPI_Comm_free_keyval(int *comm_keyval)
```

### Fortran 2008 binding

```
MPI_Comm_free_keyval(comm_keyval, ierror)
  INTEGER, INTENT(INOUT) :: comm_keyval
  INTEGER, OPTIONAL, INTENT(OUT) :: ierror
```

### Fortran binding

```
MPI_COMM_FREE_KEYVAL(COMM_KEYVAL, IERROR)
  INTEGER COMM_KEYVAL, IERROR
```

Frees an extant attribute key. This function sets the value of keyval to MPI\_KEYVAL\_INVALID. Note that it is not erroneous to free an attribute key that is in use, because the actual free does not transpire until after all references (in other communicators on the process) to the key have been freed. These references need to be explicitly freed by the program, either via calls to MPI\_COMM\_DELETE\_ATTR that free one attribute instance, or by calls to MPI\_COMM\_FREE that free all attribute instances associated with the freed communicator.

```

1 MPI_COMM_SET_ATTR(comm, comm_keyval, attribute_val)
2     INOUT    comm                communicator to which attribute will be attached (han-
3                                     dle)
4
5     IN       comm_keyval         key value (integer)
6     IN       attribute_val       attribute value
7

```

**C binding**

```

9 int MPI_Comm_set_attr(MPI_Comm comm, int comm_keyval, void *attribute_val)
10

```

**Fortran 2008 binding**

```

12 MPI_Comm_set_attr(comm, comm_keyval, attribute_val, ierror)
13     TYPE(MPI_Comm), INTENT(IN) :: comm
14     INTEGER, INTENT(IN) :: comm_keyval
15     INTEGER(KIND=MPI_ADDRESS_KIND), INTENT(IN) :: attribute_val
16     INTEGER, OPTIONAL, INTENT(OUT) :: ierror
17

```

**Fortran binding**

```

18 MPI_COMM_SET_ATTR(COMM, COMM_KEYVAL, ATTRIBUTE_VAL, IERROR)
19     INTEGER COMM, COMM_KEYVAL, IERROR
20     INTEGER(KIND=MPI_ADDRESS_KIND) ATTRIBUTE_VAL
21

```

22 This function stores the stipulated attribute value `attribute_val` for subsequent retrieval
23 by `MPI_COMM_GET_ATTR`. If the value is already present, then the outcome is as if
24 `MPI_COMM_DELETE_ATTR` was first called to delete the previous value (and the callback
25 function `comm_delete_attr_fn` was executed), and a new value was next stored. The call
26 is erroneous if there is no key with value `keyval`; in particular `MPI_KEYVAL_INVALID` is an
27 erroneous key value. The call will fail if the `comm_delete_attr_fn` function returned an error
28 code other than `MPI_SUCCESS`.
29

```

30 MPI_COMM_GET_ATTR(comm, comm_keyval, attribute_val, flag)
31

```

```

32     IN       comm                communicator to which the attribute is attached (han-
33                                     dle)
34     IN       comm_keyval         key value (integer)
35     OUT      attribute_val       attribute value, unless flag = false
36     OUT      flag                false if no attribute is associated with the key (logical)
37
38

```

**C binding**

```

39 int MPI_Comm_get_attr(MPI_Comm comm, int comm_keyval, void *attribute_val,
40                       int *flag)
41
42

```

**Fortran 2008 binding**

```

43 MPI_Comm_get_attr(comm, comm_keyval, attribute_val, flag, ierror)
44     TYPE(MPI_Comm), INTENT(IN) :: comm
45     INTEGER, INTENT(IN) :: comm_keyval
46     INTEGER(KIND=MPI_ADDRESS_KIND), INTENT(OUT) :: attribute_val
47     LOGICAL, INTENT(OUT) :: flag
48

```



```
INTEGER, OPTIONAL, INTENT(OUT) :: ierror
```

### Fortran binding

```
MPI_COMM_GET_ATTR(COMM, COMM_KEYVAL, ATTRIBUTE_VAL, FLAG, IERROR)
  INTEGER COMM, COMM_KEYVAL, IERROR
  INTEGER(KIND=MPI_ADDRESS_KIND) ATTRIBUTE_VAL
  LOGICAL FLAG
```

Retrieves attribute value by key. The call is erroneous if there is no key with value `keyval`. On the other hand, the call is correct if the key value exists, but no attribute is attached on `comm` for that key; in such case, the call returns `flag = false`. In particular `MPI_KEYVAL_INVALID` is an erroneous key value.

*Advice to users.* The call to `MPI_Comm_set_attr` passes in `attribute_val` the *value* of the attribute; the call to `MPI_Comm_get_attr` passes in `attribute_val` the *address* of the location where the attribute value is to be returned. Thus, if the attribute value itself is a pointer of type `void*`, then the actual `attribute_val` parameter to `MPI_Comm_set_attr` will be of type `void*` and the actual `attribute_val` parameter to `MPI_Comm_get_attr` will be of type `void**`. (*End of advice to users.*)

*Rationale.* The use of a formal parameter `attribute_val` of type `void*` (rather than `void**`) avoids the messy type casting that would be needed if the attribute value is declared with a type other than `void*`. (*End of rationale.*)

```
MPI_COMM_DELETE_ATTR(comm, comm_keyval)
```

INOUT	comm	communicator from which the attribute is deleted (handle)
IN	comm_keyval	key value (integer)

### C binding

```
int MPI_Comm_delete_attr(MPI_Comm comm, int comm_keyval)
```

### Fortran 2008 binding

```
MPI_Comm_delete_attr(comm, comm_keyval, ierror)
  TYPE(MPI_Comm), INTENT(IN) :: comm
  INTEGER, INTENT(IN) :: comm_keyval
  INTEGER, OPTIONAL, INTENT(OUT) :: ierror
```

### Fortran binding

```
MPI_COMM_DELETE_ATTR(COMM, COMM_KEYVAL, IERROR)
  INTEGER COMM, COMM_KEYVAL, IERROR
```

Delete attribute from cache by key. This function invokes the attribute delete function `comm_delete_attr_fn` specified when the `keyval` was created. The call will fail if the `comm_delete_attr_fn` function returns an error code other than `MPI_SUCCESS`.

Whenever a communicator is replicated using the function `MPI_COMM_DUP` or `MPI_COMM_IDUP`, all call-back copy functions for attributes that are currently set are invoked (in arbitrary order). Whenever a communicator is deleted using the function

1 MPI\_COMM\_FREE all callback delete functions for attributes that are currently set are  
 2 invoked.

### 3 4 6.7.3 Windows

5 The functions for caching on windows are:

6  
7  
8 MPI\_WIN\_CREATE\_KEYVAL(win\_copy\_attr\_fn, win\_delete\_attr\_fn, win\_keyval, extra\_state)

9  
10  
11 IN win\_copy\_attr\_fn copy callback function for win\_keyval (function)  
 12 IN win\_delete\_attr\_fn delete callback function for win\_keyval (function)  
 13 OUT win\_keyval key value for future access (integer)  
 14 IN extra\_state extra state for callback function  
 15  
16

#### 17 C binding

18 int MPI\_Win\_create\_keyval(MPI\_Win\_copy\_attr\_function \*win\_copy\_attr\_fn,  
 19 MPI\_Win\_delete\_attr\_function \*win\_delete\_attr\_fn,  
 20 int \*win\_keyval, void \*extra\_state)

#### 21 Fortran 2008 binding

22 MPI\_Win\_create\_keyval(win\_copy\_attr\_fn, win\_delete\_attr\_fn, win\_keyval,  
 23 extra\_state, ierror)  
 24 PROCEDURE(MPI\_Win\_copy\_attr\_function), INTENT(IN) :: win\_copy\_attr\_fn  
 25 PROCEDURE(MPI\_Win\_delete\_attr\_function), INTENT(IN) ::  
 26 win\_delete\_attr\_fn  
 27 INTEGER, INTENT(OUT) :: win\_keyval  
 28 INTEGER(KIND=MPI\_ADDRESS\_KIND), INTENT(IN) :: extra\_state  
 29 INTEGER, OPTIONAL, INTENT(OUT) :: ierror  
 30

#### 31 Fortran binding

32 MPI\_WIN\_CREATE\_KEYVAL(WIN\_COPY\_ATTR\_FN, WIN\_DELETE\_ATTR\_FN, WIN\_KEYVAL,  
 33 EXTRA\_STATE, IERROR)  
 34 EXTERNAL WIN\_COPY\_ATTR\_FN, WIN\_DELETE\_ATTR\_FN  
 35 INTEGER WIN\_KEYVAL, IERROR  
 36 INTEGER(KIND=MPI\_ADDRESS\_KIND) EXTRA\_STATE  
 37

38 The argument win\_copy\_attr\_fn may be specified as MPI\_WIN\_NULL\_COPY\_FN or  
 39 MPI\_WIN\_DUP\_FN from either C or Fortran. MPI\_WIN\_NULL\_COPY\_FN is a function  
 40 that does nothing other than returning flag = 0 and MPI\_SUCCESS. MPI\_WIN\_DUP\_FN is  
 41 a simple-minded copy function that sets flag = 1, returns the value of attribute\_val\_in in  
 42 attribute\_val\_out, and returns MPI\_SUCCESS.

43 The argument win\_delete\_attr\_fn may be specified as MPI\_WIN\_NULL\_DELETE\_FN  
 44 from either C or Fortran. MPI\_WIN\_NULL\_DELETE\_FN is a function that does nothing,  
 45 other than returning MPI\_SUCCESS.

46 The C callback functions are:

47 typedef int MPI\_Win\_copy\_attr\_function(MPI\_Win oldwin, int win\_keyval,  
 48 void \*extra\_state, void \*attribute\_val\_in,

```

        void *attribute_val_out, int *flag);
and
typedef int MPI_Win_delete_attr_function(MPI_Win win, int win_keyval,
        void *attribute_val, void *extra_state);

```

With the `mpi_f08` module, the Fortran callback functions are:

```

ABSTRACT INTERFACE
  SUBROUTINE MPI_Win_copy_attr_function(oldwin, win_keyval, extra_state,
        attribute_val_in, attribute_val_out, flag, ierror)
    TYPE(MPI_Win) :: oldwin
    INTEGER :: win_keyval, ierror
    INTEGER(KIND=MPI_ADDRESS_KIND) :: extra_state, attribute_val_in,
attribute_val_out
    LOGICAL :: flag

```

and

```

ABSTRACT INTERFACE
  SUBROUTINE MPI_Win_delete_attr_function(win, win_keyval, attribute_val,
        extra_state, ierror)
    TYPE(MPI_Win) :: win
    INTEGER :: win_keyval, ierror
    INTEGER(KIND=MPI_ADDRESS_KIND) :: attribute_val, extra_state

```

With the `mpi` module and `mpif.h`, the Fortran callback functions are:

```

SUBROUTINE WIN_COPY_ATTR_FUNCTION(OLDWIN, WIN_KEYVAL, EXTRA_STATE,
        ATTRIBUTE_VAL_IN, ATTRIBUTE_VAL_OUT, FLAG, IERROR)
  INTEGER OLDWIN, WIN_KEYVAL, IERROR
  INTEGER(KIND=MPI_ADDRESS_KIND) EXTRA_STATE, ATTRIBUTE_VAL_IN,
ATTRIBUTE_VAL_OUT
  LOGICAL FLAG

```

and

```

SUBROUTINE WIN_DELETE_ATTR_FUNCTION(WIN, WIN_KEYVAL, ATTRIBUTE_VAL,
        EXTRA_STATE, IERROR)
  INTEGER WIN, WIN_KEYVAL, IERROR
  INTEGER(KIND=MPI_ADDRESS_KIND) ATTRIBUTE_VAL, EXTRA_STATE

```

If an attribute copy function or attribute delete function returns other than `MPI_SUCCESS`, then the call that caused it to be invoked (for example, `MPI_WIN_FREE`), is erroneous.

`MPI_WIN_FREE_KEYVAL(win_keyval)`

INOUT win\_keyval key value (integer)

### C binding

`int MPI_Win_free_keyval(int *win_keyval)`

### Fortran 2008 binding

`MPI_Win_free_keyval(win_keyval, ierror)`

```

1     INTEGER, INTENT(INOUT) :: win_keyval
2     INTEGER, OPTIONAL, INTENT(OUT) :: ierror
3
4     Fortran binding
5     MPI_WIN_FREE_KEYVAL(WIN_KEYVAL, IERROR)
6         INTEGER WIN_KEYVAL, IERROR
7
8
9     MPI_WIN_SET_ATTR(win, win_keyval, attribute_val)
10
11     INOUT    win                window to which attribute will be attached (handle)
12     IN       win_keyval        key value (integer)
13     IN       attribute_val     attribute value
14
15     C binding
16     int MPI_Win_set_attr(MPI_Win win, int win_keyval, void *attribute_val)
17
18     Fortran 2008 binding
19     MPI_Win_set_attr(win, win_keyval, attribute_val, ierror)
20         TYPE(MPI_Win), INTENT(IN) :: win
21         INTEGER, INTENT(IN) :: win_keyval
22         INTEGER(KIND=MPI_ADDRESS_KIND), INTENT(IN) :: attribute_val
23         INTEGER, OPTIONAL, INTENT(OUT) :: ierror
24
25     Fortran binding
26     MPI_WIN_SET_ATTR(WIN, WIN_KEYVAL, ATTRIBUTE_VAL, IERROR)
27         INTEGER WIN, WIN_KEYVAL, IERROR
28         INTEGER(KIND=MPI_ADDRESS_KIND) ATTRIBUTE_VAL
29
30     MPI_WIN_GET_ATTR(win, win_keyval, attribute_val, flag)
31
32     IN       win                window to which the attribute is attached (handle)
33     IN       win_keyval        key value (integer)
34     OUT      attribute_val     attribute value, unless flag = false
35     OUT      flag              false if no attribute is associated with the key (logical)
36
37
38     C binding
39     int MPI_Win_get_attr(MPI_Win win, int win_keyval, void *attribute_val,
40                         int *flag)
41
42     Fortran 2008 binding
43     MPI_Win_get_attr(win, win_keyval, attribute_val, flag, ierror)
44         TYPE(MPI_Win), INTENT(IN) :: win
45         INTEGER, INTENT(IN) :: win_keyval
46         INTEGER(KIND=MPI_ADDRESS_KIND), INTENT(OUT) :: attribute_val
47         LOGICAL, INTENT(OUT) :: flag
48         INTEGER, OPTIONAL, INTENT(OUT) :: ierror

```

**Fortran binding**

```

MPI_WIN_GET_ATTR(WIN, WIN_KEYVAL, ATTRIBUTE_VAL, FLAG, IERROR)
    INTEGER WIN, WIN_KEYVAL, IERROR
    INTEGER(KIND=MPI_ADDRESS_KIND) ATTRIBUTE_VAL
    LOGICAL FLAG

```

```

MPI_WIN_DELETE_ATTR(win, win_keyval)

```

INOUT	win	window from which the attribute is deleted (handle)
IN	win_keyval	key value (integer)

**C binding**

```

int MPI_Win_delete_attr(MPI_Win win, int win_keyval)

```

**Fortran 2008 binding**

```

MPI_Win_delete_attr(win, win_keyval, ierror)
    TYPE(MPI_Win), INTENT(IN) :: win
    INTEGER, INTENT(IN) :: win_keyval
    INTEGER, OPTIONAL, INTENT(OUT) :: ierror

```

**Fortran binding**

```

MPI_WIN_DELETE_ATTR(WIN, WIN_KEYVAL, IERROR)
    INTEGER WIN, WIN_KEYVAL, IERROR

```

## 6.7.4 Datatypes

The new functions for caching on datatypes are:

```

MPI_TYPE_CREATE_KEYVAL(type_copy_attr_fn, type_delete_attr_fn, type_keyval, extra_state)

```

IN	type_copy_attr_fn	copy callback function for type_keyval (function)
IN	type_delete_attr_fn	delete callback function for type_keyval (function)
OUT	type_keyval	key value for future access (integer)
IN	extra_state	extra state for callback function

**C binding**

```

int MPI_Type_create_keyval(MPI_Type_copy_attr_function *type_copy_attr_fn,
    MPI_Type_delete_attr_function *type_delete_attr_fn,
    int *type_keyval, void *extra_state)

```

**Fortran 2008 binding**

```

MPI_Type_create_keyval(type_copy_attr_fn, type_delete_attr_fn, type_keyval,
    extra_state, ierror)
    PROCEDURE(MPI_Type_copy_attr_function), INTENT(IN) ::
    type_copy_attr_fn

```

```

1  PROCEDURE(MPI_Type_delete_attr_function), INTENT(IN) ::
2  type_delete_attr_fn
3  INTEGER, INTENT(OUT) :: type_keyval
4  INTEGER(KIND=MPI_ADDRESS_KIND), INTENT(IN) :: extra_state
5  INTEGER, OPTIONAL, INTENT(OUT) :: ierror

```

### Fortran binding

```

7  MPI_TYPE_CREATE_KEYVAL(TYPE_COPY_ATTR_FN, TYPE_DELETE_ATTR_FN, TYPE_KEYVAL,
8  EXTRA_STATE, IERROR)
9  EXTERNAL TYPE_COPY_ATTR_FN, TYPE_DELETE_ATTR_FN
10  INTEGER TYPE_KEYVAL, IERROR
11  INTEGER(KIND=MPI_ADDRESS_KIND) EXTRA_STATE

```

13 The argument `type_copy_attr_fn` may be specified as `MPI_TYPE_NULL_COPY_FN` or  
14 `MPI_TYPE_DUP_FN` from either C or Fortran. `MPI_TYPE_NULL_COPY_FN` is a function  
15 that does nothing other than returning `flag = 0` and `MPI_SUCCESS`. `MPI_TYPE_DUP_FN`  
16 is a simple-minded copy function that sets `flag = 1`, returns the value of `attribute_val_in` in  
17 `attribute_val_out`, and returns `MPI_SUCCESS`.

18 The argument `type_delete_attr_fn` may be specified as `MPI_TYPE_NULL_DELETE_FN`  
19 from either C or Fortran. `MPI_TYPE_NULL_DELETE_FN` is a function that does nothing,  
20 other than returning `MPI_SUCCESS`.

21 The C callback functions are:

```

22 typedef int MPI_Type_copy_attr_function(MPI_Datatype oldtype,
23 int type_keyval, void *extra_state, void *attribute_val_in,
24 void *attribute_val_out, int *flag);

```

25 and

```

26 typedef int MPI_Type_delete_attr_function(MPI_Datatype datatype,
27 int type_keyval, void *attribute_val, void *extra_state);

```

29 With the `mpi_f08` module, the Fortran callback functions are:

```

30 ABSTRACT INTERFACE
31 SUBROUTINE MPI_Type_copy_attr_function(oldtype, type_keyval, extra_state,
32 attribute_val_in, attribute_val_out, flag, ierror)
33 TYPE(MPI_Datatype) :: oldtype
34 INTEGER :: type_keyval, ierror
35 INTEGER(KIND=MPI_ADDRESS_KIND) :: extra_state, attribute_val_in,
36 attribute_val_out
37 LOGICAL :: flag

```

38 and

```

39 ABSTRACT INTERFACE
40 SUBROUTINE MPI_Type_delete_attr_function(datatype, type_keyval,
41 attribute_val, extra_state, ierror)
42 TYPE(MPI_Datatype) :: datatype
43 INTEGER :: type_keyval, ierror
44 INTEGER(KIND=MPI_ADDRESS_KIND) :: attribute_val, extra_state

```

46 With the `mpi` module and `mpif.h`, the Fortran callback functions are:

```

47 SUBROUTINE TYPE_COPY_ATTR_FUNCTION(OLDTYPE, TYPE_KEYVAL, EXTRA_STATE,

```

48

```

        ATTRIBUTE_VAL_IN, ATTRIBUTE_VAL_OUT, FLAG, IERROR)
    INTEGER OLDTYPE, TYPE_KEYVAL, IERROR
    INTEGER(KIND=MPI_ADDRESS_KIND) EXTRA_STATE, ATTRIBUTE_VAL_IN,
ATTRIBUTE_VAL_OUT
    LOGICAL FLAG

```

and

```

SUBROUTINE TYPE_DELETE_ATTR_FUNCTION(DATATYPE, TYPE_KEYVAL, ATTRIBUTE_VAL,
        EXTRA_STATE, IERROR)
    INTEGER DATATYPE, TYPE_KEYVAL, IERROR
    INTEGER(KIND=MPI_ADDRESS_KIND) ATTRIBUTE_VAL, EXTRA_STATE

```

If an attribute copy function or attribute delete function returns other than MPI\_SUCCESS, then the call that caused it to be invoked (for example, MPI\_TYPE\_FREE), is erroneous.

MPI\_TYPE\_FREE\_KEYVAL(type\_keyval)

INOUT type\_keyval key value (integer)

#### C binding

```
int MPI_Type_free_keyval(int *type_keyval)
```

#### Fortran 2008 binding

```

MPI_Type_free_keyval(type_keyval, ierror)
    INTEGER, INTENT(INOUT) :: type_keyval
    INTEGER, OPTIONAL, INTENT(OUT) :: ierror

```

#### Fortran binding

```

MPI_TYPE_FREE_KEYVAL(TYPE_KEYVAL, IERROR)
    INTEGER TYPE_KEYVAL, IERROR

```

MPI\_TYPE\_SET\_ATTR(datatype, type\_keyval, attribute\_val)

INOUT datatype datatype to which attribute will be attached (handle)  
 IN type\_keyval key value (integer)  
 IN attribute\_val attribute value

#### C binding

```
int MPI_Type_set_attr(MPI_Datatype datatype, int type_keyval,
        void *attribute_val)
```

#### Fortran 2008 binding

```

MPI_Type_set_attr(datatype, type_keyval, attribute_val, ierror)
    TYPE(MPI_Datatype), INTENT(IN) :: datatype
    INTEGER, INTENT(IN) :: type_keyval
    INTEGER(KIND=MPI_ADDRESS_KIND), INTENT(IN) :: attribute_val
    INTEGER, OPTIONAL, INTENT(OUT) :: ierror

```

**Fortran binding**

```

MPI_TYPE_SET_ATTR(DATATYPE, TYPE_KEYVAL, ATTRIBUTE_VAL, IERROR)
    INTEGER DATATYPE, TYPE_KEYVAL, IERROR
    INTEGER(KIND=MPI_ADDRESS_KIND) ATTRIBUTE_VAL

```

```

MPI_TYPE_GET_ATTR(datatype, type_keyval, attribute_val, flag)

```

IN	datatype	datatype to which the attribute is attached (handle)
IN	type_keyval	key value (integer)
OUT	attribute_val	attribute value, unless flag = false
OUT	flag	false if no attribute is associated with the key (logical)

**C binding**

```

int MPI_Type_get_attr(MPI_Datatype datatype, int type_keyval,
    void *attribute_val, int *flag)

```

**Fortran 2008 binding**

```

MPI_Type_get_attr(datatype, type_keyval, attribute_val, flag, ierror)
    TYPE(MPI_Datatype), INTENT(IN) :: datatype
    INTEGER, INTENT(IN) :: type_keyval
    INTEGER(KIND=MPI_ADDRESS_KIND), INTENT(OUT) :: attribute_val
    LOGICAL, INTENT(OUT) :: flag
    INTEGER, OPTIONAL, INTENT(OUT) :: ierror

```

**Fortran binding**

```

MPI_TYPE_GET_ATTR(DATATYPE, TYPE_KEYVAL, ATTRIBUTE_VAL, FLAG, IERROR)
    INTEGER DATATYPE, TYPE_KEYVAL, IERROR
    INTEGER(KIND=MPI_ADDRESS_KIND) ATTRIBUTE_VAL
    LOGICAL FLAG

```

```

MPI_TYPE_DELETE_ATTR(datatype, type_keyval)

```

INOUT	datatype	datatype from which the attribute is deleted (handle)
IN	type_keyval	key value (integer)

**C binding**

```

int MPI_Type_delete_attr(MPI_Datatype datatype, int type_keyval)

```

**Fortran 2008 binding**

```

MPI_Type_delete_attr(datatype, type_keyval, ierror)
    TYPE(MPI_Datatype), INTENT(IN) :: datatype
    INTEGER, INTENT(IN) :: type_keyval
    INTEGER, OPTIONAL, INTENT(OUT) :: ierror

```

**Fortran binding**

```

MPI_TYPE_DELETE_ATTR(DATATYPE, TYPE_KEYVAL, IERROR)
    INTEGER DATATYPE, TYPE_KEYVAL, IERROR

```



## 6.7.5 Error Class for Invalid Keyval

Key values for attributes are system-allocated, by `MPI_{XXX}_CREATE_KEYVAL`. Only such values can be passed to the functions that use key values as input arguments. In order to signal that an erroneous key value has been passed to one of these functions, there is a new MPI error class: `MPI_ERR_KEYVAL`. It can be returned by `MPI_ATTR_PUT`, `MPI_ATTR_GET`, `MPI_ATTR_DELETE`, `MPI_KEYVAL_FREE`, `MPI_{XXX}_DELETE_ATTR`, `MPI_{XXX}_SET_ATTR`, `MPI_{XXX}_GET_ATTR`, `MPI_{XXX}_FREE_KEYVAL`, `MPI_COMM_DUP`, `MPI_COMM_IDUP`, `MPI_COMM_DISCONNECT`, and `MPI_COMM_FREE`. The last four are included because `keyval` is an argument to the copy and delete functions for attributes.

## 6.7.6 Attributes Example

*Advice to users.* This example shows how to write a collective communication operation that uses caching to be more efficient after the first call. (*End of advice to users.*)

```

/* key for this module's stuff: */
static int gop_key = MPI_KEYVAL_INVALID;

typedef struct
{
    int ref_count; /* reference count */
    /* other stuff, whatever else we want */
} gop_stuff_type;

void Efficient_Collective_Op(MPI_Comm comm, ...)
{
    gop_stuff_type *gop_stuff;
    MPI_Group      group;
    int            foundflag;

    MPI_Comm_group(comm, &group);

    if (gop_key == MPI_KEYVAL_INVALID) /* get a key on first call ever */
    {
        if ( ! MPI_Comm_create_keyval(gop_stuff_copier,
                                     gop_stuff_destructor,
                                     &gop_key, (void *)0) ) {
            /* get the key while assigning its copy and delete callback
               behavior. */
        } else
            MPI_Abort(comm, 99);
    }
}

```

```

1
2 MPI_Comm_get_attr(comm, gop_key, &gop_stuff, &foundflag);
3 if (foundflag)
4 { /* This module has executed in this group before.
5     We will use the cached information */
6 }
7 else
8 { /* This is a group that we have not yet cached anything in.
9     We will now do so.
10    */
11
12    /* First, allocate storage for the stuff we want,
13       and initialize the reference count */
14
15    gop_stuff = (gop_stuff_type *) malloc(sizeof(gop_stuff_type));
16    if (gop_stuff == NULL) { /* abort on out-of-memory error */ }
17
18    gop_stuff->ref_count = 1;
19
20    /* Second, fill in *gop_stuff with whatever we want.
21       This part isn't shown here */
22
23    /* Third, store gop_stuff as the attribute value */
24    MPI_Comm_set_attr(comm, gop_key, gop_stuff);
25 }
26 /* Then, in any case, use contents of *gop_stuff
27    to do the global op ... */
28 }
29
30 /* The following routine is called by MPI when a group is freed */
31
32 int gop_stuff_destructor(MPI_Comm comm, int keyval, void *gop_stuffP,
33                        void *extra)
34 {
35     gop_stuff_type *gop_stuff = (gop_stuff_type *)gop_stuffP;
36     if (keyval != gop_key) { /* abort -- programming error */ }
37
38     /* The group's being freed removes one reference to gop_stuff */
39     gop_stuff->ref_count -= 1;
40
41     /* If no references remain, then free the storage */
42     if (gop_stuff->ref_count == 0) {
43         free((void *)gop_stuff);
44     }
45     return MPI_SUCCESS;
46 }
47
48 /* The following routine is called by MPI when a group is copied */

```

```

int gop_stuff_copier(MPI_Comm comm, int keyval, void *extra,
                    void *gop_stuff_inP, void *gop_stuff_outP, int *flag)
{
    gop_stuff_type *gop_stuff_in = (gop_stuff_type *)gop_stuff_inP;
    gop_stuff_type **gop_stuff_out = (gop_stuff_type **)gop_stuff_outP;
    if (keyval != gop_key) { /* abort -- programming error */ }

    /* The new group adds one reference to this gop_stuff */
    gop_stuff_in->ref_count += 1;
    *gop_stuff_out = gop_stuff_in;
    return MPI_SUCCESS;
}

```

## 6.8 Naming Objects

There are many occasions on which it would be useful to allow a user to associate a printable identifier with an MPI communicator, window, or datatype, for instance error reporting, debugging, and profiling. The names attached to opaque objects do not propagate when the object is duplicated or copied by MPI routines. For communicators this can be achieved using the following two functions.

**MPI\_COMM\_SET\_NAME(comm, comm\_name)**

INOUT	comm	communicator whose identifier is to be set (handle)
IN	comm_name	the character string which is remembered as the name (string)

### C binding

```
int MPI_Comm_set_name(MPI_Comm comm, const char *comm_name)
```

### Fortran 2008 binding

```

MPI_Comm_set_name(comm, comm_name, ierror)
    TYPE(MPI_Comm), INTENT(IN) :: comm
    CHARACTER(LEN=*), INTENT(IN) :: comm_name
    INTEGER, OPTIONAL, INTENT(OUT) :: ierror

```

### Fortran binding

```

MPI_COMM_SET_NAME(COMM, COMM_NAME, IERROR)
    INTEGER COMM, IERROR
    CHARACTER*(*) COMM_NAME

```

**MPI\_COMM\_SET\_NAME** allows a user to associate a name string with a communicator. The character string which is passed to **MPI\_COMM\_SET\_NAME** will be saved inside the MPI library (so it can be freed by the caller immediately after the call, or allocated on the stack). Leading spaces in *name* are significant but trailing ones are not.

**MPI\_COMM\_SET\_NAME** is a local (non-collective) operation, which only affects the name of the communicator as seen in the process which made the **MPI\_COMM\_SET\_NAME**

1 call. There is no requirement that the same (or any) name be assigned to a communicator  
 2 in every process where it exists.

3  
 4 *Advice to users.* Since `MPI_COMM_SET_NAME` is provided to help debug code, it  
 5 is sensible to give the same name to a communicator in all of the processes where it  
 6 exists, to avoid confusion. (*End of advice to users.*)

7  
 8 The length of the name which can be stored is limited to the value of  
 9 `MPI_MAX_OBJECT_NAME` in Fortran and `MPI_MAX_OBJECT_NAME-1` in C to allow for the  
 10 null terminator. Attempts to put names longer than this will result in truncation of the  
 11 name. `MPI_MAX_OBJECT_NAME` must have a value of at least 64.

12  
 13 *Advice to users.* Under circumstances of store exhaustion an attempt to put a name  
 14 of any length could fail, therefore the value of `MPI_MAX_OBJECT_NAME` should be  
 15 viewed only as a strict upper bound on the name length, not a guarantee that setting  
 16 names of less than this length will always succeed. (*End of advice to users.*)

17  
 18 *Advice to implementors.* Implementations which pre-allocate a fixed size space for a  
 19 name should use the length of that allocation as the value of `MPI_MAX_OBJECT_NAME`.  
 20 Implementations which allocate space for the name from the heap should still define  
 21 `MPI_MAX_OBJECT_NAME` to be a relatively small value, since the user has to allocate  
 22 space for a string of up to this size when calling `MPI_COMM_GET_NAME`. (*End of*  
 23 *advice to implementors.*)

24  
 25  
 26 `MPI_COMM_GET_NAME(comm, comm_name, resultlen)`

27	IN	<code>comm</code>	communicator whose name is to be returned (handle)
28			
29	OUT	<code>comm_name</code>	the name previously stored on the communicator, or
30			an empty string if no such name exists (string)
31	OUT	<code>resultlen</code>	length of returned name (integer)
32			

### 33 C binding

34 `int MPI_Comm_get_name(MPI_Comm comm, char *comm_name, int *resultlen)`

### 35 Fortran 2008 binding

36 `MPI_Comm_get_name(comm, comm_name, resultlen, ierror)`

37 `TYPE(MPI_Comm), INTENT(IN) :: comm`

38 `CHARACTER(LEN=MPI_MAX_OBJECT_NAME), INTENT(OUT) :: comm_name`

39 `INTEGER, INTENT(OUT) :: resultlen`

40 `INTEGER, OPTIONAL, INTENT(OUT) :: ierror`

### 41 Fortran binding

42 `MPI_COMM_GET_NAME(COMM, COMM_NAME, RESULTLEN, IERROR)`

43 `INTEGER COMM, RESULTLEN, IERROR`

44 `CHARACTER*(*) COMM_NAME`

45  
 46  
 47 `MPI_COMM_GET_NAME` returns the last name which has previously been associated  
 48 with the given communicator. The name may be set and retrieved from any language. The

same name will be returned independent of the language used. `name` should be allocated so that it can hold a resulting string of length `MPI_MAX_OBJECT_NAME` characters. `MPI_COMM_GET_NAME` returns a copy of the set name in `name`.

In C, a null character is additionally stored at `name[resultlen]`. The value of `resultlen` cannot be larger than `MPI_MAX_OBJECT_NAME-1`. In Fortran, `name` is padded on the right with blank characters. The value of `resultlen` cannot be larger than `MPI_MAX_OBJECT_NAME`.

If the user has not associated a name with a communicator, or an error occurs, `MPI_COMM_GET_NAME` will return an empty string (all spaces in Fortran, "" in C). The three predefined communicators will have predefined names associated with them. Thus, the names of `MPI_COMM_WORLD`, `MPI_COMM_SELF`, and the communicator returned by `MPI_COMM_GET_PARENT` (if not `MPI_COMM_NULL`) will have the default of `MPI_COMM_WORLD`, `MPI_COMM_SELF`, and `MPI_COMM_PARENT`. The fact that the system may have chosen to give a default name to a communicator does not prevent the user from setting a name on the same communicator; doing this removes the old name and assigns the new one.

*Rationale.* We provide separate functions for setting and getting the name of a communicator, rather than simply providing a predefined attribute key for the following reasons:

- It is not, in general, possible to store a string as an attribute from Fortran.
- It is not easy to set up the delete function for a string attribute unless it is known to have been allocated from the heap.
- To make the attribute key useful additional code to call `strdup` is necessary. If this is not standardized then users have to write it. This is extra unneeded work which we can easily eliminate.
- The Fortran binding is not trivial to write (it will depend on details of the Fortran compilation system), and will not be portable. Therefore it should be in the library rather than in user code.

*(End of rationale.)*

*Advice to users.* The above definition means that it is safe simply to print the string returned by `MPI_COMM_GET_NAME`, as it is always a valid string even if there was no name.

Note that associating a name with a communicator has no effect on the semantics of an MPI program, and will (necessarily) increase the store requirement of the program, since the names must be saved. Therefore there is no requirement that users use these functions to associate names with communicators. However debugging and profiling MPI applications may be made easier if names are associated with communicators, since the debugger or profiler should then be able to present information in a less cryptic manner. *(End of advice to users.)*

The following functions are used for setting and getting names of datatypes. The constant `MPI_MAX_OBJECT_NAME` also applies to these names.

```

1 MPI_TYPE_SET_NAME(datatype, type_name)
2     INOUT    datatype          datatype whose identifier is to be set (handle)
3
4     IN      type_name         the character string which is remembered as the name
5                               (string)
6

```

**C binding**

```

8 int MPI_Type_set_name(MPI_Datatype datatype, const char *type_name)
9

```

**Fortran 2008 binding**

```

10 MPI_Type_set_name(datatype, type_name, ierror)
11     TYPE(MPI_Datatype), INTENT(IN) :: datatype
12     CHARACTER(LEN=*), INTENT(IN) :: type_name
13     INTEGER, OPTIONAL, INTENT(OUT) :: ierror
14

```

**Fortran binding**

```

15 MPI_TYPE_SET_NAME(DATATYPE, TYPE_NAME, IERROR)
16     INTEGER DATATYPE, IERROR
17     CHARACTER*(*) TYPE_NAME
18
19
20

```

```

21 MPI_TYPE_GET_NAME(datatype, type_name, resultlen)
22

```

```

23     IN      datatype          datatype whose name is to be returned (handle)
24     OUT    type_name         the name previously stored on the datatype, or an
25                               empty string if no such name exists (string)
26     OUT    resultlen        length of returned name (integer)
27

```

**C binding**

```

28
29 int MPI_Type_get_name(MPI_Datatype datatype, char *type_name,
30                       int *resultlen)
31

```

**Fortran 2008 binding**

```

32 MPI_Type_get_name(datatype, type_name, resultlen, ierror)
33     TYPE(MPI_Datatype), INTENT(IN) :: datatype
34     CHARACTER(LEN=MPI_MAX_OBJECT_NAME), INTENT(OUT) :: type_name
35     INTEGER, INTENT(OUT) :: resultlen
36     INTEGER, OPTIONAL, INTENT(OUT) :: ierror
37

```

**Fortran binding**

```

38
39 MPI_TYPE_GET_NAME(DATATYPE, TYPE_NAME, RESULTLEN, IERROR)
40     INTEGER DATATYPE, RESULTLEN, IERROR
41     CHARACTER*(*) TYPE_NAME
42

```

Named predefined datatypes have the default names of the datatype name. For example, MPI\_WCHAR has the default name of MPI\_WCHAR.

The following functions are used for setting and getting names of windows. The constant MPI\_MAX\_OBJECT\_NAME also applies to these names.

```

MPI_WIN_SET_NAME(win, win_name) 1
    INOUT    win                window whose identifier is to be set (handle) 2
    IN       win_name           the character string which is remembered as the name 3
                                      (string) 4
                                      5
                                      6

```

**C binding**

```

int MPI_Win_set_name(MPI_Win win, const char *win_name) 7

```

**Fortran 2008 binding**

```

MPI_Win_set_name(win, win_name, ierror) 8
    TYPE(MPI_Win), INTENT(IN) :: win 9
    CHARACTER(LEN=*), INTENT(IN) :: win_name 10
    INTEGER, OPTIONAL, INTENT(OUT) :: ierror 11

```

**Fortran binding**

```

MPI_WIN_SET_NAME(WIN, WIN_NAME, IERROR) 12
    INTEGER WIN, IERROR 13
    CHARACTER*(*) WIN_NAME 14

```

```

MPI_WIN_GET_NAME(win, win_name, resultlen) 15
    IN    win                window whose name is to be returned (handle) 16
    OUT   win_name           the name previously stored on the window, or an empty 17
                                      string if no such name exists (string) 18
    OUT   resultlen          length of returned name (integer) 19

```

**C binding**

```

int MPI_Win_get_name(MPI_Win win, char *win_name, int *resultlen) 20

```

**Fortran 2008 binding**

```

MPI_Win_get_name(win, win_name, resultlen, ierror) 21
    TYPE(MPI_Win), INTENT(IN) :: win 22
    CHARACTER(LEN=MPI_MAX_OBJECT_NAME), INTENT(OUT) :: win_name 23
    INTEGER, INTENT(OUT) :: resultlen 24
    INTEGER, OPTIONAL, INTENT(OUT) :: ierror 25

```

**Fortran binding**

```

MPI_WIN_GET_NAME(WIN, WIN_NAME, RESULTLEN, IERROR) 26
    INTEGER WIN, RESULTLEN, IERROR 27
    CHARACTER*(*) WIN_NAME 28

```

## 6.9 Formalizing the Loosely Synchronous Model

In this section, we make further statements about the loosely synchronous model, with particular attention to intra-communication.

### 6.9.1 Basic Statements

When a caller passes a communicator (that contains a context and group) to a callee, that communicator must be free of side effects throughout execution of the subprogram: there should be no active operations on that communicator that might involve the process. This provides one model in which libraries can be written, and work “safely.” For libraries so designated, the callee has permission to do whatever communication it likes with the communicator, and under the above guarantee knows that no other communications will interfere. Since we permit good implementations to create new communicators without synchronization (such as by preallocated contexts on communicators), this does not impose a significant overhead.

This form of safety is analogous to other common computer-science usages, such as passing a descriptor of an array to a library routine. The library routine has every right to expect such a descriptor to be valid and modifiable.

### 6.9.2 Models of Execution

In the loosely synchronous model, transfer of control to a **parallel procedure** is effected by having each executing process invoke the procedure. The invocation is a collective operation: it is executed by all processes in the execution group, and invocations are similarly ordered at all processes. However, the invocation need not be synchronized.

We say that a parallel procedure is *active* in a process if the process belongs to a group that may collectively execute the procedure, and some member of that group is currently executing the procedure code. If a parallel procedure is active in a process, then this process may be receiving messages pertaining to this procedure, even if it does not currently execute the code of this procedure.

#### Static Communicator Allocation

This covers the case where, at any point in time, at most one invocation of a parallel procedure can be active at any process, and the group of executing processes is fixed. For example, all invocations of parallel procedures involve all processes, processes are single-threaded, and there are no recursive invocations.

In such a case, a communicator can be statically allocated to each procedure. The static allocation can be done in a preamble, as part of initialization code. If the parallel procedures can be organized into libraries, so that only one procedure of each library can be concurrently active in each processor, then it is sufficient to allocate one communicator per library.

#### Dynamic Communicator Allocation

Calls of parallel procedures are well-nested if a new parallel procedure is always invoked in a subset of a group executing the same parallel procedure. Thus, processes that execute the same parallel procedure have the same execution stack.

In such a case, a new communicator needs to be dynamically allocated for each new invocation of a parallel procedure. The allocation is done by the caller. A new communicator can be generated by a call to `MPI_COMM_DUP`, if the callee execution group is identical to the caller execution group, or by a call to `MPI_COMM_SPLIT` if the caller execution group



is split into several subgroups executing distinct parallel routines. The new communicator is passed as an argument to the invoked routine.

The need for generating a new communicator at each invocation can be alleviated or avoided altogether in some cases: If the execution group is not split, then one can allocate a stack of communicators in a preamble, and next manage the stack in a way that mimics the stack of recursive calls.

One can also take advantage of the well-ordering property of communication to avoid confusing caller and callee communication, even if both use the same communicator. To do so, one needs to abide by the following two rules:

- messages sent before a procedure call (or before a return from the procedure) are also received before the matching call (or return) at the receiving end;
- messages are always selected by source (no use is made of `MPI_ANY_SOURCE`).

#### The General Case

In the general case, there may be multiple concurrently active invocations of the same parallel procedure within the same group; invocations may not be well-nested. A new communicator needs to be created for each invocation. It is the user's responsibility to make sure that, should two distinct parallel procedures be invoked concurrently on overlapping sets of processes, communicator creation is properly coordinated.

1  
2  
3  
4  
5  
6  
7  
8  
9  
10  
11  
12  
13  
14  
15  
16  
17  
18  
19  
20  
21  
22  
23  
24  
25  
26  
27  
28  
29  
30  
31  
32  
33  
34  
35  
36  
37  
38  
39  
40  
41  
42  
43  
44  
45  
46  
47  
48

DRAFT

1  
2  
3  
4  
5  
6  
7  
8  
9  
10  
11  
12  
13  
14  
15  
16  
17  
18  
19  
20  
21  
22  
23  
24  
25  
26  
27  
28  
29  
30  
31  
32  
33  
34  
35  
36  
37  
38  
39  
40  
41  
42  
43  
44  
45  
46  
47  
48

# Chapter 7

## Process Topologies

### 7.1 Introduction

This chapter discusses the MPI topology mechanism. A topology is an extra, optional attribute that one can give to an intra-communicator; topologies cannot be added to inter-communicators. A topology can provide a convenient naming mechanism for the processes of a group (within a communicator), and additionally, may assist the runtime system in mapping the processes onto hardware.

As stated in Chapter 6, a process group in MPI is a collection of  $n$  processes. Each process in the group is assigned a rank between 0 and  $n-1$ . In many parallel applications a linear ranking of processes does not adequately reflect the logical communication pattern of the processes (which is usually determined by the underlying problem geometry and the numerical algorithm used). Often the processes are arranged in topological patterns such as two- or three-dimensional grids. More generally, the logical process arrangement is described by a graph. In this chapter we will refer to this logical process arrangement as the “virtual topology.”

A clear distinction must be made between the virtual process topology and the topology of the underlying, physical hardware. The virtual topology can be exploited by the system in the assignment of processes to physical processors, if this helps to improve the communication performance on a given machine. How this mapping is done, however, is outside the scope of MPI. The description of the virtual topology, on the other hand, depends only on the application, and is machine-independent. The functions that are described in this chapter deal with machine-independent mapping and communication on virtual process topologies.

*Rationale.* Though physical mapping is not discussed, the existence of the virtual topology information may be used as advice by the runtime system. There are well-known techniques for mapping grid/torus structures to hardware topologies such as hypercubes or grids. For more complicated graph structures good heuristics often yield nearly optimal results [46]. On the other hand, if there is no way for the user to specify the logical process arrangement as a “virtual topology,” a random mapping is most likely to result. On some machines, this will lead to unnecessary contention in the interconnection network. Some details about predicted and measured performance improvements that result from good process-to-processor mapping on modern wormhole-routing architectures can be found in [12, 13].

Besides possible performance benefits, the virtual topology can function as a convenient, process-naming structure, with significant benefits for program readability and notational power in message-passing programming. (*End of rationale.*)

## 7.2 Virtual Topologies

The communication pattern of a set of processes can be represented by a graph. The nodes represent processes, and the edges connect processes that communicate with each other. MPI provides message-passing between any pair of processes in a group. There is no requirement for opening a channel explicitly. Therefore, a “missing link” in the user-defined process graph does not prevent the corresponding processes from exchanging messages. It means rather that this connection is neglected in the virtual topology. This strategy implies that the topology gives no convenient way of naming this pathway of communication. Another possible consequence is that an automatic mapping tool (if one exists for the runtime environment) will not take account of this edge when mapping.

Specifying the virtual topology in terms of a graph is sufficient for all applications. However, in many applications the graph structure is regular, and the detailed set-up of the graph would be inconvenient for the user and might be less efficient at run time. A large fraction of all parallel applications use process topologies like rings, two- or higher-dimensional grids, or tori. These structures are completely defined by the number of dimensions and the numbers of processes in each coordinate direction. Also, the mapping of grids and tori is generally an easier problem than that of general graphs. Thus, it is desirable to address these cases explicitly.

Process coordinates in a Cartesian structure begin their numbering at 0. Row-major numbering is always used for the processes in a Cartesian structure. This means that, for example, the relation between group rank and coordinates for four processes in a  $(2 \times 2)$  grid is as follows.

coord (0,0):	rank 0
coord (0,1):	rank 1
coord (1,0):	rank 2
coord (1,1):	rank 3

## 7.3 Embedding in MPI

The support for virtual topologies as defined in this chapter is consistent with other parts of MPI, and, whenever possible, makes use of functions that are defined elsewhere. Topology information is associated with communicators. It is added to communicators using the caching mechanism described in Chapter 6.

## 7.4 Overview of the Functions

MPI supports three topology types: **Cartesian**, **graph**, and **distributed graph**. The function `MPI_CART_CREATE` is used to create Cartesian topologies, the function `MPI_GRAPH_CREATE` is used to create graph topologies, and the functions `MPI_DIST_GRAPH_CREATE_ADJACENT` and `MPI_DIST_GRAPH_CREATE` are used to create distributed graph topologies. These topology creation functions are collective. As with

other collective calls, the program must be written to work correctly, whether the call synchronizes or not.

The topology creation functions take as input an existing communicator `comm_old`, which defines the set of processes on which the topology is to be mapped. For `MPI_GRAPH_CREATE` and `MPI_CART_CREATE`, all input arguments must have identical values on all processes of the group of `comm_old`. When calling `MPI_GRAPH_CREATE`, each process specifies all nodes and edges in the graph. In contrast, the functions `MPI_DIST_GRAPH_CREATE_ADJACENT` or `MPI_DIST_GRAPH_CREATE` are used to specify the graph in a distributed fashion, whereby each process only specifies a subset of the edges in the graph such that the entire graph structure is defined collectively across the set of processes. Therefore the processes provide different values for the arguments specifying the graph. However, all processes must give the same value for `reorder` and the `info` argument. In all cases, a new communicator `comm_topol` is created that carries the topological structure as cached information (see Chapter 6). In analogy to function `MPI_COMM_CREATE`, no cached information propagates from `comm_old` to `comm_topol`.

`MPI_CART_CREATE` can be used to describe Cartesian structures of arbitrary dimension. For each coordinate direction one specifies whether the process structure is periodic or not. Note that an  $n$ -dimensional hypercube is an  $n$ -dimensional torus with 2 processes per coordinate direction. Thus, special support for hypercube structures is not necessary. The local auxiliary function `MPI_DIMS_CREATE` can be used to compute a balanced distribution of processes among a given number of dimensions.

MPI defines functions to query a communicator for topology information. The function `MPI_TOPO_TEST` is used to query for the type of topology associated with a communicator. Depending on the topology type, different information can be extracted. For a graph topology, the functions `MPI_GRAPHDIMS_GET` and `MPI_GRAPH_GET` return the values that were specified in the call to `MPI_GRAPH_CREATE`. Additionally, the functions `MPI_GRAPH_NEIGHBORS_COUNT` and `MPI_GRAPH_NEIGHBORS` can be used to obtain the neighbors of an arbitrary node in the graph. For a distributed graph topology, the functions `MPI_DIST_GRAPH_NEIGHBORS_COUNT` and `MPI_DIST_GRAPH_NEIGHBORS` can be used to obtain the neighbors of the calling process. For a Cartesian topology, the functions `MPI_CARTDIM_GET` and `MPI_CART_GET` return the values that were specified in the call to `MPI_CART_CREATE`. Additionally, the functions `MPI_CART_RANK` and `MPI_CART_COORDS` translate Cartesian coordinates into a group rank, and vice-versa. The function `MPI_CART_SHIFT` provides the information needed to communicate with neighbors along a Cartesian dimension. All of these query functions are local.

For Cartesian topologies, the function `MPI_CART_SUB` can be used to extract a Cartesian subspace (analogous to `MPI_COMM_SPLIT`). This function is collective over the input communicator's group.

The two additional functions, `MPI_GRAPH_MAP` and `MPI_CART_MAP`, are, in general, not called by the user directly. However, together with the communicator manipulation functions presented in Chapter 6, they are sufficient to implement all other topology functions. Section 7.5.8 outlines such an implementation.

The neighborhood collective communication routines `MPI_NEIGHBOR_ALLGATHER`, `MPI_NEIGHBOR_ALLGATHERV`, `MPI_NEIGHBOR_ALLTOALL`, `MPI_NEIGHBOR_ALLTOALLV`, and `MPI_NEIGHBOR_ALLTOALLW` communicate with the nearest neighbors on the topology associated with the communicator. The nonblocking variants are `MPI_INEIGHBOR_ALLGATHER`, `MPI_INEIGHBOR_ALLGATHERV`, `MPI_INEIGHBOR_ALLTOALL`, `MPI_INEIGHBOR_ALLTOALLV`, and

1 MPI\_INEIGHBOR\_ALLTOALLW.  
2  
3

## 4 7.5 Topology Constructors

### 5 7.5.1 Cartesian Constructor

6  
7  
8  
9 MPI\_CART\_CREATE(comm\_old, ndims, dims, periods, reorder, comm\_cart)  
10 IN comm\_old input communicator (handle)  
11 IN ndims number of dimensions of Cartesian grid (integer)  
12 IN dims integer array of size ndims specifying the number of  
13 processes in each dimension  
14  
15 IN periods logical array of size ndims specifying whether the grid  
16 is periodic (true) or not (false) in each dimension  
17 IN reorder ranking may be reordered (true) or not (false) (logical)  
18  
19 OUT comm\_cart communicator with new Cartesian topology (handle)  
20

#### 21 C binding

22 int MPI\_Cart\_create(MPI\_Comm comm\_old, int ndims, const int dims[],  
23 const int periods[], int reorder, MPI\_Comm \*comm\_cart)  
24

#### 25 Fortran 2008 binding

26 MPI\_Cart\_create(comm\_old, ndims, dims, periods, reorder, comm\_cart, ierror)  
27 TYPE(MPI\_Comm), INTENT(IN) :: comm\_old  
28 INTEGER, INTENT(IN) :: ndims, dims(ndims)  
29 LOGICAL, INTENT(IN) :: periods(ndims), reorder  
30 TYPE(MPI\_Comm), INTENT(OUT) :: comm\_cart  
31 INTEGER, OPTIONAL, INTENT(OUT) :: ierror

#### 32 Fortran binding

33 MPI\_CART\_CREATE(COMM\_OLD, NDIMS, DIMS, PERIODS, REORDER, COMM\_CART, IERROR)  
34 INTEGER COMM\_OLD, NDIMS, DIMS(\*), COMM\_CART, IERROR  
35 LOGICAL PERIODS(\*), REORDER  
36

37 MPI\_CART\_CREATE returns a handle to a new communicator to which the Cartesian  
38 topology information is attached. If `reorder = false` then the rank of each process in the  
39 new group is identical to its rank in the old group. Otherwise, the function may reorder  
40 the processes (possibly so as to choose a good embedding of the virtual topology onto  
41 the physical machine). If the total size of the Cartesian grid is smaller than the size of  
42 the group of `comm_old`, then some processes are returned `MPI_COMM_NULL`, in analogy to  
43 `MPI_COMM_SPLIT`. If `ndims` is zero then a zero-dimensional Cartesian topology is created.  
44 The call is erroneous if it specifies a grid that is larger than the group size or if `ndims` is  
45 negative.  
46  
47  
48

## 7.5.2 Cartesian Convenience Function: MPI\_DIMS\_CREATE

For Cartesian topologies, the function `MPI_DIMS_CREATE` helps the user select a balanced distribution of processes per coordinate direction, depending on the number of processes in the group to be balanced and optional constraints that can be specified by the user. One use is to partition all the processes (the size of `MPI_COMM_WORLD`'s group) into an  $n$ -dimensional topology.

`MPI_DIMS_CREATE`(`nnodes`, `ndims`, `dims`)

IN	<code>nnodes</code>	number of nodes in a grid (integer)
IN	<code>ndims</code>	number of Cartesian dimensions (integer)
INOUT	<code>dims</code>	integer array of size <code>ndims</code> specifying the number of nodes in each dimension

**C binding**

```
int MPI_Dims_create(int nnodes, int ndims, int dims[])
```

**Fortran 2008 binding**

```
MPI_Dims_create(nnodes, ndims, dims, ierror)
  INTEGER, INTENT(IN) :: nnodes, ndims
  INTEGER, INTENT(INOUT) :: dims(ndims)
  INTEGER, OPTIONAL, INTENT(OUT) :: ierror
```

**Fortran binding**

```
MPI_DIMS_CREATE(NNODES, NDIMS, DIMS, IERROR)
  INTEGER NNODES, NDIMS, DIMS(*), IERROR
```

The entries in the array `dims` are set to describe a Cartesian grid with `ndims` dimensions and a total of `nnodes` nodes. The dimensions are set to be as close to each other as possible, using an appropriate divisibility algorithm. The caller may further constrain the operation of this routine by specifying elements of array `dims`. If `dims[i]` is set to a positive number, the routine will not modify the number of nodes in dimension  $i$ ; only those entries where `dims[i] = 0` are modified by the call.

Negative input values of `dims[i]` are erroneous. An error will occur if `nnodes` is not a multiple of

$$\prod_{i, \text{dims}[i] \neq 0} \text{dims}[i].$$

For `dims[i]` set by the call, `dims[i]` will be ordered in non-increasing order. Array `dims` is suitable for use as input to routine `MPI_CART_CREATE`. `MPI_DIMS_CREATE` is local. If `ndims` is zero and `nnodes` is one, `MPI_DIMS_CREATE` returns `MPI_SUCCESS`.

**Example 7.1**

dims before call	function call	dims on return
(0,0)	MPI_DIMS_CREATE(6, 2, dims)	(3,2)
(0,0)	MPI_DIMS_CREATE(7, 2, dims)	(7,1)
(0,3,0)	MPI_DIMS_CREATE(6, 3, dims)	(2,3,1)
(0,3,0)	MPI_DIMS_CREATE(7, 3, dims)	erroneous call

### 7.5.3 Graph Constructor

`MPI_GRAPH_CREATE(comm_old, nnodes, index, edges, reorder, comm_graph)`

IN	<code>comm_old</code>	input communicator (handle)
IN	<code>nnodes</code>	number of nodes in graph (integer)
IN	<code>index</code>	array of integers describing node degrees (see below)
IN	<code>edges</code>	array of integers describing graph edges (see below)
IN	<code>reorder</code>	ranking may be reordered (true) or not (false) (logical)
OUT	<code>comm_graph</code>	communicator with graph topology added (handle)

#### C binding

```
int MPI_Graph_create(MPI_Comm comm_old, int nnodes, const int index[],
                    const int edges[], int reorder, MPI_Comm *comm_graph)
```

#### Fortran 2008 binding

```
MPI_Graph_create(comm_old, nnodes, index, edges, reorder, comm_graph,
                 ierror)
    TYPE(MPI_Comm), INTENT(IN) :: comm_old
    INTEGER, INTENT(IN) :: nnodes, index(nnodes), edges(*)
    LOGICAL, INTENT(IN) :: reorder
    TYPE(MPI_Comm), INTENT(OUT) :: comm_graph
    INTEGER, OPTIONAL, INTENT(OUT) :: ierror
```

#### Fortran binding

```
MPI_GRAPH_CREATE(COMM_OLD, NNODES, INDEX, EDGES, REORDER, COMM_GRAPH,
                 IERROR)
    INTEGER COMM_OLD, NNODES, INDEX(*), EDGES(*), COMM_GRAPH, IERROR
    LOGICAL REORDER
```

`MPI_GRAPH_CREATE` returns a handle to a new communicator to which the graph topology information is attached. If `reorder = false` then the rank of each process in the new group is identical to its rank in the old group. Otherwise, the function may reorder the processes. If the size, `nnodes`, of the graph is smaller than the size of the group of `comm_old`, then some processes are returned `MPI_COMM_NULL`, in analogy to `MPI_CART_CREATE` and `MPI_COMM_SPLIT`. If the graph is empty, i.e., `nnodes == 0`, then `MPI_COMM_NULL` is returned in all processes. The call is erroneous if it specifies a graph that is larger than the group size of the input communicator.

The three parameters `nnodes`, `index` and `edges` define the graph structure. `nnodes` is the number of nodes of the graph. The nodes are numbered from 0 to `nnodes-1`. The *i*-th entry



of array `index` stores the total number of neighbors of the first  $i$  graph nodes. The lists of neighbors of nodes  $0, 1, \dots, \text{nnodes}-1$  are stored in consecutive locations in array `edges`. The array `edges` is a flattened representation of the edge lists. The total number of entries in `index` is `nnodes` and the total number of entries in `edges` is equal to the number of graph edges.

The definitions of the arguments `nnodes`, `index`, and `edges` are illustrated with the following simple example.

**Example 7.2** Assume there are four processes  $0, 1, 2, 3$  with the following adjacency matrix:

process	neighbors
0	1, 3
1	0
2	3
3	0, 2

Then, the input arguments are:

```
nnodes = 4
index = 2, 3, 4, 6
edges = 1, 3, 0, 3, 0, 2
```

Thus, in C, `index[0]` is the degree of node zero, and `index[i] - index[i-1]` is the degree of node  $i$ ,  $i=1, \dots, \text{nnodes}-1$ ; the list of neighbors of node zero is stored in `edges[j]`, for  $0 \leq j \leq \text{index}[0] - 1$  and the list of neighbors of node  $i$ ,  $i > 0$ , is stored in `edges[j]`,  $\text{index}[i-1] \leq j \leq \text{index}[i] - 1$ .

In Fortran, `index(1)` is the degree of node zero, and `index(i+1) - index(i)` is the degree of node  $i$ ,  $i=1, \dots, \text{nnodes}-1$ ; the list of neighbors of node zero is stored in `edges(j)`, for  $1 \leq j \leq \text{index}(1)$  and the list of neighbors of node  $i$ ,  $i > 0$ , is stored in `edges(j)`,  $\text{index}(i)+1 \leq j \leq \text{index}(i+1)$ .

A single process is allowed to be defined multiple times in the list of neighbors of a process (i.e., there may be multiple edges between two processes). A process is also allowed to be a neighbor to itself (i.e., a self loop in the graph). The adjacency matrix is allowed to be non-symmetric.

*Advice to users.* Performance implications of using multiple edges or a non-symmetric adjacency matrix are not defined. The definition of a node-neighbor edge does not imply a direction of the communication. (*End of advice to users.*)

*Advice to implementors.* The following topology information is likely to be stored with a communicator:

- Type of topology (Cartesian/graph),
- For a Cartesian topology:
  1. `ndims` (number of dimensions),
  2. `dims` (numbers of processes per coordinate direction),
  3. `periods` (periodicity information),

1           4. `own_position` (own position in grid, could also be computed from rank and  
2            dims)

- 3           • For a graph topology:

- 4           1. `index`,  
5           2. `edges`,

6           which are the vectors defining the graph structure.

7  
8  
9           For a graph structure the number of nodes is equal to the number of processes in  
10          the group. Therefore, the number of nodes does not have to be stored explicitly.  
11          An additional zero entry at the start of array `index` simplifies access to the topology  
12          information. (*End of advice to implementors.*)

#### 13 14 7.5.4 Distributed Graph Constructor

15 `MPI_GRAPH_CREATE` requires that each process passes the full (global) communication  
16 graph to the call. This limits the scalability of this constructor. With the distributed graph  
17 interface, the communication graph is specified in a fully distributed fashion. Each process  
18 specifies only the part of the communication graph of which it is aware. Typically, this  
19 could be the set of processes from which the process will eventually receive or get data,  
20 or the set of processes to which the process will send or put data, or some combination of  
21 such edges. Two different interfaces can be used to create a distributed graph topology.  
22 `MPI_DIST_GRAPH_CREATE_ADJACENT` creates a distributed graph communicator with  
23 each process specifying each of its incoming and outgoing (adjacent) edges in the logical  
24 communication graph and thus requires minimal communication during creation.

25 `MPI_DIST_GRAPH_CREATE` provides full flexibility such that any process can indicate that  
26 communication will occur between any pair of processes in the graph.

27          To provide better possibilities for optimization by the MPI library, the distributed  
28 graph constructors permit weighted communication edges and take an `info` argument that  
29 can further influence process reordering or other optimizations performed by the MPI library.  
30 For example, hints can be provided on how edge weights are to be interpreted, the quality  
31 of the reordering, and/or the time permitted for the MPI library to process the graph.  
32  
33  
34  
35  
36  
37  
38  
39  
40  
41  
42  
43  
44  
45  
46  
47  
48

MPI_DIST_GRAPH_CREATE_ADJACENT(comm_old, indegree, sources, sourceweights, outdegree,		1	
destinations, destweights, info, reorder, comm_dist_graph)		2	
IN	comm_old	input communicator (handle)	3
IN	indegree	size of sources and sourceweights arrays (non-negative integer)	4
IN	sources	ranks of processes for which the calling process is a destination (array of non-negative integers)	5
IN	sourceweights	weights of the edges into the calling process (array of non-negative integers)	6
IN	outdegree	size of destinations and destweights arrays (non-negative integer)	7
IN	destinations	ranks of processes for which the calling process is a source (array of non-negative integers)	8
IN	destweights	weights of the edges out of the calling process (array of non-negative integers)	9
IN	info	hints on optimization and interpretation of weights (handle)	10
IN	reorder	the ranks may be reordered (true) or not (false) (logical)	11
OUT	comm_dist_graph	communicator with distributed graph topology (handle)	12

**C binding**

```

int MPI_Dist_graph_create_adjacent(MPI_Comm comm_old, int indegree,
    const int sources[], const int sourceweights[], int outdegree,
    const int destinations[], const int destweights[],
    MPI_Info info, int reorder, MPI_Comm *comm_dist_graph)

```

**Fortran 2008 binding**

```

MPI_Dist_graph_create_adjacent(comm_old, indegree, sources, sourceweights,
    outdegree, destinations, destweights, info, reorder,
    comm_dist_graph, ierror)
    TYPE(MPI_Comm), INTENT(IN) :: comm_old
    INTEGER, INTENT(IN) :: indegree, sources(indegree), sourceweights(*),
    outdegree, destinations(outdegree), destweights(*)
    TYPE(MPI_Info), INTENT(IN) :: info
    LOGICAL, INTENT(IN) :: reorder
    TYPE(MPI_Comm), INTENT(OUT) :: comm_dist_graph
    INTEGER, OPTIONAL, INTENT(OUT) :: ierror

```

**Fortran binding**

```

MPI_DIST_GRAPH_CREATE_ADJACENT(COMM_OLD, INDEGREE, SOURCES, SOURCEWEIGHTS,
    OUTDEGREE, DESTINATIONS, DESTWEIGHTS, INFO, REORDER,
    COMM_DIST_GRAPH, IERROR)

```

```

1     INTEGER COMM_OLD, INDEGREE, SOURCES(*), SOURCEWEIGHTS(*), OUTDEGREE,
2     DESTINATIONS(*), DESTWEIGHTS(*), INFO, COMM_DIST_GRAPH, IERROR
3     LOGICAL REORDER

```

4 MPI\_DIST\_GRAPH\_CREATE\_ADJACENT returns a handle to a new communicator
5 to which the distributed graph topology information is attached. Each process passes all
6 information about its incoming and outgoing edges in the virtual distributed graph topology.
7 The calling processes must ensure that each edge of the graph is described in the source
8 and in the destination process with the same weights. If there are multiple edges for a given
9 (source,dest) pair, then the sequence of the weights of these edges does not matter. The
10 complete communication topology is the combination of all edges shown in the sources arrays
11 of all processes in comm\_old, which must be identical to the combination of all edges shown
12 in the destinations arrays. Source and destination ranks must be process ranks of comm\_old.
13 This allows a fully distributed specification of the communication graph. Isolated processes
14 (i.e., processes with no outgoing or incoming edges, that is, processes that have specified
15 indegree and outdegree as zero and thus do not occur as source or destination rank in the
16 graph specification) are allowed.

17 The call creates a new communicator comm\_dist\_graph of distributed graph topology
18 type to which topology information has been attached. The number of processes in
19 comm\_dist\_graph is identical to the number of processes in comm\_old. The call to
20 MPI\_DIST\_GRAPH\_CREATE\_ADJACENT is collective.

21 Weights are specified as non-negative integers and can be used to influence the process
22 remapping strategy and other internal MPI optimizations. For instance, approximate count
23 arguments of later communication calls along specific edges could be used as their edge
24 weights. Multiplicity of edges can likewise indicate more intense communication between
25 pairs of processes. However, the exact meaning of edge weights is not specified by the MPI
26 standard and is left to the implementation. In C or Fortran, an application can supply
27 the special value MPI\_UNWEIGHTED for the weight array to indicate that all edges have
28 the same (effectively no) weight. It is erroneous to supply MPI\_UNWEIGHTED for some
29 but not all processes of comm\_old. If the graph is weighted but indegree or outdegree is
30 zero, then MPI\_WEIGHTS\_EMPTY or any arbitrary array may be passed to sourceweights
31 or destweights respectively. Note that MPI\_UNWEIGHTED and MPI\_WEIGHTS\_EMPTY are
32 not special weight values; rather they are special values for the total array argument. In
33 Fortran, MPI\_UNWEIGHTED and MPI\_WEIGHTS\_EMPTY are objects like MPI\_BOTTOM (not
34 usable for initialization or assignment). See Section 2.5.4.

35  
36 *Advice to users.* In the case of an empty weights array argument passed while
37 constructing a weighted graph, one should not pass NULL because the value of
38 MPI\_UNWEIGHTED may be equal to NULL. The value of this argument would then
39 be indistinguishable from MPI\_UNWEIGHTED to the implementation. In this case
40 MPI\_WEIGHTS\_EMPTY should be used instead. (*End of advice to users.*)

41  
42 *Advice to implementors.* It is recommended that MPI\_UNWEIGHTED not be imple-
43 mented as NULL. (*End of advice to implementors.*)

44  
45 *Rationale.* To ensure backward compatibility, MPI\_UNWEIGHTED may still be imple-
46 mented as NULL. See Annex B.4. (*End of rationale.*)

47 The meaning of the info and reorder arguments is defined in the description of the
48 following routine.

MPI_DIST_GRAPH_CREATE(comm_old, n, sources, degrees, destinations, weights, info, reorder,		1	
comm_dist_graph)		2	
IN	comm_old	input communicator (handle)	3
IN	n	number of source nodes for which this process specifies edges (non-negative integer)	4
IN	sources	array containing the n source nodes for which this process specifies edges (array of non-negative integers)	5
IN	degrees	array specifying the number of destinations for each source node in the source node array (array of non-negative integers)	6
IN	destinations	destination nodes for the source nodes in the source node array (array of non-negative integers)	7
IN	weights	weights for source to destination edges (array of non-negative integers)	8
IN	info	hints on optimization and interpretation of weights (handle)	9
IN	reorder	the ranks may be reordered (true) or not (false) (logical)	10
OUT	comm_dist_graph	communicator with distributed graph topology added (handle)	11

**C binding**

```
int MPI_Dist_graph_create(MPI_Comm comm_old, int n, const int sources[],
    const int degrees[], const int destinations[],
    const int weights[], MPI_Info info, int reorder,
    MPI_Comm *comm_dist_graph)
```

**Fortran 2008 binding**

```
MPI_Dist_graph_create(comm_old, n, sources, degrees, destinations, weights,
    info, reorder, comm_dist_graph, ierror)
    TYPE(MPI_Comm), INTENT(IN) :: comm_old
    INTEGER, INTENT(IN) :: n, sources(n), degrees(n), destinations(*),
    weights(*)
    TYPE(MPI_Info), INTENT(IN) :: info
    LOGICAL, INTENT(IN) :: reorder
    TYPE(MPI_Comm), INTENT(OUT) :: comm_dist_graph
    INTEGER, OPTIONAL, INTENT(OUT) :: ierror
```

**Fortran binding**

```
MPI_DIST_GRAPH_CREATE(COMM_OLD, N, SOURCES, DEGREES, DESTINATIONS, WEIGHTS,
    INFO, REORDER, COMM_DIST_GRAPH, IERROR)
    INTEGER COMM_OLD, N, SOURCES(*), DEGREES(*), DESTINATIONS(*),
    WEIGHTS(*), INFO, COMM_DIST_GRAPH, IERROR
    LOGICAL REORDER
```

1 MPI\_DIST\_GRAPH\_CREATE returns a handle to a new communicator to which the  
 2 distributed graph topology information is attached. Concretely, each process calls the con-  
 3 structor with a set of directed (source,destination) communication edges as described below.  
 4 Every process passes an array of  $n$  source nodes in the `sources` array. For each source node, a  
 5 non-negative number of destination nodes is specified in the `degrees` array. The destination  
 6 nodes are stored in the corresponding consecutive segment of the `destinations` array. More  
 7 precisely, if the  $i$ -th node in `sources` is  $s$ , this specifies `degrees[i]` edges  $(s,d)$  with  $d$  of the  
 8  $j$ -th such edge stored in `destinations[degrees[0]+...+degrees[i-1]+j]`. The weight of this edge  
 9 is stored in `weights[degrees[0]+...+degrees[i-1]+j]`. Both the `sources` and the `destinations`  
 10 arrays may contain the same node more than once, and the order in which nodes are listed  
 11 as destinations or sources is not significant. Similarly, different processes may specify edges  
 12 with the same source and destination nodes. Source and destination nodes must be pro-  
 13 cess ranks of `comm_old`. Different processes may specify different numbers of source and  
 14 destination nodes, as well as different source to destination edges. This allows a fully dis-  
 15 tributed specification of the communication graph. Isolated processes (i.e., processes with  
 16 no outgoing or incoming edges, that is, processes that do not occur as source or destination  
 17 node in the graph specification) are allowed.

18 The call creates a new communicator `comm_dist_graph` of distributed graph topology  
 19 type to which topology information has been attached. The number of processes in  
 20 `comm_dist_graph` is identical to the number of processes in `comm_old`. The call to  
 21 MPI\_DIST\_GRAPH\_CREATE is collective.

22 If `reorder = false`, all processes will have the same rank in `comm_dist_graph` as in  
 23 `comm_old`. If `reorder = true` then the MPI library is free to remap to other processes (of  
 24 `comm_old`) in order to improve communication on the edges of the communication graph.  
 25 The weight associated with each edge is a hint to the MPI library about the amount or  
 26 intensity of communication on that edge, and may be used to compute a “best” reordering.

27 Weights are specified as non-negative integers and can be used to influence the process  
 28 remapping strategy and other internal MPI optimizations. For instance, approximate count  
 29 arguments of later communication calls along specific edges could be used as their edge  
 30 weights. Multiplicity of edges can likewise indicate more intense communication between  
 31 pairs of processes. However, the exact meaning of edge weights is not specified by the MPI  
 32 standard and is left to the implementation. In C or Fortran, an application can supply  
 33 the special value `MPI_UNWEIGHTED` for the weight array to indicate that all edges have the  
 34 same (effectively no) weight. It is erroneous to supply `MPI_UNWEIGHTED` for some but not  
 35 all processes of `comm_old`. If the graph is weighted but  $n = 0$ , then `MPI_WEIGHTS_EMPTY`  
 36 or any arbitrary array may be passed to `weights`. Note that `MPI_UNWEIGHTED` and  
 37 `MPI_WEIGHTS_EMPTY` are not special weight values; rather they are special values for the  
 38 total array argument. In Fortran, `MPI_UNWEIGHTED` and `MPI_WEIGHTS_EMPTY` are objects  
 39 like `MPI_BOTTOM` (not usable for initialization or assignment). See Section 2.5.4.

40  
 41 *Advice to users.* In the case of an empty weights array argument passed while  
 42 constructing a weighted graph, one should not pass `NULL` because the value of  
 43 `MPI_UNWEIGHTED` may be equal to `NULL`. The value of this argument would then  
 44 be indistinguishable from `MPI_UNWEIGHTED` to the implementation.  
 45 `MPI_WEIGHTS_EMPTY` should be used instead. (*End of advice to users.*)

46  
 47 *Advice to implementors.* It is recommended that `MPI_UNWEIGHTED` not be imple-  
 48 mented as `NULL`. (*End of advice to implementors.*)

*Rationale.* To ensure backward compatibility, MPI\_UNWEIGHTED may still be implemented as NULL. See Annex B.4. (*End of rationale.*)

The meaning of the `weights` argument can be influenced by the `info` argument. Info arguments can be used to guide the mapping; possible options include minimizing the maximum number of edges between processes on different SMP nodes, or minimizing the sum of all such edges. An MPI implementation is not obliged to follow specific hints, and it is valid for an MPI implementation not to do any reordering. An MPI implementation may specify more info key-value pairs. All processes must specify the same set of key-value info pairs.

*Advice to implementors.* MPI implementations must document any additionally supported key-value info pairs. MPI\_INFO\_NULL is always valid, and may indicate the default creation of the distributed graph topology to the MPI library.

An implementation does not explicitly need to construct the topology from its distributed parts. However, all processes can construct the full topology from the distributed specification and use this in a call to MPI\_GRAPH\_CREATE to create the topology. This may serve as a reference implementation of the functionality, and may be acceptable for small communicators. However, a scalable high-quality implementation would save the topology graph in a distributed way. (*End of advice to implementors.*)

**Example 7.3** As for Example 7.2, assume there are four processes 0, 1, 2, 3 with the following adjacency matrix and unit edge weights:

process	neighbors
0	1, 3
1	0
2	3
3	0, 2

With MPI\_DIST\_GRAPH\_CREATE, this graph could be constructed in many different ways. One way would be that each process specifies its outgoing edges. The arguments per process would be:

process	n	sources	degrees	destinations	weights
0	1	0	2	1,3	1,1
1	1	1	1	0	1
2	1	2	1	3	1
3	1	3	2	0,2	1,1

Another way would be to pass the whole graph on process 0, which could be done with the following arguments per process:

process	n	sources	degrees	destinations	weights
0	4	0,1,2,3	2,1,1,2	1,3,0,3,0,2	1,1,1,1,1,1
1	0	-	-	-	-
2	0	-	-	-	-
3	0	-	-	-	-

In both cases above, the application could supply `MPI_UNWEIGHTED` instead of explicitly providing identical weights.

`MPI_DIST_GRAPH_CREATE_ADJACENT` could be used to specify this graph using the following arguments:

process	indegree	sources	sourceweights	outdegree	destinations	destweights
0	2	1,3	1,1	2	1,3	1,1
1	1	0	1	1	0	1
2	1	3	1	1	3	1
3	2	0,2	1,1	2	0,2	1,1

**Example 7.4** A two-dimensional  $P \times Q$  torus where all processes communicate along the dimensions and along the diagonal edges. This cannot be modeled with Cartesian topologies, but can easily be captured with `MPI_DIST_GRAPH_CREATE` as shown in the following code. In this example, the communication along the dimensions is twice as heavy as the communication along the diagonals:

```

/*
Input:      dimensions P, Q
Condition:  number of processes equal to P*Q; otherwise only
            ranks smaller than P*Q participate
*/
int rank, x, y;
int sources[1], degrees[1];
int destinations[8], weights[8];
MPI_Comm comm_dist_graph;

MPI_Comm_rank(MPI_COMM_WORLD, &rank);

/* get x and y dimension */
y=rank/P; x=rank%P;

/* get my communication partners along x dimension */
destinations[0] = P*y+(x+1)%P; weights[0] = 2;
destinations[1] = P*y+(P+x-1)%P; weights[1] = 2;

/* get my communication partners along y dimension */
destinations[2] = P*((y+1)%Q)+x; weights[2] = 2;
destinations[3] = P*((Q+y-1)%Q)+x; weights[3] = 2;

/* get my communication partners along diagonals */
destinations[4] = P*((y+1)%Q)+(x+1)%P; weights[4] = 1;
destinations[5] = P*((Q+y-1)%Q)+(x+1)%P; weights[5] = 1;
destinations[6] = P*((y+1)%Q)+(P+x-1)%P; weights[6] = 1;
destinations[7] = P*((Q+y-1)%Q)+(P+x-1)%P; weights[7] = 1;

sources[0] = rank;
degrees[0] = 8;

```



```
MPI_Dist_graph_create(MPI_COMM_WORLD, 1, sources, degrees, destinations,
                    weights, MPI_INFO_NULL, 1, &comm_dist_graph);
```

### 7.5.5 Topology Inquiry Functions

If a topology has been defined with one of the above functions, then the topology information can be looked up using inquiry functions. They all are local calls.

**MPI\_TOPO\_TEST(comm, status)**

IN	comm	communicator (handle)
OUT	status	topology type of communicator comm (state)

#### C binding

```
int MPI_Topo_test(MPI_Comm comm, int *status)
```

#### Fortran 2008 binding

```
MPI_Topo_test(comm, status, ierror)
  TYPE(MPI_Comm), INTENT(IN) :: comm
  INTEGER, INTENT(OUT) :: status
  INTEGER, OPTIONAL, INTENT(OUT) :: ierror
```

#### Fortran binding

```
MPI_TOPO_TEST(COMM, STATUS, IERROR)
  INTEGER COMM, STATUS, IERROR
```

The function `MPI_TOPO_TEST` returns the type of topology that is assigned to a communicator.

The output value `status` is one of the following:

<code>MPI_GRAPH</code>	graph topology
<code>MPI_CART</code>	Cartesian topology
<code>MPI_DIST_GRAPH</code>	distributed graph topology
<code>MPI_UNDEFINED</code>	no topology

**MPI\_GRAPHDIMS\_GET(comm, nnodes, nedges)**

IN	comm	communicator for group with graph structure (handle)
OUT	nnodes	number of nodes in graph (same as number of processes in the group) (integer)
OUT	nedges	number of edges in graph (integer)

#### C binding

```
int MPI_Graphdims_get(MPI_Comm comm, int *nnodes, int *nedges)
```

#### Fortran 2008 binding

```
MPI_Graphdims_get(comm, nnodes, nedges, ierror)
  TYPE(MPI_Comm), INTENT(IN) :: comm
```

```

1     INTEGER, INTENT(OUT) :: nnodes, nedges
2     INTEGER, OPTIONAL, INTENT(OUT) :: ierror

```

### Fortran binding

```

4 MPI_GRAPHDIMS_GET(COMM, NNODES, NEDGES, IERROR)
5     INTEGER COMM, NNODES, NEDGES, IERROR

```

Functions `MPI_GRAPHDIMS_GET` and `MPI_GRAPH_GET` retrieve the graph-topology information that was associated with a communicator by `MPI_GRAPH_CREATE`.

The information provided by `MPI_GRAPHDIMS_GET` can be used to dimension the vectors `index` and `edges` correctly for the following call to `MPI_GRAPH_GET`.

```

12 MPI_GRAPH_GET(comm, maxindex, maxedges, index, edges)

```

14	IN	comm	communicator with graph structure (handle)
15	IN	maxindex	length of vector <code>index</code> in the calling program (integer)
16	IN	maxedges	length of vector <code>edges</code> in the calling program (integer)
17	IN	maxedges	length of vector <code>edges</code> in the calling program (integer)
18	OUT	index	array of integers containing the graph structure (for details see the definition of <code>MPI_GRAPH_CREATE</code> )
19			
20	OUT	edges	array of integers containing the graph structure
21			

### C binding

```

23 int MPI_Graph_get(MPI_Comm comm, int maxindex, int maxedges, int index[],
24                 int edges[])

```

### Fortran 2008 binding

```

26 MPI_Graph_get(comm, maxindex, maxedges, index, edges, ierror)
27     TYPE(MPI_Comm), INTENT(IN) :: comm
28     INTEGER, INTENT(IN) :: maxindex, maxedges
29     INTEGER, INTENT(OUT) :: index(maxindex), edges(maxedges)
30     INTEGER, OPTIONAL, INTENT(OUT) :: ierror

```

### Fortran binding

```

33 MPI_GRAPH_GET(COMM, MAXINDEX, MAXEDGES, INDEX, EDGES, IERROR)
34     INTEGER COMM, MAXINDEX, MAXEDGES, INDEX(*), EDGES(*), IERROR

```

```

37 MPI_CARTDIM_GET(comm, ndims)

```

39	IN	comm	communicator with Cartesian structure (handle)
40			
41	OUT	ndims	number of dimensions of the Cartesian structure (integer)
42			

### C binding

```

44 int MPI_Cartdim_get(MPI_Comm comm, int *ndims)

```

### Fortran 2008 binding

```

47 MPI_Cartdim_get(comm, ndims, ierror)

```

```

TYPE(MPI_Comm), INTENT(IN) :: comm
INTEGER, INTENT(OUT) :: ndims
INTEGER, OPTIONAL, INTENT(OUT) :: ierror

```

**Fortran binding**

```

MPI_CARTDIM_GET(COMM, NDIMS, IERROR)
    INTEGER COMM, NDIMS, IERROR

```

The functions `MPI_CARTDIM_GET` and `MPI_CART_GET` return the Cartesian topology information that was associated with a communicator by `MPI_CART_CREATE`. If `comm` is associated with a zero-dimensional Cartesian topology, `MPI_CARTDIM_GET` returns `ndims = 0` and `MPI_CART_GET` will keep all output arguments unchanged.

```

MPI_CART_GET(comm, maxdims, dims, periods, coords)

```

IN	comm	communicator with Cartesian structure (handle)
IN	maxdims	length of vectors <code>dims</code> , <code>periods</code> , and <code>coords</code> in the calling program (integer)
OUT	dims	number of processes for each Cartesian dimension (array of integers)
OUT	periods	periodicity (true/false) for each Cartesian dimension (array of logicals)
OUT	coords	coordinates of calling process in Cartesian structure (array of integers)

**C binding**

```

int MPI_Cart_get(MPI_Comm comm, int maxdims, int dims[], int periods[],
                int coords[])

```

**Fortran 2008 binding**

```

MPI_Cart_get(comm, maxdims, dims, periods, coords, ierror)
    TYPE(MPI_Comm), INTENT(IN) :: comm
    INTEGER, INTENT(IN) :: maxdims
    INTEGER, INTENT(OUT) :: dims(maxdims), coords(maxdims)
    LOGICAL, INTENT(OUT) :: periods(maxdims)
    INTEGER, OPTIONAL, INTENT(OUT) :: ierror

```

**Fortran binding**

```

MPI_CART_GET(COMM, MAXDIMS, DIMS, PERIODS, COORDS, IERROR)
    INTEGER COMM, MAXDIMS, DIMS(*), COORDS(*), IERROR
    LOGICAL PERIODS(*)

```

```

1 MPI_CART_RANK(comm, coords, rank)
2     IN      comm      communicator with Cartesian structure (handle)
3
4     IN      coords    integer array (of size ndims) specifying the Cartesian
5                          coordinates of a process
6
7     OUT     rank      rank of specified process (integer)

```

**C binding**

```

9 int MPI_Cart_rank(MPI_Comm comm, const int coords[], int *rank)

```

**Fortran 2008 binding**

```

12 MPI_Cart_rank(comm, coords, rank, ierror)
13     TYPE(MPI_Comm), INTENT(IN) :: comm
14     INTEGER, INTENT(IN) :: coords(*)
15     INTEGER, INTENT(OUT) :: rank
16     INTEGER, OPTIONAL, INTENT(OUT) :: ierror

```

**Fortran binding**

```

18 MPI_CART_RANK(COMM, COORDS, RANK, IERROR)
19     INTEGER COMM, COORDS(*), RANK, IERROR

```

For a process group with Cartesian structure, the function `MPI_CART_RANK` translates the logical process coordinates to process ranks as they are used by the point-to-point routines.

For dimension  $i$  with `periods(i) = true`, if the coordinate, `coords(i)`, is out of range, that is, `coords(i) < 0` or `coords(i) ≥ dims(i)`, it is shifted back to the interval  $0 ≤ \text{coords}(i) < \text{dims}(i)$  automatically. Out-of-range coordinates are erroneous for non-periodic dimensions.

If `comm` is associated with a zero-dimensional Cartesian topology, `coords` is not significant and 0 is returned in `rank`.

```

31 MPI_CART_COORDS(comm, rank, maxdims, coords)
32
33     IN      comm      communicator with Cartesian structure (handle)
34
35     IN      rank      rank of a process within group of comm (integer)
36
37     IN      maxdims   length of vector coords in the calling program (inte-
38                          ger)
39
40     OUT     coords    integer array (of size maxdims) containing the Carte-
41                          sian coordinates of specified process (array of integers)

```

**C binding**

```

42 int MPI_Cart_coords(MPI_Comm comm, int rank, int maxdims, int coords[])

```

**Fortran 2008 binding**

```

44 MPI_Cart_coords(comm, rank, maxdims, coords, ierror)
45     TYPE(MPI_Comm), INTENT(IN) :: comm
46     INTEGER, INTENT(IN) :: rank, maxdims
47     INTEGER, INTENT(OUT) :: coords(maxdims)
48

```

INTEGER, OPTIONAL, INTENT(OUT) :: ierror

### Fortran binding

MPI\_CART\_COORDS(COMM, RANK, MAXDIMS, COORDS, IERROR)  
 INTEGER COMM, RANK, MAXDIMS, COORDS(\*), IERROR

The inverse mapping, rank-to-coordinates translation is provided by MPI\_CART\_COORDS.

If comm is associated with a zero-dimensional Cartesian topology, coords will be unchanged.

MPI\_GRAPH\_NEIGHBORS\_COUNT(comm, rank, nneighbors)

IN	comm	communicator with graph topology (handle)
IN	rank	rank of process in group of comm (integer)
OUT	nneighbors	number of neighbors of specified process (integer)

### C binding

int MPI\_Graph\_neighbors\_count(MPI\_Comm comm, int rank, int \*nneighbors)

### Fortran 2008 binding

MPI\_Graph\_neighbors\_count(comm, rank, nneighbors, ierror)  
 TYPE(MPI\_Comm), INTENT(IN) :: comm  
 INTEGER, INTENT(IN) :: rank  
 INTEGER, INTENT(OUT) :: nneighbors  
 INTEGER, OPTIONAL, INTENT(OUT) :: ierror

### Fortran binding

MPI\_GRAPH\_NEIGHBORS\_COUNT(COMM, RANK, NNEIGHBORS, IERROR)  
 INTEGER COMM, RANK, NNEIGHBORS, IERROR

MPI\_GRAPH\_NEIGHBORS(comm, rank, maxneighbors, neighbors)

IN	comm	communicator with graph topology (handle)
IN	rank	rank of process in group of comm (integer)
IN	maxneighbors	size of array neighbors (integer)
OUT	neighbors	ranks of processes that are neighbors to specified process (array of integers)

### C binding

int MPI\_Graph\_neighbors(MPI\_Comm comm, int rank, int maxneighbors,  
 int neighbors[])

### Fortran 2008 binding

MPI\_Graph\_neighbors(comm, rank, maxneighbors, neighbors, ierror)  
 TYPE(MPI\_Comm), INTENT(IN) :: comm  
 INTEGER, INTENT(IN) :: rank, maxneighbors

```

1     INTEGER, INTENT(OUT) :: neighbors(maxneighbors)
2     INTEGER, OPTIONAL, INTENT(OUT) :: ierror

```

### Fortran binding

```

4     MPI_GRAPH_NEIGHBORS(COMM, RANK, MAXNEIGHBORS, NEIGHBORS, IERROR)
5     INTEGER COMM, RANK, MAXNEIGHBORS, NEIGHBORS(*), IERROR

```

MPI\_GRAPH\_NEIGHBORS\_COUNT and MPI\_GRAPH\_NEIGHBORS provide adjacency information for a graph topology. The returned count and array of neighbors for the queried rank will both include *all* neighbors and reflect the same edge ordering as was specified by the original call to MPI\_GRAPH\_CREATE. Specifically, MPI\_GRAPH\_NEIGHBORS\_COUNT and MPI\_GRAPH\_NEIGHBORS will return values based on the original index and edges array passed to MPI\_GRAPH\_CREATE (for the purpose of this example, we assume that index[-1] is zero):

- The number of neighbors (nneighbors) returned from MPI\_GRAPH\_NEIGHBORS\_COUNT will be (index[rank] - index[rank-1]).
- The neighbors array returned from MPI\_GRAPH\_NEIGHBORS will be edges[index[rank-1]] through edges[index[rank]-1].

**Example 7.5** Assume there are four processes 0, 1, 2, 3 with the following adjacency matrix (note that some neighbors are listed multiple times):

process	neighbors
0	1, 1, 3
1	0, 0
2	3
3	0, 2, 2

Thus, the input arguments to MPI\_GRAPH\_CREATE are:

```

31     nnodes = 4
32     index = 3, 5, 6, 9
33     edges = 1, 1, 3, 0, 0, 3, 0, 2, 2

```

Therefore, calling MPI\_GRAPH\_NEIGHBORS\_COUNT and MPI\_GRAPH\_NEIGHBORS for each of the 4 processes will return:

Input rank	Count	Neighbors
0	3	1, 1, 3
1	2	0, 0
2	1	3
3	3	0, 2, 2

**Example 7.6** Suppose that comm is a communicator with a shuffle-exchange topology. The group has  $2^n$  members. Each process is labeled by  $a_1, \dots, a_n$  with  $a_i \in \{0, 1\}$ , and has three neighbors:  $\text{exchange}(a_1, \dots, a_n) = a_1, \dots, a_{n-1}, \bar{a}_n$  ( $\bar{a} = 1 - a$ ),  $\text{shuffle}(a_1, \dots, a_n) = a_2, \dots, a_n, a_1$ , and  $\text{unshuffle}(a_1, \dots, a_n) = a_n, a_1, \dots, a_{n-1}$ . The graph adjacency list is illustrated below for  $n = 3$ .

node	exchange neighbors(1)	shuffle neighbors(2)	unshuffle neighbors(3)
0 (000)	1	0	0
1 (001)	0	2	4
2 (010)	3	4	1
3 (011)	2	6	5
4 (100)	5	1	2
5 (101)	4	3	6
6 (110)	7	5	3
7 (111)	6	7	7

Suppose that the communicator `comm` has this topology associated with it. The following code fragment cycles through the three types of neighbors and performs an appropriate permutation for each.

```

! assume: each process has stored a real number A.
! extract neighborhood information
CALL MPI_COMM_RANK(comm, myrank, ierr)
CALL MPI_GRAPH_NEIGHBORS(comm, myrank, 3, neighbors, ierr)
! perform exchange permutation
CALL MPI_SENDRECV_REPLACE(A, 1, MPI_REAL, neighbors(1), 0, &
                        neighbors(1), 0, comm, status, ierr)
! perform shuffle permutation
CALL MPI_SENDRECV_REPLACE(A, 1, MPI_REAL, neighbors(2), 0, &
                        neighbors(3), 0, comm, status, ierr)
! perform unshuffle permutation
CALL MPI_SENDRECV_REPLACE(A, 1, MPI_REAL, neighbors(3), 0, &
                        neighbors(2), 0, comm, status, ierr)

```

`MPI_DIST_GRAPH_NEIGHBORS_COUNT` and `MPI_DIST_GRAPH_NEIGHBORS` provide adjacency information for a distributed graph topology.

`MPI_DIST_GRAPH_NEIGHBORS_COUNT(comm, indegree, outdegree, weighted)`

IN	<code>comm</code>	communicator with distributed graph topology (handle)
OUT	<code>indegree</code>	number of edges into this process (non-negative integer)
OUT	<code>outdegree</code>	number of edges out of this process (non-negative integer)
OUT	<code>weighted</code>	false if <code>MPI_UNWEIGHTED</code> was supplied during creation, true otherwise (logical)

### C binding

```

int MPI_Dist_graph_neighbors_count(MPI_Comm comm, int *indegree,
                                  int *outdegree, int *weighted)

```

### Fortran 2008 binding

```

1 MPI_Dist_graph_neighbors_count(comm, indegree, outdegree, weighted, ierror)
2     TYPE(MPI_Comm), INTENT(IN) :: comm
3     INTEGER, INTENT(OUT) :: indegree, outdegree
4     LOGICAL, INTENT(OUT) :: weighted
5     INTEGER, OPTIONAL, INTENT(OUT) :: ierror

```

### Fortran binding

```

7 MPI_DIST_GRAPH_NEIGHBORS_COUNT(COMM, INDEGREE, OUTDEGREE, WEIGHTED, IERROR)
8     INTEGER COMM, INDEGREE, OUTDEGREE, IERROR
9     LOGICAL WEIGHTED

```

```

13 MPI_DIST_GRAPH_NEIGHBORS(comm, maxindegree, sources, sourceweights, maxoutdegree,
14     destinations, destweights)

```

15	IN	comm	communicator with distributed graph topology (handle)
16			
17	IN	maxindegree	size of sources and sourceweights arrays (non-negative integer)
18			
19			
20	OUT	sources	processes for which the calling process is a destination (array of non-negative integers)
21			
22	OUT	sourceweights	weights of the edges into the calling process (array of non-negative integers)
23			
24	IN	maxoutdegree	size of destinations and destweights arrays (non-negative integer)
25			
26			
27	OUT	destinations	processes for which the calling process is a source (array of non-negative integers)
28			
29	OUT	destweights	weights of the edges out of the calling process (array of non-negative integers)
30			

### C binding

```

33 int MPI_Dist_graph_neighbors(MPI_Comm comm, int maxindegree, int sources[],
34     int sourceweights[], int maxoutdegree, int destinations[],
35     int destweights[])

```

### Fortran 2008 binding

```

37 MPI_Dist_graph_neighbors(comm, maxindegree, sources, sourceweights,
38     maxoutdegree, destinations, destweights, ierror)
39     TYPE(MPI_Comm), INTENT(IN) :: comm
40     INTEGER, INTENT(IN) :: maxindegree, maxoutdegree
41     INTEGER, INTENT(OUT) :: sources(maxindegree),
42     destinations(maxoutdegree)
43     INTEGER :: sourceweights(*), destweights(*)
44     INTEGER, OPTIONAL, INTENT(OUT) :: ierror

```

### Fortran binding

```

47 MPI_DIST_GRAPH_NEIGHBORS(COMM, MAXINDEGREE, SOURCES, SOURCEWEIGHTS,
48     MAXOUTDEGREE, DESTINATIONS, DESTWEIGHTS, IERROR)

```



INTEGER COMM, MAXINDEGREE, SOURCES(\*), SOURCEWEIGHTS(\*), MAXOUTDEGREE,  
DESTINATIONS(\*), DESTWEIGHTS(\*), IERROR

These calls are local. The number of edges into and out of the process returned by MPI\_DIST\_GRAPH\_NEIGHBORS\_COUNT are the total number of such edges given in the call to MPI\_DIST\_GRAPH\_CREATE\_ADJACENT or MPI\_DIST\_GRAPH\_CREATE (potentially by processes other than the calling process in the case of MPI\_DIST\_GRAPH\_CREATE). Multiply defined edges are all counted and returned by MPI\_DIST\_GRAPH\_NEIGHBORS in some order. If MPI\_UNWEIGHTED is supplied for sourceweights or destweights or both, or if MPI\_UNWEIGHTED was supplied during the construction of the graph then no weight information is returned in that array or those arrays. If the communicator was created with MPI\_DIST\_GRAPH\_CREATE\_ADJACENT then for each rank in comm, the order of the values in sources and destinations is identical to the input that was used by the process with the same rank in comm\_old in the creation call. If the communicator was created with MPI\_DIST\_GRAPH\_CREATE then the only requirement on the order of values in sources and destinations is that two calls to the routine with same input argument comm will return the same sequence of edges. If maxindegree or maxoutdegree is smaller than the numbers returned by MPI\_DIST\_GRAPH\_NEIGHBORS\_COUNT, then only the first part of the full list is returned.

*Advice to implementors.* Since the query calls are defined to be local, each process needs to store the list of its neighbors with incoming and outgoing edges. Communication is required at the collective MPI\_DIST\_GRAPH\_CREATE call in order to compute the neighbor lists for each process from the distributed graph specification. (*End of advice to implementors.*)

### 7.5.6 Cartesian Shift Coordinates

If the process topology is a Cartesian structure, an MPI\_SENDRECV operation may be used along a coordinate direction to perform a shift of data. As input, MPI\_SENDRECV takes the rank of a source process for the receive, and the rank of a destination process for the send. If the function MPI\_CART\_SHIFT is called for a Cartesian process group, it provides the calling process with the above identifiers, which then can be passed to MPI\_SENDRECV. The user specifies the coordinate direction and the size of the step (positive or negative). The function is local.

MPI\_CART\_SHIFT(comm, direction, disp, rank\_source, rank\_dest)

IN	comm	communicator with Cartesian structure (handle)
IN	direction	coordinate dimension of shift (integer)
IN	disp	displacement (> 0: upwards shift, < 0: downwards shift) (integer)
OUT	rank_source	rank of source process (integer)
OUT	rank_dest	rank of destination process (integer)

**C binding**

```

1 int MPI_Cart_shift(MPI_Comm comm, int direction, int disp,
2                   int *rank_source, int *rank_dest)
3

```

#### Fortran 2008 binding

```

4 MPI_Cart_shift(comm, direction, disp, rank_source, rank_dest, ierror)
5     TYPE(MPI_Comm), INTENT(IN) :: comm
6     INTEGER, INTENT(IN) :: direction, disp
7     INTEGER, INTENT(OUT) :: rank_source, rank_dest
8     INTEGER, OPTIONAL, INTENT(OUT) :: ierror
9

```

#### Fortran binding

```

10 MPI_CART_SHIFT(COMM, DIRECTION, DISP, RANK_SOURCE, RANK_DEST, IERROR)
11     INTEGER COMM, DIRECTION, DISP, RANK_SOURCE, RANK_DEST, IERROR
12
13

```

The direction argument indicates the coordinate dimension to be traversed by the shift. The dimensions are numbered from 0 to `ndims-1`, where `ndims` is the number of dimensions.

Depending on the periodicity of the Cartesian group in the specified coordinate direction, `MPI_CART_SHIFT` provides the identifiers for a circular or an end-off shift. In the case of an end-off shift, the value `MPI_PROC_NULL` may be returned in `rank_source` or `rank_dest`, indicating that the source or the destination for the shift is out of range.

It is erroneous to call `MPI_CART_SHIFT` with a direction that is either negative or greater than or equal to the number of dimensions in the Cartesian communicator. This implies that it is erroneous to call `MPI_CART_SHIFT` with a `comm` that is associated with a zero-dimensional Cartesian topology.

**Example 7.7** The communicator, `comm`, has a two-dimensional, periodic, Cartesian topology associated with it. A two-dimensional array of `REALs` is stored one element per process, in variable `A`. One wishes to skew this array, by shifting column `i` (vertically, i.e., along the column) by `i` steps.

```

24 ...
25
26
27
28
29 ...
30 ! find process rank
31 CALL MPI_COMM_RANK(comm, rank, ierr)
32 ! find Cartesian coordinates
33 CALL MPI_CART_COORDS(comm, rank, maxdims, coords, ierr)
34 ! compute shift source and destination
35 CALL MPI_CART_SHIFT(comm, 0, coords(2), source, dest, ierr)
36 ! skew array
37 CALL MPI_SENDRECV_REPLACE(A, 1, MPI_REAL, dest, 0, source, 0, comm, &
38                          status, ierr)
39

```

*Advice to users.* In Fortran, the dimension indicated by `DIRECTION = i` has `DIMS(i+1)` nodes, where `DIMS` is the array that was used to create the grid. In C, the dimension indicated by `direction = i` is the dimension specified by `dims[i]`. (*End of advice to users.*)

## 7.5.7 Partitioning of Cartesian Structures

`MPI_CART_SUB(comm, remain_dims, newcomm)`

IN	<code>comm</code>	communicator with Cartesian structure (handle)
IN	<code>remain_dims</code>	the <i>i</i> -th entry of <code>remain_dims</code> specifies whether the <i>i</i> -th dimension is kept in the subgrid ( <code>true</code> ) or is dropped ( <code>false</code> ) (array of logicals)
OUT	<code>newcomm</code>	communicator containing the subgrid that includes the calling process (handle)

**C binding**

```
int MPI_Cart_sub(MPI_Comm comm, const int remain_dims[], MPI_Comm *newcomm)
```

**Fortran 2008 binding**

```
MPI_Cart_sub(comm, remain_dims, newcomm, ierror)
  TYPE(MPI_Comm), INTENT(IN) :: comm
  LOGICAL, INTENT(IN) :: remain_dims(*)
  TYPE(MPI_Comm), INTENT(OUT) :: newcomm
  INTEGER, OPTIONAL, INTENT(OUT) :: ierror
```

**Fortran binding**

```
MPI_CART_SUB(COMM, REMAIN_DIMS, NEWCOMM, IERROR)
  INTEGER COMM, NEWCOMM, IERROR
  LOGICAL REMAIN_DIMS(*)
```

If a Cartesian topology has been created with `MPI_CART_CREATE`, the function `MPI_CART_SUB` can be used to partition the communicator group into subgroups that form lower-dimensional Cartesian subgrids, and to build for each subgroup a communicator with the associated subgrid Cartesian topology. If all entries in `remain_dims` are false or `comm` is already associated with a zero-dimensional Cartesian topology then `newcomm` is associated with a zero-dimensional Cartesian topology. (This function is closely related to `MPI_COMM_SPLIT`.)

**Example 7.8** Assume that `MPI_CART_CREATE(..., comm)` has defined a  $(2 \times 3 \times 4)$  grid. Let `remain_dims = (true, false, true)`. Then a call to

```
MPI_CART_SUB(comm, remain_dims, comm_new);
```

will create three communicators each with eight processes in a  $2 \times 4$  Cartesian topology. If `remain_dims = (false, false, true)` then the call to `MPI_CART_SUB(comm, remain_dims, comm_new)` will create six non-overlapping communicators, each with four processes, in a one-dimensional Cartesian topology.

## 7.5.8 Low-Level Topology Functions

The two additional functions introduced in this section can be used to implement all other topology functions. In general they will not be called by the user directly, unless he or she

is creating additional virtual topology capability other than that provided by MPI. The two calls are both local.

`MPI_CART_MAP(comm, ndims, dims, periods, newrank)`

IN	<code>comm</code>	input communicator (handle)
IN	<code>ndims</code>	number of dimensions of Cartesian structure (integer)
IN	<code>dims</code>	integer array of size <code>ndims</code> specifying the number of processes in each coordinate direction
IN	<code>periods</code>	logical array of size <code>ndims</code> specifying the periodicity specification in each coordinate direction
OUT	<code>newrank</code>	reordered rank of the calling process; MPI_UNDEFINED if calling process does not belong to grid (integer)

### C binding

```
int MPI_Cart_map(MPI_Comm comm, int ndims, const int dims[],
                const int periods[], int *newrank)
```

### Fortran 2008 binding

```
MPI_Cart_map(comm, ndims, dims, periods, newrank, ierror)
  TYPE(MPI_Comm), INTENT(IN) :: comm
  INTEGER, INTENT(IN) :: ndims, dims(ndims)
  LOGICAL, INTENT(IN) :: periods(ndims)
  INTEGER, INTENT(OUT) :: newrank
  INTEGER, OPTIONAL, INTENT(OUT) :: ierror
```

### Fortran binding

```
MPI_CART_MAP(COMM, NDIMS, DIMS, PERIODS, NEWRANK, IERROR)
  INTEGER COMM, NDIMS, DIMS(*), NEWRANK, IERROR
  LOGICAL PERIODS(*)
```

`MPI_CART_MAP` computes an “optimal” placement for the calling process on the physical machine. A possible implementation of this function is to always return the rank of the calling process, that is, not to perform any reordering.

*Advice to implementors.* The function `MPI_CART_CREATE(comm, ndims, dims, periods, reorder, comm_cart)`, with `reorder = true` can be implemented by calling `MPI_CART_MAP(comm, ndims, dims, periods, newrank)`, then calling `MPI_COMM_SPLIT(comm, color, key, comm_cart)`, with `color = 0` if `newrank ≠ MPI_UNDEFINED`, `color = MPI_UNDEFINED` otherwise, and `key = newrank`. If `ndims` is zero then a zero-dimensional Cartesian topology is created.

The function `MPI_CART_SUB(comm, remain_dims, comm_new)` can be implemented by a call to `MPI_COMM_SPLIT(comm, color, key, comm_new)`, using a single number encoding of the lost dimensions as `color` and a single number encoding of the preserved dimensions as `key`.

All other Cartesian topology functions can be implemented locally, using the topology information that is cached with the communicator. (*End of advice to implementors.*)

The corresponding function for graph structures is as follows.

`MPI_GRAPH_MAP(comm, nnodes, index, edges, newrank)`

IN	comm	input communicator (handle)
IN	nnodes	number of graph nodes (integer)
IN	index	integer array specifying the graph structure, see <code>MPI_GRAPH_CREATE</code>
IN	edges	integer array specifying the graph structure
OUT	newrank	reordered rank of the calling process; <code>MPI_UNDEFINED</code> if the calling process does not be- long to graph (integer)

### C binding

```
int MPI_Graph_map(MPI_Comm comm, int nnodes, const int index[],
                  const int edges[], int *newrank)
```

### Fortran 2008 binding

```
MPI_Graph_map(comm, nnodes, index, edges, newrank, ierror)
  TYPE(MPI_Comm), INTENT(IN) :: comm
  INTEGER, INTENT(IN) :: nnodes, index(nnodes), edges(*)
  INTEGER, INTENT(OUT) :: newrank
  INTEGER, OPTIONAL, INTENT(OUT) :: ierror
```

### Fortran binding

```
MPI_GRAPH_MAP(COMM, NNODES, INDEX, EDGES, NEWRANK, IERROR)
  INTEGER COMM, NNODES, INDEX(*), EDGES(*), NEWRANK, IERROR
```

*Advice to implementors.* The function `MPI_GRAPH_CREATE(comm, nnodes, index, edges, reorder, comm_graph)`, with `reorder = true` can be implemented by calling `MPI_GRAPH_MAP(comm, nnodes, index, edges, newrank)`, then calling `MPI_COMM_SPLIT(comm, color, key, comm_graph)`, with `color = 0` if `newrank ≠ MPI_UNDEFINED`, `color = MPI_UNDEFINED` otherwise, and `key = newrank`.

All other graph topology functions can be implemented locally, using the topology information that is cached with the communicator. (*End of advice to implementors.*)

## 7.6 Neighborhood Collective Communication on Process Topologies

MPI process topologies specify a communication graph, but they implement no communication function themselves. Many applications require sparse nearest neighbor communications that can be expressed as graph topologies. We now describe several collective operations that perform communication along the edges of a process topology. All of these functions are collective; i.e., they must be called by all processes in the specified communicator. See Section 5 for an overview of other dense (global) collective communication operations and the semantics of collective operations.

1 If the graph was created with `MPI_DIST_GRAPH_CREATE_ADJACENT` with `sources`  
2 and `destinations` containing `0, ..., n-1`, where `n` is the number of processes in the group  
3 of `comm_old` (i.e., the graph is fully connected and also includes an edge from each node  
4 to itself), then the sparse neighborhood communication routine performs the same data  
5 exchange as the corresponding dense (fully-connected) collective operation. In the case of a  
6 Cartesian communicator, only nearest neighbor communication is provided, corresponding  
7 to `rank_source` and `rank_dest` in `MPI_CART_SHIFT` with input `disp = 1`.  
8

9 *Rationale.* Neighborhood collective communications enable communication on a  
10 process topology. This high-level specification of data exchange among neighboring  
11 processes enables optimizations in the MPI library because the communication pattern  
12 is known statically (the topology). Thus, the implementation can compute optimized  
13 message schedules during creation of the topology [36]. This functionality can signif-  
14 icantly simplify the implementation of neighbor exchanges [32]. (*End of rationale.*)  
15

16 For a distributed graph topology, created with `MPI_DIST_GRAPH_CREATE`, the se-  
17 quence of neighbors in the send and receive buffers at each process is defined as the sequence  
18 returned by `MPI_DIST_GRAPH_NEIGHBORS` for destinations and sources, respectively. For  
19 a general graph topology, created with `MPI_GRAPH_CREATE`, the use of neighborhood col-  
20 lective communication is restricted to adjacency matrices, where the number of edges be-  
21 tween any two processes is defined to be the same for both processes (i.e., with a symmetric  
22 adjacency matrix). In this case, the order of neighbors in the send and receive buffers is  
23 defined as the sequence of neighbors as returned by `MPI_GRAPH_NEIGHBORS`. Note that  
24 general graph topologies should generally be replaced by the distributed graph topologies.

25 For a Cartesian topology, created with `MPI_CART_CREATE`, the sequence of neigh-  
26 bors in the send and receive buffers at each process is defined by order of the dimensions,  
27 first the neighbor in the negative direction and then in the positive direction with dis-  
28 placement 1. The numbers of sources and destinations in the communication routines are  
29 `2*ndims` with `ndims` defined in `MPI_CART_CREATE`. If a neighbor does not exist, i.e., at  
30 the border of a Cartesian topology in the case of a non-periodic virtual grid dimension (i.e.,  
31 `periods[...]=false`), then this neighbor is defined to be `MPI_PROC_NULL`.

32 If a neighbor in any of the functions is `MPI_PROC_NULL`, then the neighborhood collec-  
33 tive communication behaves like a point-to-point communication with `MPI_PROC_NULL` in  
34 this direction. That is, the buffer is still part of the sequence of neighbors but it is neither  
35 communicated nor updated.  
36

### 37 7.6.1 Neighborhood Gather

38 In this function, each process  $i$  gathers data items from each process  $j$  if an edge  $(j, i)$  exists  
39 in the topology graph, and each process  $i$  sends the same data items to all processes  $j$  where  
40 an edge  $(i, j)$  exists. The send buffer is sent to each neighboring process and the  $l$ -th block  
41 in the receive buffer is received from the  $l$ -th neighbor.  
42  
43  
44  
45  
46  
47  
48

	MPI_NEIGHBOR_ALLGATHER(sendbuf, sendcount, sendtype, recvbuf, recvcount, recvtype, comm)		1
			2
IN	sendbuf	starting address of send buffer (choice)	3
			4
IN	sendcount	number of elements sent to each neighbor (non-negative integer)	5
			6
IN	sendtype	data type of send buffer elements (handle)	7
OUT	recvbuf	starting address of receive buffer (choice)	8
			9
IN	recvcount	number of elements received from each neighbor (non-negative integer)	10
			11
IN	recvtype	data type of receive buffer elements (handle)	12
			13
IN	comm	communicator with topology structure (handle)	14

**C binding**

```

int MPI_Neighbor_allgather(const void *sendbuf, int sendcount,
    MPI_Datatype sendtype, void *recvbuf, int recvcount,
    MPI_Datatype recvtype, MPI_Comm comm)

```

**Fortran 2008 binding**

```

MPI_Neighbor_allgather(sendbuf, sendcount, sendtype, recvbuf, recvcount,
    recvtype, comm, ierror)
    TYPE(*), DIMENSION(..), INTENT(IN) :: sendbuf
    INTEGER, INTENT(IN) :: sendcount, recvcount
    TYPE(MPI_Datatype), INTENT(IN) :: sendtype, recvtype
    TYPE(*), DIMENSION(..) :: recvbuf
    TYPE(MPI_Comm), INTENT(IN) :: comm
    INTEGER, OPTIONAL, INTENT(OUT) :: ierror

```

**Fortran binding**

```

MPI_NEIGHBOR_ALLGATHER(SENDBUF, SENDCOUNT, SENDTYPE, RECVBUF, RECVCOUNT,
    RECVTYPE, COMM, IERROR)
    <type> SENDBUF(*), RECVBUF(*)
    INTEGER SENDCOUNT, SENDTYPE, RECVCOUNT, RECVTYPE, COMM, IERROR

```

This function supports Cartesian communicators, graph communicators, and distributed graph communicators as described in Section 7.6. If `comm` is a distributed graph communicator, the outcome is as if each process executed sends to each of its outgoing neighbors and receives from each of its incoming neighbors:

```

MPI_Dist_graph_neighbors_count(comm, &indegree, &outdegree, &weighted);
int *srcs=(int*)malloc(indegree*sizeof(int));
int *dsts=(int*)malloc(outdegree*sizeof(int));
MPI_Dist_graph_neighbors(comm, indegree, srcs, MPI_UNWEIGHTED,
    outdegree, dsts, MPI_UNWEIGHTED);

int k,l;

/* assume sendbuf and recvbuf are of type (char*) */
for(k=0; k<outdegree; ++k)

```

```

1  MPI_Isend(sendbuf, sendcount, sendtype,dsts[k],...);
2
3  for(l=0; l<indegree; ++l)
4      MPI_Irecv(recvbuf+l*recvcount*extent(recvtype), recvcount, recvtype,
5              srcs[l],...);
6
7  MPI_Waitall(...);
8

```

Figure 7.1 shows the neighborhood gather communication of one process with outgoing neighbors  $d_0 \dots d_3$  and incoming neighbors  $s_0 \dots s_5$ . The process will send its `sendbuf` to all four destinations (outgoing neighbors) and it will receive the contribution from all six sources (incoming neighbors) into separate locations of its receive buffer.

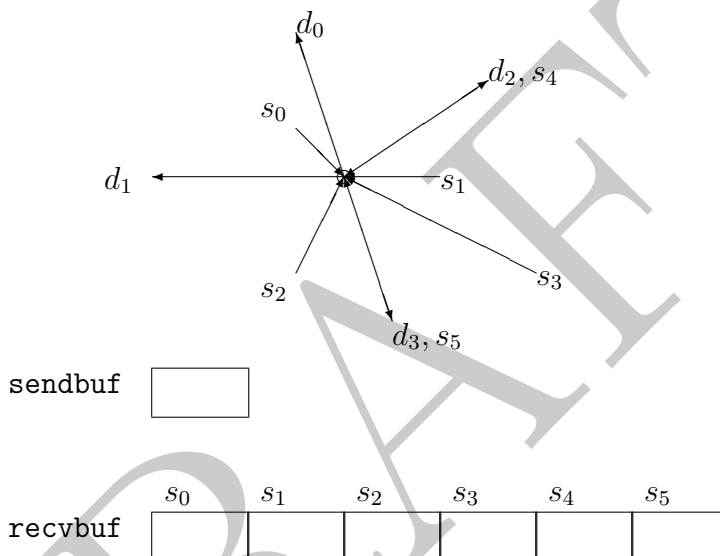

Figure 7.1: Neighborhood gather communication example.

All arguments are significant on all processes and the argument `comm` must have identical values on all processes.

The type signature associated with `sendcount`, `sendtype`, at a process must be equal to the type signature associated with `recvcount`, `recvtype` at all other processes. This implies that the amount of data sent must be equal to the amount of data received, pairwise between every pair of communicating processes. Distinct type maps between sender and receiver are still allowed.

*Rationale.* For optimization reasons, the same type signature is required independently of whether the topology graph is connected or not. (*End of rationale.*)

The “in place” option is not meaningful for this operation.

The vector variant of `MPI_NEIGHBOR_ALLGATHER` allows one to gather different numbers of elements from each neighbor.



MPI_NEIGHBOR_ALLGATHERV(sendbuf, sendcount, sendtype, recvbuf, recvcnts, displs,			1
recvtype, comm)			2
IN	sendbuf	starting address of send buffer (choice)	3
IN	sendcount	number of elements sent to each neighbor (non-negative integer)	4
IN	sendtype	data type of send buffer elements (handle)	5
OUT	recvbuf	starting address of receive buffer (choice)	6
IN	recvcnts	non-negative integer array (of length indegree) containing the number of elements that are received from each neighbor	7
IN	displs	integer array (of length indegree). Entry i specifies the displacement (relative to recvbuf) at which to place the incoming data from neighbor i	8
IN	recvtype	data type of receive buffer elements (handle)	9
IN	comm	communicator with topology structure (handle)	10

**C binding**

```
int MPI_Neighbor_allgatherv(const void *sendbuf, int sendcount,
    MPI_Datatype sendtype, void *recvbuf, const int recvcnts[],
    const int displs[], MPI_Datatype recvtype, MPI_Comm comm)
```

**Fortran 2008 binding**

```
MPI_Neighbor_allgatherv(sendbuf, sendcount, sendtype, recvbuf, recvcnts,
    displs, recvtype, comm, ierror)
    TYPE(*), DIMENSION(..), INTENT(IN) :: sendbuf
    INTEGER, INTENT(IN) :: sendcount, recvcnts(*), displs(*)
    TYPE(MPI_Datatype), INTENT(IN) :: sendtype, recvtype
    TYPE(*), DIMENSION(..) :: recvbuf
    TYPE(MPI_Comm), INTENT(IN) :: comm
    INTEGER, OPTIONAL, INTENT(OUT) :: ierror
```

**Fortran binding**

```
MPI_NEIGHBOR_ALLGATHERV(SENDBUF, SENDCOUNT, SENDTYPE, RECVBUF, RECVCOUNTS,
    DISPLS, RECVTYPE, COMM, IERROR)
    <type> SENDBUF(*), RECVBUF(*)
    INTEGER SENDCOUNT, SENDTYPE, RECVCOUNTS(*), DISPLS(*), RECVTYPE, COMM,
    IERROR
```

This function supports Cartesian communicators, graph communicators, and distributed graph communicators as described in Section 7.6. If `comm` is a distributed graph communicator, the outcome is as if each process executed sends to each of its outgoing neighbors and receives from each of its incoming neighbors:

```
MPI_Dist_graph_neighbors_count(comm, &indegree, &outdegree, &weighted);
int *srcs=(int*)malloc(indegree*sizeof(int));
int *dsts=(int*)malloc(outdegree*sizeof(int));
```

```

1 MPI_Dist_graph_neighbors(comm, indegree, srcs, MPI_UNWEIGHTED,
2                       outdegree, dsts, MPI_UNWEIGHTED);
3 int k,l;
4
5 /* assume sendbuf and recvbuf are of type (char*) */
6 for(k=0; k<outdegree; ++k)
7     MPI_Isend(sendbuf, sendcount, sendtype, dsts[k],...);
8
9 for(l=0; l<indegree; ++l)
10    MPI_Irecv(recvbuf+displs[l]*extent(recvtype), recvcnts[l], recvtype,
11            srcs[l],...);
12
13 MPI_Waitall(...);

```

The type signature associated with `sendcount`, `sendtype`, at process  $j$  must be equal to the type signature associated with `recvcnts[l]`, `recvtype` at any other process with `srcs[l]==j`. This implies that the amount of data sent must be equal to the amount of data received, pairwise between every pair of communicating processes. Distinct type maps between sender and receiver are still allowed. The data received from the  $l$ -th neighbor is placed into `recvbuf` beginning at offset `displs[l]` elements (in terms of the `recvtype`).

The “in place” option is not meaningful for this operation.

All arguments are significant on all processes and the argument `comm` must have identical values on all processes.

## 7.6.2 Neighbor Alltoall

In this function, each process  $i$  receives data items from each process  $j$  if an edge  $(j, i)$  exists in the topology graph or Cartesian topology. Similarly, each process  $i$  sends data items to all processes  $j$  where an edge  $(i, j)$  exists. This call is more general than `MPI_NEIGHBOR_ALLGATHER` in that different data items can be sent to each neighbor. The  $k$ -th block in send buffer is sent to the  $k$ -th neighboring process and the  $l$ -th block in the receive buffer is received from the  $l$ -th neighbor.

```

34 MPI_NEIGHBOR_ALLTOALL(sendbuf, sendcount, sendtype, recvbuf, recvcnt, recvtype, comm)

```

36	IN	<code>sendbuf</code>	starting address of send buffer (choice)
37	IN	<code>sendcount</code>	number of elements sent to each neighbor (non-negative integer)
38			
39	IN	<code>sendtype</code>	data type of send buffer elements (handle)
40	OUT	<code>recvbuf</code>	starting address of receive buffer (choice)
41	IN	<code>recvcnt</code>	number of elements received from each neighbor (non-negative integer)
42			
43	IN	<code>recvtype</code>	data type of receive buffer elements (handle)
44	IN	<code>comm</code>	communicator with topology structure (handle)
45			
46			

## C binding

```
int MPI_Neighbor_alltoall(const void *sendbuf, int sendcount,
                        MPI_Datatype sendtype, void *recvbuf, int recvcount,
                        MPI_Datatype recvtype, MPI_Comm comm)
```

**Fortran 2008 binding**

```
MPI_Neighbor_alltoall(sendbuf, sendcount, sendtype, recvbuf, recvcount,
                    recvtype, comm, ierror)
    TYPE(*), DIMENSION(..), INTENT(IN) :: sendbuf
    INTEGER, INTENT(IN) :: sendcount, recvcount
    TYPE(MPI_Datatype), INTENT(IN) :: sendtype, recvtype
    TYPE(*), DIMENSION(..) :: recvbuf
    TYPE(MPI_Comm), INTENT(IN) :: comm
    INTEGER, OPTIONAL, INTENT(OUT) :: ierror
```

**Fortran binding**

```
MPI_NEIGHBOR_ALLTOALL(SENDBUF, SENDCOUNT, SENDTYPE, RECVBUF, RECVCOUNT,
                    RECVTYPE, COMM, IERROR)
    <type> SENDBUF(*), RECVBUF(*)
    INTEGER SENDCOUNT, SENDTYPE, RECVCOUNT, RECVTYPE, COMM, IERROR
```

This function supports Cartesian communicators, graph communicators, and distributed graph communicators as described in Section 7.6. If `comm` is a distributed graph communicator, the outcome is as if each process executed sends to each of its outgoing neighbors and receives from each of its incoming neighbors:

```
MPI_Dist_graph_neighbors_count(comm, &indegree, &outdegree, &weighted);
int *srcs=(int*)malloc(indegree*sizeof(int));
int *dsts=(int*)malloc(outdegree*sizeof(int));
MPI_Dist_graph_neighbors(comm, indegree, srcs, MPI_UNWEIGHTED,
                        outdegree, dsts, MPI_UNWEIGHTED);

int k,l;

/* assume sendbuf and recvbuf are of type (char*) */
for(k=0; k<outdegree; ++k)
    MPI_Isend(sendbuf+k*sendcount*extent(sendtype), sendcount, sendtype,
             dsts[k],...);

for(l=0; l<indegree; ++l)
    MPI_Irecv(recvbuf+l*recvcount*extent(recvtype), recvcount, recvtype,
             srcs[l],...);

MPI_Waitall(...);
```

The type signature associated with `sendcount`, `sendtype`, at a process must be equal to the type signature associated with `recvcount`, `recvtype` at any other process. This implies that the amount of data sent must be equal to the amount of data received, pairwise between every pair of communicating processes. Distinct type maps between sender and receiver are still allowed.

The “in place” option is not meaningful for this operation.

1 All arguments are significant on all processes and the argument `comm` must have identical values on all processes.

2 The vector variant of `MPI_NEIGHBOR_ALLTOALL` allows sending/receiving different  
3 numbers of elements to and from each neighbor.

4  
5  
6  
7 `MPI_NEIGHBOR_ALLTOALLV(sendbuf, sendcounts, sdispls, sendtype, recvbuf, recvcoun-`  
8 `ts, rdispls, recvtype, comm)`

9	IN	<code>sendbuf</code>	starting address of send buffer (choice)
10	IN	<code>sendcounts</code>	non-negative integer array (of length <code>outdegree</code> ) specifying the number of elements to send to each neighbor
11			
12	IN	<code>sdispls</code>	integer array (of length <code>outdegree</code> ). Entry <code>j</code> specifies the displacement (relative to <code>sendbuf</code> ) from which to send the outgoing data to neighbor <code>j</code>
13			
14	IN	<code>sendtype</code>	data type of send buffer elements (handle)
15	OUT	<code>recvbuf</code>	starting address of receive buffer (choice)
16	IN	<code>recvcoun-</code>	non-negative integer array (of length <code>indegree</code> ) specifying the number of elements that are received from each neighbor
17			
18	IN	<code>rdispls</code>	integer array (of length <code>indegree</code> ). Entry <code>i</code> specifies the displacement (relative to <code>recvbuf</code> ) at which to place the incoming data from neighbor <code>i</code>
19			
20	IN	<code>recvtype</code>	data type of receive buffer elements (handle)
21	IN	<code>comm</code>	communicator with topology structure (handle)
22			
23			
24			
25			
26			
27			
28			

### 29 C binding

```
30 int MPI_Neighbor_alltoallv(const void *sendbuf, const int sendcounts[],
31     const int sdispls[], MPI_Datatype sendtype, void *recvbuf,
32     const int recvcoun-
33     ts[], const int rdispls[],
34     MPI_Datatype recvtype, MPI_Comm comm)
```

### 35 Fortran 2008 binding

```
36 MPI_Neighbor_alltoallv(sendbuf, sendcounts, sdispls, sendtype, recvbuf,
37     recvcoun-
38     ts, rdispls, recvtype, comm, ierror)
39     TYPE(*), DIMENSION(..), INTENT(IN) :: sendbuf
40     INTEGER, INTENT(IN) :: sendcounts(*), sdispls(*), recvcoun-
41     ts(*),
42     rdispls(*)
43     TYPE(MPI_Datatype), INTENT(IN) :: sendtype, recvtype
44     TYPE(*), DIMENSION(..) :: recvbuf
45     TYPE(MPI_Comm), INTENT(IN) :: comm
46     INTEGER, OPTIONAL, INTENT(OUT) :: ierror
```

### 45 Fortran binding

```
46 MPI_NEIGHBOR_ALLTOALLV(SENDBUF, SENDCOUNTS, SDISPLS, SENDTYPE, RECVBUF,
47     RECVCOUNTS, RDISPLS, RECVTYPE, COMM, IERROR)
48 <type> SENDBUF(*), RECVBUF(*)
```

```

    INTEGER SENDCOUNTS(*), SDISPLS(*), SENDTYPE, RECVCOUNTS(*),
    RDISPLS(*), RECVMODE, COMM, IERROR

```

This function supports Cartesian communicators, graph communicators, and distributed graph communicators as described in Section 7.6. If `comm` is a distributed graph communicator, the outcome is as if each process executed sends to each of its outgoing neighbors and receives from each of its incoming neighbors:

```

MPI_Dist_graph_neighbors_count(comm, &indegree, &outdegree, &weighted);
int *srcs=(int*)malloc(indegree*sizeof(int));
int *dsts=(int*)malloc(outdegree*sizeof(int));
MPI_Dist_graph_neighbors(comm, indegree, srcs, MPI_UNWEIGHTED,
                        outdegree, dsts, MPI_UNWEIGHTED);

int k,l;

/* assume sendbuf and recvbuf are of type (char*) */
for(k=0; k<outdegree; ++k)
    MPI_Isend(sendbuf+sdispls[k]*extent(sendtype), sendcounts[k], sendtype,
             dsts[k],...);

for(l=0; l<indegree; ++l)
    MPI_Irecv(recvbuf+rdispls[l]*extent(recvtype), recvcounts[l], recvtype,
             srcs[l],...);

MPI_Waitall(...);

```

The type signature associated with `sendcounts[k]`, `sendtype` with `dsts[k]==j` at process `i` must be equal to the type signature associated with `recvcounts[l]`, `recvtype` with `srcs[l]==i` at process `j`. This implies that the amount of data sent must be equal to the amount of data received, pairwise every pair of communicating processes. Distinct type maps between sender and receiver are still allowed. The data in the `sendbuf` beginning at offset `sdispls[k]` elements (in terms of the `sendtype`) is sent to the `k`-th outgoing neighbor. The data received from the `l`-th incoming neighbor is placed into `recvbuf` beginning at offset `rdispls[l]` elements (in terms of the `recvtype`).

The “in place” option is not meaningful for this operation.

All arguments are significant on all processes and the argument `comm` must have identical values on all processes.

`MPI_NEIGHBOR_ALLTOALLW` allows one to send and receive with different datatypes to and from each neighbor.

```

1 MPI_NEIGHBOR_ALLTOALLW(sendbuf, sendcounts, sdispls, sendtypes, recvbuf, recvcounts,
2   rdispls, recvtypes, comm)
3
4   IN      sendbuf      starting address of send buffer (choice)
5
6   IN      sendcounts   non-negative integer array (of length outdegree) speci-
7   fying the number of elements to send to each neighbor
8
9   IN      sdispls      integer array (of length outdegree). Entry j specifies
10  the displacement in bytes (relative to sendbuf) from
11  which to take the outgoing data destined for neighbor
12  j (array of integers)
13
14  IN      sendtypes     array of datatypes (of length outdegree). Entry j spec-
15  ifies the type of data to send to neighbor j (array of
16  handles)
17
18  OUT     recvbuf       starting address of receive buffer (choice)
19
20  IN      recvcounts    non-negative integer array (of length indegree) speci-
21  fying the number of elements that are received from
22  each neighbor
23
24  IN      rdispls       integer array (of length indegree). Entry i specifies the
25  displacement in bytes (relative to recvbuf) at which
26  to place the incoming data from neighbor i (array of
27  integers)
28
29  IN      recvtypes     array of datatypes (of length indegree). Entry i spec-
30  ifies the type of data received from neighbor i (array
31  of handles)
32
33  IN      comm          communicator with topology structure (handle)

```

### C binding

```

30 int MPI_Neighbor_alltoallw(const void *sendbuf, const int sendcounts[],
31   const MPI_Aint sdispls[], const MPI_Datatype sendtypes[],
32   void *recvbuf, const int recvcounts[],
33   const MPI_Aint rdispls[], const MPI_Datatype recvtypes[],
34   MPI_Comm comm)

```

### Fortran 2008 binding

```

37 MPI_Neighbor_alltoallw(sendbuf, sendcounts, sdispls, sendtypes, recvbuf,
38   recvcounts, rdispls, recvtypes, comm, ierror)
39   TYPE(*), DIMENSION(..), INTENT(IN) :: sendbuf
40   INTEGER, INTENT(IN) :: sendcounts(*), recvcounts(*)
41   INTEGER(KIND=MPI_ADDRESS_KIND), INTENT(IN) :: sdispls(*), rdispls(*)
42   TYPE(MPI_Datatype), INTENT(IN) :: sendtypes(*), recvtypes(*)
43   TYPE(*), DIMENSION(..) :: recvbuf
44   TYPE(MPI_Comm), INTENT(IN) :: comm
45   INTEGER, OPTIONAL, INTENT(OUT) :: ierror

```

### Fortran binding

```

47 MPI_NEIGHBOR_ALLTOALLW(SENDBUF, SENDCOUNTS, SDISPLS, SENDTYPES, RECVBUF,
48   RECVCOUNTS, RDISPLS, RECVTYPES, COMM, IERROR)

```

```

<type> SENDBUF(*), RECVBUF(*)
INTEGER SENDCOUNTS(*), SENDTYPES(*), RECVCOUNTS(*), RECVTYPES(*),
COMM, IERROR
INTEGER(KIND=MPI_ADDRESS_KIND) SDISPLS(*), RDISPLS(*)

```

This function supports Cartesian communicators, graph communicators, and distributed graph communicators as described in Section 7.6. If `comm` is a distributed graph communicator, the outcome is as if each process executed sends to each of its outgoing neighbors and receives from each of its incoming neighbors:

```

MPI_Dist_graph_neighbors_count(comm, &indegree, &outdegree, &weighted);
int *srcs=(int*)malloc(indegree*sizeof(int));
int *dsts=(int*)malloc(outdegree*sizeof(int));
MPI_Dist_graph_neighbors(comm, indegree, srcs, MPI_UNWEIGHTED,
                        outdegree, dsts, MPI_UNWEIGHTED);

int k,l;

/* assume sendbuf and recvbuf are of type (char*) */
for(k=0; k<outdegree; ++k)
    MPI_Isend(sendbuf+sdispls[k], sendcounts[k], sendtypes[k], dsts[k],...);

for(l=0; l<indegree; ++l)
    MPI_Irecv(recvbuf+rdispls[l], recvcounsts[l], recvtypes[l], srcs[l],...);

MPI_Waitall(...);

```

The type signature associated with `sendcounts[k]`, `sendtypes[k]` with `dsts[k]==j` at process `i` must be equal to the type signature associated with `recvcounsts[l]`, `recvtypes[l]` with `srcs[l]==i` at process `j`. This implies that the amount of data sent must be equal to the amount of data received, pairwise between every pair of communicating processes. Distinct type maps between sender and receiver are still allowed.

The “in place” option is not meaningful for this operation.

All arguments are significant on all processes and the argument `comm` must have identical values on all processes.

## 7.7 Nonblocking Neighborhood Communication on Process Topologies

Nonblocking variants of the neighborhood collective operations allow relaxed synchronization and overlapping of computation and communication. The semantics are similar to nonblocking collective operations as described in Section 5.12.

### 7.7.1 Nonblocking Neighborhood Gather

```
MPI_INEIGHBOR_ALLGATHER(sendbuf, sendcount, sendtype, recvbuf, recvcount, recvtype,
                        comm, request)
```

IN	sendbuf	starting address of send buffer (choice)
IN	sendcount	number of elements sent to each neighbor (non-negative integer)
IN	sendtype	data type of send buffer elements (handle)
OUT	recvbuf	starting address of receive buffer (choice)
IN	recvcount	number of elements received from each neighbor (non-negative integer)
IN	recvtype	data type of receive buffer elements (handle)
IN	comm	communicator with topology structure (handle)
OUT	request	communication request (handle)

#### C binding

```
int MPI_Ineighbor_allgather(const void *sendbuf, int sendcount,
                          MPI_Datatype sendtype, void *recvbuf, int recvcount,
                          MPI_Datatype recvtype, MPI_Comm comm, MPI_Request *request)
```

#### Fortran 2008 binding

```
MPI_Ineighbor_allgather(sendbuf, sendcount, sendtype, recvbuf, recvcount,
                        recvtype, comm, request, ierror)
  TYPE(*), DIMENSION(..), INTENT(IN), ASYNCHRONOUS :: sendbuf
  INTEGER, INTENT(IN) :: sendcount, recvcount
  TYPE(MPI_Datatype), INTENT(IN) :: sendtype, recvtype
  TYPE(*), DIMENSION(..), ASYNCHRONOUS :: recvbuf
  TYPE(MPI_Comm), INTENT(IN) :: comm
  TYPE(MPI_Request), INTENT(OUT) :: request
  INTEGER, OPTIONAL, INTENT(OUT) :: ierror
```

#### Fortran binding

```
MPI_INEIGHBOR_ALLGATHER(SENDBUF, SENDCOUNT, SENDTYPE, RECVBUF, RECVCOUNT,
                        RECVTYPE, COMM, REQUEST, IERROR)
  <type> SENDBUF(*), RECVBUF(*)
  INTEGER SENDCOUNT, SENDTYPE, RECVCOUNT, RECVTYPE, COMM, REQUEST,
  IERROR
```

This call starts a nonblocking variant of MPI\_NEIGHBOR\_ALLGATHER.



MPI_INEIGHBOR_ALLGATHERV(sendbuf, sendcount, sendtype, recvbuf, recvcounts, displs,			1
recvtype, comm, request)			2
IN	sendbuf	starting address of send buffer (choice)	3
IN	sendcount	number of elements sent to each neighbor (non-negative integer)	4
IN	sendtype	data type of send buffer elements (handle)	5
OUT	recvbuf	starting address of receive buffer (choice)	6
IN	recvcounts	non-negative integer array (of length indegree) containing the number of elements that are received from each neighbor	7
IN	displs	integer array (of length indegree). Entry i specifies the displacement (relative to recvbuf) at which to place the incoming data from neighbor i	8
IN	recvtype	data type of receive buffer elements (handle)	9
IN	comm	communicator with topology structure (handle)	10
OUT	request	communication request (handle)	11

**C binding**

```

int MPI_Ineighbor_allgatherv(const void *sendbuf, int sendcount,
    MPI_Datatype sendtype, void *recvbuf, const int recvcounts[],
    const int displs[], MPI_Datatype recvtype, MPI_Comm comm,
    MPI_Request *request)

```

**Fortran 2008 binding**

```

MPI_Ineighbor_allgatherv(sendbuf, sendcount, sendtype, recvbuf, recvcounts,
    displs, recvtype, comm, request, ierror)
    TYPE(*), DIMENSION(..), INTENT(IN), ASYNCHRONOUS :: sendbuf
    INTEGER, INTENT(IN) :: sendcount
    TYPE(MPI_Datatype), INTENT(IN) :: sendtype, recvtype
    TYPE(*), DIMENSION(..), ASYNCHRONOUS :: recvbuf
    INTEGER, INTENT(IN), ASYNCHRONOUS :: recvcounts(*), displs(*)
    TYPE(MPI_Comm), INTENT(IN) :: comm
    TYPE(MPI_Request), INTENT(OUT) :: request
    INTEGER, OPTIONAL, INTENT(OUT) :: ierror

```

**Fortran binding**

```

MPI_INEIGHBOR_ALLGATHERV(SENDBUF, SENDCOUNT, SENDTYPE, RECVBUF, RECVCOUNTS,
    DISPLS, RECVTYPE, COMM, REQUEST, IERROR)
    <type> SENDBUF(*), RECVBUF(*)
    INTEGER SENDCOUNT, SENDTYPE, RECVCOUNTS(*), DISPLS(*), RECVTYPE, COMM,
    REQUEST, IERROR

```

This call starts a nonblocking variant of MPI\_NEIGHBOR\_ALLGATHERV.

## 7.7.2 Nonblocking Neighborhood Alltoall

```

MPI_INEIGHBOR_ALLTOALL(sendbuf, sendcount, sendtype, recvbuf, recvcount, recvtype, comm,
                        request)

```

IN	sendbuf	starting address of send buffer (choice)
IN	sendcount	number of elements sent to each neighbor (non-negative integer)
IN	sendtype	data type of send buffer elements (handle)
OUT	recvbuf	starting address of receive buffer (choice)
IN	recvcount	number of elements received from each neighbor (non-negative integer)
IN	recvtype	data type of receive buffer elements (handle)
IN	comm	communicator with topology structure (handle)
OUT	request	communication request (handle)

**C binding**

```

int MPI_Ineighbor_alltoall(const void *sendbuf, int sendcount,
                          MPI_Datatype sendtype, void *recvbuf, int recvcount,
                          MPI_Datatype recvtype, MPI_Comm comm, MPI_Request *request)

```

**Fortran 2008 binding**

```

MPI_Ineighbor_alltoall(sendbuf, sendcount, sendtype, recvbuf, recvcount,
                      recvtype, comm, request, ierror)
TYPE(*), DIMENSION(..), INTENT(IN), ASYNCHRONOUS :: sendbuf
INTEGER, INTENT(IN) :: sendcount, recvcount
TYPE(MPI_Datatype), INTENT(IN) :: sendtype, recvtype
TYPE(*), DIMENSION(..), ASYNCHRONOUS :: recvbuf
TYPE(MPI_Comm), INTENT(IN) :: comm
TYPE(MPI_Request), INTENT(OUT) :: request
INTEGER, OPTIONAL, INTENT(OUT) :: ierror

```

**Fortran binding**

```

MPI_INEIGHBOR_ALLTOALL(SENDBUF, SENDCOUNT, SENDTYPE, RECVBUF, RECVCOUNT,
                      RECVTYPE, COMM, REQUEST, IERROR)
<type> SENDBUF(*), RECVBUF(*)
INTEGER SENDCOUNT, SENDTYPE, RECVCOUNT, RECVTYPE, COMM, REQUEST,
IERROR

```

This call starts a nonblocking variant of MPI\_NEIGHBOR\_ALLTOALL.



```

1 MPI_INEIGHBOR_ALLTOALLW(sendbuf, sendcounts, sdispls, sendtypes, recvbuf, recvcounts,
2   rdispls, recvtypes, comm, request)
3
4   IN      sendbuf      starting address of send buffer (choice)
5
6   IN      sendcounts   non-negative integer array (of length outdegree) speci-
7   fying the number of elements to send to each neighbor
8
9   IN      sdispls      integer array (of length outdegree). Entry j specifies
10  the displacement in bytes (relative to sendbuf) from
11  which to take the outgoing data destined for neighbor
12  j (array of integers)
13
14  IN      sendtypes     array of datatypes (of length outdegree). Entry j spec-
15  ifies the type of data to send to neighbor j (array of
16  handles)
17
18  OUT     recvbuf       starting address of receive buffer (choice)
19
20  IN      recvcounts    non-negative integer array (of length indegree) speci-
21  fying the number of elements that are received from
22  each neighbor
23
24  IN      rdispls       integer array (of length indegree). Entry i specifies the
25  displacement in bytes (relative to recvbuf) at which
26  to place the incoming data from neighbor i (array of
27  integers)
28
29  IN      recvtypes     array of datatypes (of length indegree). Entry i spec-
30  ifies the type of data received from neighbor i (array
31  of handles)
32
33  IN      comm          communicator with topology structure (handle)
34
35  OUT     request       communication request (handle)

```

### C binding

```

31 int MPI_Ineighbor_alltoallw(const void *sendbuf, const int sendcounts[],
32   const MPI_Aint sdispls[], const MPI_Datatype sendtypes[],
33   void *recvbuf, const int recvcounts[],
34   const MPI_Aint rdispls[], const MPI_Datatype recvtypes[],
35   MPI_Comm comm, MPI_Request *request)
36

```

### Fortran 2008 binding

```

37 MPI_Ineighbor_alltoallw(sendbuf, sendcounts, sdispls, sendtypes, recvbuf,
38   recvcounts, rdispls, recvtypes, comm, request, ierror)
39
40   TYPE(*), DIMENSION(..), INTENT(IN), ASYNCHRONOUS :: sendbuf
41   INTEGER, INTENT(IN), ASYNCHRONOUS :: sendcounts(*), recvcounts(*)
42   INTEGER(KIND=MPI_ADDRESS_KIND), INTENT(IN), ASYNCHRONOUS ::
43   sdispls(*), rdispls(*)
44   TYPE(MPI_Datatype), INTENT(IN), ASYNCHRONOUS :: sendtypes(*),
45   recvtypes(*)
46   TYPE(*), DIMENSION(..), ASYNCHRONOUS :: recvbuf
47   TYPE(MPI_Comm), INTENT(IN) :: comm
48   TYPE(MPI_Request), INTENT(OUT) :: request

```

```
INTEGER, OPTIONAL, INTENT(OUT) :: ierror
```

### Fortran binding

```
MPI_INEIGHBOR_ALLTOALLW(SENDBUF, SENDCOUNTS, SDISPLS, SENDTYPES, RECVBUF,
    RECVCOUNTS, RDISPLS, RECVTYPES, COMM, REQUEST, IERROR)
    <type> SENDBUF(*), RECVBUF(*)
    INTEGER SENDCOUNTS(*), SENDTYPES(*), RECVCOUNTS(*), RECVTYPES(*),
    COMM, REQUEST, IERROR
    INTEGER(KIND=MPI_ADDRESS_KIND) SDISPLS(*), RDISPLS(*)
```

This call starts a nonblocking variant of MPI\_NEIGHBOR\_ALLTOALLW.

## 7.8 Persistent Neighborhood Communication on Process Topologies

Persistent variants of the neighborhood collective operations can offer significant performance benefits for programs with repetitive communication patterns. The semantics are similar to persistent collective operations as described in Section 5.13.

### 7.8.1 Persistent Neighborhood Gather

```
MPI_NEIGHBOR_ALLGATHER_INIT(sendbuf, sendcount, sendtype, recvbuf, recvcount, recvtype,
    comm, info, request)
```

IN	sendbuf	starting address of send buffer (choice)
IN	sendcount	number of elements sent to each neighbor (non-negative integer)
IN	sendtype	data type of send buffer elements (handle)
OUT	recvbuf	starting address of receive buffer (choice)
IN	recvcount	number of elements received from each neighbor (non-negative integer)
IN	recvtype	data type of receive buffer elements (handle)
IN	comm	communicator with topology structure (handle)
IN	info	info argument (handle)
OUT	request	communication request (handle)

### C binding

```
int MPI_Neighbor_allgather_init(const void *sendbuf, int sendcount,
    MPI_Datatype sendtype, void *recvbuf, int recvcount,
    MPI_Datatype recvtype, MPI_Comm comm, MPI_Info info,
    MPI_Request *request)
```

### Fortran 2008 binding

```
MPI_Neighbor_allgather_init(sendbuf, sendcount, sendtype, recvbuf,
    recvcount, recvtype, comm, info, request, ierror)
    TYPE(*), DIMENSION(..), INTENT(IN), ASYNCHRONOUS :: sendbuf
```

```

1      INTEGER, INTENT(IN) :: sendcount, recvcount
2      TYPE(MPI_Datatype), INTENT(IN) :: sendtype, recvtype
3      TYPE(*), DIMENSION(..), ASYNCHRONOUS :: recvbuf
4      TYPE(MPI_Comm), INTENT(IN) :: comm
5      TYPE(MPI_Info), INTENT(IN) :: info
6      TYPE(MPI_Request), INTENT(OUT) :: request
7      INTEGER, OPTIONAL, INTENT(OUT) :: ierror

```

### Fortran binding

```

9      MPI_NEIGHBOR_ALLGATHER_INIT(SENDBUF, SENDCOUNT, SENDTYPE, RECVBUF,
10         RECVCOUNT, RECVTYPE, COMM, INFO, REQUEST, IERROR)
11         <type> SENDBUF(*), RECVBUF(*)
12         INTEGER SENDCOUNT, SENDTYPE, RECVCOUNT, RECVTYPE, COMM, INFO, REQUEST,
13         IERROR

```

Creates a persistent collective communication request for the neighborhood allgather operation.

```

15
16
17
18
19      MPI_NEIGHBOR_ALLGATHERV_INIT(sendbuf, sendcount, sendtype, recvbuf, recvcnts, displs,
20         recvtype, comm, info, request)

```

21	IN	sendbuf	starting address of send buffer (choice)
22	IN	sendcount	number of elements sent to each neighbor (non-negative integer)
23			
24	IN	sendtype	data type of send buffer elements (handle)
25	OUT	recvbuf	starting address of receive buffer (choice)
26	IN	recvcnts	non-negative integer array (of length indegree) containing the number of elements that are received from each neighbor
27			
28	IN	displs	integer array (of length indegree). Entry <i>i</i> specifies the displacement (relative to <i>recvbuf</i> ) at which to place the incoming data from neighbor <i>i</i>
29			
30	IN	recvtype	data type of receive buffer elements (handle)
31	IN	comm	communicator with topology structure (handle)
32	IN	info	info argument (handle)
33	OUT	request	communication request (handle)

### C binding

```

34      int MPI_Neighbor_allgatherv_init(const void *sendbuf, int sendcount,
35         MPI_Datatype sendtype, void *recvbuf, const int recvcnts[],
36         const int displs[], MPI_Datatype recvtype, MPI_Comm comm,
37         MPI_Info info, MPI_Request *request)

```

### Fortran 2008 binding

```

38      MPI_Neighbor_allgatherv_init(sendbuf, sendcount, sendtype, recvbuf,
39         recvcnts, displs, recvtype, comm, info, request, ierror)

```

```

TYPE(*), DIMENSION(..), INTENT(IN), ASYNCHRONOUS :: sendbuf
INTEGER, INTENT(IN) :: sendcount, displs(*)
TYPE(MPI_Datatype), INTENT(IN) :: sendtype, recvtype
TYPE(*), DIMENSION(..), ASYNCHRONOUS :: recvbuf
INTEGER, INTENT(IN), ASYNCHRONOUS :: recvcounts(*)
TYPE(MPI_Comm), INTENT(IN) :: comm
TYPE(MPI_Info), INTENT(IN) :: info
TYPE(MPI_Request), INTENT(OUT) :: request
INTEGER, OPTIONAL, INTENT(OUT) :: ierror

```

**Fortran binding**

```

MPI_NEIGHBOR_ALLGATHERV_INIT(SENDBUF, SENDCOUNT, SENDTYPE, RECVBUF,
    RECVCOUNTS, DISPLS, RECVTYPE, COMM, INFO, REQUEST, IERROR)
<type> SENDBUF(*), RECVBUF(*)
INTEGER SENDCOUNT, SENDTYPE, RECVCOUNTS(*), DISPLS(*), RECVTYPE, COMM,
INFO, REQUEST, IERROR

```

Creates a persistent collective communication request for the neighborhood allgather operation.

## 7.8.2 Persistent Neighborhood Alltoall

```

MPI_NEIGHBOR_ALLTOALL_INIT(sendbuf, sendcount, sendtype, recvbuf, recvcount, recvtype,
    comm, info, request)

```

IN	sendbuf	starting address of send buffer (choice)
IN	sendcount	number of elements sent to each neighbor (non-negative integer)
IN	sendtype	data type of send buffer elements (handle)
OUT	recvbuf	starting address of receive buffer (choice)
IN	recvcount	number of elements received from each neighbor (non-negative integer)
IN	recvtype	data type of receive buffer elements (handle)
IN	comm	communicator with topology structure (handle)
IN	info	info argument (handle)
OUT	request	communication request (handle)

**C binding**

```

int MPI_Neighbor_alltoall_init(const void *sendbuf, int sendcount,
    MPI_Datatype sendtype, void *recvbuf, int recvcount,
    MPI_Datatype recvtype, MPI_Comm comm, MPI_Info info,
    MPI_Request *request)

```

**Fortran 2008 binding**

```

MPI_Neighbor_alltoall_init(sendbuf, sendcount, sendtype, recvbuf,
    recvcount, recvtype, comm, info, request, ierror)

```

```

1  TYPE(*), DIMENSION(..), INTENT(IN), ASYNCHRONOUS :: sendbuf
2  INTEGER, INTENT(IN) :: sendcount, recvcount
3  TYPE(MPI_Datatype), INTENT(IN) :: sendtype, recvtype
4  TYPE(*), DIMENSION(..), ASYNCHRONOUS :: recvbuf
5  TYPE(MPI_Comm), INTENT(IN) :: comm
6  TYPE(MPI_Info), INTENT(IN) :: info
7  TYPE(MPI_Request), INTENT(OUT) :: request
8  INTEGER, OPTIONAL, INTENT(OUT) :: ierror

```

### Fortran binding

```

10 MPI_NEIGHBOR_ALLTOALL_INIT(SENDBUF, SENDCOUNT, SENDTYPE, RECVBUF,
11     RECVCOUNT, RECVTYPE, COMM, INFO, REQUEST, IERROR)
12     <type> SENDBUF(*), RECVBUF(*)
13     INTEGER SENDCOUNT, SENDTYPE, RECVCOUNT, RECVTYPE, COMM, INFO, REQUEST,
14     IERROR

```

16 Creates a persistent collective communication request for the neighborhood alltoall  
17 operation.

```

19
20 MPI_NEIGHBOR_ALLTOALLV_INIT(sendbuf, sendcounts, sdispls, sendtype, recvbuf, recvcounts,
21     rdispls, recvtype, comm, info, request)

```

22	IN	sendbuf	starting address of send buffer (choice)
23	IN	sendcounts	non-negative integer array (of length outdegree) specifying the number of elements to send to each neighbor
24			
25			
26	IN	sdispls	integer array (of length outdegree). Entry j specifies the displacement (relative to sendbuf) from which send the outgoing data to neighbor j
27			
28			
29	IN	sendtype	data type of send buffer elements (handle)
30	OUT	recvbuf	starting address of receive buffer (choice)
31			
32	IN	recvcounts	non-negative integer array (of length indegree) specifying the number of elements that are received from each neighbor
33			
34			
35	IN	rdispls	integer array (of length indegree). Entry i specifies the displacement (relative to recvbuf) at which to place the incoming data from neighbor i
36			
37			
38	IN	recvtype	data type of receive buffer elements (handle)
39			
40	IN	comm	communicator with topology structure (handle)
41	IN	info	info argument (handle)
42	OUT	request	communication request (handle)
43			

### C binding

```

45 int MPI_Neighbor_alltoallv_init(const void *sendbuf,
46     const int sendcounts[], const int sdispls[],
47     MPI_Datatype sendtype, void *recvbuf, const int recvcounts[],
48

```



```

    const int rdispls[], MPI_Datatype recvtype, MPI_Comm comm,
    MPI_Info info, MPI_Request *request)

```

**Fortran 2008 binding**

```

MPI_Neighbor_alltoallv_init(sendbuf, sendcounts, sdispls, sendtype,
    recvbuf, recvcounts, rdispls, recvtype, comm, info, request,
    ierror)

```

```

    TYPE(*), DIMENSION(..), INTENT(IN), ASYNCHRONOUS :: sendbuf
    INTEGER, INTENT(IN), ASYNCHRONOUS :: sendcounts(*), sdispls(*),
    recvcounts(*), rdispls(*)
    TYPE(MPI_Datatype), INTENT(IN) :: sendtype, recvtype
    TYPE(*), DIMENSION(..), ASYNCHRONOUS :: recvbuf
    TYPE(MPI_Comm), INTENT(IN) :: comm
    TYPE(MPI_Info), INTENT(IN) :: info
    TYPE(MPI_Request), INTENT(OUT) :: request
    INTEGER, OPTIONAL, INTENT(OUT) :: ierror

```

**Fortran binding**

```

MPI_NEIGHBOR_ALLTOALLV_INIT(SENDBUF, SENDCOUNTS, SDISPLS, SENDTYPE,
    RECVBUF, RECVCOUNTS, RDISPLS, RECVTYPE, COMM, INFO, REQUEST,
    IERROR)

```

```

    <type> SENDBUF(*), RECVBUF(*)
    INTEGER SENDCOUNTS(*), SDISPLS(*), SENDTYPE, RECVCOUNTS(*),
    RDISPLS(*), RECVTYPE, COMM, INFO, REQUEST, IERROR

```

Creates a persistent collective communication request for the neighborhood alltoallv operation.

```

1 MPI_NEIGHBOR_ALLTOALLW_INIT(sendbuf, sendcounts, sdispls, sendtypes, recvbuf, recvcounts,
2   rdispls, recvtypes, comm, info, request)
3
4   IN      sendbuf      starting address of send buffer (choice)
5
6   IN      sendcounts   non-negative integer array (of length outdegree) speci-
7   fying the number of elements to send to each neighbor
8
9   IN      sdispls      integer array (of length outdegree). Entry j specifies
10  the displacement in bytes (relative to sendbuf) from
11  which to take the outgoing data destined for neighbor
12  j (array of integers)
13
14  IN      sendtypes     array of datatypes (of length outdegree). Entry j spec-
15  ifies the type of data to send to neighbor j (array of
16  handles)
17
18  OUT     recvbuf       starting address of receive buffer (choice)
19
20  IN      recvcounts    non-negative integer array (of length indegree) speci-
21  fying the number of elements that are received from
22  each neighbor
23
24  IN      rdispls       integer array (of length indegree). Entry i specifies the
25  displacement in bytes (relative to recvbuf) at which
26  to place the incoming data from neighbor i (array of
27  integers)
28
29  IN      recvtypes     array of datatypes (of length indegree). Entry i spec-
30  ifies the type of data received from neighbor i (array
31  of handles)
32
33  IN      comm          communicator with topology structure (handle)
34
35  IN      info          info argument (handle)
36
37  OUT     request       communication request (handle)

```

**C binding**

```

32 int MPI_Neighbor_alltoallw_init(const void *sendbuf,
33   const int sendcounts[], const MPI_Aint sdispls[],
34   const MPI_Datatype sendtypes[], void *recvbuf,
35   const int recvcounts[], const MPI_Aint rdispls[],
36   const MPI_Datatype recvtypes[], MPI_Comm comm, MPI_Info info,
37   MPI_Request *request)
38

```

**Fortran 2008 binding**

```

39 MPI_Neighbor_alltoallw_init(sendbuf, sendcounts, sdispls, sendtypes,
40   recvbuf, recvcounts, rdispls, recvtypes, comm, info, request,
41   ierror)
42
43   TYPE(*), DIMENSION(..), INTENT(IN), ASYNCHRONOUS :: sendbuf
44   INTEGER, INTENT(IN), ASYNCHRONOUS :: sendcounts(*), recvcounts(*)
45   INTEGER(KIND=MPI_ADDRESS_KIND), INTENT(IN), ASYNCHRONOUS ::
46   sdispls(*), rdispls(*)
47   TYPE(MPI_Datatype), INTENT(IN), ASYNCHRONOUS :: sendtypes(*),
48   recvtypes(*)

```

```

TYPE(*), DIMENSION(..), ASYNCHRONOUS :: recvbuf
TYPE(MPI_Comm), INTENT(IN) :: comm
TYPE(MPI_Info), INTENT(IN) :: info
TYPE(MPI_Request), INTENT(OUT) :: request
INTEGER, OPTIONAL, INTENT(OUT) :: ierror

```

**Fortran binding**

```

MPI_NEIGHBOR_ALLTOALLW_INIT(SENDBUF, SENDCOUNTS, SDISPLS, SENDTYPES,
    RECVBUF, RECVCOUNTS, RDISPLS, RECVTYPES, COMM, INFO, REQUEST,
    IERROR)
<type> SENDBUF(*), RECVBUF(*)
INTEGER SENDCOUNTS(*), SENDTYPES(*), RECVCOUNTS(*), RECVTYPES(*),
COMM, INFO, REQUEST, IERROR
INTEGER(KIND=MPI_ADDRESS_KIND) SDISPLS(*), RDISPLS(*)

```

Creates a persistent collective communication request for the neighborhood alltoallw operation.

**7.9 An Application Example**

**Example 7.9** The example in Figures 7.2-7.5 shows how the grid definition and inquiry functions can be used in an application program. A partial differential equation, for instance the Poisson equation, is to be solved on a rectangular domain. First, the processes organize themselves in a two-dimensional structure. Each process then inquires about the ranks of its neighbors in the four directions (up, down, right, left). The numerical problem is solved by an iterative method, the details of which are hidden in the subroutine `relax`.

In each relaxation step each process computes new values for the solution grid function at the points `u(1:100,1:100)` owned by the process. Then the values at inter-process boundaries have to be exchanged with neighboring processes. For example, the newly calculated values in `u(1,1:100)` must be sent into the halo cells `u(101,1:100)` of the left-hand neighbor with coordinates `(own_coord(1)-1,own_coord(2))`.

```

1  INTEGER ndims, num_neigh
2  LOGICAL reorder
3  PARAMETER (ndims=2, num_neigh=4, reorder=.true.)
4  INTEGER comm, comm_size, comm_cart, dims(ndims), ierr
5  INTEGER neigh_rank(num_neigh), own_coords(ndims), i, j, it
6  LOGICAL periods(ndims)
7  REAL u(0:101,0:101), f(0:101,0:101)
8  DATA dims / ndims * 0 /
9  comm = MPI_COMM_WORLD
10 CALL MPI_COMM_SIZE(comm, comm_size, ierr)
11 ! Set process grid size and periodicity
12 CALL MPI_DIMS_CREATE(comm_size, ndims, dims, ierr)
13 periods(1) = .TRUE.
14 periods(2) = .TRUE.
15 ! Create a grid structure in WORLD group and inquire about own position
16 CALL MPI_CART_CREATE(comm, ndims, dims, periods, reorder, &
17                      comm_cart, ierr)
18 CALL MPI_CART_GET(comm_cart, ndims, dims, periods, own_coords, ierr)
19 i = own_coords(1)
20 j = own_coords(2)
21 ! Look up the ranks for the neighbors. Own process coordinates are (i,j).
22 ! Neighbors are (i-1,j), (i+1,j), (i,j-1), (i,j+1) modulo (dims(1),dims(2))
23 CALL MPI_CART_SHIFT(comm_cart, 0,1, neigh_rank(1), neigh_rank(2), ierr)
24 CALL MPI_CART_SHIFT(comm_cart, 1,1, neigh_rank(3), neigh_rank(4), ierr)
25 ! Initialize the grid functions and start the iteration
26 CALL init(u, f)
27 DO it=1,100
28     CALL relax(u, f)
29     ! Exchange data with neighbor processes
30     CALL exchange(u, comm_cart, neigh_rank, num_neigh)
31 END DO
32 CALL output(u)
33
34
35
36
37
38
39
40
41
42
43
44
45
46
47
48

```

Figure 7.2: Set-up of process structure for two-dimensional parallel Poisson solver.

```

SUBROUTINE exchange(u, comm_cart, neigh_rank, num_neigh) 1
REAL u(0:101,0:101) 2
INTEGER comm_cart, num_neigh, neigh_rank(num_neigh) 3
REAL sndbuf(100,num_neigh), rcvbuf(100,num_neigh) 4
INTEGER ierr 5
sndbuf(1:100,1) = u( 1,1:100) 6
sndbuf(1:100,2) = u(100,1:100) 7
sndbuf(1:100,3) = u(1:100, 1) 8
sndbuf(1:100,4) = u(1:100,100) 9
CALL MPI_NEIGHBOR_ALLTOALL(sndbuf, 100, MPI_REAL, rcvbuf, 100, MPI_REAL, & 10
                           comm_cart, ierr) 11
! instead of 12
! DO i=1,num_neigh 13
!   CALL MPI_Irecv(rcvbuf(1,i), 100, MPI_REAL, neigh_rank(i),..., & 14
!                 rq(2*i-1), ierr) 15
!   CALL MPI_Isend(sndbuf(1,i), 100, MPI_REAL, neigh_rank(i),..., & 16
!                 rq(2*i ), ierr) 17
! END DO 18
! CALL MPI_Waitall(2*num_neigh, rq, statuses, ierr) 19
20
u( 0,1:100) = rcvbuf(1:100,1) 21
u(101,1:100) = rcvbuf(1:100,2) 22
u(1:100, 0) = rcvbuf(1:100,3) 23
u(1:100,101) = rcvbuf(1:100,4) 24
END 25

```

Figure 7.3: Communication routine with local data copying and sparse neighborhood all-to-all.

```

1  SUBROUTINE exchange(u, comm_cart, neigh_rank, num_neigh)
2  IMPLICIT NONE
3  USE MPI
4  REAL u(0:101,0:101)
5  INTEGER comm_cart, num_neigh, neigh_rank(num_neigh)
6  INTEGER sndcounts(num_neigh), sndtypes(num_neigh)
7  INTEGER rcvcounts(num_neigh), rcvtypes(num_neigh)
8  INTEGER (KIND=MPI_ADDRESS_KIND) lb, sizeofreal
9  INTEGER (KIND=MPI_ADDRESS_KIND) sdispls(num_neigh), rdispls(num_neigh)
10 INTEGER type_vec, ierr
11 ! The following initialization need to be done only once
12 ! before the first call of exchange.
13 CALL MPI_TYPE_GET_EXTENT(MPI_REAL, lb, sizeofreal, ierr)
14 CALL MPI_TYPE_VECTOR(100, 1, 102, MPI_REAL, type_vec, ierr)
15 CALL MPI_TYPE_COMMIT(type_vec, ierr)
16 sndtypes(1:2) = type_vec
17 sndcounts(1:2) = 1
18 sndtypes(3:4) = MPI_REAL
19 sndcounts(3:4) = 100
20 rcvtypes = sndtypes
21 rcvcounts = sndcounts
22 sdispls(1) = ( 1 + 1*102) * sizeofreal ! first element of u( 1, 1:100)
23 sdispls(2) = (100 + 1*102) * sizeofreal ! first element of u(100, 1:100)
24 sdispls(3) = ( 1 + 1*102) * sizeofreal ! first element of u( 1:100, 1 )
25 sdispls(4) = ( 1 + 100*102) * sizeofreal ! first element of u( 1:100,100 )
26 rdispls(1) = ( 0 + 1*102) * sizeofreal ! first element of u( 0, 1:100)
27 rdispls(2) = (101 + 1*102) * sizeofreal ! first element of u(101, 1:100)
28 rdispls(3) = ( 1 + 0*102) * sizeofreal ! first element of u( 1:100, 0 )
29 rdispls(4) = ( 1 + 101*102) * sizeofreal ! first element of u( 1:100,101 )
30 ! the following communication has to be done in each call of exchange
31 CALL MPI_NEIGHBOR_ALLTOALLW(u, sndcounts, sdispls, sndtypes, &
32 u, rcvcounts, rdispls, rcvtypes, &
33 comm_cart, ierr)
34 ! The following finalizing need to be done only once
35 ! after the last call of exchange.
36 CALL MPI_TYPE_FREE(type_vec, ierr)
37 END

```

Figure 7.4: Communication routine with sparse neighborhood all-to-all-w and without local data copying.

```

INTEGER ndims, num_neigh                                1
LOGICAL reorder                                        2
PARAMETER (ndims=2, num_neigh=4, reorder=.true.)      3
INTEGER comm, comm_size, comm_cart, dims(ndims), it, ierr 4
LOGICAL periods(ndims)                                5
REAL u(0:101,0:101), f(0:101,0:101)                  6
DATA dims / ndims * 0 /                                7
INTEGER sndcounts(num_neigh), sndtypes(num_neigh)     8
INTEGER rcvcounts(num_neigh), rcvtypes(num_neigh)     9
INTEGER (KIND=MPI_ADDRESS_KIND) lb, sizeofreal       10
INTEGER (KIND=MPI_ADDRESS_KIND) sdispls(num_neigh), rdispls(num_neigh) 11
INTEGER type_vec, request, status                    12
comm = MPI_COMM_WORLD                                13
CALL MPI_COMM_SIZE(comm, comm_size, ierr)            14
! Set process grid size and periodicity              15
CALL MPI_DIMS_CREATE(comm_size, ndims, dims, ierr)   16
periods(1) = .TRUE.                                  17
periods(2) = .TRUE.                                  18
! Create a grid structure in WORLD group              19
CALL MPI_CART_CREATE(comm, ndims, dims, periods, reorder, & 20
                    comm_cart, ierr)                  21
! Create datatypes for the neighborhood communication 22
!                                                    23
! Insert code from example in Figure 7.4 to create and initialize 24
! sndcounts, sdispls, sndtypes, rcvcounts, rdispls, and rcvtypes 25
!                                                    26
! Initialize the neighborhood all-to-all-w operation 27
CALL MPI_NEIGHBOR_ALLTOALLW_INIT(u, sndcounts, sdispls, sndtypes, & 28
                                u, rcvcounts, rdispls, rcvtypes, & 29
                                comm_cart, info, request, ierr) 30
! Initialize the grid functions and start the iteration 31
CALL init(u, f)                                       32
DO it=1,100                                           33
! Start data exchange with neighbor processes        34
CALL MPI_START(request, ierr)                         35
! Compute inner cells                                36
CALL relax_inner (u, f)                               37
! Check on completion of neighbor exchange          38
CALL MPI_WAIT(request, status, ierr)                  39
! Compute edge cells                                 40
CALL relax_edges(u, f)                                41
END DO                                                42
CALL output(u)                                        43
CALL MPI_REQUEST_FREE(request, ierr)                  44
CALL MPI_TYPE_FREE(type_vec, ierr)                    45

```

Figure 7.5: Two-dimensional parallel Poisson solver with persistent sparse neighborhood all-to-all-w and without local data copying.

1  
2  
3  
4  
5  
6  
7  
8  
9  
10  
11  
12  
13  
14  
15  
16  
17  
18  
19  
20  
21  
22  
23  
24  
25  
26  
27  
28  
29  
30  
31  
32  
33  
34  
35  
36  
37  
38  
39  
40  
41  
42  
43  
44  
45  
46  
47  
48

DRAFT



1  
2  
3  
4  
5  
6  
7  
8  
9  
10  
11  
12  
13  
14  
15  
16  
17  
18  
19  
20  
21  
22  
23  
24  
25  
26  
27  
28  
29  
30  
31  
32  
33  
34  
35  
36  
37  
38  
39  
40  
41  
42  
43  
44  
45  
46  
47  
48

## Chapter 8

# MPI Environmental Management

This chapter discusses routines for getting and, where appropriate, setting various parameters that relate to the MPI implementation and the execution environment (such as error handling). The procedures for entering and leaving the MPI execution environment are also described here.

### 8.1 Implementation Information

#### 8.1.1 Version Inquiries

In order to cope with changes to the MPI Standard, there are both compile-time and run-time ways to determine which version of the standard is in use in the environment one is using.

The “version” will be represented by two separate integers, for the version and subversion: In C,

```
#define MPI_VERSION 3  
#define MPI_SUBVERSION 1
```

in Fortran,

```
INTEGER :: MPI_VERSION, MPI_SUBVERSION  
PARAMETER (MPI_VERSION = 3)  
PARAMETER (MPI_SUBVERSION = 1)
```

For runtime determination,

`MPI_GET_VERSION(version, subversion)`

OUT	version	version number (integer)
OUT	subversion	subversion number (integer)

#### C binding

```
int MPI_Get_version(int *version, int *subversion)
```

#### Fortran 2008 binding

```
MPI_Get_version(version, subversion, ierror)
```

```

1     INTEGER, INTENT(OUT) :: version, subversion
2     INTEGER, OPTIONAL, INTENT(OUT) :: ierror

```

### Fortran binding

```

4 MPI_GET_VERSION(VERSION, SUBVERSION, IERROR)
5     INTEGER VERSION, SUBVERSION, IERROR

```

MPI\_GET\_VERSION can be called at any time in an MPI program. This function must always be thread-safe, as defined in Section 10.6. Valid (MPI\_VERSION, MPI\_SUBVERSION) pairs in this and previous versions of the MPI standard are (4,0), (3,1), (3,0), (2,2), (2,1), (2,0), and (1,2).

```

13 MPI_GET_LIBRARY_VERSION(version, resultlen)

```

14	OUT	version	version number (string)
15	OUT	resultlen	Length (in printable characters) of the result returned in version (integer)

### C binding

```

19 int MPI_Get_library_version(char *version, int *resultlen)

```

### Fortran 2008 binding

```

22 MPI_Get_library_version(version, resultlen, ierror)
23     CHARACTER(LEN=MPI_MAX_LIBRARY_VERSION_STRING), INTENT(OUT) :: version
24     INTEGER, INTENT(OUT) :: resultlen
25     INTEGER, OPTIONAL, INTENT(OUT) :: ierror

```

### Fortran binding

```

28 MPI_GET_LIBRARY_VERSION(VERSION, RESULTLEN, IERROR)
29     CHARACTER*(*) VERSION
30     INTEGER RESULTLEN, IERROR

```

This routine returns a string representing the version of the MPI library. The version argument is a character string for maximum flexibility.

*Advice to implementors.* An implementation of MPI should return a different string for every change to its source code or build that could be visible to the user. (*End of advice to implementors.*)

The argument `version` must represent storage that is MPI\_MAX\_LIBRARY\_VERSION\_STRING characters long. MPI\_GET\_LIBRARY\_VERSION may write up to this many characters into `version`.

The number of characters actually written is returned in the output argument, `resultlen`. In C, a null character is additionally stored at `version[resultlen]`. The value of `resultlen` cannot be larger than MPI\_MAX\_LIBRARY\_VERSION\_STRING - 1. In Fortran, `version` is padded on the right with blank characters. The value of `resultlen` cannot be larger than MPI\_MAX\_LIBRARY\_VERSION\_STRING.

MPI\_GET\_LIBRARY\_VERSION can be called at any time in an MPI program. This function must always be thread-safe, as defined in Section 10.6.

### 8.1.2 Environmental Inquiries

When using the World Model (Section 10.2), a set of attributes that describe the execution environment is attached to the communicator `MPI_COMM_WORLD` when MPI is initialized. The values of these attributes can be inquired by using the function `MPI_COMM_GET_ATTR` described in Section 6.7 and in Section 18.2.7. It is erroneous to delete these attributes, free their keys, or change their values.

The list of predefined attribute keys include

**MPI\_TAG\_UB** Upper bound for tag value.

**MPI\_HOST** Host process rank, if such exists, `MPI_PROC_NULL`, otherwise.

**MPI\_IO** rank of a node that has regular I/O facilities (possibly myrank). Nodes in the same communicator may return different values for this parameter.

**MPI\_WTIME\_IS\_GLOBAL** Boolean variable that indicates whether clocks are synchronized.

When using the Sessions Model (Section 10.3), only the `MPI_TAG_UB` attribute is available.

Vendors may add implementation-specific parameters (such as node number, real memory size, virtual memory size, etc.)

These predefined attributes do not change value between MPI initialization (`MPI_INIT`) and MPI completion (`MPI_FINALIZE`), and cannot be updated or deleted by users.

*Advice to users.* Note that in the C binding, the value returned by these attributes is a *pointer* to an `int` containing the requested value. (*End of advice to users.*)

The required parameter values are discussed in more detail below:

#### Tag Values

Tag values range from 0 to the value returned for `MPI_TAG_UB`, inclusive. These values are guaranteed to be unchanging during the execution of an MPI program. In addition, the tag upper bound value must be *at least* 32767. An MPI implementation is free to make the value of `MPI_TAG_UB` larger than this; for example, the value  $2^{30} - 1$  is also a valid value for `MPI_TAG_UB`.

In the Sessions Model, the attribute `MPI_TAG_UB` is attached to all communicators created by `MPI_COMM_CREATE_FROM_GROUP` and `MPI_INTERCOMM_CREATE_FROM_GROUPS`, with the same value on all MPI processes in the communicator. In the World Model, the attribute `MPI_TAG_UB` has the same value on all processes of `MPI_COMM_WORLD`.

#### Host Rank

The value returned for `MPI_HOST` gets the rank of the *HOST* process in the group associated with communicator `MPI_COMM_WORLD`, if there is such. `MPI_PROC_NULL` is returned if there is no host. MPI does not specify what it means for a process to be a *HOST*, nor does it require that a *HOST* exists.

The attribute `MPI_HOST` has the same value on all processes of `MPI_COMM_WORLD`.

## IO Rank

The value returned for `MPI_IO` is the rank of a processor that can provide language-standard I/O facilities. For Fortran, this means that all of the Fortran I/O operations are supported (e.g., `OPEN`, `REWIND`, `WRITE`). For C, this means that all of the ISO C I/O operations are supported (e.g., `fopen`, `fprintf`, `lseek`).

If every process can provide language-standard I/O, then the value `MPI_ANY_SOURCE` will be returned. Otherwise, if the calling process can provide language-standard I/O, then its rank will be returned. Otherwise, if some process can provide language-standard I/O then the rank of one such process will be returned. The same value need not be returned by all processes. If no process can provide language-standard I/O, then the value `MPI_PROC_NULL` will be returned.

*Advice to users.* Note that input is not collective, and this attribute does *not* indicate which process can or does provide input. (*End of advice to users.*)

## Clock Synchronization

The value returned for `MPI_WTIME_IS_GLOBAL` is 1 if clocks at all processes in `MPI_COMM_WORLD` are synchronized, 0 otherwise. A collection of clocks is considered synchronized if explicit effort has been taken to synchronize them. The expectation is that the variation in time, as measured by calls to `MPI_WTIME`, will be less than one half the round-trip time for an MPI message of length zero. If time is measured at a process just before a send and at another process just after a matching receive, the second time should be always higher than the first one.

The attribute `MPI_WTIME_IS_GLOBAL` need not be present when the clocks are not synchronized (however, the attribute key `MPI_WTIME_IS_GLOBAL` is always valid). This attribute may be associated with communicators other than `MPI_COMM_WORLD`.

The attribute `MPI_WTIME_IS_GLOBAL` has the same value on all processes of `MPI_COMM_WORLD`.

## Inquire Processor Name

`MPI_GET_PROCESSOR_NAME(name, resultlen)`

OUT	<code>name</code>	A unique specifier for the actual (as opposed to virtual) node.
OUT	<code>resultlen</code>	Length (in printable characters) of the result returned in <code>name</code>

## C binding

```
int MPI_Get_processor_name(char *name, int *resultlen)
```

## Fortran 2008 binding

```
MPI_Get_processor_name(name, resultlen, ierror)
  CHARACTER(LEN=MPI_MAX_PROCESSOR_NAME), INTENT(OUT) :: name
  INTEGER, INTENT(OUT) :: resultlen
  INTEGER, OPTIONAL, INTENT(OUT) :: ierror
```

**Fortran binding**

```

MPI_GET_PROCESSOR_NAME(NAME, RESULTLEN, IERROR)
    CHARACTER*(*) NAME
    INTEGER RESULTLEN, IERROR

```

This routine returns the name of the processor on which it was called at the moment of the call. The name is a character string for maximum flexibility. From this value it must be possible to identify a specific piece of hardware; possible values include “processor 9 in rack 4 of mpp.cs.org” and “231” (where 231 is the actual processor number in the running homogeneous system). The argument `name` must represent storage that is at least `MPI_MAX_PROCESSOR_NAME` characters long. `MPI_GET_PROCESSOR_NAME` may write up to this many characters into `name`.

The number of characters actually written is returned in the output argument, `resultlen`. In C, a null character is additionally stored at `name[resultlen]`. The value of `resultlen` cannot be larger than `MPI_MAX_PROCESSOR_NAME-1`. In Fortran, `name` is padded on the right with blank characters. The value of `resultlen` cannot be larger than `MPI_MAX_PROCESSOR_NAME`.

*Rationale.* This function allows MPI implementations that do process migration to return the current processor. Note that nothing in MPI *requires* or defines process migration; this definition of `MPI_GET_PROCESSOR_NAME` simply allows such an implementation. (*End of rationale.*)

*Advice to users.* The user must provide at least `MPI_MAX_PROCESSOR_NAME` space to write the processor name — processor names can be this long. The user should examine the output argument, `resultlen`, to determine the actual length of the name. (*End of advice to users.*)

## 8.2 Memory Allocation

In some systems, message-passing and remote-memory-access (RMA) operations run faster when accessing specially allocated memory (e.g., memory that is shared by the other processes in the communicating group on an SMP). MPI provides a mechanism for allocating and freeing such special memory. The use of such memory for message-passing or RMA is not mandatory, and this memory can be used without restrictions as any other dynamically allocated memory. However, implementations may restrict the use of some RMA functionality as defined in Section [11.5.3](#).

```

MPI_ALLOC_MEM(size, info, baseptr)

```

IN	size	size of memory segment in bytes (non-negative integer)
IN	info	info argument (handle)
OUT	baseptr	pointer to beginning of memory segment allocated

**C binding**

```

int MPI_Alloc_mem(MPI_Aint size, MPI_Info info, void *baseptr)

```

**Fortran 2008 binding**

```

1 MPI_Alloc_mem(size, info, baseptr, ierror)
2     USE, INTRINSIC :: ISO_C_BINDING, ONLY : C_PTR
3     INTEGER(KIND=MPI_ADDRESS_KIND), INTENT(IN) :: size
4     TYPE(MPI_Info), INTENT(IN) :: info
5     TYPE(C_PTR), INTENT(OUT) :: baseptr
6     INTEGER, OPTIONAL, INTENT(OUT) :: ierror

```

### Fortran binding

```

8 MPI_ALLOC_MEM(SIZE, INFO, BASEPTR, IERROR)
9     INTEGER(KIND=MPI_ADDRESS_KIND) SIZE, BASEPTR
10    INTEGER INFO, IERROR

```

If the Fortran compiler provides `TYPE(C_PTR)`, then the following generic interface must be provided in the `mpi` module and should be provided in `mpif.h` through overloading, i.e., with the same routine name as the routine with `INTEGER(KIND=MPI_ADDRESS_KIND)` `BASEPTR`, but with a different specific procedure name:

```

17 INTERFACE MPI_ALLOC_MEM
18     SUBROUTINE MPI_ALLOC_MEM(SIZE, INFO, BASEPTR, IERROR)
19         IMPORT :: MPI_ADDRESS_KIND
20         INTEGER INFO, IERROR
21         INTEGER(KIND=MPI_ADDRESS_KIND) SIZE, BASEPTR
22     END SUBROUTINE
23     SUBROUTINE MPI_ALLOC_MEM_CPTR(SIZE, INFO, BASEPTR, IERROR)
24         USE, INTRINSIC :: ISO_C_BINDING, ONLY : C_PTR
25         IMPORT :: MPI_ADDRESS_KIND
26         INTEGER :: INFO, IERROR
27         INTEGER(KIND=MPI_ADDRESS_KIND) :: SIZE
28         TYPE(C_PTR) :: BASEPTR
29     END SUBROUTINE
30 END INTERFACE

```

The base procedure name of this overloaded function is `MPI_ALLOC_MEM_CPTR`. The implied specific procedure names are described in Section 18.1.5.

By default, the allocated memory shall be aligned to at least the alignment required for load/store accesses of any datatype corresponding to a predefined MPI datatype. The `info` argument may be used to specify a desired alternative minimum alignment in bytes for the allocated memory by setting the value of the key `mpi_minimum_memory_alignment` to an integral number equal to a power of two. An implementation may ignore values smaller than the default required alignment. The `info` argument can also be used to provide directives that control the desired location of the allocated memory. Such a directive does not affect the semantics of the call. The corresponding `info` values are implementation-dependent. A null directive value of `info = MPI_INFO_NULL` is always valid.

The function `MPI_ALLOC_MEM` may return an error code of class `MPI_ERR_NO_MEM` to indicate it failed because memory is exhausted.

```
MPI_FREE_MEM(base)
```

```
IN      base          initial address of memory segment allocated by
                        MPI_ALLOC_MEM (choice)
```

### C binding

```
int MPI_Free_mem(void *base)
```

### Fortran 2008 binding

```
MPI_Free_mem(base, ierror)
      TYPE(*), DIMENSION(..), INTENT(IN), ASYNCHRONOUS :: base
      INTEGER, OPTIONAL, INTENT(OUT) :: ierror
```

### Fortran binding

```
MPI_FREE_MEM(BASE, IERROR)
      <type> BASE(*)
      INTEGER IERROR
```

The function `MPI_FREE_MEM` may return an error code of class `MPI_ERR_BASE` to indicate an invalid base argument.

*Rationale.* The C bindings of `MPI_ALLOC_MEM` and `MPI_FREE_MEM` are similar to the bindings for the `malloc` and `free` C library calls: a call to `MPI_Alloc_mem(..., &base)` should be paired with a call to `MPI_Free_mem(base)` (one less level of indirection). Both arguments are declared to be of same type `void*` so as to facilitate type casting. The Fortran binding is consistent with the C bindings: the Fortran `MPI_ALLOC_MEM` call returns in `baseptr` the `TYPE(C_PTR)` pointer or the (integer valued) address of the allocated memory. The `base` argument of `MPI_FREE_MEM` is a choice argument, which passes (a reference to) the variable stored at that location. (*End of rationale.*)

*Advice to implementors.* If `MPI_ALLOC_MEM` allocates special memory, then a design similar to the design of C `malloc` and `free` functions has to be used, in order to find out the size of a memory segment, when the segment is freed. If no special memory is used, `MPI_ALLOC_MEM` simply invokes `malloc`, and `MPI_FREE_MEM` invokes `free`.

A call to `MPI_ALLOC_MEM` can be used in shared memory systems to allocate memory in a shared memory segment. (*End of advice to implementors.*)

**Example 8.1** Example of use of `MPI_ALLOC_MEM`, in Fortran with `TYPE(C_PTR)` pointers. We assume 4-byte REALs.

```
USE mpi_f08 ! or USE mpi      (not guaranteed with INCLUDE 'mpif.h')
USE, INTRINSIC :: ISO_C_BINDING
TYPE(C_PTR) :: p
REAL, DIMENSION(:,,:), POINTER :: a      ! no memory is allocated
INTEGER, DIMENSION(2) :: shape
INTEGER(KIND=MPI_ADDRESS_KIND) :: size
shape = (/100,100/)
```

```

1  size = 4 * shape(1) * shape(2)           ! assuming 4 bytes per REAL
2  CALL MPI_Alloc_mem(size,MPI_INFO_NULL,p,ierr) ! memory is allocated and
3  CALL C_F_POINTER(p, a, shape) ! intrinsic    ! now accessible via a(i,j)
4  ...                                     ! in ISO_C_BINDING
5  a(3,5) = 2.71
6  ...
7  CALL MPI_Free_mem(a, ierr)              ! memory is freed
8
9

```

**Example 8.2** Example of use of `MPI_ALLOC_MEM`, in Fortran with non-standard *Cray-pointers*. We assume 4-byte REALs, and assume that these pointers are address-sized.

```

12  REAL A
13  POINTER (P, A(100,100)) ! no memory is allocated
14  INTEGER(KIND=MPI_ADDRESS_KIND) SIZE
15  SIZE = 4*100*100
16  CALL MPI_ALLOC_MEM(SIZE, MPI_INFO_NULL, P, IERR)
17  ! memory is allocated
18  ...
19  A(3,5) = 2.71
20  ...
21  CALL MPI_FREE_MEM(A, IERR) ! memory is freed
22

```

This code is not Fortran 77 or Fortran 90 code. Some compilers may not support this code or need a special option, e.g., the GNU gFortran compiler needs `-fcray-pointer`.

*Advice to implementors.* Some compilers map Cray-pointers to address-sized integers, some to `TYPE(C_PTR)` pointers (e.g., Cray Fortran, version 7.3.3). From the user's viewpoint, this mapping is irrelevant because Examples 8.2 should work correctly with an MPI-3.0 (or later) library if Cray-pointers are available. (*End of advice to implementors.*)

**Example 8.3** Same example, in C.

```

33  float (* f)[100][100];
34  /* no memory is allocated */
35  MPI_Alloc_mem(sizeof(float)*100*100, MPI_INFO_NULL, &f);
36  /* memory allocated */
37  ...
38  (*f)[5][3] = 2.71;
39  ...
40  MPI_Free_mem(f);
41
42

```

### 8.3 Error Handling

An MPI implementation cannot or may choose not to handle some errors that occur during MPI calls. These can include errors that generate exceptions or traps, such as floating point errors or access violations. The set of errors that are handled by MPI is implementation-dependent. Each such error generates an **MPI exception**.



The above text takes precedence over any text on error handling within this document. Specifically, text that states that errors *will* be handled should be read as *may* be handled. More background information about how MPI treats errors can be found in Section 2.8.

A user can associate error handlers to four types of objects: communicators, windows, files, and sessions. The specified error handling routine will be used for any MPI exception that occurs during a call to MPI for the respective object. MPI calls that are not related to any MPI objects are considered to be attached to the communicator MPI\_COMM\_SELF. When MPI\_COMM\_SELF is not initialized (i.e., before MPI\_INIT / MPI\_INIT\_THREAD or after MPI\_FINALIZE) the error raises the initial error handler (set during the launch operation, see 10.8.4). The attachment of error handlers to objects is purely local: different processes may attach different error handlers to corresponding objects.

Several predefined error handlers are available in MPI:

**MPI\_ERRORS\_ARE\_FATAL** The handler, when called, causes the program to abort all connected MPI processes. This is similar to calling MPI\_ABORT using a communicator containing all connected processes with an implementation-specific value as the errorcode argument.

**MPI\_ERRORS\_ABORT** The handler, when called, is invoked on a communicator in a manner similar to calling MPI\_ABORT on that communicator. If the error handler is invoked on an window or file, it is similar to calling MPI\_ABORT using a communicator containing the group of MPI processes associated with the window or file, respectively. If the error handler is invoked on a session, the operation aborts only the local MPI process. In all cases, the value that would be provided as the errorcode argument to MPI\_ABORT is implementation-specific.

**MPI\_ERRORS\_RETURN** The handler has no effect other than returning the error code to the user.

*Advice to implementors.* The implementation-specific error information resulting from MPI\_ERRORS\_ARE\_FATAL and MPI\_ERRORS\_ABORT provided to the invoking environment should be meaningful to the end-user, for example a predefined error class. (*End of advice to implementors.*)

Implementations may provide additional predefined error handlers and programmers can code their own error handlers.

Unless otherwise requested, the error handler MPI\_ERRORS\_ARE\_FATAL is set as the default initial error handler and associated with predefined communicators. Thus, if the user chooses not to control error handling, every error that MPI handles is treated as fatal. Since (almost) all MPI calls return an error code, a user may choose to handle errors in its main code, by testing the return code of MPI calls and executing a suitable recovery code when the call was not successful. In this case, the error handler MPI\_ERRORS\_RETURN will be used. Usually it is more convenient and more efficient not to test for errors after each MPI call, and have such error handled by a non-trivial MPI error handler. Note that unlike predefined communicators, windows and files do not inherit from the initial error handler, as defined in Sections 11.6 and 13.7 respectively.

After an error is detected, MPI will provide the user as much information as possible about that error using error classes. Some errors might prevent MPI from completing further API calls successfully and those functions will continue to report errors until the

1 cause of the error is corrected or the user terminates the application. The user can make  
2 the determination of whether or not to attempt to continue after detecting such an error.

3  
4 *Advice to users.* For example, users may be unable to correct errors corresponding  
5 to some error classes, such as `MPI_ERR_INTERN`. Such errors may cause subsequent  
6 MPI calls to complete in error. (*End of advice to users.*)

7  
8 *Advice to implementors.* A high-quality implementation will, to the greatest possible  
9 extent, circumscribe the impact of an error, so that normal processing can continue  
10 after an error handler was invoked. The implementation documentation will provide  
11 information on the possible effect of each class of errors and available recovery actions.  
12 (*End of advice to implementors.*)

13  
14 An MPI error handler is an opaque object, which is accessed by a handle. MPI calls  
15 are provided to create new error handlers, to associate error handlers with objects, and to  
16 test which error handler is associated with an object. C has distinct typedefs for user de-  
17 fined error handling callback functions that accept communicator, file, window, and session  
18 arguments. In Fortran there are four user routines.

19 An error handler object is created by a call to `MPI_XXX_CREATE_ERRHANDLER`,  
20 where XXX is, respectively, `COMM`, `WIN`, `FILE`, or `SESSION`.

21 An error handler is attached to a communicator, window, file, or session by a call to  
22 `MPI_XXX_SET_ERRHANDLER`. The error handler must be either a predefined error han-  
23 dler, or an error handler that was created by a call to `MPI_XXX_CREATE_ERRHANDLER`,  
24 with matching XXX. An error handler can also be attached to a session using the `errorhandler`  
25 argument to `MPI_SESSION_INIT`. The predefined error handlers `MPI_ERRORS_RETURN` and  
26 `MPI_ERRORS_ARE_FATAL` can be attached to communicators, windows, files, or sessions.

27 The error handler currently associated with a communicator, window, file, or session  
28 can be retrieved by a call to `MPI_XXX_GET_ERRHANDLER`.

29 The MPI function `MPI_ERRHANDLER_FREE` can be used to free an error handler that  
30 was created by a call to `MPI_XXX_CREATE_ERRHANDLER`.

31 `MPI_XXX_GET_ERRHANDLER` behave as if a new error handler object is created. That  
32 is, once the error handler is no longer needed, `MPI_ERRHANDLER_FREE` should be called  
33 with the error handler returned from `MPI_XXX_GET_ERRHANDLER` to mark the error  
34 handler for deallocation. This provides behavior similar to that of `MPI_COMM_GROUP`  
35 and `MPI_GROUP_FREE`.

36  
37 *Advice to implementors.* High-quality implementations should raise an error when  
38 an error handler that was created by a call to `MPI_XXX_CREATE_ERRHANDLER` is  
39 attached to an object of the wrong type with a call to `MPI_YYY_SET_ERRHANDLER`.  
40 To do so, it is necessary to maintain, with each error handler, information on the  
41 typedef of the associated user function. (*End of advice to implementors.*)

42 The syntax for these calls is given below.  
43  
44  
45  
46  
47  
48

## 8.3.1 Error Handlers for Communicators

`MPI_COMM_CREATE_ERRHANDLER(comm_errhandler_fn, errhandler)`

IN	<code>comm_errhandler_fn</code>	user defined error handling procedure (function)
OUT	<code>errhandler</code>	MPI error handler (handle)

**C binding**

```
int MPI_Comm_create_errhandler(MPI_Comm_errhandler_function
                               *comm_errhandler_fn, MPI_Errhandler *errhandler)
```

**Fortran 2008 binding**

```
MPI_Comm_create_errhandler(comm_errhandler_fn, errhandler, ierror)
  PROCEDURE(MPI_Comm_errhandler_function), INTENT(IN) ::
  comm_errhandler_fn
  TYPE(MPI_Errhandler), INTENT(OUT) :: errhandler
  INTEGER, OPTIONAL, INTENT(OUT) :: ierror
```

**Fortran binding**

```
MPI_COMM_CREATE_ERRHANDLER(COMM_ERRHANDLER_FN, ERRHANDLER, IERROR)
  EXTERNAL COMM_ERRHANDLER_FN
  INTEGER ERRHANDLER, IERROR
```

Creates an error handler that can be attached to communicators.

The user routine should be, in C, a function of type `MPI_Comm_errhandler_function`, which is defined as

```
typedef void MPI_Comm_errhandler_function(MPI_Comm *comm, int *error_code,
                                           ...);
```

The first argument is the communicator in use. The second is the error code to be returned by the MPI routine that raised the error. If the routine would have returned `MPI_ERR_IN_STATUS`, it is the error code returned in the status for the request that caused the error handler to be invoked. The remaining arguments are “`varargs`” arguments whose number and meaning is implementation-dependent. An implementation should clearly document these arguments. Addresses are used so that the handler may be written in Fortran. With the Fortran `mpi_f08` module, the user routine `comm_errhandler_fn` should be of the form:

```
ABSTRACT INTERFACE
  SUBROUTINE MPI_Comm_errhandler_function(comm, error_code)
    TYPE(MPI_Comm) :: comm
    INTEGER :: error_code
```

With the Fortran `mpi` module and `mpif.h`, the user routine `COMM_ERRHANDLER_FN` should be of the form:

```
SUBROUTINE COMM_ERRHANDLER_FUNCTION(COMM, ERROR_CODE)
  INTEGER COMM, ERROR_CODE
```

*Rationale.* The variable argument list is provided because it provides an ISO-standard hook for providing additional information to the error handler; without this

hook, ISO C prohibits additional arguments. (*End of rationale.*)

*Advice to users.* A newly created communicator inherits the error handler that is associated with the “parent” communicator. In particular, the user can specify a “global” error handler for all communicators by associating this handler with the communicator MPI\_COMM\_WORLD immediately after initialization. (*End of advice to users.*)

MPI\_COMM\_SET\_ERRHANDLER(comm, errhandler)

INOUT comm communicator (handle)

IN errhandler new error handler for communicator (handle)

### C binding

```
int MPI_Comm_set_errhandler(MPI_Comm comm, MPI_Errhandler errhandler)
```

### Fortran 2008 binding

```
MPI_Comm_set_errhandler(comm, errhandler, ierror)
```

```
TYPE(MPI_Comm), INTENT(IN) :: comm
```

```
TYPE(MPI_Errhandler), INTENT(IN) :: errhandler
```

```
INTEGER, OPTIONAL, INTENT(OUT) :: ierror
```

### Fortran binding

```
MPI_COMM_SET_ERRHANDLER(COMM, ERRHANDLER, IERROR)
```

```
INTEGER COMM, ERRHANDLER, IERROR
```

Attaches a new error handler to a communicator. The error handler must be either a predefined error handler, or an error handler created by a call to MPI\_COMM\_CREATE\_ERRHANDLER.

MPI\_COMM\_GET\_ERRHANDLER(comm, errhandler)

IN comm communicator (handle)

OUT errhandler error handler currently associated with communicator (handle)

### C binding

```
int MPI_Comm_get_errhandler(MPI_Comm comm, MPI_Errhandler *errhandler)
```

### Fortran 2008 binding

```
MPI_Comm_get_errhandler(comm, errhandler, ierror)
```

```
TYPE(MPI_Comm), INTENT(IN) :: comm
```

```
TYPE(MPI_Errhandler), INTENT(OUT) :: errhandler
```

```
INTEGER, OPTIONAL, INTENT(OUT) :: ierror
```

### Fortran binding

```
MPI_COMM_GET_ERRHANDLER(COMM, ERRHANDLER, IERROR)
```

```
INTEGER COMM, ERRHANDLER, IERROR
```

Retrieves the error handler currently associated with a communicator. 1

For example, a library function may register at its entry point the current error handler 2  
for a communicator, set its own private error handler for this communicator, and restore 3  
before exiting the previous error handler. 4

### 8.3.2 Error Handlers for Windows 6

`MPI_WIN_CREATE_ERRHANDLER(win_errhandler_fn, errhandler)` 9

IN	win_errhandler_fn	user defined error handling procedure (function)	11
OUT	errhandler	MPI error handler (handle)	12

#### C binding 14

```
int MPI_Win_create_errhandler(MPI_Win_errhandler_function
                             *win_errhandler_fn, MPI_Errhandler *errhandler) 15
                                                                    16
```

#### Fortran 2008 binding 18

```
MPI_Win_create_errhandler(win_errhandler_fn, errhandler, ierror) 19
    PROCEDURE(MPI_Win_errhandler_function), INTENT(IN) :: 20
    win_errhandler_fn 21
    TYPE(MPI_Errhandler), INTENT(OUT) :: errhandler 22
    INTEGER, OPTIONAL, INTENT(OUT) :: ierror 23
```

#### Fortran binding 24

```
MPI_WIN_CREATE_ERRHANDLER(WIN_ERRHANDLER_FN, ERRHANDLER, IERROR) 25
    EXTERNAL WIN_ERRHANDLER_FN 26
    INTEGER ERRHANDLER, IERROR 27
```

Creates an error handler that can be attached to a window object. The user routine 29  
should be, in C, a function of type `MPI_Win_errhandler_function` which is defined as 30  
`typedef void MPI_Win_errhandler_function(MPI_Win *win, int *error_code,` 31  
`...);` 32

The first argument is the window in use, the second is the error code to be returned. 33  
With the Fortran `mpi_f08` module, the user routine `win_errhandler_fn` should be of the form: 34

```
ABSTRACT INTERFACE 35
    SUBROUTINE MPI_Win_errhandler_function(win, error_code) 36
        TYPE(MPI_Win) :: win 37
        INTEGER :: error_code 38
```

With the Fortran `mpi` module and `mpif.h`, the user routine `WIN_ERRHANDLER_FN` should 40  
be of the form: 41

```
SUBROUTINE WIN_ERRHANDLER_FUNCTION(WIN, ERROR_CODE) 42
    INTEGER WIN, ERROR_CODE 43
```

```

1 MPI_WIN_SET_ERRHANDLER(win, errhandler)
2     INOUT    win                window object (handle)
3
4     IN      errhandler          new error handler for window (handle)

```

**C binding**

```

7 int MPI_Win_set_errhandler(MPI_Win win, MPI_Errhandler errhandler)

```

**Fortran 2008 binding**

```

9 MPI_Win_set_errhandler(win, errhandler, ierror)
10     TYPE(MPI_Win), INTENT(IN) :: win
11     TYPE(MPI_Errhandler), INTENT(IN) :: errhandler
12     INTEGER, OPTIONAL, INTENT(OUT) :: ierror

```

**Fortran binding**

```

14 MPI_WIN_SET_ERRHANDLER(WIN, ERRHANDLER, IERROR)
15     INTEGER WIN, ERRHANDLER, IERROR

```

Attaches a new error handler to a window. The error handler must be either a pre-defined error handler, or an error handler created by a call to MPI\_WIN\_CREATE\_ERRHANDLER.

```

22 MPI_WIN_GET_ERRHANDLER(win, errhandler)
23
24     IN      win                window object (handle)
25     OUT    errhandler          error handler currently associated with window (handle)

```

**C binding**

```

29 int MPI_Win_get_errhandler(MPI_Win win, MPI_Errhandler *errhandler)

```

**Fortran 2008 binding**

```

32 MPI_Win_get_errhandler(win, errhandler, ierror)
33     TYPE(MPI_Win), INTENT(IN) :: win
34     TYPE(MPI_Errhandler), INTENT(OUT) :: errhandler
35     INTEGER, OPTIONAL, INTENT(OUT) :: ierror

```

**Fortran binding**

```

37 MPI_WIN_GET_ERRHANDLER(WIN, ERRHANDLER, IERROR)
38     INTEGER WIN, ERRHANDLER, IERROR

```

Retrieves the error handler currently associated with a window.

## 8.3.3 Error Handlers for Files

MPI\_FILE\_CREATE\_ERRHANDLER(file\_errhandler\_fn, errhandler)

IN	file_errhandler_fn	user defined error handling procedure (function)
OUT	errhandler	MPI error handler (handle)

**C binding**

```
int MPI_File_create_errhandler(MPI_File_errhandler_function
                             *file_errhandler_fn, MPI_Errhandler *errhandler)
```

**Fortran 2008 binding**

```
MPI_File_create_errhandler(file_errhandler_fn, errhandler, ierror)
  PROCEDURE(MPI_File_errhandler_function), INTENT(IN) ::
  file_errhandler_fn
  TYPE(MPI_Errhandler), INTENT(OUT) :: errhandler
  INTEGER, OPTIONAL, INTENT(OUT) :: ierror
```

**Fortran binding**

```
MPI_FILE_CREATE_ERRHANDLER(FILE_ERRHANDLER_FN, ERRHANDLER, IERROR)
  EXTERNAL FILE_ERRHANDLER_FN
  INTEGER ERRHANDLER, IERROR
```

Creates an error handler that can be attached to a file object. The user routine should be, in C, a function of type `MPI_File_errhandler_function`, which is defined as

```
typedef void MPI_File_errhandler_function(MPI_File *file, int *error_code,
    ...);
```

The first argument is the file in use, the second is the error code to be returned. With the Fortran `mpi_f08` module, the user routine `file_errhandler_fn` should be of the form:

```
ABSTRACT INTERFACE
  SUBROUTINE MPI_File_errhandler_function(file, error_code)
    TYPE(MPI_File) :: file
    INTEGER :: error_code
```

With the Fortran `mpi` module and `mpif.h`, the user routine `FILE_ERRHANDLER_FN` should be of the form:

```
SUBROUTINE FILE_ERRHANDLER_FUNCTION(FILE, ERROR_CODE)
  INTEGER FILE, ERROR_CODE
```

MPI\_FILE\_SET\_ERRHANDLER(file, errhandler)

INOUT	file	file (handle)
IN	errhandler	new error handler for file (handle)

**C binding**

```
int MPI_File_set_errhandler(MPI_File file, MPI_Errhandler errhandler)
```

**Fortran 2008 binding**

```

MPI_File_set_errhandler(file, errhandler, ierror)
    TYPE(MPI_File), INTENT(IN) :: file
    TYPE(MPI_Errhandler), INTENT(IN) :: errhandler
    INTEGER, OPTIONAL, INTENT(OUT) :: ierror

```

**Fortran binding**

```

MPI_FILE_SET_ERRHANDLER(FILE, ERRHANDLER, IERROR)
    INTEGER FILE, ERRHANDLER, IERROR

```

Attaches a new error handler to a file. The error handler must be either a predefined error handler, or an error handler created by a call to `MPI_FILE_CREATE_ERRHANDLER`.

```

MPI_FILE_GET_ERRHANDLER(file, errhandler)

```

IN	file	file (handle)
OUT	errhandler	error handler currently associated with file (handle)

**C binding**

```

int MPI_File_get_errhandler(MPI_File file, MPI_Errhandler *errhandler)

```

**Fortran 2008 binding**

```

MPI_File_get_errhandler(file, errhandler, ierror)
    TYPE(MPI_File), INTENT(IN) :: file
    TYPE(MPI_Errhandler), INTENT(OUT) :: errhandler
    INTEGER, OPTIONAL, INTENT(OUT) :: ierror

```

**Fortran binding**

```

MPI_FILE_GET_ERRHANDLER(FILE, ERRHANDLER, IERROR)
    INTEGER FILE, ERRHANDLER, IERROR

```

Retrieves the error handler currently associated with a file.

**8.3.4 Error Handlers for Sessions**

```

MPI_SESSION_CREATE_ERRHANDLER(session_errhandler_fn, errhandler)

```

IN	session_errhandler_fn	user defined error handling procedure (function)
OUT	errhandler	MPI error handler (handle)

**C binding**

```

int MPI_Session_create_errhandler(MPI_Session_errhandler_function
    *session_errhandler_fn, MPI_Errhandler *errhandler)

```

**Fortran 2008 binding**

```

MPI_Session_create_errhandler(session_errhandler_fn, errhandler, ierror)
    PROCEDURE(MPI_Session_errhandler_function), INTENT(IN) ::
    session_errhandler_fn
    TYPE(MPI_Errhandler), INTENT(OUT) :: errhandler

```



```
INTEGER, OPTIONAL, INTENT(OUT) :: ierror
```

### Fortran binding

```
MPI_SESSION_CREATE_ERRHANDLER(SESSION_ERRHANDLER_FN, ERRHANDLER, IERROR)
EXTERNAL SESSION_ERRHANDLER_FN
INTEGER ERRHANDLER, IERROR
```

Creates an error handler that can be attached to a session object. In C, the `session_errhandler_fn` argument should be a function of type `MPI_Session_errhandler_function`, which is defined as

```
typedef void MPI_Session_errhandler_function(MPI_Session *session,
                                             int *error_code, ...);
```

The first argument is the session in use, the second is the error code to be returned. With the Fortran `mpi_f08` module, the `session_errhandler_fn` argument should be of the form:

```
ABSTRACT INTERFACE
SUBROUTINE MPI_Session_errhandler_function(session, error_code)
TYPE(MPI_Session) :: session
INTEGER :: error_code
```

With the Fortran `mpi` module and `mpif.h`, the `SESSION_ERRHANDLER_FN` argument should be of the form:

```
SUBROUTINE SESSION_ERRHANDLER_FUNCTION(SESSION, ERROR_CODE)
INTEGER SESSION, ERROR_CODE
```

```
MPI_SESSION_SET_ERRHANDLER(session, errhandler)
```

```
INOUT session (handle)
IN errhandler new error handler for session (handle)
```

### C binding

```
int MPI_Session_set_errhandler(MPI_Session session,
                               MPI_Errhandler errhandler)
```

### Fortran 2008 binding

```
MPI_Session_set_errhandler(session, errhandler, ierror)
TYPE(MPI_Session), INTENT(IN) :: session
TYPE(MPI_Errhandler), INTENT(IN) :: errhandler
INTEGER, OPTIONAL, INTENT(OUT) :: ierror
```

### Fortran binding

```
MPI_SESSION_SET_ERRHANDLER(SESSION, ERRHANDLER, IERROR)
INTEGER SESSION, ERRHANDLER, IERROR
```

Attaches a new error handler to a session. The error handler must be either a pre-defined error handler, or an error handler created by a call to `MPI_SESSION_CREATE_ERRHANDLER`.

```

1 MPI_SESSION_GET_ERRHANDLER(session, errhandler)
2     IN      session          (handle)
3
4     OUT    errhandler       error handler currently associated with session (han-
5                               dle)
6

```

**C binding**

```

8 int MPI_Session_get_errhandler(MPI_Session session,
9                               MPI_Errhandler *errhandler)
10

```

**Fortran 2008 binding**

```

11 MPI_Session_get_errhandler(session, errhandler, ierror)
12     TYPE(MPI_Session), INTENT(IN) :: session
13     TYPE(MPI_Errhandler), INTENT(OUT) :: errhandler
14     INTEGER, OPTIONAL, INTENT(OUT) :: ierror
15

```

**Fortran binding**

```

16 MPI_SESSION_GET_ERRHANDLER(SESSION, ERRHANDLER, IERROR)
17     INTEGER SESSION, ERRHANDLER, IERROR
18

```

Retrieves the error handler currently associated with a session.

**8.3.5 Freeing Errorhandlers and Retrieving Error Strings**

```

24 MPI_ERRHANDLER_FREE(errhandler)
25
26     INOUT  errhandler       MPI error handler (handle)
27

```

**C binding**

```

28
29 int MPI_Errhandler_free(MPI_Errhandler *errhandler)
30

```

**Fortran 2008 binding**

```

31 MPI_Errhandler_free(errhandler, ierror)
32     TYPE(MPI_Errhandler), INTENT(INOUT) :: errhandler
33     INTEGER, OPTIONAL, INTENT(OUT) :: ierror
34

```

**Fortran binding**

```

35
36 MPI_ERRHANDLER_FREE(ERRHANDLER, IERROR)
37     INTEGER ERRHANDLER, IERROR
38

```

Marks the error handler associated with `errhandler` for deallocation and sets `errhandler` to `MPI_ERRHANDLER_NULL`. The error handler will be deallocated after all the objects associated with it (communicator, window, or file) have been deallocated.

MPI_ERROR_STRING(errorcode, string, resultlen)			1
IN	errorcode	Error code returned by an MPI routine	2
OUT	string	Text that corresponds to the errorcode	3
OUT	resultlen	Length (in printable characters) of the result returned in string	4
			5
			6
			7

**C binding**

```
int MPI_Error_string(int errorcode, char *string, int *resultlen)
```

**Fortran 2008 binding**

```
MPI_Error_string(errorcode, string, resultlen, ierror)
  INTEGER, INTENT(IN) :: errorcode
  CHARACTER(LEN=MPI_MAX_ERROR_STRING), INTENT(OUT) :: string
  INTEGER, INTENT(OUT) :: resultlen
  INTEGER, OPTIONAL, INTENT(OUT) :: ierror
```

**Fortran binding**

```
MPI_ERROR_STRING(ERRORCODE, STRING, RESULTLEN, IERROR)
  INTEGER ERRORCODE, RESULTLEN, IERROR
  CHARACTER*(*) STRING
```

Returns the error string associated with an error code or class. The argument `string` must represent storage that is at least `MPI_MAX_ERROR_STRING` characters long.

The number of characters actually written is returned in the output argument, `resultlen`.

This function must always be thread-safe, as defined in Section 10.6. It is one of the few routines that may be called before MPI is initialized or after MPI is finalized.

*Rationale.* The form of this function was chosen to make the Fortran and C bindings similar. A version that returns a pointer to a string has two difficulties. First, the return string must be statically allocated and different for each error message (allowing the pointers returned by successive calls to `MPI_ERROR_STRING` to point to the correct message). Second, in Fortran, a function declared as returning `CHARACTER*(*)` can not be referenced in, for example, a `PRINT` statement. (*End of rationale.*)

## 8.4 Error Codes and Classes

The error codes returned by MPI are left entirely to the implementation (with the exception of `MPI_SUCCESS`). This is done to allow an implementation to provide as much information as possible in the error code (for use with `MPI_ERROR_STRING`).

All MPI function calls shall return `MPI_SUCCESS` if and only if the specification of that function has been fulfilled at the point of return. For multiple completion functions, if the function returns `MPI_ERR_IN_STATUS`, the error code in each status object shall be set to `MPI_SUCCESS` if and only if the specification of the operation represented by the corresponding `MPI_Request` has been fulfilled at the point of return.

When an operation raises an error, it may not satisfy its specification (for example, a synchronizing operation may not have synchronized) and the content of the output buffers, targeted memory, or output parameters is undefined. However, a valid error code shall

1 always be set when an operation raises an error, whether in the return value, error field in  
 2 the status object, or element in an array of error codes.

3 To make it possible for an application to interpret an error code, the routine  
 4 `MPI_ERROR_CLASS` converts any error code into one of a small set of standard error codes,  
 5 called *error classes*. Valid error classes are shown in Table 8.1 and Table 8.2.

6 The error classes are a subset of the error codes: an MPI function may return an error  
 7 class number; and the function `MPI_ERROR_STRING` can be used to compute the error  
 8 string associated with an error class. The values defined for MPI error classes are valid MPI  
 9 error codes.

10 The error codes satisfy,

$$11 \quad 0 = \text{MPI\_SUCCESS} < \text{MPI\_ERR\_...} \leq \text{MPI\_ERR\_LASTCODE}.$$

12  
 13  
 14 *Rationale.* The difference between `MPI_ERR_UNKNOWN` and `MPI_ERR_OTHER` is that  
 15 `MPI_ERROR_STRING` can return useful information about `MPI_ERR_OTHER`.

16 Note that `MPI_SUCCESS = 0` is necessary to be consistent with C practice; the separa-  
 17 tion of error classes and error codes allows us to define the error classes this way.  
 18 Having a known `LASTCODE` is often a nice sanity check as well. (*End of rationale.*)  
 19

20  
 21  
 22 `MPI_ERROR_CLASS(errorcode, errorclass)`

23	IN	errorcode	Error code returned by an MPI routine
24	OUT	errorclass	Error class associated with errorcode

## 25 C binding

26  
 27 `int MPI_Error_class(int errorcode, int *errorclass)`

## 28 Fortran 2008 binding

29 `MPI_Error_class(errorcode, errorclass, ierror)`

```
30     INTEGER, INTENT(IN) :: errorcode
31     INTEGER, INTENT(OUT) :: errorclass
32     INTEGER, OPTIONAL, INTENT(OUT) :: ierror
```

## 33 Fortran binding

34  
 35 `MPI_ERROR_CLASS(ERRORCODE, ERRORCLASS, IERROR)`

```
36     INTEGER ERRORCODE, ERRORCLASS, IERROR
```

37  
 38 The function `MPI_ERROR_CLASS` maps each standard error code (error class) onto  
 39 itself.

40 This function must always be thread-safe, as defined in Section 10.6. It is one of the  
 41 few routines that may be called before MPI is initialized or after MPI is finalized.  
 42

## 43 8.5 Error Classes, Error Codes, and Error Handlers

44  
 45 Users may want to write a layered library on top of an existing MPI implementation, and  
 46 this library may have its own set of error codes and classes. An example of such a library  
 47 is an I/O library based on MPI, see Chapter 13. For this purpose, functions are needed to:  
 48

MPI_SUCCESS	No error	1
MPI_ERR_BUFFER	Invalid buffer pointer	2
MPI_ERR_COUNT	Invalid count argument	3
MPI_ERR_TYPE	Invalid datatype argument	4
MPI_ERR_TAG	Invalid tag argument	5
MPI_ERR_COMM	Invalid communicator	6
MPI_ERR_RANK	Invalid rank	7
MPI_ERR_REQUEST	Invalid request (handle)	8
MPI_ERR_ROOT	Invalid root	9
MPI_ERR_GROUP	Invalid group	10
MPI_ERR_OP	Invalid operation	11
MPI_ERR_TOPOLOGY	Invalid topology	12
MPI_ERR_DIMS	Invalid dimension argument	13
MPI_ERR_ARG	Invalid argument of some other kind	14
MPI_ERR_UNKNOWN	Unknown error	15
MPI_ERR_TRUNCATE	Message truncated on receive	16
MPI_ERR_OTHER	Known error not in this list	17
MPI_ERR_INTERN	Internal MPI (implementation) error	18
MPI_ERR_IN_STATUS	Error code is in status	19
MPI_ERR_PENDING	Pending request	20
MPI_ERR_KEYVAL	Invalid keyval has been passed	21
MPI_ERR_PROC_ABORTED	Operation failed because a peer process has aborted	22
MPI_ERR_NO_MEM	MPI_ALLOC_MEM failed because memory is exhausted	24
MPI_ERR_BASE	Invalid base passed to MPI_FREE_MEM	26
MPI_ERR_INFO_KEY	Key longer than MPI_MAX_INFO_KEY	27
MPI_ERR_INFO_VALUE	Value longer than MPI_MAX_INFO_VAL	28
MPI_ERR_INFO_NOKEY	Invalid key passed to MPI_INFO_DELETE	29
MPI_ERR_SPAWN	Error in spawning processes	30
MPI_ERR_PORT	Invalid port name passed to MPI_COMM_CONNECT	31
MPI_ERR_SERVICE	Invalid service name passed to MPI_UNPUBLISH_NAME	33
MPI_ERR_NAME	Invalid service name passed to MPI_LOOKUP_NAME	35
MPI_ERR_WIN	Invalid win argument	37
MPI_ERR_SIZE	Invalid size argument	38
MPI_ERR_DISP	Invalid disp argument	39
MPI_ERR_INFO	Invalid info argument	40
MPI_ERR_LOCKTYPE	Invalid locktype argument	41
MPI_ERR_ASSERT	Invalid assert argument	42
MPI_ERR_RMA_CONFLICT	Conflicting accesses to window	43
MPI_ERR_RMA_SYNC	Wrong synchronization of RMA calls	44

Table 8.1: Error classes (Part 1)

1	MPI_ERR_RMA_RANGE	Target memory is not part of the window (in the case of a window created with MPI_WIN_CREATE_DYNAMIC, target memory is not attached)
2		
3		
4		
5	MPI_ERR_RMA_ATTACH	Memory cannot be attached (e.g., because of resource exhaustion)
6		
7	MPI_ERR_RMA_SHARED	Memory cannot be shared (e.g., some process in the group of the specified communicator cannot expose shared memory)
8		
9		
10	MPI_ERR_RMA_FLAVOR	Passed window has the wrong flavor for the called function
11		
12	MPI_ERR_FILE	Invalid file handle
13	MPI_ERR_NOT_SAME	Collective argument not identical on all processes, or collective routines called in a different order by different processes
14		
15		
16	MPI_ERR_AMODE	Error related to the <code>amode</code> passed to MPI_FILE_OPEN
17		
18	MPI_ERR_UNSUPPORTED_DATAREP	Unsupported <code>datarep</code> passed to MPI_FILE_SET_VIEW
19		
20	MPI_ERR_UNSUPPORTED_OPERATION	Unsupported operation, such as seeking on a file which supports sequential access only
21		
22	MPI_ERR_NO_SUCH_FILE	File does not exist
23	MPI_ERR_FILE_EXISTS	File exists
24	MPI_ERR_BAD_FILE	Invalid file name (e.g., path name too long)
25	MPI_ERR_ACCESS	Permission denied
26	MPI_ERR_NO_SPACE	Not enough space
27	MPI_ERR_QUOTA	Quota exceeded
28	MPI_ERR_READ_ONLY	Read-only file or file system
29	MPI_ERR_FILE_IN_USE	File operation could not be completed, as the file is currently open by some process
30		
31	MPI_ERR_DUP_DATAREP	Conversion functions could not be registered because a data representation identifier that was already defined was passed to MPI_REGISTER_DATAREP
32		
33		
34		
35	MPI_ERR_CONVERSION	An error occurred in a user supplied data conversion function.
36		
37	MPI_ERR_IO	Other I/O error
38	MPI_ERR_SESSION	Invalid <code>session</code> argument
39	MPI_ERR_LASTCODE	Last error code
40		
41		
42		
43		
44		
45		
46		
47		
48		

Table 8.2: Error classes (Part 2)

1. add a new error class to the ones an MPI implementation already knows.
2. associate error codes with this error class, so that `MPI_ERROR_CLASS` works.
3. associate strings with these error codes, so that `MPI_ERROR_STRING` works.
4. invoke the error handler associated with a communicator, window, or object.

Several functions are provided to do this. They are all local. No functions are provided to free error classes or codes: it is not expected that an application will generate them in significant numbers.

`MPI_ADD_ERROR_CLASS(errorclass)`

OUT      errorclass                                  value for the new error class (integer)

#### C binding

```
int MPI_Add_error_class(int *errorclass)
```

#### Fortran 2008 binding

```
MPI_Add_error_class(errorclass, ierror)  
  INTEGER, INTENT(OUT) :: errorclass  
  INTEGER, OPTIONAL, INTENT(OUT) :: ierror
```

#### Fortran binding

```
MPI_ADD_ERROR_CLASS(ERRORCLASS, IERROR)  
  INTEGER ERRORCLASS, IERROR
```

Creates a new error class and returns the value for it.

*Rationale.* To avoid conflicts with existing error codes and classes, the value is set by the implementation and not by the user. (*End of rationale.*)

*Advice to implementors.* A high-quality implementation will return the value for a new `errorclass` in the same deterministic way on all processes. (*End of advice to implementors.*)

*Advice to users.* Since a call to `MPI_ADD_ERROR_CLASS` is local, the same `errorclass` may not be returned on all processes that make this call. Thus, it is not safe to assume that registering a new error on a set of processes at the same time will yield the same `errorclass` on all of the processes. However, if an implementation returns the new `errorclass` in a deterministic way, and they are always generated in the same order on the same set of processes (for example, all processes), then the value will be the same. However, even if a deterministic algorithm is used, the value can vary across processes. This can happen, for example, if different but overlapping groups of processes make a series of calls. As a result of these issues, getting the “same” error on multiple processes may not cause the same value of error code to be generated. (*End of advice to users.*)

The value of `MPI_ERR_LASTCODE` is a constant value and is not affected by new user-defined error codes and classes. Instead, a predefined attribute key `MPI_LASTUSED` is

1 associated with MPI\_COMM\_WORLD. The attribute value corresponding to this key is the  
 2 current maximum error class including the user-defined ones. This is a local value and may  
 3 be different on different processes. The value returned by this key is always greater than or  
 4 equal to MPI\_ERR\_LASTCODE.

5  
 6 *Advice to users.* The value returned by the key MPI\_LASTUSEDCLASS will not change  
 7 unless the user calls a function to explicitly add an error class/code. In a multi-  
 8 threaded environment, the user must take extra care in assuming this value has not  
 9 changed. Note that error codes and error classes are not necessarily dense. A user  
 10 may not assume that each error class below MPI\_LASTUSEDCLASS is valid. (*End of*  
 11 *advice to users.*)

12  
 13  
 14 MPI\_ADD\_ERROR\_CODE(errorclass, errorcode)

15  
 16 IN errorclass error class (integer)  
 17 OUT errorcode new error code to be associated with  
 18 errorclass (integer)  
 19

## 20 C binding

21 int MPI\_Add\_error\_code(int errorclass, int \*errorcode)

## 22 Fortran 2008 binding

23 MPI\_Add\_error\_code(errorclass, errorcode, ierror)  
 24 INTEGER, INTENT(IN) :: errorclass  
 25 INTEGER, INTENT(OUT) :: errorcode  
 26 INTEGER, OPTIONAL, INTENT(OUT) :: ierror

## 27 Fortran binding

28 MPI\_ADD\_ERROR\_CODE(ERRORCLASS, ERRORCODE, IERROR)  
 29 INTEGER ERRORCLASS, ERRORCODE, IERROR

30  
 31 Creates new error code associated with errorclass and returns its value in errorcode.

32  
 33  
 34 *Rationale.* To avoid conflicts with existing error codes and classes, the value of the  
 35 new error code is set by the implementation and not by the user. (*End of rationale.*)

36  
 37 *Advice to implementors.* A high-quality implementation will return the value for  
 38 a new errorcode in the same deterministic way on all processes. (*End of advice to*  
 39 *implementors.*)

40  
 41  
 42 MPI\_ADD\_ERROR\_STRING(errorcode, string)

43 IN errorcode error code or class (integer)  
 44 IN string text corresponding to errorcode (string)  
 45  
 46

## 47 C binding

48 int MPI\_Add\_error\_string(int errorcode, const char \*string)



**Fortran 2008 binding**

```

MPI_Add_error_string(errorcode, string, ierror)
    INTEGER, INTENT(IN) :: errorcode
    CHARACTER(LEN=*), INTENT(IN) :: string
    INTEGER, OPTIONAL, INTENT(OUT) :: ierror

```

**Fortran binding**

```

MPI_ADD_ERROR_STRING(ERRORCODE, STRING, IERROR)
    INTEGER ERRORCODE, IERROR
    CHARACTER*(*) STRING

```

Associates an error string with an error code or class. The string must be no more than `MPI_MAX_ERROR_STRING` characters long. The length of the string is as defined in the calling language. The length of the string does not include the null terminator in C. Trailing blanks will be stripped in Fortran. Calling `MPI_ADD_ERROR_STRING` for an `errorcode` that already has a string will replace the old string with the new string. It is erroneous to call `MPI_ADD_ERROR_STRING` for an error code or class with a value  $\leq$  `MPI_ERR_LASTCODE`.

If `MPI_ERROR_STRING` is called when no string has been set, it will return a empty string (all spaces in Fortran, "" in C).

Section 8.3 describes the methods for creating and associating error handlers with communicators, files, windows, and sessions.

```

MPI_COMM_CALL_ERRHANDLER(comm, errorcode)

```

IN	comm	communicator with error handler (handle)
IN	errorcode	error code (integer)

**C binding**

```

int MPI_Comm_call_errhandler(MPI_Comm comm, int errorcode)

```

**Fortran 2008 binding**

```

MPI_Comm_call_errhandler(comm, errorcode, ierror)
    TYPE(MPI_Comm), INTENT(IN) :: comm
    INTEGER, INTENT(IN) :: errorcode
    INTEGER, OPTIONAL, INTENT(OUT) :: ierror

```

**Fortran binding**

```

MPI_COMM_CALL_ERRHANDLER(COMM, ERRORCODE, IERROR)
    INTEGER COMM, ERRORCODE, IERROR

```

This function invokes the error handler assigned to the communicator with the error code supplied. This function returns `MPI_SUCCESS` in C and the same value in `IERROR` if the error handler was successfully called (assuming the process is not aborted and the error handler returns).

```

1 MPI_WIN_CALL_ERRHANDLER(win, errorcode)
2     IN      win                window with error handler (handle)
3
4     IN      errorcode          error code (integer)

```

**C binding**

```

7 int MPI_Win_call_errhandler(MPI_Win win, int errorcode)

```

**Fortran 2008 binding**

```

9 MPI_Win_call_errhandler(win, errorcode, ierror)
10     TYPE(MPI_Win), INTENT(IN) :: win
11     INTEGER, INTENT(IN) :: errorcode
12     INTEGER, OPTIONAL, INTENT(OUT) :: ierror

```

**Fortran binding**

```

14 MPI_WIN_CALL_ERRHANDLER(WIN, ERRORCODE, IERROR)
15     INTEGER WIN, ERRORCODE, IERROR

```

This function invokes the error handler assigned to the window with the error code supplied. This function returns `MPI_SUCCESS` in C and the same value in `IERROR` if the error handler was successfully called (assuming the process is not aborted and the error handler returns).

*Advice to users.* In contrast to communicators, the error handler `MPI_ERRORS_ARE_FATAL` is associated with a window when it is created. (*End of advice to users.*)

```

28 MPI_FILE_CALL_ERRHANDLER(fh, errorcode)
29     IN      fh                file with error handler (handle)
30
31     IN      errorcode          error code (integer)

```

**C binding**

```

34 int MPI_File_call_errhandler(MPI_File fh, int errorcode)

```

**Fortran 2008 binding**

```

36 MPI_File_call_errhandler(fh, errorcode, ierror)
37     TYPE(MPI_File), INTENT(IN) :: fh
38     INTEGER, INTENT(IN) :: errorcode
39     INTEGER, OPTIONAL, INTENT(OUT) :: ierror

```

**Fortran binding**

```

42 MPI_FILE_CALL_ERRHANDLER(FH, ERRORCODE, IERROR)
43     INTEGER FH, ERRORCODE, IERROR

```

This function invokes the error handler assigned to the file with the error code supplied. This function returns `MPI_SUCCESS` in C and the same value in `IERROR` if the error handler was successfully called (assuming the process is not aborted and the error handler returns).

*Advice to users.* The default error handler for files is MPI\_ERRORS\_RETURN. (*End of advice to users.*)

MPI\_SESSION\_CALL\_ERRHANDLER(session, errorcode)

IN session session with error handler (handle)

IN errorcode error code (integer)

### C binding

```
int MPI_Session_call_errhandler(MPI_Session session, int errorcode)
```

### Fortran 2008 binding

```
MPI_Session_call_errhandler(session, errorcode, ierror)
```

```
TYPE(MPI_Session), INTENT(IN) :: session
```

```
INTEGER, INTENT(IN) :: errorcode
```

```
INTEGER, OPTIONAL, INTENT(OUT) :: ierror
```

### Fortran binding

```
MPI_SESSION_CALL_ERRHANDLER(SESSION, ERRORCODE, IERROR)
```

```
INTEGER SESSION, ERRORCODE, IERROR
```

This function invokes the error handler assigned to the session with the error code supplied. This function returns MPI\_SUCCESS in C and the same value in IERROR if the error handler was successfully called (assuming the process is not aborted and the error handler returns).

*Advice to users.* Users are warned that handlers should not be called recursively with MPI\_COMM\_CALL\_ERRHANDLER, MPI\_FILE\_CALL\_ERRHANDLER, MPI\_WIN\_CALL\_ERRHANDLER, or MPI\_SESSION\_CALL\_ERRHANDLER. Doing this can create a situation where an infinite recursion is created. This can occur if MPI\_COMM\_CALL\_ERRHANDLER, MPI\_FILE\_CALL\_ERRHANDLER, MPI\_WIN\_CALL\_ERRHANDLER, or MPI\_SESSION\_CALL\_ERRHANDLER is called inside an error handler.

Error codes and classes are associated with a process. As a result, they may be used in any error handler. Error handlers should be prepared to deal with any error code they are given. Furthermore, it is good practice to only call an error handler with the appropriate error codes. For example, file errors would normally be sent to the file error handler. (*End of advice to users.*)

## 8.6 Timers and Synchronization

MPI defines a timer. A timer is specified even though it is not “message-passing,” because timing parallel programs is important in “performance debugging” and because existing timers (both in POSIX 1003.1-1988 and 1003.4D 14.1 and in Fortran 90) are either inconvenient or do not provide adequate access to high resolution timers. See also Section 2.6.4.

MPI\_WTIME()

**C binding**

```
double MPI_Wtime(void)
```

**Fortran 2008 binding**

```
DOUBLE PRECISION MPI_Wtime()
```

**Fortran binding**

```
DOUBLE PRECISION MPI_WTIME()
```

MPI\_WTIME returns a floating-point number of seconds, representing elapsed wall-clock time since some time in the past.

The “time in the past” is guaranteed not to change during the life of the process. The user is responsible for converting large numbers of seconds to other units if they are preferred.

This function is portable (it returns seconds, not “ticks”), it allows high-resolution, and carries no unnecessary baggage. One would use it like this:

```
{
  double starttime, endtime;
  starttime = MPI_Wtime();
  ... stuff to be timed ...
  endtime = MPI_Wtime();
  printf("That took %f seconds\n", endtime-starttime);
}
```

The times returned are local to the node that called them. There is no requirement that different nodes return “the same time.” (But see also the discussion of MPI\_WTIME\_IS\_GLOBAL in Section 8.1.2).

```
MPI_WTICK()
```

**C binding**

```
double MPI_Wtick(void)
```

**Fortran 2008 binding**

```
DOUBLE PRECISION MPI_Wtick()
```

**Fortran binding**

```
DOUBLE PRECISION MPI_WTICK()
```

MPI\_WTICK returns the resolution of MPI\_WTIME in seconds. That is, it returns, as a double precision value, the number of seconds between successive clock ticks. For example, if the clock is implemented by the hardware as a counter that is incremented every millisecond, the value returned by MPI\_WTICK should be  $(10^{-3})$ .

# Chapter 9

## The Info Object

Many of the routines in MPI take an argument `info`. `info` is an opaque object with a handle of type `MPI_Info` in C and Fortran with the `mpi_f08` module, and `INTEGER` in Fortran with the `mpi` module or the include file `mpif.h`. It stores an unordered set of (key,value) pairs (both key and value are strings). A key can have only one value. MPI reserves several keys and requires that if an implementation uses a reserved key, it must provide the specified functionality. An implementation is not required to support these keys and may support any others not reserved by MPI. Some info hints allow the MPI library to restrict its support for certain operations in order to improve performance or resource utilization. If an application provides such an info hint, it must be compatible with any changes in the behavior of the MPI library that are allowed by the info hint.

An implementation must support info objects as caches for arbitrary (key,value) pairs, regardless of whether it recognizes the key. Each function that takes hints in the form of an `MPI_Info` must be prepared to ignore any key it does not recognize. This description of info objects does not attempt to define how a particular function should react if it recognizes a key but not the associated value. `MPI_INFO_GET_NKEYS`, `MPI_INFO_GET_NTHKEY`, `MPI_INFO_GET_VALUELEN`, `MPI_INFO_GET`, and `MPI_INFO_GET_STRING` must retain all (key,value) pairs so that layered functionality can also use the Info object.

Keys have an implementation-defined maximum length of `MPI_MAX_INFO_KEY`, which is at least 32 and at most 255. Values have an implementation-defined maximum length of `MPI_MAX_INFO_VAL`. In Fortran, leading and trailing spaces are stripped from both. Returned values will never be larger than these maximum lengths. Both key and value are case sensitive.

*Rationale.* Keys have a maximum length because the set of known keys will always be finite and known to the implementation and because there is no reason for keys to be complex. The small maximum size allows applications to declare keys of size `MPI_MAX_INFO_KEY`. The limitation on value sizes is so that an implementation is not forced to deal with arbitrarily long strings. (*End of rationale.*)

*Advice to users.* `MPI_MAX_INFO_VAL` might be very large, so it might not be wise to declare a string of that size. (*End of advice to users.*)

When `info` is used as an argument to a nonblocking routine, it is parsed before that routine returns, so that it may be modified or freed immediately after return.

When the descriptions refer to a key or value as being a boolean, an integer, or a list, they mean the string representation of these types. An implementation may define its own

rules for how info value strings are converted to other types, but to ensure portability, every implementation must support the following representations. Valid values for a boolean must include the strings “true” and “false” (all lowercase). For integers, valid values must include string representations of decimal values of integers that are within the range of a standard integer type in the program. (However it is possible that not every integer is a valid value for a given key.) On positive numbers, + signs are optional. No space may appear between a + or – sign and the leading digit of a number. For comma separated lists, the string must contain valid elements separated by commas. Leading and trailing spaces are stripped automatically from the types of info values described above and for each element of a comma separated list. These rules apply to all info values of these types. Implementations are free to specify a different interpretation for values of other info keys.

#### MPI\_INFO\_CREATE(info)

OUT info info object created (handle)

#### C binding

```
int MPI_Info_create(MPI_Info *info)
```

#### Fortran 2008 binding

```
MPI_Info_create(info, ierror)
    TYPE(MPI_Info), INTENT(OUT) :: info
    INTEGER, OPTIONAL, INTENT(OUT) :: ierror
```

#### Fortran binding

```
MPI_INFO_CREATE(INFO, IERROR)
    INTEGER INFO, IERROR
```

MPI\_INFO\_CREATE creates a new info object. The newly created object contains no key/value pairs.

#### MPI\_INFO\_SET(info, key, value)

INOUT info info object (handle)  
 IN key key (string)  
 IN value value (string)

#### C binding

```
int MPI_Info_set(MPI_Info info, const char *key, const char *value)
```

#### Fortran 2008 binding

```
MPI_Info_set(info, key, value, ierror)
    TYPE(MPI_Info), INTENT(IN) :: info
    CHARACTER(LEN=*), INTENT(IN) :: key, value
    INTEGER, OPTIONAL, INTENT(OUT) :: ierror
```

#### Fortran binding

```
MPI_INFO_SET(INFO, KEY, VALUE, IERROR)
    INTEGER INFO, IERROR
```

CHARACTER\*(\*) KEY, VALUE

MPI\_INFO\_SET adds the (key,value) pair to info, and overrides the value if a value for the same key was previously set. key and value are null-terminated strings in C. In Fortran, leading and trailing spaces in key and value are stripped. If either key or value are larger than the allowed maximums, the errors MPI\_ERR\_INFO\_KEY or MPI\_ERR\_INFO\_VALUE are raised, respectively.

MPI\_INFO\_DELETE(info, key)

INOUT	info	info object (handle)
IN	key	key (string)

### C binding

```
int MPI_Info_delete(MPI_Info info, const char *key)
```

### Fortran 2008 binding

```
MPI_Info_delete(info, key, ierror)
  TYPE(MPI_Info), INTENT(IN) :: info
  CHARACTER(LEN=*), INTENT(IN) :: key
  INTEGER, OPTIONAL, INTENT(OUT) :: ierror
```

### Fortran binding

```
MPI_INFO_DELETE(INFO, KEY, IERROR)
  INTEGER INFO, IERROR
  CHARACTER*(*) KEY
```

MPI\_INFO\_DELETE deletes a (key,value) pair from info. If key is not defined in info, the call raises an error of class MPI\_ERR\_INFO\_NOKEY.

MPI\_INFO\_GET(info, key, valuelen, value, flag)

IN	info	info object (handle)
IN	key	key (string)
IN	valuelen	length of value arg (integer)
OUT	value	value (string)
OUT	flag	true if key defined, false if not (boolean)

### C binding

```
int MPI_Info_get(MPI_Info info, const char *key, int valuelen, char *value,
                int *flag)
```

### Fortran 2008 binding

```
MPI_Info_get(info, key, valuelen, value, flag, ierror)
  TYPE(MPI_Info), INTENT(IN) :: info
  CHARACTER(LEN=*), INTENT(IN) :: key
  INTEGER, INTENT(IN) :: valuelen
  CHARACTER(LEN=valuelen), INTENT(OUT) :: value
```

```

1     LOGICAL, INTENT(OUT) :: flag
2     INTEGER, OPTIONAL, INTENT(OUT) :: ierror

```

### Fortran binding

```

4 MPI_INFO_GET(INFO, KEY, VALUELEN, VALUE, FLAG, IERROR)
5     INTEGER INFO, VALUELEN, IERROR
6     CHARACTER*(*) KEY, VALUE
7     LOGICAL FLAG

```

This function retrieves the value associated with key in a previous call to MPI\_INFO\_SET. If such a key exists, it sets flag to true and returns the value in value, otherwise it sets flag to false and leaves value unchanged. valuelen is the number of characters available in value. If it is less than the actual size of the value, the value is truncated. In C, valuelen should be one less than the amount of allocated space to allow for the null terminator.

If key is larger than MPI\_MAX\_INFO\_KEY, the call is erroneous.

```

18 MPI_INFO_GET_VALUELEN(info, key, valuelen, flag)

```

19	IN	info	info object (handle)
20	IN	key	key (string)
21	OUT	valuelen	length of value arg (integer)
22	OUT	flag	true if key defined, false if not (boolean)

### C binding

```

26 int MPI_Info_get_valuelen(MPI_Info info, const char *key, int *valuelen,
27     int *flag)

```

### Fortran 2008 binding

```

30 MPI_Info_get_valuelen(info, key, valuelen, flag, ierror)
31     TYPE(MPI_Info), INTENT(IN) :: info
32     CHARACTER(LEN=*), INTENT(IN) :: key
33     INTEGER, INTENT(OUT) :: valuelen
34     LOGICAL, INTENT(OUT) :: flag
35     INTEGER, OPTIONAL, INTENT(OUT) :: ierror

```

### Fortran binding

```

37 MPI_INFO_GET_VALUELEN(INFO, KEY, VALUELEN, FLAG, IERROR)
38     INTEGER INFO, VALUELEN, IERROR
39     CHARACTER*(*) KEY
40     LOGICAL FLAG

```

Retrieves the length of the value associated with key. If key is defined, valuelen is set to the length of its associated value and flag is set to true. If key is not defined, valuelen is not touched and flag is set to false. The length returned in C does not include the end-of-string character.

If key is larger than MPI\_MAX\_INFO\_KEY, the call is erroneous.



MPI_INFO_GET_STRING(info, key, buflen, value, flag)			1
IN	info	info object (handle)	2
IN	key	key (string)	3
INOUT	buflen	length of buffer (integer)	4
OUT	value	value (string)	5
OUT	flag	true if key defined, false if not (boolean)	6
			7
			8
			9

### C binding

```
int MPI_Info_get_string(MPI_Info info, const char *key, int *buflen,
                      char *value, int *flag)
```

### Fortran 2008 binding

```
MPI_Info_get_string(info, key, buflen, value, flag, ierror)
  TYPE(MPI_Info), INTENT(IN) :: info
  CHARACTER(LEN=*), INTENT(IN) :: key
  INTEGER, INTENT(INOUT) :: buflen
  CHARACTER(LEN=*), INTENT(OUT) :: value
  LOGICAL, INTENT(OUT) :: flag
  INTEGER, OPTIONAL, INTENT(OUT) :: ierror
```

### Fortran binding

```
MPI_INFO_GET_STRING(INFO, KEY, BUFLen, VALUE, FLAG, IERROR)
  INTEGER INFO, BUFLen, IERROR
  CHARACTER*(*) KEY, VALUE
  LOGICAL FLAG
```

This function retrieves the value associated with `key` in a previous call to `MPI_INFO_SET`. If such a key exists, it sets `flag` to true and returns the value in `value`, otherwise it sets `flag` to false and leaves `value` unchanged. `buflen` on input is the size of the provided buffer, for the output of `buflen` it is the size of the buffer needed to store the value string. If the `buflen` passed into the function is less than the actual size needed to store the value string (including null terminator in C), the value is truncated. On return, the value of `buflen` will be set to the required buffer size to hold the value string. If `buflen` is set to 0, `value` is not changed. In C, `buflen` includes the required space for the null terminator. In C, this function returns a null terminated string in all cases where the `buflen` input value is greater than 0.

If `key` is larger than `MPI_MAX_INFO_KEY`, the call is erroneous.

*Advice to users.* The `MPI_INFO_GET_STRING` function can be used to obtain the size of the required buffer for a value string by setting the `buflen` to 0. The returned `buflen` can then be used to allocate memory before calling `MPI_INFO_GET_STRING` again to obtain the value string. (*End of advice to users.*)

1 MPI\_INFO\_GET\_NKEYS(info, nkeys)

2     IN        info                    info object (handle)

3     OUT       nkeys                  number of defined keys (integer)

5  
6 **C binding**

7 int MPI\_Info\_get\_nkeys(MPI\_Info info, int \*nkeys)

8  
9 **Fortran 2008 binding**

10 MPI\_Info\_get\_nkeys(info, nkeys, ierror)

11     TYPE(MPI\_Info), INTENT(IN) :: info

12     INTEGER, INTENT(OUT) :: nkeys

13     INTEGER, OPTIONAL, INTENT(OUT) :: ierror

14 **Fortran binding**

15 MPI\_INFO\_GET\_NKEYS(INFO, NKEYS, IERROR)

16     INTEGER INFO, NKEYS, IERROR

17     MPI\_INFO\_GET\_NKEYS returns the number of currently defined keys in info.

19  
20 MPI\_INFO\_GET\_NTHKEY(info, n, key)

21     IN        info                    info object (handle)

22     IN        n                      key number (integer)

23     OUT       key                    key (string)

24  
25  
26 **C binding**

27 int MPI\_Info\_get\_nthkey(MPI\_Info info, int n, char \*key)

28  
29 **Fortran 2008 binding**

30 MPI\_Info\_get\_nthkey(info, n, key, ierror)

31     TYPE(MPI\_Info), INTENT(IN) :: info

32     INTEGER, INTENT(IN) :: n

33     CHARACTER(LEN=\*), INTENT(OUT) :: key

34     INTEGER, OPTIONAL, INTENT(OUT) :: ierror

35  
36 **Fortran binding**

37 MPI\_INFO\_GET\_NTHKEY(INFO, N, KEY, IERROR)

38     INTEGER INFO, N, IERROR

39     CHARACTER\*(\*) KEY

40     This function returns the *n*th defined key in *info*. Keys are numbered  $0 \dots N - 1$  where  
41 *N* is the value returned by MPI\_INFO\_GET\_NKEYS. All keys between 0 and  $N - 1$  are  
42 guaranteed to be defined. The number of a given key does not change as long as *info* is not  
43 modified with MPI\_INFO\_SET or MPI\_INFO\_DELETE.

MPI_INFO_DUP(info, newinfo)			1
IN	info	info object (handle)	2
			3
OUT	newinfo	info object (handle)	4
			5

**C binding**

```
int MPI_Info_dup(MPI_Info info, MPI_Info *newinfo)
```

**Fortran 2008 binding**

```
MPI_Info_dup(info, newinfo, ierror)
  TYPE(MPI_Info), INTENT(IN) :: info
  TYPE(MPI_Info), INTENT(OUT) :: newinfo
  INTEGER, OPTIONAL, INTENT(OUT) :: ierror
```

**Fortran binding**

```
MPI_INFO_DUP(INFO, NEWINFO, IERROR)
  INTEGER INFO, NEWINFO, IERROR
```

MPI\_INFO\_DUP duplicates an existing info object, creating a new object, with the same (key,value) pairs and the same ordering of keys.

```
MPI_INFO_FREE(info)
```

INOUT	info	info object (handle)
-------	------	----------------------

**C binding**

```
int MPI_Info_free(MPI_Info *info)
```

**Fortran 2008 binding**

```
MPI_Info_free(info, ierror)
  TYPE(MPI_Info), INTENT(INOUT) :: info
  INTEGER, OPTIONAL, INTENT(OUT) :: ierror
```

**Fortran binding**

```
MPI_INFO_FREE(INFO, IERROR)
  INTEGER INFO, IERROR
```

This function frees info and sets it to MPI\_INFO\_NULL.

The value of an info argument is interpreted each time the info is passed to a routine. Changes to an info after return from a routine do not affect that interpretation.

1  
2  
3  
4  
5  
6  
7  
8  
9  
10  
11  
12  
13  
14  
15  
16  
17  
18  
19  
20  
21  
22  
23  
24  
25  
26  
27  
28  
29  
30  
31  
32  
33  
34  
35  
36  
37  
38  
39  
40  
41  
42  
43  
44  
45  
46  
47  
48

DRAFT

1  
2  
3  
4  
5  
6  
7  
8  
9  
10  
11  
12  
13  
14  
15  
16  
17  
18  
19  
20  
21  
22  
23  
24  
25  
26  
27  
28  
29  
30  
31  
32  
33  
34  
35  
36  
37  
38  
39  
40  
41  
42  
43  
44  
45  
46  
47  
48

## Chapter 10

# Process Initialization, Creation, and Management

### 10.1 Introduction

MPI is primarily concerned with communication rather than process or resource management. However, it is necessary to address these issues to some degree in order to define a useful framework for communication. This chapter presents a set of MPI interfaces that allows for several approaches to MPI initialization and process management while placing minimal restrictions on the execution environment.

One goal of MPI is to achieve *source code portability*. By this we mean that a program written using MPI and complying with the relevant language standards is portable as written, and must not require any source code changes when moved from one system to another. This explicitly does *not* say anything about how an MPI program is started or launched from the command line, nor what the user must do to set up the environment in which an MPI program will run. However, an implementation may require some setup or initialization procedure to be performed before the complete set of MPI routines may be called.

To this end, MPI presents two models for **MPI process initialization**. In the World Model, an initial set of processes is created that are related by their membership in a common MPI\_COMM\_WORLD (see Section 10.2) communicator. In the Sessions Model (Section 10.3), an initial set of processes is also created, but the application must explicitly manage the creation of MPI groups, and hence MPI communicators. MPI\_COMM\_WORLD is only valid for use as a communicator in the World Model, i.e., after a successful call to MPI\_INIT or MPI\_INIT\_THREAD and before a call to MPI\_FINALIZE. An application can employ both of these Process Models concurrently. In multi-component MPI applications, for example, a component such as a library can make use of the Sessions Model to instantiate MPI resources without impacting the rest of the application.

Both of these models also support the *Dynamic Process Model* (see Section 10.7), which provides for the creation and management of additional processes after an MPI application has been started. A major impetus for the *Dynamic Process Model* comes from the PVM [25] research effort. This work has provided a wealth of experience with process management and resource control that illustrates their benefits and potential pitfalls.

In developing the *Dynamic Process Model*, the MPI Forum decided not to address resource control because it was not able to design a portable interface that would be ap-

1 appropriate for the broad spectrum of existing and potential resource and process controllers.  
 2 Resource control can encompass a wide range of abilities, including adding and deleting  
 3 nodes from a virtual parallel machine, reserving and scheduling resources, managing com-  
 4 pute partitions of an MPP, and returning information about available resources. MPI as-  
 5 sumes that resource control is provided externally — probably by computer vendors, in the  
 6 case of tightly coupled systems, or by a third party software package when the environment  
 7 is a cluster of workstations.

8 The reasons for including process management in MPI are both technical and practical.  
 9 Important classes of message-passing applications require process control. These include  
 10 task farms, serial applications with parallel modules, and problems that require a run-time  
 11 assessment of the number and type of processes that should be started. On the practical  
 12 side, users of workstation clusters who are migrating from PVM to MPI may be accustomed  
 13 to using PVM’s capabilities for process and resource management. The lack of these features  
 14 would be a practical stumbling block to migration.

15 The following goals are central to the design of MPI process management:  
 16

- 17 • The MPI process model must apply to the vast majority of current parallel envi-  
 18 ronments. These include everything from tightly integrated MPPs to heterogeneous  
 19 networks of workstations.
- 20 • MPI must not take over operating system responsibilities. It should instead provide a  
 21 clean interface between an application and system software.
- 22 • MPI must guarantee communication determinism in the presense of dynamic processes,  
 23 i.e., dynamic process management must not introduce unavoidable race conditions.
- 24 • MPI must not contain features that compromise performance.

25  
 26  
 27  
 28 The *Dynamic Process Model* addresses these issues in two ways. First, MPI remains  
 29 primarily a communication library. It does not manage the parallel environment in which  
 30 a parallel program executes, though it provides a minimal interface between an application  
 31 and external resource and process managers.

32 Second, MPI maintains a consistent concept of a communicator, regardless of how its  
 33 members came into existence. A communicator is never changed once created, and it is  
 34 always created using deterministic collective operations.  
 35

## 36 10.2 The World Model

### 37 10.2.1 Starting MPI Processes

38 When using the World Model, MPI is initialized by calling either `MPI_INIT` or  
 39 `MPI_INIT_THREAD`.  
 40

41  
 42  
 43 `MPI_INIT()`  
 44

45 **C binding**

46 `int MPI_Init(int *argc, char ***argv)`  
 47

48 **Fortran 2008 binding**

```
MPI_Init(ierr)
    INTEGER, OPTIONAL, INTENT(OUT) :: ierr
```

**Fortran binding**

```
MPI_INIT(IERROR)
    INTEGER IERROR
```

In the World Model, an MPI program must contain exactly one call to an MPI initialization routine: `MPI_INIT` or `MPI_INIT_THREAD`. `MPI_COMM_WORLD` and `MPI_COMM_SELF` are not valid for use as communicators prior to invocation of `MPI_INIT` or `MPI_INIT_THREAD`. Subsequent calls to either of these initialization routines are erroneous. A subset of MPI functions may be invoked before MPI initialization routines are called. See Section 10.4. `MPI_INIT` accepts the `argc` and `argv` that are provided by the arguments to `main` or `NULL`:

```
int main(int argc, char *argv[])
{
    MPI_Init(&argc, &argv);

    /* parse arguments */
    /* main program */

    MPI_Finalize(); /* see below */
    return 0;
}
```

The Fortran version takes only `IERROR`.

Conforming implementations of MPI are required to allow applications to pass `NULL` for both the `argc` and `argv` arguments of `main` in C.

Failures may disrupt the execution of the program before or during MPI initialization. A high-quality implementation shall not deadlock during MPI initialization, even in the presence of failures. Except for functions with the `MPI_T_` prefix, failures in MPI operations prior to or during MPI initialization are reported by invoking the initial error handler. Users can use the `mpi_initial_errhandler` info key during the launch of MPI processes (e.g., `MPI_COMM_SPAWN / MPI_COMM_SPAWN_MULTIPLE`, or `mpiexec`) to set a non-fatal initial error handler before MPI initialization. When the initial error handler is set to `MPI_ERRORS_ABORT`, raising an error before or during initialization aborts the local MPI process (i.e., it is similar to calling `MPI_ABORT` on `MPI_COMM_SELF`). An implementation may not always be capable of determining, before MPI initialization, what constitutes the local MPI process, or the set of connected processes. In this case, errors before initialization may cause a different set of MPI processes to abort than specified. While MPI initialization, the initial error handler is associated with `MPI_COMM_WORLD`, `MPI_COMM_SELF`, and the communicator returned by `MPI_COMM_GET_PARENT` (if any).

*Advice to implementors.* Some failures may leave MPI in an undefined state, or raise an error before the error handling capabilities are fully operational, in which cases the implementation may be incapable of providing the desired error handling behavior. Of note, in some implementations, the notion of an MPI process is not clearly established in the early stages of MPI initialization (for example, when the implementation considers threads that called `MPI_INIT` as independent MPI processes); in this

1 case, before MPI is initialized, the MPI\_ERRORS\_ABORT error handler may abort what  
2 would have become multiple MPI processes.

3 When a failure occurs during MPI initialization, the implementation may decide to  
4 return MPI\_SUCCESS from the MPI initialization function instead of raising an error.  
5 It is recommended that an implementation masks an initialization error only when it  
6 expects that later MPI calls will result in well-specified behavior (i.e., barring addi-  
7 tional failures, either the outcome of any call will be correct, or the call will raise an  
8 appropriate error). For example, it may be difficult for an implementation to avoid  
9 unspecified behavior when the group of MPI\_COMM\_WORLD does not contain the same  
10 set of MPI processes at all members of the communicator, or if the communicator re-  
11 turned from MPI\_COMM\_GET\_PARENT was not initialized correctly. (*End of advice*  
12 *to implementors.*)  
13

14 After MPI is initialized, the application can access information about the execution  
15 environment by querying the predefined info object MPI\_INFO\_ENV. The following keys are  
16 predefined for this object, corresponding to the arguments of MPI\_COMM\_SPAWN or of  
17 mpiexec:  
18

19 `command` Name of program executed.

20 `argv` Space separated arguments to command.

21 `maxprocs` Maximum number of MPI processes to start.

22 `mpi_initial_errhandler` Name of the initial errhandler.

23 `soft` Allowed values for number of processors.

24 `host` Hostname.

25 `arch` Architecture name.

26 `wdir` Working directory of the MPI process.

27 `file` Value is the name of a file in which additional information is specified.

28 `thread_level` Requested level of thread support, if requested before the program started exe-  
29 cution.  
30

31 Note that all values are strings. Thus, the maximum number of processes is represented  
32 by a string such as "1024" and the requested level is represented by a string such as  
33 "MPI\_THREAD\_SINGLE".  
34

35 The info object MPI\_INFO\_ENV need not contain a (key,value) pair for each of these  
36 predefined keys; the set of (key,value) pairs provided is implementation-dependent. Imple-  
37 mentations may provide additional, implementation specific, (key,value) pairs.  
38

39 In cases where the MPI processes were started with MPI\_COMM\_SPAWN\_MULTIPLE  
40 or, equivalently, with a startup mechanism that supports multiple process specifications,  
41 then the values stored in the info object MPI\_INFO\_ENV at a process are those values that  
42 affect the local MPI process.  
43

44 **Example 10.1** If MPI is started with a call to  
45  
46  
47  
48



```
mpiexec -n 5 -arch sun ocean : -n 10 -arch rs6000 atmos
```

Then the first 5 processes will have in their `MPI_INFO_ENV` object the pairs (command, ocean), (maxprocs, 5), and (arch, sun). The next 10 processes will have in `MPI_INFO_ENV` (command, atmos), (maxprocs, 10), and (arch, rs6000)

*Advice to users.* The values passed in `MPI_INFO_ENV` are the values of the arguments passed to the mechanism that started the MPI execution — not the actual value provided. Thus, the value associated with `maxprocs` is the number of MPI processes requested; it can be larger than the actual number of processes obtained, if the soft option was used. (*End of advice to users.*)

*Advice to implementors.* High-quality implementations will provide a (key,value) pair for each parameter that can be passed to the command that starts an MPI program. (*End of advice to implementors.*)

The following function may be used to initialize MPI, and to initialize the MPI thread environment, instead of `MPI_INIT`.

`MPI_INIT_THREAD`(required, provided)

IN	required	desired level of thread support (integer)
OUT	provided	provided level of thread support (integer)

### C binding

```
int MPI_Init_thread(int *argc, char ***argv, int required, int *provided)
```

### Fortran 2008 binding

```
MPI_Init_thread(required, provided, ierror)
  INTEGER, INTENT(IN) :: required
  INTEGER, INTENT(OUT) :: provided
  INTEGER, OPTIONAL, INTENT(OUT) :: ierror
```

### Fortran binding

```
MPI_INIT_THREAD(REQUIRED, PROVIDED, IERROR)
  INTEGER REQUIRED, PROVIDED, IERROR
```

*Advice to users.* In C, the passing of `argc` and `argv` is optional, as with `MPI_INIT` as discussed in Section 10.2.1. In C, null pointers may be passed in their place. (*End of advice to users.*)

This call initializes MPI in the same way that a call to `MPI_INIT` would. In addition, it initializes the thread environment. The argument `required` is used to specify the desired level of thread support. The possible values are listed in increasing order of thread support.

**MPI\_THREAD\_SINGLE** Only one thread will execute.

**MPI\_THREAD\_FUNNELED** The process may be multi-threaded, but the application must ensure that only the main thread makes MPI calls (for the definition of main thread, see `MPI_IS_THREAD_MAIN` on page 421).

1 **MPI\_THREAD\_SERIALIZED** The process may be multi-threaded, and multiple threads may  
 2 make MPI calls, but only one at a time: MPI calls are not made concurrently from  
 3 two distinct threads (all MPI calls are “serialized”).  
 4

5 **MPI\_THREAD\_MULTIPLE** Multiple threads may call MPI, with no restrictions.

6 These values are monotonic; i.e., `MPI_THREAD_SINGLE < MPI_THREAD_FUNNELED <`  
 7 `MPI_THREAD_SERIALIZED < MPI_THREAD_MULTIPLE`.

8 Different processes in `MPI_COMM_WORLD` may require different levels of thread sup-  
 9 port.

10 The call returns in provided information about the actual level of thread support that  
 11 will be provided by MPI. It can be one of the four values listed above.

12 The level(s) of thread support that can be provided by `MPI_INIT_THREAD` will depend  
 13 on the implementation, and may depend on information provided by the user before the  
 14 program started to execute (e.g., with arguments to `mpiexec`). If possible, the call will  
 15 return `provided = required`. Failing this, the call will return the least supported level such  
 16 that `provided > required` (thus providing a stronger level of support than required by the  
 17 user). Finally, if the user requirement cannot be satisfied, then the call will return in  
 18 provided the highest supported level.

19 A **thread compliant** MPI implementation will be able to return `provided`  
 20 `= MPI_THREAD_MULTIPLE`. Such an implementation may always return `provided`  
 21 `= MPI_THREAD_MULTIPLE`, irrespective of the value of `required`.

22 An MPI library that is not thread compliant must always return `provided =`  
 23 `MPI_THREAD_SINGLE`, even if `MPI_INIT_THREAD` is called on a multithreaded process.  
 24 The library should also return correct values for the MPI calls that can be executed before  
 25 initialization, even if multiple threads have been spawned.  
 26

27 *Rationale.* Such code is erroneous, but if the MPI initialization is performed by a  
 28 library, the error cannot be detected until `MPI_INIT_THREAD` is called. The require-  
 29 ments in the previous paragraph ensure that the error can be properly detected. (*End*  
 30 *of rationale.*)  
 31

32 A call to `MPI_INIT` has the same effect as a call to `MPI_INIT_THREAD` with a `required`  
 33 `= MPI_THREAD_SINGLE`.

34 Vendors may provide (implementation dependent) means to specify the level(s) of  
 35 thread support available when the MPI program is started, e.g., with arguments to `mpiexec`.  
 36 This will affect the outcome of calls to `MPI_INIT` and `MPI_INIT_THREAD`. Suppose, for  
 37 example, that an MPI program has been started so that only `MPI_THREAD_MULTIPLE` is  
 38 available. Then `MPI_INIT_THREAD` will return `provided = MPI_THREAD_MULTIPLE`, irre-  
 39 spective of the value of `required`; a call to `MPI_INIT` will also initialize the MPI thread support  
 40 level to `MPI_THREAD_MULTIPLE`. Suppose, instead, that an MPI program has been started  
 41 so that all four levels of thread support are available. Then, a call to `MPI_INIT_THREAD`  
 42 will return `provided = required`; alternatively, a call to `MPI_INIT` will initialize the MPI  
 43 thread support level to `MPI_THREAD_SINGLE`.  
 44

45 *Rationale.* Various optimizations are possible when MPI code is executed single-  
 46 threaded, or is executed on multiple threads, but not concurrently: mutual exclusion  
 47 code may be omitted. Furthermore, if only one thread executes, then the MPI library  
 48 can use library functions that are not thread safe, without risking conflicts with user

threads. Also, the model of one communication thread, multiple computation threads fits many applications well, e.g., if the process code is a sequential Fortran/C program with MPI calls that has been parallelized by a compiler for execution on an SMP node, in a cluster of SMPs, then the process computation is multi-threaded, but MPI calls will likely execute on a single thread.

The design accommodates a static specification of the thread support level, for environments that require static binding of libraries, and for compatibility for current multi-threaded MPI codes. (*End of rationale.*)

*Advice to implementors.* If `provided` is not `MPI_THREAD_SINGLE` then the MPI library should not invoke C or Fortran library calls that are not thread safe, e.g., in an environment where `malloc` is not thread safe, then `malloc` should not be used by the MPI library.

Some implementors may want to use different MPI libraries for different levels of thread support. They can do so using dynamic linking and selecting which library will be linked when `MPI_INIT_THREAD` is invoked. If this is not possible, then optimizations for lower levels of thread support will occur only when the level of thread support required is specified at link time.

Note that `required` need not be the same value on all processes of `MPI_COMM_WORLD`. (*End of advice to implementors.*)

The following function can be used to query the current level of thread support.

`MPI_QUERY_THREAD(provided)`

OUT      `provided`                      provided level of thread support (integer)

#### C binding

`int MPI_Query_thread(int *provided)`

#### Fortran 2008 binding

`MPI_Query_thread(provided, ierror)`

INTEGER, INTENT(OUT) :: `provided`

INTEGER, OPTIONAL, INTENT(OUT) :: `ierror`

#### Fortran binding

`MPI_QUERY_THREAD(PROVIDED, IERROR)`

INTEGER `PROVIDED`, `IERROR`

The call returns in `provided` the current level of thread support, which will be the value returned in `provided` by `MPI_INIT_THREAD`, if MPI was initialized by a call to `MPI_INIT_THREAD()`. This function is only applicable when using the World Model to initialize MPI. In the case of applications using both the World Model and the Sessions Model, this function only returns the thread support level returned in `provided` by `MPI_INIT_THREAD`.

1 MPI\_IS\_THREAD\_MAIN(flag)

2     OUT     flag                             true if calling thread is main thread, false otherwise  
3   (logical)  
4

5  
6 **C binding**

7 int MPI\_Is\_thread\_main(int \*flag)

8 **Fortran 2008 binding**

9 MPI\_Is\_thread\_main(flag, ierror)  
10     LOGICAL, INTENT(OUT) :: flag  
11     INTEGER, OPTIONAL, INTENT(OUT) :: ierror  
12

13 **Fortran binding**

14 MPI\_IS\_THREAD\_MAIN(FLAG, IERROR)  
15     LOGICAL FLAG  
16     INTEGER IERROR  
17

18     This function can be called by a thread to determine if it is the main thread (the thread  
19     that called MPI\_INIT or MPI\_INIT\_THREAD). This function is only applicable when using  
20     the World Model to initialize MPI. In the case of applications using both the World Model  
21     and the Sessions Model, this function only returns the thread support level returned in  
22     provided by MPI\_INIT\_THREAD.

23     All routines listed in this section must be supported by all MPI implementations.

24     *Rationale.* MPI libraries are required to provide these calls even if they do not  
25     support threads, so that portable code that contains invocations to these functions  
26     can link correctly. MPI\_INIT continues to be supported so as to provide compatibility  
27     with current MPI codes. (*End of rationale.*)

28     *Advice to users.* It is possible to spawn threads before MPI is initialized, but  
29     MPI\_COMM\_WORLD and MPI\_COMM\_SELF cannot be used until the World Model is  
30     active, *i.e.* until MPI\_INIT\_THREAD is invoked by one thread (which, thereby, be-  
31     comes the main thread). In particular, it is possible to enter the MPI execution with  
32     a multi-threaded process.  
33

34     In the World Model, the level of thread support provided is a global property of the  
35     MPI process that can be specified only once, when MPI is initialized on that process (or  
36     before). Portable third party libraries have to be written so as to accommodate any  
37     provided level of thread support. Otherwise, their usage will be restricted to specific  
38     level(s) of thread support. If such a library can run only with specific level(s) of thread  
39     support, *e.g.*, only with MPI\_THREAD\_MULTIPLE, then MPI\_QUERY\_THREAD can be  
40     used to check whether the user initialized MPI to the correct level of thread support  
41     and, if not, raise an exception. (*End of advice to users.*)  
42

43 **10.2.2 Finalizing MPI**

44  
45  
46 MPI\_FINALIZE()  
47

48 **C binding**

```
int MPI_Finalize(void)
```

### Fortran 2008 binding

```
MPI_Finalize(ierr)
```

```
    INTEGER, OPTIONAL, INTENT(OUT) :: ierror
```

### Fortran binding

```
MPI_FINALIZE(IERROR)
```

```
    INTEGER IERROR
```

This routine cleans up all MPI state associated with the World Model. If an MPI program terminates normally (i.e., not due to a call to `MPI_ABORT` or an unrecoverable error) then each process must call `MPI_FINALIZE` before it exits.

Before an MPI process invokes `MPI_FINALIZE`, the process must perform all MPI calls needed to complete its involvement in MPI communications associated with the World Model. It must locally complete all MPI operations that it initiated and must execute matching calls needed to complete MPI communications initiated by other processes. For example, if the process executed a nonblocking send, it must eventually call `MPI_WAIT`, `MPI_TEST`, `MPI_REQUEST_FREE`, or any derived function; if the process is the target of a send, then it must post the matching receive; if it is part of a group executing a collective operation, then it must have completed its participation in the operation.

The call to `MPI_FINALIZE` does not clean up MPI state associated with objects created using `MPI_SESSION_INIT` and other Sessions Model methods, nor objects created using the communicator returned by `MPI_COMM_GET_PARENT`. See Sections 10.3 and 10.8.

The call to `MPI_FINALIZE` does not free objects created by MPI calls; these objects are freed using `MPI_XXX_FREE` calls.

`MPI_FINALIZE` is collective over all connected processes. If no processes were spawned, accepted or connected then this means over `MPI_COMM_WORLD`; otherwise it is collective over the union of all processes that have been and continue to be connected, as explained in Section 10.10.4.

The following examples illustrate these rules.

**Example 10.2** The following code is correct

<pre>Process 0 ----- MPI_Init(); MPI_Send(dest=1); MPI_Finalize();</pre>	<pre>Process 1 ----- MPI_Init(); MPI_Recv(src=0); MPI_Finalize();</pre>
--	---

**Example 10.3** Without a matching receive, the program is erroneous

<pre>Process 0 ----- MPI_Init(); MPI_Send (dest=1); MPI_Finalize();</pre>	<pre>Process 1 ----- MPI_Init(); MPI_Finalize();</pre>
---	--

**Example 10.4** This program is correct: Process 0 calls `MPI_Finalize` after it has executed the MPI calls that complete the send operation. Likewise, process 1 executes the MPI call that completes the matching receive operation before it calls `MPI_Finalize`.

```

5      Process 0                                Process 1
6      -----                                -----
7      MPI_Init();                              MPI_Init();
8      MPI_Isend(dest=1);                       MPI_Recv(src=0);
9      MPI_Request_free();                     MPI_Finalize();
10     MPI_Finalize();                          exit();
11     exit();

```

**Example 10.5** This program is correct. The attached buffer is a resource allocated by the user, not by MPI; it is available to the user after MPI is finalized.

```

16     Process 0                                Process 1
17     -----                                -----
18     MPI_Init();                              MPI_Init();
19     buffer = malloc(1000000);                MPI_Recv(src=0);
20     MPI_Buffer_attach();                    MPI_Finalize();
21     MPI_Send(dest=1));                      exit();
22     MPI_Finalize();
23     free(buffer);
24     exit();

```

**Example 10.6** This program is correct. The cancel operation must succeed, since the send cannot complete normally. The wait operation, after the call to `MPI_Cancel`, is local — no matching MPI call is required on process 1. Cancelling a send request by calling `MPI_CANCEL` is deprecated.

```

31     Process 0                                Process 1
32     -----                                -----
33     MPI_Issend(dest=1);                      MPI_Finalize();
34     MPI_Cancel();
35     MPI_Wait();
36     MPI_Finalize();

```

*Advice to implementors.* Even though a process has executed all MPI calls needed to complete the communications it is involved with, such communication may not yet be completed from the viewpoint of the underlying MPI system. For example, a blocking send may have returned, even though the data is still buffered at the sender in an MPI buffer; an MPI process may receive a cancel request for a message it has completed receiving. The MPI implementation must ensure that a process has completed any involvement in MPI communication before `MPI_FINALIZE` returns. Thus, if a process exits after the call to `MPI_FINALIZE`, this will not cause an ongoing communication to fail. The MPI implementation should also complete freeing all objects marked for deletion by MPI calls that freed them. (*End of advice to implementors.*)

Failures may disrupt MPI operations during and after MPI finalization. A high quality implementation shall not deadlock in MPI finalization, even in the presence of failures. The normal rules for MPI error handling continue to apply. After `MPI_COMM_SELF` has been “freed” (see Section 10.2.4), errors that are not associated with a communicator, window, or file raise the initial error handler (set during the launch operation, see 10.8.4).

Although it is not required that all processes return from `MPI_FINALIZE`, it is required that, when it has not failed or aborted, at least the MPI process that was assigned rank 0 in `MPI_COMM_WORLD` returns, so that users can know that the MPI portion of the computation is over. In addition, in a POSIX environment, users may desire to supply an exit code for each process that returns from `MPI_FINALIZE`.

Note that a failure may terminate the MPI process that was assigned rank 0 in `MPI_COMM_WORLD`, in which case it is possible that no MPI process returns from `MPI_FINALIZE`.

*Advice to users.* Applications that handle errors are encouraged to implement all rank-specific code before the call to `MPI_FINALIZE`. In Example 10.7 below, the process with rank 0 in `MPI_COMM_WORLD` may have been terminated before, during, or after the call to `MPI_FINALIZE`, possibly leading to the code after `MPI_FINALIZE` never being executed. (*End of advice to users.*)

**Example 10.7** The following illustrates the use of requiring that at least one process return and that it be known that process 0 is one of the processes that return. One wants code like the following to work no matter how many processes return.

```
...
MPI_Comm_rank(MPI_COMM_WORLD, &myrank);
...
MPI_Finalize();
if (myrank == 0) {
    resultfile = fopen("outfile", "w");
    dump_results(resultfile);
    fclose(resultfile);
}
exit(0);
```

### 10.2.3 Determining Whether MPI Has Been Initialized When Using the World Model

One of the goals of MPI is to allow for layered libraries. For a library using the World Model, it needs to know if MPI has been initialized using `MPI_INIT` or `MPI_INIT_THREAD`. In MPI the function `MPI_INITIALIZED` is provided to tell if MPI had been initialized using the World Model. In the World Model, once MPI has been finalized it cannot be restarted. A library needs to be able to determine this to act accordingly. To achieve this the function `MPI_FINALIZED` is needed.

1 MPI\_INITIALIZED(flag)

2     OUT     flag                             Flag is true if MPI\_INIT has been called and false otherwise

5 **C binding**

6 int MPI\_Initialized(int \*flag)

8 **Fortran 2008 binding**

9 MPI\_Initialized(flag, ierror)  
10     LOGICAL, INTENT(OUT) :: flag  
11     INTEGER, OPTIONAL, INTENT(OUT) :: ierror

13 **Fortran binding**

14 MPI\_INITIALIZED(FLAG, IERROR)  
15     LOGICAL FLAG  
16     INTEGER IERROR

17     This routine may be used to determine whether MPI\_INIT or MPI\_INIT\_THREAD has  
18     been called. MPI\_INITIALIZED returns true if the calling process has called either of these  
19     MPI procedures. Whether MPI\_FINALIZE has been called does not affect the behavior of  
20     MPI\_INITIALIZED. This function must always be thread-safe, as defined in Section 10.6.  
21     This function returns false for applications using the Sessions Model exclusively.

24 MPI\_FINALIZED(flag)

25     OUT     flag                             true if MPI was finalized (logical)

27 **C binding**

28 int MPI\_Finalized(int \*flag)

30 **Fortran 2008 binding**

31 MPI\_Finalized(flag, ierror)  
32     LOGICAL, INTENT(OUT) :: flag  
33     INTEGER, OPTIONAL, INTENT(OUT) :: ierror

34 **Fortran binding**

35 MPI\_FINALIZED(FLAG, IERROR)  
36     LOGICAL FLAG  
37     INTEGER IERROR

39     This routine returns true if MPI\_FINALIZE has completed. It is valid to call  
40     MPI\_FINALIZED before MPI\_INIT and after MPI\_FINALIZE. This function must always be  
41     thread-safe, as defined in Section 10.6.

43 **10.2.4 Allowing User Functions at MPI Finalization**

44     In the context of the World Model, there are times in which it would be convenient to  
45     have actions happen when an MPI process finalizes MPI. For example, a routine may do  
46     initializations that are useful until the MPI job (or that part of the job that is being termi-  
47     nated in the case of dynamically created processes) finalizes MPI. This can be accomplished



in MPI by attaching an attribute to `MPI_COMM_SELF` with a callback function. When `MPI_FINALIZE` is called, it will first execute the equivalent of an `MPI_COMM_FREE` on `MPI_COMM_SELF`. This will cause the delete callback function to be executed on all keys associated with `MPI_COMM_SELF`, in the reverse order that they were set on `MPI_COMM_SELF`. If no key has been attached to `MPI_COMM_SELF`, then no callback is invoked. The “freeing” of `MPI_COMM_SELF` occurs before any other parts of MPI are affected. Thus, for example, calling `MPI_FINALIZED` will return false in any of these callback functions. Once done with `MPI_COMM_SELF`, the order and rest of the actions taken by `MPI_FINALIZE` is not specified.

*Advice to implementors.* Since attributes can be added from any supported language, the MPI implementation needs to remember the creating language so the correct callback is made. Implementations that use the attribute delete callback on `MPI_COMM_SELF` internally should register their internal callbacks before returning from `MPI_INIT` / `MPI_INIT_THREAD`, so that libraries or applications will not have portions of the MPI implementation shut down before the application-level callbacks are made. (*End of advice to implementors.*)

### 10.3 The Sessions Model

There are a number of limitations with the World Model described in the preceding section. Among these are the following: MPI cannot be initialized from different application components without *a priori* knowledge or coordination; MPI cannot be initialized more than once; and MPI cannot be reinitialized after `MPI_Finalize` has been called. This section describes an alternative approach to MPI initialization — the Sessions Model. With this approach, an MPI application, or components of the application, can instantiate MPI resources for the specific communication needs of this component. `MPI_COMM_WORLD` is not valid for use as a communicator. `MPI_INFO_ENV` is not valid for use as an info object when only using the Sessions Model. As described in Section 10.2.1, MPI must be initialized using the World Model to use this info object.

In the Sessions Model, MPI resources can be allocated and freed multiple times in an MPI process.

As shown in Figure 10.1, when using the Sessions Model, an MPI process instantiates an *MPI Session handle*, which can be used to query the runtime system about characteristics of the job within which the process is running, as well as other system resources. Using this information, the MPI process can then create an MPI Group based on application requirements and available resources, which in turn can be used to create an MPI Communicator, Window, or File. By judicious creation of communicators, an application only needs to allocate MPI resources based on its communication requirements. Although there are existing MPI interfaces for creating communicators which can, in principle, allow for resource optimizations within an MPI implementation, this can only be done following initialization of MPI.

For multi-threaded applications the Sessions Model provides fine-grain control of the thread support level for MPI objects. It is possible to specify different thread support levels when creating different *MPI Session handles*. Thus different components of an application can use different thread support levels.

The Sessions Model introduces a concept of isolation. MPI objects derived from different *MPI Session handles*, or derived from `MPI_COMM_WORLD` and `MPI_COMM_SELF`, shall not be intermixed with each other in a single MPI function call. Additionally,

- two communicator handles compared using `MPI_COMM_COMPARE` shall be derived from the same *MPI Session Handle*,
- for `MPI_COMM_CREATE_GROUP`, the input communicator and group handles shall be derived from the same *MPI Session handle*,
- all *request handles* supplied to a multi-request completion function, for example `MPI_TESTALL`, shall represent non-blocking or persistent operations associated with MPI objects derived from the same *MPI Session handle*.

This restriction does not apply to generalized requests (Section 12.2) as such requests are not associated directly with communicators or other MPI objects. Note however, the Sessions Model does not otherwise change the semantics or behavior of MPI objects.

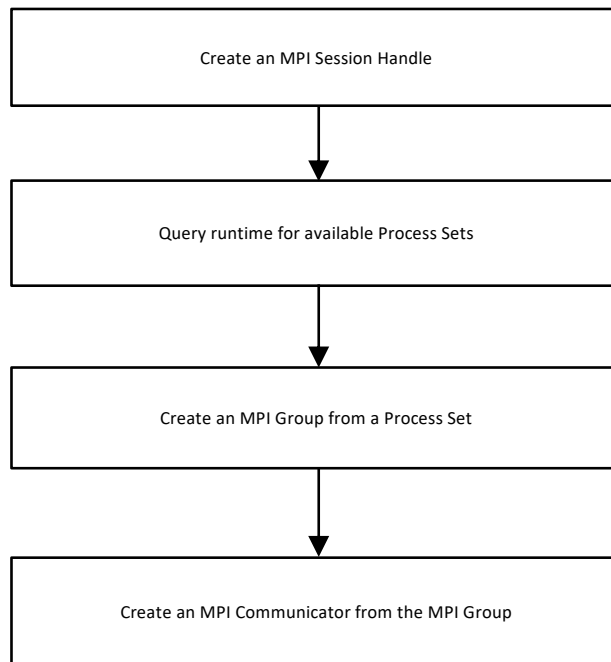

Figure 10.1: Steps to creating an MPI Communicator from an MPI Session handle.

## 10.3.1 Session Creation and Destruction Methods

MPI\_SESSION\_INIT(info, errhandler, session)

IN	info	info object to specify thread support level and MPI implementation specific resources (handle)
IN	errhandler	error handler to invoke in the event that an error is encountered during this function call (handle)
OUT	session	new session (handle)

**C binding**

```
int MPI_Session_init(MPI_Info info, MPI_Errhandler errhandler,
                    MPI_Session *session)
```

**Fortran 2008 binding**

```
MPI_Session_init(info, errhandler, session, ierror)
    TYPE(MPI_Info), INTENT(IN) :: info
    TYPE(MPI_Errhandler), INTENT(IN) :: errhandler
    TYPE(MPI_Session), INTENT(OUT) :: session
    INTEGER, OPTIONAL, INTENT(OUT) :: ierror
```

**Fortran binding**

```
MPI_SESSION_INIT(INFO, ERRHANDLER, SESSION, IERROR)
    INTEGER INFO, ERRHANDLER, SESSION, IERROR
```

The info argument is used to request MPI functionality requirements and possible MPI implementation specific capabilities. The following info key is predefined:

mpi\_thread\_support\_level used to request the thread support level required for MPI objects derived from the Session. Allowed values are "MPI\_THREAD\_SINGLE", "MPI\_THREAD\_FUNNELED", "MPI\_THREAD\_SERIALIZED", and "MPI\_THREAD\_MULTIPLE". Note that the thread support value is specified by a string rather than the integer values supplied to MPI\_INIT\_THREAD. The thread support level actually provided by the MPI implementation can be determined via a subsequent call to MPI\_SESSION\_GET\_INFO to return the info object associated with the Session. The default thread support level is MPI implementation dependent.

The errhandler argument specifies an error handler to invoke in the event that the Session instantiation call encounters an error. The error handler shall be either a pre-defined error handler (see 8.3) or one created using MPI\_SESSION\_CREATE\_ERRHANDLER. Session instantiation is intended to be a lightweight operation. An MPI process may instantiate multiple Sessions. MPI\_SESSION\_INIT is always thread safe; multiple threads within an application may invoke it concurrently.

*Advice to users.* Requesting "MPI\_THREAD\_SINGLE" thread support level is generally not recommended, because this will conflict with other components of an application requesting higher levels of thread support. (*End of advice to users.*)

*Advice to implementors.* Owing to the restrictions of the “MPI\_THREAD\_SINGLE” thread support level, implementors are discouraged from making this the default thread support level for Sessions. (*End of advice to implementors.*)

MPI\_SESSION\_FINALIZE(session)

IN session session to be finalized (handle)

### C binding

```
int MPI_Session_finalize(MPI_Session *session)
```

### Fortran 2008 binding

```
MPI_Session_finalize(session, ierror)
    TYPE(MPI_Session), INTENT(INOUT) :: session
    INTEGER, OPTIONAL, INTENT(OUT) :: ierror
```

### Fortran binding

```
MPI_SESSION_FINALIZE(SESSION, IERROR)
    INTEGER SESSION, IERROR
```

This routine cleans up all MPI state associated with the supplied `session`. Every instantiated Session must be finalized using `MPI_SESSION_FINALIZE`. The handle `session` is set to `MPI_SESSION_NULL` by the call.

Before an MPI process invokes `MPI_SESSION_FINALIZE`, the process must perform all MPI calls needed to complete its involvement in MPI communications: it must locally complete all MPI operations that it initiated and it must execute matching calls needed to complete MPI communications initiated by other processes.

The call to `MPI_SESSION_FINALIZE` does not free objects created by MPI calls; these objects are freed using `MPI_XXX_FREE` calls.

`MPI_SESSION_FINALIZE` is collective over all MPI processes that are connected via MPI Communicators, Windows, or Files that were created as part of the Session and still exist. If processes were spawned, accepted, or connected using MPI Communicators created as part of this session, this operation is collective over the union of all processes that have been and continue to be connected via those objects, as explained in Section 10.10.4.

*Advice to implementors.* An MPI implementation should be able to implement the semantics of `MPI_SESSION_FINALIZE` without synchronization with other MPI processes, provided an application frees all MPI windows, closes all MPI files, and uses `MPI_COMM_DISCONNECT` to free all MPI communicators associated with a session prior to invoking `MPI_SESSION_FINALIZE` on the corresponding session handle. (*End of advice to implementors.*)

## 10.3.2 Processes Sets

Process sets are the mechanism for MPI applications to query the runtime. Process sets are identified by process set names. Process set names have a *Uniform Resource Identifier* (URI) format. Two process set names are mandated: `mpi://WORLD` and `mpi://SELF`. Additional process set names may be defined, for example, `mpix://UNIVERSE` and `hwloc://L3Cache` may be defined by the MPI implementation. The `mpi://` namespace is reserved for exclusive use

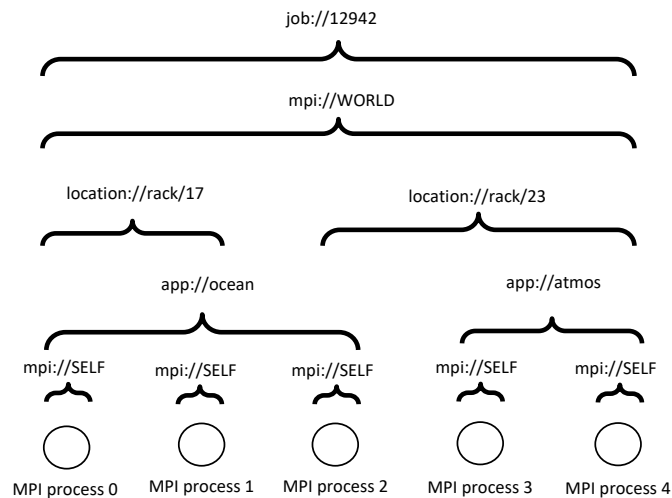

Figure 10.2: Examples of process sets. Illustrated are the two mandated process sets - `mpi://WORLD` and `mpi://SELF` - along with several optional ones that a runtime could define. In this example, `MPI_SESSION_GET_NUM_PSETS` would return five at each MPI process.

by the MPI standard. Figure 10.2 depicts process sets that the runtime could associate with an instance of an MPI job. In this example, the two mandated process sets are defined, in addition to optional, implementation specific ones.

Mechanisms for defining process sets and how system resources are assigned to these sets is considered to be implementation dependent.

A process set caches key/value tuples that are accessible to the application via an `MPI_Info` object. The `mpi_size` key is mandatory for all process sets.

### 10.3.3 Runtime Query Functions

`MPI_SESSION_GET_NUM_PSETS(session, info, npset_names)`

IN	<code>session</code>	session (handle)
IN	<code>info</code>	info object (handle)
OUT	<code>npset_names</code>	number of available process sets (non-negative integer)

#### C binding

```
int MPI_Session_get_num_psets(MPI_Session session, MPI_Info info,
                             int *npset_names)
```

#### Fortran 2008 binding

```
MPI_Session_get_num_psets(session, info, npset_names, ierror)
TYPE(MPI_Session), INTENT(IN) :: session
```

```

1     TYPE(MPI_Info), INTENT(IN) :: info
2     INTEGER, INTENT(OUT) :: npset_names
3     INTEGER, OPTIONAL, INTENT(OUT) :: ierror

```

#### Fortran binding

```

6 MPI_SESSION_GET_NUM_PSETS(SESSION, INFO, NPSET_NAMES, IERROR)
7     INTEGER SESSION, INFO, NPSET_NAMES, IERROR

```

This function is used to query the runtime for the number of available process sets in which the calling MPI process is a member. An MPI implementation is allowed to increase the number of available process sets during the execution of an MPI application when new process sets become available. However, MPI implementations are not allowed to change the index of a particular process set name, or to change the name of the process set at a particular index, or to delete a process set name once it has been added. When a process set becomes invalid, for example, when some processes become unreachable due to failures in the communication system, subsequent usage of the process set name should raise an error. For example, creating an MPI\_Group from such a process set might succeed because it is a local operation, but creating an MPI\_Comm from that group and attempting collective communication should raise an error.

*Advice to implementors.* It is anticipated that an MPI implementation may be relying on an external runtime system to provide process sets. Such runtime systems may have the ability to dynamically create process sets during the course of application execution. Requiring the number of process sets returned by MPI\_SESSION\_GET\_NUM\_PSETS to be constant over the course of application execution would prevent an application from taking advantage of such capabilities. (*End of advice to implementors.*)

```

29 MPI_SESSION_GET_NTH_PSET(session, info, n, pset_len, pset_name)

```

31	IN	session	session (handle)
32	IN	info	info object (handle)
33	IN	n	index of the desired process set name (integer)
34	INOUT	pset_len	length of the pset_name argument (integer)
35	OUT	pset_name	name of the nth process set (string)

#### C binding

```

39 int MPI_Session_get_nth_pset(MPI_Session session, MPI_Info info, int n,
40     int *pset_len, char *pset_name)

```

#### Fortran 2008 binding

```

43 MPI_Session_get_nth_pset(session, info, n, pset_len, pset_name, ierror)
44     TYPE(MPI_Session), INTENT(IN) :: session
45     TYPE(MPI_Info), INTENT(IN) :: info
46     INTEGER, INTENT(IN) :: n
47     INTEGER, INTENT(INOUT) :: pset_len
48     CHARACTER(LEN=*), INTENT(OUT) :: pset_name

```

```
INTEGER, OPTIONAL, INTENT(OUT) :: ierror
```

### Fortran binding

```
MPI_SESSION_GET_NTH_PSET(SESSION, INFO, N, PSET_LEN, PSET_NAME, IERROR)
```

```
INTEGER SESSION, INFO, N, PSET_LEN, IERROR
```

```
CHARACTER*(*) PSET_NAME
```

This function returns the name of the `n`th process set in the supplied `pset_name` buffer. `pset_len` is the size of the buffer needed to store the `n`th process set name. If the `pset_len` passed into the function is less than the actual buffer size needed for the process set name, then the string value returned in `pset_name` is truncated. If `pset_len` is set to 0, `pset_name` is not changed. On return, the value of `pset_len` will be set to the required buffer size to hold the process set name. In C, `pset_len` includes the required space for the null terminator. In C, this function returns a null terminated string in all cases where the `pset_len` input value is greater than 0.

If two MPI processes get the same process set name, then the intersection of the two process sets shall either be the empty set or identical to the union of the two process sets.

After a successful call to `MPI_SESSION_GET_NTH_PSET`, subsequent calls to routines that query information about the same process set name and same session handle must return the same information. An MPI implementation is not allowed to alter any of the returned process set names.

Process set names have an implementation-defined maximum length of `MPI_MAX_PSET_NAME_LEN`.

*Advice to users.* `MPI_MAX_PSET_NAME_LEN` might be very large, so it might not be wise to declare a string of that size. Users are encouraged to use `MPI_SESSION_GET_NTH_PSET` both for obtaining the length of a `pset_name` and the process set name. (*End of advice to users.*)

```
MPI_SESSION_GET_INFO(session, info_used)
```

```
IN      session          session (handle)
```

```
OUT     info_used        see explanation below (handle)
```

### C binding

```
int MPI_Session_get_info(MPI_Session session, MPI_Info *info_used)
```

### Fortran 2008 binding

```
MPI_Session_get_info(session, info_used, ierror)
```

```
TYPE(MPI_Session), INTENT(IN) :: session
```

```
TYPE(MPI_Info), INTENT(OUT) :: info_used
```

```
INTEGER, OPTIONAL, INTENT(OUT) :: ierror
```

### Fortran binding

```
MPI_SESSION_GET_INFO(SESSION, INFO_USED, IERROR)
```

```
INTEGER SESSION, INFO_USED, IERROR
```

`MPI_SESSION_GET_INFO` returns a new info object containing the hints of the MPI Session associated with `session`. The current setting of all hints related to this MPI Session

is returned in `info_used`. An MPI implementation is required to return all hints that are supported by the implementation and have default values specified; any user-supplied hints that were not ignored by the implementation; and any additional hints that were set by the implementation. If no such hints exist, a handle to a newly created info object is returned that contains no key/value pair. The user is responsible for freeing `info_used` via `MPI_INFO_FREE`.

```
MPI_SESSION_GET_PSET_INFO(session, pset_name, info)
```

IN	session	session (handle)
IN	pset_name	name of process set (string)
OUT	info	info object containing information about the given process set (handle)

### C binding

```
int MPI_Session_get_pset_info(MPI_Session session, const char *pset_name,
                             MPI_Info *info)
```

### Fortran 2008 binding

```
MPI_Session_get_pset_info(session, pset_name, info, ierror)
    TYPE(MPI_Session), INTENT(IN) :: session
    CHARACTER(LEN=*), INTENT(IN) :: pset_name
    TYPE(MPI_Info), INTENT(OUT) :: info
    INTEGER, OPTIONAL, INTENT(OUT) :: ierror
```

### Fortran binding

```
MPI_SESSION_GET_PSET_INFO(SESSION, PSET_NAME, INFO, IERROR)
    INTEGER SESSION, INFO, IERROR
    CHARACTER*(*) PSET_NAME
```

This function is used to query properties of a specific process set. The returned *info* object can be queried with existing MPI info object query functions. One key/value pair must be defined, `mpi_size`. The value of the `mpi_size` key specifies the number of MPI processes in the process set. The user is responsible for freeing the returned `MPI_Info` object.

## 10.3.4 Sessions Model Examples

This section presents several examples of how to use MPI Sessions to create MPI Groups and MPI Communicators.

**Example 10.8** Simple example illustrating creation of an MPI communicator using the Sessions Model.

```
#include <stdio.h>
#include <stdlib.h>
#include <string.h>
#include "mpi.h"

static MPI_Session lib_shandle = MPI_SESSION_NULL;
```



```
static MPI_Comm lib_comm = MPI_COMM_NULL; 1
                                           2
int library_foo_init(void)                 3
{                                           4
    int rc, flag;                          5
    int ret = 0;                            6
    const char pset_name[] = "mpi://WORLD"; 7
    const char mt_key[] = "mpi_thread_support_level"; 8
    const char mt_value[] = "MPI_THREAD_MULTIPLE"; 9
    char out_value[100]; /* large enough */ 10
    MPI_Group wgroup = MPI_GROUP_NULL;     11
    MPI_Info sinfo = MPI_INFO_NULL;        12
    MPI_Info tinfo = MPI_INFO_NULL;        13
                                           14

    MPI_Info_create(&sinfo);                15
    MPI_Info_set(sinfo, mt_key, mt_value); 16
    rc = MPI_Session_init(sinfo, MPI_ERRORS_RETURN, 17
                          &lib_shandle);   18
    if (rc != MPI_SUCCESS) {               19
        ret = -1;                          20
        goto fn_exit;                       21
    }                                       22
                                           23
    /*                                     24
     * check we got thread support level foo library needs 25
     */                                     26
    rc = MPI_Session_get_info(lib_shandle, &tinfo); 27
    if (rc != MPI_SUCCESS) {               28
        ret = -1;                          29
        goto fn_exit;                       30
    }                                       31
                                           32

    MPI_Info_get(tinfo, mt_key, sizeof(out_value), 33
                 out_value, &flag);        34
    if (flag != 1) {                       35
        printf("Could not find key %s\n", mt_key); 36
        ret = -1;                          37
        goto fn_exit;                       38
    }                                       39
                                           40

    if (strcmp(out_value, mt_value)) {     41
        printf("Did not get thread multiple support, got %s\n", 42
              out_value);                   43
        ret = -1;                          44
        goto fn_exit;                       45
    }                                       46
                                           47

    /*                                     48
```

```

1      * create a group from the WORLD process set
2      */
3      rc = MPI_Group_from_session_pset(lib_shandle,
4                                     pset_name,
5                                     &wgroup);
6
7      if (rc != MPI_SUCCESS) {
8          ret = -1;
9          goto fn_exit;
10     }
11
12     /*
13     * get a communicator
14     */
15     rc = MPI_Comm_create_from_group(wgroup,
16                                    "org.mpi-forum.mpi-v4_0.example-ex10_8",
17                                    MPI_INFO_NULL,
18                                    MPI_ERRORS_RETURN,
19                                    &lib_comm);
20
21     if (rc != MPI_SUCCESS) {
22         ret = -1;
23         goto fn_exit;
24     }
25
26     /*
27     * free group, library doesn't need it.
28     */
29
30     fn_exit:
31     MPI_Group_free(&wgroup);
32
33     if (sinfo != MPI_INFO_NULL) {
34         MPI_Info_free(&sinfo);
35     }
36
37     if (tinfo != MPI_INFO_NULL) {
38         MPI_Info_free(&tinfo);
39     }
40
41     if (ret != 0) {
42         MPI_Session_finalize(&lib_shandle);
43     }
44
45     return ret;
46 }

```

Example 10.8 shows how the pre-defined `mpi://WORLD` process set can be used to first create a local MPI group and then subsequently to create an MPI communicator from this group.

**Example 10.9** This example illustrates the use of Process Set query functions to select a Process Set to use for MPI Group creation.

```
#include <stdio.h>
#include <stdlib.h>
#include <string.h>
#include "mpi.h"

int main(int argc, char *argv[])
{
    int i, n_psets, psetlen, rc, ret;
    int valuelen;
    int flag = 0;
    char *pset_name = NULL;
    char *info_val = NULL;
    MPI_Session shandle = MPI_SESSION_NULL;
    MPI_Info sinfo = MPI_INFO_NULL;
    MPI_Group pgroup = MPI_GROUP_NULL;

    if (argc < 2) {
        fprintf(stderr, "A process set name fragment is required\n");
        return -1;
    }

    rc = MPI_Session_init(MPI_INFO_NULL, MPI_ERRORS_RETURN, &shandle);
    if (rc != MPI_SUCCESS) {
        fprintf(stderr, "Could not initialize session, bailing out\n");
        return -1;
    }

    MPI_Session_get_num_psets(shandle, MPI_INFO_NULL, &n_psets);

    for (i=0, pset_name=NULL; i<n_psets; i++) {
        psetlen = 0;
        MPI_Session_get_nth_pset(shandle, MPI_INFO_NULL, i,
                                &psetlen, NULL);
        pset_name = (char *)malloc(sizeof(char) * psetlen);
        MPI_Session_get_nth_pset(shandle, MPI_INFO_NULL, i,
                                &psetlen, pset_name);
        if (strstr(pset_name, argv[1]) != NULL) break;

        free(pset_name);
        pset_name = NULL;
    }

    /*
     * get instance of an info object for this Session
     */
```

```

1
2 MPI_Session_get_pset_info(shandle, pset_name, &sinfo);
3 MPI_Info_get_valuelen(sinfo, "mpi_size", &valuelen, &flag);
4 info_val = (char *)malloc(valuelen+1);
5 MPI_Info_get(sinfo, "mpi_size", valuelen, info_val, &flag);
6 free(info_val);
7
8 /*
9  * create a group from the process set
10  */
11
12 rc = MPI_Group_from_session_pset(shandle, pset_name,
13                                &pgroup);
14 ret = (rc == MPI_SUCCESS) ? 0 : -1;
15
16 free(pset_name);
17 MPI_Group_free(&pgroup);
18 MPI_Info_free(&sinfo);
19 MPI_Session_finalize(&shandle);
20
21 fprintf(stderr, "Test completed ret = %d\n", ret);
22 return ret;
23
24 }

```

Example 10.9 illustrates several aspects of the Sessions Model. First, the default error handler can be specified when instantiating a Session instance. Second, there must be at least two process sets associated with a Session. Third, the example illustrates use of the Sessions info object and the one required key: `mpi_size`.

**Example 10.10** A Fortran 2008 example illustrating how to obtain information about available process sets, create an MPI Group from a process set, and subsequently create an MPI Communicator.

```

34 PROGRAM MAIN
35   USE mpi_f08
36   IMPLICIT NONE
37   INTEGER :: pset_len, ierror, n_psets
38   CHARACTER(LEN=:), ALLOCATABLE :: pset_name
39   TYPE(MPI_Session) :: shandle
40   TYPE(MPI_Group) :: pgroup
41   TYPE(MPI_Comm) :: pcomm
42
43   CALL MPI_Session_init(MPI_INFO_NULL, MPI_ERRORS_RETURN, &
44                        shandle, ierror)
45   IF (ierror .NE. MPI_SUCCESS) THEN
46     WRITE(*,*) "MPI_Session_init failed"
47     ERROR STOP
48   END IF

```

```

1
2 CALL MPI_Session_get_num_psets(shandle, MPI_INFO_NULL, n_psets)
3
4 IF (n_psets .LT. 2) THEN
5     WRITE(*,*) "MPI_Session_get_num_psets didn't return at least 2 psets"
6     ERROR STOP
7
8 !
9 ! Just get the second pset's length and name
10 ! Note that index values are zero-based, even in Fortran
11 !
12
13 pset_len = 0
14 CALL MPI_Session_get_nth_pset(shandle, MPI_INFO_NULL, 1,      &
15                             pset_len, pset_name)
16 ALLOCATE(Character(len=pset_len)::pset_name)
17 CALL MPI_Session_get_nth_pset(shandle, MPI_INFO_NULL, 1,      &
18                             pset_len, pset_name)
19
20 !
21 ! create a group from the pset
22 !
23 CALL MPI_Group_from_session_pset(shandle, pset_name, pgroup)
24 !
25 ! free the buffer used for the pset name
26 !
27 DEALLOCATE(pset_name)
28
29 !
30 ! create a MPI communicator from the group
31 !
32 CALL MPI_Comm_create_from_group(pgroup, "session_example", &
33                                MPI_INFO_NULL, &
34                                MPI_ERRORS_RETURN, &
35                                pcomm)
36
37 CALL MPI_Barrier(pcomm, ierror)
38 IF (ierror .NE. MPI_SUCCESS) THEN
39     WRITE(*,*) "Barrier call on communicator failed"
40     ERROR STOP
41
42 END IF
43
44 CALL MPI_Comm_free(pcomm)
45 CALL MPI_Group_free(pgroup)
46 CALL MPI_Session_finalize(shandle, ierror)
47
48 END PROGRAM MAIN

```

Note in this example that the call to `MPI_SESSION_FINALIZE` may block in order to ensure that the calling MPI process has completed its involvement in the preceding `MPI_BARRIER` operation. If `MPI_COMM_DISCONNECT` had been used instead of `MPI_COMM_FREE`, the example would have blocked in `MPI_COMM_DISCONNECT` rather than `MPI_SESSION_FINALIZE`.

## 10.4 Common Elements of Both Process Models

### 10.4.1 MPI Functionality that is Always Available

Some MPI functions may be invoked at any time, including prior to calling `MPI_INIT` or `MPI_SESSION_INIT`, and following MPI finalization, independent of whether the World Model, Sessions Model, or both are used. These functions can be called concurrently by multiple threads within an MPI Process. Table 10.1 lists the applicable MPI functions.

<code>MPI_INITIALIZED</code>
<code>MPI_FINALIZED</code>
<code>MPI_GET_VERSION</code>
<code>MPI_GET_LIBRARY_VERSION</code>
<code>MPI_INFO_CREATE</code>
<code>MPI_INFO_SET</code>
<code>MPI_INFO_DELETE</code>
<code>MPI_INFO_GET</code>
<code>MPI_INFO_GET_VALUELEN</code>
<code>MPI_INFO_GET_NKEYS</code>
<code>MPI_INFO_GET_NTHKEY</code>
<code>MPI_INFO_DUP</code>
<code>MPI_INFO_FREE</code>
<code>MPI_INFO_F2C</code>
<code>MPI_INFO_C2F</code>
<code>MPI_SESSION_CREATE_ERRHANDLER</code>
<code>MPI_SESSION_CALL_ERRHANDLER</code>
<code>MPI_ERRHANDLER_FREE</code>
<code>MPI_ERRHANDLER_F2C</code>
<code>MPI_ERRHANDLER_C2F</code>
<code>MPI_ERROR_STRING</code>
<code>MPI_ERROR_CLASS</code>

Table 10.1: List of MPI Functions that can be called at any time within an MPI program, including prior to MPI initialization and following MPI finalization

In addition to the functions listed in Table 10.1, any function with the prefix `MPI_T_` (within the constraints for functions with this prefix listed in Section 14.3.4) may also be called prior to MPI initialization and after MPI finalization.

## 10.4.2 Aborting MPI Processes

MPI\_ABORT(comm, errorcode)

IN	comm	communicator of tasks to abort
IN	errorcode	error code to return to invoking environment

**C binding**

```
int MPI_Abort(MPI_Comm comm, int errorcode)
```

**Fortran 2008 binding**

```
MPI_Abort(comm, errorcode, ierror)
    TYPE(MPI_Comm), INTENT(IN) :: comm
    INTEGER, INTENT(IN) :: errorcode
    INTEGER, OPTIONAL, INTENT(OUT) :: ierror
```

**Fortran binding**

```
MPI_ABORT(COMM, ERRORCODE, IERROR)
    INTEGER COMM, ERRORCODE, IERROR
```

This routine makes a “best attempt” to abort all MPI processes in the group of `comm`. This function does not require that the invoking environment take any action with the error code. However, a Unix or POSIX environment should handle this as a `return errorcode` from the main program.

It may not be possible for an MPI implementation to abort only the processes represented by `comm` if this is a subset of the processes. In this case, the MPI implementation should attempt to abort all the connected processes but should not abort any unconnected processes. When using the World Model, and if no processes were spawned, accepted, or connected then this has the effect of aborting all the processes associated with `MPI_COMM_WORLD`. In the case of the Sessions Model, if an MPI process has instantiated multiple sessions, the union of the process sets in these sessions are considered connected processes. Thus invoking `MPI_ABORT` on a communicator derived from one of these sessions will result in all MPI processes in this union being aborted.

*Advice to implementors.* After aborting a subset of processes, a high quality implementation should be able to provide error handling for communicators, windows, and files involving both aborted and non-aborted processes. As an example, if the user changes the error handler for `MPI_COMM_WORLD` to `MPI_ERRORS_RETURN` or a custom error handler, when a subset of `MPI_COMM_WORLD` is aborted, the remaining processes in `MPI_COMM_WORLD` should be able to continue communicating with each other and receive an appropriate error code when attempting communication with an aborted process (e.g., an error of class `MPI_ERR_PROC_ABORTED`). A high quality implementation should support equivalent behavior for communicators derived from sessions. (*End of advice to implementors.*)

*Advice to users.* Whether the `errorcode` is returned from the executable or from the MPI process startup mechanism (e.g., `mpiexec`), is an aspect of quality of the MPI library but not mandatory. (*End of advice to users.*)

*Advice to implementors.* Where possible, a high-quality implementation will try to return the errorcode from the MPI process startup mechanism (e.g. `mpiexec` or `singleton init`). (*End of advice to implementors.*)

## 10.5 Portable MPI Process Startup

A number of implementations of MPI provide a startup command for MPI programs that is of the form

```
mpirun <mpirun arguments> <program> <program arguments>
```

Separating the command to start the program from the program itself provides flexibility, particularly for network and heterogeneous implementations. For example, the startup script need not run on one of the machines that will be executing the MPI program itself.

Having a standard startup mechanism also extends the portability of MPI programs one step further, to the command lines and scripts that manage them. For example, a validation suite script that runs hundreds of programs can be a portable script if it is written using such a standard startup mechanism. In order that the “standard” command not be confused with existing practice, which is not standard and not portable among implementations, instead of `mpirun MPI` specifies `mpiexec`.

While a standardized startup mechanism improves the usability of MPI, the range of environments is so diverse (e.g., there may not even be a command line interface) that MPI cannot mandate such a mechanism. Instead, MPI specifies an `mpiexec` startup command and recommends but does not require it, as advice to implementors. However, if an implementation does provide a command called `mpiexec`, it must be of the form described below.

It is suggested that

```
mpiexec -n <numprocs> <program>
```

be at least one way to start `<program>` with an initial set of `<numprocs>` processes, which will be accessible as the process set named “`mpi://world`” in the Sessions Model and/or used to the form the group associated with the built-in communicator, `MPI_COMM_WORLD` in the World Model. Other arguments to `mpiexec` may be implementation-dependent.

*Advice to implementors.* Implementors, if they do provide a special startup command for MPI programs, are advised to give it the following form. The syntax is chosen in order that `mpiexec` be able to be viewed as a command-line version of `MPI_COMM_SPAWN` (See Section 10.8.4).

Analogous to `MPI_COMM_SPAWN`, we have

```
mpiexec -n                <maxprocs>
      -soft                <      >
      -host                <      >
      -arch                <      >
      -wdir                <      >
      -path                <      >
      -file                <      >
      -initial-errhandler <      >
```



```
...
<command line>
```

for the case where a single command line for the application program and its arguments will suffice. See Section 10.8.4 for the meanings of these arguments. For the case corresponding to MPI\_COMM\_SPAWN\_MULTIPLE there are two possible formats:

Form A:

```
mpiexec { <above arguments> } : { ... } : { ... } : ... : { ... }
```

As with MPI\_COMM\_SPAWN, all the arguments are optional. (Even the `-n x` argument is optional; the default is implementation dependent. It might be 1, it might be taken from an environment variable, or it might be specified at compile time.) The names and meanings of the arguments are taken from the keys in the `info` argument to MPI\_COMM\_SPAWN. There may be other, implementation-dependent arguments as well.

Note that Form A, though convenient to type, prevents colons from being program arguments. Therefore an alternate, file-based form is allowed:

Form B:

```
mpiexec -configfile <filename>
```

where the lines of `<filename>` are of the form separated by the colons in Form A. Lines beginning with `#` are comments, and lines may be continued by terminating the partial line with `\`.

**Example 10.11** Start 16 instances of `myprog` on the current or default machine:

```
mpiexec -n 16 myprog
```

**Example 10.12** Start 10 processes on the machine called `ferrari`:

```
mpiexec -n 10 -host ferrari myprog
```

**Example 10.13** Start three copies of the same program with different command-line arguments:

```
mpiexec myprog infile1 : myprog infile2 : myprog infile3
```

**Example 10.14** Start the `ocean` program on five Suns and the `atmos` program on 10 RS/6000's:

```
mpiexec -n 5 -arch sun ocean : -n 10 -arch rs6000 atmos
```

1 It is assumed that the implementation in this case has a method for choosing hosts of  
 2 the appropriate type. Their ranks are in the order specified.

3  
 4 **Example 10.15** Start the `ocean` program on five Suns and the `atmos` program on  
 5 10 RS/6000's (Form B):

```
6  

  7     mpiexec -configfile myfile
```

8  
 9 where `myfile` contains

```
10  

  11     -n 5  -arch sun    ocean  

  12     -n 10 -arch rs6000 atmos
```

13  
 14 (*End of advice to implementors.*)

## 15 16 10.6 MPI and Threads

17  
 18 This section specifies the interaction between MPI calls and threads. Although thread com-  
 19 pliance is not required, the standard specifies how threads are to work if they are provided.  
 20 The section lists minimal requirements for **thread compliant** MPI implementations and  
 21 defines functions that can be used for initializing the thread environment. MPI may be im-  
 22 plemented in environments where threads are not supported or perform poorly. Therefore,  
 23 MPI implementations are not required to be thread compliant as defined in this section.  
 24 Regardless of whether or not the MPI implementation is thread compliant, a subset of MPI  
 25 functions must always be thread safe. A complete list of such MPI functions is given in Ta-  
 26 ble 10.1. When a thread is executing one of these routines, if another concurrently running  
 27 thread also makes an MPI call, the outcome will be as if the calls executed in some order.

28  
 29 This section generally assumes a thread package similar to POSIX threads [41], but the  
 30 syntax and semantics of thread calls are not specified here — these are beyond the scope  
 31 of this document.

### 32 33 10.6.1 General

34 In a thread-compliant implementation, an MPI process is a process that may be multi-  
 35 threaded. Each thread can issue MPI calls; however, threads are not separately addressable:  
 36 a rank in a send or receive call identifies a process, not a thread. A message sent to a process  
 37 can be received by any thread in this process.

38  
 39 *Rationale.* This model corresponds to the POSIX model of interprocess communi-  
 40 cation: the fact that a process is multi-threaded, rather than single-threaded, does  
 41 not affect the external interface of this process. MPI implementations in which MPI  
 42 ‘processes’ are POSIX threads inside a single POSIX process are not thread-compliant  
 43 by this definition (indeed, their “processes” are single-threaded). (*End of rationale.*)

44  
 45 *Advice to users.* It is the user’s responsibility to prevent races when threads within  
 46 the same application post conflicting communication calls. The user can make sure  
 47 that two threads in the same process will not issue conflicting communication calls by  
 48 using distinct communicators at each thread. (*End of advice to users.*)

The two main requirements for a thread-compliant implementation are listed below.

1. All MPI calls are *thread-safe*, i.e., two concurrently running threads may make MPI calls and the outcome will be as if the calls executed in some order, even if their execution is interleaved.
2. Blocking MPI calls will block the calling thread only, allowing another thread to execute, if available. The calling thread will be blocked until the event on which it is waiting occurs. Once the blocked communication is enabled and can proceed, then the call will complete and the thread will be marked runnable, within a finite time. A blocked thread will not prevent progress of other runnable threads on the same process, and will not prevent them from executing MPI calls.

**Example 10.16** Process 0 consists of two threads. The first thread executes a blocking send call `MPI_Send(buff1, count, type, 0, 0, comm)`, whereas the second thread executes a blocking receive call `MPI_Recv(buff2, count, type, 0, 0, comm, &status)`, i.e., the first thread sends a message that is received by the second thread. This communication should always succeed. According to the first requirement, the execution will correspond to some interleaving of the two calls. According to the second requirement, a call can only block the calling thread and cannot prevent progress of the other thread. If the send call went ahead of the receive call, then the sending thread may block, but this will not prevent the receiving thread from executing. Thus, the receive call will occur. Once both calls occur, the communication is enabled and both calls will complete. On the other hand, a single-threaded process that posts a send, followed by a matching receive, may deadlock. The progress requirement for multithreaded implementations is stronger, as a blocked call cannot prevent progress in other threads.

*Advice to implementors.* MPI calls can be made thread-safe by executing only one at a time, e.g., by protecting MPI code with one process-global lock. However, blocked operations cannot hold the lock, as this would prevent progress of other threads in the process. The lock is held only for the duration of an atomic, locally-completing suboperation such as posting a send or completing a send, and is released in between. Finer locks can provide more concurrency, at the expense of higher locking overheads. Concurrency can also be achieved by having some of the MPI protocol executed by separate server threads. (*End of advice to implementors.*)

### 10.6.2 Clarifications

**Initialization and Completion** When using the World Model, the call to `MPI_FINALIZE` should occur on the same thread that initialized MPI. We call this thread the **main thread**. The call should occur only after all process threads have completed their MPI calls, and have no pending communications or I/O operations.

*Rationale.* This constraint simplifies implementation. (*End of rationale.*)

**Threads and the Sessions Model** The Sessions Model provides a finer-grain approach to controlling the interaction between MPI calls and threads. When using this model, the desired level of thread support is specified at Session initialization time. See Section 10.3. Thus it is possible for communicators and other MPI objects derived from one Session

1 to provide a different level of thread support than those created from another Session  
 2 for which a different level of thread support was requested. Depending on the level of  
 3 thread support requested at Session initialization time, different threads in a MPI process  
 4 can make concurrent calls to MPI when using MPI objects derived from different *session*  
 5 *handles*. Note that the requested and provided level of thread support when creating a  
 6 Session may influence the granted level of thread support in a subsequent invocation of  
 7 MPI\_SESSION\_INIT. Likewise, if the application at some point calls  
 8 MPI\_INIT\_THREAD, the requested and granted level of thread support may influence the  
 9 granted level of thread support for subsequent calls to MPI\_SESSION\_INIT. Similarly, if the  
 10 application calls MPI\_INIT\_THREAD after a call to MPI\_SESSION\_INIT, the level of thread  
 11 support returned from MPI\_INIT\_THREAD may be similarly influenced by the requested  
 12 level of thread support in the prior call to MPI\_SESSION\_INIT.

13 In addition, if an MPI application is only using the Sessions Model, the provided thread  
 14 support level returned by MPI\_QUERY\_THREAD is the same as that returned prior to  
 15 invocation of MPI\_INIT\_THREAD or MPI\_INIT. If the application also used the World  
 16 Model in some component of the application, MPI\_QUERY\_THREAD will return the level  
 17 of thread support returned by the original call to MPI\_INIT\_THREAD.

18  
 19 **Multiple threads completing the same request.** A program in which two threads block, wait-  
 20 ing on the same request, is erroneous. Similarly, the same request cannot appear in the  
 21 array of requests of two concurrent MPI\_{WAIT|TEST}{ANY|SOME|ALL} calls. In MPI, a  
 22 request can only be completed once. Any combination of wait or test that violates this rule  
 23 is erroneous.

24  
 25 *Rationale.* This restriction is consistent with the view that a multithreaded execution  
 26 corresponds to an interleaving of the MPI calls. In a single threaded implementation,  
 27 once a wait is posted on a request the request handle will be nullified before it is  
 28 possible to post a second wait on the same handle. With threads, an  
 29 MPI\_WAIT{ANY|SOME|ALL} may be blocked without having nullified its request(s)  
 30 so it becomes the user's responsibility to avoid using the same request in an MPI\_WAIT  
 31 on another thread. This constraint also simplifies implementation, as only one thread  
 32 will be blocked on any communication or I/O event. (*End of rationale.*)

33  
 34 **Probe** A receive call that uses source and tag values returned by a preceding call to  
 35 MPI\_PROBE or MPI\_IProbe will receive the message matched by the probe call only  
 36 if there was no other matching receive after the probe and before that receive. In a multi-  
 37 threaded environment, it is up to the user to enforce this condition using suitable mutual  
 38 exclusion logic. This can be enforced by making sure that each communicator is used by  
 39 only one thread on each process. Alternatively, MPI\_MPROBE or MPI\_IMPROBE can be  
 40 used.

41  
 42 **Collective calls** Matching of collective calls on a communicator, window, or file handle is  
 43 done according to the order in which the calls are issued at each process. If concurrent  
 44 threads issue such calls on the same communicator, window or file handle, it is up to the  
 45 user to make sure the calls are correctly ordered, using interthread synchronization.

46  
 47 *Advice to users.* With three concurrent threads in each MPI process of a communica-  
 48 tor *comm*, it is allowed that thread A in each MPI process calls a collective operation

on `comm`, thread B calls a file operation on an existing filehandle that was formerly opened on `comm`, and thread C invokes one-sided operations on an existing window handle that was also formerly created on `comm`. (*End of advice to users.*)

*Rationale.* As specified in `MPI_FILE_OPEN` and `MPI_WIN_CREATE`, a file handle and a window handle inherit only the group of processes of the underlying communicator, but not the communicator itself. Accesses to communicators, window handles and file handles cannot affect one another. (*End of rationale.*)

*Advice to implementors.* If the implementation of file or window operations internally uses MPI communication then a duplicated communicator may be cached on the file or window object. (*End of advice to implementors.*)

**Exception handlers** An exception handler does not necessarily execute in the context of the thread that made the exception-raising MPI call; the exception handler may be executed by a thread that is distinct from the thread that will return the error code.

*Rationale.* The MPI implementation may be multithreaded, so that part of the communication protocol may execute on a thread that is distinct from the thread that made the MPI call. The design allows the exception handler to be executed on the thread where the exception occurred. (*End of rationale.*)

**Interaction with signals and cancellations** The outcome is undefined if a thread that executes an MPI call is cancelled (by another thread), or if a thread catches a signal while executing an MPI call. However, a thread of an MPI process may terminate, and may catch signals or be cancelled by another thread when not executing MPI calls.

*Rationale.* Few C library functions are signal safe, and many have cancellation points — points at which the thread executing them may be cancelled. The above restriction simplifies implementation (no need for the MPI library to be “async-cancel-safe” or “async-signal-safe”). (*End of rationale.*)

*Advice to users.* Users can catch signals in separate, non-MPI threads (e.g., by masking signals on MPI calling threads, and unmasking them in one or more non-MPI threads). A good programming practice is to have a distinct thread blocked in a call to `sigwait` for each user expected signal that may occur. Users must not catch signals used by the MPI implementation; as each MPI implementation is required to document the signals used internally, users can avoid these signals. (*End of advice to users.*)

*Advice to implementors.* The MPI library should not invoke library calls that are not thread safe, if multiple threads execute. (*End of advice to implementors.*)

## 10.7 The Dynamic Process Model

The dynamic process model allows for the creation and cooperative termination of processes after an MPI application has started. It provides a mechanism to establish communication between the newly created processes and the existing MPI application. It also provides a mechanism to establish communication between two existing MPI applications, even when one did not “start” the other.

### 10.7.1 Starting Processes

MPI applications may start new processes through an interface to an external process manager.

`MPI_COMM_SPAWN` starts MPI processes and establishes communication with them, returning an intercommunicator. `MPI_COMM_SPAWN_MULTIPLE` starts several different binaries (or the same binary with different arguments), placing them in the same `MPI_COMM_WORLD` and returning an intercommunicator.

MPI uses the group abstraction to represent processes. A process is identified by a (group, rank) pair.

### 10.7.2 The Runtime Environment

The `MPI_COMM_SPAWN` and `MPI_COMM_SPAWN_MULTIPLE` routines provide an interface between MPI and the *runtime environment* of an MPI application. The difficulty is that there is an enormous range of runtime environments and application requirements, and MPI must not be tailored to any particular one. Examples of such environments are:

- **MPP managed by a batch queueing system.** Batch queueing systems generally allocate resources before an application begins, enforce limits on resource use (CPU time, memory use, etc.), and do not allow a change in resource allocation after a job begins. Moreover, many MPPs have special limitations or extensions, such as a limit on the number of processes that may run on one processor, or the ability to gang-schedule processes of a parallel application.
- **Network of workstations with PVM.** PVM (Parallel Virtual Machine) allows a user to create a “virtual machine” out of a network of workstations. An application may extend the virtual machine or manage processes (create, kill, redirect output, etc.) through the PVM library. Requests to manage the machine or processes may be intercepted and handled by an external resource manager.
- **Network of workstations managed by a load balancing system.** A load balancing system may choose the location of spawned processes based on dynamic quantities, such as load average. It may transparently migrate processes from one machine to another when a resource becomes unavailable.
- **Large SMP with Unix.** Applications are run directly by the user. They are scheduled at a low level by the operating system. Processes may have special scheduling characteristics (gang-scheduling, processor affinity, deadline scheduling, processor locking, etc.) and be subject to OS resource limits (number of processes, amount of memory, etc.).

MPI assumes, implicitly, the existence of an environment in which an application runs. It does not provide “operating system” services, such as a general ability to query what processes are running, to kill arbitrary processes, to find out properties of the runtime environment (how many processors, how much memory, etc.).

Complex interaction of an MPI application with its runtime environment should be done through an environment-specific API. An example of such an API would be the PVM task and machine management routines — `pvm_addhosts`, `pvm_config`, `pvm_tasks`, etc.,

possibly modified to return an MPI (group, rank) when possible. A Condor or PBS API would be another possibility.

At some low level, obviously, MPI must be able to interact with the runtime system, but the interaction is not visible at the application level and the details of the interaction are not specified by the MPI standard.

In many cases, it is impossible to keep environment-specific information out of the MPI interface without seriously compromising MPI functionality. To permit applications to take advantage of environment-specific functionality, many MPI routines take an `info` argument that allows an application to specify environment-specific information. There is a tradeoff between functionality and portability: applications that make use of environment-specific `info` are not portable.

MPI does not require the existence of an underlying “virtual machine” model, in which there is a consistent global view of an MPI application and an implicit “operating system” managing resources and processes. For instance, processes spawned by one task may not be visible to another; additional hosts added to the runtime environment by one process may not be visible in another process; tasks spawned by different processes may not be automatically distributed over available resources.

Interaction between MPI and the runtime environment is limited to the following areas:

- A process may start new processes with `MPI_COMM_SPAWN` and `MPI_COMM_SPAWN_MULTIPLE`.
- When a process spawns a child process, it may optionally use an `info` argument to tell the runtime environment where or how to start the process. This extra information may be opaque to MPI.
- An attribute `MPI_UNIVERSE_SIZE` (See Section 10.10.1) on `MPI_COMM_WORLD` tells a program how “large” the initial runtime environment is, namely how many processes can usefully be started in all. One can subtract the size of `MPI_COMM_WORLD` from this value to find out how many processes might usefully be started in addition to those already running.

## 10.8 Process Manager Interface

### 10.8.1 Processes in MPI

A process is represented in MPI by a (group, rank) pair. A (group, rank) pair specifies a unique process but a process does not determine a unique (group, rank) pair, since a process may belong to several groups.

### 10.8.2 Starting Processes and Establishing Communication

The following routine starts a number of MPI processes and establishes communication with them, returning an intercommunicator.

*Advice to users.* It is possible in MPI to start a static SPMD or MPMD application by first starting one process and having that process start its siblings with `MPI_COMM_SPAWN`. This practice is discouraged primarily for reasons of performance. If possible, it is preferable to start all processes at once, as a single MPI application. (*End of advice to users.*)

```
1 MPI_COMM_SPAWN(command, argv, maxprocs, info, root, comm, intercomm, array_of_errcodes)
```

2			
3	IN	command	name of program to be spawned (string, significant
4			only at root)
5			
6	IN	argv	arguments to command (array of strings, significant
7			only at root)
8	IN	maxprocs	maximum number of processes to start (integer, sig-
9			nificant only at root)
10	IN	info	a set of key-value pairs telling the runtime system
11			where and how to start the processes (handle, signifi-
12			cant only at root)
13			
14	IN	root	rank of process in which previous arguments are ex-
15			amined (integer)
16	IN	comm	intracommunicator containing group of spawning pro-
17			cesses (handle)
18	OUT	intercomm	intercommunicator between original group and the newly
19			spawned group (handle)
20			
21	OUT	array_of_errcodes	one code per process (array of integer)
22			

### 23 C binding

```
24 int MPI_Comm_spawn(const char *command, char *argv[], int maxprocs,
25                   MPI_Info info, int root, MPI_Comm comm, MPI_Comm *intercomm,
26                   int array_of_errcodes[])
```

### 27 Fortran 2008 binding

```
28 MPI_Comm_spawn(command, argv, maxprocs, info, root, comm, intercomm,
29               array_of_errcodes, ierror)
```

```
30 CHARACTER(LEN=*), INTENT(IN) :: command, argv(*)
31 INTEGER, INTENT(IN) :: maxprocs, root
32 TYPE(MPI_Info), INTENT(IN) :: info
33 TYPE(MPI_Comm), INTENT(IN) :: comm
34 TYPE(MPI_Comm), INTENT(OUT) :: intercomm
35 INTEGER :: array_of_errcodes(*)
36 INTEGER, OPTIONAL, INTENT(OUT) :: ierror
```

### 38 Fortran binding

```
39 MPI_COMM_SPAWN(COMMAND, ARGV, MAXPROCS, INFO, ROOT, COMM, INTERCOMM,
40               ARRAY_OF_ERRCODES, IERROR)
41 CHARACTER*(*) COMMAND, ARGV(*)
42 INTEGER MAXPROCS, INFO, ROOT, COMM, INTERCOMM, ARRAY_OF_ERRCODES(*),
43 IERROR
```

44 MPI\_COMM\_SPAWN tries to start maxprocs identical copies of the MPI program spec-  
 45 ified by `command`, establishing communication with them and returning an intercommun-  
 46 icator. The spawned processes are referred to as children. The children have their own  
 47 MPI\_COMM\_WORLD, which is separate from that of the parents. MPI\_COMM\_SPAWN is  
 48



collective over `comm`, and also may not return until `MPI_INIT` has been called in the children. Similarly, `MPI_INIT` in the children may not return until all parents have called `MPI_COMM_SPAWN`. In this sense, `MPI_COMM_SPAWN` in the parents and `MPI_INIT` in the children form a collective operation over the union of parent and child processes. The intercommunicator returned by `MPI_COMM_SPAWN` contains the parent processes in the local group and the child processes in the remote group. The ordering of processes in the local and remote groups is the same as the ordering of the group of the `comm` in the parents and of `MPI_COMM_WORLD` of the children, respectively. This intercommunicator can be obtained in the children through the function `MPI_COMM_GET_PARENT`.

*Advice to users.* An implementation may automatically establish communication before `MPI_INIT` is called by the children. Thus, completion of `MPI_COMM_SPAWN` in the parent does not necessarily mean that `MPI_INIT` has been called in the children (although the returned intercommunicator can be used immediately). (*End of advice to users.*)

**The command argument** The command argument is a string containing the name of a program to be spawned. The string is null-terminated in C. In Fortran, leading and trailing spaces are stripped. MPI does not specify how to find the executable or how the working directory is determined. These rules are implementation-dependent and should be appropriate for the runtime environment.

*Advice to implementors.* The implementation should use a natural rule for finding executables and determining working directories. For instance, a homogeneous system with a global file system might look first in the working directory of the spawning process, or might search the directories in a `PATH` environment variable as do Unix shells. An implementation on top of PVM would use PVM's rules for finding executables (usually in `$HOME/pvm3/bin/$PVM_ARCH`). An MPI implementation running under POE on an IBM SP would use POE's method of finding executables. An implementation should document its rules for finding executables and determining working directories, and a high-quality implementation should give the user some control over these rules. (*End of advice to implementors.*)

If the program named in `command` does not call `MPI_INIT`, but instead forks a process that calls `MPI_INIT`, the results are undefined. Implementations may allow this case to work but are not required to.

*Advice to users.* MPI does not say what happens if the program you start is a shell script and that shell script starts a program that calls `MPI_INIT`. Though some implementations may allow you to do this, they may also have restrictions, such as requiring that arguments supplied to the shell script be supplied to the program, or requiring that certain parts of the environment not be changed. (*End of advice to users.*)

**The argv argument** `argv` is an array of strings containing arguments that are passed to the program. The first element of `argv` is the first argument passed to `command`, not, as is conventional in some contexts, the command itself. The argument list is terminated by `NULL` in C and an empty string in Fortran. In Fortran, leading and trailing spaces are

1 always stripped, so that a string consisting of all spaces is considered an empty string. The  
 2 constant `MPI_ARGV_NULL` may be used in C and Fortran to indicate an empty argument  
 3 list. In C this constant is the same as `NULL`.

4  
 5 **Example 10.17** Examples of `argv` in C and Fortran

6 To run the program “ocean” with arguments “-gridfile” and “ocean1.grd” in C:

```
7
8     char command[] = "ocean";
9     char *argv[] = {"-gridfile", "ocean1.grd", NULL};
10    MPI_Comm_spawn(command, argv, ...);
```

11 or, if not everything is known at compile time:

```
12
13    char *command;
14    char **argv;
15    command = "ocean";
16    argv=(char **)malloc(3 * sizeof(char *));
17    argv[0] = "-gridfile";
18    argv[1] = "ocean1.grd";
19    argv[2] = NULL;
20    MPI_Comm_spawn(command, argv, ...);
```

21 In Fortran:

```
22
23    CHARACTER*25 command, argv(3)
24    command = 'ocean'
25    argv(1) = '-gridfile'
26    argv(2) = 'ocean1.grd'
27    argv(3) = ' '
28    call MPI_COMM_SPAWN(command, argv, ...)
```

29  
 30 Arguments are supplied to the program if this is allowed by the operating system. In  
 31 C, the `MPI_COMM_SPAWN` argument `argv` differs from the `argv` argument of `main` in two  
 32 respects. First, it is shifted by one element. Specifically, `argv[0]` of `main` is provided by the  
 33 implementation and conventionally contains the name of the program (given by `command`).  
 34 `argv[1]` of `main` corresponds to `argv[0]` in `MPI_COMM_SPAWN`, `argv[2]` of `main` to `argv[1]`  
 35 of `MPI_COMM_SPAWN`, etc. Passing an `argv` of `MPI_ARGV_NULL` to `MPI_COMM_SPAWN`  
 36 results in `main` receiving `argc` of 1 and an `argv` whose element 0 is (conventionally) the  
 37 name of the program. Second, `argv` of `MPI_COMM_SPAWN` must be null-terminated, so  
 38 that its length can be determined.

39 If a Fortran implementation supplies routines that allow a program to obtain its ar-  
 40 guments, the arguments may be available through that mechanism. In C, if the operating  
 41 system does not support arguments appearing in `argv` of `main()`, the MPI implementation  
 42 may add the arguments to the `argv` that is passed to `MPI_INIT`.

43  
 44 The `maxprocs` argument `MPI` tries to spawn `maxprocs` processes. If it is unable to spawn  
 45 `maxprocs` processes, it raises an error of class `MPI_ERR_SPAWN`.

46 An implementation may allow the `info` argument to change the default behavior, such  
 47 that if the implementation is unable to spawn all `maxprocs` processes, it may spawn a  
 48 smaller number of processes instead of raising an error. In principle, the `info` argument

may specify an arbitrary set  $\{m_i : 0 \leq m_i \leq \text{maxprocs}\}$  of allowed values for the number of processes spawned. The set  $\{m_i\}$  does not necessarily include the value `maxprocs`. If an implementation is able to spawn one of these allowed numbers of processes, `MPI_COMM_SPAWN` returns successfully and the number of spawned processes,  $m$ , is given by the size of the remote group of `intercomm`. If  $m$  is less than `maxproc`, reasons why the other processes were not spawned are given in `array_of_errcodes` as described below. If it is not possible to spawn one of the allowed numbers of processes, `MPI_COMM_SPAWN` raises an error of class `MPI_ERR_SPAWN`.

A spawn call with the default behavior is called *hard*. A spawn call for which fewer than `maxprocs` processes may be returned is called *soft*. See Section 10.8.4 for more information on the `soft` key for `info`.

*Advice to users.* By default, requests are hard and MPI errors are fatal. This means that by default there will be a fatal error if MPI cannot spawn all the requested processes. If you want the behavior “spawn as many processes as possible, up to  $N$ ,” you should do a soft spawn, where the set of allowed values  $\{m_i\}$  is  $\{0, \dots, N\}$ . However, this is not completely portable, as implementations are not required to support soft spawning. (*End of advice to users.*)

**The `info` argument** The `info` argument to all of the routines in this chapter is an opaque handle of type `MPI_Info` in C and Fortran with the `mpi_f08` module and `INTEGER` in Fortran with the `mpi` module or the include file `mpif.h`. It is a container for a number of user-specified (key,value) pairs. `key` and `value` are strings (null-terminated `char*` in C, `character*(*)` in Fortran). Routines to create and manipulate the `info` argument are described in Chapter 9.

For the `SPAWN` calls, `info` provides additional (and possibly implementation-dependent) instructions to MPI and the runtime system on how to start processes. An application may pass `MPI_INFO_NULL` in C or Fortran. Portable programs not requiring detailed control over process locations should use `MPI_INFO_NULL`.

MPI does not specify the content of the `info` argument, except to reserve a number of special key values (see Section 10.8.4). The `info` argument is quite flexible and could even be used, for example, to specify the executable and its command-line arguments. In this case the `command` argument to `MPI_COMM_SPAWN` could be empty. The ability to do this follows from the fact that MPI does not specify how an executable is found, and the `info` argument can tell the runtime system where to “find” the executable “” (empty string). Of course a program that does this will not be portable across MPI implementations.

**The `root` argument** All arguments before the `root` argument are examined only on the process whose rank in `comm` is equal to `root`. The value of these arguments on other processes is ignored.

**The `array_of_errcodes` argument** The `array_of_errcodes` is an array of length `maxprocs` in which MPI reports the status of each process that MPI was requested to start. If all `maxprocs` processes were spawned, `array_of_errcodes` is filled in with the value `MPI_SUCCESS`. If only  $m$  ( $0 \leq m < \text{maxprocs}$ ) processes are spawned,  $m$  of the entries will contain `MPI_SUCCESS` and the rest will contain an implementation-specific error code indicating the reason MPI could not start the process. MPI does not specify which entries correspond to failed processes. An implementation may, for instance, fill in error codes in one-to-one correspondence with a detailed specification in the `info` argument. These error codes all belong to the error class

1 MPI\_ERR Spawn if there was no error in the argument list. In C or Fortran, an application  
2 may pass MPI\_ERRCODES\_IGNORE if it is not interested in the error codes.

3  
4 *Advice to implementors.* MPI\_ERRCODES\_IGNORE in Fortran is a special type of  
5 constant, like MPI\_BOTTOM. See the discussion in Section 2.5.4. (*End of advice to*  
6 *implementors.*)

7  
8  
9 MPI\_COMM\_GET\_PARENT(parent)

10 OUT parent the parent communicator (handle)

11  
12 **C binding**

13 int MPI\_Comm\_get\_parent(MPI\_Comm \*parent)

14  
15 **Fortran 2008 binding**

16 MPI\_Comm\_get\_parent(parent, ierror)  
17 TYPE(MPI\_Comm), INTENT(OUT) :: parent  
18 INTEGER, OPTIONAL, INTENT(OUT) :: ierror

19  
20 **Fortran binding**

21 MPI\_COMM\_GET\_PARENT(PARENT, IERROR)  
22 INTEGER PARENT, IERROR

23 If a process was started with MPI\_COMM\_SPAWN or MPI\_COMM\_SPAWN\_MULTIPLE,  
24 MPI\_COMM\_GET\_PARENT returns the “parent” intercommunicator of the current process.  
25 This parent intercommunicator is created implicitly inside of MPI\_INIT and is the same in-  
26 tercommunicator returned by SPAWN in the parents.

27 If the process was not spawned, MPI\_COMM\_GET\_PARENT returns MPI\_COMM\_NULL.

28 After the parent communicator is freed or disconnected, MPI\_COMM\_GET\_PARENT  
29 returns MPI\_COMM\_NULL.

30  
31 *Advice to users.* MPI\_COMM\_GET\_PARENT returns a handle to a single intercom-  
32 municator. Calling MPI\_COMM\_GET\_PARENT a second time returns a handle to  
33 the same intercommunicator. Freeing the handle with MPI\_COMM\_DISCONNECT or  
34 MPI\_COMM\_FREE will cause other references to the intercommunicator to become  
35 invalid (dangling). Note that calling MPI\_COMM\_FREE on the parent communicator  
36 is not useful. (*End of advice to users.*)

37  
38 *Rationale.* The desire of the Forum was to create a constant  
39 MPI\_COMM\_PARENT similar to MPI\_COMM\_WORLD. Unfortunately such a constant  
40 cannot be used (syntactically) as an argument to MPI\_COMM\_DISCONNECT, which  
41 is explicitly allowed. (*End of rationale.*)

42  
43 **10.8.3 Starting Multiple Executables and Establishing Communication**

44 While MPI\_COMM\_SPAWN is sufficient for most cases, it does not allow the spawning  
45 of multiple binaries, or of the same binary with multiple sets of arguments. The follow-  
46 ing routine spawns multiple binaries or the same binary with multiple sets of arguments,  
47 establishing communication with them and placing them in the same MPI\_COMM\_WORLD.  
48

MPI_COMM_SPAWN_MULTIPLE(count, array_of_commands, array_of_argv, array_of_maxprocs,			1
array_of_info, root, comm, intercomm, array_of_errcodes)			2
IN	count	number of commands (positive integer, significant only at root)	3
			4
IN	array_of_commands	programs to be executed (array of strings, significant only at root)	5
			6
IN	array_of_argv	arguments for commands (array of array of strings, significant only at root)	7
			8
IN	array_of_maxprocs	maximum number of processes to start for each command (array of integers, significant only at root)	9
			10
IN	array_of_info	info objects telling the runtime system where and how to start processes (array of handles, significant only at root)	11
			12
IN	root	rank of process in which previous arguments are examined (integer)	13
			14
IN	comm	intracommunicator containing group of spawning processes (handle)	15
			16
OUT	intercomm	intercommunicator between original group and the newly spawned group (handle)	17
			18
OUT	array_of_errcodes	one error code per process (array of integers)	19
			20
			21
			22
			23
			24

**C binding**

```

int MPI_Comm_spawn_multiple(int count, char *array_of_commands[],
                           char **array_of_argv[], const int array_of_maxprocs[],
                           const MPI_Info array_of_info[], int root, MPI_Comm comm,
                           MPI_Comm *intercomm, int array_of_errcodes[])

```

**Fortran 2008 binding**

```

MPI_Comm_spawn_multiple(count, array_of_commands, array_of_argv,
                       array_of_maxprocs, array_of_info, root, comm, intercomm,
                       array_of_errcodes, ierror)
INTEGER, INTENT(IN) :: count, array_of_maxprocs(*), root
CHARACTER(LEN=*), INTENT(IN) :: array_of_commands(*),
array_of_argv(count, *)
TYPE(MPI_Info), INTENT(IN) :: array_of_info(*)
TYPE(MPI_Comm), INTENT(IN) :: comm
TYPE(MPI_Comm), INTENT(OUT) :: intercomm
INTEGER :: array_of_errcodes(*)
INTEGER, OPTIONAL, INTENT(OUT) :: ierror

```

**Fortran binding**

```

MPI_COMM_SPAWN_MULTIPLE(COUNT, ARRAY_OF_COMMANDS, ARRAY_OF_ARGV,
                       ARRAY_OF_MAXPROCS, ARRAY_OF_INFO, ROOT, COMM, INTERCOMM,
                       ARRAY_OF_ERRCODES, IERROR)
INTEGER COUNT, ARRAY_OF_MAXPROCS(*), ARRAY_OF_INFO(*), ROOT, COMM,
INTERCOMM, ARRAY_OF_ERRCODES(*), IERROR

```

1 CHARACTER\*(\*) ARRAY\_OF\_COMMANDS(\*), ARRAY\_OF\_ARGV(COUNT, \*)

2  
3 MPI\_COMM\_SPAWN\_MULTIPLE is identical to MPI\_COMM\_SPAWN except that there  
4 are multiple executable specifications. The first argument, `count`, gives the number of  
5 specifications. Each of the next four arguments are simply arrays of the corresponding  
6 arguments in MPI\_COMM\_SPAWN. For the Fortran version of `array_of_argv`, the element  
7 `array_of_argv(i,j)` is the  $j$ -th argument to command number  $i$ .

8 *Rationale.* This may seem backwards to Fortran programmers who are familiar  
9 with Fortran's column-major ordering. However, it is necessary to do it this way to  
10 allow MPI\_COMM\_SPAWN to sort out arguments. Note that the leading dimension  
11 of `array_of_argv` *must* be the same as `count`. Also note that Fortran rules for sequence  
12 association allow a different value in the first dimension; in this case, the sequence of  
13 array elements is interpreted by MPI\_COMM\_SPAWN\_MULTIPLE as if the sequence is  
14 stored in an array defined with the first dimension set to `count`. This Fortran feature  
15 allows an implementor to define MPI\_ARGVS\_NULL (see below) with fixed dimensions,  
16 e.g., (1,1), or only with one dimension, e.g., (1). (*End of rationale.*)

17  
18 *Advice to users.* The argument `count` is interpreted by MPI only at the root, as is  
19 `array_of_argv`. Since the leading dimension of `array_of_argv` is `count`, a non-positive  
20 value of `count` at a non-root node could theoretically cause a runtime bounds check  
21 error, even though `array_of_argv` should be ignored by the subroutine. If this happens,  
22 you should explicitly supply a reasonable value of `count` on the non-root nodes. (*End*  
23 *of advice to users.*)

24  
25 In any language, an application may use the constant MPI\_ARGVS\_NULL (which is likely  
26 to be `(char ***)0` in C) to specify that no arguments should be passed to any commands.  
27 The effect of setting individual elements of `array_of_argv` to MPI\_ARGV\_NULL is not defined.  
28 To specify arguments for some commands but not others, the commands without arguments  
29 should have a corresponding `argv` whose first element is null (`(char *)0` in C and empty  
30 string in Fortran). In Fortran at non-root processes, the `count` argument must be set to  
31 a value that is consistent with the provided `array_of_argv` although the content of these  
32 arguments has no meaning for this operation.

33 All of the spawned processes have the same MPI\_COMM\_WORLD. Their ranks in  
34 MPI\_COMM\_WORLD correspond directly to the order in which the commands are specified  
35 in MPI\_COMM\_SPAWN\_MULTIPLE. Assume that  $m_1$  processes are generated by the first  
36 command,  $m_2$  by the second, etc. The processes corresponding to the first command have  
37 ranks  $0, 1, \dots, m_1 - 1$ . The processes in the second command have ranks  $m_1, m_1 + 1, \dots, m_1 +$   
38  $m_2 - 1$ . The processes in the third have ranks  $m_1 + m_2, m_1 + m_2 + 1, \dots, m_1 + m_2 + m_3 - 1$ ,  
39 etc.

40  
41 *Advice to users.* Calling MPI\_COMM\_SPAWN multiple times would create many  
42 sets of children with different MPI\_COMM\_WORLDS whereas  
43 MPI\_COMM\_SPAWN\_MULTIPLE creates children with a single MPI\_COMM\_WORLD,  
44 so the two methods are not completely equivalent. There are also two performance-  
45 related reasons why, if you need to spawn multiple executables, you may want to  
46 use MPI\_COMM\_SPAWN\_MULTIPLE instead of calling MPI\_COMM\_SPAWN several  
47 times. First, spawning several things at once may be faster than spawning them  
48 sequentially. Second, in some implementations, communication between processes

spawned at the same time may be faster than communication between processes spawned separately. (*End of advice to users.*)

The `array_of_errcodes` argument is a 1-dimensional array of size  $\sum_{i=1}^{count} n_i$ , where  $n_i$  is the  $i$ -th element of `array_of_maxprocs`. Command number  $i$  corresponds to the  $n_i$  contiguous slots in this array from element  $\sum_{j=1}^{i-1} n_j$  to  $[\sum_{j=1}^i n_j] - 1$ . Error codes are treated as for `MPI_COMM_SPAWN`.

**Example 10.18** Examples of `array_of_argv` in C and Fortran

To run the program “ocean” with arguments “-gridfile” and “ocean1.grd” and the program “atmos” with argument “atmos.grd” in C:

```
char *array_of_commands[2] = {"ocean", "atmos"};
char **array_of_argv[2];
char *argv0[] = {"-gridfile", "ocean1.grd", (char *)0};
char *argv1[] = {"atmos.grd", (char *)0};
array_of_argv[0] = argv0;
array_of_argv[1] = argv1;
MPI_Comm_spawn_multiple(2, array_of_commands, array_of_argv, ...);
```

Here is how you do it in Fortran:

```
CHARACTER*25 commands(2), array_of_argv(2, 3)
commands(1) = 'ocean'
array_of_argv(1, 1) = '-gridfile'
array_of_argv(1, 2) = 'ocean1.grd'
array_of_argv(1, 3) = ' '

commands(2) = 'atmos'
array_of_argv(2, 1) = 'atmos.grd'
array_of_argv(2, 2) = ' '

call MPI_COMM_SPAWN_MULTIPLE(2, commands, array_of_argv, ...)
```

#### 10.8.4 Reserved Keys

The following keys are reserved. An implementation is not required to interpret these keys, but if it does interpret the key, it must provide the functionality described.

`host` Value is a hostname. The format of the hostname is determined by the implementation.

`arch` Value is an architecture name. Valid architecture names and what they mean are determined by the implementation.

`wdir` Value is the name of a directory on a machine on which the spawned process(es) execute(s). This directory is made the working directory of the executing process(es). The format of the directory name is determined by the implementation.

`path` Value is a directory or set of directories where the implementation should look for the executable. The format of path is determined by the implementation.

1 file Value is the name of a file in which additional information is specified. The format of  
 2 the filename and internal format of the file are determined by the implementation.

3  
 4 `mpi_initial_errhandler` Value is the name of an errhandler that will be set as the initial error  
 5 handler. The `mpi_initial_errhandler` key can take the case insensitive values  
 6 `mpi_errors_are_fatal`, `mpi_errors_abort`, and `mpi_errors_return` representing the predefined  
 7 MPI error handlers (`MPI_ERRORS_ARE_FATAL`—the default, `MPI_ERRORS_ABORT`, and  
 8 `MPI_ERRORS_RETURN`, respectively). Other, non-standard values may be supported  
 9 by the implementation, which should document the resultant behavior.

10 `soft` Value specifies a set of numbers which are allowed values for the number of processes  
 11 that `MPI_COMM_SPAWN` (et al.) may create. The format of the value is a comma-  
 12 separated list of Fortran-90 triplets each of which specifies a set of integers and which  
 13 together specify the set formed by the union of these sets. Negative values in this set  
 14 and values greater than `maxprocs` are ignored. MPI will spawn the largest number of  
 15 processes it can, consistent with some number in the set. The order in which triplets  
 16 are given is not significant.

17 By Fortran-90 triplets, we mean:

- 19 1. `a` means  $a$
- 20 2. `a:b` means  $a, a + 1, a + 2, \dots, b$
- 21 3. `a:b:c` means  $a, a + c, a + 2c, \dots, a + ck$ , where for  $c > 0$ ,  $k$  is the largest integer  
 22 for which  $a + ck \leq b$  and for  $c < 0$ ,  $k$  is the largest integer for which  $a + ck \geq b$ .  
 23 If  $b > a$  then  $c$  must be positive. If  $b < a$  then  $c$  must be negative.

24 Examples:

- 25 1. `a:b` gives a range between  $a$  and  $b$
- 26 2. `0:N` gives full “soft” functionality
- 27 3. `1,2,4,8,16,32,64,128,256,512,1024,2048,4096` allows a power-of-two num-  
 28 ber of processes.
- 29 4. `2:10000:2` allows an even number of processes.
- 30 5. `2:10:2,7` allows 2, 4, 6, 7, 8, or 10 processes.

## 31 10.8.5 Spawn Example

32 Manager-worker Example Using `MPI_COMM_SPAWN`

```
33 /* manager */
34 #include "mpi.h"
35 int main(int argc, char *argv[])
36 {
37     int world_size, universe_size, *universe_sizep, flag;
38     MPI_Comm everyone;           /* intercommunicator */
39     char worker_program[100];
40
41     MPI_Init(&argc, &argv);
42     MPI_Comm_size(MPI_COMM_WORLD, &world_size);
```



```

1
2   if (world_size != 1)    error("Top heavy with management");
3
4   MPI_Comm_get_attr(MPI_COMM_WORLD, MPI_UNIVERSE_SIZE,
5                       &universe_sizep, &flag);
6
7   if (!flag) {
8       printf("This MPI does not support UNIVERSE_SIZE. How many\n\
9 processes total?");
10      scanf("%d", &universe_size);
11  } else universe_size = *universe_sizep;
12  if (universe_size == 1) error("No room to start workers");
13
14  /*
15   * Now spawn the workers. Note that there is a run-time determination
16   * of what type of worker to spawn, and presumably this calculation must
17   * be done at run time and cannot be calculated before starting
18   * the program. If everything is known when the application is
19   * first started, it is generally better to start them all at once
20   * in a single MPI_COMM_WORLD.
21   */
22
23  choose_worker_program(worker_program);
24  MPI_Comm_spawn(worker_program, MPI_ARGV_NULL, universe_size-1,
25                MPI_INFO_NULL, 0, MPI_COMM_SELF, &everyone,
26                MPI_ERRCODES_IGNORE);
27
28  /*
29   * Parallel code here. The communicator "everyone" can be used
30   * to communicate with the spawned processes, which have ranks 0,..
31   * MPI_UNIVERSE_SIZE-1 in the remote group of the intercommunicator
32   * "everyone".
33   */
34
35  MPI_Finalize();
36  return 0;
37  }
38
39  /* worker */
40
41  #include "mpi.h"
42  int main(int argc, char *argv[])
43  {
44      int size;
45      MPI_Comm parent;
46      MPI_Init(&argc, &argv);
47      MPI_Comm_get_parent(&parent);
48      if (parent == MPI_COMM_NULL) error("No parent!");
49      MPI_Comm_remote_size(parent, &size);
50      if (size != 1) error("Something's wrong with the parent");

```

```

1
2  /*
3   * Parallel code here.
4   * The manager is represented as the process with rank 0 in (the remote
5   * group of) the parent communicator. If the workers need to communicate
6   * among themselves, they can use MPI_COMM_WORLD.
7   */
8
9  MPI_Finalize();
10 return 0;
11 }
12
13
14
15

```

## 10.9 Establishing Communication

This section provides functions that establish communication between two sets of MPI processes that do not share a communicator.

Some situations in which these functions are useful are:

1. Two parts of an application that are started independently need to communicate.
2. A visualization tool wants to attach to a running process.
3. A server wants to accept connections from multiple clients. Both clients and server may be parallel programs.

In each of these situations, MPI must establish communication channels where none existed before, and there is no parent/child relationship. The routines described in this section establish communication between the two sets of processes by creating an MPI intercommunicator, where the two groups of the intercommunicator are the original sets of processes.

Establishing contact between two groups of processes that do not share an existing communicator is a collective but asymmetric process. One group of processes indicates its willingness to accept connections from other groups of processes. We will call this group the (parallel) *server*, even if this is not a client/server type of application. The other group connects to the server; we will call it the *client*.

*Advice to users.* While the names *client* and *server* are used throughout this section, MPI does not guarantee the traditional robustness of client/server systems. The functionality described in this section is intended to allow two cooperating parts of the same application to communicate with one another. For instance, a client that gets a segmentation fault and dies, or one that does not participate in a collective operation may cause a server to crash or hang. (*End of advice to users.*)

### 10.9.1 Names, Addresses, Ports, and All That

Almost all of the complexity in MPI client/server routines addresses the question “how does the client find out how to contact the server?” The difficulty, of course, is that there is no existing communication channel between them, yet they must somehow agree on a rendezvous point where they will establish communication.

Agreeing on a rendezvous point always involves a third party. The third party may itself provide the rendezvous point or may communicate rendezvous information from server to client. Complicating matters might be the fact that a client does not really care what server it contacts, only that it be able to get in touch with one that can handle its request.

Ideally, MPI can accommodate a wide variety of run-time systems while retaining the ability to write simple, portable code. The following should be compatible with MPI:

- The server resides at a well-known internet address host:port.
- The server prints out an address to the terminal; the user gives this address to the client program.
- The server places the address information on a nameserver, where it can be retrieved with an agreed-upon name.
- The server to which the client connects is actually a broker, acting as a middleman between the client and the real server.

MPI does not require a nameserver, so not all implementations will be able to support all of the above scenarios. However, MPI provides an optional nameserver interface, and is compatible with external name servers.

A `port_name` is a *system-supplied* string that encodes a low-level network address at which a server can be contacted. Typically this is an IP address and a port number, but an implementation is free to use any protocol. The server establishes a `port_name` with the `MPI_OPEN_PORT` routine. It accepts a connection to a given port with `MPI_COMM_ACCEPT`. A client uses `port_name` to connect to the server.

By itself, the `port_name` mechanism is completely portable, but it may be clumsy to use because of the necessity to communicate `port_name` to the client. It would be more convenient if a server could specify that it be known by an *application-supplied* `service_name` so that the client could connect to that `service_name` without knowing the `port_name`.

An MPI implementation may allow the server to publish a (`port_name`, `service_name`) pair with `MPI_PUBLISH_NAME` and the client to retrieve the port name from the service name with `MPI_LOOKUP_NAME`. This allows three levels of portability, with increasing levels of functionality.

1. Applications that do not rely on the ability to publish names are the most portable. Typically the `port_name` must be transferred “by hand” from server to client.
2. Applications that use the `MPI_PUBLISH_NAME` mechanism are completely portable among implementations that provide this service. To be portable among all implementations, these applications should have a fall-back mechanism that can be used when names are not published.
3. Applications may ignore MPI’s name publishing functionality and use their own mechanism (possibly system-supplied) to publish names. This allows arbitrary flexibility but is not portable.

### 10.9.2 Server Routines

A server makes itself available with two routines. First it must call `MPI_OPEN_PORT` to establish a port at which it may be contacted. Secondly it must call `MPI_COMM_ACCEPT` to accept connections from clients.

1 MPI\_OPEN\_PORT(info, port\_name)

2 IN info implementation-specific information on how to estab-  
3 lish an address (handle)

4  
5 OUT port\_name newly established port (string)

### 6 7 C binding

8 int MPI\_Open\_port(MPI\_Info info, char \*port\_name)

### 9 10 Fortran 2008 binding

11 MPI\_Open\_port(info, port\_name, ierror)

12 TYPE(MPI\_Info), INTENT(IN) :: info

13 CHARACTER(LEN=MPI\_MAX\_PORT\_NAME), INTENT(OUT) :: port\_name

14 INTEGER, OPTIONAL, INTENT(OUT) :: ierror

### 15 Fortran binding

16 MPI\_OPEN\_PORT(INFO, PORT\_NAME, IERROR)

17 INTEGER INFO, IERROR

18 CHARACTER\*(\*) PORT\_NAME

19  
20 This function establishes a network address, encoded in the `port_name` string, at which  
21 the server will be able to accept connections from clients. `port_name` is supplied by the  
22 system, possibly using information in the `info` argument.

23 MPI copies a system-supplied port name into `port_name`. `port_name` identifies the newly  
24 opened port and can be used by a client to contact the server. The maximum size string  
25 that may be supplied by the system is `MPI_MAX_PORT_NAME`.

26 *Advice to users.* The system copies the port name into `port_name`. The application  
27 must pass a buffer of sufficient size to hold this value. (*End of advice to users.*)

28  
29 `port_name` is essentially a network address. It is unique within the communication  
30 universe to which it belongs (determined by the implementation), and may be used by any  
31 client within that communication universe. For instance, if it is an internet (host:port)  
32 address, it will be unique on the internet. If it is a low level switch address on an IBM SP,  
33 it will be unique to that SP.

34 *Advice to implementors.* These examples are not meant to constrain implementa-  
35 tions. A `port_name` could, for instance, contain a user name or the name of a batch  
36 job, as long as it is unique within some well-defined communication domain. The  
37 larger the communication domain, the more useful MPI's client/server functionality  
38 will be. (*End of advice to implementors.*)

39  
40 The precise form of the address is implementation-defined. For instance, an internet address  
41 may be a host name or IP address, or anything that the implementation can decode into  
42 an IP address. A port name may be reused after it is freed with `MPI_CLOSE_PORT` and  
43 released by the system.

44  
45 *Advice to implementors.* Since the user may type in `port_name` by hand, it is useful  
46 to choose a form that is easily readable and does not have embedded spaces. (*End of*  
47 *advice to implementors.*)

info may be used to tell the implementation how to establish the address. It may, and usually will, be MPI\_INFO\_NULL in order to get the implementation defaults.

MPI\_CLOSE\_PORT(port\_name)

IN port\_name a port (string)

### C binding

```
int MPI_Close_port(const char *port_name)
```

### Fortran 2008 binding

```
MPI_Close_port(port_name, ierror)
  CHARACTER(LEN=*), INTENT(IN) :: port_name
  INTEGER, OPTIONAL, INTENT(OUT) :: ierror
```

### Fortran binding

```
MPI_CLOSE_PORT(PORT_NAME, IERROR)
  CHARACTER*(*) PORT_NAME
  INTEGER IERROR
```

MPI\_COMM\_ACCEPT(port\_name, info, root, comm, newcomm)

IN port\_name port name (string, significant only at root)

IN info implementation-dependent information (handle, significant only at root)

IN root rank in comm of root node (integer)

IN comm intracommunicator over which call is collective (handle)

OUT newcomm intercommunicator with client as remote group (handle)

### C binding

```
int MPI_Comm_accept(const char *port_name, MPI_Info info, int root,
  MPI_Comm comm, MPI_Comm *newcomm)
```

### Fortran 2008 binding

```
MPI_Comm_accept(port_name, info, root, comm, newcomm, ierror)
  CHARACTER(LEN=*), INTENT(IN) :: port_name
  TYPE(MPI_Info), INTENT(IN) :: info
  INTEGER, INTENT(IN) :: root
  TYPE(MPI_Comm), INTENT(IN) :: comm
  TYPE(MPI_Comm), INTENT(OUT) :: newcomm
  INTEGER, OPTIONAL, INTENT(OUT) :: ierror
```

### Fortran binding

```
MPI_COMM_ACCEPT(PORT_NAME, INFO, ROOT, COMM, NEWCOMM, IERROR)
  CHARACTER*(*) PORT_NAME
```

1           INTEGER INFO, ROOT, COMM, NEWCOMM, IERROR

2           MPI\_COMM\_ACCEPT establishes communication with a client. It is collective over the  
3 calling communicator. It returns an intercommunicator that allows communication with the  
4 client.

5           The `port_name` must have been established through a call to `MPI_OPEN_PORT`.

6           `info` can be used to provide directives that may influence the behavior of the `ACCEPT`  
7 call.  
8

### 9           10.9.3 Client Routines

10          There is only one routine on the client side.

11          MPI\_COMM\_CONNECT(`port_name`, `info`, `root`, `comm`, `newcomm`)

12	IN	<code>port_name</code>	network address (string, significant only at root)
13	IN	<code>info</code>	implementation-dependent information (handle, sig- 14 nificant only at root)
15	IN	<code>root</code>	rank in <code>comm</code> of root node (integer)
16	IN	<code>comm</code>	intracommunicator over which call is collective (han- 17 dle)
18	OUT	<code>newcomm</code>	intercommunicator with server as remote group (han- 19 dle)

#### 20          C binding

21          int MPI\_Comm\_connect(const char \*port\_name, MPI\_Info info, int root,  
22                               MPI\_Comm comm, MPI\_Comm \*newcomm)

#### 23          Fortran 2008 binding

24          MPI\_Comm\_connect(`port_name`, `info`, `root`, `comm`, `newcomm`, `ierror`)  
25            CHARACTER(LEN=\*), INTENT(IN) :: `port_name`  
26            TYPE(MPI\_Info), INTENT(IN) :: `info`  
27            INTEGER, INTENT(IN) :: `root`  
28            TYPE(MPI\_Comm), INTENT(IN) :: `comm`  
29            TYPE(MPI\_Comm), INTENT(OUT) :: `newcomm`  
30            INTEGER, OPTIONAL, INTENT(OUT) :: `ierror`

#### 31          Fortran binding

32          MPI\_COMM\_CONNECT(PORT\_NAME, INFO, ROOT, COMM, NEWCOMM, IERROR)  
33            CHARACTER\*(\*) PORT\_NAME  
34            INTEGER INFO, ROOT, COMM, NEWCOMM, IERROR

35          This routine establishes communication with a server specified by `port_name`. It is  
36 collective over the calling communicator and returns an intercommunicator in which the  
37 remote group participated in an `MPI_COMM_ACCEPT`.

38          If the named port does not exist (or has been closed), `MPI_COMM_CONNECT` raises  
39 an error of class `MPI_ERR_PORT`.  
40  
41  
42  
43  
44  
45  
46  
47  
48

If the port exists, but does not have a pending `MPI_COMM_ACCEPT`, the connection attempt will eventually time out after an implementation-defined time, or succeed when the server calls `MPI_COMM_ACCEPT`. In the case of a time out, `MPI_COMM_CONNECT` raises an error of class `MPI_ERR_PORT`.

*Advice to implementors.* The time out period may be arbitrarily short or long. However, a high-quality implementation will try to queue connection attempts so that a server can handle simultaneous requests from several clients. A high-quality implementation may also provide a mechanism, through the `info` arguments to `MPI_OPEN_PORT`, `MPI_COMM_ACCEPT`, and/or `MPI_COMM_CONNECT`, for the user to control timeout and queuing behavior. (*End of advice to implementors.*)

MPI provides no guarantee of fairness in servicing connection attempts. That is, connection attempts are not necessarily satisfied in the order they were initiated and competition from other connection attempts may prevent a particular connection attempt from being satisfied.

`port_name` is the address of the server. It must be the same as the name returned by `MPI_OPEN_PORT` on the server. Some freedom is allowed here. If there are equivalent forms of `port_name`, an implementation may accept them as well. For instance, if `port_name` is `(hostname:port)`, an implementation may accept `(ip_address:port)` as well.

#### 10.9.4 Name Publishing

The routines in this section provide a mechanism for publishing names. A `(service_name, port_name)` pair is published by the server, and may be retrieved by a client using the `service_name` only. An MPI implementation defines the *scope* of the `service_name`, that is, the domain over which the `service_name` can be retrieved. If the domain is the empty set, that is, if no client can retrieve the information, then we say that name publishing is not supported. Implementations should document how the scope is determined. High-quality implementations will give some control to users through the `info` arguments to name publishing functions. Examples are given in the descriptions of individual functions.

`MPI_PUBLISH_NAME(service_name, info, port_name)`

IN	<code>service_name</code>	a service name to associate with the port (string)
IN	<code>info</code>	implementation-specific information (handle)
IN	<code>port_name</code>	a port name (string)

#### C binding

```
int MPI_Publish_name(const char *service_name, MPI_Info info,
                   const char *port_name)
```

#### Fortran 2008 binding

```
MPI_Publish_name(service_name, info, port_name, ierror)
  CHARACTER(LEN=*), INTENT(IN) :: service_name, port_name
  TYPE(MPI_Info), INTENT(IN) :: info
  INTEGER, OPTIONAL, INTENT(OUT) :: ierror
```

#### Fortran binding

```

1 MPI_PUBLISH_NAME(SERVICE_NAME, INFO, PORT_NAME, IERROR)
2     CHARACTER*(*) SERVICE_NAME, PORT_NAME
3     INTEGER INFO, IERROR

```

This routine publishes the pair (`port_name`, `service_name`) so that an application may retrieve a system-supplied `port_name` using a well-known `service_name`.

The implementation must define the *scope* of a published service name, that is, the domain over which the service name is unique, and conversely, the domain over which the (port name, service name) pair may be retrieved. For instance, a service name may be unique to a job (where job is defined by a distributed operating system or batch scheduler), unique to a machine, or unique to a Kerberos realm. The scope may depend on the `info` argument to `MPI_PUBLISH_NAME`.

MPI permits publishing more than one `service_name` for a single `port_name`. On the other hand, if `service_name` has already been published within the scope determined by `info`, the behavior of `MPI_PUBLISH_NAME` is undefined. An MPI implementation may, through a mechanism in the `info` argument to `MPI_PUBLISH_NAME`, provide a way to allow multiple servers with the same service in the same scope. In this case, an implementation-defined policy will determine which of several port names is returned by `MPI_LOOKUP_NAME`.

Note that while `service_name` has a limited scope, determined by the implementation, `port_name` always has global scope within the communication universe used by the implementation (i.e., it is globally unique).

`port_name` should be the name of a port established by `MPI_OPEN_PORT` and not yet released by `MPI_CLOSE_PORT`. If it is not, the result is undefined.

*Advice to implementors.* In some cases, an MPI implementation may use a name service that a user can also access directly. In this case, a name published by MPI could easily conflict with a name published by a user. In order to avoid such conflicts, MPI implementations should mangle service names so that they are unlikely to conflict with user code that makes use of the same service. Such name mangling will of course be completely transparent to the user.

The following situation is problematic but unavoidable, if we want to allow implementations to use nameservers. Suppose there are multiple instances of “ocean” running on a machine. If the scope of a service name is confined to a job, then multiple oceans can coexist. If an implementation provides site-wide scope, however, multiple instances are not possible as all calls to `MPI_PUBLISH_NAME` after the first may fail. There is no universal solution to this.

To handle these situations, a high-quality implementation should make it possible to limit the domain over which names are published. (*End of advice to implementors.*)

```

41 MPI_UNPUBLISH_NAME(service_name, info, port_name)
42
43     IN        service_name        a service name (string)
44     IN        info                implementation-specific information (handle)
45     IN        port_name           a port name (string)

```

## C binding



```
int MPI_Unpublish_name(const char *service_name, MPI_Info info,
                      const char *port_name)
```

**Fortran 2008 binding**

```
MPI_Unpublish_name(service_name, info, port_name, ierror)
  CHARACTER(LEN=*), INTENT(IN) :: service_name, port_name
  TYPE(MPI_Info), INTENT(IN) :: info
  INTEGER, OPTIONAL, INTENT(OUT) :: ierror
```

**Fortran binding**

```
MPI_UNPUBLISH_NAME(SERVICE_NAME, INFO, PORT_NAME, IERROR)
  CHARACTER*(*) SERVICE_NAME, PORT_NAME
  INTEGER INFO, IERROR
```

This routine unpublishes a service name that has been previously published. Attempting to unpublish a name that has not been published or has already been unpublished is erroneous and is indicated by the error class `MPI_ERR_SERVICE`.

All published names must be unpublished before the corresponding port is closed and before the publishing process exits. The behavior of `MPI_UNPUBLISH_NAME` is implementation dependent when a process tries to unpublish a name that it did not publish.

If the `info` argument was used with `MPI_PUBLISH_NAME` to tell the implementation how to publish names, the implementation may require that `info` passed to `MPI_UNPUBLISH_NAME` contain information to tell the implementation how to unpublish a name.

```
MPI_LOOKUP_NAME(service_name, info, port_name)
```

IN	service_name	a service name (string)
IN	info	implementation-specific information (handle)
OUT	port_name	a port name (string)

**C binding**

```
int MPI_Lookup_name(const char *service_name, MPI_Info info,
                  char *port_name)
```

**Fortran 2008 binding**

```
MPI_Lookup_name(service_name, info, port_name, ierror)
  CHARACTER(LEN=*), INTENT(IN) :: service_name
  TYPE(MPI_Info), INTENT(IN) :: info
  CHARACTER(LEN=MPI_MAX_PORT_NAME), INTENT(OUT) :: port_name
  INTEGER, OPTIONAL, INTENT(OUT) :: ierror
```

**Fortran binding**

```
MPI_LOOKUP_NAME(SERVICE_NAME, INFO, PORT_NAME, IERROR)
  CHARACTER*(*) SERVICE_NAME, PORT_NAME
  INTEGER INFO, IERROR
```

This function retrieves a `port_name` published by `MPI_PUBLISH_NAME` with `service_name`. If `service_name` has not been published, it raises an error in the error class

1 MPI\_ERR\_NAME. The application must supply a `port_name` buffer large enough to hold the  
 2 largest possible port name (see discussion above under `MPI_OPEN_PORT`).

3 If an implementation allows multiple entries with the same `service_name` within the  
 4 same scope, a particular `port_name` is chosen in a way determined by the implementation.

5 If the `info` argument was used with `MPI_PUBLISH_NAME` to tell the implementation  
 6 how to publish names, a similar `info` argument may be required for `MPI_LOOKUP_NAME`.

### 8 10.9.5 Reserved Key Values

9 The following key values are reserved. An implementation is not required to interpret these  
 10 key values, but if it does interpret the key value, it must provide the functionality described.

11 `ip_port` Value contains IP port number at which to establish a `port`. (Reserved for  
 12 `MPI_OPEN_PORT` only).

13 `ip_address` Value contains IP address at which to establish a `port`. If the address is not a  
 14 valid IP address of the host on which the `MPI_OPEN_PORT` call is made, the results  
 15 are undefined. (Reserved for `MPI_OPEN_PORT` only).

### 16 10.9.6 Client/Server Examples

#### 17 Simplest Example — Completely Portable.

18 The following example shows the simplest way to use the client/server interface. It does  
 19 not use service names at all.

20 On the server side:

```
21
22 char myport[MPI_MAX_PORT_NAME];
23 MPI_Comm intercomm;
24 /* ... */
25 MPI_Open_port(MPI_INFO_NULL, myport);
26 printf("port name is: %s\n", myport);
27
28 MPI_Comm_accept(myport, MPI_INFO_NULL, 0, MPI_COMM_SELF, &intercomm);
29 /* do something with intercomm */
```

30 The server prints out the port name to the terminal and the user must type it in when  
 31 starting up the client (assuming the MPI implementation supports `stdin` such that this  
 32 works). On the client side:

```
33
34 MPI_Comm intercomm;
35 char name[MPI_MAX_PORT_NAME];
36 printf("enter port name: ");
37 gets(name);
38 MPI_Comm_connect(name, MPI_INFO_NULL, 0, MPI_COMM_SELF, &intercomm);
```

#### 39 Ocean/Atmosphere — Relies on Name Publishing

40 In this example, the “ocean” application is the “server” side of a coupled ocean-atmosphere  
 41 climate model. It assumes that the MPI implementation publishes names.

```

MPI_Open_port(MPI_INFO_NULL, port_name);
MPI_Publish_name("ocean", MPI_INFO_NULL, port_name);

MPI_Comm_accept(port_name, MPI_INFO_NULL, 0, MPI_COMM_SELF, &intercomm);
/* do something with intercomm */
MPI_Unpublish_name("ocean", MPI_INFO_NULL, port_name);

```

On the client side:

```

MPI_Lookup_name("ocean", MPI_INFO_NULL, port_name);
MPI_Comm_connect(port_name, MPI_INFO_NULL, 0, MPI_COMM_SELF,
                 &intercomm);

```

### Simple Client-Server Example

This is a simple example; the server accepts only a single connection at a time and serves that connection until the client requests to be disconnected. The server is a single process.

Here is the server. It accepts a single connection and then processes data until it receives a message with tag 1. A message with tag 0 tells the server to exit.

```

#include "mpi.h"
int main(int argc, char *argv[])
{
    MPI_Comm client;
    MPI_Status status;
    char port_name[MPI_MAX_PORT_NAME];
    double buf[MAX_DATA];
    int size, again;

    MPI_Init(&argc, &argv);
    MPI_Comm_size(MPI_COMM_WORLD, &size);
    if (size != 1) error(FATAL, "Server too big");
    MPI_Open_port(MPI_INFO_NULL, port_name);
    printf("server available at %s\n", port_name);
    while (1) {
        MPI_Comm_accept(port_name, MPI_INFO_NULL, 0, MPI_COMM_WORLD,
                       &client);

        again = 1;
        while (again) {
            MPI_Recv(buf, MAX_DATA, MPI_DOUBLE,
                    MPI_ANY_SOURCE, MPI_ANY_TAG, client, &status);
            switch (status.MPI_TAG) {
                case 0: MPI_Comm_free(&client);
                       MPI_Close_port(port_name);
                       MPI_Finalize();
                       return 0;
                case 1: MPI_Comm_disconnect(&client);
            }
        }
    }
}

```

```

1         again = 0;
2         break;
3     case 2: /* do something */
4         ...
5     default:
6         /* Unexpected message type */
7         MPI_Abort(MPI_COMM_WORLD, 1);
8     }
9 }
10 }
11 }
12
13     Here is the client.
14
15     #include "mpi.h"
16     int main(int argc, char **argv)
17     {
18         MPI_Comm server;
19         double buf[MAX_DATA];
20         char port_name[MPI_MAX_PORT_NAME];
21
22         MPI_Init(&argc, &argv);
23         strcpy(port_name, argv[1]); /* assume server's name is cmd-line arg */
24
25         MPI_Comm_connect(port_name, MPI_INFO_NULL, 0, MPI_COMM_WORLD,
26                         &server);
27
28         while (!done) {
29             tag = 2; /* Action to perform */
30             MPI_Send(buf, n, MPI_DOUBLE, 0, tag, server);
31             /* etc */
32         }
33         MPI_Send(buf, 0, MPI_DOUBLE, 0, 1, server);
34         MPI_Comm_disconnect(&server);
35         MPI_Finalize();
36         return 0;
37     }

```

## 10.10 Other Functionality

### 10.10.1 Universe Size

Many “dynamic” MPI applications are expected to exist in a static runtime environment, in which resources have been allocated before the application is run. When a user (or possibly a batch system) runs one of these quasi-static applications, she will usually specify a number of processes to start and a total number of processes that are expected. An application simply needs to know how many slots there are, i.e., how many processes it should spawn.

MPI provides an attribute on `MPI_COMM_WORLD`, `MPI_UNIVERSE_SIZE`, that allows the application to obtain this information in a portable manner. This attribute indicates the total number of processes that are expected. In Fortran, the attribute is the integer value. In C, the attribute is a pointer to the integer value. An application typically subtracts the size of `MPI_COMM_WORLD` from `MPI_UNIVERSE_SIZE` to find out how many processes it should spawn. `MPI_UNIVERSE_SIZE` is initialized in `MPI_INIT` and is not changed by MPI. If defined, it has the same value on all processes of `MPI_COMM_WORLD`. `MPI_UNIVERSE_SIZE` is determined by the application startup mechanism in a way not specified by MPI. (The size of `MPI_COMM_WORLD` is another example of such a parameter.)

Possibilities for how `MPI_UNIVERSE_SIZE` might be set include

- A `-universe_size` argument to a program that starts MPI processes.
- Automatic interaction with a batch scheduler to figure out how many processors have been allocated to an application.
- An environment variable set by the user.
- Extra information passed to `MPI_COMM_SPAWN` through the `info` argument.

An implementation must document how `MPI_UNIVERSE_SIZE` is set. An implementation may not support the ability to set `MPI_UNIVERSE_SIZE`, in which case the attribute `MPI_UNIVERSE_SIZE` is not set.

`MPI_UNIVERSE_SIZE` is a recommendation, not necessarily a hard limit. For instance, some implementations may allow an application to spawn 50 processes per processor, if they are requested. However, it is likely that the user only wants to spawn one process per processor.

`MPI_UNIVERSE_SIZE` is assumed to have been specified when an application was started, and is in essence a portable mechanism to allow the user to pass to the application (through the MPI process startup mechanism, such as `mpirexec`) a piece of critical runtime information. Note that no interaction with the runtime environment is required. If the runtime environment changes size while an application is running, `MPI_UNIVERSE_SIZE` is not updated, and the application must find out about the change through direct communication with the runtime system.

### 10.10.2 Singleton MPI Initialization

A high-quality implementation will allow any process (including those not started with a “parallel application” mechanism) to become an MPI process by calling `MPI_INIT`, `MPI_INIT_THREAD`, or `MPI_SESSION_INIT`. Such a process can then connect to other MPI processes using the `MPI_COMM_ACCEPT` and `MPI_COMM_CONNECT` routines, or spawn other MPI processes. MPI does not mandate this behavior, but strongly encourages it where technically feasible.

*Advice to implementors.* Special coordination is required to start MPI processes belonging to the same `MPI_COMM_WORLD` in the case of the World Model, or the same “`mpi://world`” process set in the Sessions Model. The processes must be started at the “same” time, they must have a mechanism to establish communication, etc. Either the user or the operating system must take special steps beyond simply starting processes.

1 Considering the World Model, when an application enters `MPI_INIT`, clearly it must  
 2 be able to determine if these special steps were taken. If a process enters `MPI_INIT` and  
 3 determines that no special steps were taken (i.e., it has not been given the information  
 4 to form an `MPI_COMM_WORLD` with other processes) it succeeds and forms a singleton  
 5 MPI program, that is, one in which `MPI_COMM_WORLD` has size 1.

6 In some implementations, MPI may not be able to function without an “MPI environ-  
 7 ment.” For example, MPI may require that daemons be running or MPI may not be  
 8 able to work at all on the front-end of an MPP. In this case, an MPI implementation  
 9 may either

- 10 1. Create the environment (e.g., start a daemon) or
- 11 2. Raise an error if it cannot create the environment and the environment has not  
 12 been started independently.

13 A high-quality implementation will try to create a singleton MPI process and not raise  
 14 an error.

15 (*End of advice to implementors.*)

### 16 10.10.3 MPI\_APPNUM

17 There is a predefined attribute `MPI_APPNUM` of `MPI_COMM_WORLD`. In Fortran, the at-  
 18 tribute is an integer value. In C, the attribute is a pointer to an integer value. If a process  
 19 was spawned with `MPI_COMM_SPAWN_MULTIPLE`, `MPI_APPNUM` is the command number  
 20 that generated the current process. Numbering starts from zero. If a process was spawned  
 21 with `MPI_COMM_SPAWN`, it will have `MPI_APPNUM` equal to zero.

22 Additionally, if the process was not started by a spawn call, but by an implementa-  
 23 tion-specific startup mechanism that can handle multiple process specifications, `MPI_APPNUM`  
 24 should be set to the number of the corresponding process specification. In particular, if it  
 25 is started with

```
26 mpiexec spec0 [: spec1 : spec2 : ...]
```

27 `MPI_APPNUM` should be set to the number of the corresponding specification.

28 If an application was not spawned with `MPI_COMM_SPAWN` or  
 29 `MPI_COMM_SPAWN_MULTIPLE`, and `MPI_APPNUM` does not make sense in the context of  
 30 the implementation-specific startup mechanism, `MPI_APPNUM` is not set.

31 MPI implementations may optionally provide a mechanism to override the value of  
 32 `MPI_APPNUM` through the info argument. MPI reserves the following key for all `SPAWN`  
 33 calls.

34 **appnum** Value contains an integer that overrides the default value for `MPI_APPNUM` in the  
 35 child.

36 *Rationale.* When a single application is started, it is able to figure out how many pro-  
 37 cesses there are by looking at the size of `MPI_COMM_WORLD`. An application consisting  
 38 of multiple SPMD sub-applications has no way to find out how many sub-applications  
 39 there are and to which sub-application the process belongs. While there are ways to  
 40 figure it out in special cases, there is no general mechanism. `MPI_APPNUM` provides  
 41 such a general mechanism. (*End of rationale.*)

## 10.10.4 Releasing Connections

Before a client and server connect, they are independent MPI applications. An error in one does not affect the other. After establishing a connection with `MPI_COMM_CONNECT` and `MPI_COMM_ACCEPT`, an error in one may affect the other. It is desirable for a client and server to be able to disconnect, so that an error in one will not affect the other. Similarly, it might be desirable for a parent and child to disconnect, so that errors in the child do not affect the parent, or vice-versa.

- Two processes are **connected** if there is a communication path (direct or indirect) between them. More precisely:
  1. Two processes are connected if
    - (a) they both belong to the same communicator (inter- or intra-, including `MPI_COMM_WORLD`) *or*
    - (b) they have previously belonged to a communicator that was freed with `MPI_COMM_FREE` instead of `MPI_COMM_DISCONNECT` *or*
    - (c) they both belong to the group of the same window or filehandle.
  2. If A is connected to B and B to C, then A is connected to C.
- Two processes are **disconnected** (also **independent**) if they are not connected.
- By the above definitions, connectivity is a transitive property, and divides the universe of MPI processes into disconnected (independent) sets (equivalence classes) of processes.
- Processes which are connected, but do not share the same `MPI_COMM_WORLD`, may become disconnected (independent) if the communication path between them is broken by using `MPI_COMM_DISCONNECT`.

The following additional rules apply to MPI routines in other chapters:

- `MPI_FINALIZE` is collective over a set of connected processes.
- `MPI_ABORT` does not abort independent processes. It may abort all processes in the caller's `MPI_COMM_WORLD` (ignoring its `comm` argument). Additionally, it may abort connected processes as well, though it makes a “best attempt” to abort only the processes in `comm`.
- If a process terminates without calling `MPI_FINALIZE`, independent processes are not affected but the effect on connected processes is not defined.

*Advice to implementors.* In practice, it may be difficult to distinguish between an MPI process failure and an erroneous program that terminates without calling an MPI finalization function: an implementation that defines semantics for process failure management may have to exhibit the behavior defined for MPI process failures with such erroneous programs. A high quality implementation should exhibit a different behavior for erroneous programs and MPI process failures. (*End of advice to implementors.*)

```

1 MPI_COMM_DISCONNECT(comm)
2     INOUT    comm                communicator (handle)
3

```

**C binding**

```

4
5 int MPI_Comm_disconnect(MPI_Comm *comm)
6

```

**Fortran 2008 binding**

```

7
8 MPI_Comm_disconnect(comm, ierror)
9     TYPE(MPI_Comm), INTENT(INOUT) :: comm
10    INTEGER, OPTIONAL, INTENT(OUT) :: ierror
11

```

**Fortran binding**

```

12 MPI_COMM_DISCONNECT(COMM, IERROR)
13     INTEGER COMM, IERROR
14

```

15 This function waits for all pending communication on `comm` to complete internally,  
16 deallocates the communicator object, and sets the handle to `MPI_COMM_NULL`. It is a  
17 collective operation.

18 It may not be called with the communicator `MPI_COMM_WORLD` or `MPI_COMM_SELF`.

19 `MPI_COMM_DISCONNECT` may be called only if all communication is complete and  
20 matched, so that buffered data can be delivered to its destination. This requirement is the  
21 same as for `MPI_FINALIZE`.

22 `MPI_COMM_DISCONNECT` has the same action as `MPI_COMM_FREE`, except that it  
23 waits for pending communication to finish internally and enables the guarantee about the  
24 behavior of disconnected processes.

25  
26 *Advice to users.* To disconnect two processes you may need to call  
27 `MPI_COMM_DISCONNECT`, `MPI_WIN_FREE`, and `MPI_FILE_CLOSE` to remove all  
28 communication paths between the two processes. Note that it may be necessary  
29 to disconnect several communicators (or to free several windows or files) before two  
30 processes are completely independent. (*End of advice to users.*)

31  
32 *Rationale.* It would be nice to be able to use `MPI_COMM_FREE` instead, but that  
33 function explicitly does not wait for pending communication to complete. (*End of*  
34 *rationale.*)

### 36 10.10.5 Another Way to Establish MPI Communication

```

37
38
39 MPI_COMM_JOIN(fd, intercomm)
40
41     IN      fd                socket file descriptor
42     OUT    intercomm         new intercommunicator (handle)
43

```

**C binding**

```

44
45 int MPI_Comm_join(int fd, MPI_Comm *intercomm)
46

```

**Fortran 2008 binding**

```

47 MPI_Comm_join(fd, intercomm, ierror)
48

```



```

INTEGER, INTENT(IN) :: fd
TYPE(MPI_Comm), INTENT(OUT) :: intercomm
INTEGER, OPTIONAL, INTENT(OUT) :: ierror

```

### Fortran binding

```

MPI_COMM_JOIN(FD, INTERCOMM, IERROR)
    INTEGER FD, INTERCOMM, IERROR

```

MPI\_COMM\_JOIN is intended for MPI implementations that exist in an environment supporting the Berkeley Socket interface [47, 52]. Implementations that exist in an environment not supporting Berkeley Sockets should provide the entry point for MPI\_COMM\_JOIN and should return MPI\_COMM\_NULL.

This call creates an intercommunicator from the union of two MPI processes which are connected by a socket. MPI\_COMM\_JOIN should normally succeed if the local and remote processes have access to the same implementation-defined MPI communication universe.

*Advice to users.* An MPI implementation may require a specific communication medium for MPI communication, such as a shared memory segment or a special switch. In this case, it may not be possible for two processes to successfully join even if there is a socket connecting them and they are using the same MPI implementation. (*End of advice to users.*)

*Advice to implementors.* A high-quality implementation will attempt to establish communication over a slow medium if its preferred one is not available. If implementations do not do this, they must document why they cannot do MPI communication over the medium used by the socket (especially if the socket is a TCP connection). (*End of advice to implementors.*)

fd is a file descriptor representing a socket of type SOCK\_STREAM (a two-way reliable byte-stream connection). Nonblocking I/O and asynchronous notification via SIGIO must not be enabled for the socket. The socket must be in a connected state. The socket must be quiescent when MPI\_COMM\_JOIN is called (see below). It is the responsibility of the application to create the socket using standard socket API calls.

MPI\_COMM\_JOIN must be called by the process at each end of the socket. It does not return until both processes have called MPI\_COMM\_JOIN. The two processes are referred to as the local and remote processes.

MPI uses the socket to bootstrap creation of the intercommunicator, and for nothing else. Upon return from MPI\_COMM\_JOIN, the file descriptor will be open and quiescent (see below).

If MPI is unable to create an intercommunicator, but is able to leave the socket in its original state, with no pending communication, it succeeds and sets intercomm to MPI\_COMM\_NULL.

The socket must be quiescent before MPI\_COMM\_JOIN is called and after MPI\_COMM\_JOIN returns. More specifically, on entry to MPI\_COMM\_JOIN, a read on the socket will not read any data that was written to the socket before the remote process called MPI\_COMM\_JOIN. On exit from MPI\_COMM\_JOIN, a read will not read any data that was written to the socket before the remote process returned from MPI\_COMM\_JOIN. It is the responsibility of the application to ensure the first condition, and the responsibility of the MPI implementation to ensure the second. In a multithreaded application, the application

1 must ensure that one thread does not access the socket while another is calling  
2 MPI\_COMM\_JOIN, or call MPI\_COMM\_JOIN concurrently.

3  
4 *Advice to implementors.* MPI is free to use any available communication path(s)  
5 for MPI messages in the new communicator; the socket is only used for the initial  
6 handshaking. (*End of advice to implementors.*)

7  
8 MPI\_COMM\_JOIN uses non-MPI communication to do its work. The interaction of  
9 non-MPI communication with pending MPI communication is not defined. Therefore, the  
10 result of calling MPI\_COMM\_JOIN on two connected processes (see Section 10.10.4 for the  
11 definition of connected) is undefined.

12 The returned communicator may be used to establish MPI communication with addi-  
13 tional processes, through the usual MPI communicator creation mechanisms.

14  
15  
16  
17  
18  
19  
20  
21  
22  
23  
24  
25  
26  
27  
28  
29  
30  
31  
32  
33  
34  
35  
36  
37  
38  
39  
40  
41  
42  
43  
44  
45  
46  
47  
48

DRAFT

1  
2  
3  
4  
5  
6  
7  
8  
9  
10  
11  
12  
13  
14  
15  
16  
17  
18  
19  
20  
21  
22  
23  
24  
25  
26  
27  
28  
29  
30  
31  
32  
33  
34  
35  
36  
37  
38  
39  
40  
41  
42  
43  
44  
45  
46  
47  
48

# Chapter 11

## One-Sided Communications

### 11.1 Introduction

**Remote Memory Access (RMA)** extends the communication mechanisms of MPI by allowing one process to specify all communication parameters, both for the sending side and for the receiving side. This mode of communication facilitates the coding of some applications with dynamically changing data access patterns where the data distribution is fixed or slowly changing. In such a case, each process can compute what data it needs to access or to update at other processes. However, the programmer may not be able to easily determine which data in a process may need to be accessed or to be updated by operations executed by a different process, and may not even know which processes may perform such updates. Thus, the transfer parameters are all available only on one side. Regular send/receive communication requires matching operations by sender and receiver. In order to issue the matching operations, an application needs to distribute the transfer parameters. This distribution may require all processes to participate in a time-consuming global computation, or to poll for potential communication requests to receive and upon which to act periodically. The use of RMA communication mechanisms avoids the need for global computations or explicit polling. A generic example of this nature is the execution of an assignment of the form  $A = B(\text{map})$ , where `map` is a permutation vector, and `A`, `B`, and `map` are distributed in the same manner.

Message-passing communication achieves two effects: *communication* of data from sender to receiver and *synchronization* of sender with receiver. The RMA design separates these two functions. The following communication calls are provided:

- Remote write: `MPI_PUT`, `MPI_RPUT`
- Remote read: `MPI_GET`, `MPI_RGET`
- Remote update: `MPI_ACCUMULATE`, `MPI_RACCUMULATE`
- Remote read and update: `MPI_GET_ACCUMULATE`, `MPI_RGET_ACCUMULATE`, and `MPI_FETCH_AND_OP`
- Remote atomic swap operations: `MPI_COMPARE_AND_SWAP`

This chapter refers to an operations set that includes all remote update, remote read and update, and remote atomic swap operations as “accumulate” operations.

1 MPI supports two fundamentally different *memory models*: *separate* and *unified*. The  
2 separate model makes no assumption about memory consistency and is highly portable.  
3 This model is similar to that of weakly coherent memory systems: the user must impose  
4 correct ordering of memory accesses through synchronization calls. The unified model can  
5 exploit cache-coherent hardware and hardware-accelerated, one-sided operations that are  
6 commonly available in high-performance systems. The two different models are discussed  
7 in detail in Section 11.4. Both models support several synchronization calls to support  
8 different synchronization styles.

9 The design of the RMA functions allows implementors to take advantage of fast or  
10 asynchronous communication mechanisms provided by various platforms, such as coherent  
11 or noncoherent shared memory, DMA engines, hardware-supported put/get operations, and  
12 communication coprocessors. The most frequently used RMA communication mechanisms  
13 can be layered on top of message-passing. However, certain RMA functions might need  
14 support for asynchronous communication agents in software (handlers, threads, etc.) in a  
15 distributed memory environment.

16 We shall denote by **origin** the process that performs the call, and by **target** the  
17 process in which the memory is accessed. Thus, in a put operation, source=origin and  
18 destination=target; in a get operation, source=target and destination=origin.  
19

## 20 11.2 Initialization

21  
22 MPI provides the following window initialization functions: `MPI_WIN_CREATE`,  
23 `MPI_WIN_ALLOCATE`, `MPI_WIN_ALLOCATE_SHARED`, and  
24 `MPI_WIN_CREATE_DYNAMIC`, which are collective on an intracommunicator.  
25 `MPI_WIN_CREATE` allows each process to specify a “window” in its memory that is made  
26 accessible to accesses by remote processes. The call returns an opaque object that represents  
27 the group of processes that own and access the set of windows, and the attributes of each  
28 window, as specified by the initialization call. `MPI_WIN_ALLOCATE` differs from  
29 `MPI_WIN_CREATE` in that the user does not pass allocated memory;  
30 `MPI_WIN_ALLOCATE` returns a pointer to memory allocated by the MPI implementation.  
31 `MPI_WIN_ALLOCATE_SHARED` differs from `MPI_WIN_ALLOCATE` in that the allocated  
32 memory can be accessed from all processes in the window’s group with direct load/store  
33 instructions. Some restrictions may apply to the specified communicator.  
34 `MPI_WIN_CREATE_DYNAMIC` creates a window that allows the user to dynamically control  
35 which memory is exposed by the window.  
36  
37  
38  
39  
40  
41  
42  
43  
44  
45  
46  
47  
48

## 11.2.1 Window Creation

MPI\_WIN\_CREATE(base, size, disp\_unit, info, comm, win)

IN	base	initial address of window (choice)
IN	size	size of window in bytes (non-negative integer)
IN	disp_unit	local unit size for displacements, in bytes (positive integer)
IN	info	info argument (handle)
IN	comm	intra-communicator (handle)
OUT	win	window object (handle)

**C binding**

```
int MPI_Win_create(void *base, MPI_Aint size, int disp_unit, MPI_Info info,
                  MPI_Comm comm, MPI_Win *win)
```

**Fortran 2008 binding**

```
MPI_Win_create(base, size, disp_unit, info, comm, win, ierror)
    TYPE(*), DIMENSION(..), ASYNCHRONOUS :: base
    INTEGER(KIND=MPI_ADDRESS_KIND), INTENT(IN) :: size
    INTEGER, INTENT(IN) :: disp_unit
    TYPE(MPI_Info), INTENT(IN) :: info
    TYPE(MPI_Comm), INTENT(IN) :: comm
    TYPE(MPI_Win), INTENT(OUT) :: win
    INTEGER, OPTIONAL, INTENT(OUT) :: ierror
```

**Fortran binding**

```
MPI_WIN_CREATE(BASE, SIZE, DISP_UNIT, INFO, COMM, WIN, IERROR)
    <type> BASE(*)
    INTEGER(KIND=MPI_ADDRESS_KIND) SIZE
    INTEGER DISP_UNIT, INFO, COMM, WIN, IERROR
```

This is a collective call executed by all processes in the group of `comm`. It returns a window object that can be used by these processes to perform RMA operations. Each process specifies a window of existing memory that it exposes to RMA accesses by the processes in the group of `comm`. The window consists of `size` bytes, starting at address `base`. In C, `base` is the starting address of a memory region. In Fortran, one can pass the first element of a memory region or a whole array, which must be ‘simply contiguous’ (for ‘simply contiguous,’ see also Section 18.1.12). A process may elect to expose no memory by specifying `size = 0`.

The displacement unit argument is provided to facilitate address arithmetic in RMA operations: the target displacement argument of an RMA operation is scaled by the factor `disp_unit` specified by the target process, at window creation.

*Rationale.* The window size is specified using an address-sized integer, rather than a basic integer type, to allow windows that span more memory than can be described with a basic integer type. (*End of rationale.*)

1       *Advice to users.* Common choices for `disp_unit` are 1 (no scaling), and (in C syntax)  
2       `sizeof(type)`, for a window that consists of an array of elements of type `type`. The  
3       latter choice will allow one to use array indices in RMA calls, and have those scaled  
4       correctly to byte displacements, even in a heterogeneous environment. (*End of advice*  
5       *to users.*)

6  
7       The `info` argument provides optimization hints to the runtime about the expected usage  
8       pattern of the window. The following info keys are predefined:

9       `no_locks` — if set to `true`, then the implementation may assume that passive target synchro-  
10       nization (i.e., `MPI_WIN_LOCK`, `MPI_WIN_LOCK_ALL`) will not be used on the given  
11       window. This implies that this window is not used for 3-party communication, and  
12       RMA can be implemented with no (less) asynchronous agent activity at this process.

13  
14       `accumulate_ordering` — controls the ordering of accumulate operations at the target. See  
15       Section 11.7.2 for details.

16       `accumulate_ops` — if set to `same_op`, the implementation will assume that all concurrent  
17       accumulate calls to the same target address will use the same operation. If set to  
18       `same_op_no_op`, then the implementation will assume that all concurrent accumulate  
19       calls to the same target address will use the same operation or `MPI_NO_OP`. This can  
20       eliminate the need to protect access for certain operation types where the hardware  
21       can guarantee atomicity. The default is `same_op_no_op`.

22  
23       `same_size` — if set to `true`, then the implementation may assume that the argument `size` is  
24       identical on all processes, and that all processes have provided this info key with the  
25       same value.

26       `same_disp_unit` — if set to `true`, then the implementation may assume that the argument  
27       `disp_unit` is identical on all processes, and that all processes have provided this info  
28       key with the same value.

29  
30       *Advice to users.* The info query mechanism described in Section 11.2.7 can be used  
31       to query the specified info arguments for windows that have been passed to a library.  
32       It is recommended that libraries check attached info keys for each passed window.  
33       (*End of advice to users.*)

34  
35       The various processes in the group of `comm` may specify completely different target  
36       windows, in location, size, displacement units, and info arguments. As long as all the get,  
37       put and accumulate accesses to a particular process fit their specific target window this  
38       should pose no problem. The same area in memory may appear in multiple windows, each  
39       associated with a different window object. However, concurrent communications to distinct,  
40       overlapping windows may lead to undefined results.

41       *Rationale.* The reason for specifying the memory that may be accessed from another  
42       process in an RMA operation is to permit the programmer to specify what memory  
43       can be a target of RMA operations and for the implementation to enforce that spec-  
44       ification. For example, with this definition, a server process can safely allow a client  
45       process to use RMA operations, knowing that (under the assumption that the MPI  
46       implementation does enforce the specified limits on the exposed memory) an error in  
47       the client cannot affect any memory other than what was explicitly exposed. (*End of*  
48       *rationale.*)

*Advice to users.* A window can be created in any part of the process memory. However, on some systems, the performance of windows in memory allocated by MPI\_ALLOC\_MEM (Section 8.2) will be better. Also, on some systems, performance is improved when window boundaries are aligned at “natural” boundaries (word, double-word, cache line, page frame, etc.). (*End of advice to users.*)

*Advice to implementors.* In cases where RMA operations use different mechanisms in different memory areas (e.g., load/store in a shared memory segment, and an asynchronous handler in private memory), the MPI\_WIN\_CREATE call needs to figure out which type of memory is used for the window. To do so, MPI maintains, internally, the list of memory segments allocated by MPI\_ALLOC\_MEM, or by other, implementation-specific, mechanisms, together with information on the type of memory segment allocated. When a call to MPI\_WIN\_CREATE occurs, then MPI checks which segment contains each window, and decides, accordingly, which mechanism to use for RMA operations.

Vendors may provide additional, implementation-specific mechanisms to allocate or to specify memory regions that are preferable for use in one-sided communication. In particular, such mechanisms can be used to place static variables into such preferred regions.

Implementors should document any performance impact of window alignment. (*End of advice to implementors.*)

### 11.2.2 Window That Allocates Memory

MPI\_WIN\_ALLOCATE(size, disp\_unit, info, comm, baseptr, win)

IN	size	size of window in bytes (non-negative integer)
IN	disp_unit	local unit size for displacements, in bytes (positive integer)
IN	info	info argument (handle)
IN	comm	intra-communicator (handle)
OUT	baseptr	initial address of window (choice)
OUT	win	window object returned by call (handle)

#### C binding

```
int MPI_Win_allocate(MPI_Aint size, int disp_unit, MPI_Info info,
                    MPI_Comm comm, void *baseptr, MPI_Win *win)
```

#### Fortran 2008 binding

```
MPI_Win_allocate(size, disp_unit, info, comm, baseptr, win, ierror)
USE, INTRINSIC :: ISO_C_BINDING, ONLY : C_PTR
INTEGER(KIND=MPI_ADDRESS_KIND), INTENT(IN) :: size
INTEGER, INTENT(IN) :: disp_unit
TYPE(MPI_Info), INTENT(IN) :: info
TYPE(MPI_Comm), INTENT(IN) :: comm
```

```

1     TYPE(C_PTR), INTENT(OUT) :: baseptr
2     TYPE(MPI_Win), INTENT(OUT) :: win
3     INTEGER, OPTIONAL, INTENT(OUT) :: ierror

```

#### Fortran binding

```

6     MPI_WIN_ALLOCATE(SIZE, DISP_UNIT, INFO, COMM, BASEPTR, WIN, IERROR)
7         INTEGER(KIND=MPI_ADDRESS_KIND) SIZE, BASEPTR
8         INTEGER DISP_UNIT, INFO, COMM, WIN, IERROR

```

This is a collective call executed by all processes in the group of `comm`. On each process, it allocates memory of at least `size` bytes, returns a pointer to it, and returns a window object that can be used by all processes in `comm` to perform RMA operations. The returned memory consists of `size` bytes local to each process, starting at address `baseptr` and is associated with the window as if the user called `MPI_WIN_CREATE` on existing memory. The size argument may be different at each process and `size = 0` is valid; however, a library might allocate and expose more memory in order to create a fast, globally symmetric allocation. The discussion of and rationales for `MPI_ALLOC_MEM` and `MPI_FREE_MEM` in Section 8.2 also apply to `MPI_WIN_ALLOCATE`; in particular, see the rationale in Section 8.2 for an explanation of the type used for `baseptr`.

If the Fortran compiler provides `TYPE(C_PTR)`, then the following generic interface must be provided in the `mpi` module and should be provided in `mpif.h` through overloading, i.e., with the same routine name as the routine with `INTEGER(KIND=MPI_ADDRESS_KIND) BASEPTR`, but with a different specific procedure name:

```

24     INTERFACE MPI_WIN_ALLOCATE
25         SUBROUTINE MPI_WIN_ALLOCATE(SIZE, DISP_UNIT, INFO, COMM, BASEPTR, &
26                                     WIN, IERROR)
27             IMPORT :: MPI_ADDRESS_KIND
28             INTEGER DISP_UNIT, INFO, COMM, WIN, IERROR
29             INTEGER(KIND=MPI_ADDRESS_KIND) SIZE, BASEPTR
30         END SUBROUTINE
31         SUBROUTINE MPI_WIN_ALLOCATE_CPTR(SIZE, DISP_UNIT, INFO, COMM, BASEPTR, &
32                                         WIN, IERROR)
33             USE, INTRINSIC :: ISO_C_BINDING, ONLY : C_PTR
34             IMPORT :: MPI_ADDRESS_KIND
35             INTEGER :: DISP_UNIT, INFO, COMM, WIN, IERROR
36             INTEGER(KIND=MPI_ADDRESS_KIND) :: SIZE
37             TYPE(C_PTR) :: BASEPTR
38         END SUBROUTINE
39     END INTERFACE

```

The base procedure name of this overloaded function is `MPI_WIN_ALLOCATE_CPTR`. The implied specific procedure names are described in Section 18.1.5.

*Rationale.* By allocating (potentially aligned) memory instead of allowing the user to pass in an arbitrary buffer, this call can improve the performance for systems with remote direct memory access. This also permits the collective allocation of memory and supports what is sometimes called the “symmetric allocation” model that can be more scalable (for example, the implementation can arrange to return an address for the allocated memory that is the same on all processes). (*End of rationale.*)



The `info` argument can be used to specify hints similar to the `info` argument for `MPI_WIN_CREATE` and `MPI_ALLOC_MEM`.

The default memory alignment requirements and the `mpi_minimum_memory_alignment` info key described for `MPI_ALLOC_MEM` in Section 8.2 apply to all processes with non-zero size argument.

### 11.2.3 Window That Allocates Shared Memory

`MPI_WIN_ALLOCATE_SHARED(size, disp_unit, info, comm, baseptr, win)`

IN	size	size of local window in bytes (non-negative integer)
IN	disp_unit	local unit size for displacements, in bytes (positive integer)
IN	info	info argument (handle)
IN	comm	intra-communicator (handle)
OUT	baseptr	address of local allocated window segment (choice)
OUT	win	window object returned by the call (handle)

#### C binding

```
int MPI_Win_allocate_shared(MPI_Aint size, int disp_unit, MPI_Info info,
                           MPI_Comm comm, void *baseptr, MPI_Win *win)
```

#### Fortran 2008 binding

```
MPI_Win_allocate_shared(size, disp_unit, info, comm, baseptr, win, ierror)
  USE, INTRINSIC :: ISO_C_BINDING, ONLY : C_PTR
  INTEGER(KIND=MPI_ADDRESS_KIND), INTENT(IN) :: size
  INTEGER, INTENT(IN) :: disp_unit
  TYPE(MPI_Info), INTENT(IN) :: info
  TYPE(MPI_Comm), INTENT(IN) :: comm
  TYPE(C_PTR), INTENT(OUT) :: baseptr
  TYPE(MPI_Win), INTENT(OUT) :: win
  INTEGER, OPTIONAL, INTENT(OUT) :: ierror
```

#### Fortran binding

```
MPI_WIN_ALLOCATE_SHARED(SIZE, DISP_UNIT, INFO, COMM, BASEPTR, WIN, IERROR)
  INTEGER(KIND=MPI_ADDRESS_KIND) SIZE, BASEPTR
  INTEGER DISP_UNIT, INFO, COMM, WIN, IERROR
```

This is a collective call executed by all processes in the group of `comm`. On each process, it allocates memory of at least `size` bytes that is shared among all processes in `comm`, and returns a pointer to the locally allocated segment in `baseptr` that can be used for load/store accesses on the calling process. The locally allocated memory can be the target of load/store accesses by remote processes; the base pointers for other processes can be queried using the function `MPI_WIN_SHARED_QUERY`. The call also returns a window object that can be used by all processes in `comm` to perform RMA operations. The size argument may be different at each process and `size = 0` is valid. It is the user's responsibility to ensure that the communicator `comm` represents a group of processes that

can create a shared memory segment that can be accessed by all processes in the group. The discussions of rationales for `MPI_ALLOC_MEM` and `MPI_FREE_MEM` in Section 8.2 also apply to `MPI_WIN_ALLOCATE_SHARED`; in particular, see the rationale in Section 8.2 for an explanation of the type used for `baseptr`. The allocated memory is contiguous across process ranks unless the info key `alloc_shared_noncontig` is specified. Contiguous across process ranks means that the first address in the memory segment of process  $i$  is consecutive with the last address in the memory segment of process  $i - 1$ . This may enable the user to calculate remote address offsets with local information only.

If the Fortran compiler provides `TYPE(C_PTR)`, then the following generic interface must be provided in the `mpi` module and should be provided in `mpif.h` through overloading, i.e., with the same routine name as the routine with `INTEGER(KIND=MPI_ADDRESS_KIND) BASEPTR`, but with a different specific procedure name:

```

INTERFACE MPI_WIN_ALLOCATE_SHARED
  SUBROUTINE MPI_WIN_ALLOCATE_SHARED(SIZE, DISP_UNIT, INFO, COMM, &
    BASEPTR, WIN, IERROR)
    IMPORT :: MPI_ADDRESS_KIND
    INTEGER DISP_UNIT, INFO, COMM, WIN, IERROR
    INTEGER(KIND=MPI_ADDRESS_KIND) SIZE, BASEPTR
  END SUBROUTINE
  SUBROUTINE MPI_WIN_ALLOCATE_SHARED_CPTR(SIZE, DISP_UNIT, INFO, COMM, &
    BASEPTR, WIN, IERROR)
    USE, INTRINSIC :: ISO_C_BINDING, ONLY : C_PTR
    IMPORT :: MPI_ADDRESS_KIND
    INTEGER :: DISP_UNIT, INFO, COMM, WIN, IERROR
    INTEGER(KIND=MPI_ADDRESS_KIND) :: SIZE
    TYPE(C_PTR) :: BASEPTR
  END SUBROUTINE
END INTERFACE

```

The base procedure name of this overloaded function is `MPI_WIN_ALLOCATE_SHARED_CPTR`. The implied specific procedure names are described in Section 18.1.5.

The `info` argument can be used to specify hints similar to the `info` argument for `MPI_WIN_CREATE`, `MPI_WIN_ALLOCATE`, and `MPI_ALLOC_MEM`. The additional info key `alloc_shared_noncontig` allows the library to optimize the layout of the shared memory segments in memory.

*Advice to users.* If the info key `alloc_shared_noncontig` is not set to true, the allocation strategy is to allocate contiguous memory across process ranks. This may limit the performance on some architectures because it does not allow the implementation to modify the data layout (e.g., padding to reduce access latency). (*End of advice to users.*)

*Advice to implementors.* If the user sets the info key `alloc_shared_noncontig` to true, the implementation can allocate the memory requested by each process in a location that is close to this process. This can be achieved by padding or allocating memory in special memory segments. Both techniques may make the address space across consecutive ranks noncontiguous. (*End of advice to implementors.*)

For contiguous shared memory allocations, the default alignment requirements outlined for `MPI_ALLOC_MEM` in Section 8.2 and the `mpi_minimum_memory_alignment` info key apply to the start of the contiguous memory that is returned in `baseptr` to the first process with non-zero size argument. For noncontiguous memory allocations, the default alignment requirements and the `mpi_minimum_memory_alignment` info key apply to all processes with non-zero size argument.

*Advice to users.* If the info key `alloc_shared_noncontig` is not set to true (or ignored by the MPI implementation), the alignment of the memory returned in `baseptr` to all but the first process with non-zero size argument depends on the value of the `size` argument provided by other processes. It is thus the user's responsibility to control the alignment of contiguous memory allocated for these processes by ensuring that each process provides a `size` argument that is an integral multiple of the alignment required for the application. (*End of advice to users.*)

The consistency of load/store accesses from/to the shared memory as observed by the user program depends on the architecture. A consistent view can be created in the *unified memory model* (see Section 11.4) by utilizing the window synchronization functions (see Section 11.5) or explicitly completing outstanding store accesses (e.g., by calling `MPI_WIN_FLUSH`). MPI does not define semantics for accessing shared memory windows in the *separate memory model*.

`MPI_WIN_SHARED_QUERY(win, rank, size, disp_unit, baseptr)`

IN	<code>win</code>	shared memory window object (handle)
IN	<code>rank</code>	rank in the group of window <code>win</code> or <code>MPI_PROC_NULL</code> (non-negative integer)
OUT	<code>size</code>	size of the window segment (non-negative integer)
OUT	<code>disp_unit</code>	local unit size for displacements, in bytes (positive integer)
OUT	<code>baseptr</code>	address for load/store access to window segment (choice)

### C binding

```
int MPI_Win_shared_query(MPI_Win win, int rank, MPI_Aint *size,
                        int *disp_unit, void *baseptr)
```

### Fortran 2008 binding

```
MPI_Win_shared_query(win, rank, size, disp_unit, baseptr, ierror)
USE, INTRINSIC :: ISO_C_BINDING, ONLY : C_PTR
TYPE(MPI_Win), INTENT(IN) :: win
INTEGER, INTENT(IN) :: rank
INTEGER(KIND=MPI_ADDRESS_KIND), INTENT(OUT) :: size
INTEGER, INTENT(OUT) :: disp_unit
TYPE(C_PTR), INTENT(OUT) :: baseptr
INTEGER, OPTIONAL, INTENT(OUT) :: ierror
```

### Fortran binding

```
MPI_WIN_SHARED_QUERY(WIN, RANK, SIZE, DISP_UNIT, BASEPTR, IERROR)
```

```

1     INTEGER WIN, RANK, DISP_UNIT, IERROR
2     INTEGER(KIND=MPI_ADDRESS_KIND) SIZE, BASEPTR

```

This function queries the process-local address for remote memory segments created with `MPI_WIN_ALLOCATE_SHARED`. This function can return different process-local addresses for the same physical memory on different processes. The returned memory can be used for load/store accesses subject to the constraints defined in Section 11.7. This function can only be called with windows of flavor `MPI_WIN_FLAVOR_SHARED`. If the passed window is not of flavor `MPI_WIN_FLAVOR_SHARED`, the error `MPI_ERR_RMA_FLAVOR` is raised. When `rank` is `MPI_PROC_NULL`, the pointer, `disp_unit`, and `size` returned are the pointer, `disp_unit`, and `size` of the memory segment belonging the lowest rank that specified `size > 0`. If all processes in the group attached to the window specified `size = 0`, then the call returns `size = 0` and a `baseptr` as if `MPI_ALLOC_MEM` was called with `size = 0`.

If the Fortran compiler provides `TYPE(C_PTR)`, then the following generic interface must be provided in the `mpi` module and should be provided in `mpif.h` through overloading, i.e., with the same routine name as the routine with `INTEGER(KIND=MPI_ADDRESS_KIND) BASEPTR`, but with a different specific procedure name:

```

18  INTERFACE MPI_WIN_SHARED_QUERY
19      SUBROUTINE MPI_WIN_SHARED_QUERY(WIN, RANK, SIZE, DISP_UNIT, &
20          BASEPTR, IERROR)
21
22          IMPORT :: MPI_ADDRESS_KIND
23          INTEGER WIN, RANK, DISP_UNIT, IERROR
24          INTEGER (KIND=MPI_ADDRESS_KIND) SIZE, BASEPTR
25      END SUBROUTINE
26      SUBROUTINE MPI_WIN_SHARED_QUERY_CPTR(WIN, RANK, SIZE, DISP_UNIT, &
27          BASEPTR, IERROR)
28
29          USE, INTRINSIC :: ISO_C_BINDING, ONLY : C_PTR
30          IMPORT :: MPI_ADDRESS_KIND
31          INTEGER :: WIN, RANK, DISP_UNIT, IERROR
32          INTEGER(KIND=MPI_ADDRESS_KIND) :: SIZE
33          TYPE(C_PTR) :: BASEPTR
34      END SUBROUTINE
35  END INTERFACE

```

The base procedure name of this overloaded function is `MPI_WIN_SHARED_QUERY_CPTR`. The implied specific procedure names are described in Section 18.1.5.

#### 11.2.4 Window of Dynamically Attached Memory

The MPI-2 RMA model requires the user to identify the local memory that may be a target of RMA calls at the time the window is created. This has advantages for both the programmer (only this memory can be updated by one-sided operations and provides greater safety) and the MPI implementation (special steps may be taken to make one-sided access to such memory more efficient). However, consider implementing a modifiable linked list using RMA operations; as new items are added to the list, memory must be allocated. In a C or C++ program, this memory is typically allocated using `malloc` or `new` respectively. In MPI-2 RMA, the programmer must create a window with a predefined

amount of memory and then implement routines for allocating memory from within the window's memory. In addition, there is no easy way to handle the situation where the predefined amount of memory turns out to be inadequate. To support this model, the routine `MPI_WIN_CREATE_DYNAMIC` creates a window that makes it possible to expose memory without remote synchronization. It must be used in combination with the local routines `MPI_WIN_ATTACH` and `MPI_WIN_DETACH`.

`MPI_WIN_CREATE_DYNAMIC`(info, comm, win)

IN	info	info argument (handle)
IN	comm	intra-communicator (handle)
OUT	win	window object returned by the call (handle)

### C binding

```
int MPI_Win_create_dynamic(MPI_Info info, MPI_Comm comm, MPI_Win *win)
```

### Fortran 2008 binding

```
MPI_Win_create_dynamic(info, comm, win, ierror)
  TYPE(MPI_Info), INTENT(IN) :: info
  TYPE(MPI_Comm), INTENT(IN) :: comm
  TYPE(MPI_Win), INTENT(OUT) :: win
  INTEGER, OPTIONAL, INTENT(OUT) :: ierror
```

### Fortran binding

```
MPI_WIN_CREATE_DYNAMIC(INFO, COMM, WIN, IERROR)
  INTEGER INFO, COMM, WIN, IERROR
```

This is a collective call executed by all processes in the group of `comm`. It returns a window `win` without memory attached. Existing process memory can be attached as described below. This routine returns a window object that can be used by these processes to perform RMA operations on attached memory. Because this window has special properties, it will sometimes be referred to as a *dynamic* window.

The `info` argument can be used to specify hints similar to the `info` argument for `MPI_WIN_CREATE`.

In the case of a window created with `MPI_WIN_CREATE_DYNAMIC`, the `target_disp` for all RMA functions is the address at the target; i.e., the effective `window_base` is `MPI_BOTTOM` and the `disp_unit` is one. For dynamic windows, the `target_disp` argument to RMA communication operations is not restricted to non-negative values. Users should use `MPI_GET_ADDRESS` at the target process to determine the address of a target memory location and communicate this address to the origin process.

*Advice to users.* Users are cautioned that displacement arithmetic can overflow in variables of type `MPI_Aint` and result in unexpected values on some platforms. The `MPI_AINT_ADD` and `MPI_AINT_DIFF` functions can be used to safely perform address arithmetic with `MPI_Aint` displacements. (*End of advice to users.*)

*Advice to implementors.* In environments with heterogeneous data representations, care must be exercised in communicating addresses between processes. For example, it is possible that an address valid at the target process (for example, a 64-bit pointer)

cannot be expressed as an address at the origin (for example, the origin uses 32-bit pointers). For this reason, a portable MPI implementation should ensure that the type `MPI_AINT` (see Table 3.3) is able to store addresses from any process. (*End of advice to implementors.*)

Memory at the target cannot be accessed with this window until that memory has been attached using the function `MPI_WIN_ATTACH`. That is, in addition to using `MPI_WIN_CREATE_DYNAMIC` to create an MPI window, the user must use `MPI_WIN_ATTACH` before any local memory may be the target of an MPI RMA operation. Only memory that is currently accessible may be attached.

```
MPI_WIN_ATTACH(win, base, size)
```

IN	win	window object (handle)
IN	base	initial address of memory to be attached
IN	size	size of memory to be attached in bytes

### C binding

```
int MPI_Win_attach(MPI_Win win, void *base, MPI_Aint size)
```

### Fortran 2008 binding

```
MPI_Win_attach(win, base, size, ierror)
  TYPE(MPI_Win), INTENT(IN) :: win
  TYPE(*), DIMENSION(..), ASYNCHRONOUS :: base
  INTEGER(KIND=MPI_ADDRESS_KIND), INTENT(IN) :: size
  INTEGER, OPTIONAL, INTENT(OUT) :: ierror
```

### Fortran binding

```
MPI_WIN_ATTACH(WIN, BASE, SIZE, IERROR)
  INTEGER WIN, IERROR
  <type> BASE(*)
  INTEGER(KIND=MPI_ADDRESS_KIND) SIZE
```

Attaches a local memory region beginning at `base` for remote access within the given window. The memory region specified must not contain any part that is already attached to the window `win`, that is, attaching overlapping memory concurrently within the same window is erroneous. The argument `win` must be a window that was created with `MPI_WIN_CREATE_DYNAMIC`. The local memory region attached to the window consists of `size` bytes, starting at address `base`. In C, `base` is the starting address of a memory region. In Fortran, one can pass the first element of a memory region or a whole array, which must be ‘simply contiguous’ (for ‘simply contiguous,’ see Section 18.1.12). Multiple (but non-overlapping) memory regions may be attached to the same window.

*Rationale.* Requiring that memory be explicitly attached before it is exposed to one-sided access by other processes can simplify implementations and improve performance. The ability to make memory available for RMA operations without requiring a collective `MPI_WIN_CREATE` call is needed for some one-sided programming models. (*End of rationale.*)

*Advice to users.* Attaching memory to a window may require the use of scarce resources; thus, attaching large regions of memory is not recommended in portable programs. Attaching memory to a window may fail if sufficient resources are not available; this is similar to the behavior of `MPI_ALLOC_MEM`.

The user is also responsible for ensuring that `MPI_WIN_ATTACH` at the target has returned before a process attempts to target that memory with an MPI RMA call.

Performing an RMA operation to memory that has not been attached to a window created with `MPI_WIN_CREATE_DYNAMIC` is erroneous. (*End of advice to users.*)

*Advice to implementors.* A high-quality implementation will attempt to make as much memory available for attaching as possible. Any limitations should be documented by the implementor. (*End of advice to implementors.*)

Attaching memory is a local operation as defined by MPI, which means that the call is not collective and completes without requiring any MPI routine to be called in any other process. Memory may be detached with the routine `MPI_WIN_DETACH`. After memory has been detached, it may not be the target of an MPI RMA operation on that window (unless the memory is re-attached with `MPI_WIN_ATTACH`).

`MPI_WIN_DETACH(win, base)`

IN	win	window object (handle)
IN	base	initial address of memory to be detached

### C binding

```
int MPI_Win_detach(MPI_Win win, const void *base)
```

### Fortran 2008 binding

```
MPI_Win_detach(win, base, ierror)
    TYPE(MPI_Win), INTENT(IN) :: win
    TYPE(*), DIMENSION(..), ASYNCHRONOUS :: base
    INTEGER, OPTIONAL, INTENT(OUT) :: ierror
```

### Fortran binding

```
MPI_WIN_DETACH(WIN, BASE, IERROR)
    INTEGER WIN, IERROR
    <type> BASE(*)
```

Detaches a previously attached memory region beginning at `base`. The arguments `base` and `win` must match the arguments passed to a previous call to `MPI_WIN_ATTACH`.

*Advice to users.* Detaching memory may permit the implementation to make more efficient use of special memory or provide memory that may be needed by a subsequent `MPI_WIN_ATTACH`. Users are encouraged to detach memory that is no longer needed. Memory should be detached before it is freed by the user. (*End of advice to users.*)

Memory becomes detached when the associated dynamic memory window is freed, see Section [11.2.5](#).

## 11.2.5 Window Destruction

MPI\_WIN\_FREE(win)

INOUT win window object (handle)

### C binding

```
int MPI_Win_free(MPI_Win *win)
```

### Fortran 2008 binding

```
MPI_Win_free(win, ierror)
    TYPE(MPI_Win), INTENT(INOUT) :: win
    INTEGER, OPTIONAL, INTENT(OUT) :: ierror
```

### Fortran binding

```
MPI_WIN_FREE(WIN, IERROR)
    INTEGER WIN, IERROR
```

Frees the window object win and returns a null handle (equal to MPI\_WIN\_NULL). This is a collective call executed by all processes in the group associated with win. MPI\_WIN\_FREE(win) can be invoked by a process only after it has completed its involvement in RMA communications on window win: e.g., the process has called MPI\_WIN\_FENCE, or called MPI\_WIN\_WAIT to match a previous call to MPI\_WIN\_POST or called MPI\_WIN\_COMPLETE to match a previous call to MPI\_WIN\_START or called MPI\_WIN\_UNLOCK to match a previous call to MPI\_WIN\_LOCK. The memory associated with windows created by a call to MPI\_WIN\_CREATE may be freed after the call returns. If the window was created with MPI\_WIN\_ALLOCATE, MPI\_WIN\_FREE will free the window memory that was allocated in MPI\_WIN\_ALLOCATE. If the window was created with MPI\_WIN\_ALLOCATE\_SHARED, MPI\_WIN\_FREE will free the window memory that was allocated in MPI\_WIN\_ALLOCATE\_SHARED.

Freeing a window that was created with a call to MPI\_WIN\_CREATE\_DYNAMIC detaches all associated memory; i.e., it has the same effect as if all attached memory was detached by calls to MPI\_WIN\_DETACH.

*Advice to implementors.* MPI\_WIN\_FREE requires a barrier synchronization: no process can return from free until all processes in the group of win call free. This ensures that no process will attempt to access a remote window (e.g., with lock/unlock) after it was freed. The only exception to this rule is when the user sets the no\_locks info key to true when creating the window. In that case, an MPI implementation may free the local window without barrier synchronization. (*End of advice to implementors.*)

## 11.2.6 Window Attributes

The following attributes are cached with a window when the window is created.

MPI_WIN_BASE	window base address.
MPI_WIN_SIZE	window size, in bytes.
MPI_WIN_DISP_UNIT	displacement unit associated with the window.
MPI_WIN_CREATE_FLAVOR	how the window was created.



MPI\_WIN\_MODEL memory model for window.

In C, calls to `MPI_Win_get_attr(win, MPI_WIN_BASE, &base, &flag)`, `MPI_Win_get_attr(win, MPI_WIN_SIZE, &size, &flag)`, `MPI_Win_get_attr(win, MPI_WIN_DISP_UNIT, &disp_unit, &flag)`, `MPI_Win_get_attr(win, MPI_WIN_CREATE_FLAVOR, &create_kind, &flag)`, and `MPI_Win_get_attr(win, MPI_WIN_MODEL, &memory_model, &flag)` will return in `base` a pointer to the start of the window `win`, and will return in `size`, `disp_unit`, `create_kind`, and `memory_model` pointers to the size, displacement unit of the window, the kind of routine used to create the window, and the memory model, respectively. A detailed listing of the type of the pointer in the attribute value argument to `MPI_WIN_GET_ATTR` and `MPI_WIN_SET_ATTR` is shown in Table 11.1.

Attribute	C Type
MPI_WIN_BASE	void *
MPI_WIN_SIZE	MPI_Aint *
MPI_WIN_DISP_UNIT	int *
MPI_WIN_CREATE_FLAVOR	int *
MPI_WIN_MODEL	int *

Table 11.1: C types of attribute value argument to `MPI_WIN_GET_ATTR` and `MPI_WIN_SET_ATTR`.

In Fortran, calls to `MPI_WIN_GET_ATTR(win, MPI_WIN_BASE, base, flag, ierror)`, `MPI_WIN_GET_ATTR(win, MPI_WIN_SIZE, size, flag, ierror)`, `MPI_WIN_GET_ATTR(win, MPI_WIN_DISP_UNIT, disp_unit, flag, ierror)`, `MPI_WIN_GET_ATTR(win, MPI_WIN_CREATE_FLAVOR, create_kind, flag, ierror)`, and `MPI_WIN_GET_ATTR(win, MPI_WIN_MODEL, memory_model, flag, ierror)` will return in `base`, `size`, `disp_unit`, `create_kind`, and `memory_model` the (integer representation of) the base address, the size, the displacement unit of the window `win`, the kind of routine used to create the window, and the memory model, respectively.

The values of `create_kind` are

MPI_WIN_FLAVOR_CREATE	Window was created with <code>MPI_WIN_CREATE</code> .
MPI_WIN_FLAVOR_ALLOCATE	Window was created with <code>MPI_WIN_ALLOCATE</code> .
MPI_WIN_FLAVOR_DYNAMIC	Window was created with <code>MPI_WIN_CREATE_DYNAMIC</code> .
MPI_WIN_FLAVOR_SHARED	Window was created with <code>MPI_WIN_ALLOCATE_SHARED</code> .

The values of `memory_model` are `MPI_WIN_SEPARATE` and `MPI_WIN_UNIFIED`. The meaning of these is described in Section 11.4.

In the case of windows created with `MPI_WIN_CREATE_DYNAMIC`, the base address is `MPI_BOTTOM` and the size is 0. In C, pointers are returned, and in Fortran, the values are returned, for the respective attributes. (The window attribute access functions are defined in Section 6.7.3.) The value returned for an attribute on a window is constant over the lifetime of the window.

The other “window attribute,” namely the group of processes attached to the window, can be retrieved using the call below.

1 MPI\_WIN\_GET\_GROUP(win, group)

2     IN       win                   window object (handle)  
 3  
 4     OUT      group                group of processes which share access to the window  
 5                                   (handle)

6  
 7 **C binding**

8 int MPI\_Win\_get\_group(MPI\_Win win, MPI\_Group \*group)

9  
 10 **Fortran 2008 binding**

11 MPI\_Win\_get\_group(win, group, ierror)  
 12     TYPE(MPI\_Win), INTENT(IN) :: win  
 13     TYPE(MPI\_Group), INTENT(OUT) :: group  
 14     INTEGER, OPTIONAL, INTENT(OUT) :: ierror

15 **Fortran binding**

16 MPI\_WIN\_GET\_GROUP(WIN, GROUP, IERROR)  
 17     INTEGER WIN, GROUP, IERROR

18     MPI\_WIN\_GET\_GROUP returns a duplicate of the group of the communicator used to  
 19     create the window associated with win. The group is returned in group.  
 20

21  
 22 **11.2.7 Window Info**

23 Hints specified via info (see Section 9) allow a user to provide information to direct opti-  
 24 mization. Providing hints may enable an implementation to deliver increased performance  
 25 or use system resources more efficiently. An implementation is free to ignore all hints;  
 26 however, applications must comply with any info hints they provide that are used by the  
 27 MPI implementation (i.e., are returned by a call to MPI\_WIN\_GET\_INFO) and that place  
 28 a restriction on the behavior of the application. Hints are specified on a per window basis,  
 29 in window creation functions and MPI\_WIN\_SET\_INFO, via the opaque info object. When  
 30 an info object that specifies a subset of valid hints is passed to MPI\_WIN\_SET\_INFO there  
 31 will be no effect on previously set or default hints that the info does not specify.  
 32

33     *Advice to implementors.* It may happen that a program is coded with hints for one  
 34     system, and later executes on another system that does not support these hints. In  
 35     general, unsupported hints should simply be ignored. Needless to say, no hint can be  
 36     mandatory. However, for each hint used by a specific implementation, a default value  
 37     must be provided when the user does not specify a value for the hint. (*End of advice*  
 38     *to implementors.*)  
 39

40  
 41 MPI\_WIN\_SET\_INFO(win, info)

42  
 43     INOUT    win                   window object (handle)  
 44     IN       info                  info argument (handle)  
 45

46 **C binding**

47 int MPI\_Win\_set\_info(MPI\_Win win, MPI\_Info info)  
 48

**Fortran 2008 binding**

```

MPI_Win_set_info(win, info, ierror)
    TYPE(MPI_Win), INTENT(IN) :: win
    TYPE(MPI_Info), INTENT(IN) :: info
    INTEGER, OPTIONAL, INTENT(OUT) :: ierror

```

**Fortran binding**

```

MPI_WIN_SET_INFO(WIN, INFO, IERROR)
    INTEGER WIN, INFO, IERROR

```

MPI\_WIN\_SET\_INFO updates the hints of the window associated with `win` using the hints provided in `info`. This operation has no effect on previously set or defaulted hints that are not specified by `info`. It also has no effect on previously set or defaulted hints that are specified by `info`, but are ignored by the MPI implementation in this call to MPI\_WIN\_SET\_INFO. The call is collective on the group of `win`. The `info` object may be different on each process, but any `info` entries that an implementation requires to be the same on all processes must appear with the same value in each process's `info` object.

*Advice to users.* Some `info` items that an implementation can use when it creates a window cannot easily be changed once the window has been created. Thus, an implementation may ignore hints issued in this call that it would have accepted in a creation call. An implementation may also be unable to update certain `info` hints in a call to MPI\_WIN\_SET\_INFO. MPI\_WIN\_GET\_INFO can be used to determine whether `info` changes were ignored by the implementation. (*End of advice to users.*)

```

MPI_WIN_GET_INFO(win, info_used)

```

IN	<code>win</code>	window object (handle)
OUT	<code>info_used</code>	new info object (handle)

**C binding**

```

int MPI_Win_get_info(MPI_Win win, MPI_Info *info_used)

```

**Fortran 2008 binding**

```

MPI_Win_get_info(win, info_used, ierror)
    TYPE(MPI_Win), INTENT(IN) :: win
    TYPE(MPI_Info), INTENT(OUT) :: info_used
    INTEGER, OPTIONAL, INTENT(OUT) :: ierror

```

**Fortran binding**

```

MPI_WIN_GET_INFO(WIN, INFO_USED, IERROR)
    INTEGER WIN, INFO_USED, IERROR

```

MPI\_WIN\_GET\_INFO returns a new `info` object containing the hints of the window associated with `win`. The current setting of all hints related to this window is returned in `info_used`. An MPI implementation is required to return all hints that are supported by the implementation and have default values specified; any user-supplied hints that were not ignored by the implementation; and any additional hints that were set by the implementa-

tion. If no such hints exist, a handle to a newly created info object is returned that contains no key/value pair. The user is responsible for freeing `info_used` via `MPI_INFO_FREE`.

### 11.3 Communication Calls

MPI supports the following RMA communication calls: `MPI_PUT` and `MPI_RPUT` transfer data from the caller memory (origin) to the target memory; `MPI_GET` and `MPI_RGET` transfer data from the target memory to the caller memory; `MPI_ACCUMULATE` and `MPI_RACCUMULATE` update locations in the target memory, e.g., by adding to these locations values sent from the caller memory; `MPI_GET_ACCUMULATE`, `MPI_RGET_ACCUMULATE`, and `MPI_FETCH_AND_OP` perform atomic read-modify-write and return the data before the accumulate operation; and `MPI_COMPARE_AND_SWAP` performs a remote atomic compare and swap operation. These operations are *nonblocking*: the call initiates the transfer, but the transfer may continue after the call returns. The transfer is completed, at the origin or both the origin and the target, when a subsequent *synchronization* call is issued by the caller on the involved window object. These synchronization calls are described in Section 11.5. Transfers can also be completed with calls to flush routines; see Section 11.5.4 for details. For the `MPI_RPUT`, `MPI_RGET`, `MPI_RACCUMULATE`, and `MPI_RGET_ACCUMULATE` calls, the transfer can be locally completed by using the MPI test or wait operations described in Section 3.7.3.

The local communication buffer of an RMA call should not be updated, and the local communication buffer of a get call should not be accessed after the RMA call until the operation completes at the origin.

The resulting data values, or outcome, of concurrent conflicting accesses to the same memory locations is undefined; if a location is updated by a put or accumulate operation, then the outcome of loads or other RMA operations is undefined until the updating operation has completed at the target. There is one exception to this rule; namely, the same location can be updated by several concurrent accumulate calls, the outcome being as if these updates occurred in some order. In addition, the outcome of concurrent load/store and RMA updates to the same memory location is undefined. These restrictions are described in more detail in Section 11.7.

The calls use general datatype arguments to specify communication buffers at the origin and at the target. Thus, a transfer operation may also gather data at the source and scatter it at the destination. However, all arguments specifying both communication buffers are provided by the caller.

For all RMA calls, the target process may be identical with the origin process; i.e., a process may use an RMA operation to move data in its memory.

*Rationale.* The choice of supporting “self-communication” is the same as for message-passing. It simplifies some coding, and is very useful with accumulate operations, to allow atomic updates of local variables. (*End of rationale.*)

`MPI_PROC_NULL` is a valid target rank in all MPI RMA communication calls. The effect is the same as for `MPI_PROC_NULL` in MPI point-to-point communication. After any RMA operation with rank `MPI_PROC_NULL`, it is still necessary to finish the RMA epoch with the synchronization method that started the epoch.

## 11.3.1 Put

The execution of a put operation is similar to the execution of a send by the origin process and a matching receive by the target process. The obvious difference is that all arguments are provided by one call — the call executed by the origin process.

```
MPI_PUT(origin_addr, origin_count, origin_datatype, target_rank, target_disp, target_count,
        target_datatype, win)
```

IN	origin_addr	initial address of origin buffer (choice)
IN	origin_count	number of entries in origin buffer (non-negative integer)
IN	origin_datatype	datatype of each entry in origin buffer (handle)
IN	target_rank	rank of target (non-negative integer)
IN	target_disp	displacement from start of window to target buffer (non-negative integer)
IN	target_count	number of entries in target buffer (non-negative integer)
IN	target_datatype	datatype of each entry in target buffer (handle)
IN	win	window object used for communication (handle)

**C binding**

```
int MPI_Put(const void *origin_addr, int origin_count,
           MPI_Datatype origin_datatype, int target_rank,
           MPI_Aint target_disp, int target_count,
           MPI_Datatype target_datatype, MPI_Win win)
```

**Fortran 2008 binding**

```
MPI_Put(origin_addr, origin_count, origin_datatype, target_rank,
        target_disp, target_count, target_datatype, win, ierror)
TYPE(*), DIMENSION(..), INTENT(IN), ASYNCHRONOUS :: origin_addr
INTEGER, INTENT(IN) :: origin_count, target_rank, target_count
TYPE(MPI_Datatype), INTENT(IN) :: origin_datatype, target_datatype
INTEGER(KIND=MPI_ADDRESS_KIND), INTENT(IN) :: target_disp
TYPE(MPI_Win), INTENT(IN) :: win
INTEGER, OPTIONAL, INTENT(OUT) :: ierror
```

**Fortran binding**

```
MPI_PUT(ORIGIN_ADDR, ORIGIN_COUNT, ORIGIN_DATATYPE, TARGET_RANK,
        TARGET_DISP, TARGET_COUNT, TARGET_DATATYPE, WIN, IERROR)
<type> ORIGIN_ADDR(*)
INTEGER ORIGIN_COUNT, ORIGIN_DATATYPE, TARGET_RANK, TARGET_COUNT,
TARGET_DATATYPE, WIN, IERROR
INTEGER(KIND=MPI_ADDRESS_KIND) TARGET_DISP
```

Transfers `origin_count` successive entries of the type specified by the `origin_datatype`, starting at address `origin_addr` on the origin node, to the target node specified by the `win`,

1 target\_rank pair. The data are written in the target buffer at address `target_addr =`  
2 `window_base + target_disp × disp_unit`, where `window_base` and `disp_unit` are the base address  
3 and window displacement unit specified at window initialization, by the target process.

4 The target buffer is specified by the arguments `target_count` and `target_datatype`.

5 The data transfer is the same as that which would occur if the origin process executed  
6 a send operation with arguments `origin_addr`, `origin_count`, `origin_datatype`, `target_rank`, `tag`,  
7 `comm`, and the target process executed a receive operation with arguments `target_addr`,  
8 `target_count`, `target_datatype`, `source`, `tag`, `comm`, where `target_addr` is the target buffer  
9 address computed as explained above, the values of `tag` are arbitrary valid matching tag  
10 values, and `comm` is a communicator for the group of `win`.

11 The communication must satisfy the same constraints as for a similar message-passing  
12 communication. The `target_datatype` may not specify overlapping entries in the target  
13 buffer. The message sent must fit, without truncation, in the target buffer. Furthermore,  
14 the target buffer must fit in the target window or in attached memory in a dynamic window.

15 The `target_datatype` argument is a handle to a datatype object defined at the origin  
16 process. However, this object is interpreted at the target process: the outcome is as if  
17 the target datatype object was defined at the target process by the same sequence of calls  
18 used to define it at the origin process. The target datatype must contain only relative  
19 displacements, not absolute addresses. The same holds for `get` and `accumulate` operations.

20  
21 *Advice to users.* The `target_datatype` argument is a handle to a datatype object that  
22 is defined at the origin process, even though it defines a data layout in the target  
23 process memory. This causes no problems in a homogeneous environment, or in a  
24 heterogeneous environment if only portable datatypes are used (portable datatypes  
25 are defined in Section 2.4).

26 The performance of a put transfer can be significantly affected, on some systems, by  
27 the choice of window location and the shape and location of the origin and target  
28 buffer: transfers to a target window in memory allocated by `MPI_ALLOC_MEM` or  
29 `MPI_WIN_ALLOCATE` may be much faster on shared memory systems; transfers from  
30 contiguous buffers will be faster on most, if not all, systems; the alignment of the  
31 communication buffers may also impact performance. (*End of advice to users.*)

32  
33 *Advice to implementors.* A high-quality implementation will attempt to prevent  
34 remote accesses to memory outside the window that was exposed by the process.  
35 This is important both for debugging purposes and for protection with client-server  
36 codes that use RMA. That is, a high-quality implementation will check, if possible,  
37 window bounds on each RMA call, and raise an MPI exception at the origin call if an  
38 out-of-bound situation occurs. Note that the condition can be checked at the origin.  
39 Of course, the added safety achieved by such checks has to be weighed against the  
40 added cost of such checks. (*End of advice to implementors.*)

## 11.3.2 Get

MPI\_GET(origin\_addr, origin\_count, origin\_datatype, target\_rank, target\_disp, target\_count, target\_datatype, win)

OUT	origin_addr	initial address of origin buffer (choice)	1
			2
			3
			4
			5
			6
IN	origin_count	number of entries in origin buffer (non-negative integer)	7
			8
			9
IN	origin_datatype	datatype of each entry in origin buffer (handle)	10
			11
IN	target_rank	rank of target (non-negative integer)	12
			13
IN	target_disp	displacement from window start to the beginning of the target buffer (non-negative integer)	14
			15
IN	target_count	number of entries in target buffer (non-negative integer)	16
			17
IN	target_datatype	datatype of each entry in target buffer (handle)	18
			19
IN	win	window object used for communication (handle)	20

**C binding**

```
int MPI_Get(void *origin_addr, int origin_count,
            MPI_Datatype origin_datatype, int target_rank,
            MPI_Aint target_disp, int target_count,
            MPI_Datatype target_datatype, MPI_Win win)
```

**Fortran 2008 binding**

```
MPI_Get(origin_addr, origin_count, origin_datatype, target_rank,
        target_disp, target_count, target_datatype, win, ierror)
TYPE(*), DIMENSION(..), ASYNCHRONOUS :: origin_addr
INTEGER, INTENT(IN) :: origin_count, target_rank, target_count
TYPE(MPI_Datatype), INTENT(IN) :: origin_datatype, target_datatype
INTEGER(KIND=MPI_ADDRESS_KIND), INTENT(IN) :: target_disp
TYPE(MPI_Win), INTENT(IN) :: win
INTEGER, OPTIONAL, INTENT(OUT) :: ierror
```

**Fortran binding**

```
MPI_GET(ORIGIN_ADDR, ORIGIN_COUNT, ORIGIN_DATATYPE, TARGET_RANK,
        TARGET_DISP, TARGET_COUNT, TARGET_DATATYPE, WIN, IERROR)
<type> ORIGIN_ADDR(*)
INTEGER ORIGIN_COUNT, ORIGIN_DATATYPE, TARGET_RANK, TARGET_COUNT,
TARGET_DATATYPE, WIN, IERROR
INTEGER(KIND=MPI_ADDRESS_KIND) TARGET_DISP
```

Similar to MPI\_PUT, except that the direction of data transfer is reversed. Data are copied from the target memory to the origin. The origin\_datatype may not specify overlapping entries in the origin buffer. The target buffer must be contained within the target window or within attached memory in a dynamic window, and the copied data must fit, without truncation, in the origin buffer.

### 11.3.3 Examples for Communication Calls

These examples show the use of the MPI\_GET function. As all MPI RMA communication functions are nonblocking, they must be completed. In the following, this is accomplished with the routine MPI\_WIN\_FENCE, introduced in Section 11.5.

**Example 11.1** We show how to implement the generic indirect assignment  $A = B(\text{map})$ , where  $A$ ,  $B$ , and  $\text{map}$  have the same distribution, and  $\text{map}$  is a permutation. To simplify, we assume a block distribution with equal size blocks.

```

SUBROUTINE MAPVALS(A, B, map, m, comm, p)
USE MPI
INTEGER m, map(m), comm, p
REAL A(m), B(m)

INTEGER otype(p), oindex(m),    & ! used to construct origin datatypes
      ttype(p), tindex(m),      & ! used to construct target datatypes
      count(p), total(p),       &
      disp_int, win, ierr
INTEGER (KIND=MPI_ADDRESS_KIND) lowerbound, size, realextent, disp_aint

! This part does the work that depends on the locations of B.
! Can be reused while this does not change

CALL MPI_TYPE_GET_EXTENT(MPI_REAL, lowerbound, realextent, ierr)
disp_int = realextent
size = m * realextent
CALL MPI_WIN_CREATE(B, size, disp_int, MPI_INFO_NULL,    &
                   comm, win, ierr)

! This part does the work that depends on the value of map and
! the locations of the arrays.
! Can be reused while these do not change

! Compute number of entries to be received from each process

DO i=1,p
  count(i) = 0
END DO
DO i=1,m
  j = map(i)/m+1
  count(j) = count(j)+1
END DO

total(1) = 0
DO i=2,p
  total(i) = total(i-1) + count(i-1)
END DO

```



```

DO i=1,p
    count(i) = 0
END DO

! compute origin and target indices of entries.
! entry i at current process is received from location
! k at process (j-1), where map(i) = (j-1)*m + (k-1),
! j = 1..p and k = 1..m

DO i=1,m
    j = map(i)/m+1
    k = MOD(map(i),m)+1
    count(j) = count(j)+1
    oindex(total(j) + count(j)) = i
    tindex(total(j) + count(j)) = k
END DO

! create origin and target datatypes for each get operation
DO i=1,p
    CALL MPI_TYPE_CREATE_INDEXED_BLOCK(count(i), 1, &
                                     oindex(total(i)+1:total(i)+count(i)), &
                                     MPI_REAL, otype(i), ierr)
    CALL MPI_TYPE_COMMIT(otype(i), ierr)
    CALL MPI_TYPE_CREATE_INDEXED_BLOCK(count(i), 1, &
                                     tindex(total(i)+1:total(i)+count(i)), &
                                     MPI_REAL, ttype(i), ierr)
    CALL MPI_TYPE_COMMIT(ttype(i), ierr)
END DO

! this part does the assignment itself
CALL MPI_WIN_FENCE(0, win, ierr)
disp_aint = 0
DO i=1,p
    CALL MPI_GET(A, 1, otype(i), i-1, disp_aint, 1, ttype(i), win, ierr)
END DO
CALL MPI_WIN_FENCE(0, win, ierr)

CALL MPI_WIN_FREE(win, ierr)
DO i=1,p
    CALL MPI_TYPE_FREE(otype(i), ierr)
    CALL MPI_TYPE_FREE(ttype(i), ierr)
END DO
RETURN
END

```

**Example 11.2** A simpler version can be written that does not require that a datatype be built for the target buffer. But, one then needs a separate get call for each entry, as

1 illustrated below. This code is much simpler, but usually much less efficient, for large arrays.

```
2
3 SUBROUTINE MAPVALS(A, B, map, m, comm, p)
4 USE MPI
5 INTEGER m, map(m), comm, p
6 REAL A(m), B(m)
7 INTEGER disp_int, win, ierr
8 INTEGER (KIND=MPI_ADDRESS_KIND) lowerbound, size, realextent, disp_aint
9
10 CALL MPI_TYPE_GET_EXTENT(MPI_REAL, lowerbound, realextent, ierr)
11 disp_int = realextent
12 size = m * realextent
13 CALL MPI_WIN_CREATE(B, size, disp_int, MPI_INFO_NULL, &
14                    comm, win, ierr)
15
16 CALL MPI_WIN_FENCE(0, win, ierr)
17 DO i=1,m
18     j = map(i)/m
19     disp_aint = MOD(map(i),m)
20     CALL MPI_GET(A(i), 1, MPI_REAL, j, disp_aint, 1, MPI_REAL, win, ierr)
21 END DO
22 CALL MPI_WIN_FENCE(0, win, ierr)
23 CALL MPI_WIN_FREE(win, ierr)
24 RETURN
25 END
```

### 26 27 11.3.4 Accumulate Functions

28 It is often useful in a put operation to combine the data moved to the target process with the  
29 data that resides at that process, rather than replacing it. This will allow, for example, the  
30 accumulation of a sum by having all involved processes add their contributions to the sum  
31 variable in the memory of one process. The accumulate functions have slightly different  
32 semantics with respect to overlapping data accesses than the put and get functions; see  
33 Section [11.7](#) for details.  
34

## Accumulate Function

			1
			2
			3
			4
			5
			6
IN	origin_addr	initial address of buffer (choice)	7
IN	origin_count	number of entries in buffer (non-negative integer)	8
IN	origin_datatype	datatype of each entry (handle)	9
IN	target_rank	rank of target (non-negative integer)	10
IN	target_disp	displacement from start of window to beginning of target buffer (non-negative integer)	12
			13
IN	target_count	number of entries in target buffer (non-negative integer)	14
			15
IN	target_datatype	datatype of each entry in target buffer (handle)	17
IN	op	reduce operation (handle)	18
IN	win	window object (handle)	19
			20

**C binding**

```

int MPI_Accumulate(const void *origin_addr, int origin_count,
                  MPI_Datatype origin_datatype, int target_rank,
                  MPI_Aint target_disp, int target_count,
                  MPI_Datatype target_datatype, MPI_Op op, MPI_Win win)

```

**Fortran 2008 binding**

```

MPI_Accumulate(origin_addr, origin_count, origin_datatype, target_rank,
               target_disp, target_count, target_datatype, op, win, ierror)
TYPE(*), DIMENSION(..), INTENT(IN), ASYNCHRONOUS :: origin_addr
INTEGER, INTENT(IN) :: origin_count, target_rank, target_count
TYPE(MPI_Datatype), INTENT(IN) :: origin_datatype, target_datatype
INTEGER(KIND=MPI_ADDRESS_KIND), INTENT(IN) :: target_disp
TYPE(MPI_Op), INTENT(IN) :: op
TYPE(MPI_Win), INTENT(IN) :: win
INTEGER, OPTIONAL, INTENT(OUT) :: ierror

```

**Fortran binding**

```

MPI_ACCUMULATE(ORIGIN_ADDR, ORIGIN_COUNT, ORIGIN_DATATYPE, TARGET_RANK,
               TARGET_DISP, TARGET_COUNT, TARGET_DATATYPE, OP, WIN, IERROR)
<type> ORIGIN_ADDR(*)
INTEGER ORIGIN_COUNT, ORIGIN_DATATYPE, TARGET_RANK, TARGET_COUNT,
TARGET_DATATYPE, OP, WIN, IERROR
INTEGER(KIND=MPI_ADDRESS_KIND) TARGET_DISP

```

Accumulate the contents of the origin buffer (as defined by `origin_addr`, `origin_count`, and `origin_datatype`) to the buffer specified by arguments `target_count` and `target_datatype`, at offset `target_disp`, in the target window specified by `target_rank` and `win`, using the operation

1 op. This is like MPI\_PUT except that data is combined into the target area instead of  
2 overwriting it.

3 Any of the predefined operations for MPI\_REDUCE can be used. User-defined functions  
4 cannot be used. For example, if op is MPI\_SUM, each element of the origin buffer is added  
5 to the corresponding element in the target, replacing the former value in the target.

6 Each datatype argument must be a predefined datatype or a derived datatype, where  
7 all basic components are of the same predefined datatype. Both datatype arguments must  
8 be constructed from the same predefined datatype. The operation op applies to elements of  
9 that predefined type. The parameter target\_datatype must not specify overlapping entries,  
10 and the target buffer must fit in the target window.

11 A new predefined operation, MPI\_REPLACE, is defined. It corresponds to the associative  
12 function  $f(a, b) = b$ ; i.e., the current value in the target memory is replaced by the value  
13 supplied by the origin.

14 MPI\_REPLACE can be used only in MPI\_ACCUMULATE, MPI\_RACCUMULATE,  
15 MPI\_GET\_ACCUMULATE, MPI\_FETCH\_AND\_OP, and MPI\_RGET\_ACCUMULATE, but not  
16 in collective reduction operations such as MPI\_REDUCE.

17 *Advice to users.* MPI\_PUT is a special case of MPI\_ACCUMULATE, with the op-  
18 eration MPI\_REPLACE. Note, however, that MPI\_PUT and MPI\_ACCUMULATE have  
19 different constraints on concurrent updates. (*End of advice to users.*)

21  
22 **Example 11.3** We want to compute  $B(j) = \sum_{\text{map}(i)=j} A(i)$ . The arrays A, B, and map  
23 are distributed in the same manner. We write the simple version.  
24

```
25 SUBROUTINE SUM(A, B, map, m, comm, p)
26 USE MPI
27 INTEGER m, map(m), comm, p, win, ierr, disp_int
28 REAL A(m), B(m)
29 INTEGER (KIND=MPI_ADDRESS_KIND) lowerbound, size, realextent, disp_aint
30
31 CALL MPI_TYPE_GET_EXTENT(MPI_REAL, lowerbound, realextent, ierr)
32 size = m * realextent
33 disp_int = realextent
34 CALL MPI_WIN_CREATE(B, size, disp_int, MPI_INFO_NULL, &
35                    comm, win, ierr)
36
37 CALL MPI_WIN_FENCE(0, win, ierr)
38 DO i=1,m
39   j = map(i)/m
40   disp_aint = MOD(map(i),m)
41   CALL MPI_ACCUMULATE(A(i), 1, MPI_REAL, j, disp_aint, 1, MPI_REAL, &
42                      MPI_SUM, win, ierr)
43 END DO
44 CALL MPI_WIN_FENCE(0, win, ierr)
45
46 CALL MPI_WIN_FREE(win, ierr)
47 RETURN
48 END
```

This code is identical to the code in Example 11.2, except that a call to get has been replaced by a call to accumulate. (Note that, if `map` is one-to-one, the code computes  $B = A(\text{map}^{-1})$ , which is the reverse assignment to the one computed in that previous example.) In a similar manner, we can replace in Example 11.1, the call to get by a call to accumulate, thus performing the computation with only one communication between any two processes.

### Get Accumulate Function

It is often useful to have fetch-and-accumulate semantics such that the remote data is returned to the caller before the sent data is accumulated into the remote data. The get and accumulate steps are executed atomically for each basic element in the datatype (see Section 11.7 for details). The predefined operation `MPI_REPLACE` provides fetch-and-set behavior.

`MPI_GET_ACCUMULATE(origin_addr, origin_count, origin_datatype, result_addr, result_count, result_datatype, target_rank, target_disp, target_count, target_datatype, op, win)`

IN	<code>origin_addr</code>	initial address of buffer (choice)
IN	<code>origin_count</code>	number of entries in origin buffer (non-negative integer)
IN	<code>origin_datatype</code>	datatype of each entry in origin buffer (handle)
OUT	<code>result_addr</code>	initial address of result buffer (choice)
IN	<code>result_count</code>	number of entries in result buffer (non-negative integer)
IN	<code>result_datatype</code>	datatype of each entry in result buffer (handle)
IN	<code>target_rank</code>	rank of target (non-negative integer)
IN	<code>target_disp</code>	displacement from start of window to beginning of target buffer (non-negative integer)
IN	<code>target_count</code>	number of entries in target buffer (non-negative integer)
IN	<code>target_datatype</code>	datatype of each entry in target buffer (handle)
IN	<code>op</code>	reduce operation (handle)
IN	<code>win</code>	window object (handle)

### C binding

```
int MPI_Get_accumulate(const void *origin_addr, int origin_count,
                      MPI_Datatype origin_datatype, void *result_addr,
                      int result_count, MPI_Datatype result_datatype,
                      int target_rank, MPI_Aint target_disp, int target_count,
                      MPI_Datatype target_datatype, MPI_Op op, MPI_Win win)
```

### Fortran 2008 binding

```

1 MPI_Get_accumulate(origin_addr, origin_count, origin_datatype, result_addr,
2                   result_count, result_datatype, target_rank, target_disp,
3                   target_count, target_datatype, op, win, ierror)
4     TYPE(*), DIMENSION(..), INTENT(IN), ASYNCHRONOUS :: origin_addr
5     INTEGER, INTENT(IN) :: origin_count, result_count, target_rank,
6     target_count
7     TYPE(MPI_Datatype), INTENT(IN) :: origin_datatype, result_datatype,
8     target_datatype
9     TYPE(*), DIMENSION(..), ASYNCHRONOUS :: result_addr
10    INTEGER(KIND=MPI_ADDRESS_KIND), INTENT(IN) :: target_disp
11    TYPE(MPI_Op), INTENT(IN) :: op
12    TYPE(MPI_Win), INTENT(IN) :: win
13    INTEGER, OPTIONAL, INTENT(OUT) :: ierror

```

### Fortran binding

```

15 MPI_GET_ACCUMULATE(ORIGIN_ADDR, ORIGIN_COUNT, ORIGIN_DATATYPE, RESULT_ADDR,
16                   RESULT_COUNT, RESULT_DATATYPE, TARGET_RANK, TARGET_DISP,
17                   TARGET_COUNT, TARGET_DATATYPE, OP, WIN, IERROR)
18     <type> ORIGIN_ADDR(*), RESULT_ADDR(*)
19     INTEGER ORIGIN_COUNT, ORIGIN_DATATYPE, RESULT_COUNT, RESULT_DATATYPE,
20     TARGET_RANK, TARGET_COUNT, TARGET_DATATYPE, OP, WIN, IERROR
21     INTEGER(KIND=MPI_ADDRESS_KIND) TARGET_DISP

```

Accumulate `origin_count` elements of type `origin_datatype` from the origin buffer (`origin_addr`) to the buffer at offset `target_disp`, in the target window specified by `target_rank` and `win`, using the operation `op` and return in the result buffer `result_addr` the content of the target buffer before the accumulation, specified by `target_disp`, `target_count`, and `target_datatype`. The data transferred from origin to target must fit, without truncation, in the target buffer. Likewise, the data copied from target to origin must fit, without truncation, in the result buffer.

The origin and result buffers (`origin_addr` and `result_addr`) must be disjoint. Each datatype argument must be a predefined datatype or a derived datatype where all basic components are of the same predefined datatype. All datatype arguments must be constructed from the same predefined datatype. The operation `op` applies to elements of that predefined type. `target_datatype` must not specify overlapping entries, and the target buffer must fit in the target window or in attached memory in a dynamic window. The operation is executed atomically for each basic datatype; see Section 11.7 for details.

Any of the predefined operations for `MPI_REDUCE`, as well as `MPI_NO_OP` or `MPI_REPLACE` can be specified as `op`. User-defined functions cannot be used. A new predefined operation, `MPI_NO_OP`, is defined. It corresponds to the associative function  $f(a, b) = a$ ; i.e., the current value in the target memory is returned in the result buffer at the origin and no operation is performed on the target buffer. When `MPI_NO_OP` is specified as the operation, the `origin_addr`, `origin_count`, and `origin_datatype` arguments are ignored. `MPI_NO_OP` can be used only in `MPI_GET_ACCUMULATE`, `MPI_RGET_ACCUMULATE`, and `MPI_FETCH_AND_OP`. `MPI_NO_OP` cannot be used in `MPI_ACCUMULATE`, `MPI_RACCUMULATE`, or collective reduction operations, such as `MPI_REDUCE` and others.

*Advice to users.* `MPI_GET` is similar to `MPI_GET_ACCUMULATE`, with the operation `MPI_NO_OP`. Note, however, that `MPI_GET` and `MPI_GET_ACCUMULATE` have

different constraints on concurrent updates. (*End of advice to users.*)

### Fetch and Op Function

The generic functionality of `MPI_GET_ACCUMULATE` might limit the performance of fetch-and-increment or fetch-and-add calls that might be supported by special hardware operations. `MPI_FETCH_AND_OP` thus allows for a fast implementation of a commonly used subset of the functionality of `MPI_GET_ACCUMULATE`.

`MPI_FETCH_AND_OP(origin_addr, result_addr, datatype, target_rank, target_disp, op, win)`

IN	<code>origin_addr</code>	initial address of buffer (choice)
OUT	<code>result_addr</code>	initial address of result buffer (choice)
IN	<code>datatype</code>	datatype of the entry in origin, result, and target buffers (handle)
IN	<code>target_rank</code>	rank of target (non-negative integer)
IN	<code>target_disp</code>	displacement from start of window to beginning of target buffer (non-negative integer)
IN	<code>op</code>	reduce operation (handle)
IN	<code>win</code>	window object (handle)

### C binding

```
int MPI_Fetch_and_op(const void *origin_addr, void *result_addr,
                    MPI_Datatype datatype, int target_rank, MPI_Aint target_disp,
                    MPI_Op op, MPI_Win win)
```

### Fortran 2008 binding

```
MPI_Fetch_and_op(origin_addr, result_addr, datatype, target_rank,
                 target_disp, op, win, ierror)
    TYPE(*), DIMENSION(..), INTENT(IN), ASYNCHRONOUS :: origin_addr
    TYPE(*), DIMENSION(..), ASYNCHRONOUS :: result_addr
    TYPE(MPI_Datatype), INTENT(IN) :: datatype
    INTEGER, INTENT(IN) :: target_rank
    INTEGER(KIND=MPI_ADDRESS_KIND), INTENT(IN) :: target_disp
    TYPE(MPI_Op), INTENT(IN) :: op
    TYPE(MPI_Win), INTENT(IN) :: win
    INTEGER, OPTIONAL, INTENT(OUT) :: ierror
```

### Fortran binding

```
MPI_FETCH_AND_OP(ORIGIN_ADDR, RESULT_ADDR, DATATYPE, TARGET_RANK,
                 TARGET_DISP, OP, WIN, IERROR)
    <type> ORIGIN_ADDR(*), RESULT_ADDR(*)
    INTEGER DATATYPE, TARGET_RANK, OP, WIN, IERROR
    INTEGER(KIND=MPI_ADDRESS_KIND) TARGET_DISP
```

Accumulate one element of type `datatype` from the origin buffer (`origin_addr`) to the buffer at offset `target_disp`, in the target window specified by `target_rank` and `win`, using

1 the operation `op` and return in the result buffer `result_addr` the content of the target buffer  
 2 before the accumulation.

3 The origin and result buffers (`origin_addr` and `result_addr`) must be disjoint. Any of the  
 4 predefined operations for `MPI_REDUCE`, as well as `MPI_NO_OP` or `MPI_REPLACE`, can be  
 5 specified as `op`; user-defined functions cannot be used. The `datatype` argument must be a  
 6 predefined datatype. The operation is executed atomically.

### 8 Compare and Swap Function

9 Another useful operation is an atomic compare and swap where the value at the origin is  
 10 compared to the value at the target, which is atomically replaced by a third value only if  
 11 the values at origin and target are equal.  
 12

13  
 14 `MPI_COMPARE_AND_SWAP(origin_addr, compare_addr, result_addr, datatype, target_rank,`  
 15 `target_disp, win)`

16			
17	IN	<code>origin_addr</code>	initial address of buffer (choice)
18	IN	<code>compare_addr</code>	initial address of compare buffer (choice)
19	OUT	<code>result_addr</code>	initial address of result buffer (choice)
20			
21	IN	<code>datatype</code>	datatype of the element in all buffers (handle)
22	IN	<code>target_rank</code>	rank of target (non-negative integer)
23	IN	<code>target_disp</code>	displacement from start of window to beginning of tar-
24			get buffer (non-negative integer)
25			
26	IN	<code>win</code>	window object (handle)

### 27 C binding

28  
 29 `int MPI_Compare_and_swap(const void *origin_addr, const void *compare_addr,`  
 30 `void *result_addr, MPI_Datatype datatype, int target_rank,`  
 31 `MPI_Aint target_disp, MPI_Win win)`

### 32 Fortran 2008 binding

33 `MPI_Compare_and_swap(origin_addr, compare_addr, result_addr, datatype,`  
 34 `target_rank, target_disp, win, ierror)`  
 35 `TYPE(*), DIMENSION(..), INTENT(IN), ASYNCHRONOUS :: origin_addr,`  
 36 `compare_addr`  
 37 `TYPE(*), DIMENSION(..), ASYNCHRONOUS :: result_addr`  
 38 `TYPE(MPI_Datatype), INTENT(IN) :: datatype`  
 39 `INTEGER, INTENT(IN) :: target_rank`  
 40 `INTEGER(KIND=MPI_ADDRESS_KIND), INTENT(IN) :: target_disp`  
 41 `TYPE(MPI_Win), INTENT(IN) :: win`  
 42 `INTEGER, OPTIONAL, INTENT(OUT) :: ierror`  
 43

### 44 Fortran binding

45 `MPI_COMPARE_AND_SWAP(ORIGIN_ADDR, COMPARE_ADDR, RESULT_ADDR, DATATYPE,`  
 46 `TARGET_RANK, TARGET_DISP, WIN, IERROR)`  
 47 `<type> ORIGIN_ADDR(*), COMPARE_ADDR(*), RESULT_ADDR(*)`  
 48 `INTEGER DATATYPE, TARGET_RANK, WIN, IERROR`



INTEGER(KIND=MPI\_ADDRESS\_KIND) TARGET\_DISP

This function compares one element of type `datatype` in the compare buffer `compare_addr` with the buffer at offset `target_disp` in the target window specified by `target_rank` and `win` and replaces the value at the target with the value in the origin buffer `origin_addr` if the compare buffer and the target buffer are identical. The original value at the target is returned in the buffer `result_addr`. The parameter `datatype` must belong to one of the following categories of predefined datatypes: C integer, Fortran integer, Logical, Multi-language types, or Byte as specified in Section 5.9.2. The origin and result buffers (`origin_addr` and `result_addr`) must be disjoint.

### 11.3.5 Request-based RMA Communication Operations

Request-based RMA communication operations allow the user to associate a request handle with the RMA operations and test or wait for the completion of these requests using the functions described in Section 3.7.3. Request-based RMA operations are only valid within a passive target epoch (see Section 11.5).

Upon returning from a completion call in which an RMA operation completes, the `MPI_ERROR` field in the associated status object is set appropriately (see Section 3.2.5). All other fields of status and the results of status query functions (e.g., `MPI_GET_COUNT`) are undefined. It is valid to mix different request types (e.g., any combination of RMA requests, collective requests, I/O requests, generalized requests, or point-to-point requests) in functions that enable multiple completions (e.g., `MPI_WAITALL`). It is erroneous to call `MPI_REQUEST_FREE` or `MPI_CANCEL` for a request associated with an RMA operation. RMA requests are not persistent.

The end of the epoch, or explicit bulk synchronization using `MPI_WIN_FLUSH`, `MPI_WIN_FLUSH_ALL`, `MPI_WIN_FLUSH_LOCAL`, or `MPI_WIN_FLUSH_LOCAL_ALL`, also indicates completion of the RMA operations. However, users must still wait or test on the request handle to allow the MPI implementation to clean up any resources associated with these requests; in such cases the wait operation will complete locally.

```

1 MPI_RPUT(origin_addr, origin_count, origin_datatype, target_rank, target_disp, target_count,
2         target_datatype, win, request)

```

3	IN	origin_addr	initial address of origin buffer (choice)
4			
5	IN	origin_count	number of entries in origin buffer (non-negative integer)
6			
7	IN	origin_datatype	datatype of each entry in origin buffer (handle)
8			
9	IN	target_rank	rank of target (non-negative integer)
10	IN	target_disp	displacement from start of window to target buffer (non-negative integer)
11			
12	IN	target_count	number of entries in target buffer (non-negative integer)
13			
14	IN	target_datatype	datatype of each entry in target buffer (handle)
15			
16	IN	win	window object used for communication (handle)
17	OUT	request	RMA request (handle)

### 19 C binding

```

20 int MPI_Rput(const void *origin_addr, int origin_count,
21             MPI_Datatype origin_datatype, int target_rank,
22             MPI_Aint target_disp, int target_count,
23             MPI_Datatype target_datatype, MPI_Win win,
24             MPI_Request *request)
25

```

### 26 Fortran 2008 binding

```

27 MPI_Rput(origin_addr, origin_count, origin_datatype, target_rank,
28         target_disp, target_count, target_datatype, win, request,
29         ierror)
30     TYPE(*), DIMENSION(..), INTENT(IN), ASYNCHRONOUS :: origin_addr
31     INTEGER, INTENT(IN) :: origin_count, target_rank, target_count
32     TYPE(MPI_Datatype), INTENT(IN) :: origin_datatype, target_datatype
33     INTEGER(KIND=MPI_ADDRESS_KIND), INTENT(IN) :: target_disp
34     TYPE(MPI_Win), INTENT(IN) :: win
35     TYPE(MPI_Request), INTENT(OUT) :: request
36     INTEGER, OPTIONAL, INTENT(OUT) :: ierror

```

### 37 Fortran binding

```

38 MPI_RPUT(ORIGIN_ADDR, ORIGIN_COUNT, ORIGIN_DATATYPE, TARGET_RANK,
39         TARGET_DISP, TARGET_COUNT, TARGET_DATATYPE, WIN, REQUEST,
40         IERROR)
41     <type> ORIGIN_ADDR(*)
42     INTEGER ORIGIN_COUNT, ORIGIN_DATATYPE, TARGET_RANK, TARGET_COUNT,
43     TARGET_DATATYPE, WIN, REQUEST, IERROR
44     INTEGER(KIND=MPI_ADDRESS_KIND) TARGET_DISP
45

```

46 MPI\_RPUT is similar to MPI\_PUT (Section 11.3.1), except that it allocates a communication request object and associates it with the request handle (the argument request).

The completion of an MPI\_RPUT operation (i.e., after the corresponding test or wait) indicates that the sender is now free to update the locations in the origin buffer. It does not indicate that the data is available at the target window. If remote completion is required, MPI\_WIN\_FLUSH, MPI\_WIN\_FLUSH\_ALL, MPI\_WIN\_UNLOCK, or MPI\_WIN\_UNLOCK\_ALL can be used.

MPI\_RGET(origin\_addr, origin\_count, origin\_datatype, target\_rank, target\_disp, target\_count, target\_datatype, win, request)

OUT	origin_addr	initial address of origin buffer (choice)
IN	origin_count	number of entries in origin buffer (non-negative integer)
IN	origin_datatype	datatype of each entry in origin buffer (handle)
IN	target_rank	rank of target (non-negative integer)
IN	target_disp	displacement from window start to the beginning of the target buffer (non-negative integer)
IN	target_count	number of entries in target buffer (non-negative integer)
IN	target_datatype	datatype of each entry in target buffer (handle)
IN	win	window object used for communication (handle)
OUT	request	RMA request (handle)

### C binding

```
int MPI_Rget(void *origin_addr, int origin_count,
             MPI_Datatype origin_datatype, int target_rank,
             MPI_Aint target_disp, int target_count,
             MPI_Datatype target_datatype, MPI_Win win,
             MPI_Request *request)
```

### Fortran 2008 binding

```
MPI_Rget(origin_addr, origin_count, origin_datatype, target_rank,
          target_disp, target_count, target_datatype, win, request,
          ierror)
TYPE(*), DIMENSION(..), ASYNCHRONOUS :: origin_addr
INTEGER, INTENT(IN) :: origin_count, target_rank, target_count
TYPE(MPI_Datatype), INTENT(IN) :: origin_datatype, target_datatype
INTEGER(KIND=MPI_ADDRESS_KIND), INTENT(IN) :: target_disp
TYPE(MPI_Win), INTENT(IN) :: win
TYPE(MPI_Request), INTENT(OUT) :: request
INTEGER, OPTIONAL, INTENT(OUT) :: ierror
```

### Fortran binding

```
MPI_RGET(ORIGIN_ADDR, ORIGIN_COUNT, ORIGIN_DATATYPE, TARGET_RANK,
          TARGET_DISP, TARGET_COUNT, TARGET_DATATYPE, WIN, REQUEST,
          IERROR)
<type> ORIGIN_ADDR(*)
```

```

1     INTEGER ORIGIN_COUNT, ORIGIN_DATATYPE, TARGET_RANK, TARGET_COUNT,
2     TARGET_DATATYPE, WIN, REQUEST, IERROR
3     INTEGER(KIND=MPI_ADDRESS_KIND) TARGET_DISP

```

MPI\_RGET is similar to MPI\_GET (Section 11.3.2), except that it allocates a communication request object and associates it with the request handle (the argument `request`) that can be used to wait or test for completion. The completion of an MPI\_RGET operation indicates that the data is available in the origin buffer. If `origin_addr` points to memory attached to a window, then the data becomes available in the private copy of this window.

```

11 MPI_RACCUMULATE(origin_addr, origin_count, origin_datatype, target_rank, target_disp, target_count,
12                 target_datatype, op, win, request)

```

14	IN	<code>origin_addr</code>	initial address of buffer (choice)
15	IN	<code>origin_count</code>	number of entries in buffer (non-negative integer)
16	IN	<code>origin_datatype</code>	datatype of each entry in origin buffer (handle)
17	IN	<code>target_rank</code>	rank of target (non-negative integer)
18	IN	<code>target_disp</code>	displacement from start of window to beginning of target buffer (non-negative integer)
19	IN	<code>target_count</code>	number of entries in target buffer (non-negative integer)
20	IN	<code>target_datatype</code>	datatype of each entry in target buffer (handle)
21	IN	<code>op</code>	reduce operation (handle)
22	IN	<code>win</code>	window object (handle)
23	OUT	<code>request</code>	RMA request (handle)

### C binding

```

30 int MPI_Raccumulate(const void *origin_addr, int origin_count,
31                    MPI_Datatype origin_datatype, int target_rank,
32                    MPI_Aint target_disp, int target_count,
33                    MPI_Datatype target_datatype, MPI_Op op, MPI_Win win,
34                    MPI_Request *request)

```

### Fortran 2008 binding

```

36 MPI_Raccumulate(origin_addr, origin_count, origin_datatype, target_rank,
37                 target_disp, target_count, target_datatype, op, win, request,
38                 ierror)
39
40     TYPE(*), DIMENSION(..), INTENT(IN), ASYNCHRONOUS :: origin_addr
41     INTEGER, INTENT(IN) :: origin_count, target_rank, target_count
42     TYPE(MPI_Datatype), INTENT(IN) :: origin_datatype, target_datatype
43     INTEGER(KIND=MPI_ADDRESS_KIND), INTENT(IN) :: target_disp
44     TYPE(MPI_Op), INTENT(IN) :: op
45     TYPE(MPI_Win), INTENT(IN) :: win
46     TYPE(MPI_Request), INTENT(OUT) :: request
47     INTEGER, OPTIONAL, INTENT(OUT) :: ierror
48

```

**Fortran binding**

```

MPI_RACCUMULATE(ORIGIN_ADDR, ORIGIN_COUNT, ORIGIN_DATATYPE, TARGET_RANK,
                TARGET_DISP, TARGET_COUNT, TARGET_DATATYPE, OP, WIN, REQUEST,
                IERROR)
    <type> ORIGIN_ADDR(*)
    INTEGER ORIGIN_COUNT, ORIGIN_DATATYPE, TARGET_RANK, TARGET_COUNT,
    TARGET_DATATYPE, OP, WIN, REQUEST, IERROR
    INTEGER(KIND=MPI_ADDRESS_KIND) TARGET_DISP

```

MPI\_RACCUMULATE is similar to MPI\_ACCUMULATE (Section 11.3.4), except that it allocates a communication request object and associates it with the request handle (the argument request) that can be used to wait or test for completion. The completion of an MPI\_RACCUMULATE operation indicates that the origin buffer is free to be updated. It does not indicate that the operation has completed at the target window.

```

MPI_RGET_ACCUMULATE(origin_addr, origin_count, origin_datatype, result_addr, result_count,
                    result_datatype, target_rank, target_disp, target_count, target_datatype, op,
                    win, request)

```

IN	origin_addr	initial address of buffer (choice)
IN	origin_count	number of entries in origin buffer (non-negative integer)
IN	origin_datatype	datatype of each entry in origin buffer (handle)
OUT	result_addr	initial address of result buffer (choice)
IN	result_count	number of entries in result buffer (non-negative integer)
IN	result_datatype	datatype of entries in result buffer (handle)
IN	target_rank	rank of target (non-negative integer)
IN	target_disp	displacement from start of window to beginning of target buffer (non-negative integer)
IN	target_count	number of entries in target buffer (non-negative integer)
IN	target_datatype	datatype of each entry in target buffer (handle)
IN	op	reduce operation (handle)
IN	win	window object (handle)
OUT	request	RMA request (handle)

**C binding**

```

int MPI_Rget_accumulate(const void *origin_addr, int origin_count,
                       MPI_Datatype origin_datatype, void *result_addr,
                       int result_count, MPI_Datatype result_datatype,
                       int target_rank, MPI_Aint target_disp, int target_count,
                       MPI_Datatype target_datatype, MPI_Op op, MPI_Win win,
                       MPI_Request *request)

```

**Fortran 2008 binding**

```

1 MPI_Rget_accumulate(origin_addr, origin_count, origin_datatype,
2     result_addr, result_count, result_datatype, target_rank,
3     target_disp, target_count, target_datatype, op, win, request,
4     ierror)
5
6     TYPE(*), DIMENSION(..), INTENT(IN), ASYNCHRONOUS :: origin_addr
7     INTEGER, INTENT(IN) :: origin_count, result_count, target_rank,
8     target_count
9     TYPE(MPI_Datatype), INTENT(IN) :: origin_datatype, result_datatype,
10    target_datatype
11    TYPE(*), DIMENSION(..), ASYNCHRONOUS :: result_addr
12    INTEGER(KIND=MPI_ADDRESS_KIND), INTENT(IN) :: target_disp
13    TYPE(MPI_Op), INTENT(IN) :: op
14    TYPE(MPI_Win), INTENT(IN) :: win
15    TYPE(MPI_Request), INTENT(OUT) :: request
16    INTEGER, OPTIONAL, INTENT(OUT) :: ierror

```

**Fortran binding**

```

18 MPI_RGET_ACCUMULATE(ORIGIN_ADDR, ORIGIN_COUNT, ORIGIN_DATATYPE,
19     RESULT_ADDR, RESULT_COUNT, RESULT_DATATYPE, TARGET_RANK,
20     TARGET_DISP, TARGET_COUNT, TARGET_DATATYPE, OP, WIN, REQUEST,
21     IERROR)
22
23     <type> ORIGIN_ADDR(*), RESULT_ADDR(*)
24     INTEGER ORIGIN_COUNT, ORIGIN_DATATYPE, RESULT_COUNT, RESULT_DATATYPE,
25     TARGET_RANK, TARGET_COUNT, TARGET_DATATYPE, OP, WIN, REQUEST, IERROR
26     INTEGER(KIND=MPI_ADDRESS_KIND) TARGET_DISP

```

MPI\_RGET\_ACCUMULATE is similar to MPI\_GET\_ACCUMULATE (Section 11.3.4), except that it allocates a communication request object and associates it with the request handle (the argument `request`) that can be used to wait or test for completion. The completion of an MPI\_RGET\_ACCUMULATE operation indicates that the data is available in the result buffer and the origin buffer is free to be updated. It does not indicate that the operation has been completed at the target window.

**11.4 Memory Model**

The memory semantics of RMA are best understood by using the concept of *public* and *private* window copies. We assume that systems have a public memory region that is addressable by all processes (e.g., the shared memory in shared memory machines or the exposed main memory in distributed memory machines). In addition, most machines have fast private buffers (e.g., transparent caches or explicit communication buffers) local to each process where copies of data elements from the main memory can be stored for faster access. Such buffers are either coherent, i.e., all updates to main memory are reflected in all private copies consistently, or non-coherent, i.e., conflicting accesses to main memory need to be synchronized and updated in all private copies explicitly. Coherent systems allow direct updates to remote memory without any participation of the remote side. Non-coherent systems, however, need to call RMA functions in order to reflect updates to the public window in their private memory. Thus, in coherent memory, the public and the

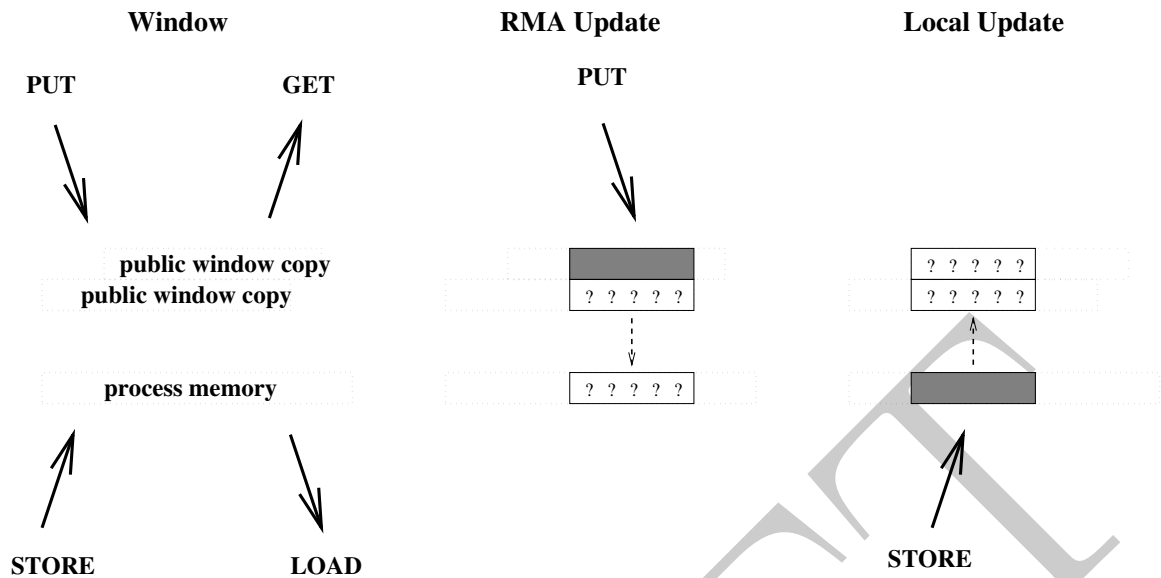

Figure 11.1: Schematic description of the public/private window operations in the MPI\_WIN\_SEPARATE memory model for two overlapping windows.

private window are identical while they remain logically separate in the non-coherent case. MPI thus differentiates between two **memory models** called **RMA unified**, if public and private window are logically identical, and **RMA separate**, otherwise.

In the RMA separate model, there is only one instance of each variable in process memory, but a distinct *public* copy of the variable for each window that contains it. A load accesses the instance in process memory (this includes MPI sends). A local store accesses and updates the instance in process memory (this includes MPI receives), but the update may affect other public copies of the same locations. A get on a window accesses the public copy of that window. A put or accumulate on a window accesses and updates the public copy of that window, but the update may affect the private copy of the same locations in process memory, and public copies of other overlapping windows. This is illustrated in Figure 11.1.

In the RMA unified model, public and private copies are identical and updates via put or accumulate calls are eventually observed by load operations without additional RMA calls. A store access to a window is eventually visible to remote get or accumulate calls without additional RMA calls. These stronger semantics of the RMA unified model allow the user to omit some synchronization calls and potentially improve performance.

*Advice to users.* If accesses in the RMA unified model are not synchronized (with locks or flushes, see Section 11.5.3), load and store operations might observe changes to the memory while they are in progress. The order in which data is written is not specified unless further synchronization is used. This might lead to inconsistent views on memory and programs that assume that a transfer is complete by only checking parts of the message are erroneous. (*End of advice to users.*)

The memory model for a particular RMA window can be determined by accessing the attribute MPI\_WIN\_MODEL. If the memory model is the unified model, the value of this attribute is MPI\_WIN\_UNIFIED; otherwise, the value is MPI\_WIN\_SEPARATE.

## 11.5 Synchronization Calls

RMA communications fall in two categories:

- **active target communication**, where data is moved from the memory of one process to the memory of another, and both are explicitly involved in the communication. This communication pattern is similar to message passing, except that all the data transfer arguments are provided by one process, and the second process only participates in the synchronization.
- **passive target communication**, where data is moved from the memory of one process to the memory of another, and only the origin process is explicitly involved in the transfer. Thus, two origin processes may communicate by accessing the same location in a target window. The process that owns the target window may be distinct from the two communicating processes, in which case it does not participate explicitly in the communication. This communication paradigm is closest to a shared memory model, where shared data can be accessed by all processes, irrespective of location.

RMA communication calls with argument `win` must occur at a process only within an **access epoch** for `win`. Such an epoch starts with an RMA synchronization call on `win`; it proceeds with zero or more RMA communication calls (e.g., `MPI_PUT`, `MPI_GET` or `MPI_ACCUMULATE`) on `win`; it completes with another synchronization call on `win`. This allows users to amortize one synchronization with multiple data transfers and provide implementors more flexibility in the implementation of RMA operations.

Distinct access epochs for `win` at the same process must be disjoint. On the other hand, epochs pertaining to different `win` arguments may overlap. Local operations or other MPI calls may also occur during an epoch.

In active target communication, a target window can be accessed by RMA operations only within an **exposure epoch**. Such an epoch is started and completed by RMA synchronization calls executed by the target process. Distinct exposure epochs at a process on the same window must be disjoint, but such an exposure epoch may overlap with exposure epochs on other windows or with access epochs for the same or other `win` arguments. There is a one-to-one matching between access epochs at origin processes and exposure epochs on target processes: RMA operations issued by an origin process for a target window will access that target window during the same exposure epoch if and only if they were issued during the same access epoch.

In passive target communication the target process does not execute RMA synchronization calls, and there is no concept of an exposure epoch.

MPI provides three synchronization mechanisms:

1. The `MPI_WIN_FENCE` collective synchronization call supports a simple synchronization pattern that is often used in parallel computations: namely a loosely-synchronous model, where global computation phases alternate with global communication phases. This mechanism is most useful for loosely synchronous algorithms where the graph of communicating processes changes very frequently, or where each process communicates with many others.

This call is used for active target communication. An access epoch at an origin process or an exposure epoch at a target process are started and completed by calls to `MPI_WIN_FENCE`. A process can access windows at all processes in the group of `win`



during such an access epoch, and the local window can be accessed by all processes in the group of win during such an exposure epoch.

2. The four functions `MPI_WIN_START`, `MPI_WIN_COMPLETE`, `MPI_WIN_POST`, and `MPI_WIN_WAIT` can be used to restrict synchronization to the minimum: only pairs of communicating processes synchronize, and they do so only when a synchronization is needed to order correctly RMA accesses to a window with respect to local accesses to that same window. This mechanism may be more efficient when each process communicates with few (logical) neighbors, and the communication graph is fixed or changes infrequently.

These calls are used for active target communication. An access epoch is started at the origin process by a call to `MPI_WIN_START` and is terminated by a call to `MPI_WIN_COMPLETE`. The start call has a group argument that specifies the group of target processes for that epoch. An exposure epoch is started at the target process by a call to `MPI_WIN_POST` and is completed by a call to `MPI_WIN_WAIT`. The post call has a group argument that specifies the set of origin processes for that epoch.

3. Finally, shared lock access is provided by the functions `MPI_WIN_LOCK`, `MPI_WIN_LOCK_ALL`, `MPI_WIN_UNLOCK`, and `MPI_WIN_UNLOCK_ALL`. `MPI_WIN_LOCK` and `MPI_WIN_UNLOCK` also provide exclusive lock capability. Lock synchronization is useful for MPI applications that emulate a shared memory model via MPI calls; e.g., in a “billboard” model, where processes can, at random times, access or update different parts of the billboard.

These four calls provide passive target communication. An access epoch is started by a call to `MPI_WIN_LOCK` or `MPI_WIN_LOCK_ALL` and terminated by a call to `MPI_WIN_UNLOCK` or `MPI_WIN_UNLOCK_ALL`, respectively.

Figure 11.2 illustrates the general synchronization pattern for active target communication. The synchronization between `post` and `start` ensures that the put call of the origin process does not start until the target process exposes the window (with the `post` call); the target process will expose the window only after preceding local accesses to the window have completed. The synchronization between `complete` and `wait` ensures that the put call of the origin process completes before the window is unexposed (with the `wait` call). The target process will execute following local accesses to the target window only after the `wait` returned.

Figure 11.2 shows operations occurring in the natural temporal order implied by the synchronizations: the `post` occurs before the matching `start`, and `complete` occurs before the matching `wait`. However, such **strong synchronization** is more than needed for correct ordering of window accesses. The semantics of MPI calls allow **weak synchronization**, as illustrated in Figure 11.3. The access to the target window is delayed until the window is exposed, after the `post`. However the `start` may complete earlier; the `put` and `complete` may also terminate earlier, if put data is buffered by the implementation. The synchronization calls order correctly window accesses, but do not necessarily synchronize other operations. This weaker synchronization semantic allows for more efficient implementations.

Figure 11.4 illustrates the general synchronization pattern for passive target communication. The first origin process communicates data to the second origin process, through the memory of the target process; the target process is not explicitly involved in the communication. The `lock` and `unlock` calls ensure that the two RMA accesses do not occur



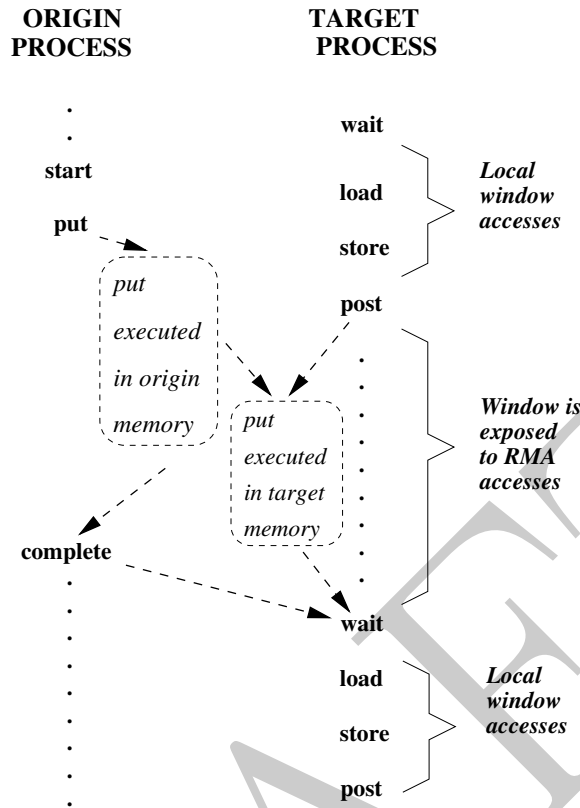

Figure 11.3: Active target communication, with weak synchronization. Dashed arrows represent synchronizations (ordering of events)

**Fortran 2008 binding**

```
MPI_Win_fence(assert, win, ierror)
  INTEGER, INTENT(IN) :: assert
  TYPE(MPI_Win), INTENT(IN) :: win
  INTEGER, OPTIONAL, INTENT(OUT) :: ierror
```

**Fortran binding**

```
MPI_WIN_FENCE(ASSERT, WIN, IERROR)
  INTEGER ASSERT, WIN, IERROR
```

The MPI call `MPI_WIN_FENCE(assert, win)` synchronizes RMA calls on `win`. The call is collective on the group of `win`. All RMA operations on `win` originating at a given process and started before the fence call will complete at that process before the fence call returns. They will be completed at their target before the fence call returns at the target. RMA operations on `win` started by a process after the fence call returns will access their target window only after `MPI_WIN_FENCE` has been called by the target process.

The call completes an RMA access epoch if it was preceded by another fence call and the local process issued RMA communication calls on `win` between these two calls. The call completes an RMA exposure epoch if it was preceded by another fence call and the local window was the target of RMA accesses between these two calls. The call starts an RMA access epoch if it is followed by another fence call and by RMA communication calls issued between these two fence calls. The call starts an exposure epoch if it is followed by another

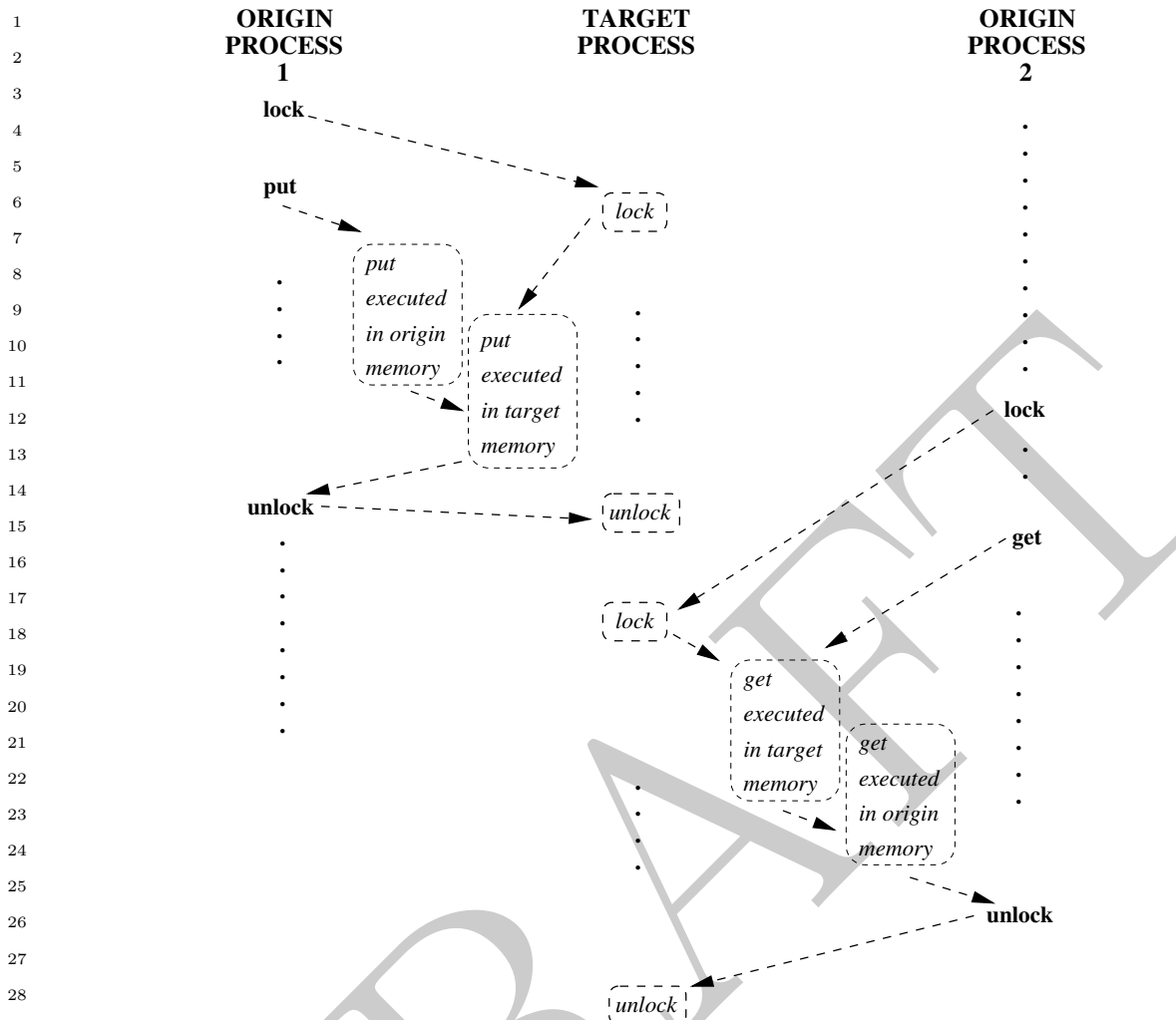

Figure 11.4: Passive target communication. Dashed arrows represent synchronizations (ordering of events).

fence call and the local window is the target of RMA accesses between these two fence calls. Thus, the fence call is equivalent to calls to a subset of `post`, `start`, `complete`, `wait`.

A fence call usually entails a barrier synchronization: a process completes a call to `MPI_WIN_FENCE` only after all other processes in the group entered their matching call. However, a call to `MPI_WIN_FENCE` that is known not to end any epoch (in particular, a call with `assert` equal to `MPI_MODE_NOPRECEDE`) does not necessarily act as a barrier.

The `assert` argument is used to provide assertions on the context of the call that may be used for various optimizations. This is described in Section 11.5.5. A value of `assert = 0` is always valid.

*Advice to users.* Calls to `MPI_WIN_FENCE` should both precede and follow calls to RMA communication functions that are synchronized with fence calls. (*End of advice to users.*)

## 11.5.2 General Active Target Synchronization

`MPI_WIN_START(group, assert, win)`

IN	group	group of target processes (handle)
IN	assert	program assertion (integer)
IN	win	window object (handle)

**C binding**

```
int MPI_Win_start(MPI_Group group, int assert, MPI_Win win)
```

**Fortran 2008 binding**

```
MPI_Win_start(group, assert, win, ierror)
  TYPE(MPI_Group), INTENT(IN) :: group
  INTEGER, INTENT(IN) :: assert
  TYPE(MPI_Win), INTENT(IN) :: win
  INTEGER, OPTIONAL, INTENT(OUT) :: ierror
```

**Fortran binding**

```
MPI_WIN_START(GROUP, ASSERT, WIN, IERROR)
  INTEGER GROUP, ASSERT, WIN, IERROR
```

Starts an RMA access epoch for `win`. RMA calls issued on `win` during this epoch must access only windows at processes in `group`. Each process in `group` must issue a matching call to `MPI_WIN_POST`. RMA accesses to each target window will be delayed, if necessary, until the target process executed the matching call to `MPI_WIN_POST`. `MPI_WIN_START` is allowed to block until the corresponding `MPI_WIN_POST` calls are executed, but is not required to.

The `assert` argument is used to provide assertions on the context of the call that may be used for various optimizations. This is described in Section 11.5.5. A value of `assert = 0` is always valid.

`MPI_WIN_COMPLETE(win)`

IN	win	window object (handle)
----	-----	------------------------

**C binding**

```
int MPI_Win_complete(MPI_Win win)
```

**Fortran 2008 binding**

```
MPI_Win_complete(win, ierror)
  TYPE(MPI_Win), INTENT(IN) :: win
  INTEGER, OPTIONAL, INTENT(OUT) :: ierror
```

**Fortran binding**

```
MPI_WIN_COMPLETE(WIN, IERROR)
  INTEGER WIN, IERROR
```

1 Completes an RMA access epoch on win started by a call to MPI\_WIN\_START. All  
 2 RMA communication calls issued on win during this epoch will have completed at the origin  
 3 when the call returns.

4 MPI\_WIN\_COMPLETE enforces completion of preceding RMA calls at the origin, but  
 5 not at the target. A put or accumulate call may not have completed at the target when it  
 6 has completed at the origin.

7 Consider the sequence of calls in the example below.

#### 8 **Example 11.4**

```
9
10 MPI_Win_start(group, flag, win);
11 MPI_Put(..., win);
12 MPI_Win_complete(win);
13
```

14 The call to MPI\_WIN\_COMPLETE does not return until the put call has completed  
 15 at the origin; and the target window will be accessed by the put operation only after the  
 16 call to MPI\_WIN\_START has matched a call to MPI\_WIN\_POST by the target process.  
 17 This still leaves much choice to implementors. The call to MPI\_WIN\_START can block  
 18 until the matching call to MPI\_WIN\_POST occurs at all target processes. One can also  
 19 have implementations where the call to MPI\_WIN\_START is nonblocking, but the call to  
 20 MPI\_PUT blocks until the matching call to MPI\_WIN\_POST occurs; or implementations  
 21 where the first two calls are nonblocking, but the call to MPI\_WIN\_COMPLETE blocks  
 22 until the call to MPI\_WIN\_POST occurred; or even implementations where all three calls  
 23 can complete before any target process has called MPI\_WIN\_POST — the data put must  
 24 be buffered, in this last case, so as to allow the put to complete at the origin ahead of its  
 25 completion at the target. However, once the call to MPI\_WIN\_POST is issued, the sequence  
 26 above must complete, without further dependencies.

```
27
28
29 MPI_WIN_POST(group, assert, win)
```

30	IN	group	group of origin processes (handle)
31	IN	assert	program assertion (integer)
32			
33	IN	win	window object (handle)
34			

#### 35 **C binding**

```
36 int MPI_Win_post(MPI_Group group, int assert, MPI_Win win)
```

#### 37 **Fortran 2008 binding**

```
38 MPI_Win_post(group, assert, win, ierror)
39     TYPE(MPI_Group), INTENT(IN) :: group
40     INTEGER, INTENT(IN) :: assert
41     TYPE(MPI_Win), INTENT(IN) :: win
42     INTEGER, OPTIONAL, INTENT(OUT) :: ierror
43
```

#### 44 **Fortran binding**

```
45 MPI_WIN_POST(GROUP, ASSERT, WIN, IERROR)
46     INTEGER GROUP, ASSERT, WIN, IERROR
47
48
```

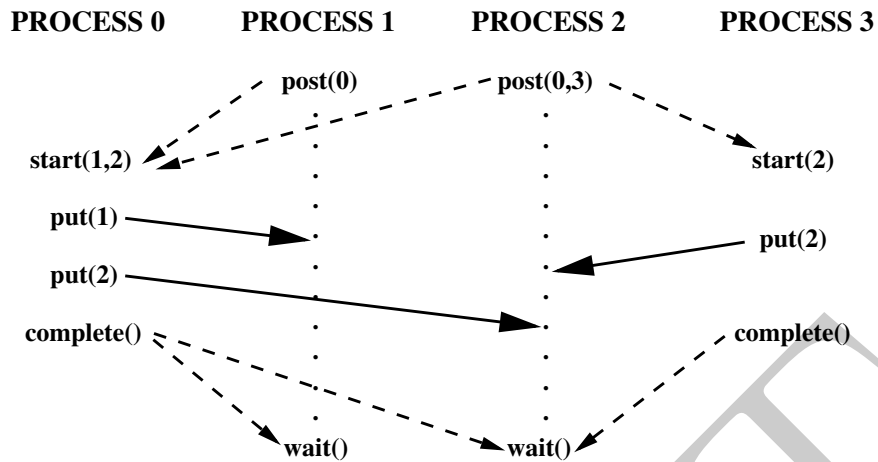

Figure 11.5: Active target communication. Dashed arrows represent synchronizations and solid arrows represent data transfer.

Starts an RMA exposure epoch for the local window associated with `win`. Only processes in `group` should access the window with RMA calls on `win` during this epoch. Each process in `group` must issue a matching call to `MPI_WIN_START`. `MPI_WIN_POST` does not block.

`MPI_WIN_WAIT(win)`

IN win window object (handle)

#### C binding

```
int MPI_Win_wait(MPI_Win win)
```

#### Fortran 2008 binding

```
MPI_Win_wait(win, ierror)
  TYPE(MPI_Win), INTENT(IN) :: win
  INTEGER, OPTIONAL, INTENT(OUT) :: ierror
```

#### Fortran binding

```
MPI_WIN_WAIT(WIN, IERROR)
  INTEGER WIN, IERROR
```

Completes an RMA exposure epoch started by a call to `MPI_WIN_POST` on `win`. This call matches calls to `MPI_WIN_COMPLETE(win)` issued by each of the origin processes that were granted access to the window during this epoch. The call to `MPI_WIN_WAIT` will block until all matching calls to `MPI_WIN_COMPLETE` have occurred. This guarantees that all these origin processes have completed their RMA accesses to the local window. When the call returns, all these RMA accesses will have completed at the target window.

Figure 11.5 illustrates the use of these four functions. Process 0 puts data in the windows of processes 1 and 2 and process 3 puts data in the window of process 2. Each start call lists the ranks of the processes whose windows will be accessed; each post call lists the ranks of the processes that access the local window. The figure illustrates a possible timing for the events, assuming strong synchronization; in a weak synchronization, the start, put or complete calls may occur ahead of the matching post calls.

```

1 MPI_WIN_TEST(win, flag)
2     IN      win                window object (handle)
3
4     OUT    flag                success flag (logical)

```

### C binding

```
7 int MPI_Win_test(MPI_Win win, int *flag)
```

### Fortran 2008 binding

```

9 MPI_Win_test(win, flag, ierror)
10     TYPE(MPI_Win), INTENT(IN) :: win
11     LOGICAL, INTENT(OUT) :: flag
12     INTEGER, OPTIONAL, INTENT(OUT) :: ierror

```

### Fortran binding

```

14 MPI_WIN_TEST(WIN, FLAG, IERROR)
15     INTEGER WIN, IERROR
16     LOGICAL FLAG

```

This is the nonblocking version of `MPI_WIN_WAIT`. It returns `flag = true` if all accesses to the local window by the group to which it was exposed by the corresponding `MPI_WIN_POST` call have been completed as signalled by matching `MPI_WIN_COMPLETE` calls, and `flag = false` otherwise. In the former case `MPI_WIN_WAIT` would have returned immediately. The effect of return of `MPI_WIN_TEST` with `flag = true` is the same as the effect of a return of `MPI_WIN_WAIT`. If `flag = false` is returned, then the call has no visible effect.

`MPI_WIN_TEST` should be invoked only where `MPI_WIN_WAIT` can be invoked. Once the call has returned `flag = true`, it must not be invoked anew, until the window is posted anew.

Assume that window `win` is associated with a “hidden” communicator `wincomm`, used for communication by the processes of `win`. The rules for matching of post and start calls and for matching complete and wait calls can be derived from the rules for matching sends and receives, by considering the following (partial) model implementation.

**`MPI_WIN_POST(group,0,win)`** initiates a nonblocking send with tag `tag0` to each process in `group`, using `wincomm`. There is no need to wait for the completion of these sends.

**`MPI_WIN_START(group,0,win)`** initiates a nonblocking receive with tag `tag0` from each process in `group`, using `wincomm`. An RMA access to a window in target process `i` is delayed until the receive from `i` is completed.

**`MPI_WIN_COMPLETE(win)`** initiates a nonblocking send with tag `tag1` to each process in the group of the preceding start call. No need to wait for the completion of these sends.

**`MPI_WIN_WAIT(win)`** initiates a nonblocking receive with tag `tag1` from each process in the group of the preceding post call. Wait for the completion of all receives.

No races can occur in a correct program: each of the sends matches a unique receive, and vice versa.



*Rationale.* The design for general active target synchronization requires the user to provide complete information on the communication pattern, at each end of a communication link: each origin specifies a list of targets, and each target specifies a list of origins. This provides maximum flexibility (hence, efficiency) for the implementor: each synchronization can be initiated by either side, since each “knows” the identity of the other. This also provides maximum protection from possible races. On the other hand, the design requires more information than RMA needs: in general, it is sufficient for the origin to know the rank of the target, but not vice versa. Users that want more “anonymous” communication will be required to use the fence or lock mechanisms. (*End of rationale.*)

*Advice to users.* Assume a communication pattern that is represented by a directed graph  $G = \langle V, E \rangle$ , where  $V = \{0, \dots, n - 1\}$  and  $ij \in E$  if origin process  $i$  accesses the window at target process  $j$ . Then each process  $i$  issues a call to `MPI_WIN_POST(ingroup $i$ , ...)`, followed by a call to `MPI_WIN_START(outgroup $i$ , ...)`, where  $outgroup_i = \{j : ij \in E\}$  and  $ingroup_i = \{j : ji \in E\}$ . A call is a noop, and can be skipped, if the `group` argument is empty. After the communications calls, each process that issued a start will issue a complete. Finally, each process that issued a post will issue a wait.

Note that each process may call with a `group` argument that has different members. (*End of advice to users.*)

### 11.5.3 Lock

`MPI_WIN_LOCK(lock_type, rank, assert, win)`

IN	<code>lock_type</code>	either <code>MPI_LOCK_EXCLUSIVE</code> or <code>MPI_LOCK_SHARED</code> (state)
IN	<code>rank</code>	rank of locked window (non-negative integer)
IN	<code>assert</code>	program assertion (integer)
IN	<code>win</code>	window object (handle)

#### C binding

```
int MPI_Win_lock(int lock_type, int rank, int assert, MPI_Win win)
```

#### Fortran 2008 binding

```
MPI_Win_lock(lock_type, rank, assert, win, ierror)
  INTEGER, INTENT(IN) :: lock_type, rank, assert
  TYPE(MPI_Win), INTENT(IN) :: win
  INTEGER, OPTIONAL, INTENT(OUT) :: ierror
```

#### Fortran binding

```
MPI_WIN_LOCK(LOCK_TYPE, RANK, ASSERT, WIN, IERROR)
  INTEGER LOCK_TYPE, RANK, ASSERT, WIN, IERROR
```

Starts an RMA access epoch. The window at the process with rank `rank` can be accessed by RMA operations on `win` during that epoch. Multiple RMA access epochs (with calls

1 to MPI\_WIN\_LOCK) can occur simultaneously; however, each access epoch must target a  
 2 different process.

3  
 4  
 5 MPI\_WIN\_LOCK\_ALL(assert, win)

6     IN        assert                    program assertion (integer)  
 7     IN        win                      window object (handle)

8  
 9  
 10 **C binding**

11 int MPI\_Win\_lock\_all(int assert, MPI\_Win win)

12 **Fortran 2008 binding**

13 MPI\_Win\_lock\_all(assert, win, ierror)  
 14     INTEGER, INTENT(IN) :: assert  
 15     TYPE(MPI\_Win), INTENT(IN) :: win  
 16     INTEGER, OPTIONAL, INTENT(OUT) :: ierror

17 **Fortran binding**

18 MPI\_WIN\_LOCK\_ALL(ASSERT, WIN, IERROR)  
 19     INTEGER ASSERT, WIN, IERROR

20  
 21     Starts an RMA access epoch to all processes in win, with a lock type of  
 22 MPI\_LOCK\_SHARED. During the epoch, the calling process can access the window memory on  
 23 all processes in win by using RMA operations. A window locked with MPI\_WIN\_LOCK\_ALL  
 24 must be unlocked with MPI\_WIN\_UNLOCK\_ALL. This routine is not collective — the ALL  
 25 refers to a lock on all members of the group of the window.

26  
 27     *Advice to users.* There may be additional overheads associated with using  
 28 MPI\_WIN\_LOCK and MPI\_WIN\_LOCK\_ALL concurrently on the same window. These  
 29 overheads could be avoided by specifying the assertion MPI\_MODE\_NOCHECK when  
 30 possible (see Section 11.5.5). (*End of advice to users.*)

31  
 32  
 33 MPI\_WIN\_UNLOCK(rank, win)

34     IN        rank                    rank of window (non-negative integer)  
 35     IN        win                    window object (handle)

36  
 37  
 38 **C binding**

39 int MPI\_Win\_unlock(int rank, MPI\_Win win)

40 **Fortran 2008 binding**

41 MPI\_Win\_unlock(rank, win, ierror)  
 42     INTEGER, INTENT(IN) :: rank  
 43     TYPE(MPI\_Win), INTENT(IN) :: win  
 44     INTEGER, OPTIONAL, INTENT(OUT) :: ierror

45 **Fortran binding**

46 MPI\_WIN\_UNLOCK(RANK, WIN, IERROR)

INTEGER RANK, WIN, IERROR

Completes an RMA access epoch started by a call to `MPI_WIN_LOCK` on window `win`. RMA operations issued during this period will have completed both at the origin and at the target when the call returns.

`MPI_WIN_UNLOCK_ALL(win)`

IN            win                            window object (handle)

### C binding

```
int MPI_Win_unlock_all(MPI_Win win)
```

### Fortran 2008 binding

```
MPI_Win_unlock_all(win, ierror)
  TYPE(MPI_Win), INTENT(IN) :: win
  INTEGER, OPTIONAL, INTENT(OUT) :: ierror
```

### Fortran binding

```
MPI_WIN_UNLOCK_ALL(WIN, IERROR)
  INTEGER WIN, IERROR
```

Completes a shared RMA access epoch started by a call to `MPI_WIN_LOCK_ALL` on window `win`. RMA operations issued during this epoch will have completed both at the origin and at the target when the call returns.

Locks are used to protect accesses to the locked target window effected by RMA calls issued between the lock and unlock calls, and to protect load/store accesses to a locked local or shared memory window executed between the lock and unlock calls. Accesses that are protected by an exclusive lock will not be concurrent at the window site with other accesses to the same window that are lock protected. Accesses that are protected by a shared lock will not be concurrent at the window site with accesses protected by an exclusive lock to the same window.

It is erroneous to have a window locked and exposed (in an exposure epoch) concurrently. For example, a process may not call `MPI_WIN_LOCK` to lock a target window if the target process has called `MPI_WIN_POST` and has not yet called `MPI_WIN_WAIT`; it is erroneous to call `MPI_WIN_POST` while the local window is locked.

*Rationale.* An alternative is to require MPI to enforce mutual exclusion between exposure epochs and locking periods. But this would entail additional overheads when locks or active target synchronization do not interact in support of those rare interactions between the two mechanisms. The programming style that we encourage here is that a set of windows is used with only one synchronization mechanism at a time, with shifts from one mechanism to another being rare and involving global synchronization. (*End of rationale.*)

*Advice to users.* Users need to use explicit synchronization code in order to enforce mutual exclusion between locking periods and exposure epochs on a window. (*End of advice to users.*)

1 Implementors may restrict the use of RMA communication that is synchronized by  
 2 lock calls to windows in memory allocated by MPI\_ALLOC\_MEM (Section 8.2),  
 3 MPI\_WIN\_ALLOCATE (Section 11.2.2), MPI\_WIN\_ALLOCATE\_SHARED (Section 11.2.3),  
 4 or attached with MPI\_WIN\_ATTACH (Section 11.2.4). Locks can be used portably only in  
 5 such memory.

6  
 7 *Rationale.* The implementation of passive target communication when memory  
 8 is not shared may require an asynchronous software agent. Such an agent can be  
 9 implemented more easily, and can achieve better performance, if restricted to specially  
 10 allocated memory. It can be avoided altogether if shared memory is used. It seems  
 11 natural to impose restrictions that allows one to use shared memory for third party  
 12 communication in shared memory machines.

13 (*End of rationale.*)

14  
 15 Consider the sequence of calls in the example below.

### 16 Example 11.5

```
17 MPI_Win_lock(MPI_LOCK_EXCLUSIVE, rank, assert, win);
18 MPI_Put(..., rank, ..., win);
19 MPI_Win_unlock(rank, win);
20
```

21  
 22 The call to MPI\_WIN\_UNLOCK will not return until the put transfer has completed at  
 23 the origin and at the target. This still leaves much freedom to implementors. The call to  
 24 MPI\_WIN\_LOCK may block until an exclusive lock on the window is acquired; or, the first  
 25 two calls may not block, while MPI\_WIN\_UNLOCK blocks until a lock is acquired — the  
 26 update of the target window is then postponed until the call to MPI\_WIN\_UNLOCK occurs.  
 27 However, if the call to MPI\_WIN\_LOCK is used to lock a local window, then the call must  
 28 block until the lock is acquired, since the lock may protect local load/store accesses to the  
 29 window issued after the lock call returns.

### 30 11.5.4 Flush and Sync

31 All flush and sync functions can be called only within passive target epochs.

32  
 33 MPI\_WIN\_FLUSH(rank, win)

34  
 35 IN rank rank of target window (non-negative integer)

36 IN win window object (handle)

### 37 C binding

38  
 39 int MPI\_Win\_flush(int rank, MPI\_Win win)

### 40 Fortran 2008 binding

```
41 MPI_Win_flush(rank, win, ierror)
42     INTEGER, INTENT(IN) :: rank
43     TYPE(MPI_Win), INTENT(IN) :: win
44     INTEGER, OPTIONAL, INTENT(OUT) :: ierror
```

### 45 Fortran binding

MPI\_WIN\_FLUSH(RANK, WIN, IERROR)  
 INTEGER RANK, WIN, IERROR

MPI\_WIN\_FLUSH completes all outstanding RMA operations initiated by the calling process to the target rank on the specified window. The operations are completed both at the origin and at the target.

MPI\_WIN\_FLUSH\_ALL(win)

IN win window object (handle)

### C binding

int MPI\_Win\_flush\_all(MPI\_Win win)

### Fortran 2008 binding

MPI\_Win\_flush\_all(win, ierror)  
 TYPE(MPI\_Win), INTENT(IN) :: win  
 INTEGER, OPTIONAL, INTENT(OUT) :: ierror

### Fortran binding

MPI\_WIN\_FLUSH\_ALL(WIN, IERROR)  
 INTEGER WIN, IERROR

All RMA operations issued by the calling process to any target on the specified window prior to this call and in the specified window will have completed both at the origin and at the target when this call returns.

MPI\_WIN\_FLUSH\_LOCAL(rank, win)

IN rank rank of target window (non-negative integer)  
 IN win window object (handle)

### C binding

int MPI\_Win\_flush\_local(int rank, MPI\_Win win)

### Fortran 2008 binding

MPI\_Win\_flush\_local(rank, win, ierror)  
 INTEGER, INTENT(IN) :: rank  
 TYPE(MPI\_Win), INTENT(IN) :: win  
 INTEGER, OPTIONAL, INTENT(OUT) :: ierror

### Fortran binding

MPI\_WIN\_FLUSH\_LOCAL(RANK, WIN, IERROR)  
 INTEGER RANK, WIN, IERROR

Locally completes at the origin all outstanding RMA operations initiated by the calling process to the target process specified by rank on the specified window. For example, after this routine completes, the user may reuse any buffers provided to put, get, or accumulate operations.

```

1 MPI_WIN_FLUSH_LOCAL_ALL(win)
2     IN        win                window object (handle)
3

```

#### C binding

```

4
5 int MPI_Win_flush_local_all(MPI_Win win)
6

```

#### Fortran 2008 binding

```

7 MPI_Win_flush_local_all(win, ierror)
8     TYPE(MPI_Win), INTENT(IN) :: win
9     INTEGER, OPTIONAL, INTENT(OUT) :: ierror
10

```

#### Fortran binding

```

11
12 MPI_WIN_FLUSH_LOCAL_ALL(WIN, IERROR)
13     INTEGER WIN, IERROR
14

```

All RMA operations issued to any target prior to this call in this window will have completed at the origin when `MPI_WIN_FLUSH_LOCAL_ALL` returns.

```

15
16
17
18
19 MPI_WIN_SYNC(win)
20     IN        win                window object (handle)
21

```

#### C binding

```

22
23 int MPI_Win_sync(MPI_Win win)
24

```

#### Fortran 2008 binding

```

25 MPI_Win_sync(win, ierror)
26     TYPE(MPI_Win), INTENT(IN) :: win
27     INTEGER, OPTIONAL, INTENT(OUT) :: ierror
28

```

#### Fortran binding

```

29
30 MPI_WIN_SYNC(WIN, IERROR)
31     INTEGER WIN, IERROR
32

```

The call `MPI_WIN_SYNC` synchronizes the private and public window copies of `win`. For the purposes of synchronizing the private and public window, `MPI_WIN_SYNC` has the effect of ending and reopening an access and exposure epoch on the window (note that it does not actually end an epoch or complete any pending MPI RMA operations).

### 11.5.5 Assertions

The `assert` argument in the calls `MPI_WIN_POST`, `MPI_WIN_START`, `MPI_WIN_FENCE`, `MPI_WIN_LOCK`, and `MPI_WIN_LOCK_ALL` is used to provide assertions on the context of the call that may be used to optimize performance. The `assert` argument does not change program semantics if it provides correct information on the program — it is erroneous to provide incorrect information. Users may always provide `assert = 0` to indicate a general case where no guarantees are made.

*Advice to users.* Many implementations may not take advantage of the information in `assert`; some of the information is relevant only for noncoherent shared memory ma-

chines. Users should consult their implementation’s manual to find which information is useful on each system. On the other hand, applications that provide correct assertions whenever applicable are portable and will take advantage of assertion specific optimizations whenever available. (*End of advice to users.*)

*Advice to implementors.* Implementations can always ignore the `assert` argument. Implementors should document which `assert` values are significant on their implementation. (*End of advice to implementors.*)

`assert` is the bit-vector OR of zero or more of the following integer constants: `MPI_MODE_NOCHECK`, `MPI_MODE_NOSTORE`, `MPI_MODE_NOPUT`, `MPI_MODE_NOPRECEDE`, and `MPI_MODE_NOSUCCEED`. The significant options are listed below for each call.

*Advice to users.* C/C++ users can use bit vector or `()` to combine these constants; Fortran 90 users can use the bit-vector `IOR` intrinsic. Alternatively, Fortran users can portably use integer addition to OR the constants (each constant should appear at most once in the addition!). (*End of advice to users.*)

#### **MPI\_WIN\_START:**

`MPI_MODE_NOCHECK` — the matching calls to `MPI_WIN_POST` have already completed on all target processes when the call to `MPI_WIN_START` is made. The `nocheck` option can be specified in a start call if and only if it is specified in each matching post call. This is similar to the optimization of “ready-send” that may save a handshake when the handshake is implicit in the code. (However, ready-send is matched by a regular receive, whereas both start and post must specify the `nocheck` option.)

#### **MPI\_WIN\_POST:**

`MPI_MODE_NOCHECK` — the matching calls to `MPI_WIN_START` have not yet occurred on any origin processes when the call to `MPI_WIN_POST` is made. The `nocheck` option can be specified by a post call if and only if it is specified by each matching start call.

`MPI_MODE_NOSTORE` — the local window was not updated by stores (or local get or receive calls) since last synchronization. This may avoid the need for cache synchronization at the post call.

`MPI_MODE_NOPUT` — the local window will not be updated by put or accumulate calls after the post call, until the ensuing (wait) synchronization. This may avoid the need for cache synchronization at the wait call.

#### **MPI\_WIN\_FENCE:**

`MPI_MODE_NOSTORE` — the local window was not updated by stores (or local get or receive calls) since last synchronization.

`MPI_MODE_NOPUT` — the local window will not be updated by put or accumulate calls after the fence call, until the ensuing (fence) synchronization.

1 MPI\_MODE\_NOPRECEDE — the fence does not complete any sequence of locally issued  
 2 RMA calls. If this assertion is given by any process in the window group, then it  
 3 must be given by all processes in the group.

4 MPI\_MODE\_NOSUCCEED — the fence does not start any sequence of locally issued  
 5 RMA calls. If the assertion is given by any process in the window group, then it  
 6 must be given by all processes in the group.  
 7

## 8 MPI\_WIN\_LOCK, MPI\_WIN\_LOCK\_ALL:

9 MPI\_MODE\_NOCHECK — no other process holds, or will attempt to acquire, a con-  
 10 flicting lock, while the caller holds the window lock. This is useful when mutual  
 11 exclusion is achieved by other means, but the coherence operations that may be  
 12 attached to the lock and unlock calls are still required.  
 13

14 *Advice to users.* Note that the nostore and noprecede flags provide information on  
 15 what happened *before* the call; the noput and nosucceed flags provide information on  
 16 what will happen *after* the call. (*End of advice to users.*)  
 17

## 18 11.5.6 Miscellaneous Clarifications

19 Once an RMA routine completes, it is safe to free any opaque objects passed as arguments  
 20 to that routine. For example, the `datatype` argument of a `MPI_PUT` call can be freed as  
 21 soon as the call returns, even though the communication may not be complete.  
 22

23 As in message-passing, datatypes must be committed before they can be used in RMA  
 24 communication.  
 25

## 26 11.6 Error Handling

### 27 11.6.1 Error Handlers

28 Errors occurring during calls to routines that create MPI windows (e.g., `MPI_WIN_CREATE`  
 29 (`...,comm,...`)) cause the error handler currently associated with `comm` to be invoked. All  
 30 other RMA calls have an input `win` argument. When an error occurs during such a call, the  
 31 error handler currently associated with `win` is invoked.  
 32

33 The error handler `MPI_ERRORS_ARE_FATAL` is associated with `win` during its creation.  
 34 Users may change this default by explicitly associating a new error handler with `win` (see  
 35 Section 8.3).  
 36

### 37 11.6.2 Error Classes

38 The error classes for one-sided communication are defined in Table 11.2. RMA routines may  
 39 (and almost certainly will) use other MPI error classes, such as `MPI_ERR_OP` or  
 40 `MPI_ERR_RANK`.  
 41

## 42 11.7 Semantics and Correctness

43 The following rules specify the latest time at which an operation must complete at the  
 44 origin or the target. The update performed by a `get` call in the origin process memory is  
 45 visible when the `get` operation is complete at the origin (or earlier); the update performed  
 46 at the target is visible when the `get` operation is complete at the target (or earlier); the update performed  
 47 at the origin is visible when the `get` operation is complete at the origin (or earlier); the update performed  
 48 at the target is visible when the `get` operation is complete at the target (or earlier).



MPI_ERR_WIN	invalid win argument	1
MPI_ERR_BASE	invalid base argument	2
MPI_ERR_SIZE	invalid size argument	3
MPI_ERR_DISP	invalid disp argument	4
MPI_ERR_LOCKTYPE	invalid locktype argument	5
MPI_ERR_ASSERT	invalid assert argument	6
MPI_ERR_RMA_CONFLICT	conflicting accesses to window	7
MPI_ERR_RMA_SYNC	invalid synchronization of RMA calls	8
MPI_ERR_RMA_RANGE	target memory is not part of the window (in the case of a window created with MPI_WIN_CREATE_DYNAMIC, target memory is not attached)	9 10 11 12
MPI_ERR_RMA_ATTACH	memory cannot be attached (e.g., because of resource exhaustion)	13 14
MPI_ERR_RMA_SHARED	memory cannot be shared (e.g., some process in the group of the specified communicator cannot expose shared memory)	15 16 17
MPI_ERR_RMA_FLAVOR	passed window has the wrong flavor for the called function	18 19 20

Table 11.2: Error classes in one-sided communication routines

by a put or accumulate call in the public copy of the target window is visible when the put or accumulate has completed at the target (or earlier). The rules also specify the latest time at which an update of one window copy becomes visible in another overlapping copy.

1. An RMA operation is completed at the origin by the ensuing call to MPI\_WIN\_COMPLETE, MPI\_WIN\_FENCE, MPI\_WIN\_FLUSH, MPI\_WIN\_FLUSH\_ALL, MPI\_WIN\_FLUSH\_LOCAL, MPI\_WIN\_FLUSH\_LOCAL\_ALL, MPI\_WIN\_UNLOCK, or MPI\_WIN\_UNLOCK\_ALL that synchronizes this access at the origin.
2. If an RMA operation is completed at the origin by a call to MPI\_WIN\_FENCE then the operation is completed at the target by the matching call to MPI\_WIN\_FENCE by the target process.
3. If an RMA operation is completed at the origin by a call to MPI\_WIN\_COMPLETE then the operation is completed at the target by the matching call to MPI\_WIN\_WAIT by the target process.
4. If an RMA operation is completed at the origin by a call to MPI\_WIN\_UNLOCK, MPI\_WIN\_UNLOCK\_ALL, MPI\_WIN\_FLUSH(rank=target), or MPI\_WIN\_FLUSH\_ALL, then the operation is completed at the target by that same call.
5. An update of a location in a private window copy in process memory becomes visible in the public window copy at latest when an ensuing call to MPI\_WIN\_POST, MPI\_WIN\_FENCE, MPI\_WIN\_UNLOCK, MPI\_WIN\_UNLOCK\_ALL, or MPI\_WIN\_SYNC is executed on that window by the window owner. In the RMA

1 unified memory model, an update of a location in a private window in process memory  
2 becomes visible without additional RMA calls.

- 3  
4 6. An update by a put or accumulate call to a public window copy becomes visible in the  
5 private copy in process memory at latest when an ensuing call to `MPI_WIN_WAIT`,  
6 `MPI_WIN_FENCE`, `MPI_WIN_LOCK`, `MPI_WIN_LOCK_ALL`, or `MPI_WIN_SYNC` is  
7 executed on that window by the window owner. In the RMA unified memory model,  
8 an update by a put or accumulate call to a public window copy eventually becomes  
9 visible in the private copy in process memory without additional RMA calls.

10 The `MPI_WIN_FENCE` or `MPI_WIN_WAIT` call that completes the transfer from public  
11 copy to private copy (6) is the same call that completes the put or accumulate operation in  
12 the window copy (2, 3). If a put or accumulate access was synchronized with a lock, then  
13 the update of the public window copy is complete as soon as the updating process executed  
14 `MPI_WIN_UNLOCK` or `MPI_WIN_UNLOCK_ALL`. In the RMA separate memory model, the  
15 update of a private copy in the process memory may be delayed until the target process  
16 executes a synchronization call on that window (6). Thus, updates to process memory can  
17 always be delayed in the RMA separate memory model until the process executes a suitable  
18 synchronization call, while they must complete in the RMA unified model without additional  
19 synchronization calls. If fence or post-start-complete-wait synchronization is used, updates  
20 to a public window copy can be delayed in both memory models until the window owner  
21 executes a synchronization call. When passive target synchronization is used, it is necessary  
22 to update the public window copy even if the window owner does not execute any related  
23 synchronization call.

24 The rules above also define, by implication, when an update to a public window copy  
25 becomes visible in another overlapping public window copy. Consider, for example, two  
26 overlapping windows, `win1` and `win2`. A call to `MPI_WIN_FENCE(0, win1)` by the window  
27 owner makes visible in the process memory previous updates to window `win1` by remote  
28 processes. A subsequent call to `MPI_WIN_FENCE(0, win2)` makes these updates visible in  
29 the public copy of `win2`.

30 The behavior of some MPI RMA operations may be *undefined* in certain situations. For  
31 example, the result of several origin processes performing concurrent `MPI_PUT` operations  
32 to the same target location is undefined. In addition, the result of a single origin process  
33 performing multiple `MPI_PUT` operations to the same target location within the same  
34 access epoch is also undefined. The result at the target may have all of the data from one  
35 of the `MPI_PUT` operations (the “last” one, in some sense), bytes from some of each of the  
36 operations, or something else. In MPI-2, such operations were *erroneous*. That meant that  
37 an MPI implementation was permitted to signal an MPI exception. Thus, user programs or  
38 tools that used MPI RMA could not portably permit such operations, even if the application  
39 code could function correctly with such an undefined result. In MPI-3, these operations are  
40 not erroneous, but do not have a defined behavior.

41  
42 *Rationale.* As discussed in [7], requiring operations such as overlapping puts to  
43 be erroneous makes it difficult to use MPI RMA to implement programming models—  
44 such as Unified Parallel C (UPC) or SHMEM—that permit these operations. Further,  
45 while MPI-2 defined these operations as erroneous, the MPI Forum is unaware of any  
46 implementation that enforces this rule, as it would require significant overhead. Thus,  
47 relaxing this condition does not impact existing implementations or applications. (*End*  
48 *of rationale.*)

*Advice to implementors.* Overlapping accesses are undefined. However, to assist users in debugging code, implementations may wish to provide a mode in which such operations are detected and reported to the user. Note, however, that in MPI-3, such operations must not generate an MPI exception. (*End of advice to implementors.*)

A program with a well-defined outcome in the MPI\_WIN\_SEPARATE memory model must obey the following rules.

- S1. A location in a window must not be accessed with load/store operations once an update to that location has started, until the update becomes visible in the private window copy in process memory.
- S2. A location in a window must not be accessed as a target of an RMA operation once an update to that location has started, until the update becomes visible in the public window copy. There is one exception to this rule, in the case where the same variable is updated by two concurrent accumulates with the same predefined datatype, on the same window. Additional restrictions on the operation apply, see the info key `accumulate_ops` in Section 11.2.1.
- S3. A put or accumulate must not access a target window once a store or a put or accumulate update to another (overlapping) target window has started on a location in the target window, until the update becomes visible in the public copy of the window. Conversely, a store to process memory to a location in a window must not start once a put or accumulate update to that target window has started, until the put or accumulate update becomes visible in process memory. In both cases, the restriction applies to operations even if they access disjoint locations in the window.

*Rationale.* The last constraint on correct RMA accesses may seem unduly restrictive, as it forbids concurrent accesses to nonoverlapping locations in a window. The reason for this constraint is that, on some architectures, explicit coherence restoring operations may be needed at synchronization points. A different operation may be needed for locations that were updated by stores and for locations that were remotely updated by put or accumulate operations. Without this constraint, the MPI library would have to track precisely which locations in a window were updated by a put or accumulate call. The additional overhead of maintaining such information is considered prohibitive. (*End of rationale.*)

Note that MPI\_WIN\_SYNC may be used within a passive target epoch to synchronize the private and public window copies (that is, updates to one are made visible to the other).

In the MPI\_WIN\_UNIFIED memory model, the rules are simpler because the public and private windows are the same. However, there are restrictions to avoid concurrent access to the same memory locations by different processes. The rules that a program with a well-defined outcome must obey in this case are:

- U1. A location in a window must not be accessed with load/store operations once an update to that location has started, until the update is complete, subject to the following special case.
- U2. Accessing a location in the window that is also the target of a remote update is valid (not erroneous) but the precise result will depend on the behavior of the implementation. Updates from a remote process will appear in the memory of the target, but

1 there are no atomicity or ordering guarantees if more than one byte is updated. Up-  
2 dates are stable in the sense that once data appears in memory of the target, the data  
3 remains until replaced by another update. This permits polling on a location for a  
4 change from zero to non-zero or for a particular value, but not polling and comparing  
5 the relative magnitude of values. Users are cautioned that polling on one memory  
6 location and then accessing a different memory location has defined behavior only if  
7 the other rules given here and in this chapter are followed.

8  
9 *Advice to users.* Some compiler optimizations can result in code that maintains  
10 the sequential semantics of the program, but violates this rule by introducing  
11 temporary values into locations in memory. Most compilers only apply such  
12 transformations under very high levels of optimization and users should be aware  
13 that such aggressive optimization may produce unexpected results. (*End of*  
14 *advice to users.*)

- 15  
16 U3. Updating a location in the window with a store operation that is also the target  
17 of a remote read (but not update) is valid (not erroneous) but the precise result  
18 will depend on the behavior of the implementation. Store updates will appear in  
19 memory, but there are no atomicity or ordering guarantees if more than one byte is  
20 updated. Updates are stable in the sense that once data appears in memory, the data  
21 remains until replaced by another update. This permits updates to memory with  
22 store operations without requiring an RMA epoch. Users are cautioned that remote  
23 accesses to a window that is updated by the local process has defined behavior only  
24 if the other rules given here and elsewhere in this chapter are followed.
- 25  
26 U4. A location in a window must not be accessed as a target of an RMA operation once  
27 an update to that location has started and until the update completes at the target.  
28 There is one exception to this rule: in the case where the same location is updated by  
29 two concurrent accumulates with the same predefined datatype on the same window.  
30 Additional restrictions on the operation apply; see the info key `accumulate_ops` in  
31 Section 11.2.1.
- 32  
33 U5. A put or accumulate must not access a target window once a store, put, or accumulate  
34 update to another (overlapping) target window has started on the same location in  
35 the target window and until the update completes at the target window. Conversely,  
36 a store operation to a location in a window must not start once a put or accumulate  
37 update to the same location in that target window has started and until the put or  
38 accumulate update completes at the target.

39 *Advice to users.* In the unified memory model, in the case where the window is  
40 in shared memory, `MPI_WIN_SYNC` can be used to order store operations and make  
41 store updates to the window visible to other processes and threads. Use of this  
42 routine is necessary to ensure portable behavior when point-to-point, collective, or  
43 shared memory synchronization is used in place of an RMA synchronization routine.  
44 `MPI_WIN_SYNC` should be called by the writer before the non-RMA synchroniza-  
45 tion operation and by the reader after the non-RMA synchronization, as shown in  
46 Example 11.21. (*End of advice to users.*)

47  
48 A program that violates these rules has undefined behavior.

*Advice to users.* A user can write correct programs by following the following rules: 1

**fence:** During each period between fence calls, each window is either updated by put 2  
or accumulate calls, or updated by stores, but not both. Locations updated by 3  
put or accumulate calls should not be accessed during the same period (with 4  
the exception of concurrent updates to the same location by accumulate calls). 5  
Locations accessed by get calls should not be updated during the same period. 6  
7

**post-start-complete-wait:** A window should not be updated with store operations 8  
while posted if it is being updated by put or accumulate calls. Locations updated 9  
by put or accumulate calls should not be accessed while the window is posted 10  
(with the exception of concurrent updates to the same location by accumulate 11  
calls). Locations accessed by get calls should not be updated while the window 12  
is posted. 13

With the post-start synchronization, the target process can tell the origin process 14  
that its window is now ready for RMA access; with the complete-wait synchroni- 15  
zation, the origin process can tell the target process that it has finished its 16  
RMA accesses to the window. 17

**lock:** Updates to the window are protected by exclusive locks if they may conflict. 18  
Nonconflicting accesses (such as read-only accesses or accumulate accesses) are 19  
protected by shared locks, both for load/store accesses and for RMA accesses. 20  
21

**changing window or synchronization mode:** One can change synchronization 22  
mode, or change the window used to access a location that belongs to two over- 23  
lapping windows, when the process memory and the window copy are guaranteed 24  
to have the same values. This is true after a local call to `MPI_WIN_FENCE`, if 25  
RMA accesses to the window are synchronized with fences; after a local call 26  
to `MPI_WIN_WAIT`, if the accesses are synchronized with post-start-complete- 27  
wait; after the call at the origin (local or remote) to `MPI_WIN_UNLOCK` or 28  
`MPI_WIN_UNLOCK_ALL` if the accesses are synchronized with locks. 29

In addition, a process should not access the local buffer of a get operation until the 30  
operation is complete, and should not update the local buffer of a put or accumulate 31  
operation until that operation is complete. 32  
33

The RMA synchronization operations define when updates are guaranteed to become 34  
visible in public and private windows. Updates may become visible earlier, but such 35  
behavior is implementation dependent. (*End of advice to users.*) 36  
37

The semantics are illustrated by the following examples: 38

**Example 11.6** The following example demonstrates updating a memory location inside 39  
a window for the separate memory model, according to Rule 5. The `MPI_WIN_LOCK` 40  
and `MPI_WIN_UNLOCK` calls around the store to `X` in process B are necessary to ensure 41  
consistency between the public and private copies of the window. 42  
43  
44  
45  
46  
47  
48

```

1 Process A:                Process B:
2                            window location X
3
4                            MPI_Win_lock(EXCLUSIVE, B)
5                            store X /* local update to private copy of B */
6                            MPI_Win_unlock(B)
7                            /* now visible in public window copy */
8
9 MPI_Barrier                MPI_Barrier
10
11 MPI_Win_lock(EXCLUSIVE, B)
12 MPI_Get(X) /* ok, read from public window */
13 MPI_Win_unlock(B)
14

```

**Example 11.7** In the RMA unified model, although the public and private copies of the windows are synchronized, caution must be used when combining load/stores and multi-process synchronization. Although the following example appears correct, the compiler or hardware may delay the store to X after the barrier, possibly resulting in the MPI\_GET returning an incorrect value of X.

```

21 Process A:                Process B:
22                            window location X
23
24                            store X /* update to private & public copy of B */
25 MPI_Barrier                MPI_Barrier
26 MPI_Win_lock_all
27 MPI_Get(X) /* ok, read from window */
28 MPI_Win_flush_local(B)
29 /* read value in X */
30 MPI_Win_unlock_all
31

```

MPI\_BARRIER provides process synchronization, but not memory synchronization. The example could potentially be made safe through the use of compiler- and hardware-specific notations to ensure the store to X occurs before process B enters the MPI\_BARRIER. The use of one-sided synchronization calls, as shown in Example 11.6, also ensures the correct result.

**Example 11.8** The following example demonstrates the reading of a memory location updated by a remote process (Rule 6) in the RMA separate memory model. Although the MPI\_WIN\_UNLOCK on process A and the MPI\_BARRIER ensure that the public copy on process B reflects the updated value of X, the call to MPI\_WIN\_LOCK by process B is necessary to synchronize the private copy with the public copy.

```

44 Process A:                Process B:
45                            window location X
46
47 MPI_Win_lock(EXCLUSIVE, B)
48 MPI_Put(X) /* update to public window */

```

```
MPI_Win_unlock(B)
```

```
MPI_Barrier
```

```
MPI_Barrier
```

```
MPI_Win_lock(EXCLUSIVE, B)
```

```
/* now visible in private copy of B */
```

```
load X
```

```
MPI_Win_unlock(B)
```

Note that in this example, the barrier is not critical to the semantic correctness. The use of exclusive locks guarantees a remote process will not modify the public copy after MPI\_WIN\_LOCK synchronizes the private and public copies. A polling implementation looking for changes in X on process B would be semantically correct. The barrier is required to ensure that process A performs the put operation before process B performs the load of X.

**Example 11.9** Similar to Example 11.7, the following example is unsafe even in the unified model, because the load of X can not be guaranteed to occur after the MPI\_BARRIER. While Process B does not need to explicitly synchronize the public and private copies through MPI\_WIN\_LOCK as the MPI\_PUT will update both the public and private copies of the window, the scheduling of the load could result in old values of X being returned. Compiler and hardware specific notations could ensure the load occurs after the data is updated, or explicit one-sided synchronization calls can be used to ensure the proper result.

```
Process A:
```

```
Process B:
```

```
window location X
```

```
MPI_Win_lock_all
```

```
MPI_Put(X) /* update to window */
```

```
MPI_Win_flush(B)
```

```
MPI_Barrier
```

```
MPI_Barrier
```

```
load X
```

```
MPI_Win_unlock_all
```

**Example 11.10** The following example further clarifies Rule 5. MPI\_WIN\_LOCK and MPI\_WIN\_LOCK\_ALL do *not* update the public copy of a window with changes to the private copy. Therefore, there is no guarantee that process A in the following sequence will see the value of X as updated by the local store by process B before the lock.

```
Process A:
```

```
Process B:
```

```
window location X
```

```
store X /* update to private copy of B */
```

```
MPI_Win_lock(SHARED, B)
```

```
MPI_Barrier
```

```
MPI_Barrier
```

```
MPI_Win_lock(SHARED, B)
```

```
MPI_Get(X) /* X may be the X before the store */
```

```

1 MPI_Win_unlock(B)
2
3 MPI_Win_unlock(B)
4
5 /* update on X now visible in public window */

```

The addition of an MPI\_WIN\_SYNC before the call to MPI\_BARRIER by process B would guarantee process A would see the updated value of X, as the public copy of the window would be explicitly synchronized with the private copy.

**Example 11.11** Similar to the previous example, Rule 5 can have unexpected implications for general active target synchronization with the RMA separate memory model. It is *not* guaranteed that process B reads the value of X as per the local update by process A, because neither MPI\_WIN\_WAIT nor MPI\_WIN\_COMPLETE calls by process A ensure visibility in the public window copy.

```

14 Process A:
15 window location X
16 window location Y
17
18 store Y
19 MPI_Win_post(A, B) /* Y visible in public window */
20 MPI_Win_start(A)
21
22 store X /* update to private window */
23
24 MPI_Win_complete
25 MPI_Win_wait
26 /* update on X may not yet visible in public window */
27
28 MPI_Barrier
29
30 MPI_Win_lock(EXCLUSIVE, A)
31 MPI_Get(X) /* may return an obsolete value */
32 MPI_Get(Y)
33 MPI_Win_unlock(A)
34

```

To allow process B to read the value of X stored by A the local store must be replaced by a local MPI\_PUT that updates the public window copy. Note that by this replacement X may become visible in the private copy of process A only after the MPI\_WIN\_WAIT call in process A. The update to Y made before the MPI\_WIN\_POST call is visible in the public window after the MPI\_WIN\_POST call and therefore process B will read the proper value of Y. The MPI\_GET(Y) call could be moved to the epoch started by the MPI\_WIN\_START operation, and process B would still get the value stored by process A.

**Example 11.12** The following example demonstrates the interaction of general active target synchronization with local read operations with the RMA separate memory model. Rules 5 and 6 do *not* guarantee that the private copy of X at process B has been updated before the load takes place.



Process A:	Process B:	1
	window location X	2
		3
MPI_Win_lock(EXCLUSIVE, B)		4
MPI_Put(X) /* update to public window */		5
MPI_Win_unlock(B)		6
		7
MPI_Barrier	MPI_Barrier	8
		9
	MPI_Win_post(B)	10
	MPI_Win_start(B)	11
		12
	load X /* access to private window */	13
	/* may return an obsolete value */	14
		15
	MPI_Win_complete	16
	MPI_Win_wait	17
		18

To ensure that the value put by process A is read, the local load must be replaced with a local MPI\_GET operation, or must be placed after the call to MPI\_WIN\_WAIT.

### 11.7.1 Atomicity

The outcome of concurrent accumulate operations to the same location with the same predefined datatype is as if the accumulates were done at that location in some serial order. Additional restrictions on the operation apply; see the info key `accumulate_ops` in Section 11.2.1. Concurrent accumulate operations with different origin and target pairs are not ordered. Thus, there is no guarantee that the entire call to an accumulate operation is executed atomically. The effect of this lack of atomicity is limited: The previous correctness conditions imply that a location updated by a call to an accumulate operation cannot be accessed by a load or an RMA call other than accumulate until the accumulate operation has completed (at the target). Different interleavings can lead to different results only to the extent that computer arithmetics are not truly associative or commutative. The outcome of accumulate operations with overlapping types of different sizes or target displacements is undefined.

### 11.7.2 Ordering

Accumulate calls enable element-wise atomic read and write to remote memory locations. MPI specifies ordering between accumulate operations from an origin process to the same (or overlapping) memory locations at a target process on a per-datatype granularity. The default ordering is strict ordering, which guarantees that overlapping updates from the same origin to a remote location are committed in program order and that reads (e.g., with MPI\_GET\_ACCUMULATE) and writes (e.g., with MPI\_ACCUMULATE) are executed and committed in program order. Ordering only applies to operations originating at the same origin that access overlapping target memory regions. MPI does not provide any guarantees for accesses or updates from different origin processes to overlapping target memory regions.

The default strict ordering may incur a significant performance penalty. MPI specifies the info key `accumulate_ordering` to allow relaxation of the ordering semantics when specified

1 to any window creation function. The values for this key are as follows. If set to none,  
2 then no ordering will be guaranteed for accumulate calls. This was the behavior for RMA  
3 in MPI-2 but is *not* the default in MPI-3. The key can be set to a comma-separated list  
4 of required access orderings at the target. Allowed values in the comma-separated list  
5 are *rar*, *war*, *raw*, and *waw* for read-after-read, write-after-read, read-after-write, and write-  
6 after-write ordering, respectively. These indicate whether operations of the specified type  
7 complete in the order they were issued. For example, *raw* means that any writes must  
8 complete at the target before subsequent reads. These ordering requirements apply only to  
9 operations issued by the same origin process and targeting the same target process. The  
10 default value for `accumulate_ordering` is *rar,raw,war,waw*, which implies that writes complete at  
11 the target in the order in which they were issued, reads complete at the target before any  
12 writes that are issued after the reads, and writes complete at the target before any reads  
13 that are issued after the writes. Any subset of these four orderings can be specified. For  
14 example, if only read-after-read and write-after-write ordering is required, then the value  
15 of the `accumulate_ordering` key could be set to *rar,waw*. The order of values is not significant.

16 Note that the above ordering semantics apply only to accumulate operations, not put  
17 and get. Put and get within an epoch are unordered.

### 19 11.7.3 Progress

20 One-sided communication has the same progress requirements as point-to-point communi-  
21 cation: once a communication is enabled it is guaranteed to complete. RMA calls must have  
22 local semantics, except when required for synchronization with other RMA calls.

23 There is some fuzziness in the definition of the time when a RMA communication  
24 becomes enabled. This fuzziness provides to the implementor more flexibility than with  
25 point-to-point communication. Access to a target window becomes enabled once the corre-  
26 sponding synchronization (such as `MPI_WIN_FENCE` or `MPI_WIN_POST`) has executed. On  
27 the origin process, an RMA communication may become enabled as soon as the correspond-  
28 ing put, get or accumulate call has executed, or as late as when the ensuing synchronization  
29 call is issued. Once the communication is enabled both at the origin and at the target, the  
30 communication must complete.

31 Consider the code fragment in Example 11.4. Some of the calls may block if the target  
32 window is not posted. However, if the target window is posted, then the code fragment  
33 must complete. The data transfer may start as soon as the put call occurs, but may be  
34 delayed until the ensuing complete call occurs.

35 Consider the code fragment in Example 11.5. Some of the calls may block if another  
36 process holds a conflicting lock. However, if no conflicting lock is held, then the code  
37 fragment must complete.

38 Consider the code illustrated in Figure 11.6. Each process updates the window of  
39 the other process using a put operation, then accesses its own window. The post calls are  
40 nonblocking, and should complete. Once the post calls occur, RMA access to the windows is  
41 enabled, so that each process should complete the sequence of calls start-put-complete. Once  
42 these are done, the wait calls should complete at both processes. Thus, this communication  
43 should not deadlock, irrespective of the amount of data transferred.

44 Assume, in the last example, that the order of the post and start calls is reversed at  
45 each process. Then, the code may deadlock, as each process may block on the start call,  
46 waiting for the matching post to occur. Similarly, the program will deadlock if the order of  
47 the complete and wait calls is reversed at each process.

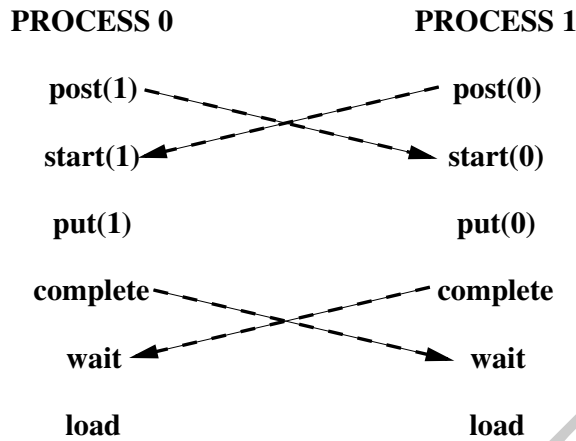

Figure 11.6: Symmetric communication

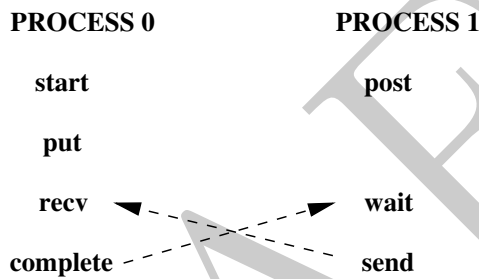

Figure 11.7: Deadlock situation

The following two examples illustrate the fact that the synchronization between complete and wait is not symmetric: the wait call blocks until the complete executes, but not vice versa. Consider the code illustrated in Figure 11.7. This code will deadlock: the wait of process 1 blocks until process 0 calls complete, and the receive of process 0 blocks until process 1 calls send. Consider, on the other hand, the code illustrated in Figure 11.8. This code will not deadlock. Once process 1 calls post, then the sequence start, put, complete on process 0 can proceed to completion. Process 0 will reach the send call, allowing the receive call of process 1 to complete.

*Rationale.* MPI implementations must guarantee that a process makes progress on all enabled communications it participates in, while blocked on an MPI call. This is true

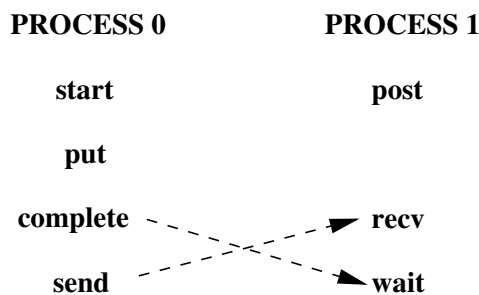

Figure 11.8: No deadlock

for send-receive communication and applies to RMA communication as well. Thus, in the example in Figure 11.8, the put and complete calls of process 0 should complete while process 1 is blocked on the receive call. This may require the involvement of process 1, e.g., to transfer the data put, while it is blocked on the receive call.

A similar issue is whether such progress must occur while a process is busy computing, or blocked in a non-MPI call. Suppose that in the last example the send-receive pair is replaced by a write-to-socket/read-from-socket pair. Then MPI does not specify whether deadlock is avoided. Suppose that the blocking receive of process 1 is replaced by a very long compute loop. Then, according to one interpretation of the MPI standard, process 0 must return from the complete call after a bounded delay, even if process 1 does not reach any MPI call in this period of time. According to another interpretation, the complete call may block until process 1 reaches the wait call, or reaches another MPI call. The qualitative behavior is the same, under both interpretations, unless a process is caught in an infinite compute loop, in which case the difference may not matter. However, the quantitative expectations are different. Different MPI implementations reflect these different interpretations. While this ambiguity is unfortunate, the MPI Forum decided not to define which interpretation of the standard is the correct one, since the issue is contentious. (*End of rationale.*)

#### 11.7.4 Registers and Compiler Optimizations

*Advice to users.* All the material in this section is an advice to users. (*End of advice to users.*)

A coherence problem exists between variables kept in registers and the memory values of these variables. An RMA call may access a variable in memory (or cache), while the up-to-date value of this variable is in register. A get will not return the latest variable value, and a put may be overwritten when the register is stored back in memory. Note that these issues are unrelated to the RMA memory model; that is, these issues apply even if the memory model is MPI\_WIN\_UNIFIED.

The problem is illustrated by the following code:

Source of Process 1	Source of Process 2	Executed in Process 2
bbbb = 777	buff = 999	reg_A:=999
call MPI_WIN_FENCE	call MPI_WIN_FENCE	
call MPI_PUT(bbbb into buff of process 2)		stop appl. thread
		buff:=777 in PUT handler
		continue appl. thread
call MPI_WIN_FENCE	call MPI_WIN_FENCE	
	ccc = buff	ccc:=reg_A

In this example, variable `buff` is allocated in the register `reg_A` and therefore `ccc` will have the old value of `buff` and not the new value 777.

This problem, which also afflicts in some cases send/receive communication, is discussed more at length in Section 18.1.16.

Programs written in C avoid this problem, because of the semantics of C. Many Fortran compilers will avoid this problem, without disabling compiler optimizations. However, in order to avoid register coherence problems in a completely portable manner, users should

restrict their use of RMA windows to variables stored in modules or COMMON blocks. To prevent problems with the argument copying and register optimization done by Fortran compilers, please note the hints in Sections 18.1.10–18.1.20. Sections 18.1.17 to 18.1.17 discuss several solutions for the problem in this example.

## 11.8 Examples

**Example 11.13** The following example shows a generic loosely synchronous, iterative code, using fence synchronization. The window at each process consists of array A, which contains the origin and target buffers of the put calls.

```

...
while (!converged(A)) {
  update(A);
  MPI_Win_fence(MPI_MODE_NOPRECEDE, win);
  for(i=0; i < toneighbors; i++)
    MPI_Put(&frombuf[i], 1, fromtype[i], toneighbor[i],
           todisp[i], 1, totype[i], win);
  MPI_Win_fence((MPI_MODE_NOSTORE | MPI_MODE_NOSUCCEED), win);
}

```

The same code could be written with get rather than put. Note that, during the communication phase, each window is concurrently read (as origin buffer of puts) and written (as target buffer of puts). This is OK, provided that there is no overlap between the target buffer of a put and another communication buffer.

**Example 11.14** Same generic example, with more computation/communication overlap. We assume that the update phase is broken into two subphases: the first, where the “boundary,” which is involved in communication, is updated, and the second, where the “core,” which neither uses nor provides communicated data, is updated.

```

...
while (!converged(A)) {
  update_boundary(A);
  MPI_Win_fence((MPI_MODE_NOPUT | MPI_MODE_NOPRECEDE), win);
  for(i=0; i < fromneighbors; i++)
    MPI_Get(&tobuf[i], 1, totype[i], fromneighbor[i],
           fromdisp[i], 1, fromtype[i], win);
  update_core(A);
  MPI_Win_fence(MPI_MODE_NOSUCCEED, win);
}

```

The get communication can be concurrent with the core update, since they do not access the same locations, and the local update of the origin buffer by the get call can be concurrent with the local update of the core by the `update_core` call. In order to get similar overlap with put communication we would need to use separate windows for the core and for the boundary. This is required because we do not allow local stores to be concurrent with puts on the same, or on overlapping, windows.

1 **Example 11.15** Same code as in Example 11.13, rewritten using post-start-complete-wait.

```

2
3 ...
4 while (!converged(A)) {
5     update(A);
6     MPI_Win_post(fromgroup, 0, win);
7     MPI_Win_start(togroup, 0, win);
8     for(i=0; i < toneighbors; i++)
9         MPI_Put(&frombuf[i], 1, fromtype[i], toneighbor[i],
10              todisp[i], 1, totype[i], win);
11     MPI_Win_complete(win);
12     MPI_Win_wait(win);
13 }

```

15 **Example 11.16** Same example, with split phases, as in Example 11.14.

```

16
17 ...
18 while (!converged(A)) {
19     update_boundary(A);
20     MPI_Win_post(togroup, MPI_MODE_NOPUT, win);
21     MPI_Win_start(fromgroup, 0, win);
22     for(i=0; i < fromneighbors; i++)
23         MPI_Get(&tobuf[i], 1, totype[i], fromneighbor[i],
24              fromdisp[i], 1, fromtype[i], win);
25     update_core(A);
26     MPI_Win_complete(win);
27     MPI_Win_wait(win);
28 }

```

30 **Example 11.17** A checkerboard, or double buffer communication pattern, that allows more computation/communication overlap. Array A0 is updated using values of array A1, and vice versa. We assume that communication is symmetric: if process A gets data from process B, then process B gets data from process A. Window wini consists of array Ai.

```

31
32 ...
33
34
35
36 if (!converged(A0,A1))
37     MPI_Win_post(neighbors, (MPI_MODE_NOCHECK | MPI_MODE_NOPUT), win0);
38 MPI_Barrier(comm0);
39 /* the barrier is needed because the start call inside the
40 loop uses the nocheck option */
41 while (!converged(A0, A1)) {
42     /* communication on A0 and computation on A1 */
43     update2(A1, A0); /* local update of A1 that depends on A0 (and A1) */
44     MPI_Win_start(neighbors, MPI_MODE_NOCHECK, win0);
45     for(i=0; i < fromneighbors; i++)
46         MPI_Get(&tobuf0[i], 1, totype0[i], neighbor[i],
47              fromdisp0[i], 1, fromtype0[i], win0);
48     update1(A1); /* local update of A1 that is

```

```

        concurrent with communication that updates A0 */
MPI_Win_post(neighbors, (MPI_MODE_NOCHECK | MPI_MODE_NOPUT), win1);
MPI_Win_complete(win0);
MPI_Win_wait(win0);

/* communication on A1 and computation on A0 */
update2(A0, A1); /* local update of A0 that depends on A1 (and A0) */
MPI_Win_start(neighbors, MPI_MODE_NOCHECK, win1);
for(i=0; i < fromneighbors; i++)
    MPI_Get(&tobuf1[i], 1, totype1[i], neighbor[i],
           fromdisp1[i], 1, fromtype1[i], win1);
update1(A0); /* local update of A0 that depends on A0 only,
             concurrent with communication that updates A1 */
if (!converged(A0,A1))
    MPI_Win_post(neighbors, (MPI_MODE_NOCHECK | MPI_MODE_NOPUT), win0);
MPI_Win_complete(win1);
MPI_Win_wait(win1);
}

```

A process posts the local window associated with `win0` before it completes RMA accesses to the remote windows associated with `win1`. When the `wait(win1)` call returns, then all neighbors of the calling process have posted the windows associated with `win0`. Conversely, when the `wait(win0)` call returns, then all neighbors of the calling process have posted the windows associated with `win1`. Therefore, the `nocheck` option can be used with the calls to `MPI_WIN_START`.

Put calls can be used, instead of get calls, if the area of array `A0` (resp. `A1`) used by the `update(A1, A0)` (resp. `update(A0, A1)`) call is disjoint from the area modified by the RMA communication. On some systems, a put call may be more efficient than a get call, as it requires information exchange only in one direction.

In the next several examples, for conciseness, the expression

```
z = MPI_Get_accumulate(...)
```

means to perform an `MPI_GET_ACCUMULATE` with the result buffer (given by `result_addr` in the description of `MPI_GET_ACCUMULATE`) on the left side of the assignment, in this case, `z`. This format is also used with `MPI_COMPARE_AND_SWAP`.

**Example 11.18** The following example implements a naive, non-scalable counting semaphore. The example demonstrates the use of `MPI_WIN_SYNC` to manipulate the public copy of `X`, as well as `MPI_WIN_FLUSH` to complete operations without ending the access epoch opened with `MPI_WIN_LOCK_ALL`. To avoid the rules regarding synchronization of the public and private copies of windows, `MPI_ACCUMULATE` and `MPI_GET_ACCUMULATE` are used to write to or read from the local public copy.

Process A:	Process B:
<code>MPI_Win_lock_all</code>	<code>MPI_Win_lock_all</code>
window location <code>X</code>	
<code>X=2</code>	
<code>MPI_Win_sync</code>	
<code>MPI_Barrier</code>	<code>MPI_Barrier</code>

```

1
2 MPI_Accumulate(X, MPI_SUM, -1)           MPI_Accumulate(X, MPI_SUM, -1)
3
4 stack variable z                         stack variable z
5 do                                       do
6     z = MPI_Get_accumulate(X,           z = MPI_Get_accumulate(X,
7         MPI_NO_OP, 0)                   MPI_NO_OP, 0)
8     MPI_Win_flush(A)                   MPI_Win_flush(A)
9 while(z!=0)                             while(z!=0)
10
11 MPI_Win_unlock_all                     MPI_Win_unlock_all
12

```

**Example 11.19** Implementing a critical region between two processes (Peterson's algorithm). Despite their appearance in the following example, `MPI_WIN_LOCK_ALL` and `MPI_WIN_UNLOCK_ALL` are not collective calls, but it is frequently useful to start shared access epochs to all processes from all other processes in a window. Once the access epochs are established, accumulate communication operations and flush and sync synchronization operations can be used to read from or write to the public copy of the window.

```

20 Process A:                               Process B:
21 window location X                         window location Y
22 window location T
23
24 MPI_Win_lock_all                           MPI_Win_lock_all
25 X=1                                        Y=1
26 MPI_Win_sync                               MPI_Win_sync
27 MPI_Barrier                               MPI_Barrier
28 MPI_Accumulate(T, MPI_REPLACE, 1)         MPI_Accumulate(T, MPI_REPLACE, 0)
29 stack variables t,y                       stack variable t,x
30 t=1                                        t=0
31 y=MPI_Get_accumulate(Y,                   x=MPI_Get_accumulate(X,
32     MPI_NO_OP, 0)                         MPI_NO_OP, 0)
33 while(y==1 && t==1) do                    while(x==1 && t==0) do
34     y=MPI_Get_accumulate(Y,               x=MPI_Get_accumulate(X,
35         MPI_NO_OP, 0)                     MPI_NO_OP, 0)
36     t=MPI_Get_accumulate(T,               t=MPI_Get_accumulate(T,
37         MPI_NO_OP, 0)                     MPI_NO_OP, 0)
38     MPI_Win_flush_all                     MPI_Win_flush(A)
39 done                                       done
40 // critical region                       // critical region
41 MPI_Accumulate(X, MPI_REPLACE, 0)         MPI_Accumulate(Y, MPI_REPLACE, 0)
42 MPI_Win_unlock_all                       MPI_Win_unlock_all
43

```

**Example 11.20** Implementing a critical region between multiple processes with compare and swap. The call to `MPI_WIN_SYNC` is necessary on Process A after local initialization of A to guarantee the public copy has been updated with the initialization value found in the private copy. It would also be valid to call `MPI_ACCUMULATE` with `MPI_REPLACE` to



directly initialize the public copy. A call to `MPI_WIN_FLUSH` would be necessary to assure A in the public copy of Process A had been updated before the barrier.

<pre> Process A: MPI_Win_lock_all atomic location A A=0 MPI_Win_sync MPI_Barrier stack variable r=1 while(r != 0) do   r = MPI_Compare_and_swap(A, 0, 1)   MPI_Win_flush(A) done // critical region r = MPI_Compare_and_swap(A, 1, 0) MPI_Win_unlock_all </pre>	<pre> Process B...: MPI_Win_lock_all  MPI_Barrier stack variable r=1 while(r != 0) do   r = MPI_Compare_and_swap(A, 0, 1)   MPI_Win_flush(A) done // critical region r = MPI_Compare_and_swap(A, 1, 0) MPI_Win_unlock_all </pre>	<pre> 1 2 3 4 5 6 7 8 9 10 11 12 13 14 15 16 17 18 19 20 21 22 23 24 25 26 27 28 29 30 31 32 33 34 35 36 37 38 39 40 41 42 43 44 45 46 47 48 </pre>
---	--	---

**Example 11.21** The following example demonstrates the proper synchronization in the unified memory model when a data transfer is implemented with load and store in the case of windows in shared memory (instead of `MPI_PUT` or `MPI_GET`) and the synchronization between processes is performed using point-to-point communication. The synchronization between processes must be supplemented with a memory synchronization through calls to `MPI_WIN_SYNC`, which act locally as a processor-memory barrier. In Fortran, if `MPI_ASYNC_PROTECTS_NONBLOCKING` is `.FALSE.` or the variable `X` is not declared as `ASYNCHRONOUS`, reordering of the accesses to the variable `X` must be prevented with `MPI_F_SYNC_REG` operations. (No equivalent function is needed in C.)

The variable `X` is contained within a shared memory window and `X` corresponds to the same memory location at both processes. The `MPI_WIN_SYNC` operation performed by process A ensures completion of the load/store operations issued by process A. The `MPI_WIN_SYNC` operation performed by process B ensures that process A's updates to `X` are visible to process B.

<pre> Process A MPI_WIN_LOCK_ALL(   MPI_MODE_NOCHECK,win) DO ...   X=... MPI_F_SYNC_REG(X) MPI_WIN_SYNC(win) MPI_SEND </pre>	<pre> Process B MPI_WIN_LOCK_ALL(   MPI_MODE_NOCHECK,win) DO ... MPI_RECV MPI_WIN_SYNC(win) MPI_F_SYNC_REG(X) print X </pre>	<pre> 34 35 36 37 38 39 40 41 42 43 44 45 46 47 48 </pre>
--	--	---

```

1
2             MPI_F_SYNC_REG(X)
3     MPI_RECV             MPI_SEND
4     MPI_F_SYNC_REG(X)
5 END DO                 END DO
6
7 MPI_WIN_UNLOCK_ALL(win)    MPI_WIN_UNLOCK_ALL(win)
8
9

```

**Example 11.22** The following example shows how request-based operations can be used to overlap communication with computation. Each process fetches, processes, and writes the result for N STEPS chunks of data. Instead of a single buffer, M local buffers are used to allow up to M communication operations to overlap with computation.

```

14 int         i, j;
15 MPI_Win     win;
16 MPI_Request put_req[M] = { MPI_REQUEST_NULL };
17 MPI_Request get_req;
18 double      *baseptr;
19 double      data[M][N];
20
21 MPI_Win_allocate(NSTEPS*N*sizeof(double), sizeof(double), MPI_INFO_NULL,
22                 MPI_COMM_WORLD, &baseptr, &win);
23
24 MPI_Win_lock_all(0, win);
25
26 for (i = 0; i < NSTEPS; i++) {
27     if (i < M)
28         j = i;
29     else
30         MPI_Waitany(M, put_req, &j, MPI_STATUS_IGNORE);
31
32     MPI_Rget(data[j], N, MPI_DOUBLE, target, i*N, N, MPI_DOUBLE, win,
33             &get_req);
34     MPI_Wait(&get_req, MPI_STATUS_IGNORE);
35     compute(i, data[j], ...);
36     MPI_Rput(data[j], N, MPI_DOUBLE, target, i*N, N, MPI_DOUBLE, win,
37             &put_req[j]);
38 }
39
40 MPI_Waitall(M, put_req, MPI_STATUSES_IGNORE);
41 MPI_Win_unlock_all(win);
42
43

```

**Example 11.23** The following example constructs a distributed shared linked list using dynamic windows. Initially process 0 creates the head of the list, attaches it to the window, and broadcasts the pointer to all processes. All processes then concurrently append N new elements to the list. When a process attempts to attach its element to the tail of the list it may discover that its tail pointer is stale and it must chase ahead to the new tail

before the element can be attached. This example requires some modification to work in an environment where the layout of the structures is different on different processes.

```

...
#define NUM_ELEMS 10

#define LLIST_ELEM_NEXT_RANK ( offsetof(llist_elem_t, next) + \
                               offsetof(llist_ptr_t, rank) )
#define LLIST_ELEM_NEXT_DISP ( offsetof(llist_elem_t, next) + \
                               offsetof(llist_ptr_t, disp) )

/* Linked list pointer */
typedef struct {
    MPI_Aint disp;
    int      rank;
} llist_ptr_t;

/* Linked list element */
typedef struct {
    llist_ptr_t next;
    int value;
} llist_elem_t;

const llist_ptr_t nil = { (MPI_Aint) MPI_BOTTOM, -1 };

/* List of locally allocated list elements. */
static llist_elem_t **my_elems = NULL;
static int my_elems_size = 0;
static int my_elems_count = 0;

/* Allocate a new shared linked list element */
MPI_Aint alloc_elem(int value, MPI_Win win) {
    MPI_Aint disp;
    llist_elem_t *elem_ptr;

    /* Allocate the new element and register it with the window */
    MPI_Alloc_mem(sizeof(llist_elem_t), MPI_INFO_NULL, &elem_ptr);
    elem_ptr->value = value;
    elem_ptr->next = nil;
    MPI_Win_attach(win, elem_ptr, sizeof(llist_elem_t));

    /* Add the element to the list of local elements so we can free
       it later. */
    if (my_elems_size == my_elems_count) {
        my_elems_size += 100;
        my_elems = realloc(my_elems, my_elems_size*sizeof(void*));
    }
    my_elems[my_elems_count] = elem_ptr;

```

```
1     my_elems_count++;
2
3     MPI_Get_address(elem_ptr, &disp);
4     return disp;
5 }
6
7 int main(int argc, char *argv[]) {
8     int          procid, nproc, i;
9     MPI_Win      llist_win;
10    llist_ptr_t   head_ptr, tail_ptr;
11
12    MPI_Init(&argc, &argv);
13
14    MPI_Comm_rank(MPI_COMM_WORLD, &procid);
15    MPI_Comm_size(MPI_COMM_WORLD, &nproc);
16
17    MPI_Win_create_dynamic(MPI_INFO_NULL, MPI_COMM_WORLD, &llist_win);
18
19    /* Process 0 creates the head node */
20    if (procid == 0)
21        head_ptr.disp = alloc_elem(-1, llist_win);
22
23    /* Broadcast the head pointer to everyone */
24    head_ptr.rank = 0;
25    MPI_Bcast(&head_ptr.disp, 1, MPI_AINT, 0, MPI_COMM_WORLD);
26    tail_ptr = head_ptr;
27
28    /* Lock the window for shared access to all targets */
29    MPI_Win_lock_all(0, llist_win);
30
31    /* All processes concurrently append NUM_ELEMS elements to the list */
32    for (i = 0; i < NUM_ELEMS; i++) {
33        llist_ptr_t new_elem_ptr;
34        int success;
35
36        /* Create a new list element and attach it to the window */
37        new_elem_ptr.rank = procid;
38        new_elem_ptr.disp = alloc_elem(procid, llist_win);
39
40        /* Append the new node to the list. This might take multiple
41         attempts if others have already appended and our tail pointer
42         is stale. */
43        do {
44            llist_ptr_t next_tail_ptr = nil;
45
46            MPI_Compare_and_swap((void*) &new_elem_ptr.rank, (void*) &nil.rank,
47                                (void*)&next_tail_ptr.rank, MPI_INT, tail_ptr.rank,
48                                MPI_Aint_add(tail_ptr.disp, LLIST_ELEM_NEXT_RANK),
```

```
        llist_win);
1
2
MPI_Win_flush(tail_ptr.rank, llist_win);
3
success = (next_tail_ptr.rank == nil.rank);
4
5
if (success) {
6
    MPI_Accumulate(&new_elem_ptr.disp, 1, MPI_AINT, tail_ptr.rank,
7
        MPI_Aint_add(tail_ptr.disp, LLIST_ELEM_NEXT_DISP), 1,
8
        MPI_AINT, MPI_REPLACE, llist_win);
9
10
    MPI_Win_flush(tail_ptr.rank, llist_win);
11
    tail_ptr = new_elem_ptr;
12
13
} else {
14
    /* Tail pointer is stale, fetch the displacement. May take
15
       multiple tries if it is being updated. */
16
    do {
17
        MPI_Get_accumulate(NULL, 0, MPI_AINT, &next_tail_ptr.disp,
18
            1, MPI_AINT, tail_ptr.rank,
19
            MPI_Aint_add(tail_ptr.disp, LLIST_ELEM_NEXT_DISP),
20
            1, MPI_AINT, MPI_NO_OP, llist_win);
21
22
        MPI_Win_flush(tail_ptr.rank, llist_win);
23
    } while (next_tail_ptr.disp == nil.disp);
24
    tail_ptr = next_tail_ptr;
25
}
26
} while (!success);
27
}
28
29
MPI_Win_unlock_all(llist_win);
30
MPI_Barrier(MPI_COMM_WORLD);
31
32
/* Free all the elements in the list */
33
for ( ; my_elems_count > 0; my_elems_count--) {
34
    MPI_Win_detach(llist_win, my_elems[my_elems_count-1]);
35
    MPI_Free_mem(my_elems[my_elems_count-1]);
36
}
37
MPI_Win_free(&llist_win);
38
...
39
40
41
42
43
44
45
46
47
48
```

1  
2  
3  
4  
5  
6  
7  
8  
9  
10  
11  
12  
13  
14  
15  
16  
17  
18  
19  
20  
21  
22  
23  
24  
25  
26  
27  
28  
29  
30  
31  
32  
33  
34  
35  
36  
37  
38  
39  
40  
41  
42  
43  
44  
45  
46  
47  
48

DRAFT

1  
2  
3  
4  
5  
6  
7  
8  
9  
10  
11  
12  
13  
14  
15  
16  
17  
18  
19  
20  
21  
22  
23  
24  
25  
26  
27  
28  
29  
30  
31  
32  
33  
34  
35  
36  
37  
38  
39  
40  
41  
42  
43  
44  
45  
46  
47  
48

# Chapter 12

## External Interfaces

### 12.1 Introduction

This chapter contains calls used to create **generalized requests**, which allow users to create new nonblocking operations with an interface similar to what is present in MPI. These calls can be used to layer new functionality on top of MPI. Next, Section 12.3 deals with setting the information found in `status`. This functionality is needed for generalized requests.

### 12.2 Generalized Requests

The goal of generalized requests is to allow users to define new nonblocking operations. Such an outstanding nonblocking operation is represented by a (generalized) request. A fundamental property of nonblocking operations is that progress toward the completion of this operation occurs asynchronously, i.e., concurrently with normal program execution. Typically, this requires execution of code concurrently with the execution of the user code, e.g., in a separate thread or in a signal handler. Operating systems provide a variety of mechanisms in support of concurrent execution. MPI does not attempt to standardize or to replace these mechanisms: it is assumed programmers who wish to define new asynchronous operations will use the mechanisms provided by the underlying operating system. Thus, the calls in this section only provide a means for defining the effect of MPI calls such as `MPI_WAIT` or `MPI_CANCEL` when they apply to generalized requests, and for signaling to MPI the completion of a generalized operation.

*Rationale.* It is tempting to also define an MPI standard mechanism for achieving concurrent execution of user-defined nonblocking operations. However, it is difficult to define such a mechanism without consideration of the specific mechanisms used in the operating system. The Forum feels that concurrency mechanisms are a proper part of the underlying operating system and should not be standardized by MPI; the MPI standard should only deal with the interaction of such mechanisms with MPI. (*End of rationale.*)

For a regular request, the operation associated with the request is performed by the MPI implementation, and the operation completes without intervention by the application. For a generalized request, the operation associated with the request is performed by the application; therefore, the application must notify MPI through a call to

1 MPI\_GREQUEST\_COMPLETE when the operation completes. MPI maintains the “completion”  
 2 status of generalized requests. Any other request state has to be maintained by the  
 3 user.

4 A new generalized request is started with

5  
 6  
 7 MPI\_GREQUEST\_START(query\_fn, free\_fn, cancel\_fn, extra\_state, request)

8	IN	query_fn	callback function invoked when request status is queried (function)
9			
10	IN	free_fn	callback function invoked when request is freed (func- tion)
11			
12	IN	cancel_fn	callback function invoked when request is cancelled (function)
13			
14	IN	extra_state	extra state
15			
16	OUT	request	generalized request (handle)
17			

### 18 C binding

19  
 20 int MPI\_Grequest\_start(MPI\_Grequest\_query\_function \*query\_fn,  
 21 MPI\_Grequest\_free\_function \*free\_fn,  
 22 MPI\_Grequest\_cancel\_function \*cancel\_fn, void \*extra\_state,  
 23 MPI\_Request \*request)

### 24 Fortran 2008 binding

25 MPI\_Grequest\_start(query\_fn, free\_fn, cancel\_fn, extra\_state, request,  
 26 ierror)  
 27 PROCEDURE(MPI\_Grequest\_query\_function), INTENT(IN) :: query\_fn  
 28 PROCEDURE(MPI\_Grequest\_free\_function), INTENT(IN) :: free\_fn  
 29 PROCEDURE(MPI\_Grequest\_cancel\_function), INTENT(IN) :: cancel\_fn  
 30 INTEGER(KIND=MPI\_ADDRESS\_KIND), INTENT(IN) :: extra\_state  
 31 TYPE(MPI\_Request), INTENT(OUT) :: request  
 32 INTEGER, OPTIONAL, INTENT(OUT) :: ierror

### 33 Fortran binding

34  
 35 MPI\_GREQUEST\_START(QUERY\_FN, FREE\_FN, CANCEL\_FN, EXTRA\_STATE, REQUEST,  
 36 IERROR)  
 37 EXTERNAL QUERY\_FN, FREE\_FN, CANCEL\_FN  
 38 INTEGER(KIND=MPI\_ADDRESS\_KIND) EXTRA\_STATE  
 39 INTEGER REQUEST, IERROR

40  
 41 *Advice to users.* Note that a generalized request is of the same type as regular  
 42 requests, in C and Fortran. (*End of advice to users.*)

43  
 44 The call starts a generalized request and returns a handle to it in request.

45 The syntax and meaning of the callback functions are listed below. All callback func-  
 46 tions are passed the extra\_state argument that was associated with the request by the  
 47 starting call MPI\_GREQUEST\_START; extra\_state can be used to maintain user-defined  
 48 state for the request.



In C, the query function is

```
typedef int MPI_Grequest_query_function(void *extra_state,
                                       MPI_Status *status);
```

in Fortran with the `mpi_f08` module

```
ABSTRACT INTERFACE
```

```
  SUBROUTINE MPI_Grequest_query_function(extra_state, status, ierror)
    INTEGER(KIND=MPI_ADDRESS_KIND) :: extra_state
    TYPE(MPI_Status) :: status
    INTEGER :: ierror
```

in Fortran with the `mpi` module and `mpif.h`

```
SUBROUTINE GREQUEST_QUERY_FUNCTION(EXTRA_STATE, STATUS, IERROR)
  INTEGER(KIND=MPI_ADDRESS_KIND) EXTRA_STATE
  INTEGER STATUS(MPI_STATUS_SIZE), IERROR
```

The `query_fn` function computes the status that should be returned for the generalized request. The status also includes information about successful/unsuccesful cancellation of the request (result to be returned by `MPI_TEST_CANCELLED`).

The `query_fn` callback is invoked by the `MPI_{WAIT|TEST}{ANY|SOME|ALL}` call that completed the generalized request associated with this callback. The callback function is also invoked by calls to `MPI_REQUEST_GET_STATUS`, if the request is complete when the call occurs. In both cases, the callback is passed a reference to the corresponding status variable passed by the user to the MPI call; the status set by the callback function is returned by the MPI call. If the user provided `MPI_STATUS_IGNORE` or `MPI_STATUSES_IGNORE` to the MPI function that causes `query_fn` to be called, then MPI will pass a valid status object to `query_fn`, and this status will be ignored upon return of the callback function. Note that `query_fn` is invoked only after `MPI_GREQUEST_COMPLETE` is called on the request; it may be invoked several times for the same generalized request, e.g., if the user calls `MPI_REQUEST_GET_STATUS` several times for this request. Note also that a call to `MPI_{WAIT|TEST}{SOME|ALL}` may cause multiple invocations of `query_fn` callback functions, one for each generalized request that is completed by the MPI call. The order of these invocations is not specified by MPI.

In C, the free function is

```
typedef int MPI_Grequest_free_function(void *extra_state);
```

in Fortran with the `mpi_f08` module

```
ABSTRACT INTERFACE
```

```
  SUBROUTINE MPI_Grequest_free_function(extra_state, ierror)
    INTEGER(KIND=MPI_ADDRESS_KIND) :: extra_state
    INTEGER :: ierror
```

in Fortran with the `mpi` module and `mpif.h`

```
SUBROUTINE GREQUEST_FREE_FUNCTION(EXTRA_STATE, IERROR)
  INTEGER(KIND=MPI_ADDRESS_KIND) EXTRA_STATE
  INTEGER IERROR
```

The `free_fn` function is invoked to clean up user-allocated resources when the generalized request is freed.

The `free_fn` callback is invoked by the `MPI_{WAIT|TEST}{ANY|SOME|ALL}` call that

1 completed the generalized request associated with this callback. `free_fn` is invoked after  
 2 the call to `query_fn` for the same request. However, if the MPI call completed multiple  
 3 generalized requests, the order in which `free_fn` callback functions are invoked is not specified  
 4 by MPI.

5 The `free_fn` callback is also invoked for generalized requests that are freed by a call  
 6 to `MPI_REQUEST_FREE` (no call to `MPI_{WAIT|TEST}{ANY|SOME|ALL}` will occur for  
 7 such a request). In this case, the callback function will be called either in the MPI call  
 8 `MPI_REQUEST_FREE(request)`, or in the MPI call `MPI_GREQUEST_COMPLETE(request)`,  
 9 whichever happens last, i.e., in this case the actual freeing code is executed as soon as both  
 10 calls `MPI_REQUEST_FREE` and `MPI_GREQUEST_COMPLETE` have occurred. The `request`  
 11 is not deallocated until after `free_fn` completes. Note that `free_fn` will be invoked only once  
 12 per request by a correct program.

13  
 14 *Advice to users.* Calling `MPI_REQUEST_FREE(request)` will cause the `request` handle  
 15 to be set to `MPI_REQUEST_NULL`. This handle to the generalized request is no longer  
 16 valid. However, user copies of this handle are valid until after `free_fn` completes since  
 17 MPI does not deallocate the object until then. Since `free_fn` is not called until after  
 18 `MPI_GREQUEST_COMPLETE`, the user copy of the handle can be used to make this  
 19 call. Users should note that MPI will deallocate the object after `free_fn` executes. At  
 20 this point, user copies of the `request` handle no longer point to a valid request. MPI will  
 21 not set user copies to `MPI_REQUEST_NULL` in this case, so it is up to the user to avoid  
 22 accessing this stale handle. This is a special case in which MPI defers deallocating the  
 23 object until a later time that is known by the user. (*End of advice to users.*)

24 In C, the cancel function is

```
25 typedef int MPI_Grequest_cancel_function(void *extra_state, int complete);
```

26 in Fortran with the `mpi_f08` module

```
27 ABSTRACT INTERFACE
```

```
28 SUBROUTINE MPI_Grequest_cancel_function(extra_state, complete, ierror)
29     INTEGER(KIND=MPI_ADDRESS_KIND) :: extra_state
30     LOGICAL :: complete
31     INTEGER :: ierror
```

32 in Fortran with the `mpi` module and `mpif.h`

```
33 SUBROUTINE GREQUEST_CANCEL_FUNCTION(EXTRA_STATE, COMPLETE, IERROR)
34     INTEGER(KIND=MPI_ADDRESS_KIND) EXTRA_STATE
35     LOGICAL COMPLETE
36     INTEGER IERROR
```

37  
 38 The `cancel_fn` function is invoked to start the cancelation of a generalized request. It  
 39 is called by `MPI_CANCEL(request)`. MPI passes `complete = true` to the callback function  
 40 if `MPI_GREQUEST_COMPLETE` was already called on the request, and `complete = false`  
 41 otherwise.  
 42

43 All callback functions return an error code. The code is passed back and dealt with as  
 44 appropriate for the error code by the MPI function that invoked the callback function. For  
 45 example, if error codes are returned then the error code returned by the callback function  
 46 will be returned by the MPI function that invoked the callback function. In the case of  
 47 an `MPI_{WAIT|TEST}{ANY}` call that invokes both `query_fn` and `free_fn`, the MPI call will  
 48 return the error code returned by the last callback, namely `free_fn`. If one or more of the



## 12.2.1 Examples

**Example 12.1** This example shows the code for a user-defined reduce operation on an `int` using a binary tree: each non-root node receives two messages, sums them, and sends them up. We assume that no status is returned and that the operation cannot be cancelled.

```
typedef struct {
    MPI_Comm comm;
    int tag;
    int root;
    int valin;
    int *valout;
    MPI_Request request;
} ARGS;

int myreduce(MPI_Comm comm, int tag, int root,
             int valin, int *valout, MPI_Request *request)
{
    ARGS *args;
    pthread_t thread;

    /* start request */
    MPI_Grequest_start(query_fn, free_fn, cancel_fn, NULL, request);

    args = (ARGS*)malloc(sizeof(ARGS));
    args->comm = comm;
    args->tag = tag;
    args->root = root;
    args->valin = valin;
    args->valout = valout;
    args->request = *request;

    /* spawn thread to handle request */
    /* The availability of the pthread_create call is system dependent */
    pthread_create(&thread, NULL, reduce_thread, args);

    return MPI_SUCCESS;
}

/* thread code */
void* reduce_thread(void *ptr)
{
    int lchild, rchild, parent, lval, rval, val;
    MPI_Request req[2];
    ARGS *args;

    args = (ARGS*)ptr;
```

```

1
2
3
4
5
6
7
8
9
10
11
12
13
14
15
16
17
18
19
20
21
22
23
24
25
26
27
28
29
30
31
32
33
34
35
36
37
38
39
40
41
42
43
44
45
46
47
48

```

```

/* compute left and right child and parent in tree; set
   to MPI_PROC_NULL if does not exist */
/* code not shown */
...

MPI_Irecv(&lval, 1, MPI_INT, lchild, args->tag, args->comm, &req[0]);
MPI_Irecv(&rval, 1, MPI_INT, rchild, args->tag, args->comm, &req[1]);
MPI_Waitall(2, req, MPI_STATUSES_IGNORE);
val = lval + args->valin + rval;
MPI_Send(&val, 1, MPI_INT, parent, args->tag, args->comm);
if (parent == MPI_PROC_NULL) *(args->valout) = val;
MPI_Grequest_complete((args->request));
free(ptr);
return(NULL);
}

int query_fn(void *extra_state, MPI_Status *status)
{
    /* always send just one int */
    MPI_Status_set_elements(status, MPI_INT, 1);
    /* can never cancel so always true */
    MPI_Status_set_cancelled(status, 0);
    /* choose not to return a value for this */
    status->MPI_SOURCE = MPI_UNDEFINED;
    /* tag has no meaning for this generalized request */
    status->MPI_TAG = MPI_UNDEFINED;
    /* this generalized request never fails */
    return MPI_SUCCESS;
}

int free_fn(void *extra_state)
{
    /* this generalized request does not need to do any freeing */
    /* as a result it never fails here */
    return MPI_SUCCESS;
}

int cancel_fn(void *extra_state, int complete)
{
    /* This generalized request does not support cancelling.
       Abort if not already done. If done then treat as if cancel failed.*/
    if (!complete) {
        fprintf(stderr,
            "Cannot cancel generalized request - aborting program\n");
        MPI_Abort(MPI_COMM_WORLD, 99);
    }
}

```

```

1     }
2     return MPI_SUCCESS;
3 }

```

## 12.3 Associating Information with Status

MPI supports several different types of requests besides those for point-to-point operations. These range from MPI calls for I/O to generalized requests. It is desirable to allow these calls to use the same request mechanism, which allows one to wait or test on different types of requests. However, `MPI_{TEST|WAIT}{ANY|SOME|ALL}` returns a status with information about the request. With the generalization of requests, one needs to define what information will be returned in the status object.

Each MPI call fills in the appropriate fields in the status object. Any unused fields will have undefined values. A call to `MPI_{TEST|WAIT}{ANY|SOME|ALL}` can modify any of the fields in the status object. Specifically, it can modify fields that are undefined. The fields with meaningful values for a given request are defined in the sections with the new request.

Generalized requests raise additional considerations. Here, the user provides the functions to deal with the request. Unlike other MPI calls, the user needs to provide the information to be returned in the status. The status argument is provided directly to the callback function where the status needs to be set. Users can directly set the values in 3 of the 5 status values. The count and cancel fields are opaque. To overcome this, these calls are provided:

`MPI_STATUS_SET_ELEMENTS(status, datatype, count)`

INOUT	status	status with which to associate count (Status)
IN	datatype	datatype associated with count (handle)
IN	count	number of elements to associate with status (integer)

### C binding

```

int MPI_Status_set_elements(MPI_Status *status, MPI_Datatype datatype,
    int count)

```

### Fortran 2008 binding

```

MPI_Status_set_elements(status, datatype, count, ierror)
    TYPE(MPI_Status), INTENT(INOUT) :: status
    TYPE(MPI_Datatype), INTENT(IN) :: datatype
    INTEGER, INTENT(IN) :: count
    INTEGER, OPTIONAL, INTENT(OUT) :: ierror

```

### Fortran binding

```

MPI_STATUS_SET_ELEMENTS(STATUS, DATATYPE, COUNT, IERROR)
    INTEGER STATUS(MPI_STATUS_SIZE), DATATYPE, COUNT, IERROR

```

MPI\_STATUS\_SET\_ELEMENTS\_X(status, datatype, count) 1

INOUT	status	status with which to associate count (Status) 2
IN	datatype	datatype associated with count (handle) 3
IN	count	number of elements to associate with status (integer) 4

### C binding 5

```
int MPI_Status_set_elements_x(MPI_Status *status, MPI_Datatype datatype,
                             MPI_Count count) 6
```

### Fortran 2008 binding 7

```
MPI_Status_set_elements_x(status, datatype, count, ierror) 8
    TYPE(MPI_Status), INTENT(INOUT) :: status 9
    TYPE(MPI_Datatype), INTENT(IN) :: datatype 10
    INTEGER(KIND=MPI_COUNT_KIND), INTENT(IN) :: count 11
    INTEGER, OPTIONAL, INTENT(OUT) :: ierror 12
```

### Fortran binding 13

```
MPI_STATUS_SET_ELEMENTS_X(STATUS, DATATYPE, COUNT, IERROR) 14
    INTEGER STATUS(MPI_STATUS_SIZE), DATATYPE, IERROR 15
    INTEGER(KIND=MPI_COUNT_KIND) COUNT 16
```

These functions modify the opaque part of status so that a call to MPI\_GET\_ELEMENTS or MPI\_GET\_ELEMENTS\_X will return count. MPI\_GET\_COUNT will return a compatible value. 17

*Rationale.* The number of elements is set instead of the count because the former can deal with a nonintegral number of datatypes. (*End of rationale.*) 18

A subsequent call to MPI\_GET\_COUNT(status, datatype, count), MPI\_GET\_ELEMENTS(status, datatype, count), or MPI\_GET\_ELEMENTS\_X(status, datatype, count) must use a datatype argument that has the same type signature as the datatype argument that was used in the call to MPI\_STATUS\_SET\_ELEMENTS or MPI\_STATUS\_SET\_ELEMENTS\_X. 19

*Rationale.* The requirement of matching type signatures for these calls is similar to the restriction that holds when count is set by a receive operation: in that case, the calls to MPI\_GET\_COUNT, MPI\_GET\_ELEMENTS, and MPI\_GET\_ELEMENTS\_X must use a datatype with the same signature as the datatype used in the receive call. (*End of rationale.*) 20

MPI\_STATUS\_SET\_CANCELLED(status, flag) 21

INOUT	status	status with which to associate cancel flag (Status) 22
IN	flag	if true, indicates request was cancelled (logical) 23

### C binding 24

```
int MPI_Status_set_cancelled(MPI_Status *status, int flag) 25
```

**Fortran 2008 binding**

```
MPI_Status_set_cancelled(status, flag, ierror)
    TYPE(MPI_Status), INTENT(INOUT) :: status
    LOGICAL, INTENT(IN) :: flag
    INTEGER, OPTIONAL, INTENT(OUT) :: ierror
```

**Fortran binding**

```
MPI_STATUS_SET_CANCELLED(STATUS, FLAG, IERROR)
    INTEGER STATUS(MPI_STATUS_SIZE), IERROR
    LOGICAL FLAG
```

If `flag` is set to true then a subsequent call to `MPI_TEST_CANCELLED(status, flag)` will also return `flag = true`, otherwise it will return false.

*Advice to users.* Users are advised not to reuse the status fields for values other than those for which they were intended. Doing so may lead to unexpected results when using the status object. For example, calling `MPI_GET_ELEMENTS` may cause an error if the value is out of range or it may be impossible to detect such an error. The `extra_state` argument provided with a generalized request can be used to return information that does not logically belong in status. Furthermore, modifying the values in a status set internally by MPI, e.g., `MPI_RECV`, may lead to unpredictable results and is strongly discouraged. (*End of advice to users.*)



1  
2  
3  
4  
5  
6  
7  
8  
9  
10  
11  
12  
13  
14  
15  
16  
17  
18  
19  
20  
21  
22  
23  
24  
25  
26  
27  
28  
29  
30  
31  
32  
33  
34  
35  
36  
37  
38  
39  
40  
41  
42  
43  
44  
45  
46  
47  
48

# Chapter 13

## I/O

### 13.1 Introduction

POSIX provides a model of a widely portable file system, but the portability and optimization needed for parallel I/O cannot be achieved with the POSIX interface.

The significant optimizations required for efficiency (e.g., grouping [50], collective buffering [8, 16, 51, 55, 62], and disk-directed I/O [45]) can only be implemented if the parallel I/O system provides a high-level interface supporting partitioning of file data among processes and a collective interface supporting complete transfers of global data structures between process memories and files. In addition, further efficiencies can be gained via support for asynchronous I/O, strided accesses, and control over physical file layout on storage devices (disks). The I/O environment described in this chapter provides these facilities.

Instead of defining I/O access modes to express the common patterns for accessing a shared file (broadcast, reduction, scatter, gather), we chose another approach in which data partitioning is expressed using derived datatypes. Compared to a limited set of predefined access patterns, this approach has the advantage of added flexibility and expressiveness.

#### 13.1.1 Definitions

**file** An MPI file is an ordered collection of typed data items. MPI supports random or sequential access to any integral set of these items. A file is opened collectively by a group of processes. All collective I/O calls on a file are collective over this group.

**displacement** A file *displacement* is an absolute byte position relative to the beginning of a file. The displacement defines the location where a *view* begins. Note that a “file displacement” is distinct from a “typemap displacement.”

**etype** An *etype* (*elementary* datatype) is the unit of data access and positioning. It can be any MPI predefined or derived datatype. Derived etypes can be constructed using any of the MPI datatype constructor routines, provided all resulting typemap displacements are non-negative and monotonically nondecreasing. Data access is performed in etype units, reading or writing whole data items of type etype. Offsets are expressed as a count of etypes; file pointers point to the beginning of etypes. Depending on context, the term “etype” is used to describe one of three aspects of an elementary datatype: a particular MPI type, a data item of that type, or the extent of that type.

**filetype** A *filetype* is the basis for partitioning a file among processes and defines a template for accessing the file. A filetype is either a single etype or a derived MPI datatype constructed from multiple instances of the same etype. In addition, the extent of any hole in the filetype must be a multiple of the etype's extent. The displacements in the typemap of the filetype are not required to be distinct, but they must be non-negative and monotonically nondecreasing.

**view** A *view* defines the current set of data visible and accessible from an open file as an ordered set of etypes. Each process has its own view of the file, defined by three quantities: a displacement, an etype, and a filetype. The pattern described by a filetype is repeated, beginning at the displacement, to define the view. The pattern of repetition is defined to be the same pattern that `MPI_TYPE_CONTIGUOUS` would produce if it were passed the filetype and an arbitrarily large count. Figure 13.1 shows how the tiling works; note that the filetype in this example must have explicit lower and upper bounds set in order for the initial and final holes to be repeated in the view. Views can be changed by the user during program execution. The default view is a linear byte stream (displacement is zero, etype and filetype equal to `MPI_BYTE`).

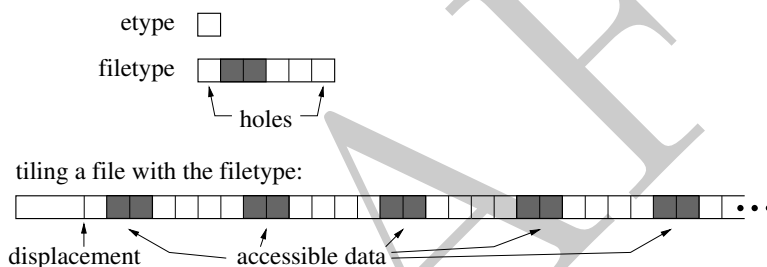

Figure 13.1: Etypes and filetypes

A group of processes can use complementary views to achieve a global data distribution such as a scatter/gather pattern (see Figure 13.2).

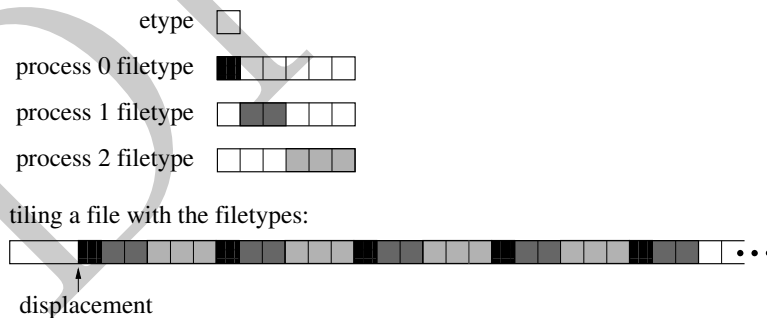

Figure 13.2: Partitioning a file among parallel processes

**offset** An *offset* is a position in the file relative to the current view, expressed as a count of etypes. Holes in the view's filetype are skipped when calculating this position. Offset 0 is the location of the first etype visible in the view (after skipping the displacement and any initial holes in the view). For example, an offset of 2 for process 1 in Figure 13.2 is the position of the eighth etype in the file after the displacement. An “explicit offset” is an offset that is used as an argument in explicit data access routines.

**file size and end of file** The *size* of an MPI file is measured in bytes from the beginning of the file. A newly created file has a size of zero bytes. Using the size as an absolute displacement gives the position of the byte immediately following the last byte in the file. For any given view, the *end of file* is the offset of the first etype accessible in the current view starting after the last byte in the file.

**file pointer** A *file pointer* is an implicit offset maintained by MPI. “Individual file pointers” are file pointers that are local to each process that opened the file. A “shared file pointer” is a file pointer that is shared by the group of processes that opened the file.

**file handle** A *file handle* is an opaque object created by MPI\_FILE\_OPEN and freed by MPI\_FILE\_CLOSE. All operations on an open file reference the file through the file handle.

## 13.2 File Manipulation

### 13.2.1 Opening a File

MPI\_FILE\_OPEN(comm, filename, amode, info, fh)

IN	comm	communicator (handle)
IN	filename	name of file to open (string)
IN	amode	file access mode (integer)
IN	info	info object (handle)
OUT	fh	new file handle (handle)

#### C binding

```
int MPI_File_open(MPI_Comm comm, const char *filename, int amode,
                 MPI_Info info, MPI_File *fh)
```

#### Fortran 2008 binding

```
MPI_File_open(comm, filename, amode, info, fh, ierror)
  TYPE(MPI_Comm), INTENT(IN) :: comm
  CHARACTER(LEN=*), INTENT(IN) :: filename
  INTEGER, INTENT(IN) :: amode
  TYPE(MPI_Info), INTENT(IN) :: info
  TYPE(MPI_File), INTENT(OUT) :: fh
  INTEGER, OPTIONAL, INTENT(OUT) :: ierror
```

#### Fortran binding

```
MPI_FILE_OPEN(COMM, FILENAME, AMODE, INFO, FH, IERROR)
  INTEGER COMM, AMODE, INFO, FH, IERROR
  CHARACTER*(*) FILENAME
```

MPI\_FILE\_OPEN opens the file identified by the file name *filename* on all processes in the *comm* communicator group. MPI\_FILE\_OPEN is a collective routine: all processes must provide the same value for *amode*, and all processes must provide *filenames* that reference

1 the same file. (Values for `info` may vary.) `comm` must be an intracommunicator; it is  
2 erroneous to pass an intercommunicator to `MPI_FILE_OPEN`. Errors in `MPI_FILE_OPEN`  
3 are raised using the default file error handler (see Section 13.7). When using the World  
4 Model (Section 10.1), a process can open a file independently of other processes by using  
5 the `MPI_COMM_SELF` communicator. Applications using the Sessions Model (Section 10.3)  
6 can achieve the same result using communicators created from the `mpi://SELF` process set.  
7 The file handle returned, `fh`, can be subsequently used to access the file until the file is  
8 closed using `MPI_FILE_CLOSE`. Before calling `MPI_FINALIZE`, the user is required to close  
9 (via `MPI_FILE_CLOSE`) all files that were opened with `MPI_FILE_OPEN`. Note that the  
10 communicator `comm` is unaffected by `MPI_FILE_OPEN` and continues to be usable in all  
11 MPI routines (e.g., `MPI_SEND`). Furthermore, the use of `comm` will not interfere with I/O  
12 behavior.

13 The format for specifying the file name in the `filename` argument is implementation  
14 dependent and must be documented by the implementation.

15  
16 *Advice to implementors.* An implementation may require that `filename` include a  
17 string or strings specifying additional information about the file. Examples include  
18 the type of filesystem (e.g., a prefix of `ufs:`), a remote hostname (e.g., a prefix of  
19 `machine.univ.edu:`), or a file password (e.g., a suffix of `/PASSWORD=SECRET`). (*End*  
20 *of advice to implementors.*)

21  
22 *Advice to users.* On some implementations of MPI, the file namespace may not be  
23 identical from all processes of all applications. For example, `"/tmp/foo"` may denote  
24 different files on different processes, or a single file may have many names, dependent  
25 on process location. The user is responsible for ensuring that a single file is referenced  
26 by the `filename` argument, as it may be impossible for an implementation to detect  
27 this type of namespace error. (*End of advice to users.*)

28  
29 Initially, all processes view the file as a linear byte stream, and each process views data  
30 in its own native representation (no data representation conversion is performed). (POSIX  
31 files are linear byte streams in the native representation.) The file view can be changed via  
32 the `MPI_FILE_SET_VIEW` routine.

33 The following access modes are supported (specified in `amode`, a bit vector OR of the  
34 following integer constants):

- 35 ● `MPI_MODE_RDONLY` — read only,
- 36 ● `MPI_MODE_RDWR` — reading and writing,
- 37 ● `MPI_MODE_WRONLY` — write only,
- 38 ● `MPI_MODE_CREATE` — create the file if it does not exist,
- 39 ● `MPI_MODE_EXCL` — error if creating file that already exists,
- 40 ● `MPI_MODE_DELETE_ON_CLOSE` — delete file on close,
- 41 ● `MPI_MODE_UNIQUE_OPEN` — file will not be concurrently opened elsewhere,
- 42 ● `MPI_MODE_SEQUENTIAL` — file will only be accessed sequentially,
- 43 ● `MPI_MODE_APPEND` — set initial position of all file pointers to end of file.

*Advice to users.* C users can use bit vector OR (|) to combine these constants; Fortran 90 users can use the bit vector IOR intrinsic. Fortran 77 users can use (nonportably) bit vector IOR on systems that support it. Alternatively, Fortran users can portably use integer addition to OR the constants (each constant should appear at most once in the addition.). (*End of advice to users.*)

*Advice to implementors.* The values of these constants must be defined such that the bitwise OR and the sum of any distinct set of these constants is equivalent. (*End of advice to implementors.*)

The modes MPI\_MODE\_RDONLY, MPI\_MODE\_RDWR, MPI\_MODE\_WRONLY, MPI\_MODE\_CREATE, and MPI\_MODE\_EXCL have identical semantics to their POSIX counterparts [41]. Exactly one of MPI\_MODE\_RDONLY, MPI\_MODE\_RDWR, or MPI\_MODE\_WRONLY, must be specified. It is erroneous to specify MPI\_MODE\_CREATE or MPI\_MODE\_EXCL in conjunction with MPI\_MODE\_RDONLY; it is erroneous to specify MPI\_MODE\_SEQUENTIAL together with MPI\_MODE\_RDWR.

The MPI\_MODE\_DELETE\_ON\_CLOSE mode causes the file to be deleted (equivalent to performing an MPI\_FILE\_DELETE) when the file is closed.

The MPI\_MODE\_UNIQUE\_OPEN mode allows an implementation to optimize access by eliminating the overhead of file locking. It is erroneous to open a file in this mode unless the file will not be concurrently opened elsewhere.

*Advice to users.* For MPI\_MODE\_UNIQUE\_OPEN, *not opened elsewhere* includes both inside and outside the MPI environment. In particular, one needs to be aware of potential external events which may open files (e.g., automated backup facilities). When MPI\_MODE\_UNIQUE\_OPEN is specified, the user is responsible for ensuring that no such external events take place. (*End of advice to users.*)

The MPI\_MODE\_SEQUENTIAL mode allows an implementation to optimize access to some sequential devices (tapes and network streams). It is erroneous to attempt nonsequential access to a file that has been opened in this mode.

Specifying MPI\_MODE\_APPEND only guarantees that all shared and individual file pointers are positioned at the initial end of file when MPI\_FILE\_OPEN returns. Subsequent positioning of file pointers is application dependent. In particular, the implementation does not ensure that all writes are appended.

Errors related to the access mode are raised in the class MPI\_ERR\_AMODE.

The info argument is used to provide information regarding file access patterns and file system specifics (see Section 13.2.8). The constant MPI\_INFO\_NULL can be used when no info needs to be specified.

*Advice to users.* Some file attributes are inherently implementation dependent (e.g., file permissions). These attributes must be set using either the info argument or facilities outside the scope of MPI. (*End of advice to users.*)

Files are opened by default using nonatomic mode file consistency semantics (see Section 13.6.1). The more stringent atomic mode consistency semantics, required for atomicity of conflicting accesses, can be set using MPI\_FILE\_SET\_ATOMICITY.

## 13.2.2 Closing a File

### MPI\_FILE\_CLOSE(fh)

INOUT fh file handle (handle)

#### C binding

```
int MPI_File_close(MPI_File *fh)
```

#### Fortran 2008 binding

```
MPI_File_close(fh, ierror)
  TYPE(MPI_File), INTENT(INOUT) :: fh
  INTEGER, OPTIONAL, INTENT(OUT) :: ierror
```

#### Fortran binding

```
MPI_FILE_CLOSE(FH, IERROR)
  INTEGER FH, IERROR
```

MPI\_FILE\_CLOSE first synchronizes file state (equivalent to performing an MPI\_FILE\_SYNC), then closes the file associated with fh. The file is deleted if it was opened with access mode MPI\_MODE\_DELETE\_ON\_CLOSE (equivalent to performing an MPI\_FILE\_DELETE). MPI\_FILE\_CLOSE is a collective routine.

*Advice to users.* If the file is deleted on close, and there are other processes currently accessing the file, the status of the file and the behavior of future accesses by these processes are implementation dependent. (*End of advice to users.*)

The user is responsible for ensuring that all outstanding nonblocking requests and split collective operations associated with fh made by a process have completed before that process calls MPI\_FILE\_CLOSE.

The MPI\_FILE\_CLOSE routine deallocates the file handle object and sets fh to MPI\_FILE\_NULL.

## 13.2.3 Deleting a File

### MPI\_FILE\_DELETE(filename, info)

IN filename name of file to delete (string)  
IN info info object (handle)

#### C binding

```
int MPI_File_delete(const char *filename, MPI_Info info)
```

#### Fortran 2008 binding

```
MPI_File_delete(filename, info, ierror)
  CHARACTER(LEN=*), INTENT(IN) :: filename
  TYPE(MPI_Info), INTENT(IN) :: info
  INTEGER, OPTIONAL, INTENT(OUT) :: ierror
```

**Fortran binding**

```
MPI_FILE_DELETE(FILENAME, INFO, IERROR)
    CHARACTER*(*) FILENAME
    INTEGER INFO, IERROR
```

MPI\_FILE\_DELETE deletes the file identified by the file name `filename`. If the file does not exist, MPI\_FILE\_DELETE raises an error in the class MPI\_ERR\_NO\_SUCH\_FILE.

The `info` argument can be used to provide information regarding file system specifics (see Section 13.2.8). The constant MPI\_INFO\_NULL refers to the null info, and can be used when no info needs to be specified.

If a process currently has the file open, the behavior of any access to the file (as well as the behavior of any outstanding accesses) is implementation dependent. In addition, whether an open file is deleted or not is also implementation dependent. If the file is not deleted, an error in the class MPI\_ERR\_FILE\_IN\_USE or MPI\_ERR\_ACCESS will be raised. Errors are raised using the default file error handler (see Section 13.7).

## 13.2.4 Resizing a File

```
MPI_FILE_SET_SIZE(fh, size)
```

INOUT	fh	file handle (handle)
IN	size	size to truncate or expand file (integer)

**C binding**

```
int MPI_File_set_size(MPI_File fh, MPI_Offset size)
```

**Fortran 2008 binding**

```
MPI_File_set_size(fh, size, ierror)
    TYPE(MPI_File), INTENT(IN) :: fh
    INTEGER(KIND=MPI_OFFSET_KIND), INTENT(IN) :: size
    INTEGER, OPTIONAL, INTENT(OUT) :: ierror
```

**Fortran binding**

```
MPI_FILE_SET_SIZE(FH, SIZE, IERROR)
    INTEGER FH, IERROR
    INTEGER(KIND=MPI_OFFSET_KIND) SIZE
```

MPI\_FILE\_SET\_SIZE resizes the file associated with the file handle `fh`. `size` is measured in bytes from the beginning of the file. MPI\_FILE\_SET\_SIZE is collective; all processes in the group must pass identical values for `size`.

If `size` is smaller than the current file size, the file is truncated at the position defined by `size`. The implementation is free to deallocate file blocks located beyond this position.

If `size` is larger than the current file size, the file size becomes `size`. Regions of the file that have been previously written are unaffected. The values of data in the new regions in the file (those locations with displacements between old file size and `size`) are undefined. It is implementation dependent whether the MPI\_FILE\_SET\_SIZE routine allocates file space — use MPI\_FILE\_PREALLOCATE to force file space to be reserved.

MPI\_FILE\_SET\_SIZE does not affect the individual file pointers or the shared file

1 pointer. If `MPI_MODE_SEQUENTIAL` mode was specified when the file was opened, it is  
 2 erroneous to call this routine.

3  
 4 *Advice to users.* It is possible for the file pointers to point beyond the end of file  
 5 after a `MPI_FILE_SET_SIZE` operation truncates a file. This is valid, and equivalent  
 6 to seeking beyond the current end of file. (*End of advice to users.*)

7  
 8 All nonblocking requests and split collective operations on `fh` must be completed before  
 9 calling `MPI_FILE_SET_SIZE`. Otherwise, calling `MPI_FILE_SET_SIZE` is erroneous. As far  
 10 as consistency semantics are concerned, `MPI_FILE_SET_SIZE` is a write operation that  
 11 conflicts with operations that access bytes at displacements between the old and new file  
 12 sizes (see Section 13.6.1).

### 13.2.5 Preallocating Space for a File

17 `MPI_FILE_PREALLOCATE(fh, size)`

18	INOUT	<code>fh</code>	file handle (handle)
19			
20	IN	<code>size</code>	size to preallocate file (integer)

#### 22 C binding

23 `int MPI_File_preallocate(MPI_File fh, MPI_Offset size)`

#### 25 Fortran 2008 binding

26 `MPI_File_preallocate(fh, size, ierror)`  
 27 `TYPE(MPI_File), INTENT(IN) :: fh`  
 28 `INTEGER(KIND=MPI_OFFSET_KIND), INTENT(IN) :: size`  
 29 `INTEGER, OPTIONAL, INTENT(OUT) :: ierror`

#### 30 Fortran binding

31 `MPI_FILE_PREALLOCATE(FH, SIZE, IERROR)`  
 32 `INTEGER FH, IERROR`  
 33 `INTEGER(KIND=MPI_OFFSET_KIND) SIZE`

34  
 35 `MPI_FILE_PREALLOCATE` ensures that storage space is allocated for the first `size` bytes  
 36 of the file associated with `fh`. `MPI_FILE_PREALLOCATE` is collective; all processes in the  
 37 group must pass identical values for `size`. Regions of the file that have previously been  
 38 written are unaffected. For newly allocated regions of the file, `MPI_FILE_PREALLOCATE`  
 39 has the same effect as writing undefined data. If `size` is larger than the current file size, the  
 40 file size increases to `size`. If `size` is less than or equal to the current file size, the file size is  
 41 unchanged.

42 The treatment of file pointers, pending nonblocking accesses, and file consistency is the  
 43 same as with `MPI_FILE_SET_SIZE`. If `MPI_MODE_SEQUENTIAL` mode was specified when  
 44 the file was opened, it is erroneous to call this routine.

45  
 46 *Advice to users.* In some implementations, file preallocation may be expensive. (*End*  
 47 *of advice to users.*)



## 13.2.6 Querying the Size of a File

`MPI_FILE_GET_SIZE(fh, size)`

IN	fh	file handle (handle)
OUT	size	size of the file in bytes (integer)

**C binding**

```
int MPI_File_get_size(MPI_File fh, MPI_Offset *size)
```

**Fortran 2008 binding**

```
MPI_File_get_size(fh, size, ierror)
  TYPE(MPI_File), INTENT(IN) :: fh
  INTEGER(KIND=MPI_OFFSET_KIND), INTENT(OUT) :: size
  INTEGER, OPTIONAL, INTENT(OUT) :: ierror
```

**Fortran binding**

```
MPI_FILE_GET_SIZE(FH, SIZE, IERROR)
  INTEGER FH, IERROR
  INTEGER(KIND=MPI_OFFSET_KIND) SIZE
```

`MPI_FILE_GET_SIZE` returns, in `size`, the current size in bytes of the file associated with the file handle `fh`. As far as consistency semantics are concerned, `MPI_FILE_GET_SIZE` is a data access operation (see Section 13.6.1).

## 13.2.7 Querying File Parameters

`MPI_FILE_GET_GROUP(fh, group)`

IN	fh	file handle (handle)
OUT	group	group which opened the file (handle)

**C binding**

```
int MPI_File_get_group(MPI_File fh, MPI_Group *group)
```

**Fortran 2008 binding**

```
MPI_File_get_group(fh, group, ierror)
  TYPE(MPI_File), INTENT(IN) :: fh
  TYPE(MPI_Group), INTENT(OUT) :: group
  INTEGER, OPTIONAL, INTENT(OUT) :: ierror
```

**Fortran binding**

```
MPI_FILE_GET_GROUP(FH, GROUP, IERROR)
  INTEGER FH, GROUP, IERROR
```

`MPI_FILE_GET_GROUP` returns a duplicate of the group of the communicator used to open the file associated with `fh`. The group is returned in `group`. The user is responsible for freeing `group`.

```
1 MPI_FILE_GET_AMODE(fh, amode)
```

```
2     IN      fh                file handle (handle)
```

```
3     OUT    amode             file access mode used to open the file (integer)
```

### 6 C binding

```
7 int MPI_File_get_amode(MPI_File fh, int *amode)
```

### 9 Fortran 2008 binding

```
10 MPI_File_get_amode(fh, amode, ierror)
```

```
11     TYPE(MPI_File), INTENT(IN) :: fh
```

```
12     INTEGER, INTENT(OUT) :: amode
```

```
13     INTEGER, OPTIONAL, INTENT(OUT) :: ierror
```

### 14 Fortran binding

```
15 MPI_FILE_GET_AMODE(FH, AMODE, IERROR)
```

```
16     INTEGER FH, AMODE, IERROR
```

17 MPI\_FILE\_GET\_AMODE returns, in amode, the access mode of the file associated with  
18 fh.

20 **Example 13.1** In Fortran 77, decoding an amode bit vector will require a routine such as  
21 the following:

```
23 SUBROUTINE BIT_QUERY(TEST_BIT, MAX_BIT, AMODE, BIT_FOUND)
```

```
24 !
```

```
25 ! TEST IF THE INPUT TEST_BIT IS SET IN THE INPUT AMODE
```

```
26 ! IF SET, RETURN 1 IN BIT_FOUND, 0 OTHERWISE
```

```
27 !
```

```
28     INTEGER TEST_BIT, AMODE, BIT_FOUND, CP_AMODE, HIFOUND
```

```
29     BIT_FOUND = 0
```

```
30     CP_AMODE = AMODE
```

```
31 100 CONTINUE
```

```
32     LBIT = 0
```

```
33     HIFOUND = 0
```

```
34     DO L = MAX_BIT, 0, -1
```

```
35         MATCHER = 2**L
```

```
36         IF (CP_AMODE .GE. MATCHER .AND. HIFOUND .EQ. 0) THEN
```

```
37             HIFOUND = 1
```

```
38             LBIT = MATCHER
```

```
39             CP_AMODE = CP_AMODE - MATCHER
```

```
40         END IF
```

```
41     END DO
```

```
42     IF (HIFOUND .EQ. 1 .AND. LBIT .EQ. TEST_BIT) BIT_FOUND = 1
```

```
43     IF (BIT_FOUND .EQ. 0 .AND. HIFOUND .EQ. 1 .AND. &
```

```
44         CP_AMODE .GT. 0) GO TO 100
```

```
45 END
```

47 This routine could be called successively to decode amode, one bit at a time. For  
48 example, the following code fragment would check for MPI\_MODE\_RDONLY.

```

CALL BIT_QUERY(MPI_MODE_RDONLY, 30, AMODE, BIT_FOUND)
IF (BIT_FOUND .EQ. 1) THEN
  PRINT *, ' FOUND READ-ONLY BIT IN AMODE=', AMODE
ELSE
  PRINT *, ' READ-ONLY BIT NOT FOUND IN AMODE=', AMODE
END IF

```

### 13.2.8 File Info

Hints specified via `info` (see Chapter 9) allow a user to provide information such as file access patterns and file system specifics to direct optimization. Providing hints may enable an implementation to deliver increased I/O performance or minimize the use of system resources. An implementation is free to ignore all hints; however, applications must comply with any `info` hints they provide that are used by the MPI implementation (i.e., are returned by a call to `MPI_FILE_GET_INFO`) and that place a restriction on the behavior of the application. Hints are specified on a per file basis, in `MPI_FILE_OPEN`, `MPI_FILE_DELETE`, `MPI_FILE_SET_VIEW`, and `MPI_FILE_SET_INFO`, via the opaque `info` object. When an `info` object that specifies a subset of valid hints is passed to `MPI_FILE_SET_VIEW` or `MPI_FILE_SET_INFO`, there will be no effect on previously set or defaulted hints that the `info` does not specify.

*Advice to implementors.* It may happen that a program is coded with hints for one system, and later executes on another system that does not support these hints. In general, unsupported hints should simply be ignored. Needless to say, no hint can be mandatory. However, for each hint used by a specific implementation, a default value must be provided when the user does not specify a value for this hint. (*End of advice to implementors.*)

#### MPI\_FILE\_SET\_INFO(fh, info)

INOUT	fh	file handle (handle)
IN	info	info object (handle)

#### C binding

```
int MPI_File_set_info(MPI_File fh, MPI_Info info)
```

#### Fortran 2008 binding

```

MPI_File_set_info(fh, info, ierror)
  TYPE(MPI_File), INTENT(IN) :: fh
  TYPE(MPI_Info), INTENT(IN) :: info
  INTEGER, OPTIONAL, INTENT(OUT) :: ierror

```

#### Fortran binding

```

MPI_FILE_SET_INFO(FH, INFO, IERROR)
  INTEGER FH, INFO, IERROR

```

`MPI_FILE_SET_INFO` updates the hints of the file associated with `fh` using the hints provided in `info`. This operation has no effect on previously set or defaulted hints that are not

1 specified by `info`. It also has no effect on previously set or defaulted hints that are specified  
 2 by `info`, but are ignored by the MPI implementation in this call to `MPI_FILE_SET_INFO`.  
 3 `MPI_FILE_SET_INFO` is a collective routine. The `info` object may be different on each  
 4 process, but any `info` entries that an implementation requires to be the same on all processes  
 5 must appear with the same value in each process's `info` object.

6  
 7 *Advice to users.* Many `info` items that an implementation can use when it creates or  
 8 opens a file cannot easily be changed once the file has been created or opened. Thus,  
 9 an implementation may ignore hints issued in this call that it would have accepted in  
 10 an open call. An implementation may also be unable to update certain `info` hints in a  
 11 call to `MPI_FILE_SET_VIEW` or `MPI_FILE_SET_INFO`. `MPI_FILE_GET_INFO` can be  
 12 used to determine whether `info` changes were ignored by the implementation. (*End of*  
 13 *advice to users.*)

14  
 15  
 16 `MPI_FILE_GET_INFO(fh, info_used)`

17  
 18     IN        fh                           file handle (handle)  
 19     OUT       info\_used                   new info object (handle)  
 20

### 21 C binding

22 `int MPI_File_get_info(MPI_File fh, MPI_Info *info_used)`

### 23 Fortran 2008 binding

24 `MPI_File_get_info(fh, info_used, ierror)`  
 25     TYPE(MPI\_File), INTENT(IN) :: fh  
 26     TYPE(MPI\_Info), INTENT(OUT) :: info\_used  
 27     INTEGER, OPTIONAL, INTENT(OUT) :: ierror  
 28

### 29 Fortran binding

30 `MPI_FILE_GET_INFO(FH, INFO_USED, IERROR)`  
 31     INTEGER FH, INFO\_USED, IERROR  
 32

33 `MPI_FILE_GET_INFO` returns a new `info` object containing the hints of the file associ-  
 34 ated with `fh`. The current setting of all hints related to this file is returned in `info_used`. An  
 35 MPI implementation is required to return all hints that are supported by the implementa-  
 36 tion and have default values specified; any user-supplied hints that were not ignored by the  
 37 implementation; and any additional hints that were set by the implementation. If no such  
 38 hints exist, a handle to a newly created `info` object is returned that contains no key/value  
 39 pairs. The user is responsible for freeing `info_used` via `MPI_INFO_FREE`.  
 40

### 41 Reserved File Hints

42  
 43 Some potentially useful hints (`info` key values) are outlined below. The following key values  
 44 are reserved. An implementation is not required to interpret these key values, but if it does  
 45 interpret the key value, it must provide the functionality described. (For more details on  
 46 “`info`,” see Chapter 9.)

47 These hints mainly affect access patterns and the layout of data on parallel I/O devices.  
 48 For each hint name introduced, we describe the purpose of the hint, and the type of the hint

value. The “[**SAME**]” annotation specifies that the hint values provided by all participating processes must be identical; otherwise the program is erroneous. In addition, some hints are context dependent, and are only used by an implementation at specific times (e.g., `file_perm` is only useful during file creation).

`access_style` (**comma separated list of strings**): This hint specifies the manner in which the file will be accessed until the file is closed or until the `access_style` key value is altered. The hint value is a comma separated list of the following: `read_once`, `write_once`, `read_mostly`, `write_mostly`, `sequential`, `reverse_sequential`, and `random`.

`collective_buffering` (**boolean**) [**SAME**]: This hint specifies whether the application may benefit from collective buffering. Collective buffering is an optimization performed on collective accesses. Accesses to the file are performed on behalf of all processes in the group by a number of target nodes. These target nodes coalesce small requests into large disk accesses. Valid values for this key are `true` and `false`. Collective buffering parameters are further directed via additional hints: `cb_block_size`, `cb_buffer_size`, and `cb_nodes`.

`cb_block_size` (**integer**) [**SAME**]: This hint specifies the block size to be used for collective buffering file access. *Target nodes* access data in chunks of this size. The chunks are distributed among target nodes in a round-robin (cyclic) pattern.

`cb_buffer_size` (**integer**) [**SAME**]: This hint specifies the total buffer space that can be used for collective buffering on each target node, usually a multiple of `cb_block_size`.

`cb_nodes` (**integer**) [**SAME**]: This hint specifies the number of target nodes to be used for collective buffering.

`chunked` (**comma separated list of integers**) [**SAME**]: This hint specifies that the file consists of a multidimensional array that is often accessed by subarrays. The value for this hint is a comma separated list of array dimensions, starting from the most significant one (for an array stored in row-major order, as in C, the most significant dimension is the first one; for an array stored in column-major order, as in Fortran, the most significant dimension is the last one, and array dimensions should be reversed).

`chunked_item` (**comma separated list of integers**) [**SAME**]: This hint specifies the size of each array entry, in bytes.

`chunked_size` (**comma separated list of integers**) [**SAME**]: This hint specifies the dimensions of the subarrays. This is a comma separated list of array dimensions, starting from the most significant one.

`filename` (**string**): This hint specifies the file name used when the file was opened. If the implementation is capable of returning the file name of an open file, it will be returned using this key by `MPI_FILE_GET_INFO`. This key is ignored when passed to `MPI_FILE_OPEN`, `MPI_FILE_SET_VIEW`, `MPI_FILE_SET_INFO`, and `MPI_FILE_DELETE`.

`file_perm` (**string**) [**SAME**]: This hint specifies the file permissions to use for file creation. Setting this hint is only useful when passed to `MPI_FILE_OPEN` with an `amode` that includes `MPI_MODE_CREATE`. The set of valid values for this key is implementation dependent.

1 `io_node_list` (**comma separated list of strings**) [**SAME**]: This hint specifies the list of  
 2 I/O devices that should be used to store the file. This hint is most relevant when the  
 3 file is created.

4  
 5 `nb_proc` (**integer**) [**SAME**]: This hint specifies the number of parallel processes that will  
 6 typically be assigned to run programs that access this file. This hint is most relevant  
 7 when the file is created.

8  
 9 `num_io_nodes` (**integer**) [**SAME**]: This hint specifies the number of I/O devices in the  
 10 system. This hint is most relevant when the file is created.

11 `striping_factor` (**integer**) [**SAME**]: This hint specifies the number of I/O devices that the  
 12 file should be striped across, and is relevant only when the file is created.

13  
 14 `striping_unit` (**integer**) [**SAME**]: This hint specifies the suggested striping unit to be used  
 15 for this file. The striping unit is the amount of consecutive data assigned to one I/O  
 16 device before progressing to the next device, when striping across a number of devices.  
 17 It is expressed in bytes. This hint is relevant only when the file is created.

### 19 13.3 File Views

22  
 23 `MPI_FILE_SET_VIEW(fh, disp, etype, filetype, datarep, info)`

24	INOUT	<code>fh</code>	file handle (handle)
25	IN	<code>disp</code>	displacement (integer)
26	IN	<code>etype</code>	elementary datatype (handle)
27	IN	<code>filetype</code>	filetype (handle)
28	IN	<code>datarep</code>	data representation (string)
29	IN	<code>info</code>	info object (handle)

#### 32 C binding

33  
 34 `int MPI_File_set_view(MPI_File fh, MPI_Offset disp, MPI_Datatype etype,`  
 35 `MPI_Datatype filetype, const char *datarep, MPI_Info info)`

#### 36 Fortran 2008 binding

37 `MPI_File_set_view(fh, disp, etype, filetype, datarep, info, ierror)`  
 38 `TYPE(MPI_File), INTENT(IN) :: fh`  
 39 `INTEGER(KIND=MPI_OFFSET_KIND), INTENT(IN) :: disp`  
 40 `TYPE(MPI_Datatype), INTENT(IN) :: etype, filetype`  
 41 `CHARACTER(LEN=*), INTENT(IN) :: datarep`  
 42 `TYPE(MPI_Info), INTENT(IN) :: info`  
 43 `INTEGER, OPTIONAL, INTENT(OUT) :: ierror`

#### 44 Fortran binding

45  
 46 `MPI_FILE_SET_VIEW(FH, DISP, ETYPE, FILETYPE, DATAREP, INFO, IERROR)`  
 47 `INTEGER FH, ETYPE, FILETYPE, INFO, IERROR`  
 48 `INTEGER(KIND=MPI_OFFSET_KIND) DISP`

CHARACTER\*(\*) DATAREP

The `MPI_FILE_SET_VIEW` routine changes the process's view of the data in the file. The start of the view is set to `disp`; the type of data is set to `etype`; the distribution of data to processes is set to `filetype`; and the representation of data in the file is set to `datarep`. In addition, `MPI_FILE_SET_VIEW` resets the individual file pointers and the shared file pointer to zero. `MPI_FILE_SET_VIEW` is collective; the values for `datarep` and the extents of `etype` in the file data representation must be identical on all processes in the group; values for `disp`, `filetype`, and `info` may vary. The datatypes passed in `etype` and `filetype` must be committed.

The `etype` always specifies the data layout in the file. If `etype` is a portable datatype (see Section 2.4), the extent of `etype` is computed by scaling any displacements in the datatype to match the file data representation. If `etype` is not a portable datatype, no scaling is done when computing the extent of `etype`. The user must be careful when using nonportable `etypes` in heterogeneous environments; see Section 13.5.1 for further details.

If `MPI_MODE_SEQUENTIAL` mode was specified when the file was opened, the special displacement `MPI_DISPLACEMENT_CURRENT` must be passed in `disp`. This sets the displacement to the current position of the shared file pointer. `MPI_DISPLACEMENT_CURRENT` is invalid unless the `amode` for the file has `MPI_MODE_SEQUENTIAL` set.

*Rationale.* For some sequential files, such as those corresponding to magnetic tapes or streaming network connections, the *displacement* may not be meaningful. `MPI_DISPLACEMENT_CURRENT` allows the view to be changed for these types of files. (*End of rationale.*)

*Advice to implementors.* It is expected that a call to `MPI_FILE_SET_VIEW` will immediately follow `MPI_FILE_OPEN` in numerous instances. A high-quality implementation will ensure that this behavior is efficient. (*End of advice to implementors.*)

The `disp` displacement argument specifies the position (absolute offset in bytes from the beginning of the file) where the view begins.

*Advice to users.* `disp` can be used to skip headers or when the file includes a sequence of data segments that are to be accessed in different patterns (see Figure 13.3). Separate views, each using a different displacement and `filetype`, can be used to access each segment.

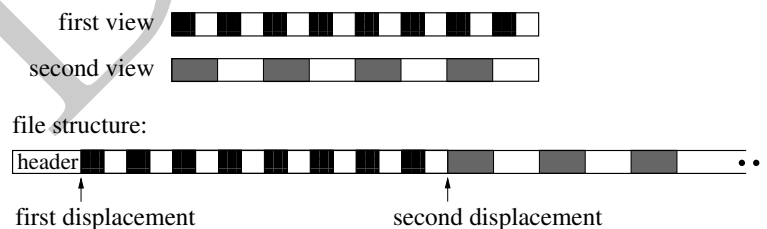

Figure 13.3: Displacements

(*End of advice to users.*)

An *etype* (*elementary* datatype) is the unit of data access and positioning. It can be any MPI predefined or derived datatype. Derived `etypes` can be constructed by using any

of the MPI datatype constructor routines, provided all resulting typemap displacements are non-negative and monotonically nondecreasing. Data access is performed in etype units, reading or writing whole data items of type etype. Offsets are expressed as a count of etypes; file pointers point to the beginning of etypes.

*Advice to users.* In order to ensure interoperability in a heterogeneous environment, additional restrictions must be observed when constructing the etype (see Section 13.5). (*End of advice to users.*)

A filetype is either a single etype or a derived MPI datatype constructed from multiple instances of the same etype. In addition, the extent of any hole in the filetype must be a multiple of the etype’s extent. These displacements are not required to be distinct, but they cannot be negative, and they must be monotonically nondecreasing.

If the file is opened for writing, neither the etype nor the filetype is permitted to contain overlapping regions. This restriction is equivalent to the “datatype used in a receive cannot specify overlapping regions” restriction for communication. Note that filetypes from different processes may still overlap each other.

If a filetype has holes in it, then the data in the holes is inaccessible to the calling process. However, the `disp`, `etype`, and `filetype` arguments can be changed via future calls to `MPI_FILE_SET_VIEW` to access a different part of the file.

It is erroneous to use absolute addresses in the construction of the etype and filetype.

The `info` argument is used to provide information regarding file access patterns and file system specifics to direct optimization (see Section 13.2.8). The constant `MPI_INFO_NULL` refers to the null info and can be used when no info needs to be specified.

The `datarep` argument is a string that specifies the representation of data in the file. See the file interoperability section (Section 13.5) for details and a discussion of valid values.

The user is responsible for ensuring that all nonblocking requests and split collective operations on `fh` have been completed before calling `MPI_FILE_SET_VIEW` — otherwise, the call to `MPI_FILE_SET_VIEW` is erroneous.

`MPI_FILE_GET_VIEW(fh, disp, etype, filetype, datarep)`

IN	<code>fh</code>	file handle (handle)
OUT	<code>disp</code>	displacement (integer)
OUT	<code>etype</code>	elementary datatype (handle)
OUT	<code>filetype</code>	filetype (handle)
OUT	<code>datarep</code>	data representation (string)

### C binding

```
int MPI_File_get_view(MPI_File fh, MPI_Offset *disp, MPI_Datatype *etype,
                    MPI_Datatype *filetype, char *datarep)
```

### Fortran 2008 binding

```
MPI_File_get_view(fh, disp, etype, filetype, datarep, ierror)
    TYPE(MPI_File), INTENT(IN) :: fh
    INTEGER(KIND=MPI_OFFSET_KIND), INTENT(OUT) :: disp
    TYPE(MPI_Datatype), INTENT(OUT) :: etype, filetype
```



```

CHARACTER(LEN=*), INTENT(OUT) :: datarep
INTEGER, OPTIONAL, INTENT(OUT) :: ierror

```

### Fortran binding

```

MPI_FILE_GET_VIEW(FH, DISP, ETYPE, FILETYPE, DATAREP, IERROR)
  INTEGER FH, ETYPE, FILETYPE, IERROR
  INTEGER(KIND=MPI_OFFSET_KIND) DISP
  CHARACTER*(*) DATAREP

```

`MPI_FILE_GET_VIEW` returns the process's view of the data in the file. The current value of the displacement is returned in `disp`. The `etype` and `filetype` are new datatypes with typemaps equal to the typemaps of the current `etype` and `filetype`, respectively.

The data representation is returned in `datarep`. The user is responsible for ensuring that `datarep` is large enough to hold the returned data representation string. The length of a data representation string is limited to the value of `MPI_MAX_DATAREP_STRING`.

In addition, if a portable datatype was used to set the current view, then the corresponding datatype returned by `MPI_FILE_GET_VIEW` is also a portable datatype. If `etype` or `filetype` are derived datatypes, the user is responsible for freeing them. The `etype` and `filetype` returned are both in a committed state.

## 13.4 Data Access

### 13.4.1 Data Access Routines

Data is moved between files and processes by issuing read and write calls. There are three orthogonal aspects to data access: positioning (explicit offset *vs.* implicit file pointer), synchronism (blocking *vs.* nonblocking and split collective), and coordination (noncollective *vs.* collective). The following combinations of these data access routines, including two types of file pointers (individual and shared) are provided in Table 13.1.

positioning	synchronism	coordination	
		noncollective	collective
explicit offsets	blocking	MPI_FILE_READ_AT MPI_FILE_WRITE_AT	MPI_FILE_READ_AT_ALL MPI_FILE_WRITE_AT_ALL
	nonblocking	MPI_FILE_IREAD_AT MPI_FILE_IWRITE_AT	MPI_FILE_IREAD_AT_ALL MPI_FILE_IWRITE_AT_ALL
	split collective	N/A	MPI_FILE_READ_AT_ALL_BEGIN MPI_FILE_READ_AT_ALL_END MPI_FILE_WRITE_AT_ALL_BEGIN MPI_FILE_WRITE_AT_ALL_END
individual file pointers	blocking	MPI_FILE_READ MPI_FILE_WRITE	MPI_FILE_READ_ALL MPI_FILE_WRITE_ALL
	nonblocking	MPI_FILE_IREAD MPI_FILE_IWRITE	MPI_FILE_IREAD_ALL MPI_FILE_IWRITE_ALL
	split collective	N/A	MPI_FILE_READ_ALL_BEGIN MPI_FILE_READ_ALL_END MPI_FILE_WRITE_ALL_BEGIN MPI_FILE_WRITE_ALL_END
shared file pointer	blocking	MPI_FILE_READ_SHARED MPI_FILE_WRITE_SHARED	MPI_FILE_READ_ORDERED MPI_FILE_WRITE_ORDERED
	nonblocking	MPI_FILE_IREAD_SHARED MPI_FILE_IWRITE_SHARED	N/A
	split collective	N/A	MPI_FILE_READ_ORDERED_BEGIN MPI_FILE_READ_ORDERED_END MPI_FILE_WRITE_ORDERED_BEGIN MPI_FILE_WRITE_ORDERED_END

Table 13.1: Data access routines

POSIX `read()`/`fread()` and `write()`/`fwrite()` are blocking, noncollective operations and use individual file pointers. The MPI equivalents are `MPI_FILE_READ` and

## 1 MPI\_FILE\_WRITE.

2 Implementations of data access routines may buffer data to improve performance. This  
 3 does not affect reads, as the data is always available in the user’s buffer after a read operation  
 4 completes. For writes, however, the `MPI_FILE_SYNC` routine provides the only guarantee  
 5 that data has been transferred to the storage device.

## 7 Positioning

8 MPI provides three types of positioning for data access routines: **explicit offsets**, **indi-**  
 9 **vidual file pointers**, and **shared file pointers**. The different positioning methods may  
 10 be mixed within the same program and do not affect each other.

11 The data access routines that accept explicit offsets contain `_AT` in their name (e.g.,  
 12 `MPI_FILE_WRITE_AT`). Explicit offset operations perform data access at the file position  
 13 given directly as an argument — no file pointer is used nor updated. Note that this is not  
 14 equivalent to an atomic seek-and-read or seek-and-write operation, as no “seek” is issued.  
 15 Operations with explicit offsets are described in Section 13.4.2.

16 The names of the individual file pointer routines contain no positional qualifier (e.g.,  
 17 `MPI_FILE_WRITE`). Operations with individual file pointers are described in Section 13.4.3.  
 18 The data access routines that use shared file pointers contain `_SHARED` or `_ORDERED`  
 19 in their name (e.g., `MPI_FILE_WRITE_SHARED`). Operations with shared file pointers are  
 20 described in Section 13.4.4.

21 The main semantic issues with MPI-maintained file pointers are how and when they are  
 22 updated by I/O operations. In general, each I/O operation leaves the file pointer pointing to  
 23 the next data item after the last one that is accessed by the operation. In a nonblocking or  
 24 split collective operation, the pointer is updated by the call that initiates the I/O, possibly  
 25 before the access completes.

26 More formally,

$$27 \quad new\_file\_offset = old\_file\_offset + \frac{elements(datatype)}{elements(etype)} \times count$$

28 where *count* is the number of *datatype* items to be accessed, *elements(X)* is the number of  
 29 predefined datatypes in the typemap of *X*, and *old\_file\_offset* is the value of the implicit  
 30 offset before the call. The file position, *new\_file\_offset*, is in terms of a count of etypes  
 31 relative to the current view.

## 35 Synchronism

36 MPI supports blocking and nonblocking I/O routines.

37 A *blocking* I/O call will not return until the I/O request is completed.

38 A *nonblocking* I/O call initiates an I/O operation, but does not wait for it to complete.

39 Given suitable hardware, this allows the transfer of data out of and into the user’s buffer  
 40 to proceed concurrently with computation. A separate *request complete* call (`MPI_WAIT`,  
 41 `MPI_TEST`, or any of their variants) is needed to complete the I/O request, i.e., to confirm  
 42 that the data has been read or written and that it is safe for the user to reuse the buffer.  
 43 The nonblocking versions of the routines are named `MPI_FILE_IXXX`, where the *l* stands  
 44 for immediate.

45 It is erroneous to access the local buffer of a nonblocking data access operation, or to  
 46 use that buffer as the source or target of other communications, between the initiation and  
 47 completion of the operation.

The split collective routines support a restricted form of “nonblocking” operations for collective data access (see Section 13.4.5).

#### Coordination

Every noncollective data access routine `MPI_FILE_XXX` has a collective counterpart. For most routines, this counterpart is `MPI_FILE_XXX_ALL` or a pair of `MPI_FILE_XXX_BEGIN` and `MPI_FILE_XXX_END`. The counterparts to the `MPI_FILE_XXX_SHARED` routines are `MPI_FILE_XXX_ORDERED`.

The completion of a noncollective call only depends on the activity of the calling process. However, the completion of a collective call (which must be called by all members of the process group) may depend on the activity of the other processes participating in the collective call. See Section 13.6.4 for rules on semantics of collective calls.

Collective operations may perform much better than their noncollective counterparts, as global data accesses have significant potential for automatic optimization.

#### Data Access Conventions

Data is moved between files and processes by calling read and write routines. Read routines move data from a file into memory. Write routines move data from memory into a file. The file is designated by a file handle, `fh`. The location of the file data is specified by an offset into the current view. The data in memory is specified by a triple: `buf`, `count`, and `datatype`. Upon completion, the amount of data accessed by the calling process is returned in a `status`.

An offset designates the starting position in the file for an access. The offset is always in `etype` units relative to the current view. Explicit offset routines pass `offset` as an argument (negative values are erroneous). The file pointer routines use implicit offsets maintained by MPI.

A data access routine attempts to transfer (read or write) `count` data items of type `datatype` between the user’s buffer `buf` and the file. The `datatype` passed to the routine must be a committed `datatype`. The layout of data in memory corresponding to `buf`, `count`, `datatype` is interpreted the same way as in MPI communication functions; see Section 3.2.2 and Section 4.1.11. The data is accessed from those parts of the file specified by the current view (Section 13.3). The type signature of `datatype` must match the type signature of some number of contiguous copies of the `etype` of the current view. As in a receive, it is erroneous to specify a `datatype` for reading that contains overlapping regions (areas of memory which would be stored into more than once).

The nonblocking data access routines indicate that MPI can start a data access and associate a request handle, `request`, with the I/O operation. Nonblocking operations are completed via `MPI_TEST`, `MPI_WAIT`, or any of their variants.

Data access operations, when completed, return the amount of data accessed in `status`.

*Advice to users.* To prevent problems with the argument copying and register optimization done by Fortran compilers, please note the hints in Sections 18.1.10–18.1.20. (*End of advice to users.*)

For blocking routines, `status` is returned directly. For nonblocking routines and split collective routines, `status` is returned when the operation is completed. The number of `datatype` entries and predefined elements accessed by the calling process can be extracted from `status` by using `MPI_GET_COUNT` and `MPI_GET_ELEMENTS` (or

MPI\_GET\_ELEMENTS\_X), respectively. The interpretation of the MPI\_ERROR field is the same as for other operations — normally undefined, but meaningful if an MPI routine returns MPI\_ERR\_IN\_STATUS. The user can pass (in C and Fortran) MPI\_STATUS\_IGNORE in the status argument if the return value of this argument is not needed. The status can be passed to MPI\_TEST\_CANCELLED to determine if the operation was cancelled. All other fields of status are undefined.

When reading, a program can detect the end of file by noting that the amount of data read is less than the amount requested. Writing past the end of file increases the file size. The amount of data accessed will be the amount requested, unless an error is raised (or a read reaches the end of file).

### 13.4.2 Data Access with Explicit Offsets

If MPI\_MODE\_SEQUENTIAL mode was specified when the file was opened, it is erroneous to call the routines in this section.

**MPI\_FILE\_READ\_AT(fh, offset, buf, count, datatype, status)**

IN	fh	file handle (handle)
IN	offset	file offset (integer)
OUT	buf	initial address of buffer (choice)
IN	count	number of elements in buffer (integer)
IN	datatype	datatype of each buffer element (handle)
OUT	status	status object (Status)

#### C binding

```
int MPI_File_read_at(MPI_File fh, MPI_Offset offset, void *buf, int count,
                    MPI_Datatype datatype, MPI_Status *status)
```

#### Fortran 2008 binding

```
MPI_File_read_at(fh, offset, buf, count, datatype, status, ierror)
    TYPE(MPI_File), INTENT(IN) :: fh
    INTEGER(KIND=MPI_OFFSET_KIND), INTENT(IN) :: offset
    TYPE(*), DIMENSION(..) :: buf
    INTEGER, INTENT(IN) :: count
    TYPE(MPI_Datatype), INTENT(IN) :: datatype
    TYPE(MPI_Status) :: status
    INTEGER, OPTIONAL, INTENT(OUT) :: ierror
```

#### Fortran binding

```
MPI_FILE_READ_AT(FH, OFFSET, BUF, COUNT, DATATYPE, STATUS, IERROR)
    INTEGER FH, COUNT, DATATYPE, STATUS(MPI_STATUS_SIZE), IERROR
    INTEGER(KIND=MPI_OFFSET_KIND) OFFSET
    <type> BUF(*)
```

MPI\_FILE\_READ\_AT reads a file beginning at the position specified by offset.

<code>MPI_FILE_READ_AT_ALL(fh, offset, buf, count, datatype, status)</code>			1
IN	fh	file handle (handle)	2
IN	offset	file offset (integer)	3
OUT	buf	initial address of buffer (choice)	4
IN	count	number of elements in buffer (integer)	5
IN	datatype	datatype of each buffer element (handle)	6
OUT	status	status object (Status)	7

**C binding**

```
int MPI_File_read_at_all(MPI_File fh, MPI_Offset offset, void *buf,
                        int count, MPI_Datatype datatype, MPI_Status *status)
```

**Fortran 2008 binding**

```
MPI_File_read_at_all(fh, offset, buf, count, datatype, status, ierror)
  TYPE(MPI_File), INTENT(IN) :: fh
  INTEGER(KIND=MPI_OFFSET_KIND), INTENT(IN) :: offset
  TYPE(*), DIMENSION(..) :: buf
  INTEGER, INTENT(IN) :: count
  TYPE(MPI_Datatype), INTENT(IN) :: datatype
  TYPE(MPI_Status) :: status
  INTEGER, OPTIONAL, INTENT(OUT) :: ierror
```

**Fortran binding**

```
MPI_FILE_READ_AT_ALL(FH, OFFSET, BUF, COUNT, DATATYPE, STATUS, IERROR)
  INTEGER FH, COUNT, DATATYPE, STATUS(MPI_STATUS_SIZE), IERROR
  INTEGER(KIND=MPI_OFFSET_KIND) OFFSET
  <type> BUF(*)
```

`MPI_FILE_READ_AT_ALL` is a collective version of the blocking `MPI_FILE_READ_AT` interface.

<code>MPI_FILE_WRITE_AT(fh, offset, buf, count, datatype, status)</code>			33
INOUT	fh	file handle (handle)	34
IN	offset	file offset (integer)	35
IN	buf	initial address of buffer (choice)	36
IN	count	number of elements in buffer (integer)	37
IN	datatype	datatype of each buffer element (handle)	38
OUT	status	status object (Status)	39

**C binding**

```
int MPI_File_write_at(MPI_File fh, MPI_Offset offset, const void *buf,
                     int count, MPI_Datatype datatype, MPI_Status *status)
```

**Fortran 2008 binding**

```
MPI_File_write_at(fh, offset, buf, count, datatype, status, ierror)
```

```

1     TYPE(MPI_File), INTENT(IN) :: fh
2     INTEGER(KIND=MPI_OFFSET_KIND), INTENT(IN) :: offset
3     TYPE(*), DIMENSION(..), INTENT(IN) :: buf
4     INTEGER, INTENT(IN) :: count
5     TYPE(MPI_Datatype), INTENT(IN) :: datatype
6     TYPE(MPI_Status) :: status
7     INTEGER, OPTIONAL, INTENT(OUT) :: ierror

```

### Fortran binding

```

9     MPI_FILE_WRITE_AT(FH, OFFSET, BUF, COUNT, DATATYPE, STATUS, IERROR)
10    INTEGER FH, COUNT, DATATYPE, STATUS(MPI_STATUS_SIZE), IERROR
11    INTEGER(KIND=MPI_OFFSET_KIND) OFFSET
12    <type> BUF(*)

```

MPI\_FILE\_WRITE\_AT writes a file beginning at the position specified by offset.

```

14    MPI_FILE_WRITE_AT_ALL(fh, offset, buf, count, datatype, status)

```

18	INOUT	fh	file handle (handle)
19	IN	offset	file offset (integer)
20	IN	buf	initial address of buffer (choice)
21	IN	count	number of elements in buffer (integer)
22	IN	datatype	datatype of each buffer element (handle)
23	IN	status	status object (Status)
24	OUT	status	status object (Status)

### C binding

```

25    int MPI_File_write_at_all(MPI_File fh, MPI_Offset offset, const void *buf,
26    int count, MPI_Datatype datatype, MPI_Status *status)

```

### Fortran 2008 binding

```

27    MPI_File_write_at_all(fh, offset, buf, count, datatype, status, ierror)
28    TYPE(MPI_File), INTENT(IN) :: fh
29    INTEGER(KIND=MPI_OFFSET_KIND), INTENT(IN) :: offset
30    TYPE(*), DIMENSION(..), INTENT(IN) :: buf
31    INTEGER, INTENT(IN) :: count
32    TYPE(MPI_Datatype), INTENT(IN) :: datatype
33    TYPE(MPI_Status) :: status
34    INTEGER, OPTIONAL, INTENT(OUT) :: ierror

```

### Fortran binding

```

35    MPI_FILE_WRITE_AT_ALL(FH, OFFSET, BUF, COUNT, DATATYPE, STATUS, IERROR)
36    INTEGER FH, COUNT, DATATYPE, STATUS(MPI_STATUS_SIZE), IERROR
37    INTEGER(KIND=MPI_OFFSET_KIND) OFFSET
38    <type> BUF(*)

```

MPI\_FILE\_WRITE\_AT\_ALL is a collective version of the blocking MPI\_FILE\_WRITE\_AT interface.

MPI_FILE_IREAD_AT(fh, offset, buf, count, datatype, request)			1
IN	fh	file handle (handle)	2
IN	offset	file offset (integer)	3
OUT	buf	initial address of buffer (choice)	4
IN	count	number of elements in buffer (integer)	5
IN	datatype	datatype of each buffer element (handle)	6
OUT	request	request object (handle)	7

**C binding**

```
int MPI_File_iread_at(MPI_File fh, MPI_Offset offset, void *buf, int count,
                    MPI_Datatype datatype, MPI_Request *request)
```

**Fortran 2008 binding**

```
MPI_File_iread_at(fh, offset, buf, count, datatype, request, ierror)
  TYPE(MPI_File), INTENT(IN) :: fh
  INTEGER(KIND=MPI_OFFSET_KIND), INTENT(IN) :: offset
  TYPE(*), DIMENSION(..), ASYNCHRONOUS :: buf
  INTEGER, INTENT(IN) :: count
  TYPE(MPI_Datatype), INTENT(IN) :: datatype
  TYPE(MPI_Request), INTENT(OUT) :: request
  INTEGER, OPTIONAL, INTENT(OUT) :: ierror
```

**Fortran binding**

```
MPI_FILE_IREAD_AT(FH, OFFSET, BUF, COUNT, DATATYPE, REQUEST, IERROR)
  INTEGER FH, COUNT, DATATYPE, REQUEST, IERROR
  INTEGER(KIND=MPI_OFFSET_KIND) OFFSET
  <type> BUF(*)
```

MPI\_FILE\_IREAD\_AT is a nonblocking version of the MPI\_FILE\_READ\_AT interface.

MPI_FILE_IREAD_AT_ALL(fh, offset, buf, count, datatype, request)			32
IN	fh	file handle (handle)	33
IN	offset	file offset (integer)	34
OUT	buf	initial address of buffer (choice)	35
IN	count	number of elements in buffer (integer)	36
IN	datatype	datatype of each buffer element (handle)	37
OUT	request	request object (handle)	38

**C binding**

```
int MPI_File_iread_at_all(MPI_File fh, MPI_Offset offset, void *buf,
                        int count, MPI_Datatype datatype, MPI_Request *request)
```

**Fortran 2008 binding**

```
MPI_File_iread_at_all(fh, offset, buf, count, datatype, request, ierror)
  TYPE(MPI_File), INTENT(IN) :: fh
```

```

1      INTEGER(KIND=MPI_OFFSET_KIND), INTENT(IN) :: offset
2      TYPE(*), DIMENSION(..), ASYNCHRONOUS :: buf
3      INTEGER, INTENT(IN) :: count
4      TYPE(MPI_Datatype), INTENT(IN) :: datatype
5      TYPE(MPI_Request), INTENT(OUT) :: request
6      INTEGER, OPTIONAL, INTENT(OUT) :: ierror

```

### Fortran binding

```

8      MPI_FILE_IREAD_AT_ALL(FH, OFFSET, BUF, COUNT, DATATYPE, REQUEST, IERROR)
9      INTEGER FH, COUNT, DATATYPE, REQUEST, IERROR
10     INTEGER(KIND=MPI_OFFSET_KIND) OFFSET
11     <type> BUF(*)

```

MPI\_FILE\_IREAD\_AT\_ALL is a nonblocking version of MPI\_FILE\_READ\_AT\_ALL. See Section 13.6.5 for semantics of nonblocking collective file operations.

MPI\_FILE\_IWRITE\_AT(fh, offset, buf, count, datatype, request)

18	INOUT	fh	file handle (handle)
19	IN	offset	file offset (integer)
20	IN	buf	initial address of buffer (choice)
21	IN	count	number of elements in buffer (integer)
22	IN	datatype	datatype of each buffer element (handle)
23	IN	request	request object (handle)
24	OUT		
25			

### C binding

```

26     int MPI_File_iread_at(MPI_File fh, MPI_Offset offset, const void *buf,
27                          int count, MPI_Datatype datatype, MPI_Request *request)

```

### Fortran 2008 binding

```

28     MPI_File_iread_at(fh, offset, buf, count, datatype, request, ierror)
29     TYPE(MPI_File), INTENT(IN) :: fh
30     INTEGER(KIND=MPI_OFFSET_KIND), INTENT(IN) :: offset
31     TYPE(*), DIMENSION(..), INTENT(IN), ASYNCHRONOUS :: buf
32     INTEGER, INTENT(IN) :: count
33     TYPE(MPI_Datatype), INTENT(IN) :: datatype
34     TYPE(MPI_Request), INTENT(OUT) :: request
35     INTEGER, OPTIONAL, INTENT(OUT) :: ierror

```

### Fortran binding

```

36     MPI_FILE_IWRITE_AT(FH, OFFSET, BUF, COUNT, DATATYPE, REQUEST, IERROR)
37     INTEGER FH, COUNT, DATATYPE, REQUEST, IERROR
38     INTEGER(KIND=MPI_OFFSET_KIND) OFFSET
39     <type> BUF(*)

```

MPI\_FILE\_IWRITE\_AT is a nonblocking version of the MPI\_FILE\_WRITE\_AT interface.



MPI_FILE_IWRITE_AT_ALL(fh, offset, buf, count, datatype, request)			1
INOUT	fh	file handle (handle)	2
			3
IN	offset	file offset (integer)	4
IN	buf	initial address of buffer (choice)	5
			6
IN	count	number of elements in buffer (integer)	7
IN	datatype	datatype of each buffer element (handle)	8
OUT	request	request object (handle)	9

**C binding**

```
int MPI_File_irewrite_at_all(MPI_File fh, MPI_Offset offset, const void *buf,
    int count, MPI_Datatype datatype, MPI_Request *request)
```

**Fortran 2008 binding**

```
MPI_File_irewrite_at_all(fh, offset, buf, count, datatype, request, ierror)
    TYPE(MPI_File), INTENT(IN) :: fh
    INTEGER(KIND=MPI_OFFSET_KIND), INTENT(IN) :: offset
    TYPE(*), DIMENSION(..), INTENT(IN), ASYNCHRONOUS :: buf
    INTEGER, INTENT(IN) :: count
    TYPE(MPI_Datatype), INTENT(IN) :: datatype
    TYPE(MPI_Request), INTENT(OUT) :: request
    INTEGER, OPTIONAL, INTENT(OUT) :: ierror
```

**Fortran binding**

```
MPI_FILE_IWRITE_AT_ALL(FH, OFFSET, BUF, COUNT, DATATYPE, REQUEST, IERROR)
    INTEGER FH, COUNT, DATATYPE, REQUEST, IERROR
    INTEGER(KIND=MPI_OFFSET_KIND) OFFSET
    <type> BUF(*)
```

MPI\_FILE\_IWRITE\_AT\_ALL is a nonblocking version of MPI\_FILE\_WRITE\_AT\_ALL.

**13.4.3 Data Access with Individual File Pointers**

MPI maintains one individual file pointer per process per file handle. The current value of this pointer implicitly specifies the offset in the data access routines described in this section. These routines only use and update the individual file pointers maintained by MPI. The shared file pointer is not used nor updated.

The individual file pointer routines have the same semantics as the data access with explicit offset routines described in Section 13.4.2, with the following modification:

- the offset is defined to be the current value of the MPI-maintained individual file pointer.

After an individual file pointer operation is initiated, the individual file pointer is updated to point to the next etype after the last one that will be accessed. The file pointer is updated relative to the current view of the file.

If MPI\_MODE\_SEQUENTIAL mode was specified when the file was opened, it is erroneous to call the routines in this section, with the exception of MPI\_FILE\_GET\_BYTE\_OFFSET.

```

1 MPI_FILE_READ(fh, buf, count, datatype, status)
2     INOUT   fh                file handle (handle)
3
4     OUT     buf                initial address of buffer (choice)
5
6     IN      count              number of elements in buffer (integer)
7
8     IN      datatype           datatype of each buffer element (handle)
9
10    OUT     status              status object (Status)

```

**C binding**

```

11 int MPI_File_read(MPI_File fh, void *buf, int count, MPI_Datatype datatype,
12                 MPI_Status *status)

```

**Fortran 2008 binding**

```

13 MPI_File_read(fh, buf, count, datatype, status, ierror)
14     TYPE(MPI_File), INTENT(IN) :: fh
15     TYPE(*), DIMENSION(..) :: buf
16     INTEGER, INTENT(IN) :: count
17     TYPE(MPI_Datatype), INTENT(IN) :: datatype
18     TYPE(MPI_Status) :: status
19     INTEGER, OPTIONAL, INTENT(OUT) :: ierror

```

**Fortran binding**

```

20 MPI_FILE_READ(FH, BUF, COUNT, DATATYPE, STATUS, IERROR)
21     INTEGER FH, COUNT, DATATYPE, STATUS(MPI_STATUS_SIZE), IERROR
22     <type> BUF(*)

```

MPI\_FILE\_READ reads a file using the individual file pointer.

**Example 13.2** The following Fortran code fragment is an example of reading a file until the end of file is reached:

```

23 ! Read a preexisting input file until all data has been read.
24 ! Call routine "process_input" if all requested data is read.
25 ! The Fortran 90 "exit" statement exits the loop.
26
27 integer bufsize, numread, totprocessed, status(MPI_STATUS_SIZE)
28 parameter (bufsize=100)
29 real localbuffer(bufsize)
30 integer (kind=MPI_OFFSET_KIND) zero
31
32 zero = 0
33
34 call MPI_FILE_OPEN(MPI_COMM_WORLD, 'myoldfile', &
35                  MPI_MODE_RDONLY, MPI_INFO_NULL, myfh, ierr)
36 call MPI_FILE_SET_VIEW(myfh, zero, MPI_REAL, MPI_REAL, 'native', &
37                      MPI_INFO_NULL, ierr)
38
39 totprocessed = 0
40 do
41     call MPI_FILE_READ(myfh, localbuffer, bufsize, MPI_REAL, &

```

```

        status, ierr)
    call MPI_GET_COUNT(status, MPI_REAL, numread, ierr)
    call process_input(localbuffer, numread)
    totprocessed = totprocessed + numread
    if (numread < bufsize) exit
end do

write(6, 1001) numread, bufsize, totprocessed
1001 format("No more data: read", I3, "and expected", I3, &
           "Processed total of", I6, "before terminating job.")

call MPI_FILE_CLOSE(myfh, ierr)

```

**MPI\_FILE\_READ\_ALL**(fh, buf, count, datatype, status)

INOUT	fh	file handle (handle)	17
OUT	buf	initial address of buffer (choice)	18
IN	count	number of elements in buffer (integer)	19
IN	datatype	datatype of each buffer element (handle)	21
OUT	status	status object (Status)	22

#### C binding

```

int MPI_File_read_all(MPI_File fh, void *buf, int count,
                     MPI_Datatype datatype, MPI_Status *status)

```

#### Fortran 2008 binding

```

MPI_File_read_all(fh, buf, count, datatype, status, ierror)
    TYPE(MPI_File), INTENT(IN) :: fh
    TYPE(*), DIMENSION(..) :: buf
    INTEGER, INTENT(IN) :: count
    TYPE(MPI_Datatype), INTENT(IN) :: datatype
    TYPE(MPI_Status) :: status
    INTEGER, OPTIONAL, INTENT(OUT) :: ierror

```

#### Fortran binding

```

MPI_FILE_READ_ALL(FH, BUF, COUNT, DATATYPE, STATUS, IERROR)
    INTEGER FH, COUNT, DATATYPE, STATUS(MPI_STATUS_SIZE), IERROR
    <type> BUF(*)

```

MPI\_FILE\_READ\_ALL is a collective version of the blocking MPI\_FILE\_READ interface.

```

1 MPI_FILE_WRITE(fh, buf, count, datatype, status)
2     INOUT   fh                file handle (handle)
3
4     IN      buf                initial address of buffer (choice)
5
6     IN      count              number of elements in buffer (integer)
7
8     IN      datatype           datatype of each buffer element (handle)
9
10    OUT     status              status object (Status)

```

**C binding**

```

11 int MPI_File_write(MPI_File fh, const void *buf, int count,
12                   MPI_Datatype datatype, MPI_Status *status)

```

**Fortran 2008 binding**

```

13 MPI_File_write(fh, buf, count, datatype, status, ierror)
14     TYPE(MPI_File), INTENT(IN) :: fh
15     TYPE(*), DIMENSION(..), INTENT(IN) :: buf
16     INTEGER, INTENT(IN) :: count
17     TYPE(MPI_Datatype), INTENT(IN) :: datatype
18     TYPE(MPI_Status) :: status
19     INTEGER, OPTIONAL, INTENT(OUT) :: ierror

```

**Fortran binding**

```

20 MPI_FILE_WRITE(FH, BUF, COUNT, DATATYPE, STATUS, IERROR)
21     INTEGER FH, COUNT, DATATYPE, STATUS(MPI_STATUS_SIZE), IERROR
22     <type> BUF(*)

```

23 MPI\_FILE\_WRITE writes a file using the individual file pointer.

```

24 MPI_FILE_WRITE_ALL(fh, buf, count, datatype, status)

```

```

25     INOUT   fh                file handle (handle)
26
27     IN      buf                initial address of buffer (choice)
28
29     IN      count              number of elements in buffer (integer)
30
31     IN      datatype           datatype of each buffer element (handle)
32
33     OUT     status              status object (Status)

```

**C binding**

```

34 int MPI_File_write_all(MPI_File fh, const void *buf, int count,
35                        MPI_Datatype datatype, MPI_Status *status)

```

**Fortran 2008 binding**

```

36 MPI_File_write_all(fh, buf, count, datatype, status, ierror)
37     TYPE(MPI_File), INTENT(IN) :: fh
38     TYPE(*), DIMENSION(..), INTENT(IN) :: buf
39     INTEGER, INTENT(IN) :: count
40     TYPE(MPI_Datatype), INTENT(IN) :: datatype
41     TYPE(MPI_Status) :: status

```

```
INTEGER, OPTIONAL, INTENT(OUT) :: ierror
```

### Fortran binding

```
MPI_FILE_WRITE_ALL(FH, BUF, COUNT, DATATYPE, STATUS, IERROR)
  INTEGER FH, COUNT, DATATYPE, STATUS(MPI_STATUS_SIZE), IERROR
  <type> BUF(*)
```

MPI\_FILE\_WRITE\_ALL is a collective version of the blocking MPI\_FILE\_WRITE interface.

```
MPI_FILE_IREAD(fh, buf, count, datatype, request)
```

INOUT	fh	file handle (handle)
OUT	buf	initial address of buffer (choice)
IN	count	number of elements in buffer (integer)
IN	datatype	datatype of each buffer element (handle)
OUT	request	request object (handle)

### C binding

```
int MPI_File_iread(MPI_File fh, void *buf, int count,
                  MPI_Datatype datatype, MPI_Request *request)
```

### Fortran 2008 binding

```
MPI_File_iread(fh, buf, count, datatype, request, ierror)
  TYPE(MPI_File), INTENT(IN) :: fh
  TYPE(*), DIMENSION(..), ASYNCHRONOUS :: buf
  INTEGER, INTENT(IN) :: count
  TYPE(MPI_Datatype), INTENT(IN) :: datatype
  TYPE(MPI_Request), INTENT(OUT) :: request
  INTEGER, OPTIONAL, INTENT(OUT) :: ierror
```

### Fortran binding

```
MPI_FILE_IREAD(FH, BUF, COUNT, DATATYPE, REQUEST, IERROR)
  INTEGER FH, COUNT, DATATYPE, REQUEST, IERROR
  <type> BUF(*)
```

MPI\_FILE\_IREAD is a nonblocking version of the MPI\_FILE\_READ interface.

**Example 13.3** The following Fortran code fragment illustrates file pointer update semantics:

```
! Read the first twenty real words in a file into two local
! buffers. Note that when the first MPI_FILE_IREAD returns,
! the file pointer has been updated to point to the
! eleventh real word in the file.
```

```
integer bufsize, req1, req2
integer, dimension(MPI_STATUS_SIZE) :: status1, status2
parameter (bufsize=10)
```

```

1  real      buf1(bufsize), buf2(bufsize)
2  integer (kind=MPI_OFFSET_KIND) zero
3
4  zero = 0
5  call MPI_FILE_OPEN(MPI_COMM_WORLD, 'myoldfile', &
6                      MPI_MODE_RDONLY, MPI_INFO_NULL, myfh, ierr)
7  call MPI_FILE_SET_VIEW(myfh, zero, MPI_REAL, MPI_REAL, 'native', &
8                          MPI_INFO_NULL, ierr)
9  call MPI_FILE_IREAD(myfh, buf1, bufsize, MPI_REAL, &
10                      req1, ierr)
11 call MPI_FILE_IREAD(myfh, buf2, bufsize, MPI_REAL, &
12                      req2, ierr)
13
14 call MPI_WAIT(req1, status1, ierr)
15 call MPI_WAIT(req2, status2, ierr)
16
17 call MPI_FILE_CLOSE(myfh, ierr)
18
19
20
21 MPI_FILE_IREAD_ALL(fh, buf, count, datatype, request)
22     INOUT   fh                file handle (handle)
23     OUT     buf                initial address of buffer (choice)
24     IN      count             number of elements in buffer (integer)
25     IN      datatype          datatype of each buffer element (handle)
26     OUT     request           request object (handle)
27
28
29

```

**C binding**

```

30 int MPI_File_iread_all(MPI_File fh, void *buf, int count,
31                       MPI_Datatype datatype, MPI_Request *request)
32

```

**Fortran 2008 binding**

```

33 MPI_File_iread_all(fh, buf, count, datatype, request, ierror)
34     TYPE(MPI_File), INTENT(IN) :: fh
35     TYPE(*), DIMENSION(..), ASYNCHRONOUS :: buf
36     INTEGER, INTENT(IN) :: count
37     TYPE(MPI_Datatype), INTENT(IN) :: datatype
38     TYPE(MPI_Request), INTENT(OUT) :: request
39     INTEGER, OPTIONAL, INTENT(OUT) :: ierror
40

```

**Fortran binding**

```

41 MPI_FILE_IREAD_ALL(FH, BUF, COUNT, DATATYPE, REQUEST, IERROR)
42     INTEGER FH, COUNT, DATATYPE, REQUEST, IERROR
43     <type> BUF(*)
44

```

MPI\_FILE\_IREAD\_ALL is a nonblocking version of MPI\_FILE\_READ\_ALL.

48

`MPI_FILE_IWRITE(fh, buf, count, datatype, request)`

INOUT	fh	file handle (handle)
IN	buf	initial address of buffer (choice)
IN	count	number of elements in buffer (integer)
IN	datatype	datatype of each buffer element (handle)
OUT	request	request object (handle)

### C binding

```
int MPI_File_ fwrite(MPI_File fh, const void *buf, int count,
                    MPI_Datatype datatype, MPI_Request *request)
```

### Fortran 2008 binding

```
MPI_File_ fwrite(fh, buf, count, datatype, request, ierror)
  TYPE(MPI_File), INTENT(IN) :: fh
  TYPE(*), DIMENSION(..), INTENT(IN), ASYNCHRONOUS :: buf
  INTEGER, INTENT(IN) :: count
  TYPE(MPI_Datatype), INTENT(IN) :: datatype
  TYPE(MPI_Request), INTENT(OUT) :: request
  INTEGER, OPTIONAL, INTENT(OUT) :: ierror
```

### Fortran binding

```
MPI_FILE_IWRITE(FH, BUF, COUNT, DATATYPE, REQUEST, IERROR)
  INTEGER FH, COUNT, DATATYPE, REQUEST, IERROR
  <type> BUF(*)
```

`MPI_FILE_IWRITE` is a nonblocking version of the `MPI_FILE_WRITE` interface.

`MPI_FILE_IWRITE_ALL(fh, buf, count, datatype, request)`

INOUT	fh	file handle (handle)
IN	buf	initial address of buffer (choice)
IN	count	number of elements in buffer (integer)
IN	datatype	datatype of each buffer element (handle)
OUT	request	request object (handle)

### C binding

```
int MPI_File_ fwrite_all(MPI_File fh, const void *buf, int count,
                        MPI_Datatype datatype, MPI_Request *request)
```

### Fortran 2008 binding

```
MPI_File_ fwrite_all(fh, buf, count, datatype, request, ierror)
  TYPE(MPI_File), INTENT(IN) :: fh
  TYPE(*), DIMENSION(..), INTENT(IN), ASYNCHRONOUS :: buf
  INTEGER, INTENT(IN) :: count
  TYPE(MPI_Datatype), INTENT(IN) :: datatype
  TYPE(MPI_Request), INTENT(OUT) :: request
```

1           INTEGER, OPTIONAL, INTENT(OUT) :: ierror

2

### Fortran binding

3 MPI\_FILE\_IWRITE\_ALL(FH, BUF, COUNT, DATATYPE, REQUEST, IERROR)

4

5           INTEGER FH, COUNT, DATATYPE, REQUEST, IERROR

6

7           <type> BUF(\*)

8

9           MPI\_FILE\_IWRITE\_ALL is a nonblocking version of MPI\_FILE\_WRITE\_ALL.

10

11 MPI\_FILE\_SEEK(fh, offset, whence)

12

13       INOUT    fh                           file handle (handle)

14

15       IN       offset                      file offset (integer)

16

17       IN       whence                     update mode (state)

18

### C binding

19 int MPI\_File\_seek(MPI\_File fh, MPI\_Offset offset, int whence)

20

### Fortran 2008 binding

21 MPI\_File\_seek(fh, offset, whence, ierror)

22

23       TYPE(MPI\_File), INTENT(IN) :: fh

24

25       INTEGER(KIND=MPI\_OFFSET\_KIND), INTENT(IN) :: offset

26

27       INTEGER, INTENT(IN) :: whence

28

29       INTEGER, OPTIONAL, INTENT(OUT) :: ierror

30

### Fortran binding

31 MPI\_FILE\_SEEK(FH, OFFSET, WHENCE, IERROR)

32

33       INTEGER FH, WHENCE, IERROR

34

35       INTEGER(KIND=MPI\_OFFSET\_KIND) OFFSET

36

37       MPI\_FILE\_SEEK updates the individual file pointer according to whence, which has the following possible values:

38

- 39       • MPI\_SEEK\_SET: the pointer is set to offset
- 40       • MPI\_SEEK\_CUR: the pointer is set to the current pointer position plus offset
- 41       • MPI\_SEEK\_END: the pointer is set to the end of file plus offset

42

43       The offset can be negative, which allows seeking backwards. It is erroneous to seek to a negative position in the view.

44

45 MPI\_FILE\_GET\_POSITION(fh, offset)

46

47       IN       fh                           file handle (handle)

48

49       OUT      offset                     offset of individual pointer (integer)

50

### C binding

51 int MPI\_File\_get\_position(MPI\_File fh, MPI\_Offset \*offset)

52

### Fortran 2008 binding



```

MPI_File_get_position(fh, offset, ierror)
    TYPE(MPI_File), INTENT(IN) :: fh
    INTEGER(KIND=MPI_OFFSET_KIND), INTENT(OUT) :: offset
    INTEGER, OPTIONAL, INTENT(OUT) :: ierror

```

**Fortran binding**

```

MPI_FILE_GET_POSITION(FH, OFFSET, IERROR)
    INTEGER FH, IERROR
    INTEGER(KIND=MPI_OFFSET_KIND) OFFSET

```

MPI\_FILE\_GET\_POSITION returns, in `offset`, the current position of the individual file pointer in etype units relative to the current view.

*Advice to users.* The `offset` can be used in a future call to `MPI_FILE_SEEK` using `whence = MPI_SEEK_SET` to return to the current position. To set the displacement to the current file pointer position, first convert `offset` into an absolute byte position using `MPI_FILE_GET_BYTE_OFFSET`, then call `MPI_FILE_SET_VIEW` with the resulting displacement. (*End of advice to users.*)

```

MPI_FILE_GET_BYTE_OFFSET(fh, offset, disp)

```

IN	fh	file handle (handle)
IN	offset	offset (integer)
OUT	disp	absolute byte position of offset (integer)

**C binding**

```

int MPI_File_get_byte_offset(MPI_File fh, MPI_Offset offset,
    MPI_Offset *disp)

```

**Fortran 2008 binding**

```

MPI_File_get_byte_offset(fh, offset, disp, ierror)
    TYPE(MPI_File), INTENT(IN) :: fh
    INTEGER(KIND=MPI_OFFSET_KIND), INTENT(IN) :: offset
    INTEGER(KIND=MPI_OFFSET_KIND), INTENT(OUT) :: disp
    INTEGER, OPTIONAL, INTENT(OUT) :: ierror

```

**Fortran binding**

```

MPI_FILE_GET_BYTE_OFFSET(FH, OFFSET, DISP, IERROR)
    INTEGER FH, IERROR
    INTEGER(KIND=MPI_OFFSET_KIND) OFFSET, DISP

```

MPI\_FILE\_GET\_BYTE\_OFFSET converts a view-relative offset into an absolute byte position. The absolute byte position (from the beginning of the file) of `offset` relative to the current view of `fh` is returned in `disp`.

**13.4.4 Data Access with Shared File Pointers**

MPI maintains exactly one shared file pointer per collective `MPI_FILE_OPEN` (shared among processes in the communicator group). The current value of this pointer implicitly specifies

the offset in the data access routines described in this section. These routines only use and update the shared file pointer maintained by MPI. The individual file pointers are not used nor updated.

The shared file pointer routines have the same semantics as the data access with explicit offset routines described in Section 13.4.2, with the following modifications:

- the `offset` is defined to be the current value of the MPI-maintained shared file pointer,
- the effect of multiple calls to shared file pointer routines is defined to behave as if the calls were serialized, and
- the use of shared file pointer routines is erroneous unless all processes use the same file view.

For the noncollective shared file pointer routines, the serialization ordering is not deterministic. The user needs to use other synchronization means to enforce a specific order.

After a shared file pointer operation is initiated, the shared file pointer is updated to point to the next etype after the last one that will be accessed. The file pointer is updated relative to the current view of the file.

## Noncollective Operations

`MPI_FILE_READ_SHARED(fh, buf, count, datatype, status)`

INOUT	fh	file handle (handle)
OUT	buf	initial address of buffer (choice)
IN	count	number of elements in buffer (integer)
IN	datatype	datatype of each buffer element (handle)
OUT	status	status object (Status)

## C binding

```
int MPI_File_read_shared(MPI_File fh, void *buf, int count,
                        MPI_Datatype datatype, MPI_Status *status)
```

## Fortran 2008 binding

```
MPI_File_read_shared(fh, buf, count, datatype, status, ierror)
    TYPE(MPI_File), INTENT(IN) :: fh
    TYPE(*), DIMENSION(..) :: buf
    INTEGER, INTENT(IN) :: count
    TYPE(MPI_Datatype), INTENT(IN) :: datatype
    TYPE(MPI_Status) :: status
    INTEGER, OPTIONAL, INTENT(OUT) :: ierror
```

## Fortran binding

```
MPI_FILE_READ_SHARED(FH, BUF, COUNT, DATATYPE, STATUS, IERROR)
    INTEGER FH, COUNT, DATATYPE, STATUS(MPI_STATUS_SIZE), IERROR
    <type> BUF(*)
```

`MPI_FILE_READ_SHARED` reads a file using the shared file pointer.

<b>MPI_FILE_WRITE_SHARED(fh, buf, count, datatype, status)</b>			1
INOUT	fh	file handle (handle)	2
IN	buf	initial address of buffer (choice)	3
IN	count	number of elements in buffer (integer)	4
IN	datatype	datatype of each buffer element (handle)	5
OUT	status	status object (Status)	6

**C binding**

```
int MPI_File_write_shared(MPI_File fh, const void *buf, int count,
                        MPI_Datatype datatype, MPI_Status *status)
```

**Fortran 2008 binding**

```
MPI_File_write_shared(fh, buf, count, datatype, status, ierror)
  TYPE(MPI_File), INTENT(IN) :: fh
  TYPE(*), DIMENSION(..), INTENT(IN) :: buf
  INTEGER, INTENT(IN) :: count
  TYPE(MPI_Datatype), INTENT(IN) :: datatype
  TYPE(MPI_Status) :: status
  INTEGER, OPTIONAL, INTENT(OUT) :: ierror
```

**Fortran binding**

```
MPI_FILE_WRITE_SHARED(FH, BUF, COUNT, DATATYPE, STATUS, IERROR)
  INTEGER FH, COUNT, DATATYPE, STATUS(MPI_STATUS_SIZE), IERROR
  <type> BUF(*)
```

MPI\_FILE\_WRITE\_SHARED writes a file using the shared file pointer.

<b>MPI_FILE_IREAD_SHARED(fh, buf, count, datatype, request)</b>			29
INOUT	fh	file handle (handle)	30
OUT	buf	initial address of buffer (choice)	31
IN	count	number of elements in buffer (integer)	32
IN	datatype	datatype of each buffer element (handle)	33
OUT	request	request object (handle)	34

**C binding**

```
int MPI_File_iread_shared(MPI_File fh, void *buf, int count,
                        MPI_Datatype datatype, MPI_Request *request)
```

**Fortran 2008 binding**

```
MPI_File_iread_shared(fh, buf, count, datatype, request, ierror)
  TYPE(MPI_File), INTENT(IN) :: fh
  TYPE(*), DIMENSION(..), ASYNCHRONOUS :: buf
  INTEGER, INTENT(IN) :: count
  TYPE(MPI_Datatype), INTENT(IN) :: datatype
  TYPE(MPI_Request), INTENT(OUT) :: request
```

1           INTEGER, OPTIONAL, INTENT(OUT) :: ierror

2

### 3 Fortran binding

4 MPI\_FILE\_IREAD\_SHARED(FH, BUF, COUNT, DATATYPE, REQUEST, IERROR)

5

6           INTEGER FH, COUNT, DATATYPE, REQUEST, IERROR

7

8           <type> BUF(\*)

9 MPI\_FILE\_IREAD\_SHARED is a nonblocking version of the MPI\_FILE\_READ\_SHARED  
10 interface.

11

12 MPI\_FILE\_IWRITE\_SHARED(fh, buf, count, datatype, request)

13

14   INOUT   fh                           file handle (handle)

15

16   IN       buf                        initial address of buffer (choice)

17

18   IN       count                     number of elements in buffer (integer)

19

20   IN       datatype                 datatype of each buffer element (handle)

21

22   OUT      request                   request object (handle)

23

### 24 C binding

25 int MPI\_File\_iread\_shared(MPI\_File fh, const void \*buf, int count,

26

27           MPI\_Datatype datatype, MPI\_Request \*request)

28

### 29 Fortran 2008 binding

30 MPI\_File\_iread\_shared(fh, buf, count, datatype, request, ierror)

31

32   TYPE(MPI\_File), INTENT(IN) :: fh

33

34   TYPE(\*), DIMENSION(..), INTENT(IN), ASYNCHRONOUS :: buf

35

36   INTEGER, INTENT(IN) :: count

37

38   TYPE(MPI\_Datatype), INTENT(IN) :: datatype

39

40   TYPE(MPI\_Request), INTENT(OUT) :: request

41

42   INTEGER, OPTIONAL, INTENT(OUT) :: ierror

43

### 44 Fortran binding

45 MPI\_FILE\_IWRITE\_SHARED(FH, BUF, COUNT, DATATYPE, REQUEST, IERROR)

46

47   INTEGER FH, COUNT, DATATYPE, REQUEST, IERROR

48

49   <type> BUF(\*)

50

51 MPI\_FILE\_IWRITE\_SHARED is a nonblocking version of the  
52 MPI\_FILE\_WRITE\_SHARED interface.

53

### 54 Collective Operations

55

56 The semantics of a collective access using a shared file pointer is that the accesses to the  
57 file will be in the order determined by the ranks of the processes within the group. For each  
58 process, the location in the file at which data is accessed is the position at which the shared  
59 file pointer would be after all processes whose ranks within the group less than that of this  
60 process had accessed their data. In addition, in order to prevent subsequent shared offset  
61 accesses by the same processes from interfering with this collective access, the call might  
62 return only after all the processes within the group have initiated their accesses. When the  
63

64

call returns, the shared file pointer points to the next etype accessible, according to the file view used by all processes, after the last etype requested.

*Advice to users.* There may be some programs in which all processes in the group need to access the file using the shared file pointer, but the program may not *require* that data be accessed in order of process rank. In such programs, using the shared ordered routines (e.g., `MPI_FILE_WRITE_ORDERED` rather than `MPI_FILE_WRITE_SHARED`) may enable an implementation to optimize access, improving performance. (*End of advice to users.*)

*Advice to implementors.* Accesses to the data requested by all processes do not have to be serialized. Once all processes have issued their requests, locations within the file for all accesses can be computed, and accesses can proceed independently from each other, possibly in parallel. (*End of advice to implementors.*)

`MPI_FILE_READ_ORDERED(fh, buf, count, datatype, status)`

INOUT	fh	file handle (handle)
OUT	buf	initial address of buffer (choice)
IN	count	number of elements in buffer (integer)
IN	datatype	datatype of each buffer element (handle)
OUT	status	status object (Status)

#### C binding

```
int MPI_File_read_ordered(MPI_File fh, void *buf, int count,
                        MPI_Datatype datatype, MPI_Status *status)
```

#### Fortran 2008 binding

```
MPI_File_read_ordered(fh, buf, count, datatype, status, ierror)
  TYPE(MPI_File), INTENT(IN) :: fh
  TYPE(*), DIMENSION(..) :: buf
  INTEGER, INTENT(IN) :: count
  TYPE(MPI_Datatype), INTENT(IN) :: datatype
  TYPE(MPI_Status) :: status
  INTEGER, OPTIONAL, INTENT(OUT) :: ierror
```

#### Fortran binding

```
MPI_FILE_READ_ORDERED(FH, BUF, COUNT, DATATYPE, STATUS, IERROR)
  INTEGER FH, COUNT, DATATYPE, STATUS(MPI_STATUS_SIZE), IERROR
  <type> BUF(*)
```

`MPI_FILE_READ_ORDERED` is a collective version of the `MPI_FILE_READ_SHARED` interface.

```

1 MPI_FILE_WRITE_ORDERED(fh, buf, count, datatype, status)
2   INOUT   fh           file handle (handle)
3
4   IN      buf           initial address of buffer (choice)
5
6   IN      count        number of elements in buffer (integer)
7
8   IN      datatype     datatype of each buffer element (handle)
9
10  OUT     status        status object (Status)

```

**C binding**

```

11 int MPI_File_write_ordered(MPI_File fh, const void *buf, int count,
12     MPI_Datatype datatype, MPI_Status *status)

```

**Fortran 2008 binding**

```

14 MPI_File_write_ordered(fh, buf, count, datatype, status, ierror)
15     TYPE(MPI_File), INTENT(IN) :: fh
16     TYPE(*), DIMENSION(..), INTENT(IN) :: buf
17     INTEGER, INTENT(IN) :: count
18     TYPE(MPI_Datatype), INTENT(IN) :: datatype
19     TYPE(MPI_Status) :: status
20     INTEGER, OPTIONAL, INTENT(OUT) :: ierror

```

**Fortran binding**

```

23 MPI_FILE_WRITE_ORDERED(FH, BUF, COUNT, DATATYPE, STATUS, IERROR)
24     INTEGER FH, COUNT, DATATYPE, STATUS(MPI_STATUS_SIZE), IERROR
25     <type> BUF(*)

```

26 MPI\_FILE\_WRITE\_ORDERED is a collective version of the MPI\_FILE\_WRITE\_SHARED  
27 interface.

**Seek**

31 If MPI\_MODE\_SEQUENTIAL mode was specified when the file was opened, it is erroneous  
32 to call the following two routines (MPI\_FILE\_SEEK\_SHARED and  
33 MPI\_FILE\_GET\_POSITION\_SHARED).

```

36 MPI_FILE_SEEK_SHARED(fh, offset, whence)
37   INOUT   fh           file handle (handle)
38
39   IN      offset       file offset (integer)
40
41   IN      whence       update mode (state)

```

**C binding**

```

43 int MPI_File_seek_shared(MPI_File fh, MPI_Offset offset, int whence)

```

**Fortran 2008 binding**

```

46 MPI_File_seek_shared(fh, offset, whence, ierror)
47     TYPE(MPI_File), INTENT(IN) :: fh
48     INTEGER(KIND=MPI_OFFSET_KIND), INTENT(IN) :: offset

```

```

INTEGER, INTENT(IN) :: whence
INTEGER, OPTIONAL, INTENT(OUT) :: ierror

```

**Fortran binding**

```

MPI_FILE_SEEK_SHARED(FH, OFFSET, WHENCE, IERROR)
  INTEGER FH, WHENCE, IERROR
  INTEGER(KIND=MPI_OFFSET_KIND) OFFSET

```

MPI\_FILE\_SEEK\_SHARED updates the shared file pointer according to whence, which has the following possible values:

- MPI\_SEEK\_SET: the pointer is set to offset
- MPI\_SEEK\_CUR: the pointer is set to the current pointer position plus offset
- MPI\_SEEK\_END: the pointer is set to the end of file plus offset

MPI\_FILE\_SEEK\_SHARED is collective; all the processes in the communicator group associated with the file handle fh must call MPI\_FILE\_SEEK\_SHARED with the same values for offset and whence.

The offset can be negative, which allows seeking backwards. It is erroneous to seek to a negative position in the view.

```

MPI_FILE_GET_POSITION_SHARED(fh, offset)

```

IN	fh	file handle (handle)
OUT	offset	offset of shared pointer (integer)

**C binding**

```

int MPI_File_get_position_shared(MPI_File fh, MPI_Offset *offset)

```

**Fortran 2008 binding**

```

MPI_File_get_position_shared(fh, offset, ierror)
  TYPE(MPI_File), INTENT(IN) :: fh
  INTEGER(KIND=MPI_OFFSET_KIND), INTENT(OUT) :: offset
  INTEGER, OPTIONAL, INTENT(OUT) :: ierror

```

**Fortran binding**

```

MPI_FILE_GET_POSITION_SHARED(FH, OFFSET, IERROR)
  INTEGER FH, IERROR
  INTEGER(KIND=MPI_OFFSET_KIND) OFFSET

```

MPI\_FILE\_GET\_POSITION\_SHARED returns, in offset, the current position of the shared file pointer in type units relative to the current view.

*Advice to users.* The offset can be used in a future call to MPI\_FILE\_SEEK\_SHARED using whence = MPI\_SEEK\_SET to return to the current position. To set the displacement to the current file pointer position, first convert offset into an absolute byte position using MPI\_FILE\_GET\_BYTE\_OFFSET, then call MPI\_FILE\_SET\_VIEW with the resulting displacement. (*End of advice to users.*)

### 13.4.5 Split Collective Data Access Routines

MPI provides a restricted form of “nonblocking collective” I/O operations for all data accesses using split collective data access routines. These routines are referred to as “split” collective routines because a single collective operation is split in two: a begin routine and an end routine. The begin routine begins the operation, much like a nonblocking data access (e.g., `MPI_FILE_IREAD`). The end routine completes the operation, much like the matching test or wait (e.g., `MPI_WAIT`). As with nonblocking data access operations, the user must not use the buffer passed to a begin routine while the routine is outstanding; the operation must be completed with an end routine before it is safe to free buffers, etc.

Split collective data access operations on a file handle `fh` are subject to the semantic rules given below.

- On any MPI process, each file handle may have at most one active split collective operation at any time.
- Begin calls are collective over the group of processes that participated in the collective open and follow the ordering rules for collective calls.
- End calls are collective over the group of processes that participated in the collective open and follow the ordering rules for collective calls. Each end call matches the preceding begin call for the same collective operation. When an “end” call is made, exactly one unmatched “begin” call for the same operation must precede it.
- An implementation is free to implement any split collective data access routine using the corresponding blocking collective routine when either the begin call (e.g., `MPI_FILE_READ_ALL_BEGIN`) or the end call (e.g., `MPI_FILE_READ_ALL_END`) is issued. The begin and end calls are provided to allow the user and MPI implementation to optimize the collective operation.
- Split collective operations do not match the corresponding regular collective operation. For example, in a single collective read operation, an `MPI_FILE_READ_ALL` on one process does not match an `MPI_FILE_READ_ALL_BEGIN/`  
`MPI_FILE_READ_ALL_END` pair on another process.
- Split collective routines must specify a buffer in both the begin and end routines. By specifying the buffer that receives data in the end routine, we can avoid the problems described in “A Problem with Code Movements and Register Optimization,” Section 18.1.17, but not all of the problems, such as those described in Sections 18.1.12, 18.1.13, and 18.1.16.
- No collective I/O operations are permitted on a file handle concurrently with a split collective access on that file handle (i.e., between the begin and end of the access). That is

```
MPI_File_read_all_begin(fh, ...);
...
MPI_File_read_all(fh, ...);
...
MPI_File_read_all_end(fh, ...);
```



is erroneous.

- In a multithreaded implementation, any split collective begin and end operation called by a process must be called from the same thread. This restriction is made to simplify the implementation in the multithreaded case. (Note that we have already disallowed having two threads begin a split collective operation on the same file handle since only one split collective operation can be active on a file handle at any time.)

The arguments for these routines have the same meaning as for the equivalent collective versions (e.g., the argument definitions for `MPI_FILE_READ_ALL_BEGIN` and `MPI_FILE_READ_ALL_END` are equivalent to the arguments for `MPI_FILE_READ_ALL`). The begin routine (e.g., `MPI_FILE_READ_ALL_BEGIN`) begins a split collective operation that, when completed with the matching end routine (i.e., `MPI_FILE_READ_ALL_END`) produces the result as defined for the equivalent collective routine (i.e., `MPI_FILE_READ_ALL`).

For the purpose of consistency semantics (Section 13.6.1), a matched pair of split collective data access operations (e.g., `MPI_FILE_READ_ALL_BEGIN` and `MPI_FILE_READ_ALL_END`) compose a single data access.

`MPI_FILE_READ_AT_ALL_BEGIN(fh, offset, buf, count, datatype)`

IN	fh	file handle (handle)
IN	offset	file offset (integer)
OUT	buf	initial address of buffer (choice)
IN	count	number of elements in buffer (integer)
IN	datatype	datatype of each buffer element (handle)

### C binding

```
int MPI_File_read_at_all_begin(MPI_File fh, MPI_Offset offset, void *buf,
                              int count, MPI_Datatype datatype)
```

### Fortran 2008 binding

```
MPI_File_read_at_all_begin(fh, offset, buf, count, datatype, ierror)
  TYPE(MPI_File), INTENT(IN) :: fh
  INTEGER(KIND=MPI_OFFSET_KIND), INTENT(IN) :: offset
  TYPE(*), DIMENSION(..), ASYNCHRONOUS :: buf
  INTEGER, INTENT(IN) :: count
  TYPE(MPI_Datatype), INTENT(IN) :: datatype
  INTEGER, OPTIONAL, INTENT(OUT) :: ierror
```

### Fortran binding

```
MPI_FILE_READ_AT_ALL_BEGIN(FH, OFFSET, BUF, COUNT, DATATYPE, IERROR)
  INTEGER FH, COUNT, DATATYPE, IERROR
  INTEGER(KIND=MPI_OFFSET_KIND) OFFSET
  <type> BUF(*)
```

```

1 MPI_FILE_READ_AT_ALL_END(fh, buf, status)
2     IN      fh                file handle (handle)
3
4     OUT     buf                initial address of buffer (choice)
5
6     OUT     status            status object (Status)
7
8 C binding
9 int MPI_File_read_at_all_end(MPI_File fh, void *buf, MPI_Status *status)
10
11 Fortran 2008 binding
12 MPI_File_read_at_all_end(fh, buf, status, ierror)
13     TYPE(MPI_File), INTENT(IN) :: fh
14     TYPE(*), DIMENSION(..), ASYNCHRONOUS :: buf
15     TYPE(MPI_Status) :: status
16     INTEGER, OPTIONAL, INTENT(OUT) :: ierror
17
18 Fortran binding
19 MPI_FILE_READ_AT_ALL_END(FH, BUF, STATUS, IERROR)
20     INTEGER FH, STATUS(MPI_STATUS_SIZE), IERROR
21     <type> BUF(*)
22
23 MPI_FILE_WRITE_AT_ALL_BEGIN(fh, offset, buf, count, datatype)
24     INOUT   fh                file handle (handle)
25
26     IN      offset            file offset (integer)
27
28     IN      buf                initial address of buffer (choice)
29
30     IN      count              number of elements in buffer (integer)
31
32     IN      datatype           datatype of each buffer element (handle)
33
34 C binding
35 int MPI_File_write_at_all_begin(MPI_File fh, MPI_Offset offset,
36     const void *buf, int count, MPI_Datatype datatype)
37
38 Fortran 2008 binding
39 MPI_File_write_at_all_begin(fh, offset, buf, count, datatype, ierror)
40     TYPE(MPI_File), INTENT(IN) :: fh
41     INTEGER(KIND=MPI_OFFSET_KIND), INTENT(IN) :: offset
42     TYPE(*), DIMENSION(..), INTENT(IN), ASYNCHRONOUS :: buf
43     INTEGER, INTENT(IN) :: count
44     TYPE(MPI_Datatype), INTENT(IN) :: datatype
45     INTEGER, OPTIONAL, INTENT(OUT) :: ierror
46
47 Fortran binding
48 MPI_FILE_WRITE_AT_ALL_BEGIN(FH, OFFSET, BUF, COUNT, DATATYPE, IERROR)
49     INTEGER FH, COUNT, DATATYPE, IERROR
50     INTEGER(KIND=MPI_OFFSET_KIND) OFFSET
51     <type> BUF(*)

```

`MPI_FILE_WRITE_AT_ALL_END(fh, buf, status)`

INOUT	fh	file handle (handle)
IN	buf	initial address of buffer (choice)
OUT	status	status object (Status)

### C binding

```
int MPI_File_write_at_all_end(MPI_File fh, const void *buf,
                             MPI_Status *status)
```

### Fortran 2008 binding

```
MPI_File_write_at_all_end(fh, buf, status, ierror)
  TYPE(MPI_File), INTENT(IN) :: fh
  TYPE(*), DIMENSION(..), INTENT(IN), ASYNCHRONOUS :: buf
  TYPE(MPI_Status) :: status
  INTEGER, OPTIONAL, INTENT(OUT) :: ierror
```

### Fortran binding

```
MPI_FILE_WRITE_AT_ALL_END(FH, BUF, STATUS, IERROR)
  INTEGER FH, STATUS(MPI_STATUS_SIZE), IERROR
  <type> BUF(*)
```

`MPI_FILE_READ_ALL_BEGIN(fh, buf, count, datatype)`

INOUT	fh	file handle (handle)
OUT	buf	initial address of buffer (choice)
IN	count	number of elements in buffer (integer)
IN	datatype	datatype of each buffer element (handle)

### C binding

```
int MPI_File_read_all_begin(MPI_File fh, void *buf, int count,
                             MPI_Datatype datatype)
```

### Fortran 2008 binding

```
MPI_File_read_all_begin(fh, buf, count, datatype, ierror)
  TYPE(MPI_File), INTENT(IN) :: fh
  TYPE(*), DIMENSION(..), ASYNCHRONOUS :: buf
  INTEGER, INTENT(IN) :: count
  TYPE(MPI_Datatype), INTENT(IN) :: datatype
  INTEGER, OPTIONAL, INTENT(OUT) :: ierror
```

### Fortran binding

```
MPI_FILE_READ_ALL_BEGIN(FH, BUF, COUNT, DATATYPE, IERROR)
  INTEGER FH, COUNT, DATATYPE, IERROR
  <type> BUF(*)
```

1 MPI\_FILE\_READ\_ALL\_END(fh, buf, status)

2     INOUT    fh                            file handle (handle)  
 3  
 4     OUT      buf                          initial address of buffer (choice)  
 5  
 6     OUT      status                        status object (Status)

7 **C binding**

8 int MPI\_File\_read\_all\_end(MPI\_File fh, void \*buf, MPI\_Status \*status)

9  
 10 **Fortran 2008 binding**

11 MPI\_File\_read\_all\_end(fh, buf, status, ierror)  
 12     TYPE(MPI\_File), INTENT(IN) :: fh  
 13     TYPE(\*), DIMENSION(..), ASYNCHRONOUS :: buf  
 14     TYPE(MPI\_Status) :: status  
 15     INTEGER, OPTIONAL, INTENT(OUT) :: ierror

16 **Fortran binding**

17 MPI\_FILE\_READ\_ALL\_END(FH, BUF, STATUS, IERROR)  
 18     INTEGER FH, STATUS(MPI\_STATUS\_SIZE), IERROR  
 19     <type> BUF(\*)

21  
 22  
 23 MPI\_FILE\_WRITE\_ALL\_BEGIN(fh, buf, count, datatype)

24     INOUT    fh                            file handle (handle)  
 25     IN        buf                          initial address of buffer (choice)  
 26     IN        count                        number of elements in buffer (integer)  
 27     IN        datatype                     datatype of each buffer element (handle)

29  
 30 **C binding**

31 int MPI\_File\_write\_all\_begin(MPI\_File fh, const void \*buf, int count,  
 32                               MPI\_Datatype datatype)

33  
 34 **Fortran 2008 binding**

35 MPI\_File\_write\_all\_begin(fh, buf, count, datatype, ierror)  
 36     TYPE(MPI\_File), INTENT(IN) :: fh  
 37     TYPE(\*), DIMENSION(..), INTENT(IN), ASYNCHRONOUS :: buf  
 38     INTEGER, INTENT(IN) :: count  
 39     TYPE(MPI\_Datatype), INTENT(IN) :: datatype  
 40     INTEGER, OPTIONAL, INTENT(OUT) :: ierror

41 **Fortran binding**

42 MPI\_FILE\_WRITE\_ALL\_BEGIN(FH, BUF, COUNT, DATATYPE, IERROR)  
 43     INTEGER FH, COUNT, DATATYPE, IERROR  
 44     <type> BUF(\*)

`MPI_FILE_WRITE_ALL_END(fh, buf, status)`

INOUT	fh	file handle (handle)
IN	buf	initial address of buffer (choice)
OUT	status	status object (Status)

### C binding

```
int MPI_File_write_all_end(MPI_File fh, const void *buf,
                          MPI_Status *status)
```

### Fortran 2008 binding

```
MPI_File_write_all_end(fh, buf, status, ierror)
  TYPE(MPI_File), INTENT(IN) :: fh
  TYPE(*), DIMENSION(..), INTENT(IN), ASYNCHRONOUS :: buf
  TYPE(MPI_Status) :: status
  INTEGER, OPTIONAL, INTENT(OUT) :: ierror
```

### Fortran binding

```
MPI_FILE_WRITE_ALL_END(FH, BUF, STATUS, IERROR)
  INTEGER FH, STATUS(MPI_STATUS_SIZE), IERROR
  <type> BUF(*)
```

`MPI_FILE_READ_ORDERED_BEGIN(fh, buf, count, datatype)`

INOUT	fh	file handle (handle)
OUT	buf	initial address of buffer (choice)
IN	count	number of elements in buffer (integer)
IN	datatype	datatype of each buffer element (handle)

### C binding

```
int MPI_File_read_ordered_begin(MPI_File fh, void *buf, int count,
                               MPI_Datatype datatype)
```

### Fortran 2008 binding

```
MPI_File_read_ordered_begin(fh, buf, count, datatype, ierror)
  TYPE(MPI_File), INTENT(IN) :: fh
  TYPE(*), DIMENSION(..), ASYNCHRONOUS :: buf
  INTEGER, INTENT(IN) :: count
  TYPE(MPI_Datatype), INTENT(IN) :: datatype
  INTEGER, OPTIONAL, INTENT(OUT) :: ierror
```

### Fortran binding

```
MPI_FILE_READ_ORDERED_BEGIN(FH, BUF, COUNT, DATATYPE, IERROR)
  INTEGER FH, COUNT, DATATYPE, IERROR
  <type> BUF(*)
```

1 MPI\_FILE\_READ\_ORDERED\_END(fh, buf, status)

2     INOUT    fh                           file handle (handle)  
 3  
 4     OUT      buf                         initial address of buffer (choice)  
 5  
 6     OUT      status                      status object (Status)

7 **C binding**

8 int MPI\_File\_read\_ordered\_end(MPI\_File fh, void \*buf, MPI\_Status \*status)

9  
 10 **Fortran 2008 binding**

11 MPI\_File\_read\_ordered\_end(fh, buf, status, ierror)  
 12     TYPE(MPI\_File), INTENT(IN) :: fh  
 13     TYPE(\*), DIMENSION(..), ASYNCHRONOUS :: buf  
 14     TYPE(MPI\_Status) :: status  
 15     INTEGER, OPTIONAL, INTENT(OUT) :: ierror

16 **Fortran binding**

17 MPI\_FILE\_READ\_ORDERED\_END(FH, BUF, STATUS, IERROR)  
 18     INTEGER FH, STATUS(MPI\_STATUS\_SIZE), IERROR  
 19     <type> BUF(\*)

21  
 22  
 23 MPI\_FILE\_WRITE\_ORDERED\_BEGIN(fh, buf, count, datatype)

24     INOUT    fh                           file handle (handle)  
 25     IN        buf                         initial address of buffer (choice)  
 26     IN        count                       number of elements in buffer (integer)  
 27     IN        datatype                    datatype of each buffer element (handle)

29  
 30 **C binding**

31 int MPI\_File\_write\_ordered\_begin(MPI\_File fh, const void \*buf, int count,  
 32                                   MPI\_Datatype datatype)

33  
 34 **Fortran 2008 binding**

35 MPI\_File\_write\_ordered\_begin(fh, buf, count, datatype, ierror)  
 36     TYPE(MPI\_File), INTENT(IN) :: fh  
 37     TYPE(\*), DIMENSION(..), INTENT(IN), ASYNCHRONOUS :: buf  
 38     INTEGER, INTENT(IN) :: count  
 39     TYPE(MPI\_Datatype), INTENT(IN) :: datatype  
 40     INTEGER, OPTIONAL, INTENT(OUT) :: ierror

41 **Fortran binding**

42 MPI\_FILE\_WRITE\_ORDERED\_BEGIN(FH, BUF, COUNT, DATATYPE, IERROR)  
 43     INTEGER FH, COUNT, DATATYPE, IERROR  
 44     <type> BUF(\*)

`MPI_FILE_WRITE_ORDERED_END(fh, buf, status)`

INOUT	fh	file handle (handle)
IN	buf	initial address of buffer (choice)
OUT	status	status object (Status)

#### C binding

```
int MPI_File_write_ordered_end(MPI_File fh, const void *buf,
                              MPI_Status *status)
```

#### Fortran 2008 binding

```
MPI_File_write_ordered_end(fh, buf, status, ierror)
  TYPE(MPI_File), INTENT(IN) :: fh
  TYPE(*), DIMENSION(..), INTENT(IN), ASYNCHRONOUS :: buf
  TYPE(MPI_Status) :: status
  INTEGER, OPTIONAL, INTENT(OUT) :: ierror
```

#### Fortran binding

```
MPI_FILE_WRITE_ORDERED_END(FH, BUF, STATUS, IERROR)
  INTEGER FH, STATUS(MPI_STATUS_SIZE), IERROR
  <type> BUF(*)
```

## 13.5 File Interoperability

At the most basic level, file interoperability is the ability to read the information previously written to a file — not just the bits of data, but the actual information the bits represent. MPI guarantees full interoperability within a single MPI environment, and supports increased interoperability outside that environment through the external data representation (Section 13.5.2) as well as the data conversion functions (Section 13.5.3).

Interoperability within a single MPI environment (which could be considered “operability”) ensures that file data written by one MPI process can be read by any other MPI process, subject to the consistency constraints (see Section 13.6.1), provided that it would have been possible to start the two processes simultaneously and have them reside in a single MPI\_COMM\_WORLD. Furthermore, both processes must see the same data values at every absolute byte offset in the file for which data was written.

This single environment file interoperability implies that file data is accessible regardless of the number of processes.

There are three aspects to file interoperability:

- transferring the bits,
- converting between different file structures, and
- converting between different machine representations.

The first two aspects of file interoperability are beyond the scope of this standard, as both are highly machine dependent. However, transferring the bits of a file into and out of the MPI environment (e.g., by writing a file to tape) is required to be supported by all MPI implementations. In particular, an implementation must specify how familiar

1 operations similar to POSIX `cp`, `rm`, and `mv` can be performed on the file. Furthermore, it  
2 is expected that the facility provided maintains the correspondence between absolute byte  
3 offsets (e.g., after possible file structure conversion, the data bits at byte offset 102 in the  
4 MPI environment are at byte offset 102 outside the MPI environment). As an example,  
5 a simple off-line conversion utility that transfers and converts files between the native file  
6 system and the MPI environment would suffice, provided it maintained the offset coherence  
7 mentioned above. In a high-quality implementation of MPI, users will be able to manipulate  
8 MPI files using the same or similar tools that the native file system offers for manipulating  
9 its files.

10 The remaining aspect of file interoperability, converting between different machine  
11 representations, is supported by the typing information specified in the `etype` and `filetype`.  
12 This facility allows the information in files to be shared between any two applications,  
13 regardless of whether they use MPI, and regardless of the machine architectures on which  
14 they run.

15 MPI supports multiple data representations: “native,” “internal,” and “external32.”  
16 An implementation may support additional data representations. MPI also supports user-  
17 defined data representations (see Section 13.5.3). The “native” and “internal” data repre-  
18 sentations are implementation dependent, while the “external32” representation is common  
19 to all MPI implementations and facilitates file interoperability. The data representation is  
20 specified in the `datarep` argument to `MPI_FILE_SET_VIEW`.

21  
22 *Advice to users.* MPI is not guaranteed to retain knowledge of what data representa-  
23 tion was used when a file is written. Therefore, to correctly retrieve file data, an MPI  
24 application is responsible for specifying the same data representation as was used to  
25 create the file. (*End of advice to users.*)

26 **“native”** Data in this representation is stored in a file exactly as it is in memory. The ad-  
27 vantage of this data representation is that data precision and I/O performance are not  
28 lost in type conversions with a purely homogeneous environment. The disadvantage  
29 is the loss of transparent interoperability within a heterogeneous MPI environment.

30  
31 *Advice to users.* This data representation should only be used in a homogeneous  
32 MPI environment, or when the MPI application is capable of performing the data  
33 type conversions itself. (*End of advice to users.*)

34  
35 *Advice to implementors.* When implementing read and write operations on  
36 top of MPI message-passing, the message data should be typed as `MPI_BYTE`  
37 to ensure that the message routines do not perform any type conversions on the  
38 data. (*End of advice to implementors.*)

39 **“internal”** This data representation can be used for I/O operations in a homogeneous  
40 or heterogeneous environment; the implementation will perform type conversions if  
41 necessary. The implementation is free to store data in any format of its choice, with  
42 the restriction that it will maintain constant extents for all predefined datatypes in any  
43 one file. The environment in which the resulting file can be reused is implementation-  
44 defined and must be documented by the implementation.

45  
46 *Rationale.* This data representation allows the implementation to perform I/O  
47 efficiently in a heterogeneous environment, though with implementation-defined  
48 restrictions on how the file can be reused. (*End of rationale.*)



*Advice to implementors.* Since “external32” is a superset of the functionality provided by “internal,” an implementation may choose to implement “internal” as “external32.” (*End of advice to implementors.*)

“external32” This data representation states that read and write operations convert all data from and to the “external32” representation defined in Section 13.5.2. The data conversion rules for communication also apply to these conversions (see Section 3.3.2). The data on the storage medium is always in this canonical representation, and the data in memory is always in the local process’s native representation.

This data representation has several advantages. First, all processes reading the file in a heterogeneous MPI environment will automatically have the data converted to their respective native representations. Second, the file can be exported from one MPI environment and imported into any other MPI environment with the guarantee that the second environment will be able to read all the data in the file.

The disadvantage of this data representation is that data precision and I/O performance may be lost in data type conversions.

*Advice to implementors.* When implementing read and write operations on top of MPI message-passing, the message data should be converted to and from the “external32” representation in the client, and sent as type MPI\_BYTE. This will avoid possible double data type conversions and the associated further loss of precision and performance. (*End of advice to implementors.*)

### 13.5.1 Datatypes for File Interoperability

If the file data representation is other than “native,” care must be taken in constructing etypes and filetypes. Any of the datatype constructor functions may be used; however, for those functions that accept displacements in bytes, the displacements must be specified in terms of their values in the file for the file data representation being used. MPI will interpret these byte displacements as is; no scaling will be done. The function MPI\_FILE\_GET\_TYPE\_EXTENT can be used to calculate the extents of datatypes in the file. For etypes and filetypes that are portable datatypes (see Section 2.4), MPI will scale any displacements in the datatypes to match the file data representation. Datatypes passed as arguments to read/write routines specify the data layout in memory; therefore, they must always be constructed using displacements corresponding to displacements in memory.

*Advice to users.* One can logically think of the file as if it were stored in the memory of a file server. The etype and filetype are interpreted as if they were defined at this file server, by the same sequence of calls used to define them at the calling process. If the data representation is “native”, then this logical file server runs on the same architecture as the calling process, so that these types define the same data layout on the file as they would define in the memory of the calling process. If the etype and filetype are portable datatypes, then the data layout defined in the file is the same as would be defined in the calling process memory, up to a scaling factor. The routine MPI\_FILE\_GET\_TYPE\_EXTENT can be used to calculate this scaling factor. Thus, two equivalent, portable datatypes will define the same data layout in the file, even in a heterogeneous environment with “internal”, “external32”, or user defined data representations. Otherwise, the etype and filetype must be constructed so that

1 their typemap and extent are the same on any architecture. This can be achieved  
 2 if they have an explicit upper bound and lower bound (defined using  
 3 `MPI_TYPE_CREATE_RESIZED`). This condition must also be fulfilled by any datatype  
 4 that is used in the construction of the `etype` and `filetype`, if this datatype is replicated  
 5 contiguously, either explicitly, by a call to `MPI_TYPE_CONTIGUOUS`, or implicitly,  
 6 by a `blocklength` argument that is greater than one. If an `etype` or `filetype` is not  
 7 portable, and has a typemap or extent that is architecture dependent, then the data  
 8 layout specified by it on a file is implementation dependent.

9 File data representations other than “native” may be different from corresponding  
 10 data representations in memory. Therefore, for these file data representations, it is  
 11 important not to use hardwired byte offsets for file positioning, including the initial  
 12 displacement that specifies the view. When a portable datatype (see Section 2.4) is  
 13 used in a data access operation, any holes in the datatype are scaled to match the data  
 14 representation. However, note that this technique only works when all the processes  
 15 that created the file view build their `etypes` from the same predefined datatypes. For  
 16 example, if one process uses an `etype` built from `MPI_INT` and another uses an `etype`  
 17 built from `MPI_FLOAT`, the resulting views may be nonportable because the relative  
 18 sizes of these types may differ from one data representation to another. (*End of advice*  
 19 *to users.*)

22  
 23 `MPI_FILE_GET_TYPE_EXTENT(fh, datatype, extent)`

24	IN	fh	file handle (handle)
25	IN	datatype	datatype (handle)
26			
27	OUT	extent	datatype extent (integer)

### 28 C binding

29  
 30 `int MPI_File_get_type_extent(MPI_File fh, MPI_Datatype datatype,`  
 31 `MPI_Aint *extent)`

### 32 Fortran 2008 binding

33 `MPI_File_get_type_extent(fh, datatype, extent, ierror)`  
 34 `TYPE(MPI_File), INTENT(IN) :: fh`  
 35 `TYPE(MPI_Datatype), INTENT(IN) :: datatype`  
 36 `INTEGER(KIND=MPI_ADDRESS_KIND), INTENT(OUT) :: extent`  
 37 `INTEGER, OPTIONAL, INTENT(OUT) :: ierror`

### 38 Fortran binding

39 `MPI_FILE_GET_TYPE_EXTENT(FH, DATATYPE, EXTENT, IERROR)`  
 40 `INTEGER FH, DATATYPE, IERROR`  
 41 `INTEGER(KIND=MPI_ADDRESS_KIND) EXTENT`

42  
 43 Returns the extent of `datatype` in the file `fh`. This extent will be the same for all  
 44 processes accessing the file `fh`. If the current view uses a user-defined data representation  
 45 (see Section 13.5.3), MPI uses the `dtype_file_extent_fn` callback to calculate the extent.  
 46

47 *Advice to implementors.* In the case of user-defined data representations, the extent  
 48 of a derived datatype can be calculated by first determining the extents of the prede-

defined datatypes in this derived datatype using `dtype_file_extent_fn` (see Section 13.5.3).  
*(End of advice to implementors.)*

### 13.5.2 External Data Representation: “external32”

All MPI implementations are required to support the data representation defined in this section. Support of optional datatypes (e.g., `MPI_INTEGER2`) is not required.

All floating point values are in big-endian IEEE format [39] of the appropriate size. Floating point values are represented by one of three IEEE formats. These are the IEEE “Single (binary32),” “Double (binary64),” and “Double Extended (binary128)” formats, requiring 4, 8, and 16 bytes of storage, respectively. For the IEEE “Double Extended (binary128)” formats, MPI specifies a Format Width of 16 bytes, with 15 exponent bits, bias = +16383, 112 fraction bits, and an encoding analogous to the “Double (binary64)” format. All integral values are in two’s complement big-endian format. Big-endian means most significant byte at lowest address byte. For C `_Bool`, Fortran `LOGICAL`, and C++ `bool`, 0 implies false and nonzero implies true. C `float` `_Complex`, `double` `_Complex`, and `long double` `_Complex`, Fortran `COMPLEX` and `DOUBLE COMPLEX`, and other complex types are represented by a pair of floating point format values for the real and imaginary components. Characters are in ISO 8859-1 format [40]. Wide characters (of type `MPI_WCHAR`) are in Unicode format [63].

All signed numerals (e.g., `MPI_INT`, `MPI_REAL`) have the sign bit at the most significant bit. `MPI_COMPLEX` and `MPI_DOUBLE_COMPLEX` have the sign bit of the real and imaginary parts at the most significant bit of each part.

According to IEEE specifications [39], the “NaN” (not a number) is system dependent. It should not be interpreted within MPI as anything other than “NaN.”

*Advice to implementors.* The MPI treatment of “NaN” is similar to the approach used in XDR [61]. *(End of advice to implementors.)*

All data is byte aligned, regardless of type. All data items are stored contiguously in the file (if the file view is contiguous).

*Advice to implementors.* All bytes of `LOGICAL` and `bool` must be checked to determine the value. *(End of advice to implementors.)*

*Advice to users.* The type `MPI_PACKED` is treated as bytes and is not converted. The user should be aware that `MPI_PACK` has the option of placing a header in the beginning of the pack buffer. *(End of advice to users.)*

The sizes of the predefined datatypes returned from `MPI_TYPE_CREATE_F90_REAL`, `MPI_TYPE_CREATE_F90_COMPLEX`, and `MPI_TYPE_CREATE_F90_INTEGER` are defined in Section 18.1.9, page 725.

*Advice to implementors.* When converting a larger size integer to a smaller size integer, only the least significant bytes are moved. Care must be taken to preserve the sign bit value. This allows no conversion errors if the data range is within the range of the smaller size integer. *(End of advice to implementors.)*

Table 13.2, 13.3, and 13.4 specify the sizes of predefined, optional, and C++ datatypes in “external32” format, respectively.

Predefined Type	Length
MPI_PACKED	1
MPI_BYTE	1
MPI_CHAR	1
MPI_UNSIGNED_CHAR	1
MPI_SIGNED_CHAR	1
MPI_WCHAR	2
MPI_SHORT	2
MPI_UNSIGNED_SHORT	2
MPI_INT	4
MPI_LONG	4
MPI_UNSIGNED	4
MPI_UNSIGNED_LONG	4
MPI_LONG_LONG_INT	8
MPI_UNSIGNED_LONG_LONG	8
MPI_FLOAT	4
MPI_DOUBLE	8
MPI_LONG_DOUBLE	16
MPI_C_BOOL	1
MPI_INT8_T	1
MPI_INT16_T	2
MPI_INT32_T	4
MPI_INT64_T	8
MPI_UINT8_T	1
MPI_UINT16_T	2
MPI_UINT32_T	4
MPI_UINT64_T	8
MPI_AINT	8
MPI_COUNT	8
MPI_OFFSET	8
MPI_C_COMPLEX	2*4
MPI_C_FLOAT_COMPLEX	2*4
MPI_C_DOUBLE_COMPLEX	2*8
MPI_C_LONG_DOUBLE_COMPLEX	2*16
MPI_CHARACTER	1
MPI_LOGICAL	4
MPI_INTEGER	4
MPI_REAL	4
MPI_DOUBLE_PRECISION	8
MPI_COMPLEX	2*4
MPI_DOUBLE_COMPLEX	2*8
MPI_CXX_BOOL	1
MPI_CXX_FLOAT_COMPLEX	2*4
MPI_CXX_DOUBLE_COMPLEX	2*8
MPI_CXX_LONG_DOUBLE_COMPLEX	2*16

Table 13.2: “external32” sizes of predefined datatypes

Predefined Type	Length
MPI_INTEGER1	1
MPI_INTEGER2	2
MPI_INTEGER4	4
MPI_INTEGER8	8
MPI_INTEGER16	16
MPI_REAL2	2
MPI_REAL4	4
MPI_REAL8	8
MPI_REAL16	16
MPI_COMPLEX4	2*2
MPI_COMPLEX8	2*4
MPI_COMPLEX16	2*8
MPI_COMPLEX32	2*16

Table 13.3: “external32” sizes of optional datatypes

C++ Types	Length
MPI_CXX_BOOL	1
MPI_CXX_FLOAT_COMPLEX	2*4
MPI_CXX_DOUBLE_COMPLEX	2*8
MPI_CXX_LONG_DOUBLE_COMPLEX	2*16

Table 13.4: “external32” sizes of C++ datatypes

### 13.5.3 User-Defined Data Representations

There are two situations that cannot be handled by the required representations:

1. a user wants to write a file in a representation unknown to the implementation, and
2. a user wants to read a file written in a representation unknown to the implementation.

User-defined data representations allow the user to insert a third party converter into the I/O stream to do the data representation conversion.

```
MPI_REGISTER_DATAREP(datarep, read_conversion_fn, write_conversion_fn, dtype_file_extent_fn,
                    extra_state)
```

13	IN	datarep	data representation identifier (string)
14	IN	read_conversion_fn	function invoked to convert from file representation to native representation (function)
15			native representation (function)
16			
17	IN	write_conversion_fn	function invoked to convert from native representation to file representation (function)
18			to file representation (function)
19	IN	dtype_file_extent_fn	function invoked to get the extent of a datatype as represented in the file (function)
20			represented in the file (function)
21	IN	extra_state	extra state
22			

#### C binding

```
int MPI_Register_datarep(const char *datarep,
                        MPI_Datarep_conversion_function *read_conversion_fn,
                        MPI_Datarep_conversion_function *write_conversion_fn,
                        MPI_Datarep_extent_function *dtype_file_extent_fn,
                        void *extra_state)
```

#### Fortran 2008 binding

```
MPI_Register_datarep(datarep, read_conversion_fn, write_conversion_fn,
                    dtype_file_extent_fn, extra_state, ierror)
CHARACTER(LEN=*), INTENT(IN) :: datarep
PROCEDURE(MPI_Datarep_conversion_function) :: read_conversion_fn,
write_conversion_fn
PROCEDURE(MPI_Datarep_extent_function) :: dtype_file_extent_fn
INTEGER(KIND=MPI_ADDRESS_KIND), INTENT(IN) :: extra_state
INTEGER, OPTIONAL, INTENT(OUT) :: ierror
```

#### Fortran binding

```
MPI_REGISTER_DATAREP(DATAREP, READ_CONVERSION_FN, WRITE_CONVERSION_FN,
                    DTYPE_FILE_EXTENT_FN, EXTRA_STATE, IERROR)
CHARACTER*(*) DATAREP
EXTERNAL READ_CONVERSION_FN, WRITE_CONVERSION_FN, DTYPE_FILE_EXTENT_FN
INTEGER(KIND=MPI_ADDRESS_KIND) EXTRA_STATE
INTEGER IERROR
```

The call associates `read_conversion_fn`, `write_conversion_fn`, and `dtype_file_extent_fn` with the data representation identifier `datarep`. `datarep` can then be used as an argument

to `MPI_FILE_SET_VIEW`, causing subsequent data access operations to call the conversion functions to convert all data items accessed between file data representation and native representation. `MPI_REGISTER_DATAREP` is a local operation and only registers the data representation for the calling MPI process. If `datarep` is already defined, an error in the error class `MPI_ERR_DUP_DATAREP` is raised using the default file error handler (see Section 13.7). The length of a data representation string is limited to the value of `MPI_MAX_DATAREP_STRING`. `MPI_MAX_DATAREP_STRING` must have a value of at least 64. No routines are provided to delete data representations and free the associated resources; it is not expected that an application will generate them in significant numbers.

#### Extent Callback

```
typedef int MPI_Datarep_extent_function(MPI_Datatype datatype,
                                       MPI_Aint *extent, void *extra_state);
ABSTRACT INTERFACE
  SUBROUTINE MPI_Datarep_extent_function(datatype, extent, extra_state,
                                       ierror)
    TYPE(MPI_Datatype) :: datatype
    INTEGER(KIND=MPI_ADDRESS_KIND) :: extent, extra_state
    INTEGER :: ierror
  SUBROUTINE DATAREP_EXTENT_FUNCTION(DATATYPE, EXTENT, EXTRA_STATE, IERROR)
    INTEGER DATATYPE, IERROR
    INTEGER(KIND=MPI_ADDRESS_KIND) EXTENT, EXTRA_STATE
```

The function `dtype_file_extent_fn` must return, in `file_extent`, the number of bytes required to store `datatype` in the file representation. The function is passed, in `extra_state`, the argument that was passed to the `MPI_REGISTER_DATAREP` call. MPI will only call this routine with predefined datatypes employed by the user.

#### Datarep Conversion Functions

```
typedef int MPI_Datarep_conversion_function(void *userbuf,
                                           MPI_Datatype datatype, int count, void *filebuf,
                                           MPI_Offset position, void *extra_state);
ABSTRACT INTERFACE
  SUBROUTINE MPI_Datarep_conversion_function(userbuf, datatype, count,
                                           filebuf, position, extra_state, ierror)
    USE, INTRINSIC :: ISO_C_BINDING, ONLY : C_PTR
    TYPE(C_PTR), VALUE :: userbuf, filebuf
    TYPE(MPI_Datatype) :: datatype
    INTEGER :: count, ierror
    INTEGER(KIND=MPI_OFFSET_KIND) :: position
    INTEGER(KIND=MPI_ADDRESS_KIND) :: extra_state
  SUBROUTINE DATAREP_CONVERSION_FUNCTION(USERBUF, DATATYPE, COUNT, FILEBUF,
                                         POSITION, EXTRA_STATE, IERROR)
    <TYPE> USERBUF(*), FILEBUF(*)
    INTEGER DATATYPE, COUNT, IERROR
```

```

1     INTEGER(KIND=MPI_OFFSET_KIND) POSITION
2     INTEGER(KIND=MPI_ADDRESS_KIND) EXTRA_STATE

```

The function `read_conversion_fn` must convert from file data representation to native representation. Before calling this routine, MPI allocates and fills `filebuf` with `count` contiguous data items. The type of each data item matches the corresponding entry for the predefined datatype in the type signature of `datatype`. The function is passed, in `extra_state`, the argument that was passed to the `MPI_REGISTER_DATAREP` call. The function must copy all `count` data items from `filebuf` to `userbuf` in the distribution described by `datatype`, converting each data item from file representation to native representation. `datatype` will be equivalent to the datatype that the user passed to the read function. If the size of `datatype` is less than the size of the `count` data items, the conversion function must treat `datatype` as being contiguously tiled over the `userbuf`. The conversion function must begin storing converted data at the location in `userbuf` specified by `position` into the (tiled) `datatype`.

*Advice to users.* Although the conversion functions have similarities to `MPI_PACK` and `MPI_UNPACK`, one should note the differences in the use of the arguments `count` and `position`. In the conversion functions, `count` is a count of data items (i.e., count of typemap entries of `datatype`), and `position` is an index into this typemap. In `MPI_PACK`, `incount` refers to the number of whole datatypes, and `position` is a number of bytes. (*End of advice to users.*)

*Advice to implementors.* A converted read operation could be implemented as follows:

1. Get file extent of all data items
2. Allocate a `filebuf` large enough to hold all `count` data items
3. Read data from file into `filebuf`
4. Call `read_conversion_fn` to convert data and place it into `userbuf`
5. Deallocate `filebuf`

*(End of advice to implementors.)*

If MPI cannot allocate a buffer large enough to hold all the data to be converted from a read operation, it may call the conversion function repeatedly using the same `datatype` and `userbuf`, and reading successive chunks of data to be converted in `filebuf`. For the first call (and in the case when all the data to be converted fits into `filebuf`), MPI will call the function with `position` set to zero. Data converted during this call will be stored in the `userbuf` according to the first `count` data items in `datatype`. Then in subsequent calls to the conversion function, MPI will increment the value in `position` by the `count` of items converted in the previous call, and the `userbuf` pointer will be unchanged.

*Rationale.* Passing the conversion function a `position` and one `datatype` for the transfer allows the conversion function to decode the `datatype` only once and cache an internal representation of it on the `datatype`. Then on subsequent calls, the conversion function can use the `position` to quickly find its place in the `datatype` and continue storing converted data where it left off at the end of the previous call. (*End of rationale.*)



*Advice to users.* Although the conversion function may usefully cache an internal representation on the datatype, it should not cache any state information specific to an ongoing conversion operation, since it is possible for the same datatype to be used concurrently in multiple conversion operations. (*End of advice to users.*)

The function `write_conversion_fn` must convert from native representation to file data representation. Before calling this routine, MPI allocates `filebuf` of a size large enough to hold `count` contiguous data items. The type of each data item matches the corresponding entry for the predefined datatype in the type signature of `datatype`. The function must copy `count` data items from `userbuf` in the distribution described by `datatype`, to a contiguous distribution in `filebuf`, converting each data item from native representation to file representation. If the size of `datatype` is less than the size of `count` data items, the conversion function must treat `datatype` as being contiguously tiled over the `userbuf`.

The function must begin copying at the location in `userbuf` specified by `position` into the (tiled) `datatype`. `datatype` will be equivalent to the datatype that the user passed to the write function. The function is passed, in `extra_state`, the argument that was passed to the `MPI_REGISTER_DATAREP` call.

The predefined constant `MPI_CONVERSION_FN_NULL` may be used as either `write_conversion_fn` or `read_conversion_fn`. In that case, MPI will not attempt to invoke `write_conversion_fn` or `read_conversion_fn`, respectively, but will perform the requested data access using the native data representation.

An MPI implementation must ensure that all data accessed is converted, either by using a `filebuf` large enough to hold all the requested data items or else by making repeated calls to the conversion function with the same `datatype` argument and appropriate values for `position`.

An implementation will only invoke the callback routines in this section (`read_conversion_fn`, `write_conversion_fn`, and `dtype_file_extent_fn`) when one of the read or write routines in Section 13.4, or `MPI_FILE_GET_TYPE_EXTENT` is called by the user. `dtype_file_extent_fn` will only be passed predefined datatypes employed by the user. The conversion functions will only be passed datatypes equivalent to those that the user has passed to one of the routines noted above.

The conversion functions must be reentrant. User defined data representations are restricted to use byte alignment for all types. Furthermore, it is erroneous for the conversion functions to call any collective routines or to free `datatype`.

The conversion functions should return an error code. If the returned error code has a value other than `MPI_SUCCESS`, the implementation will raise an error in the class `MPI_ERR_CONVERSION`.

### 13.5.4 Matching Data Representations

It is the user's responsibility to ensure that the data representation used to read data from a file is *compatible* with the data representation that was used to write that data to the file.

In general, using the same data representation name when writing and reading a file does not guarantee that the representation is compatible. Similarly, using different representation names on two different implementations may yield compatible representations.

Compatibility can be obtained when "external32" representation is used, although precision may be lost and the performance may be less than when "native" representation is

used. Compatibility is guaranteed using “external32” provided at least one of the following conditions is met.

- The data access routines directly use types enumerated in Section 13.5.2, that are supported by all implementations participating in the I/O. The predefined type used to write a data item must also be used to read a data item.
- In the case of Fortran 90 programs, the programs participating in the data accesses obtain compatible datatypes using MPI routines that specify precision and/or range (Section 18.1.9).
- For any given data item, the programs participating in the data accesses use compatible predefined types to write and read the data item.

User-defined data representations may be used to provide an implementation compatibility with another implementation’s “native” or “internal” representation.

*Advice to users.* Section 18.1.9 defines routines that support the use of matching datatypes in heterogeneous environments and contains examples illustrating their use. (*End of advice to users.*)

## 13.6 Consistency and Semantics

### 13.6.1 File Consistency

Consistency semantics define the outcome of multiple accesses to a single file. All file accesses in MPI are relative to a specific file handle created from a collective open. MPI provides three levels of consistency: sequential consistency among all accesses using a single file handle, sequential consistency among all accesses using file handles created from a single collective open with atomic mode enabled, and user-imposed consistency among accesses other than the above. Sequential consistency means the behavior of a set of operations will be as if the operations were performed in some serial order consistent with program order; each access appears atomic, although the exact ordering of accesses is unspecified. User-imposed consistency may be obtained using program order and calls to `MPI_FILE_SYNC`.

Let  $FH_1$  be the set of file handles created from one particular collective open of the file  $FOO$ , and  $FH_2$  be the set of file handles created from a different collective open of  $FOO$ . Note that nothing restrictive is said about  $FH_1$  and  $FH_2$ : the sizes of  $FH_1$  and  $FH_2$  may be different, the groups of processes used for each open may or may not intersect, the file handles in  $FH_1$  may be destroyed before those in  $FH_2$  are created, etc. Consider the following three cases: a single file handle (e.g.,  $fh_1 \in FH_1$ ), two file handles created from a single collective open (e.g.,  $fh_{1a} \in FH_1$  and  $fh_{1b} \in FH_1$ ), and two file handles from different collective opens (e.g.,  $fh_1 \in FH_1$  and  $fh_2 \in FH_2$ ).

For the purpose of consistency semantics, a matched pair (Section 13.4.5) of split collective data access operations (e.g., `MPI_FILE_READ_ALL_BEGIN` and `MPI_FILE_READ_ALL_END`) compose a single data access operation. Similarly, a non-blocking data access routine (e.g., `MPI_FILE_IREAD`) and the routine which completes the request (e.g., `MPI_WAIT`) also compose a single data access operation. For all cases below, these data access operations are subject to the same constraints as blocking data access operations.

*Advice to users.* For an MPI\_FILE\_IREAD and MPI\_WAIT pair, the operation begins when MPI\_FILE\_IREAD is called and ends when MPI\_WAIT returns. (*End of advice to users.*)

Assume that  $A_1$  and  $A_2$  are two data access operations. Let  $D_1$  ( $D_2$ ) be the set of absolute byte displacements of every byte accessed in  $A_1$  ( $A_2$ ). The two data accesses *overlap* if  $D_1 \cap D_2 \neq \emptyset$ . The two data accesses *conflict* if they overlap and at least one is a write access.

Let  $SEQ_{fh}$  be a sequence of file operations on a single file handle, bracketed by MPI\_FILE\_SYNCs on that file handle. (Both opening and closing a file implicitly perform an MPI\_FILE\_SYNC.)  $SEQ_{fh}$  is a “write sequence” if any of the data access operations in the sequence are writes or if any of the file manipulation operations in the sequence change the state of the file (e.g., MPI\_FILE\_SET\_SIZE or MPI\_FILE\_PREALLOCATE). Given two sequences,  $SEQ_1$  and  $SEQ_2$ , we say they are not *concurrent* if one sequence is guaranteed to completely precede the other (temporally).

The requirements for guaranteeing sequential consistency among all accesses to a particular file are divided into the three cases given below. If any of these requirements are not met, then the value of all data in that file is implementation dependent.

**Case 1:**  $fh_1 \in FH_1$  All operations on  $fh_1$  are sequentially consistent if atomic mode is set. If nonatomic mode is set, then all operations on  $fh_1$  are sequentially consistent if they are either nonconcurrent, nonconflicting, or both.

**Case 2:**  $fh_{1a} \in FH_1$  and  $fh_{1b} \in FH_1$  Assume  $A_1$  is a data access operation using  $fh_{1a}$ , and  $A_2$  is a data access operation using  $fh_{1b}$ . If for any access  $A_1$ , there is no access  $A_2$  that conflicts with  $A_1$ , then MPI guarantees sequential consistency.

However, unlike POSIX semantics, the default MPI semantics for conflicting accesses do not guarantee sequential consistency. If  $A_1$  and  $A_2$  conflict, sequential consistency can be guaranteed by either enabling atomic mode via the MPI\_FILE\_SET\_ATOMICITY routine, or meeting the condition described in Case 3 below.

**Case 3:**  $fh_1 \in FH_1$  and  $fh_2 \in FH_2$  Consider access to a single file using file handles from distinct collective opens. In order to guarantee sequential consistency, MPI\_FILE\_SYNC must be used (both opening and closing a file implicitly perform an MPI\_FILE\_SYNC).

Sequential consistency is guaranteed among accesses to a single file if for any write sequence  $SEQ_1$  to the file, there is no sequence  $SEQ_2$  to the file which is *concurrent* with  $SEQ_1$ . To guarantee sequential consistency when there are write sequences, MPI\_FILE\_SYNC must be used together with a mechanism that guarantees nonconcurrency of the sequences.

See the examples in Section 13.6.11 for further clarification of some of these consistency semantics.

```

1 MPI_FILE_SET_ATOMICITY(fh, flag)
2     INOUT   fh           file handle (handle)
3
4     IN      flag        true to set atomic mode, false to set nonatomic mode
5                          (logical)
6

```

**C binding**

```

8 int MPI_File_set_atomicity(MPI_File fh, int flag)
9

```

**Fortran 2008 binding**

```

10 MPI_File_set_atomicity(fh, flag, ierror)
11     TYPE(MPI_File), INTENT(IN) :: fh
12     LOGICAL, INTENT(IN) :: flag
13     INTEGER, OPTIONAL, INTENT(OUT) :: ierror
14

```

**Fortran binding**

```

15 MPI_FILE_SET_ATOMICITY(FH, FLAG, IERROR)
16     INTEGER FH, IERROR
17     LOGICAL FLAG
18

```

Let  $FH$  be the set of file handles created by one collective open. The consistency semantics for data access operations using  $FH$  is set by collectively calling `MPI_FILE_SET_ATOMICITY` on  $FH$ . `MPI_FILE_SET_ATOMICITY` is collective; all processes in the group must pass identical values for  $fh$  and  $flag$ . If  $flag$  is true, atomic mode is set; if  $flag$  is false, nonatomic mode is set.

Changing the consistency semantics for an open file only affects new data accesses. All completed data accesses are guaranteed to abide by the consistency semantics in effect during their execution. Nonblocking data accesses and split collective operations that have not completed (e.g., via `MPI_WAIT`) are only guaranteed to abide by nonatomic mode consistency semantics.

*Advice to implementors.* Since the semantics guaranteed by atomic mode are stronger than those guaranteed by nonatomic mode, an implementation is free to adhere to the more stringent atomic mode semantics for outstanding requests. (*End of advice to implementors.*)

```

37 MPI_FILE_GET_ATOMICITY(fh, flag)
38     IN      fh           file handle (handle)
39
40     OUT     flag        true if atomic mode, false if nonatomic mode (logical)
41

```

**C binding**

```

43 int MPI_File_get_atomicity(MPI_File fh, int *flag)
44

```

**Fortran 2008 binding**

```

45 MPI_File_get_atomicity(fh, flag, ierror)
46     TYPE(MPI_File), INTENT(IN) :: fh
47     LOGICAL, INTENT(OUT) :: flag
48

```

INTEGER, OPTIONAL, INTENT(OUT) :: ierror

### Fortran binding

MPI\_FILE\_GET\_ATOMICITY(FH, FLAG, IERROR)

INTEGER FH, IERROR

LOGICAL FLAG

MPI\_FILE\_GET\_ATOMICITY returns the current consistency semantics for data access operations on the set of file handles created by one collective open. If `flag` is true, atomic mode is enabled; if `flag` is false, nonatomic mode is enabled.

MPI\_FILE\_SYNC(fh)

INOUT fh file handle (handle)

### C binding

int MPI\_File\_sync(MPI\_File fh)

### Fortran 2008 binding

MPI\_File\_sync(fh, ierror)

TYPE(MPI\_File), INTENT(IN) :: fh

INTEGER, OPTIONAL, INTENT(OUT) :: ierror

### Fortran binding

MPI\_FILE\_SYNC(FH, IERROR)

INTEGER FH, IERROR

Calling MPI\_FILE\_SYNC with `fh` causes all previous writes to `fh` by the calling process to be transferred to the storage device. If other processes have made updates to the storage device, then all such updates become visible to subsequent reads of `fh` by the calling process. MPI\_FILE\_SYNC may be necessary to ensure sequential consistency in certain cases (see above).

MPI\_FILE\_SYNC is a collective operation.

The user is responsible for ensuring that all nonblocking requests and split collective operations on `fh` have been completed before calling MPI\_FILE\_SYNC — otherwise, the call to MPI\_FILE\_SYNC is erroneous.

## 13.6.2 Random Access vs. Sequential Files

MPI distinguishes ordinary random access files from sequential stream files, such as pipes and tape files. Sequential stream files must be opened with the MPI\_MODE\_SEQUENTIAL flag set in the `amode`. For these files, the only permitted data access operations are shared file pointer reads and writes. Filetypes and etypes with holes are erroneous. In addition, the notion of file pointer is not meaningful; therefore, calls to MPI\_FILE\_SEEK\_SHARED and MPI\_FILE\_GET\_POSITION\_SHARED are erroneous, and the pointer update rules specified for the data access routines do not apply. The amount of data accessed by a data access operation will be the amount requested unless the end of file is reached or an error is raised.

*Rationale.* This implies that reading on a pipe will always wait until the requested amount of data is available or until the process writing to the pipe has issued an end of file. (*End of rationale.*)

1 Finally, for some sequential files, such as those corresponding to magnetic tapes or  
2 streaming network connections, writes to the file may be destructive. In other words, a  
3 write may act as a truncate (a `MPI_FILE_SET_SIZE` with size set to the current position)  
4 followed by the write.  
5

### 6 13.6.3 Progress

7  
8 The progress rules of MPI are both a promise to users and a set of constraints on imple-  
9 mentors. In cases where the progress rules restrict possible implementation choices more  
10 than the interface specification alone, the progress rules take precedence.

11 All blocking routines must complete in finite time unless an exceptional condition (such  
12 as resource exhaustion) causes an error.

13 Nonblocking data access routines inherit the following progress rule from nonblocking  
14 point to point communication: a nonblocking write is equivalent to a nonblocking send for  
15 which a receive is eventually posted, and a nonblocking read is equivalent to a nonblocking  
16 receive for which a send is eventually posted.

17 Finally, an implementation is free to delay progress of collective routines until all pro-  
18 cesses in the group associated with the collective call have invoked the routine. Once all  
19 processes in the group have invoked the routine, the progress rule of the equivalent noncol-  
20 lective routine must be followed.  
21

### 22 13.6.4 Collective File Operations

23 Collective file operations are subject to the same restrictions as collective communication  
24 operations. For a complete discussion, please refer to the semantics set forth in Section 5.14.

25 Collective file operations are collective over a duplicate of the communicator used to  
26 open the file — this duplicate communicator is implicitly specified via the file handle ar-  
27 gument. Different processes can pass different values for other arguments of a collective  
28 routine unless specified otherwise.  
29

### 30 13.6.5 Nonblocking Collective File Operations

31  
32 Nonblocking collective file operations are defined only for data access routines with explicit  
33 offsets and individual file pointers but not with shared file pointers.

34 Nonblocking collective file operations are subject to the same restrictions as blocking  
35 collective I/O operations. All processes belonging to the group of the communicator that  
36 was used to open the file must call collective I/O operations (blocking and nonblocking)  
37 in the same order. This is consistent with the ordering rules for collective operations in  
38 threaded environments. For a complete discussion, please refer to the semantics set forth  
39 in Section 5.14.

40 Nonblocking collective I/O operations do not match with blocking collective I/O oper-  
41 ations. Multiple nonblocking collective I/O operations can be outstanding on a single file  
42 handle. High quality MPI implementations should be able to support a large number of  
43 pending nonblocking I/O operations.

44 All nonblocking collective I/O calls are local and return immediately, irrespective of the  
45 status of other processes. The call initiates the operation which may progress independently  
46 of any communication, computation, or I/O. The call returns a request handle, which must  
47 be passed to a completion call. Input buffers should not be modified and output buffers  
48 should not be accessed before the completion call returns. The same progress rules described

for nonblocking collective operations apply for nonblocking collective I/O operations. For a complete discussion, please refer to the semantics set forth in Section 5.12.

### 13.6.6 Type Matching

The type matching rules for I/O mimic the type matching rules for communication with one exception: if `etype` is `MPI_BYTE`, then this matches any `datatype` in a data access operation. In general, the `etype` of data items written must match the `etype` used to read the items, and for each data access operation, the current `etype` must also match the type declaration of the data access buffer.

*Advice to users.* In most cases, use of `MPI_BYTE` as a wild card will defeat the file interoperability features of MPI. File interoperability can only perform automatic conversion between heterogeneous data representations when the exact `datatypes` accessed are explicitly specified. (*End of advice to users.*)

### 13.6.7 Miscellaneous Clarifications

Once an I/O routine completes, it is safe to free any opaque objects passed as arguments to that routine. For example, the `comm` and `info` used in an `MPI_FILE_OPEN`, or the `etype` and `filetype` used in an `MPI_FILE_SET_VIEW`, can be freed without affecting access to the file. Note that for nonblocking routines and split collective operations, the operation must be completed before it is safe to reuse data buffers passed as arguments.

As in communication, `datatypes` must be committed before they can be used in file manipulation or data access operations. For example, the `etype` and `filetype` must be committed before calling `MPI_FILE_SET_VIEW`, and the `datatype` must be committed before calling `MPI_FILE_READ` or `MPI_FILE_WRITE`.

### 13.6.8 MPI\_Offset Type

`MPI_Offset` is an integer type of size sufficient to represent the size (in bytes) of the largest file supported by MPI. Displacements and offsets are always specified as values of type `MPI_Offset`.

In Fortran, the corresponding integer is an integer with kind parameter `MPI_OFFSET_KIND`, which is defined in the `mpi_f08` module, the `mpi` module and the `mpif.h` include file.

In Fortran 77 environments that do not support `KIND` parameters, `MPI_Offset` arguments should be declared as an `INTEGER` of suitable size. The language interoperability implications for `MPI_Offset` are similar to those for addresses (see Section 18.2).

### 13.6.9 Logical vs. Physical File Layout

MPI specifies how the data should be laid out in a virtual file structure (the view), not how that file structure is to be stored on one or more disks. Specification of the physical file structure was avoided because it is expected that the mapping of files to disks will be system specific, and any specific control over file layout would therefore restrict program portability. However, there are still cases where some information may be necessary to optimize file layout. This information can be provided as *hints* specified via `info` when a file is created (see Section 13.2.8).

### 13.6.10 File Size

The size of a file may be increased by writing to the file after the current end of file. The size may also be changed by calling MPI *size changing* routines, such as `MPI_FILE_SET_SIZE`. A call to a size changing routine does not necessarily change the file size. For example, calling `MPI_FILE_PREALLOCATE` with a size less than the current size does not change the size.

Consider a set of bytes that has been written to a file since the most recent call to a size changing routine, or since `MPI_FILE_OPEN` if no such routine has been called. Let the *high byte* be the byte in that set with the largest displacement. The file size is the larger of

- One plus the displacement of the high byte.
- The size immediately after the size changing routine, or `MPI_FILE_OPEN`, returned.

When applying consistency semantics, calls to `MPI_FILE_SET_SIZE` and `MPI_FILE_PREALLOCATE` are considered writes to the file (which conflict with operations that access bytes at displacements between the old and new file sizes), and `MPI_FILE_GET_SIZE` is considered a read of the file (which overlaps with all accesses to the file).

*Advice to users.* Any sequence of operations containing the collective routines `MPI_FILE_SET_SIZE` and `MPI_FILE_PREALLOCATE` is a write sequence. As such, sequential consistency in nonatomic mode is not guaranteed unless the conditions in Section 13.6.1 are satisfied. (*End of advice to users.*)

File pointer update semantics (i.e., file pointers are updated by the amount accessed) are only guaranteed if file size changes are sequentially consistent.

*Advice to users.* Consider the following example. Given two operations made by separate processes to a file containing 100 bytes: an `MPI_FILE_READ` of 10 bytes and an `MPI_FILE_SET_SIZE` to 0 bytes. If the user does not enforce sequential consistency between these two operations, the file pointer may be updated by the amount requested (10 bytes) even if the amount accessed is zero bytes. (*End of advice to users.*)

### 13.6.11 Examples

The examples in this section illustrate the application of the MPI consistency and semantics guarantees. These address

- conflicting accesses on file handles obtained from a single collective open, and
- all accesses on file handles obtained from two separate collective opens.

The simplest way to achieve consistency for conflicting accesses is to obtain sequential consistency by setting atomic mode. For the code below, process 1 will read either 0 or 10 integers. If the latter, every element of `b` will be 5. If nonatomic mode is set, the results of the read are undefined.



```

/* Process 0 */
int i, a[10];
int TRUE = 1;

for (i=0;i<10;i++)
    a[i] = 5;

MPI_File_open(MPI_COMM_WORLD, "workfile",
              MPI_MODE_RDWR | MPI_MODE_CREATE, MPI_INFO_NULL, &fh0);
MPI_File_set_view(fh0, 0, MPI_INT, MPI_INT, "native", MPI_INFO_NULL);
MPI_File_set_atomicity(fh0, TRUE);
MPI_File_write_at(fh0, 0, a, 10, MPI_INT, &status);
/* MPI_Barrier(MPI_COMM_WORLD); */

```

```

/* Process 1 */
int b[10];
int TRUE = 1;
MPI_File_open(MPI_COMM_WORLD, "workfile",
              MPI_MODE_RDWR | MPI_MODE_CREATE, MPI_INFO_NULL, &fh1);
MPI_File_set_view(fh1, 0, MPI_INT, MPI_INT, "native", MPI_INFO_NULL);
MPI_File_set_atomicity(fh1, TRUE);
/* MPI_Barrier(MPI_COMM_WORLD); */
MPI_File_read_at(fh1, 0, b, 10, MPI_INT, &status);

```

A user may guarantee that the write on process 0 precedes the read on process 1 by imposing temporal order with, for example, calls to `MPI_BARRIER`.

*Advice to users.* Routines other than `MPI_BARRIER` may be used to impose temporal order. In the example above, process 0 could use `MPI_SEND` to send a 0 byte message, received by process 1 using `MPI_RECV`. (*End of advice to users.*)

Alternatively, a user can impose consistency with nonatomic mode set:

```

/* Process 0 */
int i, a[10];
for (i=0;i<10;i++)
    a[i] = 5;

MPI_File_open(MPI_COMM_WORLD, "workfile",
              MPI_MODE_RDWR | MPI_MODE_CREATE, MPI_INFO_NULL, &fh0);
MPI_File_set_view(fh0, 0, MPI_INT, MPI_INT, "native", MPI_INFO_NULL);
MPI_File_write_at(fh0, 0, a, 10, MPI_INT, &status );
MPI_File_sync(fh0);
MPI_Barrier(MPI_COMM_WORLD);
MPI_File_sync(fh0);

/* Process 1 */
int b[10];
MPI_File_open(MPI_COMM_WORLD, "workfile",

```

```

1         MPI_MODE_RDWR | MPI_MODE_CREATE, MPI_INFO_NULL, &fh1);
2 MPI_File_set_view(fh1, 0, MPI_INT, MPI_INT, "native", MPI_INFO_NULL);
3 MPI_File_sync(fh1);
4 MPI_Barrier(MPI_COMM_WORLD);
5 MPI_File_sync(fh1);
6 MPI_File_read_at(fh1, 0, b, 10, MPI_INT, &status);

```

The “sync-barrier-sync” construct is required because:

- The barrier ensures that the write on process 0 occurs before the read on process 1.
- The first sync guarantees that the data written by all processes is transferred to the storage device.
- The second sync guarantees that all data which has been transferred to the storage device is visible to all processes. (This does not affect process 0 in this example.)

The following program represents an erroneous attempt to achieve consistency by eliminating the apparently superfluous second “sync” call for each process.

```

18 /* ----- THIS EXAMPLE IS ERRONEOUS ----- */
19 /* Process 0 */
20 int i, a[10];
21 for (i=0;i<10;i++)
22     a[i] = 5;
23
24 MPI_File_open(MPI_COMM_WORLD, "workfile",
25              MPI_MODE_RDWR | MPI_MODE_CREATE, MPI_INFO_NULL, &fh0);
26 MPI_File_set_view(fh0, 0, MPI_INT, MPI_INT, "native", MPI_INFO_NULL);
27 MPI_File_write_at(fh0, 0, a, 10, MPI_INT, &status);
28 MPI_File_sync(fh0);
29 MPI_Barrier(MPI_COMM_WORLD);
30
31 /* Process 1 */
32 int b[10];
33 MPI_File_open(MPI_COMM_WORLD, "workfile",
34              MPI_MODE_RDWR | MPI_MODE_CREATE, MPI_INFO_NULL, &fh1);
35 MPI_File_set_view(fh1, 0, MPI_INT, MPI_INT, "native", MPI_INFO_NULL);
36 MPI_Barrier(MPI_COMM_WORLD);
37 MPI_File_sync(fh1);
38 MPI_File_read_at(fh1, 0, b, 10, MPI_INT, &status);
39
40 /* ----- THIS EXAMPLE IS ERRONEOUS ----- */

```

The above program also violates the MPI rule against out-of-order collective operations and will deadlock for implementations in which MPI\_FILE\_SYNC blocks.

*Advice to users.* Some implementations may choose to implement MPI\_FILE\_SYNC as a temporally synchronizing function. When using such an implementation, the “sync-barrier-sync” construct above can be replaced by a single “sync.” The results of using such code with an implementation for which MPI\_FILE\_SYNC is not temporally synchronizing is undefined. (*End of advice to users.*)

## Asynchronous I/O

The behavior of asynchronous I/O operations is determined by applying the rules specified above for synchronous I/O operations.

The following examples all access a preexisting file “myfile.” Word 10 in myfile initially contains the integer 2. Each example writes and reads word 10.

First consider the following code fragment:

```
int a = 4, b, TRUE=1;
MPI_File_open(MPI_COMM_WORLD, "myfile",
              MPI_MODE_RDWR, MPI_INFO_NULL, &fh);
MPI_File_set_view(fh, 0, MPI_INT, MPI_INT, "native", MPI_INFO_NULL);
/* MPI_File_set_atomicity(fh, TRUE); Use this to set atomic mode. */
MPI_File_iread_at(fh, 10, &a, 1, MPI_INT, &reqs[0]);
MPI_File_iread_at(fh, 10, &b, 1, MPI_INT, &reqs[1]);
MPI_Waitall(2, reqs, statuses);
```

For asynchronous data access operations, MPI specifies that the access occurs at any time between the call to the asynchronous data access routine and the return from the corresponding request complete routine. Thus, executing either the read before the write, or the write before the read is consistent with program order. If atomic mode is set, then MPI guarantees sequential consistency, and the program will read either 2 or 4 into b. If atomic mode is not set, then sequential consistency is not guaranteed and the program may read something other than 2 or 4 due to the conflicting data access.

Similarly, the following code fragment does not order file accesses:

```
int a = 4, b;
MPI_File_open(MPI_COMM_WORLD, "myfile",
              MPI_MODE_RDWR, MPI_INFO_NULL, &fh);
MPI_File_set_view(fh, 0, MPI_INT, MPI_INT, "native", MPI_INFO_NULL);
/* MPI_File_set_atomicity(fh, TRUE); Use this to set atomic mode. */
MPI_File_iread_at(fh, 10, &a, 1, MPI_INT, &reqs[0]);
MPI_File_iread_at(fh, 10, &b, 1, MPI_INT, &reqs[1]);
MPI_Wait(&reqs[0], &status);
MPI_Wait(&reqs[1], &status);
```

If atomic mode is set, either 2 or 4 will be read into b. Again, MPI does not guarantee sequential consistency in nonatomic mode.

On the other hand, the following code fragment:

```
int a = 4, b;
MPI_File_open(MPI_COMM_WORLD, "myfile",
              MPI_MODE_RDWR, MPI_INFO_NULL, &fh);
MPI_File_set_view(fh, 0, MPI_INT, MPI_INT, "native", MPI_INFO_NULL);
MPI_File_iread_at(fh, 10, &a, 1, MPI_INT, &reqs[0]);
MPI_Wait(&reqs[0], &status);
MPI_File_iread_at(fh, 10, &b, 1, MPI_INT, &reqs[1]);
MPI_Wait(&reqs[1], &status);
```

defines the same ordering as:

```

1  int a = 4, b;
2  MPI_File_open(MPI_COMM_WORLD, "myfile",
3                MPI_MODE_RDWR, MPI_INFO_NULL, &fh);
4  MPI_File_set_view(fh, 0, MPI_INT, MPI_INT, "native", MPI_INFO_NULL);
5  MPI_File_write_at(fh, 10, &a, 1, MPI_INT, &status );
6  MPI_File_read_at(fh, 10, &b, 1, MPI_INT, &status );

```

Since

- nonconcurrent operations on a single file handle are sequentially consistent, and
- the program fragments specify an order for the operations,

MPI guarantees that both program fragments will read the value 4 into `b`. There is no need to set atomic mode for this example.

Similar considerations apply to conflicting accesses of the form:

```

16 MPI_File_iread_all(fh,...);
17 MPI_File_iwrite_all(fh,...);
18 MPI_Waitall(...);

```

In addition, as mentioned in Section 13.6.5, nonblocking collective I/O operations have to be called in the same order on the file handle by all processes.

Similar considerations apply to conflicting accesses of the form:

```

24 MPI_File_write_all_begin(fh,...);
25 MPI_File_iread(fh,...);
26 MPI_Wait(fh,...);
27 MPI_File_write_all_end(fh,...);

```

Recall that constraints governing consistency and semantics are not relevant to the following:

```

31 MPI_File_write_all_begin(fh,...);
32 MPI_File_read_all_begin(fh,...);
33 MPI_File_read_all_end(fh,...);
34 MPI_File_write_all_end(fh,...);

```

since split collective operations on the same file handle may not overlap (see Section 13.4.5).

## 13.7 I/O Error Handling

By default, communication errors are fatal — `MPI_ERRORS_ARE_FATAL` is the default error handler associated with `MPI_COMM_WORLD`. I/O errors are usually less catastrophic (e.g., “file not found”) than communication errors, and common practice is to catch these errors and continue executing. For this reason, MPI provides additional error facilities for I/O.

*Advice to users.* MPI does not specify the state of a computation after an erroneous MPI call has occurred. A high-quality implementation will support the I/O error handling facilities, allowing users to write programs using common practice for I/O. (*End of advice to users.*)

Like communicators, each file handle has an error handler associated with it. The MPI I/O error handling routines are defined in Section 8.3.

When MPI calls a user-defined error handler resulting from an error on a particular file handle, the first two arguments passed to the file error handler are the file handle and the error code. For I/O errors that are not associated with a valid file handle (e.g., in `MPI_FILE_OPEN` or `MPI_FILE_DELETE`), the first argument passed to the error handler is `MPI_FILE_NULL`.

I/O error handling differs from communication error handling in another important aspect. By default, the predefined error handler for file handles is `MPI_ERRORS_RETURN`. The **default file error** handler has two purposes: when a new file handle is created (by `MPI_FILE_OPEN`), the error handler for the new file handle is initially set to the default file error handler, and I/O routines that have no valid file handle on which to raise an error (e.g., `MPI_FILE_OPEN` or `MPI_FILE_DELETE`) use the default file error handler. The default file error handler can be changed by specifying `MPI_FILE_NULL` as the `fh` argument to `MPI_FILE_SET_ERRHANDLER`. The current value of the default file error handler can be determined by passing `MPI_FILE_NULL` as the `fh` argument to `MPI_FILE_GET_ERRHANDLER`.

*Rationale.* For communication, the default error handler is inherited from `MPI_COMM_WORLD` when using the World Model. In I/O, there is no analogous “root” file handle from which default properties can be inherited. Rather than invent a new global file handle, the default file error handler is manipulated as if it were attached to `MPI_FILE_NULL`. (*End of rationale.*)

## 13.8 I/O Error Classes

The implementation dependent error codes returned by the I/O routines can be converted into the error classes defined in Table 13.5.

In addition, calls to routines in this chapter may raise errors in other MPI classes, such as `MPI_ERR_TYPE`.

## 13.9 Examples

### 13.9.1 Double Buffering with Split Collective I/O

This example shows how to overlap computation and output. The computation is performed by the function `compute_buffer()`.

```

/*=====
*
* Function:          double_buffer
*
* Synopsis:
*   void double_buffer(
*       MPI_File fh,                ** IN
*       MPI_Datatype buftype,       ** IN
*       int bufcount                 ** IN
*   )

```

1	MPI_ERR_FILE	Invalid file handle
2	MPI_ERR_NOT_SAME	Collective argument not identical on all
3		processes, or collective routines called in
4		a different order by different processes
5	MPI_ERR_AMODE	Error related to the <code>amode</code> passed to
6		<code>MPI_FILE_OPEN</code>
7	MPI_ERR_UNSUPPORTED_DATAREP	Unsupported <code>datarep</code> passed to
8		<code>MPI_FILE_SET_VIEW</code>
9	MPI_ERR_UNSUPPORTED_OPERATION	Unsupported operation, such as seeking on
10		a file which supports sequential access only
11	MPI_ERR_NO_SUCH_FILE	File does not exist
12	MPI_ERR_FILE_EXISTS	File exists
13	MPI_ERR_BAD_FILE	Invalid file name (e.g., path name too long)
14	MPI_ERR_ACCESS	Permission denied
15	MPI_ERR_NO_SPACE	Not enough space
16	MPI_ERR_QUOTA	Quota exceeded
17	MPI_ERR_READ_ONLY	Read-only file or file system
18	MPI_ERR_FILE_IN_USE	File operation could not be completed, as
19		the file is currently open by some process
20	MPI_ERR_DUP_DATAREP	Conversion functions could not be regis-
21		tered because a data representation identi-
22		fier that was already defined was passed to
23		<code>MPI_REGISTER_DATAREP</code>
24	MPI_ERR_CONVERSION	An error occurred in a user supplied data
25		conversion function.
26	MPI_ERR_IO	Other I/O error

Table 13.5: I/O Error Classes

27  
28  
29  
30  
31  
32  
33  
34  
35  
36  
37  
38  
39  
40  
41  
42  
43  
44  
45  
46  
47  
48

```

* 1
* Description: 2
*   Performs the steps to overlap computation with a collective write 3
*   by using a double-buffering technique. 4
* 5
* Parameters: 6
*   fh          previously opened MPI file handle 7
*   buftype     MPI datatype for memory layout 8
*               (Assumes a compatible view has been set on fh) 9
*   bufcount    # buftype elements to transfer 10
*-----*/ 11
12
/* this macro switches which buffer "x" is pointing to */ 13
#define TOGGLE_PTR(x) (((x)==(buffer1)) ? (x=buffer2) : (x=buffer1)) 14
15
void double_buffer(MPI_File fh, MPI_Datatype buftype, int bufcount) 16
{ 17
18
    MPI_Status status;          /* status for MPI calls */ 19
    float *buffer1, *buffer2;  /* buffers to hold results */ 20
    float *compute_buf_ptr;    /* destination buffer */ 21
                                /* for computing */ 22
    float *write_buf_ptr;      /* source for writing */ 23
    int done;                  /* determines when to quit */ 24
25

    /* buffer initialization */ 26
    buffer1 = (float *) 27
                malloc(bufcount*sizeof(float)); 28
    buffer2 = (float *) 29
                malloc(bufcount*sizeof(float)); 30
    compute_buf_ptr = buffer1;  /* initially point to buffer1 */ 31
    write_buf_ptr   = buffer1; /* initially point to buffer1 */ 32
33
34
    /* DOUBLE-BUFFER prolog: 35
     *   compute buffer1; then initiate writing buffer1 to disk 36
     */ 37
    compute_buffer(compute_buf_ptr, bufcount, &done); 38
    MPI_File_write_all_begin(fh, write_buf_ptr, bufcount, buftype); 39
40

    /* DOUBLE-BUFFER steady state: 41
     *   Overlap writing old results from buffer pointed to by write_buf_ptr 42
     *   with computing new results into buffer pointed to by compute_buf_ptr. 43
     */ 44
     *   There is always one write-buffer and one compute-buffer in use 45
     *   during steady state. 46
     */ 47
    while (!done) { 48

```

```

1     TOGGLE_PTR(compute_buf_ptr);
2     compute_buffer(compute_buf_ptr, bufcount, &done);
3     MPI_File_write_all_end(fh, write_buf_ptr, &status);
4     TOGGLE_PTR(write_buf_ptr);
5     MPI_File_write_all_begin(fh, write_buf_ptr, bufcount, buftype);
6 }
7
8 /* DOUBLE-BUFFER epilog:
9  *   wait for final write to complete.
10  */
11 MPI_File_write_all_end(fh, write_buf_ptr, &status);
12
13
14 /* buffer cleanup */
15 free(buffer1);
16 free(buffer2);
17 }
18

```

### 13.9.2 Subarray Filetype Constructor

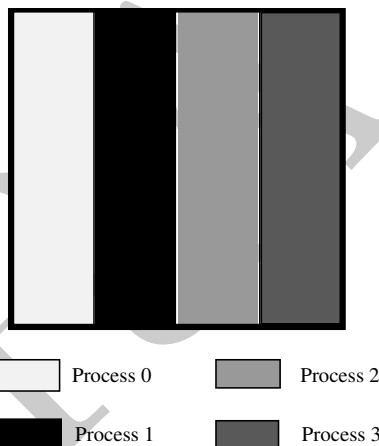

Figure 13.4: Example array file layout

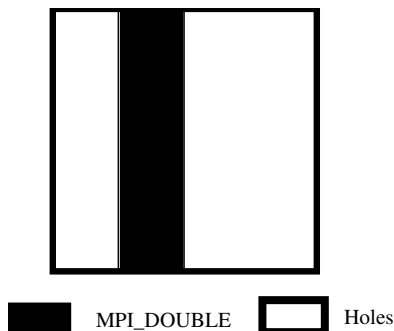

Figure 13.5: Example local array filetype for process 1



Assume we are writing out a  $100 \times 100$  2D array of double precision floating point numbers that is distributed among 4 processes such that each process has a block of 25 columns (e.g., process 0 has columns 0–24, process 1 has columns 25–49, etc.; see Figure 13.4). To create the filetypes for each process one could use the following C program (see Section 4.1.3):

```
double subarray[100][25];
MPI_Datatype filetype;
int sizes[2], subsizes[2], starts[2];
int rank;

MPI_Comm_rank(MPI_COMM_WORLD, &rank);
sizes[0]=100; sizes[1]=100;
subsizes[0]=100; subsizes[1]=25;
starts[0]=0; starts[1]=rank*subsizes[1];

MPI_Type_create_subarray(2, sizes, subsizes, starts, MPI_ORDER_C,
                        MPI_DOUBLE, &filetype);
```

Or, equivalently in Fortran:

```
double precision subarray(100,25)
integer filetype, rank, ierror
integer sizes(2), subsizes(2), starts(2)

call MPI_COMM_RANK(MPI_COMM_WORLD, rank, ierror)
sizes(1) = 100
sizes(2) = 100
subsizes(1) = 100
subsizes(2) = 25
starts(1) = 0
starts(2) = rank*subsizes(2)

call MPI_TYPE_CREATE_SUBARRAY(2, sizes, subsizes, starts, &
                             MPI_ORDER_FORTRAN, MPI_DOUBLE_PRECISION, &
                             filetype, ierror)
```

The generated filetype will then describe the portion of the file contained within the process's subarray with holes for the space taken by the other processes. Figure 13.5 shows the filetype created for process 1.

1  
2  
3  
4  
5  
6  
7  
8  
9  
10  
11  
12  
13  
14  
15  
16  
17  
18  
19  
20  
21  
22  
23  
24  
25  
26  
27  
28  
29  
30  
31  
32  
33  
34  
35  
36  
37  
38  
39  
40  
41  
42  
43  
44  
45  
46  
47  
48

DRAFT

# Chapter 14

## Tool Support

### 14.1 Introduction

This chapter discusses interfaces that allow debuggers, performance analyzers, and other tools to extract information about the operation of MPI processes. Specifically, this chapter defines both the MPI profiling interface (Section 14.2), which supports the transparent interception and inspection of MPI calls, and the MPI tool information interface (Section 14.3), which supports the inspection and manipulation of MPI control and performance variables, as well as the registration of callbacks for MPI library events. The interfaces described in this chapter are all defined in the context of an MPI process, i.e., are callable from the same code that invokes other MPI functions.

### 14.2 Profiling Interface

#### 14.2.1 Requirements

To meet the requirements for the MPI profiling interface, an implementation of the MPI functions *must*

1. provide a mechanism through which all of the MPI defined functions, except those allowed as macros (See Section 2.6.4), may be accessed with a name shift. This requires, in C and Fortran, an alternate entry point name, with the prefix `PMPI_` for each MPI function in each provided language binding and language support method. For routines implemented as macros, it is still required that the `PMPI_` version be supplied and work as expected, but it is not possible to replace at link time the `MPI_` version with a user-defined version.

For Fortran, the different support methods cause several specific procedure names. Therefore, several profiling routines (with these specific procedure names) are needed for each Fortran MPI routine, as described in Section 18.1.5.

2. ensure that those MPI functions that are not replaced may still be linked into an executable image without causing name clashes.
3. document the implementation of different language bindings of the MPI interface if they are layered on top of each other, so that the profiler developer knows whether she must implement the profile interface for each binding, or can economize by implementing it only for the lowest level routines.

- 1 4. where the implementation of different language bindings is done through a layered  
2 approach (e.g., the Fortran binding is a set of “wrapper” functions that call the C  
3 implementation), ensure that these wrapper functions are separable from the rest of  
4 the library.

5 This separability is necessary to allow a separate profiling library to be correctly  
6 implemented, since (at least with Unix linker semantics) the profiling library must  
7 contain these wrapper functions if it is to perform as expected. This requirement  
8 allows the person who builds the profiling library to extract these functions from the  
9 original MPI library and add them into the profiling library without bringing along  
10 any other unnecessary code.

- 11
- 12 5. provide a no-op routine `MPI_PCONTROL` in the MPI library.
- 13

## 14 14.2.2 Discussion

15 The objective of the MPI profiling interface is to ensure that it is relatively easy for authors  
16 of profiling (and other similar) tools to interface their codes to MPI implementations on  
17 different machines.

18 Since MPI is a machine independent standard with many different implementations,  
19 it is unreasonable to expect that the authors of profiling tools for MPI will have access to  
20 the source code that implements MPI on any particular machine. It is therefore necessary  
21 to provide a mechanism by which the implementors of such tools can collect whatever  
22 performance information they wish *without* access to the underlying implementation.

23 We believe that having such an interface is important if MPI is to be attractive to end  
24 users, since the availability of many different tools will be a significant factor in attracting  
25 users to the MPI standard.

26 The profiling interface is just that, an interface. It says *nothing* about the way in which  
27 it is used. There is therefore no attempt to lay down what information is collected through  
28 the interface, or how the collected information is saved, filtered, or displayed.

29 While the initial impetus for the development of this interface arose from the desire to  
30 permit the implementation of profiling tools, it is clear that an interface like that specified  
31 may also prove useful for other purposes, such as “internetworking” multiple MPI imple-  
32 mentations. Since all that is defined is an interface, there is no objection to its being used  
33 wherever it is useful.

34 As the issues being addressed here are intimately tied up with the way in which ex-  
35 ecutable images are built, which may differ greatly on different machines, the examples  
36 given below should be treated solely as one way of implementing the objective of the MPI  
37 profiling interface. The actual requirements made of an implementation are those detailed  
38 in the Requirements section above, the whole of the rest of this section is only present as  
39 justification and discussion of the logic for those requirements.

40 The examples below show one way in which an implementation could be constructed to  
41 meet the requirements on a Unix system (there are doubtless others that would be equally  
42 valid).

## 43 44 14.2.3 Logic of the Design

45 Provided that an MPI implementation meets the requirements above, it is possible for  
46 the implementor of the profiling system to intercept the MPI calls that are made by the  
47  
48

user program. She can then collect whatever information she requires before calling the underlying MPI implementation (through its name shifted entry points) to achieve the desired effects.

#### 14.2.4 Miscellaneous Control of Profiling

There is a clear requirement for the user code to be able to control the profiler dynamically at run time. This capability is normally used for (at least) the purposes of

- Enabling and disabling profiling depending on the state of the calculation.
- Flushing trace buffers at non-critical points in the calculation.
- Adding user events to a trace file.

These requirements are met by use of `MPI_PCONTROL`.

`MPI_PCONTROL(level, ...)`

IN            level                                    Profiling level (integer)

##### C binding

`int MPI_Pcontrol(const int level, ...)`

##### Fortran 2008 binding

`MPI_Pcontrol(level)`  
`INTEGER, INTENT(IN) :: level`

##### Fortran binding

`MPI_PCONTROL(LEVEL)`  
`INTEGER LEVEL`

MPI libraries themselves make no use of this routine, and simply return immediately to the user code. However the presence of calls to this routine allows a profiling package to be explicitly called by the user.

Since MPI has no control of the implementation of the profiling code, we are unable to specify precisely the semantics that will be provided by calls to `MPI_PCONTROL`. This vagueness extends to the number of arguments to the function, and their datatypes.

However to provide some level of portability of user codes to different profiling libraries, we request the following meanings for certain values of `level`.

- `level==0` Profiling is disabled.
- `level==1` Profiling is enabled at a normal default level of detail.
- `level==2` Profile buffers are flushed, which may be a no-op in some profilers.
- All other values of `level` have profile library defined effects and additional arguments.

We also request that the default state after MPI has been initialized is for profiling to be enabled at the normal default level. (i.e., as if `MPI_PCONTROL` had just been called with the argument 1). This allows users to link with a profiling library and to obtain profile output without having to modify their source code at all.

1 The provision of MPI\_PCONTROL as a no-op in the standard MPI library supports the  
 2 collection of more detailed profiling information with source code that can still link against  
 3 the standard MPI library.

#### 5 14.2.5 Profiler Implementation Example

6 A profiler can accumulate the total amount of data sent by the MPI\_SEND function, along  
 7 with the total elapsed time spent in the function as the following example shows:  
 8

##### 9 **Example 14.1**

```
10
11 static int totalBytes = 0;
12 static double totalTime = 0.0;
13
14 int MPI_Send(const void* buffer, int count, MPI_Datatype datatype,
15             int dest, int tag, MPI_Comm comm)
16 {
17     double tstart = MPI_Wtime();      /* Pass on all arguments */
18     int size;
19     int result = PMPI_Send(buffer, count, datatype, dest, tag, comm);
20
21     totalTime += MPI_Wtime() - tstart; /* and time */
22
23     MPI_Type_size(datatype, &size); /* Compute size */
24     totalBytes += count*size;
25
26     return result;
27 }
28
```

#### 29 14.2.6 MPI Library Implementation Example

30 If the MPI library is implemented in C on a Unix system, then there are various options,  
 31 including the two presented here, for supporting the name-shift requirement. The choice  
 32 between these two options depends partly on whether the linker and compiler support weak  
 33 symbols.  
 34

##### 35 **Systems with Weak Symbols**

36 If the compiler and linker support weak external symbols (e.g., Solaris 2.x, other System  
 37 V.4 machines), then only a single library is required as the following example shows:  
 38

##### 39 **Example 14.2**

```
40
41 #pragma weak MPI_Example = PMPI_Example
42
43 int PMPI_Example(/* appropriate args */)
44 {
45     /* Useful content */
46 }
47
48
```

The effect of this `#pragma` is to define the external symbol `MPI_Example` as a weak definition. This means that the linker will not complain if there is another definition of the symbol (for instance in the profiling library); however if no other definition exists, then the linker will use the weak definition.

### Systems without Weak Symbols

In the absence of weak symbols then one possible solution would be to use the `C` macro preprocessor as the following example shows:

#### Example 14.3

```
#ifndef PROFILELIB
#   ifdef __STDC__
#       define FUNCTION(name) P##name
#   else
#       define FUNCTION(name) P/**/name
#   endif
#else
#   define FUNCTION(name) name
#endif
```

Each of the user visible functions in the library would then be declared thus

```
int FUNCTION(MPI_Example)(/* appropriate args */)
{
    /* Useful content */
}
```

The same source file can then be compiled to produce both versions of the library, depending on the state of the `PROFILELIB` macro symbol.

It is required that the standard MPI library be built in such a way that the inclusion of MPI functions can be achieved one at a time. This is a somewhat unpleasant requirement, since it may mean that each external function has to be compiled from a separate file. However this is necessary so that the author of the profiling library need only define those MPI functions that she wishes to intercept, references to any others being fulfilled by the normal MPI library. Therefore the link step can look something like this

```
% cc ... -lmyprof -lmpmi -lmpi
```

Here `libmyprof.a` contains the profiler functions that intercept some of the MPI functions, `libmpmi.a` contains the “name shifted” MPI functions, and `libmpi.a` contains the normal definitions of the MPI functions.

### 14.2.7 Complications

#### Multiple Counting

Since parts of the MPI library may themselves be implemented using more basic MPI functions (e.g., a portable implementation of the collective operations implemented using point

1 to point communications), there is potential for profiling functions to be called from within  
2 an MPI function that was called from a profiling function. This could lead to “double  
3 counting” of the time spent in the inner routine. Since this effect could actually be useful  
4 under some circumstances (e.g., it might allow one to answer the question “How much time  
5 is spent in the point to point routines when they are called from collective functions?”), we  
6 have decided not to enforce any restrictions on the author of the MPI library that would  
7 overcome this. Therefore the author of the profiling library should be aware of this problem,  
8 and guard against it. In a single-threaded world this is easily achieved through use of a  
9 static variable in the profiling code that remembers if you are already inside a profiling  
10 routine. It becomes more complex in a multi-threaded environment (as does the meaning  
11 of the times recorded).

### 13 Linker Oddities

14 The Unix linker traditionally operates in one pass: the effect of this is that functions from  
15 libraries are only included in the image if they are needed at the time the library is scanned.  
16 When combined with weak symbols, or multiple definitions of the same function, this can  
17 cause odd (and unexpected) effects.

18 Consider, for instance, an implementation of MPI in which the Fortran binding is  
19 achieved by using wrapper functions on top of the C implementation. The author of the  
20 profile library then assumes that it is reasonable only to provide profile functions for the C  
21 binding, since Fortran will eventually call these, and the cost of the wrappers is assumed  
22 to be small. However, if the wrapper functions are not in the profiling library, then none  
23 of the profiled entry points will be undefined when the profiling library is called. Therefore  
24 none of the profiling code will be included in the image. When the standard MPI library  
25 is scanned, the Fortran wrappers will be resolved, and will also pull in the base versions of  
26 the MPI functions. The overall effect is that the code will link successfully, but will not be  
27 profiled.

28 To overcome this we must ensure that the Fortran wrapper functions are included in  
29 the profiling version of the library. We ensure that this is possible by requiring that these  
30 be separable from the rest of the base MPI library. This allows them to be copied out of  
31 the base library and into the profiling one using a tool such as `ar`.

### 34 Fortran Support Methods

35 The different Fortran support methods and possible options for the support of subarrays  
36 (depending on whether the compiler can support `TYPE(*)`, `DIMENSION(...)` choice buffers)  
37 imply different specific procedure names for the same Fortran MPI routine. The rules and  
38 implications for the profiling interface are described in Section [18.1.5](#).

#### 40 14.2.8 Multiple Levels of Interception

41 The scheme given here does not directly support the nesting of profiling functions, since it  
42 provides only a single alternative name for each MPI function. Consideration was given to  
43 an implementation that would allow multiple levels of call interception, however we were  
44 unable to construct an implementation of this that did not have the following disadvantages

- 45 • assuming a particular implementation language,
- 46 • imposing a run time cost even when no profiling was taking place.



Since one of the objectives of MPI is to permit efficient, low latency implementations, and it is not the business of a standard to require a particular implementation language, we decided to accept the scheme outlined above.

Note, however, that it is possible to use the scheme above to implement a multi-level system, since the function called by the user may call many different profiling functions before calling the underlying MPI function. This capability has been demonstrated in the P<sup>N</sup>MPI tool infrastructure [54].

### 14.3 The MPI Tool Information Interface

MPI implementations often use internal variables to control their operation and performance and rely on internal events for their implementation. Understanding and manipulating these variables and tracking these events can provide a more efficient execution environment or improve performance for many applications. This section describes the MPI tool information interface, which provides a mechanism for MPI implementors to expose variables, each of which represents a particular property, setting, or performance measurement from within the MPI implementation, as well as expose events that can be tracked by tools. The interface is split into three parts: the first part provides information about, and supports the setting of, control variables through which the MPI implementation tunes its configuration. The second part provides access to performance variables that can provide insight into internal performance information of the MPI implementation. The third part enables tools to query available events within an MPI implementation and register callbacks for them.

To avoid restrictions on the MPI implementation, the MPI tool information interface allows the implementation to specify which control variables, performance variables, and events exist. Additionally, the user of the MPI tool information interface can obtain meta-data about each available variable or event, such as its datatype, and a textual description. The MPI tool information interface provides the necessary routines to find all variables and events that exist in a particular MPI implementation; to query their properties; to retrieve descriptions about their meaning; to access and, if appropriate, to alter their values; and (in case of events) set callbacks triggered by them.

Variables, events, and categories across connected MPI processes with equivalent names are required to have the same meaning (see the definition of “equivalent” as related to strings in Section 14.3.3). Furthermore, enumerations with equivalent names across connected MPI processes are required to have the same meaning, but are allowed to comprise different enumeration items. Enumeration items that have equivalent names across connected MPI processes in enumerations with the same meaning must also have the same meaning. In order for variables and categories to have the same meaning, routines in the tools information interface that return details for those variables and categories have requirements on what parameters must be identical. These requirements are specified in their respective sections.

*Rationale.* The intent of requiring the same meaning for entities with equivalent names is to enforce consistency across connected MPI processes. For example, variables describing the number of packets sent on different types of network devices should have different names to reflect their potentially different meanings. (*End of rationale.*)

The MPI tool information interface can be used independently from the MPI communication functionality. In particular, the routines of this interface can be called before MPI is

1 initialized and after MPI is finalized. In order to support this behavior cleanly, the MPI tool  
2 information interface uses separate initialization and finalization routines. All identifiers  
3 used in the MPI tool information interface have the prefix `MPI_T_`.

4 On success, all MPI tool information interface routines return `MPI_SUCCESS`, otherwise  
5 they return an appropriate and unique return code indicating the reason why the call was not  
6 successfully completed. Details on return codes can be found in Section 14.3.10. However,  
7 unsuccessful calls to the MPI tool information interface are not fatal and do not impact the  
8 execution of subsequent MPI routines.

9 Since the MPI tool information interface primarily focuses on tools and support li-  
10 braries, MPI implementations are only required to provide C bindings for functions and  
11 constants introduced in this section. Except where otherwise noted, all conventions and  
12 principles governing the C bindings of the MPI API also apply to the MPI tool information  
13 interface, which is available by including the `mpi.h` header file. All routines in this interface  
14 have local semantics.

15 *Advice to users.* The number and type of control variables, performance variables,  
16 and events can vary between MPI implementations, platforms and different builds of  
17 the same implementation on the same platform as well as between runs. Hence, any  
18 application relying on a particular variable will not be portable. Further, there is  
19 no guarantee that the number of variables and variable indices are the same across  
20 connected MPI processes.  
21

22 This interface is primarily intended for performance monitoring tools, support tools,  
23 and libraries controlling the application's environment. When maximum portability  
24 is desired, application programmers should either avoid using the MPI tool informa-  
25 tion interface or avoid being dependent on the existence of a particular control or  
26 performance variable or of a particular event. (*End of advice to users.*)  
27

### 28 14.3.1 Verbosity Levels

29 The MPI tool information interface provides access to internal configuration and perfor-  
30 mance information through a set of control and performance variables defined by the MPI  
31 implementation. Since some implementations may export a large number of variables,  
32 variables are classified by a verbosity level that categorizes both their intended audience  
33 (end users, performance tuners or MPI implementors) and a relative measure of level of  
34 detail (basic, detailed or all). These verbosity levels are described by a single integer.  
35 Table 14.1 lists the constants for all possible verbosity levels. The values of the con-  
36 stants are monotonic in the order listed in the table; i.e., `MPI_T_VERBOSITY_USER_BASIC`  
37 `< MPI_T_VERBOSITY_USER_DETAIL < ... < MPI_T_VERBOSITY_MPIDEV_ALL`.  
38

### 39 14.3.2 Binding MPI Tool Information Interface Variables to MPI Objects

40 Each MPI tool information interface variable provides access to a particular control setting  
41 or performance property of the MPI implementation. A variable may refer to a specific  
42 MPI object such as a communicator, datatype, or one-sided communication window, or the  
43 variable may refer more generally to the MPI environment of the process. Except for the  
44 last case, the variable must be bound to exactly one MPI object before it can be used.  
45 Table 14.2 lists all MPI object types to which an MPI tool information interface variable  
46 can be bound, together with the matching constant that MPI tool information interface  
47 routines return to identify the object type.  
48

MPI_T_VERBOSITY_USER_BASIC	Basic information of interest to users	1
MPI_T_VERBOSITY_USER_DETAIL	Detailed information of interest to users	2
MPI_T_VERBOSITY_USER_ALL	All remaining information of interest to users	3
MPI_T_VERBOSITY_TUNER_BASIC	Basic information required for tuning	4
MPI_T_VERBOSITY_TUNER_DETAIL	Detailed information required for tuning	5
MPI_T_VERBOSITY_TUNER_ALL	All remaining information required for tuning	6
MPI_T_VERBOSITY_MPIDEV_BASIC	Basic information for MPI implementors	7
MPI_T_VERBOSITY_MPIDEV_DETAIL	Detailed information for MPI implementors	8
MPI_T_VERBOSITY_MPIDEV_ALL	All remaining information for MPI implementors	9

Table 14.1: MPI tool information interface verbosity levels

Constant	MPI object
MPI_T_BIND_NO_OBJECT	N/A; applies globally to entire MPI process
MPI_T_BIND_MPI_COMM	MPI communicators
MPI_T_BIND_MPI_DATATYPE	MPI datatypes
MPI_T_BIND_MPI_ERRHANDLER	MPI error handlers
MPI_T_BIND_MPI_FILE	MPI file handles
MPI_T_BIND_MPI_GROUP	MPI groups
MPI_T_BIND_MPI_OP	MPI reduction operators
MPI_T_BIND_MPI_REQUEST	MPI requests
MPI_T_BIND_MPI_WIN	MPI windows for one-sided communication
MPI_T_BIND_MPI_MESSAGE	MPI message object
MPI_T_BIND_MPI_INFO	MPI info object
MPI_T_BIND_MPI_SESSION	MPI session object

Table 14.2: Constants to identify associations of variables

*Rationale.* Some variables have meanings tied to a specific MPI object. Examples include the number of send or receive operations that use a particular datatype, the number of times a particular error handler has been called, or the communication protocol and “eager limit” used for a particular communicator. Creating a new MPI tool information interface variable for each MPI object would cause the number of variables to grow without bound, since they cannot be reused to avoid naming conflicts. By associating MPI tool information interface variables with a specific MPI object, the MPI implementation only must specify and maintain a single variable, which can then be applied to as many MPI objects of the respective type as created during the program’s execution. (*End of rationale.*)

### 14.3.3 Convention for Returning Strings

Several MPI tool information interface functions return one or more strings. These functions have two arguments for each string to be returned: an OUT parameter that identifies a pointer to the buffer in which the string will be returned, and an INOUT parameter to pass the length of the buffer. The user is responsible for the memory allocation of the buffer and must pass the size of the buffer ( $n$ ) as the length argument. Let  $n$  be the length value specified to the function. On return, the function writes at most  $n - 1$  of the string’s

characters into the buffer, followed by a null terminator. If the returned string's length is greater than or equal to  $n$ , the string will be truncated to  $n - 1$  characters. In this case, the length of the string plus one (for the terminating null character) is returned in the length argument. If the user passes the null pointer as the buffer argument or passes 0 as the length argument, the function does not return the string and only returns the length of the string plus one in the length argument. If the user passes the null pointer as the length argument, the buffer argument is ignored and nothing is returned.

MPI implementations behave as if they have an internal character array that is copied to the output character array supplied by the user. Such output strings are only defined to be equivalent if their notional source-internal character arrays are identical (up to and including the null terminator), even if the output string is truncated due to a small input length parameter  $n$ .

### 14.3.4 Initialization and Finalization

The MPI tool information interface requires a separate set of initialization and finalization routines.

`MPI_T_INIT_THREAD(required, provided)`

IN	required	desired level of thread support (integer)
OUT	provided	provided level of thread support (integer)

#### C binding

`int MPI_T_init_thread(int required, int *provided)`

All programs or tools that use the MPI tool information interface must initialize the MPI tool information interface in the processes that will use the interface before calling any other of its routines. A user can initialize the MPI tool information interface by calling `MPI_T_INIT_THREAD`, which can be called multiple times. In addition, this routine initializes the thread environment for all routines in the MPI tool information interface. Calling this routine when the MPI tool information interface is already initialized has no effect beyond increasing the reference count of how often the interface has been initialized. The argument `required` is used to specify the desired level of thread support. The possible values and their semantics are identical to the ones that can be used with `MPI_INIT_THREAD` listed in Section 10.6. The call returns in `provided` information about the actual level of thread support that will be provided by the MPI implementation for calls to MPI tool information interface routines. It can be one of the four values listed in Section 10.6.

The MPI specification does not require all MPI processes to exist before MPI is initialized. If the MPI tool information interface is used before initialization of MPI, the user is responsible for ensuring that the MPI tool information interface is initialized on all processes it is used in. Processes created by the MPI implementation during initialization inherit the status of the MPI tool information interface (whether it is initialized or not as well as all active sessions and handles) from the process from which they are created.

Processes created at runtime as a result of calls to MPI's dynamic process management require their own initialization before they can use the MPI tool information interface.

*Advice to users.* If `MPI_T_INIT_THREAD` is called before `MPI_INIT_THREAD`, the

requested and provided thread level for `MPI_T_INIT_THREAD` may influence the behavior and return value of `MPI_INIT_THREAD`. The same is true for the reverse order. Likewise, when using the Sessions Model (Section 10.3), the requested and provided thread level for `MPI_T_INIT_THREAD` may influence the behavior and return values of `MPI_SESSION_INIT` (see Section 10.3), with the same being true for the reverse order. (*End of advice to users.*)

*Advice to implementors.* MPI implementations should strive to make as many control or performance variables available before MPI initialization (instead of adding them during initialization) to allow tools the most flexibility. In particular, control variables should be available before MPI initialization if their value cannot be changed after MPI initialization. (*End of advice to implementors.*)

## MPI\_T\_FINALIZE()

### C binding

```
int MPI_T_finalize(void)
```

This routine finalizes the use of the MPI tool information interface and may be called as often as the corresponding `MPI_T_INIT_THREAD` routine up to the current point of execution. Calling it more times returns a corresponding error code. As long as the number of calls to `MPI_T_FINALIZE` is smaller than the number of calls to `MPI_T_INIT_THREAD` up to the current point of execution, the MPI tool information interface remains initialized and calls to its routines are permissible. Further, additional calls to `MPI_T_INIT_THREAD` after one or more calls to `MPI_T_FINALIZE` are permissible.

Once `MPI_T_FINALIZE` is called the same number of times as the routine `MPI_T_INIT_THREAD` up to the current point of execution, the MPI tool information interface is no longer initialized. The user can reinitialize the interface by a subsequent call to `MPI_T_INIT_THREAD`.

At the end of the program execution, unless `MPI_ABORT` is called, an application must have called `MPI_T_INIT_THREAD` and `MPI_T_FINALIZE` an equal number of times.

### 14.3.5 Datatype System

All variables managed through the MPI tool information interface represent their values through typed buffers of a given length and type using an MPI datatype (similar to regular send/receive buffers). Since the initialization of the MPI tool information interface is separate from the initialization of MPI, MPI tool information interface routines can be called before MPI initialization. Consequently, these routines can also use MPI datatypes before MPI initialization. Therefore, within the context of the MPI tool information interface, it is permissible to use a subset of MPI datatypes as specified below before MPI initialization.

*Rationale.* The MPI tool information interface relies mainly on unsigned datatypes for integer values since most variables are expected to represent counters or resource sizes. `MPI_INT` is provided for additional flexibility and is expected to be used mainly for control variables and enumeration types (see below).

Providing all basic datatypes, in particular providing all signed and unsigned variants of integer types, would lead to a larger number of types, which tools need to interpret.

```

1      MPI_INT
2      MPI_INT32_T
3      MPI_INT64_T
4      MPI_UNSIGNED
5      MPI_UNSIGNED_LONG
6      MPI_UNSIGNED_LONG_LONG
7      MPI_UINT32_T
8      MPI_UINT64_T
9      MPI_COUNT
10     MPI_CHAR
11     MPI_DOUBLE
12
13

```

Table 14.3: MPI datatypes that can be used by the MPI tool information interface

This would cause unnecessary complexity in the implementation of tools based on the MPI tool information interface. (*End of rationale.*)

The MPI tool information interface only relies on a subset of the basic MPI datatypes and does not use any derived MPI datatypes. Table 14.3 lists all MPI datatypes that can be returned by the MPI tool information interface to represent its variables.

The use of the datatype `MPI_CHAR` in the MPI tool information interface implies a null-terminated character array, i.e., a string in the C language. If a variable has type `MPI_CHAR`, the value of the `count` parameter returned by `MPI_T_CVAR_HANDLE_ALLOC` and `MPI_T_PVAR_HANDLE_ALLOC` must be large enough to include any valid value, including its terminating null character. The contents of returned `MPI_CHAR` arrays are only defined from index 0 through the location of the first null character.

*Rationale.* The MPI tool information interface requires a significantly simpler type system than MPI itself. Therefore, only its required subset must be present before MPI initialization and MPI implementations do not need to initialize the complete MPI datatype system. (*End of rationale.*)

For variables of type `MPI_INT`, an MPI implementation can provide additional information by associating names with a fixed number of values. We refer to this information in the following as an enumeration. In this case, the respective calls that provide additional metadata for each control or performance variable, i.e., `MPI_T_CVAR_GET_INFO` (Section 14.3.6), `MPI_T_PVAR_GET_INFO` (Section 14.3.7), and `MPI_T_EVENT_GET_INFO` (Section 14.3.8), return a handle of type `MPI_T_enum` that can be passed to the following functions to extract additional information. Thus, the MPI implementation can describe variables with a fixed set of values that each represents a particular state. Each enumeration type can have  $N$  different values, with a fixed  $N$  that can be queried using `MPI_T_ENUM_GET_INFO`.

MPI\_T\_ENUM\_GET\_INFO(enumtype, num, name, name\_len) 1

IN	enumtype	enumeration to be queried (handle) <span style="float: right;">2</span>
OUT	num	number of discrete values represented by this enumeration (integer) <span style="float: right;">3</span>
OUT	name	buffer to return the string containing the name of the enumeration item (string) <span style="float: right;">4</span>
INOUT	name_len	length of the string and/or buffer for name (integer) <span style="float: right;">5</span>

### C binding 6

```
int MPI_T_enum_get_info(MPI_T_enum enumtype, int *num, char *name,
                        int *name_len) 7
```

If `enumtype` is a valid enumeration, this routine returns the number of items represented by this enumeration type as well as its name.  $N$  must be greater than 0, i.e., the enumeration must represent at least one value. 8

The arguments `name` and `name_len` are used to return the name of the enumeration as described in Section 14.3.3. 9

The routine is required to return a name of at least length one. This name must be unique with respect to all other names for enumerations that the MPI implementation uses. 10

Names associated with individual values in each enumeration `enumtype` can be queried using `MPI_T_ENUM_GET_ITEM`. 11

MPI\_T\_ENUM\_GET\_ITEM(enumtype, index, value, name, name\_len) 12

IN	enumtype	enumeration to be queried (handle) <span style="float: right;">13</span>
IN	index	number of the value to be queried in this enumeration (integer) <span style="float: right;">14</span>
OUT	value	variable value (integer) <span style="float: right;">15</span>
OUT	name	buffer to return the string containing the name of the enumeration item (string) <span style="float: right;">16</span>
INOUT	name_len	length of the string and/or buffer for name (integer) <span style="float: right;">17</span>

### C binding 18

```
int MPI_T_enum_get_item(MPI_T_enum enumtype, int index, int *value,
                        char *name, int *name_len) 19
```

The arguments `name` and `name_len` are used to return the name of the enumeration item as described in Section 14.3.3. 20

If completed successfully, the routine returns the name/value pair that describes the enumeration at the specified index. The call is further required to return a name of at least length one. This name must be unique with respect to all other names of items for the same enumeration. 21

### 14.3.6 Control Variables

The routines described in this section of the MPI tool information interface specification focus on the ability to list, query, and possibly set control variables exposed by the MPI implementation. These variables can typically be used by the user to fine tune properties and configuration settings of the MPI implementation. On many systems, such variables can be set using environment variables, although other configuration mechanisms may be available, such as configuration files or central configuration registries. A typical example that is available in several existing MPI implementations is the ability to specify an “eager limit,” i.e., an upper bound on the size of messages sent or received using an eager protocol.

#### Control Variable Query Functions

An MPI implementation exports a set of  $N$  control variables through the MPI tool information interface. If  $N$  is zero, then the MPI implementation does not export any control variables, otherwise the provided control variables are indexed from 0 to  $N - 1$ . This index number is used in subsequent calls to identify the individual variables.

An MPI implementation is allowed to increase the number of control variables during the execution of an MPI application when new variables become available through dynamic loading. However, MPI implementations are not allowed to change the index of a control variable or to delete a variable once it has been added to the set. When a variable becomes inactive, e.g., through dynamic unloading, accessing its value should return a corresponding error code.

*Advice to users.* While the MPI tool information interface guarantees that indices or variable properties do not change during a particular run of an MPI program, it does not provide a similar guarantee between runs. (*End of advice to users.*)

The following function can be used to query the number of control variables, `num_cvar`:

```
MPI_T_CVAR_GET_NUM(num_cvar)
```

OUT `num_cvar` returns number of control variables (integer)

#### C binding

```
int MPI_T_cvar_get_num(int *num_cvar)
```

The function `MPI_T_CVAR_GET_INFO` provides access to additional information for each variable.



MPI_T_CVAR_GET_INFO(cvar_index, name, name_len, verbosity, datatype, enumtype, desc,			1
desc_len, bind, scope)			2
IN	cvar_index	index of the control variable to be queried, value between 0 and num_cvar - 1 (integer)	3
			4
OUT	name	buffer to return the string containing the name of the control variable (string)	5
			6
INOUT	name_len	length of the string and/or buffer for name (integer)	7
			8
OUT	verbosity	verbosity level of this variable (integer)	9
			10
OUT	datatype	MPI datatype of the information stored in the control variable (handle)	11
			12
OUT	enumtype	optional descriptor for enumeration information (handle)	13
			14
OUT	desc	buffer to return the string containing a description of the control variable (string)	15
			16
INOUT	desc_len	length of the string and/or buffer for desc (integer)	17
			18
OUT	bind	type of MPI object to which this variable must be bound (integer)	19
			20
OUT	scope	scope of when changes to this variable are possible (integer)	21
			22

### C binding

```
int MPI_T_cvar_get_info(int cvar_index, char *name, int *name_len,
                       int *verbosity, MPI_Datatype *datatype, MPI_T_enum *enumtype,
                       char *desc, int *desc_len, int *bind, int *scope)
```

After a successful call to MPI\_T\_CVAR\_GET\_INFO for a particular variable, subsequent calls to this routine that query information about the same variable must return the same information. An MPI implementation is not allowed to alter any of the returned values.

If any OUT parameter to MPI\_T\_CVAR\_GET\_INFO is a NULL pointer, the implementation will ignore the parameter and not return a value for the parameter.

The arguments name and name\_len are used to return the name of the control variable as described in Section 14.3.3.

If completed successfully, the routine is required to return a name of at least length one. The name must be unique with respect to all other names for control variables used by the MPI implementation.

The argument verbosity returns the verbosity level of the variable (see Section 14.3.1).

The argument datatype returns the MPI datatype that is used to represent the control variable.

If the variable is of type MPI\_INT, MPI can optionally specify an enumeration for the values represented by this variable and return it in enumtype. In this case, MPI returns an enumeration identifier, which can then be used to gather more information as described in Section 14.3.5. Otherwise, enumtype is set to MPI\_T\_ENUM\_NULL. If the datatype is not MPI\_INT or the argument enumtype is the null pointer, no enumeration type is returned.

The arguments desc and desc\_len are used to return a description of the control variable as described in Section 14.3.3.

Returning a description is optional. If an MPI implementation does not return a description, the first character for `desc` must be set to the null character and `desc_len` must be set to one at the return of this call.

The parameter `bind` returns the type of the MPI object to which the variable must be bound or the value `MPI_T_BIND_NO_OBJECT` (see Section 14.3.2).

The scope of a variable determines whether changing a variable's value is either local to the MPI process or must be done by the user across multiple connected MPI processes. The latter is further split into variables that require changes in a group of MPI processes and those that require collective changes among all connected MPI processes. Both cases can require variables on all participating MPI processes either to be set to consistent (but potentially different) values or to equal values. The description provided with the variable must contain an explanation about the requirements and/or restrictions for setting the particular variable.

On successful return from `MPI_T_CVAR_GET_INFO`, the argument `scope` will be set to one of the constants listed in Table 14.4.

If the name of a control variable is equivalent across connected MPI processes, the following OUT parameters must be identical: `verbosity`, `datatype`, `enumtype`, `bind`, and `scope`. The returned description must be equivalent.

Scope Constant	Description
<code>MPI_T_SCOPE_CONSTANT</code>	read-only, value is constant
<code>MPI_T_SCOPE_READONLY</code>	read-only, cannot be written, but can change
<code>MPI_T_SCOPE_LOCAL</code>	may be writeable, writing is a local operation
<code>MPI_T_SCOPE_GROUP</code>	may be writeable, must be set to consistent values across a group of connected MPI processes
<code>MPI_T_SCOPE_GROUP_EQ</code>	may be writeable, must be set to the same value across a group of connected MPI processes
<code>MPI_T_SCOPE_ALL</code>	may be writeable, must be set to consistent values across all connected MPI processes
<code>MPI_T_SCOPE_ALL_EQ</code>	may be writeable, must be set to the same value across all connected MPI processes

Table 14.4: Scopes for control variables

*Advice to users.* The `scope` of a variable only indicates if a variable might be changeable; it is not a guarantee that it can be changed at any time. (*End of advice to users.*)

`MPI_T_CVAR_GET_INDEX(name, cvar_index)`

IN        `name`                                name of the control variable (string)  
 OUT      `cvar_index`                        index of the control variable (integer)

### C binding

`int MPI_T_cvar_get_index(const char *name, int *cvar_index)`

MPI\_T\_CVAR\_GET\_INDEX is a function for retrieving the index of a control variable given a known variable name. The name parameter is provided by the caller, and cvar\_index is returned by the MPI implementation. The name parameter is a string terminated with a null character.

This routine returns MPI\_SUCCESS on success and returns MPI\_T\_ERR\_INVALID\_NAME if name does not match the name of any control variable provided by the implementation at the time of the call.

*Rationale.* This routine is provided to enable fast retrieval of control variables by a tool, assuming it knows the name of the variable for which it is looking. The number of variables exposed by the implementation can change over time, so it is not possible for the tool to simply iterate over the list of variables once at initialization. Although using MPI implementation specific variable names is not portable across MPI implementations, tool developers may choose to take this route for lower overhead at runtime because the tool will not have to iterate over the entire set of variables to find a specific one. (*End of rationale.*)

Example: Printing All Control Variables

**Example 14.4** The following example shows how the MPI tool information interface can be used to query and to print the names of all available control variables.

```
#include <stdio.h>
#include <stdlib.h>
#include <mpi.h>

int main(int argc, char *argv[]) {
    int i, err, num, namelen, bind, verbose, scope;
    int threadsupport;
    char name[100];
    MPI_Datatype datatype;

    err=MPI_T_init_thread(MPI_THREAD_SINGLE,&threadsupport);
    if (err!=MPI_SUCCESS)
        return err;

    err=MPI_T_cvar_get_num(&num);
    if (err!=MPI_SUCCESS)
        return err;

    for (i=0; i<num; i++) {
        namelen=100;
        err=MPI_T_cvar_get_info(i, name, &namelen,
                               &verbose, &datatype, NULL,
                               NULL, NULL, /*no description */
                               &bind, &scope);
        if (err!=MPI_SUCCESS && err!=MPI_T_ERR_INVALID_INDEX) return err;
        printf("Var %i: %s\n", i, name);
    }
}
```

```

1   }
2
3   err=MPI_T_finalize();
4   if (err!=MPI_SUCCESS)
5       return 1;
6   else
7       return 0;
8   }
9

```

## 10 Handle Allocation and Deallocation

11 Before reading or writing the value of a variable, a user must first allocate a handle of type  
 12 MPI\_T\_cvar\_handle for the variable by binding it to an MPI object (see also Section 14.3.2).  
 13

14 *Rationale.* Handles used in the MPI tool information interface are distinct from  
 15 handles used in the remaining parts of the MPI standard because they must be usable  
 16 before MPI is initialized and after MPI is finalized. Further, accessing handles, in  
 17 particular for performance variables, can be time critical and having a separate handle  
 18 space enables optimizations. (*End of rationale.*)  
 19

## 22 MPI\_T\_CVAR\_HANDLE\_ALLOC(cvar\_index, obj\_handle, handle, count)

23	IN	cvar_index	index of control variable for which handle is to be al-
24			located (index)
25	IN	obj_handle	reference to a handle of the MPI object to which this
26			variable is supposed to be bound (pointer)
27			
28	OUT	handle	allocated handle (handle)
29	OUT	count	number of elements used to represent this variable (in-
30			teger)
31			

## 32 C binding

```

33 int MPI_T_cvar_handle_alloc(int cvar_index, void *obj_handle,
34     MPI_T_cvar_handle *handle, int *count)
35

```

36 This routine binds the control variable specified by the argument `index` to an MPI object.  
 37 The object is passed in the argument `obj_handle` as an address to a local variable that stores  
 38 the object's handle. The argument `obj_handle` is ignored if the `MPI_T_CVAR_GET_INFO`  
 39 call for this control variable returned `MPI_T_BIND_NO_OBJECT` in the argument `bind`. The  
 40 handle allocated to reference the variable is returned in the argument `handle`. Upon success-  
 41 ful return, `count` contains the number of elements (of the datatype returned by a previous  
 42 `MPI_T_CVAR_GET_INFO` call) used to represent this variable.  
 43

44 *Advice to users.* The `count` can be different based on the MPI object to which the  
 45 control variable was bound. For example, variables bound to communicators could  
 46 have a count that matches the size of the communicator.

47 It is not portable to pass references to predefined MPI object handles, such as  
 48 `MPI_COMM_WORLD` to this routine, since their implementation depends on the MPI

library. Instead, such object handles should be stored in a local variable and the address of this local variable should be passed into `MPI_T_CVAR_HANDLE_ALLOC`. (*End of advice to users.*)

The value of `cvar_index` should be in the range 0 to `num_cvar - 1`, where `num_cvar` is the number of available control variables as determined from a prior call to `MPI_T_CVAR_GET_NUM`. The type of the MPI object it references must be consistent with the type returned in the `bind` argument in a prior call to `MPI_T_CVAR_GET_INFO`.

`MPI_T_CVAR_HANDLE_FREE(handle)`

INOUT handle handle to be freed (handle)

### C binding

`int MPI_T_cvar_handle_free(MPI_T_cvar_handle *handle)`

When a handle is no longer needed, a user of the MPI tool information interface should call `MPI_T_CVAR_HANDLE_FREE` to free the handle and the associated resources in the MPI implementation. On a successful return, MPI sets the handle to `MPI_T_CVAR_HANDLE_NULL`.

### Control Variable Access Functions

`MPI_T_CVAR_READ(handle, buf)`

IN handle handle to the control variable to be read (handle)  
 OUT buf initial address of storage location for variable value  
 (choice)

### C binding

`int MPI_T_cvar_read(MPI_T_cvar_handle handle, void *buf)`

This routine queries the value of a control variable identified by the argument `handle` and stores the result in the buffer identified by the parameter `buf`. The user must ensure that the buffer is of the appropriate size to hold the entire value of the control variable (based on the returned datatype and count from prior corresponding calls to `MPI_T_CVAR_GET_INFO` and `MPI_T_CVAR_HANDLE_ALLOC`, respectively).

`MPI_T_CVAR_WRITE(handle, buf)`

IN handle handle to the control variable to be written (handle)  
 IN buf initial address of storage location for variable value  
 (choice)

### C binding

`int MPI_T_cvar_write(MPI_T_cvar_handle handle, const void *buf)`

1 This routine sets the value of the control variable identified by the argument `handle` to  
 2 the data stored in the buffer identified by the parameter `buf`. The user must ensure that the  
 3 buffer is of the appropriate size to hold the entire value of the control variable (based on the  
 4 returned datatype and count from prior corresponding calls to `MPI_T_CVAR_GET_INFO`  
 5 and `MPI_T_CVAR_HANDLE_ALLOC`, respectively).

6 If the variable has a global scope (as returned by a prior corresponding  
 7 `MPI_T_CVAR_GET_INFO` call), any write call to this variable must be issued by the user  
 8 in all connected (as defined in Section 10.10.4) MPI processes. If the variable has group  
 9 scope, any write call to this variable must be issued by the user in all MPI processes in  
 10 the group, which must be described by the MPI implementation in the description by the  
 11 `MPI_T_CVAR_GET_INFO`.

12 In both cases, the user must ensure that the writes in all participating MPI processes  
 13 are consistent. If the scope is either `MPI_T_SCOPE_ALL_EQ` or `MPI_T_SCOPE_GROUP_EQ`  
 14 this means that the variable in all connected MPI processes or MPI processes of the group,  
 15 respectively, must be set to the same value.

16 If it is not possible to change the variable at the time the call is made, the function  
 17 returns either `MPI_T_ERR_CVAR_SET_NOT_NOW`, if there may be a later time at which the  
 18 variable could be set, or `MPI_T_ERR_CVAR_SET_NEVER`, if the variable cannot be set for the  
 19 remainder of the application's execution.

21 Example: Reading the Value of a Control Variable

22  
 23 **Example 14.5** The following example shows a routine that can be used to query the  
 24 value with a control variable with a given index. The example assumes that the variable is  
 25 intended to be bound to an MPI communicator.

```

26
27 int getValue_int_comm(int index, MPI_Comm comm, int *val) {
28     int err,count;
29     MPI_T_cvar_handle handle;
30
31     /* This example assumes that the variable index */
32     /* can be bound to a communicator */
33
34     err=MPI_T_cvar_handle_alloc(index, &comm, &handle, &count);
35     if (err!=MPI_SUCCESS) return err;
36
37     /* The following assumes that the variable is */
38     /* represented by a single integer */
39
40     err=MPI_T_cvar_read(handle,val);
41     if (err!=MPI_SUCCESS) return err;
42
43     err=MPI_T_cvar_handle_free(&handle);
44     return err;
45 }
46
47
48
```

### 14.3.7 Performance Variables

The following section focuses on the ability to list and to query performance variables provided by the MPI implementation. Performance variables provide insight into MPI implementation specific internals and can represent information such as the state of the MPI implementation (e.g., waiting blocked, receiving, not active), aggregated timing data for submodules, or queue sizes and lengths.

*Rationale.* The interface for performance variables is separate from the interface for control variables, since performance variables have different requirements and parameters. By keeping them separate, the interface provides cleaner semantics and allows for more performance optimization opportunities. (*End of rationale.*)

Some performance variables and classes refer to *events*. In general, such events describe state transitions within software or hardware related to the performance of an MPI application. The events offered through the callback-driven event-notification interface described in Section 14.3.8 also refer to such state transitions; however, the set of state transitions referred to by performance variables and events as described in Section 14.3.8 may not be identical.

#### Performance Variable Classes

Each performance variable is associated with a class that describes its basic semantics, possible datatypes, basic behavior, its starting value, whether it can overflow, and when and how an MPI implementation can change the variable's value. The starting value is the value that is assigned to the variable the first time that it is used or whenever it is reset.

*Advice to users.* If a performance variable belongs to a class that can overflow, it is up to the user to protect against this overflow, e.g., by frequently reading and resetting the variable value. (*End of advice to users.*)

*Advice to implementors.* MPI implementations should use large enough datatypes for each performance variable to avoid overflows under normal circumstances. (*End of advice to implementors.*)

The classes are defined by the following constants:

- **MPI\_T\_PVAR\_CLASS\_STATE**  
A performance variable in this class represents a set of discrete states. Variables of this class are represented by `MPI_INT` and can be set by the MPI implementation at any time. Variables of this type should be described further using an enumeration, as discussed in Section 14.3.5. The starting value is the current state of the implementation at the time that the starting value is set. MPI implementations must ensure that variables of this class cannot overflow.
- **MPI\_T\_PVAR\_CLASS\_LEVEL**  
A performance variable in this class represents a value that describes the utilization level of a resource. The value of a variable of this class can change at any time to match the current utilization level of the resource. Values returned from variables in this class are non-negative and represented by one of the following datatypes: `MPI_UNSIGNED`,

1 MPI\_UNSIGNED\_LONG, MPI\_UNSIGNED\_LONG\_LONG, MPI\_DOUBLE. The starting value  
2 is the current utilization level of the resource at the time that the starting value is  
3 set. MPI implementations must ensure that variables of this class cannot overflow.

4  
5 ● MPI\_T\_PVAR\_CLASS\_SIZE

6 A performance variable in this class represents a value that is the size of a resource.  
7 Values returned from variables in this class are non-negative and represented by one  
8 of the following datatypes: MPI\_UNSIGNED, MPI\_UNSIGNED\_LONG,  
9 MPI\_UNSIGNED\_LONG\_LONG, MPI\_DOUBLE. The starting value is the current size of  
10 the resource at the time that the starting value is set. MPI implementations must  
11 ensure that variables of this class cannot overflow.

12  
13 ● MPI\_T\_PVAR\_CLASS\_PERCENTAGE

14 The value of a performance variable in this class represents the percentage utiliza-  
15 tion of a finite resource. The value of a variable of this class can change at any  
16 time to match the current utilization level of the resource. It will be returned as an  
17 MPI\_DOUBLE datatype. The value must always be between 0.0 (resource not used at  
18 all) and 1.0 (resource completely used). The starting value is the current percent-  
19 age utilization level of the resource at the time that the starting value is set. MPI  
20 implementations must ensure that variables of this class cannot overflow.

21  
22 ● MPI\_T\_PVAR\_CLASS\_HIGHWATERMARK

23 A performance variable in this class represents a value that describes the high water-  
24 mark utilization of a resource. The value of a variable of this class is non-negative  
25 and grows monotonically from the initialization or reset of the variable. It can be rep-  
26 resented by one of the following datatypes: MPI\_UNSIGNED, MPI\_UNSIGNED\_LONG,  
27 MPI\_UNSIGNED\_LONG\_LONG, MPI\_DOUBLE. The starting value is the current utiliza-  
28 tion level of the resource at the time that the variable is started or reset. MPI imple-  
29 mentations must ensure that variables of this class cannot overflow.

30  
31 ● MPI\_T\_PVAR\_CLASS\_LOWWATERMARK

32 A performance variable in this class represents a value that describes the low water-  
33 mark utilization of a resource. The value of a variable of this class is non-negative  
34 and decreases monotonically from the initialization or reset of the variable. It can be  
35 represented by one of the following datatypes: MPI\_UNSIGNED, MPI\_UNSIGNED\_LONG,  
36 MPI\_UNSIGNED\_LONG\_LONG, MPI\_DOUBLE. The starting value is the current utiliza-  
37 tion level of the resource at the time that the variable is started or reset. MPI imple-  
38 mentations must ensure that variables of this class cannot overflow.

39  
40 ● MPI\_T\_PVAR\_CLASS\_COUNTER

41 A performance variable in this class counts the number of occurrences of a specific  
42 event (e.g., the number of memory allocations within an MPI library). The value of  
43 a variable of this class increases monotonically from the initialization or reset of the  
44 performance variable by one for each specific event that is observed. Values must  
45 be non-negative and represented by one of the following datatypes: MPI\_UNSIGNED,  
46 MPI\_UNSIGNED\_LONG, MPI\_UNSIGNED\_LONG\_LONG. The starting value for variables  
47 of this class is 0. Variables of this class can overflow.

48  
49 ● MPI\_T\_PVAR\_CLASS\_AGGREGATE

The value of a performance variable in this class is an aggregated value that



represents a sum of arguments processed during a specific event (e.g., the amount of memory allocated by all memory allocations). This class is similar to the counter class, but instead of counting individual events, the value can be incremented by arbitrary amounts. The value of a variable of this class increases monotonically from the initialization or reset of the performance variable. It must be non-negative and represented by one of the following datatypes: `MPI_UNSIGNED`, `MPI_UNSIGNED_LONG`, `MPI_UNSIGNED_LONG_LONG`, `MPI_DOUBLE`. The starting value for variables of this class is 0. Variables of this class can overflow.

- `MPI_T_PVAR_CLASS_TIMER`

The value of a performance variable in this class represents the aggregated time that the MPI implementation spends executing a particular event, type of event, or section of the MPI library. This class has the same basic semantics as `MPI_T_PVAR_CLASS_AGGREGATE`, but explicitly records a timing value. The value of a variable of this class increases monotonically from the initialization or reset of the performance variable. It must be non-negative and represented by one of the following datatypes: `MPI_UNSIGNED`, `MPI_UNSIGNED_LONG`, `MPI_UNSIGNED_LONG_LONG`, `MPI_DOUBLE`. The starting value for variables of this class is 0. If the type `MPI_DOUBLE` is used, the units that represent time in this datatype must match the units used by `MPI_WTIME`. Otherwise, the time units should be documented, e.g., in the description returned by `MPI_T_PVAR_GET_INFO`. Variables of this class can overflow.

- `MPI_T_PVAR_CLASS_GENERIC`

This class can be used to describe a variable that does not fit into any of the other classes. For variables in this class, the starting value is variable-specific and implementation-defined.

### Performance Variable Query Functions

An MPI implementation exports a set of  $N$  performance variables through the MPI tool information interface. If  $N$  is zero, then the MPI implementation does not export any performance variables; otherwise the provided performance variables are indexed from 0 to  $N - 1$ . This index number is used in subsequent calls to identify the individual variables.

An MPI implementation is allowed to increase the number of performance variables during the execution of an MPI application when new variables become available through dynamic loading. However, MPI implementations are not allowed to change the index of a performance variable or to delete a variable once it has been added to the set. When a variable becomes inactive, e.g., through dynamic unloading, accessing its value should return a corresponding error code.

The following function can be used to query the number of performance variables, `num_pvar`:

`MPI_T_PVAR_GET_NUM(num_pvar)`

OUT      `num_pvar`                      returns number of performance variables (integer)

### C binding

```
1 int MPI_T_pvar_get_num(int *num_pvar)
```

2 The function `MPI_T_PVAR_GET_INFO` provides access to additional information for  
3 each variable.  
4

```
5  
6 MPI_T_PVAR_GET_INFO(pvar_index, name, name_len, verbosity, var_class, datatype, enumtype,  
7 desc, desc_len, bind, readonly, continuous, atomic)
```

8			
9	IN	pvar_index	index of the performance variable to be queried between 0 and num_pvar - 1 (integer)
10			
11	OUT	name	buffer to return the string containing the name of the performance variable (string)
12			
13	INOUT	name_len	length of the string and/or buffer for name (integer)
14	OUT	verbosity	verbosity level of this variable (integer)
15	OUT	var_class	class of performance variable (integer)
16	OUT	datatype	MPI datatype of the information stored in the performance variable (handle)
17			
18	OUT	enumtype	optional descriptor for enumeration information (handle)
19			
20	OUT	desc	buffer to return the string containing a description of the performance variable (string)
21			
22	INOUT	desc_len	length of the string and/or buffer for desc (integer)
23	OUT	bind	type of MPI object to which this variable must be bound (integer)
24			
25	OUT	readonly	flag indicating whether the variable can be written/reset (integer)
26			
27	OUT	continuous	flag indicating whether the variable can be started and stopped or is continuously active (integer)
28			
29	OUT	atomic	flag indicating whether the variable can be atomically read and reset (integer)
30			
31			
32			
33			
34			

### 35 C binding

```
36 int MPI_T_pvar_get_info(int pvar_index, char *name, int *name_len,  
37 int *verbosity, int *var_class, MPI_Datatype *datatype,  
38 MPI_T_enum *enumtype, char *desc, int *desc_len, int *bind,  
39 int *readonly, int *continuous, int *atomic)  
40
```

41 After a successful call to `MPI_T_PVAR_GET_INFO` for a particular variable, subsequent  
42 calls to this routine that query information about the same variable must return the same  
43 information. An MPI implementation is not allowed to alter any of the returned values.

44 If any OUT parameter to `MPI_T_PVAR_GET_INFO` is a NULL pointer, the implementa-  
45 tion will ignore the parameter and not return a value for the parameter.

46 The arguments `name` and `name_len` are used to return the name of the performance  
47 variable as described in Section 14.3.3. If completed successfully, the routine is required  
48 to return a name of at least length one.

The argument `verbosity` returns the verbosity level of the variable (see Section 14.3.1).

The class of the performance variable is returned in the parameter `var_class`. The class must be one of the constants defined in Section 14.3.7.

The combination of the name and the class of the performance variable must be unique with respect to all other names for performance variables used by the MPI implementation.

*Advice to implementors.* Groups of variables that belong closely together, but have different classes, can have the same name. This choice is useful, e.g., to refer to multiple variables that describe a single resource (like the level, the total size, as well as high and low watermarks). (*End of advice to implementors.*)

The argument `datatype` returns the MPI datatype that is used to represent the performance variable.

If the variable is of type `MPI_INT`, MPI can optionally specify an enumeration for the values represented by this variable and return it in `enumtype`. In this case, MPI returns an enumeration identifier, which can then be used to gather more information as described in Section 14.3.5. Otherwise, `enumtype` is set to `MPI_T_ENUM_NULL`. If the datatype is not `MPI_INT` or the argument `enumtype` is the null pointer, no enumeration type is returned.

Returning a description is optional. If an MPI implementation does not return a description, the first character for `desc` must be set to the null character and `desc_len` must be set to one at the return from this function.

The parameter `bind` returns the type of the MPI object to which the variable must be bound or the value `MPI_T_BIND_NO_OBJECT` (see Section 14.3.2).

Upon return, the argument `readonly` is set to zero if the variable can be written or reset by the user. It is set to one if the variable can only be read.

Upon return, the argument `continuous` is set to zero if the variable can be started and stopped by the user, i.e., it is possible for the user to control if and when the value of a variable is updated. It is set to one if the variable is always active and cannot be controlled by the user.

Upon return, the argument `atomic` is set to zero if the variable cannot be read and reset atomically. Only variables for which the call sets `atomic` to one can be used in a call to `MPI_T_PVAR_READRESET`.

If a performance variable has an equivalent name and has the same class across connected MPI processes, the following OUT parameters must be identical: `verbosity`, `varclass`, `datatype`, `enumtype`, `bind`, `readonly`, `continuous`, and `atomic`. The returned description must be equivalent.

`MPI_T_PVAR_GET_INDEX(name, var_class, pvar_index)`

IN	<code>name</code>	the name of the performance variable (string)
IN	<code>var_class</code>	the class of the performance variable (integer)
OUT	<code>pvar_index</code>	the index of the performance variable (integer)

### C binding

```
int MPI_T_pvar_get_index(const char *name, int var_class, int *pvar_index)
```

`MPI_T_PVAR_GET_INDEX` is a function for retrieving the index of a performance variable given a known variable name and class. The `name` and `var_class` parameters are

provided by the caller, and `pvar_index` is returned by the MPI implementation. The name parameter is a string terminated with a null character.

This routine returns `MPI_SUCCESS` on success and returns `MPI_T_ERR_INVALID_NAME` if `name` does not match the name of any performance variable of the specified `var_class` provided by the implementation at the time of the call.

*Rationale.* This routine is provided to enable fast retrieval of performance variables by a tool, assuming it knows the name of the variable for which it is looking. The number of variables exposed by the implementation can change over time, so it is not possible for the tool to simply iterate over the list of variables once at initialization. Although using MPI implementation specific variable names is not portable across MPI implementations, tool developers may choose to take this route for lower overhead at runtime because the tool will not have to iterate over the entire set of variables to find a specific one. (*End of rationale.*)

### Performance Experiment Sessions

Within a single program, multiple components can use the MPI tool information interface. To avoid collisions with respect to accesses to performance variables, users of the MPI tool information interface must first create a session. Subsequent calls that access performance variables can then be made within the context of this session. Any call executed in a session must not influence the results in any other session.

`MPI_T_PVAR_SESSION_CREATE(session)`

OUT      `session`                      identifier of performance session (handle)

#### C binding

`int MPI_T_pvar_session_create(MPI_T_pvar_session *session)`

This call creates a new session for accessing performance variables and returns a handle for this session in the argument `session` of type `MPI_T_pvar_session`.

`MPI_T_PVAR_SESSION_FREE(session)`

INOUT    `session`                      identifier of performance experiment session (handle)

#### C binding

`int MPI_T_pvar_session_free(MPI_T_pvar_session *session)`

This call frees an existing session. Calls to the MPI tool information interface can no longer be made within the context of a session after it is freed. On a successful return, MPI sets the session identifier to `MPI_T_PVAR_SESSION_NULL`.

### Handle Allocation and Deallocation

Before using a performance variable, a user must first allocate a handle of type `MPI_T_pvar_handle` for the variable by binding it to an MPI object (see also Section 14.3.2).

MPI_T_PVAR_HANDLE_ALLOC(session, pvar_index, obj_handle, handle, count)			1
IN	session	identifier of performance experiment session (handle)	2
IN	pvar_index	index of performance variable for which handle is to be allocated (integer)	3
IN	obj_handle	reference to a handle of the MPI object to which this variable is supposed to be bound (pointer)	4
OUT	handle	allocated handle (handle)	5
OUT	count	number of elements used to represent this variable (integer)	6

### C binding

```
int MPI_T_pvar_handle_alloc(MPI_T_pvar_session session, int pvar_index,
    void *obj_handle, MPI_T_pvar_handle *handle, int *count)
```

This routine binds the performance variable specified by the argument `index` to an MPI object in the session identified by the parameter `session`. The object is passed in the argument `obj_handle` as an address to a local variable that stores the object's handle. The argument `obj_handle` is ignored if the `MPI_T_PVAR_GET_INFO` call for this performance variable returned `MPI_T_BIND_NO_OBJECT` in the argument `bind`. The handle allocated to reference the variable is returned in the argument `handle`. Upon successful return, `count` contains the number of elements (of the datatype returned by a previous `MPI_T_PVAR_GET_INFO` call) used to represent this variable.

*Advice to users.* The `count` can be different based on the MPI object to which the performance variable was bound. For example, variables bound to communicators could have a count that matches the size of the communicator.

It is not portable to pass references to predefined MPI object handles, such as `MPI_COMM_WORLD`, to this routine, since their implementation depends on the MPI library. Instead, such an object handle should be stored in a local variable and the address of this local variable should be passed into `MPI_T_PVAR_HANDLE_ALLOC`. (*End of advice to users.*)

The value of `index` should be in the range 0 to `num_pvar - 1`, where `num_pvar` is the number of available performance variables as determined from a prior call to `MPI_T_PVAR_GET_NUM`. The type of the MPI object it references must be consistent with the type returned in the `bind` argument in a prior call to `MPI_T_PVAR_GET_INFO`.

For all routines in the rest of this section that take both `handle` and `session` as IN or INOUT arguments, if the `handle` argument passed in is not associated with the `session` argument, `MPI_T_ERR_INVALID_HANDLE` is returned.

MPI_T_PVAR_HANDLE_FREE(session, handle)			43
IN	session	identifier of performance experiment session (handle)	44
INOUT	handle	handle to be freed (handle)	45

### C binding

```

1 int MPI_T_pvar_handle_free(MPI_T_pvar_session session,
2     MPI_T_pvar_handle *handle)
3

```

When a handle is no longer needed, a user of the MPI tool information interface should call `MPI_T_PVAR_HANDLE_FREE` to free the handle in the session identified by the parameter `session` and the associated resources in the MPI implementation. On a successful return, MPI sets the handle to `MPI_T_PVAR_HANDLE_NULL`.

### Starting and Stopping of Performance Variables

Performance variables that have the continuous flag set during the query operation are continuously operating once a handle has been allocated. Such variables may be queried at any time, but they cannot be started or stopped by the user. All other variables are in a stopped state after their handle has been allocated; their values are not updated until they have been started by the user.

```

17 MPI_T_PVAR_START(session, handle)

```

18	IN	session	identifier of performance experiment session (handle)
19			
20	IN	handle	handle of a performance variable (handle)

### C binding

```

23 int MPI_T_pvar_start(MPI_T_pvar_session session, MPI_T_pvar_handle handle)

```

This function starts the performance variable with the handle identified by the parameter `handle` in the session identified by the parameter `session`.

If the constant `MPI_T_PVAR_ALL_HANDLES` is passed in `handle`, the MPI implementation attempts to start all variables within the session identified by the parameter `session` for which handles have been allocated. In this case, the routine returns `MPI_SUCCESS` if all variables are started successfully (even if there are no non-continuous variables to be started), otherwise `MPI_T_ERR_PVAR_NO_STARTSTOP` is returned. Continuous variables and variables that are already started are ignored when `MPI_T_PVAR_ALL_HANDLES` is specified.

```

34 MPI_T_PVAR_STOP(session, handle)

```

35	IN	session	identifier of performance experiment session (handle)
36			
37	IN	handle	handle of a performance variable (handle)

### C binding

```

40 int MPI_T_pvar_stop(MPI_T_pvar_session session, MPI_T_pvar_handle handle)

```

This function stops the performance variable with the handle identified by the parameter `handle` in the session identified by the parameter `session`.

If the constant `MPI_T_PVAR_ALL_HANDLES` is passed in `handle`, the MPI implementation attempts to stop all variables within the session identified by the parameter `session` for which handles have been allocated. In this case, the routine returns `MPI_SUCCESS` if all variables are stopped successfully (even if there are no non-continuous variables to be stopped), otherwise `MPI_T_ERR_PVAR_NO_STARTSTOP` is returned. Continuous variables

and variables that are already stopped are ignored when `MPI_T_PVAR_ALL_HANDLES` is specified.

#### Performance Variable Access Functions

`MPI_T_PVAR_READ(session, handle, buf)`

IN	<code>session</code>	identifier of performance experiment session (handle)
IN	<code>handle</code>	handle of a performance variable (handle)
OUT	<code>buf</code>	initial address of storage location for variable value (choice)

#### C binding

```
int MPI_T_pvar_read(MPI_T_pvar_session session, MPI_T_pvar_handle handle,
                   void *buf)
```

The `MPI_T_PVAR_READ` call queries the value of the performance variable with the handle `handle` in the session identified by the parameter `session` and stores the result in the buffer identified by the parameter `buf`. The user is responsible to ensure that the buffer is of the appropriate size to hold the entire value of the performance variable (based on the datatype and count returned by the corresponding previous calls to `MPI_T_PVAR_GET_INFO` and `MPI_T_PVAR_HANDLE_ALLOC`, respectively).

The constant `MPI_T_PVAR_ALL_HANDLES` cannot be used as an argument for the function `MPI_T_PVAR_READ`.

`MPI_T_PVAR_WRITE(session, handle, buf)`

IN	<code>session</code>	identifier of performance experiment session (handle)
IN	<code>handle</code>	handle of a performance variable (handle)
IN	<code>buf</code>	initial address of storage location for variable value (choice)

#### C binding

```
int MPI_T_pvar_write(MPI_T_pvar_session session, MPI_T_pvar_handle handle,
                    const void *buf)
```

The `MPI_T_PVAR_WRITE` call attempts to write the value of the performance variable with the handle identified by the parameter `handle` in the session identified by the parameter `session`. The value to be written is passed in the buffer identified by the parameter `buf`. The user must ensure that the buffer is of the appropriate size to hold the entire value of the performance variable (based on the datatype and count returned by the corresponding previous calls to `MPI_T_PVAR_GET_INFO` and `MPI_T_PVAR_HANDLE_ALLOC`, respectively).

If it is not possible to change the variable, the function returns `MPI_T_ERR_PVAR_NO_WRITE`.

The constant `MPI_T_PVAR_ALL_HANDLES` cannot be used as an argument for the function `MPI_T_PVAR_WRITE`.

1 MPI\_T\_PVAR\_RESET(session, handle)

2 IN session identifier of performance experiment session (handle)

3 IN handle handle of a performance variable (handle)

### 6 C binding

7 int MPI\_T\_pvar\_reset(MPI\_T\_pvar\_session session, MPI\_T\_pvar\_handle handle)

8  
9 The MPI\_T\_PVAR\_RESET call sets the performance variable with the handle identified  
10 by the parameter `handle` to its starting value specified in Section 14.3.7. If it is not possible  
11 to change the variable, the function returns MPI\_T\_ERR\_PVAR\_NO\_WRITE.

12 If the constant MPI\_T\_PVAR\_ALL\_HANDLES is passed in `handle`, the MPI implementation  
13 attempts to reset all variables within the session identified by the parameter `session` for  
14 which handles have been allocated. In this case, the routine returns MPI\_SUCCESS if all  
15 variables are reset successfully (even if there are no valid handles or all are read-only),  
16 otherwise MPI\_T\_ERR\_PVAR\_NO\_WRITE is returned. Read-only variables are ignored when  
17 MPI\_T\_PVAR\_ALL\_HANDLES is specified.

18  
19 MPI\_T\_PVAR\_READRESET(session, handle, buf)

20 IN session identifier of performance experiment session (handle)

21 IN handle handle of a performance variable (handle)

22 OUT buf initial address of storage location for variable value  
23 (choice)

### 26 C binding

27 int MPI\_T\_pvar\_readreset(MPI\_T\_pvar\_session session,  
28 MPI\_T\_pvar\_handle handle, void \*buf)

29  
30 This call atomically combines the functionality of MPI\_T\_PVAR\_READ and  
31 MPI\_T\_PVAR\_RESET with the same semantics as if these two calls were called separately.  
32 If atomic operations on this variable are not supported, this routine returns  
33 MPI\_T\_ERR\_PVAR\_NO\_ATOMIC.

34 The constant MPI\_T\_PVAR\_ALL\_HANDLES cannot be used as an argument for the func-  
35 tion MPI\_T\_PVAR\_READRESET.

36  
37 *Advice to implementors.* Sampling-based tools rely on the ability to call the MPI tool  
38 information interface, in particular routines to start, stop, read, write, and reset per-  
39 formance variables, from any program context, including asynchronous contexts such  
40 as signal handlers. MPI implementations should strive, if possible in their particular  
41 environment, to enable these usage scenarios for all or a subset of the routines men-  
42 tioned above. If implementing only a subset, the read, write, and reset routines are  
43 typically the most critical for sampling based tools. An MPI implementation should  
44 clearly document any restrictions on the program contexts in which the MPI tool infor-  
45 mation interface can be used. Restrictions might include guaranteeing usage outside  
46 of all signals or outside a specific set of signals. Any restrictions could be documented,  
47 for example, through the description returned by MPI\_T\_PVAR\_GET\_INFO. (*End of*  
48 *advice to implementors.*)



*Rationale.* All routines to read, to write or to reset performance variables require the session argument. This requirement keeps the interface consistent and allows the use of MPI\_T\_PVAR\_ALL\_HANDLES where appropriate. Further, this opens up additional performance optimizations for the implementation of handles. (*End of rationale.*)

Example: Tool to Detect Receives with Long Unexpected Message Queues

**Example 14.6** The following example shows a sample tool to identify receive operations that occur during times with long message queues. This examples assumes that the MPI implementation exports a variable with the name “MPI\_T\_UMQ\_LENGTH” to represent the current length of the unexpected message queue. The tool is implemented as a PMPI tool using the MPI profiling interface.

The tool consists of three parts: (1) the initialization (by intercepting the call to MPI\_INIT), (2) the test for long unexpected message queues (by intercepting calls to MPI\_RECV), and (3) the clean-up phase (by intercepting the call to MPI\_FINALIZE). To capture all receives, the example would have to be extended to have similar wrappers for all receive operations.

Part 1 — Initialization: During initialization, the tool searches for the variable and, once the right index is found, allocates a session and a handle for the variable with the found index, and starts the performance variable.

```
#include <stdio.h>
#include <stdlib.h>
#include <string.h>
#include <assert.h>
#include <mpi.h>

/* Global variables for the tool */
static MPI_T_pvar_session session;
static MPI_T_pvar_handle handle;

int MPI_Init(int *argc, char ***argv ) {
    int err, num, i, index, namelen, verbosity;
    int var_class, bind, threadsup;
    int readonly, continuous, atomic, count;
    char name[18];
    MPI_Comm comm;
    MPI_Datatype datatype;
    MPI_T_enum enumtype;

    err=PMPI_Init(argc, argv);
    if (err!=MPI_SUCCESS) return err;

    err=PMPI_T_init_thread(MPI_THREAD_SINGLE, &threadsup);
    if (err!=MPI_SUCCESS) return err;
```

```

1   err=PMPI_T_pvar_get_num(&num);
2   if (err!=MPI_SUCCESS) return err;
3   index=-1;
4   i=0;
5   while ((i<num) && (index<0) && (err==MPI_SUCCESS)) {
6       /* Pass a buffer that is at least one character longer than */
7       /* the name of the variable being searched for to avoid */
8       /* finding variables that have a name that has a prefix */
9       /* equal to the name of the variable being searched. */
10      namelen=18;
11      err=PMPI_T_pvar_get_info(i, name, &namelen, &verbosity,
12                             &var_class, &datatype, &enumtype, NULL, NULL, &bind,
13                             &readonly, &continuous, &atomic);
14      if (strcmp(name,"MPI_T_UMQ_LENGTH")==0) index=i;
15      i++; }
16   if (err!=MPI_SUCCESS) return err;
17
18   /* this could be handled in a more flexible way for a generic tool */
19   assert(index>=0);
20   assert(var_class==MPI_T_PVAR_CLASS_LEVEL);
21   assert(datatype==MPI_INT);
22   assert(bind==MPI_T_BIND_MPI_COMM);
23
24   /* Create a session */
25   err=PMPI_T_pvar_session_create(&session);
26   if (err!=MPI_SUCCESS) return err;
27
28   /* Get a handle and bind to MPI_COMM_WORLD */
29   comm=MPI_COMM_WORLD;
30   err=PMPI_T_pvar_handle_alloc(session, index, &comm, &handle, &count);
31   if (err!=MPI_SUCCESS) return err;
32
33   /* this could be handled in a more flexible way for a generic tool */
34   assert(count==1);
35
36   /* Start variable */
37   err=PMPI_T_pvar_start(session, handle);
38   if (err!=MPI_SUCCESS) return err;
39
40   return MPI_SUCCESS;
41 }

```

Part 2 — Testing the Queue Lengths During Receives: During every receive operation, the tool reads the unexpected queue length through the matching performance variable and compares it against a predefined threshold.

```
#define THRESHOLD 5
```

```

int MPI_Recv(void *buf, int count, MPI_Datatype datatype, int source,
             int tag, MPI_Comm comm, MPI_Status *status)
{
    int value, err;

    if (comm==MPI_COMM_WORLD) {
        err=PMPI_T_pvar_read(session, handle, &value);
        if ((err==MPI_SUCCESS) && (value>THRESHOLD))
        {
            /* tool identified receive called with long UMQ */
            /* execute tool functionality, */
            /* e.g., gather and print call stack */
        }
    }

    return PMPI_Recv(buf, count, datatype, source, tag, comm, status);
}

```

Part 3 — Termination: In the wrapper for MPI\_FINALIZE, the MPI tool information interface is finalized.

```

int MPI_Finalize(void)
{
    int err;
    err=PMPI_T_pvar_handle_free(session, &handle);
    err=PMPI_T_pvar_session_free(&session);
    err=PMPI_T_finalize();
    return PMPI_Finalize();
}

```

### 14.3.8 Events

During the execution of an MPI application, the MPI implementation can raise *events* of a specific type to inform the user of a state change in the implementation. *Event types* describe specific state changes within the MPI implementation. In comparison to aggregate performance variables, events provide per-instance information on such state changes. The MPI implementation is said to *raise an event* when it invokes a callback function previously registered for the corresponding event type by the user. Each callback invocation for a specific event instance has a timestamp associated with it, which can be queried by the user, describing the time when the event was observed by the implementation. This decouples the observation of the state change from the communication of this information to the user. A timestamp in this context is a count of clock ticks elapsed since some time in the past and represented as a variable of type MPI\_Count.

#### Event Sources

As a means to manage multiple state changes to be observed concurrently by different parts of the software and hardware system, the event interface of the MPI Tool Information

Interface uses the concept of *sources*. A source in this context is a concept describing the logical entity raising the event. A source may or may not directly represent a concrete part of the software or hardware system. This concept is used primarily to describe partial ordering of events across different components where total ordering cannot necessarily be determined or is too costly to enforce.

The following function can be used to query the number of event sources, *num\_sources*:

```
MPI_T_SOURCE_GET_NUM(num_sources)
```

```
OUT    num_sources    returns number of event sources (integer)
```

### C binding

```
int MPI_T_source_get_num(int *num_sources)
```

The number of available event sources can be queried with a call to `MPI_T_SOURCE_GET_NUM`. An MPI implementation is allowed to increase the number of sources during the execution of an MPI process. However, MPI implementations are not allowed to change the index of an event source or to delete an event source once it has been made visible to the user (e.g., if new event sources become available via dynamic loading of additional components in the MPI implementation).

```
MPI_T_SOURCE_GET_INFO(source_index, name, name_len, desc, desc_len, ordering,
                      ticks_per_second, max_ticks, info)
```

```
IN     source_index    index of the source to be queried between 0 and
                      num_sources - 1 (integer)
```

```
OUT    name            buffer to return the string containing the name of the
                      source (string)
```

```
INOUT  name_len        length of the string and/or buffer for name (integer)
```

```
OUT    desc            buffer to return the string containing the description
                      of the source (string)
```

```
INOUT  desc_len        length of the string and/or buffer for desc (integer)
```

```
OUT    ordering        flag indicating chronological ordering guarantees given
                      by the source (integer)
```

```
OUT    ticks_per_second the number of ticks per second for the timer of this
                      source (integer)
```

```
OUT    max_ticks        the maximum count of ticks reported by this source
                      before overflow occurs (integer)
```

```
OUT    info            optional info object (handle)
```

### C binding

```
int MPI_T_source_get_info(int source_index, char *name, int *name_len,
                          char *desc, int *desc_len, MPI_T_source_order *ordering,
                          MPI_Count *ticks_per_second, MPI_Count *max_ticks,
                          MPI_Info *info)
```

A call to `MPI_T_SOURCE_GET_INFO` returns additional information on the source identified by the `source_index` argument.

The arguments `name` and `name_len` are used to return the name of the source as described in Section 14.3.3.

The arguments `desc` and `desc_len` are used to return the description of the source as described in Section 14.3.3.

The `ordering` argument returns whether event callbacks of this source will be invoked in chronological order, i.e., the timestamps reported by `MPI_T_EVENT_GET_TIMESTAMP` of subsequent events of the same source are monotonically increasing. The value of `ordering` can be `MPI_T_SOURCE_ORDERED` or `MPI_T_SOURCE_UNORDERED`.

The `ticks_per_seconds` argument returns the number of ticks elapsed in one second for the timer used for the specific source.

The `max_ticks` argument returns the largest number of ticks reported by this source as a timestamp before the value overflows.

*Advice to users.* As the size of `MPI_Count` is defined in relation to the types `MPI_Aint` and `MPI_Offset`, the effective size of `MPI_Count` may lead to overflows of the timestamp values reported. Users can use the argument `max_ticks` to mitigate resulting problems. (*End of advice to users.*)

MPI can optionally return an info object containing the default hints set for this source. If MPI is not yet initialized, already finalized, or the argument to `info` provided by the user is the NULL pointer, this argument is ignored. If an info object is returned, an MPI implementation is required to return all hints that are supported by the implementation for this source and have default values specified; any user-supplied hints that were not ignored by the implementation; and any additional hints that were set by the implementation. If no such hints exist, a handle to a newly created info object is returned that contains no key/value pair. The user is responsible for freeing `info` via `MPI_INFO_FREE`.

`MPI_T_SOURCE_GET_TIMESTAMP(source_index, timestamp)`

IN	<code>source_index</code>	index of the source
OUT	<code>timestamp</code>	Current timestamp from specified source

### C binding

`int MPI_T_source_get_timestamp(int source_index, MPI_Count *timestamp)`

To enable proper query of a reference timestamp for a specific source, a user can obtain a current timestamp using `MPI_T_SOURCE_GET_TIMESTAMP`. The argument `source_index` identifies the index of the source to query. The call returns `MPI_SUCCESS` and a current timestamp in the argument `timestamp` if the source supports ad-hoc generation of timestamps. The call returns `MPI_T_ERR_INVALID_INDEX` if the index does not identify a valid source. The call returns `MPI_T_ERR_NOT_SUPPORTED` if the source does not support the ad-hoc generation of timestamps.

### Callback Safety Requirements

The actions a user is allowed to perform inside a callback function may vary with its execution context. As the user has no control over the execution context of specific callback

function invocations, MPI provides a way to communicate this information using callback safety levels.

Safety Requirement
MPI_T_CB_REQUIRE_NONE
MPI_T_CB_REQUIRE_MPI_RESTRICTED
MPI_T_CB_REQUIRE_THREAD_SAFE
MPI_T_CB_REQUIRE_ASYNC_SIGNAL_SAFE

Table 14.5: Hierarchy of safety requirement levels for event callback routines.

Table 14.5 provides the hierarchy of callback safety requirements levels within user-defined callback functions. The MPI implementation provides the safety requirement as an argument to the callback when it is invoked.

The level of `MPI_T_CB_REQUIRE_NONE` is the lowest level and does not impose any restrictions on the callback function.

The level of `MPI_T_CB_REQUIRE_MPI_RESTRICTED` restricts the set of MPI functions that can be called from inside the callback to all functions with the prefix `MPI_T` as well as `MPI_WTICK` and `MPI_WTIME`.

*Advice to users.* While some MPI functions are safe to be called inside a callback function used in the MPI tool information interface—which may in some implementations be issued from asynchronous contexts such as signal handlers—this does not imply that those MPI functions are generally safe to be called in asynchronous contexts such as signal handlers. (*End of advice to users.*)

The level of `MPI_T_CB_REQUIRE_THREAD_SAFE` includes all the limitations of `MPI_T_CB_REQUIRE_MPI_RESTRICTED` and additionally requires the callback to be reentrant and thread-safe. This means the callback must allow its execution to be interrupted by or happen concurrently with any other callback including itself.

The level of `MPI_T_CB_REQUIRE_ASYNC_SIGNAL_SAFE` includes all the limitations of `MPI_T_CB_REQUIRE_THREAD_SAFE` and additionally requires the callback to meet the safety requirements needed to support invocations from asynchronous contexts, such as signal handlers.

*Advice to users.* It is always safe to assume the highest restrictions for a callback invocation (i.e., `MPI_T_CB_REQUIRE_ASYNC_SIGNAL_SAFE`). By evaluating the specific requirements at runtime, a tool may obtain more freedom of action within the callback. (*End of advice to users.*)

*Advice to implementors.* A high-quality implementation will strive to set callback safety requirements to the most permissive level for a given callback invocation. (*End of advice to implementors.*)

All functions with the prefix `MPI_T`, except those listed in Table 14.6, may return the error code `MPI_T_ERR_NOT_ACCESSIBLE` to indicate that the user may not access this function at this time.

MPI_T_EVENT_COPY	PMPI_T_EVENT_COPY	1
MPI_T_EVENT_GET_SOURCE	PMPI_T_EVENT_GET_SOURCE	2
MPI_T_EVENT_GET_TIMESTAMP	PMPI_T_EVENT_GET_TIMESTAMP	3
MPI_T_EVENT_READ	PMPI_T_EVENT_READ	4
MPI_T_PVAR_READ	PMPI_T_PVAR_READ	5
MPI_T_PVAR_READRESET	PMPI_T_PVAR_READRESET	6
MPI_T_PVAR_RESET	PMPI_T_PVAR_RESET	7
MPI_T_PVAR_START	PMPI_T_PVAR_START	8
MPI_T_PVAR_STOP	PMPI_T_PVAR_STOP	9
MPI_T_PVAR_WRITE	PMPI_T_PVAR_WRITE	10
MPI_T_SOURCE_GET_TIMESTAMP	PMPI_T_SOURCE_GET_TIMESTAMP	11

Table 14.6: List of MPI functions that when called from within a callback function may not return MPI\_T\_ERR\_NOT\_ACCESSIBLE.

*Rationale.* A call may be implemented in a way that is not safe for all execution contexts of a callback function, e.g., inside a signal handler. An MPI implementation therefore needs a way to communicate its inability to perform a certain action due to the execution context of a callback invocation. (*End of rationale.*)

*Advice to implementors.* A high-quality implementation shall not return MPI\_T\_ERR\_NOT\_ACCESSIBLE except where absolutely necessary. (*End of advice to implementors.*)

*Advice to users.* Users intercepting calls into the MPI tool information interface using the PMPI interface must ensure that the safety requirements for the calling context are met. This means that users may have to implement the wrapper with the highest safety level used by the MPI implementation. (*End of advice to users.*)

### Event Type Query Functions

An MPI implementation exports a set of  $N$  event types through the MPI tool information interface. If  $N$  is zero, then the MPI implementation does not export any event types; otherwise, the provided event types are indexed from 0 to  $N - 1$ . This index number is used in subsequent calls to identify a specific event type.

An MPI implementation is allowed to increase the number of event types during the execution of an MPI process. However, MPI implementations are not allowed to change the index of an event type or to delete an event type once it has been made visible to the user (e.g., if new event types become available via dynamic loading of additional components in the MPI implementation).

The following function can be used to query the number of event types, *num\_events*:

MPI\_T\_EVENT\_GET\_NUM(*num\_events*)

OUT      *num\_events*                      returns number of event types (integer)

### C binding

```
1 int MPI_T_event_get_num(int *num_events)
```

2 The function `MPI_T_EVENT_GET_INFO` provides access to additional information  
3 about a specific event type.  
4

```
6 MPI_T_EVENT_GET_INFO(event_index, name, name_len, verbosity, array_of_datatypes,  
7 array_of_displacements, num_elements, enumtype, info, desc, desc_len, bind)
```

9			
10	IN	event_index	index of the event type to be queried between 0 and num_events - 1 (integer)
11			
12	OUT	name	buffer to return the string containing the name of the event type (string)
13			
14	INOUT	name_len	length of the string and/or buffer for name (integer)
15	OUT	verbosity	verbosity level of this event type (integer)
16			
17	OUT	array_of_datatypes	array of MPI basic datatypes used to encode the event data (array of handles)
18			
19	OUT	array_of_displacements	array of byte displacements of the elements in the event buffer (array of non-negative integers)
20			
21	INOUT	num_elements	length of array_of_datatypes and array_of_displacements arrays (integer)
22			
23	OUT	enumtype	optional descriptor for enumeration information (han- dle)
24			
25	OUT	info	optional info object (handle)
26			
27	OUT	desc	buffer to return the string containing a description of the event type (string)
28			
29	INOUT	desc_len	length of the string and/or buffer for desc (integer)
30	OUT	bind	type of MPI object to which an event of this type must be bound (integer)
31			
32			
33			

### 34 C binding

```
35 int MPI_T_event_get_info(int event_index, char *name, int *name_len,  
36 int *verbosity, MPI_Datatype *array_of_datatypes,  
37 MPI_Aint *array_of_displacements, int *num_elements,  
38 MPI_T_enum *enumtype, MPI_Info* info, char *desc,  
39 int *desc_len, int *bind)
```

41 After a successful call to `MPI_T_EVENT_GET_INFO` for a particular event type, sub-  
42 sequent calls to this routine that query information about the same event type must return  
43 the same information. If any INOUT or OUT argument to `MPI_T_EVENT_GET_INFO` is a  
44 NULL pointer, the implementation will ignore the argument and not return a value for the  
45 specific argument.

46 The arguments `name` and `name_len` are used to return the name of the event type as  
47 described in Section 14.3.3. If completed successfully, the routine is required to return a  
48



name of at least length one. The name of the event type must be unique with respect to all other names for event types used by the MPI implementation.

The argument `verbosity` returns the verbosity level of the event type (see Section 14.3.1).

The argument `array_of_datatypes` returns an array of MPI datatype handles that describe the elements returned for an instance of the event type with index `event_index`. The event data can either be queried element by element with `MPI_T_EVENT_READ` or copied into a contiguous event buffer with `MPI_T_EVENT_COPY`. For the latter case, the argument `array_of_displacements` returns an array of byte displacements in the event buffer in ascending order starting with zero.

The user is responsible for the memory allocation for the `array_of_datatypes` and `array_of_displacements` arrays. The number of elements in each array is supplied by the user in `num_elements`. If the number of elements used by the event type is larger than the value of `num_elements` provided by the user, the number of datatype handles and displacements returned in the corresponding arrays is truncated to the value of `num_elements` passed in by the user. If the user passes the NULL pointer for `array_of_datatypes` or `array_of_displacements`, the respective arguments are ignored. Unless the user passes the NULL pointer for `num_elements`, the function returns the number of elements required for this event type. If the user passes the NULL pointer for `num_elements`, the arguments `num_elements`, `array_of_datatypes`, and `array_of_displacements` are ignored.

MPI can optionally return an enumeration identifier in the `enumtype` argument, describing the individual elements in the `array_of_datatypes` argument. Otherwise, `enumtype` is set to `MPI_T_ENUM_NULL`. If the argument to `enumtype` provided by the user is the `MPI_T_ENUM_NULL` pointer, no enumeration type is returned.

MPI can optionally return an info object containing the default hints set for a registration handle for this event type. If MPI is not yet initialized, already finalized, or the argument to `info` provided by the user is the NULL pointer, this argument is ignored. If an info object is returned, an MPI implementation is required to return all hints that are supported by the implementation for a registration handle for this event type and have default values specified; any user-supplied hints that were not ignored by the implementation; and any additional hints that were set by the implementation. If no such hints exist, a handle to a newly created info object is returned that contains no key/value pair. The user is responsible for freeing `info` via `MPI_INFO_FREE`.

The arguments `desc` and `desc_len` are used to return the description of the event type as described in Section 14.3.3. Returning a description is optional. If an MPI implementation does not return a description, the first character for `desc` must be set to the null character and `desc_len` must be set to one at the return from this function.

The parameter `bind` returns the type of the MPI object to which the event type must be bound or the value `MPI_T_BIND_NO_OBJECT` (see Section 14.3.2).

If an event type has an equivalent name across connected MPI processes, the following OUT parameters must be identical: `verbosity`, `array_of_datatypes`, `num_elements`, `enumtype`, and `bind`. The returned description must be equivalent. As the argument `array_of_displacements` is process dependent, it may differ across connected MPI processes.

This routine returns `MPI_SUCCESS` on success and returns `MPI_T_ERR_INVALID_INDEX` if `event_index` does not match a valid event type index provided by the implementation at the time of the call.

```

1 MPI_T_EVENT_GET_INDEX(name, event_index)
2     IN      name                name of the event type (string)
3
4     OUT    event_index         index of the event type (integer)

```

### C binding

```

7 int MPI_T_event_get_index(const char *name, int *event_index)

```

MPI\_T\_EVENT\_GET\_INDEX returns the index of an event type identified by a known event type name. The name parameter is provided by the caller, and `event_index` is returned by the MPI implementation. The name parameter is a string terminated with a null character.

This routine returns `MPI_SUCCESS` on success and returns `MPI_T_ERR_INVALID_NAME` if `name` does not match the name of any event type provided by the implementation at the time of the call.

*Rationale.* This routine is provided to enable fast retrieval of an event index by a tool, assuming it knows the name of the event type for which it is looking. The number of event types exposed by the implementation can change over time, so it is not possible for the tool to simply iterate over the list of event types once at initialization. Although using MPI implementation specific event type names is not portable across MPI implementations, tool developers may choose to take this route for lower overhead at runtime because the tool will not have to iterate over the entire set of event types to find a specific one. (*End of rationale.*)

### Handle Allocation and Deallocation

Before the MPI implementation calls a callback function on the occurrence of a specific event, the user needs to register a callback function to be called for that event type and obtain a handle of type `MPI_T_event_registration`.

```

32 MPI_T_EVENT_HANDLE_ALLOC(event_index, obj_handle, info,
33                          event_registration)
34     IN      event_index         index of the event type to be queried between 0 and
35                                          num_events - 1 (integer)
36
37     IN      obj_handle         pointer to a handle of the MPI object to which this
38                                          event is supposed to be bound (pointer)
39
40     IN      info               info argument (handle)
41
42     OUT    event_registration   event registration (handle)

```

### C binding

```

43 int MPI_T_event_handle_alloc(int event_index, void *obj_handle,
44                             MPI_Info info, MPI_T_event_registration *event_registration)

```

MPI\_T\_EVENT\_HANDLE\_ALLOC creates a *registration handle* for the event type identified by `event_index`. Furthermore, if required by the event type, the registration handle is bound to the object referred to by the argument `obj_handle`. The argument `obj_handle`

is ignored if the `MPI_T_EVENT_GET_INFO` call for this event type returned `MPI_T_BIND_NO_OBJECT` in the argument `bind`. The user can pass hints for the handle allocation to the MPI implementation via the `info` argument. The allocated event-registration handle is returned in the argument `event_registration`.

`MPI_T_EVENT_HANDLE_SET_INFO(event_registration, info)`

IN	<code>event_registration</code>	event registration (handle)
IN	<code>info</code>	info argument (handle)

### C binding

```
int MPI_T_event_handle_set_info(
    MPI_T_event_registration event_registration, MPI_Info info)
```

`MPI_T_EVENT_HANDLE_SET_INFO` updates the hints of the event-registration handle associated with `event_registration` using the hints provided in `info`. This operation has no effect on previously set or defaulted hints that are not specified by `info`. It also has no effect on previously set or defaulted hints that are specified by `info`, but are ignored by the MPI implementation in this call to `MPI_T_EVENT_HANDLE_SET_INFO`.

*Advice to users.* Some info items that an implementation can use when it creates an event-registration handle cannot easily be changed once the registration handle is created. Thus, an implementation may ignore hints issued in this call that it would have accepted in an handle allocation call. An implementation may also be unable to update certain info hints in a call to `MPI_T_EVENT_HANDLE_SET_INFO`. `MPI_T_EVENT_HANDLE_GET_INFO` can be used to determine whether info changes were ignored by the implementation. (*End of advice to users.*)

`MPI_T_EVENT_HANDLE_GET_INFO(event_registration, info_used)`

IN	<code>event_registration</code>	event registration (handle)
OUT	<code>info_used</code>	info argument (handle)

### C binding

```
int MPI_T_event_handle_get_info(
    MPI_T_event_registration event_registration,
    MPI_Info *info_used)
```

`MPI_EVENT_HANDLE_GET_INFO` returns a new info object containing the hints of the event-registration handle associated with `event_registration`. The current setting of all hints related to this registration handle is returned in `info_used`. An MPI implementation is required to return all hints that are supported by the implementation and have default values specified; any user-supplied hints that were not ignored by the implementation; and any additional hints that were set by the implementation. If no such hints exist, a handle to a newly created info object is returned that contains no key/value pairs. The user is responsible for freeing `info_used` via `MPI_INFO_FREE`.

```

1 MPI_T_EVENT_REGISTER_CALLBACK(event_registration, cb_safety,
2     info, user_data, event_cb_function)
3
4     IN     event_registration     event registration (handle)
5     IN     cb_safety             Maximum callback safety level (integer)
6     IN     info                 info argument (handle)
7     IN     user_data            pointer to a user-controlled buffer (pointer)
8     IN     event_cb_function     pointer to user-defined callback function (pointer)
9

```

## C binding

```

10
11
12 int MPI_T_event_register_callback(
13     MPI_T_event_registration event_registration,
14     MPI_T_cb_safety cb_safety, MPI_Info info, void *user_data,
15     MPI_T_event_cb_function event_cb_function)
16

```

MPI\_T\_EVENT\_REGISTER\_CALLBACK associates a user-defined function pointed to by `event_cb_function` with an allocated event-registration handle. The maximum callback safety level supported by the callback function is passed in the argument `cb_safety`. The safety levels are defined in Table 14.5. A user can register multiple callback functions for a given event-registration handle, potentially specifying one for each callback safety level. Registering a callback function for a specific callback safety level overwrites any previously registered callback function pointer and info object associated with the event registration for the specific callback safety level. If `event_cb_function` is the NULL pointer, the association of a callback function for that callback safety level is removed.

When an event is triggered, the implementation will select from all registered callbacks the callback with the lowest safety level valid in the context in which the callback is invoked. In situations where the required callback safety level exceeds the highest level for which a callback function is registered for a given registration handle, the event instance is dropped.

At invocation time, the implementation passes the pointer to a user-defined memory region specified during callback registration with the argument `user_data`.

The user can pass hints for the registration of the specified callback function to the MPI implementation via the info argument.

*Advice to users.* As event instances can be raised as soon as the registration handle is associated with the first callback function, the callback function with the highest callback safety guarantees should be registered before any further registrations for lower callback safety guarantees, to avoid dropped events due to insufficient callback safety guarantees. (*End of advice to users.*)

The callback function passed to MPI\_T\_EVENT\_REGISTER\_CALLBACK in the argument `event_cb_function` needs to have the following type:

```

17
18
19
20
21
22
23
24
25
26
27
28
29
30
31
32
33
34
35
36
37
38
39
40
41
42
43 typedef void (*MPI_T_event_cb_function)(
44     MPI_T_event_instance event_instance,
45     MPI_T_event_registration event_registration,
46     MPI_T_cb_safety cb_safety,
47     void *user_data);
48

```

The argument `event_instance` corresponds to a handle for the opaque event-instance object of type `MPI_T_event_instance`. This handle is only valid inside the corresponding invocation of the function to which it is passed. The argument `event_registration` corresponds to the event-registration handle returned by `MPI_T_EVENT_HANDLE_ALLOC` for the user function to the same event type and bound object combination. The handle can be used to identify the specific event registration information, such as event type and bound object, or even to deallocate the handle from within the callback invocation. The argument `cb_safety` describes the safety requirements the callback function must fulfill in the current invocation. The argument `user_data` is the pointer to user-allocated memory that was passed to the MPI implementation during callback registration.

`MPI_T_EVENT_CALLBACK_SET_INFO(event_registration, cb_safety, info)`

IN	<code>event_registration</code>	event registration (handle)
IN	<code>cb_safety</code>	Callback safety level (integer)
IN	<code>info</code>	info argument (handle)

### C binding

```
int MPI_T_event_callback_set_info(
    MPI_T_event_registration event_registration,
    MPI_T_cb_safety cb_safety, MPI_Info info)
```

`MPI_T_EVENT_CALLBACK_SET_INFO` updates the hints of the callback function registered for the callback safety level specified by `cb_safety` of the event-registration handle associated with `event_registration` using the hints provided in `info`. This operation has no effect on previously set or defaulted hints that are not specified by `info`. It also has no effect on previously set or defaulted hints that are specified by `info`, but are ignored by the MPI implementation in this call to `MPI_T_EVENT_CALLBACK_SET_INFO`.

`MPI_T_EVENT_CALLBACK_GET_INFO(event_registration, cb_safety, info_used)`

IN	<code>event_registration</code>	event registration (handle)
IN	<code>cb_safety</code>	Callback safety level (integer)
OUT	<code>info_used</code>	info argument (handle)

### C binding

```
int MPI_T_event_callback_get_info(
    MPI_T_event_registration event_registration,
    MPI_T_cb_safety cb_safety, MPI_Info *info_used)
```

`MPI_EVENT_CALLBACK_GET_INFO` returns a new `info` object containing the hints of the callback function registered for the callback safety level specified by `cb_safety` of the event-registration handle associated with `event_registration`. The current setting of all hints related to this callback safety level of the event-registration handle is returned in `info_used`. An MPI implementation is required to return all hints that are supported by the implementation and have default values specified; any user-supplied hints that were not ignored by the implementation; and any additional hints that were set by

1 the implementation. If no such hints exist, a handle to a newly created info object is  
 2 returned that contains no key/value pairs. The user is responsible for freeing info\_used via  
 3 MPI\_INFO\_FREE.

4 To stop the MPI implementation from raising events for a specific registration, a user  
 5 needs to free the corresponding event-registration handle.

```

  6
  7
  8 MPI_T_EVENT_HANDLE_FREE(event_registration, user_data, free_cb_function)
  9     IN     event_registration     event registration (handle)
 10     IN     user_data              pointer to a user-controlled buffer (pointer)
 11     IN     free_cb_function       pointer to user-defined callback function (pointer)
 12
 13
  
```

### 14 C binding

```

 15 int MPI_T_event_handle_free(MPI_T_event_registration event_registration,
 16                             MPI_T_event_free_cb_function free_cb_function)
 17
  
```

18 MPI\_T\_EVENT\_HANDLE\_FREE returns MPI\_SUCCESS when deallocation of the handle  
 19 was initiated successfully and returns MPI\_T\_ERR\_INVALID\_HANDLE if  
 20 event\_registration does not match a valid allocated event-registration handle at the time  
 21 of the call. The callback function free\_cb\_function is called by the MPI implementation,  
 22 when it is able to guarantee that no further event instances for the corresponding event-  
 23 registration handle will be raised. If the pointer to free\_cb\_function is the NULL pointer, no  
 24 user function is invoked after successful deallocation of the event registration handle. The  
 25 pointer to user-controlled memory provided in the user\_data argument will be passed to the  
 26 function provided in the free\_cb\_function on invocation.

27 *Advice to users.* A free-callback function associated with a registration handle should  
 28 always be prepared to postpone any pending actions, should the provided callback  
 29 safety requirements exceed those required by the pending actions. (*End of advice to*  
 30 *users.*)

31  
 32 The callback function passed to MPI\_T\_EVENT\_HANDLE\_FREE in the argument  
 33 free\_cb\_function needs to have the following type:

```

 34
 35 typedef void (*MPI_T_event_free_cb_function)(
 36             MPI_T_event_registration event_registration,
 37             MPI_T_cb_safety cb_safety,
 38             void *user_data);
 39
  
```

### 40 Handling Dropped Events

41  
 42 Events may occur at times when the MPI implementation cannot invoke the user function  
 43 corresponding to a matching event handle. An implementation is allowed to buffer such  
 44 events and delay the callback invocation. If an event occurs at times when the corresponding  
 45 callback function cannot be called and the corresponding data cannot be buffered, or no  
 46 callback function meeting the required callback safety level is registered, the event data may  
 47 be dropped. To discover such data loss, the user can set a handler function for a specific  
 48 event-registration handle.

```

MPI_T_EVENT_SET_DROPPED_HANDLER(event_registration, dropped_cb_function)
    IN      event_registration      valid event registration (handle)
    IN      dropped_cb_function     pointer to user-defined callback function (pointer)

```

### C binding

```

int MPI_T_event_set_dropped_handler(
    MPI_T_event_registration event_registration,
    MPI_T_event_dropped_cb_function dropped_cb_function)

```

MPI\_T\_EVENT\_SET\_DROPPED\_HANDLER registers the function `dropped_cb_function` to be called by the MPI implementation when event information is dropped for the registration handle specified in `event_registration`. Subsequent calls to MPI\_T\_EVENT\_SET\_DROPPED\_HANDLER with the same registration handle will replace previously registered callback functions for that registration handle. If the pointer to `dropped_cb_function` is the NULL pointer, no data loss is recorded or reported until a new valid callback function is registered.

*Advice to users.* The invocation of the dropped handler callback function may not occur close to the time the event was actually lost. (*End of advice to users.*)

The callback function passed to MPI\_T\_EVENT\_SET\_DROPPED\_HANDLER in the argument `dropped_cb_function` needs to have the following type:

```

typedef void (*MPI_T_event_dropped_cb_function)(int count,
    MPI_T_event_registration event_registration,
    int source_index,
    MPI_T_cb_safety cb_safety,
    void *user_data);

```

The argument `event_registration` corresponds to the event registration handle to which the dropped data corresponds. The argument `count` provides a best effort estimation of the number of invocations to a registered event callback corresponding to `event_registration` that were not executed since the registration of the dropped-callback handler or the last invocation of a registered dropped-callback handler. The `source_index` provides the index of the source that dropped the corresponding event information. The argument `cb_safety` describes the safety requirements the callback function must fulfill in the current invocation. The possible values for `cb_safety` are described in Table 14.5. The argument `user_data` is the pointer to user-allocated memory that was passed to the MPI implementation during callback registration.

*Advice to users.* A callback function for dropped events associated with a registration handle should always be prepared to postpone any pending actions, should the provided callback safety requirements exceed those required by the pending actions. (*End of advice to users.*)

*Advice to implementors.* A high-quality implementation will strive to invoke a callback function for dropped events associated with a registration handle at times that provide as much freedom of action to the function as possible. (*End of advice to implementors.*)

1 If events are dropped for a specific source, the corresponding handler callback function  
 2 must be called before other events are raised for this source. This means in a sequence of five  
 3 events E1 to E5 from the same source, where E3 and E4 were dropped, any handler func-  
 4 tion set through `MPI_T_EVENT_SET_DROPPED_HANDLER` for event-registration handles  
 5 associated with E3 or E4 must be called before E5 is raised.

## 7 Reading Event Data

8  
 9 In event callbacks, the parameter `event_instance` provides access to the per-instance event  
 10 data, i.e., the data encoded by the specific event type for this instance. The user can obtain  
 11 event data as well as event meta data, such as a time stamp and the source, by providing  
 12 this handle to the respective query functions. The event-instance handle is invalid beyond  
 13 the scope of the current invocation of the callback function to which it is provided.

14 The callback function argument `event_registration` identifies the registration handle that  
 15 was used to register the callback function.

16 The callback function argument `cb_safety` indicates the requirements for the specific  
 17 callback invocation. The value is one of the safety requirements levels described in Ta-  
 18 ble 14.5. The argument `user_data` passes the pointer provided by the user during callback  
 19 registration back to the function call.

20  
 21 *Advice to users.* Depending on the registered event and usage of MPI by the applica-  
 22 tion, a callback function may be invoked with high frequency. Users should therefore  
 23 strive to minimize the amount of work done inside callback functions. Furthermore,  
 24 the time spent in a callback function may influence the capability of an implementa-  
 25 tion to buffer events and long execution times may lead to an increased number of  
 26 dropped events. (*End of advice to users.*)

27 MPI provides the following function calls to access data of a specific event instance and  
 28 its corresponding meta data (such as its time and source).

30  
 31 `MPI_T_EVENT_READ(event_instance, element_index, buffer)`

32	IN	<code>event_instance</code>	event-instance handle provided to the callback func- 33 tion (handle)
34			
35	IN	<code>element_index</code>	index into the array of datatypes of the item to be 36 queried (integer)
37			
38	OUT	<code>buffer</code>	pointer to a memory location to store the item data 39 (pointer)

## 40 C binding

41 `int MPI_T_event_read(MPI_T_event_instance event_instance,`  
 42 `int element_index, void *buffer)`

43  
 44 `MPI_T_EVENT_READ` allows users to copy one element of the event data to a user-  
 45 specified buffer at a time.

46 The `event_instance` argument identifies the event instance to query. It is erroneous  
 47 to provide any other event-instance handle to the call than the one passed by the MPI  
 48 implementation to the callback function in which the data is read. The `buffer` argument



must point to a memory location the MPI implementation can copy the element of the event data to identified by `element_index`.

`MPI_T_EVENT_COPY(event_instance, buffer)`

IN	<code>event_instance</code>	event instance provided to the callback function (handle)
OUT	<code>buffer</code>	user-allocated buffer for event data (pointer)

### C binding

`int MPI_T_event_copy(MPI_T_event_instance event_instance, void *buffer)`

`MPI_T_EVENT_COPY` copies the event data as a whole into the user-provided `buffer`. The user must assure that the buffer is of at least the size of the extent of the event type, which can be computed from the type and displacement information returned by the corresponding call to `MPI_T_EVENT_GET_INFO`. The data may include padding bytes between individual elements of the event data in the buffer. A user can reconstruct the location and size of the data contained in the buffer through the information returned by `MPI_T_EVENT_GET_INFO`.

*Advice to implementors.* An implementation should strive to use an appropriately compact representation when copying event instance data to a user buffer via `MPI_T_EVENT_COPY` to reduce the amount of memory required for the user buffer. *(End of advice to implementors.)*

### Reading Event Meta Data

Additional to the specific event data encoded by each event type, supplemental information available across all event types can be queried.

`MPI_T_EVENT_GET_TIMESTAMP(event_instance, event_timestamp)`

IN	<code>event_instance</code>	event-instance provided to the callback function (handle)
OUT	<code>event_timestamp</code>	timestamp the event was observed (integer)

### C binding

`int MPI_T_event_get_timestamp(MPI_T_event_instance event_instance, MPI_Count *event_timestamp)`

`MPI_T_EVENT_GET_TIMESTAMP` returns the timestamp of when the event was initially observed by the implementation. The `event_instance` argument identifies the event instance to query. It is erroneous to provide any other handle to the call than the one passed by the MPI implementation to the callback function in which the timestamp is read.

*Advice to users.* An MPI implementation may postpone the call to the user's callback function. In this case, the call to `MPI_T_EVENT_GET_TIMESTAMP` may yield a timestamp in the past that is closer to the time the event was initially observed, as

1       opposed to a timestamp captured during callback function invocation. (*End of advice*  
2       *to users.*)

3  
4       *Advice to implementors.* A high-quality implementation will return a timestamp as  
5       close as possible to the earliest time the event was observed by the MPI implementa-  
6       tion. (*End of advice to implementors.*)

7  
8       An event may be raised from different components acting as event sources in the MPI  
9       implementation. A source in this context is an abstract concept that helps to define partial  
10       ordering of raised events, as each source provides its own ordering guarantees. A source  
11       describes the entity that raises the event, rather than the origin of the data.

12       To identify the source of an event instance, the user can query the index of the source  
13       within the corresponding event callback function invocation.

14  
15       *Advice to implementors.* An excessive number of event sources may negatively impact  
16       performance of a tool due to per-source overhead in event handling. (*End of advice*  
17       *to implementors.*)

18  
19  
20   MPI\_T\_EVENT\_GET\_SOURCE(event\_instance, source\_index)

21	IN	event_instance	event instance provided to the callback function (handle)
22			
23			
24	OUT	source_index	index identifying the source
25			

## 26   C binding

```
27   int MPI_T_event_get_source(MPI_T_event_instance event_instance,
28                            int *source_index)
```

29  
30       The `event_instance` argument identifies the event instance to query. It is erroneous  
31       to provide any other event-instance handle to the call than the one passed by the MPI  
32       implementation to the callback function in which the source is queried.

33       The `source_index` argument returns the index of the source of the event instance. It  
34       can be used to query more information on the source using `MPI_T_SOURCE_GET_INFO`.

35  
36       *Rationale.* Event callback function invocations are associated with a source to enable  
37       chronological processing of events on the tool side, when required, while retaining low  
38       overhead on the side of the MPI implementation. (*End of rationale.*)

### 39   14.3.9 Variable Categorization

40  
41       MPI implementations can optionally group performance and control variables into categories  
42       to express logical relationships between various variables. For example, an MPI implementa-  
43       tion could group all control and performance variables that refer to message transfers in  
44       the MPI implementation and thereby distinguish them from variables that refer to local  
45       resources such as memory allocations or other interactions with the operating system.

46       Categories can also contain other categories to form a hierarchical grouping. Categories  
47       can never include themselves, either directly or transitively within other included categories.  
48       Expanding on the example above, this allows MPI to refine the grouping of variables referring

to message transfers into variables to control and to monitor message queues, message matching activities and communication protocols. Each of these groups of variables would be represented by a separate category and these categories would then be listed in a single category representing variables for message transfers.

The category information may be queried in a fashion similar to the mechanism for querying variable information. The MPI implementation exports a set of  $N$  categories via the MPI tool information interface. If  $N = 0$ , then the MPI implementation does not export any categories, otherwise the provided categories are indexed from 0 to  $N - 1$ . This index number is used in subsequent calls to functions of the MPI tool information interface to identify the individual categories.

An MPI implementation is permitted to increase the number of categories during the execution of an MPI program when new categories become available through dynamic loading. However, MPI implementations are not allowed to change the index of a category or delete it once it has been added to the set.

Similarly, MPI implementations are allowed to add variables to categories, but they are not allowed to remove variables from categories or change the order in which they are returned.

#### Category Query Functions

The following function can be used to query the number of categories, `num_cat`.

`MPI_T_CATEGORY_GET_NUM(num_cat)`

OUT      `num_cat`                      current number of categories (integer)

#### C binding

`int MPI_T_category_get_num(int *num_cat)`

Individual category information can then be queried by calling the following function:

```

1 MPI_T_CATEGORY_GET_INFO(cat_index, name, name_len, desc, desc_len, num_cvars, num_pvars,
2     num_categories)

```

3	IN	cat_index	index of the category to be queried (integer)
4			
5	OUT	name	buffer to return the string containing the name of the category (string)
6			
7	INOUT	name_len	length of the string and/or buffer for name (integer)
8			
9	OUT	desc	buffer to return the string containing the description of the category (string)
10			
11	INOUT	desc_len	length of the string and/or buffer for desc (integer)
12			
13	OUT	num_cvars	number of control variables in the category (integer)
14	OUT	num_pvars	number of performance variables in the category (integer)
15			
16	OUT	num_categories	number of categories contained in the category (integer)
17			

### 19 C binding

```

20 int MPI_T_category_get_info(int cat_index, char *name, int *name_len,
21     char *desc, int *desc_len, int *num_cvars, int *num_pvars,
22     int *num_categories)

```

23  
24 The arguments `name` and `name_len` are used to return the name of the category as described in Section 14.3.3.

25  
26 The routine is required to return a name of at least length one. This name must be unique with respect to all other names for categories used by the MPI implementation.

27  
28 If any OUT parameter to `MPI_T_CATEGORY_GET_INFO` is the NULL pointer, the implementation will ignore the parameter and not return a value for the parameter.

29  
30 The arguments `desc` and `desc_len` are used to return the description of the category as described in Section 14.3.3.

31  
32 Returning a description is optional. If an MPI implementation decides not to return a description, the first character for `desc` must be set to the null character and `desc_len` must be set to one at the return of this call.

33  
34 The function returns the number of control variables, performance variables and other categories contained in the queried category in the arguments `num_cvars`, `num_pvars`, and `num_categories`, respectively.

35  
36 If the name of a category is equivalent across connected MPI processes, then the returned description must be equivalent.

```

41 MPI_T_CATEGORY_GET_NUM_EVENTS(cat_index, num_events)

```

42	IN	cat_index	index of the category to be queried (integer)
43			
44	OUT	num_events	number of event types in the category (integer)
45			

### 46 C binding

```

47 int MPI_T_category_get_num_events(int cat_index, int *num_events)
48

```

MPI\_T\_CATEGORY\_GET\_NUM\_EVENTS returns the number of event types contained in the queried category.

MPI\_T\_CATEGORY\_GET\_INDEX(name, cat\_index)

IN	name	the name of the category (string)
OUT	cat_index	the index of the category (integer)

### C binding

```
int MPI_T_category_get_index(const char *name, int *cat_index)
```

MPI\_T\_CATEGORY\_GET\_INDEX is a function for retrieving the index of a category given a known category name. The name parameter is provided by the caller, and cat\_index is returned by the MPI implementation. The name parameter is a string terminated with a null character.

This routine returns MPI\_SUCCESS on success and returns MPI\_T\_ERR\_INVALID\_NAME if name does not match the name of any category provided by the implementation at the time of the call.

*Rationale.* This routine is provided to enable fast retrieval of a category index by a tool, assuming it knows the name of the category for which it is looking. The number of categories exposed by the implementation can change over time, so it is not possible for the tool to simply iterate over the list of categories once at initialization. Although using MPI implementation specific category names is not portable across MPI implementations, tool developers may choose to take this route for lower overhead at runtime because the tool will not have to iterate over the entire set of categories to find a specific one. (*End of rationale.*)

### Category Member Query Functions

MPI\_T\_CATEGORY\_GET\_CVARS(cat\_index, len, indices)

IN	cat_index	index of the category to be queried, in the range 0 and num_cat - 1 (integer)
IN	len	the length of the indices array (integer)
OUT	indices	an integer array of size len, indicating control variable indices (array of integers)

### C binding

```
int MPI_T_category_get_cvars(int cat_index, int len, int indices[])
```

MPI\_T\_CATEGORY\_GET\_CVARS can be used to query which control variables are contained in a particular category. A category contains zero or more control variables.

1 MPI\_T\_CATEGORY\_GET\_PVARS(cat\_index, len, indices)

2     IN        cat\_index                index of the category to be queried, in the range 0 and  
3                                        num\_cat - 1 (integer)  
4  
5     IN        len                     the length of the indices array (integer)  
6  
7     OUT       indices                 an integer array of size len, indicating performance  
8                                        variable indices (array of integers)

9 **C binding**

10 int MPI\_T\_category\_get\_pvars(int cat\_index, int len, int indices[])

11  
12 MPI\_T\_CATEGORY\_GET\_PVARS can be used to query which performance variables  
13 are contained in a particular category. A category contains zero or more performance  
14 variables.

15  
16 MPI\_T\_CATEGORY\_GET\_EVENTS(cat\_index, len, indices)

17  
18     IN        cat\_index                index of the category to be queried, in the range 0 and  
19                                        num\_cat - 1 (integer)  
20  
21     IN        len                     the length of the indices array (integer)  
22  
23     OUT       indices                 an integer array of size len, indicating event type in-  
24                                        dices (array of integers)

25 **C binding**

26 int MPI\_T\_category\_get\_events(int cat\_index, int len, int indices[])

27  
28 MPI\_T\_CATEGORY\_GET\_EVENTS can be used to query which event types are con-  
29 tained in a particular category. A category contains zero or more event types.

30  
31 MPI\_T\_CATEGORY\_GET\_CATEGORIES(cat\_index, len, indices)

32     IN        cat\_index                index of the category to be queried, in the range 0 and  
33                                        num\_cat - 1 (integer)  
34  
35     IN        len                     the length of the indices array (integer)  
36  
37     OUT       indices                 an integer array of size len, indicating category indices  
38                                        (array of integers)

39 **C binding**

40 int MPI\_T\_category\_get\_categories(int cat\_index, int len, int indices[])

41  
42 MPI\_T\_CATEGORY\_GET\_CATEGORIES can be used to query which other categories  
43 are contained in a particular category. A category contains zero or more other categories.

44 As mentioned above, MPI implementations can grow the number of categories as well  
45 as the number of variables or other categories within a category. In order to allow users  
46 of the MPI tool information interface to check quickly whether new categories have been  
47 added or new variables or categories have been added to a category, MPI maintains a  
48

virtual timestamp. This timestamp is monotonically increasing during the execution and is returned by the following function:

`MPI_T_CATEGORY_CHANGED(stamp)`

OUT      stamp                      a virtual time stamp to indicate the last change to the categories (integer)

### C binding

`int MPI_T_category_changed(int *stamp)`

If two subsequent calls to this routine return the same timestamp, it is guaranteed that the category information has not changed between the two calls. If the timestamp retrieved from the second call is higher, then some categories have been added or expanded.

*Advice to users.* The timestamp value is purely virtual and only intended to check for changes in the category information. It should not be used for any other purpose. (*End of advice to users.*)

The index values returned in indices by `MPI_T_CATEGORY_GET_CVARS`, `MPI_T_CATEGORY_GET_PVARS` and `MPI_T_CATEGORY_GET_CATEGORIES` can be used as input to `MPI_T_CVAR_GET_INFO`, `MPI_T_PVAR_GET_INFO` and `MPI_T_CATEGORY_GET_INFO`, respectively.

The user is responsible for allocating the arrays passed into the functions `MPI_T_CATEGORY_GET_CVARS`, `MPI_T_CATEGORY_GET_PVARS` and `MPI_T_CATEGORY_GET_CATEGORIES`. Starting from array index 0, each function writes up to `len` elements into the array. If the category contains more than `len` elements, the function returns an arbitrary subset of size `len`. Otherwise, the entire set of elements is returned in the beginning entries of the array, and any remaining array entries are not modified.

#### 14.3.10 Return Codes for the MPI Tool Information Interface

All functions defined as part of the MPI tool information interface return an integer error code (see Table 14.7) to indicate whether the function was completed successfully or was aborted. In the latter case the error code indicates the reason for not completing the routine. Such errors neither impact the execution of the MPI process nor invoke MPI error handlers. The MPI process continues executing regardless of the return code from the call. The MPI implementation is not required to check all user-provided parameters; if a user passes invalid parameter values to any routine the behavior of the implementation is undefined.

All error codes with the prefix `MPI_T_` must be unique values and cannot overlap with any other error codes or error classes returned by the MPI implementation. Further, they shall be treated as MPI error classes as defined in Section 8.4 and follow the same rules and restrictions. In particular, they must satisfy:

$$0 = \text{MPI\_SUCCESS} < \text{MPI\_T\_ERR\_XXX} \leq \text{MPI\_ERR\_LASTCODE}.$$

*Rationale.* All MPI tool information interface functions must return error classes, because applications cannot portably call `MPI_ERROR_CLASS` before MPI initialization to map an arbitrary error code to an error class. (*End of rationale.*)

### 14.3.11 Profiling Interface

All requirements for the profiling interfaces, as described in Section 14.2, also apply to the MPI tool information interface. All rules, guidelines, and recommendations from Section 14.2 apply equally to calls defined as part of the MPI tool information interface.

DRAFT



Return Code	Description
Return Codes for All Functions in the MPI Tool Information Interface	
MPI_SUCCESS	Call completed successfully
MPI_T_ERR_INVALID	Invalid or bad parameter value(s)
MPI_T_ERR_MEMORY	Out of memory
MPI_T_ERR_NOT_INITIALIZED	Interface not initialized
MPI_T_ERR_CANNOT_INIT	Interface not in the state to be initialized
MPI_T_ERR_NOT_ACCESSIBLE	Requested functionality not accessible
Return Codes for Datatype Functions: MPI_T_ENUM_*	
MPI_T_ERR_INVALID_INDEX	The enumeration index is invalid
MPI_T_ERR_INVALID_ITEM	The item index queried is out of range (for MPI_T_ENUM_GET_ITEM only)
Return Codes for Variable, Category, and Event Query Functions: MPI_T_*_GET_*	
MPI_T_ERR_INVALID_INDEX	The variable or category index is invalid
MPI_T_ERR_INVALID_NAME	The variable or category name is invalid
Return Codes for Handle Functions: MPI_T_*_{ALLOC FREE}	
MPI_T_ERR_INVALID_INDEX	The variable index is invalid
MPI_T_ERR_INVALID_HANDLE	The handle is invalid
MPI_T_ERR_OUT_OF_HANDLES	No more handles available
Return Codes for Session Functions: MPI_T_PVAR_SESSION_*	
MPI_T_ERR_OUT_OF_SESSIONS	No more sessions available
MPI_T_ERR_INVALID_SESSION	Session argument is not a valid session
Return Codes for Control Variable Access Functions: MPI_T_CVAR_{READ WRITE}	
MPI_T_ERR_CVAR_SET_NOT_NOW	Variable cannot be set at this moment
MPI_T_ERR_CVAR_SET_NEVER	Variable cannot be set until end of execution
MPI_T_ERR_INVALID_HANDLE	The handle is invalid
Return Codes for Performance Variable Access and Control:	
MPI_T_PVAR_{START STOP READ WRITE RESET READREST}	
MPI_T_ERR_INVALID_HANDLE	The handle is invalid
MPI_T_ERR_INVALID_SESSION	Session argument is not a valid session
MPI_T_ERR_PVAR_NO_STARTSTOP	Variable cannot be started or stopped (for MPI_T_PVAR_START and MPI_T_PVAR_STOP)
MPI_T_ERR_PVAR_NO_WRITE	Variable cannot be written or reset (for MPI_T_PVAR_WRITE and MPI_T_PVAR_RESET)
MPI_T_ERR_PVAR_NO_ATOMIC	Variable cannot be read and written atomically (for MPI_T_PVAR_READRESET)
Return Codes for Source Functions: MPI_T_SOURCE_*	
MPI_T_ERR_INVALID_INDEX	The source index is invalid
MPI_T_ERR_NOT_SUPPORTED	Requested functionality not supported
Return Codes for Category Functions: MPI_T_CATEGORY_*	
MPI_T_ERR_INVALID_INDEX	The category index is invalid

Table 14.7: Return codes used in functions of the MPI tool information interface

1  
2  
3  
4  
5  
6  
7  
8  
9  
10  
11  
12  
13  
14  
15  
16  
17  
18  
19  
20  
21  
22  
23  
24  
25  
26  
27  
28  
29  
30  
31  
32  
33  
34  
35  
36  
37  
38  
39  
40  
41  
42  
43  
44  
45  
46  
47  
48

DRAFT

# Chapter 15

## Deprecated Interfaces

### 15.1 Deprecated since MPI-2.0

The following function is deprecated and is superseded by `MPI_COMM_CREATE_KEYVAL` in MPI-2.0. The language independent definition of the deprecated function is the same as that of the new function, except for the function name and a different behavior in the C/Fortran language interoperability, see Section 18.2.7. The language bindings are modified.

`MPI_KEYVAL_CREATE(copy_fn, delete_fn, keyval, extra_state)`

IN	<code>copy_fn</code>	Copy callback function for <code>keyval</code>
IN	<code>delete_fn</code>	Delete callback function for <code>keyval</code>
OUT	<code>keyval</code>	key value for future access (integer)
IN	<code>extra_state</code>	Extra state for callback functions

#### C binding

```
int MPI_Keyval_create(MPI_Copy_function *copy_fn,  
                    MPI_Delete_function *delete_fn, int *keyval,  
                    void *extra_state)
```

For this routine, an interface within the `mpi_f08` module was never defined.

#### Fortran binding

```
MPI_KEYVAL_CREATE(COPY_FN, DELETE_FN, KEYVAL, EXTRA_STATE, IERROR)  
    EXTERNAL COPY_FN, DELETE_FN  
    INTEGER KEYVAL, EXTRA_STATE, IERROR
```

The `copy_fn` function is invoked when a communicator is duplicated by `MPI_COMM_DUP`. `copy_fn` should be of type `MPI_Copy_function`, which is defined as follows:

```
typedef int MPI_Copy_function(MPI_Comm oldcomm, int keyval,  
                             void *extra_state, void *attribute_val_in,  
                             void *attribute_val_out, int *flag);
```

A Fortran declaration for such a function is as follows:

For this routine, an interface within the `mpi_f08` module was never defined.

```

1  SUBROUTINE COPY_FUNCTION(OLDCOMM, KEYVAL, EXTRA_STATE, ATTRIBUTE_VAL_IN,
2      ATTRIBUTE_VAL_OUT, FLAG, IERR)
3      INTEGER OLDCOMM, KEYVAL, EXTRA_STATE, ATTRIBUTE_VAL_IN,
4      ATTRIBUTE_VAL_OUT, IERR
5      LOGICAL FLAG

```

6 `copy_fn` may be specified as `MPI_NULL_COPY_FN` or `MPI_DUP_FN` from either C or Fortran; `MPI_NULL_COPY_FN` is a function that does nothing other than returning `flag = 0` and `MPI_SUCCESS`. `MPI_DUP_FN` is a simple-minded copy function that sets `flag = 1`, returns the value of `attribute_val_in` in `attribute_val_out`, and returns `MPI_SUCCESS`. Note that `MPI_NULL_COPY_FN` and `MPI_DUP_FN` are also deprecated.

7 Analogous to `copy_fn` is a callback deletion function, defined as follows. The `delete_fn` function is invoked when a communicator is deleted by `MPI_COMM_FREE` or when a call is made explicitly to `MPI_ATTR_DELETE`. `delete_fn` should be of type `MPI_Delete_function`, which is defined as follows:

```

12  typedef int MPI_Delete_function(MPI_Comm comm, int keyval,
13      void *attribute_val, void *extra_state);

```

14 A Fortran declaration for such a function is as follows:

15 For this routine, an interface within the `mpi_f08` module was never defined.

```

18  SUBROUTINE DELETE_FUNCTION(COMM, KEYVAL, ATTRIBUTE_VAL, EXTRA_STATE, IERR)
19      INTEGER COMM, KEYVAL, ATTRIBUTE_VAL, EXTRA_STATE, IERR

```

20 `delete_fn` may be specified as `MPI_NULL_DELETE_FN` from either C or Fortran; `MPI_NULL_DELETE_FN` is a function that does nothing, other than returning `MPI_SUCCESS`. Note that `MPI_NULL_DELETE_FN` is also deprecated.

21 The following function is deprecated and is superseded by `MPI_COMM_FREE_KEYVAL` in MPI-2.0. The language independent definition of the deprecated function is the same as of the new function, except of the function name. The language bindings are modified.

```

22  MPI_KEYVAL_FREE(keyval)

```

23 INOUT keyval Frees the integer key value (integer)

### 24 C binding

```

25  int MPI_Keyval_free(int *keyval)

```

26 For this routine, an interface within the `mpi_f08` module was never defined.

### 27 Fortran binding

```

28  MPI_KEYVAL_FREE(KEYVAL, IERROR)
29  INTEGER KEYVAL, IERROR

```

30 The following function is deprecated and is superseded by `MPI_COMM_SET_ATTR` in MPI-2.0. The language independent definition of the deprecated function is the same as of the new function, except of the function name. The language bindings are modified.

MPI\_ATTR\_PUT(comm, keyval, attribute\_val) 1

INOUT	comm	communicator to which attribute will be attached (handle)	2 3
IN	keyval	key value, as returned by MPI_KEYVAL_CREATE (integer)	4 5 6
IN	attribute_val	attribute value	7 8

### C binding 9

```
int MPI_Attr_put(MPI_Comm comm, int keyval, void *attribute_val) 10
```

For this routine, an interface within the `mpi_f08` module was never defined. 11  
12

### Fortran binding 13

```
MPI_ATTR_PUT(COMM, KEYVAL, ATTRIBUTE_VAL, IERROR) 14
      INTEGER COMM, KEYVAL, ATTRIBUTE_VAL, IERROR 15
```

The following function is deprecated and is superseded by `MPI_COMM_GET_ATTR` in MPI-2.0. The language independent definition of the deprecated function is the same as of the new function, except of the function name. The language bindings are modified. 16  
17  
18  
19

MPI\_ATTR\_GET(comm, keyval, attribute\_val, flag) 21

IN	comm	communicator to which attribute is attached (handle)	22 23
IN	keyval	key value (integer)	24
OUT	attribute_val	attribute value, unless flag = false	25 26
OUT	flag	true if an attribute value was extracted; false if no attribute is associated with the key	27 28

### C binding 29

```
int MPI_Attr_get(MPI_Comm comm, int keyval, void *attribute_val, int *flag) 30
```

For this routine, an interface within the `mpi_f08` module was never defined. 31  
32  
33

### Fortran binding 34

```
MPI_ATTR_GET(COMM, KEYVAL, ATTRIBUTE_VAL, FLAG, IERROR) 35
      INTEGER COMM, KEYVAL, ATTRIBUTE_VAL, IERROR 36
      LOGICAL FLAG 37
```

The following function is deprecated and is superseded by `MPI_COMM_DELETE_ATTR` in MPI-2.0. The language independent definition of the deprecated function is the same as of the new function, except of the function name. The language bindings are modified. 38  
39  
40  
41

MPI\_ATTR\_DELETE(comm, keyval) 42  
43

INOUT	comm	communicator to which attribute is attached (handle)	44 45
IN	keyval	The key value of the deleted attribute (integer)	46 47

### C binding 48

```
1 int MPI_Attr_delete(MPI_Comm comm, int keyval)
```

2 For this routine, an interface within the `mpi_f08` module was never defined.

#### 4 Fortran binding

```
5 MPI_ATTR_DELETE(COMM, KEYVAL, IERROR)
6     INTEGER COMM, KEYVAL, IERROR
```

## 9 15.2 Deprecated since MPI-2.2

11 The entire set of C++ language bindings have been removed. See Chapter 16, [Removed Interfaces](#) for more information.

13 The following function typedefs have been deprecated and are superseded by new names. Other than the typedef names, the function signatures are exactly the same; the names were updated to match conventions of other function typedef names.

Deprecated Name	New Name
<code>MPI_Comm_errhandler_fn</code>	<code>MPI_Comm_errhandler_function</code>
<code>MPI_File_errhandler_fn</code>	<code>MPI_File_errhandler_function</code>
<code>MPI_Win_errhandler_fn</code>	<code>MPI_Win_errhandler_function</code>

## 22 15.3 Deprecated since MPI-3.2

24 Cancelling a send request by calling `MPI_CANCEL` has been deprecated and may be removed in a future version of the MPI specification.

## 28 15.4 Deprecated since MPI-4.0

29 The following function is deprecated and is superseded by the new `MPI_INFO_GET_STRING` call in MPI-4.0.

```
33 MPI_INFO_GET(info, key, valuelen, value, flag)
```

34	IN	info	info object (handle)
35	IN	key	key (string)
36	IN	valuelen	length of value arg (integer)
37	IN	valuelen	length of value arg (integer)
38	OUT	value	value (string)
39	OUT	value	value (string)
40	OUT	flag	true if key defined, false if not (boolean)

#### 42 C binding

```
43 int MPI_Info_get(MPI_Info info, const char *key, int valuelen, char *value,
44                 int *flag)
```

#### 45 Fortran 2008 binding

```
46 MPI_Info_get(info, key, valuelen, value, flag, ierror)
47     TYPE(MPI_Info), INTENT(IN) :: info
```

```

CHARACTER(LEN=*), INTENT(IN) :: key
INTEGER, INTENT(IN) :: valuelen
CHARACTER(LEN=valuelen), INTENT(OUT) :: value
LOGICAL, INTENT(OUT) :: flag
INTEGER, OPTIONAL, INTENT(OUT) :: ierror

```

**Fortran binding**

```

MPI_INFO_GET(INFO, KEY, VALUELEN, VALUE, FLAG, IERROR)
  INTEGER INFO, VALUELEN, IERROR
  CHARACTER*(*) KEY, VALUE
  LOGICAL FLAG

```

The following function is deprecated and is superseded by the new MPI\_INFO\_GET\_STRING call in MPI-4.0.

```

MPI_INFO_GET_VALUELEN(info, key, valuelen, flag)

```

IN	info	info object (handle)
IN	key	key (string)
OUT	valuelen	length of value arg (integer)
OUT	flag	true if key defined, false if not (boolean)

**C binding**

```

int MPI_Info_get_valuelen(MPI_Info info, const char *key, int *valuelen,
                          int *flag)

```

**Fortran 2008 binding**

```

MPI_Info_get_valuelen(info, key, valuelen, flag, ierror)
  TYPE(MPI_Info), INTENT(IN) :: info
  CHARACTER(LEN=*), INTENT(IN) :: key
  INTEGER, INTENT(OUT) :: valuelen
  LOGICAL, INTENT(OUT) :: flag
  INTEGER, OPTIONAL, INTENT(OUT) :: ierror

```

**Fortran binding**

```

MPI_INFO_GET_VALUELEN(INFO, KEY, VALUELEN, FLAG, IERROR)
  INTEGER INFO, VALUELEN, IERROR
  CHARACTER*(*) KEY
  LOGICAL FLAG

```

The following return class has been deprecated and is superseded by a new name.

Deprecated Name	Replacement Name
<u>MPI_T_ERR_INVALID_ITEM</u>	<u>MPI_T_ERR_INVALID_INDEX</u>

The following Fortran subroutines are deprecated because the Fortran language storage\_size() and c\_sizeof() intrinsic functions provide similar functionality. Note that while MPI\_SIZEOF and c\_sizeof() return the size in bytes, storage\_size() provides the size in bits.

```
1 MPI_SIZEOF(x, size)
2   IN      x                a Fortran variable of numeric intrinsic type (choice)
3
4   OUT    size              size of machine representation of that type (integer)
5
```

```
6 Fortran 2008 binding
7 MPI_Sizeof(x, size, ierror)
8     TYPE(*), DIMENSION(..) :: x
9     INTEGER, INTENT(OUT) :: size
10    INTEGER, OPTIONAL, INTENT(OUT) :: ierror
11
```

```
12 Fortran binding
13 MPI_SIZEOF(X, SIZE, IERROR)
14     <type> X
15     INTEGER SIZE, IERROR
16
17
18
19
20
21
22
23
24
25
26
27
28
29
30
31
32
33
34
35
36
37
38
39
40
41
42
43
44
45
46
47
48
```



1  
2  
3  
4  
5  
6  
7  
8  
9  
10  
11  
12  
13  
14  
15  
16  
17  
18  
19  
20  
21  
22  
23  
24  
25  
26  
27  
28  
29  
30  
31  
32  
33  
34  
35  
36  
37  
38  
39  
40  
41  
42  
43  
44  
45  
46  
47  
48

# Chapter 16

## Removed Interfaces

### 16.1 Removed MPI-1 Bindings

#### 16.1.1 Overview

The following MPI-1 bindings were deprecated as of MPI-2 and are removed in MPI-3. They may be provided by an implementation for backwards compatibility, but are not required. Removal of these bindings affects all language-specific definitions thereof. Only the language-neutral bindings are listed when possible.

#### 16.1.2 Removed MPI-1 Functions

Table 16.1 shows the removed MPI-1 functions and their replacements.

Removed	MPI-2 Replacement
MPI_ADDRESS	MPI_GET_ADDRESS
MPI_ERRHANDLER_CREATE	MPI_COMM_CREATE_ERRHANDLER
MPI_ERRHANDLER_GET	MPI_COMM_GET_ERRHANDLER
MPI_ERRHANDLER_SET	MPI_COMM_SET_ERRHANDLER
MPI_TYPE_EXTENT	MPI_TYPE_GET_EXTENT
MPI_TYPE_HINDEXED	MPI_TYPE_CREATE_HINDEXED
MPI_TYPE_HVECTOR	MPI_TYPE_CREATE_HVECTOR
MPI_TYPE_LB	MPI_TYPE_GET_EXTENT
MPI_TYPE_STRUCT	MPI_TYPE_CREATE_STRUCT
MPI_TYPE_UB	MPI_TYPE_GET_EXTENT

Table 16.1: Removed MPI-1 functions and their replacements

#### 16.1.3 Removed MPI-1 Datatypes

Table 16.2 shows the removed MPI-1 datatypes and their replacements.

#### 16.1.4 Removed MPI-1 Constants

Table 16.3 shows the removed MPI-1 constants. There are no MPI-2 replacements.

Removed	MPI-2 Replacement
MPI_LB	MPI_TYPE_CREATE_RESIZED
MPI_UB	MPI_TYPE_CREATE_RESIZED

Table 16.2: Removed MPI-1 datatypes and their replacements

Removed MPI-1 Constants
C type: <code>const int</code> (or unnamed <code>enum</code> )
Fortran type: <code>INTEGER</code>
MPI_COMBINER_HINDEXED_INTEGER
MPI_COMBINER_HVECTOR_INTEGER
MPI_COMBINER_STRUCT_INTEGER

Table 16.3: Removed MPI-1 constants

### 16.1.5 Removed MPI-1 Callback Prototypes

Table 16.4 shows the removed MPI-1 callback prototypes and their MPI-2 replacements.

Removed	MPI-2 Replacement
MPI_Handler_function	MPI_Comm_errhandler_function

Table 16.4: Removed MPI-1 callback prototypes and their replacements

## 16.2 C++ Bindings

The C++ bindings were deprecated as of MPI-2.2. The C++ bindings are removed in MPI-3.0. The namespace is still reserved, however, and bindings may only be provided by an implementation as described in the MPI-2.2 standard.

1  
2  
3  
4  
5  
6  
7  
8  
9  
10  
11  
12  
13  
14  
15  
16  
17  
18  
19  
20  
21  
22  
23  
24  
25  
26  
27  
28  
29  
30  
31  
32  
33  
34  
35  
36  
37  
38  
39  
40  
41  
42  
43  
44  
45  
46  
47  
48

## Chapter 17

# Backward Incompatibilities

### 17.1 Backward Incompatible since MPI-3.2

The default communicator where errors are raised when not involving a communicator, window, or file was changed from `MPI_COMM_WORLD` to `MPI_COMM_SELF`.

DRAFT

1  
2  
3  
4  
5  
6  
7  
8  
9  
10  
11  
12  
13  
14  
15  
16  
17  
18  
19  
20  
21  
22  
23  
24  
25  
26  
27  
28  
29  
30  
31  
32  
33  
34  
35  
36  
37  
38  
39  
40  
41  
42  
43  
44  
45  
46  
47  
48

DRAFT

1  
2  
3  
4  
5  
6  
7  
8  
9  
10  
11  
12  
13  
14  
15  
16  
17  
18  
19  
20  
21  
22  
23  
24  
25  
26  
27  
28  
29  
30  
31  
32  
33  
34  
35  
36  
37  
38  
39  
40  
41  
42  
43  
44  
45  
46  
47  
48

# Chapter 18

## Language Bindings

### 18.1 Fortran Support

#### 18.1.1 Overview

The Fortran MPI language bindings have been designed to be compatible with the Fortran 90 standard with additional features from Fortran 2003 and Fortran 2008 [42] + TS 29113 [43].

*Rationale.* Fortran 90 contains numerous features designed to make it a more “modern” language than Fortran 77. It seems natural that MPI should be able to take advantage of these new features with a set of bindings tailored to Fortran 90. In Fortran 2008 + TS 29113, the major new language features used are the `ASYNCHRONOUS` attribute to protect nonblocking MPI operations, and assumed-type and assumed-rank dummy arguments for choice buffer arguments. Further requirements for compiler support are listed in Section 18.1.7. (*End of rationale.*)

MPI defines three methods of Fortran support:

1. **USE mpi\_f08:** This method is described in Section 18.1.2. It requires compile-time argument checking with unique MPI handle types and provides techniques to fully solve the optimization problems with nonblocking calls. This is the only Fortran support method that is consistent with the Fortran standard (Fortran 2008 + TS 29113 and later). This method is highly recommended for all MPI applications.
2. **USE mpi:** This method is described in Section 18.1.3 and requires compile-time argument checking. Handles are defined as `INTEGER`. This Fortran support method is inconsistent with the Fortran standard, and its use is therefore not recommended. It exists only for backwards compatibility.
3. **INCLUDE 'mpif.h':** This method is described in Section 18.1.4. The use of the include file `mpif.h` is strongly discouraged starting with MPI-3.0, because this method neither guarantees compile-time argument checking nor provides sufficient techniques to solve the optimization problems with nonblocking calls, and is therefore inconsistent with the Fortran standard. It exists only for backwards compatibility with legacy MPI applications.

Compliant MPI-3 implementations providing a Fortran interface must provide one or both of the following:

- The `USE mpi_f08` Fortran support method.
- The `USE mpi` and `INCLUDE 'mpif.h'` Fortran support methods.

Section 18.1.6 describes restrictions if the compiler does not support all the needed features.

Application subroutines and functions may use either one of the modules or the `mpif.h` include file. An implementation may require the use of one of the modules to prevent type mismatch errors.

*Advice to users.* Users are advised to utilize one of the MPI modules even if `mpif.h` enforces type checking on a particular system. Using a module provides several potential advantages over using an include file; the `mpi_f08` module offers the most robust and complete Fortran support. (*End of advice to users.*)

In a single application, it must be possible to link together routines which `USE mpi_f08`, `USE mpi`, and `INCLUDE 'mpif.h'`.

The LOGICAL compile-time constant `MPI_SUBARRAYS_SUPPORTED` is set to `.TRUE.` if all buffer choice arguments are defined in explicit interfaces with assumed-type and assumed-rank [43]; otherwise it is set to `.FALSE.`. The LOGICAL compile-time constant `MPI_ASYNC_PROTECTS_NONBLOCKING` is set to `.TRUE.` if the `ASYNCHRONOUS` attribute was added to the choice buffer arguments of all nonblocking interfaces **and** the underlying Fortran compiler supports the `ASYNCHRONOUS` attribute for MPI communication (as part of TS 29113), otherwise it is set to `.FALSE.`. These constants exist for each Fortran support method, but not in the C header file. The values may be different for each Fortran support method. All other constants and the integer values of handles must be the same for each Fortran support method.

Section 18.1.2 through 18.1.4 define the Fortran support methods. The Fortran interfaces of each MPI routine are shorthands. Section 18.1.5 defines the corresponding full interface specification together with the specific procedure names and implications for the profiling interface. Section 18.1.6 the implementation of the MPI routines for different versions of the Fortran standard. Section 18.1.7 summarizes major requirements for valid MPI-3.0 implementations with Fortran support. Section 18.1.8 and Section 18.1.9 describe additional functionality that is part of the Fortran support. `MPI_F_SYNC_REG` is needed for one of the methods to prevent register optimization problems. A set of functions provides additional support for Fortran intrinsic numeric types, including parameterized types: `MPI_TYPE_MATCH_SIZE`, `MPI_TYPE_CREATE_F90_INTEGER`, `MPI_TYPE_CREATE_F90_REAL` and `MPI_TYPE_CREATE_F90_COMPLEX`. In the context of MPI, parameterized types are Fortran intrinsic types which are specified using `KIND` type parameters. Sections 18.1.10 through 18.1.19 give an overview and details on known problems when using Fortran together with MPI; Section 18.1.20 compares the Fortran problems with those in C.

### 18.1.2 Fortran Support Through the `mpi_f08` Module

An MPI implementation providing a Fortran interface must provide a module named `mpi_f08` that can be used in a Fortran program. Section 18.1.6 describes restrictions if the compiler does not support all the needed features. Within all MPI function specifications, the first

of the set of two Fortran routine interface specifications is provided by this module. This module must:

- Define all named MPI constants.
- Declare MPI functions that return a value.
- Provide explicit interfaces according to the Fortran routine interface specifications. This module therefore guarantees compile-time argument checking for all arguments which are not `TYPE(*)`, with the following exception:

Only one Fortran interface is defined for functions that are deprecated as of MPI-3.0. This interface must be provided as an explicit interface according to the rules defined for the `mpi` module, see Section 18.1.3.

*Advice to users.* It is strongly recommended that developers substitute calls to deprecated routines when upgrading from `mpif.h` or the `mpi` module to the `mpi_f08` module. (*End of advice to users.*)

- Define the derived type `MPI_Status`, and define all MPI handles with uniquely named handle types (instead of `INTEGER` handles, as in the `mpi` module). This is reflected in the first Fortran binding in each MPI function definition throughout this document (except for the deprecated routines).
- Overload the operators `.EQ.` and `.NE.` to allow the comparison of these MPI handles with `.EQ.`, `.NE.`, `==` and `/=`.
- Use the `ASYNCHRONOUS` attribute to protect the buffers of nonblocking operations, and set the `LOGICAL` compile-time constant `MPI_ASYNC_PROTECTS_NONBLOCKING` to `.TRUE.` if the underlying Fortran compiler supports the `ASYNCHRONOUS` attribute for MPI communication (as part of TS 29113). See Section 18.1.6 for older compiler versions.
- Set the `LOGICAL` compile-time constant `MPI_SUBARRAYS_SUPPORTED` to `.TRUE.` and declare choice buffers using the Fortran 2008 TS 29113 features assumed-type and assumed-rank, i.e., `TYPE(*)`, `DIMENSION(..)` in all nonblocking, split collective and persistent communication routines, if the underlying Fortran compiler supports it. With this, non-contiguous sub-arrays can be used as buffers in nonblocking routines.

*Rationale.* In all blocking routines, i.e., if the choice-buffer is not declared as `ASYNCHRONOUS`, the TS 29113 feature is not needed for the support of non-contiguous buffers because the compiler can pass the buffer by in-and-out-copy through a contiguous scratch array. (*End of rationale.*)

- Set the `MPI_SUBARRAYS_SUPPORTED` compile-time constant to `.FALSE.` and declare choice buffers with a compiler-dependent mechanism that overrides type checking if the underlying Fortran compiler does not support the Fortran 2008 TS 29113 assumed-type and assumed-rank notation. In this case, the use of non-contiguous sub-arrays as buffers in nonblocking calls may be invalid. See Section 18.1.6 for details.
- Declare each argument with an `INTENT` of `IN`, `OUT`, or `INOUT` as defined in this standard.

1 *Rationale.* For these definitions in the `mpi_f08` bindings, in most cases, `INTENT(IN)`  
 2 is used if the C interface uses call-by-value. For all buffer arguments and for `OUT` and  
 3 `INOUT` dummy arguments that allow one of the non-ordinary Fortran constants (see  
 4 `MPI_BOTTOM`, etc. in Section 2.5.4) as input, an `INTENT` is not specified. (*End of*  
 5 *rationale.*)

6  
 7 *Advice to users.* If a dummy argument is declared with `INTENT(OUT)`, then the  
 8 Fortran standard stipulates that the actual argument becomes undefined upon invo-  
 9 cation of the MPI routine, i.e., it may be overwritten by some other values, e.g. zeros;  
 10 according to [42], 12.5.2.4 Ordinary dummy variables, Paragraph 17: “If a dummy  
 11 argument has `INTENT(OUT)`, the actual argument becomes undefined at the time  
 12 the association is established, except [...]”. For example, if the dummy argument is  
 13 an assumed-size array and the actual argument is a strided array, the call may be im-  
 14 plemented with copy-in and copy-out of the argument. In the case of `INTENT(OUT)` the  
 15 copy-in may be suppressed by the optimization and the routine starts execution using  
 16 an array of undefined values. If the routine stores fewer elements into the dummy  
 17 argument than is provided in the actual argument, then the remaining locations are  
 18 overwritten with these undefined values. See also both advices to implementors in  
 19 Section 18.1.3. (*End of advice to users.*)

- 20  
 21 • Declare all `ierror` output arguments as `OPTIONAL`, except for user-defined callback  
 22 functions (e.g., `COMM_COPY_ATTR_FUNCTION`) and predefined callbacks (e.g.,  
 23 `MPI_COMM_NULL_COPY_FN`).

24  
 25 *Rationale.* For user-defined callback functions (e.g., `COMM_COPY_ATTR_FUNCTION`) and  
 26 their predefined callbacks (e.g., `MPI_COMM_NULL_COPY_FN`), the `ierror` argument  
 27 is not optional. The MPI library must always call these routines with an actual `ierror`  
 28 argument. Therefore, these user-defined functions need not check whether the MPI  
 29 library calls these routines with or without an actual `ierror` output argument. (*End of*  
 30 *rationale.*)

31  
 32 The MPI Fortran bindings in the `mpi_f08` module are designed based on the Fortran  
 33 2008 standard [42] together with the Technical Specification “TS 29113 Further Interoper-  
 34 ability with C” [43] of the ISO/IEC JTC1/SC22/WG5 (Fortran) working group.

35  
 36 *Rationale.* The features in TS 29113 on further interoperability with C were decided  
 37 on by ISO/IEC JTC1/SC22/WG5 and designed by PL22.3 (formerly J3) to support a  
 38 higher level of integration between Fortran-specific features and C than was provided  
 39 in the Fortran 2008 standard; part of this design is based on requirements from the  
 40 MPI Forum to support MPI-3.0. According to [43], “an ISO/IEC TS is reviewed after  
 41 three years in order to decide whether it will be confirmed for a further three years,  
 42 revised to become an International Standard, or withdrawn. If the ISO/IEC TS is  
 43 confirmed, it is reviewed again after a further three years, at which time it must either  
 44 be transformed into an International Standard or be withdrawn.”

45 The TS 29113 contains the following language features that are needed for the MPI  
 46 bindings in the `mpi_f08` module: assumed-type and assumed-rank. It is important  
 47 that any possible actual argument can be used for such dummy arguments, e.g.,  
 48 scalars, arrays, assumed-shape arrays, assumed-size arrays, allocatable arrays, and



with any element type, e.g., `REAL`, `CHARACTER*5`, `CHARACTER*(*)`, sequence derived types, or `BIND(C)` derived types. Especially for backward compatibility reasons, it is important that any possible actual argument in an implicit interface implementation of a choice buffer dummy argument (e.g., with `mpif.h` without argument-checking) can be used in an implementation with assumed-type and assumed-rank argument in an explicit interface (e.g., with the `mpi_f08` module).

A further feature useful for MPI is the extension of the semantics of the `ASYNCHRONOUS` attribute: In F2003 and F2008, this attribute could be used only to protect buffers of Fortran asynchronous I/O. With TS 29113, this attribute now also covers asynchronous communication occurring within library routines written in C.

The MPI Forum hereby wishes to acknowledge this important effort by the Fortran PL22.3 and WG5 committee. (*End of rationale.*)

### 18.1.3 Fortran Support Through the `mpi` Module

An MPI implementation providing a Fortran interface must provide a module named `mpi` that can be used in a Fortran program. Within all MPI function specifications, the second of the set of two Fortran routine interface specifications is provided by this module. This module must:

- Define all named MPI constants
- Declare MPI functions that return a value.
- Provide explicit interfaces according to the Fortran routine interface specifications. This module therefore guarantees compile-time argument checking and allows positional and keyword-based argument lists. If an implementation is paired with a compiler that either does not support `TYPE(*)`, `DIMENSION(..)` from TS 29113, or is otherwise unable to ignore the types of choice buffers, then the implementation must provide explicit interfaces only for MPI routines with no choice buffer arguments. See Section 18.1.6 for more details.
- Define all MPI handles as type `INTEGER`.
- Define the derived type `MPI_Status` and all named handle types that are used in the `mpi_f08` module. For these named handle types, overload the operators `.EQ.` and `.NE.` to allow handle comparison via the `.EQ.`, `.NE.`, `==` and `/=` operators.

*Rationale.* They are needed only when the application converts old-style `INTEGER` handles into new-style handles with a named type. (*End of rationale.*)

- A high quality MPI implementation may enhance the interface by using the `ASYNCHRONOUS` attribute in the same way as in the `mpi_f08` module if it is supported by the underlying compiler.
- Set the `LOGICAL` compile-time constant `MPI_ASYNC_PROTECTS_NONBLOCKING` to `.TRUE.` if the `ASYNCHRONOUS` attribute is used in all nonblocking interfaces **and** the underlying Fortran compiler supports the `ASYNCHRONOUS` attribute for MPI communication (as part of TS 29113), otherwise to `.FALSE..`

*Advice to users.* For an MPI implementation that fully supports nonblocking calls with the `ASYNCHRONOUS` attribute for choice buffers, an existing MPI-2.2 application may fail to compile even if it compiled and executed with expected results with an MPI-2.2 implementation. One reason may be that the application uses “contiguous” but not “simply contiguous” `ASYNCHRONOUS` arrays as actual arguments for choice buffers of nonblocking routines, e.g., by using subscript triplets with stride one or specifying `(1:n)` for a whole dimension instead of using `(:)`. This should be fixed to fulfill the Fortran constraints for `ASYNCHRONOUS` dummy arguments. This is not considered a violation of backward compatibility because existing applications can not use the `ASYNCHRONOUS` attribute to protect nonblocking calls. Another reason may be that the application does not conform either to MPI-2.2, or to MPI-3.0, or to the Fortran standard, typically because the program forces the compiler to perform copy-in/out for a choice buffer argument in a nonblocking MPI call. This is also not a violation of backward compatibility because the application itself is non-conforming. See Section 18.1.12 for more details. (*End of advice to users.*)

- A high quality MPI implementation may enhance the interface by using `TYPE(*)`, `DIMENSION(..)` choice buffer dummy arguments instead of using non-standardized extensions such as `!$PRAGMA IGNORE_TKR` or a set of overloaded functions as described by M. Hennecke in [29], if the compiler supports this TS 29113 language feature. See Section 18.1.6 for further details.
- Set the `LOGICAL` compile-time constant `MPI_SUBARRAYS_SUPPORTED` to `.TRUE.` if all choice buffer arguments in all nonblocking, split collective and persistent communication routines are declared with `TYPE(*)`, `DIMENSION(..)`, otherwise set it to `.FALSE.`. When `MPI_SUBARRAYS_SUPPORTED` is defined as `.TRUE.`, non-contiguous sub-arrays can be used as buffers in nonblocking routines.
- Set the `MPI_SUBARRAYS_SUPPORTED` compile-time constant to `.FALSE.` and declare choice buffers with a compiler-dependent mechanism that overrides type checking if the underlying Fortran compiler does not support the TS 29113 assumed-type and assumed-rank features. In this case, the use of non-contiguous sub-arrays in nonblocking calls may be disallowed. See Section 18.1.6 for details.

An MPI implementation may provide other features in the `mpi` module that enhance the usability of MPI while maintaining adherence to the standard. For example, it may provide `INTENT` information in these interface blocks.

*Advice to implementors.* The appropriate `INTENT` may be different from what is given in the MPI language-neutral bindings. Implementations must choose `INTENT` so that the function adheres to the MPI standard, e.g., by defining the `INTENT` as provided in the `mpi_f08` bindings. (*End of advice to implementors.*)

*Rationale.* The intent given by the MPI generic interface is not precisely defined and does not in all cases correspond to the correct Fortran `INTENT`. For instance, receiving into a buffer specified by a datatype with absolute addresses may require associating `MPI_BOTTOM` with a dummy `OUT` argument. Moreover, “constants” such as `MPI_BOTTOM` and `MPI_STATUS_IGNORE` are not constants as defined by Fortran, but “special addresses” used in a nonstandard way. Finally, the MPI-1 generic intent

was changed in several places in MPI-2. For instance, `MPI_IN_PLACE` changes the intent of an `OUT` argument to be `INOUT`. (*End of rationale.*)

*Advice to implementors.* The Fortran 2008 standard illustrates in its Note 5.17 that “`INTENT(OUT)` means that the value of the argument after invoking the procedure is entirely the result of executing that procedure. If an argument should retain its value rather than being redefined, `INTENT(INOUT)` should be used rather than `INTENT(OUT)`, even if there is no explicit reference to the value of the dummy argument. Furthermore, `INTENT(INOUT)` is not equivalent to omitting the `INTENT` attribute, because `INTENT(INOUT)` always requires that the associated actual argument is definable.” Applications that include `mpif.h` may not expect that `INTENT(OUT)` is used. In particular, output array arguments are expected to keep their content as long as the MPI routine does not modify them. To keep this behavior, it is recommended that implementations not use `INTENT(OUT)` in the `mpi` module and the `mpif.h` include file, even though `INTENT(OUT)` is specified in an interface description of the `mpi_f08` module. (*End of advice to implementors.*)

#### 18.1.4 Fortran Support Through the `mpif.h` Include File

The use of the `mpif.h` include file is strongly discouraged and may be deprecated in a future version of MPI.

An MPI implementation providing a Fortran interface must provide an include file named `mpif.h` that can be used in a Fortran program. Within all MPI function specifications, the second of the set of two Fortran routine interface specifications is supported by this include file. This include file must:

- Define all named MPI constants.
- Declare MPI functions that return a value.
- Define all handles as `INTEGER`.
- Be valid and equivalent for both fixed and free source form.

For each MPI routine, an implementation can choose to use an implicit or explicit interface for the second Fortran binding (in deprecated routines, the first one may be omitted).

- Set the `LOGICAL` compile-time constants `MPI_SUBARRAYS_SUPPORTED` and `MPI_ASYNC_PROTECTS_NONBLOCKING` according to the same rules as for the `mpi` module. In the case of implicit interfaces for choice buffer or nonblocking routines, the constants must be set to `.FALSE..`

*Advice to users.* Instead of using `mpif.h`, the use of the `mpi_f08` or `mpi` module is strongly encouraged for the following reasons:

- Most `mpif.h` implementations do not include compile-time argument checking.
- Therefore, many bugs in MPI applications remain undetected at compile-time, such as:
  - Missing `ierror` as last argument in most Fortran bindings.

- Declaration of a `status` as an `INTEGER` variable instead of an `INTEGER` array with size `MPI_STATUS_SIZE`.
  - Incorrect argument positions; e.g., interchanging the `count` and `datatype` arguments.
  - Passing incorrect MPI handles; e.g., passing a `datatype` instead of a communicator.
- The migration from `mpif.h` to the `mpi` module should be relatively straightforward (i.e., substituting `include 'mpif.h'` after an `implicit` statement by `use mpi` before that `implicit` statement) as long as the application syntax is correct.
  - Migrating portable and correctly written applications to the `mpi` module is not expected to be difficult. No compile or runtime problems should occur because an `mpif.h` include file was always allowed to provide explicit Fortran interfaces.

*(End of advice to users.)*

*Rationale.* With MPI-3.0, the `mpif.h` include file was not deprecated in order to retain strong backward compatibility. Internally, `mpif.h` and the `mpi` module may be implemented so that essentially the same library implementation of the MPI routines can be used. *(End of rationale.)*

### 18.1.5 Interface Specifications, Procedure Names, and the Profiling Interface

The Fortran interface specification of each MPI routine specifies the routine name that must be called by the application program, and the names and types of the dummy arguments together with additional attributes. The Fortran standard allows a given Fortran interface to be implemented with several methods, e.g., within or outside of a module, with or without `BIND(C)`, or the buffers with or without TS 29113. Such implementation decisions imply different binary interfaces and different specific procedure names. The requirements for several implementation schemes together with the rules for the specific procedure names and its implications for the profiling interface are specified within this section, but not the implementation details.

*Rationale.* This section was introduced in MPI-3.0 on Sep. 21, 2012. The major goals for implementing the three Fortran support methods have been:

- Portable implementation of the wrappers from the MPI Fortran interfaces to the MPI routines in C.
- Binary backward compatible implementation path when switching `MPI_SUBARRAYS_SUPPORTED` from `.FALSE.` to `.TRUE.`
- The Fortran PMPI interface need not be backward compatible, but a method must be included that a tools layer can use to examine the MPI library about the specific procedure names and interfaces used.
- No performance drawbacks.
- Consistency between all three Fortran support methods.
- Consistent with Fortran 2008 + TS 29113.

No.	Specific procedure name	Calling convention
1A	MPI_Isend_f08	Fortran interface and arguments, as in Annex A.3, except that in routines with a choice buffer dummy argument, this dummy argument is implemented with non-standard extensions like !\$PRAGMA IGNORE_TKR, which provides a call-by-reference argument without type, kind, and dimension checking.
1B	MPI_Isend_f08ts	Fortran interface and arguments, as in Annex A.3, but only for routines with one or more choice buffer dummy arguments; these dummy arguments are implemented with TYPE(*), DIMENSION(..).
2A	MPI_ISEND	Fortran interface and arguments, as in Annex A.4, except that in routines with a choice buffer dummy argument, this dummy argument is implemented with non-standard extensions like !\$PRAGMA IGNORE_TKR, which provides a call-by-reference argument without type, kind, and dimension checking.
2B	MPI_ISEND_FTS	Fortran interface and arguments, as in Annex A.4, but only for routines with one or more choice buffer dummy arguments; these dummy arguments are implemented with TYPE(*), DIMENSION(..).

Table 18.1: Specific Fortran procedure names and related calling conventions. MPI\_ISEND is used as an example. For routines without choice buffers, only 1A and 2A apply.

The design expected that all dummy arguments in the MPI Fortran interfaces are interoperable with C according to Fortran 2008 + TS 29113. This expectation was not fulfilled. The LOGICAL arguments are not interoperable with C, mainly because the internal representations for .FALSE. and .TRUE. are compiler dependent. The provided interface was mainly based on BIND(C) interfaces and therefore inconsistent with Fortran. To be consistent with Fortran, the BIND(C) had to be removed from the callback procedure interfaces and the predefined callbacks, e.g., MPI\_COMM\_DUP\_FN. Non-BIND(C) procedures are also not interoperable with C, and therefore the BIND(C) had to be removed from all routines with PROCEDURE arguments, e.g., from MPI\_OP\_CREATE.

Therefore, this section was rewritten as an erratum to MPI-3.0. (*End of rationale.*)

A Fortran call to an MPI routine shall result in a call to a procedure with one of the specific procedure names and calling conventions, as described in Table 18.1. Case is not significant in the names.

Note that for the deprecated routines in Section 15.1, which are reported only in Annex A.4, scheme 2A is utilized in the mpi module and mpif.h, and also in the mpi\_f08 module.

To set MPI\_SUBARRAYS\_SUPPORTED to .TRUE. within a Fortran support method, it is required that all nonblocking and split-collective routines with buffer arguments are

1 implemented according to 1B and 2B, i.e., with `MPI_Xxxx_f08ts` in the `mpi_f08` module,  
 2 and with `MPI_XXXX_FTS` in the `mpi` module and the `mpif.h` include file.

3 The `mpi` and `mpi_f08` modules and the `mpif.h` include file will each correspond to  
 4 exactly one implementation scheme from Table 18.1. However, the MPI library may contain  
 5 multiple implementation schemes from Table 18.1.

6  
 7 *Advice to implementors.* This may be desirable for backwards binary compatibility  
 8 in the scope of a single MPI implementation, for example. (*End of advice to imple-*  
 9 *mentors.*)

10  
 11 *Rationale.* After a compiler provides the facilities from TS 29113, i.e., `TYPE(*)`,  
 12 `DIMENSION(. .)`, it is possible to change the bindings within a Fortran support method  
 13 to support subarrays without recompiling the complete application provided that the  
 14 previous interfaces with their specific procedure names are still included in the li-  
 15 brary. Of course, only recompiled routines can benefit from the added facilities.  
 16 There is no binary compatibility conflict because each interface uses its own spe-  
 17 cific procedure names and all interfaces use the same constants (except the value of  
 18 `MPI_SUBARRAYS_SUPPORTED` and `MPI_ASYNC_PROTECTS_NONBLOCKING`) and type  
 19 definitions. After a compiler also ensures that buffer arguments of nonblocking MPI  
 20 operations can be protected through the `ASYNCHRONOUS` attribute, and the proce-  
 21 dure declarations in the `mpi_f08` and `mpi` module and the `mpif.h` include file declare  
 22 choice buffers with the `ASYNCHRONOUS` attribute, then the value of  
 23 `MPI_ASYNC_PROTECTS_NONBLOCKING` can be switched to `.TRUE.` in the module def-  
 24 inition and include file. (*End of rationale.*)

25  
 26 *Advice to users.* Partial recompilation of user applications when upgrading MPI  
 27 implementations is a highly complex and subtle topic. Users are strongly advised to  
 28 consult their MPI implementation’s documentation to see exactly what is — and what  
 29 is not — supported. (*End of advice to users.*)

30 Within the `mpi_f08` and `mpi` modules and `mpif.h`, for all MPI procedures, a second  
 31 procedure with the same calling conventions shall be supplied, except that the name is  
 32 modified by prefixing with the letter “P”, e.g., `PMPI_Isend`. The specific procedure names  
 33 for these `PMPI_Xxxx` procedures must be different from the specific procedure names for  
 34 the `MPI_Xxxx` procedures and are not specified by this standard.

35 A user-written or middleware profiling routine should provide the same specific Fortran  
 36 procedure names and calling conventions, and therefore can interpose itself as the MPI  
 37 library routine. The profiling routine can internally call the matching  
 38 `PMPI` routine with any of its existing bindings, except for routines that have callback routine  
 39 dummy arguments, choice buffer arguments, or that are attribute caching routines (  
 40 `MPI_{COMM|WIN|TYPE}_{SET|GET}_ATTR`). In this case, the profiling software should  
 41 invoke the corresponding `PMPI` routine using the same Fortran support method as used in  
 42 the calling application program, because the C, `mpi_f08` and `mpi` callback prototypes are  
 43 different or the meaning of the choice buffer or `attribute_val` arguments are different.  
 44

45  
 46 *Advice to users.* Although for each support method and MPI routine (e.g.,  
 47 `MPI_ISEND` in `mpi_f08`), multiple routines may need to be provided to intercept  
 48 the specific procedures in the MPI library (e.g., `MPI_Isend_f08` and `MPI_Isend_f08ts`),  
 each profiling routine itself uses only one support method (e.g., `mpi_f08`) and calls

the real MPI routine through the one PMPI routine defined in this support method (i.e., `PMPI_Isend` in this example). (*End of advice to users.*)

*Advice to implementors.* If all of the following conditions are fulfilled:

- the handles in the `mpi_f08` module occupy one Fortran numerical storage unit (same as an `INTEGER` handle),
- the internal argument passing mechanism used to pass an actual `ierror` argument to a non-optional `ierror` dummy argument is binary compatible to passing an actual `ierror` argument to an `ierror` dummy argument that is declared as `OPTIONAL`,
- the internal argument passing mechanism for `ASYNCHRONOUS` and non-`ASYNCHRONOUS` arguments is the same,
- the internal routine call mechanism is the same for the Fortran and the C compilers for which the MPI library is compiled,
- the compiler does not provide TS 29113,

then the implementor may use the same internal routine implementations for all Fortran support methods but with several different specific procedure names. If the accompanying Fortran compiler supports TS 29113, then the new routines are needed only for routines with choice buffer arguments. (*End of advice to implementors.*)

*Advice to implementors.* In the Fortran support method `mpif.h`, compile-time argument checking can be also implemented for all routines. For `mpif.h`, the argument names are not specified through the MPI standard, i.e., only positional argument lists are defined, and not key-word based lists. Due to the rule that `mpif.h` must be valid for fixed and free source form, the subroutine declaration is restricted to one line with 72 characters. To keep the argument lists short, each argument name can be shortened to a minimum of one character. With this, the two longest subroutine declaration statements are

```
SUBROUTINE PMPI_Dist_graph_create_adjacent(a,b,c,d,e,f,g,h,i,j,k)
SUBROUTINE PMPI_Rget_accumulate(a,b,c,d,e,f,g,h,i,j,k,l,m,n)
```

with 71 and 66 characters. With buffers implemented with TS 29113, the specific procedure names have an additional postfix. The longest of such interface definitions is

```
INTERFACE PMPI_Rget_accumulate
SUBROUTINE PMPI_Rget_accumulate_fts(a,b,c,d,e,f,g,h,i,j,k,l,m,n)
```

with 70 characters. In principle, continuation lines would be possible in `mpif.h` (spaces in columns 73–131, & in column 132, and in column 6 of the continuation line) but this would not be valid if the source line length is extended with a compiler flag to 132 characters. Column 133 is also not available for the continuation character because lines longer than 132 characters are invalid with some compilers by default.

The longest specific procedure names are `PMPI_Dist_graph_create_adjacent_f08` and `PMPI_File_write_ordered_begin_f08ts` both with 35 characters in the `mpi_f08` module. For example, the interface specifications together with the specific procedure names can be implemented with

```

1  MODULE mpi_f08
2      TYPE, BIND(C) :: MPI_Comm
3      INTEGER :: MPI_VAL
4      END TYPE MPI_Comm
5      ...
6      INTERFACE MPI_Comm_rank ! (as defined in Chapter 6)
7          SUBROUTINE MPI_Comm_rank_f08(comm, rank, ierror)
8              IMPORT :: MPI_Comm
9              TYPE(MPI_Comm),      INTENT(IN)  :: comm
10             INTEGER,              INTENT(OUT) :: rank
11             INTEGER, OPTIONAL,    INTENT(OUT) :: ierror
12         END SUBROUTINE
13     END INTERFACE
14 END MODULE mpi_f08
15
16 MODULE mpi
17     INTERFACE MPI_Comm_rank ! (as defined in Chapter 6)
18         SUBROUTINE MPI_Comm_rank(comm, rank, ierror)
19             INTEGER, INTENT(IN)  :: comm ! The INTENT may be added although
20             INTEGER, INTENT(OUT) :: rank ! it is not defined in the
21             INTEGER, INTENT(OUT) :: ierror ! official routine definition.
22         END SUBROUTINE
23     END INTERFACE
24 END MODULE mpi

```

And if interfaces are provided in `mpif.h`, they might look like this (outside of any module and in fixed source format):

```

25
26 !23456789012345678901234567890123456789012345678901234567890123456789012
27     INTERFACE MPI_Comm_rank ! (as defined in Chapter 6)
28         SUBROUTINE MPI_Comm_rank(comm, rank, ierror)
29             INTEGER, INTENT(IN)  :: comm ! The argument names may be
30             INTEGER, INTENT(OUT) :: rank ! shortened so that the
31             INTEGER, INTENT(OUT) :: ierror ! subroutine line fits to the
32         END SUBROUTINE ! maximum of 72 characters.
33     END INTERFACE

```

*(End of advice to implementors.)*

*Advice to users.* The following is an example of how a user-written or middleware profiling routine can be implemented:

```

34
35
36
37
38 SUBROUTINE MPI_Isend_f08ts(buf, count, datatype, dest, tag, comm, request, ierror)
39     USE :: mpi_f08, my_noname => MPI_Isend_f08ts
40     TYPE(*), DIMENSION(..), ASYNCHRONOUS :: buf
41     INTEGER, INTENT(IN) :: count, dest, tag
42     TYPE(MPI_Datatype), INTENT(IN) :: datatype
43     TYPE(MPI_Comm), INTENT(IN) :: comm
44     TYPE(MPI_Request), INTENT(OUT) :: request
45     INTEGER, OPTIONAL, INTENT(OUT) :: ierror
46     ! ... some code for the begin of profiling
47     call PMPI_Isend (buf, count, datatype, dest, tag, comm, request, ierror)
48     ! ... some code for the end of profiling
49 END SUBROUTINE MPI_Isend_f08ts

```



Note that this routine is used to intercept the existing specific procedure name `MPI_Isend_f08ts` in the MPI library. This routine must not be part of a module. This routine itself calls `PMPI_Isend`. The `USE` of the `mpi_f08` module is needed for definitions of handle types and the interface for `PMPI_Isend`. However, this module also contains an interface definition for the specific procedure name `MPI_Isend_f08ts` that conflicts with the definition of this profiling routine (i.e., the name is doubly defined). Therefore, the `USE` here specifically excludes the interface from the module by renaming the unused routine name in the `mpi_f08` module into “`my_noname`” in the scope of this routine. (*End of advice to users.*)

*Advice to users.* The PMPI interface allows intercepting MPI routines. For example, an additional `MPI_ISEND` profiling wrapper can be provided that is called by the application and internally calls `PMPI_ISEND`. There are two typical use cases: a profiling layer that is developed independently from the application and the MPI library, and profiling routines that are part of the application and have access to the application data. With MPI-3.0, new Fortran interfaces and implementation schemes were introduced that have several implications on how Fortran MPI routines are internally implemented and optimized. For profiling layers, these schemes imply that several internal interfaces with different specific procedure names may need to be intercepted, as shown in the example code above. Therefore, for wrapper routines that are part of a Fortran application, it may be more convenient to make the name shift within the application, i.e., to substitute the call to the MPI routine (e.g., `MPI_ISEND`) by a call to a user-written profiling wrapper with a new name (e.g., `X_MPI_ISEND`) and to call the Fortran `MPI_ISEND` from this wrapper, instead of using the PMPI interface. (*End of advice to users.*)

*Advice to implementors.* An implementation that provides a Fortran interface must provide a combination of MPI library and module or include file that uses the specific procedure names as described in Table 18.1 so that the MPI Fortran routines are interceptable as described above. (*End of advice to implementors.*)

### 18.1.6 MPI for Different Fortran Standard Versions

This section describes which Fortran interface functionality can be provided for different versions of the Fortran standard.

- *For Fortran 77* with some extensions:
  - MPI identifiers may be up to 30 characters (31 with the profiling interface).
  - MPI identifiers may contain underscores after the first character.
  - An MPI subroutine with a choice argument may be called with different argument types.
  - Although not required by the MPI standard, the `INCLUDE` statement should be available for including `mpif.h` into the user application source code.

Only MPI-1.1, MPI-1.2, and MPI-1.3 can be implemented. The use of absolute addresses from `MPI_ADDRESS` and `MPI_BOTTOM` may cause problems if an address does not fit into the memory space provided by an `INTEGER`. (In MPI-2.0 this problem is solved with `MPI_GET_ADDRESS`, but not for Fortran 77.)

1 • *For Fortran 90:*

2 The major additional features that are needed from Fortran 90 are:

- 3
- 4 – The `MODULE` and `INTERFACE` concept.
- 5 – The `KIND=` and `SELECTED_..._KIND` concept.
- 6 – Fortran derived `TYPE`s and the `SEQUENCE` attribute.
- 7 – The `OPTIONAL` attribute for dummy arguments.
- 8
- 9 – Cray pointers, which are a non-standard compiler extension, are needed for the
- 10 use of `MPI_ALLOC_MEM`.

11 With these features, MPI-1.1 – MPI-2.2 can be implemented without restrictions.

12 MPI-3.0 can be implemented with some restrictions. The Fortran support methods

13 are abbreviated with `S1` = the `mpi_f08` module, `S2` = the `mpi` module, and `S3` = the

14 `mpif.f` include file. If not stated otherwise, restrictions exist for each method which

15 prevent implementing the complete semantics of MPI-3.0.

- 16
- 17 – `MPI_SUBARRAYS_SUPPORTED` equals `.FALSE.`, i.e., subscript triplets and non-
- 18 contiguous subarrays cannot be used as buffers in nonblocking routines, RMA,
- 19 or split-collective I/O.
- 20
- 21 – `S1`, `S2`, and `S3` can be implemented, but for `S1`, only a preliminary implementa-
- 22 tion is possible.
- 23 – In this preliminary interface of `S1`, the following changes are necessary:
- 24 \* `TYPE(*)`, `DIMENSION(..)` is substituted by non-standardized extensions
- 25 like `!$PRAGMA IGNORE_TKR`.
- 26 \* The `ASYNCHRONOUS` attribute is omitted.
- 27 \* `PROCEDURE(...)` callback declarations are substituted by `EXTERNAL`.
- 28
- 29 – The specific procedure names are specified in Section 18.1.5.
- 30 – Due to the rules specified in Section 18.1.5, choice buffer declarations should be
- 31 implemented only with non-standardized extensions like `!$PRAGMA IGNORE_TKR`
- 32 (as long as F2008+TS 29113 is not available).

33 In `S2` and `S3`: Without such extensions, routines with choice buffers should be

34 provided with an implicit interface, instead of overloading with a different MPI

35 function for each possible buffer type (as mentioned in Section 18.1.11). Such

36 overloading would also imply restrictions for passing Fortran derived types as

37 choice buffer, see also Section 18.1.15.

38 Only in `S1`: The implicit interfaces for routines with choice buffer arguments

39 imply that the `ierror` argument cannot be defined as `OPTIONAL`. For this reason,

40 it is recommended not to provide the `mpi_f08` module if such an extension is not

41 available.

- 42
- 43 – The `ASYNCHRONOUS` attribute can **not** be used in applications to protect buffers
- 44 in nonblocking MPI calls (`S1–S3`).
- 45 – The `TYPE(C_PTR)` binding of the `MPI_ALLOC_MEM` and `MPI_WIN_ALLOCATE`
- 46 routines is not available.
- 47
- 48

- In S1 and S2, the definition of the handle types (e.g., `TYPE(MPI_Comm)` and the status type `TYPE(MPI_Status)` must be modified: The `SEQUENCE` attribute must be used instead of `BIND(C)` (which is not available in Fortran 90/95). This restriction implies that the application must be fully recompiled if one switches to an MPI library for Fortran 2003 and later because the internal memory size of the handles may have changed. For this reason, an implementor may choose not to provide the `mpi_f08` module for Fortran 90 compilers. In this case, the `mpi_f08` handle types and all routines, constants and types related to `TYPE(MPI_Status)` (see Section 18.2.5) are also not available in the `mpi` module and `mpif.h`.
- *For Fortran 95:*  
The quality of the MPI interface and the restrictions are the same as with Fortran 90.
- *For Fortran 2003:*  
The major features that are needed from Fortran 2003 are:
  - Interoperability with C, i.e.,
    - \* `BIND(C)` derived types.
    - \* The `ISO_C_BINDING` intrinsic type `C_PTR` and routine `C_F_POINTER`.
  - The ability to define an `ABSTRACT INTERFACE` and to use it for `PROCEDURE` dummy arguments.
  - The ability to overload the operators `.EQ.` and `.NE.` to allow the comparison of derived types (used in MPI-3.0 for MPI handles).
  - The `ASYNCHRONOUS` attribute is available to protect Fortran asynchronous I/O. This feature is not yet used by MPI, but it is the basis for the enhancement for MPI communication in the TS 29113.

With these features (but still without the features of TS 29113), MPI-1.1 – MPI-2.2 can be implemented without restrictions, but with one enhancement:

- The user application can use `TYPE(C_PTR)` together with `MPI_ALLOC_MEM` as long as `MPI_ALLOC_MEM` is defined with an implicit interface because a `C_PTR` and an `INTEGER(KIND=MPI_ADDRESS_KIND)` argument must both map to a `void *` argument.

MPI-3.0 can be implemented with the following restrictions:

- `MPI_SUBARRAYS_SUPPORTED` equals `.FALSE.`
- For S1, only a preliminary implementation is possible. The following changes are necessary:
  - \* `TYPE(*)`, `DIMENSION(..)` is substituted by non-standardized extensions like `!$PRAGMA IGNORE_TKR`.
- The specific procedure names are specified in Section 18.1.5.
- With S1, the `ASYNCHRONOUS` is required as specified in the second Fortran interfaces. With S2 and S3 the implementation can also add this attribute if explicit interfaces are used.

- 1       – The `ASYNCHRONOUS` Fortran attribute can be used in applications to *try to* protect
- 2       buffers in nonblocking MPI calls, but the protection can work only if the compiler
- 3       is able to protect asynchronous Fortran I/O and makes no difference between such
- 4       asynchronous Fortran I/O and MPI communication.
- 5       – The `TYPE(C_PTR)` binding of the `MPI_ALLOC_MEM`, `MPI_WIN_ALLOCATE`,
- 6       `MPI_WIN_ALLOCATE_SHARED`, and `MPI_WIN_SHARED_QUERY` routines can
- 7       be used only for Fortran types that are C compatible.
- 8       – The same restriction as for Fortran 90 applies if non-standardized extensions like
- 9       `!$PRAGMA IGNORE_TKR` are not available.
- 10
- 11   • *For Fortran 2008 + TS 29113 and later and*
- 12   *For Fortran 2003 + TS 29113:*

13   The major feature that are needed from TS 29113 are:

- 14       – `TYPE(*)`, `DIMENSION(..)` is available.
- 15       – The `ASYNCHRONOUS` attribute is extended to protect also nonblocking MPI com-
- 16       munication.
- 17       – The array dummy argument of the `ISO_C_BINDING` intrinsic `C_F_POINTER` is not
- 18       restricted to Fortran types for which a corresponding type in C exists.
- 19

20   Using these features, MPI-3.0 can be implemented without any restrictions.

- 21
- 22       – With `S1`, `MPI_SUBARRAYS_SUPPORTED` equals `.TRUE.`. The `ASYNCHRONOUS` at-
- 23       tribute can be used to protect buffers in nonblocking MPI calls. The `TYPE(C_PTR)`
- 24       binding of the `MPI_ALLOC_MEM`, `MPI_WIN_ALLOCATE`,
- 25       `MPI_WIN_ALLOCATE_SHARED`, and `MPI_WIN_SHARED_QUERY` routines can
- 26       be used for any Fortran type.
- 27       – With `S2` and `S3`, the value of `MPI_SUBARRAYS_SUPPORTED` is implementation
- 28       dependent. A high quality implementation will also provide
- 29       `MPI_SUBARRAYS_SUPPORTED==.TRUE.` and will use the `ASYNCHRONOUS` attribute
- 30       in the same way as in `S1`.
- 31       – If non-standardized extensions like `!$PRAGMA IGNORE_TKR` are not available then
- 32       `S2` must be implemented with `TYPE(*)`, `DIMENSION(..)`.
- 33

34   *Advice to implementors.* If `MPI_SUBARRAYS_SUPPORTED==.FALSE.`, the choice

35   argument may be implemented with an explicit interface using compiler directives,

36   for example:

```

37   INTERFACE
38       SUBROUTINE MPI_...(buf, ...)
39           !DEC$ ATTRIBUTES NO_ARG_CHECK :: buf
40           !$PRAGMA IGNORE_TKR buf
41           !DIR$ IGNORE_TKR buf
42           !IBM* IGNORE_TKR buf
43           REAL, DIMENSION(*) :: buf
44           ... ! declarations of the other arguments
45       END SUBROUTINE
46   END INTERFACE
47
```

48   *(End of advice to implementors.)*

### 18.1.7 Requirements on Fortran Compilers

MPI-3.0 (and later) compliant Fortran bindings are not only a property of the MPI library itself, but rather a property of an MPI library together with the Fortran compiler suite for which it is compiled.

*Advice to users.* Users must take appropriate steps to ensure that proper options are specified to compilers. MPI libraries must document these options. Some MPI libraries are shipped together with special compilation scripts (e.g., `mpif90`, `mpicc`) that set these options automatically. (*End of advice to users.*)

An MPI library together with the Fortran compiler suite is only compliant with MPI-3.0 (and later), as referred by `MPI_GET_VERSION`, if all the solutions described in Sections 18.1.11 through 18.1.19 work correctly. Based on this rule, major requirements for all three Fortran support methods (i.e., the `mpi_f08` and `mpi` modules, and `mpif.h`) are:

- The language features assumed-type and assumed-rank from Fortran 2008 TS 29113 [43] are available. This is required only for `mpi_f08`. As long as this requirement is not supported by the compiler, it is valid to build an MPI library that implements the `mpi_f08` module with `MPI_SUBARRAYS_SUPPORTED` set to `.FALSE..`
- “Simply contiguous” arrays and scalars must be passed to choice buffer dummy arguments of nonblocking routines with call by reference. This is needed only if one of the support methods does not use the `ASYNCHRONOUS` attribute. See Section 18.1.12 for more details.
- `SEQUENCE` and `BIND(C)` derived types are valid as actual arguments passed to choice buffer dummy arguments, and, in the case of `MPI_SUBARRAYS_SUPPORTED==.FALSE.`, they are passed with call by reference, and passed by descriptor in the case of `.TRUE..`
- All actual arguments that are allowed for a dummy argument in an implicitly defined and separately compiled Fortran routine with the given compiler (e.g., `CHARACTER(LEN=*)` strings and array of strings) must also be valid for choice buffer dummy arguments with all Fortran support methods.
- The array dummy argument of the `ISO_C_BINDING` intrinsic module procedure `C_F_POINTER` is not restricted to Fortran types for which a corresponding type in C exists.
- The Fortran compiler shall not provide `TYPE(*)` unless the `ASYNCHRONOUS` attribute protects MPI communication as described in TS 29113. Specifically, the TS 29113 must be implemented as a whole.

The following rules are required at least as long as the compiler does not provide the extension of the `ASYNCHRONOUS` attribute as part of TS 29113 and there still exists a Fortran support method with `MPI_ASYNC_PROTECTS_NONBLOCKING==.FALSE..` Observation of these rules by the MPI application developer is especially recommended for backward compatibility of existing applications that use the `mpi` module or the `mpif.h` include file. The rules are as follows:

- 1 • Separately compiled empty Fortran routines with implicit interfaces and separately  
2 compiled empty C routines with BIND(C) Fortran interfaces (e.g., MPI\_F\_SYNC\_REG  
3 on page 742 and Section 18.1.8, and DD on page 743) solve the problems described in  
4 Section 18.1.17.
- 5
- 6 • The problems with temporary data movement (described in detail in Section 18.1.18)  
7 are solved as long as the application uses different sets of variables for the nonblocking  
8 communication (or nonblocking or split collective I/O) and the computation when  
9 overlapping communication and computation.
- 10
- 11 • Problems caused by automatic and permanent data movement (e.g., within a garbage  
12 collection, see Section 18.1.19) are resolved **without** any further requirements on the  
13 application program, neither on the usage of the buffers, nor on the declaration of  
14 application routines that are involved in invoking MPI procedures.

15 All of these rules are valid for the `mpi_f08` and `mpi` modules and independently of whether  
16 `mpif.h` uses explicit interfaces.

17 *Advice to implementors.* Some of these rules are already part of the Fortran 2003  
18 standard, some of these requirements require the Fortran TS 29113 [43], and some of  
19 these requirements for MPI-3.0 are beyond the scope of TS 29113. (*End of advice to*  
20 *implementors.*)

### 23 18.1.8 Additional Support for Fortran Register-Memory-Synchronization

24 As described in Section 18.1.17, a dummy call may be necessary to tell the compiler that  
25 registers are to be flushed for a given buffer or that accesses to a buffer may not be moved  
26 across a given point in the execution sequence. Only a Fortran binding exists for this call.

29 MPI\_F\_SYNC\_REG(buf)

30 INOUT buf initial address of buffer (choice)

#### 32 Fortran 2008 binding

33 MPI\_F\_sync\_reg(buf)

34 TYPE(\*), DIMENSION(..), ASYNCHRONOUS :: buf

#### 36 Fortran binding

37 MPI\_F\_SYNC\_REG(BUF)

38 <type> BUF(\*)

39

40 This routine has no executable statements. It must be compiled in the MPI library in  
41 such a manner that a Fortran compiler cannot detect in the module that the routine has  
42 an empty body. It is used only to force the compiler to flush a cached register value of a  
43 variable or buffer back to memory (when necessary), or to invalidate the register value.

44 *Rationale.* This function is not available in other languages because it would not be  
45 useful. This routine has no `ierror` return argument because there is no operation that  
46 can fail. (*End of rationale.*)

*Advice to implementors.* This routine can be bound to a C routine to minimize the risk that the Fortran compiler can learn that this routine is empty (and that the call to this routine can be removed as part of an optimization). However, it is explicitly allowed to implement this routine within the `mpi_f08` module according to the definition for the `mpi` module or `mpif.h` to circumvent the overhead of building the internal dope vector to handle the assumed-type, assumed-rank argument. (*End of advice to implementors.*)

*Rationale.* This routine is not defined with `TYPE(*)`, `DIMENSION(*)`, i.e., assumed size instead of assumed rank, because this would restrict the usability to “simply contiguous” arrays and would require overloading with another interface for scalar arguments. (*End of rationale.*)

*Advice to users.* If only a part of an array (e.g., defined by a subscript triplet) is used in a nonblocking routine, it is recommended to pass the whole array to `MPI_F_SYNC_REG` anyway to minimize the overhead of this no-operation call. Note that this routine need not be called if `MPI_ASYNC_PROTECTS_NONBLOCKING` is `.TRUE.` and the application fully uses the facilities of `ASYNCHRONOUS` arrays. (*End of advice to users.*)

### 18.1.9 Additional Support for Fortran Numeric Intrinsic Types

MPI provides a small number of named datatypes that correspond to named intrinsic types supported by C and Fortran. These include `MPI_INTEGER`, `MPI_REAL`, `MPI_INT`, `MPI_DOUBLE`, etc., as well as the optional types `MPI_REAL4`, `MPI_REAL8`, etc. There is a one-to-one correspondence between language declarations and MPI types.

Fortran (starting with Fortran 90) provides so-called `KIND`-parameterized types. These types are declared using an intrinsic type (one of `INTEGER`, `REAL`, `COMPLEX`, `LOGICAL`, and `CHARACTER`) with an optional integer `KIND` parameter that selects from among one or more variants. The specific meaning of different `KIND` values themselves are implementation dependent and not specified by the language. Fortran provides the `KIND` selection functions `selected_real_kind` for `REAL` and `COMPLEX` types, and `selected_int_kind` for `INTEGER` types that allow users to declare variables with a minimum precision or number of digits. These functions provide a portable way to declare `KIND`-parameterized `REAL`, `COMPLEX`, and `INTEGER` variables in Fortran. This scheme is backward compatible with Fortran 77. `REAL` and `INTEGER` Fortran variables have a default `KIND` if none is specified. Fortran `DOUBLE PRECISION` variables are of intrinsic type `REAL` with a non-default `KIND`. The following two declarations are equivalent:

```
double precision x
real(KIND(0.0d0)) x
```

MPI provides two orthogonal methods for handling communication buffers of numeric intrinsic types. The first method (see the following section) can be used when variables have been declared in a portable way — using default `KIND` or using `KIND` parameters obtained with the `selected_int_kind` or `selected_real_kind` functions. With this method, MPI automatically selects the correct data size (e.g., 4 or 8 bytes) and provides representation conversion in heterogeneous environments. The second method (see “Support for size-specific MPI Datatypes” on page 726) gives the user complete control over communication by exposing machine representations.

## Parameterized Datatypes with Specified Precision and Exponent Range

MPI provides named datatypes corresponding to standard Fortran 77 numeric types: MPI\_INTEGER, MPI\_COMPLEX, MPI\_REAL, MPI\_DOUBLE\_PRECISION and MPI\_DOUBLE\_COMPLEX. MPI automatically selects the correct data size and provides representation conversion in heterogeneous environments. The mechanism described in this section extends this model to support portable parameterized numeric types.

The model for supporting portable parameterized types is as follows. Real variables are declared (perhaps indirectly) using `selected_real_kind(p, r)` to determine the KIND parameter, where `p` is decimal digits of precision and `r` is an exponent range. Implicitly MPI maintains a two-dimensional array of predefined MPI datatypes `D(p, r)`. `D(p, r)` is defined for each value of `(p, r)` supported by the compiler, including pairs for which one value is unspecified. Attempting to access an element of the array with an index `(p, r)` not supported by the compiler is erroneous. MPI implicitly maintains a similar array of COMPLEX datatypes. For integers, there is a similar implicit array related to `selected_int_kind` and indexed by the requested number of digits `r`. Note that the predefined datatypes contained in these implicit arrays are not the same as the named MPI datatypes MPI\_REAL, etc., but a new set.

*Advice to implementors.* The above description is for explanatory purposes only. It is not expected that implementations will have such internal arrays. (*End of advice to implementors.*)

*Advice to users.* `selected_real_kind()` maps a large number of `(p,r)` pairs to a much smaller number of KIND parameters supported by the compiler. KIND parameters are not specified by the language and are not portable. From the language point of view intrinsic types of the same base type and KIND parameter are of the same type. In order to allow interoperability in a heterogeneous environment, MPI is more stringent. The corresponding MPI datatypes match if and only if they have the same `(p,r)` value (REAL and COMPLEX) or `r` value (INTEGER). Thus MPI has many more datatypes than there are fundamental language types. (*End of advice to users.*)

`MPI_TYPE_CREATE_F90_REAL(p, r, newtype)`

IN	<code>p</code>	precision, in decimal digits (integer)
IN	<code>r</code>	decimal exponent range (integer)
OUT	<code>newtype</code>	the requested MPI datatype (handle)

### C binding

```
int MPI_Type_create_f90_real(int p, int r, MPI_Datatype *newtype)
```

### Fortran 2008 binding

```
MPI_Type_create_f90_real(p, r, newtype, ierror)
  INTEGER, INTENT(IN) :: p, r
  TYPE(MPI_Datatype), INTENT(OUT) :: newtype
  INTEGER, OPTIONAL, INTENT(OUT) :: ierror
```

### Fortran binding



```
MPI_TYPE_CREATE_F90_REAL(P, R, NEWTYPE, IERROR)
```

```
INTEGER P, R, NEWTYPE, IERROR
```

This function returns a predefined MPI datatype that matches a `REAL` variable of `KIND selected_real_kind(p, r)`. In the model described above it returns a handle for the element `D(p, r)`. Either `p` or `r` may be omitted from calls to `selected_real_kind(p, r)` (but not both). Analogously, either `p` or `r` may be set to `MPI_UNDEFINED`. In communication, an MPI datatype `A` returned by `MPI_TYPE_CREATE_F90_REAL` matches a datatype `B` if and only if `B` was returned by `MPI_TYPE_CREATE_F90_REAL` called with the same values for `p` and `r` or `B` is a duplicate of such a datatype. Restrictions on using the returned datatype with the “external32” data representation are given on page 725.

It is erroneous to supply values for `p` and `r` not supported by the compiler.

```
MPI_TYPE_CREATE_F90_COMPLEX(p, r, newtype)
```

IN	<code>p</code>	precision, in decimal digits (integer)
IN	<code>r</code>	decimal exponent range (integer)
OUT	<code>newtype</code>	the requested MPI datatype (handle)

### C binding

```
int MPI_Type_create_f90_complex(int p, int r, MPI_Datatype *newtype)
```

### Fortran 2008 binding

```
MPI_Type_create_f90_complex(p, r, newtype, ierror)
  INTEGER, INTENT(IN) :: p, r
  TYPE(MPI_Datatype), INTENT(OUT) :: newtype
  INTEGER, OPTIONAL, INTENT(OUT) :: ierror
```

### Fortran binding

```
MPI_TYPE_CREATE_F90_COMPLEX(P, R, NEWTYPE, IERROR)
  INTEGER P, R, NEWTYPE, IERROR
```

This function returns a predefined MPI datatype that matches a `COMPLEX` variable of `KIND selected_real_kind(p, r)`. Either `p` or `r` may be omitted from calls to `selected_real_kind(p, r)` (but not both). Analogously, either `p` or `r` may be set to `MPI_UNDEFINED`. Matching rules for datatypes created by this function are analogous to the matching rules for datatypes created by `MPI_TYPE_CREATE_F90_REAL`. Restrictions on using the returned datatype with the “external32” data representation are given on page 725.

It is erroneous to supply values for `p` and `r` not supported by the compiler.

```
MPI_TYPE_CREATE_F90_INTEGER(r, newtype)
```

IN	<code>r</code>	decimal exponent range, i.e., number of decimal digits (integer)
OUT	<code>newtype</code>	the requested MPI datatype (handle)

### C binding

```
1 int MPI_Type_create_f90_integer(int r, MPI_Datatype *newtype)
```

### 2 Fortran 2008 binding

```
3 MPI_Type_create_f90_integer(r, newtype, ierror)
4     INTEGER, INTENT(IN) :: r
5     TYPE(MPI_Datatype), INTENT(OUT) :: newtype
6     INTEGER, OPTIONAL, INTENT(OUT) :: ierror
```

### 7 Fortran binding

```
8 MPI_TYPE_CREATE_F90_INTEGER(R, NEWTYPE, IERROR)
9     INTEGER R, NEWTYPE, IERROR
```

11 This function returns a predefined MPI datatype that matches a `INTEGER` variable of  
 12 `KIND selected_int_kind(r)`. Matching rules for datatypes created by this function are  
 13 analogous to the matching rules for datatypes created by `MPI_TYPE_CREATE_F90_REAL`.  
 14 Restrictions on using the returned datatype with the “external32” data representation are  
 15 given on page 725.

16 It is erroneous to supply a value for `r` that is not supported by the compiler.

17 Example:

```
18
19 integer      longtype, quadtype
20 integer, parameter :: long = selected_int_kind(15)
21 integer(long) ii(10)
22 real(selected_real_kind(30)) x(10)
23 call MPI_TYPE_CREATE_F90_INTEGER(15, longtype, ierror)
24 call MPI_TYPE_CREATE_F90_REAL(30, MPI_UNDEFINED, quadtype, ierror)
25 ...
26
27 call MPI_SEND(ii, 10, longtype, ...)
28 call MPI_SEND(x, 10, quadtype, ...)
```

29 *Advice to users.* The datatypes returned by the above functions are predefined  
 30 datatypes. They cannot be freed; they do not need to be committed; they can be  
 31 used with predefined reduction operations. There are two situations in which they  
 32 behave differently syntactically, but not semantically, from the MPI named predefined  
 33 datatypes.

- 34 1. `MPI_TYPE_GET_ENVELOPE` returns special combinators that allow a program to  
 35 retrieve the values of `p` and `r`.
- 36 2. Because the datatypes are not named, they cannot be used as compile-time  
 37 initializers or otherwise accessed before a call to one of the  
 38 `MPI_TYPE_CREATE_F90_XXX` routines.

39 If a variable was declared specifying a non-default `KIND` value that was not obtained  
 40 with `selected_real_kind()` or `selected_int_kind()`, the only way to obtain a  
 41 matching MPI datatype is to use the size-based mechanism described in the next  
 42 section.

43 (*End of advice to users.*)

*Advice to implementors.* An application may often repeat a call to `MPI_TYPE_CREATE_F90_XXX` with the same combination of `(XXX,p,r)`. The application is not allowed to free the returned predefined, unnamed datatype handles. To prevent the creation of a potentially huge amount of handles, a high quality MPI implementation should return the same datatype handle for the same `(REAL/COMPLEX/INTEGER,p,r)` combination. Checking for the combination `(p,r)` in the preceding call to `MPI_TYPE_CREATE_F90_XXX` and using a hash table to find formerly generated handles should limit the overhead of finding a previously generated datatype with same combination of `(XXX,p,r)`. (*End of advice to implementors.*)

*Rationale.* The `MPI_TYPE_CREATE_F90_REAL/COMPLEX/INTEGER` interface needs as input the original range and precision values to be able to define useful and compiler-independent external (Section 13.5.2) or user-defined (Section 13.5.3) data representations, and in order to be able to perform automatic and efficient data conversions in a heterogeneous environment. (*End of rationale.*)

We now specify how the datatypes described in this section behave when used with the “external32” external data representation described in Section 13.5.2.

The external32 representation specifies data formats for integer and floating point values. Integer values are represented in two’s complement big-endian format. Floating point values are represented by one of three IEEE formats. These are the IEEE “Single,” “Double,” and “Double Extended” formats, requiring 4, 8, and 16 bytes of storage, respectively. For the IEEE “Double Extended” formats, MPI specifies a Format Width of 16 bytes, with 15 exponent bits, bias = +10383, 112 fraction bits, and an encoding analogous to the “Double” format.

The external32 representations of the datatypes returned by `MPI_TYPE_CREATE_F90_REAL/COMPLEX/INTEGER` are given by the following rules.

For `MPI_TYPE_CREATE_F90_REAL`:

```

if      (p > 33) or (r > 4931) then external32 representation
                                     is undefined
else if (p > 15) or (r > 307) then  external32_size = 16
else if (p > 6)  or (r > 37)  then  external32_size = 8
else                                     external32_size = 4

```

For `MPI_TYPE_CREATE_F90_COMPLEX`: twice the size as for `MPI_TYPE_CREATE_F90_REAL`.

For `MPI_TYPE_CREATE_F90_INTEGER`:

```

if      (r > 38) then external32 representation is undefined
else if (r > 18) then external32_size = 16
else if (r > 9)  then external32_size = 8
else if (r > 4)  then external32_size = 4
else if (r > 2)  then external32_size = 2
else                                     external32_size = 1

```

If the external32 representation of a datatype is undefined, the result of using the datatype directly or indirectly (i.e., as part of another datatype or through a duplicated datatype) in operations that require the external32 representation is undefined. These operations include `MPI_PACK_EXTERNAL`, `MPI_UNPACK_EXTERNAL`, and many `MPI_FILE` functions,

when the “external32” data representation is used. The ranges for which the external32 representation is undefined are reserved for future standardization.

#### Support for Size-specific MPI Datatypes

MPI provides named datatypes corresponding to optional Fortran 77 numeric types that contain explicit byte lengths — `MPI_REAL4`, `MPI_INTEGER8`, etc. This section describes a mechanism that generalizes this model to support all Fortran numeric intrinsic types.

We assume that for each **typeclass** (integer, real, complex) and each word size there is a unique machine representation. For every pair (**typeclass**, **n**) supported by a compiler, MPI must provide a named size-specific datatype. The name of this datatype is of the form `MPI_<TYPE>n` in C and Fortran where `<TYPE>` is one of `REAL`, `INTEGER` and `COMPLEX`, and **n** is the length in bytes of the machine representation. This datatype locally matches all variables of type (**typeclass**, **n**) in Fortran. The list of names for such types includes:

```
MPI_REAL4
MPI_REAL8
MPI_REAL16
MPI_COMPLEX8
MPI_COMPLEX16
MPI_COMPLEX32
MPI_INTEGER1
MPI_INTEGER2
MPI_INTEGER4
MPI_INTEGER8
MPI_INTEGER16
```

One datatype is required for each representation supported by the Fortran compiler.

*Rationale.* Particularly for the longer floating-point types, C and Fortran may use different representations. For example, a Fortran compiler may define a 16-byte `REAL` type with 33 decimal digits of precision while a C compiler may define a 16-byte `long double` type that implements an 80-bit (10 byte) extended precision floating point value. Both of these types are 16 bytes long, but they are not interoperable. Thus, these types are defined by Fortran, even though C may define types of the same length. (*End of rationale.*)

To be backward compatible with the interpretation of these types in MPI-1, we assume that the nonstandard declarations `REAL*n`, `INTEGER*n`, always create a variable whose representation is of size **n**. These datatypes may also be used for variables declared with `KIND=INT8/16/32/64` or `KIND=REAL32/64/128`, which are defined in the `ISO_FORTRAN_ENV` intrinsic module. Note that the MPI datatypes and the `REAL*n`, `INTEGER*n` declarations count bytes whereas the Fortran `KIND` values count bits. All these datatypes are predefined.

MPI\_TYPE\_MATCH\_SIZE(typeclass, size, datatype) 1

IN	typeclass	generic type specifier (integer)	2
IN	size	size, in bytes, of representation (integer)	3
OUT	datatype	datatype with correct type, size (handle)	4

### C binding 7

```
int MPI_Type_match_size(int typeclass, int size, MPI_Datatype *datatype) 8
```

### Fortran 2008 binding 9

```
MPI_Type_match_size(typeclass, size, datatype, ierror) 10
```

```
    INTEGER, INTENT(IN) :: typeclass, size 11
    TYPE(MPI_Datatype), INTENT(OUT) :: datatype 12
    INTEGER, OPTIONAL, INTENT(OUT) :: ierror 13
```

### Fortran binding 14

```
MPI_TYPE_MATCH_SIZE(TYPECLASS, SIZE, DATATYPE, IERROR) 15
```

```
    INTEGER TYPECLASS, SIZE, DATATYPE, IERROR 16
```

typeclass is one of MPI\_TYPECLASS\_REAL, MPI\_TYPECLASS\_INTEGER and MPI\_TYPECLASS\_COMPLEX, corresponding to the desired **typeclass**. The function returns an MPI datatype matching a local variable of type (**typeclass**, **size**). 17

This function returns a reference (handle) to one of the predefined named datatypes, not a duplicate. This type cannot be freed. MPI\_TYPE\_MATCH\_SIZE can be used to obtain a size-specific type that matches a Fortran numeric intrinsic type by first calling storage\_size() in order to compute the variable size in bits, dividing it by eight, and then calling MPI\_TYPE\_MATCH\_SIZE to find a suitable datatype. In C, one can use the C function sizeof() (which returns the size in bytes) instead of storage\_size() (which returns the size in bits). In addition, for variables of default kind the variable's size can be computed by a call to MPI\_TYPE\_GET\_EXTENT, if the typeclass is known. It is erroneous to specify a size not supported by the compiler. 18

*Rationale.* This is a convenience function. Without it, it can be tedious to find the correct named type. See note to implementors below. (*End of rationale.*) 19

*Advice to implementors.* This function could be implemented as a series of tests. 20

```
int MPI_Type_match_size(int typeclass, int size, MPI_Datatype *rtype) 21
{ 22
```

```
    switch(typeclass) { 23
        case MPI_TYPECLASS_REAL: switch(size) { 24
            case 4: *rtype = MPI_REAL4; return MPI_SUCCESS; 25
            case 8: *rtype = MPI_REAL8; return MPI_SUCCESS; 26
            default: error(...); 27
        } 28
        case MPI_TYPECLASS_INTEGER: switch(size) { 29
            case 4: *rtype = MPI_INTEGER4; return MPI_SUCCESS; 30
            case 8: *rtype = MPI_INTEGER8; return MPI_SUCCESS; 31
            default: error(...); 32
        } 33
    } 34
```

```

1         }
2         ... etc. ...
3     }
4
5     return MPI_SUCCESS;
6 }

```

(End of advice to implementors.)

## Communication With Size-specific Types

The usual type matching rules apply to size-specific datatypes: a value sent with datatype `MPI_<TYPE>n` can be received with this same datatype on another process. Most modern computers use 2's complement for integers and IEEE format for floating point. Thus, communication using these size-specific datatypes will not entail loss of precision or truncation errors.

*Advice to users.* Care is required when communicating in a heterogeneous environment. Consider the following code:

```

20 real(selected_real_kind(5)) x(100)
21 size = storage_size(x) / 8
22 call MPI_TYPE_MATCH_SIZE(MPI_TYPECLASS_REAL, size, xtype, ierror)
23 if (myrank .eq. 0) then
24     ... initialize x ...
25     call MPI_SEND(x, xtype, 100, 1, ...)
26 else if (myrank .eq. 1) then
27     call MPI_RECV(x, xtype, 100, 0, ...)
28 endif

```

This may not work in a heterogeneous environment if the value of `size` is not the same on process 1 and process 0. There should be no problem in a homogeneous environment. To communicate in a heterogeneous environment, there are at least four options. The first is to declare variables of default type and use the MPI datatypes for these types, e.g., declare a variable of type `REAL` and use `MPI_REAL`. The second is to use `selected_real_kind` or `selected_int_kind` and with the functions of the previous section. The third is to declare a variable that is known to be the same size on all architectures (e.g., `selected_real_kind(12)` on almost all compilers will result in an 8-byte representation). The fourth is to carefully check representation size before communication. This may require explicit conversion to a variable of size that can be communicated and handshaking between sender and receiver to agree on a size.

Note finally that using the “external32” representation for I/O requires explicit attention to the representation sizes. Consider the following code:

```

46 real(selected_real_kind(5)) x(100)
47 size = storage_size(x) / 8
48 call MPI_TYPE_MATCH_SIZE(MPI_TYPECLASS_REAL, size, xtype, ierror)

```

```

1
2
3
4
5
6
7
8
9
10
11
12
13
14
15
16
17
18
19
20
21
22
23
24
25
26
27
28
29
30
31
32
33
34
35
36
37
38
39
40
41
42
43
44
45
46
47
48

```

```

if (myrank .eq. 0) then
  call MPI_FILE_OPEN(MPI_COMM_SELF, 'foo',
                    &
                    MPI_MODE_CREATE+MPI_MODE_WRONLY, &
                    MPI_INFO_NULL, fh, ierror)
  call MPI_FILE_SET_VIEW(fh, zero, xtype, xtype, 'external32', &
                    MPI_INFO_NULL, ierror)
  call MPI_FILE_WRITE(fh, x, 100, xtype, status, ierror)
  call MPI_FILE_CLOSE(fh, ierror)
endif

call MPI_BARRIER(MPI_COMM_WORLD, ierror)

if (myrank .eq. 1) then
  call MPI_FILE_OPEN(MPI_COMM_SELF, 'foo', MPI_MODE_RDONLY, &
                    MPI_INFO_NULL, fh, ierror)
  call MPI_FILE_SET_VIEW(fh, zero, xtype, xtype, 'external32', &
                    MPI_INFO_NULL, ierror)
  call MPI_FILE_WRITE(fh, x, 100, xtype, status, ierror)
  call MPI_FILE_CLOSE(fh, ierror)
endif

```

If processes 0 and 1 are on different machines, this code may not work as expected if the size is different on the two machines. (*End of advice to users.*)

### 18.1.10 Problems With Fortran Bindings for MPI

This section discusses a number of problems that may arise when using MPI in a Fortran program. It is intended as advice to users, and clarifies how MPI interacts with Fortran. It is intended to clarify, not add to, this standard.

As noted in the original MPI specification, the interface violates the Fortran standard in several ways. While these may cause few problems for Fortran 77 programs, they become more significant for Fortran 90 programs, so that users must exercise care when using new Fortran 90 features. With Fortran 2008 and the new semantics defined in TS 29113, most violations are resolved, and this is hinted at in an addendum to each item. The violations were originally adopted and have been retained because they are important for the usability of MPI. The rest of this section describes the potential problems in detail.

The following MPI features are inconsistent with Fortran 90 and Fortran 77.

1. An MPI subroutine with a choice argument may be called with different argument types. When using the `mpi_f08` module together with a compiler that supports Fortran 2008 + TS 29113, this problem is resolved.
2. An MPI subroutine with an assumed-size dummy argument may be passed an actual scalar argument. This is only solved for choice buffers through the use of `DIMENSION(...)`.
3. Nonblocking and split-collective MPI routines assume that actual arguments are passed by address or descriptor and that arguments and the associated data are not copied

1 on entrance to or exit from the subroutine. This problem is solved with the use of the  
2 `ASYNCHRONOUS` attribute.

- 3
- 4 4. An MPI implementation may read or modify user data (e.g., communication buffers  
5 used by nonblocking communications) concurrently with a user program that is ex-  
6 ecuting outside of MPI calls. This problem is resolved by relying on the extended  
7 semantics of the `ASYNCHRONOUS` attribute as specified in TS 29113.
- 8
- 9 5. Several named “constants,” such as `MPI_BOTTOM`, `MPI_IN_PLACE`,  
10 `MPI_STATUS_IGNORE`, `MPI_STATUSES_IGNORE`, `MPI_ERRCODES_IGNORE`,  
11 `MPI_UNWEIGHTED`, `MPI_WEIGHTS_EMPTY`, `MPI_ARGV_NULL`, and `MPI_ARGVS_NULL`  
12 are not ordinary Fortran constants and require a special implementation. See Sec-  
13 tion 2.5.4 for more information.
- 14 6. The memory allocation routine `MPI_ALLOC_MEM` cannot be used from  
15 Fortran 77/90/95 without a language extension (for example, Cray pointers) that  
16 allows the allocated memory to be associated with a Fortran variable. Therefore,  
17 address sized integers were used in MPI-2.0 – MPI-2.2. In Fortran 2003,  
18 `TYPE(C_PTR)` entities were added, which allow a standard-conforming implementation  
19 of the semantics of `MPI_ALLOC_MEM`. In MPI-3.0 and later, `MPI_ALLOC_MEM` has  
20 an additional, overloaded interface to support this language feature. The use of Cray  
21 pointers is deprecated. The `mpi_f08` module only supports `TYPE(C_PTR)` pointers.

22 Additionally, MPI is inconsistent with Fortran 77 in a number of ways, as noted below.

- 23
- 24 • MPI identifiers exceed 6 characters.
  - 25
  - 26 • MPI identifiers may contain underscores after the first character.
  - 27
  - 28 • MPI requires an include file, `mpif.h`. On systems that do not support include files,  
29 the implementation should specify the values of named constants.
  - 30
  - 31 • Many routines in MPI have `KIND`-parameterized integers (e.g., `MPI_ADDRESS_KIND`  
32 and `MPI_OFFSET_KIND`) that hold address information. On systems that do not sup-  
33 port Fortran 90-style parameterized types, `INTEGER*8` or `INTEGER` should be used  
34 instead.

35 MPI-1 contained several routines that take address-sized information as input or return  
36 address-sized information as output. In C such arguments were of type `MPI_Aint` and in  
37 Fortran of type `INTEGER`. On machines where integers are smaller than addresses, these  
38 routines can lose information. In MPI-2 the use of these functions has been deprecated and  
39 they have been replaced by routines taking `INTEGER` arguments of `KIND=MPI_ADDRESS_KIND`.  
40 A number of new MPI-2 functions also take `INTEGER` arguments of non-default `KIND`. See  
41 Section 2.6 and Section 4.1.1 for more information.

42 Sections 18.1.11 through 18.1.19 describe several problems in detail which concern  
43 the interaction of MPI and Fortran as well as their solutions. Some of these solutions  
44 require special capabilities from the compilers. Major requirements are summarized in  
45 Section 18.1.7.



### 18.1.11 Problems Due to Strong Typing

All MPI functions with choice arguments associate actual arguments of different Fortran datatypes with the same dummy argument. This is not allowed by Fortran 77, and in Fortran 90, it is technically only allowed if the function is overloaded with a different function for each type (see also Section 18.1.6). In C, the use of `void*` formal arguments avoids these problems. Similar to C, with Fortran 2008 + TS 29113 (and later) together with the `mpi_f08` module, the problem is avoided by declaring choice arguments with `TYPE(*)`, `DIMENSION(..)`, i.e., as assumed-type and assumed-rank dummy arguments.

Using `INCLUDE 'mpif.h'`, the following code fragment is technically invalid and may generate a compile-time error.

```
integer i(5)
real    x(5)
...
call mpi_send(x, 5, MPI_REAL, ...)
call mpi_send(i, 5, MPI_INTEGER, ...)
```

In practice, it is rare for compilers to do more than issue a warning. When using either the `mpi_f08` or `mpi` module, the problem is usually resolved through the assumed-type and assumed-rank declarations of the dummy arguments, or with a compiler-dependent mechanism that overrides type checking for choice arguments.

It is also technically invalid in Fortran to pass a scalar actual argument to an array dummy argument that is not a choice buffer argument. Thus, when using the `mpi_f08` or `mpi` module, the following code fragment usually generates an error since the `dims` and `periods` arguments to `MPI_CART_CREATE` are declared as assumed size arrays `INTEGER :: DIMS(*)` and `LOGICAL :: PERIODS(*)`.

```
USE mpi_f08      ! or USE mpi
INTEGER size
CALL MPI_Cart_create(comm_old, 1, size, .TRUE., .TRUE., comm_cart, ierror)
```

Although this is a non-conforming MPI call, compiler warnings are not expected (but may occur) when using `INCLUDE 'mpif.h'` and this include file does not use Fortran explicit interfaces.

### 18.1.12 Problems Due to Data Copying and Sequence Association with Subscript Triplets

Arrays with subscript **triplets** describe Fortran subarrays with or without strides, e.g.,

```
REAL a(100,100,100)
CALL MPI_Send(a(11:17, 12:99:3, 1:100), 7*30*100, MPI_REAL, ...)
```

The handling of subscript triplets depends on the value of the constant `MPI_SUBARRAYS_SUPPORTED`:

- If `MPI_SUBARRAYS_SUPPORTED` equals `.TRUE.:`

Choice buffer arguments are declared as `TYPE(*)`, `DIMENSION(..)`. For example, consider the following code fragment:

```

1     REAL s(100), r(100)
2     CALL MPI_Isend(s(1:100:5), 3, MPI_REAL, ..., rq, ierror)
3     CALL MPI_Wait(rq, status, ierror)
4     CALL MPI_Irecv(r(1:100:5), 3, MPI_REAL, ..., rq, ierror)
5     CALL MPI_Wait(rq, status, ierror)

```

In this case, the individual elements `s(1)`, `s(6)`, and `s(11)` are sent between the start of `MPI_ISEND` and the end of `MPI_WAIT` even though the compiled code will not copy `s(1:100:5)` to a real contiguous temporary scratch buffer. Instead, the compiled code will pass a descriptor to `MPI_ISEND` that allows MPI to operate directly on `s(1)`, `s(6)`, `s(11)`, ..., `s(96)`. The called `MPI_ISEND` routine will take only the first three of these elements due to the type signature “3, MPI\_REAL”.

All nonblocking MPI functions (e.g., `MPI_ISEND`, `MPI_PUT`, `MPI_FILE_WRITE_ALL_BEGIN`) behave as if *the user-specified elements of choice buffers are copied to a contiguous scratch buffer in the MPI runtime environment*. All datatype descriptions (in the example above, “3, MPI\_REAL”) read and store data from and to this virtual contiguous scratch buffer. Displacements in MPI derived datatypes are relative to the beginning of this virtual contiguous scratch buffer. Upon completion of a nonblocking receive operation (e.g., when `MPI_WAIT` on a corresponding `MPI_Request` returns), it is as if the received data has been copied from the virtual contiguous scratch buffer back to the non-contiguous application buffer. In the example above, `r(1)`, `r(6)`, and `r(11)` are guaranteed to be defined with the received data when `MPI_WAIT` returns.

Note that the above definition does not supercede restrictions about buffers used with nonblocking operations (e.g., those specified in Section 3.7.2).

*Advice to implementors.* The Fortran descriptor for `TYPE(*)`, `DIMENSION(..)` arguments contains enough information that, if desired, the MPI library can make a real contiguous copy of non-contiguous user buffers when the nonblocking operation is started, and release this buffer not before the nonblocking communication has completed (e.g., the `MPI_WAIT` routine). Efficient implementations may avoid such additional memory-to-memory data copying. (*End of advice to implementors.*)

*Rationale.* If `MPI_SUBARRAYS_SUPPORTED` equals `.TRUE.`, non-contiguous buffers are handled inside the MPI library instead of by the compiler through argument association conventions. Therefore, the scope of MPI library scratch buffers can be from the beginning of a nonblocking operation until the completion of the operation although beginning and completion are implemented in different routines. (*End of rationale.*)

- If `MPI_SUBARRAYS_SUPPORTED` equals `.FALSE.`:

In this case, the use of Fortran arrays with subscript triplets as actual choice buffer arguments in any nonblocking MPI operation (which also includes persistent request, and split collectives) may cause undefined behavior. They may, however, be used in blocking MPI operations.

Implicit in MPI is the idea of a contiguous chunk of memory accessible through a linear address space. MPI copies data to and from this memory. An MPI program specifies the location of data by providing memory addresses and offsets. In the C language, sequence association rules plus pointers provide all the necessary low-level structure.

In Fortran, array data is not necessarily stored contiguously. For example, the array section `A(1:N:2)` involves only the elements of `A` with indices 1, 3, 5, . . . . The same is true for a pointer array whose target is such a section. Most compilers ensure that an array that is a dummy argument is held in contiguous memory if it is declared with an explicit shape (e.g., `B(N)`) or is of assumed size (e.g., `B(*)`). If necessary, they do this by making a copy of the array into contiguous memory.<sup>1</sup>

Because MPI dummy buffer arguments are assumed-size arrays if `MPI_SUBARRAYS_SUPPORTED` equals `.FALSE.`, this leads to a serious problem for a nonblocking call: the compiler copies the temporary array back on return but MPI continues to copy data to the memory that held it. For example, consider the following code fragment:

```
real a(100)
call MPI_IRECV(a(1:100:2), MPI_REAL, 50, ...)
```

Since the first dummy argument to `MPI_IRECV` is an assumed-size array (`<type> buf(*)`), the array section `a(1:100:2)` is copied to a temporary before being passed to `MPI_IRECV`, so that it is contiguous in memory. `MPI_IRECV` returns immediately, and data is copied from the temporary back into the array `a`. Sometime later, MPI may write to the address of the deallocated temporary. Copying is also a problem for `MPI_ISEND` since the temporary array may be deallocated before the data has all been sent from it.

Most Fortran 90 compilers do not make a copy if the actual argument is the whole of an explicit-shape or assumed-size array or is a “simply contiguous” section such as `A(1:N)` of such an array. (“Simply contiguous” is defined in the next paragraph.) Also, many compilers treat allocatable arrays the same as they treat explicit-shape arrays in this regard (though we know of one that does not). However, the same is not true for assumed-shape and pointer arrays; since they may be discontinuous, copying is often done. It is this copying that causes problems for MPI as described in the previous paragraph.

According to the Fortran 2008 Standard, Section 6.5.4, a “simply contiguous” array section is

```
name ( [:,]... [<subscript>]:[<subscript>] [,<subscript>]... )
```

That is, there are zero or more dimensions that are selected in full, then one dimension selected without a stride, then zero or more dimensions that are selected with a simple subscript. The compiler can detect from analyzing the source code that the array is contiguous. Examples are

<sup>1</sup>Technically, the Fortran standard is worded to allow non-contiguous storage of any array data, unless the dummy argument has the `CONTIGUOUS` attribute.

```

1      A(1:N), A(:,N), A(:,1:N,1), A(1:6,N), A(:, :, 1:N)
2
3

```

4 Because of Fortran’s column-major ordering, where the first index varies fastest, a  
5 “simply contiguous” section of a contiguous array will also be contiguous.

6 The same problem can occur with a scalar argument. A compiler may make a copy of  
7 scalar dummy arguments within a called procedure when passed as an actual argument  
8 to a choice buffer routine. That this can cause a problem is illustrated by the example

```

9
10     real :: a
11     call user1(a,rq)
12     call MPI_WAIT(rq,status,ierr)
13     write (*,*) a
14
15     subroutine user1(buf,request)
16     call MPI_Irecv(buf,...,request,...)
17     end
18
19

```

20 If `a` is copied, `MPI_Irecv` will alter the copy when it completes the communication  
21 and will not alter `a` itself.

22 Note that copying will almost certainly occur for an argument that is a non-trivial  
23 expression (one with at least one operator or function call), a section that does not  
24 select a contiguous part of its parent (e.g., `A(1:n:2)`), a pointer whose target is such  
25 a section, or an assumed-shape array that is (directly or indirectly) associated with  
26 such a section.

27 If a compiler option exists that inhibits copying of arguments, in either the calling or  
28 called procedure, this must be employed.

29 If a compiler makes copies in the calling procedure of arguments that are explicit-  
30 shape or assumed-size arrays, “simply contiguous” array sections of such arrays, or  
31 scalars, and if no compiler option exists to inhibit such copying, then the compiler  
32 cannot be used for applications that use `MPI_GET_ADDRESS`, or any nonblocking  
33 MPI routine. If a compiler copies scalar arguments in the called procedure and there  
34 is no compiler option to inhibit this, then this compiler cannot be used for applications  
35 that use memory references across subroutine calls as in the example above.

### 37 18.1.13 Problems Due to Data Copying and Sequence Association with Vector Subscripts

38 Fortran arrays with **vector** subscripts describe subarrays containing a possibly irregular  
39 set of elements

```

40
41     REAL a(100)
42     CALL MPI_Send(A((/7,9,23,81,82/)), 5, MPI_REAL, ...)
43
44

```

45 Fortran arrays with a vector subscript must not be used as actual choice buffer argu-  
46 ments in any nonblocking or split collective MPI operations. They may, however, be used  
47 in blocking MPI operations.

## 18.1.14 Special Constants

MPI requires a number of special “constants” that cannot be implemented as normal Fortran constants, e.g., `MPI_BOTTOM`. The complete list can be found in Section 2.5.4. In C, these are implemented as constant pointers, usually as `NULL` and are used where the function prototype calls for a pointer to a variable, not the variable itself.

In Fortran, using special values for the constants (e.g., by defining them through `parameter` statements) is not possible because an implementation cannot distinguish these values from valid data. Typically these constants are implemented as predefined static variables (e.g., a variable in an MPI-declared `COMMON` block), relying on the fact that the target compiler passes data by address. Inside the subroutine, the address of the actual choice buffer argument can be compared with the address of such a predefined static variable.

These special constants also cause an exception with the usage of Fortran `INTENT`: with `USE mpi_f08`, the attributes `INTENT(IN)`, `INTENT(OUT)`, and `INTENT(INOUT)` are used in the Fortran interface. In most cases, `INTENT(IN)` is used if the C interface uses call-by-value. For all buffer arguments and for dummy arguments that may be modified and allow one of these special constants as input, an `INTENT` is not specified.

## 18.1.15 Fortran Derived Types

MPI supports passing Fortran entities of `BIND(C)` and `SEQUENCE` derived types to choice dummy arguments, provided no type component has the `ALLOCATABLE` or `POINTER` attribute.

The following code fragment shows some possible ways to send scalars or arrays of interoperable derived type in Fortran. The example assumes that all data is passed by address.

```

type, BIND(C) :: mytype
  integer :: i
  real :: x
  double precision :: d
  logical :: l
end type mytype

type(mytype) :: foo, fooarr(5)
integer :: blocklen(4), type(4)
integer(KIND=MPI_ADDRESS_KIND) :: disp(4), base, lb, extent

call MPI_GET_ADDRESS(foo%i, disp(1), ierr)
call MPI_GET_ADDRESS(foo%x, disp(2), ierr)
call MPI_GET_ADDRESS(foo%d, disp(3), ierr)
call MPI_GET_ADDRESS(foo%l, disp(4), ierr)

base = disp(1)
disp(1) = disp(1) - base
disp(2) = disp(2) - base
disp(3) = disp(3) - base
disp(4) = disp(4) - base

blocklen(1) = 1

```

```

1  blocklen(2) = 1
2  blocklen(3) = 1
3  blocklen(4) = 1
4
5  type(1) = MPI_INTEGER
6  type(2) = MPI_REAL
7  type(3) = MPI_DOUBLE_PRECISION
8  type(4) = MPI_LOGICAL
9
10 call MPI_TYPE_CREATE_STRUCT(4, blocklen, disp, type, newtype, ierr)
11 call MPI_TYPE_COMMIT(newtype, ierr)
12
13 call MPI_SEND(foo%i, 1, newtype, dest, tag, comm, ierr)
14 ! or
15 call MPI_SEND(foo, 1, newtype, dest, tag, comm, ierr)
16 ! expects that base == address(foo%i) == address(foo)
17
18 call MPI_GET_ADDRESS(fooarr(1), disp(1), ierr)
19 call MPI_GET_ADDRESS(fooarr(2), disp(2), ierr)
20 extent = disp(2) - disp(1)
21 lb = 0
22 call MPI_TYPE_CREATE_RESIZED(newtype, lb, extent, newarrtype, ierr)
23 call MPI_TYPE_COMMIT(newarrtype, ierr)
24
25 call MPI_SEND(fooarr, 5, newarrtype, dest, tag, comm, ierr)

```

26  
27 Using the derived type variable `foo` instead of its first basic type element `foo%i` may  
28 be impossible if the MPI library implements choice buffer arguments through overloading  
29 instead of using `TYPE(*)`, `DIMENSION(...)`, or through a non-standardized extension such  
30 as `!$PRAGMA IGNORE_TKR`; see Section 18.1.6.

31 To use a derived type in an array requires a correct extent of the datatype handle  
32 to take care of the alignment rules applied by the compiler. These alignment rules may  
33 imply that there are gaps between the components of a derived type, and also between the  
34 subsequent elements of an array of a derived type. The extent of an interoperable derived  
35 type (i.e., defined with `BIND(C)`) and a `SEQUENCE` derived type with the same content may  
36 be different because C and Fortran may apply different alignment rules. As recommended  
37 in the advice to users in Section 4.1.6, one should add an additional fifth structure element  
38 with one numerical storage unit at the end of this structure to force in most cases that  
39 the array of structures is contiguous. Even with such an additional element, one should  
40 keep this resizing due to the special alignment rules that can be used by the compiler for  
41 structures, as also mentioned in this advice.

42 Using the extended semantics defined in TS 29113, it is also possible to use entities  
43 or derived types without either the `BIND(C)` or the `SEQUENCE` attribute as choice buffer  
44 arguments; some additional constraints must be observed, e.g., no `ALLOCATABLE` or `POINTER`  
45 type components may exist. In this case, the `base` address in the example must be changed  
46 to become the address of `foo` instead of `foo%i`, because the Fortran compiler may rearrange  
47 type components or add padding. Sending the structure `foo` should then also be performed  
48 by providing it (and not `foo%i`) as actual argument for `MPI_Send`.

## 18.1.16 Optimization Problems, an Overview

MPI provides operations that may be hidden from the user code and run concurrently with it, accessing the same memory as user code. Examples include the data transfer for an `MPI_IRECV`. The optimizer of a compiler will assume that it can recognize periods when a copy of a variable can be kept in a register without reloading from or storing to memory. When the user code is working with a register copy of some variable while the hidden operation reads or writes the memory copy, problems occur. These problems are independent of the Fortran support method; i.e., they occur with the `mpi_f08` module, the `mpi` module, and the `mpif.h` include file.

This section shows four problematic usage areas (the abbreviations in parentheses are used in the table below):

- Use of nonblocking routines or persistent requests (*Nonbl.*).
- Use of one-sided routines (*1-sided*).
- Use of MPI parallel file I/O split collective operations (*Split*).
- Use of `MPI_BOTTOM` together with absolute displacements in MPI datatypes, or relative displacements between two variables in such datatypes (*Bottom*).

The following compiler optimization strategies (valid for serial code) may cause problems in MPI applications:

- Code movement and register optimization problems; see Section 18.1.17.
- Temporary data movement and temporary memory modifications; see Section 18.1.18.
- Permanent data movement (e.g., through garbage collection); see Section 18.1.19.

Table 18.2 shows the only usage areas where these optimization problems may occur.

Optimization ...	... may cause a problem in following usage areas			
	Nonbl.	1-sided	Split	Bottom
Code movement and register optimization	yes	yes	no	yes
Temporary data movement	yes	yes	yes	no
Permanent data movement	yes	yes	yes	yes

Table 18.2: Occurrence of Fortran optimization problems in several usage areas

The solutions in the following sections are based on compromises:

- to minimize the burden for the application programmer, e.g., as shown in Sections “Solutions” through “The (Poorly Performing) Fortran VOLATILE Attribute” on pages 740–744,
- to minimize the drawbacks on compiler based optimization, and
- to minimize the requirements defined in Section 18.1.7.

## 18.1.17 Problems with Code Movement and Register Optimization

## Nonblocking Operations

If a variable is local to a Fortran subroutine (i.e., not in a module or a `COMMON` block), the compiler will assume that it cannot be modified by a called subroutine unless it is an actual argument of the call. In the most common linkage convention, the subroutine is expected to save and restore certain registers. Thus, the optimizer will assume that a register which held a valid copy of such a variable before the call will still hold a valid copy on return.

**Example 18.1** Fortran 90 register optimization — extreme.

Source	compiled as	or compiled as
REAL :: buf, b1	REAL :: buf, b1	REAL :: buf, b1
call MPI_Irecv(buf,..req)	call MPI_Irecv(buf,..req)	call MPI_Irecv(buf,..req)
	register = buf	b1 = buf
call MPI_WAIT(req,..)	call MPI_WAIT(req,..)	call MPI_WAIT(req,..)
b1 = buf	b1 = register	

Example 18.1 shows extreme, but allowed, possibilities. `MPI_WAIT` on a concurrent thread modifies `buf` between the invocation of `MPI_Irecv` and the completion of `MPI_WAIT`. But the compiler cannot see any possibility that `buf` can be changed after `MPI_Irecv` has returned, and may schedule the load of `buf` earlier than typed in the source. The compiler has no reason to avoid using a register to hold `buf` across the call to `MPI_WAIT`. It also may reorder the instructions as illustrated in the rightmost column.

**Example 18.2** Similar example with `MPI_ISEND`

Source	compiled as	with a possible MPI-internal execution sequence
REAL :: buf, copy	REAL :: buf, copy	REAL :: buf, copy
buf = val	buf = val	buf = val
call MPI_ISEND(buf,..req)	call MPI_ISEND(buf,..req)	addr = &buf
copy = buf	copy = buf	copy = buf
	buf = val_overwrite	buf = val_overwrite
call MPI_WAIT(req,..)	call MPI_WAIT(req,..)	call send(*addr) ! within
		! MPI_WAIT
buf = val_overwrite		

Due to valid compiler code movement optimizations in Example 18.2, the content of `buf` may already have been overwritten by the compiler when the content of `buf` is sent. The code movement is permitted because the compiler cannot detect a possible access to `buf` in `MPI_WAIT` (or in a second thread between the start of `MPI_ISEND` and the end of `MPI_WAIT`).

Such register optimization is based on moving code; here, the access to `buf` was moved from after `MPI_WAIT` to before `MPI_WAIT`. Note that code movement may also occur across subroutine boundaries when subroutines or functions are inlined.

This register optimization/code movement problem for nonblocking operations does not occur with MPI parallel file I/O split collective operations, because in the `..._BEGIN`



and ...\_END calls, the same buffer has to be provided as an actual argument. The register optimization / code movement problem for MPI\_BOTTOM and derived MPI datatypes may occur in each blocking and nonblocking communication call, as well as in each parallel file I/O operation.

### Persistent Operations

With persistent requests, the buffer argument is hidden from the MPI\_START and MPI\_STARTALL calls, i.e., the Fortran compiler may move buffer accesses across the MPI\_START or MPI\_STARTALL call, similar to the MPI\_WAIT call as described in the Nonblocking Operations subsection in Section 18.1.17.

### One-sided Communication

An example with instruction reordering due to register optimization can be found in Section 11.7.4.

### MPI\_BOTTOM and Combining Independent Variables in Datatypes

This section is only relevant if the MPI program uses a buffer argument to an MPI\_SEND, MPI\_RECV, etc., that hides the actual variables involved in the communication. MPI\_BOTTOM with an MPI\_Datatype containing *absolute addresses* is one example. Creating a datatype which uses one variable as an anchor and brings along others by using MPI\_GET\_ADDRESS to determine their offsets from the anchor is another. The anchor variable would be the only one referenced in the call. Also attention must be paid if MPI operations are used that run in parallel with the user's application.

Example 18.3 shows what Fortran compilers are allowed to do.

#### Example 18.3 Fortran 90 register optimization.

This source ...

can be compiled as:

call MPI_GET_ADDRESS(buf,bufaddr, ierror)	call MPI_GET_ADDRESS(buf,...)
call MPI_TYPE_CREATE_STRUCT(1,1, bufaddr, MPI_REAL,type,ierror)	call MPI_TYPE_CREATE_STRUCT(...)
call MPI_TYPE_COMMIT(type,ierror)	call MPI_TYPE_COMMIT(...)
val_old = buf	register = buf
	val_old = register
call MPI_RECV(MPI_BOTTOM,1,type,...)	call MPI_RECV(MPI_BOTTOM,...)
val_new = buf	val_new = register

In Example 18.3, the compiler does not invalidate the register because it cannot see that MPI\_RECV changes the value of buf. The access to buf is hidden by the use of MPI\_GET\_ADDRESS and MPI\_BOTTOM.

In Example 18.4, several successive assignments to the same variable buf can be combined in a way such that only the last assignment is executed. "Successive" means that no interfering load access to this variable occurs between the assignments. The compiler

**Example 18.4** Similar example with MPI\_SEND

<pre> 1 2 3 This source ... 4 5 ! buf contains val_old 6 buf = val_new 7 call MPI_SEND(MPI_BOTTOM,1,type,...) 8 ! with buf as a displacement in type 9 10 11 12 13 14 buf = val_overwrite 15 16 </pre>	<pre> can be compiled as: ! buf contains val_old call MPI_SEND(...) ! i.e. val_old is sent ! ! buf=val_new is moved to here ! and detected as dead code ! and therefore removed ! buf = val_overwrite </pre>
--	--

cannot detect that the call to MPI\_SEND statement is interfering because the load access to buf is hidden by the usage of MPI\_BOTTOM.

**Solutions**

The following sections show in detail how the problems with code movement and register optimization can be portably solved. Application writers can partially or fully avoid these compiler optimization problems by using one or more of the special Fortran declarations with the send and receive buffers used in nonblocking operations, or in operations in which MPI\_BOTTOM is used, or if datatype handles that combine several variables are used:

- Use of the Fortran `ASYNCHRONOUS` attribute.
- Use of the helper routine `MPI_F_SYNC_REG`, or an equivalent user-written dummy routine.
- Declare the buffer as a Fortran module variable or within a Fortran common block.
- Use of the Fortran `VOLATILE` attribute.

Each of these methods solves the problems of code movement and register optimization, but may incur various degrees of performance impact, and may not be usable in every application context. These methods may not be guaranteed by the Fortran standard, but they must be guaranteed by a MPI-3.0 (and later) compliant MPI library and associated compiler suite according to the requirements listed in Section 18.1.7. The performance impact of using `MPI_F_SYNC_REG` is expected to be low, that of using module variables or the `ASYNCHRONOUS` attribute is expected to be low to medium, and that of using the `VOLATILE` attribute is expected to be high or very high. Note that there is one attribute that cannot be used for this purpose: the Fortran `TARGET` attribute does not solve code movement problems in MPI applications.

**The Fortran ASYNCHRONOUS Attribute**

Declaring an actual buffer argument with the `ASYNCHRONOUS` Fortran attribute in a scoping unit (or `BLOCK`) informs the compiler that any statement in the scoping unit may be executed

while the buffer is affected by a pending asynchronous Fortran input/output operation (since Fortran 2003) or by an asynchronous communication (TS 29113 extension). Without the extensions specified in TS 29113, a Fortran compiler may totally ignore this attribute if the Fortran compiler implements asynchronous Fortran input/output operations with blocking I/O. The `ASYNCHRONOUS` attribute protects the buffer accesses from optimizations through code movements across routine calls, and the buffer itself from temporary and permanent data movements. If the choice buffer dummy argument of a nonblocking MPI routine is declared with `ASYNCHRONOUS` (which is mandatory for the `mpi_f08` module, with allowable exceptions listed in Section 18.1.6), then the compiler has to guarantee call by reference and should report a compile-time error if call by reference is impossible, e.g., if vector subscripts are used. The `MPI_ASYNC_PROTECTS_NONBLOCKING` is set to `.TRUE.` if both the protection of the actual buffer argument through `ASYNCHRONOUS` according to the TS 29113 extension and the declaration of the dummy argument with `ASYNCHRONOUS` in the Fortran support method is guaranteed for all nonblocking routines, otherwise it is set to `.FALSE..`

The `ASYNCHRONOUS` attribute has some restrictions. Section 5.4.2 of the TS 29113 specifies:

“Asynchronous communication for a Fortran variable occurs through the action of procedures defined by means other than Fortran. It is initiated by execution of an asynchronous communication initiation procedure and completed by execution of an asynchronous communication completion procedure. Between the execution of the initiation and completion procedures, any variable of which any part is associated with any part of the asynchronous communication variable is a pending communication affector. Whether a procedure is an asynchronous communication initiation or completion procedure is processor dependent.

Asynchronous communication is either input communication or output communication. For input communication, a pending communication affector shall not be referenced, become defined, become undefined, become associated with a dummy argument that has the `VALUE` attribute, or have its pointer association status changed. For output communication, a pending communication affector shall not be redefined, become undefined, or have its pointer association status changed.”

In Example 18.5 Case (a) on page 747, the read accesses to `b` within `function(b(i-1), b(i), b(i+1))` cannot be moved by compiler optimizations to before the wait call because `b` was declared as `ASYNCHRONOUS`. Note that only the elements 0, 1, 100, and 101 of `b` are involved in asynchronous communication but by definition, the total variable `b` is the pending communication affector and is usable for input and output asynchronous communication between the `MPI_I...` routines and `MPI_Waitall`. Case (a) works fine because the read accesses to `b` occur after the communication has completed.

In Case (b), the read accesses to `b(1:100)` in the loop `i=2,99` are read accesses to a pending communication affector while input communication (i.e., the two `MPI_Irecv` calls) is pending. This is a contradiction to the rule that *for input communication, a pending communication affector shall not be referenced*. The problem can be solved by using separate variables for the halos and the inner array, or by splitting a common array into disjoint subarrays which are passed through different dummy arguments into a subroutine, as shown in Example 18.9.

If one does not overlap communication and computation on the same variable, then all optimization problems can be solved through the `ASYNCHRONOUS` attribute.

The problems with `MPI_BOTTOM`, as shown in Example 18.3 and Example 18.4, can also be solved by declaring the buffer `buf` with the `ASYNCHRONOUS` attribute.

In some MPI routines, a buffer dummy argument is defined as `ASYNCHRONOUS` to guarantee passing by reference, provided that the actual argument is also defined as `ASYNCHRONOUS`.

### Calling `MPI_F_SYNC_REG`

The compiler may be prevented from moving a reference to a buffer across a call to an MPI subroutine by surrounding the call by calls to an external subroutine with the buffer as an actual argument. The MPI library provides the `MPI_F_SYNC_REG` routine for this purpose; see Section 18.1.8.

- The problems illustrated by the Examples 18.1 and 18.2 can be solved by calling `MPI_F_SYNC_REG(buf)` once immediately after `MPI_WAIT`.

#### Example 18.1

can be solved with

```
call MPI_Irecv(buf, ..req)
```

```
call MPI_WAIT(req, ..)
```

```
call MPI_F_SYNC_REG(buf)
```

```
b1 = buf
```

#### Example 18.2

can be solved with

```
buf = val
```

```
call MPI_Isend(buf, ..req)
```

```
copy = buf
```

```
call MPI_WAIT(req, ..)
```

```
call MPI_F_SYNC_REG(buf)
```

```
buf = val_overwrite
```

The call to `MPI_F_SYNC_REG(buf)` prevents moving the last line before the `MPI_WAIT` call. Further calls to `MPI_F_SYNC_REG(buf)` are not needed because it is still correct if the additional read access `copy=buf` is moved below `MPI_WAIT` and before `buf=val_overwrite`.

- The problems illustrated by the Examples 18.3 and 18.4 can be solved with two additional `MPI_F_SYNC_REG(buf)` statements; one directly before `MPI_RECV/MPI_SEND`, and one directly after this communication operation.

#### Example 18.3

can be solved with

```
call MPI_F_SYNC_REG(buf)
```

```
call MPI_RECV(MPI_BOTTOM, ...)
```

```
call MPI_F_SYNC_REG(buf)
```

#### Example 18.4

can be solved with

```
call MPI_F_SYNC_REG(buf)
```

```
call MPI_SEND(MPI_BOTTOM, ...)
```

```
call MPI_F_SYNC_REG(buf)
```

The first call to `MPI_F_SYNC_REG(buf)` is needed to finish all load and store references to `buf` prior to `MPI_RECV/MPI_SEND`; the second call is needed to assure that any subsequent access to `buf` is not moved before `MPI_RECV/SEND`.

- In the example in Section 11.7.4, two asynchronous accesses must be protected: in Process 1, the access to `bbbb` must be protected similar to Example 18.1, i.e., a call to `MPI_F_SYNC_REG(bbbb)` is needed after the second `MPI_WIN_FENCE` to guarantee that further accesses to `bbbb` are not moved ahead of the call to `MPI_WIN_FENCE`. In Process 2, both calls to `MPI_WIN_FENCE` together act as a communication call with

MPI\_BOTTOM as the buffer. That is, before the first fence and after the second fence, a call to MPI\_F\_SYNC\_REG(buff) is needed to guarantee that accesses to buff are not moved after or ahead of the calls to MPI\_WIN\_FENCE. Using MPI\_GET instead of MPI\_PUT, the same calls to MPI\_F\_SYNC\_REG are necessary.

Source of Process 1	Source of Process 2
bbbb = 777	buff = 999
call MPI_WIN_FENCE	call MPI_F_SYNC_REG(buff)
call MPI_PUT(bbbb	call MPI_WIN_FENCE
into buff of process 2)	
call MPI_WIN_FENCE	call MPI_WIN_FENCE
call MPI_F_SYNC_REG(bbbb)	call MPI_F_SYNC_REG(buff)
	ccc = buff

- The temporary memory modification problem, i.e., Example 18.6, can **not** be solved with this method.

#### A User Defined Routine Instead of MPI\_F\_SYNC\_REG

Instead of MPI\_F\_SYNC\_REG, one can also use a user defined external subroutine, which is separately compiled:

```
subroutine DD(buf)
  integer buf
end
```

Note that if the intent is declared in an explicit interface for the external subroutine, it must be OUT or INOUT. The subroutine itself may have an empty body, but the compiler does not know this and has to assume that the buffer may be altered. For example, a call to MPI\_RECV with MPI\_BOTTOM as buffer might be replaced by

```
call DD(buf)
call MPI_RECV(MPI_BOTTOM, ...)
call DD(buf)
```

Such a user-defined routine was introduced in MPI-2.0 and is still included here to document such usage in existing application programs although new applications should prefer MPI\_F\_SYNC\_REG or one of the other possibilities. In an existing application, calls to such a user-written routine should be substituted by a call to MPI\_F\_SYNC\_REG because the user-written routine may not be implemented in accordance with the rules specified in Section 18.1.7.

#### Module Variables and COMMON Blocks

An alternative to the previously mentioned methods is to put the buffer or variable into a module or a common block and access it through a USE or COMMON statement in each scope where it is referenced, defined or appears as an actual argument in a call to an MPI routine.

1 The compiler will then have to assume that the MPI procedure may alter the buffer or  
2 variable, provided that the compiler cannot infer that the MPI procedure does not reference  
3 the module or common block.

- 4 • This method solves problems of instruction reordering, code movement, and register  
5 optimization related to nonblocking and one-sided communication, or related to the  
6 usage of MPI\_BOTTOM and derived datatype handles.
- 7 • Unfortunately, this method does **not** solve problems caused by asynchronous accesses  
8 between the start and end of a nonblocking or one-sided communication. Specifically,  
9 problems caused by temporary memory modifications are not solved.

### 12 The (Poorly Performing) Fortran VOLATILE Attribute

13 The VOLATILE attribute gives the buffer or variable the properties needed to avoid register  
14 optimization or code movement problems, but it may inhibit optimization of any code  
15 containing references or definitions of the buffer or variable. On many modern systems, the  
16 performance impact will be large because not only register, but also cache optimizations  
17 will not be applied. Therefore, use of the VOLATILE attribute to enforce correct execution  
18 of MPI programs is discouraged.

### 21 The Fortran TARGET Attribute

22 The TARGET attribute does not solve the code movement problem because it is not specified  
23 for the choice buffer dummy arguments of nonblocking routines. If the compiler detects that  
24 the application program specifies the TARGET attribute for an actual buffer argument used  
25 in the call to a nonblocking routine, the compiler may ignore this attribute if no pointer  
26 reference to this buffer exists.

27  
28 *Rationale.* The Fortran standardization body decided to extend the ASYNCHRONOUS  
29 attribute within the TS 29113 to protect buffers in nonblocking calls from all kinds of  
30 optimization, instead of extending the TARGET attribute. (*End of rationale.*)

### 32 18.1.18 Temporary Data Movement and Temporary Memory Modification

33 The compiler is allowed to temporarily modify data in memory. Normally, this problem  
34 may occur only when overlapping communication and computation, as in Example 18.5,  
35 Case (b) on page 747. Example 18.6 also shows a possibility that could be problematic.

36 In the compiler-generated, possible optimization in Example 18.7, `buf(100,100)` from  
37 Example 18.6 is equivalenced with the 1-dimensional array `buf_1dim(10000)`. The nonblock-  
38 ing receive may asynchronously receive the data in the boundary `buf(1,1:100)` while the fused  
39 loop is temporarily using this part of the buffer. When the `tmp` data is written back to `buf`,  
40 the previous data of `buf(1,1:100)` is restored and the received data is lost. The principle  
41 behind this optimization is that the receive buffer data `buf(1,1:100)` was temporarily moved  
42 to `tmp`.

43 Example 18.8 shows a second possible optimization. The whole array is temporarily  
44 moved to `local_buf`.

45 When storing `local_buf` back to the original location `buf`, then this implies overwriting  
46 the section of `buf` that serves as a receive buffer in the nonblocking MPI call, i.e., this  
47  
48

storing back of `local_buf` is therefore likely to interfere with asynchronously received data in `buf(1,1:100)`.

Note that this problem may also occur:

- With the local buffer at the origin process, between an RMA communication call and the ensuing synchronization call; see Chapter 11.
- With the window buffer at the target process between two ensuing RMA synchronization calls.
- With the local buffer in MPI parallel file I/O split collective operations between the `..._BEGIN` and `..._END` calls; see Section 13.4.5.

As already mentioned in subsection *The Fortran ASYNCHRONOUS attribute* on page 740 of Section 18.1.17, the `ASYNCHRONOUS` attribute can prevent compiler optimization with temporary data movement, but only if the receive buffer and the local references are separated into different variables, as shown in Example 18.9 and in Example 18.10.

Note also that the methods

- calling `MPI_F_SYNC_REG` (or such a user-defined routine),
- using module variables and `COMMON` blocks, and
- the `TARGET` attribute

cannot be used to prevent such temporary data movement. These methods influence compiler optimization when library routines are called. They cannot prevent the optimizations of the code fragments shown in Example 18.6 and 18.7.

Note also that compiler optimization with temporary data movement should **not** be prevented by declaring `buf` as `VOLATILE` because the `VOLATILE` implies that all accesses to any storage unit (word) of `buf` must be directly done in the main memory exactly in the sequence defined by the application program. The `VOLATILE` attribute prevents all register and cache optimizations. Therefore, `VOLATILE` may cause a huge performance degradation.

Instead of solving the problem, it is better to **prevent** the problem: when overlapping communication and computation, the nonblocking communication (or nonblocking or split collective I/O) and the computation should be executed **on different variables**, and the communication should be *protected* with the `ASYNCHRONOUS` attribute. In this case, the temporary memory modifications are done only on the variables used in the computation and cannot have any side effect on the data used in the nonblocking MPI operations.

*Rationale.* This is a strong restriction for application programs. To weaken this restriction, a new or modified asynchronous feature in the Fortran language would be necessary: an asynchronous attribute that can be used on parts of an array and together with asynchronous operations outside the scope of Fortran. If such a feature becomes available in a future edition of the Fortran standard, then this restriction also may be weakened in a later version of the MPI standard. (*End of rationale.*)

In Example 18.9 (which is a solution for the problem shown in Example 18.5 and in Example 18.10 (which is a solution for the problem shown in Example 18.8)), the array is split into inner and halo part and both disjoint parts are passed to a subroutine `separated_sections`. This routine overlaps the receiving of the halo data and the calculations on the inner part of the array. In a second step, the whole array is used to do the

1 calculation on the elements where inner+halo is needed. Note that the halo and the inner  
2 area are strided arrays. Those can be used in nonblocking communication only with a TS  
3 29113 based MPI library.  
4

#### 5 18.1.19 Permanent Data Movement

6 A Fortran compiler may implement permanent data movement during the execution of a  
7 Fortran program. This would require that pointers to such data are appropriately updated.  
8 An implementation with automatic garbage collection is one use case. Such permanent data  
9 movement is in conflict with MPI in several areas:  
10

- 11 • MPI datatype handles with absolute addresses in combination with MPI\_BOTTOM.
- 12
- 13 • All nonblocking MPI operations if the internally used pointers to the buffers are not  
14 updated by the Fortran runtime, or if within an MPI process, the data movement is  
15 executed in parallel with the MPI operation.  
16

17 This problem can be also solved by using the `ASYNCHRONOUS` attribute for such buffers.  
18 This MPI standard requires that the problems with permanent data movement do not  
19 occur by imposing suitable restrictions on the MPI library together with the compiler used;  
20 see Section [18.1.7](#).

#### 21 18.1.20 Comparison with C

22 In C, subroutines which modify variables that are not in the argument list will not cause  
23 register optimization problems. This is because taking pointers to storage objects by using  
24 the `&` operator and later referencing the objects by indirection on the pointer is an integral  
25 part of the language. A C compiler understands the implications, so that the problem should  
26 not occur, in general. However, some compilers do offer optional aggressive optimization  
27 levels which may not be safe. Problems due to temporary memory modifications can also  
28 occur in C. As above, the best advice is to avoid the problem: use different variables for  
29 buffers in nonblocking MPI operations and computation that is executed while a nonblocking  
30 operation is pending.  
31  
32  
33  
34  
35  
36  
37  
38  
39  
40  
41  
42  
43  
44  
45  
46  
47  
48



**Example 18.5** Protecting nonblocking communication with the ASYNCHRONOUS attribute.

```

USE mpi_f08
REAL, ASYNCHRONOUS :: b(0:101) ! elements 0 and 101 are halo cells
REAL :: bnew(0:101)           ! elements 1 and 100 are newly computed
TYPE(MPI_Request) :: req(4)
INTEGER :: left, right, i
CALL MPI_Cart_shift(...,left,right,...)
CALL MPI_Irecv(b( 0), ..., left, ..., req(1), ...)
CALL MPI_Irecv(b(101), ..., right, ..., req(2), ...)
CALL MPI_Isend(b( 1), ..., left, ..., req(3), ...)
CALL MPI_Isend(b(100), ..., right, ..., req(4), ...)

#ifdef WITHOUT_OVERLAPPING_COMMUNICATION_AND_COMPUTATION
! Case (a)
CALL MPI_Waitall(4, req, ...)
DO i=1,100 ! compute all new local data
  bnew(i) = function(b(i-1), b(i), b(i+1))
END DO
#endif

#ifdef WITH_OVERLAPPING_COMMUNICATION_AND_COMPUTATION
! Case (b)
DO i=2,99 ! compute only elements for which halo data is not needed
  bnew(i) = function(b(i-1), b(i), b(i+1))
END DO
CALL MPI_Waitall(4, req, ...)
i=1 ! compute leftmost element
  bnew(i) = function(b(i-1), b(i), b(i+1))
i=100 ! compute rightmost element
  bnew(i) = function(b(i-1), b(i), b(i+1))
#endif

```

**Example 18.6** Overlapping Communication and Computation.

```

USE mpi_f08
REAL :: buf(100,100)
CALL MPI_Irecv(buf(1,1:100),..., req,...)
DO j=1,100
  DO i=2,100
    buf(i,j)=...
  END DO
END DO
CALL MPI_Wait(req,...)

```

**Example 18.7** The compiler may substitute the nested loops through loop fusion.

```

1
2
3 REAL :: buf(100,100), buf_1dim(10000)
4 EQUIVALENCE (buf(1,1), buf_1dim(1))
5 CALL MPI_Irecv(buf(1,1:100),..., req,...)
6 tmp(1:100) = buf(1,1:100)
7 DO j=1,10000
8   buf_1dim(h)=...
9 END DO
10 buf(1,1:100) = tmp(1:100)
11 CALL MPI_Wait(req,...)
12
13
14
15
16
17
18
19
20
21
22
23
24
25
26
27

```

**Example 18.8** Another optimization is based on the usage of a separate memory storage area, e.g., in a GPU.

```

28
29
30 REAL :: buf(100,100), local_buf(100,100)
31 CALL MPI_Irecv(buf(1,1:100),..., req,...)
32 local_buf = buf
33 DO j=1,100
34   DO i=2,100
35     local_buf(i,j)=...
36   END DO
37 END DO
38 buf = local_buf ! may overwrite asynchronously received
39                 ! data in buf(1,1:100)
40 CALL MPI_Wait(req,...)
41
42
43
44
45
46
47
48

```

**Example 18.9** Using separated variables for overlapping communication and computation to allow the protection of nonblocking communication with the ASYNCHRONOUS attribute.

```

USE mpi_f08
REAL :: b(0:101)      ! elements 0 and 101 are halo cells
REAL :: bnew(0:101)  ! elements 1 and 100 are newly computed
INTEGER :: i
CALL separated_sections(b(0), b(1:100), b(101), bnew(0:101))
i=1 ! compute leftmost element
  bnew(i) = function(b(i-1), b(i), b(i+1))
i=100 ! compute rightmost element
  bnew(i) = function(b(i-1), b(i), b(i+1))
END

SUBROUTINE separated_sections(b_lefthalo, b_inner, b_righthalo, bnew)
USE mpi_f08
REAL, ASYNCHRONOUS :: b_lefthalo(0:0), b_inner(1:100), b_righthalo(101:101)
REAL :: bnew(0:101) ! elements 1 and 100 are newly computed
TYPE(MPI_Request) :: req(4)
INTEGER :: left, right, i
CALL MPI_Cart_shift(...,left, right,...)
CALL MPI_Irecv(b_lefthalo ( 0), ..., left, ..., req(1), ...)
CALL MPI_Irecv(b_righthalo(101), ..., right, ..., req(2), ...)
! b_lefthalo and b_righthalo is written asynchronously.
! There is no other concurrent access to b_lefthalo and b_righthalo.
CALL MPI_Isend(b_inner( 1), ..., left, ..., req(3), ...)
CALL MPI_Isend(b_inner(100), ..., right, ..., req(4), ...)

DO i=2,99 ! compute only elements for which halo data is not needed
  bnew(i) = function(b_inner(i-1), b_inner(i), b_inner(i+1))
  ! b_inner is read and sent at the same time.
  ! This is allowed based on the rules for ASYNCHRONOUS.
END DO
CALL MPI_Waitall(4, req,...)
END SUBROUTINE

```

**Example 18.10** Protecting GPU optimizations with the ASYNCHRONOUS attribute.

```
1
2
3 USE mpi_f08
4 REAL :: buf(100,100)
5 CALL separated_sections(buf(1:1,1:100), buf(2:100,1:100))
6 END
7
8 SUBROUTINE separated_sections(buf_halo, buf_inner)
9 REAL, ASYNCHRONOUS :: buf_halo(1:1,1:100)
10 REAL :: buf_inner(2:100,1:100)
11 REAL :: local_buf(2:100,100)
12
13 CALL MPI_Irecv(buf_halo(1,1:100),..., req,...)
14 local_buf = buf_inner
15 DO j=1,100
16   DO i=2,100
17     local_buf(i,j)=...
18   END DO
19 END DO
20 buf_inner = local_buf ! buf_halo is not touched!!!
21
22 CALL MPI_Wait(req,...)
23
24
25
26
27
28
29
30
31
32
33
34
35
36
37
38
39
40
41
42
43
44
45
46
47
48
```

## 18.2 Language Interoperability

### 18.2.1 Introduction

It is not uncommon for library developers to use one language to develop an application library that may be called by an application program written in a different language. MPI currently supports ISO (previously ANSI) C and Fortran bindings. It should be possible for applications in any of the supported languages to call MPI-related functions in another language.

Moreover, MPI allows the development of client-server code, with MPI communication used between a parallel client and a parallel server. It should be possible to code the server in one language and the clients in another language. To do so, communications should be possible between applications written in different languages.

There are several issues that need to be addressed in order to achieve interoperability.

**Initialization** We need to specify how the MPI environment is initialized for all languages.

**Interlanguage passing of MPI opaque objects** We need to specify how MPI object handles are passed between languages. We also need to specify what happens when an MPI object is accessed in one language, to retrieve information (e.g., attributes) set in another language.

**Interlanguage communication** We need to specify how messages sent in one language can be received in another language.

It is highly desirable that the solution for interlanguage interoperability be extensible to new languages, should MPI bindings be defined for such languages.

### 18.2.2 Assumptions

We assume that conventions exist for programs written in one language to call routines written in another language. These conventions specify how to link routines in different languages into one program, how to call functions in a different language, how to pass arguments between languages, and the correspondence between basic data types in different languages. In general, these conventions will be implementation dependent. Furthermore, not every basic datatype may have a matching type in other languages. For example, C character strings may not be compatible with Fortran CHARACTER variables. However, we assume that a Fortran INTEGER, as well as a (sequence associated) Fortran array of INTEGERS, can be passed to a C program. We also assume that Fortran and C have address-sized integers. This does not mean that the default-size integers are the same size as default-sized pointers, but only that there is some way to hold (and pass) a C address in a Fortran integer. It is also assumed that INTEGER(KIND=MPI\_OFFSET\_KIND) can be passed from Fortran to C as MPI\_Offset.

### 18.2.3 Initialization

A call to MPI\_INIT or MPI\_INIT\_THREAD, from any language, initializes MPI for execution in all languages.

*Advice to users.* Certain implementations use the (inout) argc, argv arguments of the C version of MPI\_INIT in order to propagate values for argc and argv to all

1       executing processes. Use of the Fortran version of `MPI_INIT` to initialize MPI may  
2       result in a loss of this ability. (*End of advice to users.*)

3  
4       The function `MPI_INITIALIZED` returns the same answer in all languages.

5       The function `MPI_FINALIZE` finalizes the MPI environments for all languages.

6       The function `MPI_FINALIZED` returns the same answer in all languages.

7       The function `MPI_ABORT` kills processes, irrespective of the language used by the  
8       caller or by the processes killed.

9       The MPI environment is initialized in the same manner for all languages by  
10      `MPI_INIT`. E.g., `MPI_COMM_WORLD` carries the same information regardless of language:  
11      same processes, same environmental attributes, same error handlers.

12      Information can be added to info objects in one language and retrieved in another.

13  
14      *Advice to users.* The use of several languages in one MPI program may require the  
15      use of special options at compile and/or link time. (*End of advice to users.*)

16  
17      *Advice to implementors.* Implementations may selectively link language specific MPI  
18      libraries only to codes that need them, so as not to increase the size of binaries for codes  
19      that use only one language. The MPI initialization code need perform initialization for  
20      a language only if that language library is loaded. (*End of advice to implementors.*)

## 21 22 18.2.4 Transfer of Handles

23      Handles are passed between Fortran and C by using an explicit C wrapper to convert Fortran  
24      handles to C handles. There is no direct access to C handles in Fortran.

25      The type definition `MPI_Fint` is provided in C for an integer of the size that matches a  
26      Fortran `INTEGER`; usually, `MPI_Fint` will be equivalent to `int`. With the Fortran `mpi` module  
27      or the `mpif.h` include file, a Fortran handle is a Fortran `INTEGER` value that can be used in  
28      the following conversion functions. With the Fortran `mpi_f08` module, a Fortran handle is a  
29      `BIND(C)` derived type that contains an `INTEGER` component named `MPI_VAL`. This `INTEGER`  
30      value can be used in the following conversion functions.

31      The following functions are provided in C to convert from a Fortran communicator  
32      handle (which is an integer) to a C communicator handle, and vice versa. See also Sec-  
33      tion [2.6.4](#).

### 34 **C binding**

35 `MPI_Comm MPI_Comm_f2c(MPI_Fint comm)`

36  
37      If `comm` is a valid Fortran handle to a communicator, then `MPI_Comm_f2c` returns a  
38      valid C handle to that same communicator; if `comm = MPI_COMM_NULL` (Fortran value),  
39      then `MPI_Comm_f2c` returns a null C handle; if `comm` is an invalid Fortran handle, then  
40      `MPI_Comm_f2c` returns an invalid C handle.

41 `MPI_Fint MPI_Comm_c2f(MPI_Comm comm)`

42      The function `MPI_Comm_c2f` translates a C communicator handle into a Fortran handle  
43      to the same communicator; it maps a null handle into a null handle and an invalid handle  
44      into an invalid handle.

45      Similar functions are provided for the other types of opaque objects.

46 `MPI_Datatype MPI_Type_f2c(MPI_Fint datatype)`

47  
48 `MPI_Fint MPI_Type_c2f(MPI_Datatype datatype)`

```

MPI_Group MPI_Group_f2c(MPI_Fint group)           1
MPI_Fint MPI_Group_c2f(MPI_Group group)          2
MPI_Request MPI_Request_f2c(MPI_Fint request)     3
MPI_Fint MPI_Request_c2f(MPI_Request request)     4
MPI_File MPI_File_f2c(MPI_Fint file)             5
MPI_Fint MPI_File_c2f(MPI_File file)             6
MPI_Win MPI_Win_f2c(MPI_Fint win)               7
MPI_Fint MPI_Win_c2f(MPI_Win win)               8
MPI_Op MPI_Op_f2c(MPI_Fint op)                  9
MPI_Fint MPI_Op_c2f(MPI_Op op)                 10
MPI_Info MPI_Info_f2c(MPI_Fint info)           11
MPI_Fint MPI_Info_c2f(MPI_Info info)           12
MPI_Errhandler MPI_Errhandler_f2c(MPI_Fint errhandler) 13
MPI_Fint MPI_Errhandler_c2f(MPI_Errhandler errhandler) 14
MPI_Message MPI_Message_f2c(MPI_Fint message) 15
MPI_Fint MPI_Message_c2f(MPI_Message message) 16
MPI_Session MPI_Session_f2c(MPI_Fint session) 17
MPI_Fint MPI_Session_c2f(MPI_Session session) 18

```

**Example 18.11** The example below illustrates how the Fortran MPI function `MPI_TYPE_COMMIT` can be implemented by wrapping the C MPI function `MPI_Type_commit` with a C wrapper to do handle conversions. In this example a Fortran-C interface is assumed where a Fortran function is all upper case when referred to from C and arguments are passed by addresses.

```

! FORTRAN PROCEDURE                               19
SUBROUTINE MPI_TYPE_COMMIT(DATATYPE, IERR)        20
INTEGER :: DATATYPE, IERR                        21
CALL MPI_X_TYPE_COMMIT(DATATYPE, IERR)           22
RETURN                                           23
END                                               24

/* C wrapper */                                  25

void MPI_X_TYPE_COMMIT(MPI_Fint *f_handle, MPI_Fint *ierr) 26
{
    MPI_Datatype datatype;                        27

    datatype = MPI_Type_f2c(*f_handle);          28
}

```

```

1   *ierr = (MPI_Fint)MPI_Type_commit(&datatype);
2   *f_handle = MPI_Type_c2f(datatype);
3   return;
4 }

```

The same approach can be used for all other MPI functions. The call to `MPI_XXX_f2c` (resp. `MPI_XXX_c2f`) can be omitted when the handle is an OUT (resp. IN) argument, rather than INOUT.

*Rationale.* The design here provides a convenient solution for the prevalent case, where a C wrapper is used to allow Fortran code to call a C library, or C code to call a Fortran library. The use of C wrappers is much more likely than the use of Fortran wrappers, because it is much more likely that a variable of type `INTEGER` can be passed to C, than a C handle can be passed to Fortran.

Returning the converted value as a function value rather than through the argument list allows the generation of efficient inlined code when these functions are simple (e.g., the identity). The conversion function in the wrapper does not catch an invalid handle argument. Instead, an invalid handle is passed below to the library function, which, presumably, checks its input arguments. (*End of rationale.*)

## 18.2.5 Status

The following two procedures are provided in C to convert from a Fortran (with the `mpi` module or `mpif.h`) status (which is an array of integers) to a C status (which is a structure), and vice versa. The conversion occurs on all the information in status, including that which is hidden. That is, no status information is lost in the conversion.

```

27 int MPI_Status_f2c(const MPI_Fint *f_status, MPI_Status *c_status)

```

If `f_status` is a valid Fortran status, but not the Fortran value of `MPI_STATUS_IGNORE` or `MPI_STATUSES_IGNORE`, then `MPI_Status_f2c` returns in `c_status` a valid C status with the same content. If `f_status` is the Fortran value of `MPI_STATUS_IGNORE` or `MPI_STATUSES_IGNORE`, or if `f_status` is not a valid Fortran status, then the call is erroneous.

The C status has the same source, tag and error code values as the Fortran status, and returns the same answers when queried for count, elements, and cancellation. The conversion function may be called with a Fortran status argument that has an undefined error field, in which case the value of the error field in the C status argument is undefined.

Two global variables of type `MPI_Fint*`, `MPI_F_STATUS_IGNORE` and `MPI_F_STATUSES_IGNORE` are declared in `mpi.h`. They can be used to test, in C, whether `f_status` is the Fortran value of `MPI_STATUS_IGNORE` or `MPI_STATUSES_IGNORE` defined in the `mpi` module or `mpif.h`. These are global variables, not C constant expressions and cannot be used in places where C requires constant expressions. Their value is defined only between the calls to `MPI_INIT` and `MPI_FINALIZE` and should not be changed by user code.

To do the conversion in the other direction, we have the following:

```

44 int MPI_Status_c2f(const MPI_Status *c_status, MPI_Fint *f_status)

```

This call converts a C status into a Fortran status, and has a behavior similar to `MPI_Status_f2c`. That is, the value of `c_status` must not be either `MPI_STATUS_IGNORE` or `MPI_STATUSES_IGNORE`.





`f_status` is the Fortran value of `MPI_STATUS_IGNORE` or `MPI_STATUSES_IGNORE` defined in the `mpi_f08` module. These are global variables, not C constant expressions and cannot be used in places where C requires constant expressions. Their value is defined only between the calls to `MPI_INIT` and `MPI_FINALIZE` and should not be changed by user code.

Conversion between the two Fortran versions of a status can be done with:

```
MPI_STATUS_F2F08(f_status, f08_status)
```

```
IN      f_status          status object declared as array
OUT     f08_status        status object declared as named type
```

### C binding

```
int MPI_Status_f2f08(MPI_Fint *f_status, MPI_F08_status *f08_status)
```

### Fortran 2008 binding

```
MPI_Status_f2f08(f_status, f08_status, ierror)
  INTEGER, INTENT(IN) :: f_status(MPI_STATUS_SIZE)
  TYPE(MPI_Status), INTENT(OUT) :: f08_status
  INTEGER, OPTIONAL, INTENT(OUT) :: ierror
```

### Fortran binding

```
MPI_STATUS_F2F08(F_STATUS, F08_STATUS, IERROR)
  INTEGER :: F_STATUS(MPI_STATUS_SIZE), IERROR
  TYPE(MPI_Status) :: F08_STATUS
```

This routine converts a Fortran `INTEGER, DIMENSION(MPI_STATUS_SIZE)` status array into a Fortran `mpi_f08 TYPE(MPI_Status)`.

```
MPI_STATUS_F082F(f08_status, f_status)
```

```
IN      f08_status        status object declared as named type
OUT     f_status          status object declared as array
```

### C binding

```
int MPI_Status_f082f(MPI_F08_status *f08_status, MPI_Fint *f_status)
```

### Fortran 2008 binding

```
MPI_Status_f082f(f08_status, f_status, ierror)
  TYPE(MPI_Status), INTENT(IN) :: f08_status
  INTEGER, INTENT(OUT) :: f_status(MPI_STATUS_SIZE)
  INTEGER, OPTIONAL, INTENT(OUT) :: ierror
```

### Fortran binding

```
MPI_STATUS_F082F(F08_STATUS, F_STATUS, IERROR)
  TYPE(MPI_Status) :: F08_STATUS
  INTEGER :: F_STATUS(MPI_STATUS_SIZE), IERROR
```

This routine converts a Fortran `mpi_f08 TYPE(MPI_Status)` into a Fortran `INTEGER, DIMENSION(MPI_STATUS_SIZE)` status array.

## 18.2.6 MPI Opaque Objects

Unless said otherwise, opaque objects are “the same” in all languages: they carry the same information, and have the same meaning in both languages. The mechanism described in the previous section can be used to pass references to MPI objects from language to language. An object created in one language can be accessed, modified or freed in another language.

We examine below in more detail issues that arise for each type of MPI object.

### Datatypes

Datatypes encode the same information in all languages. E.g., a datatype accessor like `MPI_TYPE_GET_EXTENT` will return the same information in all languages. If a datatype defined in one language is used for a communication call in another language, then the message sent will be identical to the message that would be sent from the first language: the same communication buffer is accessed, and the same representation conversion is performed, if needed. All predefined datatypes can be used in datatype constructors in any language. If a datatype is committed, it can be used for communication in any language.

The function `MPI_GET_ADDRESS` returns the same value in all languages. Note that we do not require that the constant `MPI_BOTTOM` have the same value in all languages (see Section 18.2.9).

### Example 18.12

```

! FORTRAN CODE
REAL :: R(5)
INTEGER :: TYPE, IERR, AOBLEN(1), AOTYPE(1)
INTEGER (KIND=MPI_ADDRESS_KIND) :: AODISP(1)

! create an absolute datatype for array R
AOBLEN(1) = 5
CALL MPI_GET_ADDRESS(R, AODISP(1), IERR)
AOTYPE(1) = MPI_REAL
CALL MPI_TYPE_CREATE_STRUCT(1, AOBLEN, AODISP, AOTYPE, TYPE, IERR)
CALL C_ROUTINE(TYPE)

/* C code */

void C_ROUTINE(MPI_Fint *ftype)
{
    int count = 5;
    int lens[2] = {1,1};
    MPI_Aint displs[2];
    MPI_Datatype types[2], newtype;

    /* create an absolute datatype for buffer that consists
    /*   of count, followed by R(5)

    MPI_Get_address(&count, &displs[0]);

```

```

1  displs[1] = 0;
2  types[0] = MPI_INT;
3  types[1] = MPI_Type_f2c(*ftype);
4  MPI_Type_create_struct(2, lens, displs, types, &newtype);
5  MPI_Type_commit(&newtype);
6
7  MPI_Send(MPI_BOTTOM, 1, newtype, 1, 0, MPI_COMM_WORLD);
8  /* the message sent contains an int count of 5, followed */
9  /* by the 5 REAL entries of the Fortran array R.          */
10 }
11

```

12 *Advice to implementors.* The following implementation can be used: MPI addresses,
13 as returned by `MPI_GET_ADDRESS`, will have the same value in all languages. One
14 obvious choice is that MPI addresses be identical to regular addresses. The address
15 is stored in the datatype, when datatypes with absolute addresses are constructed.
16 When a send or receive operation is performed, then addresses stored in a datatype
17 are interpreted as displacements that are all augmented by a base address. This base
18 address is (the address of) `buf`, or zero, if `buf = MPI_BOTTOM`. Thus, if `MPI_BOTTOM`
19 is zero then a send or receive call with `buf = MPI_BOTTOM` is implemented exactly as
20 a call with a regular buffer argument: in both cases the base address is `buf`. On the
21 other hand, if `MPI_BOTTOM` is not zero, then the implementation has to be slightly
22 different. A test is performed to check whether `buf = MPI_BOTTOM`. If true, then the
23 base address is zero, otherwise it is `buf`. In particular, if `MPI_BOTTOM` does not have
24 the same value in Fortran and C, then an additional test for `buf = MPI_BOTTOM` is
25 needed in at least one of the languages.

26 It may be desirable to use a value other than zero for `MPI_BOTTOM` even in C, so as
27 to distinguish it from a NULL pointer. If `MPI_BOTTOM = c` then one can still avoid
28 the test `buf = MPI_BOTTOM`, by using the displacement from `MPI_BOTTOM`, i.e., the
29 regular address - `c`, as the MPI address returned by `MPI_GET_ADDRESS` and stored
30 in absolute datatypes. (*End of advice to implementors.*)

## 32 Callback Functions

33 MPI calls may associate callback functions with MPI objects: error handlers are associated
34 with communicators, files, windows, and sessions; attribute copy and delete functions are
35 associated with attribute keys; reduce operations are associated with operation objects, etc.
36 In a multilanguage environment, a function passed in an MPI call in one language may be
37 invoked by an MPI call in another language. MPI implementations must make sure that
38 such invocation will use the calling convention of the language the function is bound to.
39

40 *Advice to implementors.* Callback functions need to have a language tag. This
41 tag is set when the callback function is passed in by the library function (which is
42 presumably different for each language and language support method), and is used
43 to generate the right calling sequence when the callback function is invoked. (*End of*
44 *advice to implementors.*)

45 *Advice to users.* If a subroutine written in one language or Fortran support method
46 wants to pass a callback routine including the predefined Fortran functions (e.g.,
47
48

MPI\_COMM\_NULL\_COPY\_FN) to another application routine written in another language or Fortran support method, then it must be guaranteed that both routines use the callback interface definition that is defined for the argument when passing the callback to an MPI routine (e.g., MPI\_COMM\_CREATE\_KEYVAL); see also the advice to users on page 305. (*End of advice to users.*)

## Error Handlers

*Advice to implementors.* Error handlers, have, in C, a variable length argument list. It might be useful to provide to the handler information on the language environment where the error occurred. (*End of advice to implementors.*)

## Reduce Operations

All predefined named and unnamed datatypes as listed in Section 5.9.2 can be used in the listed predefined operations independent of the programming language from which the MPI routine is called.

*Advice to users.* Reduce operations receive as one of their arguments the datatype of the operands. Thus, one can define “polymorphic” reduce operations that work for C and Fortran datatypes. (*End of advice to users.*)

### 18.2.7 Attributes

Attribute keys can be allocated in one language and freed in another. Similarly, attribute values can be set in one language and accessed in another. To achieve this, attribute keys will be allocated in an integer range that is valid all languages. The same holds true for system-defined attribute values (such as MPI\_TAG\_UB, MPI\_WTIME\_IS\_GLOBAL, etc.).

Attribute keys declared in one language are associated with copy and delete functions in that language (the functions provided by the MPI\_XXX\_CREATE\_KEYVAL call). When a communicator is duplicated, for each attribute, the corresponding copy function is called, using the right calling convention for the language of that function; and similarly, for the delete callback function.

*Advice to implementors.* This requires that attributes be tagged either as “C” or “Fortran” and that the language tag be checked in order to use the right calling convention for the callback function. (*End of advice to implementors.*)

The attribute manipulation functions described in Section 6.7 defines attributes arguments to be of type void\* in C, and of type INTEGER, in Fortran. On some systems, INTEGERS will have 32 bits, while C pointers will have 64 bits. This is a problem if communicator attributes are used to move information from a Fortran caller to a C callee, or vice-versa.

MPI behaves as if it stores, internally, address sized attributes. If Fortran INTEGERS are smaller, then the (deprecated) Fortran function MPI\_ATTR\_GET will return the least significant part of the attribute word; the (deprecated) Fortran function MPI\_ATTR\_PUT will set the least significant part of the attribute word, which will be sign extended to the entire word. (These two functions may be invoked explicitly by user code, or implicitly, by attribute copying callback functions.)

As for addresses, new functions are provided that manipulate Fortran address sized attributes, and have the same functionality as the old functions in C. These functions are described in Section 6.7. Users are encouraged to use these new functions.

MPI supports two types of attributes: address-valued (pointer) attributes, and integer-valued attributes. C attribute functions put and get address-valued attributes. Fortran attribute functions put and get integer-valued attributes. When an integer-valued attribute is accessed from C, then `MPI_XXX_get_attr` will return the address of (a pointer to) the integer-valued attribute, which is a pointer to `MPI_Aint` if the attribute was stored with Fortran `MPI_XXX_SET_ATTR`, and a pointer to `int` if it was stored with the deprecated Fortran `MPI_ATTR_PUT`. When an address-valued attribute is accessed from Fortran, then `MPI_XXX_GET_ATTR` will convert the address into an integer and return the result of this conversion. This conversion is lossless if new style attribute functions are used, and an integer of kind `MPI_ADDRESS_KIND` is returned. The conversion may cause truncation if deprecated attribute functions are used. In C, the deprecated routines `MPI_Attr_put` and `MPI_Attr_get` behave identical to `MPI_Comm_set_attr` and `MPI_Comm_get_attr`.

### Example 18.13

A. Setting an attribute value in C

```
int set_val = 3;
struct foo set_struct;

/* Set a value that is a pointer to an int */
MPI_Comm_set_attr(MPI_COMM_WORLD, keyval1, &set_val);
/* Set a value that is a pointer to a struct */
MPI_Comm_set_attr(MPI_COMM_WORLD, keyval2, &set_struct);
/* Set an integer value */
MPI_Comm_set_attr(MPI_COMM_WORLD, keyval3, (void *) 17);
```

B. Reading the attribute value in C

```
int flag, *get_val;
struct foo *get_struct;

/* Upon successful return, get_val == &set_val
   (and therefore *get_val == 3) */
MPI_Comm_get_attr(MPI_COMM_WORLD, keyval1, &get_val, &flag);
/* Upon successful return, get_struct == &set_struct */
MPI_Comm_get_attr(MPI_COMM_WORLD, keyval2, &get_struct, &flag);
/* Upon successful return, get_val == (void*) 17 */
/*      i.e., (MPI_Aint) get_val == 17 */
MPI_Comm_get_attr(MPI_COMM_WORLD, keyval3, &get_val, &flag);
```

C. Reading the attribute value with (deprecated) Fortran MPI-1 calls

```

LOGICAL FLAG
INTEGER IERR, GET_VAL, GET_STRUCT

! Upon successful return, GET_VAL == &set_val, possibly truncated
CALL MPI_ATTR_GET(MPI_COMM_WORLD, KEYVAL1, GET_VAL, FLAG, IERR)
! Upon successful return, GET_STRUCT == &set_struct, possibly truncated
CALL MPI_ATTR_GET(MPI_COMM_WORLD, KEYVAL2, GET_STRUCT, FLAG, IERR)
! Upon successful return, GET_VAL == 17
CALL MPI_ATTR_GET(MPI_COMM_WORLD, KEYVAL3, GET_VAL, FLAG, IERR)

```

D. Reading the attribute value with Fortran MPI-2 calls

```

LOGICAL FLAG
INTEGER IERR
INTEGER (KIND=MPI_ADDRESS_KIND) GET_VAL, GET_STRUCT

! Upon successful return, GET_VAL == &set_val
CALL MPI_COMM_GET_ATTR(MPI_COMM_WORLD, KEYVAL1, GET_VAL, FLAG, IERR)
! Upon successful return, GET_STRUCT == &set_struct
CALL MPI_COMM_GET_ATTR(MPI_COMM_WORLD, KEYVAL2, GET_STRUCT, FLAG, IERR)
! Upon successful return, GET_VAL == 17
CALL MPI_COMM_GET_ATTR(MPI_COMM_WORLD, KEYVAL3, GET_VAL, FLAG, IERR)

```

**Example 18.14** A. Setting an attribute value with the (deprecated) Fortran MPI-1 call

```

INTEGER IERR, VAL
VAL = 7
CALL MPI_ATTR_PUT(MPI_COMM_WORLD, KEYVAL, VAL, IERR)

```

B. Reading the attribute value in C

```

int flag;
int *value;

/* Upon successful return, value points to internal MPI storage and
   *value == (int) 7 */
MPI_Comm_get_attr(MPI_COMM_WORLD, keyval, &value, &flag);

```

C. Reading the attribute value with (deprecated) Fortran MPI-1 calls

```

LOGICAL FLAG
INTEGER IERR, VALUE

! Upon successful return, VALUE == 7
CALL MPI_ATTR_GET(MPI_COMM_WORLD, KEYVAL, VALUE, FLAG, IERR)

```

D. Reading the attribute value with Fortran MPI-2 calls

```

1 LOGICAL FLAG
2 INTEGER IERR
3 INTEGER (KIND=MPI_ADDRESS_KIND) VALUE
4
5 ! Upon successful return, VALUE == 7 (sign extended)
6 CALL MPI_COMM_GET_ATTR(MPI_COMM_WORLD, KEYVAL, VALUE, FLAG, IERR)
7

```

**Example 18.15** A. Setting an attribute value via a Fortran MPI-2 call

```

9
10 INTEGER IERR
11 INTEGER(KIND=MPI_ADDRESS_KIND) VALUE1
12 INTEGER(KIND=MPI_ADDRESS_KIND) VALUE2
13 VALUE1 = 42
14 VALUE2 = INT(2, KIND=MPI_ADDRESS_KIND) ** 40
15
16 CALL MPI_COMM_SET_ATTR(MPI_COMM_WORLD, KEYVAL1, VALUE1, IERR)
17 CALL MPI_COMM_SET_ATTR(MPI_COMM_WORLD, KEYVAL2, VALUE2, IERR)

```

B. Reading the attribute value in C

```

18
19 int flag;
20 MPI_Aint *value1, *value2;
21
22
23 /* Upon successful return, value1 points to internal MPI storage and
24  *value1 == 42 */
25 MPI_Comm_get_attr(MPI_COMM_WORLD, keyval1, &value1, &flag);
26 /* Upon successful return, value2 points to internal MPI storage and
27  *value2 == 2^40 */
28 MPI_Comm_get_attr(MPI_COMM_WORLD, keyval2, &value2, &flag);

```

C. Reading the attribute value with (deprecated) Fortran MPI-1 calls

```

29
30
31 LOGICAL FLAG
32 INTEGER IERR, VALUE1, VALUE2
33
34 ! Upon successful return, VALUE1 == 42
35 CALL MPI_ATTR_GET(MPI_COMM_WORLD, KEYVAL1, VALUE1, FLAG, IERR)
36 ! Upon successful return, VALUE2 == 2^40, or 0 if truncation
37 ! needed (i.e., the least significant part of the attribute word)
38 CALL MPI_ATTR_GET(MPI_COMM_WORLD, KEYVAL2, VALUE2, FLAG, IERR)
39

```

D. Reading the attribute value with Fortran MPI-2 calls

```

40
41 LOGICAL FLAG
42 INTEGER IERR
43 INTEGER (KIND=MPI_ADDRESS_KIND) VALUE1, VALUE2
44
45 ! Upon successful return, VALUE1 == 42
46 CALL MPI_COMM_GET_ATTR(MPI_COMM_WORLD, KEYVAL1, VALUE1, FLAG, IERR)
47 ! Upon successful return, VALUE2 == 2^40
48 CALL MPI_COMM_GET_ATTR(MPI_COMM_WORLD, KEYVAL2, VALUE2, FLAG, IERR)

```



The predefined MPI attributes can be integer valued or address-valued. Predefined integer valued attributes, such as `MPI_TAG_UB`, behave as if they were put by a call to the deprecated Fortran routine `MPI_ATTR_PUT`, i.e., in Fortran, `MPI_COMM_GET_ATTR(MPI_COMM_WORLD, MPI_TAG_UB, val, flag, ierr)` will return in `val` the upper bound for tag value; in C, `MPI_Comm_get_attr(MPI_COMM_WORLD, MPI_TAG_UB, &p, &flag)` will return in `p` a pointer to an int containing the upper bound for tag value.

Address-valued predefined attributes, such as `MPI_WIN_BASE` behave as if they were put by a C call, i.e., in Fortran, `MPI_WIN_GET_ATTR(win, MPI_WIN_BASE, val, flag, ierr)` will return in `val` the base address of the window, converted to an integer. In C, `MPI_Win_get_attr(win, MPI_WIN_BASE, &p, &flag)` will return in `p` a pointer to the window base, cast to `(void *)`.

*Rationale.* The design is consistent with the behavior specified for predefined attributes, and ensures that no information is lost when attributes are passed from language to language. Because the language interoperability for predefined attributes was defined based on `MPI_ATTR_PUT`, this definition is kept for compatibility reasons although the routine itself is now deprecated. (*End of rationale.*)

*Advice to implementors.* Implementations should tag attributes either as (1) address attributes, (2) as `INTEGER(KIND=MPI_ADDRESS_KIND)` attributes or (3) as `INTEGER` attributes, according to whether they were set in (1) C (with `MPI_Attr_put` or `MPI_XXX_set_attr`), (2) in Fortran with `MPI_XXX_SET_ATTR` or (3) with the deprecated Fortran routine `MPI_ATTR_PUT`. Thus, the right choice can be made when the attribute is retrieved. (*End of advice to implementors.*)

### 18.2.8 Extra-State

Extra-state should not be modified by the copy or delete callback functions. (This is obvious from the C binding, but not obvious from the Fortran binding). However, these functions may update state that is indirectly accessed via extra-state. E.g., in C, extra-state can be a pointer to a data structure that is modified by the copy or callback functions; in Fortran, extra-state can be an index into an entry in a `COMMON` array that is modified by the copy or callback functions. In a multithreaded environment, users should be aware that distinct threads may invoke the same callback function concurrently: if this function modifies state associated with extra-state, then mutual exclusion code must be used to protect updates and accesses to the shared state.

### 18.2.9 Constants

MPI constants have the same value in all languages, unless specified otherwise. This does not apply to constant handles (`MPI_INT`, `MPI_COMM_WORLD`, `MPI_ERRORS_RETURN`, `MPI_SUM`, etc.) These handles need to be converted, as explained in Section 18.2.4. Constants that specify maximum lengths of strings (see Section A.1.1 for a listing) have a value one less in Fortran than C since in C the length includes the null terminating character. Thus, these constants represent the amount of space which must be allocated to hold the largest possible such string, rather than the maximum number of printable characters the string could contain.

1 *Advice to users.* This definition means that it is safe in C to allocate a buffer to  
 2 receive a string using a declaration like

```
3
4     char name [MPI_MAX_OBJECT_NAME];
```

5  
 6 (*End of advice to users.*)

7  
 8 Also constant “addresses,” i.e., special values for reference arguments that are not han-  
 9 dles, such as MPI\_BOTTOM or MPI\_STATUS\_IGNORE may have different values in different  
 10 languages.

11  
 12 *Rationale.* The current MPI standard specifies that MPI\_BOTTOM can be used in  
 13 initialization expressions in C, but not in Fortran. Since Fortran does not normally  
 14 support call by value, then MPI\_BOTTOM in Fortran must be the name of a predefined  
 15 static variable, e.g., a variable in an MPI declared COMMON block. On the other hand,  
 16 in C, it is natural to take MPI\_BOTTOM = 0 (Caveat: Defining MPI\_BOTTOM =  
 17 0 implies that NULL pointer cannot be distinguished from MPI\_BOTTOM; it may be  
 18 that MPI\_BOTTOM = 1 is better. See the advice to implementors in the *Datatypes*  
 19 subsection in Section 18.2.6) Requiring that the Fortran and C values be the same  
 20 will complicate the initialization process. (*End of rationale.*)

## 21 22 18.2.10 Interlanguage Communication

23 The type matching rules for communication in MPI are not changed: the datatype specifi-  
 24 cation for each item sent should match, in type signature, the datatype specification used to  
 25 receive this item (unless one of the types is MPI\_PACKED). Also, the type of a message item  
 26 should match the type declaration for the corresponding communication buffer location,  
 27 unless the type is MPI\_BYTE or MPI\_PACKED. Interlanguage communication is allowed if it  
 28 complies with these rules.

29  
 30 **Example 18.16** In the example below, a Fortran array is sent from Fortran and received  
 31 in C.

```
32
33 ! FORTRAN CODE
34 SUBROUTINE MYEXAMPLE()
35 USE mpi_f08
36 REAL :: R(5)
37 INTEGER :: IERR, MYRANK, AOBLEN(1)
38 TYPE(MPI_Datatype) :: TYPE, AOTYPE(1)
39 INTEGER (KIND=MPI_ADDRESS_KIND) :: AODISP(1)
40
41 ! create an absolute datatype for array R
42 AOBLEN(1) = 5
43 CALL MPI_GET_ADDRESS(R, AODISP(1), IERR)
44 AOTYPE(1) = MPI_REAL
45 CALL MPI_TYPE_CREATE_STRUCT(1, AOBLEN, AODISP, AOTYPE, TYPE, IERR)
46 CALL MPI_TYPE_COMMIT(TYPE, IERR)
47
48 CALL MPI_COMM_RANK(MPI_COMM_WORLD, MYRANK, IERR)
```

```
IF (MYRANK.EQ.0) THEN
  CALL MPI_SEND(MPI_BOTTOM, 1, TYPE, 1, 0, MPI_COMM_WORLD, IERR)
ELSE
  CALL C_ROUTINE(TYPE%MPI_VAL)
END IF
END SUBROUTINE
```

```
/* C code */
```

```
void C_ROUTINE(MPI_Fint *fhandle)
{
  MPI_Datatype type;
  MPI_Status status;

  type = MPI_Type_f2c(*fhandle);

  MPI_Recv(MPI_BOTTOM, 1, type, 0, 0, MPI_COMM_WORLD, &status);
}
```

MPI implementors may weaken these type matching rules, and allow messages to be sent with Fortran types and received with C types, and vice versa, when those types match. I.e., if the Fortran type `INTEGER` is identical to the C type `int`, then an MPI implementation may allow data to be sent with datatype `MPI_INTEGER` and be received with datatype `MPI_INT`. However, such code is not portable.

1  
2  
3  
4  
5  
6  
7  
8  
9  
10  
11  
12  
13  
14  
15  
16  
17  
18  
19  
20  
21  
22  
23  
24  
25  
26  
27  
28  
29  
30  
31  
32  
33  
34  
35  
36  
37  
38  
39  
40  
41  
42  
43  
44  
45  
46  
47  
48

DRAFT

1  
2  
3  
4  
5  
6  
7  
8  
9  
10  
11  
12  
13  
14  
15  
16  
17  
18  
19  
20  
21  
22  
23  
24  
25  
26  
27  
28  
29  
30  
31  
32  
33  
34  
35  
36  
37  
38  
39  
40  
41  
42  
43  
44  
45  
46  
47  
48

## Annex A

# Language Bindings Summary

In this section we summarize the specific bindings for C and Fortran. First we present the constants, type definitions, info values and keys. Then we present the routine prototypes separately for each binding. Listings are alphabetical within chapter.

### A.1 Defined Values and Handles

#### A.1.1 Defined Constants

The C and Fortran names are listed below. Constants with the type `const int` may also be implemented as literal integer constants substituted by the preprocessor.

#### **Error classes**

---

C type: `const int` (or unnamed `enum`)

Fortran type: `INTEGER`

---

`MPI_SUCCESS`

`MPI_ERR_BUFFER`

`MPI_ERR_COUNT`

`MPI_ERR_TYPE`

`MPI_ERR_TAG`

`MPI_ERR_COMM`

`MPI_ERR_RANK`

`MPI_ERR_REQUEST`

`MPI_ERR_ROOT`

`MPI_ERR_GROUP`

`MPI_ERR_OP`

`MPI_ERR_TOPOLOGY`

`MPI_ERR_DIMS`

`MPI_ERR_ARG`

`MPI_ERR_UNKNOWN`

`MPI_ERR_TRUNCATE`

`MPI_ERR_OTHER`

`MPI_ERR_INTERN`

`MPI_ERR_PENDING`

---

(Continued on next page)

**Error classes (continued)**

---

 C type: `const int` (or unnamed `enum`)

 Fortran type: `INTEGER`

---

MPI\_ERR\_IN\_STATUS

MPI\_ERR\_ACCESS

MPI\_ERR\_AMODE

MPI\_ERR\_ASSERT

MPI\_ERR\_BAD\_FILE

MPI\_ERR\_BASE

MPI\_ERR\_CONVERSION

MPI\_ERR\_DISP

MPI\_ERR\_DUP\_DATAREP

MPI\_ERR\_FILE\_EXISTS

MPI\_ERR\_FILE\_IN\_USE

MPI\_ERR\_FILE

MPI\_ERR\_INFO\_KEY

MPI\_ERR\_INFO\_NOKEY

MPI\_ERR\_INFO\_VALUE

MPI\_ERR\_INFO

MPI\_ERR\_IO

MPI\_ERR\_KEYVAL

MPI\_ERR\_LOCKTYPE

MPI\_ERR\_NAME

MPI\_ERR\_NO\_MEM

MPI\_ERR\_NOT\_SAME

MPI\_ERR\_NO\_SPACE

MPI\_ERR\_NO\_SUCH\_FILE

MPI\_ERR\_PORT

MPI\_ERR\_PROC\_ABORTED

MPI\_ERR\_QUOTA

MPI\_ERR\_READ\_ONLY

MPI\_ERR\_RMA\_ATTACH

MPI\_ERR\_RMA\_CONFLICT

MPI\_ERR\_RMA\_RANGE

MPI\_ERR\_RMA\_SHARED

MPI\_ERR\_RMA\_SYNC

MPI\_ERR\_RMA\_FLAVOR

MPI\_ERR\_SERVICE

MPI\_ERR\_SIZE

MPI\_ERR\_SPAWN

MPI\_ERR\_UNSUPPORTED\_DATAREP

MPI\_ERR\_UNSUPPORTED\_OPERATION

MPI\_ERR\_WIN

---

 (Continued on next page)

**Error classes (continued)**C type: `const int` (or unnamed `enum`)Fortran type: `INTEGER`

---

MPI\_T\_ERR\_CANNOT\_INIT

MPI\_T\_ERR\_NOT\_ACCESSIBLE

MPI\_T\_ERR\_NOT\_INITIALIZED

MPI\_T\_ERR\_NOT\_SUPPORTED

MPI\_T\_ERR\_MEMORY

MPI\_T\_ERR\_INVALID

MPI\_T\_ERR\_INVALID\_INDEX

MPI\_T\_ERR\_INVALID\_ITEM

MPI\_T\_ERR\_INVALID\_SESSION

MPI\_T\_ERR\_INVALID\_HANDLE

MPI\_T\_ERR\_INVALID\_NAME

MPI\_T\_ERR\_OUT\_OF\_HANDLES

MPI\_T\_ERR\_OUT\_OF\_SESSIONS

MPI\_T\_ERR\_CVAR\_SET\_NOT\_NOW

MPI\_T\_ERR\_CVAR\_SET\_NEVER

MPI\_T\_ERR\_PVAR\_NO\_WRITE

MPI\_T\_ERR\_PVAR\_NO\_STARTSTOP

MPI\_T\_ERR\_PVAR\_NO\_ATOMIC

---

MPI\_ERR\_LASTCODE

---

**Buffer Address Constants**

---

C type: `void * const`Fortran type: (predefined memory location)<sup>1</sup>

---

MPI\_BOTTOM

---

MPI\_IN\_PLACE

---

<sup>1</sup> Note that in Fortran these constants are not usable for initialization expressions or assignment. See Section 2.5.4.**Assorted Constants**

---

C type: `const int` (or unnamed `enum`)Fortran type: `INTEGER`

---

MPI\_PROC\_NULL

MPI\_ANY\_SOURCE

MPI\_ANY\_TAG

MPI\_UNDEFINED

MPI\_BSEND\_OVERHEAD

MPI\_KEYVAL\_INVALID

MPI\_LOCK\_EXCLUSIVE

MPI\_LOCK\_SHARED

---

MPI\_ROOT

---

**No Process Message Handle**

---

C type: `MPI_Message`Fortran type: `INTEGER` or `TYPE(MPI_Message)`

---

MPI\_MESSAGE\_NO\_PROC

---

### Fortran Support Method Specific Constants

---

Fortran type: LOGICAL

---

MPI\_SUBARRAYS\_SUPPORTED (Fortran only)

---

MPI\_ASYNC\_PROTECTS\_NONBLOCKING (Fortran only)

---

### Status size and reserved index values (Fortran only)

---

Fortran type: INTEGER

---

MPI\_STATUS\_SIZE

MPI\_SOURCE

MPI\_TAG

MPI\_ERROR

---

### Variable Address Size (Fortran only)

---

Fortran type: INTEGER

---

MPI\_ADDRESS\_KIND

MPI\_COUNT\_KIND

MPI\_INTEGER\_KIND

MPI\_OFFSET\_KIND

---

### Error-handling specifiers

---

C type: MPI\_Errhandler

Fortran type: INTEGER or TYPE(MPI\_Errhandler)

---

MPI\_ERRORS\_ARE\_FATAL

MPI\_ERRORS\_RETURN

---

### Maximum Sizes for Strings

---

C type: const int (or unnamed enum)

Fortran type: INTEGER

---

MPI\_MAX\_DATAREP\_STRING

MPI\_MAX\_ERROR\_STRING

MPI\_MAX\_INFO\_KEY

MPI\_MAX\_INFO\_VAL

MPI\_MAX\_LIBRARY\_VERSION\_STRING

MPI\_MAX\_OBJECT\_NAME

MPI\_MAX\_PORT\_NAME

MPI\_MAX\_PROCESSOR\_NAME

MPI\_MAX\_FROM\_GROUP\_TAG

MPI\_MAX\_PSET\_NAME\_LEN

---



Named Predefined Datatypes	C types	
C type: MPI_Datatype		1
Fortran type: INTEGER		2
or TYPE(MPI_Datatype)		3
MPI_CHAR	char	4
	(treated as printable character)	5
MPI_SHORT	signed short int	6
MPI_INT	signed int	7
MPI_LONG	signed long	8
MPI_LONG_LONG_INT	signed long long	9
MPI_LONG_LONG (as a synonym)	signed long long	10
MPI_SIGNED_CHAR	signed char	11
	(treated as integral value)	12
MPI_UNSIGNED_CHAR	unsigned char	13
	(treated as integral value)	14
MPI_UNSIGNED_SHORT	unsigned short	15
MPI_UNSIGNED	unsigned int	16
MPI_UNSIGNED_LONG	unsigned long	17
MPI_UNSIGNED_LONG_LONG	unsigned long long	18
MPI_FLOAT	float	19
MPI_DOUBLE	double	20
MPI_LONG_DOUBLE	long double	21
MPI_WCHAR	wchar_t	22
	(defined in <stddef.h>)	23
	(treated as printable character)	24
MPI_C_BOOL	_Bool	25
MPI_INT8_T	int8_t	26
MPI_INT16_T	int16_t	27
MPI_INT32_T	int32_t	28
MPI_INT64_T	int64_t	29
MPI_UINT8_T	uint8_t	30
MPI_UINT16_T	uint16_t	31
MPI_UINT32_T	uint32_t	32
MPI_UINT64_T	uint64_t	33
MPI_AINT	MPI_Aint	34
MPI_COUNT	MPI_Count	35
MPI_OFFSET	MPI_Offset	36
MPI_C_COMPLEX	float _Complex	37
MPI_C_FLOAT_COMPLEX	float _Complex	38
MPI_C_DOUBLE_COMPLEX	double _Complex	39
MPI_C_LONG_DOUBLE_COMPLEX	long double _Complex	40
MPI_BYTE	(any C type)	41
MPI_PACKED	(any C type)	42

Named Predefined Datatypes	Fortran types
C type: MPI_Datatype Fortran type: INTEGER or TYPE(MPI_Datatype)	
MPI_INTEGER	INTEGER
MPI_REAL	REAL
MPI_DOUBLE_PRECISION	DOUBLE PRECISION
MPI_COMPLEX	COMPLEX
MPI_LOGICAL	LOGICAL
MPI_CHARACTER	CHARACTER(1)
MPI_AINT	INTEGER (KIND=MPI_ADDRESS_KIND)
MPI_COUNT	INTEGER (KIND=MPI_COUNT_KIND)
MPI_OFFSET	INTEGER (KIND=MPI_OFFSET_KIND)
MPI_BYTE	(any Fortran type)
MPI_PACKED	(any Fortran type)

Named Predefined Datatypes <sup>1</sup>	C++ types
C type: MPI_Datatype Fortran type: INTEGER or TYPE(MPI_Datatype)	
MPI_CXX_BOOL	bool
MPI_CXX_FLOAT_COMPLEX	std::complex<float>
MPI_CXX_DOUBLE_COMPLEX	std::complex<double>
MPI_CXX_LONG_DOUBLE_COMPLEX	std::complex<long double>

<sup>1</sup> If an accompanying C++ compiler is missing, then the MPI datatypes in this table are not defined.

Optional datatypes (Fortran)	Fortran types
C type: MPI_Datatype Fortran type: INTEGER or TYPE(MPI_Datatype)	
MPI_DOUBLE_COMPLEX	DOUBLE COMPLEX
MPI_INTEGER1	INTEGER*1
MPI_INTEGER2	INTEGER*2
MPI_INTEGER4	INTEGER*4
MPI_INTEGER8	INTEGER*8
MPI_INTEGER16	INTEGER*16
MPI_REAL2	REAL*2
MPI_REAL4	REAL*4
MPI_REAL8	REAL*8
MPI_REAL16	REAL*16
MPI_COMPLEX4	COMPLEX*4
MPI_COMPLEX8	COMPLEX*8
MPI_COMPLEX16	COMPLEX*16
MPI_COMPLEX32	COMPLEX*32

<b>Datatypes for reduction functions (C)</b>	1
C type: MPI_Datatype	2
Fortran type: INTEGER or TYPE(MPI_Datatype)	3
MPI_FLOAT_INT	4
MPI_DOUBLE_INT	5
MPI_LONG_INT	6
MPI_2INT	7
MPI_SHORT_INT	8
MPI_LONG_DOUBLE_INT	9
	10
<b>Datatypes for reduction functions (Fortran)</b>	11
C type: MPI_Datatype	12
Fortran type: INTEGER or TYPE(MPI_Datatype)	13
MPI_2REAL	14
MPI_2DOUBLE_PRECISION	15
MPI_2INTEGER	16
	17
<b>Reserved communicators</b>	18
C type: MPI_Comm	19
Fortran type: INTEGER or TYPE(MPI_Comm)	20
MPI_COMM_WORLD	21
MPI_COMM_SELF	22
	23
<b>Communicator split type constants</b>	24
C type: const int (or unnamed enum)	25
Fortran type: INTEGER	26
MPI_COMM_TYPE_SHARED	27
	28
<b>Results of communicator and group comparisons</b>	29
C type: const int (or unnamed enum)	30
Fortran type: INTEGER	31
MPI_IDENT	32
MPI_CONGRUENT	33
MPI_SIMILAR	34
MPI_UNEQUAL	35
	36
<b>Environmental inquiry info key</b>	37
C type: MPI_Info	38
Fortran type: INTEGER or TYPE(MPI_Info)	39
MPI_INFO_ENV	40
	41
<b>Environmental inquiry keys</b>	42
C type: const int (or unnamed enum)	43
Fortran type: INTEGER	44
MPI_TAG_UB	45
MPI_IO	46
MPI_HOST	47
MPI_WTIME_IS_GLOBAL	48

---

**Collective Operations**

---

C type: MPI\_Op  
 Fortran type: INTEGER or TYPE(MPI\_Op)

---

MPI\_MAX  
 MPI\_MIN  
 MPI\_SUM  
 MPI\_PROD  
 MPI\_MAXLOC  
 MPI\_MINLOC  
 MPI\_BAND  
 MPI\_BOR  
 MPI\_BXOR  
 MPI\_LAND  
 MPI\_LOR  
 MPI\_LXOR  
 MPI\_REPLACE  
 MPI\_NO\_OP

---



---

**Null Handles**

---

C/Fortran name	C type / Fortran type
MPI_GROUP_NULL	MPI_Group / INTEGER or TYPE(MPI_Group)
MPI_COMM_NULL	MPI_Comm / INTEGER or TYPE(MPI_Comm)
MPI_DATATYPE_NULL	MPI_Datatype / INTEGER or TYPE(MPI_Datatype)
MPI_REQUEST_NULL	MPI_Request / INTEGER or TYPE(MPI_Request)
MPI_OP_NULL	MPI_Op / INTEGER or TYPE(MPI_Op)
MPI_ERRHANDLER_NULL	MPI_Errhandler / INTEGER or TYPE(MPI_Errhandler)
MPI_FILE_NULL	MPI_File / INTEGER or TYPE(MPI_File)
MPI_INFO_NULL	MPI_Info / INTEGER or TYPE(MPI_Info)
MPI_SESSION_NULL	MPI_Session / INTEGER MPI_WIN_NULL
	MPI_Win / INTEGER or TYPE(MPI_Win)
MPI_MESSAGE_NULL	MPI_Message / INTEGER or TYPE(MPI_Message)

---



---

**Empty group**

---

C type: MPI\_Group  
 Fortran type: INTEGER or TYPE(MPI\_Group)

---

MPI\_GROUP\_EMPTY

---

**Topologies**

C type: <code>const int</code> (or unnamed <code>enum</code> )
Fortran type: <code>INTEGER</code>
<code>MPI_GRAPH</code>
<code>MPI_CART</code>
<code>MPI_DIST_GRAPH</code>

**Predefined functions**

C/Fortran name	
C type	
/ Fortran type with <code>mpi</code> module	/ Fortran type with <code>mpi_f08</code> module
<code>MPI_COMM_NULL_COPY_FN</code>	
<code>MPI_Comm_copy_attr_function</code>	
/ <code>COMM_COPY_ATTR_FUNCTION</code>	/ <code>PROCEDURE(MPI_Comm_copy_attr_function)</code> <sup>1)</sup>
<code>MPI_COMM_DUP_FN</code>	
<code>MPI_Comm_copy_attr_function</code>	
/ <code>COMM_COPY_ATTR_FUNCTION</code>	/ <code>PROCEDURE(MPI_Comm_copy_attr_function)</code> <sup>1)</sup>
<code>MPI_COMM_NULL_DELETE_FN</code>	
<code>MPI_Comm_delete_attr_function</code>	
/ <code>COMM_DELETE_ATTR_FUNCTION</code>	/ <code>PROCEDURE(MPI_Comm_delete_attr_function)</code> <sup>1)</sup>
<code>MPI_WIN_NULL_COPY_FN</code>	
<code>MPI_Win_copy_attr_function</code>	
/ <code>WIN_COPY_ATTR_FUNCTION</code>	/ <code>PROCEDURE(MPI_Win_copy_attr_function)</code> <sup>1)</sup>
<code>MPI_WIN_DUP_FN</code>	
<code>MPI_Win_copy_attr_function</code>	
/ <code>WIN_COPY_ATTR_FUNCTION</code>	/ <code>PROCEDURE(MPI_Win_copy_attr_function)</code> <sup>1)</sup>
<code>MPI_WIN_NULL_DELETE_FN</code>	
<code>MPI_Win_delete_attr_function</code>	
/ <code>WIN_DELETE_ATTR_FUNCTION</code>	/ <code>PROCEDURE(MPI_Win_delete_attr_function)</code> <sup>1)</sup>
<code>MPI_TYPE_NULL_COPY_FN</code>	
<code>MPI_Type_copy_attr_function</code>	
/ <code>TYPE_COPY_ATTR_FUNCTION</code>	/ <code>PROCEDURE(MPI_Type_copy_attr_function)</code> <sup>1)</sup>
<code>MPI_TYPE_DUP_FN</code>	
<code>MPI_Type_copy_attr_function</code>	
/ <code>TYPE_COPY_ATTR_FUNCTION</code>	/ <code>PROCEDURE(MPI_Type_copy_attr_function)</code> <sup>1)</sup>
<code>MPI_TYPE_NULL_DELETE_FN</code>	
<code>MPI_Type_delete_attr_function</code>	
/ <code>TYPE_DELETE_ATTR_FUNCTION</code>	/ <code>PROCEDURE(MPI_Type_delete_attr_function)</code> <sup>1)</sup>
<code>MPI_CONVERSION_FN_NULL</code>	
<code>MPI_Datarep_conversion_function</code>	
/ <code>DATAREP_CONVERSION_FUNCTION</code>	/ <code>PROCEDURE(MPI_Datarep_conversion_function)</code> <sup>1)</sup>

<sup>1)</sup> See the advice to implementors (on page 305) and advice to users (on page 305) on the predefined Fortran functions `MPI_COMM_NULL_COPY_FN`, ... in Section 6.7.2.

<b>Deprecated predefined functions</b>	
C/Fortran name	C type / Fortran type with mpi module
MPI_NULL_COPY_FN	MPI_Copy_function / COPY_FUNCTION
MPI_DUP_FN	MPI_Copy_function / COPY_FUNCTION
MPI_NULL_DELETE_FN	MPI_Delete_function / DELETE_FUNCTION

<b>Predefined Attribute Keys</b>	
C type: <code>const int</code> (or unnamed <code>enum</code> )	Fortran type: <code>INTEGER</code>
MPI_APPNUM	
MPI_LASTUSED	
MPI_UNIVERSE_SIZE	
MPI_WIN_BASE	
MPI_WIN_DISP_UNIT	
MPI_WIN_SIZE	
MPI_WIN_CREATE_FLAVOR	
MPI_WIN_MODEL	

<b>MPI Window Create Flavors</b>	
C type: <code>const int</code> (or unnamed <code>enum</code> )	Fortran type: <code>INTEGER</code>
MPI_WIN_FLAVOR_CREATE	
MPI_WIN_FLAVOR_ALLOCATE	
MPI_WIN_FLAVOR_DYNAMIC	
MPI_WIN_FLAVOR_SHARED	

<b>MPI Window Models</b>	
C type: <code>const int</code> (or unnamed <code>enum</code> )	Fortran type: <code>INTEGER</code>
MPI_WIN_SEPARATE	
MPI_WIN_UNIFIED	

**Mode Constants**C type: `const int` (or unnamed `enum`)Fortran type: `INTEGER`

---

MPI\_MODE\_APPEND

MPI\_MODE\_CREATE

MPI\_MODE\_DELETE\_ON\_CLOSE

MPI\_MODE\_EXCL

MPI\_MODE\_NOCHECK

MPI\_MODE\_NOPRECEDE

MPI\_MODE\_NOPUT

MPI\_MODE\_NOSTORE

MPI\_MODE\_NOSUCCEED

MPI\_MODE\_RDONLY

MPI\_MODE\_RDWR

MPI\_MODE\_SEQUENTIAL

MPI\_MODE\_UNIQUE\_OPEN

MPI\_MODE\_WRONLY

---

**Datatype Decoding Constants**C type: `const int` (or unnamed `enum`)Fortran type: `INTEGER`

---

MPI\_COMBINER\_CONTIGUOUS

MPI\_COMBINER\_DARRAY

MPI\_COMBINER\_DUP

MPI\_COMBINER\_F90\_COMPLEX

MPI\_COMBINER\_F90\_INTEGER

MPI\_COMBINER\_F90\_REAL

MPI\_COMBINER\_HINDEXED

MPI\_COMBINER\_HVECTOR

MPI\_COMBINER\_INDEXED\_BLOCK

MPI\_COMBINER\_HINDEXED\_BLOCK

MPI\_COMBINER\_INDEXED

MPI\_COMBINER\_NAMED

MPI\_COMBINER\_RESIZED

MPI\_COMBINER\_STRUCT

MPI\_COMBINER\_SUBARRAY

MPI\_COMBINER\_VECTOR

---

**Threads Constants**C type: `const int` (or unnamed `enum`)Fortran type: `INTEGER`

---

MPI\_THREAD\_FUNNELED

MPI\_THREAD\_MULTIPLE

MPI\_THREAD\_SERIALIZED

MPI\_THREAD\_SINGLE

---

**File Operation Constants, Part 1**

---

C type: `const MPI_Offset` (or unnamed `enum`)  
 Fortran type: `INTEGER (KIND=MPI_OFFSET_KIND)`

---

`MPI_DISPLACEMENT_CURRENT`

---

**File Operation Constants, Part 2**

---

C type: `const int` (or unnamed `enum`)  
 Fortran type: `INTEGER`

---

`MPI_DISTRIBUTE_BLOCK`  
`MPI_DISTRIBUTE_CYCLIC`  
`MPI_DISTRIBUTE_DFLT_DARG`  
`MPI_DISTRIBUTE_NONE`  
`MPI_ORDER_C`  
`MPI_ORDER_FORTRAN`  
`MPI_SEEK_CUR`  
`MPI_SEEK_END`  
`MPI_SEEK_SET`

---

**F90 Datatype Matching Constants**

---

C type: `const int` (or unnamed `enum`)  
 Fortran type: `INTEGER`

---

`MPI_TYPECLASS_COMPLEX`  
`MPI_TYPECLASS_INTEGER`  
`MPI_TYPECLASS_REAL`

---

**Constants Specifying Empty or Ignored Input**

---

C/Fortran name	C type / Fortran type <sup>1</sup>
<code>MPI_ARGVS_NULL</code>	<code>char***</code> / 2-dim. array of <code>CHARACTER*(*)</code>
<code>MPI_ARGV_NULL</code>	<code>char**</code> / array of <code>CHARACTER*(*)</code>
<code>MPI_ERRCODES_IGNORE</code>	<code>int*</code> / <code>INTEGER</code> array
<code>MPI_STATUSES_IGNORE</code>	<code>MPI_Status*</code> / <code>INTEGER, DIMENSION(MPI_STATUS_SIZE,*)</code> or <code>TYPE(MPI_Status), DIMENSION(*)</code>
<code>MPI_STATUS_IGNORE</code>	<code>MPI_Status*</code> / <code>INTEGER, DIMENSION(MPI_STATUS_SIZE)</code> or <code>TYPE(MPI_Status)</code>
<code>MPI_UNWEIGHTED</code>	<code>int*</code> / <code>INTEGER</code> array
<code>MPI_WEIGHTS_EMPTY</code>	<code>int*</code> / <code>INTEGER</code> array

---

<sup>1</sup> Note that in Fortran these constants are not usable for initialization expressions or assignment. See Section [2.5.4](#).



**C Constants Specifying Ignored Input (no Fortran)**

C type: MPI_Fint*	equivalent to Fortran	1
MPI_F_STATUSES_IGNORE	MPI_STATUSES_IGNORE in mpi / mpif.h	2
MPI_F_STATUS_IGNORE	MPI_STATUS_IGNORE in mpi / mpif.h	3
C type: MPI_F08_status*	equivalent to Fortran	4
MPI_F08_STATUSES_IGNORE	MPI_STATUSES_IGNORE in mpi_f08	5
MPI_F08_STATUS_IGNORE	MPI_STATUS_IGNORE in mpi_f08	6

**C preprocessor Constants and Fortran Parameters**

C type: C-preprocessor macro that expands to an int value

Fortran type: INTEGER

MPI\_SUBVERSION

MPI\_VERSION

**Null handles used in the MPI tool information interface**

MPI\_T\_ENUM\_NULL

MPI\_T\_enum

MPI\_T\_CVAR\_HANDLE\_NULL

MPI\_T\_cvar\_handle

MPI\_T\_PVAR\_HANDLE\_NULL

MPI\_T\_pvar\_handle

MPI\_T\_PVAR\_SESSION\_NULL

MPI\_T\_pvar\_session

**Verbosity Levels in the MPI tool information interface**

C type: const int (or unnamed enum)

MPI\_T\_VERBOSITY\_USER\_BASIC

MPI\_T\_VERBOSITY\_USER\_DETAIL

MPI\_T\_VERBOSITY\_USER\_ALL

MPI\_T\_VERBOSITY\_TUNER\_BASIC

MPI\_T\_VERBOSITY\_TUNER\_DETAIL

MPI\_T\_VERBOSITY\_TUNER\_ALL

MPI\_T\_VERBOSITY\_MPIDEV\_BASIC

MPI\_T\_VERBOSITY\_MPIDEV\_DETAIL

MPI\_T\_VERBOSITY\_MPIDEV\_ALL

**Constants to identify associations of variables  
in the MPI tool information interface**

---

C type: const int (or unnamed enum)

---

MPI\_T\_BIND\_NO\_OBJECT  
 MPI\_T\_BIND\_MPI\_COMM  
 MPI\_T\_BIND\_MPI\_DATATYPE  
 MPI\_T\_BIND\_MPI\_ERRHANDLER  
 MPI\_T\_BIND\_MPI\_FILE  
 MPI\_T\_BIND\_MPI\_GROUP  
 MPI\_T\_BIND\_MPI\_OP  
 MPI\_T\_BIND\_MPI\_REQUEST  
 MPI\_T\_BIND\_MPI\_WIN  
 MPI\_T\_BIND\_MPI\_MESSAGE  
 MPI\_T\_BIND\_MPI\_INFO

---

**Constants describing the scope of a control variable  
in the MPI tool information interface**

---

C type: const int (or unnamed enum)

---

MPI\_T\_SCOPE\_CONSTANT  
 MPI\_T\_SCOPE\_READONLY  
 MPI\_T\_SCOPE\_LOCAL  
 MPI\_T\_SCOPE\_GROUP  
 MPI\_T\_SCOPE\_GROUP\_EQ  
 MPI\_T\_SCOPE\_ALL  
 MPI\_T\_SCOPE\_ALL\_EQ

---

**Additional constants used  
by the MPI tool information interface**

---

C type: MPI\_T\_pvar\_handle

---

MPI\_T\_PVAR\_ALL\_HANDLES

---

**Performance variables classes used by the  
MPI tool information interface**

---

C type: const int (or unnamed enum)

---

MPI\_T\_PVAR\_CLASS\_STATE  
 MPI\_T\_PVAR\_CLASS\_LEVEL  
 MPI\_T\_PVAR\_CLASS\_SIZE  
 MPI\_T\_PVAR\_CLASS\_PERCENTAGE  
 MPI\_T\_PVAR\_CLASS\_HIGHWATERMARK  
 MPI\_T\_PVAR\_CLASS\_LOWWATERMARK  
 MPI\_T\_PVAR\_CLASS\_COUNTER  
 MPI\_T\_PVAR\_CLASS\_AGGREGATE  
 MPI\_T\_PVAR\_CLASS\_TIMER  
 MPI\_T\_PVAR\_CLASS\_GENERIC

---

**Source event ordering guarantees in the  
MPI tool information interface**

---

C type: MPI\_T\_source\_order

---

MPI\_T\_SOURCE\_ORDERED

MPI\_T\_SOURCE\_UNORDERED

---

**Callback safety requirement levels used in the  
MPI tool information interface**

---

C type: MPI\_T\_cb\_safety

---

MPI\_T\_CB\_REQUIRE\_NONE

MPI\_T\_CB\_REQUIRE\_MPI\_RESTRICTED

MPI\_T\_CB\_REQUIRE\_THREAD\_SAFE

MPI\_T\_CB\_REQUIRE\_ASYNC\_SIGNAL\_SAFE

---

## A.1.2 Types

The following are defined C type definitions, included in the file `mpi.h`.

```
/* C opaque types */
```

```
MPI_Aint
```

```
MPI_Count
```

```
MPI_Fint
```

```
MPI_Offset
```

```
MPI_Status
```

```
MPI_F08_status
```

```
/* C handles to assorted structures */
```

```
MPI_Comm
```

```
MPI_Datatype
```

```
MPI_Errhandler
```

```
MPI_File
```

```
MPI_Group
```

```
MPI_Info
```

```
MPI_Message
```

```
MPI_Op
```

```
MPI_Request
```

```
MPI_Session
```

```
MPI_Win
```

```
/* Types for the MPI_T interface */
```

```
MPI_T_enum
```

```
MPI_T_cvar_handle
```

```
MPI_T_pvar_handle
```

```
MPI_T_pvar_session
```

```
MPI_T_event_instance
```

```
MPI_T_event_registration
```

```
MPI_T_source_order
```

```
MPI_T_cb_safety
```

1  
2  
3 The following are defined Fortran type definitions, included in the `mpi_f08` and `mpi`  
4 modules.

5 ! Fortran opaque types in the `mpi_f08` and `mpi` modules  
6 TYPE(MPI\_Status)  
7

8 ! Fortran handles in the `mpi_f08` and `mpi` modules  
9 TYPE(MPI\_Comm)  
10 TYPE(MPI\_Datatype)  
11 TYPE(MPI\_Errhandler)  
12 TYPE(MPI\_File)  
13 TYPE(MPI\_Group)  
14 TYPE(MPI\_Info)  
15 TYPE(MPI\_Message)  
16 TYPE(MPI\_Op)  
17 TYPE(MPI\_Request)  
18 TYPE(MPI\_Session)  
19 TYPE(MPI\_Win)  
20

### 21 A.1.3 Prototype Definitions

#### 22 C Bindings

23 The following are defined C typedefs for user-defined functions, also included in the file  
24 `mpi.h`.

25 /\* prototypes for user-defined functions \*/  
26  
27 typedef void MPI\_User\_function(void \*invec, void \*inoutvec, int \*len,  
28 MPI\_Datatype \*datatype);  
29  
30 typedef int MPI\_Comm\_copy\_attr\_function(MPI\_Comm oldcomm, int comm\_keyval,  
31 void \*extra\_state, void \*attribute\_val\_in,  
32 void \*attribute\_val\_out, int \*flag);  
33  
34 typedef int MPI\_Comm\_delete\_attr\_function(MPI\_Comm comm, int comm\_keyval,  
35 void \*attribute\_val, void \*extra\_state);  
36  
37 typedef int MPI\_Win\_copy\_attr\_function(MPI\_Win oldwin, int win\_keyval,  
38 void \*extra\_state, void \*attribute\_val\_in,  
39 void \*attribute\_val\_out, int \*flag);  
40  
41 typedef int MPI\_Win\_delete\_attr\_function(MPI\_Win win, int win\_keyval,  
42 void \*attribute\_val, void \*extra\_state);  
43  
44 typedef int MPI\_Type\_copy\_attr\_function(MPI\_Datatype oldtype,  
45 int type\_keyval, void \*extra\_state, void \*attribute\_val\_in,  
46 void \*attribute\_val\_out, int \*flag);  
47  
48 typedef int MPI\_Type\_delete\_attr\_function(MPI\_Datatype datatype,  
int type\_keyval, void \*attribute\_val, void \*extra\_state);

```

typedef void MPI_Comm_errhandler_function(MPI_Comm *comm, int *error_code,
    ...);
typedef void MPI_Win_errhandler_function(MPI_Win *win, int *error_code,
    ...);
typedef void MPI_File_errhandler_function(MPI_File *file, int *error_code,
    ...);
typedef void MPI_Session_errhandler_function(MPI_Session *session,
    int *error_code, ...);
typedef int MPI_Grequest_query_function(void *extra_state,
    MPI_Status *status);
typedef int MPI_Grequest_free_function(void *extra_state);
typedef int MPI_Grequest_cancel_function(void *extra_state, int complete);
typedef int MPI_Datarep_extent_function(MPI_Datatype datatype,
    MPI_Aint *extent, void *extra_state);
typedef int MPI_Datarep_conversion_function(void *userbuf,
    MPI_Datatype datatype, int count, void *filebuf,
    MPI_Offset position, void *extra_state);
typedef void MPI_T_event_cb_function(
    MPI_T_event_instance event_instance,
    MPI_T_event_registration event_registration,
    MPI_T_cb_safety cb_safety,
    void *user_data);
typedef void MPI_T_event_free_cb_function(
    MPI_T_event_registration event_registration,
    MPI_T_cb_safety cb_safety,
    void *user_data);
typedef void MPI_T_event_dropped_cb_function(int count,
    MPI_T_event_registration event_registration,
    MPI_T_cb_safety cb_safety,
    void *user_data);

```

Fortran 2008 Bindings with the mpi\_f08 Module

The callback prototypes when using the Fortran mpi\_f08 module are shown below:

The user-function argument to MPI\_Op\_create should be declared according to:

ABSTRACT INTERFACE

```

SUBROUTINE MPI_User_function(invec, inoutvec, len, datatype)
    USE, INTRINSIC :: ISO_C_BINDING, ONLY : C_PTR
    TYPE(C_PTR), VALUE :: invec, inoutvec

```

```

1     INTEGER :: len
2     TYPE(MPI_Datatype) :: datatype

```

The copy and delete function arguments to MPI\_Comm\_create\_keyval should be declared according to:

```

6 ABSTRACT INTERFACE

```

```

7     SUBROUTINE MPI_Comm_copy_attr_function(oldcomm, comm_keyval, extra_state,
8         attribute_val_in, attribute_val_out, flag, ierror)

```

```

9         TYPE(MPI_Comm) :: oldcomm

```

```

10        INTEGER :: comm_keyval, ierror

```

```

11        INTEGER(KIND=MPI_ADDRESS_KIND) :: extra_state, attribute_val_in,
12        attribute_val_out

```

```

13        LOGICAL :: flag

```

```

14 ABSTRACT INTERFACE

```

```

15     SUBROUTINE MPI_Comm_delete_attr_function(comm, comm_keyval,
16         attribute_val, extra_state, ierror)

```

```

17     TYPE(MPI_Comm) :: comm

```

```

18     INTEGER :: comm_keyval, ierror

```

```

19     INTEGER(KIND=MPI_ADDRESS_KIND) :: attribute_val, extra_state

```

The copy and delete function arguments to MPI\_Win\_create\_keyval should be declared according to:

```

23 ABSTRACT INTERFACE

```

```

24     SUBROUTINE MPI_Win_copy_attr_function(oldwin, win_keyval, extra_state,
25         attribute_val_in, attribute_val_out, flag, ierror)

```

```

26     TYPE(MPI_Win) :: oldwin

```

```

27     INTEGER :: win_keyval, ierror

```

```

28     INTEGER(KIND=MPI_ADDRESS_KIND) :: extra_state, attribute_val_in,
29     attribute_val_out

```

```

30     LOGICAL :: flag

```

```

31 ABSTRACT INTERFACE

```

```

32     SUBROUTINE MPI_Win_delete_attr_function(win, win_keyval, attribute_val,
33         extra_state, ierror)

```

```

34     TYPE(MPI_Win) :: win

```

```

35     INTEGER :: win_keyval, ierror

```

```

36     INTEGER(KIND=MPI_ADDRESS_KIND) :: attribute_val, extra_state

```

The copy and delete function arguments to MPI\_Type\_create\_keyval should be declared according to:

```

40 ABSTRACT INTERFACE

```

```

41     SUBROUTINE MPI_Type_copy_attr_function(oldtype, type_keyval, extra_state,
42         attribute_val_in, attribute_val_out, flag, ierror)

```

```

43     TYPE(MPI_Datatype) :: oldtype

```

```

44     INTEGER :: type_keyval, ierror

```

```

45     INTEGER(KIND=MPI_ADDRESS_KIND) :: extra_state, attribute_val_in,
46     attribute_val_out

```

```

47     LOGICAL :: flag

```

ABSTRACT INTERFACE

```

SUBROUTINE MPI_Type_delete_attr_function(datatype, type_keyval,
    attribute_val, extra_state, ierror)
    TYPE(MPI_Datatype) :: datatype
    INTEGER :: type_keyval, ierror
    INTEGER(KIND=MPI_ADDRESS_KIND) :: attribute_val, extra_state

```

The handler-function argument to MPI\_Comm\_create\_errhandler should be declared like this:

ABSTRACT INTERFACE

```

SUBROUTINE MPI_Comm_errhandler_function(comm, error_code)
    TYPE(MPI_Comm) :: comm
    INTEGER :: error_code

```

The handler-function argument to MPI\_Win\_create\_errhandler should be declared like this:

ABSTRACT INTERFACE

```

SUBROUTINE MPI_Win_errhandler_function(win, error_code)
    TYPE(MPI_Win) :: win
    INTEGER :: error_code

```

The handler-function argument to MPI\_File\_create\_errhandler should be declared like this:

ABSTRACT INTERFACE

```

SUBROUTINE MPI_File_errhandler_function(file, error_code)
    TYPE(MPI_File) :: file
    INTEGER :: error_code

```

ABSTRACT INTERFACE

```

SUBROUTINE MPI_File_errhandler_function(file, error_code)
    TYPE(MPI_File) :: file
    INTEGER :: error_code

```

The handler-function argument to MPI\_Session\_create\_errhandler should be declared like this:

ABSTRACT INTERFACE

```

SUBROUTINE MPI_Session_errhandler_function(session, error_code)
    TYPE(MPI_Session) :: session
    INTEGER :: error_code

```

ABSTRACT INTERFACE

```

SUBROUTINE MPI_Session_errhandler_function(session, error_code)
    TYPE(MPI_Session) :: session
    INTEGER :: error_code

```

The query, free, and cancel function arguments to MPI\_Grequest\_start should be declared according to:

ABSTRACT INTERFACE

```

SUBROUTINE MPI_Grequest_query_function(extra_state, status, ierror)
    INTEGER(KIND=MPI_ADDRESS_KIND) :: extra_state
    TYPE(MPI_Status) :: status

```

```

1      INTEGER :: ierror
2
3      ABSTRACT INTERFACE
4          SUBROUTINE MPI_Grequest_free_function(extra_state, ierror)
5              INTEGER(KIND=MPI_ADDRESS_KIND) :: extra_state
6              INTEGER :: ierror
7
8      ABSTRACT INTERFACE
9          SUBROUTINE MPI_Grequest_cancel_function(extra_state, complete, ierror)
10             INTEGER(KIND=MPI_ADDRESS_KIND) :: extra_state
11             LOGICAL :: complete
12             INTEGER :: ierror

```

The extent and conversion function arguments to MPI\_Register\_datarep should be declared according to:

```

15     ABSTRACT INTERFACE
16         SUBROUTINE MPI_Datarep_extent_function(datatype, extent, extra_state,
17             ierror)
18             TYPE(MPI_Datatype) :: datatype
19             INTEGER(KIND=MPI_ADDRESS_KIND) :: extent, extra_state
20             INTEGER :: ierror
21
22     ABSTRACT INTERFACE
23         SUBROUTINE MPI_Datarep_conversion_function(userbuf, datatype, count,
24             filebuf, position, extra_state, ierror)
25         USE, INTRINSIC :: ISO_C_BINDING, ONLY : C_PTR
26         TYPE(C_PTR), VALUE :: userbuf, filebuf
27         TYPE(MPI_Datatype) :: datatype
28         INTEGER :: count, ierror
29         INTEGER(KIND=MPI_OFFSET_KIND) :: position
30         INTEGER(KIND=MPI_ADDRESS_KIND) :: extra_state

```

### Fortran Bindings with mpif.h or the mpi Module

With the Fortran mpi module or mpif.h, here are examples of how each of the user-defined subroutines should be declared.

The user-function argument to MPI\_OP\_CREATE should be declared like this:

```

36         SUBROUTINE USER_FUNCTION(INVEC, INOUTVEC, LEN, DATATYPE)
37         <type> INVEC(LEN), INOUTVEC(LEN)
38         INTEGER LEN, DATATYPE

```

The copy and delete function arguments to MPI\_COMM\_CREATE\_KEYVAL should be declared like these:

```

42     SUBROUTINE COMM_COPY_ATTR_FUNCTION(OLDCOMM, COMM_KEYVAL, EXTRA_STATE,
43         ATTRIBUTE_VAL_IN, ATTRIBUTE_VAL_OUT, FLAG, IERROR)
44         INTEGER OLDCOMM, COMM_KEYVAL, IERROR
45         INTEGER(KIND=MPI_ADDRESS_KIND) EXTRA_STATE, ATTRIBUTE_VAL_IN,
46         ATTRIBUTE_VAL_OUT
47         LOGICAL FLAG

```



```

SUBROUTINE COMM_DELETE_ATTR_FUNCTION(COMM, COMM_KEYVAL, ATTRIBUTE_VAL,
    EXTRA_STATE, IERROR)
    INTEGER COMM, COMM_KEYVAL, IERROR
    INTEGER(KIND=MPI_ADDRESS_KIND) ATTRIBUTE_VAL, EXTRA_STATE

```

The copy and delete function arguments to MPI\_WIN\_CREATE\_KEYVAL should be declared like these:

```

SUBROUTINE WIN_COPY_ATTR_FUNCTION(OLDWIN, WIN_KEYVAL, EXTRA_STATE,
    ATTRIBUTE_VAL_IN, ATTRIBUTE_VAL_OUT, FLAG, IERROR)
    INTEGER OLDWIN, WIN_KEYVAL, IERROR
    INTEGER(KIND=MPI_ADDRESS_KIND) EXTRA_STATE, ATTRIBUTE_VAL_IN,
    ATTRIBUTE_VAL_OUT
    LOGICAL FLAG

```

```

SUBROUTINE WIN_DELETE_ATTR_FUNCTION(WIN, WIN_KEYVAL, ATTRIBUTE_VAL,
    EXTRA_STATE, IERROR)
    INTEGER WIN, WIN_KEYVAL, IERROR
    INTEGER(KIND=MPI_ADDRESS_KIND) ATTRIBUTE_VAL, EXTRA_STATE

```

The delete function argument to MPI\_SESSION\_CREATE\_KEYVAL should be declared like this:

```

SUBROUTINE SESSION_DELETE_ATTR_FUNCTION(SESSION, SESSION_KEYVAL, ATTRIBUTE_VAL,
    EXTRA_STATE, IERROR)
    INTEGER SESSION, SESSION_KEYVAL, IERROR
    INTEGER(KIND=MPI_ADDRESS_KIND) ATTRIBUTE_VAL, EXTRA_STATE

```

The copy and delete function arguments to MPI\_TYPE\_CREATE\_KEYVAL should be declared like these:

```

SUBROUTINE TYPE_COPY_ATTR_FUNCTION(OLDTYPE, TYPE_KEYVAL, EXTRA_STATE,
    ATTRIBUTE_VAL_IN, ATTRIBUTE_VAL_OUT, FLAG, IERROR)
    INTEGER OLDTYPE, TYPE_KEYVAL, IERROR
    INTEGER(KIND=MPI_ADDRESS_KIND) EXTRA_STATE, ATTRIBUTE_VAL_IN,
    ATTRIBUTE_VAL_OUT
    LOGICAL FLAG

```

```

SUBROUTINE TYPE_DELETE_ATTR_FUNCTION(DATATYPE, TYPE_KEYVAL, ATTRIBUTE_VAL,
    EXTRA_STATE, IERROR)
    INTEGER DATATYPE, TYPE_KEYVAL, IERROR
    INTEGER(KIND=MPI_ADDRESS_KIND) ATTRIBUTE_VAL, EXTRA_STATE

```

The handler-function argument to MPI\_COMM\_CREATE\_ERRHANDLER should be declared like this:

```

SUBROUTINE COMM_ERRHANDLER_FUNCTION(COMM, ERROR_CODE)
    INTEGER COMM, ERROR_CODE

```

The handler-function argument to MPI\_WIN\_CREATE\_ERRHANDLER should be declared like this:

```

SUBROUTINE WIN_ERRHANDLER_FUNCTION(WIN, ERROR_CODE)
    INTEGER WIN, ERROR_CODE

```

1 The handler-function argument to MPI\_FILE\_CREATE\_ERRHANDLER should be de-  
2 clared like this:

```
3 SUBROUTINE FILE_ERRHANDLER_FUNCTION(FILE, ERROR_CODE)
4     INTEGER FILE, ERROR_CODE
```

5  
6 The handler-function argument to MPI\_SESSION\_CREATE\_ERRHANDLER should be  
7 declared like this:

```
8 SUBROUTINE SESSION_ERRHANDLER_FUNCTION(SESSION, ERROR_CODE)
9     INTEGER SESSION, ERROR_CODE
```

10 The query, free, and cancel function arguments to MPI\_GREQUEST\_START should be  
11 declared like these:

```
12 SUBROUTINE GREQUEST_QUERY_FUNCTION(EXTRA_STATE, STATUS, IERROR)
13     INTEGER(KIND=MPI_ADDRESS_KIND) EXTRA_STATE
14     INTEGER STATUS(MPI_STATUS_SIZE), IERROR
```

```
15 SUBROUTINE GREQUEST_FREE_FUNCTION(EXTRA_STATE, IERROR)
16     INTEGER(KIND=MPI_ADDRESS_KIND) EXTRA_STATE
17     INTEGER IERROR
```

```
18  
19 SUBROUTINE GREQUEST_CANCEL_FUNCTION(EXTRA_STATE, COMPLETE, IERROR)
20     INTEGER(KIND=MPI_ADDRESS_KIND) EXTRA_STATE
21     LOGICAL COMPLETE
22     INTEGER IERROR
```

23  
24 The extent and conversion function arguments to MPI\_REGISTER\_DATAREP should  
25 be declared like these:

```
26 SUBROUTINE DATAREP_EXTENT_FUNCTION(DATATYPE, EXTENT, EXTRA_STATE, IERROR)
27     INTEGER DATATYPE, IERROR
28     INTEGER(KIND=MPI_ADDRESS_KIND) EXTENT, EXTRA_STATE
```

```
29 SUBROUTINE DATAREP_CONVERSION_FUNCTION(USERBUF, DATATYPE, COUNT, FILEBUF,
30     POSITION, EXTRA_STATE, IERROR)
31     <TYPE> USERBUF(*), FILEBUF(*)
32     INTEGER DATATYPE, COUNT, IERROR
33     INTEGER(KIND=MPI_OFFSET_KIND) POSITION
34     INTEGER(KIND=MPI_ADDRESS_KIND) EXTRA_STATE
```

#### 36 37 A.1.4 Deprecated Prototype Definitions

38 The following are defined C typedefs for deprecated user-defined functions, also included in  
39 the file `mpi.h`.

```
40  
41 /* prototypes for user-defined functions */
42  
43 typedef int MPI_Copy_function(MPI_Comm oldcomm, int keyval,
44     void *extra_state, void *attribute_val_in,
45     void *attribute_val_out, int *flag);
46  
47 typedef int MPI_Delete_function(MPI_Comm comm, int keyval,
48     void *attribute_val, void *extra_state);
```

The following are deprecated Fortran user-defined callback subroutine prototypes. The deprecated copy and delete function arguments to MPI\_KEYVAL\_CREATE should be declared like these:

```

SUBROUTINE COPY_FUNCTION(OLDCOMM, KEYVAL, EXTRA_STATE, ATTRIBUTE_VAL_IN,
    ATTRIBUTE_VAL_OUT, FLAG, IERR)
    INTEGER OLDCOMM, KEYVAL, EXTRA_STATE, ATTRIBUTE_VAL_IN,
    ATTRIBUTE_VAL_OUT, IERR
    LOGICAL FLAG

SUBROUTINE DELETE_FUNCTION(COMM, KEYVAL, ATTRIBUTE_VAL, EXTRA_STATE, IERR)
    INTEGER COMM, KEYVAL, ATTRIBUTE_VAL, EXTRA_STATE, IERR

```

### A.1.5 Info Keys

The following info keys are reserved. They are strings.

access\_style  
accumulate\_ops  
accumulate\_ordering  
alloc\_shared\_noncontig  
appnum  
arch  
cb\_block\_size  
cb\_buffer\_size  
cb\_nodes  
chunked\_item  
chunked\_size  
chunked  
collective\_buffering  
file  
file\_perm  
filename  
host  
io\_node\_list  
ip\_address  
ip\_port  
mpi\_assert\_allow\_overtaking  
mpi\_assert\_exact\_length  
mpi\_assert\_no\_any\_source  
mpi\_assert\_no\_any\_tag  
mpi\_assert\_strict\_start\_ordering  
mpi\_initial\_errhandler  
mpi\_optimization\_goal  
mpi\_reuse\_count  
mpi\_minimum\_memory\_alignment  
nb\_proc  
no\_locks  
num\_io\_nodes  
path

1 same\_disp\_unit  
2 same\_size  
3 soft  
4 striping\_factor  
5 striping\_unit  
6 wdir  
7  
8

### 9 A.1.6 Info Values

10 The following info values are reserved. They are strings.

11 false  
12 mpi\_errors\_abort  
13 mpi\_errors\_are\_fatal  
14 mpi\_errors\_return  
15 random  
16 rar  
17 raw  
18 read\_mostly  
19 read\_once  
20 reverse\_sequential  
21 same\_op  
22 same\_op\_no\_op  
23 sequential  
24 true  
25 war  
26 waw  
27 write\_mostly  
28 write\_once  
29  
30  
31  
32  
33  
34  
35  
36  
37  
38  
39  
40  
41  
42  
43  
44  
45  
46  
47  
48

## A.2 C Bindings

### A.2.1 Point-to-Point Communication C Bindings

#### C binding

```
int MPI_Bsend(const void *buf, int count, MPI_Datatype datatype, int dest,
              int tag, MPI_Comm comm)

int MPI_Bsend_init(const void *buf, int count, MPI_Datatype datatype,
                  int dest, int tag, MPI_Comm comm, MPI_Request *request)

int MPI_Buffer_attach(void *buffer, int size)

int MPI_Buffer_detach(void *buffer_addr, int *size)

int MPI_Cancel(MPI_Request *request)

int MPI_Get_count(const MPI_Status *status, MPI_Datatype datatype,
                 int *count)

int MPI_Ibsend(const void *buf, int count, MPI_Datatype datatype, int dest,
              int tag, MPI_Comm comm, MPI_Request *request)

int MPI_Improbe(int source, int tag, MPI_Comm comm, int *flag,
               MPI_Message *message, MPI_Status *status)

int MPI_Imrecv(void *buf, int count, MPI_Datatype datatype,
              MPI_Message *message, MPI_Request *request)

int MPI_Iprobe(int source, int tag, MPI_Comm comm, int *flag,
              MPI_Status *status)

int MPI_Irecv(void *buf, int count, MPI_Datatype datatype, int source,
             int tag, MPI_Comm comm, MPI_Request *request)

int MPI_Irsend(const void *buf, int count, MPI_Datatype datatype, int dest,
              int tag, MPI_Comm comm, MPI_Request *request)

int MPI_Isend(const void *buf, int count, MPI_Datatype datatype, int dest,
             int tag, MPI_Comm comm, MPI_Request *request)

int MPI_Issend(const void *buf, int count, MPI_Datatype datatype, int dest,
              int tag, MPI_Comm comm, MPI_Request *request)

int MPI_Mprobe(int source, int tag, MPI_Comm comm, MPI_Message *message,
              MPI_Status *status)

int MPI_Mrecv(void *buf, int count, MPI_Datatype datatype,
             MPI_Message *message, MPI_Status *status)

int MPI_Probe(int source, int tag, MPI_Comm comm, MPI_Status *status)

int MPI_Recv(void *buf, int count, MPI_Datatype datatype, int source,
            int tag, MPI_Comm comm, MPI_Status *status)

int MPI_Recv_init(void *buf, int count, MPI_Datatype datatype, int source,
                 int tag, MPI_Comm comm, MPI_Request *request)
```

```
1 int MPI_Request_free(MPI_Request *request)
2
3 int MPI_Request_get_status(MPI_Request request, int *flag,
4     MPI_Status *status)
5
6 int MPI_Rsend(const void *buf, int count, MPI_Datatype datatype, int dest,
7     int tag, MPI_Comm comm)
8
9 int MPI_Rsend_init(const void *buf, int count, MPI_Datatype datatype,
10     int dest, int tag, MPI_Comm comm, MPI_Request *request)
11
12 int MPI_Send(const void *buf, int count, MPI_Datatype datatype, int dest,
13     int tag, MPI_Comm comm)
14
15 int MPI_Send_init(const void *buf, int count, MPI_Datatype datatype,
16     int dest, int tag, MPI_Comm comm, MPI_Request *request)
17
18 int MPI_Sendrecv(const void *sendbuf, int sendcount, MPI_Datatype sendtype,
19     int dest, int sendtag, void *recvbuf, int recvcount,
20     MPI_Datatype recvtype, int source, int recvtag, MPI_Comm comm,
21     MPI_Status *status)
22
23 int MPI_Sendrecv_replace(void *buf, int count, MPI_Datatype datatype,
24     int dest, int sendtag, int source, int recvtag, MPI_Comm comm,
25     MPI_Status *status)
26
27 int MPI_Ssend(const void *buf, int count, MPI_Datatype datatype, int dest,
28     int tag, MPI_Comm comm)
29
30 int MPI_Ssend_init(const void *buf, int count, MPI_Datatype datatype,
31     int dest, int tag, MPI_Comm comm, MPI_Request *request)
32
33 int MPI_Start(MPI_Request *request)
34
35 int MPI_Startall(int count, MPI_Request array_of_requests[])
36
37 int MPI_Test(MPI_Request *request, int *flag, MPI_Status *status)
38
39 int MPI_Test_cancelled(const MPI_Status *status, int *flag)
40
41 int MPI_Testall(int count, MPI_Request array_of_requests[], int *flag,
42     MPI_Status array_of_statuses[])
43
44 int MPI_Testany(int count, MPI_Request array_of_requests[], int *index,
45     int *flag, MPI_Status *status)
46
47 int MPI_Testsome(int incount, MPI_Request array_of_requests[],
48     int *outcount, int array_of_indices[],
49     MPI_Status array_of_statuses[])
50
51 int MPI_Wait(MPI_Request *request, MPI_Status *status)
52
53 int MPI_Waitall(int count, MPI_Request array_of_requests[],
54     MPI_Status array_of_statuses[])
55
56 int MPI_Waitany(int count, MPI_Request array_of_requests[], int *index,
```

```
        MPI_Status *status) 1
int MPI_Waitsome(int incount, MPI_Request array_of_requests[], 2
        int *outcount, int array_of_indices[], 3
        MPI_Status array_of_statuses[]) 4
5
6
A.2.2 Datatypes C Bindings 7
MPI_Aint MPI_Aint_add(MPI_Aint base, MPI_Aint disp) 8
MPI_Aint MPI_Aint_diff(MPI_Aint addr1, MPI_Aint addr2) 9
int MPI_Get_address(const void *location, MPI_Aint *address) 10
int MPI_Pack(const void *inbuf, int incount, MPI_Datatype datatype, 11
        void *outbuf, int outsize, int *position, MPI_Comm comm) 12
int MPI_Pack_external(const char datarep[], const void *inbuf, int incount, 13
        MPI_Datatype datatype, void *outbuf, MPI_Aint outsize, 14
        MPI_Aint *position) 15
int MPI_Pack_external_size(const char datarep[], int incount, 16
        MPI_Datatype datatype, MPI_Aint *size) 17
int MPI_Pack_size(int incount, MPI_Datatype datatype, MPI_Comm comm, 18
        int *size) 19
int MPI_Type_commit(MPI_Datatype *datatype) 20
int MPI_Type_contiguous(int count, MPI_Datatype oldtype, 21
        MPI_Datatype *newtype) 22
int MPI_Type_create_darray(int size, int rank, int ndims, 23
        const int array_of_gsizes[], const int array_of_distrib[], 24
        const int array_of_dargs[], const int array_of_psize[], 25
        int order, MPI_Datatype oldtype, MPI_Datatype *newtype) 26
int MPI_Type_create_hindexed(int count, const int array_of_blocklengths[], 27
        const MPI_Aint array_of_displacements[], MPI_Datatype oldtype, 28
        MPI_Datatype *newtype) 29
int MPI_Type_create_hindexed_block(int count, int blocklength, 30
        const MPI_Aint array_of_displacements[], MPI_Datatype oldtype, 31
        MPI_Datatype *newtype) 32
int MPI_Type_create_hvector(int count, int blocklength, MPI_Aint stride, 33
        MPI_Datatype oldtype, MPI_Datatype *newtype) 34
int MPI_Type_create_indexed_block(int count, int blocklength, 35
        const int array_of_displacements[], MPI_Datatype oldtype, 36
        MPI_Datatype *newtype) 37
int MPI_Type_create_resized(MPI_Datatype oldtype, MPI_Aint lb, 38
        MPI_Aint extent, MPI_Datatype *newtype) 39
40
41
42
43
44
45
46
47
48
```

```
1 int MPI_Type_create_struct(int count, const int array_of_blocklengths[],
2     const MPI_Aint array_of_displacements[],
3     const MPI_Datatype array_of_types[], MPI_Datatype *newtype)
4
5 int MPI_Type_create_subarray(int ndims, const int array_of_sizes[],
6     const int array_of_subsizes[], const int array_of_starts[],
7     int order, MPI_Datatype oldtype, MPI_Datatype *newtype)
8
9 int MPI_Type_dup(MPI_Datatype oldtype, MPI_Datatype *newtype)
10
11 int MPI_Type_free(MPI_Datatype *datatype)
12
13 int MPI_Type_get_contents(MPI_Datatype datatype, int max_integers,
14     int max_addresses, int max_datatypes, int array_of_integers[],
15     MPI_Aint array_of_addresses[],
16     MPI_Datatype array_of_datatypes[])
17
18 int MPI_Type_get_elements(MPI_Status *status, MPI_Datatype datatype,
19     int *count)
20
21 int MPI_Type_get_elements_x(MPI_Status *status, MPI_Datatype datatype,
22     MPI_Count *count)
23
24 int MPI_Type_get_envelope(MPI_Datatype datatype, int *num_integers,
25     int *num_addresses, int *num_datatypes, int *combiner)
26
27 int MPI_Type_get_extent(MPI_Datatype datatype, MPI_Aint *lb,
28     MPI_Aint *extent)
29
30 int MPI_Type_get_extent_x(MPI_Datatype datatype, MPI_Count *lb,
31     MPI_Count *extent)
32
33 int MPI_Type_get_true_extent(MPI_Datatype datatype, MPI_Aint *true_lb,
34     MPI_Aint *true_extent)
35
36 int MPI_Type_get_true_extent_x(MPI_Datatype datatype, MPI_Count *true_lb,
37     MPI_Count *true_extent)
38
39 int MPI_Type_indexed(int count, const int array_of_blocklengths[],
40     const int array_of_displacements[], MPI_Datatype oldtype,
41     MPI_Datatype *newtype)
42
43 int MPI_Type_size(MPI_Datatype datatype, int *size)
44
45 int MPI_Type_size_x(MPI_Datatype datatype, MPI_Count *size)
46
47 int MPI_Type_vector(int count, int blocklength, int stride,
48     MPI_Datatype oldtype, MPI_Datatype *newtype)
49
50 int MPI_Unpack(const void *inbuf, int insize, int *position, void *outbuf,
51     int outcount, MPI_Datatype datatype, MPI_Comm comm)
52
53 int MPI_Unpack_external(const char datarep[], const void *inbuf,
54     MPI_Aint insize, MPI_Aint *position, void *outbuf,
55     int outcount, MPI_Datatype datatype)
```



## A.2.3 Collective Communication C Bindings

```
int MPI_Allgather(const void *sendbuf, int sendcount,
                 MPI_Datatype sendtype, void *recvbuf, int recvcnt,
                 MPI_Datatype recvtype, MPI_Comm comm)
int MPI_Allgather_init(const void *sendbuf, int sendcount,
                      MPI_Datatype sendtype, void *recvbuf, int recvcnt,
                      MPI_Datatype recvtype, MPI_Comm comm, MPI_Info info,
                      MPI_Request *request)
int MPI_Allgatherv(const void *sendbuf, int sendcount,
                  MPI_Datatype sendtype, void *recvbuf, const int recvcnts[],
                  const int displs[], MPI_Datatype recvtype, MPI_Comm comm)
int MPI_Allgatherv_init(const void *sendbuf, int sendcount,
                       MPI_Datatype sendtype, void *recvbuf, const int recvcnts[],
                       const int displs[], MPI_Datatype recvtype, MPI_Comm comm,
                       MPI_Info info, MPI_Request *request)
int MPI_Allreduce(const void *sendbuf, void *recvbuf, int count,
                 MPI_Datatype datatype, MPI_Op op, MPI_Comm comm)
int MPI_Allreduce_init(const void *sendbuf, void *recvbuf, int count,
                      MPI_Datatype datatype, MPI_Op op, MPI_Comm comm,
                      MPI_Info info, MPI_Request *request)
int MPI_Alltoall(const void *sendbuf, int sendcount, MPI_Datatype sendtype,
                void *recvbuf, int recvcnt, MPI_Datatype recvtype,
                MPI_Comm comm)
int MPI_Alltoall_init(const void *sendbuf, int sendcount,
                    MPI_Datatype sendtype, void *recvbuf, int recvcnt,
                    MPI_Datatype recvtype, MPI_Comm comm, MPI_Info info,
                    MPI_Request *request)
int MPI_Alltoallv(const void *sendbuf, const int sendcounts[],
                 const int sdispls[], MPI_Datatype sendtype, void *recvbuf,
                 const int recvcnts[], const int rdispls[],
                 MPI_Datatype recvtype, MPI_Comm comm)
int MPI_Alltoallv_init(const void *sendbuf, const int sendcounts[],
                     const int sdispls[], MPI_Datatype sendtype, void *recvbuf,
                     const int recvcnts[], const int rdispls[],
                     MPI_Datatype recvtype, MPI_Comm comm, MPI_Info info,
                     MPI_Request *request)
int MPI_Alltoallw(const void *sendbuf, const int sendcounts[],
                 const int sdispls[], const MPI_Datatype sendtypes[],
                 void *recvbuf, const int recvcnts[], const int rdispls[],
                 const MPI_Datatype recvtypes[], MPI_Comm comm)
int MPI_Alltoallw_init(const void *sendbuf, const int sendcounts[],
```

```
1         const int sdispls[], const MPI_Datatype sendtypes[],
2         void *recvbuf, const int recvcnts[], const int rdispls[],
3         const MPI_Datatype recvtypes[], MPI_Comm comm, MPI_Info info,
4         MPI_Request *request)
5
6 int MPI_Barrier(MPI_Comm comm)
7
8 int MPI_Barrier_init(MPI_Comm comm, MPI_Info info, MPI_Request *request)
9
10 int MPI_Bcast(void *buffer, int count, MPI_Datatype datatype, int root,
11             MPI_Comm comm)
12
13 int MPI_Bcast_init(void *buffer, int count, MPI_Datatype datatype,
14                 int root, MPI_Comm comm, MPI_Info info, MPI_Request *request)
15
16 int MPI_Exscan(const void *sendbuf, void *recvbuf, int count,
17             MPI_Datatype datatype, MPI_Op op, MPI_Comm comm)
18
19 int MPI_Exscan_init(const void *sendbuf, void *recvbuf, int count,
20                 MPI_Datatype datatype, MPI_Op op, MPI_Comm comm,
21                 MPI_Info info, MPI_Request *request)
22
23 int MPI_Gather(const void *sendbuf, int sendcount, MPI_Datatype sendtype,
24             void *recvbuf, int recvcnt, MPI_Datatype recvtpe, int root,
25             MPI_Comm comm)
26
27 int MPI_Gather_init(const void *sendbuf, int sendcount,
28                 MPI_Datatype sendtype, void *recvbuf, int recvcnt,
29                 MPI_Datatype recvtpe, int root, MPI_Comm comm, MPI_Info info,
30                 MPI_Request *request)
31
32 int MPI_Gatherv(const void *sendbuf, int sendcount, MPI_Datatype sendtype,
33             void *recvbuf, const int recvcnts[], const int displs[],
34             MPI_Datatype recvtpe, int root, MPI_Comm comm)
35
36 int MPI_Gatherv_init(const void *sendbuf, int sendcount,
37                 MPI_Datatype sendtype, void *recvbuf, const int recvcnts[],
38                 const int displs[], MPI_Datatype recvtpe, int root,
39                 MPI_Comm comm, MPI_Info info, MPI_Request *request)
40
41 int MPI_Iallgather(const void *sendbuf, int sendcount,
42                 MPI_Datatype sendtype, void *recvbuf, int recvcnt,
43                 MPI_Datatype recvtpe, MPI_Comm comm, MPI_Request *request)
44
45 int MPI_Iallgather(const void *sendbuf, int sendcount,
46                 MPI_Datatype sendtype, void *recvbuf, const int recvcnts[],
47                 const int displs[], MPI_Datatype recvtpe, MPI_Comm comm,
48                 MPI_Request *request)
49
50 int MPI_Iallreduce(const void *sendbuf, void *recvbuf, int count,
51                 MPI_Datatype datatype, MPI_Op op, MPI_Comm comm,
52                 MPI_Request *request)
53
54 int MPI_Ialltoall(const void *sendbuf, int sendcount,
```

```
    MPI_Datatype sendtype, void *recvbuf, int recvcnt, 1
    MPI_Datatype recvtype, MPI_Comm comm, MPI_Request *request) 2
3
int MPI_Ialltoallv(const void *sendbuf, const int sendcounts[], 4
    const int sdispls[], MPI_Datatype sendtype, void *recvbuf, 5
    const int recvcnts[], const int rdispls[], 6
    MPI_Datatype recvtype, MPI_Comm comm, MPI_Request *request) 7
8
int MPI_Ialltoallw(const void *sendbuf, const int sendcounts[], 8
    const int sdispls[], const MPI_Datatype sendtypes[], 9
    void *recvbuf, const int recvcnts[], const int rdispls[], 10
    const MPI_Datatype recvtypes[], MPI_Comm comm, 11
    MPI_Request *request) 12
13
int MPI_Ibarrier(MPI_Comm comm, MPI_Request *request) 14
15
int MPI_Ibcast(void *buffer, int count, MPI_Datatype datatype, int root,
    MPI_Comm comm, MPI_Request *request) 16
17
int MPI_Iexscan(const void *sendbuf, void *recvbuf, int count,
    MPI_Datatype datatype, MPI_Op op, MPI_Comm comm,
    MPI_Request *request) 18
19
int MPI_Igather(const void *sendbuf, int sendcount, MPI_Datatype sendtype,
    void *recvbuf, int recvcnt, MPI_Datatype recvtype, int root,
    MPI_Comm comm, MPI_Request *request) 21
22
int MPI_Igatherv(const void *sendbuf, int sendcount, MPI_Datatype sendtype,
    void *recvbuf, const int recvcnts[], const int displs[],
    MPI_Datatype recvtype, int root, MPI_Comm comm,
    MPI_Request *request) 25
26
int MPI_Ireduce(const void *sendbuf, void *recvbuf, int count,
    MPI_Datatype datatype, MPI_Op op, int root, MPI_Comm comm,
    MPI_Request *request) 29
30
int MPI_Ireduce_scatter(const void *sendbuf, void *recvbuf,
    const int recvcnts[], MPI_Datatype datatype, MPI_Op op,
    MPI_Comm comm, MPI_Request *request) 33
34
int MPI_Ireduce_scatter_block(const void *sendbuf, void *recvbuf,
    int recvcnt, MPI_Datatype datatype, MPI_Op op,
    MPI_Comm comm, MPI_Request *request) 37
38
int MPI_Iscan(const void *sendbuf, void *recvbuf, int count,
    MPI_Datatype datatype, MPI_Op op, MPI_Comm comm,
    MPI_Request *request) 40
41
int MPI_Iscatter(const void *sendbuf, int sendcount, MPI_Datatype sendtype,
    void *recvbuf, int recvcnt, MPI_Datatype recvtype, int root,
    MPI_Comm comm, MPI_Request *request) 44
45
int MPI_Iscatterv(const void *sendbuf, const int sendcounts[],
    const int displs[], MPI_Datatype sendtype, void *recvbuf, 47
48
```

```
1         int recvcount, MPI_Datatype recvtype, int root, MPI_Comm comm,
2         MPI_Request *request)
3
4     int MPI_Op_commutative(MPI_Op op, int *commute)
5
6     int MPI_Op_create(MPI_User_function *user_fn, int commute, MPI_Op *op)
7
8     int MPI_Op_free(MPI_Op *op)
9
10    int MPI_Reduce(const void *sendbuf, void *recvbuf, int count,
11                 MPI_Datatype datatype, MPI_Op op, int root, MPI_Comm comm)
12
13    int MPI_Reduce_init(const void *sendbuf, void *recvbuf, int count,
14                      MPI_Datatype datatype, MPI_Op op, int root, MPI_Comm comm,
15                      MPI_Info info, MPI_Request *request)
16
17    int MPI_Reduce_local(const void *inbuf, void *inoutbuf, int count,
18                      MPI_Datatype datatype, MPI_Op op)
19
20    int MPI_Reduce_scatter(const void *sendbuf, void *recvbuf,
21                          const int recvcounts[], MPI_Datatype datatype, MPI_Op op,
22                          MPI_Comm comm)
23
24    int MPI_Reduce_scatter_block(const void *sendbuf, void *recvbuf,
25                                int recvcount, MPI_Datatype datatype, MPI_Op op,
26                                MPI_Comm comm)
27
28    int MPI_Reduce_scatter_block_init(const void *sendbuf, void *recvbuf,
29                                     int recvcount, MPI_Datatype datatype, MPI_Op op,
30                                     MPI_Comm comm, MPI_Info info, MPI_Request *request)
31
32    int MPI_Reduce_scatter_init(const void *sendbuf, void *recvbuf,
33                               const int recvcounts[], MPI_Datatype datatype, MPI_Op op,
34                               MPI_Comm comm, MPI_Info info, MPI_Request *request)
35
36    int MPI_Scan(const void *sendbuf, void *recvbuf, int count,
37               MPI_Datatype datatype, MPI_Op op, MPI_Comm comm)
38
39    int MPI_Scan_init(const void *sendbuf, void *recvbuf, int count,
40                    MPI_Datatype datatype, MPI_Op op, MPI_Comm comm,
41                    MPI_Info info, MPI_Request *request)
42
43    int MPI_Scatter(const void *sendbuf, int sendcount, MPI_Datatype sendtype,
44                  void *recvbuf, int recvcount, MPI_Datatype recvtype, int root,
45                  MPI_Comm comm)
46
47    int MPI_Scatter_init(const void *sendbuf, int sendcount,
48                       MPI_Datatype sendtype, void *recvbuf, int recvcount,
49                       MPI_Datatype recvtype, int root, MPI_Comm comm, MPI_Info info,
50                       MPI_Request *request)
51
52    int MPI_Scatterv(const void *sendbuf, const int sendcounts[],
53                   const int displs[], MPI_Datatype sendtype, void *recvbuf,
54                   int recvcount, MPI_Datatype recvtype, int root, MPI_Comm comm)
```

```

int MPI_Scatterv_init(const void *sendbuf, const int sendcounts[],
                    const int displs[], MPI_Datatype sendtype, void *recvbuf,
                    int recvcnt, MPI_Datatype recvtype, int root, MPI_Comm comm,
                    MPI_Info info, MPI_Request *request)

```

#### A.2.4 Groups, Contexts, Communicators, and Caching C Bindings

```

int MPI_COMM_DUP_FN(MPI_Comm oldcomm, int comm_keyval, void *extra_state,
                   void *attribute_val_in, void *attribute_val_out, int *flag)

int MPI_COMM_NULL_COPY_FN(MPI_Comm oldcomm, int comm_keyval,
                          void *extra_state, void *attribute_val_in,
                          void *attribute_val_out, int *flag)

int MPI_COMM_NULL_DELETE_FN(MPI_Comm comm, int comm_keyval,
                            void *attribute_val, void *extra_state)

int MPI_Comm_compare(MPI_Comm comm1, MPI_Comm comm2, int *result)

int MPI_Comm_create(MPI_Comm comm, MPI_Group group, MPI_Comm *newcomm)

int MPI_Comm_create_from_group(MPI_Group group, const char *stringtag,
                              MPI_Info info, MPI_Errhandler errhandler, MPI_Comm *newcomm)

int MPI_Comm_create_group(MPI_Comm comm, MPI_Group group, int tag,
                          MPI_Comm *newcomm)

int MPI_Comm_create_keyval(MPI_Comm_copy_attr_function *comm_copy_attr_fn,
                          MPI_Comm_delete_attr_function *comm_delete_attr_fn,
                          int *comm_keyval, void *extra_state)

int MPI_Comm_delete_attr(MPI_Comm comm, int comm_keyval)

int MPI_Comm_dup(MPI_Comm comm, MPI_Comm *newcomm)

int MPI_Comm_dup_with_info(MPI_Comm comm, MPI_Info info, MPI_Comm *newcomm)

int MPI_Comm_free(MPI_Comm *comm)

int MPI_Comm_free_keyval(int *comm_keyval)

int MPI_Comm_get_attr(MPI_Comm comm, int comm_keyval, void *attribute_val,
                    int *flag)

int MPI_Comm_get_info(MPI_Comm comm, MPI_Info *info_used)

int MPI_Comm_get_name(MPI_Comm comm, char *comm_name, int *resultlen)

int MPI_Comm_group(MPI_Comm comm, MPI_Group *group)

int MPI_Comm_idup(MPI_Comm comm, MPI_Comm *newcomm, MPI_Request *request)

int MPI_Comm_idup_with_info(MPI_Comm comm, MPI_Info info,
                          MPI_Comm *newcomm, MPI_Request *request)

int MPI_Comm_rank(MPI_Comm comm, int *rank)

```

```
1 int MPI_Comm_remote_group(MPI_Comm comm, MPI_Group *group)
2
3 int MPI_Comm_remote_size(MPI_Comm comm, int *size)
4
5 int MPI_Comm_set_attr(MPI_Comm comm, int comm_keyval, void *attribute_val)
6
7 int MPI_Comm_set_info(MPI_Comm comm, MPI_Info info)
8
9 int MPI_Comm_set_name(MPI_Comm comm, const char *comm_name)
10
11 int MPI_Comm_size(MPI_Comm comm, int *size)
12
13 int MPI_Comm_split(MPI_Comm comm, int color, int key, MPI_Comm *newcomm)
14
15 int MPI_Comm_split_type(MPI_Comm comm, int split_type, int key,
16 MPI_Info info, MPI_Comm *newcomm)
17
18 int MPI_Comm_test_inter(MPI_Comm comm, int *flag)
19
20 int MPI_Group_compare(MPI_Group group1, MPI_Group group2, int *result)
21
22 int MPI_Group_difference(MPI_Group group1, MPI_Group group2,
23 MPI_Group *newgroup)
24
25 int MPI_Group_excl(MPI_Group group, int n, const int ranks[],
26 MPI_Group *newgroup)
27
28 int MPI_Group_free(MPI_Group *group)
29
30 int MPI_Group_from_session_pset(MPI_Session session, const char *pset_name,
31 MPI_Group *newgroup)
32
33 int MPI_Group_incl(MPI_Group group, int n, const int ranks[],
34 MPI_Group *newgroup)
35
36 int MPI_Group_intersection(MPI_Group group1, MPI_Group group2,
37 MPI_Group *newgroup)
38
39 int MPI_Group_range_excl(MPI_Group group, int n, int ranges[][3],
40 MPI_Group *newgroup)
41
42 int MPI_Group_range_incl(MPI_Group group, int n, int ranges[][3],
43 MPI_Group *newgroup)
44
45 int MPI_Group_rank(MPI_Group group, int *rank)
46
47 int MPI_Group_size(MPI_Group group, int *size)
48
49 int MPI_Group_translate_ranks(MPI_Group group1, int n, const int ranks1[],
50 MPI_Group group2, int ranks2[])
51
52 int MPI_Group_union(MPI_Group group1, MPI_Group group2,
53 MPI_Group *newgroup)
54
55 int MPI_Intercomm_create(MPI_Comm local_comm, int local_leader,
56 MPI_Comm peer_comm, int remote_leader, int tag,
57 MPI_Comm *newintercomm)
58
```

```
int MPI_Intercomm_create_from_groups(MPI_Group local_group,      1
    int local_leader, MPI_Group remote_group, int remote_leader, 2
    const char *stringtag, MPI_Info info,                        3
    MPI_Errhandler errhandler, MPI_Comm *newintercomm)          4
                                                                5
int MPI_Intercomm_merge(MPI_Comm intercomm, int high,           6
    MPI_Comm *newintracomm)                                     7
                                                                8
int MPI_TYPE_DUP_FN(MPI_Datatype oldtype, int type_keyval,     9
    void *extra_state, void *attribute_val_in,                 10
    void *attribute_val_out, int *flag)                         11
                                                                12
int MPI_TYPE_NULL_COPY_FN(MPI_Datatype oldtype, int type_keyval, 13
    void *extra_state, void *attribute_val_in,                 14
    void *attribute_val_out, int *flag)                         15
                                                                16
int MPI_TYPE_NULL_DELETE_FN(MPI_Datatype datatype, int type_keyval, 17
    void *attribute_val, void *extra_state)                     18
                                                                19
int MPI_Type_create_keyval(MPI_Type_copy_attr_function *type_copy_attr_fn, 18
    MPI_Type_delete_attr_function *type_delete_attr_fn,        19
    int *type_keyval, void *extra_state)                       20
                                                                21
int MPI_Type_delete_attr(MPI_Datatype datatype, int type_keyval) 21
                                                                22
int MPI_Type_free_keyval(int *type_keyval)                     23
                                                                24
int MPI_Type_get_attr(MPI_Datatype datatype, int type_keyval,  24
    void *attribute_val, int *flag)                            25
                                                                26
int MPI_Type_get_name(MPI_Datatype datatype, char *type_name,  27
    int *resultlen)                                           28
                                                                29
int MPI_Type_set_attr(MPI_Datatype datatype, int type_keyval,  29
    void *attribute_val)                                       30
                                                                31
int MPI_Type_set_name(MPI_Datatype datatype, const char *type_name) 32
                                                                33
int MPI_WIN_DUP_FN(MPI_Win oldwin, int win_keyval, void *extra_state, 34
    void *attribute_val_in, void *attribute_val_out, int *flag) 35
                                                                36
int MPI_WIN_NULL_COPY_FN(MPI_Win oldwin, int win_keyval, void *extra_state, 36
    void *attribute_val_in, void *attribute_val_out, int *flag) 37
                                                                38
int MPI_WIN_NULL_DELETE_FN(MPI_Win win, int win_keyval,        38
    void *attribute_val, void *extra_state)                    39
                                                                40
int MPI_Win_create_keyval(MPI_Win_copy_attr_function *win_copy_attr_fn, 41
    MPI_Win_delete_attr_function *win_delete_attr_fn,          42
    int *win_keyval, void *extra_state)                        43
                                                                44
int MPI_Win_delete_attr(MPI_Win win, int win_keyval)          44
                                                                45
int MPI_Win_free_keyval(int *win_keyval)                       46
                                                                47
int MPI_Win_get_attr(MPI_Win win, int win_keyval, void *attribute_val, 47
                                                                48
```

```

1         int *flag)
2
3     int MPI_Win_get_name(MPI_Win win, char *win_name, int *resultlen)
4
5     int MPI_Win_set_attr(MPI_Win win, int win_keyval, void *attribute_val)
6
7     int MPI_Win_set_name(MPI_Win win, const char *win_name)

```

### A.2.5 Process Topologies C Bindings

```

9
10    int MPI_Cart_coords(MPI_Comm comm, int rank, int maxdims, int coords[])
11
12    int MPI_Cart_create(MPI_Comm comm_old, int ndims, const int dims[],
13                       const int periods[], int reorder, MPI_Comm *comm_cart)
14
15    int MPI_Cart_get(MPI_Comm comm, int maxdims, int dims[], int periods[],
16                   int coords[])
17
18    int MPI_Cart_map(MPI_Comm comm, int ndims, const int dims[],
19                   const int periods[], int *newrank)
20
21    int MPI_Cart_rank(MPI_Comm comm, const int coords[], int *rank)
22
23    int MPI_Cart_shift(MPI_Comm comm, int direction, int disp,
24                      int *rank_source, int *rank_dest)
25
26    int MPI_Cart_sub(MPI_Comm comm, const int remain_dims[], MPI_Comm *newcomm)
27
28    int MPI_Cartdim_get(MPI_Comm comm, int *ndims)
29
30    int MPI_Dims_create(int nnodes, int ndims, int dims[])
31
32    int MPI_Dist_graph_create(MPI_Comm comm_old, int n, const int sources[],
33                             const int degrees[], const int destinations[],
34                             const int weights[], MPI_Info info, int reorder,
35                             MPI_Comm *comm_dist_graph)
36
37    int MPI_Dist_graph_create_adjacent(MPI_Comm comm_old, int indegree,
38                                       const int sources[], const int sourceweights[], int outdegree,
39                                       const int destinations[], const int destweights[],
40                                       MPI_Info info, int reorder, MPI_Comm *comm_dist_graph)
41
42    int MPI_Dist_graph_neighbors(MPI_Comm comm, int maxindegree, int sources[],
43                                 int sourceweights[], int maxoutdegree, int destinations[],
44                                 int destweights[])
45
46    int MPI_Dist_graph_neighbors_count(MPI_Comm comm, int *indegree,
47                                       int *outdegree, int *weighted)
48
49    int MPI_Graph_create(MPI_Comm comm_old, int nnodes, const int index[],
50                        const int edges[], int reorder, MPI_Comm *comm_graph)
51
52    int MPI_Graph_get(MPI_Comm comm, int maxindex, int maxedges, int index[],
53                     int edges[])

```



```
int MPI_Graph_map(MPI_Comm comm, int nnodes, const int index[],           1
                  const int edges[], int *newrank)                       2
int MPI_Graph_neighbors(MPI_Comm comm, int rank, int maxneighbors,       3
                        int neighbors[])                                 4
int MPI_Graph_neighbors_count(MPI_Comm comm, int rank, int *nneighbors)  5
int MPI_Graphdims_get(MPI_Comm comm, int *nnodes, int *nedges)         6
int MPI_Ineighbor_allgather(const void *sendbuf, int sendcount,         7
                             MPI_Datatype sendtype, void *recvbuf, int  8
                             recvcount, MPI_Datatype recvtype, MPI_Comm  9
                             comm, MPI_Request *request)              10
int MPI_Ineighbor_allgatherv(const void *sendbuf, int sendcount,       11
                              MPI_Datatype sendtype, void *recvbuf,    12
                              const int recvcnts[], MPI_Datatype        13
                              recvtype, MPI_Comm comm, MPI_Request     14
                              *request)                                15
int MPI_Ineighbor_alltoall(const void *sendbuf, int sendcount,        16
                            MPI_Datatype sendtype, void *recvbuf,     17
                            MPI_Datatype recvtype, MPI_Comm comm,     18
                            MPI_Request *request)                    19
int MPI_Ineighbor_alltoallv(const void *sendbuf, const int sendcounts[], 20
                             const int sdispls[], MPI_Datatype         21
                             sendtype, void *recvbuf,                 22
                             const int recvcnts[], const int rdispls[], 23
                             MPI_Datatype recvtype, MPI_Comm comm,     24
                             MPI_Request *request)                  25
int MPI_Ineighbor_alltoallw(const void *sendbuf, const int sendcounts[], 26
                             const MPI_Aint sdispls[], const MPI_Datatype 27
                             sendtypes[], void *recvbuf, const int      28
                             recvcnts[], const MPI_Aint rdispls[],     29
                             const MPI_Datatype recvtypes[], MPI_Comm  30
                             comm, MPI_Request *request)            31
int MPI_Neighbor_allgather(const void *sendbuf, int sendcount,         32
                            MPI_Datatype sendtype, void *recvbuf,     33
                            MPI_Datatype recvtype, MPI_Comm comm)     34
int MPI_Neighbor_allgather_init(const void *sendbuf, int sendcount,    35
                                 MPI_Datatype sendtype, void *recvbuf,  36
                                 MPI_Datatype recvtype, MPI_Comm comm,  37
                                 MPI_Info info, MPI_Request *request)  38
int MPI_Neighbor_allgatherv(const void *sendbuf, int sendcount,       39
                              MPI_Datatype sendtype, void *recvbuf,   40
                              const int recvcnts[], MPI_Datatype       41
                              recvtype, MPI_Comm comm)                42
int MPI_Neighbor_allgatherv_init(const void *sendbuf, int sendcount,   43
                                  MPI_Datatype sendtype, void *recvbuf, 44
                                  const int recvcnts[], MPI_Datatype    45
                                  recvtype, MPI_Comm comm, MPI_Info    46
                                  info, MPI_Request *request)         47
int MPI_Neighbor_alltoall(const void *sendbuf, int sendcount,         48
                           MPI_Datatype sendtype, void *recvbuf,     49
```

```

1         MPI_Datatype recvtype, MPI_Comm comm)
2
3     int MPI_Neighbor_alltoall_init(const void *sendbuf, int sendcount,
4         MPI_Datatype sendtype, void *recvbuf, int recvcnt,
5         MPI_Datatype recvtype, MPI_Comm comm, MPI_Info info,
6         MPI_Request *request)
7
8     int MPI_Neighbor_alltoallv(const void *sendbuf, const int sendcounts[],
9         const int sdispls[], MPI_Datatype sendtype, void *recvbuf,
10        const int recvcnts[], const int rdispls[],
11        MPI_Datatype recvtype, MPI_Comm comm)
12
13    int MPI_Neighbor_alltoallv_init(const void *sendbuf,
14        const int sendcounts[], const int sdispls[],
15        MPI_Datatype sendtype, void *recvbuf, const int recvcnts[],
16        const int rdispls[], MPI_Datatype recvtype, MPI_Comm comm,
17        MPI_Info info, MPI_Request *request)
18
19    int MPI_Neighbor_alltoallw(const void *sendbuf, const int sendcounts[],
20        const MPI_Aint sdispls[], const MPI_Datatype sendtypes[],
21        void *recvbuf, const int recvcnts[],
22        const MPI_Aint rdispls[], const MPI_Datatype recvtypes[],
23        MPI_Comm comm)
24
25    int MPI_Neighbor_alltoallw_init(const void *sendbuf,
26        const int sendcounts[], const MPI_Aint sdispls[],
27        const MPI_Datatype sendtypes[], void *recvbuf,
28        const int recvcnts[], const MPI_Aint rdispls[],
29        const MPI_Datatype recvtypes[], MPI_Comm comm, MPI_Info info,
30        MPI_Request *request)
31
32    int MPI_Topo_test(MPI_Comm comm, int *status)

```

## A.2.6 MPI Environmental Management C Bindings

```

33    double MPI_Wtick(void)
34
35    double MPI_Wtime(void)
36
37    int MPI_Add_error_class(int *errorclass)
38
39    int MPI_Add_error_code(int errorclass, int *errorcode)
40
41    int MPI_Add_error_string(int errorcode, const char *string)
42
43    int MPI_Alloc_mem(MPI_Aint size, MPI_Info info, void *baseptr)
44
45    int MPI_Comm_call_errhandler(MPI_Comm comm, int errorcode)
46
47    int MPI_Comm_create_errhandler(MPI_Comm_errhandler_function
48        *comm_errhandler_fn, MPI_Errhandler *errhandler)

```

```
int MPI_Comm_set_errhandler(MPI_Comm comm, MPI_Errhandler errhandler) 1
int MPI_Errhandler_free(MPI_Errhandler *errhandler) 2
int MPI_Error_class(int errorcode, int *errorclass) 3
int MPI_Error_string(int errorcode, char *string, int *resultlen) 4
int MPI_File_call_errhandler(MPI_File fh, int errorcode) 5
int MPI_File_create_errhandler(MPI_File_errhandler_function 6
    *file_errhandler_fn, MPI_Errhandler *errhandler) 7
int MPI_File_get_errhandler(MPI_File file, MPI_Errhandler *errhandler) 8
int MPI_File_set_errhandler(MPI_File file, MPI_Errhandler errhandler) 9
int MPI_Free_mem(void *base) 10
int MPI_Get_library_version(char *version, int *resultlen) 11
int MPI_Get_processor_name(char *name, int *resultlen) 12
int MPI_Get_version(int *version, int *subversion) 13
int MPI_Session_call_errhandler(MPI_Session session, int errorcode) 14
int MPI_Session_create_errhandler(MPI_Session_errhandler_function 15
    *session_errhandler_fn, MPI_Errhandler *errhandler) 16
int MPI_Session_get_errhandler(MPI_Session session, 17
    MPI_Errhandler *errhandler) 18
int MPI_Session_set_errhandler(MPI_Session session, 19
    MPI_Errhandler errhandler) 20
int MPI_Win_call_errhandler(MPI_Win win, int errorcode) 21
int MPI_Win_create_errhandler(MPI_Win_errhandler_function 22
    *win_errhandler_fn, MPI_Errhandler *errhandler) 23
int MPI_Win_get_errhandler(MPI_Win win, MPI_Errhandler *errhandler) 24
int MPI_Win_set_errhandler(MPI_Win win, MPI_Errhandler errhandler) 25
```

### A.2.7 The Info Object C Bindings

```
int MPI_Info_create(MPI_Info *info) 26
int MPI_Info_delete(MPI_Info info, const char *key) 27
int MPI_Info_dup(MPI_Info info, MPI_Info *newinfo) 28
int MPI_Info_free(MPI_Info *info) 29
int MPI_Info_get(MPI_Info info, const char *key, int valuelen, char *value, 30
    int *flag) 31
int MPI_Info_get_nkeys(MPI_Info info, int *nkeys) 32
```

```
1 int MPI_Info_get_nthkey(MPI_Info info, int n, char *key)
2
3 int MPI_Info_get_string(MPI_Info info, const char *key, int *buflen,
4     char *value, int *flag)
5
6 int MPI_Info_get_valuelen(MPI_Info info, const char *key, int *valuelen,
7     int *flag)
8
9 int MPI_Info_set(MPI_Info info, const char *key, const char *value)
10
11 A.2.8 Process Creation and Management C Bindings
12
13 int MPI_Abort(MPI_Comm comm, int errorcode)
14
15 int MPI_Close_port(const char *port_name)
16
17 int MPI_Comm_accept(const char *port_name, MPI_Info info, int root,
18     MPI_Comm comm, MPI_Comm *newcomm)
19
20 int MPI_Comm_connect(const char *port_name, MPI_Info info, int root,
21     MPI_Comm comm, MPI_Comm *newcomm)
22
23 int MPI_Comm_disconnect(MPI_Comm *comm)
24
25 int MPI_Comm_get_parent(MPI_Comm *parent)
26
27 int MPI_Comm_join(int fd, MPI_Comm *intercomm)
28
29 int MPI_Comm_spawn(const char *command, char *argv[], int maxprocs,
30     MPI_Info info, int root, MPI_Comm comm, MPI_Comm *intercomm,
31     int array_of_errcodes[])
32
33 int MPI_Comm_spawn_multiple(int count, char *array_of_commands[],
34     char **array_of_argv[], const int array_of_maxprocs[],
35     const MPI_Info array_of_info[], int root, MPI_Comm comm,
36     MPI_Comm *intercomm, int array_of_errcodes[])
37
38 int MPI_Finalize(void)
39
40 int MPI_Finalized(int *flag)
41
42 int MPI_Init(int *argc, char ***argv)
43
44 int MPI_Init_thread(int *argc, char ***argv, int required, int *provided)
45
46 int MPI_Initialized(int *flag)
47
48 int MPI_Is_thread_main(int *flag)
49
50 int MPI_Lookup_name(const char *service_name, MPI_Info info,
51     char *port_name)
52
53 int MPI_Open_port(MPI_Info info, char *port_name)
54
55 int MPI_Publish_name(const char *service_name, MPI_Info info,
56     const char *port_name)
```

```
int MPI_Query_thread(int *provided) 1
int MPI_Session_finalize(MPI_Session *session) 2
int MPI_Session_get_info(MPI_Session session, MPI_Info *info_used) 3
int MPI_Session_get_nth_pset(MPI_Session session, MPI_Info info, int n, 4
    int *pset_len, char *pset_name) 5
int MPI_Session_get_num_psets(MPI_Session session, MPI_Info info, 6
    int *npset_names) 7
int MPI_Session_get_pset_info(MPI_Session session, const char *pset_name, 8
    MPI_Info *info) 9
int MPI_Session_init(MPI_Info info, MPI_Errhandler errhandler, 10
    MPI_Session *session) 11
int MPI_Unpublish_name(const char *service_name, MPI_Info info, 12
    const char *port_name) 13
int MPI_Unpublish_name(const char *service_name, MPI_Info info, 14
    const char *port_name) 15
int MPI_Unpublish_name(const char *service_name, MPI_Info info, 16
    const char *port_name) 17
int MPI_Unpublish_name(const char *service_name, MPI_Info info, 18
    const char *port_name) 19
```

### A.2.9 One-Sided Communications C Bindings

```
int MPI_Accumulate(const void *origin_addr, int origin_count, 20
    MPI_Datatype origin_datatype, int target_rank, 21
    MPI_Aint target_disp, int target_count, 22
    MPI_Datatype target_datatype, MPI_Op op, MPI_Win win) 23
int MPI_Compare_and_swap(const void *origin_addr, const void *compare_addr, 24
    void *result_addr, MPI_Datatype datatype, int target_rank, 25
    MPI_Aint target_disp, MPI_Win win) 26
int MPI_Fetch_and_op(const void *origin_addr, void *result_addr, 27
    MPI_Datatype datatype, int target_rank, MPI_Aint target_disp, 28
    MPI_Op op, MPI_Win win) 29
int MPI_Get(void *origin_addr, int origin_count, 30
    MPI_Datatype origin_datatype, int target_rank, 31
    MPI_Aint target_disp, int target_count, 32
    MPI_Datatype target_datatype, MPI_Win win) 33
int MPI_Get_accumulate(const void *origin_addr, int origin_count, 34
    MPI_Datatype origin_datatype, void *result_addr, 35
    int result_count, MPI_Datatype result_datatype, 36
    int target_rank, MPI_Aint target_disp, int target_count, 37
    MPI_Datatype target_datatype, MPI_Op op, MPI_Win win) 38
int MPI_Put(const void *origin_addr, int origin_count, 39
    MPI_Datatype origin_datatype, int target_rank, 40
    MPI_Aint target_disp, int target_count, 41
    MPI_Datatype target_datatype, MPI_Win win) 42
int MPI_Raccumulate(const void *origin_addr, int origin_count, 43
    MPI_Datatype origin_datatype, int target_rank, 44
    MPI_Aint target_disp, int target_count, 45
    MPI_Datatype target_datatype, MPI_Win win) 46
int MPI_Raccumulate(const void *origin_addr, int origin_count, 47
    MPI_Datatype origin_datatype, int target_rank, 48
    MPI_Aint target_disp, int target_count, 49
    MPI_Datatype target_datatype, MPI_Win win) 50
```

```
1      MPI_Datatype origin_datatype, int target_rank,
2      MPI_Aint target_disp, int target_count,
3      MPI_Datatype target_datatype, MPI_Op op, MPI_Win win,
4      MPI_Request *request)
5
6  int MPI_Rget(void *origin_addr, int origin_count,
7      MPI_Datatype origin_datatype, int target_rank,
8      MPI_Aint target_disp, int target_count,
9      MPI_Datatype target_datatype, MPI_Win win,
10     MPI_Request *request)
11
12 int MPI_Rget_accumulate(const void *origin_addr, int origin_count,
13     MPI_Datatype origin_datatype, void *result_addr,
14     int result_count, MPI_Datatype result_datatype,
15     int target_rank, MPI_Aint target_disp, int target_count,
16     MPI_Datatype target_datatype, MPI_Op op, MPI_Win win,
17     MPI_Request *request)
18
19 int MPI_Rput(const void *origin_addr, int origin_count,
20     MPI_Datatype origin_datatype, int target_rank,
21     MPI_Aint target_disp, int target_count,
22     MPI_Datatype target_datatype, MPI_Win win,
23     MPI_Request *request)
24
25 int MPI_Win_allocate(MPI_Aint size, int disp_unit, MPI_Info info,
26     MPI_Comm comm, void *baseptr, MPI_Win *win)
27
28 int MPI_Win_allocate_shared(MPI_Aint size, int disp_unit, MPI_Info info,
29     MPI_Comm comm, void *baseptr, MPI_Win *win)
30
31 int MPI_Win_attach(MPI_Win win, void *base, MPI_Aint size)
32
33 int MPI_Win_complete(MPI_Win win)
34
35 int MPI_Win_create(void *base, MPI_Aint size, int disp_unit, MPI_Info info,
36     MPI_Comm comm, MPI_Win *win)
37
38 int MPI_Win_create_dynamic(MPI_Info info, MPI_Comm comm, MPI_Win *win)
39
40 int MPI_Win_detach(MPI_Win win, const void *base)
41
42 int MPI_Win_fence(int assert, MPI_Win win)
43
44 int MPI_Win_flush(int rank, MPI_Win win)
45
46 int MPI_Win_flush_all(MPI_Win win)
47
48 int MPI_Win_flush_local(int rank, MPI_Win win)
49
50 int MPI_Win_flush_local_all(MPI_Win win)
51
52 int MPI_Win_free(MPI_Win *win)
53
54 int MPI_Win_get_group(MPI_Win win, MPI_Group *group)
55
56 int MPI_Win_get_info(MPI_Win win, MPI_Info *info_used)
```

```
int MPI_Win_lock(int lock_type, int rank, int assert, MPI_Win win) 1
int MPI_Win_lock_all(int assert, MPI_Win win) 2
int MPI_Win_post(MPI_Group group, int assert, MPI_Win win) 3
int MPI_Win_set_info(MPI_Win win, MPI_Info info) 4
int MPI_Win_shared_query(MPI_Win win, int rank, MPI_Aint *size, 5
    int *disp_unit, void *baseptr) 6
int MPI_Win_start(MPI_Group group, int assert, MPI_Win win) 7
int MPI_Win_sync(MPI_Win win) 8
int MPI_Win_test(MPI_Win win, int *flag) 9
int MPI_Win_unlock(int rank, MPI_Win win) 10
int MPI_Win_unlock_all(MPI_Win win) 11
int MPI_Win_wait(MPI_Win win) 12
```

#### A.2.10 External Interfaces C Bindings

```
int MPI_Grequest_complete(MPI_Request request) 13
int MPI_Grequest_start(MPI_Grequest_query_function *query_fn, 14
    MPI_Grequest_free_function *free_fn, 15
    MPI_Grequest_cancel_function *cancel_fn, void *extra_state, 16
    MPI_Request *request) 17
int MPI_Status_set_cancelled(MPI_Status *status, int flag) 18
int MPI_Status_set_elements(MPI_Status *status, MPI_Datatype datatype, 19
    int count) 20
int MPI_Status_set_elements_x(MPI_Status *status, MPI_Datatype datatype, 21
    MPI_Count count) 22
```

#### A.2.11 I/O C Bindings

```
int MPI_CONVERSION_FN_NULL(void *userbuf, MPI_Datatype datatype, int count, 23
    void *filebuf, MPI_Offset position, void *extra_state) 24
int MPI_File_close(MPI_File *fh) 25
int MPI_File_delete(const char *filename, MPI_Info info) 26
int MPI_File_get_amode(MPI_File fh, int *amode) 27
int MPI_File_get_atomicity(MPI_File fh, int *flag) 28
int MPI_File_get_byte_offset(MPI_File fh, MPI_Offset offset, 29
    MPI_Offset *disp) 30
int MPI_File_get_group(MPI_File fh, MPI_Group *group) 31
```

```
1 int MPI_File_get_info(MPI_File fh, MPI_Info *info_used)
2
3 int MPI_File_get_position(MPI_File fh, MPI_Offset *offset)
4
5 int MPI_File_get_position_shared(MPI_File fh, MPI_Offset *offset)
6
7 int MPI_File_get_size(MPI_File fh, MPI_Offset *size)
8
9 int MPI_File_get_type_extent(MPI_File fh, MPI_Datatype datatype,
10 MPI_Aint *extent)
11
12 int MPI_File_get_view(MPI_File fh, MPI_Offset *disp, MPI_Datatype *etype,
13 MPI_Datatype *filetype, char *datarep)
14
15 int MPI_File_iread(MPI_File fh, void *buf, int count,
16 MPI_Datatype datatype, MPI_Request *request)
17
18 int MPI_File_iread_all(MPI_File fh, void *buf, int count,
19 MPI_Datatype datatype, MPI_Request *request)
20
21 int MPI_File_iread_at(MPI_File fh, MPI_Offset offset, void *buf, int count,
22 MPI_Datatype datatype, MPI_Request *request)
23
24 int MPI_File_iread_at_all(MPI_File fh, MPI_Offset offset, void *buf,
25 int count, MPI_Datatype datatype, MPI_Request *request)
26
27 int MPI_File_iread_shared(MPI_File fh, void *buf, int count,
28 MPI_Datatype datatype, MPI_Request *request)
29
30 int MPI_File_iwrite(MPI_File fh, const void *buf, int count,
31 MPI_Datatype datatype, MPI_Request *request)
32
33 int MPI_File_iwrite_all(MPI_File fh, const void *buf, int count,
34 MPI_Datatype datatype, MPI_Request *request)
35
36 int MPI_File_iwrite_at(MPI_File fh, MPI_Offset offset, const void *buf,
37 int count, MPI_Datatype datatype, MPI_Request *request)
38
39 int MPI_File_iwrite_at_all(MPI_File fh, MPI_Offset offset, const void *buf,
40 int count, MPI_Datatype datatype, MPI_Request *request)
41
42 int MPI_File_iwrite_shared(MPI_File fh, const void *buf, int count,
43 MPI_Datatype datatype, MPI_Request *request)
44
45 int MPI_File_open(MPI_Comm comm, const char *filename, int amode,
46 MPI_Info info, MPI_File *fh)
47
48 int MPI_File_preallocate(MPI_File fh, MPI_Offset size)
49
50 int MPI_File_read(MPI_File fh, void *buf, int count, MPI_Datatype datatype,
51 MPI_Status *status)
52
53 int MPI_File_read_all(MPI_File fh, void *buf, int count,
54 MPI_Datatype datatype, MPI_Status *status)
55
56 int MPI_File_read_all_begin(MPI_File fh, void *buf, int count,
57 MPI_Datatype datatype)
```



```
int MPI_File_read_all_end(MPI_File fh, void *buf, MPI_Status *status) 1
int MPI_File_read_at(MPI_File fh, MPI_Offset offset, void *buf, int count, 2
    MPI_Datatype datatype, MPI_Status *status) 3
int MPI_File_read_at_all(MPI_File fh, MPI_Offset offset, void *buf, 4
    int count, MPI_Datatype datatype, MPI_Status *status) 5
int MPI_File_read_at_all_begin(MPI_File fh, MPI_Offset offset, void *buf, 6
    int count, MPI_Datatype datatype) 7
int MPI_File_read_at_all_end(MPI_File fh, void *buf, MPI_Status *status) 8
int MPI_File_read_ordered(MPI_File fh, void *buf, int count, 9
    MPI_Datatype datatype, MPI_Status *status) 10
int MPI_File_read_ordered_begin(MPI_File fh, void *buf, int count, 11
    MPI_Datatype datatype) 12
int MPI_File_read_ordered_end(MPI_File fh, void *buf, MPI_Status *status) 13
int MPI_File_read_shared(MPI_File fh, void *buf, int count, 14
    MPI_Datatype datatype, MPI_Status *status) 15
int MPI_File_seek(MPI_File fh, MPI_Offset offset, int whence) 16
int MPI_File_seek_shared(MPI_File fh, MPI_Offset offset, int whence) 17
int MPI_File_set_atomicity(MPI_File fh, int flag) 18
int MPI_File_set_info(MPI_File fh, MPI_Info info) 19
int MPI_File_set_size(MPI_File fh, MPI_Offset size) 20
int MPI_File_set_view(MPI_File fh, MPI_Offset disp, MPI_Datatype etype, 21
    MPI_Datatype filetype, const char *datarep, MPI_Info info) 22
int MPI_File_sync(MPI_File fh) 23
int MPI_File_write(MPI_File fh, const void *buf, int count, 24
    MPI_Datatype datatype, MPI_Status *status) 25
int MPI_File_write_all(MPI_File fh, const void *buf, int count, 26
    MPI_Datatype datatype, MPI_Status *status) 27
int MPI_File_write_all_begin(MPI_File fh, const void *buf, int count, 28
    MPI_Datatype datatype) 29
int MPI_File_write_all_end(MPI_File fh, const void *buf, 30
    MPI_Status *status) 31
int MPI_File_write_at(MPI_File fh, MPI_Offset offset, const void *buf, 32
    int count, MPI_Datatype datatype, MPI_Status *status) 33
int MPI_File_write_at_all(MPI_File fh, MPI_Offset offset, const void *buf, 34
    int count, MPI_Datatype datatype, MPI_Status *status) 35
int MPI_File_write_at_all_begin(MPI_File fh, MPI_Offset offset, const void *buf, 36
    int count, MPI_Datatype datatype, MPI_Status *status) 37
int MPI_File_write_at_all_end(MPI_File fh, MPI_Offset offset, const void *buf, 38
    int count, MPI_Datatype datatype, MPI_Status *status) 39
int MPI_File_write_at_all_begin(MPI_File fh, MPI_Offset offset, const void *buf, 40
    int count, MPI_Datatype datatype, MPI_Status *status) 41
int MPI_File_write_at_all_end(MPI_File fh, MPI_Offset offset, const void *buf, 42
    int count, MPI_Datatype datatype, MPI_Status *status) 43
int MPI_File_write_at_all_begin(MPI_File fh, MPI_Offset offset, const void *buf, 44
    int count, MPI_Datatype datatype, MPI_Status *status) 45
int MPI_File_write_at_all_end(MPI_File fh, MPI_Offset offset, const void *buf, 46
    int count, MPI_Datatype datatype, MPI_Status *status) 47
int MPI_File_write_at_all_end(MPI_File fh, MPI_Offset offset, const void *buf, 48
    int count, MPI_Datatype datatype, MPI_Status *status) 48
```

```

1  int MPI_File_write_at_all_begin(MPI_File fh, MPI_Offset offset,
2      const void *buf, int count, MPI_Datatype datatype)
3
4  int MPI_File_write_at_all_end(MPI_File fh, const void *buf,
5      MPI_Status *status)
6
7  int MPI_File_write_ordered(MPI_File fh, const void *buf, int count,
8      MPI_Datatype datatype, MPI_Status *status)
9
10 int MPI_File_write_ordered_begin(MPI_File fh, const void *buf, int count,
11     MPI_Datatype datatype)
12
13 int MPI_File_write_ordered_end(MPI_File fh, const void *buf,
14     MPI_Status *status)
15
16 int MPI_File_write_shared(MPI_File fh, const void *buf, int count,
17     MPI_Datatype datatype, MPI_Status *status)
18
19 int MPI_Register_datarep(const char *datarep,
20     MPI_Datarep_conversion_function *read_conversion_fn,
21     MPI_Datarep_conversion_function *write_conversion_fn,
22     MPI_Datarep_extent_function *dtype_file_extent_fn,
23     void *extra_state)

```

#### A.2.12 Language Bindings C Bindings

```

24 int MPI_Status_f082f(MPI_F08_status *f08_status, MPI_Fint *f_status)
25
26 int MPI_Status_f2f08(MPI_Fint *f_status, MPI_F08_status *f08_status)
27
28 int MPI_Type_create_f90_complex(int p, int r, MPI_Datatype *newtype)
29
30 int MPI_Type_create_f90_integer(int r, MPI_Datatype *newtype)
31
32 int MPI_Type_create_f90_real(int p, int r, MPI_Datatype *newtype)
33
34 int MPI_Type_match_size(int typeclass, int size, MPI_Datatype *datatype)
35
36 MPI_Fint MPI_Comm_c2f(MPI_Comm comm)
37
38 MPI_Comm MPI_Comm_f2c(MPI_Fint comm)
39
40 MPI_Fint MPI_Errhandler_c2f(MPI_Errhandler errhandler)
41
42 MPI_Errhandler MPI_Errhandler_f2c(MPI_Fint errhandler)
43
44 MPI_Fint MPI_File_c2f(MPI_File file)
45
46 MPI_File MPI_File_f2c(MPI_Fint file)
47
48 MPI_Fint MPI_Group_c2f(MPI_Group group)
49
50 MPI_Group MPI_Group_f2c(MPI_Fint group)
51
52 MPI_Fint MPI_Info_c2f(MPI_Info info)
53
54 MPI_Info MPI_Info_f2c(MPI_Fint info)

```

```

MPI_Fint MPI_Message_c2f(MPI_Message message) 1
MPI_Message MPI_Message_f2c(MPI_Fint message) 2
MPI_Fint MPI_Op_c2f(MPI_Op op) 3
MPI_Op MPI_Op_f2c(MPI_Fint op) 4
MPI_Fint MPI_Request_c2f(MPI_Request request) 5
MPI_Request MPI_Request_f2c(MPI_Fint request) 6
MPI_Fint MPI_Session_c2f(MPI_Session session) 7
MPI_Session MPI_Session_f2c(MPI_Fint session) 8
int MPI_Status_c2f(const MPI_Status *c_status, MPI_Fint *f_status) 9
int MPI_Status_c2f08(const MPI_Status *c_status, 10
    MPI_F08_status *f08_status) 11
int MPI_Status_f082c(const MPI_F08_status *f08_status, 12
    MPI_Status *c_status) 13
int MPI_Status_f2c(const MPI_Fint *f_status, MPI_Status *c_status) 14
MPI_Fint MPI_Type_c2f(MPI_Datatype datatype) 15
MPI_Datatype MPI_Type_f2c(MPI_Fint datatype) 16
MPI_Fint MPI_Win_c2f(MPI_Win win) 17
MPI_Win MPI_Win_f2c(MPI_Fint win) 18

A.2.13 Tools / Profiling Interface C Bindings 19
int MPI_Pcontrol(const int level, ...) 20

A.2.14 Tools / MPI Tool Information Interface C Bindings 21
int MPI_T_category_changed(int *stamp) 22
int MPI_T_category_get_categories(int cat_index, int len, int indices[]) 23
int MPI_T_category_get_cvars(int cat_index, int len, int indices[]) 24
int MPI_T_category_get_events(int cat_index, int len, int indices[]) 25
int MPI_T_category_get_index(const char *name, int *cat_index) 26
int MPI_T_category_get_info(int cat_index, char *name, int *name_len, 27
    char *desc, int *desc_len, int *num_cvars, int *num_pvars, 28
    int *num_categories) 29
int MPI_T_category_get_num(int *num_cat) 30
int MPI_T_category_get_num_events(int cat_index, int *num_events) 31

```

```
1 int MPI_T_category_get_pvars(int cat_index, int len, int indices[])
2
3 int MPI_T_cvar_get_index(const char *name, int *cvar_index)
4
5 int MPI_T_cvar_get_info(int cvar_index, char *name, int *name_len,
6     int *verbosity, MPI_Datatype *datatype, MPI_T_enum *enumtype,
7     char *desc, int *desc_len, int *bind, int *scope)
8
9 int MPI_T_cvar_get_num(int *num_cvar)
10
11 int MPI_T_cvar_handle_alloc(int cvar_index, void *obj_handle,
12     MPI_T_cvar_handle *handle, int *count)
13
14 int MPI_T_cvar_handle_free(MPI_T_cvar_handle *handle)
15
16 int MPI_T_cvar_read(MPI_T_cvar_handle handle, void *buf)
17
18 int MPI_T_cvar_write(MPI_T_cvar_handle handle, const void *buf)
19
20 int MPI_T_enum_get_info(MPI_T_enum enumtype, int *num, char *name,
21     int *name_len)
22
23 int MPI_T_enum_get_item(MPI_T_enum enumtype, int index, int *value,
24     char *name, int *name_len)
25
26 int MPI_T_event_callback_get_info(
27     MPI_T_event_registration event_registration,
28     MPI_T_cb_safety cb_safety, MPI_Info *info_used)
29
30 int MPI_T_event_callback_set_info(
31     MPI_T_event_registration event_registration,
32     MPI_T_cb_safety cb_safety, MPI_Info info)
33
34 int MPI_T_event_copy(MPI_T_event_instance event_instance, void *buffer)
35
36 int MPI_T_event_get_index(const char *name, int *event_index)
37
38 int MPI_T_event_get_info(int event_index, char *name, int *name_len,
39     int *verbosity, MPI_Datatype *array_of_datatypes,
40     MPI_Aint *array_of_displacements, int *num_elements,
41     MPI_T_enum *enumtype, MPI_Info* info, char *desc,
42     int *desc_len, int *bind)
43
44 int MPI_T_event_get_num(int *num_events)
45
46 int MPI_T_event_get_source(MPI_T_event_instance event_instance,
47     int *source_index)
48
49 int MPI_T_event_get_timestamp(MPI_T_event_instance event_instance,
50     MPI_Count *event_timestamp)
51
52 int MPI_T_event_handle_alloc(int event_index, void *obj_handle,
53     MPI_Info info, MPI_T_event_registration *event_registration)
54
55 int MPI_T_event_handle_free(MPI_T_event_registration event_registration,
56     MPI_T_event_free_cb_function free_cb_function)
```

```
int MPI_T_event_handle_get_info(
    MPI_T_event_registration event_registration,
    MPI_Info *info_used)
int MPI_T_event_handle_set_info(
    MPI_T_event_registration event_registration, MPI_Info info)
int MPI_T_event_read(MPI_T_event_instance event_instance,
    int element_index, void *buffer)
int MPI_T_event_register_callback(
    MPI_T_event_registration event_registration,
    MPI_T_cb_safety cb_safety, MPI_Info info, void *user_data,
    MPI_T_event_cb_function event_cb_function)
int MPI_T_event_set_dropped_handler(
    MPI_T_event_registration event_registration,
    MPI_T_event_dropped_cb_function dropped_cb_function)
int MPI_T_finalize(void)
int MPI_T_init_thread(int required, int *provided)
int MPI_T_pvar_get_index(const char *name, int var_class, int *pvar_index)
int MPI_T_pvar_get_info(int pvar_index, char *name, int *name_len,
    int *verbosity, int *var_class, MPI_Datatype *datatype,
    MPI_T_enum *enumtype, char *desc, int *desc_len, int *bind,
    int *readonly, int *continuous, int *atomic)
int MPI_T_pvar_get_num(int *num_pvar)
int MPI_T_pvar_handle_alloc(MPI_T_pvar_session session, int pvar_index,
    void *obj_handle, MPI_T_pvar_handle *handle, int *count)
int MPI_T_pvar_handle_free(MPI_T_pvar_session session,
    MPI_T_pvar_handle *handle)
int MPI_T_pvar_read(MPI_T_pvar_session session, MPI_T_pvar_handle handle,
    void *buf)
int MPI_T_pvar_readreset(MPI_T_pvar_session session,
    MPI_T_pvar_handle handle, void *buf)
int MPI_T_pvar_reset(MPI_T_pvar_session session, MPI_T_pvar_handle handle)
int MPI_T_pvar_session_create(MPI_T_pvar_session *session)
int MPI_T_pvar_session_free(MPI_T_pvar_session *session)
int MPI_T_pvar_start(MPI_T_pvar_session session, MPI_T_pvar_handle handle)
int MPI_T_pvar_stop(MPI_T_pvar_session session, MPI_T_pvar_handle handle)
int MPI_T_pvar_write(MPI_T_pvar_session session, MPI_T_pvar_handle handle,
    const void *buf)
```

```
1 int MPI_T_source_get_info(int source_index, char *name, int *name_len,  
2     char *desc, int *desc_len, MPI_T_source_order *ordering,  
3     MPI_Count *ticks_per_second, MPI_Count *max_ticks,  
4     MPI_Info *info)
```

```
5  
6 int MPI_T_source_get_num(int *num_sources)
```

```
7 int MPI_T_source_get_timestamp(int source_index, MPI_Count *timestamp)
```

#### 10 A.2.15 Deprecated C Bindings

```
11 int MPI_Attr_delete(MPI_Comm comm, int keyval)
```

```
12  
13 int MPI_Attr_get(MPI_Comm comm, int keyval, void *attribute_val, int *flag)
```

```
14 int MPI_Attr_put(MPI_Comm comm, int keyval, void *attribute_val)
```

```
15  
16 int MPI_DUP_FN(MPI_Comm oldcomm, int keyval, void *extra_state,  
17     void *attribute_val_in, void *attribute_val_out, int *flag)
```

```
18 int MPI_Info_get(MPI_Info info, const char *key, int valuelen, char *value,  
19     int *flag)
```

```
20  
21 int MPI_Info_get_valuelen(MPI_Info info, const char *key, int *valuelen,  
22     int *flag)
```

```
23  
24 int MPI_Keyval_create(MPI_Copy_function *copy_fn,  
25     MPI_Delete_function *delete_fn, int *keyval,  
26     void *extra_state)
```

```
27 int MPI_Keyval_free(int *keyval)
```

```
28  
29 int MPI_NULL_COPY_FN(MPI_Comm oldcomm, int keyval, void *extra_state,  
30     void *attribute_val_in, void *attribute_val_out, int *flag)
```

```
31 int MPI_NULL_DELETE_FN(MPI_Comm comm, int keyval, void *attribute_val,  
32     void *extra_state)
```

## A.3 Fortran 2008 Bindings with the mpi\_f08 Module

### A.3.1 Point-to-Point Communication Fortran 2008 Bindings

#### Fortran 2008 binding

MPI\_Bsend(buf, count, datatype, dest, tag, comm, ierror)

TYPE(\*), DIMENSION(..), INTENT(IN) :: buf

INTEGER, INTENT(IN) :: count, dest, tag

TYPE(MPI\_Datatype), INTENT(IN) :: datatype

TYPE(MPI\_Comm), INTENT(IN) :: comm

INTEGER, OPTIONAL, INTENT(OUT) :: ierror

MPI\_Bsend\_init(buf, count, datatype, dest, tag, comm, request, ierror)

TYPE(\*), DIMENSION(..), INTENT(IN), ASYNCHRONOUS :: buf

INTEGER, INTENT(IN) :: count, dest, tag

TYPE(MPI\_Datatype), INTENT(IN) :: datatype

TYPE(MPI\_Comm), INTENT(IN) :: comm

TYPE(MPI\_Request), INTENT(OUT) :: request

INTEGER, OPTIONAL, INTENT(OUT) :: ierror

MPI\_Buffer\_attach(buffer, size, ierror)

TYPE(\*), DIMENSION(..), ASYNCHRONOUS :: buffer

INTEGER, INTENT(IN) :: size

INTEGER, OPTIONAL, INTENT(OUT) :: ierror

MPI\_Buffer\_detach(buffer\_addr, size, ierror)

USE, INTRINSIC :: ISO\_C\_BINDING, ONLY : C\_PTR

TYPE(C\_PTR), INTENT(OUT) :: buffer\_addr

INTEGER, INTENT(OUT) :: size

INTEGER, OPTIONAL, INTENT(OUT) :: ierror

MPI\_Cancel(request, ierror)

TYPE(MPI\_Request), INTENT(IN) :: request

INTEGER, OPTIONAL, INTENT(OUT) :: ierror

MPI\_Get\_count(status, datatype, count, ierror)

TYPE(MPI\_Status), INTENT(IN) :: status

TYPE(MPI\_Datatype), INTENT(IN) :: datatype

INTEGER, INTENT(OUT) :: count

INTEGER, OPTIONAL, INTENT(OUT) :: ierror

MPI\_Ibsend(buf, count, datatype, dest, tag, comm, request, ierror)

TYPE(\*), DIMENSION(..), INTENT(IN), ASYNCHRONOUS :: buf

INTEGER, INTENT(IN) :: count, dest, tag

TYPE(MPI\_Datatype), INTENT(IN) :: datatype

TYPE(MPI\_Comm), INTENT(IN) :: comm

TYPE(MPI\_Request), INTENT(OUT) :: request

INTEGER, OPTIONAL, INTENT(OUT) :: ierror

MPI\_Iprobe(source, tag, comm, flag, message, status, ierror)

INTEGER, INTENT(IN) :: source, tag

```

1     TYPE(MPI_Comm), INTENT(IN) :: comm
2     LOGICAL, INTENT(OUT) :: flag
3     TYPE(MPI_Message), INTENT(OUT) :: message
4     TYPE(MPI_Status) :: status
5     INTEGER, OPTIONAL, INTENT(OUT) :: ierror
6
7 MPI_Imrecv(buf, count, datatype, message, request, ierror)
8     TYPE(*), DIMENSION(..), ASYNCHRONOUS :: buf
9     INTEGER, INTENT(IN) :: count
10    TYPE(MPI_Datatype), INTENT(IN) :: datatype
11    TYPE(MPI_Message), INTENT(INOUT) :: message
12    TYPE(MPI_Request), INTENT(OUT) :: request
13    INTEGER, OPTIONAL, INTENT(OUT) :: ierror
14
15 MPI_Iprobe(source, tag, comm, flag, status, ierror)
16    INTEGER, INTENT(IN) :: source, tag
17    TYPE(MPI_Comm), INTENT(IN) :: comm
18    LOGICAL, INTENT(OUT) :: flag
19    TYPE(MPI_Status) :: status
20    INTEGER, OPTIONAL, INTENT(OUT) :: ierror
21
22 MPI_Irecv(buf, count, datatype, source, tag, comm, request, ierror)
23    TYPE(*), DIMENSION(..), ASYNCHRONOUS :: buf
24    INTEGER, INTENT(IN) :: count, source, tag
25    TYPE(MPI_Datatype), INTENT(IN) :: datatype
26    TYPE(MPI_Comm), INTENT(IN) :: comm
27    TYPE(MPI_Request), INTENT(OUT) :: request
28    INTEGER, OPTIONAL, INTENT(OUT) :: ierror
29
30 MPI_Irsend(buf, count, datatype, dest, tag, comm, request, ierror)
31    TYPE(*), DIMENSION(..), INTENT(IN), ASYNCHRONOUS :: buf
32    INTEGER, INTENT(IN) :: count, dest, tag
33    TYPE(MPI_Datatype), INTENT(IN) :: datatype
34    TYPE(MPI_Comm), INTENT(IN) :: comm
35    TYPE(MPI_Request), INTENT(OUT) :: request
36    INTEGER, OPTIONAL, INTENT(OUT) :: ierror
37
38 MPI_Isend(buf, count, datatype, dest, tag, comm, request, ierror)
39    TYPE(*), DIMENSION(..), INTENT(IN), ASYNCHRONOUS :: buf
40    INTEGER, INTENT(IN) :: count, dest, tag
41    TYPE(MPI_Datatype), INTENT(IN) :: datatype
42    TYPE(MPI_Comm), INTENT(IN) :: comm
43    TYPE(MPI_Request), INTENT(OUT) :: request
44    INTEGER, OPTIONAL, INTENT(OUT) :: ierror
45
46 MPI_Issend(buf, count, datatype, dest, tag, comm, request, ierror)
47    TYPE(*), DIMENSION(..), INTENT(IN), ASYNCHRONOUS :: buf
48    INTEGER, INTENT(IN) :: count, dest, tag
49    TYPE(MPI_Datatype), INTENT(IN) :: datatype
50    TYPE(MPI_Comm), INTENT(IN) :: comm

```



```

TYPE(MPI_Request), INTENT(OUT) :: request      1
INTEGER, OPTIONAL, INTENT(OUT) :: ierror      2
                                                    3
MPI_Mprobe(source, tag, comm, message, status, ierror)  4
  INTEGER, INTENT(IN) :: source, tag          5
  TYPE(MPI_Comm), INTENT(IN) :: comm         6
  TYPE(MPI_Message), INTENT(OUT) :: message  7
  TYPE(MPI_Status) :: status                 8
  INTEGER, OPTIONAL, INTENT(OUT) :: ierror   9
                                                    10
MPI_Mrecv(buf, count, datatype, message, status, ierror) 11
  TYPE(*), DIMENSION(..) :: buf            12
  INTEGER, INTENT(IN) :: count              13
  TYPE(MPI_Datatype), INTENT(IN) :: datatype 14
  TYPE(MPI_Message), INTENT(INOUT) :: message 15
  TYPE(MPI_Status) :: status                16
  INTEGER, OPTIONAL, INTENT(OUT) :: ierror   17
                                                    18
MPI_Probe(source, tag, comm, status, ierror) 19
  INTEGER, INTENT(IN) :: source, tag        20
  TYPE(MPI_Comm), INTENT(IN) :: comm        21
  TYPE(MPI_Status) :: status                22
  INTEGER, OPTIONAL, INTENT(OUT) :: ierror   23
                                                    24
MPI_Recv(buf, count, datatype, source, tag, comm, status, ierror) 25
  TYPE(*), DIMENSION(..) :: buf            26
  INTEGER, INTENT(IN) :: count, source, tag 27
  TYPE(MPI_Datatype), INTENT(IN) :: datatype 28
  TYPE(MPI_Comm), INTENT(IN) :: comm        29
  TYPE(MPI_Status) :: status                30
  INTEGER, OPTIONAL, INTENT(OUT) :: ierror   31
                                                    32
MPI_Recv_init(buf, count, datatype, source, tag, comm, request, ierror) 33
  TYPE(*), DIMENSION(..), ASYNCHRONOUS :: buf 34
  INTEGER, INTENT(IN) :: count, source, tag 35
  TYPE(MPI_Datatype), INTENT(IN) :: datatype 36
  TYPE(MPI_Comm), INTENT(IN) :: comm        37
  TYPE(MPI_Request), INTENT(OUT) :: request 38
  INTEGER, OPTIONAL, INTENT(OUT) :: ierror   39
                                                    40
MPI_Request_free(request, ierror) 41
  TYPE(MPI_Request), INTENT(INOUT) :: request 42
  INTEGER, OPTIONAL, INTENT(OUT) :: ierror   43
                                                    44
MPI_Request_get_status(request, flag, status, ierror) 45
  TYPE(MPI_Request), INTENT(IN) :: request 46
  LOGICAL, INTENT(OUT) :: flag              47
  TYPE(MPI_Status) :: status                48
  INTEGER, OPTIONAL, INTENT(OUT) :: ierror
MPI_Rsend(buf, count, datatype, dest, tag, comm, ierror)

```

```

1     TYPE(*), DIMENSION(..), INTENT(IN) :: buf
2     INTEGER, INTENT(IN) :: count, dest, tag
3     TYPE(MPI_Datatype), INTENT(IN) :: datatype
4     TYPE(MPI_Comm), INTENT(IN) :: comm
5     INTEGER, OPTIONAL, INTENT(OUT) :: ierror
6
7 MPI_Rsend_init(buf, count, datatype, dest, tag, comm, request, ierror)
8     TYPE(*), DIMENSION(..), INTENT(IN), ASYNCHRONOUS :: buf
9     INTEGER, INTENT(IN) :: count, dest, tag
10    TYPE(MPI_Datatype), INTENT(IN) :: datatype
11    TYPE(MPI_Comm), INTENT(IN) :: comm
12    TYPE(MPI_Request), INTENT(OUT) :: request
13    INTEGER, OPTIONAL, INTENT(OUT) :: ierror
14
15 MPI_Send(buf, count, datatype, dest, tag, comm, ierror)
16    TYPE(*), DIMENSION(..), INTENT(IN) :: buf
17    INTEGER, INTENT(IN) :: count, dest, tag
18    TYPE(MPI_Datatype), INTENT(IN) :: datatype
19    TYPE(MPI_Comm), INTENT(IN) :: comm
20    INTEGER, OPTIONAL, INTENT(OUT) :: ierror
21
22 MPI_Send_init(buf, count, datatype, dest, tag, comm, request, ierror)
23    TYPE(*), DIMENSION(..), INTENT(IN), ASYNCHRONOUS :: buf
24    INTEGER, INTENT(IN) :: count, dest, tag
25    TYPE(MPI_Datatype), INTENT(IN) :: datatype
26    TYPE(MPI_Comm), INTENT(IN) :: comm
27    TYPE(MPI_Request), INTENT(OUT) :: request
28    INTEGER, OPTIONAL, INTENT(OUT) :: ierror
29
30 MPI_Sendrecv(sendbuf, sendcount, sendtype, dest, sendtag, recvbuf,
31             recvcount, recvtype, source, recvtag, comm, status, ierror)
32    TYPE(*), DIMENSION(..), INTENT(IN) :: sendbuf
33    INTEGER, INTENT(IN) :: sendcount, dest, sendtag, recvcount, source,
34    recvtag
35    TYPE(MPI_Datatype), INTENT(IN) :: sendtype, recvtype
36    TYPE(*), DIMENSION(..) :: recvbuf
37    TYPE(MPI_Comm), INTENT(IN) :: comm
38    TYPE(MPI_Status) :: status
39    INTEGER, OPTIONAL, INTENT(OUT) :: ierror
40
41 MPI_Sendrecv_replace(buf, count, datatype, dest, sendtag, source, recvtag,
42                    comm, status, ierror)
43    TYPE(*), DIMENSION(..) :: buf
44    INTEGER, INTENT(IN) :: count, dest, sendtag, source, recvtag
45    TYPE(MPI_Datatype), INTENT(IN) :: datatype
46    TYPE(MPI_Comm), INTENT(IN) :: comm
47    TYPE(MPI_Status) :: status
48    INTEGER, OPTIONAL, INTENT(OUT) :: ierror
49
50 MPI_Ssend(buf, count, datatype, dest, tag, comm, ierror)

```

```

TYPE(*), DIMENSION(..), INTENT(IN) :: buf           1
INTEGER, INTENT(IN) :: count, dest, tag             2
TYPE(MPI_Datatype), INTENT(IN) :: datatype          3
TYPE(MPI_Comm), INTENT(IN) :: comm                  4
INTEGER, OPTIONAL, INTENT(OUT) :: ierror            5
                                                    6
MPI_Ssend_init(buf, count, datatype, dest, tag, comm, request, ierror) 7
  TYPE(*), DIMENSION(..), INTENT(IN), ASYNCHRONOUS :: buf           8
  INTEGER, INTENT(IN) :: count, dest, tag                       9
  TYPE(MPI_Datatype), INTENT(IN) :: datatype                   10
  TYPE(MPI_Comm), INTENT(IN) :: comm                           11
  TYPE(MPI_Request), INTENT(OUT) :: request                    12
  INTEGER, OPTIONAL, INTENT(OUT) :: ierror                      13
                                                    14
MPI_Start(request, ierror)
  TYPE(MPI_Request), INTENT(INOUT) :: request                  15
  INTEGER, OPTIONAL, INTENT(OUT) :: ierror                      16
                                                    17
MPI_Startall(count, array_of_requests, ierror)
  INTEGER, INTENT(IN) :: count                                  18
  TYPE(MPI_Request), INTENT(INOUT) :: array_of_requests(count) 19
  INTEGER, OPTIONAL, INTENT(OUT) :: ierror                      20
                                                    21
MPI_Test(request, flag, status, ierror)
  TYPE(MPI_Request), INTENT(INOUT) :: request                  22
  LOGICAL, INTENT(OUT) :: flag                                  23
  TYPE(MPI_Status) :: status                                    24
  INTEGER, OPTIONAL, INTENT(OUT) :: ierror                      25
                                                    26
MPI_Test_cancelled(status, flag, ierror)
  TYPE(MPI_Status), INTENT(IN) :: status                        27
  LOGICAL, INTENT(OUT) :: flag                                  28
  INTEGER, OPTIONAL, INTENT(OUT) :: ierror                      29
                                                    30
MPI_Testall(count, array_of_requests, flag, array_of_statuses, ierror)
  INTEGER, INTENT(IN) :: count                                  31
  TYPE(MPI_Request), INTENT(INOUT) :: array_of_requests(count) 32
  LOGICAL, INTENT(OUT) :: flag                                  33
  TYPE(MPI_Status) :: array_of_statuses(*)                      34
  INTEGER, OPTIONAL, INTENT(OUT) :: ierror                      35
                                                    36
MPI_Testany(count, array_of_requests, index, flag, status, ierror)
  INTEGER, INTENT(IN) :: count                                  37
  TYPE(MPI_Request), INTENT(INOUT) :: array_of_requests(count) 38
  INTEGER, INTENT(OUT) :: index                                  39
  LOGICAL, INTENT(OUT) :: flag                                  40
  TYPE(MPI_Status) :: status                                    41
  INTEGER, OPTIONAL, INTENT(OUT) :: ierror                      42
                                                    43
MPI_Testsome(incount, array_of_requests, outcount, array_of_indices,
  array_of_statuses, ierror)
  INTEGER, INTENT(IN) :: incount, outcount                      44
  TYPE(MPI_Request), INTENT(INOUT) :: array_of_requests(count) 45
  INTEGER, INTENT(OUT) :: array_of_indices                     46
  LOGICAL, INTENT(OUT) :: flag                                  47
  TYPE(MPI_Status) :: array_of_statuses(*)                      48
  INTEGER, OPTIONAL, INTENT(OUT) :: ierror

```

```

1      INTEGER, INTENT(IN) :: incount
2      TYPE(MPI_Request), INTENT(INOUT) :: array_of_requests(incount)
3      INTEGER, INTENT(OUT) :: outcount, array_of_indices(*)
4      TYPE(MPI_Status) :: array_of_statuses(*)
5      INTEGER, OPTIONAL, INTENT(OUT) :: ierror
6
7      MPI_Wait(request, status, ierror)
8          TYPE(MPI_Request), INTENT(INOUT) :: request
9          TYPE(MPI_Status) :: status
10         INTEGER, OPTIONAL, INTENT(OUT) :: ierror
11
12     MPI_Waitall(count, array_of_requests, array_of_statuses, ierror)
13         INTEGER, INTENT(IN) :: count
14         TYPE(MPI_Request), INTENT(INOUT) :: array_of_requests(count)
15         TYPE(MPI_Status) :: array_of_statuses(*)
16         INTEGER, OPTIONAL, INTENT(OUT) :: ierror
17
18     MPI_Waitany(count, array_of_requests, index, status, ierror)
19         INTEGER, INTENT(IN) :: count
20         TYPE(MPI_Request), INTENT(INOUT) :: array_of_requests(count)
21         INTEGER, INTENT(OUT) :: index
22         TYPE(MPI_Status) :: status
23         INTEGER, OPTIONAL, INTENT(OUT) :: ierror
24
25     MPI_Waitsome(incount, array_of_requests, outcount, array_of_indices,
26                 array_of_statuses, ierror)
27         INTEGER, INTENT(IN) :: incount
28         TYPE(MPI_Request), INTENT(INOUT) :: array_of_requests(incount)
29         INTEGER, INTENT(OUT) :: outcount, array_of_indices(*)
30         TYPE(MPI_Status) :: array_of_statuses(*)
31         INTEGER, OPTIONAL, INTENT(OUT) :: ierror
32
33     A.3.2 Datatypes Fortran 2008 Bindings
34     INTEGER(KIND=MPI_ADDRESS_KIND) MPI_Aint_add(base, disp)
35         INTEGER(KIND=MPI_ADDRESS_KIND), INTENT(IN) :: base, disp
36
37     INTEGER(KIND=MPI_ADDRESS_KIND) MPI_Aint_diff(addr1, addr2)
38         INTEGER(KIND=MPI_ADDRESS_KIND), INTENT(IN) :: addr1, addr2
39
40     MPI_Get_address(location, address, ierror)
41         TYPE(*), DIMENSION(..), ASYNCHRONOUS :: location
42         INTEGER(KIND=MPI_ADDRESS_KIND), INTENT(OUT) :: address
43         INTEGER, OPTIONAL, INTENT(OUT) :: ierror
44
45     MPI_Pack(inbuf, incount, datatype, outbuf, outsize, position, comm, ierror)
46         TYPE(*), DIMENSION(..), INTENT(IN) :: inbuf
47         INTEGER, INTENT(IN) :: incount, outsize
48         TYPE(MPI_Datatype), INTENT(IN) :: datatype
49         TYPE(*), DIMENSION(..) :: outbuf
50         INTEGER, INTENT(INOUT) :: position

```

```

TYPE(MPI_Comm), INTENT(IN) :: comm
INTEGER, OPTIONAL, INTENT(OUT) :: ierror
MPI_Pack_external(datarep, inbuf, incount, datatype, outbuf, outsize,
                 position, ierror)
CHARACTER(LEN=*), INTENT(IN) :: datarep
TYPE(*), DIMENSION(..), INTENT(IN) :: inbuf
INTEGER, INTENT(IN) :: incount
TYPE(MPI_Datatype), INTENT(IN) :: datatype
TYPE(*), DIMENSION(..) :: outbuf
INTEGER(KIND=MPI_ADDRESS_KIND), INTENT(IN) :: outsize
INTEGER(KIND=MPI_ADDRESS_KIND), INTENT(INOUT) :: position
INTEGER, OPTIONAL, INTENT(OUT) :: ierror
MPI_Pack_external_size(datarep, incount, datatype, size, ierror)
CHARACTER(LEN=*), INTENT(IN) :: datarep
INTEGER, INTENT(IN) :: incount
TYPE(MPI_Datatype), INTENT(IN) :: datatype
INTEGER(KIND=MPI_ADDRESS_KIND), INTENT(OUT) :: size
INTEGER, OPTIONAL, INTENT(OUT) :: ierror
MPI_Pack_size(incount, datatype, comm, size, ierror)
INTEGER, INTENT(IN) :: incount
TYPE(MPI_Datatype), INTENT(IN) :: datatype
TYPE(MPI_Comm), INTENT(IN) :: comm
INTEGER, INTENT(OUT) :: size
INTEGER, OPTIONAL, INTENT(OUT) :: ierror
MPI_Type_commit(datatype, ierror)
TYPE(MPI_Datatype), INTENT(INOUT) :: datatype
INTEGER, OPTIONAL, INTENT(OUT) :: ierror
MPI_Type_contiguous(count, oldtype, newtype, ierror)
INTEGER, INTENT(IN) :: count
TYPE(MPI_Datatype), INTENT(IN) :: oldtype
TYPE(MPI_Datatype), INTENT(OUT) :: newtype
INTEGER, OPTIONAL, INTENT(OUT) :: ierror
MPI_Type_create_darray(size, rank, ndims, array_of_gsizes,
                     array_of_distribs, array_of_dargs, array_of_psizes, order,
                     oldtype, newtype, ierror)
INTEGER, INTENT(IN) :: size, rank, ndims, array_of_gsizes(ndims),
array_of_distribs(ndims), array_of_dargs(ndims),
array_of_psizes(ndims), order
TYPE(MPI_Datatype), INTENT(IN) :: oldtype
TYPE(MPI_Datatype), INTENT(OUT) :: newtype
INTEGER, OPTIONAL, INTENT(OUT) :: ierror
MPI_Type_create_hindexed(count, array_of_blocklengths,
                        array_of_displacements, oldtype, newtype, ierror)
INTEGER, INTENT(IN) :: count, array_of_blocklengths(count)

```

```

1     INTEGER(KIND=MPI_ADDRESS_KIND), INTENT(IN) ::
2     array_of_displacements(count)
3     TYPE(MPI_Datatype), INTENT(IN) :: oldtype
4     TYPE(MPI_Datatype), INTENT(OUT) :: newtype
5     INTEGER, OPTIONAL, INTENT(OUT) :: ierror
6
7 MPI_Type_create_hindexed_block(count, blocklength, array_of_displacements,
8     oldtype, newtype, ierror)
9     INTEGER, INTENT(IN) :: count, blocklength
10    INTEGER(KIND=MPI_ADDRESS_KIND), INTENT(IN) ::
11    array_of_displacements(count)
12    TYPE(MPI_Datatype), INTENT(IN) :: oldtype
13    TYPE(MPI_Datatype), INTENT(OUT) :: newtype
14    INTEGER, OPTIONAL, INTENT(OUT) :: ierror
15
16 MPI_Type_create_hvector(count, blocklength, stride, oldtype, newtype,
17     ierror)
18    INTEGER, INTENT(IN) :: count, blocklength
19    INTEGER(KIND=MPI_ADDRESS_KIND), INTENT(IN) :: stride
20    TYPE(MPI_Datatype), INTENT(IN) :: oldtype
21    TYPE(MPI_Datatype), INTENT(OUT) :: newtype
22    INTEGER, OPTIONAL, INTENT(OUT) :: ierror
23
24 MPI_Type_create_indexed_block(count, blocklength, array_of_displacements,
25     oldtype, newtype, ierror)
26    INTEGER, INTENT(IN) :: count, blocklength,
27    array_of_displacements(count)
28    TYPE(MPI_Datatype), INTENT(IN) :: oldtype
29    TYPE(MPI_Datatype), INTENT(OUT) :: newtype
30    INTEGER, OPTIONAL, INTENT(OUT) :: ierror
31
32 MPI_Type_create_resized(oldtype, lb, extent, newtype, ierror)
33    TYPE(MPI_Datatype), INTENT(IN) :: oldtype
34    INTEGER(KIND=MPI_ADDRESS_KIND), INTENT(IN) :: lb, extent
35    TYPE(MPI_Datatype), INTENT(OUT) :: newtype
36    INTEGER, OPTIONAL, INTENT(OUT) :: ierror
37
38 MPI_Type_create_struct(count, array_of_blocklengths,
39     array_of_displacements, array_of_types, newtype, ierror)
40    INTEGER, INTENT(IN) :: count, array_of_blocklengths(count)
41    INTEGER(KIND=MPI_ADDRESS_KIND), INTENT(IN) ::
42    array_of_displacements(count)
43    TYPE(MPI_Datatype), INTENT(IN) :: array_of_types(count)
44    TYPE(MPI_Datatype), INTENT(OUT) :: newtype
45    INTEGER, OPTIONAL, INTENT(OUT) :: ierror
46
47 MPI_Type_create_subarray(ndims, array_of_sizes, array_of_subsizes,
48     array_of_starts, order, oldtype, newtype, ierror)
49    INTEGER, INTENT(IN) :: ndims, array_of_sizes(ndims),
50    array_of_subsizes(ndims), array_of_starts(ndims), order

```

```

TYPE(MPI_Datatype), INTENT(IN) :: oldtype
TYPE(MPI_Datatype), INTENT(OUT) :: newtype
INTEGER, OPTIONAL, INTENT(OUT) :: ierror

MPI_Type_dup(oldtype, newtype, ierror)
TYPE(MPI_Datatype), INTENT(IN) :: oldtype
TYPE(MPI_Datatype), INTENT(OUT) :: newtype
INTEGER, OPTIONAL, INTENT(OUT) :: ierror

MPI_Type_free(datatype, ierror)
TYPE(MPI_Datatype), INTENT(INOUT) :: datatype
INTEGER, OPTIONAL, INTENT(OUT) :: ierror

MPI_Type_get_contents(datatype, max_integers, max_addresses, max_datatypes,
array_of_integers, array_of_addresses, array_of_datatypes,
ierror)
TYPE(MPI_Datatype), INTENT(IN) :: datatype
INTEGER, INTENT(IN) :: max_integers, max_addresses, max_datatypes
INTEGER, INTENT(OUT) :: array_of_integers(max_integers)
INTEGER(KIND=MPI_ADDRESS_KIND), INTENT(OUT) ::
array_of_addresses(max_addresses)
TYPE(MPI_Datatype), INTENT(OUT) :: array_of_datatypes(max_datatypes)
INTEGER, OPTIONAL, INTENT(OUT) :: ierror

MPI_Type_get_elements(status, datatype, count, ierror)
TYPE(MPI_Status), INTENT(IN) :: status
TYPE(MPI_Datatype), INTENT(IN) :: datatype
INTEGER, INTENT(OUT) :: count
INTEGER, OPTIONAL, INTENT(OUT) :: ierror

MPI_Type_get_elements_x(status, datatype, count, ierror)
TYPE(MPI_Status), INTENT(IN) :: status
TYPE(MPI_Datatype), INTENT(IN) :: datatype
INTEGER(KIND=MPI_COUNT_KIND), INTENT(OUT) :: count
INTEGER, OPTIONAL, INTENT(OUT) :: ierror

MPI_Type_get_envelope(datatype, num_integers, num_addresses, num_datatypes,
combiner, ierror)
TYPE(MPI_Datatype), INTENT(IN) :: datatype
INTEGER, INTENT(OUT) :: num_integers, num_addresses, num_datatypes,
combiner
INTEGER, OPTIONAL, INTENT(OUT) :: ierror

MPI_Type_get_extent(datatype, lb, extent, ierror)
TYPE(MPI_Datatype), INTENT(IN) :: datatype
INTEGER(KIND=MPI_ADDRESS_KIND), INTENT(OUT) :: lb, extent
INTEGER, OPTIONAL, INTENT(OUT) :: ierror

MPI_Type_get_extent_x(datatype, lb, extent, ierror)
TYPE(MPI_Datatype), INTENT(IN) :: datatype
INTEGER(KIND=MPI_COUNT_KIND), INTENT(OUT) :: lb, extent

```

```

1     INTEGER, OPTIONAL, INTENT(OUT) :: ierror
2
3     MPI_Type_get_true_extent(datatype, true_lb, true_extent, ierror)
4         TYPE(MPI_Datatype), INTENT(IN) :: datatype
5         INTEGER(KIND=MPI_ADDRESS_KIND), INTENT(OUT) :: true_lb, true_extent
6         INTEGER, OPTIONAL, INTENT(OUT) :: ierror
7
8     MPI_Type_get_true_extent_x(datatype, true_lb, true_extent, ierror)
9         TYPE(MPI_Datatype), INTENT(IN) :: datatype
10        INTEGER(KIND=MPI_COUNT_KIND), INTENT(OUT) :: true_lb, true_extent
11        INTEGER, OPTIONAL, INTENT(OUT) :: ierror
12
13    MPI_Type_indexed(count, array_of_blocklengths, array_of_displacements,
14                    oldtype, newtype, ierror)
15        INTEGER, INTENT(IN) :: count, array_of_blocklengths(count),
16        array_of_displacements(count)
17        TYPE(MPI_Datatype), INTENT(IN) :: oldtype
18        TYPE(MPI_Datatype), INTENT(OUT) :: newtype
19        INTEGER, OPTIONAL, INTENT(OUT) :: ierror
20
21    MPI_Type_size(datatype, size, ierror)
22        TYPE(MPI_Datatype), INTENT(IN) :: datatype
23        INTEGER, INTENT(OUT) :: size
24        INTEGER, OPTIONAL, INTENT(OUT) :: ierror
25
26    MPI_Type_size_x(datatype, size, ierror)
27        TYPE(MPI_Datatype), INTENT(IN) :: datatype
28        INTEGER(KIND=MPI_COUNT_KIND), INTENT(OUT) :: size
29        INTEGER, OPTIONAL, INTENT(OUT) :: ierror
30
31    MPI_Type_vector(count, blocklength, stride, oldtype, newtype, ierror)
32        INTEGER, INTENT(IN) :: count, blocklength, stride
33        TYPE(MPI_Datatype), INTENT(IN) :: oldtype
34        TYPE(MPI_Datatype), INTENT(OUT) :: newtype
35        INTEGER, OPTIONAL, INTENT(OUT) :: ierror
36
37    MPI_Unpack(inbuf, insize, position, outbuf, outcount, datatype, comm,
38              ierror)
39        TYPE(*), DIMENSION(..), INTENT(IN) :: inbuf
40        INTEGER, INTENT(IN) :: insize, outcount
41        INTEGER, INTENT(INOUT) :: position
42        TYPE(*), DIMENSION(..) :: outbuf
43        TYPE(MPI_Datatype), INTENT(IN) :: datatype
44        TYPE(MPI_Comm), INTENT(IN) :: comm
45        INTEGER, OPTIONAL, INTENT(OUT) :: ierror
46
47    MPI_Unpack_external(datarep, inbuf, insize, position, outbuf, outcount,
48                        datatype, ierror)
49        CHARACTER(LEN=*), INTENT(IN) :: datarep
50        TYPE(*), DIMENSION(..), INTENT(IN) :: inbuf
51        INTEGER(KIND=MPI_ADDRESS_KIND), INTENT(IN) :: insize

```



```

INTEGER(KIND=MPI_ADDRESS_KIND), INTENT(INOUT) :: position
TYPE(*), DIMENSION(..) :: outbuf
INTEGER, INTENT(IN) :: outcount
TYPE(MPI_Datatype), INTENT(IN) :: datatype
INTEGER, OPTIONAL, INTENT(OUT) :: ierror

```

### A.3.3 Collective Communication Fortran 2008 Bindings

```

MPI_Allgather(sendbuf, sendcount, sendtype, recvbuf, recvcount, recvtype,
              comm, ierror)
TYPE(*), DIMENSION(..), INTENT(IN) :: sendbuf
INTEGER, INTENT(IN) :: sendcount, recvcount
TYPE(MPI_Datatype), INTENT(IN) :: sendtype, recvtype
TYPE(*), DIMENSION(..) :: recvbuf
TYPE(MPI_Comm), INTENT(IN) :: comm
INTEGER, OPTIONAL, INTENT(OUT) :: ierror

MPI_Allgather_init(sendbuf, sendcount, sendtype, recvbuf, recvcount,
                  recvtype, comm, info, request, ierror)
TYPE(*), DIMENSION(..), INTENT(IN), ASYNCHRONOUS :: sendbuf
INTEGER, INTENT(IN) :: sendcount, recvcount
TYPE(MPI_Datatype), INTENT(IN) :: sendtype, recvtype
TYPE(*), DIMENSION(..), ASYNCHRONOUS :: recvbuf
TYPE(MPI_Comm), INTENT(IN) :: comm
TYPE(MPI_Info), INTENT(IN) :: info
TYPE(MPI_Request), INTENT(OUT) :: request
INTEGER, OPTIONAL, INTENT(OUT) :: ierror

MPI_Allgatherv(sendbuf, sendcount, sendtype, recvbuf, recvcounts, displs,
              recvtype, comm, ierror)
TYPE(*), DIMENSION(..), INTENT(IN) :: sendbuf
INTEGER, INTENT(IN) :: sendcount, recvcounts(*), displs(*)
TYPE(MPI_Datatype), INTENT(IN) :: sendtype, recvtype
TYPE(*), DIMENSION(..) :: recvbuf
TYPE(MPI_Comm), INTENT(IN) :: comm
INTEGER, OPTIONAL, INTENT(OUT) :: ierror

MPI_Allgatherv_init(sendbuf, sendcount, sendtype, recvbuf, recvcounts,
                   displs, recvtype, comm, info, request, ierror)
TYPE(*), DIMENSION(..), INTENT(IN), ASYNCHRONOUS :: sendbuf
INTEGER, INTENT(IN) :: sendcount
TYPE(MPI_Datatype), INTENT(IN) :: sendtype, recvtype
TYPE(*), DIMENSION(..), ASYNCHRONOUS :: recvbuf
INTEGER, INTENT(IN), ASYNCHRONOUS :: recvcounts(*), displs(*)
TYPE(MPI_Comm), INTENT(IN) :: comm
TYPE(MPI_Info), INTENT(IN) :: info
TYPE(MPI_Request), INTENT(OUT) :: request
INTEGER, OPTIONAL, INTENT(OUT) :: ierror

```

```

1 MPI_Allreduce(sendbuf, recvbuf, count, datatype, op, comm, ierror)
2     TYPE(*), DIMENSION(..), INTENT(IN) :: sendbuf
3     TYPE(*), DIMENSION(..) :: recvbuf
4     INTEGER, INTENT(IN) :: count
5     TYPE(MPI_Datatype), INTENT(IN) :: datatype
6     TYPE(MPI_Op), INTENT(IN) :: op
7     TYPE(MPI_Comm), INTENT(IN) :: comm
8     INTEGER, OPTIONAL, INTENT(OUT) :: ierror
9
10 MPI_Allreduce_init(sendbuf, recvbuf, count, datatype, op, comm, info,
11     request, ierror)
12     TYPE(*), DIMENSION(..), INTENT(IN), ASYNCHRONOUS :: sendbuf
13     TYPE(*), DIMENSION(..), ASYNCHRONOUS :: recvbuf
14     INTEGER, INTENT(IN) :: count
15     TYPE(MPI_Datatype), INTENT(IN) :: datatype
16     TYPE(MPI_Op), INTENT(IN) :: op
17     TYPE(MPI_Comm), INTENT(IN) :: comm
18     TYPE(MPI_Info), INTENT(IN) :: info
19     TYPE(MPI_Request), INTENT(OUT) :: request
20     INTEGER, OPTIONAL, INTENT(OUT) :: ierror
21
22 MPI_Alltoall(sendbuf, sendcount, sendtype, recvbuf, recvcount, recvtype,
23     comm, ierror)
24     TYPE(*), DIMENSION(..), INTENT(IN) :: sendbuf
25     INTEGER, INTENT(IN) :: sendcount, recvcount
26     TYPE(MPI_Datatype), INTENT(IN) :: sendtype, recvtype
27     TYPE(*), DIMENSION(..) :: recvbuf
28     TYPE(MPI_Comm), INTENT(IN) :: comm
29     INTEGER, OPTIONAL, INTENT(OUT) :: ierror
30
31 MPI_Alltoall_init(sendbuf, sendcount, sendtype, recvbuf, recvcount,
32     recvtype, comm, info, request, ierror)
33     TYPE(*), DIMENSION(..), INTENT(IN), ASYNCHRONOUS :: sendbuf
34     INTEGER, INTENT(IN) :: sendcount, recvcount
35     TYPE(MPI_Datatype), INTENT(IN) :: sendtype, recvtype
36     TYPE(*), DIMENSION(..), ASYNCHRONOUS :: recvbuf
37     TYPE(MPI_Comm), INTENT(IN) :: comm
38     TYPE(MPI_Info), INTENT(IN) :: info
39     TYPE(MPI_Request), INTENT(OUT) :: request
40     INTEGER, OPTIONAL, INTENT(OUT) :: ierror
41
42 MPI_Alltoallv(sendbuf, sendcounts, sdispls, sendtype, recvbuf, recvcounts,
43     rdispls, recvtype, comm, ierror)
44     TYPE(*), DIMENSION(..), INTENT(IN) :: sendbuf
45     INTEGER, INTENT(IN) :: sendcounts(*), sdispls(*), recvcounts(*),
46     rdispls(*)
47     TYPE(MPI_Datatype), INTENT(IN) :: sendtype, recvtype
48     TYPE(*), DIMENSION(..) :: recvbuf
49     TYPE(MPI_Comm), INTENT(IN) :: comm

```

```

    INTEGER, OPTIONAL, INTENT(OUT) :: ierror
1
MPI_Alltoallv_init(sendbuf, sendcounts, sdispls, sendtype, recvbuf,
2
3
4
5
6
7
8
9
10
11
12
13
14
15
16
17
18
19
20
21
22
23
24
25
26
27
28
29
30
31
32
33
34
35
36
37
38
39
40
41
42
43
44
45
46
47
48
    MPI_Alltoallw(sendbuf, sendcounts, sdispls, sendtypes, recvbuf, recvcounts,
    rdispls, recvtypes, comm, ierror)
    TYPE(*), DIMENSION(..), INTENT(IN) :: sendbuf
    INTEGER, INTENT(IN) :: sendcounts(*), sdispls(*), recvcounts(*),
    rdispls(*)
    TYPE(MPI_Datatype), INTENT(IN) :: sendtypes(*), recvtypes(*)
    TYPE(*), DIMENSION(..) :: recvbuf
    TYPE(MPI_Comm), INTENT(IN) :: comm
    TYPE(MPI_Info), INTENT(IN) :: info
    TYPE(MPI_Request), INTENT(OUT) :: request
    INTEGER, OPTIONAL, INTENT(OUT) :: ierror

MPI_Alltoallw_init(sendbuf, sendcounts, sdispls, sendtypes, recvbuf,
    recvcounts, rdispls, recvtypes, comm, info, request, ierror)
    TYPE(*), DIMENSION(..), INTENT(IN), ASYNCHRONOUS :: sendbuf
    INTEGER, INTENT(IN), ASYNCHRONOUS :: sendcounts(*), sdispls(*),
    recvcounts(*), rdispls(*)
    TYPE(MPI_Datatype), INTENT(IN), ASYNCHRONOUS :: sendtypes(*),
    recvtypes(*)
    TYPE(*), DIMENSION(..), ASYNCHRONOUS :: recvbuf
    TYPE(MPI_Comm), INTENT(IN) :: comm
    TYPE(MPI_Info), INTENT(IN) :: info
    TYPE(MPI_Request), INTENT(OUT) :: request
    INTEGER, OPTIONAL, INTENT(OUT) :: ierror

MPI_Barrier(comm, ierror)
    TYPE(MPI_Comm), INTENT(IN) :: comm
    INTEGER, OPTIONAL, INTENT(OUT) :: ierror

MPI_Barrier_init(comm, info, request, ierror)
    TYPE(MPI_Comm), INTENT(IN) :: comm
    TYPE(MPI_Info), INTENT(IN) :: info
    TYPE(MPI_Request), INTENT(OUT) :: request
    INTEGER, OPTIONAL, INTENT(OUT) :: ierror

MPI_Bcast(buffer, count, datatype, root, comm, ierror)
    TYPE(*), DIMENSION(..) :: buffer
    INTEGER, INTENT(IN) :: count, root

```

```

1     TYPE(MPI_Datatype), INTENT(IN) :: datatype
2     TYPE(MPI_Comm), INTENT(IN) :: comm
3     INTEGER, OPTIONAL, INTENT(OUT) :: ierror
4
5 MPI_Bcast_init(buffer, count, datatype, root, comm, info, request, ierror)
6     TYPE(*), DIMENSION(..), ASYNCHRONOUS :: buffer
7     INTEGER, INTENT(IN) :: count, root
8     TYPE(MPI_Datatype), INTENT(IN) :: datatype
9     TYPE(MPI_Comm), INTENT(IN) :: comm
10    TYPE(MPI_Info), INTENT(IN) :: info
11    TYPE(MPI_Request), INTENT(OUT) :: request
12    INTEGER, OPTIONAL, INTENT(OUT) :: ierror
13
14 MPI_Exscan(sendbuf, recvbuf, count, datatype, op, comm, ierror)
15    TYPE(*), DIMENSION(..), INTENT(IN) :: sendbuf
16    TYPE(*), DIMENSION(..) :: recvbuf
17    INTEGER, INTENT(IN) :: count
18    TYPE(MPI_Datatype), INTENT(IN) :: datatype
19    TYPE(MPI_Op), INTENT(IN) :: op
20    TYPE(MPI_Comm), INTENT(IN) :: comm
21    INTEGER, OPTIONAL, INTENT(OUT) :: ierror
22
23 MPI_Exscan_init(sendbuf, recvbuf, count, datatype, op, comm, info, request,
24                ierror)
25    TYPE(*), DIMENSION(..), INTENT(IN), ASYNCHRONOUS :: sendbuf
26    TYPE(*), DIMENSION(..), ASYNCHRONOUS :: recvbuf
27    INTEGER, INTENT(IN) :: count
28    TYPE(MPI_Datatype), INTENT(IN) :: datatype
29    TYPE(MPI_Op), INTENT(IN) :: op
30    TYPE(MPI_Comm), INTENT(IN) :: comm
31    TYPE(MPI_Info), INTENT(IN) :: info
32    TYPE(MPI_Request), INTENT(OUT) :: request
33    INTEGER, OPTIONAL, INTENT(OUT) :: ierror
34
35 MPI_Gather(sendbuf, sendcount, sendtype, recvbuf, recvcount, recvtype,
36           root, comm, ierror)
37    TYPE(*), DIMENSION(..), INTENT(IN) :: sendbuf
38    INTEGER, INTENT(IN) :: sendcount, recvcount, root
39    TYPE(MPI_Datatype), INTENT(IN) :: sendtype, recvtype
40    TYPE(*), DIMENSION(..) :: recvbuf
41    TYPE(MPI_Comm), INTENT(IN) :: comm
42    INTEGER, OPTIONAL, INTENT(OUT) :: ierror
43
44 MPI_Gather_init(sendbuf, sendcount, sendtype, recvbuf, recvcount, recvtype,
45                root, comm, info, request, ierror)
46    TYPE(*), DIMENSION(..), INTENT(IN), ASYNCHRONOUS :: sendbuf
47    INTEGER, INTENT(IN) :: sendcount, recvcount, root
48    TYPE(MPI_Datatype), INTENT(IN) :: sendtype, recvtype
49    TYPE(*), DIMENSION(..), ASYNCHRONOUS :: recvbuf
50    TYPE(MPI_Comm), INTENT(IN) :: comm

```

```

TYPE(MPI_Info), INTENT(IN) :: info
TYPE(MPI_Request), INTENT(OUT) :: request
INTEGER, OPTIONAL, INTENT(OUT) :: ierror

MPI_Gatherv(sendbuf, sendcount, sendtype, recvbuf, recvcnts, displs,
            recvtype, root, comm, ierror)
TYPE(*), DIMENSION(..), INTENT(IN) :: sendbuf
INTEGER, INTENT(IN) :: sendcount, recvcnts(*), displs(*), root
TYPE(MPI_Datatype), INTENT(IN) :: sendtype, recvtype
TYPE(*), DIMENSION(..) :: recvbuf
TYPE(MPI_Comm), INTENT(IN) :: comm
INTEGER, OPTIONAL, INTENT(OUT) :: ierror

MPI_Gatherv_init(sendbuf, sendcount, sendtype, recvbuf, recvcnts, displs,
                recvtype, root, comm, info, request, ierror)
TYPE(*), DIMENSION(..), INTENT(IN), ASYNCHRONOUS :: sendbuf
INTEGER, INTENT(IN) :: sendcount, root
TYPE(MPI_Datatype), INTENT(IN) :: sendtype, recvtype
TYPE(*), DIMENSION(..), ASYNCHRONOUS :: recvbuf
INTEGER, INTENT(IN), ASYNCHRONOUS :: recvcnts(*), displs(*)
TYPE(MPI_Comm), INTENT(IN) :: comm
TYPE(MPI_Info), INTENT(IN) :: info
TYPE(MPI_Request), INTENT(OUT) :: request
INTEGER, OPTIONAL, INTENT(OUT) :: ierror

MPI_Iallgather(sendbuf, sendcount, sendtype, recvbuf, recvcount, recvtype,
              comm, request, ierror)
TYPE(*), DIMENSION(..), INTENT(IN), ASYNCHRONOUS :: sendbuf
INTEGER, INTENT(IN) :: sendcount, recvcount
TYPE(MPI_Datatype), INTENT(IN) :: sendtype, recvtype
TYPE(*), DIMENSION(..), ASYNCHRONOUS :: recvbuf
TYPE(MPI_Comm), INTENT(IN) :: comm
TYPE(MPI_Request), INTENT(OUT) :: request
INTEGER, OPTIONAL, INTENT(OUT) :: ierror

MPI_Iallgatherv(sendbuf, sendcount, sendtype, recvbuf, recvcnts, displs,
               recvtype, comm, request, ierror)
TYPE(*), DIMENSION(..), INTENT(IN), ASYNCHRONOUS :: sendbuf
INTEGER, INTENT(IN) :: sendcount
TYPE(MPI_Datatype), INTENT(IN) :: sendtype, recvtype
TYPE(*), DIMENSION(..), ASYNCHRONOUS :: recvbuf
INTEGER, INTENT(IN), ASYNCHRONOUS :: recvcnts(*), displs(*)
TYPE(MPI_Comm), INTENT(IN) :: comm
TYPE(MPI_Request), INTENT(OUT) :: request
INTEGER, OPTIONAL, INTENT(OUT) :: ierror

MPI_Iallreduce(sendbuf, recvbuf, count, datatype, op, comm, request,
              ierror)
TYPE(*), DIMENSION(..), INTENT(IN), ASYNCHRONOUS :: sendbuf
TYPE(*), DIMENSION(..), ASYNCHRONOUS :: recvbuf

```

```

1     INTEGER, INTENT(IN) :: count
2     TYPE(MPI_Datatype), INTENT(IN) :: datatype
3     TYPE(MPI_Op), INTENT(IN) :: op
4     TYPE(MPI_Comm), INTENT(IN) :: comm
5     TYPE(MPI_Request), INTENT(OUT) :: request
6     INTEGER, OPTIONAL, INTENT(OUT) :: ierror
7
8 MPI_Ialltoall(sendbuf, sendcount, sendtype, recvbuf, recvcount, recvtype,
9             comm, request, ierror)
10    TYPE(*), DIMENSION(..), INTENT(IN), ASYNCHRONOUS :: sendbuf
11    INTEGER, INTENT(IN) :: sendcount, recvcount
12    TYPE(MPI_Datatype), INTENT(IN) :: sendtype, recvtype
13    TYPE(*), DIMENSION(..), ASYNCHRONOUS :: recvbuf
14    TYPE(MPI_Comm), INTENT(IN) :: comm
15    TYPE(MPI_Request), INTENT(OUT) :: request
16    INTEGER, OPTIONAL, INTENT(OUT) :: ierror
17
18 MPI_Ialltoallv(sendbuf, sendcounts, sdispls, sendtype, recvbuf, recvcounts,
19             rdispls, recvtype, comm, request, ierror)
20    TYPE(*), DIMENSION(..), INTENT(IN), ASYNCHRONOUS :: sendbuf
21    INTEGER, INTENT(IN), ASYNCHRONOUS :: sendcounts(*), sdispls(*),
22    recvcounts(*), rdispls(*)
23    TYPE(MPI_Datatype), INTENT(IN) :: sendtype, recvtype
24    TYPE(*), DIMENSION(..), ASYNCHRONOUS :: recvbuf
25    TYPE(MPI_Comm), INTENT(IN) :: comm
26    TYPE(MPI_Request), INTENT(OUT) :: request
27    INTEGER, OPTIONAL, INTENT(OUT) :: ierror
28
29 MPI_Ialltoallw(sendbuf, sendcounts, sdispls, sendtypes, recvbuf,
30             recvcounts, rdispls, recvtypes, comm, request, ierror)
31    TYPE(*), DIMENSION(..), INTENT(IN), ASYNCHRONOUS :: sendbuf
32    INTEGER, INTENT(IN), ASYNCHRONOUS :: sendcounts(*), sdispls(*),
33    recvcounts(*), rdispls(*)
34    TYPE(MPI_Datatype), INTENT(IN), ASYNCHRONOUS :: sendtypes(*),
35    recvtypes(*)
36    TYPE(*), DIMENSION(..), ASYNCHRONOUS :: recvbuf
37    TYPE(MPI_Comm), INTENT(IN) :: comm
38    TYPE(MPI_Request), INTENT(OUT) :: request
39    INTEGER, OPTIONAL, INTENT(OUT) :: ierror
40
41 MPI_Ibarrier(comm, request, ierror)
42    TYPE(MPI_Comm), INTENT(IN) :: comm
43    TYPE(MPI_Request), INTENT(OUT) :: request
44    INTEGER, OPTIONAL, INTENT(OUT) :: ierror
45
46 MPI_Ibcast(buffer, count, datatype, root, comm, request, ierror)
47    TYPE(*), DIMENSION(..), ASYNCHRONOUS :: buffer
48    INTEGER, INTENT(IN) :: count, root
49    TYPE(MPI_Datatype), INTENT(IN) :: datatype
50    TYPE(MPI_Comm), INTENT(IN) :: comm

```

```

TYPE(MPI_Request), INTENT(OUT) :: request      1
INTEGER, OPTIONAL, INTENT(OUT) :: ierror      2
3
MPI_Iexscan(sendbuf, recvbuf, count, datatype, op, comm, request, ierror)  4
TYPE(*), DIMENSION(..), INTENT(IN), ASYNCHRONOUS :: sendbuf      5
TYPE(*), DIMENSION(..), ASYNCHRONOUS :: recvbuf      6
INTEGER, INTENT(IN) :: count      7
TYPE(MPI_Datatype), INTENT(IN) :: datatype      8
TYPE(MPI_Op), INTENT(IN) :: op      9
TYPE(MPI_Comm), INTENT(IN) :: comm      10
TYPE(MPI_Request), INTENT(OUT) :: request      11
INTEGER, OPTIONAL, INTENT(OUT) :: ierror      12
13
MPI_Igather(sendbuf, sendcount, sendtype, recvbuf, recvcount, recvttype,
            root, comm, request, ierror)      14
TYPE(*), DIMENSION(..), INTENT(IN), ASYNCHRONOUS :: sendbuf      15
INTEGER, INTENT(IN) :: sendcount, recvcount, root      16
TYPE(MPI_Datatype), INTENT(IN) :: sendtype, recvttype      17
TYPE(*), DIMENSION(..), ASYNCHRONOUS :: recvbuf      18
TYPE(MPI_Comm), INTENT(IN) :: comm      19
TYPE(MPI_Request), INTENT(OUT) :: request      20
INTEGER, OPTIONAL, INTENT(OUT) :: ierror      21
22
MPI_Igatherv(sendbuf, sendcount, sendtype, recvbuf, recvcnts, displs,
            recvttype, root, comm, request, ierror)      23
TYPE(*), DIMENSION(..), INTENT(IN), ASYNCHRONOUS :: sendbuf      24
INTEGER, INTENT(IN) :: sendcount, displs(*), root      25
TYPE(MPI_Datatype), INTENT(IN) :: sendtype, recvttype      26
TYPE(*), DIMENSION(..), ASYNCHRONOUS :: recvbuf      27
INTEGER, INTENT(IN), ASYNCHRONOUS :: recvcnts(*)      28
TYPE(MPI_Comm), INTENT(IN) :: comm      29
TYPE(MPI_Request), INTENT(OUT) :: request      30
INTEGER, OPTIONAL, INTENT(OUT) :: ierror      31
32
MPI_Ireduce(sendbuf, recvbuf, count, datatype, op, root, comm, request,
            ierror)      33
TYPE(*), DIMENSION(..), INTENT(IN), ASYNCHRONOUS :: sendbuf      34
TYPE(*), DIMENSION(..), ASYNCHRONOUS :: recvbuf      35
INTEGER, INTENT(IN) :: count, root      36
TYPE(MPI_Datatype), INTENT(IN) :: datatype      37
TYPE(MPI_Op), INTENT(IN) :: op      38
TYPE(MPI_Comm), INTENT(IN) :: comm      39
TYPE(MPI_Request), INTENT(OUT) :: request      40
INTEGER, OPTIONAL, INTENT(OUT) :: ierror      41
42
MPI_Ireduce_scatter(sendbuf, recvbuf, recvcnts, datatype, op, comm,
                    request, ierror)      43
TYPE(*), DIMENSION(..), INTENT(IN), ASYNCHRONOUS :: sendbuf      44
TYPE(*), DIMENSION(..), ASYNCHRONOUS :: recvbuf      45
INTEGER, INTENT(IN), ASYNCHRONOUS :: recvcnts(*)      46
47
48

```

```

1     TYPE(MPI_Datatype), INTENT(IN) :: datatype
2     TYPE(MPI_Op), INTENT(IN) :: op
3     TYPE(MPI_Comm), INTENT(IN) :: comm
4     TYPE(MPI_Request), INTENT(OUT) :: request
5     INTEGER, OPTIONAL, INTENT(OUT) :: ierror
6
7     MPI_Ireduce_scatter_block(sendbuf, recvbuf, recvcount, datatype, op, comm,
8         request, ierror)
9         TYPE(*), DIMENSION(..), INTENT(IN), ASYNCHRONOUS :: sendbuf
10        TYPE(*), DIMENSION(..), ASYNCHRONOUS :: recvbuf
11        INTEGER, INTENT(IN) :: recvcount
12        TYPE(MPI_Datatype), INTENT(IN) :: datatype
13        TYPE(MPI_Op), INTENT(IN) :: op
14        TYPE(MPI_Comm), INTENT(IN) :: comm
15        TYPE(MPI_Request), INTENT(OUT) :: request
16        INTEGER, OPTIONAL, INTENT(OUT) :: ierror
17
18    MPI_Iscan(sendbuf, recvbuf, count, datatype, op, comm, request, ierror)
19        TYPE(*), DIMENSION(..), INTENT(IN), ASYNCHRONOUS :: sendbuf
20        TYPE(*), DIMENSION(..), ASYNCHRONOUS :: recvbuf
21        INTEGER, INTENT(IN) :: count
22        TYPE(MPI_Datatype), INTENT(IN) :: datatype
23        TYPE(MPI_Op), INTENT(IN) :: op
24        TYPE(MPI_Comm), INTENT(IN) :: comm
25        TYPE(MPI_Request), INTENT(OUT) :: request
26        INTEGER, OPTIONAL, INTENT(OUT) :: ierror
27
28    MPI_Iscatter(sendbuf, sendcount, sendtype, recvbuf, recvcount, recvttype,
29        root, comm, request, ierror)
30        TYPE(*), DIMENSION(..), INTENT(IN), ASYNCHRONOUS :: sendbuf
31        INTEGER, INTENT(IN) :: sendcount, recvcount, root
32        TYPE(MPI_Datatype), INTENT(IN) :: sendtype, recvttype
33        TYPE(*), DIMENSION(..), ASYNCHRONOUS :: recvbuf
34        TYPE(MPI_Comm), INTENT(IN) :: comm
35        TYPE(MPI_Request), INTENT(OUT) :: request
36        INTEGER, OPTIONAL, INTENT(OUT) :: ierror
37
38    MPI_Iscatterv(sendbuf, sendcounts, displs, sendtype, recvbuf, recvcount,
39        recvttype, root, comm, request, ierror)
40        TYPE(*), DIMENSION(..), INTENT(IN), ASYNCHRONOUS :: sendbuf
41        INTEGER, INTENT(IN), ASYNCHRONOUS :: sendcounts(*)
42        INTEGER, INTENT(IN) :: displs(*), recvcount, root
43        TYPE(MPI_Datatype), INTENT(IN) :: sendtype, recvttype
44        TYPE(*), DIMENSION(..), ASYNCHRONOUS :: recvbuf
45        TYPE(MPI_Comm), INTENT(IN) :: comm
46        TYPE(MPI_Request), INTENT(OUT) :: request
47        INTEGER, OPTIONAL, INTENT(OUT) :: ierror
48
49    MPI_Op_commutative(op, commute, ierror)
50        TYPE(MPI_Op), INTENT(IN) :: op

```



```

LOGICAL, INTENT(OUT) :: commute                                1
INTEGER, OPTIONAL, INTENT(OUT) :: ierror                    2
                                                                3
MPI_Op_create(user_fn, commute, op, ierror)                 4
  PROCEDURE(MPI_User_function) :: user_fn                  5
  LOGICAL, INTENT(IN) :: commute                            6
  TYPE(MPI_Op), INTENT(OUT) :: op                           7
  INTEGER, OPTIONAL, INTENT(OUT) :: ierror                  8
                                                                9
MPI_Op_free(op, ierror)                                     10
  TYPE(MPI_Op), INTENT(INOUT) :: op                         11
  INTEGER, OPTIONAL, INTENT(OUT) :: ierror                  12
                                                                13
MPI_Reduce(sendbuf, recvbuf, count, datatype, op, root, comm, ierror)
  TYPE(*), DIMENSION(..), INTENT(IN) :: sendbuf           14
  TYPE(*), DIMENSION(..) :: recvbuf                       15
  INTEGER, INTENT(IN) :: count, root                       16
  TYPE(MPI_Datatype), INTENT(IN) :: datatype               17
  TYPE(MPI_Op), INTENT(IN) :: op                           18
  TYPE(MPI_Comm), INTENT(IN) :: comm                       19
  INTEGER, OPTIONAL, INTENT(OUT) :: ierror                 20
                                                                21
MPI_Reduce_init(sendbuf, recvbuf, count, datatype, op, root, comm, info,
  request, ierror)                                         22
  TYPE(*), DIMENSION(..), INTENT(IN), ASYNCHRONOUS :: sendbuf 23
  TYPE(*), DIMENSION(..), ASYNCHRONOUS :: recvbuf          24
  INTEGER, INTENT(IN) :: count, root                       25
  TYPE(MPI_Datatype), INTENT(IN) :: datatype               26
  TYPE(MPI_Op), INTENT(IN) :: op                           27
  TYPE(MPI_Comm), INTENT(IN) :: comm                       28
  TYPE(MPI_Info), INTENT(IN) :: info                       29
  TYPE(MPI_Request), INTENT(OUT) :: request                30
  INTEGER, OPTIONAL, INTENT(OUT) :: ierror                 31
                                                                32
MPI_Reduce_local(inbuf, inoutbuf, count, datatype, op, ierror)
  TYPE(*), DIMENSION(..), INTENT(IN) :: inbuf              33
  TYPE(*), DIMENSION(..) :: inoutbuf                       34
  INTEGER, INTENT(IN) :: count                              35
  TYPE(MPI_Datatype), INTENT(IN) :: datatype               36
  TYPE(MPI_Op), INTENT(IN) :: op                           37
  INTEGER, OPTIONAL, INTENT(OUT) :: ierror                  38
                                                                39
MPI_Reduce_scatter(sendbuf, recvbuf, recvcnts, datatype, op, comm,
  ierror)                                                  40
  TYPE(*), DIMENSION(..), INTENT(IN) :: sendbuf           41
  TYPE(*), DIMENSION(..) :: recvbuf                       42
  INTEGER, INTENT(IN) :: recvcnts(*)                       43
  TYPE(MPI_Datatype), INTENT(IN) :: datatype               44
  TYPE(MPI_Op), INTENT(IN) :: op                           45
  TYPE(MPI_Comm), INTENT(IN) :: comm                       46
                                                                47
                                                                48

```

```

1     INTEGER, OPTIONAL, INTENT(OUT) :: ierror
2
3     MPI_Reduce_scatter_block(sendbuf, recvbuf, recvcnt, datatype, op, comm,
4         ierror)
5     TYPE(*), DIMENSION(..), INTENT(IN) :: sendbuf
6     TYPE(*), DIMENSION(..) :: recvbuf
7     INTEGER, INTENT(IN) :: recvcnt
8     TYPE(MPI_Datatype), INTENT(IN) :: datatype
9     TYPE(MPI_Op), INTENT(IN) :: op
10    TYPE(MPI_Comm), INTENT(IN) :: comm
11    INTEGER, OPTIONAL, INTENT(OUT) :: ierror
12
13    MPI_Reduce_scatter_block_init(sendbuf, recvbuf, recvcnt, datatype, op,
14        comm, info, request, ierror)
15    TYPE(*), DIMENSION(..), INTENT(IN), ASYNCHRONOUS :: sendbuf
16    TYPE(*), DIMENSION(..), ASYNCHRONOUS :: recvbuf
17    INTEGER, INTENT(IN) :: recvcnt
18    TYPE(MPI_Datatype), INTENT(IN) :: datatype
19    TYPE(MPI_Op), INTENT(IN) :: op
20    TYPE(MPI_Comm), INTENT(IN) :: comm
21    TYPE(MPI_Info), INTENT(IN) :: info
22    TYPE(MPI_Request), INTENT(OUT) :: request
23    INTEGER, OPTIONAL, INTENT(OUT) :: ierror
24
25    MPI_Reduce_scatter_init(sendbuf, recvbuf, recvcnts, datatype, op, comm,
26        info, request, ierror)
27    TYPE(*), DIMENSION(..), INTENT(IN), ASYNCHRONOUS :: sendbuf
28    TYPE(*), DIMENSION(..), ASYNCHRONOUS :: recvbuf
29    INTEGER, INTENT(IN), ASYNCHRONOUS :: recvcnts(*)
30    TYPE(MPI_Datatype), INTENT(IN) :: datatype
31    TYPE(MPI_Op), INTENT(IN) :: op
32    TYPE(MPI_Comm), INTENT(IN) :: comm
33    TYPE(MPI_Info), INTENT(IN) :: info
34    TYPE(MPI_Request), INTENT(OUT) :: request
35    INTEGER, OPTIONAL, INTENT(OUT) :: ierror
36
37    MPI_Scan(sendbuf, recvbuf, count, datatype, op, comm, ierror)
38    TYPE(*), DIMENSION(..), INTENT(IN) :: sendbuf
39    TYPE(*), DIMENSION(..) :: recvbuf
40    INTEGER, INTENT(IN) :: count
41    TYPE(MPI_Datatype), INTENT(IN) :: datatype
42    TYPE(MPI_Op), INTENT(IN) :: op
43    TYPE(MPI_Comm), INTENT(IN) :: comm
44    INTEGER, OPTIONAL, INTENT(OUT) :: ierror
45
46    MPI_Scan_init(sendbuf, recvbuf, count, datatype, op, comm, info, request,
47        ierror)
48    TYPE(*), DIMENSION(..), INTENT(IN), ASYNCHRONOUS :: sendbuf
49    TYPE(*), DIMENSION(..), ASYNCHRONOUS :: recvbuf
50    INTEGER, INTENT(IN) :: count

```

```

TYPE(MPI_Datatype), INTENT(IN) :: datatype
TYPE(MPI_Op), INTENT(IN) :: op
TYPE(MPI_Comm), INTENT(IN) :: comm
TYPE(MPI_Info), INTENT(IN) :: info
TYPE(MPI_Request), INTENT(OUT) :: request
INTEGER, OPTIONAL, INTENT(OUT) :: ierror

MPI_Scatter(sendbuf, sendcount, sendtype, recvbuf, recvcount, recvtpe,
            root, comm, ierror)
TYPE(*), DIMENSION(..), INTENT(IN) :: sendbuf
INTEGER, INTENT(IN) :: sendcount, recvcount, root
TYPE(MPI_Datatype), INTENT(IN) :: sendtype, recvtpe
TYPE(*), DIMENSION(..) :: recvbuf
TYPE(MPI_Comm), INTENT(IN) :: comm
INTEGER, OPTIONAL, INTENT(OUT) :: ierror

MPI_Scatter_init(sendbuf, sendcount, sendtype, recvbuf, recvcount,
                recvtpe, root, comm, info, request, ierror)
TYPE(*), DIMENSION(..), INTENT(IN), ASYNCHRONOUS :: sendbuf
INTEGER, INTENT(IN) :: sendcount, recvcount, root
TYPE(MPI_Datatype), INTENT(IN) :: sendtype, recvtpe
TYPE(*), DIMENSION(..), ASYNCHRONOUS :: recvbuf
TYPE(MPI_Comm), INTENT(IN) :: comm
TYPE(MPI_Info), INTENT(IN) :: info
TYPE(MPI_Request), INTENT(OUT) :: request
INTEGER, OPTIONAL, INTENT(OUT) :: ierror

MPI_Scatterv(sendbuf, sendcounts, displs, sendtype, recvbuf, recvcount,
             recvtpe, root, comm, ierror)
TYPE(*), DIMENSION(..), INTENT(IN) :: sendbuf
INTEGER, INTENT(IN) :: sendcounts(*), displs(*), recvcount, root
TYPE(MPI_Datatype), INTENT(IN) :: sendtype, recvtpe
TYPE(*), DIMENSION(..) :: recvbuf
TYPE(MPI_Comm), INTENT(IN) :: comm
INTEGER, OPTIONAL, INTENT(OUT) :: ierror

MPI_Scatterv_init(sendbuf, sendcounts, displs, sendtype, recvbuf,
                 recvcount, recvtpe, root, comm, info, request, ierror)
TYPE(*), DIMENSION(..), INTENT(IN), ASYNCHRONOUS :: sendbuf
INTEGER, INTENT(IN), ASYNCHRONOUS :: sendcounts(*), displs(*)
TYPE(MPI_Datatype), INTENT(IN) :: sendtype, recvtpe
TYPE(*), DIMENSION(..), ASYNCHRONOUS :: recvbuf
INTEGER, INTENT(IN) :: recvcount, root
TYPE(MPI_Comm), INTENT(IN) :: comm
TYPE(MPI_Info), INTENT(IN) :: info
TYPE(MPI_Request), INTENT(OUT) :: request
INTEGER, OPTIONAL, INTENT(OUT) :: ierror

```

### A.3.4 Groups, Contexts, Communicators, and Caching Fortran 2008 Bindings

```

1  MPI_COMM_DUP_FN(oldcomm, comm_keyval, extra_state, attribute_val_in,
2      attribute_val_out, flag, ierror)
3      TYPE(MPI_Comm) :: oldcomm
4      INTEGER :: comm_keyval, ierror
5      INTEGER(KIND=MPI_ADDRESS_KIND) :: extra_state, attribute_val_in,
6      attribute_val_out
7      LOGICAL :: flag
8
9  MPI_COMM_NULL_COPY_FN(oldcomm, comm_keyval, extra_state, attribute_val_in,
10     attribute_val_out, flag, ierror)
11     TYPE(MPI_Comm) :: oldcomm
12     INTEGER :: comm_keyval, ierror
13     INTEGER(KIND=MPI_ADDRESS_KIND) :: extra_state, attribute_val_in,
14     attribute_val_out
15     LOGICAL :: flag
16
17  MPI_COMM_NULL_DELETE_FN(comm, comm_keyval, attribute_val, extra_state,
18     ierror)
19     TYPE(MPI_Comm) :: comm
20     INTEGER :: comm_keyval, ierror
21     INTEGER(KIND=MPI_ADDRESS_KIND) :: attribute_val, extra_state
22
23  MPI_Comm_compare(comm1, comm2, result, ierror)
24     TYPE(MPI_Comm), INTENT(IN) :: comm1, comm2
25     INTEGER, INTENT(OUT) :: result
26     INTEGER, OPTIONAL, INTENT(OUT) :: ierror
27
28  MPI_Comm_create(comm, group, newcomm, ierror)
29     TYPE(MPI_Comm), INTENT(IN) :: comm
30     TYPE(MPI_Group), INTENT(IN) :: group
31     TYPE(MPI_Comm), INTENT(OUT) :: newcomm
32     INTEGER, OPTIONAL, INTENT(OUT) :: ierror
33
34  MPI_Comm_create_from_group(group, stringtag, info, errhandler, newcomm,
35     ierror)
36     TYPE(MPI_Group), INTENT(IN) :: group
37     CHARACTER(LEN=*), INTENT(IN) :: stringtag
38     TYPE(MPI_Info), INTENT(IN) :: info
39     TYPE(MPI_Errhandler), INTENT(IN) :: errhandler
40     TYPE(MPI_Comm), INTENT(OUT) :: newcomm
41     INTEGER, OPTIONAL, INTENT(OUT) :: ierror
42
43  MPI_Comm_create_group(comm, group, tag, newcomm, ierror)
44     TYPE(MPI_Comm), INTENT(IN) :: comm
45     TYPE(MPI_Group), INTENT(IN) :: group
46     INTEGER, INTENT(IN) :: tag
47     TYPE(MPI_Comm), INTENT(OUT) :: newcomm
48     INTEGER, OPTIONAL, INTENT(OUT) :: ierror

```

```

MPI_Comm_create_keyval(comm_copy_attr_fn, comm_delete_attr_fn, comm_keyval,
    extra_state, ierror)
    PROCEDURE(MPI_Comm_copy_attr_function), INTENT(IN) ::
comm_copy_attr_fn
    PROCEDURE(MPI_Comm_delete_attr_function), INTENT(IN) ::
comm_delete_attr_fn
    INTEGER, INTENT(OUT) :: comm_keyval
    INTEGER(KIND=MPI_ADDRESS_KIND), INTENT(IN) :: extra_state
    INTEGER, OPTIONAL, INTENT(OUT) :: ierror

MPI_Comm_delete_attr(comm, comm_keyval, ierror)
    TYPE(MPI_Comm), INTENT(IN) :: comm
    INTEGER, INTENT(IN) :: comm_keyval
    INTEGER, OPTIONAL, INTENT(OUT) :: ierror

MPI_Comm_dup(comm, newcomm, ierror)
    TYPE(MPI_Comm), INTENT(IN) :: comm
    TYPE(MPI_Comm), INTENT(OUT) :: newcomm
    INTEGER, OPTIONAL, INTENT(OUT) :: ierror

MPI_Comm_dup_with_info(comm, info, newcomm, ierror)
    TYPE(MPI_Comm), INTENT(IN) :: comm
    TYPE(MPI_Info), INTENT(IN) :: info
    TYPE(MPI_Comm), INTENT(OUT) :: newcomm
    INTEGER, OPTIONAL, INTENT(OUT) :: ierror

MPI_Comm_free(comm, ierror)
    TYPE(MPI_Comm), INTENT(INOUT) :: comm
    INTEGER, OPTIONAL, INTENT(OUT) :: ierror

MPI_Comm_free_keyval(comm_keyval, ierror)
    INTEGER, INTENT(INOUT) :: comm_keyval
    INTEGER, OPTIONAL, INTENT(OUT) :: ierror

MPI_Comm_get_attr(comm, comm_keyval, attribute_val, flag, ierror)
    TYPE(MPI_Comm), INTENT(IN) :: comm
    INTEGER, INTENT(IN) :: comm_keyval
    INTEGER(KIND=MPI_ADDRESS_KIND), INTENT(OUT) :: attribute_val
    LOGICAL, INTENT(OUT) :: flag
    INTEGER, OPTIONAL, INTENT(OUT) :: ierror

MPI_Comm_get_info(comm, info_used, ierror)
    TYPE(MPI_Comm), INTENT(IN) :: comm
    TYPE(MPI_Info), INTENT(OUT) :: info_used
    INTEGER, OPTIONAL, INTENT(OUT) :: ierror

MPI_Comm_get_name(comm, comm_name, resultlen, ierror)
    TYPE(MPI_Comm), INTENT(IN) :: comm
    CHARACTER(LEN=MPI_MAX_OBJECT_NAME), INTENT(OUT) :: comm_name
    INTEGER, INTENT(OUT) :: resultlen
    INTEGER, OPTIONAL, INTENT(OUT) :: ierror

```

```
1 MPI_Comm_group(comm, group, ierror)
2     TYPE(MPI_Comm), INTENT(IN) :: comm
3     TYPE(MPI_Group), INTENT(OUT) :: group
4     INTEGER, OPTIONAL, INTENT(OUT) :: ierror
5
6 MPI_Comm_idup(comm, newcomm, request, ierror)
7     TYPE(MPI_Comm), INTENT(IN) :: comm
8     TYPE(MPI_Comm), INTENT(OUT), ASYNCHRONOUS :: newcomm
9     TYPE(MPI_Request), INTENT(OUT) :: request
10    INTEGER, OPTIONAL, INTENT(OUT) :: ierror
11
12 MPI_Comm_idup_with_info(comm, info, newcomm, request, ierror)
13    TYPE(MPI_Comm), INTENT(IN) :: comm
14    TYPE(MPI_Info), INTENT(IN) :: info
15    TYPE(MPI_Comm), INTENT(OUT), ASYNCHRONOUS :: newcomm
16    TYPE(MPI_Request), INTENT(OUT) :: request
17    INTEGER, OPTIONAL, INTENT(OUT) :: ierror
18
19 MPI_Comm_rank(comm, rank, ierror)
20    TYPE(MPI_Comm), INTENT(IN) :: comm
21    INTEGER, INTENT(OUT) :: rank
22    INTEGER, OPTIONAL, INTENT(OUT) :: ierror
23
24 MPI_Comm_remote_group(comm, group, ierror)
25    TYPE(MPI_Comm), INTENT(IN) :: comm
26    TYPE(MPI_Group), INTENT(OUT) :: group
27    INTEGER, OPTIONAL, INTENT(OUT) :: ierror
28
29 MPI_Comm_remote_size(comm, size, ierror)
30    TYPE(MPI_Comm), INTENT(IN) :: comm
31    INTEGER, INTENT(OUT) :: size
32    INTEGER, OPTIONAL, INTENT(OUT) :: ierror
33
34 MPI_Comm_set_attr(comm, comm_keyval, attribute_val, ierror)
35    TYPE(MPI_Comm), INTENT(IN) :: comm
36    INTEGER, INTENT(IN) :: comm_keyval
37    INTEGER(KIND=MPI_ADDRESS_KIND), INTENT(IN) :: attribute_val
38    INTEGER, OPTIONAL, INTENT(OUT) :: ierror
39
40 MPI_Comm_set_info(comm, info, ierror)
41    TYPE(MPI_Comm), INTENT(IN) :: comm
42    TYPE(MPI_Info), INTENT(IN) :: info
43    INTEGER, OPTIONAL, INTENT(OUT) :: ierror
44
45 MPI_Comm_set_name(comm, comm_name, ierror)
46    TYPE(MPI_Comm), INTENT(IN) :: comm
47    CHARACTER(LEN=*), INTENT(IN) :: comm_name
48    INTEGER, OPTIONAL, INTENT(OUT) :: ierror
49
50 MPI_Comm_size(comm, size, ierror)
51    TYPE(MPI_Comm), INTENT(IN) :: comm
52    INTEGER, INTENT(OUT) :: size
```

```

    INTEGER, OPTIONAL, INTENT(OUT) :: ierror
1
MPI_Comm_split(comm, color, key, newcomm, ierror)
2
    TYPE(MPI_Comm), INTENT(IN) :: comm
3
    INTEGER, INTENT(IN) :: color, key
4
    TYPE(MPI_Comm), INTENT(OUT) :: newcomm
5
    INTEGER, OPTIONAL, INTENT(OUT) :: ierror
6
7
MPI_Comm_split_type(comm, split_type, key, info, newcomm, ierror)
8
    TYPE(MPI_Comm), INTENT(IN) :: comm
9
    INTEGER, INTENT(IN) :: split_type, key
10
    TYPE(MPI_Info), INTENT(IN) :: info
11
    TYPE(MPI_Comm), INTENT(OUT) :: newcomm
12
    INTEGER, OPTIONAL, INTENT(OUT) :: ierror
13
14
MPI_Comm_test_inter(comm, flag, ierror)
15
    TYPE(MPI_Comm), INTENT(IN) :: comm
16
    LOGICAL, INTENT(OUT) :: flag
17
    INTEGER, OPTIONAL, INTENT(OUT) :: ierror
18
19
MPI_Group_compare(group1, group2, result, ierror)
20
    TYPE(MPI_Group), INTENT(IN) :: group1, group2
21
    INTEGER, INTENT(OUT) :: result
22
    INTEGER, OPTIONAL, INTENT(OUT) :: ierror
23
24
MPI_Group_difference(group1, group2, newgroup, ierror)
25
    TYPE(MPI_Group), INTENT(IN) :: group1, group2
26
    TYPE(MPI_Group), INTENT(OUT) :: newgroup
27
    INTEGER, OPTIONAL, INTENT(OUT) :: ierror
28
29
MPI_Group_excl(group, n, ranks, newgroup, ierror)
30
    TYPE(MPI_Group), INTENT(IN) :: group
31
    INTEGER, INTENT(IN) :: n, ranks(n)
32
    TYPE(MPI_Group), INTENT(OUT) :: newgroup
33
    INTEGER, OPTIONAL, INTENT(OUT) :: ierror
34
35
MPI_Group_free(group, ierror)
36
    TYPE(MPI_Group), INTENT(INOUT) :: group
37
    INTEGER, OPTIONAL, INTENT(OUT) :: ierror
38
39
MPI_Group_from_session_pset(session, pset_name, newgroup, ierror)
40
    TYPE(MPI_Session), INTENT(IN) :: session
41
    CHARACTER(LEN=*), INTENT(IN) :: pset_name
42
    TYPE(MPI_Group), INTENT(OUT) :: newgroup
43
    INTEGER, OPTIONAL, INTENT(OUT) :: ierror
44
45
MPI_Group_incl(group, n, ranks, newgroup, ierror)
46
    TYPE(MPI_Group), INTENT(IN) :: group
47
    INTEGER, INTENT(IN) :: n, ranks(n)
48
    TYPE(MPI_Group), INTENT(OUT) :: newgroup
49
    INTEGER, OPTIONAL, INTENT(OUT) :: ierror
50

```

```

1 MPI_Group_intersection(group1, group2, newgroup, ierror)
2     TYPE(MPI_Group), INTENT(IN) :: group1, group2
3     TYPE(MPI_Group), INTENT(OUT) :: newgroup
4     INTEGER, OPTIONAL, INTENT(OUT) :: ierror
5
6 MPI_Group_range_excl(group, n, ranges, newgroup, ierror)
7     TYPE(MPI_Group), INTENT(IN) :: group
8     INTEGER, INTENT(IN) :: n, ranges(3, n)
9     TYPE(MPI_Group), INTENT(OUT) :: newgroup
10    INTEGER, OPTIONAL, INTENT(OUT) :: ierror
11
12 MPI_Group_range_incl(group, n, ranges, newgroup, ierror)
13    TYPE(MPI_Group), INTENT(IN) :: group
14    INTEGER, INTENT(IN) :: n, ranges(3, n)
15    TYPE(MPI_Group), INTENT(OUT) :: newgroup
16    INTEGER, OPTIONAL, INTENT(OUT) :: ierror
17
18 MPI_Group_rank(group, rank, ierror)
19    TYPE(MPI_Group), INTENT(IN) :: group
20    INTEGER, INTENT(OUT) :: rank
21    INTEGER, OPTIONAL, INTENT(OUT) :: ierror
22
23 MPI_Group_size(group, size, ierror)
24    TYPE(MPI_Group), INTENT(IN) :: group
25    INTEGER, INTENT(OUT) :: size
26    INTEGER, OPTIONAL, INTENT(OUT) :: ierror
27
28 MPI_Group_translate_ranks(group1, n, ranks1, group2, ranks2, ierror)
29    TYPE(MPI_Group), INTENT(IN) :: group1, group2
30    INTEGER, INTENT(IN) :: n, ranks1(n)
31    INTEGER, INTENT(OUT) :: ranks2(n)
32    INTEGER, OPTIONAL, INTENT(OUT) :: ierror
33
34 MPI_Group_union(group1, group2, newgroup, ierror)
35    TYPE(MPI_Group), INTENT(IN) :: group1, group2
36    TYPE(MPI_Group), INTENT(OUT) :: newgroup
37    INTEGER, OPTIONAL, INTENT(OUT) :: ierror
38
39 MPI_Intercomm_create(local_comm, local_leader, peer_comm, remote_leader,
40    tag, newintercomm, ierror)
41    TYPE(MPI_Comm), INTENT(IN) :: local_comm, peer_comm
42    INTEGER, INTENT(IN) :: local_leader, remote_leader, tag
43    TYPE(MPI_Comm), INTENT(OUT) :: newintercomm
44    INTEGER, OPTIONAL, INTENT(OUT) :: ierror
45
46 MPI_Intercomm_create_from_groups(local_group, local_leader, remote_group,
47    remote_leader, stringtag, info, errhandler, newintercomm,
48    ierror)
49    TYPE(MPI_Group), INTENT(IN) :: local_group, remote_group
50    INTEGER, INTENT(IN) :: local_leader, remote_leader
51    CHARACTER(LEN=*), INTENT(IN) :: stringtag

```



```

TYPE(MPI_Info), INTENT(IN) :: info
TYPE(MPI_Errhandler), INTENT(IN) :: errhandler
TYPE(MPI_Comm), INTENT(OUT) :: newintercomm
INTEGER, OPTIONAL, INTENT(OUT) :: ierror

MPI_Intercomm_merge(intercomm, high, newintracomm, ierror)
TYPE(MPI_Comm), INTENT(IN) :: intercomm
LOGICAL, INTENT(IN) :: high
TYPE(MPI_Comm), INTENT(OUT) :: newintracomm
INTEGER, OPTIONAL, INTENT(OUT) :: ierror

MPI_TYPE_DUP_FN(oldtype, type_keyval, extra_state, attribute_val_in,
                attribute_val_out, flag, ierror)
TYPE(MPI_Datatype) :: oldtype
INTEGER :: type_keyval, ierror
INTEGER(KIND=MPI_ADDRESS_KIND) :: extra_state, attribute_val_in,
attribute_val_out
LOGICAL :: flag

MPI_TYPE_NULL_COPY_FN(oldtype, type_keyval, extra_state, attribute_val_in,
                    attribute_val_out, flag, ierror)
TYPE(MPI_Datatype) :: oldtype
INTEGER :: type_keyval, ierror
INTEGER(KIND=MPI_ADDRESS_KIND) :: extra_state, attribute_val_in,
attribute_val_out
LOGICAL :: flag

MPI_TYPE_NULL_DELETE_FN(datatype, type_keyval, attribute_val, extra_state,
                       ierror)
TYPE(MPI_Datatype) :: datatype
INTEGER :: type_keyval
INTEGER(KIND=MPI_ADDRESS_KIND) :: attribute_val, extra_state
INTEGER, INTENT(OUT) :: ierror

MPI_Type_create_keyval(type_copy_attr_fn, type_delete_attr_fn, type_keyval,
                    extra_state, ierror)
PROCEDURE(MPI_Type_copy_attr_function), INTENT(IN) ::
type_copy_attr_fn
PROCEDURE(MPI_Type_delete_attr_function), INTENT(IN) ::
type_delete_attr_fn
INTEGER, INTENT(OUT) :: type_keyval
INTEGER(KIND=MPI_ADDRESS_KIND), INTENT(IN) :: extra_state
INTEGER, OPTIONAL, INTENT(OUT) :: ierror

MPI_Type_delete_attr(datatype, type_keyval, ierror)
TYPE(MPI_Datatype), INTENT(IN) :: datatype
INTEGER, INTENT(IN) :: type_keyval
INTEGER, OPTIONAL, INTENT(OUT) :: ierror

MPI_Type_free_keyval(type_keyval, ierror)
INTEGER, INTENT(INOUT) :: type_keyval

```

```

1     INTEGER, OPTIONAL, INTENT(OUT) :: ierror
2
3     MPI_Type_get_attr(datatype, type_keyval, attribute_val, flag, ierror)
4     TYPE(MPI_Datatype), INTENT(IN) :: datatype
5     INTEGER, INTENT(IN) :: type_keyval
6     INTEGER(KIND=MPI_ADDRESS_KIND), INTENT(OUT) :: attribute_val
7     LOGICAL, INTENT(OUT) :: flag
8     INTEGER, OPTIONAL, INTENT(OUT) :: ierror
9
10    MPI_Type_get_name(datatype, type_name, resultlen, ierror)
11    TYPE(MPI_Datatype), INTENT(IN) :: datatype
12    CHARACTER(LEN=MPI_MAX_OBJECT_NAME), INTENT(OUT) :: type_name
13    INTEGER, INTENT(OUT) :: resultlen
14    INTEGER, OPTIONAL, INTENT(OUT) :: ierror
15
16    MPI_Type_set_attr(datatype, type_keyval, attribute_val, ierror)
17    TYPE(MPI_Datatype), INTENT(IN) :: datatype
18    INTEGER, INTENT(IN) :: type_keyval
19    INTEGER(KIND=MPI_ADDRESS_KIND), INTENT(IN) :: attribute_val
20    INTEGER, OPTIONAL, INTENT(OUT) :: ierror
21
22    MPI_Type_set_name(datatype, type_name, ierror)
23    TYPE(MPI_Datatype), INTENT(IN) :: datatype
24    CHARACTER(LEN=*), INTENT(IN) :: type_name
25    INTEGER, OPTIONAL, INTENT(OUT) :: ierror
26
27    MPI_WIN_DUP_FN(oldwin, win_keyval, extra_state, attribute_val_in,
28                  attribute_val_out, flag, ierror)
29    TYPE(MPI_Win) :: oldwin
30    INTEGER :: win_keyval, ierror
31    INTEGER(KIND=MPI_ADDRESS_KIND) :: extra_state, attribute_val_in,
32    attribute_val_out
33    LOGICAL :: flag
34
35    MPI_WIN_NULL_COPY_FN(oldwin, win_keyval, extra_state, attribute_val_in,
36                        attribute_val_out, flag, ierror)
37    TYPE(MPI_Win) :: oldwin
38    INTEGER :: win_keyval, ierror
39    INTEGER(KIND=MPI_ADDRESS_KIND) :: extra_state, attribute_val_in,
40    attribute_val_out
41    LOGICAL :: flag
42
43    MPI_WIN_NULL_DELETE_FN(win, win_keyval, attribute_val, extra_state, ierror)
44    TYPE(MPI_Win) :: win
45    INTEGER :: win_keyval, ierror
46    INTEGER(KIND=MPI_ADDRESS_KIND) :: attribute_val, extra_state
47
48    MPI_Win_create_keyval(win_copy_attr_fn, win_delete_attr_fn, win_keyval,
49                          extra_state, ierror)
50    PROCEDURE(MPI_Win_copy_attr_function), INTENT(IN) :: win_copy_attr_fn
51    PROCEDURE(MPI_Win_delete_attr_function), INTENT(IN) ::

```

```

win_delete_attr_fn
  INTEGER, INTENT(OUT) :: win_keyval
  INTEGER(KIND=MPI_ADDRESS_KIND), INTENT(IN) :: extra_state
  INTEGER, OPTIONAL, INTENT(OUT) :: ierror

MPI_Win_delete_attr(win, win_keyval, ierror)
  TYPE(MPI_Win), INTENT(IN) :: win
  INTEGER, INTENT(IN) :: win_keyval
  INTEGER, OPTIONAL, INTENT(OUT) :: ierror

MPI_Win_free_keyval(win_keyval, ierror)
  INTEGER, INTENT(INOUT) :: win_keyval
  INTEGER, OPTIONAL, INTENT(OUT) :: ierror

MPI_Win_get_attr(win, win_keyval, attribute_val, flag, ierror)
  TYPE(MPI_Win), INTENT(IN) :: win
  INTEGER, INTENT(IN) :: win_keyval
  INTEGER(KIND=MPI_ADDRESS_KIND), INTENT(OUT) :: attribute_val
  LOGICAL, INTENT(OUT) :: flag
  INTEGER, OPTIONAL, INTENT(OUT) :: ierror

MPI_Win_get_name(win, win_name, resultlen, ierror)
  TYPE(MPI_Win), INTENT(IN) :: win
  CHARACTER(LEN=MPI_MAX_OBJECT_NAME), INTENT(OUT) :: win_name
  INTEGER, INTENT(OUT) :: resultlen
  INTEGER, OPTIONAL, INTENT(OUT) :: ierror

MPI_Win_set_attr(win, win_keyval, attribute_val, ierror)
  TYPE(MPI_Win), INTENT(IN) :: win
  INTEGER, INTENT(IN) :: win_keyval
  INTEGER(KIND=MPI_ADDRESS_KIND), INTENT(IN) :: attribute_val
  INTEGER, OPTIONAL, INTENT(OUT) :: ierror

MPI_Win_set_name(win, win_name, ierror)
  TYPE(MPI_Win), INTENT(IN) :: win
  CHARACTER(LEN=*), INTENT(IN) :: win_name
  INTEGER, OPTIONAL, INTENT(OUT) :: ierror

```

### A.3.5 Process Topologies Fortran 2008 Bindings

```

MPI_Cart_coords(comm, rank, maxdims, coords, ierror)
  TYPE(MPI_Comm), INTENT(IN) :: comm
  INTEGER, INTENT(IN) :: rank, maxdims
  INTEGER, INTENT(OUT) :: coords(maxdims)
  INTEGER, OPTIONAL, INTENT(OUT) :: ierror

MPI_Cart_create(comm_old, ndims, dims, periods, reorder, comm_cart, ierror)
  TYPE(MPI_Comm), INTENT(IN) :: comm_old
  INTEGER, INTENT(IN) :: ndims, dims(ndims)
  LOGICAL, INTENT(IN) :: periods(ndims), reorder
  TYPE(MPI_Comm), INTENT(OUT) :: comm_cart

```

```

1     INTEGER, OPTIONAL, INTENT(OUT) :: ierror
2
3     MPI_Cart_get(comm, maxdims, dims, periods, coords, ierror)
4         TYPE(MPI_Comm), INTENT(IN) :: comm
5         INTEGER, INTENT(IN) :: maxdims
6         INTEGER, INTENT(OUT) :: dims(maxdims), coords(maxdims)
7         LOGICAL, INTENT(OUT) :: periods(maxdims)
8         INTEGER, OPTIONAL, INTENT(OUT) :: ierror
9
10    MPI_Cart_map(comm, ndims, dims, periods, newrank, ierror)
11        TYPE(MPI_Comm), INTENT(IN) :: comm
12        INTEGER, INTENT(IN) :: ndims, dims(ndims)
13        LOGICAL, INTENT(IN) :: periods(ndims)
14        INTEGER, INTENT(OUT) :: newrank
15        INTEGER, OPTIONAL, INTENT(OUT) :: ierror
16
17    MPI_Cart_rank(comm, coords, rank, ierror)
18        TYPE(MPI_Comm), INTENT(IN) :: comm
19        INTEGER, INTENT(IN) :: coords(*)
20        INTEGER, INTENT(OUT) :: rank
21        INTEGER, OPTIONAL, INTENT(OUT) :: ierror
22
23    MPI_Cart_shift(comm, direction, disp, rank_source, rank_dest, ierror)
24        TYPE(MPI_Comm), INTENT(IN) :: comm
25        INTEGER, INTENT(IN) :: direction, disp
26        INTEGER, INTENT(OUT) :: rank_source, rank_dest
27        INTEGER, OPTIONAL, INTENT(OUT) :: ierror
28
29    MPI_Cart_sub(comm, remain_dims, newcomm, ierror)
30        TYPE(MPI_Comm), INTENT(IN) :: comm
31        LOGICAL, INTENT(IN) :: remain_dims(*)
32        TYPE(MPI_Comm), INTENT(OUT) :: newcomm
33        INTEGER, OPTIONAL, INTENT(OUT) :: ierror
34
35    MPI_Cartdim_get(comm, ndims, ierror)
36        TYPE(MPI_Comm), INTENT(IN) :: comm
37        INTEGER, INTENT(OUT) :: ndims
38        INTEGER, OPTIONAL, INTENT(OUT) :: ierror
39
40    MPI_Dims_create(nnodes, ndims, dims, ierror)
41        INTEGER, INTENT(IN) :: nnodes, ndims
42        INTEGER, INTENT(INOUT) :: dims(ndims)
43        INTEGER, OPTIONAL, INTENT(OUT) :: ierror
44
45    MPI_Dist_graph_create(comm_old, n, sources, degrees, destinations, weights,
46        info, reorder, comm_dist_graph, ierror)
47        TYPE(MPI_Comm), INTENT(IN) :: comm_old
48        INTEGER, INTENT(IN) :: n, sources(n), degrees(n), destinations(*),
49        weights(*)
50        TYPE(MPI_Info), INTENT(IN) :: info
51        LOGICAL, INTENT(IN) :: reorder

```

```

TYPE(MPI_Comm), INTENT(OUT) :: comm_dist_graph           1
INTEGER, OPTIONAL, INTENT(OUT) :: ierror                 2
                                                         3
MPI_Dist_graph_create_adjacent(comm_old, indegree, sources, sourceweights,
                                outdegree, destinations, destweights, info, reorder,
                                comm_dist_graph, ierror)  4
                                                         5
TYPE(MPI_Comm), INTENT(IN) :: comm_old                   6
INTEGER, INTENT(IN) :: indegree, sources(indegree), sourceweights(*),
outdegree, destinations(outdegree), destweights(*)      7
TYPE(MPI_Info), INTENT(IN) :: info                       8
LOGICAL, INTENT(IN) :: reorder                           9
TYPE(MPI_Comm), INTENT(OUT) :: comm_dist_graph          10
INTEGER, OPTIONAL, INTENT(OUT) :: ierror                 11
                                                         12
MPI_Dist_graph_neighbors(comm, maxindegree, sources, sourceweights,
                          maxoutdegree, destinations, destweights, ierror) 13
TYPE(MPI_Comm), INTENT(IN) :: comm                       14
INTEGER, INTENT(IN) :: maxindegree, maxoutdegree         15
INTEGER, INTENT(OUT) :: sources(maxindegree),
destinations(maxoutdegree)                               16
INTEGER :: sourceweights(*), destweights(*)              17
INTEGER, OPTIONAL, INTENT(OUT) :: ierror                 18
                                                         19
MPI_Dist_graph_neighbors_count(comm, indegree, outdegree, weighted, ierror) 20
TYPE(MPI_Comm), INTENT(IN) :: comm                       21
INTEGER, INTENT(OUT) :: indegree, outdegree              22
LOGICAL, INTENT(OUT) :: weighted                         23
INTEGER, OPTIONAL, INTENT(OUT) :: ierror                 24
                                                         25
MPI_Graph_create(comm_old, nnodes, index, edges, reorder, comm_graph,
                 ierror)                                  26
TYPE(MPI_Comm), INTENT(IN) :: comm_old                   27
INTEGER, INTENT(IN) :: nnodes, index(nnodes), edges(*)  28
LOGICAL, INTENT(IN) :: reorder                           29
TYPE(MPI_Comm), INTENT(OUT) :: comm_graph                30
INTEGER, OPTIONAL, INTENT(OUT) :: ierror                 31
                                                         32
MPI_Graph_get(comm, maxindex, maxedges, index, edges, ierror) 33
TYPE(MPI_Comm), INTENT(IN) :: comm                       34
INTEGER, INTENT(IN) :: maxindex, maxedges                35
INTEGER, INTENT(OUT) :: index(maxindex), edges(maxedges) 36
INTEGER, OPTIONAL, INTENT(OUT) :: ierror                 37
                                                         38
MPI_Graph_map(comm, nnodes, index, edges, newrank, ierror) 39
TYPE(MPI_Comm), INTENT(IN) :: comm                       40
INTEGER, INTENT(IN) :: nnodes, index(nnodes), edges(*)  41
INTEGER, INTENT(OUT) :: newrank                           42
INTEGER, OPTIONAL, INTENT(OUT) :: ierror                 43
                                                         44
MPI_Graph_neighbors(comm, rank, maxneighbors, neighbors, ierror) 45
TYPE(MPI_Comm), INTENT(IN) :: comm                       46

```

```

1     INTEGER, INTENT(IN) :: rank, maxneighbors
2     INTEGER, INTENT(OUT) :: neighbors(maxneighbors)
3     INTEGER, OPTIONAL, INTENT(OUT) :: ierror
4
5     MPI_Graph_neighbors_count(comm, rank, nneighbors, ierror)
6         TYPE(MPI_Comm), INTENT(IN) :: comm
7         INTEGER, INTENT(IN) :: rank
8         INTEGER, INTENT(OUT) :: nneighbors
9         INTEGER, OPTIONAL, INTENT(OUT) :: ierror
10
11    MPI_Graphdims_get(comm, nnodes, nedges, ierror)
12        TYPE(MPI_Comm), INTENT(IN) :: comm
13        INTEGER, INTENT(OUT) :: nnodes, nedges
14        INTEGER, OPTIONAL, INTENT(OUT) :: ierror
15
16    MPI_Ineighbor_allgather(sendbuf, sendcount, sendtype, recvbuf, recvcount,
17                            recvtype, comm, request, ierror)
18        TYPE(*), DIMENSION(..), INTENT(IN), ASYNCHRONOUS :: sendbuf
19        INTEGER, INTENT(IN) :: sendcount, recvcount
20        TYPE(MPI_Datatype), INTENT(IN) :: sendtype, recvtype
21        TYPE(*), DIMENSION(..), ASYNCHRONOUS :: recvbuf
22        TYPE(MPI_Comm), INTENT(IN) :: comm
23        TYPE(MPI_Request), INTENT(OUT) :: request
24        INTEGER, OPTIONAL, INTENT(OUT) :: ierror
25
26    MPI_Ineighbor_allgatherv(sendbuf, sendcount, sendtype, recvbuf, recvcoun
27                                ts, displs, recvtype, comm, request, ierror)
28        TYPE(*), DIMENSION(..), INTENT(IN), ASYNCHRONOUS :: sendbuf
29        INTEGER, INTENT(IN) :: sendcount
30        TYPE(MPI_Datatype), INTENT(IN) :: sendtype, recvtype
31        TYPE(*), DIMENSION(..), ASYNCHRONOUS :: recvbuf
32        INTEGER, INTENT(IN), ASYNCHRONOUS :: recvcoun
33                                ts(*), displs(*)
34        TYPE(MPI_Comm), INTENT(IN) :: comm
35        TYPE(MPI_Request), INTENT(OUT) :: request
36        INTEGER, OPTIONAL, INTENT(OUT) :: ierror
37
38    MPI_Ineighbor_alltoall(sendbuf, sendcount, sendtype, recvbuf, recvcount,
39                            recvtype, comm, request, ierror)
40        TYPE(*), DIMENSION(..), INTENT(IN), ASYNCHRONOUS :: sendbuf
41        INTEGER, INTENT(IN) :: sendcount, recvcount
42        TYPE(MPI_Datatype), INTENT(IN) :: sendtype, recvtype
43        TYPE(*), DIMENSION(..), ASYNCHRONOUS :: recvbuf
44        TYPE(MPI_Comm), INTENT(IN) :: comm
45        TYPE(MPI_Request), INTENT(OUT) :: request
46        INTEGER, OPTIONAL, INTENT(OUT) :: ierror
47
48    MPI_Ineighbor_alltoallv(sendbuf, sendcounts, sdispls, sendtype, recvbuf,
49                            recvcoun
50                                ts, rdispls, recvtype, comm, request, ierror)
51        TYPE(*), DIMENSION(..), INTENT(IN), ASYNCHRONOUS :: sendbuf
52        INTEGER, INTENT(IN), ASYNCHRONOUS :: sendcounts(*), sdispls(*),

```

```

recvcounts(*), rdispls(*)
  TYPE(MPI_Datatype), INTENT(IN) :: sendtype, recvtype
  TYPE(*), DIMENSION(..), ASYNCHRONOUS :: recvbuf
  TYPE(MPI_Comm), INTENT(IN) :: comm
  TYPE(MPI_Request), INTENT(OUT) :: request
  INTEGER, OPTIONAL, INTENT(OUT) :: ierror

MPI_Ineighbor_alltoallw(sendbuf, sendcounts, sdispls, sendtypes, recvbuf,
  recvcounts, rdispls, recvtypes, comm, request, ierror)
  TYPE(*), DIMENSION(..), INTENT(IN), ASYNCHRONOUS :: sendbuf
  INTEGER, INTENT(IN), ASYNCHRONOUS :: sendcounts(*), recvcounts(*)
  INTEGER(KIND=MPI_ADDRESS_KIND), INTENT(IN), ASYNCHRONOUS ::
sdispls(*), rdispls(*)
  TYPE(MPI_Datatype), INTENT(IN), ASYNCHRONOUS :: sendtypes(*),
recvtypes(*)
  TYPE(*), DIMENSION(..), ASYNCHRONOUS :: recvbuf
  TYPE(MPI_Comm), INTENT(IN) :: comm
  TYPE(MPI_Request), INTENT(OUT) :: request
  INTEGER, OPTIONAL, INTENT(OUT) :: ierror

MPI_Neighbor_allgather(sendbuf, sendcount, sendtype, recvbuf, recvcount,
  recvtype, comm, ierror)
  TYPE(*), DIMENSION(..), INTENT(IN) :: sendbuf
  INTEGER, INTENT(IN) :: sendcount, recvcount
  TYPE(MPI_Datatype), INTENT(IN) :: sendtype, recvtype
  TYPE(*), DIMENSION(..) :: recvbuf
  TYPE(MPI_Comm), INTENT(IN) :: comm
  INTEGER, OPTIONAL, INTENT(OUT) :: ierror

MPI_Neighbor_allgather_init(sendbuf, sendcount, sendtype, recvbuf,
  recvcount, recvtype, comm, info, request, ierror)
  TYPE(*), DIMENSION(..), INTENT(IN), ASYNCHRONOUS :: sendbuf
  INTEGER, INTENT(IN) :: sendcount, recvcount
  TYPE(MPI_Datatype), INTENT(IN) :: sendtype, recvtype
  TYPE(*), DIMENSION(..), ASYNCHRONOUS :: recvbuf
  TYPE(MPI_Comm), INTENT(IN) :: comm
  TYPE(MPI_Info), INTENT(IN) :: info
  TYPE(MPI_Request), INTENT(OUT) :: request
  INTEGER, OPTIONAL, INTENT(OUT) :: ierror

MPI_Neighbor_allgatherv(sendbuf, sendcount, sendtype, recvbuf, recvcounts,
  displs, recvtype, comm, ierror)
  TYPE(*), DIMENSION(..), INTENT(IN) :: sendbuf
  INTEGER, INTENT(IN) :: sendcount, recvcounts(*), displs(*)
  TYPE(MPI_Datatype), INTENT(IN) :: sendtype, recvtype
  TYPE(*), DIMENSION(..) :: recvbuf
  TYPE(MPI_Comm), INTENT(IN) :: comm
  INTEGER, OPTIONAL, INTENT(OUT) :: ierror

MPI_Neighbor_allgatherv_init(sendbuf, sendcount, sendtype, recvbuf,

```

```

1         recvcnts, displs, recvtype, comm, info, request, ierror)
2     TYPE(*), DIMENSION(..), INTENT(IN), ASYNCHRONOUS :: sendbuf
3     INTEGER, INTENT(IN) :: sendcount, displs(*)
4     TYPE(MPI_Datatype), INTENT(IN) :: sendtype, recvtype
5     TYPE(*), DIMENSION(..), ASYNCHRONOUS :: recvbuf
6     INTEGER, INTENT(IN), ASYNCHRONOUS :: recvcnts(*)
7     TYPE(MPI_Comm), INTENT(IN) :: comm
8     TYPE(MPI_Info), INTENT(IN) :: info
9     TYPE(MPI_Request), INTENT(OUT) :: request
10    INTEGER, OPTIONAL, INTENT(OUT) :: ierror
11
12 MPI_Neighbor_alltoall(sendbuf, sendcount, sendtype, recvbuf, recvcount,
13     recvtype, comm, ierror)
14     TYPE(*), DIMENSION(..), INTENT(IN) :: sendbuf
15     INTEGER, INTENT(IN) :: sendcount, recvcount
16     TYPE(MPI_Datatype), INTENT(IN) :: sendtype, recvtype
17     TYPE(*), DIMENSION(..) :: recvbuf
18     TYPE(MPI_Comm), INTENT(IN) :: comm
19     INTEGER, OPTIONAL, INTENT(OUT) :: ierror
20
21 MPI_Neighbor_alltoall_init(sendbuf, sendcount, sendtype, recvbuf,
22     recvcount, recvtype, comm, info, request, ierror)
23     TYPE(*), DIMENSION(..), INTENT(IN), ASYNCHRONOUS :: sendbuf
24     INTEGER, INTENT(IN) :: sendcount, recvcount
25     TYPE(MPI_Datatype), INTENT(IN) :: sendtype, recvtype
26     TYPE(*), DIMENSION(..), ASYNCHRONOUS :: recvbuf
27     TYPE(MPI_Comm), INTENT(IN) :: comm
28     TYPE(MPI_Info), INTENT(IN) :: info
29     TYPE(MPI_Request), INTENT(OUT) :: request
30     INTEGER, OPTIONAL, INTENT(OUT) :: ierror
31
32 MPI_Neighbor_alltoallv(sendbuf, sendcounts, sdispls, sendtype, recvbuf,
33     recvcnts, rdispls, recvtype, comm, ierror)
34     TYPE(*), DIMENSION(..), INTENT(IN) :: sendbuf
35     INTEGER, INTENT(IN) :: sendcounts(*), sdispls(*), recvcnts(*),
36     rdispls(*)
37     TYPE(MPI_Datatype), INTENT(IN) :: sendtype, recvtype
38     TYPE(*), DIMENSION(..) :: recvbuf
39     TYPE(MPI_Comm), INTENT(IN) :: comm
40     INTEGER, OPTIONAL, INTENT(OUT) :: ierror
41
42 MPI_Neighbor_alltoallv_init(sendbuf, sendcounts, sdispls, sendtype,
43     recvbuf, recvcnts, rdispls, recvtype, comm, info, request,
44     ierror)
45     TYPE(*), DIMENSION(..), INTENT(IN), ASYNCHRONOUS :: sendbuf
46     INTEGER, INTENT(IN), ASYNCHRONOUS :: sendcounts(*), sdispls(*),
47     recvcnts(*), rdispls(*)
48     TYPE(MPI_Datatype), INTENT(IN) :: sendtype, recvtype
49     TYPE(*), DIMENSION(..), ASYNCHRONOUS :: recvbuf

```



```

TYPE(MPI_Comm), INTENT(IN) :: comm
TYPE(MPI_Info), INTENT(IN) :: info
TYPE(MPI_Request), INTENT(OUT) :: request
INTEGER, OPTIONAL, INTENT(OUT) :: ierror

MPI_Neighbor_alltoallw(sendbuf, sendcounts, sdispls, sendtypes, recvbuf,
    recvcounts, rdispls, recvtypes, comm, ierror)
TYPE(*), DIMENSION(..), INTENT(IN) :: sendbuf
INTEGER, INTENT(IN) :: sendcounts(*), recvcounts(*)
INTEGER(KIND=MPI_ADDRESS_KIND), INTENT(IN) :: sdispls(*), rdispls(*)
TYPE(MPI_Datatype), INTENT(IN) :: sendtypes(*), recvtypes(*)
TYPE(*), DIMENSION(..) :: recvbuf
TYPE(MPI_Comm), INTENT(IN) :: comm
INTEGER, OPTIONAL, INTENT(OUT) :: ierror

MPI_Neighbor_alltoallw_init(sendbuf, sendcounts, sdispls, sendtypes,
    recvbuf, recvcounts, rdispls, recvtypes, comm, info, request,
    ierror)
TYPE(*), DIMENSION(..), INTENT(IN), ASYNCHRONOUS :: sendbuf
INTEGER, INTENT(IN), ASYNCHRONOUS :: sendcounts(*), recvcounts(*)
INTEGER(KIND=MPI_ADDRESS_KIND), INTENT(IN), ASYNCHRONOUS ::
sdispls(*), rdispls(*)
TYPE(MPI_Datatype), INTENT(IN), ASYNCHRONOUS :: sendtypes(*),
recvtypes(*)
TYPE(*), DIMENSION(..), ASYNCHRONOUS :: recvbuf
TYPE(MPI_Comm), INTENT(IN) :: comm
TYPE(MPI_Info), INTENT(IN) :: info
TYPE(MPI_Request), INTENT(OUT) :: request
INTEGER, OPTIONAL, INTENT(OUT) :: ierror

MPI_Topo_test(comm, status, ierror)
TYPE(MPI_Comm), INTENT(IN) :: comm
INTEGER, INTENT(OUT) :: status
INTEGER, OPTIONAL, INTENT(OUT) :: ierror

A.3.6 MPI Environmental Management Fortran 2008 Bindings

DOUBLE PRECISION MPI_Wtick()
DOUBLE PRECISION MPI_Wtime()

MPI_Add_error_class(errorclass, ierror)
INTEGER, INTENT(OUT) :: errorclass
INTEGER, OPTIONAL, INTENT(OUT) :: ierror

MPI_Add_error_code(errorclass, errorcode, ierror)
INTEGER, INTENT(IN) :: errorclass
INTEGER, INTENT(OUT) :: errorcode
INTEGER, OPTIONAL, INTENT(OUT) :: ierror

MPI_Add_error_string(errorcode, string, ierror)

```

```
1     INTEGER, INTENT(IN) :: errorcode
2     CHARACTER(LEN=*), INTENT(IN) :: string
3     INTEGER, OPTIONAL, INTENT(OUT) :: ierror
4
5     MPI_Alloc_mem(size, info, baseptr, ierror)
6     USE, INTRINSIC :: ISO_C_BINDING, ONLY : C_PTR
7     INTEGER(KIND=MPI_ADDRESS_KIND), INTENT(IN) :: size
8     TYPE(MPI_Info), INTENT(IN) :: info
9     TYPE(C_PTR), INTENT(OUT) :: baseptr
10    INTEGER, OPTIONAL, INTENT(OUT) :: ierror
11
12    MPI_Comm_call_errhandler(comm, errorcode, ierror)
13    TYPE(MPI_Comm), INTENT(IN) :: comm
14    INTEGER, INTENT(IN) :: errorcode
15    INTEGER, OPTIONAL, INTENT(OUT) :: ierror
16
17    MPI_Comm_create_errhandler(comm_errhandler_fn, errhandler, ierror)
18    PROCEDURE(MPI_Comm_errhandler_function), INTENT(IN) ::
19    comm_errhandler_fn
20    TYPE(MPI_Errhandler), INTENT(OUT) :: errhandler
21    INTEGER, OPTIONAL, INTENT(OUT) :: ierror
22
23    MPI_Comm_get_errhandler(comm, errhandler, ierror)
24    TYPE(MPI_Comm), INTENT(IN) :: comm
25    TYPE(MPI_Errhandler), INTENT(OUT) :: errhandler
26    INTEGER, OPTIONAL, INTENT(OUT) :: ierror
27
28    MPI_Comm_set_errhandler(comm, errhandler, ierror)
29    TYPE(MPI_Comm), INTENT(IN) :: comm
30    TYPE(MPI_Errhandler), INTENT(IN) :: errhandler
31    INTEGER, OPTIONAL, INTENT(OUT) :: ierror
32
33    MPI_Errhandler_free(errhandler, ierror)
34    TYPE(MPI_Errhandler), INTENT(INOUT) :: errhandler
35    INTEGER, OPTIONAL, INTENT(OUT) :: ierror
36
37    MPI_Error_class(errorcode, errorclass, ierror)
38    INTEGER, INTENT(IN) :: errorcode
39    INTEGER, INTENT(OUT) :: errorclass
40    INTEGER, OPTIONAL, INTENT(OUT) :: ierror
41
42    MPI_Error_string(errorcode, string, resultlen, ierror)
43    INTEGER, INTENT(IN) :: errorcode
44    CHARACTER(LEN=MPI_MAX_ERROR_STRING), INTENT(OUT) :: string
45    INTEGER, INTENT(OUT) :: resultlen
46    INTEGER, OPTIONAL, INTENT(OUT) :: ierror
47
48    MPI_File_call_errhandler(fh, errorcode, ierror)
49    TYPE(MPI_File), INTENT(IN) :: fh
50    INTEGER, INTENT(IN) :: errorcode
51    INTEGER, OPTIONAL, INTENT(OUT) :: ierror
```

```
MPI_File_create_errhandler(file_errhandler_fn, errhandler, ierror) 1
  PROCEDURE(MPI_File_errhandler_function), INTENT(IN) :: 2
  file_errhandler_fn 3
  TYPE(MPI_Errhandler), INTENT(OUT) :: errhandler 4
  INTEGER, OPTIONAL, INTENT(OUT) :: ierror 5
  6
MPI_File_get_errhandler(file, errhandler, ierror) 7
  TYPE(MPI_File), INTENT(IN) :: file 8
  TYPE(MPI_Errhandler), INTENT(OUT) :: errhandler 9
  INTEGER, OPTIONAL, INTENT(OUT) :: ierror 10
  11
MPI_File_set_errhandler(file, errhandler, ierror) 11
  TYPE(MPI_File), INTENT(IN) :: file 12
  TYPE(MPI_Errhandler), INTENT(IN) :: errhandler 13
  INTEGER, OPTIONAL, INTENT(OUT) :: ierror 14
  15
MPI_Free_mem(base, ierror) 16
  TYPE(*), DIMENSION(..), INTENT(IN), ASYNCHRONOUS :: base 17
  INTEGER, OPTIONAL, INTENT(OUT) :: ierror 18
  19
MPI_Get_library_version(version, resultlen, ierror) 19
  CHARACTER(LEN=MPI_MAX_LIBRARY_VERSION_STRING), INTENT(OUT) :: version 20
  INTEGER, INTENT(OUT) :: resultlen 21
  INTEGER, OPTIONAL, INTENT(OUT) :: ierror 22
  23
MPI_Get_processor_name(name, resultlen, ierror) 24
  CHARACTER(LEN=MPI_MAX_PROCESSOR_NAME), INTENT(OUT) :: name 25
  INTEGER, INTENT(OUT) :: resultlen 26
  INTEGER, OPTIONAL, INTENT(OUT) :: ierror 27
  28
MPI_Get_version(version, subversion, ierror) 28
  INTEGER, INTENT(OUT) :: version, subversion 29
  INTEGER, OPTIONAL, INTENT(OUT) :: ierror 30
  31
MPI_Session_call_errhandler(session, errorcode, ierror) 32
  TYPE(MPI_Session), INTENT(IN) :: session 33
  INTEGER, INTENT(IN) :: errorcode 34
  INTEGER, OPTIONAL, INTENT(OUT) :: ierror 35
  36
MPI_Session_create_errhandler(session_errhandler_fn, errhandler, ierror) 36
  PROCEDURE(MPI_Session_errhandler_function), INTENT(IN) :: 37
  session_errhandler_fn 38
  TYPE(MPI_Errhandler), INTENT(OUT) :: errhandler 39
  INTEGER, OPTIONAL, INTENT(OUT) :: ierror 40
  41
MPI_Session_get_errhandler(session, errhandler, ierror) 42
  TYPE(MPI_Session), INTENT(IN) :: session 43
  TYPE(MPI_Errhandler), INTENT(OUT) :: errhandler 44
  INTEGER, OPTIONAL, INTENT(OUT) :: ierror 45
  46
MPI_Session_set_errhandler(session, errhandler, ierror) 46
  TYPE(MPI_Session), INTENT(IN) :: session 47
  48
```

```

1      TYPE(MPI_Errhandler), INTENT(IN) :: errhandler
2      INTEGER, OPTIONAL, INTENT(OUT) :: ierror
3
4      MPI_Win_call_errhandler(win, errorcode, ierror)
5          TYPE(MPI_Win), INTENT(IN) :: win
6          INTEGER, INTENT(IN) :: errorcode
7          INTEGER, OPTIONAL, INTENT(OUT) :: ierror
8
9      MPI_Win_create_errhandler(win_errhandler_fn, errhandler, ierror)
10         PROCEDURE(MPI_Win_errhandler_function), INTENT(IN) ::
11         win_errhandler_fn
12         TYPE(MPI_Errhandler), INTENT(OUT) :: errhandler
13         INTEGER, OPTIONAL, INTENT(OUT) :: ierror
14
15     MPI_Win_get_errhandler(win, errhandler, ierror)
16         TYPE(MPI_Win), INTENT(IN) :: win
17         TYPE(MPI_Errhandler), INTENT(OUT) :: errhandler
18         INTEGER, OPTIONAL, INTENT(OUT) :: ierror
19
20     MPI_Win_set_errhandler(win, errhandler, ierror)
21         TYPE(MPI_Win), INTENT(IN) :: win
22         TYPE(MPI_Errhandler), INTENT(IN) :: errhandler
23         INTEGER, OPTIONAL, INTENT(OUT) :: ierror
24
25     A.3.7 The Info Object Fortran 2008 Bindings
26
27     MPI_Info_create(info, ierror)
28         TYPE(MPI_Info), INTENT(OUT) :: info
29         INTEGER, OPTIONAL, INTENT(OUT) :: ierror
30
31     MPI_Info_delete(info, key, ierror)
32         TYPE(MPI_Info), INTENT(IN) :: info
33         CHARACTER(LEN=*), INTENT(IN) :: key
34         INTEGER, OPTIONAL, INTENT(OUT) :: ierror
35
36     MPI_Info_dup(info, newinfo, ierror)
37         TYPE(MPI_Info), INTENT(IN) :: info
38         TYPE(MPI_Info), INTENT(OUT) :: newinfo
39         INTEGER, OPTIONAL, INTENT(OUT) :: ierror
40
41     MPI_Info_free(info, ierror)
42         TYPE(MPI_Info), INTENT(INOUT) :: info
43         INTEGER, OPTIONAL, INTENT(OUT) :: ierror
44
45     MPI_Info_get(info, key, valuelen, value, flag, ierror)
46         TYPE(MPI_Info), INTENT(IN) :: info
47         CHARACTER(LEN=*), INTENT(IN) :: key
48         INTEGER, INTENT(IN) :: valuelen
49         CHARACTER(LEN=valuelen), INTENT(OUT) :: value
50         LOGICAL, INTENT(OUT) :: flag
51         INTEGER, OPTIONAL, INTENT(OUT) :: ierror

```

```

MPI_Info_get_nkeys(info, nkeys, ierror)           1
    TYPE(MPI_Info), INTENT(IN) :: info           2
    INTEGER, INTENT(OUT) :: nkeys               3
    INTEGER, OPTIONAL, INTENT(OUT) :: ierror    4
                                                    5
MPI_Info_get_nthkey(info, n, key, ierror)        6
    TYPE(MPI_Info), INTENT(IN) :: info           7
    INTEGER, INTENT(IN) :: n                   8
    CHARACTER(LEN=*), INTENT(OUT) :: key        9
    INTEGER, OPTIONAL, INTENT(OUT) :: ierror   10
                                                    11
MPI_Info_get_string(info, key, buflen, value, flag, ierror)
    TYPE(MPI_Info), INTENT(IN) :: info           12
    CHARACTER(LEN=*), INTENT(IN) :: key         13
    INTEGER, INTENT(INOUT) :: buflen           14
    CHARACTER(LEN=*), INTENT(OUT) :: value      15
    LOGICAL, INTENT(OUT) :: flag               16
    INTEGER, OPTIONAL, INTENT(OUT) :: ierror   17
                                                    18
MPI_Info_get_valuelen(info, key, valuelen, flag, ierror)
    TYPE(MPI_Info), INTENT(IN) :: info           19
    CHARACTER(LEN=*), INTENT(IN) :: key         20
    INTEGER, INTENT(OUT) :: valuelen           21
    LOGICAL, INTENT(OUT) :: flag               22
    INTEGER, OPTIONAL, INTENT(OUT) :: ierror   23
                                                    24
MPI_Info_set(info, key, value, ierror)           25
    TYPE(MPI_Info), INTENT(IN) :: info           26
    CHARACTER(LEN=*), INTENT(IN) :: key, value  27
    INTEGER, OPTIONAL, INTENT(OUT) :: ierror   28
                                                    29
A.3.8 Process Creation and Management Fortran 2008 Bindings 30
                                                    31
MPI_Abort(comm, errorcode, ierror)              32
    TYPE(MPI_Comm), INTENT(IN) :: comm         33
    INTEGER, INTENT(IN) :: errorcode           34
    INTEGER, OPTIONAL, INTENT(OUT) :: ierror   35
                                                    36
MPI_Close_port(port_name, ierror)               37
    CHARACTER(LEN=*), INTENT(IN) :: port_name  38
    INTEGER, OPTIONAL, INTENT(OUT) :: ierror   39
                                                    40
MPI_Comm_accept(port_name, info, root, comm, newcomm, ierror)
    CHARACTER(LEN=*), INTENT(IN) :: port_name  41
    TYPE(MPI_Info), INTENT(IN) :: info         42
    INTEGER, INTENT(IN) :: root                 43
    TYPE(MPI_Comm), INTENT(IN) :: comm         44
    TYPE(MPI_Comm), INTENT(OUT) :: newcomm     45
    INTEGER, OPTIONAL, INTENT(OUT) :: ierror   46
                                                    47
MPI_Comm_connect(port_name, info, root, comm, newcomm, ierror) 48

```

```

1     CHARACTER(LEN=*), INTENT(IN) :: port_name
2     TYPE(MPI_Info), INTENT(IN) :: info
3     INTEGER, INTENT(IN) :: root
4     TYPE(MPI_Comm), INTENT(IN) :: comm
5     TYPE(MPI_Comm), INTENT(OUT) :: newcomm
6     INTEGER, OPTIONAL, INTENT(OUT) :: ierror
7
8     MPI_Comm_disconnect(comm, ierror)
9         TYPE(MPI_Comm), INTENT(INOUT) :: comm
10        INTEGER, OPTIONAL, INTENT(OUT) :: ierror
11
12    MPI_Comm_get_parent(parent, ierror)
13        TYPE(MPI_Comm), INTENT(OUT) :: parent
14        INTEGER, OPTIONAL, INTENT(OUT) :: ierror
15
16    MPI_Comm_join(fd, intercomm, ierror)
17        INTEGER, INTENT(IN) :: fd
18        TYPE(MPI_Comm), INTENT(OUT) :: intercomm
19        INTEGER, OPTIONAL, INTENT(OUT) :: ierror
20
21    MPI_Comm_spawn(command, argv, maxprocs, info, root, comm, intercomm,
22        array_of_errcodes, ierror)
23        CHARACTER(LEN=*), INTENT(IN) :: command, argv(*)
24        INTEGER, INTENT(IN) :: maxprocs, root
25        TYPE(MPI_Info), INTENT(IN) :: info
26        TYPE(MPI_Comm), INTENT(IN) :: comm
27        TYPE(MPI_Comm), INTENT(OUT) :: intercomm
28        INTEGER :: array_of_errcodes(*)
29        INTEGER, OPTIONAL, INTENT(OUT) :: ierror
30
31    MPI_Comm_spawn_multiple(count, array_of_commands, array_of_argv,
32        array_of_maxprocs, array_of_info, root, comm, intercomm,
33        array_of_errcodes, ierror)
34        INTEGER, INTENT(IN) :: count, array_of_maxprocs(*), root
35        CHARACTER(LEN=*), INTENT(IN) :: array_of_commands(*),
36        array_of_argv(count, *)
37        TYPE(MPI_Info), INTENT(IN) :: array_of_info(*)
38        TYPE(MPI_Comm), INTENT(IN) :: comm
39        TYPE(MPI_Comm), INTENT(OUT) :: intercomm
40        INTEGER :: array_of_errcodes(*)
41        INTEGER, OPTIONAL, INTENT(OUT) :: ierror
42
43    MPI_Finalize(ierror)
44        INTEGER, OPTIONAL, INTENT(OUT) :: ierror
45
46    MPI_Finalized(flag, ierror)
47        LOGICAL, INTENT(OUT) :: flag
48        INTEGER, OPTIONAL, INTENT(OUT) :: ierror
49
50    MPI_Init(ierror)
51        INTEGER, OPTIONAL, INTENT(OUT) :: ierror
52

```

```

MPI_Init_thread(required, provided, ierror)           1
    INTEGER, INTENT(IN) :: required                   2
    INTEGER, INTENT(OUT) :: provided                  3
    INTEGER, OPTIONAL, INTENT(OUT) :: ierror          4
                                                    5
MPI_Initialized(flag, ierror)                         6
    LOGICAL, INTENT(OUT) :: flag                      7
    INTEGER, OPTIONAL, INTENT(OUT) :: ierror          8
                                                    9
MPI_Is_thread_main(flag, ierror)                    10
    LOGICAL, INTENT(OUT) :: flag                     11
    INTEGER, OPTIONAL, INTENT(OUT) :: ierror          12
                                                    13
MPI_Lookup_name(service_name, info, port_name, ierror) 14
    CHARACTER(LEN=*), INTENT(IN) :: service_name     15
    TYPE(MPI_Info), INTENT(IN) :: info                16
    CHARACTER(LEN=MPI_MAX_PORT_NAME), INTENT(OUT) :: port_name 17
    INTEGER, OPTIONAL, INTENT(OUT) :: ierror          18
                                                    19
MPI_Open_port(info, port_name, ierror)               20
    TYPE(MPI_Info), INTENT(IN) :: info                21
    CHARACTER(LEN=MPI_MAX_PORT_NAME), INTENT(OUT) :: port_name 22
    INTEGER, OPTIONAL, INTENT(OUT) :: ierror          23
                                                    24
MPI_Publish_name(service_name, info, port_name, ierror) 25
    CHARACTER(LEN=*), INTENT(IN) :: service_name, port_name 26
    TYPE(MPI_Info), INTENT(IN) :: info                27
    INTEGER, OPTIONAL, INTENT(OUT) :: ierror          28
                                                    29
MPI_Query_thread(provided, ierror)                   30
    INTEGER, INTENT(OUT) :: provided                  31
    INTEGER, OPTIONAL, INTENT(OUT) :: ierror          32
                                                    33
MPI_Session_finalize(session, ierror)                 34
    TYPE(MPI_Session), INTENT(INOUT) :: session      35
    INTEGER, OPTIONAL, INTENT(OUT) :: ierror          36
                                                    37
MPI_Session_get_info(session, info_used, ierror)     38
    TYPE(MPI_Session), INTENT(IN) :: session          39
    TYPE(MPI_Info), INTENT(OUT) :: info_used          40
    INTEGER, OPTIONAL, INTENT(OUT) :: ierror          41
                                                    42
MPI_Session_get_nth_pset(session, info, n, pset_len, pset_name, ierror) 43
    TYPE(MPI_Session), INTENT(IN) :: session          44
    TYPE(MPI_Info), INTENT(IN) :: info                45
    INTEGER, INTENT(IN) :: n                          46
    INTEGER, INTENT(INOUT) :: pset_len                47
    CHARACTER(LEN=*), INTENT(OUT) :: pset_name        48
    INTEGER, OPTIONAL, INTENT(OUT) :: ierror          49
                                                    50
MPI_Session_get_num_psets(session, info, npset_names, ierror)
    TYPE(MPI_Session), INTENT(IN) :: session

```

```

1     TYPE(MPI_Info), INTENT(IN) :: info
2     INTEGER, INTENT(OUT) :: npset_names
3     INTEGER, OPTIONAL, INTENT(OUT) :: ierror
4
5     MPI_Session_get_pset_info(session, pset_name, info, ierror)
6         TYPE(MPI_Session), INTENT(IN) :: session
7         CHARACTER(LEN=*), INTENT(IN) :: pset_name
8         TYPE(MPI_Info), INTENT(OUT) :: info
9         INTEGER, OPTIONAL, INTENT(OUT) :: ierror
10
11     MPI_Session_init(info, errhandler, session, ierror)
12         TYPE(MPI_Info), INTENT(IN) :: info
13         TYPE(MPI_Errhandler), INTENT(IN) :: errhandler
14         TYPE(MPI_Session), INTENT(OUT) :: session
15         INTEGER, OPTIONAL, INTENT(OUT) :: ierror
16
17     MPI_Unpublish_name(service_name, info, port_name, ierror)
18         CHARACTER(LEN=*), INTENT(IN) :: service_name, port_name
19         TYPE(MPI_Info), INTENT(IN) :: info
20         INTEGER, OPTIONAL, INTENT(OUT) :: ierror
21
22     A.3.9 One-Sided Communications Fortran 2008 Bindings
23
24     MPI_Accumulate(origin_addr, origin_count, origin_datatype, target_rank,
25                   target_disp, target_count, target_datatype, op, win, ierror)
26         TYPE(*), DIMENSION(..), INTENT(IN), ASYNCHRONOUS :: origin_addr
27         INTEGER, INTENT(IN) :: origin_count, target_rank, target_count
28         TYPE(MPI_Datatype), INTENT(IN) :: origin_datatype, target_datatype
29         INTEGER(KIND=MPI_ADDRESS_KIND), INTENT(IN) :: target_disp
30         TYPE(MPI_Op), INTENT(IN) :: op
31         TYPE(MPI_Win), INTENT(IN) :: win
32         INTEGER, OPTIONAL, INTENT(OUT) :: ierror
33
34     MPI_Compare_and_swap(origin_addr, compare_addr, result_addr, datatype,
35                          target_rank, target_disp, win, ierror)
36         TYPE(*), DIMENSION(..), INTENT(IN), ASYNCHRONOUS :: origin_addr,
37         compare_addr
38         TYPE(*), DIMENSION(..), ASYNCHRONOUS :: result_addr
39         TYPE(MPI_Datatype), INTENT(IN) :: datatype
40         INTEGER, INTENT(IN) :: target_rank
41         INTEGER(KIND=MPI_ADDRESS_KIND), INTENT(IN) :: target_disp
42         TYPE(MPI_Win), INTENT(IN) :: win
43         INTEGER, OPTIONAL, INTENT(OUT) :: ierror
44
45     MPI_Fetch_and_op(origin_addr, result_addr, datatype, target_rank,
46                     target_disp, op, win, ierror)
47         TYPE(*), DIMENSION(..), INTENT(IN), ASYNCHRONOUS :: origin_addr
48         TYPE(*), DIMENSION(..), ASYNCHRONOUS :: result_addr
49         TYPE(MPI_Datatype), INTENT(IN) :: datatype
50         INTEGER, INTENT(IN) :: target_rank

```



```

INTEGER(KIND=MPI_ADDRESS_KIND), INTENT(IN) :: target_disp      1
TYPE(MPI_Op), INTENT(IN) :: op                                2
TYPE(MPI_Win), INTENT(IN) :: win                              3
INTEGER, OPTIONAL, INTENT(OUT) :: ierror                      4
                                                                5
MPI_Get(origin_addr, origin_count, origin_datatype, target_rank,  6
        target_disp, target_count, target_datatype, win, ierror)  7
TYPE(*), DIMENSION(..), ASYNCHRONOUS :: origin_addr          8
INTEGER, INTENT(IN) :: origin_count, target_rank, target_count  9
TYPE(MPI_Datatype), INTENT(IN) :: origin_datatype, target_datatype 10
INTEGER(KIND=MPI_ADDRESS_KIND), INTENT(IN) :: target_disp     11
TYPE(MPI_Win), INTENT(IN) :: win                              12
INTEGER, OPTIONAL, INTENT(OUT) :: ierror                      13
                                                                14
MPI_Get_accumulate(origin_addr, origin_count, origin_datatype, result_addr,  15
        result_count, result_datatype, target_rank, target_disp,  16
        target_count, target_datatype, op, win, ierror)      17
TYPE(*), DIMENSION(..), INTENT(IN), ASYNCHRONOUS :: origin_addr  18
INTEGER, INTENT(IN) :: origin_count, result_count, target_rank,  19
target_count
TYPE(MPI_Datatype), INTENT(IN) :: origin_datatype, result_datatype,  20
target_datatype
TYPE(*), DIMENSION(..), ASYNCHRONOUS :: result_addr          22
INTEGER(KIND=MPI_ADDRESS_KIND), INTENT(IN) :: target_disp     23
TYPE(MPI_Op), INTENT(IN) :: op                                24
TYPE(MPI_Win), INTENT(IN) :: win                              25
INTEGER, OPTIONAL, INTENT(OUT) :: ierror                      26
                                                                27
MPI_Put(origin_addr, origin_count, origin_datatype, target_rank,  28
        target_disp, target_count, target_datatype, win, ierror)  29
TYPE(*), DIMENSION(..), INTENT(IN), ASYNCHRONOUS :: origin_addr  30
INTEGER, INTENT(IN) :: origin_count, target_rank, target_count  31
TYPE(MPI_Datatype), INTENT(IN) :: origin_datatype, target_datatype  32
INTEGER(KIND=MPI_ADDRESS_KIND), INTENT(IN) :: target_disp     33
TYPE(MPI_Win), INTENT(IN) :: win                              34
INTEGER, OPTIONAL, INTENT(OUT) :: ierror                      35
                                                                36
MPI_Raccumulate(origin_addr, origin_count, origin_datatype, target_rank,  37
        target_disp, target_count, target_datatype, op, win, request,  38
        ierror)
TYPE(*), DIMENSION(..), INTENT(IN), ASYNCHRONOUS :: origin_addr  39
INTEGER, INTENT(IN) :: origin_count, target_rank, target_count  40
TYPE(MPI_Datatype), INTENT(IN) :: origin_datatype, target_datatype  41
INTEGER(KIND=MPI_ADDRESS_KIND), INTENT(IN) :: target_disp     42
TYPE(MPI_Op), INTENT(IN) :: op                                43
TYPE(MPI_Win), INTENT(IN) :: win                              44
TYPE(MPI_Request), INTENT(OUT) :: request                     45
INTEGER, OPTIONAL, INTENT(OUT) :: ierror                      46
                                                                47
MPI_Rget(origin_addr, origin_count, origin_datatype, target_rank,  48

```

```

1         target_disp, target_count, target_datatype, win, request,
2         ierror)
3     TYPE(*), DIMENSION(..), ASYNCHRONOUS :: origin_addr
4     INTEGER, INTENT(IN) :: origin_count, target_rank, target_count
5     TYPE(MPI_Datatype), INTENT(IN) :: origin_datatype, target_datatype
6     INTEGER(KIND=MPI_ADDRESS_KIND), INTENT(IN) :: target_disp
7     TYPE(MPI_Win), INTENT(IN) :: win
8     TYPE(MPI_Request), INTENT(OUT) :: request
9     INTEGER, OPTIONAL, INTENT(OUT) :: ierror
10
11 MPI_Rget_accumulate(origin_addr, origin_count, origin_datatype,
12                    result_addr, result_count, result_datatype, target_rank,
13                    target_disp, target_count, target_datatype, op, win, request,
14                    ierror)
15     TYPE(*), DIMENSION(..), INTENT(IN), ASYNCHRONOUS :: origin_addr
16     INTEGER, INTENT(IN) :: origin_count, result_count, target_rank,
17     target_count
18     TYPE(MPI_Datatype), INTENT(IN) :: origin_datatype, result_datatype,
19     target_datatype
20     TYPE(*), DIMENSION(..), ASYNCHRONOUS :: result_addr
21     INTEGER(KIND=MPI_ADDRESS_KIND), INTENT(IN) :: target_disp
22     TYPE(MPI_Op), INTENT(IN) :: op
23     TYPE(MPI_Win), INTENT(IN) :: win
24     TYPE(MPI_Request), INTENT(OUT) :: request
25     INTEGER, OPTIONAL, INTENT(OUT) :: ierror
26
27 MPI_Rput(origin_addr, origin_count, origin_datatype, target_rank,
28          target_disp, target_count, target_datatype, win, request,
29          ierror)
30     TYPE(*), DIMENSION(..), INTENT(IN), ASYNCHRONOUS :: origin_addr
31     INTEGER, INTENT(IN) :: origin_count, target_rank, target_count
32     TYPE(MPI_Datatype), INTENT(IN) :: origin_datatype, target_datatype
33     INTEGER(KIND=MPI_ADDRESS_KIND), INTENT(IN) :: target_disp
34     TYPE(MPI_Win), INTENT(IN) :: win
35     TYPE(MPI_Request), INTENT(OUT) :: request
36     INTEGER, OPTIONAL, INTENT(OUT) :: ierror
37
38 MPI_Win_allocate(size, disp_unit, info, comm, baseptr, win, ierror)
39     USE, INTRINSIC :: ISO_C_BINDING, ONLY : C_PTR
40     INTEGER(KIND=MPI_ADDRESS_KIND), INTENT(IN) :: size
41     INTEGER, INTENT(IN) :: disp_unit
42     TYPE(MPI_Info), INTENT(IN) :: info
43     TYPE(MPI_Comm), INTENT(IN) :: comm
44     TYPE(C_PTR), INTENT(OUT) :: baseptr
45     TYPE(MPI_Win), INTENT(OUT) :: win
46     INTEGER, OPTIONAL, INTENT(OUT) :: ierror
47
48 MPI_Win_allocate_shared(size, disp_unit, info, comm, baseptr, win, ierror)
49     USE, INTRINSIC :: ISO_C_BINDING, ONLY : C_PTR

```

```

INTEGER(KIND=MPI_ADDRESS_KIND), INTENT(IN) :: size           1
INTEGER, INTENT(IN) :: disp_unit                             2
TYPE(MPI_Info), INTENT(IN) :: info                           3
TYPE(MPI_Comm), INTENT(IN) :: comm                           4
TYPE(C_PTR), INTENT(OUT) :: baseptr                          5
TYPE(MPI_Win), INTENT(OUT) :: win                            6
INTEGER, OPTIONAL, INTENT(OUT) :: ierror                     7
                                                                8
MPI_Win_attach(win, base, size, ierror)                       9
  TYPE(MPI_Win), INTENT(IN) :: win                            10
  TYPE(*), DIMENSION(..), ASYNCHRONOUS :: base               11
  INTEGER(KIND=MPI_ADDRESS_KIND), INTENT(IN) :: size          12
  INTEGER, OPTIONAL, INTENT(OUT) :: ierror                    13
                                                                14
MPI_Win_complete(win, ierror)                                 15
  TYPE(MPI_Win), INTENT(IN) :: win                            16
  INTEGER, OPTIONAL, INTENT(OUT) :: ierror                    17
                                                                18
MPI_Win_create(base, size, disp_unit, info, comm, win, ierror) 19
  TYPE(*), DIMENSION(..), ASYNCHRONOUS :: base               20
  INTEGER(KIND=MPI_ADDRESS_KIND), INTENT(IN) :: size          21
  INTEGER, INTENT(IN) :: disp_unit                             22
  TYPE(MPI_Info), INTENT(IN) :: info                           23
  TYPE(MPI_Comm), INTENT(IN) :: comm                           24
  TYPE(MPI_Win), INTENT(OUT) :: win                            25
  INTEGER, OPTIONAL, INTENT(OUT) :: ierror                    26
                                                                27
MPI_Win_create_dynamic(info, comm, win, ierror)               28
  TYPE(MPI_Info), INTENT(IN) :: info                           29
  TYPE(MPI_Comm), INTENT(IN) :: comm                           30
  TYPE(MPI_Win), INTENT(OUT) :: win                            31
  INTEGER, OPTIONAL, INTENT(OUT) :: ierror                    32
                                                                33
MPI_Win_detach(win, base, ierror)                              34
  TYPE(MPI_Win), INTENT(IN) :: win                            35
  TYPE(*), DIMENSION(..), ASYNCHRONOUS :: base               36
  INTEGER, OPTIONAL, INTENT(OUT) :: ierror                    37
                                                                38
MPI_Win_fence(assert, win, ierror)                             39
  INTEGER, INTENT(IN) :: assert                                40
  TYPE(MPI_Win), INTENT(IN) :: win                            41
  INTEGER, OPTIONAL, INTENT(OUT) :: ierror                    42
                                                                43
MPI_Win_flush(rank, win, ierror)                               44
  INTEGER, INTENT(IN) :: rank                                  45
  TYPE(MPI_Win), INTENT(IN) :: win                            46
  INTEGER, OPTIONAL, INTENT(OUT) :: ierror                    47
                                                                48
MPI_Win_flush_all(win, ierror)                                 49
  TYPE(MPI_Win), INTENT(IN) :: win                            50
  INTEGER, OPTIONAL, INTENT(OUT) :: ierror                    51

```

```
1 MPI_Win_flush_local(rank, win, ierror)
2     INTEGER, INTENT(IN) :: rank
3     TYPE(MPI_Win), INTENT(IN) :: win
4     INTEGER, OPTIONAL, INTENT(OUT) :: ierror
5
6 MPI_Win_flush_local_all(win, ierror)
7     TYPE(MPI_Win), INTENT(IN) :: win
8     INTEGER, OPTIONAL, INTENT(OUT) :: ierror
9
10 MPI_Win_free(win, ierror)
11     TYPE(MPI_Win), INTENT(INOUT) :: win
12     INTEGER, OPTIONAL, INTENT(OUT) :: ierror
13
14 MPI_Win_get_group(win, group, ierror)
15     TYPE(MPI_Win), INTENT(IN) :: win
16     TYPE(MPI_Group), INTENT(OUT) :: group
17     INTEGER, OPTIONAL, INTENT(OUT) :: ierror
18
19 MPI_Win_get_info(win, info_used, ierror)
20     TYPE(MPI_Win), INTENT(IN) :: win
21     TYPE(MPI_Info), INTENT(OUT) :: info_used
22     INTEGER, OPTIONAL, INTENT(OUT) :: ierror
23
24 MPI_Win_lock(lock_type, rank, assert, win, ierror)
25     INTEGER, INTENT(IN) :: lock_type, rank, assert
26     TYPE(MPI_Win), INTENT(IN) :: win
27     INTEGER, OPTIONAL, INTENT(OUT) :: ierror
28
29 MPI_Win_lock_all(assert, win, ierror)
30     INTEGER, INTENT(IN) :: assert
31     TYPE(MPI_Win), INTENT(IN) :: win
32     INTEGER, OPTIONAL, INTENT(OUT) :: ierror
33
34 MPI_Win_post(group, assert, win, ierror)
35     TYPE(MPI_Group), INTENT(IN) :: group
36     INTEGER, INTENT(IN) :: assert
37     TYPE(MPI_Win), INTENT(IN) :: win
38     INTEGER, OPTIONAL, INTENT(OUT) :: ierror
39
40 MPI_Win_set_info(win, info, ierror)
41     TYPE(MPI_Win), INTENT(IN) :: win
42     TYPE(MPI_Info), INTENT(IN) :: info
43     INTEGER, OPTIONAL, INTENT(OUT) :: ierror
44
45 MPI_Win_shared_query(win, rank, size, disp_unit, baseptr, ierror)
46     USE, INTRINSIC :: ISO_C_BINDING, ONLY : C_PTR
47     TYPE(MPI_Win), INTENT(IN) :: win
48     INTEGER, INTENT(IN) :: rank
49     INTEGER(KIND=MPI_ADDRESS_KIND), INTENT(OUT) :: size
50     INTEGER, INTENT(OUT) :: disp_unit
51     TYPE(C_PTR), INTENT(OUT) :: baseptr
52     INTEGER, OPTIONAL, INTENT(OUT) :: ierror
```

```

MPI_Win_start(group, assert, win, ierror) 1
    TYPE(MPI_Group), INTENT(IN) :: group 2
    INTEGER, INTENT(IN) :: assert 3
    TYPE(MPI_Win), INTENT(IN) :: win 4
    INTEGER, OPTIONAL, INTENT(OUT) :: ierror 5
6
MPI_Win_sync(win, ierror) 7
    TYPE(MPI_Win), INTENT(IN) :: win 8
    INTEGER, OPTIONAL, INTENT(OUT) :: ierror 9
10
MPI_Win_test(win, flag, ierror) 11
    TYPE(MPI_Win), INTENT(IN) :: win 12
    LOGICAL, INTENT(OUT) :: flag 13
    INTEGER, OPTIONAL, INTENT(OUT) :: ierror 14
15
MPI_Win_unlock(rank, win, ierror) 16
    INTEGER, INTENT(IN) :: rank 17
    TYPE(MPI_Win), INTENT(IN) :: win 18
    INTEGER, OPTIONAL, INTENT(OUT) :: ierror 19
20
MPI_Win_unlock_all(win, ierror) 21
    TYPE(MPI_Win), INTENT(IN) :: win 22
    INTEGER, OPTIONAL, INTENT(OUT) :: ierror 23
24
MPI_Win_wait(win, ierror) 25
    TYPE(MPI_Win), INTENT(IN) :: win 26
    INTEGER, OPTIONAL, INTENT(OUT) :: ierror 27
28
A.3.10 External Interfaces Fortran 2008 Bindings 29
MPI_Grequest_complete(request, ierror) 30
    TYPE(MPI_Request), INTENT(IN) :: request 31
    INTEGER, OPTIONAL, INTENT(OUT) :: ierror 32
33
MPI_Grequest_start(query_fn, free_fn, cancel_fn, extra_state, request,
    ierror) 34
    PROCEDURE(MPI_Grequest_query_function), INTENT(IN) :: query_fn 35
    PROCEDURE(MPI_Grequest_free_function), INTENT(IN) :: free_fn 36
    PROCEDURE(MPI_Grequest_cancel_function), INTENT(IN) :: cancel_fn 37
    INTEGER(KIND=MPI_ADDRESS_KIND), INTENT(IN) :: extra_state 38
    TYPE(MPI_Request), INTENT(OUT) :: request 39
    INTEGER, OPTIONAL, INTENT(OUT) :: ierror 40
41
MPI_Status_set_cancelled(status, flag, ierror) 42
    TYPE(MPI_Status), INTENT(INOUT) :: status 43
    LOGICAL, INTENT(IN) :: flag 44
    INTEGER, OPTIONAL, INTENT(OUT) :: ierror 45
46
MPI_Status_set_elements(status, datatype, count, ierror) 47
    TYPE(MPI_Status), INTENT(INOUT) :: status 48
    TYPE(MPI_Datatype), INTENT(IN) :: datatype

```

```

1     INTEGER, INTENT(IN) :: count
2     INTEGER, OPTIONAL, INTENT(OUT) :: ierror
3
4 MPI_Status_set_elements_x(status, datatype, count, ierror)
5     TYPE(MPI_Status), INTENT(INOUT) :: status
6     TYPE(MPI_Datatype), INTENT(IN) :: datatype
7     INTEGER(KIND=MPI_COUNT_KIND), INTENT(IN) :: count
8     INTEGER, OPTIONAL, INTENT(OUT) :: ierror
9

```

### 10 A.3.11 I/O Fortran 2008 Bindings

```

11
12 MPI_CONVERSION_FN_NULL(userbuf, datatype, count, filebuf, position,
13     extra_state, ierror)
14     USE, INTRINSIC :: ISO_C_BINDING, ONLY : C_PTR
15     TYPE(C_PTR), VALUE :: userbuf, filebuf
16     TYPE(MPI_Datatype) :: datatype
17     INTEGER :: count, ierror
18     INTEGER(KIND=MPI_OFFSET_KIND) :: position
19     INTEGER(KIND=MPI_ADDRESS_KIND) :: extra_state
20
21 MPI_File_close(fh, ierror)
22     TYPE(MPI_File), INTENT(INOUT) :: fh
23     INTEGER, OPTIONAL, INTENT(OUT) :: ierror
24
25 MPI_File_delete(filename, info, ierror)
26     CHARACTER(LEN=*), INTENT(IN) :: filename
27     TYPE(MPI_Info), INTENT(IN) :: info
28     INTEGER, OPTIONAL, INTENT(OUT) :: ierror
29
30 MPI_File_get_amode(fh, amode, ierror)
31     TYPE(MPI_File), INTENT(IN) :: fh
32     INTEGER, INTENT(OUT) :: amode
33     INTEGER, OPTIONAL, INTENT(OUT) :: ierror
34
35 MPI_File_get_atomicity(fh, flag, ierror)
36     TYPE(MPI_File), INTENT(IN) :: fh
37     LOGICAL, INTENT(OUT) :: flag
38     INTEGER, OPTIONAL, INTENT(OUT) :: ierror
39
40 MPI_File_get_byte_offset(fh, offset, disp, ierror)
41     TYPE(MPI_File), INTENT(IN) :: fh
42     INTEGER(KIND=MPI_OFFSET_KIND), INTENT(IN) :: offset
43     INTEGER(KIND=MPI_OFFSET_KIND), INTENT(OUT) :: disp
44     INTEGER, OPTIONAL, INTENT(OUT) :: ierror
45
46 MPI_File_get_group(fh, group, ierror)
47     TYPE(MPI_File), INTENT(IN) :: fh
48     TYPE(MPI_Group), INTENT(OUT) :: group
49     INTEGER, OPTIONAL, INTENT(OUT) :: ierror
50
51 MPI_File_get_info(fh, info_used, ierror)

```

```

TYPE(MPI_File), INTENT(IN) :: fh
TYPE(MPI_Info), INTENT(OUT) :: info_used
INTEGER, OPTIONAL, INTENT(OUT) :: ierror

MPI_File_get_position(fh, offset, ierror)
TYPE(MPI_File), INTENT(IN) :: fh
INTEGER(KIND=MPI_OFFSET_KIND), INTENT(OUT) :: offset
INTEGER, OPTIONAL, INTENT(OUT) :: ierror

MPI_File_get_position_shared(fh, offset, ierror)
TYPE(MPI_File), INTENT(IN) :: fh
INTEGER(KIND=MPI_OFFSET_KIND), INTENT(OUT) :: offset
INTEGER, OPTIONAL, INTENT(OUT) :: ierror

MPI_File_get_size(fh, size, ierror)
TYPE(MPI_File), INTENT(IN) :: fh
INTEGER(KIND=MPI_OFFSET_KIND), INTENT(OUT) :: size
INTEGER, OPTIONAL, INTENT(OUT) :: ierror

MPI_File_get_type_extent(fh, datatype, extent, ierror)
TYPE(MPI_File), INTENT(IN) :: fh
TYPE(MPI_Datatype), INTENT(IN) :: datatype
INTEGER(KIND=MPI_ADDRESS_KIND), INTENT(OUT) :: extent
INTEGER, OPTIONAL, INTENT(OUT) :: ierror

MPI_File_get_view(fh, disp, etype, filetype, datarep, ierror)
TYPE(MPI_File), INTENT(IN) :: fh
INTEGER(KIND=MPI_OFFSET_KIND), INTENT(OUT) :: disp
TYPE(MPI_Datatype), INTENT(OUT) :: etype, filetype
CHARACTER(LEN=*), INTENT(OUT) :: datarep
INTEGER, OPTIONAL, INTENT(OUT) :: ierror

MPI_File_iread(fh, buf, count, datatype, request, ierror)
TYPE(MPI_File), INTENT(IN) :: fh
TYPE(*), DIMENSION(..), ASYNCHRONOUS :: buf
INTEGER, INTENT(IN) :: count
TYPE(MPI_Datatype), INTENT(IN) :: datatype
TYPE(MPI_Request), INTENT(OUT) :: request
INTEGER, OPTIONAL, INTENT(OUT) :: ierror

MPI_File_iread_all(fh, buf, count, datatype, request, ierror)
TYPE(MPI_File), INTENT(IN) :: fh
TYPE(*), DIMENSION(..), ASYNCHRONOUS :: buf
INTEGER, INTENT(IN) :: count
TYPE(MPI_Datatype), INTENT(IN) :: datatype
TYPE(MPI_Request), INTENT(OUT) :: request
INTEGER, OPTIONAL, INTENT(OUT) :: ierror

MPI_File_iread_at(fh, offset, buf, count, datatype, request, ierror)
TYPE(MPI_File), INTENT(IN) :: fh
INTEGER(KIND=MPI_OFFSET_KIND), INTENT(IN) :: offset

```

```

1     TYPE(*), DIMENSION(..), ASYNCHRONOUS :: buf
2     INTEGER, INTENT(IN) :: count
3     TYPE(MPI_Datatype), INTENT(IN) :: datatype
4     TYPE(MPI_Request), INTENT(OUT) :: request
5     INTEGER, OPTIONAL, INTENT(OUT) :: ierror
6
7 MPI_File_iread_at_all(fh, offset, buf, count, datatype, request, ierror)
8     TYPE(MPI_File), INTENT(IN) :: fh
9     INTEGER(KIND=MPI_OFFSET_KIND), INTENT(IN) :: offset
10    TYPE(*), DIMENSION(..), ASYNCHRONOUS :: buf
11    INTEGER, INTENT(IN) :: count
12    TYPE(MPI_Datatype), INTENT(IN) :: datatype
13    TYPE(MPI_Request), INTENT(OUT) :: request
14    INTEGER, OPTIONAL, INTENT(OUT) :: ierror
15
16 MPI_File_iread_shared(fh, buf, count, datatype, request, ierror)
17    TYPE(MPI_File), INTENT(IN) :: fh
18    TYPE(*), DIMENSION(..), ASYNCHRONOUS :: buf
19    INTEGER, INTENT(IN) :: count
20    TYPE(MPI_Datatype), INTENT(IN) :: datatype
21    TYPE(MPI_Request), INTENT(OUT) :: request
22    INTEGER, OPTIONAL, INTENT(OUT) :: ierror
23
24 MPI_File_fwrite(fh, buf, count, datatype, request, ierror)
25    TYPE(MPI_File), INTENT(IN) :: fh
26    TYPE(*), DIMENSION(..), INTENT(IN), ASYNCHRONOUS :: buf
27    INTEGER, INTENT(IN) :: count
28    TYPE(MPI_Datatype), INTENT(IN) :: datatype
29    TYPE(MPI_Request), INTENT(OUT) :: request
30    INTEGER, OPTIONAL, INTENT(OUT) :: ierror
31
32 MPI_File_fwrite_all(fh, buf, count, datatype, request, ierror)
33    TYPE(MPI_File), INTENT(IN) :: fh
34    TYPE(*), DIMENSION(..), INTENT(IN), ASYNCHRONOUS :: buf
35    INTEGER, INTENT(IN) :: count
36    TYPE(MPI_Datatype), INTENT(IN) :: datatype
37    TYPE(MPI_Request), INTENT(OUT) :: request
38    INTEGER, OPTIONAL, INTENT(OUT) :: ierror
39
40 MPI_File_fwrite_at(fh, offset, buf, count, datatype, request, ierror)
41    TYPE(MPI_File), INTENT(IN) :: fh
42    INTEGER(KIND=MPI_OFFSET_KIND), INTENT(IN) :: offset
43    TYPE(*), DIMENSION(..), INTENT(IN), ASYNCHRONOUS :: buf
44    INTEGER, INTENT(IN) :: count
45    TYPE(MPI_Datatype), INTENT(IN) :: datatype
46    TYPE(MPI_Request), INTENT(OUT) :: request
47    INTEGER, OPTIONAL, INTENT(OUT) :: ierror
48
49 MPI_File_fwrite_at_all(fh, offset, buf, count, datatype, request, ierror)
50    TYPE(MPI_File), INTENT(IN) :: fh

```



```

INTEGER(KIND=MPI_OFFSET_KIND), INTENT(IN) :: offset           1
TYPE(*), DIMENSION(..), INTENT(IN), ASYNCHRONOUS :: buf      2
INTEGER, INTENT(IN) :: count                                  3
TYPE(MPI_Datatype), INTENT(IN) :: datatype                   4
TYPE(MPI_Request), INTENT(OUT) :: request                    5
INTEGER, OPTIONAL, INTENT(OUT) :: ierror                     6
                                                                7
MPI_File_iread_shared(fh, buf, count, datatype, request, ierror) 8
  TYPE(MPI_File), INTENT(IN) :: fh                            9
  TYPE(*), DIMENSION(..), INTENT(IN), ASYNCHRONOUS :: buf    10
  INTEGER, INTENT(IN) :: count                                 11
  TYPE(MPI_Datatype), INTENT(IN) :: datatype                  12
  TYPE(MPI_Request), INTENT(OUT) :: request                   13
  INTEGER, OPTIONAL, INTENT(OUT) :: ierror                    14
                                                                15
MPI_File_iorwrite_shared(fh, buf, count, datatype, request, ierror) 16
  TYPE(MPI_File), INTENT(IN) :: fh                            17
  TYPE(*), DIMENSION(..), INTENT(IN), ASYNCHRONOUS :: buf    18
  INTEGER, INTENT(IN) :: count                                 19
  TYPE(MPI_Datatype), INTENT(IN) :: datatype                  20
  TYPE(MPI_Request), INTENT(OUT) :: request                   21
  INTEGER, OPTIONAL, INTENT(OUT) :: ierror                    22
                                                                23
MPI_File_open(comm, filename, amode, info, fh, ierror)         24
  TYPE(MPI_Comm), INTENT(IN) :: comm                          25
  CHARACTER(LEN=*), INTENT(IN) :: filename                   26
  INTEGER, INTENT(IN) :: amode                                27
  TYPE(MPI_Info), INTENT(IN) :: info                          28
  TYPE(MPI_File), INTENT(OUT) :: fh                           29
  INTEGER, OPTIONAL, INTENT(OUT) :: ierror                    30
                                                                31
MPI_File_preallocate(fh, size, ierror)                          32
  TYPE(MPI_File), INTENT(IN) :: fh                            33
  INTEGER(KIND=MPI_OFFSET_KIND), INTENT(IN) :: size           34
  INTEGER, OPTIONAL, INTENT(OUT) :: ierror                    35
                                                                36
MPI_File_read(fh, buf, count, datatype, status, ierror)        37
  TYPE(MPI_File), INTENT(IN) :: fh                            38
  TYPE(*), DIMENSION(..) :: buf                               39
  INTEGER, INTENT(IN) :: count                                 40
  TYPE(MPI_Datatype), INTENT(IN) :: datatype                  41
  TYPE(MPI_Status) :: status                                  42
  INTEGER, OPTIONAL, INTENT(OUT) :: ierror                    43
                                                                44
MPI_File_read_all(fh, buf, count, datatype, status, ierror)    45
  TYPE(MPI_File), INTENT(IN) :: fh                            46
  TYPE(*), DIMENSION(..) :: buf                               47
  INTEGER, INTENT(IN) :: count                                 48
  TYPE(MPI_Datatype), INTENT(IN) :: datatype                  49
  TYPE(MPI_Status) :: status                                  50
  INTEGER, OPTIONAL, INTENT(OUT) :: ierror                    51
                                                                52
MPI_File_read_all_begin(fh, buf, count, datatype, ierror)     53
  TYPE(MPI_File), INTENT(IN) :: fh                            54
  TYPE(*), DIMENSION(..), ASYNCHRONOUS :: buf                55
  INTEGER, INTENT(IN) :: count                                 56
  TYPE(MPI_Datatype), INTENT(IN) :: datatype                  57
  INTEGER, OPTIONAL, INTENT(OUT) :: ierror                    58

```

```
1 MPI_File_read_all_end(fh, buf, status, ierror)
2     TYPE(MPI_File), INTENT(IN) :: fh
3     TYPE(*), DIMENSION(..), ASYNCHRONOUS :: buf
4     TYPE(MPI_Status) :: status
5     INTEGER, OPTIONAL, INTENT(OUT) :: ierror
6
7 MPI_File_read_at(fh, offset, buf, count, datatype, status, ierror)
8     TYPE(MPI_File), INTENT(IN) :: fh
9     INTEGER(KIND=MPI_OFFSET_KIND), INTENT(IN) :: offset
10    TYPE(*), DIMENSION(..) :: buf
11    INTEGER, INTENT(IN) :: count
12    TYPE(MPI_Datatype), INTENT(IN) :: datatype
13    TYPE(MPI_Status) :: status
14    INTEGER, OPTIONAL, INTENT(OUT) :: ierror
15
16 MPI_File_read_at_all(fh, offset, buf, count, datatype, status, ierror)
17    TYPE(MPI_File), INTENT(IN) :: fh
18    INTEGER(KIND=MPI_OFFSET_KIND), INTENT(IN) :: offset
19    TYPE(*), DIMENSION(..) :: buf
20    INTEGER, INTENT(IN) :: count
21    TYPE(MPI_Datatype), INTENT(IN) :: datatype
22    TYPE(MPI_Status) :: status
23    INTEGER, OPTIONAL, INTENT(OUT) :: ierror
24
25 MPI_File_read_at_all_begin(fh, offset, buf, count, datatype, ierror)
26    TYPE(MPI_File), INTENT(IN) :: fh
27    INTEGER(KIND=MPI_OFFSET_KIND), INTENT(IN) :: offset
28    TYPE(*), DIMENSION(..), ASYNCHRONOUS :: buf
29    INTEGER, INTENT(IN) :: count
30    TYPE(MPI_Datatype), INTENT(IN) :: datatype
31    INTEGER, OPTIONAL, INTENT(OUT) :: ierror
32
33 MPI_File_read_at_all_end(fh, buf, status, ierror)
34    TYPE(MPI_File), INTENT(IN) :: fh
35    TYPE(*), DIMENSION(..), ASYNCHRONOUS :: buf
36    TYPE(MPI_Status) :: status
37    INTEGER, OPTIONAL, INTENT(OUT) :: ierror
38
39 MPI_File_read_ordered(fh, buf, count, datatype, status, ierror)
40    TYPE(MPI_File), INTENT(IN) :: fh
41    TYPE(*), DIMENSION(..) :: buf
42    INTEGER, INTENT(IN) :: count
43    TYPE(MPI_Datatype), INTENT(IN) :: datatype
44    TYPE(MPI_Status) :: status
45    INTEGER, OPTIONAL, INTENT(OUT) :: ierror
46
47 MPI_File_read_ordered_begin(fh, buf, count, datatype, ierror)
48    TYPE(MPI_File), INTENT(IN) :: fh
49    TYPE(*), DIMENSION(..), ASYNCHRONOUS :: buf
50    INTEGER, INTENT(IN) :: count
```

```

TYPE(MPI_Datatype), INTENT(IN) :: datatype           1
INTEGER, OPTIONAL, INTENT(OUT) :: ierror           2
                                                    3
MPI_File_read_ordered_end(fh, buf, status, ierror)  4
TYPE(MPI_File), INTENT(IN) :: fh                   5
TYPE(*), DIMENSION(..), ASYNCHRONOUS :: buf        6
TYPE(MPI_Status) :: status                           7
INTEGER, OPTIONAL, INTENT(OUT) :: ierror           8
                                                    9
MPI_File_read_shared(fh, buf, count, datatype, status, ierror) 10
TYPE(MPI_File), INTENT(IN) :: fh                   11
TYPE(*), DIMENSION(..) :: buf                       12
INTEGER, INTENT(IN) :: count                         13
TYPE(MPI_Datatype), INTENT(IN) :: datatype          14
TYPE(MPI_Status) :: status                           15
INTEGER, OPTIONAL, INTENT(OUT) :: ierror           16
                                                    17
MPI_File_seek(fh, offset, whence, ierror)           18
TYPE(MPI_File), INTENT(IN) :: fh                   19
INTEGER(KIND=MPI_OFFSET_KIND), INTENT(IN) :: offset 20
INTEGER, INTENT(IN) :: whence                       21
INTEGER, OPTIONAL, INTENT(OUT) :: ierror           22
                                                    23
MPI_File_seek_shared(fh, offset, whence, ierror)   24
TYPE(MPI_File), INTENT(IN) :: fh                   25
INTEGER(KIND=MPI_OFFSET_KIND), INTENT(IN) :: offset 26
INTEGER, INTENT(IN) :: whence                       27
INTEGER, OPTIONAL, INTENT(OUT) :: ierror           28
                                                    29
MPI_File_set_atomicity(fh, flag, ierror)           30
TYPE(MPI_File), INTENT(IN) :: fh                   31
LOGICAL, INTENT(IN) :: flag                         32
INTEGER, OPTIONAL, INTENT(OUT) :: ierror           33
                                                    34
MPI_File_set_info(fh, info, ierror)                35
TYPE(MPI_File), INTENT(IN) :: fh                   36
TYPE(MPI_Info), INTENT(IN) :: info                  37
INTEGER, OPTIONAL, INTENT(OUT) :: ierror           38
                                                    39
MPI_File_set_size(fh, size, ierror)                40
TYPE(MPI_File), INTENT(IN) :: fh                   41
INTEGER(KIND=MPI_OFFSET_KIND), INTENT(IN) :: size   42
INTEGER, OPTIONAL, INTENT(OUT) :: ierror           43
                                                    44
MPI_File_set_view(fh, disp, etype, filetype, datarep, info, ierror) 45
TYPE(MPI_File), INTENT(IN) :: fh                   46
INTEGER(KIND=MPI_OFFSET_KIND), INTENT(IN) :: disp   47
TYPE(MPI_Datatype), INTENT(IN) :: etype, filetype  48
CHARACTER(LEN=*), INTENT(IN) :: datarep            49
TYPE(MPI_Info), INTENT(IN) :: info                  50
INTEGER, OPTIONAL, INTENT(OUT) :: ierror           51

```

```

1 MPI_File_sync(fh, ierror)
2     TYPE(MPI_File), INTENT(IN) :: fh
3     INTEGER, OPTIONAL, INTENT(OUT) :: ierror
4
5 MPI_File_write(fh, buf, count, datatype, status, ierror)
6     TYPE(MPI_File), INTENT(IN) :: fh
7     TYPE(*), DIMENSION(..), INTENT(IN) :: buf
8     INTEGER, INTENT(IN) :: count
9     TYPE(MPI_Datatype), INTENT(IN) :: datatype
10    TYPE(MPI_Status) :: status
11    INTEGER, OPTIONAL, INTENT(OUT) :: ierror
12
13 MPI_File_write_all(fh, buf, count, datatype, status, ierror)
14    TYPE(MPI_File), INTENT(IN) :: fh
15    TYPE(*), DIMENSION(..), INTENT(IN) :: buf
16    INTEGER, INTENT(IN) :: count
17    TYPE(MPI_Datatype), INTENT(IN) :: datatype
18    TYPE(MPI_Status) :: status
19    INTEGER, OPTIONAL, INTENT(OUT) :: ierror
20
21 MPI_File_write_all_begin(fh, buf, count, datatype, ierror)
22    TYPE(MPI_File), INTENT(IN) :: fh
23    TYPE(*), DIMENSION(..), INTENT(IN), ASYNCHRONOUS :: buf
24    INTEGER, INTENT(IN) :: count
25    TYPE(MPI_Datatype), INTENT(IN) :: datatype
26    INTEGER, OPTIONAL, INTENT(OUT) :: ierror
27
28 MPI_File_write_all_end(fh, buf, status, ierror)
29    TYPE(MPI_File), INTENT(IN) :: fh
30    TYPE(*), DIMENSION(..), INTENT(IN), ASYNCHRONOUS :: buf
31    TYPE(MPI_Status) :: status
32    INTEGER, OPTIONAL, INTENT(OUT) :: ierror
33
34 MPI_File_write_at(fh, offset, buf, count, datatype, status, ierror)
35    TYPE(MPI_File), INTENT(IN) :: fh
36    INTEGER(KIND=MPI_OFFSET_KIND), INTENT(IN) :: offset
37    TYPE(*), DIMENSION(..), INTENT(IN) :: buf
38    INTEGER, INTENT(IN) :: count
39    TYPE(MPI_Datatype), INTENT(IN) :: datatype
40    TYPE(MPI_Status) :: status
41    INTEGER, OPTIONAL, INTENT(OUT) :: ierror
42
43 MPI_File_write_at_all(fh, offset, buf, count, datatype, status, ierror)
44    TYPE(MPI_File), INTENT(IN) :: fh
45    INTEGER(KIND=MPI_OFFSET_KIND), INTENT(IN) :: offset
46    TYPE(*), DIMENSION(..), INTENT(IN) :: buf
47    INTEGER, INTENT(IN) :: count
48    TYPE(MPI_Datatype), INTENT(IN) :: datatype
49    TYPE(MPI_Status) :: status
50    INTEGER, OPTIONAL, INTENT(OUT) :: ierror

```

```

MPI_File_write_at_all_begin(fh, offset, buf, count, datatype, ierror)      1
    TYPE(MPI_File), INTENT(IN) :: fh                                     2
    INTEGER(KIND=MPI_OFFSET_KIND), INTENT(IN) :: offset                3
    TYPE(*), DIMENSION(..), INTENT(IN), ASYNCHRONOUS :: buf           4
    INTEGER, INTENT(IN) :: count                                       5
    TYPE(MPI_Datatype), INTENT(IN) :: datatype                         6
    INTEGER, OPTIONAL, INTENT(OUT) :: ierror                           7
                                                                    8
MPI_File_write_at_all_end(fh, buf, status, ierror)                       9
    TYPE(MPI_File), INTENT(IN) :: fh                                   10
    TYPE(*), DIMENSION(..), INTENT(IN), ASYNCHRONOUS :: buf          11
    TYPE(MPI_Status) :: status                                         12
    INTEGER, OPTIONAL, INTENT(OUT) :: ierror                           13
                                                                    14
MPI_File_write_ordered(fh, buf, count, datatype, status, ierror)        15
    TYPE(MPI_File), INTENT(IN) :: fh                                   16
    TYPE(*), DIMENSION(..), INTENT(IN) :: buf                         17
    INTEGER, INTENT(IN) :: count                                       18
    TYPE(MPI_Datatype), INTENT(IN) :: datatype                       19
    TYPE(MPI_Status) :: status                                         20
    INTEGER, OPTIONAL, INTENT(OUT) :: ierror                           21
                                                                    22
MPI_File_write_ordered_begin(fh, buf, count, datatype, ierror)          23
    TYPE(MPI_File), INTENT(IN) :: fh                                   24
    TYPE(*), DIMENSION(..), INTENT(IN), ASYNCHRONOUS :: buf          25
    INTEGER, INTENT(IN) :: count                                       26
    TYPE(MPI_Datatype), INTENT(IN) :: datatype                       27
    INTEGER, OPTIONAL, INTENT(OUT) :: ierror                           28
                                                                    29
MPI_File_write_ordered_end(fh, buf, status, ierror)                     30
    TYPE(MPI_File), INTENT(IN) :: fh                                   31
    TYPE(*), DIMENSION(..), INTENT(IN), ASYNCHRONOUS :: buf          32
    TYPE(MPI_Status) :: status                                         33
    INTEGER, OPTIONAL, INTENT(OUT) :: ierror                           34
                                                                    35
MPI_File_write_shared(fh, buf, count, datatype, status, ierror)         36
    TYPE(MPI_File), INTENT(IN) :: fh                                   37
    TYPE(*), DIMENSION(..), INTENT(IN) :: buf                         38
    INTEGER, INTENT(IN) :: count                                       39
    TYPE(MPI_Datatype), INTENT(IN) :: datatype                       40
    TYPE(MPI_Status) :: status                                         41
    INTEGER, OPTIONAL, INTENT(OUT) :: ierror                           42
                                                                    43
MPI_Register_datarep(datarep, read_conversion_fn, write_conversion_fn,    44
                    dtype_file_extent_fn, extra_state, ierror)          45
    CHARACTER(LEN=*), INTENT(IN) :: datarep                            46
    PROCEDURE(MPI_Datarep_conversion_function) :: read_conversion_fn,  47
    write_conversion_fn                                                48
    PROCEDURE(MPI_Datarep_extent_function) :: dtype_file_extent_fn    49
    INTEGER(KIND=MPI_ADDRESS_KIND), INTENT(IN) :: extra_state         50

```

1       INTEGER, OPTIONAL, INTENT(OUT) :: ierror

### 4   A.3.12 Language Bindings Fortran 2008 Bindings

5   MPI\_F\_sync\_reg(buf)

6       TYPE(\*), DIMENSION(..), ASYNCHRONOUS :: buf

8   MPI\_Status\_f082f(f08\_status, f\_status, ierror)

9       TYPE(MPI\_Status), INTENT(IN) :: f08\_status

10      INTEGER, INTENT(OUT) :: f\_status(MPI\_STATUS\_SIZE)

11      INTEGER, OPTIONAL, INTENT(OUT) :: ierror

12   MPI\_Status\_f2f08(f\_status, f08\_status, ierror)

13      INTEGER, INTENT(IN) :: f\_status(MPI\_STATUS\_SIZE)

14      TYPE(MPI\_Status), INTENT(OUT) :: f08\_status

15      INTEGER, OPTIONAL, INTENT(OUT) :: ierror

17   MPI\_Type\_create\_f90\_complex(p, r, newtype, ierror)

18      INTEGER, INTENT(IN) :: p, r

19      TYPE(MPI\_Datatype), INTENT(OUT) :: newtype

20      INTEGER, OPTIONAL, INTENT(OUT) :: ierror

21   MPI\_Type\_create\_f90\_integer(r, newtype, ierror)

22      INTEGER, INTENT(IN) :: r

23      TYPE(MPI\_Datatype), INTENT(OUT) :: newtype

24      INTEGER, OPTIONAL, INTENT(OUT) :: ierror

26   MPI\_Type\_create\_f90\_real(p, r, newtype, ierror)

27      INTEGER, INTENT(IN) :: p, r

28      TYPE(MPI\_Datatype), INTENT(OUT) :: newtype

29      INTEGER, OPTIONAL, INTENT(OUT) :: ierror

30   MPI\_Type\_match\_size(typeclass, size, datatype, ierror)

31      INTEGER, INTENT(IN) :: typeclass, size

32      TYPE(MPI\_Datatype), INTENT(OUT) :: datatype

33      INTEGER, OPTIONAL, INTENT(OUT) :: ierror

### 36   A.3.13 Tools / Profiling Interface Fortran 2008 Bindings

38   MPI\_Pcontrol(level)

39      INTEGER, INTENT(IN) :: level

### 41   A.3.14 Deprecated Fortran 2008 Bindings

43   MPI\_Info\_get(info, key, valuelen, value, flag, ierror)

44      TYPE(MPI\_Info), INTENT(IN) :: info

45      CHARACTER(LEN=\*), INTENT(IN) :: key

46      INTEGER, INTENT(IN) :: valuelen

47      CHARACTER(LEN=valuelen), INTENT(OUT) :: value

48      LOGICAL, INTENT(OUT) :: flag

```
INTEGER, OPTIONAL, INTENT(OUT) :: ierror 1
MPI_Info_get_valuelen(info, key, valuelen, flag, ierror) 2
TYPE(MPI_Info), INTENT(IN) :: info 3
CHARACTER(LEN=*), INTENT(IN) :: key 4
INTEGER, INTENT(OUT) :: valuelen 5
LOGICAL, INTENT(OUT) :: flag 6
INTEGER, OPTIONAL, INTENT(OUT) :: ierror 7
MPI_Sizeof(x, size, ierror) 8
TYPE(*), DIMENSION(..) :: x 9
INTEGER, INTENT(OUT) :: size 10
INTEGER, OPTIONAL, INTENT(OUT) :: ierror 11
12
13
14
15
16
17
18
19
20
21
22
23
24
25
26
27
28
29
30
31
32
33
34
35
36
37
38
39
40
41
42
43
44
45
46
47
48
```

## A.4 Fortran Bindings with `mpif.h` or the `mpi` Module

### A.4.1 Point-to-Point Communication Fortran Bindings

#### Fortran binding

```

5 MPI_BSEND(BUF, COUNT, DATATYPE, DEST, TAG, COMM, IERROR)
6     <type> BUF(*)
7     INTEGER COUNT, DATATYPE, DEST, TAG, COMM, IERROR
8
9 MPI_BSEND_INIT(BUF, COUNT, DATATYPE, DEST, TAG, COMM, REQUEST, IERROR)
10    <type> BUF(*)
11    INTEGER COUNT, DATATYPE, DEST, TAG, COMM, REQUEST, IERROR
12
13 MPI_BUFFER_ATTACH(BUFFER, SIZE, IERROR)
14    <type> BUFFER(*)
15    INTEGER SIZE, IERROR
16
17 MPI_BUFFER_DETACH(BUFFER_ADDR, SIZE, IERROR)
18    <type> BUFFER_ADDR(*)
19    INTEGER SIZE, IERROR
20
21 MPI_CANCEL(REQUEST, IERROR)
22    INTEGER REQUEST, IERROR
23
24 MPI_GET_COUNT(STATUS, DATATYPE, COUNT, IERROR)
25    INTEGER STATUS(MPI_STATUS_SIZE), DATATYPE, COUNT, IERROR
26
27 MPI_IBSEND(BUF, COUNT, DATATYPE, DEST, TAG, COMM, REQUEST, IERROR)
28    <type> BUF(*)
29    INTEGER COUNT, DATATYPE, DEST, TAG, COMM, REQUEST, IERROR
30
31 MPI_IMPROBE(SOURCE, TAG, COMM, FLAG, MESSAGE, STATUS, IERROR)
32    INTEGER SOURCE, TAG, COMM, MESSAGE, STATUS(MPI_STATUS_SIZE), IERROR
33    LOGICAL FLAG
34
35 MPI_IMRECV(BUF, COUNT, DATATYPE, MESSAGE, REQUEST, IERROR)
36    <type> BUF(*)
37    INTEGER COUNT, DATATYPE, MESSAGE, REQUEST, IERROR
38
39 MPI_IProbe(SOURCE, TAG, COMM, FLAG, STATUS, IERROR)
40    INTEGER SOURCE, TAG, COMM, STATUS(MPI_STATUS_SIZE), IERROR
41    LOGICAL FLAG
42
43 MPI_IRECV(BUF, COUNT, DATATYPE, SOURCE, TAG, COMM, REQUEST, IERROR)
44    <type> BUF(*)
45    INTEGER COUNT, DATATYPE, SOURCE, TAG, COMM, REQUEST, IERROR
46
47 MPI_IRSEND(BUF, COUNT, DATATYPE, DEST, TAG, COMM, REQUEST, IERROR)
48    <type> BUF(*)
49    INTEGER COUNT, DATATYPE, DEST, TAG, COMM, REQUEST, IERROR

```



```

MPI_ISSEND(BUF, COUNT, DATATYPE, DEST, TAG, COMM, REQUEST, IERROR)      1
  <type> BUF(*)                                                            2
  INTEGER COUNT, DATATYPE, DEST, TAG, COMM, REQUEST, IERROR              3
                                                                              4
MPI_MPROBE(SOURCE, TAG, COMM, MESSAGE, STATUS, IERROR)                    5
  INTEGER SOURCE, TAG, COMM, MESSAGE, STATUS(MPI_STATUS_SIZE), IERROR    6
                                                                              7
MPI_MRECV(BUF, COUNT, DATATYPE, MESSAGE, STATUS, IERROR)                  8
  <type> BUF(*)                                                            9
  INTEGER COUNT, DATATYPE, MESSAGE, STATUS(MPI_STATUS_SIZE), IERROR     10
                                                                              11
MPI_PROBE(SOURCE, TAG, COMM, STATUS, IERROR)                              12
  INTEGER SOURCE, TAG, COMM, STATUS(MPI_STATUS_SIZE), IERROR             13
                                                                              14
MPI_RECV(BUF, COUNT, DATATYPE, SOURCE, TAG, COMM, STATUS, IERROR)        15
  <type> BUF(*)                                                            16
  INTEGER COUNT, DATATYPE, SOURCE, TAG, COMM, STATUS(MPI_STATUS_SIZE),  17
  IERROR                                                                    18
                                                                              19
MPI_RECV_INIT(BUF, COUNT, DATATYPE, SOURCE, TAG, COMM, REQUEST, IERROR)  20
  <type> BUF(*)                                                            21
  INTEGER COUNT, DATATYPE, SOURCE, TAG, COMM, REQUEST, IERROR           22
                                                                              23
MPI_REQUEST_FREE(REQUEST, IERROR)                                         24
  INTEGER REQUEST, IERROR                                                  25
                                                                              26
MPI_REQUEST_GET_STATUS(REQUEST, FLAG, STATUS, IERROR)                     27
  INTEGER REQUEST, STATUS(MPI_STATUS_SIZE), IERROR                       28
  LOGICAL FLAG                                                            29
                                                                              30
MPI_RSEND(BUF, COUNT, DATATYPE, DEST, TAG, COMM, IERROR)                 31
  <type> BUF(*)                                                            32
  INTEGER COUNT, DATATYPE, DEST, TAG, COMM, IERROR                       33
                                                                              34
MPI_RSEND_INIT(BUF, COUNT, DATATYPE, DEST, TAG, COMM, REQUEST, IERROR)   35
  <type> BUF(*)                                                            36
  INTEGER COUNT, DATATYPE, DEST, TAG, COMM, REQUEST, IERROR             37
                                                                              38
MPI_SEND(BUF, COUNT, DATATYPE, DEST, TAG, COMM, IERROR)                  39
  <type> BUF(*)                                                            40
  INTEGER COUNT, DATATYPE, DEST, TAG, COMM, IERROR                       41
                                                                              42
MPI_SENDRECV(SENDBUF, SENDCOUNT, SENDTYPE, DEST, SENDTAG, RECVBUFF,    43
  RECVCOUNT, RECVMODE, SOURCE, RECVMODE, COMM, STATUS, IERROR)           44
  <type> SENDBUF(*), RECVBUFF(*)                                          45
  INTEGER SENDCOUNT, SENDTYPE, DEST, SENDTAG, RECVCOUNT, RECVMODE,     46
  SOURCE, RECVMODE, COMM, STATUS(MPI_STATUS_SIZE), IERROR               47
                                                                              48
MPI_SENDRECV_REPLACE(BUF, COUNT, DATATYPE, DEST, SENDTAG, SOURCE, RECVMODE,
  COMM, STATUS, IERROR)
  <type> BUF(*)
  INTEGER COUNT, DATATYPE, DEST, SENDTAG, SOURCE, RECVMODE, COMM,
  STATUS(MPI_STATUS_SIZE), IERROR

```

```
1 MPI_SEND_INIT(BUF, COUNT, DATATYPE, DEST, TAG, COMM, REQUEST, IERROR)
2     <type> BUF(*)
3     INTEGER COUNT, DATATYPE, DEST, TAG, COMM, REQUEST, IERROR
4
5 MPI_SSEND(BUF, COUNT, DATATYPE, DEST, TAG, COMM, IERROR)
6     <type> BUF(*)
7     INTEGER COUNT, DATATYPE, DEST, TAG, COMM, IERROR
8
9 MPI_SSEND_INIT(BUF, COUNT, DATATYPE, DEST, TAG, COMM, REQUEST, IERROR)
10    <type> BUF(*)
11    INTEGER COUNT, DATATYPE, DEST, TAG, COMM, REQUEST, IERROR
12
13 MPI_START(REQUEST, IERROR)
14    INTEGER REQUEST, IERROR
15
16 MPI_STARTALL(COUNT, ARRAY_OF_REQUESTS, IERROR)
17    INTEGER COUNT, ARRAY_OF_REQUESTS(*), IERROR
18
19 MPI_TEST(REQUEST, FLAG, STATUS, IERROR)
20    INTEGER REQUEST, STATUS(MPI_STATUS_SIZE), IERROR
21    LOGICAL FLAG
22
23 MPI_TESTALL(COUNT, ARRAY_OF_REQUESTS, FLAG, ARRAY_OF_STATUSES, IERROR)
24    INTEGER COUNT, ARRAY_OF_REQUESTS(*),
25    ARRAY_OF_STATUSES(MPI_STATUS_SIZE, *), IERROR
26    LOGICAL FLAG
27
28 MPI_TESTANY(COUNT, ARRAY_OF_REQUESTS, INDEX, FLAG, STATUS, IERROR)
29    INTEGER COUNT, ARRAY_OF_REQUESTS(*), INDEX, STATUS(MPI_STATUS_SIZE),
30    IERROR
31    LOGICAL FLAG
32
33 MPI_TESTSOME(INCOUNT, ARRAY_OF_REQUESTS, OUTCOUNT, ARRAY_OF_INDICES,
34    ARRAY_OF_STATUSES, IERROR)
35    INTEGER INCOUNT, ARRAY_OF_REQUESTS(*), OUTCOUNT, ARRAY_OF_INDICES(*),
36    ARRAY_OF_STATUSES(MPI_STATUS_SIZE, *), IERROR
37
38 MPI_TEST_CANCELLED(STATUS, FLAG, IERROR)
39    INTEGER STATUS(MPI_STATUS_SIZE), IERROR
40    LOGICAL FLAG
41
42 MPI_WAIT(REQUEST, STATUS, IERROR)
43    INTEGER REQUEST, STATUS(MPI_STATUS_SIZE), IERROR
44
45 MPI_WAITALL(COUNT, ARRAY_OF_REQUESTS, ARRAY_OF_STATUSES, IERROR)
46    INTEGER COUNT, ARRAY_OF_REQUESTS(*),
47    ARRAY_OF_STATUSES(MPI_STATUS_SIZE, *), IERROR
48
49 MPI_WAITANY(COUNT, ARRAY_OF_REQUESTS, INDEX, STATUS, IERROR)
50    INTEGER COUNT, ARRAY_OF_REQUESTS(*), INDEX, STATUS(MPI_STATUS_SIZE),
51    IERROR
52
53 MPI_WAITSOME(INCOUNT, ARRAY_OF_REQUESTS, OUTCOUNT, ARRAY_OF_INDICES,
54    ARRAY_OF_STATUSES, IERROR)
```

```

    INTEGER INCOUNT, ARRAY_OF_REQUESTS(*), OUTCOUNT, ARRAY_OF_INDICES(*),
    ARRAY_OF_STATUSES(MPI_STATUS_SIZE, *), IERROR

```

#### A.4.2 Datatypes Fortran Bindings

```

INTEGER(KIND=MPI_ADDRESS_KIND) MPI_AINT_ADD(BASE, DISP)
    INTEGER(KIND=MPI_ADDRESS_KIND) BASE, DISP

INTEGER(KIND=MPI_ADDRESS_KIND) MPI_AINT_DIFF(ADDR1, ADDR2)
    INTEGER(KIND=MPI_ADDRESS_KIND) ADDR1, ADDR2

MPI_GET_ADDRESS(LOCATION, ADDRESS, IERROR)
    <type> LOCATION(*)
    INTEGER(KIND=MPI_ADDRESS_KIND) ADDRESS
    INTEGER IERROR

MPI_PACK(INBUF, INCOUNT, DATATYPE, OUTBUF, OUTSIZE, POSITION, COMM, IERROR)
    <type> INBUF(*), OUTBUF(*)
    INTEGER INCOUNT, DATATYPE, OUTSIZE, POSITION, COMM, IERROR

MPI_PACK_EXTERNAL(DATAREP, INBUF, INCOUNT, DATATYPE, OUTBUF, OUTSIZE,
    POSITION, IERROR)
    CHARACTER(*) DATAREP
    <type> INBUF(*), OUTBUF(*)
    INTEGER INCOUNT, DATATYPE, IERROR
    INTEGER(KIND=MPI_ADDRESS_KIND) OUTSIZE, POSITION

MPI_PACK_EXTERNAL_SIZE(DATAREP, INCOUNT, DATATYPE, SIZE, IERROR)
    CHARACTER(*) DATAREP
    INTEGER INCOUNT, DATATYPE, IERROR
    INTEGER(KIND=MPI_ADDRESS_KIND) SIZE

MPI_PACK_SIZE(INCOUNT, DATATYPE, COMM, SIZE, IERROR)
    INTEGER INCOUNT, DATATYPE, COMM, SIZE, IERROR

MPI_TYPE_COMMIT(DATATYPE, IERROR)
    INTEGER DATATYPE, IERROR

MPI_TYPE_CONTIGUOUS(COUNT, OLDTYPE, NEWTYPE, IERROR)
    INTEGER COUNT, OLDTYPE, NEWTYPE, IERROR

MPI_TYPE_CREATE_DARRAY(SIZE, RANK, NDIMS, ARRAY_OF_GSIZES,
    ARRAY_OF_DISTRIBS, ARRAY_OF_DARGS, ARRAY_OF_PSIZEs, ORDER,
    OLDTYPE, NEWTYPE, IERROR)
    INTEGER SIZE, RANK, NDIMS, ARRAY_OF_GSIZES(*), ARRAY_OF_DISTRIBS(*),
    ARRAY_OF_DARGS(*), ARRAY_OF_PSIZEs(*), ORDER, OLDTYPE, NEWTYPE, IERROR

MPI_TYPE_CREATE_HINDEXED(COUNT, ARRAY_OF_BLOCKLENGTHS,
    ARRAY_OF_DISPLACEMENTS, OLDTYPE, NEWTYPE, IERROR)
    INTEGER COUNT, ARRAY_OF_BLOCKLENGTHS(*), OLDTYPE, NEWTYPE, IERROR
    INTEGER(KIND=MPI_ADDRESS_KIND) ARRAY_OF_DISPLACEMENTS(*)

```

```

1 MPI_TYPE_CREATE_HINDEXED_BLOCK(COUNT, BLOCKLENGTH, ARRAY_OF_DISPLACEMENTS,
2     OLDTYPE, NEWTYPE, IERROR)
3     INTEGER COUNT, BLOCKLENGTH, OLDTYPE, NEWTYPE, IERROR
4     INTEGER(KIND=MPI_ADDRESS_KIND) ARRAY_OF_DISPLACEMENTS(*)
5
6 MPI_TYPE_CREATE_HVECTOR(COUNT, BLOCKLENGTH, STRIDE, OLDTYPE, NEWTYPE,
7     IERROR)
8     INTEGER COUNT, BLOCKLENGTH, OLDTYPE, NEWTYPE, IERROR
9     INTEGER(KIND=MPI_ADDRESS_KIND) STRIDE
10
11 MPI_TYPE_CREATE_INDEXED_BLOCK(COUNT, BLOCKLENGTH, ARRAY_OF_DISPLACEMENTS,
12     OLDTYPE, NEWTYPE, IERROR)
13     INTEGER COUNT, BLOCKLENGTH, ARRAY_OF_DISPLACEMENTS(*), OLDTYPE,
14     NEWTYPE, IERROR
15
16 MPI_TYPE_CREATE_RESIZED(OLDTYPE, LB, EXTENT, NEWTYPE, IERROR)
17     INTEGER OLDTYPE, NEWTYPE, IERROR
18     INTEGER(KIND=MPI_ADDRESS_KIND) LB, EXTENT
19
20 MPI_TYPE_CREATE_STRUCT(COUNT, ARRAY_OF_BLOCKLENGTHS,
21     ARRAY_OF_DISPLACEMENTS, ARRAY_OF_TYPES, NEWTYPE, IERROR)
22     INTEGER COUNT, ARRAY_OF_BLOCKLENGTHS(*), ARRAY_OF_TYPES(*), NEWTYPE,
23     IERROR
24     INTEGER(KIND=MPI_ADDRESS_KIND) ARRAY_OF_DISPLACEMENTS(*)
25
26 MPI_TYPE_CREATE_SUBARRAY(NDIMS, ARRAY_OF_SIZES, ARRAY_OF_SUBSIZES,
27     ARRAY_OF_STARTS, ORDER, OLDTYPE, NEWTYPE, IERROR)
28     INTEGER NDIMS, ARRAY_OF_SIZES(*), ARRAY_OF_SUBSIZES(*),
29     ARRAY_OF_STARTS(*), ORDER, OLDTYPE, NEWTYPE, IERROR
30
31 MPI_TYPE_DUP(OLDTYPE, NEWTYPE, IERROR)
32     INTEGER OLDTYPE, NEWTYPE, IERROR
33
34 MPI_TYPE_FREE(DATATYPE, IERROR)
35     INTEGER DATATYPE, IERROR
36
37 MPI_TYPE_GET_CONTENTS(DATATYPE, MAX_INTEGERS, MAX_ADDRESSES, MAX_DATATYPES,
38     ARRAY_OF_INTEGERS, ARRAY_OF_ADDRESSES, ARRAY_OF_DATATYPES,
39     IERROR)
40     INTEGER DATATYPE, MAX_INTEGERS, MAX_ADDRESSES, MAX_DATATYPES,
41     ARRAY_OF_INTEGERS(*), ARRAY_OF_DATATYPES(*), IERROR
42     INTEGER(KIND=MPI_ADDRESS_KIND) ARRAY_OF_ADDRESSES(*)
43
44 MPI_TYPE_GET_ELEMENTS(STATUS, DATATYPE, COUNT, IERROR)
45     INTEGER STATUS(MPI_STATUS_SIZE), DATATYPE, COUNT, IERROR
46
47 MPI_TYPE_GET_ELEMENTS_X(STATUS, DATATYPE, COUNT, IERROR)
48     INTEGER STATUS(MPI_STATUS_SIZE), DATATYPE, IERROR
49     INTEGER(KIND=MPI_COUNT_KIND) COUNT
50
51 MPI_TYPE_GET_ENVELOPE(DATATYPE, NUM_INTEGERS, NUM_ADDRESSES, NUM_DATATYPES,
52     COMBINER, IERROR)
53     INTEGER DATATYPE, NUM_INTEGERS, NUM_ADDRESSES, NUM_DATATYPES,

```

```

COMBINER, IERROR 1
MPI_TYPE_GET_EXTENT(DATATYPE, LB, EXTENT, IERROR) 2
    INTEGER DATATYPE, IERROR 3
    INTEGER(KIND=MPI_ADDRESS_KIND) LB, EXTENT 4
MPI_TYPE_GET_EXTENT_X(DATATYPE, LB, EXTENT, IERROR) 5
    INTEGER DATATYPE, IERROR 6
    INTEGER(KIND=MPI_COUNT_KIND) LB, EXTENT 7
MPI_TYPE_GET_TRUE_EXTENT(DATATYPE, TRUE_LB, TRUE_EXTENT, IERROR) 8
    INTEGER DATATYPE, IERROR 9
    INTEGER(KIND=MPI_ADDRESS_KIND) TRUE_LB, TRUE_EXTENT 10
MPI_TYPE_GET_TRUE_EXTENT_X(DATATYPE, TRUE_LB, TRUE_EXTENT, IERROR) 11
    INTEGER DATATYPE, IERROR 12
    INTEGER(KIND=MPI_COUNT_KIND) TRUE_LB, TRUE_EXTENT 13
MPI_TYPE_INDEXED(COUNT, ARRAY_OF_BLOCKLENGTHS, ARRAY_OF_DISPLACEMENTS, 14
    OLDTYPE, NEWTYPE, IERROR) 15
    INTEGER COUNT, ARRAY_OF_BLOCKLENGTHS(*), ARRAY_OF_DISPLACEMENTS(*), 16
    OLDTYPE, NEWTYPE, IERROR 17
MPI_TYPE_SIZE(DATATYPE, SIZE, IERROR) 18
    INTEGER DATATYPE, SIZE, IERROR 19
MPI_TYPE_SIZE_X(DATATYPE, SIZE, IERROR) 20
    INTEGER DATATYPE, IERROR 21
    INTEGER(KIND=MPI_COUNT_KIND) SIZE 22
MPI_TYPE_VECTOR(COUNT, BLOCKLENGTH, STRIDE, OLDTYPE, NEWTYPE, IERROR) 23
    INTEGER COUNT, BLOCKLENGTH, STRIDE, OLDTYPE, NEWTYPE, IERROR 24
MPI_UNPACK(INBUF, INSIZE, POSITION, OUTBUF, OUTCOUNT, DATATYPE, COMM, 25
    IERROR) 26
    <type> INBUF(*), OUTBUF(*) 27
    INTEGER INSIZE, POSITION, OUTCOUNT, DATATYPE, COMM, IERROR 28
MPI_UNPACK_EXTERNAL(DATAREP, INBUF, INSIZE, POSITION, OUTBUF, OUTCOUNT, 29
    DATATYPE, IERROR) 30
    CHARACTER*(*) DATAREP 31
    <type> INBUF(*), OUTBUF(*) 32
    INTEGER(KIND=MPI_ADDRESS_KIND) INSIZE, POSITION 33
    INTEGER OUTCOUNT, DATATYPE, IERROR 34

```

#### A.4.3 Collective Communication Fortran Bindings

```

MPI_ALLGATHER(SENDBUF, SENDCOUNT, SENDTYPE, RECVBUFF, RECVCOUNT, RECVTYPE, 42
    COMM, IERROR) 43
    <type> SENDBUF(*), RECVBUFF(*) 44
    INTEGER SENDCOUNT, SENDTYPE, RECVCOUNT, RECVTYPE, COMM, IERROR 45

```

```

1 MPI_ALLGATHERV(SENDBUF, SENDCOUNT, SENDTYPE, RECVBUF, RECVCOUNTS, DISPLS,
2               RECVTYPE, COMM, IERROR)
3     <type> SENDBUF(*), RECVBUF(*)
4     INTEGER SENDCOUNT, SENDTYPE, RECVCOUNTS(*), DISPLS(*), RECVTYPE, COMM,
5     IERROR
6
7 MPI_ALLGATHERV_INIT(SENDBUF, SENDCOUNT, SENDTYPE, RECVBUF, RECVCOUNTS,
8                    DISPLS, RECVTYPE, COMM, INFO, REQUEST, IERROR)
9     <type> SENDBUF(*), RECVBUF(*)
10    INTEGER SENDCOUNT, SENDTYPE, RECVCOUNTS(*), DISPLS(*), RECVTYPE, COMM,
11    INFO, REQUEST, IERROR
12
13 MPI_ALLGATHER_INIT(SENDBUF, SENDCOUNT, SENDTYPE, RECVBUF, RECVCOUNT,
14                  RECVTYPE, COMM, INFO, REQUEST, IERROR)
15    <type> SENDBUF(*), RECVBUF(*)
16    INTEGER SENDCOUNT, SENDTYPE, RECVCOUNT, RECVTYPE, COMM, INFO, REQUEST,
17    IERROR
18
19 MPI_ALLREDUCE(SENDBUF, RECVBUF, COUNT, DATATYPE, OP, COMM, IERROR)
20    <type> SENDBUF(*), RECVBUF(*)
21    INTEGER COUNT, DATATYPE, OP, COMM, IERROR
22
23 MPI_ALLREDUCE_INIT(SENDBUF, RECVBUF, COUNT, DATATYPE, OP, COMM, INFO,
24                   REQUEST, IERROR)
25    <type> SENDBUF(*), RECVBUF(*)
26    INTEGER COUNT, DATATYPE, OP, COMM, INFO, REQUEST, IERROR
27
28 MPI_ALLTOALL(SENDBUF, SENDCOUNT, SENDTYPE, RECVBUF, RECVCOUNT, RECVTYPE,
29             COMM, IERROR)
30    <type> SENDBUF(*), RECVBUF(*)
31    INTEGER SENDCOUNT, SENDTYPE, RECVCOUNT, RECVTYPE, COMM, IERROR
32
33 MPI_ALLTOALLV(SENDBUF, SENDCOUNTS, SDISPLS, SENDTYPE, RECVBUF, RECVCOUNTS,
34              RDISPLS, RECVTYPE, COMM, IERROR)
35    <type> SENDBUF(*), RECVBUF(*)
36    INTEGER SENDCOUNTS(*), SDISPLS(*), SENDTYPE, RECVCOUNTS(*),
37    RDISPLS(*), RECVTYPE, COMM, IERROR
38
39 MPI_ALLTOALLV_INIT(SENDBUF, SENDCOUNTS, SDISPLS, SENDTYPE, RECVBUF,
40                   RECVCOUNTS, RDISPLS, RECVTYPE, COMM, INFO, REQUEST, IERROR)
41    <type> SENDBUF(*), RECVBUF(*)
42    INTEGER SENDCOUNTS(*), SDISPLS(*), SENDTYPE, RECVCOUNTS(*),
43    RDISPLS(*), RECVTYPE, COMM, INFO, REQUEST, IERROR
44
45 MPI_ALLTOALLW(SENDBUF, SENDCOUNTS, SDISPLS, SENDTYPES, RECVBUF, RECVCOUNTS,
46              RDISPLS, RECVTYPES, COMM, IERROR)
47    <type> SENDBUF(*), RECVBUF(*)
48    INTEGER SENDCOUNTS(*), SDISPLS(*), SENDTYPES(*), RECVCOUNTS(*),
49    RDISPLS(*), RECVTYPES(*), COMM, IERROR
50
51 MPI_ALLTOALLW_INIT(SENDBUF, SENDCOUNTS, SDISPLS, SENDTYPES, RECVBUF,
52                   RECVCOUNTS, RDISPLS, RECVTYPES, COMM, INFO, REQUEST, IERROR)

```

```

    <type> SENDBUF(*), RECVBUF(*)
    INTEGER SENDCOUNTS(*), SDISPLS(*), SENDTYPES(*), RECVCOUNTS(*),
    RDISPLS(*), RECVTYPES(*), COMM, INFO, REQUEST, IERROR
MPI_ALLTOALL_INIT(SENDBUF, SENDCOUNT, SENDTYPE, RECVBUF, RECVCOUNT,
    RECVTYPE, COMM, INFO, REQUEST, IERROR)
    <type> SENDBUF(*), RECVBUF(*)
    INTEGER SENDCOUNT, SENDTYPE, RECVCOUNT, RECVTYPE, COMM, INFO, REQUEST,
    IERROR
MPI_BARRIER(COMM, IERROR)
    INTEGER COMM, IERROR
MPI_BARRIER_INIT(COMM, INFO, REQUEST, IERROR)
    INTEGER COMM, INFO, REQUEST, IERROR
MPI_BCAST(BUFFER, COUNT, DATATYPE, ROOT, COMM, IERROR)
    <type> BUFFER(*)
    INTEGER COUNT, DATATYPE, ROOT, COMM, IERROR
MPI_BCAST_INIT(BUFFER, COUNT, DATATYPE, ROOT, COMM, INFO, REQUEST, IERROR)
    <type> BUFFER(*)
    INTEGER COUNT, DATATYPE, ROOT, COMM, INFO, REQUEST, IERROR
MPI_EXSCAN(SENDBUF, RECVBUF, COUNT, DATATYPE, OP, COMM, IERROR)
    <type> SENDBUF(*), RECVBUF(*)
    INTEGER COUNT, DATATYPE, OP, COMM, IERROR
MPI_EXSCAN_INIT(SENDBUF, RECVBUF, COUNT, DATATYPE, OP, COMM, INFO, REQUEST,
    IERROR)
    <type> SENDBUF(*), RECVBUF(*)
    INTEGER COUNT, DATATYPE, OP, COMM, INFO, REQUEST, IERROR
MPI_GATHER(SENDBUF, SENDCOUNT, SENDTYPE, RECVBUF, RECVCOUNT, RECVTYPE,
    ROOT, COMM, IERROR)
    <type> SENDBUF(*), RECVBUF(*)
    INTEGER SENDCOUNT, SENDTYPE, RECVCOUNT, RECVTYPE, ROOT, COMM, IERROR
MPI_GATHERV(SENDBUF, SENDCOUNT, SENDTYPE, RECVBUF, RECVCOUNTS, DISPLS,
    RECVTYPE, ROOT, COMM, IERROR)
    <type> SENDBUF(*), RECVBUF(*)
    INTEGER SENDCOUNT, SENDTYPE, RECVCOUNTS(*), DISPLS(*), RECVTYPE, ROOT,
    COMM, IERROR
MPI_GATHERV_INIT(SENDBUF, SENDCOUNT, SENDTYPE, RECVBUF, RECVCOUNTS, DISPLS,
    RECVTYPE, ROOT, COMM, INFO, REQUEST, IERROR)
    <type> SENDBUF(*), RECVBUF(*)
    INTEGER SENDCOUNT, SENDTYPE, RECVCOUNTS(*), DISPLS(*), RECVTYPE, ROOT,
    COMM, INFO, REQUEST, IERROR
MPI_GATHER_INIT(SENDBUF, SENDCOUNT, SENDTYPE, RECVBUF, RECVCOUNT, RECVTYPE,
    ROOT, COMM, INFO, REQUEST, IERROR)
    <type> SENDBUF(*), RECVBUF(*)

```

```

1     INTEGER SENDCOUNT, SENDTYPE, RECVCOUNT, RECVMYPE, ROOT, COMM, INFO,
2     REQUEST, IERROR
3
4     MPI_IALLGATHER(SENDBUF, SENDCOUNT, SENDTYPE, RECVBUF, RECVCOUNT, RECVMYPE,
5         COMM, REQUEST, IERROR)
6     <type> SENDBUF(*), RECVBUF(*)
7     INTEGER SENDCOUNT, SENDTYPE, RECVCOUNT, RECVMYPE, COMM, REQUEST,
8     IERROR
9
10    MPI_IALLGATHERV(SENDBUF, SENDCOUNT, SENDTYPE, RECVBUF, RECVCOUNTS, DISPLS,
11        RECVMYPE, COMM, REQUEST, IERROR)
12    <type> SENDBUF(*), RECVBUF(*)
13    INTEGER SENDCOUNT, SENDTYPE, RECVCOUNTS(*), DISPLS(*), RECVMYPE, COMM,
14    REQUEST, IERROR
15
16    MPI_IALLREDUCE(SENDBUF, RECVBUF, COUNT, DATATYPE, OP, COMM, REQUEST,
17        IERROR)
18    <type> SENDBUF(*), RECVBUF(*)
19    INTEGER COUNT, DATATYPE, OP, COMM, REQUEST, IERROR
20
21    MPI_IALLTOALL(SENDBUF, SENDCOUNT, SENDTYPE, RECVBUF, RECVCOUNT, RECVMYPE,
22        COMM, REQUEST, IERROR)
23    <type> SENDBUF(*), RECVBUF(*)
24    INTEGER SENDCOUNT, SENDTYPE, RECVCOUNT, RECVMYPE, COMM, REQUEST,
25    IERROR
26
27    MPI_IALLTOALLV(SENDBUF, SENDCOUNTS, SDISPLS, SENDTYPE, RECVBUF, RECVCOUNTS,
28        RDISPLS, RECVMYPE, COMM, REQUEST, IERROR)
29    <type> SENDBUF(*), RECVBUF(*)
30    INTEGER SENDCOUNTS(*), SDISPLS(*), SENDTYPE, RECVCOUNTS(*),
31    RDISPLS(*), RECVMYPE, COMM, REQUEST, IERROR
32
33    MPI_IALLTOALLW(SENDBUF, SENDCOUNTS, SDISPLS, SENDTYPES, RECVBUF,
34        RECVCOUNTS, RDISPLS, RECVMYPES, COMM, REQUEST, IERROR)
35    <type> SENDBUF(*), RECVBUF(*)
36    INTEGER SENDCOUNTS(*), SDISPLS(*), SENDTYPES(*), RECVCOUNTS(*),
37    RDISPLS(*), RECVMYPES(*), COMM, REQUEST, IERROR
38
39    MPI_IBARRIER(COMM, REQUEST, IERROR)
40    INTEGER COMM, REQUEST, IERROR
41
42    MPI_IBCAST(BUFFER, COUNT, DATATYPE, ROOT, COMM, REQUEST, IERROR)
43    <type> BUFFER(*)
44    INTEGER COUNT, DATATYPE, ROOT, COMM, REQUEST, IERROR
45
46    MPI_IEXSCAN(SENDBUF, RECVBUF, COUNT, DATATYPE, OP, COMM, REQUEST, IERROR)
47    <type> SENDBUF(*), RECVBUF(*)
48    INTEGER COUNT, DATATYPE, OP, COMM, REQUEST, IERROR
49
50    MPI_IGATHER(SENDBUF, SENDCOUNT, SENDTYPE, RECVBUF, RECVCOUNT, RECVMYPE,
51        ROOT, COMM, REQUEST, IERROR)
52    <type> SENDBUF(*), RECVBUF(*)

```



```

    INTEGER SENDCOUNT, SENDTYPE, RECVCOUNT, RECVTYPE, ROOT, COMM, REQUEST,
    IERROR
1
2
3
MPI_IGATHERV(SENDBUF, SENDCOUNT, SENDTYPE, RECVBUF, RECVCOUNTS, DISPLS,
4
5
6
7
8
9
10
11
12
13
14
15
16
17
18
19
20
21
22
23
24
25
26
27
28
29
30
31
32
33
34
35
36
37
38
39
40
41
42
43
44
45
46
47
48
MPI_IGATHERV(SENDBUF, SENDCOUNT, SENDTYPE, RECVBUF, RECVCOUNTS, DISPLS,
    RECVTYPE, ROOT, COMM, REQUEST, IERROR)
    <type> SENDBUF(*), RECVBUF(*)
    INTEGER SENDCOUNT, SENDTYPE, RECVCOUNTS(*), DISPLS(*), RECVTYPE, ROOT,
    COMM, REQUEST, IERROR

MPI_IREDUCE(SENDBUF, RECVBUF, COUNT, DATATYPE, OP, ROOT, COMM, REQUEST,
    IERROR)
    <type> SENDBUF(*), RECVBUF(*)
    INTEGER COUNT, DATATYPE, OP, ROOT, COMM, REQUEST, IERROR

MPI_IREDUCE_SCATTER(SENDBUF, RECVBUF, RECVCOUNTS, DATATYPE, OP, COMM,
    REQUEST, IERROR)
    <type> SENDBUF(*), RECVBUF(*)
    INTEGER RECVCOUNTS(*), DATATYPE, OP, COMM, REQUEST, IERROR

MPI_IREDUCE_SCATTER_BLOCK(SENDBUF, RECVBUF, RECVCOUNT, DATATYPE, OP, COMM,
    REQUEST, IERROR)
    <type> SENDBUF(*), RECVBUF(*)
    INTEGER RECVCOUNT, DATATYPE, OP, COMM, REQUEST, IERROR

MPI_ISCAN(SENDBUF, RECVBUF, COUNT, DATATYPE, OP, COMM, REQUEST, IERROR)
    <type> SENDBUF(*), RECVBUF(*)
    INTEGER COUNT, DATATYPE, OP, COMM, REQUEST, IERROR

MPI_ISCATTER(SENDBUF, SENDCOUNT, SENDTYPE, RECVBUF, RECVCOUNT, RECVTYPE,
    ROOT, COMM, REQUEST, IERROR)
    <type> SENDBUF(*), RECVBUF(*)
    INTEGER SENDCOUNT, SENDTYPE, RECVCOUNT, RECVTYPE, ROOT, COMM, REQUEST,
    IERROR

MPI_ISCATTERV(SENDBUF, SENDCOUNTS, DISPLS, SENDTYPE, RECVBUF, RECVCOUNT,
    RECVTYPE, ROOT, COMM, REQUEST, IERROR)
    <type> SENDBUF(*), RECVBUF(*)
    INTEGER SENDCOUNTS(*), DISPLS(*), SENDTYPE, RECVCOUNT, RECVTYPE, ROOT,
    COMM, REQUEST, IERROR

MPI_OP_COMMUTATIVE(OP, COMMUTE, IERROR)
    INTEGER OP, IERROR
    LOGICAL COMMUTE

MPI_OP_CREATE(USER_FN, COMMUTE, OP, IERROR)
    EXTERNAL USER_FN
    LOGICAL COMMUTE
    INTEGER OP, IERROR

MPI_OP_FREE(OP, IERROR)
    INTEGER OP, IERROR

MPI_REDUCE(SENDBUF, RECVBUF, COUNT, DATATYPE, OP, ROOT, COMM, IERROR)

```

```

1     <type> SENDBUF(*), RECVBUF(*)
2     INTEGER COUNT, DATATYPE, OP, ROOT, COMM, IERROR
3
4     MPI_REDUCE_INIT(SENDBUF, RECVBUF, COUNT, DATATYPE, OP, ROOT, COMM, INFO,
5         REQUEST, IERROR)
6     <type> SENDBUF(*), RECVBUF(*)
7     INTEGER COUNT, DATATYPE, OP, ROOT, COMM, INFO, REQUEST, IERROR
8
9     MPI_REDUCE_LOCAL(INBUF, INOUTBUF, COUNT, DATATYPE, OP, IERROR)
10    <type> INBUF(*), INOUTBUF(*)
11    INTEGER COUNT, DATATYPE, OP, IERROR
12
13    MPI_REDUCE_SCATTER(SENDBUF, RECVBUF, RECVCOUNTS, DATATYPE, OP, COMM,
14        IERROR)
15    <type> SENDBUF(*), RECVBUF(*)
16    INTEGER RECVCOUNTS(*), DATATYPE, OP, COMM, IERROR
17
18    MPI_REDUCE_SCATTER_BLOCK(SENDBUF, RECVBUF, RECVCOUNT, DATATYPE, OP, COMM,
19        IERROR)
20    <type> SENDBUF(*), RECVBUF(*)
21    INTEGER RECVCOUNT, DATATYPE, OP, COMM, IERROR
22
23    MPI_REDUCE_SCATTER_BLOCK_INIT(SENDBUF, RECVBUF, RECVCOUNT, DATATYPE, OP,
24        COMM, INFO, REQUEST, IERROR)
25    <type> SENDBUF(*), RECVBUF(*)
26    INTEGER RECVCOUNT, DATATYPE, OP, COMM, INFO, REQUEST, IERROR
27
28    MPI_REDUCE_SCATTER_INIT(SENDBUF, RECVBUF, RECVCOUNTS, DATATYPE, OP, COMM,
29        INFO, REQUEST, IERROR)
30    <type> SENDBUF(*), RECVBUF(*)
31    INTEGER RECVCOUNTS(*), DATATYPE, OP, COMM, INFO, REQUEST, IERROR
32
33    MPI_SCAN(SENDBUF, RECVBUF, COUNT, DATATYPE, OP, COMM, IERROR)
34    <type> SENDBUF(*), RECVBUF(*)
35    INTEGER COUNT, DATATYPE, OP, COMM, IERROR
36
37    MPI_SCAN_INIT(SENDBUF, RECVBUF, COUNT, DATATYPE, OP, COMM, INFO, REQUEST,
38        IERROR)
39    <type> SENDBUF(*), RECVBUF(*)
40    INTEGER COUNT, DATATYPE, OP, COMM, INFO, REQUEST, IERROR
41
42    MPI_SCATTER(SENDBUF, SENDCOUNT, SENDTYPE, RECVBUF, RECVCOUNT, RECVTYPE,
43        ROOT, COMM, IERROR)
44    <type> SENDBUF(*), RECVBUF(*)
45    INTEGER SENDCOUNT, SENDTYPE, RECVCOUNT, RECVTYPE, ROOT, COMM, IERROR
46
47    MPI_SCATTERV(SENDBUF, SENDCOUNTS, DISPLS, SENDTYPE, RECVBUF, RECVCOUNT,
48        RECVTYPE, ROOT, COMM, IERROR)
49    <type> SENDBUF(*), RECVBUF(*)
50    INTEGER SENDCOUNTS(*), DISPLS(*), SENDTYPE, RECVCOUNT, RECVTYPE, ROOT,
51    COMM, IERROR
52
53    MPI_SCATTERV_INIT(SENDBUF, SENDCOUNTS, DISPLS, SENDTYPE, RECVBUF,
54        RECVTYPE, ROOT, COMM, INFO, REQUEST, IERROR)
55    <type> SENDBUF(*), RECVBUF(*)
56    INTEGER SENDCOUNTS(*), DISPLS(*), SENDTYPE, RECVCOUNT, RECVTYPE, ROOT,
57    COMM, INFO, REQUEST, IERROR

```

```

    RECVCOUNT, RECVTYPE, ROOT, COMM, INFO, REQUEST, IERROR)      1
    <type> SENDBUF(*), RECVBUF(*)                                  2
    INTEGER SENDCOUNTS(*), DISPLS(*), SENDTYPE, RECVCOUNT, RECVTYPE, ROOT,  3
    COMM, INFO, REQUEST, IERROR                                  4
                                                                5
MPI_SCATTER_INIT(SENDBUF, SENDCOUNT, SENDTYPE, RECVBUF, RECVCOUNT,  6
    RECVTYPE, ROOT, COMM, INFO, REQUEST, IERROR)                7
    <type> SENDBUF(*), RECVBUF(*)                                  8
    INTEGER SENDCOUNT, SENDTYPE, RECVCOUNT, RECVTYPE, ROOT, INFO,  9
    REQUEST, IERROR                                             10
                                                                11
A.4.4 Groups, Contexts, Communicators, and Caching Fortran Bindings 12
                                                                13
MPI_COMM_COMPARE(COMM1, COMM2, RESULT, IERROR)                  14
    INTEGER COMM1, COMM2, RESULT, IERROR                        15
                                                                16
MPI_COMM_CREATE(COMM, GROUP, NEWCOMM, IERROR)                  17
    INTEGER COMM, GROUP, NEWCOMM, IERROR                        18
                                                                19
MPI_COMM_CREATE_FROM_GROUP(GROUP, STRINGTAG, INFO, ERRHANDLER, NEWCOMM,  19
    IERROR)                                                     20
    INTEGER GROUP, INFO, ERRHANDLER, NEWCOMM, IERROR           21
    CHARACTER*(*) STRINGTAG                                     22
                                                                23
MPI_COMM_CREATE_GROUP(COMM, GROUP, TAG, NEWCOMM, IERROR)       24
    INTEGER COMM, GROUP, TAG, NEWCOMM, IERROR                  25
                                                                26
MPI_COMM_CREATE_KEYVAL(COMM_COPY_ATTR_FN, COMM_DELETE_ATTR_FN, COMM_KEYVAL,  26
    EXTRA_STATE, IERROR)                                       27
    EXTERNAL COMM_COPY_ATTR_FN, COMM_DELETE_ATTR_FN            28
    INTEGER COMM_KEYVAL, IERROR                                 29
    INTEGER(KIND=MPI_ADDRESS_KIND) EXTRA_STATE                 30
                                                                31
MPI_COMM_DELETE_ATTR(COMM, COMM_KEYVAL, IERROR)                 32
    INTEGER COMM, COMM_KEYVAL, IERROR                           33
                                                                34
MPI_COMM_DUP(COMM, NEWCOMM, IERROR)                             34
    INTEGER COMM, NEWCOMM, IERROR                               35
                                                                36
MPI_COMM_DUP_FN(OLDCOMM, COMM_KEYVAL, EXTRA_STATE, ATTRIBUTE_VAL_IN,  37
    ATTRIBUTE_VAL_OUT, FLAG, IERROR)                             38
    INTEGER OLDCOMM, COMM_KEYVAL, IERROR                        39
    INTEGER(KIND=MPI_ADDRESS_KIND) EXTRA_STATE, ATTRIBUTE_VAL_IN,  40
    ATTRIBUTE_VAL_OUT                                           41
    LOGICAL FLAG                                               42
                                                                43
MPI_COMM_DUP_WITH_INFO(COMM, INFO, NEWCOMM, IERROR)            43
    INTEGER COMM, INFO, NEWCOMM, IERROR                         44
                                                                45
MPI_COMM_FREE(COMM, IERROR)                                     46
    INTEGER COMM, IERROR                                        47
                                                                48
MPI_COMM_FREE_KEYVAL(COMM_KEYVAL, IERROR)

```

```
1     INTEGER COMM_KEYVAL, IERROR
2
3     MPI_COMM_GET_ATTR(COMM, COMM_KEYVAL, ATTRIBUTE_VAL, FLAG, IERROR)
4         INTEGER COMM, COMM_KEYVAL, IERROR
5         INTEGER(KIND=MPI_ADDRESS_KIND) ATTRIBUTE_VAL
6         LOGICAL FLAG
7
8     MPI_COMM_GET_INFO(COMM, INFO_USED, IERROR)
9         INTEGER COMM, INFO_USED, IERROR
10
11    MPI_COMM_GET_NAME(COMM, COMM_NAME, RESULTLEN, IERROR)
12        INTEGER COMM, RESULTLEN, IERROR
13        CHARACTER*(*) COMM_NAME
14
15    MPI_COMM_GROUP(COMM, GROUP, IERROR)
16        INTEGER COMM, GROUP, IERROR
17
18    MPI_COMM_IDUP(COMM, NEWCOMM, REQUEST, IERROR)
19        INTEGER COMM, NEWCOMM, REQUEST, IERROR
20
21    MPI_COMM_IDUP_WITH_INFO(COMM, INFO, NEWCOMM, REQUEST, IERROR)
22        INTEGER COMM, INFO, NEWCOMM, REQUEST, IERROR
23
24    MPI_COMM_NULL_COPY_FN(OLDCOMM, COMM_KEYVAL, EXTRA_STATE, ATTRIBUTE_VAL_IN,
25        ATTRIBUTE_VAL_OUT, FLAG, IERROR)
26        INTEGER OLDCOMM, COMM_KEYVAL, IERROR
27        INTEGER(KIND=MPI_ADDRESS_KIND) EXTRA_STATE, ATTRIBUTE_VAL_IN,
28        ATTRIBUTE_VAL_OUT
29        LOGICAL FLAG
30
31    MPI_COMM_NULL_DELETE_FN(COMM, COMM_KEYVAL, ATTRIBUTE_VAL, EXTRA_STATE,
32        IERROR)
33        INTEGER COMM, COMM_KEYVAL, IERROR
34        INTEGER(KIND=MPI_ADDRESS_KIND) ATTRIBUTE_VAL, EXTRA_STATE
35
36    MPI_COMM_RANK(COMM, RANK, IERROR)
37        INTEGER COMM, RANK, IERROR
38
39    MPI_COMM_REMOTE_GROUP(COMM, GROUP, IERROR)
40        INTEGER COMM, GROUP, IERROR
41
42    MPI_COMM_REMOTE_SIZE(COMM, SIZE, IERROR)
43        INTEGER COMM, SIZE, IERROR
44
45    MPI_COMM_SET_ATTR(COMM, COMM_KEYVAL, ATTRIBUTE_VAL, IERROR)
46        INTEGER COMM, COMM_KEYVAL, IERROR
47        INTEGER(KIND=MPI_ADDRESS_KIND) ATTRIBUTE_VAL
48
49    MPI_COMM_SET_INFO(COMM, INFO, IERROR)
50        INTEGER COMM, INFO, IERROR
51
52    MPI_COMM_SET_NAME(COMM, COMM_NAME, IERROR)
53        INTEGER COMM, IERROR
54        CHARACTER*(*) COMM_NAME
```

MPI_COMM_SIZE(COMM, SIZE, IERROR)	1
INTEGER COMM, SIZE, IERROR	2
	3
MPI_COMM_SPLIT(COMM, COLOR, KEY, NEWCOMM, IERROR)	4
INTEGER COMM, COLOR, KEY, NEWCOMM, IERROR	5
	6
MPI_COMM_SPLIT_TYPE(COMM, SPLIT_TYPE, KEY, INFO, NEWCOMM, IERROR)	7
INTEGER COMM, SPLIT_TYPE, KEY, INFO, NEWCOMM, IERROR	8
	9
MPI_COMM_TEST_INTER(COMM, FLAG, IERROR)	10
INTEGER COMM, IERROR	11
LOGICAL FLAG	12
	13
MPI_GROUP_COMPARE(GROUP1, GROUP2, RESULT, IERROR)	14
INTEGER GROUP1, GROUP2, RESULT, IERROR	15
	16
MPI_GROUP_DIFFERENCE(GROUP1, GROUP2, NEWGROUP, IERROR)	17
INTEGER GROUP1, GROUP2, NEWGROUP, IERROR	18
	19
MPI_GROUP_EXCL(GROUP, N, RANKS, NEWGROUP, IERROR)	20
INTEGER GROUP, N, RANKS(*), NEWGROUP, IERROR	21
	22
MPI_GROUP_FREE(GROUP, IERROR)	23
INTEGER GROUP, IERROR	24
	25
MPI_GROUP_FROM_SESSION_PSET(SESSION, PSET_NAME, NEWGROUP, IERROR)	26
INTEGER SESSION, NEWGROUP, IERROR	27
CHARACTER*(*) PSET_NAME	28
	29
MPI_GROUP_INCL(GROUP, N, RANKS, NEWGROUP, IERROR)	30
INTEGER GROUP, N, RANKS(*), NEWGROUP, IERROR	31
	32
MPI_GROUP_INTERSECTION(GROUP1, GROUP2, NEWGROUP, IERROR)	33
INTEGER GROUP1, GROUP2, NEWGROUP, IERROR	34
	35
MPI_GROUP_RANGE_EXCL(GROUP, N, RANGES, NEWGROUP, IERROR)	36
INTEGER GROUP, N, RANGES(3, *), NEWGROUP, IERROR	37
	38
MPI_GROUP_RANGE_INCL(GROUP, N, RANGES, NEWGROUP, IERROR)	39
INTEGER GROUP, N, RANGES(3, *), NEWGROUP, IERROR	40
	41
MPI_GROUP_RANK(GROUP, RANK, IERROR)	42
INTEGER GROUP, RANK, IERROR	43
	44
MPI_GROUP_SIZE(GROUP, SIZE, IERROR)	45
INTEGER GROUP, SIZE, IERROR	46
	47
MPI_GROUP_TRANSLATE_RANKS(GROUP1, N, RANKS1, GROUP2, RANKS2, IERROR)	48
INTEGER GROUP1, N, RANKS1(*), GROUP2, RANKS2(*), IERROR	
MPI_GROUP_UNION(GROUP1, GROUP2, NEWGROUP, IERROR)	
INTEGER GROUP1, GROUP2, NEWGROUP, IERROR	
MPI_INTERCOMM_CREATE(LOCAL_COMM, LOCAL_LEADER, PEER_COMM, REMOTE_LEADER, TAG, NEWINTERCOMM, IERROR)	

```

1     INTEGER LOCAL_COMM, LOCAL_LEADER, PEER_COMM, REMOTE_LEADER, TAG,
2     NEWINTERCOMM, IERROR
3
4     MPI_INTERCOMM_CREATE_FROM_GROUPS(LOCAL_GROUP, LOCAL_LEADER, REMOTE_GROUP,
5         REMOTE_LEADER, STRINGTAG, INFO, ERRHANDLER, NEWINTERCOMM,
6         IERROR)
7     INTEGER LOCAL_GROUP, LOCAL_LEADER, REMOTE_GROUP, REMOTE_LEADER, INFO,
8     ERRHANDLER, NEWINTERCOMM, IERROR
9     CHARACTER*(*) STRINGTAG
10
11    MPI_INTERCOMM_MERGE(INTERCOMM, HIGH, NEWINTRACOMM, IERROR)
12    INTEGER INTERCOMM, NEWINTRACOMM, IERROR
13    LOGICAL HIGH
14
15    MPI_TYPE_CREATE_KEYVAL(TYPE_COPY_ATTR_FN, TYPE_DELETE_ATTR_FN, TYPE_KEYVAL,
16        EXTRA_STATE, IERROR)
17    EXTERNAL TYPE_COPY_ATTR_FN, TYPE_DELETE_ATTR_FN
18    INTEGER TYPE_KEYVAL, IERROR
19    INTEGER(KIND=MPI_ADDRESS_KIND) EXTRA_STATE
20
21    MPI_TYPE_DELETE_ATTR(DATATYPE, TYPE_KEYVAL, IERROR)
22    INTEGER DATATYPE, TYPE_KEYVAL, IERROR
23
24    MPI_TYPE_DUP_FN(OLDTYPE, TYPE_KEYVAL, EXTRA_STATE, ATTRIBUTE_VAL_IN,
25        ATTRIBUTE_VAL_OUT, FLAG, IERROR)
26    INTEGER OLDTYPE, TYPE_KEYVAL, IERROR
27    INTEGER(KIND=MPI_ADDRESS_KIND) EXTRA_STATE, ATTRIBUTE_VAL_IN,
28    ATTRIBUTE_VAL_OUT
29    LOGICAL FLAG
30
31    MPI_TYPE_FREE_KEYVAL(TYPE_KEYVAL, IERROR)
32    INTEGER TYPE_KEYVAL, IERROR
33
34    MPI_TYPE_GET_ATTR(DATATYPE, TYPE_KEYVAL, ATTRIBUTE_VAL, FLAG, IERROR)
35    INTEGER DATATYPE, TYPE_KEYVAL, IERROR
36    INTEGER(KIND=MPI_ADDRESS_KIND) ATTRIBUTE_VAL
37    LOGICAL FLAG
38
39    MPI_TYPE_GET_NAME(DATATYPE, TYPE_NAME, RESULTLEN, IERROR)
40    INTEGER DATATYPE, RESULTLEN, IERROR
41    CHARACTER*(*) TYPE_NAME
42
43    MPI_TYPE_NULL_COPY_FN(OLDTYPE, TYPE_KEYVAL, EXTRA_STATE, ATTRIBUTE_VAL_IN,
44        ATTRIBUTE_VAL_OUT, FLAG, IERROR)
45    INTEGER OLDTYPE, TYPE_KEYVAL, IERROR
46    INTEGER(KIND=MPI_ADDRESS_KIND) EXTRA_STATE, ATTRIBUTE_VAL_IN,
47    ATTRIBUTE_VAL_OUT
48    LOGICAL FLAG
49
50    MPI_TYPE_NULL_DELETE_FN(DATATYPE, TYPE_KEYVAL, ATTRIBUTE_VAL, EXTRA_STATE,
51        IERROR)
52    INTEGER DATATYPE, TYPE_KEYVAL, IERROR

```

```

    INTEGER(KIND=MPI_ADDRESS_KIND) ATTRIBUTE_VAL, EXTRA_STATE           1
MPI_TYPE_SET_ATTR(DATATYPE, TYPE_KEYVAL, ATTRIBUTE_VAL, IERROR)       2
    INTEGER DATATYPE, TYPE_KEYVAL, IERROR                             3
    INTEGER(KIND=MPI_ADDRESS_KIND) ATTRIBUTE_VAL                       4
MPI_TYPE_SET_NAME(DATATYPE, TYPE_NAME, IERROR)                         5
    INTEGER DATATYPE, IERROR                                          6
    CHARACTER*(*) TYPE_NAME                                          7
MPI_WIN_CREATE_KEYVAL(WIN_COPY_ATTR_FN, WIN_DELETE_ATTR_FN, WIN_KEYVAL, 8
    EXTRA_STATE, IERROR)                                           9
    EXTERNAL WIN_COPY_ATTR_FN, WIN_DELETE_ATTR_FN                   10
    INTEGER WIN_KEYVAL, IERROR                                       11
    INTEGER(KIND=MPI_ADDRESS_KIND) EXTRA_STATE                       12
MPI_WIN_DELETE_ATTR(WIN, WIN_KEYVAL, IERROR)                           13
    INTEGER WIN, WIN_KEYVAL, IERROR                                  14
MPI_WIN_DUP_FN(OLDWIN, WIN_KEYVAL, EXTRA_STATE, ATTRIBUTE_VAL_IN,     15
    ATTRIBUTE_VAL_OUT, FLAG, IERROR)                                  16
    INTEGER OLDWIN, WIN_KEYVAL, IERROR                                17
    INTEGER(KIND=MPI_ADDRESS_KIND) EXTRA_STATE, ATTRIBUTE_VAL_IN,   18
    ATTRIBUTE_VAL_OUT                                               19
    LOGICAL FLAG                                                    20
MPI_WIN_FREE_KEYVAL(WIN_KEYVAL, IERROR)                                21
    INTEGER WIN_KEYVAL, IERROR                                       22
MPI_WIN_GET_ATTR(WIN, WIN_KEYVAL, ATTRIBUTE_VAL, FLAG, IERROR)        23
    INTEGER WIN, WIN_KEYVAL, IERROR                                  24
    INTEGER(KIND=MPI_ADDRESS_KIND) ATTRIBUTE_VAL                     25
    LOGICAL FLAG                                                    26
MPI_WIN_GET_NAME(WIN, WIN_NAME, RESULTLEN, IERROR)                    27
    INTEGER WIN, RESULTLEN, IERROR                                   28
    CHARACTER*(*) WIN_NAME                                          29
MPI_WIN_NULL_COPY_FN(OLDWIN, WIN_KEYVAL, EXTRA_STATE, ATTRIBUTE_VAL_IN, 30
    ATTRIBUTE_VAL_OUT, FLAG, IERROR)                                  31
    INTEGER OLDWIN, WIN_KEYVAL, IERROR                                32
    INTEGER(KIND=MPI_ADDRESS_KIND) EXTRA_STATE, ATTRIBUTE_VAL_IN,   33
    ATTRIBUTE_VAL_OUT                                               34
    LOGICAL FLAG                                                    35
MPI_WIN_NULL_DELETE_FN(WIN, WIN_KEYVAL, ATTRIBUTE_VAL, EXTRA_STATE, IERROR) 36
    INTEGER WIN, WIN_KEYVAL, IERROR                                  37
    INTEGER(KIND=MPI_ADDRESS_KIND) ATTRIBUTE_VAL, EXTRA_STATE       38
MPI_WIN_SET_ATTR(WIN, WIN_KEYVAL, ATTRIBUTE_VAL, IERROR)              39
    INTEGER WIN, WIN_KEYVAL, IERROR                                  40
    INTEGER(KIND=MPI_ADDRESS_KIND) ATTRIBUTE_VAL                     41

```

```

1 MPI_WIN_SET_NAME(WIN, WIN_NAME, IERROR)
2     INTEGER WIN, IERROR
3     CHARACTER*(*) WIN_NAME
4
5

```

#### 6 A.4.5 Process Topologies Fortran Bindings

```

7 MPI_CARTDIM_GET(COMM, NDIMS, IERROR)
8     INTEGER COMM, NDIMS, IERROR
9
10 MPI_CART_COORDS(COMM, RANK, MAXDIMS, COORDS, IERROR)
11     INTEGER COMM, RANK, MAXDIMS, COORDS(*), IERROR
12
13 MPI_CART_CREATE(COMM_OLD, NDIMS, DIMS, PERIODS, REORDER, COMM_CART, IERROR)
14     INTEGER COMM_OLD, NDIMS, DIMS(*), COMM_CART, IERROR
15     LOGICAL PERIODS(*), REORDER
16
17 MPI_CART_GET(COMM, MAXDIMS, DIMS, PERIODS, COORDS, IERROR)
18     INTEGER COMM, MAXDIMS, DIMS(*), COORDS(*), IERROR
19     LOGICAL PERIODS(*)
20
21 MPI_CART_MAP(COMM, NDIMS, DIMS, PERIODS, NEWRANK, IERROR)
22     INTEGER COMM, NDIMS, DIMS(*), NEWRANK, IERROR
23     LOGICAL PERIODS(*)
24
25 MPI_CART_RANK(COMM, COORDS, RANK, IERROR)
26     INTEGER COMM, COORDS(*), RANK, IERROR
27
28 MPI_CART_SHIFT(COMM, DIRECTION, DISP, RANK_SOURCE, RANK_DEST, IERROR)
29     INTEGER COMM, DIRECTION, DISP, RANK_SOURCE, RANK_DEST, IERROR
30
31 MPI_CART_SUB(COMM, REMAIN_DIMS, NEWCOMM, IERROR)
32     INTEGER COMM, NEWCOMM, IERROR
33     LOGICAL REMAIN_DIMS(*)
34
35 MPI_DIMS_CREATE(NNODES, NDIMS, DIMS, IERROR)
36     INTEGER NNODES, NDIMS, DIMS(*), IERROR
37
38 MPI_DIST_GRAPH_CREATE(COMM_OLD, N, SOURCES, DEGREES, DESTINATIONS, WEIGHTS,
39     INFO, REORDER, COMM_DIST_GRAPH, IERROR)
40     INTEGER COMM_OLD, N, SOURCES(*), DEGREES(*), DESTINATIONS(*),
41     WEIGHTS(*), INFO, COMM_DIST_GRAPH, IERROR
42     LOGICAL REORDER
43
44 MPI_DIST_GRAPH_CREATE_ADJACENT(COMM_OLD, INDEGREE, SOURCES, SOURCEWEIGHTS,
45     OUTDEGREE, DESTINATIONS, DESTWEIGHTS, INFO, REORDER,
46     COMM_DIST_GRAPH, IERROR)
47     INTEGER COMM_OLD, INDEGREE, SOURCES(*), SOURCEWEIGHTS(*), OUTDEGREE,
48     DESTINATIONS(*), DESTWEIGHTS(*), INFO, COMM_DIST_GRAPH, IERROR
49     LOGICAL REORDER

```



```

    INTEGER COMM, MAXINDEGREE, SOURCES(*), SOURCEWEIGHTS(*), MAXOUTDEGREE,
    DESTINATIONS(*), DESTWEIGHTS(*), IERROR
1
2
3
MPI_DIST_GRAPH_NEIGHBORS_COUNT(COMM, INDEGREE, OUTDEGREE, WEIGHTED, IERROR)
4
    INTEGER COMM, INDEGREE, OUTDEGREE, IERROR
5
    LOGICAL WEIGHTED
6
MPI_GRAPHDIMS_GET(COMM, NNODES, NEDGES, IERROR)
7
    INTEGER COMM, NNODES, NEDGES, IERROR
8
9
MPI_GRAPH_CREATE(COMM_OLD, NNODES, INDEX, EDGES, REORDER, COMM_GRAPH,
10
    IERROR)
11
    INTEGER COMM_OLD, NNODES, INDEX(*), EDGES(*), COMM_GRAPH, IERROR
12
    LOGICAL REORDER
13
MPI_GRAPH_GET(COMM, MAXINDEX, MAXEDGES, INDEX, EDGES, IERROR)
14
    INTEGER COMM, MAXINDEX, MAXEDGES, INDEX(*), EDGES(*), IERROR
15
16
MPI_GRAPH_MAP(COMM, NNODES, INDEX, EDGES, NEWRANK, IERROR)
17
    INTEGER COMM, NNODES, INDEX(*), EDGES(*), NEWRANK, IERROR
18
19
MPI_GRAPH_NEIGHBORS(COMM, RANK, MAXNEIGHBORS, NEIGHBORS, IERROR)
20
    INTEGER COMM, RANK, MAXNEIGHBORS, NEIGHBORS(*), IERROR
21
22
MPI_GRAPH_NEIGHBORS_COUNT(COMM, RANK, NNEIGHBORS, IERROR)
23
    INTEGER COMM, RANK, NNEIGHBORS, IERROR
24
25
MPI_INEIGHBOR_ALLGATHER(SENDBUF, SENDCOUNT, SENDTYPE, RECVBUF, RECVCOUNT,
26
    RECVTYPE, COMM, REQUEST, IERROR)
27
    <type> SENDBUF(*), RECVBUF(*)
28
    INTEGER SENDCOUNT, SENDTYPE, RECVCOUNT, RECVTYPE, COMM, REQUEST,
29
    IERROR
30
31
MPI_INEIGHBOR_ALLGATHERV(SENDBUF, SENDCOUNT, SENDTYPE, RECVBUF, RECVCOUNTS,
32
    DISPLS, RECVTYPE, COMM, REQUEST, IERROR)
33
    <type> SENDBUF(*), RECVBUF(*)
34
    INTEGER SENDCOUNT, SENDTYPE, RECVCOUNTS(*), DISPLS(*), RECVTYPE, COMM,
35
    REQUEST, IERROR
36
37
MPI_INEIGHBOR_ALLTOALL(SENDBUF, SENDCOUNT, SENDTYPE, RECVBUF, RECVCOUNT,
38
    RECVTYPE, COMM, REQUEST, IERROR)
39
    <type> SENDBUF(*), RECVBUF(*)
40
    INTEGER SENDCOUNT, SENDTYPE, RECVCOUNT, RECVTYPE, COMM, REQUEST,
41
    IERROR
42
43
MPI_INEIGHBOR_ALLTOALLV(SENDBUF, SENDCOUNTS, SDISPLS, SENDTYPE, RECVBUF,
44
    RECVCOUNTS, RDISPLS, RECVTYPE, COMM, REQUEST, IERROR)
45
    <type> SENDBUF(*), RECVBUF(*)
46
    INTEGER SENDCOUNTS(*), SDISPLS(*), SENDTYPE, RECVCOUNTS(*),
47
    RDISPLS(*), RECVTYPE, COMM, REQUEST, IERROR
48
49
MPI_INEIGHBOR_ALLTOALLW(SENDBUF, SENDCOUNTS, SDISPLS, SENDTYPES, RECVBUF,
50
    RECVCOUNTS, RDISPLS, RECVTYPES, COMM, REQUEST, IERROR)
51

```

```

1     <type> SENDBUF(*), RECVBUF(*)
2     INTEGER SENDCOUNTS(*), SENDTYPES(*), RECVCOUNTS(*), RECVTYPES(*),
3     COMM, REQUEST, IERROR
4     INTEGER(KIND=MPI_ADDRESS_KIND) SDISPLS(*), RDISPLS(*)
5
6     MPI_NEIGHBOR_ALLGATHER(SENDBUF, SENDCOUNT, SENDTYPE, RECVBUF, RECVCOUNT,
7     RECVTYPE, COMM, IERROR)
8     <type> SENDBUF(*), RECVBUF(*)
9     INTEGER SENDCOUNT, SENDTYPE, RECVCOUNT, RECVTYPE, COMM, IERROR
10
11    MPI_NEIGHBOR_ALLGATHERV(SENDBUF, SENDCOUNT, SENDTYPE, RECVBUF, RECVCOUNTS,
12    DISPLS, RECVTYPE, COMM, IERROR)
13    <type> SENDBUF(*), RECVBUF(*)
14    INTEGER SENDCOUNT, SENDTYPE, RECVCOUNTS(*), DISPLS(*), RECVTYPE, COMM,
15    IERROR
16
17    MPI_NEIGHBOR_ALLGATHERV_INIT(SENDBUF, SENDCOUNT, SENDTYPE, RECVBUF,
18    RECVCOUNTS, DISPLS, RECVTYPE, COMM, INFO, REQUEST, IERROR)
19    <type> SENDBUF(*), RECVBUF(*)
20    INTEGER SENDCOUNT, SENDTYPE, RECVCOUNTS(*), DISPLS(*), RECVTYPE, COMM,
21    INFO, REQUEST, IERROR
22
23    MPI_NEIGHBOR_ALLGATHER_INIT(SENDBUF, SENDCOUNT, SENDTYPE, RECVBUF,
24    RECVCOUNT, RECVTYPE, COMM, INFO, REQUEST, IERROR)
25    <type> SENDBUF(*), RECVBUF(*)
26    INTEGER SENDCOUNT, SENDTYPE, RECVCOUNT, RECVTYPE, COMM, INFO, REQUEST,
27    IERROR
28
29    MPI_NEIGHBOR_ALLTOALL(SENDBUF, SENDCOUNT, SENDTYPE, RECVBUF, RECVCOUNT,
30    RECVTYPE, COMM, IERROR)
31    <type> SENDBUF(*), RECVBUF(*)
32    INTEGER SENDCOUNT, SENDTYPE, RECVCOUNT, RECVTYPE, COMM, IERROR
33
34    MPI_NEIGHBOR_ALLTOALLV(SENDBUF, SENDCOUNTS, SDISPLS, SENDTYPE, RECVBUF,
35    RECVCOUNTS, RDISPLS, RECVTYPE, COMM, IERROR)
36    <type> SENDBUF(*), RECVBUF(*)
37    INTEGER SENDCOUNTS(*), SDISPLS(*), SENDTYPE, RECVCOUNTS(*),
38    RDISPLS(*), RECVTYPE, COMM, IERROR
39
40    MPI_NEIGHBOR_ALLTOALLV_INIT(SENDBUF, SENDCOUNTS, SDISPLS, SENDTYPE,
41    RECVBUF, RECVCOUNTS, RDISPLS, RECVTYPE, COMM, INFO, REQUEST,
42    IERROR)
43    <type> SENDBUF(*), RECVBUF(*)
44    INTEGER SENDCOUNTS(*), SDISPLS(*), SENDTYPE, RECVCOUNTS(*),
45    RDISPLS(*), RECVTYPE, COMM, INFO, REQUEST, IERROR
46
47    MPI_NEIGHBOR_ALLTOALLW(SENDBUF, SENDCOUNTS, SDISPLS, SENDTYPES, RECVBUF,
48    RECVCOUNTS, RDISPLS, RECVTYPES, COMM, IERROR)
49    <type> SENDBUF(*), RECVBUF(*)
50    INTEGER SENDCOUNTS(*), SENDTYPES(*), RECVCOUNTS(*), RECVTYPES(*),
51    COMM, IERROR

```

```

INTEGER(KIND=MPI_ADDRESS_KIND) SDISPLS(*), RDISPLS(*)
MPI_NEIGHBOR_ALLTOALLW_INIT(SENDBUF, SENDCOUNTS, SDISPLS, SENDTYPES,
RECVBUF, RECVCOUNTS, RDISPLS, RECVTYPES, COMM, INFO, REQUEST,
IERROR)
<type> SENDBUF(*), RECVBUF(*)
INTEGER SENDCOUNTS(*), SENDTYPES(*), RECVCOUNTS(*), RECVTYPES(*),
COMM, INFO, REQUEST, IERROR
INTEGER(KIND=MPI_ADDRESS_KIND) SDISPLS(*), RDISPLS(*)
MPI_NEIGHBOR_ALLTOALL_INIT(SENDBUF, SENDCOUNT, SENDTYPE, RECVBUF,
REVCOUNT, RECVTYPE, COMM, INFO, REQUEST, IERROR)
<type> SENDBUF(*), RECVBUF(*)
INTEGER SENDCOUNT, SENDTYPE, REVCOUNT, RECVTYPE, COMM, INFO, REQUEST,
IERROR
MPI_TOPO_TEST(COMM, STATUS, IERROR)
INTEGER COMM, STATUS, IERROR

```

#### A.4.6 MPI Environmental Management Fortran Bindings

```

DOUBLE PRECISION MPI_WTICK()
DOUBLE PRECISION MPI_WTIME()
MPI_ADD_ERROR_CLASS(ERRORCLASS, IERROR)
INTEGER ERRORCLASS, IERROR
MPI_ADD_ERROR_CODE(ERRORCLASS, ERRORCODE, IERROR)
INTEGER ERRORCLASS, ERRORCODE, IERROR
MPI_ADD_ERROR_STRING(ERRORCODE, STRING, IERROR)
INTEGER ERRORCODE, IERROR
CHARACTER*(*) STRING
MPI_ALLOC_MEM(SIZE, INFO, BASEPTR, IERROR)
INTEGER(KIND=MPI_ADDRESS_KIND) SIZE, BASEPTR
INTEGER INFO, IERROR
If the Fortran compiler provides TYPE(C_PTR), then overloaded by:
INTERFACE MPI_ALLOC_MEM
SUBROUTINE MPI_ALLOC_MEM(SIZE, INFO, BASEPTR, IERROR)
IMPORT :: MPI_ADDRESS_KIND
INTEGER :: INFO, IERROR
INTEGER(KIND=MPI_ADDRESS_KIND) :: SIZE, BASEPTR
END SUBROUTINE
SUBROUTINE MPI_ALLOC_MEM_CPTR(SIZE, INFO, BASEPTR, IERROR)
USE, INTRINSIC :: ISO_C_BINDING, ONLY : C_PTR
IMPORT :: MPI_ADDRESS_KIND
INTEGER :: INFO, IERROR
INTEGER(KIND=MPI_ADDRESS_KIND) :: SIZE
TYPE(C_PTR) :: BASEPTR

```

```
1      END SUBROUTINE
2      END INTERFACE
3
4      MPI_COMM_CALL_ERRHANDLER(COMM, ERRORCODE, IERROR)
5          INTEGER COMM, ERRORCODE, IERROR
6
7      MPI_COMM_CREATE_ERRHANDLER(COMM_ERRHANDLER_FN, ERRHANDLER, IERROR)
8          EXTERNAL COMM_ERRHANDLER_FN
9          INTEGER ERRHANDLER, IERROR
10
11     MPI_COMM_GET_ERRHANDLER(COMM, ERRHANDLER, IERROR)
12         INTEGER COMM, ERRHANDLER, IERROR
13
14     MPI_COMM_SET_ERRHANDLER(COMM, ERRHANDLER, IERROR)
15         INTEGER COMM, ERRHANDLER, IERROR
16
17     MPI_ERRHANDLER_FREE(ERRHANDLER, IERROR)
18         INTEGER ERRHANDLER, IERROR
19
20     MPI_ERROR_CLASS(ERRORCODE, ERRORCLASS, IERROR)
21         INTEGER ERRORCODE, ERRORCLASS, IERROR
22
23     MPI_ERROR_STRING(ERRORCODE, STRING, RESULTLEN, IERROR)
24         INTEGER ERRORCODE, RESULTLEN, IERROR
25         CHARACTER*(*) STRING
26
27     MPI_FILE_CALL_ERRHANDLER(FH, ERRORCODE, IERROR)
28         INTEGER FH, ERRORCODE, IERROR
29
30     MPI_FILE_CREATE_ERRHANDLER(FILE_ERRHANDLER_FN, ERRHANDLER, IERROR)
31         EXTERNAL FILE_ERRHANDLER_FN
32         INTEGER ERRHANDLER, IERROR
33
34     MPI_FILE_GET_ERRHANDLER(FILE, ERRHANDLER, IERROR)
35         INTEGER FILE, ERRHANDLER, IERROR
36
37     MPI_FILE_SET_ERRHANDLER(FILE, ERRHANDLER, IERROR)
38         INTEGER FILE, ERRHANDLER, IERROR
39
40     MPI_FREE_MEM(BASE, IERROR)
41         <type> BASE(*)
42         INTEGER IERROR
43
44     MPI_GET_LIBRARY_VERSION(VERSION, RESULTLEN, IERROR)
45         CHARACTER*(*) VERSION
46         INTEGER RESULTLEN, IERROR
47
48     MPI_GET_PROCESSOR_NAME(NAME, RESULTLEN, IERROR)
49         CHARACTER*(*) NAME
50         INTEGER RESULTLEN, IERROR
51
52     MPI_GET_VERSION(VERSION, SUBVERSION, IERROR)
53         INTEGER VERSION, SUBVERSION, IERROR
54
55     MPI_SESSION_CALL_ERRHANDLER(SESSION, ERRORCODE, IERROR)
```

INTEGER SESSION, ERRORCODE, IERROR	1
MPI_SESSION_CREATE_ERRHANDLER(SESSION_ERRHANDLER_FN, ERRHANDLER, IERROR)	2
EXTERNAL SESSION_ERRHANDLER_FN	3
INTEGER ERRHANDLER, IERROR	4
MPI_SESSION_GET_ERRHANDLER(SESSION, ERRHANDLER, IERROR)	5
INTEGER SESSION, ERRHANDLER, IERROR	6
MPI_SESSION_SET_ERRHANDLER(SESSION, ERRHANDLER, IERROR)	7
INTEGER SESSION, ERRHANDLER, IERROR	8
MPI_WIN_CALL_ERRHANDLER(WIN, ERRORCODE, IERROR)	9
INTEGER WIN, ERRORCODE, IERROR	10
MPI_WIN_CREATE_ERRHANDLER(WIN_ERRHANDLER_FN, ERRHANDLER, IERROR)	11
EXTERNAL WIN_ERRHANDLER_FN	12
INTEGER ERRHANDLER, IERROR	13
MPI_WIN_GET_ERRHANDLER(WIN, ERRHANDLER, IERROR)	14
INTEGER WIN, ERRHANDLER, IERROR	15
MPI_WIN_SET_ERRHANDLER(WIN, ERRHANDLER, IERROR)	16
INTEGER WIN, ERRHANDLER, IERROR	17
	18
	19
	20
	21
	22
A.4.7 The Info Object Fortran Bindings	23
MPI_INFO_CREATE(INFO, IERROR)	24
INTEGER INFO, IERROR	25
MPI_INFO_DELETE(INFO, KEY, IERROR)	26
INTEGER INFO, IERROR	27
CHARACTER*(*) KEY	28
MPI_INFO_DUP(INFO, NEWINFO, IERROR)	29
INTEGER INFO, NEWINFO, IERROR	30
MPI_INFO_FREE(INFO, IERROR)	31
INTEGER INFO, IERROR	32
MPI_INFO_GET(INFO, KEY, VALUELEN, VALUE, FLAG, IERROR)	33
INTEGER INFO, VALUELEN, IERROR	34
CHARACTER*(*) KEY, VALUE	35
LOGICAL FLAG	36
MPI_INFO_GET_NKEYS(INFO, NKEYS, IERROR)	37
INTEGER INFO, NKEYS, IERROR	38
MPI_INFO_GET_NTHKEY(INFO, N, KEY, IERROR)	39
INTEGER INFO, N, IERROR	40
CHARACTER*(*) KEY	41
MPI_INFO_GET_STRING(INFO, KEY, BUFLen, VALUE, FLAG, IERROR)	42
INTEGER INFO, BUFLen, IERROR	43
	44
	45
	46
	47
	48

```

1      CHARACTER*(*) KEY, VALUE
2      LOGICAL FLAG
3
4      MPI_INFO_GET_VALUELEN(INFO, KEY, VALUELEN, FLAG, IERROR)
5          INTEGER INFO, VALUELEN, IERROR
6          CHARACTER*(*) KEY
7          LOGICAL FLAG
8
9      MPI_INFO_SET(INFO, KEY, VALUE, IERROR)
10         INTEGER INFO, IERROR
11         CHARACTER*(*) KEY, VALUE
12
13     A.4.8 Process Creation and Management Fortran Bindings
14
15     MPI_ABORT(COMM, ERRORCODE, IERROR)
16         INTEGER COMM, ERRORCODE, IERROR
17
18     MPI_CLOSE_PORT(PORT_NAME, IERROR)
19         CHARACTER*(*) PORT_NAME
20         INTEGER IERROR
21
22     MPI_COMM_ACCEPT(PORT_NAME, INFO, ROOT, COMM, NEWCOMM, IERROR)
23         CHARACTER*(*) PORT_NAME
24         INTEGER INFO, ROOT, COMM, NEWCOMM, IERROR
25
26     MPI_COMM_CONNECT(PORT_NAME, INFO, ROOT, COMM, NEWCOMM, IERROR)
27         CHARACTER*(*) PORT_NAME
28         INTEGER INFO, ROOT, COMM, NEWCOMM, IERROR
29
30     MPI_COMM_DISCONNECT(COMM, IERROR)
31         INTEGER COMM, IERROR
32
33     MPI_COMM_GET_PARENT(PARENT, IERROR)
34         INTEGER PARENT, IERROR
35
36     MPI_COMM_JOIN(FD, INTERCOMM, IERROR)
37         INTEGER FD, INTERCOMM, IERROR
38
39     MPI_COMM_SPAWN(COMMAND, ARGV, MAXPROCS, INFO, ROOT, COMM, INTERCOMM,
40                   ARRAY_OF_ERRCODES, IERROR)
41         CHARACTER*(*) COMMAND, ARGV(*)
42         INTEGER MAXPROCS, INFO, ROOT, COMM, INTERCOMM, ARRAY_OF_ERRCODES(*),
43         IERROR
44
45     MPI_COMM_SPAWN_MULTIPLE(COUNT, ARRAY_OF_COMMANDS, ARRAY_OF_ARGV,
46                             ARRAY_OF_MAXPROCS, ARRAY_OF_INFO, ROOT, COMM, INTERCOMM,
47                             ARRAY_OF_ERRCODES, IERROR)
48         INTEGER COUNT, ARRAY_OF_MAXPROCS(*), ARRAY_OF_INFO(*), ROOT, COMM,
49         INTERCOMM, ARRAY_OF_ERRCODES(*), IERROR
50         CHARACTER*(*) ARRAY_OF_COMMANDS(*), ARRAY_OF_ARGV(COUNT, *)
51
52     MPI_FINALIZE(IERROR)
53         INTEGER IERROR

```

MPI_FINALIZED(FLAG, IERROR)	1
LOGICAL FLAG	2
INTEGER IERROR	3
MPI_INIT(IERROR)	4
INTEGER IERROR	5
MPI_INITIALIZED(FLAG, IERROR)	6
LOGICAL FLAG	7
INTEGER IERROR	8
MPI_INIT_THREAD(REQUIRED, PROVIDED, IERROR)	9
INTEGER REQUIRED, PROVIDED, IERROR	10
MPI_IS_THREAD_MAIN(FLAG, IERROR)	11
LOGICAL FLAG	12
INTEGER IERROR	13
MPI_LOOKUP_NAME(SERVICE_NAME, INFO, PORT_NAME, IERROR)	14
CHARACTER*(*) SERVICE_NAME, PORT_NAME	15
INTEGER INFO, IERROR	16
MPI_OPEN_PORT(INFO, PORT_NAME, IERROR)	17
INTEGER INFO, IERROR	18
CHARACTER*(*) PORT_NAME	19
MPI_PUBLISH_NAME(SERVICE_NAME, INFO, PORT_NAME, IERROR)	20
CHARACTER*(*) SERVICE_NAME, PORT_NAME	21
INTEGER INFO, IERROR	22
MPI_QUERY_THREAD(PROVIDED, IERROR)	23
INTEGER PROVIDED, IERROR	24
MPI_SESSION_FINALIZE(SESSION, IERROR)	25
INTEGER SESSION, IERROR	26
MPI_SESSION_GET_INFO(SESSION, INFO_USED, IERROR)	27
INTEGER SESSION, INFO_USED, IERROR	28
MPI_SESSION_GET_NTH_PSET(SESSION, INFO, N, PSET_LEN, PSET_NAME, IERROR)	29
INTEGER SESSION, INFO, N, PSET_LEN, IERROR	30
CHARACTER*(*) PSET_NAME	31
MPI_SESSION_GET_NUM_PSETS(SESSION, INFO, NPSET_NAMES, IERROR)	32
INTEGER SESSION, INFO, NPSET_NAMES, IERROR	33
MPI_SESSION_GET_PSET_INFO(SESSION, PSET_NAME, INFO, IERROR)	34
INTEGER SESSION, INFO, IERROR	35
CHARACTER*(*) PSET_NAME	36
MPI_SESSION_INIT(INFO, ERRHANDLER, SESSION, IERROR)	37
INTEGER INFO, ERRHANDLER, SESSION, IERROR	38
MPI_UNPUBLISH_NAME(SERVICE_NAME, INFO, PORT_NAME, IERROR)	39
CHARACTER*(*) SERVICE_NAME, PORT_NAME	40
	41
	42
	43
	44
	45
	46
	47
	48

1           INTEGER INFO, IERROR  
2  
3

#### 4   A.4.9 One-Sided Communications Fortran Bindings

5   MPI\_ACCUMULATE(ORIGIN\_ADDR, ORIGIN\_COUNT, ORIGIN\_DATATYPE, TARGET\_RANK,  
6                    TARGET\_DISP, TARGET\_COUNT, TARGET\_DATATYPE, OP, WIN, IERROR)

7       <type> ORIGIN\_ADDR(\*)

8       INTEGER ORIGIN\_COUNT, ORIGIN\_DATATYPE, TARGET\_RANK, TARGET\_COUNT,  
9       TARGET\_DATATYPE, OP, WIN, IERROR

10      INTEGER(KIND=MPI\_ADDRESS\_KIND) TARGET\_DISP  
11

12   MPI\_COMPARE\_AND\_SWAP(ORIGIN\_ADDR, COMPARE\_ADDR, RESULT\_ADDR, DATATYPE,  
13                        TARGET\_RANK, TARGET\_DISP, WIN, IERROR)

14      <type> ORIGIN\_ADDR(\*), COMPARE\_ADDR(\*), RESULT\_ADDR(\*)

15      INTEGER DATATYPE, TARGET\_RANK, WIN, IERROR

16      INTEGER(KIND=MPI\_ADDRESS\_KIND) TARGET\_DISP  
17

18   MPI\_FETCH\_AND\_OP(ORIGIN\_ADDR, RESULT\_ADDR, DATATYPE, TARGET\_RANK,  
19                     TARGET\_DISP, OP, WIN, IERROR)

20      <type> ORIGIN\_ADDR(\*), RESULT\_ADDR(\*)

21      INTEGER DATATYPE, TARGET\_RANK, OP, WIN, IERROR

22      INTEGER(KIND=MPI\_ADDRESS\_KIND) TARGET\_DISP  
23

24   MPI\_GET(ORIGIN\_ADDR, ORIGIN\_COUNT, ORIGIN\_DATATYPE, TARGET\_RANK,  
25            TARGET\_DISP, TARGET\_COUNT, TARGET\_DATATYPE, WIN, IERROR)

26      <type> ORIGIN\_ADDR(\*)

27      INTEGER ORIGIN\_COUNT, ORIGIN\_DATATYPE, TARGET\_RANK, TARGET\_COUNT,  
28      TARGET\_DATATYPE, WIN, IERROR

29      INTEGER(KIND=MPI\_ADDRESS\_KIND) TARGET\_DISP  
30

31   MPI\_GET\_ACCUMULATE(ORIGIN\_ADDR, ORIGIN\_COUNT, ORIGIN\_DATATYPE, RESULT\_ADDR,  
32                        RESULT\_COUNT, RESULT\_DATATYPE, TARGET\_RANK, TARGET\_DISP,  
33                        TARGET\_COUNT, TARGET\_DATATYPE, OP, WIN, IERROR)

34      <type> ORIGIN\_ADDR(\*), RESULT\_ADDR(\*)

35      INTEGER ORIGIN\_COUNT, ORIGIN\_DATATYPE, RESULT\_COUNT, RESULT\_DATATYPE,  
36      TARGET\_RANK, TARGET\_COUNT, TARGET\_DATATYPE, OP, WIN, IERROR

37      INTEGER(KIND=MPI\_ADDRESS\_KIND) TARGET\_DISP  
38

39   MPI\_PUT(ORIGIN\_ADDR, ORIGIN\_COUNT, ORIGIN\_DATATYPE, TARGET\_RANK,  
40            TARGET\_DISP, TARGET\_COUNT, TARGET\_DATATYPE, WIN, IERROR)

41      <type> ORIGIN\_ADDR(\*)

42      INTEGER ORIGIN\_COUNT, ORIGIN\_DATATYPE, TARGET\_RANK, TARGET\_COUNT,  
43      TARGET\_DATATYPE, WIN, IERROR

44      INTEGER(KIND=MPI\_ADDRESS\_KIND) TARGET\_DISP  
45

46   MPI\_RACCUMULATE(ORIGIN\_ADDR, ORIGIN\_COUNT, ORIGIN\_DATATYPE, TARGET\_RANK,  
47                    TARGET\_DISP, TARGET\_COUNT, TARGET\_DATATYPE, OP, WIN, REQUEST,  
48                    IERROR)

49      <type> ORIGIN\_ADDR(\*)

50      INTEGER ORIGIN\_COUNT, ORIGIN\_DATATYPE, TARGET\_RANK, TARGET\_COUNT,  
51



```

TARGET_DATATYPE, OP, WIN, REQUEST, IERROR
    INTEGER(KIND=MPI_ADDRESS_KIND) TARGET_DISP
MPI_RGET(ORIGIN_ADDR, ORIGIN_COUNT, ORIGIN_DATATYPE, TARGET_RANK,
        TARGET_DISP, TARGET_COUNT, TARGET_DATATYPE, WIN, REQUEST,
        IERROR)
    <type> ORIGIN_ADDR(*)
    INTEGER ORIGIN_COUNT, ORIGIN_DATATYPE, TARGET_RANK, TARGET_COUNT,
    TARGET_DATATYPE, WIN, REQUEST, IERROR
    INTEGER(KIND=MPI_ADDRESS_KIND) TARGET_DISP
MPI_RGET_ACCUMULATE(ORIGIN_ADDR, ORIGIN_COUNT, ORIGIN_DATATYPE,
        RESULT_ADDR, RESULT_COUNT, RESULT_DATATYPE, TARGET_RANK,
        TARGET_DISP, TARGET_COUNT, TARGET_DATATYPE, OP, WIN, REQUEST,
        IERROR)
    <type> ORIGIN_ADDR(*), RESULT_ADDR(*)
    INTEGER ORIGIN_COUNT, ORIGIN_DATATYPE, RESULT_COUNT, RESULT_DATATYPE,
    TARGET_RANK, TARGET_COUNT, TARGET_DATATYPE, OP, WIN, REQUEST, IERROR
    INTEGER(KIND=MPI_ADDRESS_KIND) TARGET_DISP
MPI_RPUT(ORIGIN_ADDR, ORIGIN_COUNT, ORIGIN_DATATYPE, TARGET_RANK,
        TARGET_DISP, TARGET_COUNT, TARGET_DATATYPE, WIN, REQUEST,
        IERROR)
    <type> ORIGIN_ADDR(*)
    INTEGER ORIGIN_COUNT, ORIGIN_DATATYPE, TARGET_RANK, TARGET_COUNT,
    TARGET_DATATYPE, WIN, REQUEST, IERROR
    INTEGER(KIND=MPI_ADDRESS_KIND) TARGET_DISP
MPI_WIN_ALLOCATE(SIZE, DISP_UNIT, INFO, COMM, BASEPTR, WIN, IERROR)
    INTEGER(KIND=MPI_ADDRESS_KIND) SIZE, BASEPTR
    INTEGER DISP_UNIT, INFO, COMM, WIN, IERROR
If the Fortran compiler provides TYPE(C_PTR), then overloaded by:
INTERFACE MPI_WIN_ALLOCATE
    SUBROUTINE MPI_WIN_ALLOCATE(SIZE, DISP_UNIT, INFO, COMM, BASEPTR, &
        WIN, IERROR)
        IMPORT :: MPI_ADDRESS_KIND
        INTEGER :: DISP_UNIT, INFO, COMM, WIN, IERROR
        INTEGER(KIND=MPI_ADDRESS_KIND) :: SIZE, BASEPTR
    END SUBROUTINE
    SUBROUTINE MPI_WIN_ALLOCATE_CPTR(SIZE, DISP_UNIT, INFO, COMM, BASEPTR, &
        WIN, IERROR)
        USE, INTRINSIC :: ISO_C_BINDING, ONLY : C_PTR
        IMPORT :: MPI_ADDRESS_KIND
        INTEGER :: DISP_UNIT, INFO, COMM, WIN, IERROR
        INTEGER(KIND=MPI_ADDRESS_KIND) :: SIZE
        TYPE(C_PTR) :: BASEPTR
    END SUBROUTINE
END INTERFACE
MPI_WIN_ALLOCATE_SHARED(SIZE, DISP_UNIT, INFO, COMM, BASEPTR, WIN, IERROR)

```

```

1     INTEGER(KIND=MPI_ADDRESS_KIND) SIZE, BASEPTR
2     INTEGER DISP_UNIT, INFO, COMM, WIN, IERROR
3
4     If the Fortran compiler provides TYPE(C_PTR), then overloaded by:
5     INTERFACE MPI_WIN_ALLOCATE_SHARED
6         SUBROUTINE MPI_WIN_ALLOCATE_SHARED(SIZE, DISP_UNIT, INFO, COMM, &
7             BASEPTR, WIN, IERROR)
8             IMPORT :: MPI_ADDRESS_KIND
9             INTEGER :: DISP_UNIT, INFO, COMM, WIN, IERROR
10            INTEGER(KIND=MPI_ADDRESS_KIND) :: SIZE, BASEPTR
11        END SUBROUTINE
12        SUBROUTINE MPI_WIN_ALLOCATE_SHARED_CPTR(SIZE, DISP_UNIT, INFO, COMM, &
13            BASEPTR, WIN, IERROR)
14            USE, INTRINSIC :: ISO_C_BINDING, ONLY : C_PTR
15            IMPORT :: MPI_ADDRESS_KIND
16            INTEGER :: DISP_UNIT, INFO, COMM, WIN, IERROR
17            INTEGER(KIND=MPI_ADDRESS_KIND) :: SIZE
18            TYPE(C_PTR) :: BASEPTR
19        END SUBROUTINE
20    END INTERFACE
21
22    MPI_WIN_ATTACH(WIN, BASE, SIZE, IERROR)
23        INTEGER WIN, IERROR
24        <type> BASE(*)
25        INTEGER(KIND=MPI_ADDRESS_KIND) SIZE
26
27    MPI_WIN_COMPLETE(WIN, IERROR)
28        INTEGER WIN, IERROR
29
30    MPI_WIN_CREATE(BASE, SIZE, DISP_UNIT, INFO, COMM, WIN, IERROR)
31        <type> BASE(*)
32        INTEGER(KIND=MPI_ADDRESS_KIND) SIZE
33        INTEGER DISP_UNIT, INFO, COMM, WIN, IERROR
34
35    MPI_WIN_CREATE_DYNAMIC(INFO, COMM, WIN, IERROR)
36        INTEGER INFO, COMM, WIN, IERROR
37
38    MPI_WIN_DETACH(WIN, BASE, IERROR)
39        INTEGER WIN, IERROR
40        <type> BASE(*)
41
42    MPI_WIN_FENCE(ASSERT, WIN, IERROR)
43        INTEGER ASSERT, WIN, IERROR
44
45    MPI_WIN_FLUSH(RANK, WIN, IERROR)
46        INTEGER RANK, WIN, IERROR
47
48    MPI_WIN_FLUSH_ALL(WIN, IERROR)
49        INTEGER WIN, IERROR
50
51    MPI_WIN_FLUSH_LOCAL(RANK, WIN, IERROR)
52        INTEGER RANK, WIN, IERROR

```

```

MPI_WIN_FLUSH_LOCAL_ALL(WIN, IERROR) 1
    INTEGER WIN, IERROR 2
3
MPI_WIN_FREE(WIN, IERROR) 4
    INTEGER WIN, IERROR 5
6
MPI_WIN_GET_GROUP(WIN, GROUP, IERROR) 6
    INTEGER WIN, GROUP, IERROR 7
8
MPI_WIN_GET_INFO(WIN, INFO_USED, IERROR) 9
    INTEGER WIN, INFO_USED, IERROR 10
11
MPI_WIN_LOCK(LOCK_TYPE, RANK, ASSERT, WIN, IERROR) 11
    INTEGER LOCK_TYPE, RANK, ASSERT, WIN, IERROR 12
13
MPI_WIN_LOCK_ALL(ASSERT, WIN, IERROR) 14
    INTEGER ASSERT, WIN, IERROR 15
16
MPI_WIN_POST(GROUP, ASSERT, WIN, IERROR) 16
    INTEGER GROUP, ASSERT, WIN, IERROR 17
18
MPI_WIN_SET_INFO(WIN, INFO, IERROR) 19
    INTEGER WIN, INFO, IERROR 20
21
MPI_WIN_SHARED_QUERY(WIN, RANK, SIZE, DISP_UNIT, BASEPTR, IERROR) 21
    INTEGER WIN, RANK, DISP_UNIT, IERROR 22
    INTEGER(KIND=MPI_ADDRESS_KIND) SIZE, BASEPTR 23
24
If the Fortran compiler provides TYPE(C_PTR), then overloaded by: 25
INTERFACE MPI_WIN_SHARED_QUERY 26
    SUBROUTINE MPI_WIN_SHARED_QUERY(WIN, RANK, SIZE, DISP_UNIT, & 27
        BASEPTR, IERROR) 28
    IMPORT :: MPI_ADDRESS_KIND 29
    INTEGER :: WIN, RANK, DISP_UNIT, IERROR 30
    INTEGER(KIND=MPI_ADDRESS_KIND) :: SIZE, BASEPTR 31
END SUBROUTINE 32
SUBROUTINE MPI_WIN_SHARED_QUERY_CPTR(WIN, RANK, SIZE, DISP_UNIT, & 33
    BASEPTR, IERROR) 34
    USE, INTRINSIC :: ISO_C_BINDING, ONLY : C_PTR 35
    IMPORT :: MPI_ADDRESS_KIND 36
    INTEGER :: WIN, RANK, DISP_UNIT, IERROR 37
    INTEGER(KIND=MPI_ADDRESS_KIND) :: SIZE 38
    TYPE(C_PTR) :: BASEPTR 39
END SUBROUTINE 40
END INTERFACE 41
42
MPI_WIN_START(GROUP, ASSERT, WIN, IERROR) 42
    INTEGER GROUP, ASSERT, WIN, IERROR 43
44
MPI_WIN_SYNC(WIN, IERROR) 44
    INTEGER WIN, IERROR 45
46
MPI_WIN_TEST(WIN, FLAG, IERROR) 47
    INTEGER WIN, IERROR 48

```

1 LOGICAL FLAG

2 MPI\_WIN\_UNLOCK(RANK, WIN, IERROR)  
3 INTEGER RANK, WIN, IERROR

4 MPI\_WIN\_UNLOCK\_ALL(WIN, IERROR)  
5 INTEGER WIN, IERROR

6 MPI\_WIN\_WAIT(WIN, IERROR)  
7 INTEGER WIN, IERROR

#### 11 A.4.10 External Interfaces Fortran Bindings

12 MPI\_GREQUEST\_COMPLETE(REQUEST, IERROR)  
13 INTEGER REQUEST, IERROR

14 MPI\_GREQUEST\_START(QUERY\_FN, FREE\_FN, CANCEL\_FN, EXTRA\_STATE, REQUEST,  
15 IERROR)

16 EXTERNAL QUERY\_FN, FREE\_FN, CANCEL\_FN  
17 INTEGER(KIND=MPI\_ADDRESS\_KIND) EXTRA\_STATE  
18 INTEGER REQUEST, IERROR

19 MPI\_STATUS\_SET\_CANCELLED(STATUS, FLAG, IERROR)  
20 INTEGER STATUS(MPI\_STATUS\_SIZE), IERROR  
21 LOGICAL FLAG

22 MPI\_STATUS\_SET\_ELEMENTS(STATUS, DATATYPE, COUNT, IERROR)  
23 INTEGER STATUS(MPI\_STATUS\_SIZE), DATATYPE, COUNT, IERROR

24 MPI\_STATUS\_SET\_ELEMENTS\_X(STATUS, DATATYPE, COUNT, IERROR)  
25 INTEGER STATUS(MPI\_STATUS\_SIZE), DATATYPE, IERROR  
26 INTEGER(KIND=MPI\_COUNT\_KIND) COUNT

#### 31 A.4.11 I/O Fortran Bindings

32 MPI\_CONVERSION\_FN\_NULL(USERBUF, DATATYPE, COUNT, FILEBUF, POSITION,  
33 EXTRA\_STATE, IERROR)

34 <TYPE> USERBUF(\*), FILEBUF(\*)  
35 INTEGER DATATYPE, COUNT, IERROR  
36 INTEGER(KIND=MPI\_OFFSET\_KIND) POSITION  
37 INTEGER(KIND=MPI\_ADDRESS\_KIND) EXTRA\_STATE

38 MPI\_FILE\_CLOSE(FH, IERROR)  
39 INTEGER FH, IERROR

40 MPI\_FILE\_DELETE(FILENAME, INFO, IERROR)  
41 CHARACTER\*(\*) FILENAME  
42 INTEGER INFO, IERROR

43 MPI\_FILE\_GET\_AMODE(FH, AMODE, IERROR)  
44 INTEGER FH, AMODE, IERROR

MPI_FILE_GET_ATOMICITY(FH, FLAG, IERROR)	1
INTEGER FH, IERROR	2
LOGICAL FLAG	3
	4
MPI_FILE_GET_BYTE_OFFSET(FH, OFFSET, DISP, IERROR)	5
INTEGER FH, IERROR	6
INTEGER(KIND=MPI_OFFSET_KIND) OFFSET, DISP	7
	8
MPI_FILE_GET_GROUP(FH, GROUP, IERROR)	9
INTEGER FH, GROUP, IERROR	10
	11
MPI_FILE_GET_INFO(FH, INFO_USED, IERROR)	12
INTEGER FH, INFO_USED, IERROR	13
	14
MPI_FILE_GET_POSITION(FH, OFFSET, IERROR)	15
INTEGER FH, IERROR	16
INTEGER(KIND=MPI_OFFSET_KIND) OFFSET	17
	18
MPI_FILE_GET_POSITION_SHARED(FH, OFFSET, IERROR)	19
INTEGER FH, IERROR	20
INTEGER(KIND=MPI_OFFSET_KIND) OFFSET	21
	22
MPI_FILE_GET_SIZE(FH, SIZE, IERROR)	23
INTEGER FH, IERROR	24
INTEGER(KIND=MPI_OFFSET_KIND) SIZE	25
	26
MPI_FILE_GET_TYPE_EXTENT(FH, DATATYPE, EXTENT, IERROR)	27
INTEGER FH, DATATYPE, IERROR	28
INTEGER(KIND=MPI_ADDRESS_KIND) EXTENT	29
	30
MPI_FILE_GET_VIEW(FH, DISP, ETYPE, FILETYPE, DATAREP, IERROR)	31
INTEGER FH, ETYPE, FILETYPE, IERROR	32
INTEGER(KIND=MPI_OFFSET_KIND) DISP	33
CHARACTER*(*) DATAREP	34
	35
MPI_FILE_IREAD(FH, BUF, COUNT, DATATYPE, REQUEST, IERROR)	36
INTEGER FH, COUNT, DATATYPE, REQUEST, IERROR	37
<type> BUF(*)	38
	39
MPI_FILE_IREAD_ALL(FH, BUF, COUNT, DATATYPE, REQUEST, IERROR)	40
INTEGER FH, COUNT, DATATYPE, REQUEST, IERROR	41
<type> BUF(*)	42
	43
MPI_FILE_IREAD_AT(FH, OFFSET, BUF, COUNT, DATATYPE, REQUEST, IERROR)	44
INTEGER FH, COUNT, DATATYPE, REQUEST, IERROR	45
INTEGER(KIND=MPI_OFFSET_KIND) OFFSET	46
<type> BUF(*)	47
	48
MPI_FILE_IREAD_SHARED(FH, BUF, COUNT, DATATYPE, REQUEST, IERROR)	

```

1     INTEGER FH, COUNT, DATATYPE, REQUEST, IERROR
2     <type> BUF(*)
3
4     MPI_FILE_IWRITE(FH, BUF, COUNT, DATATYPE, REQUEST, IERROR)
5     INTEGER FH, COUNT, DATATYPE, REQUEST, IERROR
6     <type> BUF(*)
7
8     MPI_FILE_IWRITE_ALL(FH, BUF, COUNT, DATATYPE, REQUEST, IERROR)
9     INTEGER FH, COUNT, DATATYPE, REQUEST, IERROR
10    <type> BUF(*)
11
12    MPI_FILE_IWRITE_AT(FH, OFFSET, BUF, COUNT, DATATYPE, REQUEST, IERROR)
13    INTEGER FH, COUNT, DATATYPE, REQUEST, IERROR
14    INTEGER(KIND=MPI_OFFSET_KIND) OFFSET
15    <type> BUF(*)
16
17    MPI_FILE_IWRITE_AT_ALL(FH, OFFSET, BUF, COUNT, DATATYPE, REQUEST, IERROR)
18    INTEGER FH, COUNT, DATATYPE, REQUEST, IERROR
19    INTEGER(KIND=MPI_OFFSET_KIND) OFFSET
20    <type> BUF(*)
21
22    MPI_FILE_IWRITE_SHARED(FH, BUF, COUNT, DATATYPE, REQUEST, IERROR)
23    INTEGER FH, COUNT, DATATYPE, REQUEST, IERROR
24    <type> BUF(*)
25
26    MPI_FILE_OPEN(COMM, FILENAME, AMODE, INFO, FH, IERROR)
27    INTEGER COMM, AMODE, INFO, FH, IERROR
28    CHARACTER*(*) FILENAME
29
30    MPI_FILE_PREALLOCATE(FH, SIZE, IERROR)
31    INTEGER FH, IERROR
32    INTEGER(KIND=MPI_OFFSET_KIND) SIZE
33
34    MPI_FILE_READ(FH, BUF, COUNT, DATATYPE, STATUS, IERROR)
35    INTEGER FH, COUNT, DATATYPE, STATUS(MPI_STATUS_SIZE), IERROR
36    <type> BUF(*)
37
38    MPI_FILE_READ_ALL(FH, BUF, COUNT, DATATYPE, STATUS, IERROR)
39    INTEGER FH, COUNT, DATATYPE, STATUS(MPI_STATUS_SIZE), IERROR
40    <type> BUF(*)
41
42    MPI_FILE_READ_ALL_BEGIN(FH, BUF, COUNT, DATATYPE, IERROR)
43    INTEGER FH, COUNT, DATATYPE, IERROR
44    <type> BUF(*)
45
46    MPI_FILE_READ_ALL_END(FH, BUF, STATUS, IERROR)
47    INTEGER FH, STATUS(MPI_STATUS_SIZE), IERROR
48    <type> BUF(*)

```

```

MPI_FILE_READ_AT_ALL(FH, OFFSET, BUF, COUNT, DATATYPE, STATUS, IERROR)      1
    INTEGER FH, COUNT, DATATYPE, STATUS(MPI_STATUS_SIZE), IERROR           2
    INTEGER(KIND=MPI_OFFSET_KIND) OFFSET                                   3
    <type> BUF(*)                                                         4
                                                                           5
MPI_FILE_READ_AT_ALL_BEGIN(FH, OFFSET, BUF, COUNT, DATATYPE, IERROR)       6
    INTEGER FH, COUNT, DATATYPE, IERROR                                   7
    INTEGER(KIND=MPI_OFFSET_KIND) OFFSET                                   8
    <type> BUF(*)                                                         9
                                                                           10
MPI_FILE_READ_AT_ALL_END(FH, BUF, STATUS, IERROR)                          11
    INTEGER FH, STATUS(MPI_STATUS_SIZE), IERROR                          12
    <type> BUF(*)                                                         13
                                                                           14
MPI_FILE_READ_ORDERED(FH, BUF, COUNT, DATATYPE, STATUS, IERROR)            15
    INTEGER FH, COUNT, DATATYPE, STATUS(MPI_STATUS_SIZE), IERROR        16
    <type> BUF(*)                                                         17
                                                                           18
MPI_FILE_READ_ORDERED_BEGIN(FH, BUF, COUNT, DATATYPE, IERROR)             19
    INTEGER FH, COUNT, DATATYPE, IERROR                                   20
    <type> BUF(*)                                                         21
                                                                           22
MPI_FILE_READ_ORDERED_END(FH, BUF, STATUS, IERROR)                         23
    INTEGER FH, STATUS(MPI_STATUS_SIZE), IERROR                          24
    <type> BUF(*)                                                         25
                                                                           26
MPI_FILE_READ_SHARED(FH, BUF, COUNT, DATATYPE, STATUS, IERROR)            27
    INTEGER FH, COUNT, DATATYPE, STATUS(MPI_STATUS_SIZE), IERROR        28
    <type> BUF(*)                                                         29
                                                                           30
MPI_FILE_SEEK(FH, OFFSET, WHENCE, IERROR)                                   31
    INTEGER FH, WHENCE, IERROR                                           32
    INTEGER(KIND=MPI_OFFSET_KIND) OFFSET                                   33
                                                                           34
MPI_FILE_SEEK_SHARED(FH, OFFSET, WHENCE, IERROR)                           35
    INTEGER FH, WHENCE, IERROR                                           36
    INTEGER(KIND=MPI_OFFSET_KIND) OFFSET                                   37
                                                                           38
MPI_FILE_SET_ATOMICITY(FH, FLAG, IERROR)                                    39
    INTEGER FH, IERROR                                                    40
    LOGICAL FLAG                                                            41
                                                                           42
MPI_FILE_SET_INFO(FH, INFO, IERROR)                                        43
    INTEGER FH, INFO, IERROR                                              44
                                                                           45
MPI_FILE_SET_SIZE(FH, SIZE, IERROR)                                        46
    INTEGER FH, IERROR                                                    47
    INTEGER(KIND=MPI_OFFSET_KIND) SIZE                                     48
                                                                           49
MPI_FILE_SET_VIEW(FH, DISP, ETYPE, FILETYPE, DATAREP, INFO, IERROR)        50
    INTEGER FH, ETYPE, FILETYPE, INFO, IERROR                            51
    INTEGER(KIND=MPI_OFFSET_KIND) DISP                                    52
    CHARACTER*(*) DATAREP                                                53

```

```
1 MPI_FILE_SYNC(FH, IERROR)
2     INTEGER FH, IERROR
3
4 MPI_FILE_WRITE(FH, BUF, COUNT, DATATYPE, STATUS, IERROR)
5     INTEGER FH, COUNT, DATATYPE, STATUS(MPI_STATUS_SIZE), IERROR
6     <type> BUF(*)
7
8 MPI_FILE_WRITE_ALL(FH, BUF, COUNT, DATATYPE, STATUS, IERROR)
9     INTEGER FH, COUNT, DATATYPE, STATUS(MPI_STATUS_SIZE), IERROR
10    <type> BUF(*)
11
12 MPI_FILE_WRITE_ALL_BEGIN(FH, BUF, COUNT, DATATYPE, IERROR)
13    INTEGER FH, COUNT, DATATYPE, IERROR
14    <type> BUF(*)
15
16 MPI_FILE_WRITE_ALL_END(FH, BUF, STATUS, IERROR)
17    INTEGER FH, STATUS(MPI_STATUS_SIZE), IERROR
18    <type> BUF(*)
19
20 MPI_FILE_WRITE_AT(FH, OFFSET, BUF, COUNT, DATATYPE, STATUS, IERROR)
21    INTEGER FH, COUNT, DATATYPE, STATUS(MPI_STATUS_SIZE), IERROR
22    INTEGER(KIND=MPI_OFFSET_KIND) OFFSET
23    <type> BUF(*)
24
25 MPI_FILE_WRITE_AT_ALL(FH, OFFSET, BUF, COUNT, DATATYPE, STATUS, IERROR)
26    INTEGER FH, COUNT, DATATYPE, STATUS(MPI_STATUS_SIZE), IERROR
27    INTEGER(KIND=MPI_OFFSET_KIND) OFFSET
28    <type> BUF(*)
29
30 MPI_FILE_WRITE_AT_ALL_BEGIN(FH, OFFSET, BUF, COUNT, DATATYPE, IERROR)
31    INTEGER FH, COUNT, DATATYPE, IERROR
32    INTEGER(KIND=MPI_OFFSET_KIND) OFFSET
33    <type> BUF(*)
34
35 MPI_FILE_WRITE_AT_ALL_END(FH, BUF, STATUS, IERROR)
36    INTEGER FH, STATUS(MPI_STATUS_SIZE), IERROR
37    <type> BUF(*)
38
39 MPI_FILE_WRITE_ORDERED(FH, BUF, COUNT, DATATYPE, STATUS, IERROR)
40    INTEGER FH, COUNT, DATATYPE, STATUS(MPI_STATUS_SIZE), IERROR
41    <type> BUF(*)
42
43 MPI_FILE_WRITE_ORDERED_BEGIN(FH, BUF, COUNT, DATATYPE, IERROR)
44    INTEGER FH, COUNT, DATATYPE, IERROR
45    <type> BUF(*)
46
47 MPI_FILE_WRITE_ORDERED_END(FH, BUF, STATUS, IERROR)
48    INTEGER FH, STATUS(MPI_STATUS_SIZE), IERROR
49    <type> BUF(*)
```



```

MPI_REGISTER_DATAREP(DATAREP, READ_CONVERSION_FN, WRITE_CONVERSION_FN,
                    DTYPE_FILE_EXTENT_FN, EXTRA_STATE, IERROR)
CHARACTER*(*) DATAREP
EXTERNAL READ_CONVERSION_FN, WRITE_CONVERSION_FN, DTYPE_FILE_EXTENT_FN
INTEGER(KIND=MPI_ADDRESS_KIND) EXTRA_STATE
INTEGER IERROR

```

#### A.4.12 Language Bindings Fortran Bindings

```

MPI_F_SYNC_REG(BUF)
    <type> BUF(*)

MPI_STATUS_F082F(F08_STATUS, F_STATUS, IERROR)
    TYPE(MPI_Status) :: F08_STATUS
    INTEGER :: F_STATUS(MPI_STATUS_SIZE), IERROR

MPI_STATUS_F2F08(F_STATUS, F08_STATUS, IERROR)
    INTEGER :: F_STATUS(MPI_STATUS_SIZE), IERROR
    TYPE(MPI_Status) :: F08_STATUS

MPI_TYPE_CREATE_F90_COMPLEX(P, R, NEWTYPE, IERROR)
    INTEGER P, R, NEWTYPE, IERROR

MPI_TYPE_CREATE_F90_INTEGER(R, NEWTYPE, IERROR)
    INTEGER R, NEWTYPE, IERROR

MPI_TYPE_CREATE_F90_REAL(P, R, NEWTYPE, IERROR)
    INTEGER P, R, NEWTYPE, IERROR

MPI_TYPE_MATCH_SIZE(TYPECLASS, SIZE, DATATYPE, IERROR)
    INTEGER TYPECLASS, SIZE, DATATYPE, IERROR

```

#### A.4.13 Tools / Profiling Interface Fortran Bindings

```

MPI_PCONTROL(LEVEL)
    INTEGER LEVEL

```

#### A.4.14 Deprecated Fortran Bindings

```

MPI_ATTR_DELETE(COMM, KEYVAL, IERROR)
    INTEGER COMM, KEYVAL, IERROR

MPI_ATTR_GET(COMM, KEYVAL, ATTRIBUTE_VAL, FLAG, IERROR)
    INTEGER COMM, KEYVAL, ATTRIBUTE_VAL, IERROR
    LOGICAL FLAG

MPI_ATTR_PUT(COMM, KEYVAL, ATTRIBUTE_VAL, IERROR)
    INTEGER COMM, KEYVAL, ATTRIBUTE_VAL, IERROR

MPI_DUP_FN(OLDCOMM, KEYVAL, EXTRA_STATE, ATTRIBUTE_VAL_IN,
           ATTRIBUTE_VAL_OUT, FLAG, IERR)

```

```
1     INTEGER OLDCOMM, KEYVAL, EXTRA_STATE, ATTRIBUTE_VAL_IN,  
2     ATTRIBUTE_VAL_OUT, IERR  
3     LOGICAL FLAG  
4  
5     MPI_INFO_GET(INFO, KEY, VALUELEN, VALUE, FLAG, IERROR)  
6         INTEGER INFO, VALUELEN, IERROR  
7         CHARACTER*(*) KEY, VALUE  
8         LOGICAL FLAG  
9  
10    MPI_INFO_GET_VALUELEN(INFO, KEY, VALUELEN, FLAG, IERROR)  
11        INTEGER INFO, VALUELEN, IERROR  
12        CHARACTER*(*) KEY  
13        LOGICAL FLAG  
14  
15    MPI_KEYVAL_CREATE(COPY_FN, DELETE_FN, KEYVAL, EXTRA_STATE, IERROR)  
16        EXTERNAL COPY_FN, DELETE_FN  
17        INTEGER KEYVAL, EXTRA_STATE, IERROR  
18  
19    MPI_KEYVAL_FREE(KEYVAL, IERROR)  
20        INTEGER KEYVAL, IERROR  
21  
22    MPI_NULL_COPY_FN(OLDCOMM, KEYVAL, EXTRA_STATE, ATTRIBUTE_VAL_IN,  
23        ATTRIBUTE_VAL_OUT, FLAG, IERR)  
24        INTEGER OLDCOMM, KEYVAL, EXTRA_STATE, ATTRIBUTE_VAL_IN,  
25        ATTRIBUTE_VAL_OUT, IERR  
26        LOGICAL FLAG  
27  
28    MPI_NULL_DELETE_FN(COMM, KEYVAL, ATTRIBUTE_VAL, EXTRA_STATE, IERROR)  
29        INTEGER COMM, KEYVAL, ATTRIBUTE_VAL, EXTRA_STATE, IERROR  
30  
31    MPI_SIZEOF(X, SIZE, IERROR)  
32        <type> X  
33        INTEGER SIZE, IERROR  
34  
35  
36  
37  
38  
39  
40  
41  
42  
43  
44  
45  
46  
47  
48
```

1  
2  
3  
4  
5  
6  
7  
8  
9  
10  
11  
12  
13  
14  
15  
16  
17  
18  
19  
20  
21  
22  
23  
24  
25  
26  
27  
28  
29  
30  
31  
32  
33  
34  
35  
36  
37  
38  
39  
40  
41  
42  
43  
44  
45  
46  
47  
48

# Annex B

## Change-Log

Annex B.1 summarizes changes from the previous version of the MPI standard to the version presented by this document. Only significant changes (i.e., clarifications and new features) that might either require implementation effort in the MPI libraries or change the understanding of MPI from a user’s perspective are presented. Editorial modifications, formatting, typo corrections and minor clarifications are not shown. If not otherwise noted, the section and page references refer to the locations of the change or new functionality in this version of the standard. Changes in Annexes B.2–B.6 were already introduced in the corresponding sections in previous versions of this standard.

### B.1 Changes from Version 3.2 to Version 4.0

#### B.1.1 Changes in MPI-4.0

1. Section 15.3 on page 697.  
MPI\_SIZEOF was deprecated.
2. Section 14.3.8.  
A callback-driven event interface was added to the MPI tool information interface.
3. Chapter 10, Sections 2.8, 3.2.3, 6.2.4, 6.3.2, 6.4.2, 6.6.2, 7.4, 7.5.1, 7.5.3, 7.5.4, 8.1.1, 8.1.2, 8.3, 8.3.4, 8.5, 10.6, 13.2.1, 13.2.7, 13.7, 14.3.4, 18.2.4, 18.2.6, and Annex A on pages 415, 20, 29, 255, 258, 267, 294, 326, 328, 330, 332, 379, 381, 386, 394, 398, 444, 565, 571, 630, 646, 752, 757, and 767  
The Sessions Model was added to the standard.

### B.2 Changes from Version 3.1 to Version 3.2

#### B.2.1 Changes in MPI-3.2

1. Section 3.8.4 on page 75.  
Cancelling a send request by calling MPI\_CANCEL has been deprecated and may be removed in a future version of the MPI specification.
2. Sections 3.7.3, 3.9, 5.13, 7.8, and 7.9 on pages 55, 77, 223, 367, and 373.  
Persistent collective communication and persistent neighborhood communication were added to the standard.

- 1 3. Section 6.4.2 on page 267, and MPI-3.1 Section 6.4.2 on page 237.  
2 The functions MPI\_COMM\_DUP and MPI\_COMM\_IDUP were updated to no longer  
3 propagate info hints.  
4 This change may affect backward compatibility.
- 5  
6 4. Sections 6.4.4, 11.2.7, and 13.2.8 on pages 281, 492, and 573, and  
7 MPI-3.1 Sections 6.4.4, 11.2.7, and 13.2.8 on pages 248, 415, and 500.  
8 The definition of info hints was updated to allow applications to provide assertions  
9 regarding their usage of MPI objects and operations.
- 10 5. Section 6.4.4 on page 281.  
11 The new info hints mpi\_assert\_no\_any\_tag, mpi\_assert\_no\_any\_source,  
12 mpi\_assert\_exact\_length, and mpi\_assert\_allow\_overtaking were added for use with commu-  
13 nicators.
- 14  
15 6. Section 6.4.2 on page 267.  
16 The MPI\_COMM\_IDUP\_WITH\_INFO function was added.
- 17 7. Sections 6.4.4, 11.2.7, and 13.2.8 on pages 281, 492, and 573.  
18 The semantics of the MPI\_COMM\_SET\_INFO, MPI\_COMM\_GET\_INFO,  
19 MPI\_WIN\_SET\_INFO, MPI\_WIN\_GET\_INFO, MPI\_FILE\_SET\_INFO, and  
20 MPI\_FILE\_GET\_INFO were clarified.
- 21  
22 8. Section 14.3.10 and Table 14.7 on pages 689 and 691.  
23 MPI\_T\_ERR\_INVALID\_ITEM is deprecated. MPI routines should return  
24 MPI\_T\_ERR\_INVALID\_INDEX instead of MPI\_T\_ERR\_INVALID\_ITEM.
- 25  
26 9. Section 7.5.  
27 MPI\_DIMS\_CREATE is now guaranteed to return MPI\_SUCCESS if the number of di-  
28 mensions passed to the routine is set to 0 and the number of nodes is set to 1.
- 29 10. Sections 2.8, 8.3, 8.5, and 10.2.1 on pages 20, 386, 398, and 416.  
30 MPI calls that are not related to any objects are considered to be attached to the  
31 communicator MPI\_COMM\_SELF instead of MPI\_COMM\_WORLD. The definition of  
32 MPI\_ERRORS\_ARE\_FATAL was clarified to cover all connected processes, and a new  
33 error handler, MPI\_ERRORS\_ABORT, was created to limit the scope of aborting.
- 34  
35 11. Sections 8.2, 11.2.2, and 11.2.3 on pages 383, 481, and 483.  
36 Introduced alignment requirements for memory allocated through MPI\_Alloc\_mem,  
37 MPI\_Win\_allocate, and MPI\_Win\_allocate\_shared and added a new info key  
38 mpi\_minimum\_memory\_alignment to specify a desired alternative minimum alignment.
- 39 12. Section 8.4 on page 399.  
40 The error class MPI\_ERR\_PROC\_ABORTED has been added.
- 41  
42 13. Section 12.3 on page ??  
43 The mpi\_f08 binding incorrectly had the dummy parameter flag in the MPI F08  
44 binding for MPI\_STATUS\_SET\_CANCELLED marked as INTENT(OUT). It has been  
45 fixed to be INTENT(IN).
- 46 14. Sections 8.3 and 8.4 on pages 386 and 397.  
47 Clarified definition of errors to say that MPI should continue whenever possible and  
48 allow the user to recover from errors.

15. Section ??.  
Added a new function `MPI_INFO_GET_STRING` that takes a buffer length argument for returning info value strings. This function returns the required buffer length for the requested string and guarantees null termination for C strings where buffer size is greater than 0.
16. Section ?? on page ?? and Section 15.4 on page ??.  
`MPI_INFO_GET` and `MPI_INFO_GET_VALUELEN` were deprecated.
17. Section 8.4 on page 397.  
Added text to clarify what is implied about the status of MPI and user visible buffers when MPI functions return `MPI_SUCCESS` or other error codes.
18. Section 10.2.1 on page 416. Section 10.10.4 on page 473.  
Clarified the semantic of failure and error reporting before (and during) `MPI_INIT` and after `MPI_FINALIZE`.
19. Section 10.8.4 on page 457. Section 10.8.4 on page 457.  
Added the `mpi_initial_errhandler` reserved info key with the reserved values `mpi_errors_abort`, `mpi_errors_are_fatal`, and `mpi_errors_return` to the launch keys in `MPI_COMM_SPAWN`, `MPI_COMM_SPAWN_MULTIPLE`, and `mpiexec`.

## B.3 Changes from Version 3.0 to Version 3.1

### B.3.1 Fixes to Errata in Previous Versions of MPI

1. Chapters 3–18, Annex A.3 on page 817, and Example 5.21 on page 195, and MPI-3.0 Chapters 3–17, Annex A.3 on page 707, and Example 5.21 on page 187.  
Within the `mpi_f08` Fortran support method, `BIND(C)` was removed from all `SUBROUTINE`, `FUNCTION`, and `ABSTRACT INTERFACE` definitions.
2. Section 3.2.5 on page 32, and MPI-3.0 Section 3.2.5 on page 30.  
The three public fields `MPI_SOURCE`, `MPI_TAG`, and `MPI_ERROR` of the Fortran derived type `TYPE(MPI_Status)` must be of type `INTEGER`.
3. Section 3.8.2 on page 71, and MPI-3.0 Section 3.8.2 on page 67.  
The flag arguments of the Fortran interfaces of `MPI_IMPROBE` were originally incorrectly defined as `INTEGER` (instead as `LOGICAL`).
4. Section 6.4.2 on page 267, and MPI-3.0 Section 6.4.2 on page 237.  
In the `mpi_f08` binding of `MPI_COMM_IDUP`, the output argument `newcomm` is declared as `ASYNCHRONOUS`.
5. Section 6.4.4 on page 281, and MPI-3.0 Section 6.4.4 on page 248.  
In the `mpi_f08` binding of `MPI_COMM_SET_INFO`, the intent of `comm` is `IN`, and the optional output argument `ierror` was missing.
6. Section 7.6 on page 351, and MPI-3.0 Sections 7.6, on pages 314.  
In the case of virtual general graph topologies (created with `MPI_CART_CREATE`), the use of neighborhood collective communication is restricted to adjacency matrices with the number of edges between any two processes is defined to be the same for both processes (i.e., with a symmetric adjacency matrix).

- 1 7. Section [8.1.1](#) on page [379](#), and MPI-3.0 Section 8.1.1 on page 335.  
2 In the `mpi_f08` binding of `MPI_GET_LIBRARY_VERSION`, a typo in the `resultlen`  
3 argument was corrected.  
4
- 5 8. Sections [8.2](#) (`MPI_ALLOC_MEM` and `MPI_ALLOC_MEM_CPTR`),  
6 [11.2.2](#) (`MPI_WIN_ALLOCATE` and `MPI_WIN_ALLOCATE_CPTR`),  
7 [11.2.3](#) (`MPI_WIN_ALLOCATE_SHARED` and `MPI_WIN_ALLOCATE_SHARED_CPTR`),  
8 [11.2.3](#) (`MPI_WIN_SHARED_QUERY` and `MPI_WIN_SHARED_QUERY_CPTR`),  
9 [14.2.1](#) and [14.2.7](#) (Profiling interface), and corresponding sections in MPI-3.0.  
10 The linker name concept was substituted by defining specific procedure names.
- 11 9. Section [11.2.1](#) on page [479](#), and MPI-3.0 Section 11.2.2 on page 407.  
12 The `same_size` info key can be used with all window flavors, and requires that all  
13 processes in the process group of the communicator have provided this info key with  
14 the same value.  
15
- 16 10. Section [11.3.4](#) on page [500](#), and MPI-3.0 Section 11.3.4 on page 424.  
17 Origin buffer arguments to `MPI_GET_ACCUMULATE` are ignored when the  
18 `MPI_NO_OP` operation is used.  
19
- 20 11. Section [11.3.4](#) on page [500](#), and MPI-3.0 Section 11.3.4 on page 424.  
21 Clarify the roles of origin, result, and target communication parameters in  
22 `MPI_GET_ACCUMULATE`.
- 23 12. Section [14.3](#) on page [643](#), and MPI-3.0 Section 14.3 on page 561  
24 New paragraph and advice to users clarifying intent of variable names in the tools  
25 information interface.  
26
- 27 13. Section [14.3.3](#) on page [645](#), and MPI-3.0 Section 14.3.3 on page 563.  
28 New paragraph clarifying variable name equivalence in the tools information interface.  
29
- 30 14. Sections [14.3.6](#), [14.3.7](#), and [14.3.9](#) on pages [650](#), [657](#), and [684](#), and  
31 MPI-3.0 Sections 14.3.6, 14.3.7, and 14.3.8 on pages 567, 573, and 584.  
32 In functions `MPI_T_CVAR_GET_INFO`, `MPI_T_PVAR_GET_INFO`, and  
33 `MPI_T_CATEGORY_GET_INFO`, clarification of parameters that must be identical for  
34 equivalent control variable / performance variable / category names across connected  
35 processes.  
36
- 37 15. Section [14.3.7](#) on page [657](#), and MPI-3.0 Section 14.3.7 on page 573.  
38 Clarify return code of `MPI_T_PVAR_{START,STOP,RESET}` routines.
- 39 16. Section [14.3.7](#) on page [657](#), and MPI-3.0 Section 14.3.7 on page 579, line 7.  
40 Clarify the return code when bad handle is passed to an `MPI_T_PVAR_*` routine.  
41
- 42 17. Section [18.1.4](#) on page [709](#), and MPI-3.0 Section 17.1.4 on page 603.  
43 The advice to implementors at the end of the section was rewritten and moved into  
44 the following section.
- 45 18. Section [18.1.5](#) on page [710](#), and MPI-3.0 Section 17.1.5 on page 605.  
46 The section was fully rewritten. The linker name concept was substituted by defining  
47 specific procedure names.  
48

19. Section 18.1.6 on page 715, and MPI-3.0 Section 17.1.6 on page 611.  
The requirements on BIND(C) procedure interfaces were removed.
20. Annexes A.2, A.3, and A.4 on pages 791, 817, and 874, and  
MPI-3.0 Annexes A.2, A.3, and A.4 on pages 685, 707, and 756.  
The predefined callback MPI\_CONVERSION\_FN\_NULL was added to all three annexes.
21. Annex A.3.4 on page 838, and MPI-3.0 Annex A.3.4 on page 724.  
In the mpi\_f08 binding of  
MPI\_{COMM|TYPE|WIN}\_{DUP|NULL\_COPY|NULL\_DELETE}\_FN, all INTENT(...) information was removed.

### B.3.2 Changes in MPI-3.1

1. Sections 2.6.4 and 4.1.5 on pages 20 and 106.  
The use of the intrinsic operators “+” and “-” for absolute addresses is substituted by MPI\_AINT\_ADD and MPI\_AINT\_DIFF. In C, they can be implemented as macros.
2. Sections 8.1.1, 10.2.1, and 10.6 on pages 379, 416, and 444.  
The routines MPI\_INITIALIZED, MPI\_FINALIZED, MPI\_QUERY\_THREAD, MPI\_IS\_THREAD\_MAIN, MPI\_GET\_VERSION, and MPI\_GET\_LIBRARY\_VERSION are callable from threads without restriction (in the sense of MPI\_THREAD\_MULTIPLE), irrespective of the actual level of thread support provided, in the case where the implementation supports threads.
3. Section 11.2.1 on page 479.  
The same\_disp\_unit info key was added for use in RMA window creation routines.
4. Sections 13.4.2 and 13.4.3 on pages 582 and 587.  
Added MPI\_FILE\_IREAD\_AT\_ALL, MPI\_FILE\_IWRITE\_AT\_ALL, MPI\_FILE\_IREAD\_ALL, and MPI\_FILE\_IWRITE\_ALL.
5. Sections 14.3.6, 14.3.7, and 14.3.9 on pages 650, 657, and 684.  
Clarified that NULL parameters can be provided in MPI\_T\_{CVAR|PVAR|CATEGORY}\_GET\_INFO routines.
6. Sections 14.3.6, 14.3.7, 14.3.9, and 14.3.10 on pages 650, 657, 684, and 689.  
New routines MPI\_T\_CVAR\_GET\_INDEX, MPI\_T\_PVAR\_GET\_INDEX, MPI\_T\_CATEGORY\_GET\_INDEX, were added to support retrieving indices of variables and categories. The error codes MPI\_T\_ERR\_INVALID and MPI\_T\_ERR\_INVALID\_NAME were added to indicate invalid uses of the interface.

## B.4 Changes from Version 2.2 to Version 3.0

### B.4.1 Fixes to Errata in Previous Versions of MPI

1. Sections 2.6.2 and 2.6.3 on pages 18 and 18, and MPI-2.2 Section 2.6.2 on page 17, lines 41–42, Section 2.6.3 on page 18, lines 15–16, and Section 2.6.4 on page 18, lines 40–41.

1 This is an MPI-2 erratum: The scope for the reserved prefix `MPI_` and the C++  
 2 namespace `MPI` is now any name as originally intended in MPI-1.

- 3  
 4 2. Sections 3.2.2, 5.9.2, 13.5.2 Table 13.2, and Annex A.1.1 on pages 27, 184, 614, and  
 5 767, and MPI-2.2 Sections 3.2.2, 5.9.2, 13.5.2 Table 13.2, 16.1.16 Table 16.1, and  
 6 Annex A.1.1 on pages 27, 164, 433, 472 and 513

7 This is an MPI-2.2 erratum: New named predefined datatypes `MPI_CXX_BOOL`,  
 8 `MPI_CXX_FLOAT_COMPLEX`, `MPI_CXX_DOUBLE_COMPLEX`, and  
 9 `MPI_CXX_LONG_DOUBLE_COMPLEX` were added in C and Fortran corresponding  
 10 to the C++ types `bool`, `std::complex<float>`, `std::complex<double>`, and  
 11 `std::complex<long double>`. These datatypes also correspond to the deprecated  
 12 C++ predefined datatypes `MPI::BOOL`, `MPI::COMPLEX`, `MPI::DOUBLE_COMPLEX`,  
 13 and `MPI::LONG_DOUBLE_COMPLEX`, which were removed in MPI-3.0. The non-  
 14 standard C++ types `Complex<...>` were substituted by the standard types  
 15 `std::complex<...>`.

- 16 3. Sections 5.9.2 on pages 184 and MPI-2.2 Section 5.9.2, page 165, line 47.  
 17 This is an MPI-2.2 erratum: `MPI_C_COMPLEX` was added to the “Complex” reduc-  
 18 tion group.  
 19  
 20 4. Section 7.5.5 on page 339, and MPI-2.2, Section 7.5.5 on page 257, C++ interface on  
 21 page 264, line 3.  
 22 This is an MPI-2.2 erratum: The argument `rank` was removed and `in/outdegree` are  
 23 now defined as `int& indegree` and `int& outdegree` in the C++ interface of  
 24 `MPI_DIST_GRAPH_NEIGHBORS_COUNT`.

- 25  
 26 5. Section 13.5.2, Table 13.2 on page 614, and MPI-2.2, Section 13.5.3, Table 13.2 on  
 27 page 433.  
 28 This was an MPI-2.2 erratum: The `MPI_C_BOOL` “external32” representation is cor-  
 29 rected to a 1-byte size.

- 30 6. MPI-2.2 Section 16.1.16 on page 471, line 45.  
 31 This is an MPI-2.2 erratum: The constant `MPI::_LONG_LONG` should be  
 32 `MPI::LONG_LONG`.

- 33  
 34 7. Annex A.1.1 on page 767, Table “Optional datatypes (Fortran),” and  
 35 MPI-2.2, Annex A.1.1, Table on page 517, lines 34, and 37–41.  
 36 This is an MPI-2.2 erratum: The C++ datatype handles `MPI::INTEGER16`,  
 37 `MPI::REAL16`, `MPI::F_COMPLEX4`, `MPI::F_COMPLEX8`, `MPI::F_COMPLEX16`,  
 38 `MPI::F_COMPLEX32` were added to the table.

#### 39 40 B.4.2 Changes in MPI-3.0

- 41 1. Section 2.6.1 on page 17, Section 16.2 on page 700 and all other chapters.  
 42 The C++ bindings were removed from the standard. See errata in Section B.4.1 on  
 43 page 913 for the latest changes to the MPI C++ binding defined in MPI-2.2.  
 44 This change may affect backward compatibility.  
 45  
 46 2. Section 2.6.1 on page 17, Section 15.1 on page 693 and Section 16.1 on page 699.  
 47 The deprecated functions `MPI_TYPE_HVECTOR`, `MPI_TYPE_HINDEXED`,  
 48 `MPI_TYPE_STRUCT`, `MPI_ADDRESS`, `MPI_TYPE_EXTENT`, `MPI_TYPE_LB`,



MPI\_TYPE\_UB, MPI\_ERRHANDLER\_CREATE (and its callback function prototype MPI\_Handler\_function), MPI\_ERRHANDLER\_SET, MPI\_ERRHANDLER\_GET, the deprecated special datatype handles MPI\_LB, MPI\_UB, and the constants MPI\_COMBINER\_HINDEXED\_INTEGER, MPI\_COMBINER\_HVECTOR\_INTEGER, MPI\_COMBINER\_STRUCT\_INTEGER were removed from the standard.

This change may affect backward compatibility.

3. Section 2.3 on page 10.  
Clarified parameter usage for IN parameters. C bindings are now const-correct where backward compatibility is preserved.
4. Section 2.5.4 on page 15 and Section 7.5.4 on page 332.  
The recommended C implementation value for MPI\_UNWEIGHTED changed from NULL to non-NULL. An additional weight array constant (MPI\_WEIGHTS\_EMPTY) was introduced.
5. Section 2.5.4 on page 15 and Section 8.1.1 on page 379.  
Added the new routine MPI\_GET\_LIBRARY\_VERSION to query library specific versions, and the new constant MPI\_MAX\_LIBRARY\_VERSION\_STRING.
6. Sections 2.5.8, 3.2.2, 3.3, 5.9.2, on pages 17, 27, 29, 184, Sections 4.1, 4.1.7, 4.1.8, 4.1.11, 12.3 on pages 87, 112, 114, 117, 560, and Annex A.1.1 on page 767.  
New inquiry functions, MPI\_TYPE\_SIZE\_X, MPI\_TYPE\_GET\_EXTENT\_X, MPI\_TYPE\_GET\_TRUE\_EXTENT\_X, and MPI\_GET\_ELEMENTS\_X, return their results as an MPI\_Count value, which is a new type large enough to represent element counts in memory, file views, etc. A new function, MPI\_STATUS\_SET\_ELEMENTS\_X, modifies the opaque part of an MPI\_Status object so that a call to MPI\_GET\_ELEMENTS\_X returns the provided MPI\_Count value (in Fortran, INTEGER (KIND=MPI\_COUNT\_KIND)). The corresponding predefined datatype is MPI\_COUNT.
7. Chapter 3 on page 25 through Chapter 18 on page 703.  
In the C language bindings, the array-arguments' interfaces were modified to consistently use use [] instead of \*.  
Exceptions are MPI\_INIT, which continues to use char \*\*\*argv (correct because of subtle rules regarding the use of the & operator with char \*argv[]), and MPI\_INIT\_THREAD, which is changed to be consistent with MPI\_INIT.
8. Sections 3.2.5, 4.1.5, 4.1.11, 4.2 on pages 32, 106, 117, 138.  
The functions MPI\_GET\_COUNT and MPI\_GET\_ELEMENTS were defined to set the count argument to MPI\_UNDEFINED when that argument would overflow. The functions MPI\_PACK\_SIZE and MPI\_TYPE\_SIZE were defined to set the size argument to MPI\_UNDEFINED when that argument would overflow. In all other MPI-2.2 routines, the type and semantics of the count arguments remain unchanged, i.e., int or INTEGER.
9. Section 3.2.6 on page 34, and Section 3.8 on page 68.  
MPI\_STATUS\_IGNORE can be also used in MPI\_IPROBE, MPI\_PROBE, MPI\_IMPROBE, and MPI\_MPROBE.

- 1      10. Section 3.8 on page 68 and Section 3.11 on page 85.  
2      The use of MPI\_PROC\_NULL in probe operations was clarified. A special predefined  
3      message MPI\_MESSAGE\_NO\_PROC was defined for the use of matching probe (i.e., the  
4      new MPI\_MPROBE and MPI\_IMPROBE) with MPI\_PROC\_NULL.  
5
- 6      11. Sections 3.8.2, 3.8.3, 18.2.4, A.1.1 on pages 71, 73, 752, 767.  
7      Like MPI\_PROBE and MPI\_IPROBE, the new MPI\_MPROBE and MPI\_IMPROBE  
8      operations allow incoming messages to be queried without actually receiving them,  
9      except that MPI\_MPROBE and MPI\_IMPROBE provide a mechanism to receive the  
10     specific message with the new routines MPI\_MRECV and MPI\_IMRECV regardless of  
11     other intervening probe or receive operations. The opaque object MPI\_Message, the  
12     null handle MPI\_MESSAGE\_NULL, and the conversion functions MPI\_Message\_c2f and  
13     MPI\_Message\_f2c were defined.
- 14     12. Section 4.1.2 on page 89 and Section 4.1.13 on page 122.  
15     The routine MPI\_TYPE\_CREATE\_HINDEXED\_BLOCK and constant  
16     MPI\_COMBINER\_HINDEXED\_BLOCK were added.  
17
- 18     13. Chapter 5 on page 149 and Section 5.12 on page 205.  
19     Added nonblocking interfaces to all collective operations.  
20
- 21     14. Sections 6.4.2, 6.4.4, 11.2.7, on pages 267, 281, 492.  
22     The new routines MPI\_COMM\_DUP\_WITH\_INFO, MPI\_COMM\_SET\_INFO,  
23     MPI\_COMM\_GET\_INFO, MPI\_WIN\_SET\_INFO, and MPI\_WIN\_GET\_INFO were  
24     added. The routine MPI\_COMM\_DUP must also duplicate info hints.
- 25     15. Section 6.4.2 on page 267.  
26     Added MPI\_COMM\_IDUP.  
27
- 28     16. Section 6.4.2 on page 267.  
29     Added the new communicator construction routine MPI\_COMM\_CREATE\_GROUP,  
30     which is invoked only by the processes in the group of the new communicator being  
31     constructed.  
32
- 33     17. Section 6.4.2 on page 267.  
34     Added the MPI\_COMM\_SPLIT\_TYPE routine and the communicator split type con-  
35     stant MPI\_COMM\_TYPE\_SHARED.
- 36     18. Section 6.6.2 on page 294.  
37     In MPI-2.2, communication involved in an MPI\_INTERCOMM\_CREATE operation  
38     could interfere with point-to-point communication on the parent communicator with  
39     the same tag or MPI\_ANY\_TAG. This interference has been removed in MPI-3.0.  
40
- 41     19. Section 6.8 on page 317.  
42     Section 6.8 on page 238. The constant MPI\_MAX\_OBJECT\_NAME also applies for type  
43     and window names.  
44
- 45     20. Section 7.5.8 on page 349.  
46     MPI\_CART\_MAP can also be used for a zero-dimensional topologies.  
47  
48

21. Section 7.6 on page 351 and Section 7.7 on page 361.
 

The following neighborhood collective communication routines were added to support sparse communication on virtual topology grids: `MPI_NEIGHBOR_ALLGATHER`, `MPI_NEIGHBOR_ALLGATHERV`, `MPI_NEIGHBOR_ALLTOALL`, `MPI_NEIGHBOR_ALLTOALLV`, `MPI_NEIGHBOR_ALLTOALLW` and the nonblocking variants `MPI_INEIGHBOR_ALLGATHER`, `MPI_INEIGHBOR_ALLGATHERV`, `MPI_INEIGHBOR_ALLTOALL`, `MPI_INEIGHBOR_ALLTOALLV`, and `MPI_INEIGHBOR_ALLTOALLW`. The displacement arguments in `MPI_NEIGHBOR_ALLTOALLW` and `MPI_INEIGHBOR_ALLTOALLW` were defined as address size integers. In `MPI_DIST_GRAPH_NEIGHBORS`, an ordering rule was added for communicators created with `MPI_DIST_GRAPH_CREATE_ADJACENT`.
22. Section 10.2.1 on page 416 and Section 10.2.1 on page 419.
 

The use of `MPI_INIT`, `MPI_INIT_THREAD` and `MPI_FINALIZE` was clarified. After MPI is initialized, the application can access information about the execution environment by querying the new predefined info object `MPI_INFO_ENV`.
23. Section 10.2.1 on page 416.
 

Allow calls to `MPI_T` routines before `MPI_INIT` and after `MPI_FINALIZE`.
24. Chapter 11 on page 477.
 

Substantial revision of the entire One-sided chapter, with new routines for window creation, additional synchronization methods in passive target communication, new one-sided communication routines, a new memory model, and other changes.
25. Section 14.3 on page 643.
 

A new MPI Tool Information Interface was added.

The following changes are related to the Fortran language support.
26. Section 2.3 on page 10, and Sections 18.1.1, 18.1.2, 18.1.7 on pages 703, 704, and 719.
 

The new `mpi_08` Fortran module was introduced.
27. Section 2.5.1 on page 12, and Sections 18.1.2, 18.1.3, 18.1.7 on pages 704, 707, and 719.
 

Handles to opaque objects were defined as named types within the `mpi_08` Fortran module. The operators `.EQ.`, `.NE.`, `==`, and `/=` were overloaded to allow the comparison of these handles. The handle types and the overloaded operators are also available through the `mpi` Fortran module.
28. Sections 2.5.4, 2.5.5 on pages 15, 16, Sections 18.1.1, 18.1.10, 18.1.11, 18.1.12, 18.1.13 on pages 703, 729, 731, 731, 734, and Sections 18.1.2, 18.1.3, 18.1.7 on pages 704, 707, 719.
 

Within the `mpi_08` Fortran module, choice buffers were defined as assumed-type and assumed-rank according to Fortran 2008 TS 29113 [43], and the compile-time constant `MPI_SUBARRAYS_SUPPORTED` was set to `.TRUE.`. With this, Fortran subscript triplets can be used in nonblocking MPI operations; vector subscripts are not supported in nonblocking operations. If the compiler does not support this Fortran TS 29113 feature, the constant is set to `.FALSE.`.
29. Section 2.6.2 on page 18, Section 18.1.2 on page 704, and Section 18.1.7 on page 719.
 

The `ierror` dummy arguments are `OPTIONAL` within the `mpi_08` Fortran module.

- 1 30. Section 3.2.5 on page 32, Sections 18.1.2, 18.1.3, 18.1.7, on pages 704, 707, 719, and  
2 Section 18.2.5 on page 754.  
3 Within the `mpi_08` Fortran module, the status was defined as `TYPE(MPI_Status)`.  
4 Additionally, within both the `mpi` and the `mpi_f08` modules, the constants  
5 `MPI_STATUS_SIZE`, `MPI_SOURCE`, `MPI_TAG`, `MPI_ERROR`, and `TYPE(MPI_Status)` are  
6 defined. New conversion routines were added: `MPI_STATUS_F2F08`,  
7 `MPI_STATUS_F082F`, `MPI_Status_c2f08`, and `MPI_Status_f082c`. In `mpi.h`, the new  
8 type `MPI_F08_status`, and the external variables `MPI_F08_STATUS_IGNORE` and  
9 `MPI_F08_STATUSES_IGNORE` were added.
- 10  
11 31. Section 3.6 on page 47.  
12 In Fortran with the `mpi` module or `mpif.h`, the type of the `buffer_addr` argument of  
13 `MPI_BUFFER_DETACH` is incorrectly defined and the argument is therefore unused.
- 14  
15 32. Section 4.1 on page 87, Section 4.1.6 on page 110, and Section 18.1.15 on page 735.  
16 The Fortran alignments of basic datatypes within Fortran derived types are imple-  
17 mentation dependent; therefore it is recommended to use the `BIND(C)` attribute for  
18 derived types in MPI communication buffers. If an array of structures (in C/C++)  
19 or derived types (in Fortran) is to be used in MPI communication buffers, it is rec-  
20 ommended that the user creates a portable datatype handle and additionally applies  
21 `MPI_TYPE_CREATE_RESIZED` to this datatype handle.
- 22  
23 33. Sections 4.1.10, 5.9.5, 5.9.7, 6.7.4, 6.8, 8.3.1, 8.3.2, 8.3.3, 15.1, 18.1.9 on pages 117,  
24 191, 197, 311, 317, 389, 391, 393, 693, and 721. In some routines, the dummy argu-  
25 ment names were changed because they were identical to the Fortran keywords  
26 `TYPE` and `FUNCTION`. The new dummy argument names must be used because the  
27 `mpi` and `mpi_08` modules guarantee keyword-based actual argument lists. The argu-  
28 ment name `type` was changed in `MPI_TYPE_DUP`, the Fortran  
29 `USER_FUNCTION` of `MPI_OP_CREATE`, `MPI_TYPE_SET_ATTR`,  
30 `MPI_TYPE_GET_ATTR`, `MPI_TYPE_DELETE_ATTR`, `MPI_TYPE_SET_NAME`,  
31 `MPI_TYPE_GET_NAME`, `MPI_TYPE_MATCH_SIZE`, the callback prototype defini-  
32 tion `MPI_Type_delete_attr_function`, and the predefined callback function  
33 `MPI_TYPE_NULL_DELETE_FN`; function was changed in `MPI_OP_CREATE`,  
34 `MPI_COMM_CREATE_ERRHANDLER`, `MPI_WIN_CREATE_ERRHANDLER`,  
35 `MPI_FILE_CREATE_ERRHANDLER`, and `MPI_ERRHANDLER_CREATE`. For consis-  
36 tency reasons, `INOUBUF` was changed to `INOUTBUF` in `MPI_REDUCE_LOCAL`, and  
37 `intracomm` to `newintracomm` in `MPI_INTERCOMM_MERGE`.
- 38  
39 34. Section 6.7.2 on page 302.  
40 It was clarified that in Fortran, the flag values returned by a `comm_copy_attr_fn`  
41 callback, including `MPI_COMM_NULL_COPY_FN` and `MPI_COMM_DUP_FN`, are  
42 `.FALSE.` and `.TRUE.`; see `MPI_COMM_CREATE_KEYVAL`.
- 43  
44 35. Section 8.2 on page 383.  
45 With the `mpi` and `mpi_f08` Fortran modules, `MPI_ALLOC_MEM` now also supports  
46 `TYPE(C_PTR)` C-pointers instead of only returning an address-sized integer that may  
47 be usable together with a non-standard Cray-pointer.
- 48  
49 36. Section 18.1.15 on page 735, and Section 18.1.7 on page 719.  
50 Fortran `SEQUENCE` and `BIND(C)` derived application types can now be used as buffers

in MPI operations.

37. Section 18.1.16 on page 737 to Section 18.1.19 on page 746, Section 18.1.7 on page 719, and Section 18.1.8 on page 720.  
The sections about Fortran optimization problems and their solutions were partially rewritten and new methods are added, e.g., the use of the `ASYNCHRONOUS` attribute. The constant `MPI_ASYNC_PROTECTS_NONBLOCKING` tells whether the semantics of the `ASYNCHRONOUS` attribute is extended to protect nonblocking operations. The Fortran routine `MPI_F_SYNC_REG` is added. MPI-3.0 compliance for an MPI library together with a Fortran compiler is defined in Section 18.1.7.
38. Section 18.1.2 on page 704.  
Within the `mpi_08` Fortran module, dummy arguments are now declared with `INTENT=IN`, `OUT`, or `INOUT` as defined in the `mpi_08` interfaces.
39. Section 18.1.3 on page 707, and Section 18.1.7 on page 719.  
The existing `mpi` Fortran module must implement compile-time argument checking.
40. Section 18.1.4 on page 709.  
The use of the `mpif.h` Fortran include file is now strongly discouraged.
41. Section A.1.1, Table “*Predefined functions*” on page 775, Section A.1.3 on page 782, and Section A.3.4 on page 838.  
Within the new `mpi_f08` module, all callback prototype definitions are now defined with explicit interfaces `PROCEDURE(MPI_...)` that have the `BIND(C)` attribute; user-written callbacks must be modified if the `mpi_f08` module is used.
42. Section A.1.3 on page 782.  
In some routines, the Fortran callback prototype names were changed from `..._FN` to `..._FUNCTION` to be consistent with the other language bindings.

## B.5 Changes from Version 2.1 to Version 2.2

1. Section 2.5.4 on page 15.  
It is now guaranteed that predefined named constant handles (as other constants) can be used in initialization expressions or assignments, i.e., also before the call to `MPI_INIT`.
2. Section 2.6 on page 17, and Section 16.2 on page 700.  
The C++ language bindings have been deprecated and may be removed in a future version of the MPI specification.
3. Section 3.2.2 on page 27.  
`MPI_CHAR` for printable characters is now defined for C type char (instead of signed char). This change should not have any impact on applications nor on MPI libraries (except some comment lines), because printable characters could and can be stored in any of the C types char, signed char, and unsigned char, and `MPI_CHAR` is not allowed for predefined reduction operations.
4. Section 3.2.2 on page 27.  
`MPI_(U)INT{8,16,32,64}_T`, `MPI_AINT`, `MPI_OFFSET`, `MPI_C_BOOL`,

1 MPI\_C\_COMPLEX, MPI\_C\_FLOAT\_COMPLEX, MPI\_C\_DOUBLE\_COMPLEX, and  
2 MPI\_C\_LONG\_DOUBLE\_COMPLEX are now valid predefined MPI datatypes.

- 3  
4 5. Section 3.4 on page 39, Section 3.7.2 on page 51, Section 3.9 on page 77, and Section 5.1  
5 on page 149.

6 The read access restriction on the send buffer for blocking, non blocking and collective  
7 API has been lifted. It is permitted to access for read the send buffer while the  
8 operation is in progress.

- 9 6. Section 3.7 on page 49.

10 The Advice to users for IBSEND and IRSEND was slightly changed.

- 11  
12 7. Section 3.7.3 on page 55.

13 The advice to free an active request was removed in the Advice to users for  
14 MPI\_REQUEST\_FREE.

- 15  
16 8. Section 3.7.6 on page 67.

17 MPI\_REQUEST\_GET\_STATUS changed to permit inactive or null requests as input.

- 18  
19 9. Section 5.8 on page 176.

20 “In place” option is added to MPI\_ALLTOALL, MPI\_ALLTOALLV, and  
21 MPI\_ALLTOALLW for intracommunicators.

- 22 10. Section 5.9.2 on page 184.

23 Predefined parameterized datatypes (e.g., returned by  
24 MPI\_TYPE\_CREATE\_F90\_REAL) and optional named predefined datatypes (e.g.  
25 MPI\_REAL8) have been added to the list of valid datatypes in reduction operations.

- 26  
27 11. Section 5.9.2 on page 184.

28 MPI\_(U)INT{8,16,32,64}\_T are all considered C integer types for the purposes of the  
29 predefined reduction operators. MPI\_AINT and MPI\_OFFSET are considered Fortran  
30 integer types. MPI\_C\_BOOL is considered a Logical type.  
31 MPI\_C\_COMPLEX, MPI\_C\_FLOAT\_COMPLEX, MPI\_C\_DOUBLE\_COMPLEX, and  
32 MPI\_C\_LONG\_DOUBLE\_COMPLEX are considered Complex types.

- 33  
34 12. Section 5.9.7 on page 197.

35 The local routines MPI\_REDUCE\_LOCAL and MPI\_OP\_COMMUTATIVE have been  
36 added.

- 37  
38 13. Section 5.10.1 on page 199.

39 The collective function MPI\_REDUCE\_SCATTER\_BLOCK is added to the MPI stan-  
40 dard.

- 41  
42 14. Section 5.11.2 on page 203.

43 Added in place argument to MPI\_EXSCAN.

- 44  
45 15. Section 6.4.2 on page 267, and Section 6.6 on page 290.

46 Implementations that did not implement MPI\_COMM\_CREATE on intercommuni-  
47 cators will need to add that functionality. As the standard described the behav-  
48 ior of this operation on intercommunicators, it is believed that most implementa-  
tions already provide this functionality. Note also that the C++ binding for both  
MPI\_COMM\_CREATE and MPI\_COMM\_SPLIT explicitly allow Intercomms.

16. Section [6.4.2](#) on page [267](#).  
 MPI\_COMM\_CREATE is extended to allow several disjoint subgroups as input if comm is an intracommunicator. If comm is an intercommunicator it was clarified that all processes in the same local group of comm must specify the same value for group.
17. Section [7.5.4](#) on page [332](#).  
 New functions for a scalable distributed graph topology interface has been added. In this section, the functions MPI\_DIST\_GRAPH\_CREATE\_ADJACENT and MPI\_DIST\_GRAPH\_CREATE, the constants MPI\_UNWEIGHTED, and the derived C++ class Distgraphcomm were added.
18. Section [7.5.5](#) on page [339](#).  
 For the scalable distributed graph topology interface, the functions MPI\_DIST\_GRAPH\_NEIGHBORS\_COUNT and MPI\_DIST\_GRAPH\_NEIGHBORS and the constant MPI\_DIST\_GRAPH were added.
19. Section [7.5.5](#) on page [339](#).  
 Remove ambiguity regarding duplicated neighbors with MPI\_GRAPH\_NEIGHBORS and MPI\_GRAPH\_NEIGHBORS\_COUNT.
20. Section [8.1.1](#) on page [379](#).  
 The subversion number changed from 1 to 2.
21. Section [8.3](#) on page [386](#), Section [15.2](#) on page [696](#), and Annex [A.1.3](#) on page [782](#).  
 Changed function pointer typedef names MPI\_{Comm,File,Win}\_errhandler\_fn to MPI\_{Comm,File,Win}\_errhandler\_function. Deprecated old “\_fn” names.
22. Section [10.2.4](#) on page [426](#).  
 Attribute deletion callbacks on MPI\_COMM\_SELF are now called in LIFO order. Implementors must now also register all implementation-internal attribute deletion callbacks on MPI\_COMM\_SELF before returning from MPI\_INIT/MPI\_INIT\_THREAD.
23. Section [11.3.4](#) on page [500](#).  
 The restriction added in MPI 2.1 that the operation MPI\_REPLACE in MPI\_ACCUMULATE can be used only with predefined datatypes has been removed. MPI\_REPLACE can now be used even with derived datatypes, as it was in MPI 2.0. Also, a clarification has been made that MPI\_REPLACE can be used only in MPI\_ACCUMULATE, not in collective operations that do reductions, such as MPI\_REDUCE and others.
24. Section [12.2](#) on page [553](#).  
 Add “\*” to the query\_fn, free\_fn, and cancel\_fn arguments to the C++ binding for MPI::Grequest::Start() for consistency with the rest of MPI functions that take function pointer arguments.
25. Section [13.5.2](#) on page [613](#), and Table [13.2](#) on page [614](#).  
 MPI\_(U)INT{8,16,32,64}\_T, MPI\_AINT, MPI\_OFFSET, MPI\_C\_COMPLEX, MPI\_C\_FLOAT\_COMPLEX, MPI\_C\_DOUBLE\_COMPLEX, MPI\_C\_LONG\_DOUBLE\_COMPLEX, and MPI\_C\_BOOL are added as predefined datatypes in the external32 representation.

- 1 26. Section [18.2.7](#) on page [759](#).  
 2 The description was modified that it only describes how an MPI implementation be-  
 3 haves, but not how MPI stores attributes internally. The erroneous MPI-2.1 Example  
 4 16.17 was replaced with three new examples [18.13](#), [18.14](#), and [18.15](#) on pages [760–762](#)  
 5 explicitly detailing cross-language attribute behavior. Implementations that matched  
 6 the behavior of the old example will need to be updated.
- 7  
 8 27. Annex [A.1.1](#) on page [767](#).  
 9 Removed type MPI::Fint (compare MPI\_Fint in Section [A.1.2](#) on page [781](#)).
- 10  
 11 28. Annex [A.1.1](#) on page [767](#). Table *Named Predefined Datatypes*.  
 12 Added MPI\_(U)INT{8,16,32,64}\_T, MPI\_AINT, MPI\_OFFSET, MPI\_C\_BOOL,  
 13 MPI\_C\_FLOAT\_COMPLEX, MPI\_C\_COMPLEX, MPI\_C\_DOUBLE\_COMPLEX, and  
 14 MPI\_C\_LONG\_DOUBLE\_COMPLEX are added as predefined datatypes.

## 15 B.6 Changes from Version 2.0 to Version 2.1

- 16  
 17 1. Section [3.2.2](#) on page [27](#), and Annex [A.1](#) on page [767](#).  
 18 In addition, the MPI\_LONG\_LONG should be added as an optional type; it is a syn-  
 19 onym for MPI\_LONG\_LONG\_INT.
- 20  
 21 2. Section [3.2.2](#) on page [27](#), and Annex [A.1](#) on page [767](#).  
 22 MPI\_LONG\_LONG\_INT, MPI\_LONG\_LONG (as synonym),  
 23 MPI\_UNSIGNED\_LONG\_LONG, MPI\_SIGNED\_CHAR, and MPI\_WCHAR are moved  
 24 from optional to official and they are therefore defined for all three language bindings.
- 25  
 26 3. Section [3.2.5](#) on page [32](#).  
 27 MPI\_GET\_COUNT with zero-length datatypes: The value returned as the  
 28 count argument of MPI\_GET\_COUNT for a datatype of length zero where zero bytes  
 29 have been transferred is zero. If the number of bytes transferred is greater than zero,  
 30 MPI\_UNDEFINED is returned.
- 31  
 32 4. Section [4.1](#) on page [87](#).  
 33 General rule about derived datatypes: Most datatype constructors have replication  
 34 count or block length arguments. Allowed values are non-negative integers. If the  
 35 value is zero, no elements are generated in the type map and there is no effect on  
 36 datatype bounds or extent.
- 37  
 38 5. Section [4.3](#) on page [144](#).  
 39 MPI\_BYTE should be used to send and receive data that is packed using  
 40 MPI\_PACK\_EXTERNAL.
- 41  
 42 6. Section [5.9.6](#) on page [195](#).  
 43 If comm is an intercommunicator in MPI\_ALLREDUCE, then both groups should pro-  
 44 vide count and datatype arguments that specify the same type signature (i.e., it is not  
 45 necessary that both groups provide the same count value).
- 46  
 47 7. Section [6.3.1](#) on page [256](#).  
 48 MPI\_GROUP\_TRANSLATE\_RANKS and MPI\_PROC\_NULL: MPI\_PROC\_NULL is a valid  
 rank for input to MPI\_GROUP\_TRANSLATE\_RANKS, which returns MPI\_PROC\_NULL  
 as the translated rank.



8. Section 6.7 on page 300.

About the attribute caching functions:

*Advice to implementors.* High-quality implementations should raise an error when a keyval that was created by a call to `MPI_XXX_CREATE_KEYVAL` is used with an object of the wrong type with a call to `MPI_YYY_GET_ATTR`, `MPI_YYY_SET_ATTR`, `MPI_YYY_DELETE_ATTR`, or `MPI_YYY_FREE_KEYVAL`. To do so, it is necessary to maintain, with each keyval, information on the type of the associated user function. (*End of advice to implementors.*)

9. Section 6.8 on page 317.

In `MPI_COMM_GET_NAME`: In C, a null character is additionally stored at `name[resultlen]`. `resultlen` cannot be larger than `MPI_MAX_OBJECT_NAME-1`. In Fortran, `name` is padded on the right with blank characters. `resultlen` cannot be larger than `MPI_MAX_OBJECT_NAME`.

10. Section 7.4 on page 326.

About `MPI_GRAPH_CREATE` and `MPI_CART_CREATE`: All input arguments must have identical values on all processes of the group of `comm_old`.

11. Section 7.5.1 on page 328.

In `MPI_CART_CREATE`: If `ndims` is zero then a zero-dimensional Cartesian topology is created. The call is erroneous if it specifies a grid that is larger than the group size or if `ndims` is negative.

12. Section 7.5.3 on page 330.

In `MPI_GRAPH_CREATE`: If the graph is empty, i.e., `nnodes == 0`, then `MPI_COMM_NULL` is returned in all processes.

13. Section 7.5.3 on page 330.

In `MPI_GRAPH_CREATE`: A single process is allowed to be defined multiple times in the list of neighbors of a process (i.e., there may be multiple edges between two processes). A process is also allowed to be a neighbor to itself (i.e., a self loop in the graph). The adjacency matrix is allowed to be non-symmetric.

*Advice to users.* Performance implications of using multiple edges or a non-symmetric adjacency matrix are not defined. The definition of a node-neighbor edge does not imply a direction of the communication. (*End of advice to users.*)

14. Section 7.5.5 on page 339.

In `MPI_CARTDIM_GET` and `MPI_CART_GET`: If `comm` is associated with a zero-dimensional Cartesian topology, `MPI_CARTDIM_GET` returns `ndims=0` and `MPI_CART_GET` will keep all output arguments unchanged.

15. Section 7.5.5 on page 339.

In `MPI_CART_RANK`: If `comm` is associated with a zero-dimensional Cartesian topology, `coord` is not significant and 0 is returned in `rank`.

16. Section 7.5.5 on page 339.

In `MPI_CART_COORDS`: If `comm` is associated with a zero-dimensional Cartesian topology, `coords` will be unchanged.

1 17. Section 7.5.6 on page 347.

2 In MPI\_CART\_SHIFT: It is erroneous to call MPI\_CART\_SHIFT with a direction that  
3 is either negative or greater than or equal to the number of dimensions in the Cartesian  
4 communicator. This implies that it is erroneous to call MPI\_CART\_SHIFT with a  
5 comm that is associated with a zero-dimensional Cartesian topology.

6  
7 18. Section 7.5.7 on page 349.

8 In MPI\_CART\_SUB: If all entries in remain\_dims are false or comm is already associ-  
9 ated with a zero-dimensional Cartesian topology then newcomm is associated with a  
10 zero-dimensional Cartesian topology.

11 18.1. Section 8.1.1 on page 379.

12 The subversion number changed from 0 to 1.

13  
14 19. Section 8.1.2 on page 381.

15 In MPI\_GET\_PROCESSOR\_NAME: In C, a null character is additionally stored at  
16 name[resultlen]. resultlen cannot be larger than MPI\_MAX\_PROCESSOR\_NAME-1. In  
17 Fortran, name is padded on the right with blank characters. resultlen cannot be larger  
18 than MPI\_MAX\_PROCESSOR\_NAME.

19  
20 20. Section 8.3 on page 386.

21 MPI\_{COMM,WIN,FILE}\_GET\_ERRHANDLER behave as if a new error handler object  
22 is created. That is, once the error handler is no longer needed,  
23 MPI\_ERRHANDLER\_FREE should be called with the error handler returned from  
24 MPI\_ERRHANDLER\_GET or MPI\_{COMM,WIN,FILE}\_GET\_ERRHANDLER to mark  
25 the error handler for deallocation. This provides behavior similar to that of  
26 MPI\_COMM\_GROUP and MPI\_GROUP\_FREE.

27  
28 21. Section 10.2.1 on page 416, see explanations to MPI\_FINALIZE.

29 MPI\_FINALIZE is collective over all connected processes. If no processes were spawned,  
30 accepted or connected then this means over MPI\_COMM\_WORLD; otherwise it is col-  
31 lective over the union of all processes that have been and continue to be connected,  
32 as explained in Section 10.10.4 on page 473.

33 22. Section 10.2.1 on page 416.

34 About MPI\_ABORT:

35  
36 *Advice to users.* Whether the errorcode is returned from the executable or from  
37 the MPI process startup mechanism (e.g., mpiexec), is an aspect of quality of the  
38 MPI library but not mandatory. (*End of advice to users.*)

39  
40 *Advice to implementors.* Where possible, a high-quality implementation will try  
41 to return the errorcode from the MPI process startup mechanism (e.g. mpiexec  
42 or singleton init). (*End of advice to implementors.*)

43  
44 23. Section 9 on page 407.

45 An implementation must support info objects as caches for arbitrary (key, value)  
46 pairs, regardless of whether it recognizes the key. Each function that takes hints in  
47 the form of an MPI\_Info must be prepared to ignore any key it does not recognize. This  
48 description of info objects does not attempt to define how a particular function should

react if it recognizes a key but not the associated value. `MPI_INFO_GET_NKEYS`, `MPI_INFO_GET_NTHKEY`, `MPI_INFO_GET_VALUELEN`, and `MPI_INFO_GET` must retain all (key,value) pairs so that layered functionality can also use the Info object.

24. Section 11.3 on page 494.  
`MPI_PROC_NULL` is a valid target rank in the MPI RMA calls `MPI_ACCUMULATE`, `MPI_GET`, and `MPI_PUT`. The effect is the same as for `MPI_PROC_NULL` in MPI point-to-point communication. See also item 25 in this list.
25. Section 11.3 on page 494.  
 After any RMA operation with rank `MPI_PROC_NULL`, it is still necessary to finish the RMA epoch with the synchronization method that started the epoch. See also item 24 in this list.
26. Section 11.3.4 on page 500.  
`MPI_REPLACE` in `MPI_ACCUMULATE`, like the other predefined operations, is defined only for the predefined MPI datatypes.
27. Section 13.2.8 on page 573.  
 About `MPI_FILE_SET_VIEW` and `MPI_FILE_SET_INFO`: When an info object that specifies a subset of valid hints is passed to `MPI_FILE_SET_VIEW` or `MPI_FILE_SET_INFO`, there will be no effect on previously set or defaulted hints that the info does not specify.
28. Section 13.2.8 on page 573.  
 About `MPI_FILE_GET_INFO`: If no hint exists for the file associated with `fh`, a handle to a newly created info object is returned that contains no key/value pair.
29. Section 13.3 on page 576.  
 If a file does not have the mode `MPI_MODE_SEQUENTIAL`, then `MPI_DISPLACEMENT_CURRENT` is invalid as `disp` in `MPI_FILE_SET_VIEW`.
30. Section 13.5.2 on page 613.  
 The bias of 16 byte doubles was defined with 10383. The correct value is 16383.
31. MPI-2.2, Section 16.1.4 (Section was removed in MPI-3.0).  
 In the example in this section, the buffer should be declared as `const void* buf`.
32. Section 18.1.9 on page 721.  
 About `MPI_TYPE_CREATE_F90_XXX`:  

*Advice to implementors.* An application may often repeat a call to `MPI_TYPE_CREATE_F90_XXX` with the same combination of (XXX,p,r). The application is not allowed to free the returned predefined, unnamed datatype handles. To prevent the creation of a potentially huge amount of handles, the MPI implementation should return the same datatype handle for the same (REAL/COMPLEX/INTEGER,p,r) combination. Checking for the combination (p,r) in the preceding call to `MPI_TYPE_CREATE_F90_XXX` and using a hash-table to find formerly generated handles should limit the overhead of finding a previously generated datatype with same combination of (XXX,p,r). (*End of advice to implementors.*)

1  
2  
3  
4  
5  
6  
7  
8  
9  
10  
11  
12  
13  
14  
15  
16  
17  
18  
19  
20  
21  
22  
23  
24  
25  
26  
27  
28  
29  
30  
31  
32  
33  
34  
35  
36  
37  
38  
39  
40  
41  
42  
43  
44  
45  
46  
47  
48

33. Section [A.1.1](#) on page [767](#).

MPI\_BOTTOM is defined as `void * const MPI::BOTTOM`.

DRAFT

# Bibliography

- [1] Reverse domain name notation convention. <https://docs.oracle.com/javase/tutorial/java/package6.4.2>
- [2] V. Bala and S. Kipnis. Process groups: a mechanism for the coordination of and communication among processes in the Venus collective communication library. Technical report, IBM T. J. Watson Research Center, October 1992. Preprint. 1.2
- [3] V. Bala, S. Kipnis, L. Rudolph, and Marc Snir. Designing efficient, scalable, and portable collective communication libraries. Technical report, IBM T. J. Watson Research Center, October 1992. Preprint. 1.2
- [4] Purushotham V. Bangalore, Nathan E. Doss, and Anthony Skjellum. MPI++: Issues and Features. In *OODN-SKI '94*, page in press, 1994. 6.1
- [5] A. Beguelin, J. Dongarra, A. Geist, R. Manchek, and V. Sunderam. Visualization and debugging in a heterogeneous environment. *IEEE Computer*, 26(6):88--95, June 1993. 1.2
- [6] Luc Bomans and Rolf Hempel. The Argonne/GMD macros in FORTRAN for portable parallel programming and their implementation on the Intel iPSC/2. *Parallel Computing*, 15:119--132, 1990. 1.2
- [7] Dan Bonachea and Jason Duell. Problems with using MPI 1.1 and 2.0 as compilation targets for parallel language implementations. *IJHPCN*, 1(1/2/3):91--99, 2004. 11.7
- [8] Rajesh Bordawekar, Juan Miguel del Rosario, and Alok Choudhary. Design and evaluation of primitives for parallel I/O. In *Proceedings of Supercomputing '93*, pages 452--461, 1993. 13.1
- [9] R. Butler and E. Lusk. User's guide to the p4 programming system. Technical Report TM-ANL--92/17, Argonne National Laboratory, 1992. 1.2
- [10] Ralph Butler and Ewing Lusk. Monitors, messages, and clusters: The p4 parallel programming system. *Parallel Computing*, 20(4):547--564, April 1994. Also Argonne National Laboratory Mathematics and Computer Science Division preprint P362-0493. 1.2
- [11] Robin Calkin, Rolf Hempel, Hans-Christian Hoppe, and Peter Wypior. Portable programming with the PARMACS message-passing library. *Parallel Computing*, 20(4):615--632, April 1994. 1.2

- 1 [12] S. Chittor and R. J. Enbody. Performance evaluation of mesh-connected  
2 wormhole-routed networks for interprocessor communication in  
3 multicomputers. In *Proceedings of the 1990 Supercomputing Conference*,  
4 pages 647--656, 1990. [7.1](#)
- 5  
6 [13] S. Chittor and R. J. Enbody. Predicting the effect of mapping on  
7 the communication performance of large multicomputers. In *Proceedings*  
8 *of the 1991 International Conference on Parallel Processing, vol. II*  
9 *(Software)*, pages II--1--II--4, 1991. [7.1](#)
- 10 [14] Parasoft Corporation. Express version 1.0: A communication  
11 environment for parallel computers, 1988. [1.2](#)
- 12  
13 [15] Yiannis Cotronis, Anthony Danalis, Dimitrios S. Nikolopoulos, and Jack  
14 Dongarra, editors. *Recent Advances in the Message Passing Interface*  
15 *- 18th European MPI Users' Group Meeting, EuroMPI 2011, Santorini,*  
16 *Greece, September 18-21, 2011. Proceedings*, volume 6960 of *Lecture*  
17 *Notes in Computer Science*. Springer, 2011. [17](#), [37](#)
- 18  
19 [16] Juan Miguel del Rosario, Rajesh Bordawekar, and Alok Choudhary.  
20 Improved parallel I/O via a two-phase run-time access strategy. In  
21 *IPPS '93 Workshop on Input/Output in Parallel Computer Systems*, pages  
22 56--70, 1993. Also published in *Computer Architecture News* 21(5),  
23 December 1993, pages 31--38. [13.1](#)
- 24 [17] James Dinan, Sriram Krishnamoorthy, Pavan Balaji, Jeff R. Hammond,  
25 Manojkumar Krishnan, Vinod Tipparaju, and Abhinav Vishnu. Noncollective  
26 communicator creation in MPI. In Cotronis et al. [15], pages 282--291.  
27 [6.4.2](#)
- 28  
29 [18] J. Dongarra, A. Geist, R. Manchek, and V. Sunderam. Integrated PVM  
30 framework supports heterogeneous network computing. *Computers in*  
31 *Physics*, 7(2):166--75, April 1993. [1.2](#)
- 32  
33 [19] J. J. Dongarra, R. Hempel, A. J. G. Hey, and D. W. Walker. A proposal  
34 for a user-level, message passing interface in a distributed memory  
35 environment. Technical Report TM-12231, Oak Ridge National Laboratory,  
36 February 1993. [1.2](#)
- 37 [20] Edinburgh Parallel Computing Centre, University of Edinburgh. *CHIMP*  
38 *Concepts*, June 1991. [1.2](#)
- 39  
40 [21] Edinburgh Parallel Computing Centre, University of Edinburgh. *CHIMP*  
41 *Version 1.0 Interface*, May 1992. [1.2](#)
- 42  
43 [22] D. Feitelson. Communicators: Object-based multiparty interactions for  
44 parallel programming. Technical Report 91-12, Dept. Computer Science,  
45 The Hebrew University of Jerusalem, November 1991. [6.1.2](#)
- 46 [23] Message Passing Interface Forum. MPI: A Message-Passing Interface  
47 standard. *The International Journal of Supercomputer Applications and*  
48 *High Performance Computing*, 8, 1994. [1.3](#)

- [24] Message Passing Interface Forum. MPI: A Message-Passing Interface standard (version 1.1). Technical report, 1995. <http://www.mpi-forum.org>. 1.3
- [25] Al Geist, Adam Beguelin, Jack Dongarra, Weicheng Jiang, Bob Manchek, and Vaidy Sunderam. *PVM: Parallel Virtual Machine---A User's Guide and Tutorial for Network Parallel Computing*. MIT Press, 1994. 10.1
- [26] G. A. Geist, M. T. Heath, B. W. Peyton, and P. H. Worley. PICL: A portable instrumented communications library, C reference manual. Technical Report TM-11130, Oak Ridge National Laboratory, Oak Ridge, TN, July 1990. 1.2
- [27] D. Gregor, T. Hoefler, B. Barrett, and A. Lumsdaine. Fixing probe for multi-threaded MPI applications. Technical Report 674, Indiana University, Jan. 2009. 3.8.2
- [28] William D. Gropp and Barry Smith. Chameleon parallel programming tools users manual. Technical Report ANL-93/23, Argonne National Laboratory, March 1993. 1.2
- [29] Michael Hennecke. A Fortran 90 interface to MPI version 1.1. Technical Report Internal Report 63/96, Rechenzentrum, Universität Karlsruhe, D-76128 Karlsruhe, Germany, June 1996. Available via world wide web from [http://www.uni-karlsruhe.de/~Michael.Hennecke/Publications/#MPI\\_F90](http://www.uni-karlsruhe.de/~Michael.Hennecke/Publications/#MPI_F90). 18.1.3
- [30] T. Hoefler, G. Bronevetsky, B. Barrett, B. R. de Supinski, and A. Lumsdaine. Efficient MPI support for advanced hybrid programming models. In *Recent Advances in the Message Passing Interface (EuroMPI'10)*, volume LNCS 6305, pages 50--61. Springer, Sep. 2010. 3.8.1, 3.8.2
- [31] T. Hoefler, P. Gottschling, A. Lumsdaine, and W. Rehm. Optimizing a conjugate gradient solver with non-blocking collective operations. *Elsevier Journal of Parallel Computing (PARCO)*, 33(9):624--633, Sep. 2007. 5.12
- [32] T. Hoefler, F. Lorenzen, and A. Lumsdaine. Sparse non-blocking collectives in quantum mechanical calculations. In *Recent Advances in Parallel Virtual Machine and Message Passing Interface, 15th European PVM/MPI Users' Group Meeting*, volume LNCS 5205, pages 55--63. Springer, Sep. 2008. 7.6
- [33] T. Hoefler and A. Lumsdaine. Message progression in parallel computing --- to thread or not to thread? In *Proceedings of the 2008 IEEE International Conference on Cluster Computing*. IEEE Computer Society, Oct. 2008. 5.12

- [34] T. Hoefler, A. Lumsdaine, and W. Rehm. Implementation and performance analysis of non-blocking collective operations for MPI. In *Proceedings of the 2007 International Conference on High Performance Computing, Networking, Storage and Analysis, SC07*. IEEE Computer Society/ACM, Nov. 2007. [5.12](#)
- [35] T. Hoefler, M. Schellmann, S. Gorlatch, and A. Lumsdaine. Communication optimization for medical image reconstruction algorithms. In *Recent Advances in Parallel Virtual Machine and Message Passing Interface, 15th European PVM/MPI Users' Group Meeting*, volume LNCS 5205, pages 75--83. Springer, Sep. 2008. [5.12](#)
- [36] T. Hoefler and J. L. Traeff. Sparse collective operations for MPI. In *Proceedings of the 23rd IEEE International Parallel & Distributed Processing Symposium, HIPS'09 Workshop*, May 2009. [7.6](#)
- [37] Torsten Hoefler and Marc Snir. Writing parallel libraries with MPI --- common practice, issues, and extensions. In Cotronis et al. [[15](#)], pages 345--355. [6.4.2](#)
- [38] Daniel J. Holmes, Bradley Morgan, Anthony Skjellum, Purushotham V. Bangalore, and Srinivas Sridharan. Planning for performance: Enhancing achievable performance for MPI through persistent collective operations. *Parallel Computing*, 81:32 -- 57, 2019. [5.13](#)
- [39] Institute of Electrical and Electronics Engineers, New York. *IEEE Standard for Binary Floating-Point Arithmetic, IEEE Standard 754-2008*, 2008. [13.5.2](#)
- [40] International Organization for Standardization, Geneva, ISO 8859-1:1987. *Information processing --- 8-bit single-byte coded graphic character sets --- Part 1: Latin alphabet No. 1*, 1987. [13.5.2](#)
- [41] International Organization for Standardization, Geneva, ISO/IEC 9945-1:1996(E). *Information technology --- Portable Operating System Interface (POSIX) --- Part 1: System Application Program Interface (API) [C Language]*, December 1996. [10.6](#), [13.2.1](#)
- [42] International Organization for Standardization, Geneva, ISO/IEC 1539-1:2010. *Information technology -- Programming languages -- Fortran -- Part 1: Base language*, November 2010. [18.1.1](#), [18.1.2](#)
- [43] International Organization for Standardization, ISO/IEC/SC22/WG5 (Fortran), Geneva, TS 29113. *TS on further interoperability with C*, 2012. <http://www.nag.co.uk/sc22wg5/>, successfully balloted DTS at <ftp://ftp.nag.co.uk/sc22wg5/N1901-N1950/N1917.pdf>. [18.1.1](#), [18.1.1](#), [18.1.2](#), [18.1.7](#), [28](#)
- [44] Charles H. Koelbel, David B. Loveman, Robert S. Schreiber, Guy L. Steele Jr., and Mary E. Zosel. *The High Performance Fortran Handbook*. MIT Press, 1993. [4.1.4](#)



- [45] David Kotz. Disk-directed I/O for MIMD multiprocessors. In *Proceedings of the 1994 Symposium on Operating Systems Design and Implementation*, pages 61--74, November 1994. Updated as Dartmouth TR PCS-TR94-226 on November 8, 1994. [13.1](#)
- [46] O. Krämer and H. Mühlenbein. Mapping strategies in message-based multiprocessor systems. *Parallel Computing*, 9:213--225, 1989. [7.1](#)
- [47] S. J. Lefflet, R. S. Fabry, W. N. Joy, P. Lapsley, S. Miller, and C. Torek. An advanced 4.4BSD interprocess communication tutorial, Unix programmer's supplementary documents (PSD) 21. Technical report, Computer Systems Research Group, Department of Electrical Engineering and Computer Science, University of California, Berkeley, 1993. Also available at <http://www.netbsd.org/Documentation/lite2/psd/>. [10.10.5](#)
- [48] Bradley Morgan, Daniel J. Holmes, Anthony Skjellum, Purushotham Bangalore, and Srinivas Sridharan. Planning for performance: Persistent collective operations for MPI. In *Proceedings of the 24th European MPI Users' Group Meeting, EuroMPI '17*, pages 4:1--4:11, New York, NY, USA, 2017. ACM. [5.13](#)
- [49] nCUBE Corporation. *nCUBE 2 Programmers Guide, r2.0*, December 1990. [1.2](#)
- [50] Bill Nitzberg. Performance of the iPSC/860 Concurrent File System. Technical Report RND-92-020, NAS Systems Division, NASA Ames, December 1992. [13.1](#)
- [51] William J. Nitzberg. *Collective Parallel I/O*. PhD thesis, Department of Computer and Information Science, University of Oregon, December 1995. [13.1](#)
- [52] *4.4BSD Programmer's Supplementary Documents (PSD)*. O'Reilly and Associates, 1994. [10.10.5](#)
- [53] Paul Pierce. The NX/2 operating system. In *Proceedings of the Third Conference on Hypercube Concurrent Computers and Applications*, pages 384--390. ACM Press, 1988. [1.2](#)
- [54] Martin Schulz and Bronis R. de Supinski. P<sup>N</sup>MPI tools: A whole lot greater than the sum of their parts. In *ACM/IEEE Supercomputing Conference (SC)*, pages 1--10. ACM, 2007. [14.2.8](#)
- [55] K. E. Seamons, Y. Chen, P. Jones, J. Jozwiak, and M. Winslett. Server-directed collective I/O in Panda. In *Proceedings of Supercomputing '95*, December 1995. [13.1](#)
- [56] A. Skjellum and A. Leung. Zipcode: a portable multicomputer communication library atop the reactive kernel. In D. W. Walker and Q. F. Stout, editors, *Proceedings of the Fifth Distributed Memory Concurrent Computing Conference*, pages 767--776. IEEE Press, 1990. [1.2](#), [6.1.2](#)

- 1 [57] A. Skjellum, S. Smith, C. Still, A. Leung, and M. Morari. The Zipcode  
2 message passing system. Technical report, Lawrence Livermore National  
3 Laboratory, September 1992. [1.2](#)  
4
- 5 [58] Anthony Skjellum, Nathan E. Doss, and Purushotham V. Bangalore.  
6 Writing Libraries in MPI. In Anthony Skjellum and Donna S. Reese,  
7 editors, *Proceedings of the Scalable Parallel Libraries Conference*,  
8 pages 166--173. IEEE Computer Society Press, October 1993. [6.1](#)  
9
- 10 [59] Anthony Skjellum, Nathan E. Doss, and Kishore Viswanathan.  
11 Inter-communicator extensions to MPI in the MPIX (MPI  
12 eXtension) Library. Technical Report MSU-940722, Mississippi  
13 State University --- Dept. of Computer Science, April 1994.  
14 <http://www.erc.msstate.edu/mpi/mpix.html>. [5.2.2](#)
- 15 [60] Anthony Skjellum, Steven G. Smith, Nathan E. Doss, Alvin P. Leung,  
16 and Manfred Morari. The Design and Evolution of Zipcode. *Parallel*  
17 *Computing*, 20(4):565--596, April 1994. [6.1.2](#), [6.5.6](#)  
18
- 19 [61] The Internet Society. XDR: External Data Representation Standard,  
20 2008. <http://www.rfc-editor.org/pdfrfc/rfc4506.txt.pdf>. [13.5.2](#)  
21
- 22 [62] Rajeev Thakur and Alok Choudhary. An extended two-phase method for  
23 accessing sections of out-of-core arrays. *Scientific Programming*,  
24 5(4):301--317, Winter 1996. [13.1](#)
- 25 [63] *The Unicode Standard, Version 2.0*. Addison-Wesley, 1996. ISBN  
26 0-201-48345-9. [13.5.2](#)  
27
- 28 [64] D. Walker. Standards for message passing in a distributed memory  
29 environment. Technical Report TM-12147, Oak Ridge National Laboratory,  
30 August 1992. [1.2](#)  
31  
32  
33  
34  
35  
36  
37  
38  
39  
40  
41  
42  
43  
44  
45  
46  
47  
48

# General Index

This index lists mainly terms of the MPI specification. The underlined page numbers refer to the definitions or parts of the definition of the terms. Bold face numbers mark section titles.

- absolute addresses, [16](#), [106](#), [739](#)
- access epoch, [514](#)
- action
  - in function names, [10](#)
- active, [55](#), [322](#)
- active target communication, [514](#)
- addresses, [121](#)
  - absolute, [16](#), [106](#), [739](#)
  - correct use, [121](#)
  - relative displacement, [16](#), [106](#)
- alignment, [384](#), [483](#), [485](#), [910](#)
- all-reduce, [195](#)
  - nonblocking, [219](#)
  - persistent, [237](#)
- all-to-all, [176](#)
  - nonblocking, [215](#)
  - persistent, [233](#)
- array arguments, [14](#)
- assertions, [528](#)
- ASYNCHRONOUS
  - Fortran attribute, [740](#)
- attribute, [253](#), [300](#), [759](#)
  - caching, [252](#)
- backward incompatibilities, [701](#)
- barrier synchronization, [155](#)
  - nonblocking, [207](#)
  - persistent, [225](#)
- blocking, [11](#), [39](#), [42](#), [579](#)
  - I/O, [580](#)
- bounds of datatypes, [112](#)
- broadcast, [156](#)
  - nonblocking, [208](#)
  - persistent, [225](#)
- buffer allocation, [47](#)
- buffered, [40](#), [50](#), [51](#)
  - nonblocking, [50](#)
- buffered send, [43](#)
- C
  - language binding, [18](#)
- caching, [251](#), [252](#), [300](#)
- callback functions
  - language interoperability, [758](#)
  - prototype definitions, [782](#)
    - deprecated, [788](#)
- cancel, [19](#), [56](#), [68](#), [75](#), [424](#), [696](#), [909](#)
- canonical pack and unpack, [144](#)
- Cartesian
  - topology, [326](#), [328](#)
- change-log, [909](#)
- choice, [16](#)
- class
  - in function names, [10](#)
- clock synchronization, [382](#)
- collective, [11](#), [579](#)
- collective communication, [149](#)
  - correctness, [241](#)
  - file data access operations, [598](#)
  - neighborhood, [351](#)
  - nonblocking, [205](#)
- commit, [115](#)
- COMMON blocks, [743](#)
- communication, [477](#)
  - collective, [149](#)
  - modes, [39](#)
  - one-sided, [477](#)
  - point-to-point, [25](#)
  - RMA, [477](#)
- communicator, [29](#), [251](#), [252](#)
- completes
  - operation, [11](#)
- completion, [55](#)
  - multiple, [60](#)
- connected, [473](#)
- constants, [15](#), [763](#), [767](#)
- context, [251](#), [252](#), [254](#)
- control variables
  - tools interface, [650](#)
- conversion, [38](#)
- counts, [17](#)
- create
  - in function names, [10](#)

- 1 data, [27](#)
- 2 data conversion, [38](#)
- 3 datatypes, [87](#), [757](#)
- 4 default file error, [631](#)
- 5 delete
  - 6 in function names, [10](#)
- 7 deprecated interfaces, [17](#), [693](#)
- 8 derived datatype, [12](#), [87](#), [735](#)
- 9 disconnected, [473](#)
- 10 displacement, [563](#), [577](#)
- 11 distributed graph
  - 12 topology, [326](#), [332](#)
- 13 Dynamic Process Model, [415](#)
- 14 dynamically attached memory, [486](#)
- 15 elementary datatype, [563](#), [577](#)
- 16 empty, [55](#)
- 17 end of file, [565](#)
- 18 envelope, [25](#), [29](#)
- 19 environmental inquiries, [381](#)
- 20 equivalent datatypes, [12](#)
- 21 error handling, [20](#), [386](#)
  - 22 default file error handler, [566](#), [569](#), [631](#)
  - 23 error codes and classes, [397](#), [398](#)
  - 24 error handlers, [389](#), [398](#), [759](#)
  - 25 finalize, [21](#), [425](#), [473](#)
  - 26 I/O, [630](#), [631](#)
  - 27 initial error handler, [21](#), [387](#), [417](#), [425](#), [458](#)
  - 28 one-sided communication, [530](#)
  - 29 process failure, [21](#), [473](#)
  - 30 program error, [21](#)
  - 31 resource error, [21](#)
  - 32 startup, [21](#), [417](#), [458](#)
  - 33 transmission failure, [20](#)
- 34 establishing communication, [460](#)
- 35 etype, [563](#), [577](#)
- 36 events
  - 37 tools interface, [669](#)
- 38 exception, [386](#)
- 39 exclusive scan
  - 40 nonblocking, [223](#)
  - 41 persistent, [241](#)
- 42 explicit offsets, [580](#), [582](#)
- 43 exposure epoch, [514](#)
- 44 extent of datatypes, [88](#), [111](#), [112](#)
  - 45 true extent, [114](#)
- 46 external32
  - 47 file data representation, [611](#)
- 48 extra-state, [763](#)
- fairness, [44](#), [65](#)
- file, [563](#)
  - data access, [579](#)
  - collective operations, [598](#)
  - explicit offsets, [582](#)
  - individual file pointers, [587](#)
  - seek, [600](#)
  - shared file pointers, [595](#)
  - split collective, [602](#)
- end of file, [565](#)
- filetype, [564](#)
- handle, [565](#)
- interoperability, [609](#)
- manipulation, [565](#)
- offset, [16](#), [564](#)
- pointer, [565](#)
- size, [565](#)
- view, [563](#), [564](#), [576](#)
- file size, [626](#)
- finalize, [422](#)
- finished, [425](#)
- Fortran
  - language binding, [18](#), [703](#)
- Fortran support, [703](#)
- gather, [157](#)
  - nonblocking, [209](#)
  - persistent, [226](#)
- gather-to-all, [173](#)
  - nonblocking, [213](#)
  - persistent, [231](#)
- general datatype, [87](#)
- generalized requests, [553](#), [553](#)
- get
  - in function names, [10](#)
- graph
  - topology, [326](#), [330](#)
- group, [251](#), [252](#), [254](#), [291](#)
- group objects, [254](#)
- handles, [12](#), [752](#)
- host rank, [381](#)
- immediate, [51](#)
- inactive, [55](#)
- inclusive scan, [202](#)
  - nonblocking, [222](#)
  - persistent, [240](#)
- independent, [473](#)
- individual file pointers, [580](#), [587](#)
- info object, [407](#)
  - file info, [573](#)
  - keys, [789](#)
  - values, [790](#)
- initial error handler, [21](#)
- initiation, [51](#)
- inter-communication, [253](#), [290](#)
- inter-communicator, [253](#), [290](#)
  - collective operations, [153](#), [154](#)

- interlanguage communication, [764](#)
- internal
  - file data representation, [610](#)
- interoperability, [609](#)
- intra-communication, [253](#), [290](#)
- intra-communicator, [252](#), [290](#)
  - collective operations, [152](#)
- intra-communicator objects, [255](#)
- I/O, [563](#)
- IO rank, [382](#)
- is
  - in function names, [10](#)
- language binding, [17](#), [703](#)
  - interoperability, [751](#)
  - summary, [767](#)
- lb\_marker, [100](#), [104](#), [110](#), [110](#), [115](#)
  - erased, [113](#)
- local, [11](#), [40](#)
- local group, [268](#)
- loosely synchronous model, [321](#)
- lower bound, [110](#)
- lower-bound markers, [110](#)
- macros, [20](#)
- main thread, [445](#)
- matched receives, [73](#)
- matching
  - type, [35](#), [118](#), [625](#)
- matching probe, [71](#)
- memory
  - alignment, [384](#), [483](#), [485](#), [910](#)
  - allocation, [383](#), [481](#), [483](#)
  - system, [12](#)
- memory model, [478](#), [513](#)
  - separate, [478](#), [485](#)
  - unified, [478](#), [485](#)
- message, [25](#)
  - data, [27](#)
  - envelope, [29](#)
- modes, [39](#)
- module variables, [743](#)
- mpi module
  - Fortran support, [707](#)
- MPI process initialization, [415](#)
  - Dynamic Process Model, [415](#)
  - Sessions Model, [566](#)
  - Sessions Model, [255](#), [258](#), [381](#), [415](#), [445](#)
  - World Model, [255](#), [258](#), [381](#), [415](#), [445](#), [566](#), [631](#)
- mpi\_f08 module
  - Fortran support, [704](#)
- MPI\_SIZEOF and storage\_size, [19](#), [697](#), [727–729](#)
- mpiexec, [418](#), [441](#), [442](#), [442](#)
- mpif.h include file
  - Fortran support, [709](#)
- mpirun, [442](#)
- multiple completions, [60](#)
- named datatype, [12](#)
- names, [460](#)
  - name publishing, [465](#)
- naming objects, [317](#)
- native
  - file data representation, [610](#)
- neighborhood collective communication, [351](#)
  - nonblocking, [362](#)
- non-local, [11](#), [39](#), [40](#)
- nonblocking, [11](#), [49](#), [494](#), [579](#)
  - communication, [49](#)
  - completion, [55](#)
  - Fortran problems, [738](#)
  - I/O, [580](#)
  - initiation, [51](#)
  - request objects, [51](#)
- null handle, [55](#)
- null processes, [85](#)
- offset, [16](#), [564](#)
- one-sided communication, [477](#)
  - Fortran problems, [739](#)
- opaque objects, [12](#), [757](#)
- operation completes, [11](#)
- origin, [478](#)
- pack, [138](#)
  - canonical, [144](#)
- packing unit, [140](#)
- parallel procedure, [322](#)
- passive target communication, [514](#)
- performance variables
  - tools interface, [657](#)
- persistent communication requests, [58](#), [77](#)
  - collective persistent, [223](#), [367](#)
  - Fortran problems, [739](#)
- PMPI\_, [637](#)
- point-to-point communication, [25](#)
- portable datatype, [12](#)
- ports, [460](#)
- predefined datatype, [12](#)
- predefined reduction operations, [184](#)
- private window copy, [512](#)
- probe, [68](#)
- probe, matching, [71](#)
- process creation, [415](#)
- process failures, [21](#)
- process group, [29](#)
- processes, [20](#)

- 1 processor name, [382](#)
- 2 profiling interface, [637](#)
- 3 program error, [21](#)
- 4 prototype definitions, [782](#)
- 5     deprecated, [788](#)
- 6 public window copy, [512](#)
- 7
- 8 rank, [254](#)
- 9 ready, [40](#), [50](#), [51](#)
- 10     nonblocking, [50](#)
- 11 ready send, [42](#)
- 12 receive, [25](#), [26](#), [30](#)
- 13     buffer, [26](#)
- 14     complete, [50](#)
- 15     context, [291](#)
- 16     start call, [50](#)
- 17 reduce, [182](#)
- 18     nonblocking, [218](#)
- 19     persistent, [236](#)
- 20 reduce-scatter, [198](#)
- 21     nonblocking, [220](#), [221](#)
- 22     persistent, [238](#), [239](#)
- 23 reduction operations, [181](#), [759](#)
- 24     predefined, [184](#)
- 25     process-local, [197](#)
- 26     scan, [202](#)
- 27     user-defined, [191](#)
- 28 related, [140](#)
- 29 relative displacement, [16](#), [106](#)
- 30 remote group, [268](#)
- 31 Remote Memory Access, *see* RMA
- 32 removed interfaces, [17](#), [699](#)
- 33 request complete
- 34     I/O, [580](#)
- 35 request objects, [51](#)
- 36 resource error, [21](#)
- 37 RMA, [477](#)
- 38     communication calls, [494](#)
- 39     request-based, [507](#)
- 40     memory model, [512](#)
- 41     synchronization calls, [514](#)
- 42 scan, [202](#)
- 43     inclusive, [202](#)
- 44 scatter, [167](#)
- 45     nonblocking, [211](#)
- 46     persistent, [229](#)
- 47 seek, [600](#)
- 48 semantics
- file consistency, [620](#)
- nonblocking communications, [59](#)
- point-to-point communication, [43](#)
- semantics and correctness
- one-sided communication, [530](#)
- send, [25](#), [26](#)
- buffer, [25](#)
- complete, [49](#)
- context, [291](#)
- start, [49](#)
- send-receive, [83](#)
- separate memory model, [478](#), [485](#), [513](#)
- sequential storage, [121](#)
- Sessions Model, [566](#)
- Sessions Model, [255](#), [258](#), [381](#), [415](#), [445](#)
- set
- in function names, [10](#)
- shared file pointers, [580](#), [595](#)
- shared memory allocation, [483](#)
- signals, [22](#)
- singleton init, [471](#)
- size changing
- I/O, [626](#)
- source, [291](#)
- split collective, [579](#), [602](#)
- standard, [39](#), [50](#)
- nonblocking, [50](#)
- standard send, [43](#)
- started, [425](#)
- starting processes, [448](#), [449](#)
- startup, [416](#)
- portable, [442](#)
- state, [14](#)
- status, [32](#), [754](#)
- associating information, [560](#)
- ignore, [34](#)
- test, [67](#)
- strong synchronization, [515](#)
- synchronization, [477](#), [494](#)
- synchronization calls
- RMA, [514](#)
- synchronous, [40](#), [50](#), [51](#), [55](#)
- nonblocking, [50](#)
- synchronous send, [42](#)
- system memory, [12](#)
- tag values, [381](#)
- target, [478](#)
- thread compliant, [420](#), [444](#)
- threads, [444](#)
- timers and synchronization, [405](#)
- tool information interface, [643](#)
- tool support, [637](#)
- topologies, [325](#)
- topology
- Cartesian, [326](#), [328](#)
- distributed graph, [326](#), [332](#)
- graph, [326](#), [330](#)
- virtual, [326](#)

transmission failures, <a href="#">20</a>	1
true extent of datatypes, <a href="#">114</a>	2
type map, <a href="#">88</a>	3
type matching, <a href="#">35</a> , <a href="#">118</a>	4
type signature, <a href="#">88</a>	5
types, <a href="#">781</a>	6
ub_marker, <a href="#">100</a> , <a href="#">104</a> , <a href="#">105</a> , <a href="#">110</a> , <a href="#">110</a> , <a href="#">115</a>	7
erased, <a href="#">113</a>	8
unified memory model, <a href="#">478</a> , <a href="#">485</a> , <a href="#">513</a>	9
universe size, <a href="#">470</a>	10
unnamed datatype, <a href="#">12</a>	11
unpack, <a href="#">138</a>	12
canonical, <a href="#">144</a>	13
upper bound, <a href="#">110</a>	14
upper-bound markers, <a href="#">110</a>	15
user functions at process termination, <a href="#">426</a>	16
user-defined data representations, <a href="#">616</a>	17
user-defined reduction operations, <a href="#">191</a>	18
verbosity levels	19
tools interface, <a href="#">644</a>	20
version inquiries, <a href="#">379</a>	21
view, <a href="#">563</a> , <a href="#">564</a> , <a href="#">576</a>	22
virtual topology, <a href="#">252</a> , <a href="#">253</a> , <a href="#">326</a>	23
weak synchronization, <a href="#">515</a>	24
window	25
allocation, <a href="#">481</a>	26
creation, <a href="#">479</a>	27
dynamically attached memory, <a href="#">486</a>	28
shared memory allocation, <a href="#">483</a>	29
World Model, <a href="#">255</a> , <a href="#">258</a> , <a href="#">381</a> , <a href="#">415</a> , <a href="#">445</a> , <a href="#">566</a> , <a href="#">631</a>	30
	31
	32
	33
	34
	35
	36
	37
	38
	39
	40
	41
	42
	43
	44
	45
	46
	47
	48

# Examples Index

This index lists code examples throughout the text. Some examples are referred to by content; others are listed by the major MPI function that they are demonstrating. MPI functions listed in all capital letter are Fortran examples; MPI functions listed in mixed case are C examples.

- ASYNCHRONOUS, [547](#), [747](#), [749](#)
- Attributes between languages, [760](#)
- Basic tool using performance variables in the MPI tool information interface, [667](#)
- C/Fortran handle conversion, [753](#)
- Cartesian virtual topologies, [373](#)
- Client-server code, [66](#)
  - with blocking probe, [69](#)
  - with blocking probe, wrong, [70](#)
- Datatype
  - 3D array, [129](#)
  - absolute addresses, [134](#)
  - array of structures, [131](#)
  - elaborate example, [142](#), [143](#)
  - matching type, [118](#)
  - matrix transpose, [130](#)
  - union, [135](#)
- Datatypes
  - matching, [36](#)
  - not matching, [36](#)
  - untyped, [36](#)
- Deadlock
  - if not buffered, [46](#)
  - with MPI\_Bcast, [242](#)
  - wrong message exchange, [45](#)
- False matching of collective operations, [245](#)
- Fortran 90
  - copying and sequence problem, [731](#), [733](#), [734](#)
  - derived types, [735](#)
  - heterogeneous communication, [728](#)
  - invalid KIND, [724](#)
  - MPI\_TYPE\_MATCH\_SIZE
    - implementation, [727](#)
  - overlapping communication and computation, [747](#), [748](#), [750](#)
  - register optimization, [738–740](#)
  - Independence of nonblocking operations, [248](#)
  - Intercommunicator, [272](#), [276](#)
  - Interlanguage communication, [764](#)
  - Intertwined matching pairs, [44](#)
  - Message exchange, [45](#)
  - Mixing blocking and nonblocking collective operations, [244](#)
  - Mixing collective and point-to-point requests, [247](#)
  - MPI\_ACCUMULATE, [502](#)
  - MPI\_Accumulate, [545](#), [546](#), [549](#)
  - MPI\_Aint, [131](#)
  - MPI\_Aint\_add, [549](#)
  - MPI\_Allgather, [175](#)
  - MPI\_ALLOC\_MEM, [385](#), [386](#)
  - MPI\_Alloc\_mem, [386](#), [549](#)
  - MPI\_ALLREDUCE, [196](#)
  - MPI\_Alltoall, [246](#)
  - MPI\_ASYNC\_PROTECTS\_NONBLOCKING, [547](#)
  - MPI\_BARRIER, [438](#)
  - MPI\_Barrier, [424](#), [535–538](#), [544–546](#)
  - MPI\_Bcast, [157](#), [242–245](#)
  - MPI\_BSEND, [43](#), [44](#)
  - MPI\_Buffer\_attach, [48](#), [424](#)
  - MPI\_Buffer\_detach, [48](#)
  - MPI\_BYTE, [36](#)
  - MPI\_Cancel, [424](#)
  - MPI\_CART\_COORDS, [348](#)
  - MPI\_CART\_GET, [373](#)
  - MPI\_CART\_RANK, [348](#)
  - MPI\_CART\_SHIFT, [348](#), [373](#)
  - MPI\_CART\_SUB, [349](#)
  - MPI\_CHARACTER, [37](#)
  - MPI\_Comm\_create, [272](#), [285](#), [286](#), [288](#)
  - MPI\_COMM\_CREATE\_FROM\_GROUP, [434](#), [438](#)
  - MPI\_Comm\_create\_keyval, [315](#)
  - MPI\_Comm\_dup, [287](#)
  - MPI\_Comm\_get\_attr, [315](#)



- MPI\_Comm\_group, 272, 288, 315
- MPI\_Comm\_remote\_size, 276
- MPI\_Comm\_set\_attr, 315
- MPI\_COMM\_SPAWN, 452
- MPI\_Comm\_spawn, 452
- MPI\_COMM\_SPAWN\_MULTIPLE, 457
- MPI\_Comm\_spawn\_multiple, 457
- MPI\_Comm\_split, 276, 298, 299
- MPI\_Compare\_and\_swap, 546, 549
- MPI\_DIMS\_CREATE, 329, 373
- MPI\_DIST\_GRAPH\_CREATE, 337
- MPI\_Dist\_graph\_create, 338
- MPI\_DIST\_GRAPH\_CREATE\_ADJACENT, 337
- MPI\_F\_sync\_reg, 547
- MPI\_FILE\_CLOSE, 588, 591
- MPI\_FILE\_GET\_AMODE, 572
- MPI\_FILE\_IREAD, 591
- MPI\_FILE\_OPEN, 588, 591
- MPI\_FILE\_READ, 588
- MPI\_FILE\_SET\_ATOMICITY, 626
- MPI\_FILE\_SET\_VIEW, 588, 591
- MPI\_FILE\_SYNC, 627
- MPI\_Finalize, 423–425
- MPI\_FREE\_MEM, 385, 386
- MPI\_Free\_mem, 549
- MPI\_Gather, 143, 160, 161, 165
- MPI\_Gatherv, 143, 162–165
- MPI\_GET, 498, 499
- MPI\_Get, 535–538, 543, 544
- MPI\_Get\_accumulate, 545, 546, 549
- MPI\_GET\_ADDRESS, 107, 735, 736, 757
- MPI\_Get\_address, 131, 134, 135, 142
- MPI\_GET\_COUNT, 120
- MPI\_GET\_ELEMENTS, 120
- MPI\_GRAPH\_CREATE, 331, 344
- MPI\_GRAPH\_NEIGHBORS, 344
- MPI\_GRAPH\_NEIGHBORS\_COUNT, 344
- MPI\_Grequest\_complete, 558
- MPI\_Grequest\_start, 558
- MPI\_Group\_excl, 285
- MPI\_Group\_free, 272, 285, 286
- MPI\_GROUP\_FROM\_SESSION\_PSET, 434, 437, 438
- MPI\_Group\_incl, 272, 286, 288
- MPI\_Iallreduce, 247
- MPI\_Ialltoall, 246
- MPI\_Ibarrier, 244–247
- MPI\_Ibcast, 209, 247, 248
- MPI\_INFO\_CREATE, 434
- MPI\_INFO\_ENV, 418
- MPI\_INFO\_SET, 434
- MPI\_Intercomm\_create, 298, 299
- MPI\_Iprobe, 424
- MPI\_Irecv, 57–59, 66
- MPI\_Irecv, 247
- MPI\_ISEND, 57–59, 66
- MPI\_Op\_create, 194, 195, 204
- MPI\_Pack, 141–143
- MPI\_Pack\_size, 143
- MPI\_PROBE, 69, 70
- MPI\_Put, 520, 526, 536–538, 543, 544
- MPI\_RECV, 36, 37, 43–46, 59, 69, 70, 118
- MPI\_Recv, 246
- MPI\_REDUCE, 185, 186, 189
- MPI\_Reduce, 189, 190, 194, 195
- MPI\_REQUEST\_FREE, 58
- MPI\_Request\_free, 424
- MPI\_Rget, 548
- MPI\_Rput, 548
- MPI\_Scan, 204
- MPI\_Scatter, 170
- MPI\_Scatterv, 170, 171
- MPI\_SEND, 36, 37, 45, 46, 59, 69, 70, 118
- MPI\_Send, 131, 134, 135, 142, 246, 247
- MPI\_SENDRCV, 129, 130
- MPI\_SENDRCV\_REPLACE, 348
- MPI\_SESSION\_FINALIZE, 434, 437, 438
- MPI\_SESSION\_GET\_NTH\_PSET, 437, 438
- MPI\_SESSION\_GET\_NUM\_PSETS, 437, 438
- MPI\_SESSION\_INIT, 434, 437, 438
- MPI\_SSEND, 44, 59
- MPI\_Test\_cancelled, 424
- MPI\_TYPE\_COMMIT, 116, 129, 130, 498, 735, 736
- MPI\_Type\_commit, 131, 134, 135, 142, 161–165, 171, 204
- MPI\_TYPE\_CONTIGUOUS, 90, 110, 118, 120
- MPI\_Type\_contiguous, 161
- MPI\_TYPE\_CREATE\_DARRAY, 106
- MPI\_TYPE\_CREATE\_HVECTOR, 129, 130
- MPI\_Type\_create\_hvector, 131, 134
- MPI\_TYPE\_CREATE\_INDEXED\_BLOCK, 498
- MPI\_TYPE\_CREATE\_RESIZED, 735, 736
- MPI\_TYPE\_CREATE\_STRUCT, 98, 110, 130, 735, 736
- MPI\_Type\_create\_struct, 131, 134, 135, 142, 164, 165, 204
- MPI\_TYPE\_CREATE\_SUBARRAY, 635
- MPI\_TYPE\_EXTENT, 498
- MPI\_TYPE\_FREE, 498
- MPI\_Type\_get\_contents, 136
- MPI\_Type\_get\_envelope, 136
- MPI\_TYPE\_GET\_EXTENT, 129, 130, 499, 502
- MPI\_Type\_get\_extent, 131
- MPI\_TYPE\_INDEXED, 94, 129

- 1 MPI\_Type\_indexed, [131](#), [134](#)
- 2 MPI\_TYPE\_VECTOR, [91](#), [129](#), [130](#)
- 3 MPI\_Type\_vector, [162](#), [163](#), [165](#), [171](#)
- 4 MPI\_Unpack, [142](#), [143](#)
- 5 MPI\_User\_function, [195](#)
- 6 MPI\_WAIT, [57–59](#), [66](#), [591](#)
- 7 MPI\_Wait, [244–247](#)
- 8 MPI\_Waitall, [247](#), [548](#)
- 9 MPI\_WAITANY, [66](#)
- 10 MPI\_Waitany, [548](#)
- 11 MPI\_WAITSOME, [66](#)
- 12 MPI\_Win\_attach, [549](#)
- 13 MPI\_Win\_complete, [520](#), [538](#), [544](#)
- 14 MPI\_WIN\_CREATE, [498](#), [499](#), [502](#)
- 15 MPI\_Win\_create\_dynamic, [549](#)
- 16 MPI\_Win\_detach, [549](#)
- 17 MPI\_WIN\_FENCE, [498](#), [499](#), [502](#)
- 18 MPI\_Win\_fence, [543](#)
- 19 MPI\_Win\_flush, [537](#), [545](#), [546](#), [549](#)
- 20 MPI\_Win\_flush\_all, [546](#)
- 21 MPI\_Win\_flush\_local, [536](#)
- 22 MPI\_WIN\_FREE, [499](#), [502](#)
- 23 MPI\_Win\_lock, [526](#), [535–538](#)
- 24 MPI\_Win\_lock\_all, [547–549](#)
- 25 MPI\_Win\_post, [538](#), [544](#)
- 26 MPI\_Win\_start, [520](#), [538](#), [544](#)
- 27 MPI\_Win\_sync, [536](#), [537](#), [545](#), [546](#)
- 28     shared memory windows, [547](#)
- 29 MPI\_Win\_unlock, [526](#), [535–538](#)
- 30 MPI\_Win\_unlock\_all, [548](#), [549](#)
- 31 MPI\_Win\_wait, [538](#), [544](#)
- 32 mpiexec, [418](#), [443](#), [444](#)
- 33 Neighborhood collective communication, [373](#)
- 34 No Matching of Blocking and Nonblocking  
35     collective operations, [246](#)
- 36 Non-deterministic program with MPI\_Bcast,  
37     [243](#)
- 38 Non-overtaking messages, [43](#)
- 39 Nonblocking operations, [57](#), [58](#)
- 40     message ordering, [59](#)
- 41     progress, [59](#)
- 42 Overlapping Communicators, [247](#)
- 43 Pipelining nonblocking collective operations,  
44     [247](#)
- 45 Profiling interface, [640](#)
- 46 Progression of nonblocking collective  
47     operations, [246](#)
- 48 Reading the value of a control variable in the  
   MPI tool information interface, [656](#)
- Shared memory windows
  - MPI\_Win\_sync, [547](#)
  - Threads and MPI, [445](#)
  - Topologies, [373](#)
  - Typemap, [89–91](#), [94](#), [98](#), [106](#)
  - Using MPI\_T\_CVAR\_GET\_INFO to list all  
   names of control variables., [653](#)
  - Virtual topologies, [373](#)

# MPI Constant and Predefined Handle Index

This index lists predefined MPI constants and handles.

MPI::\_LONG\_LONG, 914  
MPI::BOOL, 914  
MPI::COMPLEX, 914  
MPI::DOUBLE\_COMPLEX, 914  
MPI::F\_COMPLEX16, 914  
MPI::F\_COMPLEX32, 914  
MPI::F\_COMPLEX4, 914  
MPI::F\_COMPLEX8, 914  
MPI::INTEGER16, 914  
MPI::LONG\_DOUBLE\_COMPLEX, 914  
MPI::LONG\_LONG, 914  
MPI::REAL16, 914  
MPI\_2DOUBLE\_PRECISION, 188, 773  
MPI\_2INT, 188, 773  
MPI\_2INTEGER, 188, 773  
MPI\_2REAL, 188, 773  
MPI\_ADDRESS\_KIND, 15, 16, 16, 28, 301, 730, 760, 770  
MPI\_AINT, 28, 29, 185, 488, 614, 771, 772, 919–922  
MPI\_ANY\_SOURCE, 30, 31, 31, 43, 54, 55, 68–73, 80, 83, 84, 281, 323, 382, 769  
MPI\_ANY\_TAG, 15, 30, 31, 31, 33, 54, 55, 68, 69, 71–75, 80, 83–85, 281, 769, 916  
MPI\_APPNUM, 472, 776  
MPI\_ARGV\_NULL, 16, 452, 456, 730, 778  
MPI\_ARGVS\_NULL, 16, 456, 730, 778  
MPI\_ASYNC\_PROTECTS\_NONBLOCKING, 15, 547, 704, 705, 707, 709, 712, 719, 721, 741, 770, 919  
MPI\_BAND, 184, 185, 774  
MPI\_BOR, 184, 185, 774  
MPI\_BOTTOM, 10, 15, 16, 34, 106, 121, 122, 152, 334, 336, 454, 487, 491, 706, 708, 715, 730, 735, 737, 739, 740, 742–744, 746, 757, 758, 764, 769, 926  
MPI\_BSEND\_OVERHEAD, 49, 769  
MPI\_BXOR, 184, 185, 774  
MPI\_BYTE, 27, 28, 35–38, 144, 185, 564, 610, 611, 614, 625, 764, 771, 772, 922  
MPI\_C\_BOOL, 28, 185, 614, 771, 914, 919–922  
MPI\_C\_COMPLEX, 28, 185, 614, 771, 914, 920–922  
MPI\_C\_DOUBLE\_COMPLEX, 28, 185, 614, 771, 920–922  
MPI\_C\_FLOAT\_COMPLEX, 185, 614, 771, 920–922  
MPI\_C\_LONG\_DOUBLE\_COMPLEX, 28, 185, 614, 771, 920–922  
MPI\_CART, 339, 775  
MPI\_CHAR, 28, 38, 98, 186, 187, 614, 648, 771, 919  
MPI\_CHARACTER, 27, 37, 38, 186, 187, 614, 772  
MPI\_COMBINER\_CONTIGUOUS, 123, 126, 777  
MPI\_COMBINER\_DARRAY, 123, 128, 777  
MPI\_COMBINER\_DUP, 123, 126, 777  
MPI\_COMBINER\_F90\_COMPLEX, 123, 128, 777  
MPI\_COMBINER\_F90\_INTEGER, 123, 128, 777  
MPI\_COMBINER\_F90\_REAL, 123, 128, 777  
MPI\_COMBINER\_HINDEXED, 19, 123, 127, 777  
MPI\_COMBINER\_HINDEXED\_BLOCK, 123, 127, 777, 916  
MPI\_COMBINER\_HINDEXED\_INTEGER, 19, 700, 915  
MPI\_COMBINER\_HVECTOR, 19, 123, 127, 777  
MPI\_COMBINER\_HVECTOR\_INTEGER, 19, 700, 915  
MPI\_COMBINER\_INDEXED, 123, 127, 777  
MPI\_COMBINER\_INDEXED\_BLOCK, 123, 127, 777  
MPI\_COMBINER\_NAMED, 123, 126, 777  
MPI\_COMBINER\_RESIZED, 123, 129, 777  
MPI\_COMBINER\_STRUCT, 19, 123, 128, 777  
MPI\_COMBINER\_STRUCT\_INTEGER, 19,

1	700, 915	MPI_DUP_FN, 19, 304, 694, 776
2	MPI_COMBINER_SUBARRAY, 123, 128, 777	MPI_ERR_ACCESS, 400, 569, 632, 768
3	MPI_COMBINER_VECTOR, 123, 126, 777	MPI_ERR_AMODE, 400, 567, 632, 768
4	MPI_COMM_DUP_FN, 19, 304, 775, 918	MPI_ERR_ARG, 399, 767
5	MPI_COMM_NULL, 255, 271, 272, 274–276,	MPI_ERR_ASSERT, 399, 531, 768
6	279, 280, 297, 319, 328, 330, 454, 474,	MPI_ERR_BAD_FILE, 400, 632, 768
7	475, 752, 774, 923	MPI_ERR_BASE, 385, 399, 531, 768
8	MPI_COMM_NULL_COPY_FN, 19, 304, 706,	MPI_ERR_BUFFER, 399, 767
9	759, 775, 918	MPI_ERR_COMM, 399, 767
10	MPI_COMM_NULL_DELETE_FN, 19, 304,	MPI_ERR_CONVERSION, 400, 619, 632, 768
11	775	MPI_ERR_COUNT, 399, 767
12	MPI_COMM_PARENT, 319	MPI_ERR_DIMS, 399, 767
13	MPI_COMM_SELF, 21, 255, 274, 282, 301,	MPI_ERR_DISP, 399, 531, 768
14	319, 387, 417, 422, 425, 427, 474, 566,	MPI_ERR_DUP_DATAREP, 400, 617, 632,
15	701, 773, 910, 921	768
16	MPI_COMM_TYPE_SHARED, 279, 773, 916	MPI_ERR_FILE, 400, 632, 768
17	MPI_COMM_WORLD, 15, 22, 30, 253,	MPI_ERR_FILE_EXISTS, 400, 632, 768
18	255–258, 266, 267, 282, 285, 294, 319,	MPI_ERR_FILE_IN_USE, 400, 569, 632, 768
19	329, 381, 382, 390, 402, 415, 417, 418,	MPI_ERR_GROUP, 399, 767
20	420–423, 425, 427, 441, 442, 448–451,	MPI_ERR_IN_STATUS, 33, 35, 55, 63, 65,
21	454, 456, 471–474, 609, 630, 631, 654,	389, 397, 399, 557, 582, 768
22	663, 701, 752, 763, 773, 910, 924	MPI_ERR_INFO, 399, 768
23	MPI_COMPLEX, 27, 185, 613, 614, 722, 772	MPI_ERR_INFO_KEY, 399, 409, 768
24	MPI_COMPLEX16, 185, 615, 772	MPI_ERR_INFO_NOKEY, 399, 409, 768
25	MPI_COMPLEX32, 185, 615, 772	MPI_ERR_INFO_VALUE, 399, 409, 768
26	MPI_COMPLEX4, 185, 615, 772	MPI_ERR_INTERN, 388, 399, 767
27	MPI_COMPLEX8, 185, 615, 772	MPI_ERR_IO, 400, 632, 768
28	MPI_CONGRUENT, 267, 293, 773	MPI_ERR_KEYVAL, 315, 399, 768
29	MPI_CONVERSION_FN_NULL, 619, 775	MPI_ERR_LASTCODE, 398, 400–403, 689,
30	MPI_COUNT, 28, 29, 185, 614, 648, 771, 772,	769
31	915	MPI_ERR_LOCKTYPE, 399, 531, 768
32	MPI_COUNT_KIND, 15, 17, 28, 770	MPI_ERR_NAME, 399, 468, 768
33	MPI_CXX_BOOL, 29, 185, 614, 615, 772, 914	MPI_ERR_NO_MEM, 384, 399, 768
34	MPI_CXX_DOUBLE_COMPLEX, 29, 185,	MPI_ERR_NO_SPACE, 400, 632, 768
35	614, 615, 772, 914	MPI_ERR_NO_SUCH_FILE, 400, 569, 632,
36	MPI_CXX_FLOAT_COMPLEX, 29, 185, 614,	768
37	615, 772, 914	MPI_ERR_NOT_SAME, 400, 632, 768
38	MPI_CXX_LONG_DOUBLE_COMPLEX, 29,	MPI_ERR_OP, 399, 530, 767
39	185, 614, 615, 772, 914	MPI_ERR_OTHER, 398, 399, 767
40	MPI_DATATYPE_NULL, 116, 774	MPI_ERR_PENDING, 63, 399, 767
41	MPI_DISPLACEMENT_CURRENT, 577,	MPI_ERR_PORT, 399, 464, 465, 768
42	778, 925	MPI_ERR_PROC_ABORTED, 399, 441, 768,
43	MPI_DIST_GRAPH, 339, 775, 921	910
44	MPI_DISTRIBUTE_BLOCK, 103, 778	MPI_ERR_QUOTA, 400, 632, 768
45	MPI_DISTRIBUTE_CYCLIC, 103, 778	MPI_ERR_RANK, 399, 530, 767
46	MPI_DISTRIBUTE_DFLT_DARG, 103, 778	MPI_ERR_READ_ONLY, 400, 632, 768
47	MPI_DISTRIBUTE_NONE, 103, 778	MPI_ERR_REQUEST, 399, 767
48	MPI_DOUBLE, 28, 185, 614, 648, 658, 659,	MPI_ERR_RMA_ATTACH, 400, 531, 768
	721, 771	MPI_ERR_RMA_CONFLICT, 399, 531, 768
	MPI_DOUBLE_COMPLEX, 27, 185, 613, 614,	MPI_ERR_RMA_FLAVOR, 400, 486, 531, 768
	722, 772	MPI_ERR_RMA_RANGE, 400, 531, 768
	MPI_DOUBLE_INT, 188, 189, 773	MPI_ERR_RMA_SHARED, 400, 531, 768
	MPI_DOUBLE_PRECISION, 27, 185, 614,	MPI_ERR_RMA_SYNC, 399, 531, 768
	722, 772	MPI_ERR_ROOT, 399, 767

MPI_ERR_SERVICE, 399, 467, 768	MPI_INTEGERS, 185, 615, 726, 772	1
MPI_ERR_SESSION, 400	MPI_INTEGER_KIND, 15, 770	2
MPI_ERR_SIZE, 399, 531, 768	MPI_IO, 381, 382, 773	3
MPI_ERR_SPAWN, 399, 452–454, 768	MPI_KEYVAL_INVALID, 305–307, 769	4
MPI_ERR_TAG, 399, 767	MPI_LAND, 184, 185, 774	5
MPI_ERR_TOPOLOGY, 399, 767	MPI_LASTUSED_CODE, 401, 402, 776	6
MPI_ERR_TRUNCATE, 399, 767	MPI_LB, 19, 700, 915	7
MPI_ERR_TYPE, 399, 767	MPI_LOCK_EXCLUSIVE, 523, 769	8
MPI_ERR_UNKNOWN, 398, 399, 767	MPI_LOCK_SHARED, 523, 524, 769	9
MPI_ERR_UNSUPPORTED_DATAREP, 400, 632, 768	MPI_LOGICAL, 27, 185, 614, 772	10
MPI_ERR_UNSUPPORTED_OPERATION, 400, 632, 768	MPI_LONG, 28, 184, 614, 771	11
MPI_ERR_WIN, 399, 531, 768	MPI_LONG_DOUBLE, 28, 185, 614, 771	12
MPI_ERRCODES_IGNORE, 16, 454, 730, 778	MPI_LONG_DOUBLE_INT, 188, 773	13
MPI_ERRHANDLER_NULL, 396, 774	MPI_LONG_INT, 188, 189, 773	14
MPI_ERROR, 32, 32, 55, 206, 507, 770, 911, 918	MPI_LONG_LONG, 28, 184, 771, 922	15
MPI_ERRORS_ABORT, 387, 417, 418, 458, 910	MPI_LONG_LONG_INT, 28, 184, 614, 771, 922	16
MPI_ERRORS_ARE_FATAL, 387, 388, 404, 458, 530, 630, 770, 910	MPI_LOR, 184, 185, 774	17
MPI_ERRORS_RETURN, 387, 388, 405, 441, 458, 631, 763, 770	MPI_LXOR, 184, 185, 774	18
MPI_F08_STATUS_IGNORE, 755, 779, 918	MPI_MAX, 182, 184, 185, 204, 774	19
MPI_F08_STATUSES_IGNORE, 755, 779, 918	MPI_MAX_DATAREP_STRING, 15, 579, 617, 770	20
MPI_F_STATUS_IGNORE, 754, 779	MPI_MAX_ERROR_STRING, 15, 397, 403, 770	21
MPI_F_STATUSES_IGNORE, 754, 779	MPI_MAX_FROM_GROUP_STRINGTAG, 297	22
MPI_FILE_NULL, 568, 631, 774	MPI_MAX_FROM_GROUP_TAG, 280, 770	23
MPI_FLOAT, 28, 98, 183, 185, 612, 614, 771	MPI_MAX_INFO_KEY, 15, 399, 407, 410, 411, 770	24
MPI_FLOAT_INT, 12, 188, 189, 773	MPI_MAX_INFO_VAL, 15, 399, 407, 770	25
MPI_GRAPH, 339, 775	MPI_MAX_LIBRARY_VERSION_STRING, 15, 380, 770, 915	26
MPI_GROUP_EMPTY, 254, 260, 261, 271, 272, 274, 280, 297, 774	MPI_MAX_OBJECT_NAME, 15, 318–320, 770, 916, 923	27
MPI_GROUP_NULL, 254, 264, 265, 774	MPI_MAX_PORT_NAME, 15, 462, 770	28
MPI_HOST, 381, 773	MPI_MAX_PROCESSOR_NAME, 15, 383, 770, 924	29
MPI_IDENT, 258, 267, 773	MPI_MAX_PSET_NAME_LEN, 433, 770	30
MPI_IN_PLACE, 16, 152, 179, 709, 730, 769	MPI_MAXLOC, 184, 187, 188, 191, 774	31
MPI_INFO, 224	MPI_MESSAGE_NO_PROC, 72, 74, 75, 85, 769, 916	32
MPI_INFO_ENV, 418, 419, 427, 773, 917	MPI_MESSAGE_NULL, 72, 74, 75, 774, 916	33
MPI_INFO_NULL, 337, 384, 413, 453, 463, 567, 569, 578, 774	MPI_MESSAGE_PROC_NULL, 72	34
MPI_INT, 12, 28, 88, 184, 612–614, 647, 648, 651, 657, 661, 721, 763, 765, 771	MPI_MIN, 184, 185, 774	35
MPI_INT16_T, 28, 184, 614, 771, 919–922	MPI_MINLOC, 184, 187, 188, 191, 774	36
MPI_INT32_T, 28, 184, 614, 648, 771, 919–922	MPI_MODE_APPEND, 566, 567, 777	37
MPI_INT64_T, 28, 184, 614, 648, 771, 919–922	MPI_MODE_CREATE, 566, 567, 575, 777	38
MPI_INT8_T, 28, 184, 614, 771, 919–922	MPI_MODE_DELETE_ON_CLOSE, 566–568, 777	39
MPI_INTEGER, 27, 35, 184, 614, 721, 722, 765, 772	MPI_MODE_EXCL, 566, 567, 777	40
MPI_INTEGER1, 27, 185, 615, 772	MPI_MODE_NOCHECK, 524, 529, 530, 777	41
MPI_INTEGER16, 185, 615, 772	MPI_MODE_NOPRECEDE, 518, 529, 530, 777	42
MPI_INTEGER2, 27, 185, 613, 615, 772	MPI_MODE_NOPUT, 529, 777	43
MPI_INTEGER4, 27, 185, 615, 772		44
		45
		46
		47
		48

- 1 MPI\_MODE\_NOSTORE, 529, 777  
2 MPI\_MODE\_NOSUCCEED, 529, 530, 777  
3 MPI\_MODE\_RDONLY, 566, 567, 572, 777  
4 MPI\_MODE\_RDWR, 566, 567, 777  
5 MPI\_MODE\_SEQUENTIAL, 566, 567, 570,  
6 577, 582, 587, 600, 623, 777, 925  
7 MPI\_MODE\_UNIQUE\_OPEN, 566, 567, 777  
8 MPI\_MODE\_WRONLY, 566, 567, 777  
9 MPI\_NO\_OP, 480, 504, 506, 774, 912  
10 MPI\_NULL\_COPY\_FN, 19, 304, 694, 776  
11 MPI\_NULL\_DELETE\_FN, 19, 305, 694, 776  
12 MPI\_OFFSET, 28, 185, 614, 771, 772, 919–922  
13 MPI\_OFFSET\_KIND, 15, 17, 28, 625, 730, 770  
14 MPI\_OP\_NULL, 194, 774  
15 MPI\_ORDER\_C, 15, 100, 103, 104, 778  
16 MPI\_ORDER\_FORTRAN, 15, 100, 103, 778  
17 MPI\_PACKED, 12, 27, 28, 35, 36, 139, 140,  
18 144, 613, 614, 764, 771, 772  
19 MPI\_PROC\_NULL, 26, 30–32, 69, 72, 74, 75,  
20 85, 154, 156, 158, 160, 168, 170, 184,  
21 257, 348, 352, 381, 382, 485, 486, 494,  
22 769, 916, 922, 925  
23 MPI\_PROD, 184, 185, 774  
24 MPI\_REAL, 27, 35, 185, 613, 614, 721, 722,  
25 728, 772  
26 MPI\_REAL16, 185, 615, 772  
27 MPI\_REAL2, 27, 185, 615, 772  
28 MPI\_REAL4, 27, 185, 615, 721, 726, 772  
29 MPI\_REAL8, 27, 185, 615, 721, 772, 920  
30 MPI\_REPLACE, 502–504, 506, 546, 774, 921,  
31 925  
32 MPI\_REQUEST\_NULL, 55–58, 61–64, 556,  
33 774  
34 MPI\_ROOT, 154, 769  
35 MPI\_SEEK\_CUR, 594, 601, 778  
36 MPI\_SEEK\_END, 594, 601, 778  
37 MPI\_SEEK\_SET, 594, 595, 601, 778  
38 MPI\_SESSION\_NULL, 430, 774  
39 MPI\_SHORT, 28, 184, 614, 771  
40 MPI\_SHORT\_INT, 188, 773  
41 MPI\_SIGNED\_CHAR, 28, 184, 186, 187, 614,  
42 771, 922  
43 MPI\_SIMILAR, 258, 267, 293, 773  
44 MPI\_SOURCE, 32, 32, 206, 770, 911, 918  
45 MPI\_STATUS\_IGNORE, 10, 15, 34, 35, 555,  
46 582, 708, 730, 754–756, 764, 778, 779,  
47 915  
48 MPI\_STATUS\_SIZE, 15, 32, 32, 710, 770, 918  
MPI\_STATUSES\_IGNORE, 14, 15, 34, 35,  
555, 557, 730, 754, 756, 778, 779  
MPI\_SUBARRAYS\_SUPPORTED, 15, 704,  
705, 708–712, 716–719, 731–733, 770,  
917  
MPI\_SUBVERSION, 15, 380, 779  
MPI\_SUCCESS, 18, 19, 55, 63, 65, 304–309,  
312, 313, 329, 397–399, 403–405, 418,  
453, 619, 644, 653, 662, 664, 666, 671,  
675, 676, 680, 687, 689, 691, 694, 767,  
910, 911  
MPI\_SUM, 184, 185, 502, 763, 774  
MPI\_T\_BIND\_MPI\_COMM, 645, 780  
MPI\_T\_BIND\_MPI\_DATATYPE, 645, 780  
MPI\_T\_BIND\_MPI\_ERRHANDLER, 645,  
780  
MPI\_T\_BIND\_MPI\_FILE, 645, 780  
MPI\_T\_BIND\_MPI\_GROUP, 645, 780  
MPI\_T\_BIND\_MPI\_INFO, 645, 780  
MPI\_T\_BIND\_MPI\_MESSAGE, 645, 780  
MPI\_T\_BIND\_MPI\_OP, 645, 780  
MPI\_T\_BIND\_MPI\_REQUEST, 645, 780  
MPI\_T\_BIND\_MPI\_SESSION, 645  
MPI\_T\_BIND\_MPI\_WIN, 645, 780  
MPI\_T\_BIND\_NO\_OBJECT, 645, 652, 654,  
661, 663, 675, 677, 780  
MPI\_T\_CB\_REQUIRE\_ASYNC\_SIGNAL\_SAFE,  
672, 781  
MPI\_T\_CB\_REQUIRE\_MPI\_RESTRICTED,  
672, 781  
MPI\_T\_CB\_REQUIRE\_NONE, 672, 781  
MPI\_T\_CB\_REQUIRE\_THREAD\_SAFE,  
672, 781  
MPI\_T\_CVAR\_HANDLE\_NULL, 655, 779  
MPI\_T\_ENUM\_NULL, 651, 661, 675, 779  
MPI\_T\_ERR\_CANNOT\_INIT, 691, 769  
MPI\_T\_ERR\_CVAR\_SET\_NEVER, 656, 691,  
769  
MPI\_T\_ERR\_CVAR\_SET\_NOT\_NOW, 656,  
691, 769  
MPI\_T\_ERR\_INVALID, 691, 769, 913  
MPI\_T\_ERR\_INVALID\_HANDLE, 663, 680,  
691, 769  
MPI\_T\_ERR\_INVALID\_INDEX, 19, 671, 675,  
691, 697, 769, 910  
MPI\_T\_ERR\_INVALID\_ITEM, 19, 691, 697,  
769, 910  
MPI\_T\_ERR\_INVALID\_NAME, 653, 662,  
676, 687, 691, 769, 913  
MPI\_T\_ERR\_INVALID\_SESSION, 691, 769  
MPI\_T\_ERR\_MEMORY, 691, 769  
MPI\_T\_ERR\_NOT\_ACCESSIBLE, 691, 769  
MPI\_T\_ERR\_NOT\_INITIALIZED, 691, 769  
MPI\_T\_ERR\_NOT\_SUPPORTED, 671, 691,  
769  
MPI\_T\_ERR\_OUT\_OF\_HANDLES, 691, 769  
MPI\_T\_ERR\_OUT\_OF\_SESSIONS, 691, 769  
MPI\_T\_ERR\_PVAR\_NO\_ATOMIC, 666, 691,  
769  
MPI\_T\_ERR\_PVAR\_NO\_STARTSTOP, 664,

691, 769		
MPI_T_ERR_PVAR_NO_WRITE, 665, 666, 691, 769	MPI_TYPE_NULL_DELETE_FN, 312, 775, 918	1
MPI_T_PVAR_ALL_HANDLES, 664–667, 780	MPI_TYPECLASS_COMPLEX, 727, 778	2
MPI_T_PVAR_CLASS_AGGREGATE, 658, 659, 780	MPI_TYPECLASS_INTEGER, 727, 778	3
MPI_T_PVAR_CLASS_COUNTER, 658, 780	MPI_TYPECLASS_REAL, 727, 778	4
MPI_T_PVAR_CLASS_GENERIC, 659, 780	MPI_UB, 4, 19, 700, 915	5
MPI_T_PVAR_CLASS_HIGHWATERMARK, 658, 780	MPI_UINT16_T, 28, 184, 614, 771, 919–922	6
MPI_T_PVAR_CLASS_LEVEL, 657, 780	MPI_UINT32_T, 28, 184, 614, 648, 771, 919–922	7
MPI_T_PVAR_CLASS_LOWWATERMARK, 658, 780	MPI_UINT64_T, 28, 184, 614, 648, 771, 919–922	8
MPI_T_PVAR_CLASS_PERCENTAGE, 658, 780	MPI_UINT8_T, 28, 184, 614, 771, 919–922	9
MPI_T_PVAR_CLASS_SIZE, 658, 780	MPI_UNDEFINED, 33, 34, 61, 62, 64, 65, 110, 113, 115, 120, 141, 256, 257, 275, 276, 279, 339, 350, 351, 723, 769, 915, 922	10
MPI_T_PVAR_CLASS_STATE, 657, 780	MPI_UNEQUAL, 258, 267, 292, 773	11
MPI_T_PVAR_CLASS_TIMER, 659, 780	MPI_UNIVERSE_SIZE, 449, 471, 776	12
MPI_T_PVAR_HANDLE_NULL, 664, 779	MPI_UNSIGNED, 28, 184, 614, 648, 657–659, 771	13
MPI_T_PVAR_SESSION_NULL, 662, 779	MPI_UNSIGNED_CHAR, 28, 184, 186, 187, 614, 771	14
MPI_T_SCOPE_ALL, 652, 780	MPI_UNSIGNED_LONG, 28, 184, 614, 648, 658, 659, 771	15
MPI_T_SCOPE_ALL_EQ, 652, 656, 780	MPI_UNSIGNED_LONG_LONG, 28, 184, 614, 648, 658, 659, 771, 922	16
MPI_T_SCOPE_CONSTANT, 652, 780	MPI_UNSIGNED_SHORT, 28, 184, 614, 771	17
MPI_T_SCOPE_GROUP, 652, 780	MPI_UNWEIGHTED, 16, 334, 336–338, 345, 347, 730, 778, 915, 921	18
MPI_T_SCOPE_GROUP_EQ, 652, 656, 780	MPI_VAL, 12, 752	19
MPI_T_SCOPE_LOCAL, 652, 780	MPI_VERSION, 15, 380, 779	20
MPI_T_SCOPE_READONLY, 652, 780	MPI_WCHAR, 28, 186, 187, 320, 613, 614, 771, 922	21
MPI_T_SOURCE_ORDERED, 671, 781	MPI_WEIGHTS_EMPTY, 16, 334, 336, 730, 778, 915	22
MPI_T_SOURCE_UNORDERED, 671, 781	MPI_WIN_BASE, 490, 491, 763, 776	23
MPI_T_VERBOSITY_MPIDEV_ALL, 644, 645, 779	MPI_WIN_CREATE_FLAVOR, 490, 491, 776	24
MPI_T_VERBOSITY_MPIDEV_BASIC, 645, 779	MPI_WIN_DISP_UNIT, 490, 491, 776	25
MPI_T_VERBOSITY_MPIDEV_DETAIL, 645, 779	MPI_WIN_DUP_FN, 308, 775	26
MPI_T_VERBOSITY_TUNER_ALL, 645, 779	MPI_WIN_FLAVOR_ALLOCATE, 491, 776	27
MPI_T_VERBOSITY_TUNER_BASIC, 645, 779	MPI_WIN_FLAVOR_CREATE, 491, 776	28
MPI_T_VERBOSITY_TUNER_DETAIL, 645, 779	MPI_WIN_FLAVOR_DYNAMIC, 491, 776	29
MPI_T_VERBOSITY_USER_ALL, 645, 779	MPI_WIN_FLAVOR_SHARED, 486, 491, 776	30
MPI_T_VERBOSITY_USER_BASIC, 644, 645, 779	MPI_WIN_MODEL, 491, 513, 776	31
MPI_T_VERBOSITY_USER_DETAIL, 644, 645, 779	MPI_WIN_NULL, 490, 774	32
MPI_TAG, 32, 32, 206, 770, 911, 918	MPI_WIN_NULL_COPY_FN, 308, 775	33
MPI_TAG_UB, 29, 381, 759, 763, 773	MPI_WIN_NULL_DELETE_FN, 308, 775	34
MPI_THREAD_FUNNELED, 419, 420, 777	MPI_WIN_SEPARATE, 491, 513, 533, 776	35
MPI_THREAD_MULTIPLE, 420, 422, 777, 913	MPI_WIN_SIZE, 490, 491, 776	36
MPI_THREAD_SERIALIZED, 420, 777	MPI_WIN_UNIFIED, 491, 513, 533, 542, 776	37
MPI_THREAD_SINGLE, 419–421, 429, 777	MPI_WTIME_IS_GLOBAL, 381, 382, 406, 759, 773	38
MPI_TYPE_DUP_FN, 312, 775		39
MPI_TYPE_NULL_COPY_FN, 312, 775		40
		41
		42
		43
		44
		45
		46
		47
		48

# MPI Declarations Index

This index refers to declarations needed in C, such as address kind integers, handles, etc. The underlined page numbers is the “main” reference (sometimes there are more than one when key concepts are discussed in multiple areas).

MPI\_Aint, [16](#), [16](#), [17](#), [28](#), [89](#), [89](#), [92](#), [94](#), [97](#),  
[107–109](#), [112–114](#), [123](#), [144–146](#), [479](#),  
[481](#), [483](#), [487](#), [495](#), [497](#), [501](#), [503](#),  
[505–507](#), [509–511](#), [612](#), [617](#), [671](#), [730](#),  
[760](#), [781](#)

MPI\_Comm, [12](#), [26](#), [258](#), [265](#), [266](#), [268–270](#),  
[275](#), [278](#), [280](#), [282](#), [292–295](#), [297](#), [303](#),  
[305–307](#), [432](#), [773](#), [774](#), [781](#), [782](#)

MPI\_Count, [17](#), [17](#), [28](#), [669](#), [671](#), [781](#), [915](#)

MPI\_Datatype, [89](#), [739](#), [771–774](#), [781](#), [782](#)

MPI\_Errhandler, [389](#), [390–396](#), [753](#), [770](#), [774](#),  
[781](#), [782](#)

MPI\_F08\_status, [755](#), [779](#), [781](#), [918](#)

MPI\_File, [393](#), [394](#), [565](#), [568–571](#), [573](#), [574](#),  
[576](#), [578](#), [582–587](#), [589–601](#), [603–608](#),  
[612](#), [621–623](#), [753](#), [774](#), [781](#), [782](#)

MPI\_Fint, [752](#), [752](#), [779](#), [781](#), [922](#)

MPI\_Group, [256](#), [257](#), [257–262](#), [264](#), [293](#), [432](#),  
[491](#), [519](#), [520](#), [571](#), [753](#), [774](#), [781](#), [782](#)

MPI\_Info, [383](#), [407](#), [407–413](#), [431](#), [434](#), [450](#),  
[453](#), [454](#), [461](#), [465–467](#), [474](#), [492](#), [493](#),  
[565](#), [568](#), [573](#), [574](#), [576](#), [696](#), [753](#), [773](#),  
[774](#), [781](#), [782](#), [924](#)

MPI\_Message, [71](#), [753](#), [769](#), [774](#), [781](#), [782](#), [916](#)

MPI\_Offset, [17](#), [17](#), [28](#), [569–571](#), [576](#), [578](#),  
[582–586](#), [594](#), [595](#), [600](#), [601](#), [603](#), [604](#),  
[617](#), [625](#), [625](#), [671](#), [751](#), [781](#)

MPI\_Op, [182](#), [191](#), [194](#), [195](#), [197–200](#), [202](#),  
[203](#), [218–223](#), [236–241](#), [501](#), [503](#), [505](#),  
[510](#), [511](#), [753](#), [774](#), [781](#), [782](#)

MPI\_Request, [51–54](#), [55](#), [56](#), [57](#), [60–65](#), [67](#),  
[75–81](#), [397](#), [554](#), [557](#), [584–586](#),  
[591–593](#), [597](#), [598](#), [732](#), [753](#), [774](#), [781](#),  
[782](#)

MPI\_Session, [395](#), [753](#), [774](#), [781](#), [782](#)

MPI\_Status, [30](#), [32–34](#), [55](#), [56](#), [60–65](#), [67–69](#),  
[71–73](#), [76](#), [83](#), [84](#), [119](#), [555](#), [560](#), [561](#),  
[582–584](#), [587](#), [589](#), [590](#), [596](#), [599](#), [603](#),  
[605–608](#), [707](#), [754–756](#), [778](#), [781](#), [782](#),  
[911](#), [915](#), [918](#)

MPI\_T\_ERR\_NOT\_ACCESSIBLE, [672](#), [673](#)

MPI\_T\_cvar\_handle, [654](#), [654](#), [655](#), [779](#)

MPI\_T\_enum, [648](#), [648–650](#), [660](#), [674](#), [779](#)

MPI\_T\_event\_instance, [679](#), [679](#)

MPI\_T\_event\_registration, [676](#), [676](#)

MPI\_T\_pvar\_handle, [662](#), [662–666](#), [779](#)

MPI\_T\_pvar\_session, [662](#), [662–666](#), [779](#)

MPI\_Win, [308–311](#), [391](#), [392](#), [479](#), [481](#), [483](#),  
[487](#), [490–493](#), [495](#), [497](#), [501](#), [503](#),  
[505–507](#), [509–511](#), [516](#), [519–521](#),  
[523–528](#), [753](#), [774](#), [781](#), [782](#)



1  
2  
3  
4  
5  
6  
7  
8  
9  
10  
11  
12  
13  
14  
15  
16  
17  
18  
19  
20  
21  
22  
23  
24  
25  
26  
27  
28  
29  
30  
31  
32  
33  
34  
35  
36  
37  
38  
39  
40  
41  
42  
43  
44  
45  
46  
47  
48

# MPI Callback Function Prototype Index

This index lists the C typedef names for callback routines, such as those used with attribute caching or user-defined reduction operations. Fortran example prototypes are given near the text of the C name.

- MPI\_Comm\_copy\_attr\_function, [18](#), [19](#), [303](#),  
[706](#), [775](#), [782](#)
- MPI\_Comm\_delete\_attr\_function, [19](#), [303](#),  
[775](#), [782](#)
- MPI\_Comm\_errhandler\_fn, [696](#), [921](#)
- MPI\_Comm\_errhandler\_function, [19](#), [389](#), [696](#),  
[700](#), [783](#), [921](#)
- MPI\_Copy\_function, [19](#), [693](#), [776](#), [788](#)
- MPI\_Datarep\_conversion\_function, [617](#), [775](#),  
[783](#)
- MPI\_Datarep\_extent\_function, [617](#), [783](#)
- MPI\_Delete\_function, [19](#), [694](#), [776](#), [788](#)
- MPI\_File\_errhandler\_fn, [696](#), [921](#)
- MPI\_File\_errhandler\_function, [393](#), [696](#), [783](#),  
[921](#)
- MPI\_Grequest\_cancel\_function, [556](#), [783](#)
- MPI\_Grequest\_free\_function, [555](#), [783](#)
- MPI\_Grequest\_query\_function, [555](#), [783](#)
- MPI\_Handler\_function, [19](#), [700](#), [915](#)
- MPI\_Session\_errhandler\_function, [395](#), [783](#)
- MPI\_T\_event\_cb\_function, [678](#), [783](#)
- MPI\_T\_event\_dropped\_function, [681](#), [783](#)
- MPI\_T\_event\_free\_cb\_function, [680](#), [783](#)
- MPI\_Type\_copy\_attr\_function, [312](#), [775](#), [782](#)
- MPI\_Type\_delete\_attr\_function, [312](#), [775](#),  
[782](#), [918](#)
- MPI\_User\_function, [192](#), [195](#), [782](#)
- MPI\_Win\_copy\_attr\_function, [309](#), [775](#), [782](#)
- MPI\_Win\_delete\_attr\_function, [309](#), [775](#), [782](#)
- MPI\_Win\_errhandler\_fn, [696](#), [921](#)
- MPI\_Win\_errhandler\_function, [391](#), [696](#), [783](#),  
[921](#)

# MPI Function Index

The underlined page numbers refer to the function definitions.

- MPI\_ABORT, 192, 387, 417, 423, 441, 441,  
473, 647, 752, 924
- MPI\_ACCUMULATE, 477, 494, 501, 502, 504,  
511, 514, 539, 545, 546, 921, 925
- MPI\_ADD\_ERROR\_CLASS, 401, 401
- MPI\_ADD\_ERROR\_CODE, 402
- MPI\_ADD\_ERROR\_STRING, 402, 403
- MPI\_ADDRESS, 19, 699, 715, 914
- MPI\_AINT\_ADD, 20, 106, 108, 108, 487, 913
- MPI\_AINT\_DIFF, 20, 106, 108, 108, 109, 487,  
913
- MPI\_ALLGATHER, 149, 153, 154, 173,  
173–175, 177, 214
- MPI\_ALLGATHER\_INIT, 231
- MPI\_ALLGATHERV, 149, 153, 154, 174, 175,  
215
- MPI\_ALLGATHERV\_INIT, 232
- MPI\_ALLOC\_MEM, 383, 384–386, 399,  
481–486, 489, 496, 526, 716–718, 730,  
912, 918
- MPI\_Alloc\_mem, 910
- MPI\_ALLOC\_MEM\_CPTR, 384, 912
- MPI\_ALLREDUCE, 149, 152–154, 184, 191,  
196, 196, 220, 922
- MPI\_ALLREDUCE\_INIT, 237
- MPI\_ALLTOALL, 149, 153, 154, 176, 177–179,  
216, 920
- MPI\_ALLTOALL\_INIT, 233
- MPI\_ALLTOALLV, 149, 153, 154, 178, 178,  
179, 181, 217, 920
- MPI\_ALLTOALLV\_INIT, 234
- MPI\_ALLTOALLW, 149, 153, 154, 180, 181,  
218, 920
- MPI\_ALLTOALLW\_INIT, 235
- MPI\_ATTR\_DELETE, 19, 315, 694, 695
- MPI\_ATTR\_GET, 19, 315, 695, 759, 760
- MPI\_ATTR\_PUT, 19, 315, 695, 759, 760, 763
- MPI\_BARRIER, 149, 153, 155, 155, 208, 440,  
536–538, 627
- MPI\_BARRIER\_INIT, 225
- MPI\_BCAST, 149, 153, 156, 156, 157, 183,  
209, 245
- MPI\_BCAST\_INIT, 225
- MPI\_BSEND, 40, 49
- MPI\_BSEND\_INIT, 78, 81
- MPI\_BUFFER\_ATTACH, 47, 56
- MPI\_BUFFER\_DETACH, 47, 918
- MPI\_CANCEL, 19, 43, 56, 68, 75, 75–77, 206,  
224, 424, 507, 553, 556, 557, 696, 909
- MPI\_CART\_COORDS, 327, 342, 343, 923
- MPI\_CART\_CREATE, 291, 326, 327, 328,  
328–330, 341, 349, 350, 352, 731, 911,  
923
- MPI\_CART\_GET, 327, 341, 341, 923
- MPI\_CART\_MAP, 327, 350, 350, 916
- MPI\_CART\_RANK, 327, 342, 342, 923
- MPI\_CART\_SHIFT, 327, 347, 347, 348, 352,  
924
- MPI\_CART\_SUB, 327, 349, 349, 350, 924
- MPI\_CARTDIM\_GET, 327, 340, 341, 923
- MPI\_CLOSE\_PORT, 462, 463, 466
- MPI\_COMM\_ACCEPT, 461, 463, 464, 465,  
471, 473
- MPI\_COMM\_C2F, 752
- MPI\_COMM\_CALL\_ERRHANDLER, 403,  
405
- MPI\_COMM\_COMPARE, 267, 292, 428
- MPI\_COMM\_CONNECT, 399, 464, 464, 465,  
471, 473
- MPI\_COMM\_CREATE, 265, 267, 271,  
271–276, 327, 920, 921
- MPI\_COMM\_CREATE\_ERRHANDLER, 19,  
388, 389, 390, 699, 785, 787, 918
- MPI\_COMM\_CREATE\_FROM\_GROUP, 267,  
279, 279, 280, 297, 381
- MPI\_COMM\_CREATE\_GROUP, 267, 273,  
274, 275, 279, 280, 428, 916
- MPI\_COMM\_CREATE\_KEYVAL, 19, 301,  
302, 304, 305, 315, 693, 759, 784, 786,  
918, 923
- MPI\_COMM\_DELETE\_ATTR, 19, 301,  
304–306, 307, 315, 695
- MPI\_COMM\_DISCONNECT, 315, 430, 440,  
454, 473, 474, 474

MPI_COMM_DUP, <a href="#">258</a> , <a href="#">265</a> , <a href="#">267</a> , <a href="#">268</a> , <a href="#">268–270</a> , <a href="#">272</a> , <a href="#">294</a> , <a href="#">297</a> , <a href="#">301</a> , <a href="#">304</a> , <a href="#">307</a> , <a href="#">315</a> , <a href="#">322</a> , <a href="#">693</a> , <a href="#">910</a> , <a href="#">916</a>	MPI_COMM_TEST_INTER, <a href="#">291</a> , <a href="#">292</a>	1
MPI_COMM_DUP_FN, <a href="#">19</a> , <a href="#">304</a> , <a href="#">304</a> , <a href="#">305</a> , <a href="#">711</a> , <a href="#">775</a> , <a href="#">913</a> , <a href="#">918</a>	MPI_COMPARE_AND_SWAP, <a href="#">477</a> , <a href="#">494</a> , <a href="#">506</a> , <a href="#">545</a>	2
MPI_COMM_DUP_WITH_INFO, <a href="#">267</a> , <a href="#">269</a> , <a href="#">269</a> , <a href="#">270</a> , <a href="#">281</a> , <a href="#">916</a>	MPI_CONVERSION_FN_NULL, <a href="#">619</a> , <a href="#">775</a> , <a href="#">913</a>	3
MPI_COMM_F2C, <a href="#">752</a>	MPI_CWIN_GET_ATTR, <a href="#">712</a>	4
MPI_COMM_FREE, <a href="#">265</a> , <a href="#">268</a> , <a href="#">280</a> , <a href="#">294</a> , <a href="#">297</a> , <a href="#">304</a> , <a href="#">305</a> , <a href="#">308</a> , <a href="#">315</a> , <a href="#">423</a> , <a href="#">427</a> , <a href="#">430</a> , <a href="#">440</a> , <a href="#">454</a> , <a href="#">473</a> , <a href="#">474</a> , <a href="#">694</a>	MPI_DIMS_CREATE, <a href="#">327</a> , <a href="#">329</a> , <a href="#">329</a> , <a href="#">330</a> , <a href="#">910</a>	5
MPI_COMM_FREE_KEYVAL, <a href="#">19</a> , <a href="#">301</a> , <a href="#">305</a> , <a href="#">315</a> , <a href="#">694</a>	MPI_DIST_GRAPH_CREATE, <a href="#">281</a> , <a href="#">326</a> , <a href="#">327</a> , <a href="#">332</a> , <a href="#">335</a> , <a href="#">336–338</a> , <a href="#">347</a> , <a href="#">352</a> , <a href="#">921</a>	6
MPI_COMM_GET_ATTR, <a href="#">19</a> , <a href="#">301</a> , <a href="#">306</a> , <a href="#">306</a> , <a href="#">315</a> , <a href="#">381</a> , <a href="#">695</a> , <a href="#">712</a> , <a href="#">760</a> , <a href="#">763</a>	MPI_DIST_GRAPH_CREATE_ADJACENT, <a href="#">281</a> , <a href="#">326</a> , <a href="#">327</a> , <a href="#">332</a> , <a href="#">333</a> , <a href="#">334</a> , <a href="#">338</a> , <a href="#">347</a> , <a href="#">352</a> , <a href="#">917</a> , <a href="#">921</a>	7
MPI_COMM_GET_ERRHANDLER, <a href="#">19</a> , <a href="#">388</a> , <a href="#">390</a> , <a href="#">699</a> , <a href="#">924</a>	MPI_DIST_GRAPH_NEIGHBORS, <a href="#">327</a> , <a href="#">345</a> , <a href="#">346</a> , <a href="#">347</a> , <a href="#">352</a> , <a href="#">917</a> , <a href="#">921</a>	8
MPI_COMM_GET_INFO, <a href="#">281</a> , <a href="#">282</a> , <a href="#">283</a> , <a href="#">283</a> , <a href="#">910</a> , <a href="#">916</a>	MPI_DIST_GRAPH_NEIGHBORS_COUNT, <a href="#">327</a> , <a href="#">345</a> , <a href="#">345</a> , <a href="#">347</a> , <a href="#">914</a> , <a href="#">921</a>	9
MPI_COMM_GET_NAME, <a href="#">318</a> , <a href="#">318</a> , <a href="#">319</a> , <a href="#">923</a>	MPI_DUP_FN, <a href="#">19</a> , <a href="#">304</a> , <a href="#">694</a> , <a href="#">776</a>	10
MPI_COMM_GET_PARENT, <a href="#">319</a> , <a href="#">417</a> , <a href="#">418</a> , <a href="#">423</a> , <a href="#">451</a> , <a href="#">454</a> , <a href="#">454</a>	MPI_ERRHANDLER_C2F, <a href="#">440</a> , <a href="#">753</a>	11
MPI_COMM_GROUP, <a href="#">14</a> , <a href="#">256</a> , <a href="#">258</a> , <a href="#">258</a> , <a href="#">259</a> , <a href="#">265</a> , <a href="#">266</a> , <a href="#">293</a> , <a href="#">388</a> , <a href="#">924</a>	MPI_ERRHANDLER_CREATE, <a href="#">19</a> , <a href="#">699</a> , <a href="#">915</a> , <a href="#">918</a>	12
MPI_COMM_IDUP, <a href="#">265</a> , <a href="#">267</a> , <a href="#">269</a> , <a href="#">270</a> , <a href="#">291</a> , <a href="#">301</a> , <a href="#">304</a> , <a href="#">307</a> , <a href="#">315</a> , <a href="#">910</a> , <a href="#">911</a> , <a href="#">916</a>	MPI_ERRHANDLER_F2C, <a href="#">440</a> , <a href="#">753</a>	13
MPI_COMM_IDUP_WITH_INFO, <a href="#">267</a> , <a href="#">270</a> , <a href="#">270</a> , <a href="#">281</a> , <a href="#">910</a>	MPI_ERRHANDLER_FREE, <a href="#">388</a> , <a href="#">396</a> , <a href="#">423</a> , <a href="#">430</a> , <a href="#">440</a> , <a href="#">924</a>	14
MPI_COMM_JOIN, <a href="#">474</a> , <a href="#">475</a> , <a href="#">476</a>	MPI_ERRHANDLER_GET, <a href="#">19</a> , <a href="#">699</a> , <a href="#">915</a> , <a href="#">924</a>	15
MPI_COMM_NULL_COPY_FN, <a href="#">19</a> , <a href="#">304</a> , <a href="#">304</a> , <a href="#">305</a> , <a href="#">706</a> , <a href="#">759</a> , <a href="#">775</a> , <a href="#">913</a> , <a href="#">918</a>	MPI_ERRHANDLER_SET, <a href="#">19</a> , <a href="#">699</a> , <a href="#">915</a>	16
MPI_COMM_NULL_DELETE_FN, <a href="#">19</a> , <a href="#">304</a> , <a href="#">305</a> , <a href="#">775</a> , <a href="#">913</a>	MPI_ERROR_CLASS, <a href="#">398</a> , <a href="#">398</a> , <a href="#">401</a> , <a href="#">440</a> , <a href="#">689</a>	17
MPI_COMM_RANK, <a href="#">266</a> , <a href="#">266</a> , <a href="#">293</a> , <a href="#">713</a>	MPI_ERROR_STRING, <a href="#">397</a> , <a href="#">397</a> , <a href="#">398</a> , <a href="#">401</a> , <a href="#">403</a> , <a href="#">440</a>	18
MPI_COMM_RANK_F08, <a href="#">713</a>	MPI_EVENT_CALLBACK_GET_INFO, <a href="#">679</a>	19
MPI_COMM_REMOTE_GROUP, <a href="#">293</a>	MPI_EVENT_HANDLE_GET_INFO, <a href="#">677</a>	20
MPI_COMM_REMOTE_SIZE, <a href="#">293</a> , <a href="#">294</a>	MPI_EXSCAN, <a href="#">150</a> , <a href="#">153</a> , <a href="#">184</a> , <a href="#">191</a> , <a href="#">203</a> , <a href="#">203</a> , <a href="#">223</a> , <a href="#">920</a>	21
MPI_COMM_SET_ATTR, <a href="#">19</a> , <a href="#">301</a> , <a href="#">304</a> , <a href="#">306</a> , <a href="#">315</a> , <a href="#">694</a> , <a href="#">712</a> , <a href="#">760</a> , <a href="#">763</a>	MPI_EXSCAN_INIT, <a href="#">241</a>	22
MPI_COMM_SET_ERRHANDLER, <a href="#">19</a> , <a href="#">388</a> , <a href="#">390</a> , <a href="#">699</a>	MPI_F_SYNC_REG, <a href="#">107</a> , <a href="#">547</a> , <a href="#">704</a> , <a href="#">720</a> , <a href="#">720</a> , <a href="#">721</a> , <a href="#">740</a> , <a href="#">742</a> , <a href="#">743</a> , <a href="#">745</a> , <a href="#">919</a>	23
MPI_COMM_SET_INFO, <a href="#">225</a> , <a href="#">281</a> , <a href="#">282</a> , <a href="#">282</a> , <a href="#">910</a> , <a href="#">911</a> , <a href="#">916</a>	MPI_FETCH_AND_OP, <a href="#">477</a> , <a href="#">494</a> , <a href="#">502</a> , <a href="#">504</a> , <a href="#">505</a> , <a href="#">505</a>	24
MPI_COMM_SET_NAME, <a href="#">317</a> , <a href="#">317</a> , <a href="#">318</a>	MPI_FILE_C2F, <a href="#">753</a>	25
MPI_COMM_SIZE, <a href="#">265</a> , <a href="#">266</a> , <a href="#">293</a>	MPI_FILE_CALL_ERRHANDLER, <a href="#">404</a> , <a href="#">405</a>	26
MPI_COMM_SPAWN, <a href="#">417</a> , <a href="#">418</a> , <a href="#">442</a> , <a href="#">443</a> , <a href="#">448</a> , <a href="#">449</a> , <a href="#">450</a> , <a href="#">450–454</a> , <a href="#">456–458</a> , <a href="#">471</a> , <a href="#">472</a> , <a href="#">911</a>	MPI_FILE_CLOSE, <a href="#">474</a> , <a href="#">565</a> , <a href="#">566</a> , <a href="#">568</a> , <a href="#">568</a>	27
MPI_COMM_SPAWN_MULTIPLE, <a href="#">417</a> , <a href="#">418</a> , <a href="#">443</a> , <a href="#">448</a> , <a href="#">449</a> , <a href="#">454</a> , <a href="#">455</a> , <a href="#">456</a> , <a href="#">472</a> , <a href="#">911</a>	MPI_FILE_CREATE_ERRHANDLER, <a href="#">388</a> , <a href="#">393</a> , <a href="#">394</a> , <a href="#">785</a> , <a href="#">788</a> , <a href="#">918</a>	28
MPI_COMM_SPLIT, <a href="#">267</a> , <a href="#">271</a> , <a href="#">272</a> , <a href="#">275</a> , <a href="#">275–277</a> , <a href="#">322</a> , <a href="#">327</a> , <a href="#">328</a> , <a href="#">330</a> , <a href="#">349–351</a> , <a href="#">920</a>	MPI_FILE_DELETE, <a href="#">567</a> , <a href="#">568</a> , <a href="#">568</a> , <a href="#">569</a> , <a href="#">573</a> , <a href="#">575</a> , <a href="#">631</a>	29
MPI_COMM_SPLIT_TYPE, <a href="#">278</a> , <a href="#">281</a> , <a href="#">916</a>	MPI_FILE_F2C, <a href="#">753</a>	30
	MPI_FILE_GET_AMODE, <a href="#">572</a> , <a href="#">572</a>	31
	MPI_FILE_GET_ATOMICITY, <a href="#">622</a> , <a href="#">623</a>	32
	MPI_FILE_GET_BYTE_OFFSET, <a href="#">587</a> , <a href="#">595</a> , <a href="#">595</a> , <a href="#">601</a>	33
	MPI_FILE_GET_ERRHANDLER, <a href="#">388</a> , <a href="#">394</a> , <a href="#">631</a> , <a href="#">924</a>	34
	MPI_FILE_GET_GROUP, <a href="#">571</a> , <a href="#">571</a>	35
	MPI_FILE_GET_INFO, <a href="#">573</a> , <a href="#">574</a> , <a href="#">574</a> , <a href="#">575</a> , <a href="#">910</a> , <a href="#">925</a>	36
		37
		38
		39
		40
		41
		42
		43
		44
		45
		46
		47
		48

- 1 MPI\_FILE\_GET\_POSITION, [594](#), [595](#)  
2 MPI\_FILE\_GET\_POSITION\_SHARED, [600](#),  
3 [601](#), [601](#), [623](#)  
4 MPI\_FILE\_GET\_SIZE, [571](#), [571](#), [626](#)  
5 MPI\_FILE\_GET\_TYPE\_EXTENT, [611](#), [612](#),  
6 [619](#)  
7 MPI\_FILE\_GET\_VIEW, [578](#), [579](#)  
8 MPI\_FILE\_IREAD, [579](#), [591](#), [591](#), [602](#), [620](#),  
9 [621](#)  
10 MPI\_FILE\_IREAD\_ALL, [579](#), [592](#), [592](#), [913](#)  
11 MPI\_FILE\_IREAD\_AT, [579](#), [585](#), [585](#)  
12 MPI\_FILE\_IREAD\_AT\_ALL, [579](#), [585](#), [586](#),  
13 [913](#)  
14 MPI\_FILE\_IREAD\_SHARED, [579](#), [597](#), [598](#)  
15 MPI\_FILE\_IWRITE, [579](#), [593](#), [593](#)  
16 MPI\_FILE\_IWRITE\_ALL, [579](#), [593](#), [594](#), [913](#)  
17 MPI\_FILE\_IWRITE\_AT, [579](#), [586](#), [586](#)  
18 MPI\_FILE\_IWRITE\_AT\_ALL, [579](#), [587](#), [587](#),  
19 [913](#)  
20 MPI\_FILE\_IWRITE\_SHARED, [579](#), [598](#), [598](#)  
21 MPI\_FILE\_OPEN, [400](#), [447](#), [565](#), [565](#)–[567](#),  
22 [573](#), [575](#), [577](#), [595](#), [625](#), [626](#), [631](#), [632](#)  
23 MPI\_FILE\_PREALLOCATE, [569](#), [570](#), [570](#),  
24 [621](#), [626](#)  
25 MPI\_FILE\_READ, [579](#), [588](#), [588](#), [589](#), [591](#),  
26 [625](#), [626](#)  
27 MPI\_FILE\_READ\_ALL, [579](#), [589](#), [589](#), [592](#),  
28 [602](#), [603](#)  
29 MPI\_FILE\_READ\_ALL\_BEGIN, [579](#), [602](#),  
30 [603](#), [605](#), [620](#), [745](#)  
31 MPI\_FILE\_READ\_ALL\_END, [579](#), [602](#), [603](#),  
32 [606](#), [620](#), [745](#)  
33 MPI\_FILE\_READ\_AT, [579](#), [582](#), [582](#), [583](#), [585](#)  
34 MPI\_FILE\_READ\_AT\_ALL, [579](#), [583](#), [583](#),  
35 [586](#)  
36 MPI\_FILE\_READ\_AT\_ALL\_BEGIN, [579](#),  
37 [603](#), [745](#)  
38 MPI\_FILE\_READ\_AT\_ALL\_END, [579](#), [604](#),  
39 [745](#)  
40 MPI\_FILE\_READ\_ORDERED, [579](#), [599](#), [599](#)  
41 MPI\_FILE\_READ\_ORDERED\_BEGIN, [579](#),  
42 [607](#), [745](#)  
43 MPI\_FILE\_READ\_ORDERED\_END, [579](#),  
44 [608](#), [745](#)  
45 MPI\_FILE\_READ\_SHARED, [579](#), [596](#), [596](#),  
46 [598](#), [599](#)  
47 MPI\_FILE\_SEEK, [594](#), [594](#), [595](#)  
48 MPI\_FILE\_SEEK\_SHARED, [600](#), [600](#), [601](#),  
[623](#)  
MPI\_FILE\_SET\_ATOMICITY, [567](#), [621](#), [622](#),  
[622](#)  
MPI\_FILE\_SET\_ERRHANDLER, [388](#), [393](#),  
[631](#)  
MPI\_FILE\_SET\_INFO, [573](#), [573](#)–[575](#), [910](#), [925](#)  
MPI\_FILE\_SET\_SIZE, [569](#), [569](#), [570](#), [621](#),  
[624](#), [626](#)  
MPI\_FILE\_SET\_VIEW, [101](#), [400](#), [566](#),  
[573](#)–[575](#), [576](#), [577](#), [578](#), [595](#), [601](#), [610](#),  
[617](#), [625](#), [632](#), [925](#)  
MPI\_FILE\_SYNC, [568](#), [580](#), [620](#), [621](#), [623](#),  
[623](#), [628](#)  
MPI\_FILE\_WRITE, [579](#), [580](#), [590](#), [590](#), [591](#),  
[593](#), [625](#)  
MPI\_FILE\_WRITE\_ALL, [579](#), [590](#), [591](#), [594](#)  
MPI\_FILE\_WRITE\_ALL\_BEGIN, [579](#), [606](#),  
[732](#), [745](#)  
MPI\_FILE\_WRITE\_ALL\_END, [579](#), [607](#), [745](#)  
MPI\_FILE\_WRITE\_AT, [579](#), [580](#), [583](#), [584](#),  
[586](#)  
MPI\_FILE\_WRITE\_AT\_ALL, [579](#), [584](#), [584](#),  
[587](#)  
MPI\_FILE\_WRITE\_AT\_ALL\_BEGIN, [579](#),  
[604](#), [745](#)  
MPI\_FILE\_WRITE\_AT\_ALL\_END, [579](#), [605](#),  
[745](#)  
MPI\_FILE\_WRITE\_ORDERED, [579](#), [599](#),  
[600](#), [600](#)  
MPI\_FILE\_WRITE\_ORDERED\_BEGIN,  
[579](#), [608](#), [745](#)  
MPI\_FILE\_WRITE\_ORDERED\_END, [579](#),  
[609](#), [745](#)  
MPI\_FILE\_WRITE\_SHARED, [579](#), [580](#), [597](#),  
[597](#)–[600](#)  
MPI\_FINALIZE, [15](#), [21](#), [22](#), [381](#), [387](#), [415](#), [422](#),  
[423](#)–[427](#), [445](#), [473](#), [474](#), [566](#), [644](#), [654](#),  
[667](#), [669](#), [752](#), [754](#), [756](#), [911](#), [917](#), [924](#)  
MPI\_Finalize, [427](#)  
MPI\_FINALIZED, [425](#), [426](#), [426](#), [427](#), [440](#),  
[752](#), [913](#)  
MPI\_FREE\_MEM, [385](#), [385](#), [399](#), [482](#), [484](#)  
MPI\_GATHER, [149](#), [152](#), [153](#), [157](#), [159](#), [160](#),  
[167](#), [168](#), [173](#), [174](#), [183](#), [210](#)  
MPI\_GATHER\_INIT, [226](#)  
MPI\_GATHERV, [149](#), [153](#), [159](#), [159](#)–[161](#), [169](#),  
[175](#), [211](#)  
MPI\_GATHERV\_INIT, [227](#)  
MPI\_GET, [477](#), [494](#), [497](#), [498](#), [504](#), [510](#), [514](#),  
[536](#), [538](#), [539](#), [547](#), [743](#), [925](#)  
MPI\_GET\_ACCUMULATE, [477](#), [494](#), [502](#),  
[503](#), [504](#), [505](#), [512](#), [539](#), [545](#), [912](#)  
MPI\_GET\_ADDRESS, [19](#), [89](#), [106](#), [107](#),  
[107](#)–[109](#), [121](#), [487](#), [699](#), [715](#), [734](#), [739](#),  
[757](#), [758](#)  
MPI\_GET\_COUNT, [33](#), [33](#), [34](#), [55](#), [120](#), [507](#),  
[561](#), [581](#), [915](#), [922](#)  
MPI\_GET\_ELEMENTS, [55](#), [119](#)–[121](#), [561](#),  
[562](#), [581](#), [915](#)  
MPI\_GET\_ELEMENTS\_X, [55](#), [119](#)–[121](#), [561](#),

- 582, 915
- MPI\_GET\_LIBRARY\_VERSION, [380](#), [380](#),  
[440](#), [912](#), [913](#), [915](#)
- MPI\_GET\_PROCESSOR\_NAME, [382](#), [383](#),  
[924](#)
- MPI\_GET\_VERSION, [379](#), [380](#), [440](#), [719](#), [913](#)
- MPI\_GRAPH\_CREATE, [326](#), [327](#), [330](#), [330](#),  
[332](#), [337](#), [340](#), [344](#), [351](#), [352](#), [923](#)
- MPI\_GRAPH\_GET, [327](#), [340](#), [340](#)
- MPI\_GRAPH\_MAP, [327](#), [351](#), [351](#)
- MPI\_GRAPH\_NEIGHBORS, [327](#), [343](#), [344](#),  
[352](#), [921](#)
- MPI\_GRAPH\_NEIGHBORS\_COUNT, [327](#),  
[343](#), [344](#), [921](#)
- MPI\_GRAPHDIMS\_GET, [327](#), [339](#), [340](#)
- MPI\_GREQUEST\_COMPLETE, [554](#)–[556](#),  
[557](#), [557](#)
- MPI\_GREQUEST\_START, [554](#), [554](#), [785](#), [788](#),  
[921](#)
- MPI\_GROUP\_C2F, [753](#)
- MPI\_GROUP\_COMPARE, [257](#), [261](#)
- MPI\_GROUP\_DIFFERENCE, [260](#)
- MPI\_GROUP\_EXCL, [261](#), [261](#), [263](#)
- MPI\_GROUP\_F2C, [753](#)
- MPI\_GROUP\_FREE, [264](#), [265](#), [266](#), [388](#), [423](#),  
[430](#), [924](#)
- MPI\_GROUP\_FROM\_SESSION\_PSET, [264](#),  
[264](#)
- MPI\_GROUP\_INCL, [260](#), [261](#), [262](#)
- MPI\_GROUP\_INTERSECTION, [259](#)
- MPI\_GROUP\_RANGE\_EXCL, [263](#), [263](#)
- MPI\_GROUP\_RANGE\_INCL, [262](#), [262](#)
- MPI\_GROUP\_RANK, [256](#), [266](#)
- MPI\_GROUP\_SIZE, [256](#), [265](#)
- MPI\_GROUP\_TRANSLATE\_RANKS, [257](#),  
[257](#), [922](#)
- MPI\_GROUP\_UNION, [259](#)
- MPI\_IALLGATHER, [149](#), [153](#), [154](#), [213](#)
- MPI\_IALLGATHERV, [149](#), [153](#), [154](#), [214](#)
- MPI\_IALLREDUCE, [149](#), [153](#), [154](#), [219](#)
- MPI\_IALLTOALL, [149](#), [153](#), [154](#), [215](#)
- MPI\_IALLTOALLV, [149](#), [153](#), [154](#), [216](#)
- MPI\_IALLTOALLW, [149](#), [153](#), [154](#), [217](#)
- MPI\_IBARRIER, [149](#), [153](#), [206](#), [207](#), [208](#), [245](#)
- MPI\_IBCAST, [149](#), [153](#), [208](#), [209](#), [249](#)
- MPI\_IBSEND, [52](#), [56](#), [81](#)
- MPI\_IEXSCAN, [150](#), [153](#), [223](#)
- MPI\_IGATHER, [149](#), [153](#), [209](#)
- MPI\_IGATHERV, [149](#), [153](#), [210](#)
- MPI\_IMPROBE, [68](#), [71](#), [71](#)–[73](#), [75](#), [446](#), [911](#),  
[915](#), [916](#)
- MPI\_IMRECV, [71](#)–[73](#), [74](#), [75](#), [916](#)
- MPI\_INEIGHBOR\_ALLGATHER, [327](#), [362](#),  
[917](#)
- MPI\_INEIGHBOR\_ALLGATHERV, [327](#), [363](#),  
[917](#)
- MPI\_INEIGHBOR\_ALLTOALL, [327](#), [364](#), [917](#)
- MPI\_INEIGHBOR\_ALLTOALLV, [327](#), [365](#),  
[917](#)
- MPI\_INEIGHBOR\_ALLTOALLW, [328](#), [366](#),  
[917](#)
- MPI\_INFO\_C2F, [440](#), [753](#)
- MPI\_INFO\_CREATE, [408](#), [408](#), [440](#)
- MPI\_INFO\_DELETE, [399](#), [409](#), [409](#), [412](#), [440](#)
- MPI\_INFO\_DUP, [413](#), [413](#), [440](#)
- MPI\_INFO\_F2C, [440](#), [753](#)
- MPI\_INFO\_FREE, [283](#), [413](#), [423](#), [430](#), [434](#),  
[440](#), [494](#), [574](#), [671](#), [675](#), [677](#), [680](#)
- MPI\_INFO\_GET, [19](#), [407](#), [409](#), [440](#), [696](#), [911](#),  
[925](#)
- MPI\_INFO\_GET\_NKEYS, [407](#), [412](#), [412](#), [440](#),  
[925](#)
- MPI\_INFO\_GET\_NTHKEY, [407](#), [412](#), [440](#),  
[925](#)
- MPI\_INFO\_GET\_STRING, [19](#), [407](#), [411](#), [411](#),  
[696](#), [697](#), [911](#)
- MPI\_INFO\_GET\_VALUEN, [19](#), [407](#), [410](#),  
[440](#), [697](#), [911](#), [925](#)
- MPI\_INFO\_SET, [408](#), [409](#)–[412](#), [440](#)
- MPI\_INIT, [15](#), [21](#), [22](#), [255](#), [381](#), [387](#), [415](#), [416](#),  
[416](#), [417](#), [419](#), [420](#), [422](#), [425](#)–[427](#), [440](#),  
[446](#), [451](#), [452](#), [454](#), [471](#), [472](#), [644](#), [646](#),  
[654](#), [667](#), [751](#), [752](#), [754](#), [756](#), [911](#), [915](#),  
[917](#), [919](#), [921](#)
- MPI\_INIT\_THREAD, [21](#), [255](#), [387](#), [415](#)–[417](#),  
[419](#), [420](#)–[422](#), [425](#)–[427](#), [429](#), [446](#), [471](#),  
[644](#), [646](#), [647](#), [654](#), [751](#), [915](#), [917](#), [921](#)
- MPI\_INITIALIZED, [425](#), [426](#), [426](#), [440](#), [752](#),  
[913](#)
- MPI\_INTERCOMM\_CREATE, [268](#), [274](#), [294](#),  
[295](#), [297](#), [916](#)
- MPI\_Intercomm\_create, [296](#)
- MPI\_INTERCOMM\_CREATE\_FROM\_GROUPS,  
[267](#), [268](#), [294](#), [296](#), [381](#)
- MPI\_INTERCOMM\_MERGE, [267](#), [274](#), [291](#),  
[294](#), [297](#), [297](#), [918](#)
- MPI\_IPROBE, [34](#), [68](#), [68](#)–[73](#), [75](#), [446](#), [915](#), [916](#)
- MPI\_Irecv, [54](#), [75](#), [733](#), [734](#), [737](#), [738](#)
- MPI\_IREDUCE, [149](#), [153](#), [154](#), [218](#), [219](#)
- MPI\_IREDUCE\_SCATTER, [149](#), [153](#), [154](#),  
[221](#)
- MPI\_IREDUCE\_SCATTER\_BLOCK, [149](#),  
[153](#), [154](#), [220](#)
- MPI\_IRSEND, [53](#)
- MPI\_IS\_THREAD\_MAIN, [419](#), [422](#), [913](#)
- MPI\_ISCAN, [150](#), [153](#), [222](#)
- MPI\_ISCATTER, [149](#), [153](#), [211](#)
- MPI\_ISCATTERV, [149](#), [153](#), [212](#)

- 1 MPI\_ISEND, [51](#), [81](#), [711](#), [712](#), [715](#), [732](#), [733](#),  
2 [738](#)
- 3 MPI\_ISSEND, [53](#)
- 4 MPI\_KEYVAL\_CREATE, [19](#), [693](#), [695](#), [789](#)
- 5 MPI\_KEYVAL\_FREE, [19](#), [315](#), [694](#)
- 6 MPI\_LOOKUP\_NAME, [399](#), [461](#), [466](#), [467](#),  
7 [468](#)
- 8 MPI\_MESSAGE\_C2F, [753](#), [916](#)
- 9 MPI\_MESSAGE\_F2C, [753](#), [916](#)
- 10 MPI\_MPROBE, [68](#), [71](#), [72](#), [73](#), [73](#), [75](#), [446](#),  
11 [915](#), [916](#)
- 12 MPI\_MRECV, [71](#), [72](#), [73](#), [73–75](#), [916](#)
- 13 MPI\_NEIGHBOR\_ALLGATHER, [327](#), [353](#),  
14 [354](#), [356](#), [362](#), [917](#)
- 15 MPI\_NEIGHBOR\_ALLGATHER\_INIT, [367](#)
- 16 MPI\_NEIGHBOR\_ALLGATHERV, [327](#), [355](#),  
17 [363](#), [917](#)
- 18 MPI\_NEIGHBOR\_ALLGATHERV\_INIT, [368](#)
- 19 MPI\_NEIGHBOR\_ALLTOALL, [327](#), [356](#), [358](#),  
20 [364](#), [917](#)
- 21 MPI\_NEIGHBOR\_ALLTOALL\_INIT, [369](#)
- 22 MPI\_NEIGHBOR\_ALLTOALLV, [327](#), [358](#),  
23 [365](#), [917](#)
- 24 MPI\_NEIGHBOR\_ALLTOALLV\_INIT, [370](#)
- 25 MPI\_NEIGHBOR\_ALLTOALLW, [327](#), [359](#),  
26 [360](#), [367](#), [917](#)
- 27 MPI\_NEIGHBOR\_ALLTOALLW\_INIT, [372](#)
- 28 MPI\_NULL\_COPY\_FN, [18](#), [19](#), [304](#), [694](#), [776](#)
- 29 MPI\_NULL\_DELETE\_FN, [19](#), [305](#), [694](#), [776](#)
- 30 MPI\_OP\_C2F, [753](#)
- 31 MPI\_OP\_COMMUTATIVE, [198](#), [920](#)
- 32 MPI\_OP\_CREATE, [191](#), [191](#), [193](#), [711](#), [783](#),  
33 [786](#), [918](#)
- 34 MPI\_OP\_F2C, [753](#)
- 35 MPI\_OP\_FREE, [194](#), [423](#), [430](#)
- 36 MPI\_OPEN\_PORT, [461](#), [462](#), [464–466](#), [468](#)
- 37 MPI\_PACK, [49](#), [138](#), [140](#), [141](#), [144](#), [613](#), [618](#)
- 38 MPI\_PACK\_EXTERNAL, [8](#), [144](#), [145](#), [725](#),  
39 [922](#)
- 40 MPI\_PACK\_EXTERNAL\_SIZE, [146](#)
- 41 MPI\_PACK\_SIZE, [49](#), [141](#), [141](#), [915](#)
- 42 MPI\_PCONTROL, [638](#), [639](#), [639](#), [640](#)
- 43 MPI\_PROBE, [31](#), [34](#), [35](#), [68](#), [69](#), [69–71](#), [73](#), [75](#),  
44 [446](#), [915](#), [916](#)
- 45 MPI\_PUBLISH\_NAME, [461](#), [465](#), [466–468](#)
- 46 MPI\_PUT, [477](#), [494](#), [495](#), [497](#), [502](#), [508](#), [514](#),  
47 [520](#), [530](#), [532](#), [537](#), [538](#), [547](#), [732](#), [743](#),  
48 [925](#)
- MPI\_QUERY\_THREAD, [421](#), [422](#), [446](#), [913](#)
- MPI\_RACCUMULATE, [477](#), [494](#), [502](#), [504](#),  
[510](#), [511](#)
- MPI\_RECV, [26](#), [30](#), [32](#), [34](#), [68](#), [71](#), [72](#), [88](#), [118](#),  
[119](#), [139](#), [140](#), [150](#), [158](#), [246](#), [562](#), [627](#),  
[667](#), [739](#), [742](#), [743](#)
- MPI\_RECV\_INIT, [80](#), [81](#)
- MPI\_REDUCE, [149](#), [153](#), [154](#), [182](#), [182–184](#),  
[191–193](#), [196](#), [199](#), [201–203](#), [219](#), [502](#),  
[504](#), [506](#), [921](#)
- MPI\_REDUCE\_INIT, [236](#)
- MPI\_REDUCE\_LOCAL, [183](#), [184](#), [191](#), [197](#),  
[918](#), [920](#)
- MPI\_REDUCE\_SCATTER, [149](#), [153](#), [154](#),  
[184](#), [191](#), [200](#), [200](#), [201](#), [222](#)
- MPI\_REDUCE\_SCATTER\_BLOCK, [149](#),  
[153](#), [154](#), [184](#), [191](#), [199](#), [199](#), [200](#), [221](#),  
[920](#)
- MPI\_REDUCE\_SCATTER\_BLOCK\_INIT, [238](#)
- MPI\_REDUCE\_SCATTER\_INIT, [239](#)
- MPI\_REGISTER\_DATAREP, [400](#), [616](#),  
[617–619](#), [632](#), [786](#), [788](#)
- MPI\_REQUEST\_C2F, [753](#)
- MPI\_REQUEST\_F2C, [753](#)
- MPI\_REQUEST\_FREE, [58](#), [58](#), [75](#), [82](#), [206](#),  
[224](#), [423](#), [430](#), [507](#), [556](#), [557](#), [920](#)
- MPI\_REQUEST\_GET\_STATUS, [35](#), [67](#), [67](#),  
[555](#), [920](#)
- MPI\_RGET, [477](#), [494](#), [509](#), [510](#)
- MPI\_RGET\_ACCUMULATE, [477](#), [494](#), [502](#),  
[504](#), [511](#), [512](#)
- MPI\_RPUT, [477](#), [494](#), [508](#), [508](#), [509](#)
- MPI\_RSEND, [42](#)
- MPI\_RSEND\_INIT, [80](#)
- MPI\_SCAN, [150](#), [153](#), [184](#), [191](#), [202](#), [202](#), [204](#),  
[222](#)
- MPI\_SCAN\_INIT, [240](#)
- MPI\_SCATTER, [149](#), [153](#), [167](#), [167](#), [169](#), [170](#),  
[199](#), [212](#)
- MPI\_SCATTER\_INIT, [229](#)
- MPI\_SCATTERV, [149](#), [153](#), [169](#), [169](#), [170](#),  
[201](#), [213](#)
- MPI\_SCATTERV\_INIT, [230](#)
- MPI\_SEND, [25](#), [26](#), [27](#), [34](#), [37](#), [88](#), [117](#), [118](#),  
[139](#), [246](#), [566](#), [627](#), [640](#), [739](#), [740](#), [742](#)
- MPI\_SEND\_INIT, [78](#), [81](#)
- MPI\_SENDRECV, [83](#), [347](#)
- MPI\_SENDRECV\_REPLACE, [84](#)
- MPI\_SESSION\_C2F, [753](#)
- MPI\_SESSION\_CALL\_ERRHANDLER, [405](#),  
[405](#), [440](#)
- MPI\_SESSION\_CREATE\_ERRHANDLER,  
[388](#), [394](#), [395](#), [429](#), [440](#), [785](#), [788](#)
- MPI\_SESSION\_CREATE\_KEYVAL, [787](#)
- MPI\_SESSION\_F2C, [753](#)
- MPI\_SESSION\_FINALIZE, [430](#), [430](#), [440](#)
- MPI\_SESSION\_GET\_ERRHANDLER, [388](#),  
[396](#)
- MPI\_SESSION\_GET\_INFO, [429](#), [433](#), [433](#)

MPI_SESSION_GET_NTH_PSET, <a href="#">264</a> , <a href="#">432</a> , <a href="#">433</a>	MPI_T_EVENT_CALLBACK_GET_INFO, <a href="#">679</a>	1
MPI_SESSION_GET_NUM_PSETS, <a href="#">431</a> , <a href="#">431</a> , <a href="#">432</a>	MPI_T_EVENT_CALLBACK_SET_INFO, <a href="#">679</a> , <a href="#">679</a>	2
MPI_SESSION_GET_PSET_INFO, <a href="#">434</a>	MPI_T_EVENT_COPY, <a href="#">673</a> , <a href="#">675</a> , <a href="#">683</a> , <a href="#">683</a>	3
MPI_SESSION_INIT, <a href="#">388</a> , <a href="#">423</a> , <a href="#">429</a> , <a href="#">429</a> , <a href="#">440</a> , <a href="#">446</a> , <a href="#">471</a> , <a href="#">647</a>	MPI_T_EVENT_GET_INDEX, <a href="#">676</a> , <a href="#">676</a> , <a href="#">691</a>	4
MPI_SESSION_SET_ERRHANDLER, <a href="#">388</a> , <a href="#">395</a>	MPI_T_EVENT_GET_INFO, <a href="#">648</a> , <a href="#">674</a> , <a href="#">674</a> , <a href="#">677</a> , <a href="#">683</a> , <a href="#">691</a>	5
MPI_SIZEOF, <a href="#">19</a> , <a href="#">697</a> , <a href="#">698</a> , <a href="#">909</a>	MPI_T_EVENT_GET_NUM, <a href="#">673</a>	6
MPI_SSEND, <a href="#">41</a>	MPI_T_EVENT_GET_SOURCE, <a href="#">673</a> , <a href="#">684</a>	7
MPI_SSEND_INIT, <a href="#">79</a>	MPI_T_EVENT_GET_TIMESTAMP, <a href="#">671</a> , <a href="#">673</a> , <a href="#">683</a> , <a href="#">683</a>	8
MPI_START, <a href="#">81</a> , <a href="#">81</a> , <a href="#">82</a> , <a href="#">224</a> , <a href="#">739</a>	MPI_T_EVENT_HANDLE_ALLOC, <a href="#">676</a> , <a href="#">676</a> , <a href="#">679</a> , <a href="#">691</a>	9
MPI_STARTALL, <a href="#">82</a> , <a href="#">82</a> , <a href="#">224</a> , <a href="#">739</a>	MPI_T_EVENT_HANDLE_FREE, <a href="#">680</a> , <a href="#">680</a> , <a href="#">691</a>	10
MPI_STATUS_C2F, <a href="#">754</a>	MPI_T_EVENT_HANDLE_GET_INFO, <a href="#">677</a> , <a href="#">677</a>	11
MPI_STATUS_C2F08, <a href="#">755</a> , <a href="#">918</a>	MPI_T_EVENT_HANDLE_SET_INFO, <a href="#">677</a> , <a href="#">677</a>	12
MPI_STATUS_F082C, <a href="#">755</a> , <a href="#">918</a>	MPI_T_EVENT_READ, <a href="#">673</a> , <a href="#">675</a> , <a href="#">682</a> , <a href="#">682</a>	13
MPI_STATUS_F082F, <a href="#">756</a> , <a href="#">918</a>	MPI_T_EVENT_REGISTER_CALLBACK, <a href="#">678</a> , <a href="#">678</a>	14
MPI_STATUS_F2C, <a href="#">754</a>	MPI_T_EVENT_SET_DROPPED_HANDLER, <a href="#">681</a> , <a href="#">681</a> , <a href="#">682</a>	15
MPI_STATUS_F2F08, <a href="#">756</a> , <a href="#">918</a>	MPI_T_FINALIZE, <a href="#">647</a> , <a href="#">647</a>	16
MPI_STATUS_SET_CANCELLED, <a href="#">561</a> , <a href="#">910</a>	MPI_T_INIT_THREAD, <a href="#">646</a> , <a href="#">646</a> , <a href="#">647</a>	17
MPI_STATUS_SET_ELEMENTS, <a href="#">560</a> , <a href="#">561</a>	MPI_T_PVAR_GET_INDEX, <a href="#">661</a> , <a href="#">661</a> , <a href="#">691</a> , <a href="#">913</a>	18
MPI_STATUS_SET_ELEMENTS_X, <a href="#">561</a> , <a href="#">561</a> , <a href="#">915</a>	MPI_T_PVAR_GET_INFO, <a href="#">648</a> , <a href="#">659</a> , <a href="#">660</a> , <a href="#">660</a> , <a href="#">663</a> , <a href="#">665</a> , <a href="#">666</a> , <a href="#">689</a> , <a href="#">691</a> , <a href="#">912</a> , <a href="#">913</a>	19
MPI_T_CATEGORY_CHANGED, <a href="#">689</a>	MPI_T_PVAR_GET_NUM, <a href="#">659</a> , <a href="#">663</a>	20
MPI_T_CATEGORY_GET_CATEGORIES, <a href="#">688</a> , <a href="#">688</a> , <a href="#">689</a> , <a href="#">691</a>	MPI_T_PVAR_HANDLE_ALLOC, <a href="#">648</a> , <a href="#">663</a> , <a href="#">663</a> , <a href="#">665</a> , <a href="#">691</a>	21
MPI_T_CATEGORY_GET_CVARS, <a href="#">687</a> , <a href="#">687</a> , <a href="#">689</a> , <a href="#">691</a>	MPI_T_PVAR_HANDLE_FREE, <a href="#">663</a> , <a href="#">664</a> , <a href="#">691</a> , <a href="#">912</a>	22
MPI_T_CATEGORY_GET_EVENTS, <a href="#">688</a> , <a href="#">688</a>	MPI_T_PVAR_READ, <a href="#">665</a> , <a href="#">665</a> , <a href="#">666</a> , <a href="#">673</a> , <a href="#">691</a> , <a href="#">912</a>	23
MPI_T_CATEGORY_GET_INDEX, <a href="#">687</a> , <a href="#">687</a> , <a href="#">691</a> , <a href="#">913</a>	MPI_T_PVAR_READRESET, <a href="#">661</a> , <a href="#">666</a> , <a href="#">666</a> , <a href="#">673</a> , <a href="#">691</a> , <a href="#">912</a>	24
MPI_T_CATEGORY_GET_INFO, <a href="#">686</a> , <a href="#">686</a> , <a href="#">689</a> , <a href="#">691</a> , <a href="#">912</a> , <a href="#">913</a>	MPI_T_PVAR_RESET, <a href="#">666</a> , <a href="#">666</a> , <a href="#">673</a> , <a href="#">691</a> , <a href="#">912</a>	25
MPI_T_CATEGORY_GET_NUM, <a href="#">685</a>	MPI_T_PVAR_SESSION_CREATE, <a href="#">662</a> , <a href="#">691</a>	26
MPI_T_CATEGORY_GET_NUM_EVENTS, <a href="#">686</a> , <a href="#">687</a>	MPI_T_PVAR_SESSION_FREE, <a href="#">662</a> , <a href="#">691</a>	27
MPI_T_CATEGORY_GET_PVARS, <a href="#">688</a> , <a href="#">688</a> , <a href="#">689</a> , <a href="#">691</a>	MPI_T_PVAR_START, <a href="#">664</a> , <a href="#">673</a> , <a href="#">691</a> , <a href="#">912</a>	28
MPI_T_CVAR_GET_INDEX, <a href="#">652</a> , <a href="#">653</a> , <a href="#">691</a> , <a href="#">913</a>	MPI_T_PVAR_STOP, <a href="#">664</a> , <a href="#">673</a> , <a href="#">691</a> , <a href="#">912</a>	29
MPI_T_CVAR_GET_INFO, <a href="#">648</a> , <a href="#">650</a> , <a href="#">651</a> , <a href="#">651</a> , <a href="#">652</a> , <a href="#">654</a> – <a href="#">656</a> , <a href="#">689</a> , <a href="#">691</a> , <a href="#">912</a> , <a href="#">913</a>	MPI_T_PVAR_WRITE, <a href="#">665</a> , <a href="#">665</a> , <a href="#">673</a> , <a href="#">691</a> , <a href="#">912</a>	30
MPI_T_CVAR_GET_NUM, <a href="#">650</a> , <a href="#">655</a>	MPI_T_SOURCE_GET_INFO, <a href="#">670</a> , <a href="#">671</a> , <a href="#">684</a> , <a href="#">691</a>	31
MPI_T_CVAR_HANDLE_ALLOC, <a href="#">648</a> , <a href="#">654</a> , <a href="#">655</a> , <a href="#">656</a> , <a href="#">691</a>	MPI_T_SOURCE_GET_NUM, <a href="#">670</a> , <a href="#">670</a> , <a href="#">691</a>	32
MPI_T_CVAR_HANDLE_FREE, <a href="#">655</a> , <a href="#">655</a> , <a href="#">691</a>	MPI_T_SOURCE_GET_TIMESTAMP, <a href="#">671</a> , <a href="#">671</a> , <a href="#">673</a> , <a href="#">691</a>	33
MPI_T_CVAR_READ, <a href="#">655</a> , <a href="#">691</a>	MPI_TEST, <a href="#">35</a> , <a href="#">55</a> , <a href="#">56</a> , <a href="#">57</a> , <a href="#">58</a> , <a href="#">60</a> , <a href="#">62</a> , <a href="#">67</a> , <a href="#">75</a> ,	34
MPI_T_CVAR_WRITE, <a href="#">655</a> , <a href="#">691</a>		35
MPI_T_ENUM_GET_INFO, <a href="#">648</a> , <a href="#">649</a> , <a href="#">691</a>		36
MPI_T_ENUM_GET_ITEM, <a href="#">649</a> , <a href="#">649</a> , <a href="#">691</a>		37

- 1           76, 82, 224, 423, 557, 580, 581  
2 MPI\_TEST\_CANCELLED, 55–57, [76](#), [77](#), 555,  
3           [562](#), [582](#)  
4 MPI\_TESTALL, [60](#), [63](#), [64](#), 428, 446, 555–557,  
5           [560](#)  
6 MPI\_TESTANY, [60](#), [61](#), [62](#), [66](#), 446, 555, 556,  
7           [560](#)  
8 MPI\_TESTSOME, [60](#), [65](#), [65](#), [66](#), 446,  
9           555–557, [560](#)  
10 MPI\_TOPO\_TEST, [327](#), [339](#), [339](#)  
11 MPI\_TYPE\_C2F, [752](#)  
12 MPI\_TYPE\_COMMIT, [115](#), [116](#), [753](#)  
13 MPI\_TYPE\_CONTIGUOUS, [12](#), [89](#), [89](#), [91](#),  
14           [110](#), [123](#), [564](#), [612](#)  
15 MPI\_TYPE\_CREATE\_DARRAY, [12](#), [34](#), [102](#),  
16           [102](#), [123](#)  
17 MPI\_TYPE\_CREATE\_F90\_COMPLEX, [12](#),  
18           [123](#), [125](#), [185](#), [613](#), [704](#), [723](#), [725](#)  
19 MPI\_TYPE\_CREATE\_F90\_INTEGER, [12](#),  
20           [123](#), [125](#), [185](#), [613](#), [704](#), [723](#), [725](#)  
21 MPI\_TYPE\_CREATE\_F90\_REAL, [12](#), [123](#),  
22           [125](#), [185](#), [613](#), [704](#), [722](#), [723](#)–[725](#), [920](#)  
23 MPI\_TYPE\_CREATE\_HINDEXED, [12](#), [19](#),  
24           [89](#), [94](#), [94](#), [97](#), [98](#), [123](#), [699](#)  
25 MPI\_TYPE\_CREATE\_HINDEXED\_BLOCK,  
26           [12](#), [89](#), [96](#), [96](#), [123](#), [916](#)  
27 MPI\_TYPE\_CREATE\_HVECTOR, [12](#), [19](#),  
28           [89](#), [92](#), [92](#), [123](#), [699](#)  
29 MPI\_TYPE\_CREATE\_INDEXED\_BLOCK,  
30           [12](#), [96](#), [96](#), [123](#)  
31 MPI\_TYPE\_CREATE\_KEYVAL, [301](#), [311](#),  
32           [315](#), [759](#), [784](#), [787](#), [923](#)  
33 MPI\_TYPE\_CREATE\_RESIZED, [19](#), [89](#), [110](#),  
34           [113](#), [114](#), [123](#), [612](#), [700](#), [918](#)  
35 MPI\_TYPE\_CREATE\_STRUCT, [12](#), [19](#), [89](#),  
36           [97](#), [97](#), [98](#), [111](#), [123](#), [181](#), [699](#)  
37 MPI\_TYPE\_CREATE\_SUBARRAY, [12](#), [15](#),  
38           [99](#), [101](#), [103](#), [123](#)  
39 MPI\_TYPE\_DELETE\_ATTR, [301](#), [314](#), [315](#),  
40           [918](#)  
41 MPI\_TYPE\_DUP, [12](#), [117](#), [117](#), [123](#), [918](#)  
42 MPI\_TYPE\_DUP\_FN, [312](#), [312](#), [775](#), [913](#)  
43 MPI\_TYPE\_EXTENT, [19](#), [699](#), [914](#)  
44 MPI\_TYPE\_F2C, [752](#)  
45 MPI\_TYPE\_FREE, [116](#), [125](#), [313](#), [423](#), [430](#)  
46 MPI\_TYPE\_FREE\_KEYVAL, [301](#), [313](#), [315](#)  
47 MPI\_TYPE\_GET\_ATTR, [301](#), [314](#), [315](#), [712](#),  
48           [760](#), [918](#)  
MPI\_TYPE\_GET\_CONTENTS, [123](#), [124](#),  
          [125](#), [126](#)  
MPI\_TYPE\_GET\_ELEMENTS, [119](#)  
MPI\_TYPE\_GET\_ELEMENTS\_X, [119](#)  
MPI\_TYPE\_GET\_ENVELOPE, [122](#), [123](#),  
          [124](#), [126](#), [724](#)  
MPI\_TYPE\_GET\_EXTENT, [19](#), [112](#), [115](#),  
          [699](#), [727](#), [757](#)  
MPI\_TYPE\_GET\_EXTENT\_X, [112](#), [915](#)  
MPI\_TYPE\_GET\_NAME, [320](#), [918](#)  
MPI\_TYPE\_GET\_TRUE\_EXTENT, [114](#), [114](#)  
MPI\_TYPE\_GET\_TRUE\_EXTENT\_X, [114](#),  
          [114](#), [915](#)  
MPI\_TYPE\_HINDEXED, [19](#), [699](#), [914](#)  
MPI\_TYPE\_HVECTOR, [19](#), [699](#), [914](#)  
MPI\_TYPE\_INDEXED, [12](#), [93](#), [93](#)–[95](#), [123](#)  
MPI\_TYPE\_LB, [19](#), [699](#), [914](#)  
MPI\_TYPE\_MATCH\_SIZE, [704](#), [727](#), [727](#), [918](#)  
MPI\_TYPE\_NULL\_COPY\_FN, [312](#), [312](#), [775](#),  
          [913](#)  
MPI\_TYPE\_NULL\_DELETE\_FN, [312](#), [775](#),  
          [913](#), [918](#)  
MPI\_TYPE\_SET\_ATTR, [301](#), [313](#), [315](#), [712](#),  
          [760](#), [763](#), [918](#)  
MPI\_TYPE\_SET\_NAME, [320](#), [918](#)  
MPI\_TYPE\_SIZE, [109](#), [110](#), [640](#), [915](#)  
MPI\_TYPE\_SIZE\_X, [109](#), [110](#), [915](#)  
MPI\_TYPE\_STRUCT, [19](#), [699](#), [914](#)  
MPI\_TYPE\_UB, [19](#), [699](#), [915](#)  
MPI\_TYPE\_VECTOR, [12](#), [90](#), [90](#)–[92](#), [94](#), [123](#)  
MPI\_UNPACK, [139](#), [140](#), [144](#), [618](#)  
MPI\_UNPACK\_EXTERNAL, [8](#), [146](#), [725](#)  
MPI\_UNPUBLISH\_NAME, [399](#), [466](#), [467](#)  
MPI\_WAIT, [33](#), [35](#), [55](#), [56](#), [56](#)–[59](#), [61](#), [63](#), [75](#),  
          [76](#), [82](#), [206](#), [224](#), [246](#), [423](#), [446](#), [553](#),  
          [557](#), [580](#), [581](#), [602](#), [620](#)–[622](#), [732](#), [738](#),  
          [739](#), [742](#)  
MPI\_WAITALL, [60](#), [62](#), [62](#)–[64](#), [206](#), [247](#), [446](#),  
          [507](#), [555](#)–[557](#), [560](#)  
MPI\_WAITANY, [43](#), [60](#), [60](#), [61](#), [66](#), [446](#), [555](#),  
          [556](#), [560](#)  
MPI\_WAIT SOME, [60](#), [64](#), [64](#)–[66](#), [446](#),  
          [555](#)–[557](#), [560](#)  
MPI\_WIN\_ALLOCATE, [478](#), [481](#), [482](#), [484](#),  
          [490](#), [491](#), [496](#), [526](#), [716](#), [718](#), [912](#)  
MPI\_Win\_allocate, [910](#)  
MPI\_WIN\_ALLOCATE\_CPTR, [482](#), [912](#)  
MPI\_WIN\_ALLOCATE\_SHARED, [478](#), [483](#),  
          [484](#), [486](#), [490](#), [491](#), [526](#), [718](#), [912](#)  
MPI\_Win\_allocate\_shared, [910](#)  
MPI\_WIN\_ALLOCATE\_SHARED\_CPTR,  
          [484](#), [912](#)  
MPI\_WIN\_ATTACH, [487](#), [488](#), [488](#), [489](#), [526](#)  
MPI\_WIN\_C2F, [753](#)  
MPI\_WIN\_CALL\_ERRHANDLER, [404](#), [405](#)  
MPI\_WIN\_COMPLETE, [490](#), [515](#), [519](#),  
          [520](#)–[522](#), [531](#), [538](#)  
MPI\_WIN\_CREATE, [447](#), [478](#), [479](#), [481](#)–[484](#),  
          [487](#), [488](#), [490](#), [491](#), [530](#)



MPI_WIN_CREATE_DYNAMIC, 400, 478, 487, 487–491, 531	531, 532, 535, 536	1
MPI_WIN_CREATE_ERRHANDLER, 388, 391, 392, 785, 787, 918	MPI_WIN_UNLOCK_ALL, 509, 515, 524, 525, 531, 532, 535, 546	2
MPI_WIN_CREATE_KEYVAL, 301, 308, 315, 759, 784, 787, 923	MPI_WIN_WAIT, 490, 515, 521, 521, 522, 525, 531, 532, 535, 538, 539	3
MPI_WIN_DELETE_ATTR, 301, 311, 315	MPI_WTICK, 20, 406, 406, 672	4
MPI_WIN_DETACH, 487, 489, 489, 490	MPI_WTIME, 20, 382, 405, 406, 640, 659, 672	5
MPI_WIN_DUP_FN, 308, 308, 775, 913	mpiexec, 417, 418, 420, 441, 442, 442, 911	6
MPI_WIN_F2C, 753	mpirun, 442	7
MPI_WIN_FENCE, 490, 498, 514, 516, 517, 518, 528, 529, 531, 532, 535, 540, 742, 743	PMPI_, 637, 712	8
MPI_WIN_FLUSH, 485, 507, 509, 526, 527, 531, 545, 547	PMPI_AINT_ADD, 20	9
MPI_WIN_FLUSH_ALL, 507, 509, 527, 531	PMPI_AINT_DIFF, 20	10
MPI_WIN_FLUSH_LOCAL, 507, 527, 531	PMPI_ISEND, 712, 715	11
MPI_WIN_FLUSH_LOCAL_ALL, 507, 528, 528, 531	PMPI_T_EVENT_COPY, 673	12
MPI_WIN_FREE, 309, 423, 430, 474, 490, 490	PMPI_T_EVENT_GET_SOURCE, 673	13
MPI_WIN_FREE_KEYVAL, 301, 309, 315	PMPI_T_EVENT_GET_TIMESTAMP, 673	14
MPI_WIN_GET_ATTR, 301, 310, 315, 491, 760, 763	PMPI_T_EVENT_READ, 673	15
MPI_WIN_GET_ERRHANDLER, 388, 392, 924	PMPI_T_PVAR_READ, 673	16
MPI_WIN_GET_GROUP, 492, 492	PMPI_T_PVAR_READRESET, 673	17
MPI_WIN_GET_INFO, 492, 493, 493, 910, 916	PMPI_T_PVAR_RESET, 673	18
MPI_WIN_GET_NAME, 321	PMPI_T_PVAR_START, 673	19
MPI_WIN_LOCK, 480, 490, 515, 523, 524–526, 528, 530, 532, 535–537	PMPI_T_PVAR_STOP, 673	20
MPI_WIN_LOCK_ALL, 480, 515, 524, 524, 525, 528, 530, 532, 537, 545, 546	PMPI_T_PVAR_WRITE, 673	21
MPI_WIN_NULL_COPY_FN, 308, 308, 775, 913	PMPI_T_SOURCE_GET_TIMESTAMP, 673	22
MPI_WIN_NULL_DELETE_FN, 308, 775, 913	PMPI_WTICK, 20	23
MPI_WIN_POST, 490, 515, 519, 520, 520–523, 525, 528, 529, 531, 538, 540	PMPI_WTIME, 20	24
MPI_WIN_SET_ATTR, 301, 310, 315, 491, 712, 760, 763		25
MPI_WIN_SET_ERRHANDLER, 388, 392		26
MPI_WIN_SET_INFO, 492, 492, 493, 910, 916		27
MPI_WIN_SET_NAME, 321		28
MPI_WIN_SHARED_QUERY, 483, 485, 718, 912		29
MPI_WIN_SHARED_QUERY_CPTR, 486, 912		30
MPI_WIN_START, 490, 515, 519, 519–523, 528, 529, 538, 545		31
MPI_WIN_SYNC, 528, 528, 531–534, 538, 545–547		32
MPI_WIN_TEST, 522, 522		33
MPI_WIN_UNLOCK, 490, 509, 515, 524, 526,		34