

# MPI: A Message-Passing Interface Standard

Version 4.0

(Draft)

Unofficial, for comment only

Message Passing Interface Forum

December 18, 2020

1 This document describes the 2020 Draft Specification of the Message-Passing Interface  
2 (MPI) standard, intended for comment. It is not an official version of the standard. The  
3 MPI standard includes point-to-point message-passing, collective communications, group  
4 and communicator concepts, process topologies, environmental management, process crea-  
5 tion and management, one-sided communications, extended collective operations, external  
6 interfaces, I/O, some miscellaneous topics, and multiple tool interfaces. Language bindings  
7 for C and Fortran are defined.

8 Historically, the evolution of the standards is from MPI-1.0 (May 5, 1994) to MPI-1.1  
9 (June 12, 1995) to MPI-1.2 (July 18, 1997), with several clarifications and additions and  
10 published as part of the MPI-2 document, to MPI-2.0 (July 18, 1997), with new functionality,  
11 to MPI-1.3 (May 30, 2008), combining for historical reasons the documents 1.1 and 1.2  
12 and some errata documents to one combined document, and to MPI-2.1 (June 23, 2008),  
13 combining the previous documents. Version MPI-2.2 (September 4, 2009) added additional  
14 clarifications and seven new routines. Version MPI-3.0 (September 21, 2012) is an extension  
15 of MPI-2.2. Version MPI-3.1 (June 4, 2015) adds clarifications and minor extensions to  
16 MPI-3.0.

17  
18 **Comments.** Please send comments on MPI to the MPI Forum as follows:

- 19  
20 1. Subscribe to <https://lists.mpi-forum.org/mailman/listinfo/mpi-comments>
- 21  
22 2. Send your comment to: [mpi-comments@lists.mpi-forum.org](mailto:mpi-comments@lists.mpi-forum.org), together with the version  
23 of the MPI standard and the page and line numbers on which you are commenting.

24 Your comment will be forwarded to MPI Forum committee members for consideration.  
25 Messages sent from an unsubscribed e-mail address will not be considered.

26  
27  
28  
29  
30  
31  
32  
33  
34  
35  
36  
37  
38  
39  
40  
41  
42  
43  
44  
45 ©1993, 1994, 1995, 1996, 1997, 2008, 2009, 2012, 2015, 2020 University of Tennessee,  
46 Knoxville, Tennessee. Permission to copy without fee all or part of this material is granted,  
47 provided the University of Tennessee copyright notice and the title of this document appear,  
48 and notice is given that copying is by permission of the University of Tennessee.

2020 Draft Specification, November, 2020. This document contains a draft of the MPI specification as of the date of publication. It has not been adopted as an official MPI specification, and is provided for comment only. This document includes a number of new features that will be present in the final MPI-4.0 document. The largest changes are the addition of large-count versions of many routines to address the limitations of using an `int` or `INTEGER` for the count parameter, persistent collectives, partitioned communications, an alternative way to initialize MPI, application info assertions, and improvements to the definitions of error handling. In addition, there are a number of smaller improvements and corrections.

Version 3.1: June 4, 2015. This document contains mostly corrections and clarifications to the MPI-3.0 document. The largest change is a correction to the Fortran bindings introduced in MPI-3.0. Additionally, new functions added include routines to manipulate `MPI_Aint` values in a portable manner, nonblocking collective I/O routines, and routines to get the index value by name for `MPI_T` performance and control variables.

Version 3.0: September 21, 2012. Coincident with the development of MPI-2.2, the MPI Forum began discussions of a major extension to MPI. This document contains the MPI-3 Standard. This version of the MPI-3 standard contains significant extensions to MPI functionality, including nonblocking collectives, new one-sided communication operations, and Fortran 2008 bindings. Unlike MPI-2.2, this standard is considered a major update to the MPI standard. As with previous versions, new features have been adopted only when there were compelling needs for the users. Some features, however, may have more than a minor impact on existing MPI implementations.

Version 2.2: September 4, 2009. This document contains mostly corrections and clarifications to the MPI-2.1 document. A few extensions have been added; however all correct MPI-2.1 programs are correct MPI-2.2 programs. New features were adopted only when there were compelling needs for users, open source implementations, and minor impact on existing MPI implementations.

Version 2.1: June 23, 2008. This document combines the previous documents MPI-1.3 (May 30, 2008) and MPI-2.0 (July 18, 1997). Certain parts of MPI-2.0, such as some sections of Chapter 4, Miscellany, and Chapter 7, Extended Collective Operations, have been merged into the chapters of MPI-1.3. Additional errata and clarifications collected by the MPI Forum are also included in this document.

Version 1.3: May 30, 2008. This document combines the previous documents MPI-1.1 (June 12, 1995) and the MPI-1.2 Chapter in MPI-2 (July 18, 1997). Additional errata collected by the MPI Forum referring to MPI-1.1 and MPI-1.2 are also included in this document.

Version 2.0: July 18, 1997. Beginning after the release of MPI-1.1, the MPI Forum began meeting to consider corrections and extensions. MPI-2 has been focused on process creation and management, one-sided communications, extended collective communications, external interfaces and parallel I/O. A miscellany chapter discusses items that do not fit elsewhere, in particular language interoperability.

1 Version 1.2: July 18, 1997. The MPI-2 Forum introduced MPI-1.2 as Chapter 3 in the  
2 standard “MPI-2: Extensions to the Message-Passing Interface”, July 18, 1997. This section  
3 contains clarifications and minor corrections to Version 1.1 of the MPI Standard. The only  
4 new function in MPI-1.2 is one for identifying to which version of the MPI Standard the  
5 implementation conforms. There are small differences between MPI-1 and MPI-1.1. There  
6 are very few differences between MPI-1.1 and MPI-1.2, but large differences between MPI-1.2  
7 and MPI-2.  
8

9 Version 1.1: June, 1995. Beginning in March, 1995, the Message-Passing Interface Forum  
10 reconvened to correct errors and make clarifications in the MPI document of May 5, 1994,  
11 referred to below as Version 1.0. These discussions resulted in Version 1.1. The changes  
12 from Version 1.0 are minor. A version of this document with all changes marked is available.  
13

14 Version 1.0: May, 1994. The Message-Passing Interface Forum, with participation from  
15 over 40 organizations, has been meeting since January 1993 to discuss and define a set of  
16 library interface standards for message passing. The Message-Passing Interface Forum is  
17 not sanctioned or supported by any official standards organization.

18 The goal of the Message-Passing Interface, simply stated, is to develop a widely used  
19 standard for writing message-passing programs. As such the interface should establish a  
20 practical, portable, efficient, and flexible standard for message-passing.

21 This is the final report, Version 1.0, of the Message-Passing Interface Forum. This  
22 document contains all the technical features proposed for the interface. This copy of the  
23 draft was processed by L<sup>A</sup>T<sub>E</sub>X on May 5, 1994.  
24  
25  
26  
27  
28  
29  
30  
31  
32  
33  
34  
35  
36  
37  
38  
39  
40  
41  
42  
43  
44  
45  
46  
47  
48

# Contents

<b>List of Figures</b>	<b>xviii</b>
<b>List of Tables</b>	<b>xx</b>
<b>Acknowledgments</b>	<b>xxii</b>
<b>1 Introduction to MPI</b>	<b>1</b>
1.1 Overview and Goals	1
1.2 Background of MPI-1.0	2
1.3 Background of MPI-1.1, MPI-1.2, and MPI-2.0	2
1.4 Background of MPI-1.3 and MPI-2.1	3
1.5 Background of MPI-2.2	4
1.6 Background of MPI-3.0	4
1.7 Background of MPI-3.1	4
1.8 Background of 2020 Draft Specification	5
1.9 Who Should Use This Standard?	5
1.10 What Platforms Are Targets for Implementation?	5
1.11 What Is Included in the Standard?	5
1.12 What Is Not Included in the Standard?	6
1.13 Organization of This Document	6
<b>2 MPI Terms and Conventions</b>	<b>9</b>
2.1 Document Notation	9
2.2 Naming Conventions	9
2.3 Procedure Specification	10
2.4 Semantic Terms	11
2.4.1 MPI Operations	11
2.4.2 MPI Procedures	13
2.4.3 MPI Datatypes	15
2.5 Datatypes	16
2.5.1 Opaque Objects	16
2.5.2 Array Arguments	18
2.5.3 State	18
2.5.4 Named Constants	18
2.5.5 Choice	19
2.5.6 Absolute Addresses and Relative Address Displacements	20
2.5.7 File Offsets	20
2.5.8 Counts	20
2.6 Language Binding	21

2.6.1	Deprecated and Removed Interfaces	22
2.6.2	Fortran Binding Issues	22
2.6.3	C Binding Issues	23
2.6.4	Functions and Macros	24
2.7	Processes	24
2.8	Error Handling	25
2.9	Implementation Issues	26
2.9.1	Independence of Basic Runtime Routines	26
2.9.2	Interaction with Signals	27
2.10	Examples	27
<b>3</b>	<b>Point-to-Point Communication</b>	<b>29</b>
3.1	Introduction	29
3.2	Blocking Send and Receive Operations	30
3.2.1	Blocking Send	30
3.2.2	Message Data	31
3.2.3	Message Envelope	33
3.2.4	Blocking Receive	34
3.2.5	Return Status	36
3.2.6	Passing MPI_STATUS_IGNORE for Status	39
3.2.7	Send-Receive	40
3.3	Datatype Matching and Data Conversion	43
3.3.1	Type Matching Rules	43
	Type MPI_CHARACTER	45
3.3.2	Data Conversion	46
3.4	Communication Modes	47
3.5	Semantics of Point-to-Point Communication	52
3.6	Buffer Allocation and Usage	56
3.6.1	Model Implementation of Buffered Mode	58
3.7	Nonblocking Communication	59
3.7.1	Communication Request Objects	61
3.7.2	Communication Initiation	61
3.7.3	Communication Completion	68
3.7.4	Semantics of Nonblocking Communications	72
3.7.5	Multiple Completions	73
3.7.6	Non-Destructive Test of status	81
3.8	Probe and Cancel	82
3.8.1	Probe	82
3.8.2	Matching Probe	85
3.8.3	Matched Receives	87
3.8.4	Cancel	90
3.9	Persistent Communication Requests	92
3.10	Null Processes	98
<b>4</b>	<b>Partitioned Point-to-Point Communication</b>	<b>101</b>
4.1	Introduction	101
4.2	Semantics of Partitioned Point-to-Point Communication	102
4.2.1	Communication Initialization and Starting with Partitioning	104

4.2.2	Communication Completion under Partitioning . . . . .	108
4.2.3	Semantics of Communications in Partitioned Mode . . . . .	109
4.3	Partitioned Communication Examples . . . . .	110
4.3.1	Partition Communication with Threads/Tasks Using OpenMP 4.0 or later . . . . .	110
4.3.2	Send-only Partitioning Example with Tasks and OpenMP version 4.0 or later . . . . .	111
4.3.3	Send and Receive Partitioning Example with OpenMP version 4.0 or later . . . . .	113
<b>5</b>	<b>Datatypes</b> . . . . .	<b>117</b>
5.1	Derived Datatypes . . . . .	117
5.1.1	Type Constructors with Explicit Addresses . . . . .	119
5.1.2	Datatype Constructors . . . . .	119
5.1.3	Subarray Datatype Constructor . . . . .	131
5.1.4	Distributed Array Datatype Constructor . . . . .	133
5.1.5	Address and Size Functions . . . . .	139
5.1.6	Lower-Bound and Upper-Bound Markers . . . . .	142
5.1.7	Extent and Bounds of Datatypes . . . . .	145
5.1.8	True Extent of Datatypes . . . . .	147
5.1.9	Commit and Free . . . . .	148
5.1.10	Duplicating a Datatype . . . . .	150
5.1.11	Use of General Datatypes in Communication . . . . .	151
5.1.12	Correct Use of Addresses . . . . .	154
5.1.13	Decoding a Datatype . . . . .	155
5.1.14	Examples . . . . .	164
5.2	Pack and Unpack . . . . .	172
5.3	Canonical MPI_PACK and MPI_UNPACK . . . . .	180
<b>6</b>	<b>Collective Communication</b> . . . . .	<b>185</b>
6.1	Introduction and Overview . . . . .	185
6.2	Communicator Argument . . . . .	188
6.2.1	Specifics for Intra-Communicator Collective Operations . . . . .	188
6.2.2	Applying Collective Operations to Inter-Communicators . . . . .	189
6.2.3	Specifics for Inter-Communicator Collective Operations . . . . .	190
6.3	Barrier Synchronization . . . . .	191
6.4	Broadcast . . . . .	192
6.4.1	Example using MPI_BCAST . . . . .	193
6.5	Gather . . . . .	194
6.5.1	Examples using MPI_GATHER, MPI_GATHERV . . . . .	198
6.6	Scatter . . . . .	204
6.6.1	Examples using MPI_SCATTER, MPI_SCATTERV . . . . .	208
6.7	Gather-to-all . . . . .	211
6.7.1	Example using MPI_ALLGATHER . . . . .	214
6.8	All-to-All Scatter/Gather . . . . .	215
6.9	Global Reduction Operations . . . . .	221
6.9.1	Reduce . . . . .	222
6.9.2	Predefined Reduction Operations . . . . .	224

6.9.3	Signed Characters and Reductions	227
6.9.4	MINLOC and MAXLOC	227
6.9.5	User-Defined Reduction Operations	231
	Example of User-Defined Reduce	235
6.9.6	All-Reduce	236
6.9.7	Process-Local Reduction	238
6.10	Reduce-Scatter	240
6.10.1	MPI_REDUCE_SCATTER_BLOCK	240
6.10.2	MPI_REDUCE_SCATTER	241
6.11	Scan	243
6.11.1	Inclusive Scan	243
6.11.2	Exclusive Scan	245
6.11.3	Example using MPI_SCAN	246
6.12	Nonblocking Collective Operations	248
6.12.1	Nonblocking Barrier Synchronization	250
6.12.2	Nonblocking Broadcast	251
	Example using MPI_IBCAST	251
6.12.3	Nonblocking Gather	252
6.12.4	Nonblocking Scatter	255
6.12.5	Nonblocking Gather-to-all	258
6.12.6	Nonblocking All-to-All Scatter/Gather	261
6.12.7	Nonblocking Reduce	267
6.12.8	Nonblocking All-Reduce	268
6.12.9	Nonblocking Reduce-Scatter with Equal Blocks	269
6.12.10	Nonblocking Reduce-Scatter	271
6.12.11	Nonblocking Inclusive Scan	272
6.12.12	Nonblocking Exclusive Scan	273
6.13	Persistent Collective Operations	274
6.13.1	Persistent Barrier Synchronization	275
6.13.2	Persistent Broadcast	276
6.13.3	Persistent Gather	277
6.13.4	Persistent Scatter	281
6.13.5	Persistent Gather-to-all	284
6.13.6	Persistent All-to-All Scatter/Gather	287
6.13.7	Persistent Reduce	292
6.13.8	Persistent All-Reduce	293
6.13.9	Persistent Reduce-Scatter with Equal Blocks	294
6.13.10	Persistent Reduce-Scatter	296
6.13.11	Persistent Inclusive Scan	297
6.13.12	Persistent Exclusive Scan	298
6.14	Correctness	299
<b>7</b>	<b>Groups, Contexts, Communicators, and Caching</b>	<b>307</b>
7.1	Introduction	307
7.1.1	Features Needed to Support Libraries	307
7.1.2	MPI's Support for Libraries	308
7.2	Basic Concepts	310
7.2.1	Groups	310



7.2.2	Contexts . . . . .	310
7.2.3	Intra-Communicators . . . . .	311
7.2.4	Predefined Intra-Communicators . . . . .	311
7.3	Group Management . . . . .	312
7.3.1	Group Accessors . . . . .	312
7.3.2	Group Constructors . . . . .	314
7.3.3	Group Destructors . . . . .	320
7.4	Communicator Management . . . . .	321
7.4.1	Communicator Accessors . . . . .	321
7.4.2	Communicator Constructors . . . . .	323
7.4.3	Communicator Destructors . . . . .	341
7.4.4	Communicator Info . . . . .	341
7.5	Motivating Examples . . . . .	344
7.5.1	Current Practice #1 . . . . .	344
7.5.2	Current Practice #2 . . . . .	345
7.5.3	(Approximate) Current Practice #3 . . . . .	345
7.5.4	Example #4 . . . . .	346
7.5.5	Library Example #1 . . . . .	347
7.5.6	Library Example #2 . . . . .	348
7.6	Inter-Communication . . . . .	351
7.6.1	Inter-Communicator Accessors . . . . .	353
7.6.2	Inter-Communicator Operations . . . . .	354
7.6.3	Inter-Communication Examples . . . . .	358
	Example 1: Three-Group “Pipeline” . . . . .	358
	Example 2: Three-Group “Ring” . . . . .	359
7.7	Caching . . . . .	361
7.7.1	Functionality . . . . .	361
7.7.2	Communicators . . . . .	362
7.7.3	Windows . . . . .	368
7.7.4	Datatypes . . . . .	372
7.7.5	Error Class for Invalid Keyval . . . . .	375
7.7.6	Attributes Example . . . . .	375
7.8	Naming Objects . . . . .	377
7.9	Formalizing the Loosely Synchronous Model . . . . .	382
7.9.1	Basic Statements . . . . .	382
7.9.2	Models of Execution . . . . .	382
	Static Communicator Allocation . . . . .	383
	Dynamic Communicator Allocation . . . . .	383
	The General Case . . . . .	383
<b>8</b>	<b>Process Topologies</b> . . . . .	<b>385</b>
8.1	Introduction . . . . .	385
8.2	Virtual Topologies . . . . .	386
8.3	Embedding in MPI . . . . .	386
8.4	Overview of the Functions . . . . .	387
8.5	Topology Constructors . . . . .	388
8.5.1	Cartesian Constructor . . . . .	388
8.5.2	Cartesian Convenience Function: MPI_DIMS_CREATE . . . . .	389

8.5.3	Graph Constructor . . . . .	390
8.5.4	Distributed Graph Constructor . . . . .	392
8.5.5	Topology Inquiry Functions . . . . .	399
8.5.6	Cartesian Shift Coordinates . . . . .	407
8.5.7	Partitioning of Cartesian Structures . . . . .	409
8.5.8	Low-Level Topology Functions . . . . .	410
8.6	Neighborhood Collective Communication . . . . .	412
8.6.1	Neighborhood Gather . . . . .	413
8.6.2	Neighbor Alltoall . . . . .	417
8.7	Nonblocking Neighborhood Communication . . . . .	425
8.7.1	Nonblocking Neighborhood Gather . . . . .	425
8.7.2	Nonblocking Neighborhood Alltoall . . . . .	428
8.8	Persistent Neighborhood Communication . . . . .	432
8.8.1	Persistent Neighborhood Gather . . . . .	433
8.8.2	Persistent Neighborhood Alltoall . . . . .	436
8.9	An Application Example . . . . .	440
<b>9</b>	<b>MPI Environmental Management</b> . . . . .	<b>447</b>
9.1	Implementation Information . . . . .	447
9.1.1	Version Inquiries . . . . .	447
9.1.2	Environmental Inquiries . . . . .	449
Tag Values . . . . .	449	
Host Rank . . . . .	449	
IO Rank . . . . .	450	
Clock Synchronization . . . . .	450	
Inquire Processor Name . . . . .	450	
9.2	Memory Allocation . . . . .	451
9.3	Error Handling . . . . .	454
9.3.1	Error Handlers for Communicators . . . . .	457
9.3.2	Error Handlers for Windows . . . . .	459
9.3.3	Error Handlers for Files . . . . .	461
9.3.4	Error Handlers for Sessions . . . . .	463
9.3.5	Freeing Errorhandlers and Retrieving Error Strings . . . . .	465
9.4	Error Codes and Classes . . . . .	466
9.5	Error Classes, Error Codes, and Error Handlers . . . . .	469
9.6	Timers and Synchronization . . . . .	473
<b>10</b>	<b>The Info Object</b> . . . . .	<b>475</b>
<b>11</b>	<b>Process Initialization, Creation, and Management</b> . . . . .	<b>483</b>
11.1	Introduction . . . . .	483
11.2	The World Model . . . . .	484
11.2.1	Starting MPI Processes . . . . .	484
11.2.2	Finalizing MPI . . . . .	490
11.2.3	Determining Whether MPI Has Been Initialized When Using the World Model . . . . .	493
11.2.4	Allowing User Functions at MPI Finalization . . . . .	494
11.3	The Sessions Model . . . . .	495

11.3.1	Session Creation and Destruction Methods	497
11.3.2	Processes Sets	498
11.3.3	Runtime Query Functions	499
11.3.4	Sessions Model Examples	502
11.4	Common Elements of Both Process Models	508
11.4.1	MPI Functionality that is Always Available	508
11.4.2	Aborting MPI Processes	508
11.5	Portable MPI Process Startup	510
11.6	MPI and Threads	512
11.6.1	General	512
11.6.2	Clarifications	514
11.7	The Dynamic Process Model	516
11.7.1	Starting Processes	516
11.7.2	The Runtime Environment	516
11.8	Process Manager Interface	517
11.8.1	Processes in MPI	517
11.8.2	Starting Processes and Establishing Communication	517
11.8.3	Starting Multiple Executables and Establishing Communication	522
11.8.4	Reserved Keys	525
11.8.5	Spawn Example	526
11.9	Establishing Communication	528
11.9.1	Names, Addresses, Ports, and All That	529
11.9.2	Server Routines	530
11.9.3	Client Routines	532
11.9.4	Name Publishing	534
11.9.5	Reserved Key Values	536
11.9.6	Client/Server Examples	537
11.10	Other Functionality	539
11.10.1	Universe Size	539
11.10.2	Singleton MPI Initialization	540
11.10.3	MPI_APPNUM	541
11.10.4	Releasing Connections	541
11.10.5	Another Way to Establish MPI Communication	543
<b>12</b>	<b>One-Sided Communications</b>	<b>545</b>
12.1	Introduction	545
12.2	Initialization	546
12.2.1	Window Creation	547
12.2.2	Window That Allocates Memory	550
12.2.3	Window That Allocates Shared Memory	552
12.2.4	Window of Dynamically Attached Memory	556
12.2.5	Window Destruction	559
12.2.6	Window Attributes	560
12.2.7	Window Info	561
12.3	Communication Calls	563
12.3.1	Put	564
12.3.2	Get	567
12.3.3	Examples for Communication Calls	568

12.3.4	Accumulate Functions . . . . .	570
	Accumulate Function . . . . .	571
	Get Accumulate Function . . . . .	573
	Fetch and Op Function . . . . .	576
	Compare and Swap Function . . . . .	577
12.3.5	Request-based RMA Communication Operations . . . . .	578
12.4	Memory Model . . . . .	585
12.5	Synchronization Calls . . . . .	587
12.5.1	Fence . . . . .	590
12.5.2	General Active Target Synchronization . . . . .	592
12.5.3	Lock . . . . .	596
12.5.4	Flush and Sync . . . . .	599
12.5.5	Assertions . . . . .	601
12.5.6	Miscellaneous Clarifications . . . . .	603
12.6	Error Handling . . . . .	603
12.6.1	Error Handlers . . . . .	603
12.6.2	Error Classes . . . . .	603
12.7	Semantics and Correctness . . . . .	604
12.7.1	Atomicity . . . . .	612
12.7.2	Ordering . . . . .	612
12.7.3	Progress . . . . .	613
12.7.4	Registers and Compiler Optimizations . . . . .	615
12.8	Examples . . . . .	616
<b>13</b>	<b>External Interfaces</b> . . . . .	<b>625</b>
13.1	Introduction . . . . .	625
13.2	Generalized Requests . . . . .	625
13.2.1	Examples . . . . .	630
13.3	Associating Information with Status . . . . .	632
<b>14</b>	<b>I/O</b> . . . . .	<b>635</b>
14.1	Introduction . . . . .	635
14.1.1	Definitions . . . . .	635
14.2	File Manipulation . . . . .	637
14.2.1	Opening a File . . . . .	637
14.2.2	Closing a File . . . . .	640
14.2.3	Deleting a File . . . . .	640
14.2.4	Resizing a File . . . . .	641
14.2.5	Preallocating Space for a File . . . . .	642
14.2.6	Querying the Size of a File . . . . .	643
14.2.7	Querying File Parameters . . . . .	643
14.2.8	File Info . . . . .	645
Reserved File Hints . . . . .	646	
14.3	File Views . . . . .	648
14.4	Data Access . . . . .	651
14.4.1	Data Access Routines . . . . .	651
Positioning . . . . .	652	
Synchronism . . . . .	652	

	Coordination . . . . .	653
	Data Access Conventions . . . . .	653
14.4.2	Data Access with Explicit Offsets . . . . .	654
14.4.3	Data Access with Individual File Pointers . . . . .	661
14.4.4	Data Access with Shared File Pointers . . . . .	672
	Noncollective Operations . . . . .	673
	Collective Operations . . . . .	676
	Seek . . . . .	679
14.4.5	Split Collective Data Access Routines . . . . .	680
14.5	File Interoperability . . . . .	689
14.5.1	Datatypes for File Interoperability . . . . .	691
14.5.2	External Data Representation: "external32" . . . . .	693
14.5.3	User-Defined Data Representations . . . . .	696
	Extent Callback . . . . .	697
	Datarep Conversion Functions . . . . .	698
14.5.4	Matching Data Representations . . . . .	700
14.6	Consistency and Semantics . . . . .	701
14.6.1	File Consistency . . . . .	701
14.6.2	Random Access vs. Sequential Files . . . . .	704
14.6.3	Progress . . . . .	705
14.6.4	Collective File Operations . . . . .	705
14.6.5	Nonblocking Collective File Operations . . . . .	705
14.6.6	Type Matching . . . . .	706
14.6.7	Miscellaneous Clarifications . . . . .	706
14.6.8	MPI_Offset Type . . . . .	706
14.6.9	Logical vs. Physical File Layout . . . . .	706
14.6.10	File Size . . . . .	707
14.6.11	Examples . . . . .	707
	Asynchronous I/O . . . . .	710
14.7	I/O Error Handling . . . . .	711
14.8	I/O Error Classes . . . . .	712
14.9	Examples . . . . .	712
14.9.1	Double Buffering with Split Collective I/O . . . . .	712
14.9.2	Subarray Filetype Constructor . . . . .	715
<b>15</b>	<b>Tool Support</b> . . . . .	<b>717</b>
15.1	Introduction . . . . .	717
15.2	Profiling Interface . . . . .	717
15.2.1	Requirements . . . . .	717
15.2.2	Discussion . . . . .	718
15.2.3	Logic of the Design . . . . .	718
15.2.4	Miscellaneous Control of Profiling . . . . .	719
15.2.5	MPI Library Implementation . . . . .	720
15.2.6	Complications . . . . .	721
	Multiple Counting . . . . .	721
	Linker Oddities . . . . .	722
	Fortran Support Methods . . . . .	722
15.2.7	Multiple Levels of Interception . . . . .	722

15.3	The MPI Tool Information Interface . . . . .	723
15.3.1	Verbosity Levels . . . . .	724
15.3.2	Binding MPI Tool Information Interface Variables to MPI Objects . . . . .	724
15.3.3	Convention for Returning Strings . . . . .	725
15.3.4	Initialization and Finalization . . . . .	726
15.3.5	Datatype System . . . . .	727
15.3.6	Control Variables . . . . .	730
	Control Variable Query Functions . . . . .	730
	Handle Allocation and Deallocation . . . . .	734
	Control Variable Access Functions . . . . .	735
15.3.7	Performance Variables . . . . .	736
	Performance Variable Classes . . . . .	737
	Performance Variable Query Functions . . . . .	739
	Performance Experiment Sessions . . . . .	742
	Handle Allocation and Deallocation . . . . .	742
	Starting and Stopping of Performance Variables . . . . .	744
	Performance Variable Access Functions . . . . .	745
15.3.8	Events . . . . .	749
	Event Sources . . . . .	750
	Callback Safety Requirements . . . . .	752
	Event Type Query Functions . . . . .	753
	Handle Allocation and Deallocation . . . . .	756
	Handling Dropped Events . . . . .	760
	Reading Event Data . . . . .	762
	Reading Event Meta Data . . . . .	763
15.3.9	Variable Categorization . . . . .	764
	Category Query Functions . . . . .	765
	Category Member Query Functions . . . . .	767
15.3.10	Return Codes for the MPI Tool Information Interface . . . . .	769
15.3.11	Profiling Interface . . . . .	770
<b>16</b>	<b>Deprecated Interfaces</b> . . . . .	<b>773</b>
16.1	Deprecated since MPI-2.0 . . . . .	773
16.2	Deprecated since MPI-2.2 . . . . .	776
16.3	Deprecated since MPI-4.0 . . . . .	776
<b>17</b>	<b>Removed Interfaces</b> . . . . .	<b>779</b>
17.1	Removed MPI-1 Bindings . . . . .	779
17.1.1	Overview . . . . .	779
17.1.2	Removed MPI-1 Functions . . . . .	779
17.1.3	Removed MPI-1 Datatypes . . . . .	779
17.1.4	Removed MPI-1 Constants . . . . .	779
17.1.5	Removed MPI-1 Callback Prototypes . . . . .	780
17.2	C++ Bindings . . . . .	780
<b>18</b>	<b>Backward Incompatibilities</b> . . . . .	<b>781</b>
18.1	Backward Incompatibilities Starting in MPI-4.0 . . . . .	781

<b>19 Language Bindings</b>	<b>783</b>
19.1 Support for Fortran	783
19.1.1 Overview	783
19.1.2 Fortran Support Through the <code>mpi_f08</code> Module	784
19.1.3 Fortran Support Through the <code>mpi</code> Module	787
19.1.4 Fortran Support Through the <code>mpif.h</code> Include File	789
19.1.5 Interface Specifications, Procedure Names, and the Profiling Interface	790
19.1.6 MPI for Different Fortran Standard Versions	795
19.1.7 Requirements on Fortran Compilers	799
19.1.8 Additional Support for Fortran Register-Memory-Synchronization	800
19.1.9 Additional Support for Fortran Numeric Intrinsic Types	801
Parameterized Datatypes with Specified Precision and Exponent Range	802
Support for Size-specific MPI Datatypes	806
Communication With Size-specific Types	808
19.1.10 Problems With Fortran Bindings for MPI	809
19.1.11 Problems Due to Strong Typing	811
19.1.12 Problems Due to Data Copying and Sequence Association with Subscript Triplets	811
19.1.13 Problems Due to Data Copying and Sequence Association with Vector Subscripts	814
19.1.14 Special Constants	815
19.1.15 Fortran Derived Types	815
19.1.16 Optimization Problems, an Overview	817
19.1.17 Problems with Code Movement and Register Optimization	818
Nonblocking Operations	818
Persistent Operations	819
One-sided Communication	819
MPI_BOTTOM and Combining Independent Variables in Datatypes	819
Solutions	819
The Fortran <code>ASYNCHRONOUS</code> Attribute	821
Calling <code>MPI_F_SYNC_REG</code>	822
A User Defined Routine Instead of <code>MPI_F_SYNC_REG</code>	823
Module Variables and <code>COMMON</code> Blocks	824
The (Poorly Performing) Fortran <code>VOLATILE</code> Attribute	824
The Fortran <code>TARGET</code> Attribute	824
19.1.18 Temporary Data Movement and Temporary Memory Modification	824
19.1.19 Permanent Data Movement	826
19.1.20 Comparison with C	826
19.2 Support for Large Count and Large Byte Displacement	831
19.3 Language Interoperability	832
19.3.1 Introduction	832
19.3.2 Assumptions	832
19.3.3 Initialization	833
19.3.4 Transfer of Handles	833
19.3.5 Status	835
19.3.6 MPI Opaque Objects	838
Datatypes	838

	Callback Functions . . . . .	840
	Error Handlers . . . . .	840
	Reduce Operations . . . . .	840
	19.3.7 Attributes . . . . .	841
	19.3.8 Extra-State . . . . .	845
	19.3.9 Constants . . . . .	845
	19.3.10 Interlanguage Communication . . . . .	846
<b>A</b>	<b>Language Bindings Summary . . . . .</b>	<b>849</b>
A.1	Defined Values and Handles . . . . .	849
A.1.1	Defined Constants . . . . .	849
A.1.2	Types . . . . .	863
A.1.3	Prototype Definitions . . . . .	864
C Bindings . . . . .	864	
Fortran 2008 Bindings with the <code>mpi_f08</code> Module . . . . .	866	
Fortran Bindings with <code>mpif.h</code> or the <code>mpi</code> Module . . . . .	869	
A.1.4	Deprecated Prototype Definitions . . . . .	871
A.1.5	Info Keys . . . . .	871
A.1.6	Info Values . . . . .	872
A.2	Summary of the Semantics of all Op.-Related Routines . . . . .	873
A.3	C Bindings . . . . .	874
A.3.1	Point-to-Point Communication C Bindings . . . . .	874
A.3.2	Partitioned Communication C Bindings . . . . .	877
A.3.3	Datatypes C Bindings . . . . .	878
A.3.4	Collective Communication C Bindings . . . . .	881
A.3.5	Groups, Contexts, Communicators, and Caching C Bindings . . . . .	889
A.3.6	Process Topologies C Bindings . . . . .	892
A.3.7	MPI Environmental Management C Bindings . . . . .	896
A.3.8	The Info Object C Bindings . . . . .	898
A.3.9	Process Creation and Management C Bindings . . . . .	898
A.3.10	One-Sided Communications C Bindings . . . . .	899
A.3.11	External Interfaces C Bindings . . . . .	902
A.3.12	I/O C Bindings . . . . .	903
A.3.13	Language Bindings C Bindings . . . . .	907
A.3.14	Tools / Profiling Interface C Bindings . . . . .	907
A.3.15	Tools / MPI Tool Information Interface C Bindings . . . . .	907
A.3.16	Deprecated C Bindings . . . . .	910
A.4	Fortran 2008 Bindings with the <code>mpi_f08</code> Module . . . . .	911
A.4.1	Point-to-Point Communication Fortran 2008 Bindings . . . . .	911
A.4.2	Partitioned Communication Fortran 2008 Bindings . . . . .	921
A.4.3	Datatypes Fortran 2008 Bindings . . . . .	922
A.4.4	Collective Communication Fortran 2008 Bindings . . . . .	930
A.4.5	Groups, Contexts, Communicators, and Caching Fortran 2008 Bindings . . . . .	952
A.4.6	Process Topologies Fortran 2008 Bindings . . . . .	959
A.4.7	MPI Environmental Management Fortran 2008 Bindings . . . . .	969
A.4.8	The Info Object Fortran 2008 Bindings . . . . .	972
A.4.9	Process Creation and Management Fortran 2008 Bindings . . . . .	973



A.4.10	One-Sided Communications Fortran 2008 Bindings . . . . .	976
A.4.11	External Interfaces Fortran 2008 Bindings . . . . .	984
A.4.12	I/O Fortran 2008 Bindings . . . . .	984
A.4.13	Language Bindings Fortran 2008 Bindings . . . . .	997
A.4.14	Tools / Profiling Interface Fortran 2008 Bindings . . . . .	998
A.4.15	Deprecated Fortran 2008 Bindings . . . . .	998
A.5	Fortran Bindings with <code>mpif.h</code> or the <code>mpi</code> Module . . . . .	999
A.5.1	Point-to-Point Communication Fortran Bindings . . . . .	999
A.5.2	Partitioned Communication Fortran Bindings . . . . .	1002
A.5.3	Datatypes Fortran Bindings . . . . .	1002
A.5.4	Collective Communication Fortran Bindings . . . . .	1005
A.5.5	Groups, Contexts, Communicators, and Caching Fortran Bindings . . . . .	1011
A.5.6	Process Topologies Fortran Bindings . . . . .	1015
A.5.7	MPI Environmental Management Fortran Bindings . . . . .	1019
A.5.8	The Info Object Fortran Bindings . . . . .	1021
A.5.9	Process Creation and Management Fortran Bindings . . . . .	1022
A.5.10	One-Sided Communications Fortran Bindings . . . . .	1023
A.5.11	External Interfaces Fortran Bindings . . . . .	1028
A.5.12	I/O Fortran Bindings . . . . .	1028
A.5.13	Language Bindings Fortran Bindings . . . . .	1033
A.5.14	Tools / Profiling Interface Fortran Bindings . . . . .	1033
A.5.15	Deprecated Fortran Bindings . . . . .	1033
<b>B</b>	<b>Change-Log</b>	<b>1035</b>
B.1	Changes from Version 3.1 to Version 4.0 . . . . .	1035
B.1.1	Fixes to Errata in Previous Versions of MPI . . . . .	1035
B.1.2	Changes in MPI-4.0 . . . . .	1036
B.2	Changes from Version 3.0 to Version 3.1 . . . . .	1038
B.2.1	Fixes to Errata in Previous Versions of MPI . . . . .	1038
B.2.2	Changes in MPI-3.1 . . . . .	1040
B.3	Changes from Version 2.2 to Version 3.0 . . . . .	1041
B.3.1	Fixes to Errata in Previous Versions of MPI . . . . .	1041
B.3.2	Changes in MPI-3.0 . . . . .	1042
B.4	Changes from Version 2.1 to Version 2.2 . . . . .	1047
B.5	Changes from Version 2.0 to Version 2.1 . . . . .	1049
	<b>Bibliography</b>	<b>1055</b>
	<b>General Index</b>	<b>1061</b>
	<b>Examples Index</b>	<b>1067</b>
	<b>MPI Constant and Predefined Handle Index</b>	<b>1070</b>
	<b>MPI Declarations Index</b>	<b>1076</b>
	<b>MPI Callback Function Prototype Index</b>	<b>1077</b>
	<b>MPI Function Index</b>	<b>1078</b>

# List of Figures

2.1	State Transition Diagram for Blocking Operations	12
2.2	State Transition Diagram for Nonblocking Operations	12
2.3	State Transition Diagram for Persistent Operations	12
6.1	Collective communications, an overview	187
6.2	Inter-communicator allgather	190
6.3	Inter-communicator reduce-scatter	191
6.4	Gather example	198
6.5	Gatherv example with strides	199
6.6	Gatherv example, 2-dimensional	200
6.7	Gatherv example, 2-dimensional, subarrays with different sizes	201
6.8	Gatherv example, 2-dimensional, subarrays with different sizes and strides	203
6.9	Scatter example	208
6.10	Scatterv example with strides	209
6.11	Scatterv example with different strides and counts	210
6.12	Race conditions with point-to-point and collective communications	302
6.13	Overlapping Communicators Example	306
7.1	Inter-communicator creation using <code>MPI_COMM_CREATE</code>	329
7.2	Inter-communicator construction with <code>MPI_COMM_SPLIT</code>	333
7.3	Recursive communicator creation with <code>MPI_COMM_SPLIT_TYPE</code>	338
7.4	Three-group pipeline	358
7.5	Three-group ring	359
8.1	Neighborhood gather communication example	415
8.2	Cartesian neighborhood allgather example for 3 and 1 processes in a dimension	415
8.3	Cartesian neighborhood alltoall example for 3 and 1 processes in a dimension	420
8.4	Set-up of process structure for two-dimensional parallel Poisson solver	442
8.5	Communication routine with local data copying and sparse neighborhood all-to-all	443
8.6	Communication routine with sparse neighborhood all-to-all-w and without local data copying	444
8.7	Two-dimensional parallel Poisson solver with persistent sparse neighborhood all-to-all-w and without local data copying	445
11.1	Session handle to communicator	496
11.2	Process set examples	499
12.1	Schematic description of the public/private window operations in the <code>MPI_WIN_SEPARATE</code> memory model for two overlapping windows	586

12.2 Active target communication . . . . .	589
12.3 Active target communication, with weak synchronization . . . . .	590
12.4 Passive target communication . . . . .	591
12.5 Active target communication with several processes . . . . .	595
12.6 Symmetric communication . . . . .	614
12.7 Deadlock situation . . . . .	614
12.8 No deadlock . . . . .	614
14.1 Etypes and filetypes . . . . .	636
14.2 Partitioning a file among parallel processes . . . . .	636
14.3 Displacements . . . . .	649
14.4 Example array file layout . . . . .	715
14.5 Example local array filetype for process 1 . . . . .	715
19.1 Status conversion routines . . . . .	837

DRAFT

# List of Tables

2.1	Deprecated and Removed constructs . . . . .	23
3.1	Predefined MPI datatypes corresponding to Fortran datatypes . . . . .	31
3.2	Predefined MPI datatypes corresponding to C datatypes . . . . .	32
3.3	Predefined MPI datatypes corresponding to both C and Fortran datatypes . . . . .	33
3.4	Predefined MPI datatypes corresponding to C++ datatypes . . . . .	33
5.1	combiner values returned from MPI_TYPE_GET_ENVELOPE . . . . .	157
7.1	MPI_COMM_* Function Behavior (in Inter-Communication Mode) . . . . .	353
9.1	Error classes (Part 1) . . . . .	467
9.2	Error classes (Part 2) . . . . .	468
11.1	List of MPI Functions that can be called at any time within an MPI program, including prior to MPI initialization and following MPI finalization . . . . .	509
12.1	C types of attribute value argument to MPI_WIN_GET_ATTR and MPI_WIN_SET_ATTR . . . . .	560
12.2	Error classes in one-sided communication routines . . . . .	604
14.1	Data access routines . . . . .	651
14.2	"external32" sizes of predefined datatypes . . . . .	694
14.3	"external32" sizes of optional datatypes . . . . .	695
14.4	"external32" sizes of C++ datatypes . . . . .	695
14.5	I/O Error Classes . . . . .	713
15.1	MPI tool information interface verbosity levels . . . . .	724
15.2	Constants to identify associations of variables . . . . .	725
15.3	MPI datatypes that can be used by the MPI tool information interface . . . . .	728
15.4	Scopes for control variables . . . . .	732
15.5	Hierarchy of safety requirement levels for event callback routines . . . . .	752
15.6	List of MPI functions that when called from within a callback function may not return MPI_T_ERR_NOT_ACCESSIBLE . . . . .	753
15.7	Return codes used in functions of the MPI tool information interface . . . . .	771
17.1	Removed MPI-1 functions and their replacements . . . . .	779
17.2	Removed MPI-1 datatypes. The indicated routine may be used for changing the lower and upper bound respectively. . . . .	780
17.3	Removed MPI-1 constants . . . . .	780
17.4	Removed MPI-1 callback prototypes and their replacements . . . . .	780

19.1 Specific Fortran procedure names and related calling conventions . . . . . 791  
19.2 Occurrence of Fortran optimization problems . . . . . 817

1  
2  
3  
4  
5  
6  
7  
8  
9  
10  
11  
12  
13  
14  
15  
16  
17  
18  
19  
20  
21  
22  
23  
24  
25  
26  
27  
28  
29  
30  
31  
32  
33  
34  
35  
36  
37  
38  
39  
40  
41  
42  
43  
44  
45  
46  
47  
48

DRAFT

# Acknowledgments

This document is the product of a number of distinct efforts in four distinct phases: one for each of MPI-1, MPI-2, MPI-3, and MPI-4. This section describes these in historical order, starting with MPI-1. Some efforts, particularly parts of MPI-2, had distinct groups of individuals associated with them, and these efforts are detailed separately.

This document represents the work of many people who have served on the MPI Forum. The meetings have been attended by dozens of people from many parts of the world. It is the hard and dedicated work of this group that has led to the MPI standard.

The technical development was carried out by subgroups, whose work was reviewed by the full committee. During the period of development of the Message-Passing Interface (MPI), many people helped with this effort.

Those who served as primary coordinators in MPI-1.0 and MPI-1.1 are:

- Jack Dongarra, David Walker, Conveners and Meeting Chairs
- Ewing Lusk, Bob Knighten, Minutes
- Marc Snir, William Gropp, Ewing Lusk, Point-to-Point Communication
- Al Geist, Marc Snir, Steve Otto, Collective Communication
- Steve Otto, Editor
- Rolf Hempel, Process Topologies
- Ewing Lusk, Language Binding
- William Gropp, Environmental Management
- James Cownie, Profiling
- Tony Skjellum, Lyndon Clarke, Marc Snir, Richard Littlefield, Mark Sears, Groups, Contexts, and Communicators
- Steven Huss-Lederman, Initial Implementation Subset

The following list includes some of the active participants in the MPI-1.0 and MPI-1.1 process not mentioned above.

Ed Anderson	Robert Babb	Joe Baron	Eric Barszcz	1
Scott Berryman	Rob Bjornson	Nathan Doss	Anne Elster	2
Jim Feeney	Vince Fernando	Sam Fineberg	Jon Flower	3
Daniel Frye	Ian Glendinning	Adam Greenberg	Robert Harrison	4
Leslie Hart	Tom Haupt	Don Heller	Tom Henderson	5
Alex Ho	C.T. Howard Ho	Gary Howell	John Kapenga	6
James Kohl	Susan Krauss	Bob Leary	Arthur Maccabe	7
Peter Madams	Alan Mainwaring	Oliver McBryan	Phil McKinley	8
Charles Mosher	Dan Nessett	Peter Pacheco	Howard Palmer	9
Paul Pierce	Sanjay Ranka	Peter Rigsbee	Arch Robison	10
Erich Schikuta	Ambuj Singh	Alan Sussman	Robert Tomlinson	11
Robert G. Voigt	Dennis Weeks	Stephen Wheat	Steve Zenith	12

The University of Tennessee and Oak Ridge National Laboratory made the draft available by anonymous FTP mail servers and were instrumental in distributing the document.

The work on the MPI-1 standard was supported in part by ARPA and NSF under grant ASC-9310330, the National Science Foundation Science and Technology Center Cooperative Agreement No. CCR-8809615, and by the Commission of the European Community through Esprit project P6643 (PPPE).

#### MPI-1.2 and MPI-2.0:

Those who served as primary coordinators in MPI-1.2 and MPI-2.0 are:

- Ewing Lusk, Convener and Meeting Chair
- Steve Huss-Lederman, Editor
- Ewing Lusk, Miscellany
- Bill Saphir, Process Creation and Management
- Marc Snir, One-Sided Communications
- William Gropp and Anthony Skjellum, Extended Collective Operations
- Steve Huss-Lederman, External Interfaces
- Bill Nitzberg, I/O
- Andrew Lumsdaine, Bill Saphir, and Jeffrey M. Squyres, Language Bindings
- Anthony Skjellum and Arkady Kanevsky, Real-Time

The following list includes some of the active participants who attended MPI-2 Forum meetings and are not mentioned above.

1	Greg Astfalk	Robert Babb	Ed Benson	Rajesh Bordawekar
2	Pete Bradley	Peter Brennan	Ron Brightwell	Maciej Brodowicz
3	Eric Brunner	Greg Burns	Margaret Cahir	Pang Chen
4	Ying Chen	Albert Cheng	Yong Cho	Joel Clark
5	Lyndon Clarke	Laurie Costello	Dennis Cottel	Jim Cownie
6	Zhenqian Cui	Suresh Damodaran-Kamal		Raja Daoud
7	Judith Devaney	David DiNucci	Doug Doefler	Jack Dongarra
8	Terry Dontje	Nathan Doss	Anne Elster	Mark Fallon
9	Karl Feind	Sam Fineberg	Craig Fischberg	Stephen Fleischman
10	Ian Foster	Hubertus Franke	Richard Frost	Al Geist
11	Robert George	David Greenberg	John Hagedorn	Kei Harada
12	Leslie Hart	Shane Hebert	Rolf Hempel	Tom Henderson
13	Alex Ho	Hans-Christian Hoppe	Joefon Jann	Terry Jones
14	Karl Kesselman	Koichi Konishi	Susan Kraus	Steve Kubica
15	Steve Landherr	Mario Lauria	Mark Law	Juan Leon
16	Lloyd Lewins	Ziyang Lu	Bob Madahar	Peter Madams
17	John May	Oliver McBryan	Brian McCandless	Tyce McLarty
18	Thom McMahon	Harish Nag	Nick Nevin	Jarek Nieplocha
19	Ron Oldfield	Peter Ossadnik	Steve Otto	Peter Pacheco
20	Yoonho Park	Perry Partow	Pratap Pattnaik	Elsie Pierce
21	Paul Pierce	Heidi Poxon	Jean-Pierre Prost	Boris Protopopov
22	James Pruyve	Rolf Rabenseifner	Joe Rieken	Peter Rigsbee
23	Tom Robey	Anna Rounbehler	Nobutoshi Sagawa	Arindam Saha
24	Eric Salo	Darren Sanders	Eric Sharakan	Andrew Sherman
25	Fred Shirley	Lance Shuler	A. Gordon Smith	Ian Stockdale
26	David Taylor	Stephen Taylor	Greg Tensa	Rajeev Thakur
27	Marydell Tholburn	Dick Treumann	Simon Tsang	Manuel Ujaldon
28	David Walker	Jerrell Watts	Klaus Wolf	Parkson Wong
29	Dave Wright			

30  
31 The MPI Forum also acknowledges and appreciates the valuable input from people via  
32 e-mail and in person.

33 The following institutions supported the MPI-2 effort through time and travel support  
34 for the people listed above.

- 35 Argonne National Laboratory
- 36 Bolt, Beranek, and Newman
- 37 California Institute of Technology
- 38 Center for Computing Sciences
- 39 Convex Computer Corporation
- 40 Cray Research
- 41 Digital Equipment Corporation
- 42 Dolphin Interconnect Solutions, Inc.
- 43 Edinburgh Parallel Computing Centre
- 44 General Electric Company
- 45 German National Research Center for Information Technology
- 46 Hewlett-Packard
- 47 Hitachi
- 48 Hughes Aircraft Company



Intel Corporation	1
International Business Machines	2
Khoral Research	3
Lawrence Livermore National Laboratory	4
Los Alamos National Laboratory	5
MPI Software Technology, Inc.	6
Mississippi State University	7
NEC Corporation	8
National Aeronautics and Space Administration	9
National Energy Research Scientific Computing Center	10
National Institute of Standards and Technology	11
National Oceanic and Atmospheric Administration	12
Oak Ridge National Laboratory	13
The Ohio State University	14
PALLAS GmbH	15
Pacific Northwest National Laboratory	16
Pratt & Whitney	17
San Diego Supercomputer Center	18
Sanders, A Lockheed-Martin Company	19
Sandia National Laboratories	20
Schlumberger	21
Scientific Computing Associates, Inc.	22
Silicon Graphics Incorporated	23
Sky Computers	24
Sun Microsystems Computer Corporation	25
Syracuse University	26
The MITRE Corporation	27
Thinking Machines Corporation	28
United States Navy	29
University of Colorado	30
University of Denver	31
University of Houston	32
University of Illinois	33
University of Maryland	34
University of Notre Dame	35
University of San Francisco	36
University of Stuttgart Computing Center	37
University of Wisconsin	38

MPI-2 operated on a very tight budget (in reality, it had no budget when the first meeting was announced). Many institutions helped the MPI-2 effort by supporting the efforts and travel of the members of the MPI Forum. Direct support was given by NSF and DARPA under NSF contract CDA-9115428 for travel by U.S. academic participants and Esprit under project HPC Standards (21111) for European participants.

1 MPI-1.3 and MPI-2.1:

2 The editors and organizers of the combined documents have been:

- 3
- 4 • Richard Graham, Convener and Meeting Chair
  - 5
  - 6 • Jack Dongarra, Steering Committee
  - 7
  - 8 • Al Geist, Steering Committee
  - 9
  - 10 • William Gropp, Steering Committee
  - 11
  - 12 • Rainer Keller, Merge of MPI-1.3
  - 13
  - 14 • Andrew Lumsdaine, Steering Committee
  - 15
  - 16 • Ewing Lusk, Steering Committee, MPI-1.1-Errata (Oct. 12, 1998) MPI-2.1-Errata
  - 17 Ballots 1, 2 (May 15, 2002)
  - 18
  - 19 • Rolf Rabenseifner, Steering Committee, Merge of MPI-2.1 and MPI-2.1-Errata Ballots
  - 20 3, 4 (2008)

21 All chapters have been revisited to achieve a consistent MPI-2.1 text. Those who served as authors for the necessary modifications are:

- 22 • William Gropp, Front Matter, Introduction, and Bibliography
- 23
- 24 • Richard Graham, Point-to-Point Communication
- 25
- 26 • Adam Moody, Collective Communication
- 27
- 28 • Richard Treumann, Groups, Contexts, and Communicators
- 29
- 30 • Jesper Larsson Träff, Process Topologies, Info-Object, and One-Sided Communica-
- 31 tions
- 32
- 33 • George Bosilca, Environmental Management
- 34
- 35 • David Solt, Process Creation and Management
- 36
- 37 • Bronis R. de Supinski, External Interfaces, and Profiling
- 38
- 39 • Rajeev Thakur, I/O
- 40
- 41 • Jeffrey M. Squyres, Language Bindings and MPI-2.1 Secretary
- 42
- 43 • Rolf Rabenseifner, Deprecated Functions and Annex Change-Log
- 44
- 45 • Alexander Supalov and Denis Nagorny, Annex Language Bindings

46 The following list includes some of the active participants who attended MPI-2 Forum

47 meetings and in the e-mail discussions of the errata items and are not mentioned above.

48

Pavan Balaji	Purushotham V. Bangalore	Brian Barrett	1
Richard Barrett	Christian Bell	Robert Blackmore	2
Gil Bloch	Ron Brightwell	Jeffrey Brown	3
Darius Buntinas	Jonathan Carter	Nathan DeBardeleben	4
Terry Dontje	Gabor Dozsa	Edric Ellis	5
Karl Feind	Edgar Gabriel	Patrick Geoffray	6
David Gingold	Dave Goodell	Erez Haba	7
Robert Harrison	Thomas Herauld	Steve Hodson	8
Torsten Hoefler	Joshua Hursey	Yann Kalemkarian	9
Matthew Koop	Quincey Koziol	Sameer Kumar	10
Miron Livny	Kannan Narasimhan	Mark Pagel	11
Avneesh Pant	Steve Poole	Howard Pritchard	12
Craig Rasmussen	Hubert Ritzdorf	Rob Ross	13
Tony Skjellum	Brian Smith	Vinod Tipparaju	14
Jesper Larsson Träff	Keith Underwood		15

The MPI Forum also acknowledges and appreciates the valuable input from people via e-mail and in person.

The following institutions supported the MPI-2 effort through time and travel support for the people listed above.

Argonne National Laboratory	21
Bull	22
Cisco Systems, Inc.	23
Cray Inc.	24
The HDF Group	25
Hewlett-Packard	26
IBM T.J. Watson Research	27
Indiana University	28
Institut National de Recherche en Informatique et Automatique (Inria)	29
Intel Corporation	30
Lawrence Berkeley National Laboratory	31
Lawrence Livermore National Laboratory	32
Los Alamos National Laboratory	33
Mathworks	34
Mellanox Technologies	35
Microsoft	36
Myricom	37
NEC Laboratories Europe, NEC Europe Ltd.	38
Oak Ridge National Laboratory	39
The Ohio State University	40
Pacific Northwest National Laboratory	41
QLogic Corporation	42
Sandia National Laboratories	43
SiCortex	44
Silicon Graphics Incorporated	45
Sun Microsystems, Inc.	46
University of Alabama at Birmingham	47
University of Houston	48

1 University of Illinois at Urbana-Champaign  
2 University of Stuttgart, High Performance Computing Center Stuttgart (HLRS)  
3 University of Tennessee, Knoxville  
4 University of Wisconsin

5  
6 Funding for the MPI Forum meetings was partially supported by award #CCF-0816909  
7 from the National Science Foundation. In addition, the HDF Group provided travel support  
8 for one U.S. academic.

9  
10 **MPI-2.2:**

11 All chapters have been revisited to achieve a consistent MPI-2.2 text. Those who served as  
12 authors for the necessary modifications are:

- 13
- 14 • William Gropp, Front Matter, Introduction, and Bibliography; MPI-2.2 Chair.
- 15
- 16 • Richard Graham, Point-to-Point Communication and Datatypes
- 17
- 18 • Adam Moody, Collective Communication
- 19
- 20 • Torsten Hoefler, Collective Communication and Process Topologies
- 21
- 22 • Richard Treumann, Groups, Contexts, and Communicators
- 23
- 24 • Jesper Larsson Träff, Process Topologies, Info-Object and One-Sided Communications
- 25
- 26 • George Bosilca, Datatypes and Environmental Management
- 27
- 28 • David Solt, Process Creation and Management
- 29
- 30 • Bronis R. de Supinski, External Interfaces, and Profiling
- 31
- 32 • Rajeev Thakur, I/O
- 33
- 34 • Jeffrey M. Squyres, Language Bindings and MPI-2.2 Secretary
- 35
- 36 • Rolf Rabenseifner, Deprecated Functions, Annex Change-Log, and Annex Language Bindings
- 37
- 38 • Alexander Supalov, Annex Language Bindings

39  
40  
41  
42  
43  
44  
45  
46  
47  
48  
The following list includes some of the active participants who attended MPI-2 Forum meetings and in the e-mail discussions of the errata items and are not mentioned above.

Pavan Balaji	Purushotham V. Bangalore	Brian Barrett	1
Richard Barrett	Christian Bell	Robert Blackmore	2
Gil Bloch	Ron Brightwell	Greg Bronevetsky	3
Jeff Brown	Darius Buntinas	Jonathan Carter	4
Nathan DeBardeleben	Terry Dontje	Gabor Dozsa	5
Edric Ellis	Karl Feind	Edgar Gabriel	6
Patrick Geoffray	Johann George	David Gingold	7
David Goodell	Erez Haba	Robert Harrison	8
Thomas Herault	Marc-André Hermanns	Steve Hodson	9
Joshua Hursey	Yutaka Ishikawa	Bin Jia	10
Hideyuki Jitsumoto	Terry Jones	Yann Kalemkarian	11
Ranier Keller	Matthew Koop	Quincey Koziol	12
Manojkumar Krishnan	Sameer Kumar	Miron Livny	13
Andrew Lumsdaine	Miao Luo	Ewing Lusk	14
Timothy I. Mattox	Kannan Narasimhan	Mark Pagel	15
Avneesh Pant	Steve Poole	Howard Pritchard	16
Craig Rasmussen	Hubert Ritzdorf	Rob Ross	17
Martin Schulz	Pavel Shamis	Galen Shipman	18
Christian Siebert	Anthony Skjellum	Brian Smith	19
Naoki Sueyasu	Vinod Tipparaju	Keith Underwood	20
Rolf Vandevaart	Abhinav Vishnu	Weikuan Yu	21

The MPI Forum also acknowledges and appreciates the valuable input from people via e-mail and in person. 23

The following institutions supported the MPI-2.2 effort through time and travel support for the people listed above. 24

Argonne National Laboratory	27
Auburn University	28
Bull	29
Cisco Systems, Inc.	30
Cray Inc.	31
Forschungszentrum Jülich	32
Fujitsu	33
The HDF Group	34
Hewlett-Packard	35
International Business Machines	36
Indiana University	37
Institut National de Recherche en Informatique et Automatique (Inria)	38
Institute for Advanced Science & Engineering Corporation	39
Intel Corporation	40
Lawrence Berkeley National Laboratory	41
Lawrence Livermore National Laboratory	42
Los Alamos National Laboratory	43
Mathworks	44
Mellanox Technologies	45
Microsoft	46
Myricom	47
NEC Corporation	48

1 Oak Ridge National Laboratory  
2 The Ohio State University  
3 Pacific Northwest National Laboratory  
4 QLogic Corporation  
5 RunTime Computing Solutions, LLC  
6 Sandia National Laboratories  
7 SiCortex, Inc.  
8 Silicon Graphics Inc.  
9 Sun Microsystems, Inc.  
10 Tokyo Institute of Technology  
11 University of Alabama at Birmingham  
12 University of Houston  
13 University of Illinois at Urbana-Champaign  
14 University of Stuttgart, High Performance Computing Center Stuttgart (HLRS)  
15 University of Tennessee, Knoxville  
16 University of Tokyo  
17 University of Wisconsin

18 Funding for the MPI Forum meetings was partially supported by awards #CCF-0816909  
19 and #CCF-1144042 from the National Science Foundation. In addition, the HDF Group  
20 provided travel support for one U.S. academic.  
21

## 22 MPI-3.0:

23 MPI-3.0 is a significant effort to extend and modernize the MPI Standard.  
24 The editors and organizers of the MPI-3.0 have been:

- 25 • William Gropp, Steering Committee, Front Matter, Introduction, Groups, Contexts,  
26 and Communicators, One-Sided Communications, and Bibliography
- 27 • Richard Graham, Steering Committee, Point-to-Point Communication, Meeting Con-  
28 vener, and MPI-3.0 Chair
- 29 • Torsten Hoefler, Collective Communication, One-Sided Communications, and Process  
30 Topologies
- 31 • George Bosilca, Datatypes and Environmental Management
- 32 • David Solt, Process Creation and Management
- 33 • Bronis R. de Supinski, External Interfaces and Tool Support
- 34 • Rajeev Thakur, I/O and One-Sided Communications
- 35 • Darius Buntinas, Info Object
- 36 • Jeffrey M. Squyres, Language Bindings and MPI-3.0 Secretary
- 37 • Rolf Rabenseifner, Steering Committee, Terms and Definitions, and Fortran Bindings,  
38 Deprecated Functions, Annex Change-Log, and Annex Language Bindings
- 39 • Craig Rasmussen, Fortran Bindings

The following list includes some of the active participants who attended MPI-3 Forum meetings or participated in the e-mail discussions and who are not mentioned above.

Tatsuya Abe	Tomoya Adachi	Sadaf Alam
Reinhold Bader	Pavan Balaji	Purushotham V. Bangalore
Brian Barrett	Richard Barrett	Robert Blackmore
Aurelien Bouteiller	Ron Brightwell	Greg Bronevetsky
Jed Brown	Darius Buntinas	Devendar Bureddy
Arno Candel	George Carr	Mohamad Chaarawi
Raghunath Raja Chandrasekar	James Dinan	Terry Dontje
Edgar Gabriel	Balazs Gerofi	Brice Goglin
David Goodell	Manjunath Gorentla	Erez Haba
Jeff Hammond	Thomas Herault	Marc-André Hermanns
Jennifer Herrett-Skjellum	Nathan Hjelm	Atsushi Hori
Joshua Hursey	Marty Itzkowitz	Yutaka Ishikawa
Nysal Jan	Bin Jia	Hideyuki Jitsumoto
Yann Kalemkarian	Krishna Kandalla	Takahiro Kawashima
Chulho Kim	Dries Kimpe	Christof Klausecker
Alice Koniges	Quincey Koziol	Dieter Kranzlmuller
Manojkumar Krishnan	Sameer Kumar	Eric Lantz
Jay Lofstead	Bill Long	Andrew Lumsdaine
Miao Luo	Ewing Lusk	Adam Moody
Nick M. Maclaren	Amith Mamidala	Guillaume Mercier
Scott McMillan	Douglas Miller	Kathryn Mohror
Tim Murray	Tomotake Nakamura	Takeshi Nanri
Steve Oyanagi	Mark Pagel	Swann Perarnau
Sreeram Potluri	Howard Pritchard	Rolf Riesen
Hubert Ritzdorf	Kuninobu Sasaki	Timo Schneider
Martin Schulz	Gilad Shainer	Christian Siebert
Anthony Skjellum	Brian Smith	Marc Snir
Raffaele Giuseppe Solca	Shinji Sumimoto	Alexander Supalov
Sayantana Sur	Masamichi Takagi	Fabian Tillier
Vinod Tipparaju	Jesper Larsson Träff	Richard Treumann
Keith Underwood	Rolf Vandevaart	Anh Vo
Abhinav Vishnu	Min Xie	Enqiang Zhou

The MPI Forum also acknowledges and appreciates the valuable input from people via e-mail and in person.

The MPI Forum also thanks those that provided feedback during the public comment period. In particular, the Forum would like to thank Jeremiah Wilcock for providing detailed comments on the entire draft standard.

The following institutions supported the MPI-3 effort through time and travel support for the people listed above.

Argonne National Laboratory  
Bull  
Cisco Systems, Inc.  
Cray Inc.  
CSCS

1 ETH Zurich  
2 Fujitsu Ltd.  
3 German Research School for Simulation Sciences  
4 The HDF Group  
5 Hewlett-Packard  
6 International Business Machines  
7 IBM India Private Ltd  
8 Indiana University  
9 Institut National de Recherche en Informatique et Automatique (Inria)  
10 Institute for Advanced Science & Engineering Corporation  
11 Intel Corporation  
12 Lawrence Berkeley National Laboratory  
13 Lawrence Livermore National Laboratory  
14 Los Alamos National Laboratory  
15 Mellanox Technologies, Inc.  
16 Microsoft Corporation  
17 NEC Corporation  
18 National Oceanic and Atmospheric Administration, Global Systems Division  
19 NVIDIA Corporation  
20 Oak Ridge National Laboratory  
21 The Ohio State University  
22 Oracle America  
23 Platform Computing  
24 RIKEN AICS  
25 RunTime Computing Solutions, LLC  
26 Sandia National Laboratories  
27 Technical University of Chemnitz  
28 Tokyo Institute of Technology  
29 University of Alabama at Birmingham  
30 University of Chicago  
31 University of Houston  
32 University of Illinois at Urbana-Champaign  
33 University of Stuttgart, High Performance Computing Center Stuttgart (HLRS)  
34 University of Tennessee, Knoxville  
35 University of Tokyo

36 Funding for the MPI Forum meetings was partially supported by awards #CCF-0816909  
37 and #CCF-1144042 from the National Science Foundation. In addition, the HDF Group  
38 and Sandia National Laboratories provided travel support for one U.S. academic each.  
39

#### 40 MPI-3.1:

41 MPI-3.1 is a minor update to the MPI Standard.  
42 The editors and organizers of the MPI-3.1 have been:

- 43 • Martin Schulz, MPI-3.1 Chair
- 44 • William Gropp, Steering Committee, Front Matter, Introduction, One-Sided Commu-  
45 nications, and Bibliography; Overall Editor



- Rolf Rabenseifner, Steering Committee, Terms and Definitions, and Fortran Bindings, Deprecated Functions, Annex Change-Log, and Annex Language Bindings
- Richard L. Graham, Steering Committee, Meeting Convener
- Jeffrey M. Squyres, Language Bindings and MPI-3.1 Secretary
- Daniel Holmes, Point-to-Point Communication
- George Bosilca, Datatypes and Environmental Management
- Torsten Hoefler, Collective Communication and Process Topologies
- Pavan Balaji, Groups, Contexts, and Communicators, and External Interfaces
- Jeff Hammond, The Info Object
- David Solt, Process Creation and Management
- Quincey Koziol, I/O
- Kathryn Mohror, Tool Support
- Rajeev Thakur, One-Sided Communications

The following list includes some of the active participants who attended MPI Forum meetings or participated in the e-mail discussions.

Charles Archer	Pavan Balaji	Purushotham V. Bangalore
Brian Barrett	Wesley Bland	Michael Blocksome
George Bosilca	Aurelien Bouteiller	Devendar Bureddy
Yohann Burette	Mohamad Chaarawi	Alexey Cheptsov
James Dinan	Dmitry Durnov	Thomas Francois
Edgar Gabriel	Todd Gamblin	Balazs Gerofi
Paddy Gillies	David Goodell	Manjunath Gorentla Venkata
Richard L. Graham	Ryan E. Grant	William Gropp
Khaled Hamidouche	Jeff Hammond	Amin Hassani
Marc-André Hermanns	Nathan Hjelm	Torsten Hoefler
Daniel Holmes	Atsushi Hori	Yutaka Ishikawa
Hideyuki Jitsumoto	Jithin Jose	Krishna Kandalla
Christos Kavouklis	Takahiro Kawashima	Chulho Kim
Michael Knobloch	Alice Koniges	Quincey Koziol
Sameer Kumar	Joshua Ladd	Ignacio Laguna
Huiwei Lu	Guillaume Mercier	Kathryn Mohror
Adam Moody	Tomotake Nakamura	Takeshi Nanri
Steve Oyanagi	Antonio J. Pëna	Sreeram Potluri
Howard Pritchard	Rolf Rabenseifner	Nicholas Radcliffe
Ken Raffenetti	Raghunath Raja	Craig Rasmussen
Davide Rossetti	Kento Sato	Martin Schulz
Sangmin Seo	Christian Siebert	Anthony Skjellum
Brian Smith	David Solt	Jeffrey M. Squyres

1 Hari Subramoni Shinji Sumimoto Alexander Supalov  
2 Bronis R. de Supinski Sayantan Sur Masamichi Takagi  
3 Keita Teranishi Rajeev Thakur Fabian Tillier  
4 Yuichi Tsujita Geoffroy Vallée Rolf vandeVaart  
5 Akshay Venkatesh Jerome Vienne Venkat Vishwanath  
6 Anh Vo Huseyin S. Yildiz Junchao Zhang  
7 Xin Zhao

8  
9 The MPI Forum also acknowledges and appreciates the valuable input from people via  
10 e-mail and in person.

11 The following institutions supported the MPI-3.1 effort through time and travel support  
12 for the people listed above.

13 Argonne National Laboratory  
14 Auburn University  
15 Cisco Systems, Inc.  
16 Cray  
17 EPCC, The University of Edinburgh  
18 ETH Zurich  
19 Forschungszentrum Jülich  
20 Fujitsu  
21 German Research School for Simulation Sciences  
22 The HDF Group  
23 International Business Machines  
24 Institut National de Recherche en Informatique et Automatique (Inria)  
25 Intel Corporation  
26 Kyushu University  
27 Lawrence Berkeley National Laboratory  
28 Lawrence Livermore National Laboratory  
29 Lenovo  
30 Los Alamos National Laboratory  
31 Mellanox Technologies, Inc.  
32 Microsoft Corporation  
33 NEC Corporation  
34 NVIDIA Corporation  
35 Oak Ridge National Laboratory  
36 The Ohio State University  
37 RIKEN AICS  
38 Sandia National Laboratories  
39 Texas Advanced Computing Center  
40 Tokyo Institute of Technology  
41 University of Alabama at Birmingham  
42 University of Houston  
43 University of Illinois at Urbana-Champaign  
44 University of Oregon  
45 University of Stuttgart, High Performance Computing Center Stuttgart (HLRS)  
46 University of Tennessee, Knoxville  
47 University of Tokyo  
48

## MPI-4.0:

MPI-4.0 is a major update to the MPI Standard.

The editors and organizers of the MPI-4.0 have been:

- Martin Schulz, MPI-4.0 Chair, Info Object, External Interfaces
- Wesley Bland, MPI-4.0 Secretary, Backward Incompatibilities
- William Gropp, MPI-4.0 Editor, Steering Committee, Front Matter, Introduction, One-Sided Communications, and Bibliography
- Rolf Rabenseifner, Steering Committee, Process Topologies, Deprecated Functions, Removed Interfaces, Annex Language Bindings Summary, and Annex Change-Log.
- Purushotham V. Bangalore, Language Bindings
- Claudia Blaas-Schenner, Terms and Conventions
- George Bosilca, Datatypes and Environmental Management
- Ryan E. Grant, Partitioned Communication
- Marc-André Hermanns, Tool Support
- Daniel Holmes, Point-to-Point Communication, Sessions
- Guillaume Mercier, Groups, Contexts, Communicators, Caching
- Howard Pritchard, Process Creation and Management
- Anthony Skjellum, Collective Communication, I/O

As part of the development of MPI-4.0, a number of working groups were established. In some cases, the work for these groups overlapped with multiple chapters. The following describes the major working groups and the leaders of those groups:

**Collective Communication, Topology, Communicators** Torsten Hoefer, Andrew Lumsdaine, and Anthony Skjellum

**Fault Tolerance** Wesley Bland, Aurélien Bouteiller, and Richard Graham

**Hardware-Topologies** Guillaume Mercier

**Hybrid & Accelerator** Pavan Balaji and James Dinan

**Large Counts** Jeff Hammond

**Persistence** Anthony Skjellum

**Point to Point Communication** Dan Holmes and Richard Graham

**Remote Memory Access** William Gropp and Rajeev Thakur

**Semantic Terms** Purushotham V. Bangalore and Rolf Rabenseifner

**Sessions** Daniel Holmes and Howard Pritchard

1 **Tools** Kathryn Mohror and Marc-André Hermanns

2  
3 The following list includes some of the active participants who attended MPI Forum  
4 meetings or participated in the e-mail discussions.

5  
6 Julien Adam  
7 Charles Archer  
8 Pavan Balaji  
9 Purushotham V. Bangalore  
10 Jean-Baptiste Besnard  
11 Wesley Bland  
12 George Bosilca  
13 Ben Bratu  
14 Nicholas Chaimov  
15 Steffen Christgau  
16 Mikhail Chuvelev  
17 Carsten Clauss  
18 Giuseppe Congiu  
19 James Custer  
20 Hoang-Vu Dang  
21 Matthew Dosanjh  
22 Christian Engelmann  
23 Ana Gainaru  
24 Balazs Gerofi  
25 Brice Goglin  
26 Richard Graham  
27 Stanley Graves  
28 Siegmar Gross  
29 Yanfei Guo  
30 Jeff Hammond  
31 Nathan Hjelm  
32 Daniel Holmes  
33 Josh Hursey  
34 Julien Jaeger  
35 Sylvain Jaugey  
36 Krishna Kandalla  
37 Chulho Kim  
38 Alice Koniges  
39 Kim Kyunghun  
40 Stefan Lankes  
41 Xioyi Lu  
42 Alexey Malhanov  
43 William Marts  
44 Ali Mohammed  
45 Takeshi Nanri  
46 Christoph Niethammer  
47  
48 Abdelhalim Amer  
Ammar Ahmad Awan  
Marc Gamell Balmana  
Mohammadreza Bayatpour  
Claudia Blaas-Schenner  
Gil Bloch  
Aurelien Bouteiller  
Alexander Calvert  
Sourav Chakraborty  
Ching-Hsiang Chu  
James Clark  
Isaias Alberto Compres Urena  
Brandon Cook  
Anna Daly  
James Dinan  
Murali Emani  
Noah Evans  
Esthela Gallardo  
Salvatore Di Girolamo  
Manjunath Gorentla Venkata  
Ryan E. Grant  
William Gropp  
Taylor Groves  
Khaled Hamidouche  
Marc-André Hermanns  
Torsten Hoefler  
Atsushi Hori  
Ilya Ivanov  
Emmanuel Jeannot  
Jithin Jose  
Takahiro Kawashima  
Michael Knobloch  
Sameer Kumar  
Ignacio Laguna Peralta  
Tonglin Li  
Kavitha Madhu  
Ryan Marshall  
Guillaume Mercier  
Kathryn Mohror  
Thomas Naughton  
Takafumi Nose

Lena Oden	Steve Oyanagi	Guillaume Papauré	1
Ivy Peng	Antonio Peña	Simon Pickartz	2
Artem Polyakov	Sreeram Potluri	Howard Pritchard	3
Martina Prugger	Marc Pérache	Rolf Rabenseifner	4
Nicholas Radcliffe	Ken Raffenetti	Craig Rasmussen	5
Soren Rasmussen	Hubert Ritzdorf	Sergio Rivas-Gomez	6
Davide Rossetti	Martin Ruefenacht	Amit Ruhela	7
Whit Schonbein	Joseph Schuchart	Martin Schulz	8
Sangmin Seo	Sameh Sharkawi	Sameer Shende	9
Min Si	Anthony Skjellum	Brian Smith	10
David Solt	Jeffrey M. Squyres	Srinivas Sridharan	11
Hari Subramoni	Nawrin Sultana	Shinji Sumimoto	12
Sayantana Sur	Hugo Taboada	Keita Teranishi	13
Rajeev Thakur	Keith Underwood	Geoffroy Vallee	14
Akshay Venkatesh	Jerome Vienne	Anh Vo	15
Justin Wozniak	Junchao Zhang	Dong Zhong	16
Hui Zhou			17

The MPI Forum also acknowledges and appreciates the valuable input from people via e-mail and in person.

The following institutions supported the MPI-4.0 effort through time and travel support for the people listed above.

ATOS	24
Argonne National Laboratory	25
Arm	26
Auburn University	27
Barcelona Supercomputing Center	28
CEA	29
Cisco Systems Inc.	30
Cray Inc.	31
EPCC, The University Of Edinburgh	32
ETH Zürich	33
Fujitsu	34
Fulda University of Applied Sciences	35
German Research School for Simulation Sciences	36
Hewlett Packard Enterprise	37
International Business Machines	38
Institut National de Recherche en Informatique et Automatique (Inria)	39
Intel Corporation	40
Jülich Supercomputing Center, Forschungszentrum Jülich	41
KTH Royal Institute Of Technology	42
Kyushu University	43
Lawrence Berkeley National Laboratory	44
Lawrence Livermore National Laboratory	45
Lenovo	46
Los Alamos National Laboratory	47
Mellanox Technologies, Inc.	48

1 Microsoft Corporation  
2 NEC Corporation  
3 NVIDIA Corporation  
4 Oak Ridge National Laboratory  
5 PAR-TEC  
6 Paratools, Inc.  
7 RIKEN AICS (R-CCS as of 2017)  
8 RWTH Aachen University  
9 Rutgers University  
10 Sandia National Laboratories  
11 Silicon Graphics, Inc.  
12 Technical University of Munich  
13 The HDF Group  
14 The Ohio State University  
15 Texas Advanced Computing Center  
16 Tokyo Institute of Technology  
17 University of Alabama at Birmingham  
18 University of Basel, Switzerland  
19 University of Houston  
20 University of Illinois at Urbana-Champaign and the National Center for Supercomputing Applications  
21  
22 University of Innsbruck  
23 University of Oregon  
24 University of Potsdam  
25 University of Stuttgart, High Performance Computing Center Stuttgart (HLRS)  
26 University of Tennessee, Chattanooga  
27 University of Tennessee, Knoxville  
28 University of Texas at El Paso  
29 University of Tokyo  
30 VSC Research Center, TU Wien  
31  
32  
33  
34  
35  
36  
37  
38  
39  
40  
41  
42  
43  
44  
45  
46  
47  
48



1  
2  
3  
4  
5  
6  
7  
8  
9  
10  
11  
12  
13  
14  
15  
16  
17  
18  
19  
20  
21  
22  
23  
24  
25  
26  
27  
28  
29  
30  
31  
32  
33  
34  
35  
36  
37  
38  
39  
40  
41  
42  
43  
44  
45  
46  
47  
48

# Chapter 1

## Introduction to MPI

### 1.1 Overview and Goals

MPI (Message-Passing Interface) is a *message-passing library interface specification*. All parts of this definition are significant. MPI addresses primarily the message-passing parallel programming model, in which data is moved from the address space of one process to that of another process through cooperative operations on each process. Extensions to the “classical” message-passing model are provided in collective operations, remote-memory access operations, dynamic process creation, and parallel I/O. MPI is a *specification*, not an implementation; there are multiple implementations of MPI. This specification is for a *library interface*; MPI is not a language, and all MPI operations are expressed as functions, subroutines, or methods, according to the appropriate language bindings which, for C and Fortran, are part of the MPI standard. The standard has been defined through an open process by a community of parallel computing vendors, computer scientists, and application developers. The next few sections provide an overview of the history of MPI’s development.

The main advantages of establishing a message-passing standard are portability and ease of use. In a distributed memory communication environment in which the higher level routines and/or abstractions are built upon lower level message-passing routines the benefits of standardization are particularly apparent. Furthermore, the definition of a message-passing standard, such as that proposed here, provides vendors with a clearly defined base set of routines that they can implement efficiently, or in some cases for which they can provide hardware support, thereby enhancing scalability.

The goal of the Message-Passing Interface simply stated is to develop a widely used standard for writing message-passing programs. As such the interface should establish a practical, portable, efficient, and flexible standard for message passing.

A complete list of goals follows.

- Design an application programming interface (not necessarily for compilers or a system implementation library).
- Allow efficient communication: Avoid memory-to-memory copying, allow overlap of computation and communication, and offload to communication co-processors, where available.
- Allow for implementations that can be used in a heterogeneous environment.
- Allow convenient C and Fortran bindings for the interface.

- 1 • Assume a reliable communication interface: the user need not cope with communi-  
2 cation failures. Such failures are dealt with by the underlying communication subsystem.
- 3
- 4 • Define an interface that can be implemented on many vendor's platforms, with no  
5 significant changes in the underlying communication and system software.
- 6
- 7 • Semantics of the interface should be language independent.
- 8
- 9 • The interface should be designed to allow for thread safety.

## 10 1.2 Background of MPI-1.0

12 MPI sought to make use of the most attractive features of a number of existing message-  
13 passing systems, rather than selecting one of them and adopting it as the standard. Thus,  
14 MPI was strongly influenced by work at the IBM T. J. Watson Research Center [2, 3], Intel's  
15 NX/2 [57], Express [14], nCUBE's Vertex [53], p4 [9, 10], and PARMACS [6, 11]. Other  
16 important contributions have come from Zipcode [60, 61], Chimp [20, 21], PVM [5, 18],  
17 Chameleon [31], and PICL [26].

18 The MPI standardization effort involved about 60 people from 40 organizations mainly  
19 from the United States and Europe. Most of the major vendors of concurrent computers  
20 were involved in MPI, along with researchers from universities, government laboratories, and  
21 industry. The standardization process began with the Workshop on Standards for Message-  
22 Passing in a Distributed Memory Environment, sponsored by the Center for Research on  
23 Parallel Computing, held April 29–30, 1992, in Williamsburg, Virginia [69]. At this work-  
24 shop the basic features essential to a standard message-passing interface were discussed,  
25 and a working group established to continue the standardization process.

26 A preliminary draft proposal, known as MPI-1, was put forward by Dongarra, Hempel,  
27 Hey, and Walker in November 1992, and a revised version was completed in February  
28 1993 [19]. MPI-1 embodied the main features that were identified at the Williamsburg  
29 workshop as being necessary in a message passing standard. Since MPI-1 was primarily  
30 intended to promote discussion and “get the ball rolling,” it focused mainly on point-to-point  
31 communications. MPI-1 brought to the forefront a number of important standardization  
32 issues, but did not include any collective communication routines and was not thread-safe.

33 In November 1992, a meeting of the MPI working group was held in Minneapolis, at  
34 which it was decided to place the standardization process on a more formal footing, and to  
35 generally adopt the procedures and organization of the High Performance Fortran Forum.  
36 Subcommittees were formed for the major component areas of the standard, and an email  
37 discussion service established for each. In addition, the goal of producing a draft MPI  
38 standard by the Fall of 1993 was set. To achieve this goal the MPI working group met every  
39 6 weeks for two days throughout the first 9 months of 1993, and presented the draft MPI  
40 standard at the Supercomputing 93 conference in November 1993. These meetings and the  
41 email discussion together constituted the MPI Forum, membership of which has been open  
42 to all members of the high performance computing community.

## 44 1.3 Background of MPI-1.1, MPI-1.2, and MPI-2.0

46 Beginning in March 1995, the MPI Forum began meeting to consider corrections and exten-  
47 sions to the original MPI Standard document [23]. The first product of these deliberations  
48



was Version 1.1 of the MPI specification, released in June of 1995 [24] (see <http://www.mpi-forum.org> for official MPI document releases). At that time, effort focused in five areas.

1. Further corrections and clarifications for the MPI-1.1 document.
2. Additions to MPI-1.1 that do not significantly change its types of functionality (new datatype constructors, language interoperability, etc.).
3. Completely new types of functionality (dynamic processes, one-sided communication, parallel I/O, etc.) that are what everyone thinks of as “MPI-2 functionality.”
4. Bindings for Fortran 90 and C++. MPI-2 specifies C++ bindings for both MPI-1 and MPI-2 functions, and extensions to the Fortran 77 binding of MPI-1 and MPI-2 to handle Fortran 90 issues.
5. Discussions of areas in which the MPI process and framework seem likely to be useful, but where more discussion and experience are needed before standardization (e.g., zero-copy semantics on shared-memory machines, real-time specifications).

Corrections and clarifications (items of type 1 in the above list) were collected in Chapter 3 of the MPI-2 document: “Version 1.2 of MPI.” That chapter also contains the function for identifying the version number. Additions to MPI-1.1 (items of types 2, 3, and 4 in the above list) are in the remaining chapters of the MPI-2 document, and constitute the specification for MPI-2. Items of type 5 in the above list have been moved to a separate document, the “MPI Journal of Development” (JOD), and are not part of the MPI-2 Standard.

This structure makes it easy for users and implementors to understand what level of MPI compliance a given implementation has:

- MPI-1 compliance will mean compliance with MPI-1.3. This is a useful level of compliance. It means that the implementation conforms to the clarifications of MPI-1.1 function behavior given in Chapter 3 of the MPI-2 document. Some implementations may require changes to be MPI-1 compliant.
- MPI-2 compliance will mean compliance with all of MPI-2.1.
- The MPI Journal of Development is not part of the MPI Standard.

It is to be emphasized that forward compatibility is preserved. That is, a valid MPI-1.1 program is both a valid MPI-1.3 program and a valid MPI-2.1 program, and a valid MPI-1.3 program is a valid MPI-2.1 program.

## 1.4 Background of MPI-1.3 and MPI-2.1

After the release of MPI-2.0, the MPI Forum kept working on errata and clarifications for both standard documents (MPI-1.1 and MPI-2.0). The short document “Errata for MPI-1.1” was released October 12, 1998. On July 5, 2001, a first ballot of errata and clarifications for MPI-2.0 was released, and a second ballot was voted on May 22, 2002. Both votes were done electronically. Both ballots were combined into one document: “Errata for MPI-2,” May 15, 2002. This errata process was then interrupted, but the Forum and its e-mail reflectors kept working on new requests for clarification.

1 Restarting regular work of the MPI Forum was initiated in three meetings, at Eu-  
2 roPVM/MPI'06 in Bonn, at EuroPVM/MPI'07 in Paris, and at SC'07 in Reno. In De-  
3 cember 2007, a steering committee started the organization of new MPI Forum meetings at  
4 regular 8-weeks intervals. At the January 14–16, 2008 meeting in Chicago, the MPI Forum  
5 decided to combine the existing and future MPI documents to one document for each ver-  
6 sion of the MPI standard. For technical and historical reasons, this series was started with  
7 MPI-1.3. Additional Ballots 3 and 4 solved old questions from the errata list started in 1995  
8 up to new questions from the last years. After all documents (MPI-1.1, MPI-2, Errata for  
9 MPI-1.1 (Oct. 12, 1998), and MPI-2.1 Ballots 1–4) were combined into one draft document,  
10 for each chapter, a chapter author and review team were defined. They cleaned up the  
11 document to achieve a consistent MPI-2.1 document. The final MPI-2.1 standard document  
12 was finished in June 2008, and finally released with a second vote in September 2008 in  
13 the meeting at Dublin, just before EuroPVM/MPI'08. The major work of the current MPI  
14 Forum is the preparation of MPI-3.

## 15 16 1.5 Background of MPI-2.2

17  
18 MPI-2.2 is a minor update to the MPI-2.1 standard. This version addresses additional errors  
19 and ambiguities that were not corrected in the MPI-2.1 standard as well as a small number  
20 of extensions to MPI-2.1 that met the following criteria:

- 21  
22 • Any correct MPI-2.1 program is a correct MPI-2.2 program.
- 23  
24 • Any extension must have significant benefit for users.
- 25  
26 • Any extension must not require significant implementation effort. To that end, all  
27 such changes are accompanied by an open source implementation.

28 The discussions of MPI-2.2 proceeded concurrently with the MPI-3 discussions; in some  
29 cases, extensions were proposed for MPI-2.2 but were later moved to MPI-3.

## 30 31 1.6 Background of MPI-3.0

32  
33 MPI-3.0 is a major update to the MPI standard. The updates include the extension of  
34 collective operations to include nonblocking versions, extensions to the one-sided operations,  
35 and a new Fortran 2008 binding. In addition, the deprecated C++ bindings have been  
36 removed, as well as many of the deprecated routines and MPI objects (such as the MPI\_UB  
37 datatype).

## 38 39 1.7 Background of MPI-3.1

40  
41 MPI-3.1 is a minor update to the MPI standard. Most of the updates are corrections  
42 and clarifications to the standard, especially for the Fortran bindings. New functions added  
43 include routines to manipulate MPI\_Aint values in a portable manner, nonblocking collective  
44 I/O routines, and routines to get the index value by name for MPI\_T performance and  
45 control variables. A general index was also added.

## 1.8 Background of 2020 Draft Specification

The 2020 draft specification is expected to become the MPI-4.0 specification once all features have been merged. MPI-4.0 is a major update to the MPI standard. This update includes a number of new features which will be present in the final MPI-4.0 document. The largest changes are the addition of large-count versions of many routines to address the limitations of using an `int` or `INTEGER` for the count parameter, persistent collectives, partitioned communications, an alternative way to initialize MPI, application info assertions, and improvements to the definitions of error handling. In addition, there are a number of smaller improvements and corrections.

## 1.9 Who Should Use This Standard?

This standard is intended for use by all those who want to write portable message-passing programs in Fortran and C (and access the C bindings from C++). This includes individual application programmers, developers of software designed to run on parallel machines, and creators of environments and tools. In order to be attractive to this wide audience, the standard must provide a simple, easy-to-use interface for the basic user while not semantically precluding the high-performance message-passing operations available on advanced machines.

## 1.10 What Platforms Are Targets for Implementation?

The attractiveness of the message-passing paradigm at least partially stems from its wide portability. Programs expressed this way may run on distributed-memory multiprocessors, networks of workstations, and combinations of all of these. In addition, shared-memory implementations, including those for multi-core processors and hybrid architectures, are possible. The paradigm will not be made obsolete by architectures combining the shared- and distributed-memory views, or by increases in network speeds. It thus should be both possible and useful to implement this standard on a great variety of machines, including those “machines” consisting of collections of other machines, parallel or not, connected by a communication network.

The interface is suitable for use by fully general MIMD programs, as well as those written in the more restricted style of SPMD. MPI provides many features intended to improve performance on scalable parallel computers with specialized interprocessor communication hardware. Thus, we expect that native, high-performance implementations of MPI will be provided on such machines. At the same time, implementations of MPI on top of standard Unix interprocessor communication protocols will provide portability to workstation clusters and heterogenous networks of workstations.

## 1.11 What Is Included in the Standard?

The standard includes:

- Point-to-point communication,
- Datatypes,

- 1 • Collective operations,
- 2
- 3 • Process groups,
- 4
- 5 • Communication contexts,
- 6
- 7 • Process topologies,
- 8
- 9 • Environmental management and inquiry,
- 10
- 11 • The Info object,
- 12
- 13 • Process creation and management,
- 14
- 15 • One-sided communication,
- 16
- 17 • External interfaces,
- 18
- 19 • Parallel file I/O,
- 20
- 21 • Language bindings for Fortran and C,
- 22
- 23 • Tool support.

## 24 1.12 What Is Not Included in the Standard?

25 The standard does not specify:

- 26 • Operations that require more operating system support than is currently standard;  
27 for example, interrupt-driven receives, remote execution, or active messages,
- 28 • Program construction tools,
- 29
- 30 • Debugging facilities.

31 There are many features that have been considered and not included in this standard.  
32 This happened for a number of reasons, one of which is the time constraint that was self-  
33 imposed in finishing the standard. Features that are not included can always be offered as  
34 extensions by specific implementations. Perhaps future versions of MPI will address some  
35 of these issues.  
36

## 37 1.13 Organization of This Document

38 The following is a list of the remaining chapters in this document, along with a brief  
39 description of each.

- 40 • Chapter 2, [MPI Terms and Conventions](#), explains notational terms and conventions  
41 used throughout the MPI document.
- 42
- 43 • Chapter 3, [Point-to-Point Communication](#), defines the basic, pairwise communication  
44 subset of MPI. *Send* and *receive* are found here, along with many associated functions  
45 designed to make basic communication powerful and efficient.
- 46
- 47
- 48

- Chapter 4, [Partitioned Point-to-Point Communication](#), defines a method of performing partitioned communication in MPI. Partitioned communication allows multiple contributions of data to be made, potentially, from multiple actors (e.g., threads or tasks) in an MPI process to a single message.
- Chapter 5, [Datatypes](#), defines a method to describe any data layout, e.g., an array of structures in the memory, which can be used as message send or receive buffer.
- Chapter 6, [Collective Communication](#), defines process-group collective communication operations. Well known examples of this are barrier and broadcast over a group of processes (not necessarily all the processes). With MPI-2, the semantics of collective communication was extended to include inter-communicators. It also adds two new collective operations. MPI-3 adds nonblocking collective operations.
- Chapter 7, [Groups, Contexts, Communicators, and Caching](#), shows how groups of processes are formed and manipulated, how unique communication contexts are obtained, and how the two are bound together into a *communicator*.
- Chapter 8, [Process Topologies](#), explains a set of utility functions meant to assist in the mapping of process groups (a linearly ordered set) to richer topological structures such as multi-dimensional grids.
- Chapter 9, [MPI Environmental Management](#), explains how the programmer can manage and make inquiries of the current MPI environment. These functions are needed for the writing of correct, robust programs, and are especially important for the construction of highly-portable message-passing programs.
- Chapter 10, [The Info Object](#), defines an opaque object, that is used as input in several MPI routines.
- Chapter 11, [Process Initialization, Creation, and Management](#), defines routines that allow for creation of processes.
- Chapter 12, [One-Sided Communications](#), defines communication routines that can be completed by a single process. These include shared-memory operations (put/get) and remote accumulate operations.
- Chapter 13, [External Interfaces](#), defines routines designed to allow developers to layer on top of MPI. This includes generalized requests, routines that decode MPI opaque objects, and threads.
- Chapter 14, [I/O](#), defines MPI support for parallel I/O.
- Chapter 15, [Tool Support](#), covers interfaces that allow debuggers, performance analyzers, and other tools to obtain data about the operation of MPI processes. This chapter includes Section 15.2 ([Profiling Interface](#)), which was a chapter in previous versions of MPI.
- Chapter 16, [Deprecated Interfaces](#), describes routines that are kept for reference. However usage of these functions is discouraged, as they may be deleted in future versions of the standard.

- Chapter 17, [Removed Interfaces](#), describes routines and constructs that have been removed from MPI. Some of these were deprecated in MPI-2, and the MPI Forum decided to remove these from the MPI-3 standard. Others of these were deprecated in MPI-3, and the MPI Forum decided to remove these from the MPI-4 standard.
- Chapter 18, [Backward Incompatibilities](#), describes incompatibilities with previous versions of MPI.
- Chapter 19, [Language Bindings](#), discusses Fortran issues, and describes language interoperability aspects between C and Fortran.

The Appendices are:

- Annex A, [Language Bindings Summary](#), gives specific syntax in C and Fortran, for all MPI functions, constants, and types.
- Annex B, [Change-Log](#), summarizes some changes since the previous version of the standard.
- Several Index pages show the locations of [examples](#), [constants and predefined handles](#), [declarations of C and Fortran types](#), [callback routine prototypes](#), and all [MPI functions](#).

MPI provides various interfaces to facilitate interoperability of distinct MPI implementations. Among these are the canonical data representation for MPI I/O and for `MPI_PACK_EXTERNAL` and `MPI_UNPACK_EXTERNAL`. The definition of an actual binding of these interfaces that will enable interoperability is outside the scope of this document.

A separate document consists of ideas that were discussed in the MPI Forum during the MPI-2 development and deemed to have value, but are not included in the MPI Standard. They are part of the “Journal of Development” (JOD), lest good ideas be lost and in order to provide a starting point for further work. The chapters in the JOD are

- Chapter 2, Spawning Independent Processes, includes some elements of dynamic process management, in particular management of processes with which the spawning processes do not intend to communicate, that the Forum discussed at length but ultimately decided not to include in the MPI Standard.
- Chapter 3, Threads and MPI, describes some of the expected interaction between an MPI implementation and a thread library in a multithreaded environment.
- Chapter 4, Communicator ID, describes an approach to providing identifiers for communicators.
- Chapter 5, Miscellany, discusses Miscellaneous topics in the MPI JOD, in particular single-copy routines for use in shared-memory environments and new datatype constructors.
- Chapter 6, Toward a Full Fortran 90 Interface, describes an approach to providing a more elaborate Fortran 90 interface.
- Chapter 7, Split Collective Communication, describes a specification for certain non-blocking collective operations.
- Chapter 8, Real-Time MPI, discusses MPI support for real time processing.

1  
2  
3  
4  
5  
6  
7  
8  
9  
10  
11  
12  
13  
14  
15  
16  
17  
18  
19  
20  
21  
22  
23  
24  
25  
26  
27  
28  
29  
30  
31  
32  
33  
34  
35  
36  
37  
38  
39  
40  
41  
42  
43  
44  
45  
46  
47  
48

## Chapter 2

# MPI Terms and Conventions

This chapter explains notational terms and conventions used throughout the MPI document, some of the choices that have been made, and the rationale behind those choices.

### 2.1 Document Notation

*Rationale.* Throughout this document, the rationale for the design choices made in the interface specification is set off in this format. Some readers may wish to skip these sections, while readers interested in interface design may want to read them carefully. (*End of rationale.*)

*Advice to users.* Throughout this document, material aimed at users and that illustrates usage is set off in this format. Some readers may wish to skip these sections, while readers interested in programming in MPI may want to read them carefully. (*End of advice to users.*)

*Advice to implementors.* Throughout this document, material that is primarily commentary to implementors is set off in this format. Some readers may wish to skip these sections, while readers interested in MPI implementations may want to read them carefully. (*End of advice to implementors.*)

### 2.2 Naming Conventions

In many cases MPI names for C functions are of the form `MPI_Class_action_subset`. This convention originated with MPI-1. Since MPI-2 an attempt has been made to standardize the names of MPI functions according to the following rules.

1. In C, all routines associated with a particular type of MPI object should be of the form `MPI_Class_action_subset` or, if no subset exists, of the form `MPI_Class_action`. In Fortran, all routines associated with a particular type of MPI object should be of the form `MPI_CLASS_ACTION_SUBSET` or, if no subset exists, of the form `MPI_CLASS_ACTION`.
2. If the routine is not associated with a class, the name should be of the form `MPI_Action_subset` in C and `MPI_ACTION_SUBSET` in Fortran.

- 1       3. The names of certain actions have been standardized. In particular, **Create** creates  
 2       a new object, **Get** retrieves information about an object, **Set** sets this information,  
 3       **Delete** deletes information, **Is** asks whether or not an object has a certain property.

4  
 5       C and Fortran names for some MPI functions (that were defined during the MPI-1  
 6       process) violate these rules in several cases. The most common exceptions are the omission  
 7       of the **Class** name from the routine and the omission of the **Action** where one can be  
 8       inferred.

## 10   2.3 Procedure Specification

11  
 12   MPI procedures are specified using a language-independent notation. The arguments of  
 13   procedure calls are marked as IN, OUT, or INOUT. The meanings of these are:

- 14       • IN: the call may use the input value but does not update the argument from the  
 15       perspective of the caller at any time during the call's execution,
- 16       • OUT: the call may update the argument but does not use its input value,
- 17       • INOUT: the call may both use and update the argument.

18  
 19  
 20   There is one special case—if an argument is a handle to an opaque object (these terms  
 21   are defined in Section 2.5.1), and the object is updated by the procedure call, then the  
 22   argument is marked INOUT or OUT. It is marked this way even though the handle itself is  
 23   not modified—we use the INOUT or OUT attribute to denote that what the handle *references*  
 24   is updated.

25  
 26       *Rationale.* The definition of MPI tries to avoid, to the largest possible extent, the use  
 27       of INOUT arguments, because such use is error-prone, especially for scalar arguments.  
 28       (*End of rationale.*)

29  
 30   MPI's use of IN, OUT, and INOUT is intended to indicate to the user how an argument  
 31   is to be used, but does not provide a rigorous classification that can be translated directly  
 32   into all language bindings (e.g., `INTENT` in Fortran 90 bindings or `const` in C bindings).  
 33   For instance, the “constant” `MPI_BOTTOM` can usually be passed to OUT buffer arguments.  
 34   Similarly, `MPI_STATUS_IGNORE` can be passed as the OUT status argument.

35   A common occurrence for MPI functions is an argument that is used as IN by some pro-  
 36   cesses and OUT by other processes. Such an argument is, syntactically, an INOUT argument  
 37   and is marked as such, although, semantically, it is not used in one call both for input and  
 38   for output on a single process.

39   Another frequent situation arises when an argument value is needed only by a subset  
 40   of the processes. When an argument is not significant at a process then an arbitrary value  
 41   can be passed as an argument.

42   Unless specified otherwise, an argument of type OUT or type INOUT cannot be aliased  
 43   with any other argument passed to an MPI procedure. An example of argument aliasing in  
 44   C appears below. If we define a C procedure like this,

```
45 void copyIntBuffer(int *pin, int *pout, int len)
46 {   int i;
47     for (i=0; i<len; ++i) *pout++ = *pin++;
48 }
```



then a call to it in the following code fragment has aliased arguments.

```
int a[10];  
copyIntBuffer(a, a+3, 7);
```

Although the C language allows this, such usage of MPI procedures is forbidden unless otherwise specified. Note that Fortran prohibits aliasing of arguments.

All MPI functions are first specified in the language-independent notation. Immediately below this, language dependent bindings follow:

- The ISO C version(s) of the function.
- The Fortran version(s) used with `USE mpi_f08`.
- The Fortran version of the same function used with `USE mpi` or `INCLUDE 'mpif.h'`.

An exception is Section 15.3 “The MPI Tool Information Interface”, which only provides ISO C interfaces.

“Fortran” in this document refers to Fortran 90 and higher; see Section 2.6.

The words function, routine, procedure, procedure call, and call are often used as synonyms within this standard.

## 2.4 Semantic Terms

When discussing MPI procedures the following semantic terms are used. The term **message data buffer** refers to the send/receive buffer used in a communication procedure. The term **file data buffer** refers to the data buffers used by MPI I/O procedures. In this section we use the term **data buffer** and depending on the MPI procedure it will refer to message data buffer or file data buffer.

### 2.4.1 MPI Operations

**MPI operation** An MPI operation is a sequence of steps performed by the MPI library to establish and enable data transfer and/or synchronization. It consists of four stages: initialization, starting, completion, and freeing, and it is implemented as a set of one or more MPI procedures, see Section 2.4.2.

**Initialization** hands over the argument list to the operation but not the content of the data buffers, if any. The specification of an operation may state that array arguments must not be changed until the operation is freed.

**Starting** hands over the control of the data buffers, if any, to the associated operation.

Note that **initiation** refers to the combination of the initialization and starting stages.

**Completion** returns control of the content of the data buffers to the application and indicates that output buffers and arguments, if any, have been updated.

Note that an MPI operation is **complete** when the MPI procedure implementing the completion stage returns.

**Freeing** returns control of the rest of the argument list (e.g., the data buffer address and array arguments).

MPI operations are available in one or more of these forms: blocking, nonblocking, and persistent.

**Blocking operation** For a **blocking operation**, all four stages are combined in a single procedure call (as shown in Figure 2.1 and defined in Section 2.4.2).



Figure 2.1: State Transition Diagram for Blocking Operations

**Nonblocking operation** For a **nonblocking operation**, the initialization and starting stages are combined into a single nonblocking procedure call and the completion and freeing stages are combined into a separate, single procedure call, which can be blocking or nonblocking (as shown in Figure 2.2 and defined in Section 2.4.2).

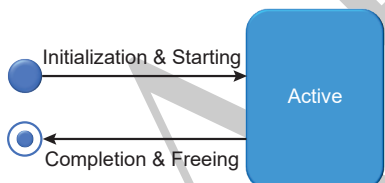

Figure 2.2: State Transition Diagram for Nonblocking Operations

**Persistent operation** For a **persistent operation**, there is a separate procedure for each of the four stages (as shown in Figure 2.3 and defined in Section 2.4.2). Each of these procedures may be blocking or nonblocking.

For a partitioned send operation, an additional call to activate each partition of the send buffer (see Section 4.2.1) is required to finish the starting stage. For a partitioned receive operation, before the operation is complete the user is allowed to access a partition of the output buffer after verifying that it has arrived (see Section 4.2.2).

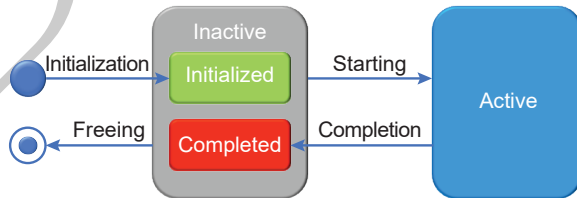

Figure 2.3: State Transition Diagram for Persistent Operations

Additionally, an MPI operation can be collective or noncollective.

**Collective operation** Collective operations are defined as operations that involve a group or groups of MPI processes. For collective operations the completion stage may or may not finish before all processes in the group have started the operation.

Collective MPI operations are also available as blocking, nonblocking, or persistent operations.

**Noncollective operation** Noncollective operations are defined as operations that are not collective.

#### 2.4.2 MPI Procedures

All MPI procedures can either be local or non-local - defined as follows:

**Non-local procedure** An MPI procedure is **non-local** if returning may require, during its execution, some specific semantically-related MPI procedure to be called on another MPI process.

**Local procedure** An MPI procedure is **local** if it is not non-local.

An MPI operation is implemented as a set of one or more MPI procedures. An **MPI operation-related procedure** implements at least a part of a stage of an MPI operation as described in Section 2.4.1. An MPI operation-related procedure may also implement one or more stages of one or several MPI operations. In certain cases, more than one MPI operation-related procedure may be needed to implement a single stage.

There are also other MPI procedures that do not implement any stage of any MPI operation.

The semantics of MPI operation-related procedures are described using two orthogonal (independent) concepts: completeness (depends on which stages are included) and locality. Such procedures can be either incomplete, or completing, or freeing, or completing and freeing based on the status of the associated operation at the time the procedure returns. Also, all such procedures can be described as either blocking or nonblocking, but these latter two terms refer to combinations of the completeness and locality concepts. Additionally, all MPI operation-related procedures can be collective or noncollective.

The following are properties of MPI operation-related procedures:

**Initialization procedure** An MPI procedure is an **initialization procedure** if return from the procedure indicates that the associated operation has completed its initialization stage, which implies that the user has handed over control of the argument list (but not contents of the data buffers) to MPI. The user is still allowed to read or modify the contents of the data buffers. If an initializing procedure is not also the freeing procedure of the associated operation (see below) then the user is not permitted to deallocate the data buffers or to modify the array arguments.

**Starting procedure** An MPI procedure is a **starting procedure** if return from the procedure indicates that the associated operation has completed its starting stage, which implies that the user has handed over control of the data buffers to MPI. If a starting procedure is not also a completing procedure of the associated operation (see below) then the user is not permitted to modify input data buffers or to read output data buffers.

**Initiation procedure** An MPI procedure is an **initiation procedure** if return from the procedure indicates that both the initialization and the starting stage have completed, which implies control of the entire argument list is handed over to MPI.

**Completing procedure** An MPI procedure is called **completing** if return from the procedure indicates that at least one associated operation has finished its completion stage, which implies that the user can rely on the content of the output data buffers and modify the content of input and output data buffers of such operation(s). If a completing procedure is not also a freeing procedure (see below) then the user is not permitted to deallocate the data buffers or to modify the array arguments.

**Incomplete procedure** An MPI procedure is called **incomplete** if it is not a completing procedure.

**Freeing procedure** An MPI procedure is **freeing** if return from the procedure indicates that at least one associated operation has finished its freeing stage, which implies that the user can reuse all parameters specified when initializing such associated operation(s).

**Nonblocking procedure** An MPI procedure is **nonblocking** if it is incomplete and local.

**Blocking procedure** An MPI procedure is **blocking** if it is not nonblocking.

*Advice to users.* Note that for operation-related MPI procedures, in most cases incomplete procedures are local and completing procedures are non-local. Exceptions are noted where such procedures are defined. In many cases an additional prefix letter **l** as an abbreviation of the words **incomplete** and **immediate** marks nonblocking procedures in the procedure name.

Some categorization examples are listed below.

Nonblocking procedures:

- incomplete and local: MPI\_ISEND, MPI\_IRecv, MPI\_IBCAST, MPI\_IMPROBE, MPI\_SEND\_INIT, MPI\_RECV\_INIT, ...

Blocking procedures:

- completing and non-local: MPI\_SEND, MPI\_RECV, MPI\_BCAST, ...
- incomplete and non-local: MPI\_MPROBE, MPI\_BCAST\_INIT, ..., MPI\_FILE\_{READ|WRITE}\_{AT\_ALL|ALL|ORDERED}\_BEGIN.
- completing and local: MPI\_BSEND, MPI\_RSEND, MPI\_MRECV.

MPI procedures that are not MPI operation-related:

- MPI\_COMM\_RANK, MPI\_WTIME, MPI\_PROBE, MPI\_IPROBE, ...

*(End of advice to users.)*

**Collective procedure** An MPI procedure is **collective** if all processes in a group or groups of MPI processes need to invoke the procedure.

Initialization procedures of collective operations over the same process group must be executed in the same order by all members of the process group.

An MPI collective procedure is **synchronizing** if it will only return once all processes in the associated group or groups of MPI processes have called the appropriate matching MPI procedure.

The initiation procedures for nonblocking collective operations and the starting procedures for persistent collective operations are local and shall not be synchronizing.

All other procedures for collective operations, such as for blocking collective operations and the initialization procedures for persistent collective operations, may or may not be synchronizing.

*Advice to users.* Calling any synchronizing function is erroneous when there is no possibility of corresponding calls at all other processes in the associated process group.

Waiting for completion of any collective operation is erroneous when there is no possibility that all other processes in the associated group will be able to start the corresponding operation. (*End of advice to users.*)

### 2.4.3 MPI Datatypes

For datatypes, the following terms are defined:

**predefined** A predefined datatype is a datatype with a predefined (constant) name (such as `MPI_INT`, `MPI_FLOAT_INT`, or `MPI_PACKED`) or a datatype constructed with `MPI_TYPE_CREATE_F90_INTEGER`, `MPI_TYPE_CREATE_F90_REAL`, or `MPI_TYPE_CREATE_F90_COMPLEX`. The former are **named** whereas the latter are **unnamed**.

**derived** A derived datatype is any datatype that is not predefined.

**portable** A datatype is portable if it is a predefined datatype, or it is derived from a portable datatype using only the type constructors `MPI_TYPE_CONTIGUOUS`, `MPI_TYPE_VECTOR`, `MPI_TYPE_INDEXED`, `MPI_TYPE_CREATE_INDEXED_BLOCK`, `MPI_TYPE_CREATE_SUBARRAY`, `MPI_TYPE_DUP`, and `MPI_TYPE_CREATE_DARRAY`. Such a datatype is portable because all displacements in the datatype are in terms of extents of one predefined datatype. Therefore, if such a datatype fits a data layout in one memory, it will fit the corresponding data layout in another memory, if the same declarations were used, even if the two systems have different architectures. On the other hand, if a datatype was constructed using `MPI_TYPE_CREATE_HINDEXED`, `MPI_TYPE_CREATE_HINDEXED_BLOCK`, `MPI_TYPE_CREATE_HVECTOR` or `MPI_TYPE_CREATE_STRUCT`, then the datatype contains explicit byte displacements (e.g., providing padding to meet alignment restrictions). These displacements are unlikely to be chosen correctly if they fit data layout on one memory, but are used for data layouts on another process, running on a processor with a different architecture.

**equivalent** Two datatypes are equivalent if they appear to have been created with the same sequence of calls (and arguments) and thus have the same typemap. Two equivalent datatypes do not necessarily have the same cached attributes or the same names.

## 2.5 Datatypes

### 2.5.1 Opaque Objects

MPI manages **system memory** that is used for buffering messages and for storing internal representations of various MPI objects such as groups, communicators, datatypes, etc. This memory is not directly accessible to the user, and objects stored there are **opaque**: their size and shape is not visible to the user. Opaque objects are accessed via **handles**, which exist in user space. MPI procedures that operate on opaque objects are passed handle arguments to access these objects. In addition to their use by MPI calls for object access, handles can participate in assignments and comparisons.

In Fortran with `USE mpi` or `INCLUDE 'mpif.h'`, all handles have type `INTEGER`. In Fortran with `USE mpi_f08`, and in C, a different handle type is defined for each category of objects. With Fortran `USE mpi_f08`, the handles are defined as Fortran `BIND(C)` derived types that consist of only one element `INTEGER :: MPI_VAL`. The internal handle value is identical to the Fortran `INTEGER` value used in the `mpi` module and `mpif.h`. The operators `.EQ.`, `.NE.`, `==` and `/=` are overloaded to allow the comparison of these handles. The type names are identical to the names in C, except that they are not case sensitive. For example:

```

TYPE, BIND(C) :: MPI_Comm
  INTEGER      :: MPI_VAL
END TYPE MPI_Comm

```

The C types must support the use of the assignment and equality operators.

*Advice to implementors.* In Fortran, the handle can be an index into a table of opaque objects in a system table; in C it can be such an index or a pointer to the object. (*End of advice to implementors.*)

*Rationale.* Since the Fortran integer values are equivalent, applications can easily convert MPI handles between all three supported Fortran methods. For example, an integer communicator handle `COMM` can be converted directly into an exactly equivalent `mpi_f08` communicator handle named `comm_f08` by `comm_f08%MPI_VAL=COMM`, and vice versa. The use of the `INTEGER` defined handles and the `BIND(C)` derived type handles is different: Fortran 2003 (and later) define that `BIND(C)` derived types can be used within user defined common blocks, but it is up to the rules of the companion C compiler how many numerical storage units are used for these `BIND(C)` derived type handles. Most compilers use one unit for both, the `INTEGER` handles and the handles defined as `BIND(C)` derived types. (*End of rationale.*)

*Advice to users.* If a user wants to substitute `mpif.h` or the `mpi` module by the `mpi_f08` module and the application program stores a handle in a Fortran common block then it is necessary to change the Fortran support method in all application routines that use this common block, because the number of numerical storage units of such a handle can be different in the two modules. (*End of advice to users.*)

Opaque objects are allocated and deallocated by calls that are specific to each object type. These are listed in the sections where the objects are described. The calls accept a handle argument of matching type. In an allocate call this is an OUT argument that returns

a valid reference to the object. In a call to deallocate this is an INOUT argument which returns with an “invalid handle” value. MPI provides an “invalid handle” constant for each object type. Comparisons to this constant are used to test for validity of the handle.

A call to a deallocate routine invalidates the handle and marks the object for deallocation. The object is not accessible to the user after the call. However, MPI need not deallocate the object immediately. Any operation pending (at the time of the deallocate) that involves this object will complete normally; the object will be deallocated afterwards.

An opaque object and its handle are significant only at the process where the object was created and cannot be transferred to another process.

MPI provides certain predefined opaque objects and predefined, static handles to these objects. The user must not free such objects.

*Rationale.* This design hides the internal representation used for MPI data structures, thus allowing similar calls in C and Fortran. It also avoids conflicts with the typing rules in these languages, and easily allows future extensions of functionality. The mechanism for opaque objects used here loosely follows the POSIX Fortran binding standard.

The explicit separation of handles in user space and objects in system space allows space-reclaiming and deallocation calls to be made at appropriate points in the user program. If the opaque objects were in user space, one would have to be very careful not to go out of scope before any pending operation requiring that object completed. The specified design allows an object to be marked for deallocation, the user program can then go out of scope, and the object itself still persists until any pending operations are complete.

The requirement that handles support assignment/comparison is made since such operations are common. This restricts the domain of possible implementations. The alternative in C would have been to allow handles to have been an arbitrary, opaque type. This would force the introduction of routines to do assignment and comparison, adding complexity, and was therefore ruled out. In Fortran, the handles are defined such that assignment and comparison are available through the operators of the language or overloaded versions of these operators. (*End of rationale.*)

*Advice to users.* A user may accidentally create a dangling reference by assigning to a handle the value of another handle, and then deallocating the object associated with these handles. Conversely, if a handle variable is deallocated before the associated object is freed, then the object becomes inaccessible (this may occur, for example, if the handle is a local variable within a subroutine, and the subroutine is exited before the associated object is deallocated). It is the user’s responsibility to avoid adding or deleting references to opaque objects, except as a result of MPI calls that allocate or deallocate such objects. (*End of advice to users.*)

*Advice to implementors.* The intended semantics of opaque objects is that opaque objects are separate from one another; each call to allocate such an object copies all the information required for the object. Implementations may avoid excessive copying by substituting referencing for copying. For example, a derived datatype may contain references to its components, rather than copies of its components; a call to MPI\_COMM\_GROUP may return a reference to the group associated with the communicator, rather than a copy of this group. In such cases, the implementation

1 must maintain reference counts, and allocate and deallocate objects in such a way that  
2 the visible effect is as if the objects were copied. (*End of advice to implementors.*)  
3

## 4 2.5.2 Array Arguments

5  
6 An MPI call may need an argument that is an array of opaque objects, or an array of  
7 handles. The array-of-handles is a regular array with entries that are handles to objects  
8 of the same type in consecutive locations in the array. Whenever such an array is used,  
9 an additional `len` argument is required to indicate the number of valid entries (unless this  
10 number can be derived otherwise). The valid entries are at the beginning of the array;  
11 `len` indicates how many of them there are, and need not be the size of the entire array.  
12 The same approach is followed for other array arguments. In some cases `NULL` handles are  
13 considered valid entries. When a `NULL` argument is desired for an array of statuses, one  
14 uses `MPI_STATUSES_IGNORE`.  
15

## 16 2.5.3 State

17 MPI procedures use at various places arguments with *state* types. The values of such a  
18 datatype are all identified by names, and no operation is defined on them. For example,  
19 the `MPI_TYPE_CREATE_SUBARRAY` routine has a state argument `order` with values  
20 `MPI_ORDER_C` and `MPI_ORDER_FORTRAN`.  
21

## 22 2.5.4 Named Constants

23  
24 MPI procedures sometimes assign a special meaning to a special value of a basic type argu-  
25 ment; e.g., `tag` is an integer-valued argument of point-to-point communication operations,  
26 with a special wild-card value, `MPI_ANY_TAG`. Such arguments will have a range of regular  
27 values, which is a proper subrange of the range of values of the corresponding basic type;  
28 special values (such as `MPI_ANY_TAG`) will be outside the regular range. The range of regu-  
29 lar values, such as `tag`, can be queried using environmental inquiry functions, see Chapter 9.  
30 The range of other values, such as `source`, depends on values given by other MPI routines  
31 (in the case of `source` it is the communicator size).  
32

33 MPI also provides predefined named constant handles, such as `MPI_COMM_WORLD`.

34 All named constants, with the exceptions noted below for Fortran, can be used in  
35 initialization expressions or assignments, but not necessarily in array declarations or as  
36 labels in C `switch` or Fortran `select/case` statements. This implies named constants  
37 to be link-time but not necessarily compile-time constants. The named constants listed  
38 below are required to be compile-time constants in both C and Fortran. These constants  
39 do not change values during execution. Opaque objects accessed by constant handles are  
40 defined and do not change value between MPI initialization (`MPI_INIT`) and MPI completion  
41 (`MPI_FINALIZE`). The handles themselves are constants and can be also used in initialization  
42 expressions or assignments.  
43

44 The constants that are required to be compile-time constants (and can thus be used  
45 for array length declarations and labels in C `switch` and Fortran `case/select` statements)  
46  
47  
48



are:

MPI_MAX_PROCESSOR_NAME	1
MPI_MAX_LIBRARY_VERSION_STRING	2
MPI_MAX_ERROR_STRING	3
MPI_MAX_DATAREP_STRING	4
MPI_MAX_INFO_KEY	5
MPI_MAX_INFO_VAL	6
MPI_MAX_OBJECT_NAME	7
MPI_MAX_PORT_NAME	8
MPI_VERSION	9
MPI_SUBVERSION	10
MPI_F_STATUS_SIZE (C only)	11
MPI_STATUS_SIZE (Fortran only)	12
MPI_ADDRESS_KIND (Fortran only)	13
MPI_COUNT_KIND (Fortran only)	14
MPI_INTEGER_KIND (Fortran only)	15
MPI_OFFSET_KIND (Fortran only)	16
MPI_SUBARRAYS_SUPPORTED (Fortran only)	17
MPI_ASYNC_PROTECTS_NONBLOCKING (Fortran only)	18

The constants that cannot be used in initialization expressions or assignments in Fortran are as follows:

MPI_BOTTOM	19
MPI_STATUS_IGNORE	20
MPI_STATUSES_IGNORE	21
MPI_ERRCODES_IGNORE	22
MPI_IN_PLACE	23
MPI_ARGV_NULL	24
MPI_ARGVS_NULL	25
MPI_UNWEIGHTED	26
MPI_WEIGHTS_EMPTY	27

*Advice to implementors.* In Fortran the implementation of these special constants may require the use of language constructs that are outside the Fortran standard. Using special values for the constants (e.g., by defining them through `PARAMETER` statements) is not possible because an implementation cannot distinguish these values from valid data. Typically, these constants are implemented as predefined static variables (e.g., a variable in an MPI-declared `COMMON` block), relying on the fact that the target compiler passes data by address. Inside the subroutine, this address can be extracted by some mechanism outside the Fortran standard (e.g., by Fortran extensions or by implementing the function in C). (*End of advice to implementors.*)

### 2.5.5 Choice

MPI functions sometimes use arguments with a *choice* (or union) data type. Distinct calls to the same routine may pass by reference actual arguments of different types. The mechanism for providing such arguments will differ from language to language. For Fortran with the include file `mpif.h` or the `mpi` module, the document uses `<type>` to represent a choice

variable; with the Fortran `mpi_f08` module, such arguments are declared with the Fortran 2008 + TS 29113 syntax `TYPE(*)`, `DIMENSION(..)`; for C, we use `void*`.

*Advice to implementors.* Implementors can freely choose how to implement choice arguments in the `mpi` module, e.g., with a non-standard compiler-dependent method that has the quality of the call mechanism in the implicit Fortran interfaces, or with the method defined for the `mpi_f08` module. See details in Section 19.1.1. (*End of advice to implementors.*)

## 2.5.6 Absolute Addresses and Relative Address Displacements

Some MPI procedures use *address* arguments that represent an *absolute address* in the calling program, or *relative displacement* arguments that represent differences of two absolute addresses. The datatype of such arguments is `MPI_Aint` in C and `INTEGER (KIND=MPI_ADDRESS_KIND)` in Fortran. These types must have the same width and encode address values in the same manner such that address values in one language may be passed directly to another language without conversion. There is the MPI constant `MPI_BOTTOM` to indicate the start of the address range. For retrieving absolute addresses or any calculation with absolute addresses, one should use the routines and functions provided in Section 5.1.5. Section 5.1.12 provides additional rules for the correct use of absolute addresses. For expressions with relative displacements or other usage without absolute addresses, intrinsic operators (e.g., `+`, `-`, `*`) can be used.

*Rationale.* Byte displacement values need to be large enough to encode any value used for expressing absolute or relative memory addresses. Prior to MPI-4.0, some MPI routines used `int` in C and `INTEGER` in Fortran as the type for *byte displacement* arguments. To avoid breaking backward compatibility, this version of the standard continues to support `int` in C as well as `INTEGER` in Fortran in such routines. In addition, this version of the standard supports using `MPI_Aint` in C (via separate “\_c” suffixed procedures) as well as `INTEGER (KIND=MPI_ADDRESS_KIND)` in Fortran (via polymorphic interfaces in newer MPI Fortran bindings (USE `mpi_f08`)) in such routines. See Section 19.2 for a full explanation. (*End of rationale.*)

## 2.5.7 File Offsets

For I/O there is a need to give the size, displacement, and offset into a file. These quantities can easily be larger than 32 bits which can be the default size of a Fortran integer. To overcome this, these quantities are declared to be `INTEGER(KIND=MPI_OFFSET_KIND)` in Fortran. In C one uses `MPI_Offset`. These types must have the same width and encode address values in the same manner such that offset values in one language may be passed directly to another language without conversion.

## 2.5.8 Counts

As described above, MPI defines types (e.g., `MPI_Aint`) to address locations within memory and other types (e.g., `MPI_Offset`) to address locations within files. In addition, some MPI procedures use *count* arguments that represent a number of MPI datatypes on which to operate. Furthermore, *timestamps* in the context of the MPI Tool Information Interface are a count of clock ticks elapsed since some time in the past. At times, one needs a single

type that can be used to address locations within either memory or files as well as express *count* values, and that type is `MPI_Count` in C and `INTEGER(KIND=MPI_COUNT_KIND)` in Fortran. These types must have the same width and encode values in the same manner such that count values in one language may be passed directly to another language without conversion. The size of the `MPI_Count` type is determined by the MPI implementation with the restriction that it must be minimally capable of encoding any value that may be stored in a variable of type `int`, `MPI_Aint`, or `MPI_Offset` in C and of type `INTEGER`, `INTEGER (KIND=MPI_ADDRESS_KIND)`, or `INTEGER (KIND=MPI_OFFSET_KIND)` in Fortran. Even though the `MPI_Count` type is large enough to encode address locations, `MPI_Count` type shall not be used to represent an *absolute address*.

*Rationale.* Count values need to be large enough to encode any value used for expressing element counts, stride, offset, index, displacement, typemaps in memory, typemaps in file views, etc. Prior to MPI-4.0, many MPI routines used `int` in C and `INTEGER` in Fortran as the type for *count* arguments. To avoid breaking backward compatibility, this version of the standard continues to support `int` in C as well as `INTEGER` in Fortran in such routines. In addition, this version of the standard supports using `MPI_Count` in C (via separate “\_c” suffixed procedures) as well as `INTEGER (KIND=MPI_COUNT_KIND)` in Fortran (via polymorphic interfaces in newer MPI Fortran bindings (`USE mpi_f08`)) in such routines. See Section 19.2 for a full explanation. (*End of rationale.*)

The phrase **large count** refers to the use of `MPI_Count` and `INTEGER (KIND=MPI_COUNT_KIND)` parameter types.

There are cases where `MPI_UNDEFINED` can be returned in a **large count** OUT parameter. Per Table A.1.1 (page 851), the `MPI_UNDEFINED` constant is defined to be a C `int` (or unnamed `enum`) and a Fortran `INTEGER`. Implementations shall therefore choose the underlying types for `MPI_Count` and `INTEGER(KIND=MPI_COUNT_KIND)` such that they can be compared to `MPI_UNDEFINED`.

*Advice to implementors.* The comparison of `MPI_UNDEFINED` to an `MPI_Count` or `INTEGER(KIND=MPI_COUNT_KIND)` may need to be via a casting operation. (*End of advice to implementors.*)

## 2.6 Language Binding

This section defines the rules for MPI language binding in general and for Fortran, and ISO C, in particular. (Note that ANSI C has been replaced by ISO C.) Defined here are various object representations, as well as the naming conventions used for expressing this standard. The actual calling sequences are defined elsewhere.

MPI bindings are for Fortran 90 or later, though they were originally designed to be usable in Fortran 77 environments. With the `mpi_f08` module, two new Fortran features, *assumed type* and *assumed rank*, are also required, see Section 2.5.5.

Since the word `PARAMETER` is a keyword in the Fortran language, we use the word “argument” to denote the arguments to a subroutine. These are normally referred to as parameters in C, however, we expect that C programmers will understand the word “argument” (which has no specific meaning in C), thus allowing us to avoid unnecessary confusion for Fortran programmers.

1 Since Fortran is case insensitive, linkers may use either lower case or upper case when  
2 resolving Fortran names. Users of case sensitive languages should avoid any prefix of the  
3 form “MPI\_” and “PMPI\_”, where any of the letters are either upper or lower case.  
4

### 5 2.6.1 Deprecated and Removed Interfaces

6 A number of chapters refer to deprecated or replaced MPI constructs. These are constructs  
7 that continue to be part of the MPI standard, as documented in Chapter 16, but that users  
8 are recommended not to continue using, since better solutions were provided with newer  
9 versions of MPI. For example, the Fortran binding for MPI-1 functions that have address  
10 arguments uses `INTEGER`. This is not consistent with the C binding, and causes problems on  
11 machines with 32 bit `INTEGER`s and 64 bit addresses. In MPI-2, these functions were given  
12 new names with new bindings for the address arguments. The use of the old functions was  
13 declared as deprecated. For consistency, here and in a few other cases, new C functions are  
14 also provided, even though the new functions are equivalent to the old functions. The old  
15 names are deprecated.  
16

17 Some of the deprecated constructs are now removed, as documented in Chapter 17.  
18 They may still be provided by an implementation for backwards compatibility, but are not  
19 required.

20 Table 2.1 shows a list of all of the deprecated and removed constructs. Note that some  
21 C typedefs and Fortran subroutine names are included in this list; they are the types of  
22 callback functions.  
23

### 24 2.6.2 Fortran Binding Issues

25 Originally, MPI-1.1 provided bindings for Fortran 77. These bindings are retained, but they  
26 are now interpreted in the context of the Fortran 90 standard. MPI can still be used with  
27 most Fortran 77 compilers, as noted below. When the term “Fortran” is used it means  
28 Fortran 90 or later; it means Fortran 2008 + TS 29113 and later if the `mpi_f08` module is  
29 used.  
30

31 All MPI names have an `MPI_` prefix, and all characters are capitals. Programs must  
32 not declare names, e.g., for variables, subroutines, functions, parameters, derived types,  
33 abstract interfaces, or modules, beginning with the prefix `MPI_`. To avoid conflicting with  
34 the profiling interface, programs must also avoid subroutines and functions with the prefix  
35 `PMPI_`. This is mandated to avoid possible name collisions.

36 All MPI Fortran subroutines have a return code in the last argument. With `USE`  
37 `mpi_f08`, this last argument is declared as `OPTIONAL`, except for user-defined callback func-  
38 tions (e.g., `COMM_COPY_ATTR_FUNCTION`) and their predefined callbacks (e.g.,  
39 `MPI_NULL_COPY_FN`). A few MPI operations which are functions do not have the return  
40 code argument. The return code value for successful completion is `MPI_SUCCESS`. Other  
41 error codes are implementation dependent; see the error codes in Chapter 9 and Annex A.

42 Constants representing the maximum length of a string are one smaller in Fortran than  
43 in C as discussed in Section 19.3.9.

44 Handles are represented in Fortran as `INTEGER`s, or as a `BIND(C)` derived type with the  
45 `mpi_f08` module; see Section 2.5.1. Binary-valued variables are of type `LOGICAL`.

46 Array arguments are indexed from one.

47 The older MPI Fortran bindings (`mpif.h` and `use mpi`) are inconsistent with the For-  
48 tran standard in several respects. These inconsistencies, such as register optimization prob-

Deprecated or removed construct	deprecated since	removed since	Replacement	
MPI_ADDRESS	MPI-2.0	MPI-3.0	MPI_GET_ADDRESS	1
MPI_TYPE_HINDEXED	MPI-2.0	MPI-3.0	MPI_TYPE_CREATE_HINDEXED	2
MPI_TYPE_HVECTOR	MPI-2.0	MPI-3.0	MPI_TYPE_CREATE_HVECTOR	3
MPI_TYPE_STRUCT	MPI-2.0	MPI-3.0	MPI_TYPE_CREATE_STRUCT	4
MPI_TYPE_EXTENT	MPI-2.0	MPI-3.0	MPI_TYPE_GET_EXTENT	5
MPI_TYPE_UB	MPI-2.0	MPI-3.0	MPI_TYPE_GET_EXTENT	6
MPI_TYPE_LB	MPI-2.0	MPI-3.0	MPI_TYPE_GET_EXTENT	7
MPI_LB <sup>1</sup>	MPI-2.0	MPI-3.0	MPI_TYPE_CREATE_RESIZED	8
MPI_UB <sup>1</sup>	MPI-2.0	MPI-3.0	MPI_TYPE_CREATE_RESIZED	9
MPI_ERRHANDLER_CREATE	MPI-2.0	MPI-3.0	MPI_COMM_CREATE_ERRHANDLER	10
MPI_ERRHANDLER_GET	MPI-2.0	MPI-3.0	MPI_COMM_GET_ERRHANDLER	11
MPI_ERRHANDLER_SET	MPI-2.0	MPI-3.0	MPI_COMM_SET_ERRHANDLER	12
MPI_Handler_function <sup>2</sup>	MPI-2.0	MPI-3.0	MPI_Comm_errhandler_function <sup>2</sup>	13
MPI_KEYVAL_CREATE	MPI-2.0		MPI_COMM_CREATE_KEYVAL	14
MPI_KEYVAL_FREE	MPI-2.0		MPI_COMM_FREE_KEYVAL	15
MPI_DUP_FN <sup>3</sup>	MPI-2.0		MPI_COMM_DUP_FN <sup>3</sup>	16
MPI_NULL_COPY_FN <sup>3</sup>	MPI-2.0		MPI_COMM_NULL_COPY_FN <sup>3</sup>	17
MPI_NULL_DELETE_FN <sup>3</sup>	MPI-2.0		MPI_COMM_NULL_DELETE_FN <sup>3</sup>	18
MPI_Copy_function <sup>2</sup>	MPI-2.0		MPI_Comm_copy_attr_function <sup>2</sup>	19
COPY_FUNCTION <sup>3</sup>	MPI-2.0		COMM_COPY_ATTR_FUNCTION <sup>3</sup>	20
MPI_Delete_function <sup>2</sup>	MPI-2.0		MPI_Comm_delete_attr_function <sup>2</sup>	21
DELETE_FUNCTION <sup>3</sup>	MPI-2.0		COMM_DELETE_ATTR_FUNCTION <sup>3</sup>	22
MPI_ATTR_DELETE	MPI-2.0		MPI_COMM_DELETE_ATTR	23
MPI_ATTR_GET	MPI-2.0		MPI_COMM_GET_ATTR	24
MPI_ATTR_PUT	MPI-2.0		MPI_COMM_SET_ATTR	25
MPI_COMBINER_HVECTOR_INTEGER <sup>4</sup>	-	MPI-3.0	MPI_COMBINER_HVECTOR <sup>4</sup>	26
MPI_COMBINER_HINDEXED_INTEGER <sup>4</sup>	-	MPI-3.0	MPI_COMBINER_HINDEXED <sup>4</sup>	27
MPI_COMBINER_STRUCT_INTEGER <sup>4</sup>	-	MPI-3.0	MPI_COMBINER_STRUCT <sup>4</sup>	28
MPI::...	MPI-2.2	MPI-3.0	C language binding	29
MPI_CANCEL for send requests	MPI-4.0		no direct replacement	30
MPI_INFO_GET	MPI-4.0		MPI_INFO_GET_STRING	31
MPI_INFO_GET_VALUELEN	MPI-4.0		MPI_INFO_GET_STRING	32
MPI_T_ERR_INVALID_ITEM	MPI-4.0		MPI_T_ERR_INVALID_INDEX	33
MPI_SIZEOF	MPI-4.0		storage_size() <sup>5</sup>	34
<sup>1</sup> Predefined datatype.				35
<sup>2</sup> Callback prototype definition.				36
<sup>3</sup> Predefined callback routine.				37
<sup>4</sup> Constant.				38
<sup>5</sup> Fortran intrinsic. It returns the size in bits instead of bytes.				39
Other entries are regular MPI routines.				40

Table 2.1: Deprecated and Removed constructs

lems, have implications for user codes that are discussed in detail in Section 19.1.16.

The support for large count and displacement in Fortran is only available when using newer MPI Fortran bindings (USE mpi\_f08).

### 2.6.3 C Binding Issues

We use the ISO C declaration format. All MPI names have an MPI\_ prefix, defined constants are in all capital letters, and defined types and functions have one capital letter after the prefix. Programs must not declare names (identifiers), e.g., for variables, functions, constants, types, or macros, beginning with any prefix of the form MPI\_, where any of the

1 letters are either upper or lower case. To support the profiling interface, programs must  
2 not declare functions with names beginning with any prefix of the form `PMPI_`, where any  
3 of the letters are either upper or lower case.

4 The definition of named constants, function prototypes, and type definitions must be  
5 supplied in an include file `mpi.h`.

6 Almost all C functions return an error code. The successful return code will be  
7 `MPI_SUCCESS`, but failure return codes are implementation dependent.

8 Type declarations are provided for handles to each category of opaque objects.

9 Array arguments are indexed from zero.

10 Logical flags are integers with value 0 meaning “false” and a non-zero value meaning  
11 “true.”

12 Choice arguments are pointers of type `void*`.

## 14 2.6.4 Functions and Macros

15 An implementation is allowed to implement `MPI_WTIME`, `PMPI_WTIME`, `MPI_WTICK`,  
16 `PMPI_WTICK`, `MPI_AINT_ADD`, `PMPI_AINT_ADD`, `MPI_AINT_DIFF`, `PMPI_AINT_DIFF`,  
17 and the handle-conversion functions (`MPI_Group_f2c`, etc.) in Section 19.3.4, and no others,  
18 as macros in C.

19  
20 *Advice to implementors.* Implementors should document which routines are imple-  
21 mented as macros. (*End of advice to implementors.*)

22  
23 *Advice to users.* If these routines are implemented as macros, they will not work  
24 with the MPI profiling interface. (*End of advice to users.*)

## 26 2.7 Processes

27  
28 An MPI program consists of autonomous processes, executing their own code, in an MIMD  
29 style. The codes executed by each process need not be identical. The processes communicate  
30 via calls to MPI communication primitives. Typically, each process executes in its own  
31 address space, although shared-memory implementations of MPI are possible.

32 This document specifies the behavior of a parallel program assuming that only MPI  
33 calls are used. The interaction of an MPI program with other possible means of commu-  
34 nication, I/O, and process management is not specified. Unless otherwise stated in the  
35 specification of the standard, MPI places no requirements on the result of its interaction  
36 with external mechanisms that provide similar or equivalent functionality. This includes,  
37 but is not limited to, interactions with external mechanisms for process control, shared and  
38 remote memory access, file system access and control, interprocess communication, process  
39 signaling, and terminal I/O. High quality implementations should strive to make the results  
40 of such interactions intuitive to users, and attempt to document restrictions where deemed  
41 necessary.

42  
43 *Advice to implementors.* Implementations that support such additional mechanisms  
44 for functionality supported within MPI are expected to document how these interact  
45 with MPI. (*End of advice to implementors.*)

46  
47 The interaction of MPI and threads is defined in Section 11.6.



## 2.8 Error Handling

MPI provides the user with reliable message transmission. A message sent is always received correctly, and the user does not need to check for transmission errors, time-outs, or other error conditions. In other words, MPI does not provide mechanisms for dealing with **transmission failures** in the communication system. If the MPI implementation is built on an unreliable underlying mechanism, then it is the job of the implementor of the MPI subsystem to insulate the user from this unreliability, and to reflect only unrecoverable transmission failures. Whenever possible, such failures will be reflected as errors in the relevant communication call.

Similarly, MPI itself provides no mechanisms for handling **MPI process failures**, that is, when an MPI process unexpectedly and permanently stops communicating (e.g., a software or hardware crash results in an MPI process terminating unexpectedly).

Of course, MPI programs may still be erroneous. A **program error** can occur when an MPI call is made with an incorrect argument (non-existing destination in a send operation, buffer too small in a receive operation, etc.). This type of error would occur in any implementation. In addition, a **resource error** may occur when a program exceeds the amount of available system resources (number of pending messages, system buffers, etc.). The occurrence of this type of error depends on the amount of available resources in the system and the resource allocation mechanism used; this may differ from system to system. A high-quality implementation will provide generous limits on the important resources so as to alleviate the portability problem this represents.

In C and Fortran, almost all MPI calls return a code that indicates successful completion of the operation. Whenever possible, MPI calls return an error code if an error occurred during the call. By default, an error detected during the execution of the MPI library causes the parallel computation to abort, except for file operations. However, MPI provides mechanisms for users to change this default and to handle recoverable errors. The user may specify that no error is fatal, and handle error codes returned by MPI calls by himself or herself. Also, the user may provide his or her own error-handling routines, which will be invoked whenever an MPI call returns abnormally. The MPI error handling facilities are described in Section 9.3.

Several factors limit the ability of MPI calls to return with meaningful error codes when an error occurs. MPI may not be able to detect some errors; other errors may be too expensive to detect in normal execution mode; some faults (e.g., memory faults) may corrupt the state of the MPI library and its outputs; finally some errors may be “catastrophic” and may prevent MPI from returning control to the caller. On the other hand, some errors may be detected after the associated operation has completed; some errors may not have a communicator, window, or file on which an error may be raised. In such cases, these errors will be raised on the communicator `MPI_COMM_SELF`. When `MPI_COMM_SELF` is not initialized (i.e., before `MPI_INIT` / `MPI_INIT_THREAD` or after `MPI_FINALIZE`) the error raises the **initial error handler** (set during the launch operation, see 11.8.4).

An example of such a case arises because of the nature of asynchronous communications: MPI calls may initiate operations that continue asynchronously after the call returned. Thus, the operation may return with a code indicating successful completion, yet later cause an error to be raised. If there is a subsequent call that relates to the same operation (e.g., a call that verifies that an asynchronous operation has completed) then the error argument associated with this call will be used to indicate the nature of the error. In a few cases, the error may occur after all calls that relate to the operation have completed, so that no error

1 value can be used to indicate the nature of the error (e.g., an error on the receiver in a send  
2 with the ready mode).

3 This document does not specify the state of a computation after an erroneous MPI call  
4 has occurred. The desired behavior is that a relevant error code be returned, and the effect  
5 of the error be localized to the greatest possible extent. E.g., it is highly desirable that an  
6 erroneous receive call will not cause any part of the receiver's memory to be overwritten,  
7 beyond the area specified for receiving the message.

8 Implementations may go beyond this document in supporting in a meaningful manner  
9 MPI calls that are defined here to be erroneous. For example, MPI specifies strict type  
10 matching rules between matching send and receive operations: it is erroneous to send a  
11 floating point variable and receive an integer. Implementations may go beyond these type  
12 matching rules, and provide automatic type conversion in such situations. It will be helpful  
13 to generate warnings for such non-conforming behavior.

14 MPI defines a way for users to create new error codes as defined in Section 9.5.

## 16 2.9 Implementation Issues

18 There are a number of areas where an MPI implementation may interact with the operating  
19 environment and system. While MPI does not mandate that any services (such as signal  
20 handling) be provided, it does strongly suggest the behavior to be provided if those services  
21 are available. This is an important point in achieving portability across platforms that  
22 provide the same set of services.

### 24 2.9.1 Independence of Basic Runtime Routines

26 MPI programs require that library routines that are part of the basic language environment  
27 (such as `write` in Fortran and `printf` and `malloc` in ISO C) and are executed after  
28 `MPI_INIT` and before `MPI_FINALIZE` operate independently and that their *completion* is  
29 independent of the action of other processes in an MPI program.

30 Note that this in no way prevents the creation of library routines that provide parallel  
31 services whose operation is collective. However, the following program is expected to com-  
32 plete in an ISO C environment regardless of the size of `MPI_COMM_WORLD` (assuming that  
33 `printf` is available at the executing nodes).

```
34 int rank;  
35 MPI_Init((void *)0, (void *)0);  
36 MPI_Comm_rank(MPI_COMM_WORLD, &rank);  
37 if (rank == 0) printf("Starting program\n");  
38 MPI_Finalize();
```

40 The corresponding Fortran programs are also expected to complete.

41 An example of what is *not* required is any particular ordering of the action of these  
42 routines when called by several tasks. For example, MPI makes neither requirements nor  
43 recommendations for the output from the following program (again assuming that I/O is  
44 available at the executing nodes).

```
46 MPI_Comm_rank(MPI_COMM_WORLD, &rank);  
47 printf("Output from task rank %d\n", rank);
```



In addition, calls that fail because of resource exhaustion or other error are not considered a violation of the requirements here (however, they are required to complete, just not to complete successfully).

### 2.9.2 Interaction with Signals

MPI does not specify the interaction of processes with signals and does not require that MPI be signal safe. The implementation may reserve some signals for its own use. It is required that the implementation document which signals it uses, and it is strongly recommended that it not use `SIGALRM`, `SIGFPE`, or `SIGIO`. Implementations may also prohibit the use of MPI calls from within signal handlers.

In multithreaded environments, users can avoid conflicts between signals and the MPI library by catching signals only on threads that do not execute MPI calls. High quality single-threaded implementations will be signal safe: an MPI call suspended by a signal will resume and complete normally after the signal is handled.

## 2.10 Examples

The examples in this document are for illustration purposes only. They are not intended to specify the standard. Furthermore, the examples have not been carefully checked or verified.

1  
2  
3  
4  
5  
6  
7  
8  
9  
10  
11  
12  
13  
14  
15  
16  
17  
18  
19  
20  
21  
22  
23  
24  
25  
26  
27  
28  
29  
30  
31  
32  
33  
34  
35  
36  
37  
38  
39  
40  
41  
42  
43  
44  
45  
46  
47  
48

DRAFT

## Chapter 3

# Point-to-Point Communication

### 3.1 Introduction

Sending and receiving of messages by processes is the basic MPI communication mechanism. The basic point-to-point communication operations are **send** and **receive**. Their use is illustrated in Example 3.1.

**Example 3.1** A simple ‘hello world’ example usage of point-to-point communication.

```
#include "mpi.h"
int main(int argc, char *argv[])
{
    char message[20];
    int myrank;
    MPI_Status status;
    MPI_Init(&argc, &argv);
    MPI_Comm_rank(MPI_COMM_WORLD, &myrank);
    if (myrank == 0) /* code for process zero */
    {
        strcpy(message, "Hello, there");
        MPI_Send(message, strlen(message)+1, MPI_CHAR, 1, 99, MPI_COMM_WORLD);
    }
    else if (myrank == 1) /* code for process one */
    {
        MPI_Recv(message, 20, MPI_CHAR, 0, 99, MPI_COMM_WORLD, &status);
        printf("received :%s:\n", message);
    }
    MPI_Finalize();
    return 0;
}
```

In Example 3.1, process zero (`myrank = 0`) sends a message to process one using the **send** operation `MPI_SEND`. The operation specifies a **send buffer** in the sender memory from which the message data is taken. In the example above, the send buffer consists of the storage containing the variable `message` in the memory of process zero. The location, size and type of the send buffer are specified by the first three parameters of the send

operation. The message sent will contain the 13 characters of this variable. In addition, the send operation associates an **envelope** with the message. This envelope specifies the message destination and contains distinguishing information that can be used by the **receive** operation to select a particular message. The last three parameters of the send operation, along with the rank of the sender, specify the envelope for the message sent. Process one (`myrank = 1`) receives this message with the **receive** operation `MPI_RECV`. The message to be received is selected according to the value of its envelope, and the message data is stored into the **receive buffer**. In the example above, the receive buffer consists of the storage containing the string `message` in the memory of process one. The first three parameters of the receive operation specify the location, size and type of the receive buffer. The next three parameters are used for selecting the incoming message. The last parameter is used to return information on the message just received.

The next sections describe the blocking send and receive operations. We discuss send, receive, blocking communication semantics, type matching requirements, type conversion in heterogeneous environments, and more general communication modes. Nonblocking communication is addressed next, followed by probing and canceling a message, channel-like constructs and send-receive operations, ending with a description of the “dummy” process, `MPI_PROC_NULL`.

## 3.2 Blocking Send and Receive Operations

### 3.2.1 Blocking Send

The syntax of the blocking send operation is given below.

```
MPI_SEND(buf, count, datatype, dest, tag, comm)
```

IN	<code>buf</code>	initial address of send buffer (choice)
IN	<code>count</code>	number of elements in send buffer (non-negative integer)
IN	<code>datatype</code>	datatype of each send buffer element (handle)
IN	<code>dest</code>	rank of destination (integer)
IN	<code>tag</code>	message tag (integer)
IN	<code>comm</code>	communicator (handle)

#### C binding

```
int MPI_Send(const void *buf, int count, MPI_Datatype datatype, int dest,
            int tag, MPI_Comm comm)
```

```
int MPI_Send_c(const void *buf, MPI_Count count, MPI_Datatype datatype,
              int dest, int tag, MPI_Comm comm)
```

#### Fortran 2008 binding

```
MPI_Send(buf, count, datatype, dest, tag, comm, ierror)
```

```
TYPE(*), DIMENSION(..), INTENT(IN) :: buf
```

```
INTEGER, INTENT(IN) :: count, dest, tag
```

```
TYPE(MPI_Datatype), INTENT(IN) :: datatype
```

```

TYPE(MPI_Comm), INTENT(IN) :: comm
INTEGER, OPTIONAL, INTENT(OUT) :: ierror
MPI_Send(buf, count, datatype, dest, tag, comm, ierror)
TYPE(*), DIMENSION(..), INTENT(IN) :: buf
INTEGER(KIND=MPI_COUNT_KIND), INTENT(IN) :: count
TYPE(MPI_Datatype), INTENT(IN) :: datatype
INTEGER, INTENT(IN) :: dest, tag
TYPE(MPI_Comm), INTENT(IN) :: comm
INTEGER, OPTIONAL, INTENT(OUT) :: ierror

```

**Fortran binding**

```

MPI_SEND(BUF, COUNT, DATATYPE, DEST, TAG, COMM, IERROR)
<type> BUF(*)
INTEGER COUNT, DATATYPE, DEST, TAG, COMM, IERROR

```

The blocking semantics of this call are described in Section 3.4.

**3.2.2 Message Data**

The send buffer specified by the MPI\_SEND operation consists of `count` successive entries of the type indicated by `datatype`, starting with the entry at address `buf`. Note that we specify the message length in terms of number of *elements*, not number of *bytes*. The former is machine independent and closer to the application level.

The data part of the message consists of a sequence of `count` values, each of the type indicated by `datatype`. `count` may be zero, in which case the data part of the message is empty. The basic datatypes that can be specified for message data values correspond to the basic datatypes of the host language. Possible values of this argument for Fortran and the corresponding Fortran types are listed in Table 3.1.

MPI datatype	Fortran datatype
MPI_INTEGER	INTEGER
MPI_REAL	REAL
MPI_DOUBLE_PRECISION	DOUBLE PRECISION
MPI_COMPLEX	COMPLEX
MPI_LOGICAL	LOGICAL
MPI_CHARACTER	CHARACTER(1)
MPI_BYTE	
MPI_PACKED	

Table 3.1: Predefined MPI datatypes corresponding to Fortran datatypes

Possible values for this argument for C and the corresponding C types are listed in Table 3.2.

The datatypes MPI\_BYTE and MPI\_PACKED do not correspond to a Fortran or C datatype. A value of type MPI\_BYTE consists of a byte (8 binary digits). A byte is uninterpreted and is different from a character. Different machines may have different representations for characters, or may use more than one byte to represent characters. On

MPI datatype	C datatype
MPI_CHAR	char (treated as printable character)
MPI_SHORT	signed short int
MPI_INT	signed int
MPI_LONG	signed long int
MPI_LONG_LONG_INT	signed long long int
MPI_LONG_LONG (as a synonym)	signed long long int
MPI_SIGNED_CHAR	signed char (treated as integral value)
MPI_UNSIGNED_CHAR	unsigned char (treated as integral value)
MPI_UNSIGNED_SHORT	unsigned short int
MPI_UNSIGNED	unsigned int
MPI_UNSIGNED_LONG	unsigned long int
MPI_UNSIGNED_LONG_LONG	unsigned long long int
MPI_FLOAT	float
MPI_DOUBLE	double
MPI_LONG_DOUBLE	long double
MPI_WCHAR	wchar_t (defined in <stddef.h> (treated as printable character)
MPI_C_BOOL	_Bool
MPI_INT8_T	int8_t
MPI_INT16_T	int16_t
MPI_INT32_T	int32_t
MPI_INT64_T	int64_t
MPI_UINT8_T	uint8_t
MPI_UINT16_T	uint16_t
MPI_UINT32_T	uint32_t
MPI_UINT64_T	uint64_t
MPI_C_COMPLEX	float _Complex
MPI_C_FLOAT_COMPLEX (as a synonym)	float _Complex
MPI_C_DOUBLE_COMPLEX	double _Complex
MPI_C_LONG_DOUBLE_COMPLEX	long double _Complex
MPI_BYTE	
MPI_PACKED	

Table 3.2: Predefined MPI datatypes corresponding to C datatypes

the other hand, a byte has the same binary value on all machines. The use of the type MPI\_PACKED is explained in Section 5.2.

MPI requires support of these datatypes, which match the basic datatypes of Fortran and ISO C. Additional MPI datatypes should be provided if the host language has additional datatypes<sup>1</sup>: MPI\_DOUBLE\_COMPLEX for double precision complex in Fortran declared to

<sup>1</sup>These types, such as DOUBLE COMPLEX and INTEGER\*4, are not specified by any Fortran standard

MPI datatype	C datatype	Fortran datatype
MPI_AINT	MPI_Aint	INTEGER (KIND=MPI_ADDRESS_KIND)
MPI_OFFSET	MPI_Offset	INTEGER (KIND=MPI_OFFSET_KIND)
MPI_COUNT	MPI_Count	INTEGER (KIND=MPI_COUNT_KIND)

Table 3.3: Predefined MPI datatypes corresponding to both C and Fortran datatypes

be of type `DOUBLE COMPLEX`; `MPI_REAL2`, `MPI_REAL4`, `MPI_REAL8`, and `MPI_REAL16` for Fortran reals, declared to be of type `REAL*2`, `REAL*4`, `REAL*8`, and `REAL*16`, respectively; `MPI_INTEGER1`, `MPI_INTEGER2`, `MPI_INTEGER4`, and `MPI_INTEGER8` for Fortran integers, declared to be of type `INTEGER*1`, `INTEGER*2`, `INTEGER*4`, and `INTEGER*8`, respectively; `MPI_COMPLEX4`, `MPI_COMPLEX8`, `MPI_COMPLEX16`, and `MPI_COMPLEX32` for complex numbers in Fortran declared to be of type `COMPLEX*4`, `COMPLEX*8`, `COMPLEX*16`, and `COMPLEX*32`, respectively; etc.

*Rationale.* One goal of the design is to allow for MPI to be implemented as a library, with no need for additional preprocessing or compilation. Thus, one cannot assume that a communication call has information on the datatype of variables in the communication buffer; this information must be supplied by an explicit argument. The need for such datatype information will become clear in Section 3.3.2. (*End of rationale.*)

The datatypes `MPI_AINT`, `MPI_OFFSET`, and `MPI_COUNT` correspond to the MPI-defined C types `MPI_Aint`, `MPI_Offset`, and `MPI_Count` and their Fortran equivalents `INTEGER (KIND=MPI_ADDRESS_KIND)`, `INTEGER (KIND=MPI_OFFSET_KIND)`, and `INTEGER (KIND=MPI_COUNT_KIND)`. This is described in Table 3.3. All predefined datatype handles are available in all language bindings. See Sections 19.3.6 and 19.3.10 on page 838 and 846 for information on interlanguage communication with these types.

If there is an accompanying C++ compiler then the datatypes in Table 3.4 are also supported in C and Fortran.

MPI datatype	C++ datatype
<code>MPI_CXX_BOOL</code>	<code>bool</code>
<code>MPI_CXX_FLOAT_COMPLEX</code>	<code>std::complex&lt;float&gt;</code>
<code>MPI_CXX_DOUBLE_COMPLEX</code>	<code>std::complex&lt;double&gt;</code>
<code>MPI_CXX_LONG_DOUBLE_COMPLEX</code>	<code>std::complex&lt;long double&gt;</code>

Table 3.4: Predefined MPI datatypes corresponding to C++ datatypes

### 3.2.3 Message Envelope

In addition to the data part, messages carry information that can be used to distinguish messages and selectively receive them. This information consists of a fixed number of fields, which we collectively call the **message envelope**. These fields are

but are extensions commonly accepted by Fortran compilers.

```

1           source
2           destination
3           tag
4           communicator
5

```

The message source is implicitly determined by the identity of the message sender. The other fields are specified by arguments in the send operation.

The message destination is specified by the `dest` argument.

The integer-valued message tag is specified by the `tag` argument. This integer can be used by the program to distinguish different types of messages. The range of valid tag values is  $0, \dots, \text{UB}$ , where the value of `UB` is implementation dependent. It can be found by querying the value of the attribute `MPI_TAG_UB`, as described in Chapter 9. MPI requires that `UB` be no less than 32767.

The `comm` argument specifies the **communicator** that is used for the send operation. Communicators are explained in Chapter 7; below is a brief summary of their usage.

A communicator specifies the communication context for a communication operation. Each communication context provides a separate “communication universe”: messages are always received within the context they were sent, and messages sent in different contexts do not interfere.

The communicator also specifies the set of processes that share this communication context. This **process group** is ordered and processes are identified by their rank within this group. Thus, the range of valid values for `dest` is  $0, \dots, n-1 \cup \{\text{MPI\_PROC\_NULL}\}$ , where  $n$  is the number of processes in the group. (If the communicator is an inter-communicator, then destinations are identified by their rank in the remote group. See Chapter 7.)

When using the World Model (see Section 11.1), a predefined communicator `MPI_COMM_WORLD` is provided by MPI. It allows communication with all processes that are accessible after MPI initialization and processes are identified by their rank in the group of `MPI_COMM_WORLD`.

*Advice to users.* Users that are comfortable with the notion of a flat name space for processes, and a single communication context, as offered by most existing communication libraries, need only use the World Model for MPI initialization, and the predefined variable `MPI_COMM_WORLD` as the `comm` argument. This will allow communication with all the processes available at initialization time.

Users may define new communicators, as explained in Chapter 7. Communicators provide an important encapsulation mechanism for libraries and modules. They allow modules to have their own disjoint communication universe and their own process numbering scheme. (*End of advice to users.*)

*Advice to implementors.* The message envelope would normally be encoded by a fixed-length message header. However, the actual encoding is implementation dependent. Some of the information (e.g., source or destination) may be implicit, and need not be explicitly carried by messages. Also, processes may be identified by relative ranks, or absolute ids, etc. (*End of advice to implementors.*)

### 3.2.4 Blocking Receive

The syntax of the blocking receive operation is given below.



MPI_RECV(buf, count, datatype, source, tag, comm, status)			1
OUT	buf	initial address of receive buffer (choice)	2
			3
IN	count	number of elements in receive buffer (non-negative integer)	4
			5
IN	datatype	datatype of each receive buffer element (handle)	6
			7
IN	source	rank of source or MPI_ANY_SOURCE (integer)	8
			9
IN	tag	message tag or MPI_ANY_TAG (integer)	9
			10
IN	comm	communicator (handle)	10
			11
OUT	status	status object (status)	11
			12

**C binding**

```

int MPI_Recv(void *buf, int count, MPI_Datatype datatype, int source,
             int tag, MPI_Comm comm, MPI_Status *status)
int MPI_Recv_c(void *buf, MPI_Count count, MPI_Datatype datatype,
              int source, int tag, MPI_Comm comm, MPI_Status *status)

```

**Fortran 2008 binding**

```

MPI_Recv(buf, count, datatype, source, tag, comm, status, ierror)
  TYPE(*), DIMENSION(..) :: buf
  INTEGER, INTENT(IN) :: count, source, tag
  TYPE(MPI_Datatype), INTENT(IN) :: datatype
  TYPE(MPI_Comm), INTENT(IN) :: comm
  TYPE(MPI_Status) :: status
  INTEGER, OPTIONAL, INTENT(OUT) :: ierror
MPI_Recv(buf, count, datatype, source, tag, comm, status, ierror)
  TYPE(*), DIMENSION(..) :: buf
  INTEGER(KIND=MPI_COUNT_KIND), INTENT(IN) :: count
  TYPE(MPI_Datatype), INTENT(IN) :: datatype
  INTEGER, INTENT(IN) :: source, tag
  TYPE(MPI_Comm), INTENT(IN) :: comm
  TYPE(MPI_Status) :: status
  INTEGER, OPTIONAL, INTENT(OUT) :: ierror

```

**Fortran binding**

```

MPI_RECV(BUF, COUNT, DATATYPE, SOURCE, TAG, COMM, STATUS, IERROR)
  <type> BUF(*)
  INTEGER COUNT, DATATYPE, SOURCE, TAG, COMM, STATUS(MPI_STATUS_SIZE),
  IERROR

```

The blocking semantics of this call are described in Section 3.4.

The receive buffer consists of the storage containing `count` consecutive elements of the type specified by `datatype`, starting at address `buf`. The length of the received message must be less than or equal to the length of the receive buffer. An overflow error occurs if all incoming data does not fit, without truncation, into the receive buffer.

If a message that is shorter than the receive buffer arrives, then only those locations corresponding to the (shorter) message are modified.

1 *Advice to users.* The MPI\_PROBE function described in Section 3.8 can be used to  
2 receive messages of unknown length. (*End of advice to users.*)

3  
4 *Advice to implementors.* Even though no specific behavior is mandated by MPI for  
5 erroneous programs, the recommended handling of overflow situations is to return in  
6 status information about the source and tag of the incoming message. The receive  
7 operation will return an error code. A quality implementation will also ensure that  
8 no memory that is outside the receive buffer will ever be overwritten.

9 In the case of a message shorter than the receive buffer, MPI is quite strict in that it  
10 allows no modification of the other locations. A more lenient statement would allow  
11 for some optimizations but this is not allowed. The implementation must be ready to  
12 end a copy into the receiver memory exactly at the end of the receive buffer, even if  
13 it is an odd address. (*End of advice to implementors.*)

14 The selection of a message by a receive operation is governed by the value of the  
15 message envelope. A message can be received by a receive operation if its envelope matches  
16 the source, tag and comm values specified by the receive operation. The receiver may specify  
17 a wildcard MPI\_ANY\_SOURCE value for source, and/or a wildcard MPI\_ANY\_TAG value for  
18 tag, indicating that any source and/or tag are acceptable. It cannot specify a wildcard value  
19 for comm. Thus, a message can be received by a receive operation only if it is addressed  
20 to the receiving process, has a matching communicator, has matching source unless source  
21 = MPI\_ANY\_SOURCE in the pattern, and has a matching tag unless tag = MPI\_ANY\_TAG in  
22 the pattern.

23 The message tag is specified by the tag argument of the receive operation. The  
24 argument source, if different from MPI\_ANY\_SOURCE, is specified as a rank within the  
25 process group associated with that same communicator (remote process group, for inter-  
26 communicators). Thus, the range of valid values for the source argument is  $\{0, \dots, n - 1\} \cup$   
27  $\{\text{MPI\_ANY\_SOURCE}\} \cup \{\text{MPI\_PROC\_NULL}\}$ , where  $n$  is the number of processes in this group.

28 Note the asymmetry between send and receive operations: A receive operation may  
29 accept messages from an arbitrary sender, on the other hand, a send operation must specify  
30 a unique receiver. This matches a “push” communication mechanism, where data transfer  
31 is effected by the sender (rather than a “pull” mechanism, where data transfer is effected  
32 by the receiver).

33 Source = destination is allowed, that is, a process can send a message to itself. However,  
34 it is unsafe to do so with the blocking send and receive operations described above, since  
35 this may lead to deadlock. See Section 3.5.

36  
37 *Advice to implementors.* Message context and other communicator information can  
38 be implemented as an additional tag field. It differs from the regular message tag  
39 in that wild card matching is not allowed on this field, and that value setting for  
40 this field is controlled by communicator manipulation functions. (*End of advice to*  
41 *implementors.*)

42 The use of dest = MPI\_PROC\_NULL or source = MPI\_PROC\_NULL to define a “dummy”  
43 destination or source in any send or receive call is described in Section 3.10.

### 44 3.2.5 Return Status

45  
46 The source or tag of a received message may not be known if wildcard values were used  
47 in the receive operation. Also, if multiple requests are completed by a single MPI function  
48

(see Section 3.7.5), a distinct error code may need to be returned for each request. The information is returned by the `status` argument of `MPI_RECV`. The type of `status` is MPI-defined. Status variables need to be explicitly allocated by the user, that is, they are not system objects.

In C, `status` is a structure that contains three fields named `MPI_SOURCE`, `MPI_TAG`, and `MPI_ERROR`; the structure may contain additional fields. Thus, `status.MPI_SOURCE`, `status.MPI_TAG`, and `status.MPI_ERROR` contain the source, tag, and error code, respectively, of the received message.

In Fortran with `USE mpi` or `INCLUDE 'mpif.h'`, `status` is an array of `INTEGER`s of size `MPI_STATUS_SIZE`. The constants `MPI_SOURCE`, `MPI_TAG`, and `MPI_ERROR` are the indices of the entries that store the source, tag, and error fields. Thus, `status(MPI_SOURCE)`, `status(MPI_TAG)`, and `status(MPI_ERROR)` contain, respectively, the source, tag, and error code of the received message.

With Fortran `USE mpi_f08`, `status` is defined as the Fortran `BIND(C)` derived type `TYPE(MPI_Status)` containing three public `INTEGER` fields named `MPI_SOURCE`, `MPI_TAG`, and `MPI_ERROR`. `TYPE(MPI_Status)` may contain additional, implementation-specific fields. Thus, `status%MPI_SOURCE`, `status%MPI_TAG`, and `status%MPI_ERROR` contain the source, tag, and error code of a received message respectively. Additionally, within both the `mpi` and the `mpi_f08` modules, the constants `MPI_STATUS_SIZE`, `MPI_SOURCE`, `MPI_TAG`, `MPI_ERROR`, and `TYPE(MPI_Status)` are defined to allow conversion between both `status` representations. Conversion routines are provided in Section 19.3.5.

*Rationale.* The Fortran `TYPE(MPI_Status)` is defined as a `BIND(C)` derived type so that it can be used at any location where the `status` integer array representation can be used, e.g., in user defined common blocks. (*End of rationale.*)

*Rationale.* It is allowed to have the same name (e.g., `MPI_SOURCE`) defined as a constant (e.g., Fortran parameter) and as a field of a derived type. (*End of rationale.*)

In general, message-passing calls do not modify the value of the error code field of `status` variables. This field may be updated only by the functions in Section 3.7.5 which return multiple statuses. The field is updated if and only if such function returns with an error code of `MPI_ERR_IN_STATUS`.

*Rationale.* The error field in `status` is not needed for calls that return only one status, such as `MPI_WAIT`, since that would only duplicate the information returned by the function itself. The current design avoids the additional overhead of setting it, in such cases. The field is needed for calls that return multiple statuses, since each request may have had a different failure. (*End of rationale.*)

The `status` argument also returns information on the length of the message received. However, this information is not directly available as a field of the `status` variable and a call to `MPI_GET_COUNT` is required to “decode” this information.

1 MPI\_GET\_COUNT(status, datatype, count)

2     IN        status                    return status of receive operation (status)  
 3  
 4     IN        datatype                 datatype of each receive buffer entry (handle)  
 5  
 6     OUT       count                    number of received entries (integer)

### 7 C binding

8 int MPI\_Get\_count(const MPI\_Status \*status, MPI\_Datatype datatype,  
 9                   int \*count)

10  
 11 int MPI\_Get\_count\_c(const MPI\_Status \*status, MPI\_Datatype datatype,  
 12                   MPI\_Count \*count)

### 13 Fortran 2008 binding

14 MPI\_Get\_count(status, datatype, count, ierror)  
 15     TYPE(MPI\_Status), INTENT(IN) :: status  
 16     TYPE(MPI\_Datatype), INTENT(IN) :: datatype  
 17     INTEGER, INTENT(OUT) :: count  
 18     INTEGER, OPTIONAL, INTENT(OUT) :: ierror

19  
 20 MPI\_Get\_count(status, datatype, count, ierror)  
 21     TYPE(MPI\_Status), INTENT(IN) :: status  
 22     TYPE(MPI\_Datatype), INTENT(IN) :: datatype  
 23     INTEGER(KIND=MPI\_COUNT\_KIND), INTENT(OUT) :: count  
 24     INTEGER, OPTIONAL, INTENT(OUT) :: ierror

### 25 Fortran binding

26 MPI\_GET\_COUNT(STATUS, DATATYPE, COUNT, IERROR)  
 27     INTEGER STATUS(MPI\_STATUS\_SIZE), DATATYPE, COUNT, IERROR

28  
 29 Returns the number of entries received. (Again, we count *entries*, each of type *datatype*,  
 30 not *bytes*.) The *datatype* argument should match the argument provided by the receive call  
 31 that set the *status* variable. If the number of entries received exceeds the limits of the *count*  
 32 parameter, then MPI\_GET\_COUNT sets the value of *count* to MPI\_UNDEFINED. There are  
 33 other situations where the value of *count* can be set to MPI\_UNDEFINED; see Section 5.1.11.

34  
 35 *Rationale.* Some message-passing libraries use INOUT *count*, *tag* and *source* argu-  
 36 ments, thus using them both to specify the selection criteria for incoming messages  
 37 and return the actual envelope values of the received message. The use of a separate  
 38 status argument prevents errors that are often attached with INOUT argument (e.g.,  
 39 using the MPI\_ANY\_TAG constant as the tag in a receive). Some libraries use calls  
 40 that refer implicitly to the “last message received.” This is not thread safe.

41 The *datatype* argument is passed to MPI\_GET\_COUNT so as to improve performance.  
 42 A message might be received without counting the number of elements it contains,  
 43 and the *count* value is often not needed. Also, this allows the same function to be  
 44 used after a call to MPI\_PROBE or MPI\_Iprobe. With a status from MPI\_PROBE  
 45 or MPI\_Iprobe, the same datatypes are allowed as in a call to MPI\_RECV to receive  
 46 this message. (*End of rationale.*)

The value returned as the `count` argument of `MPI_GET_COUNT` for a datatype of length zero where zero bytes have been transferred is zero. If the number of bytes transferred is greater than zero, `MPI_UNDEFINED` is returned.

*Rationale.* Zero-length datatypes may be created in a number of cases. An important case is `MPI_TYPE_CREATE_DARRAY`, where the definition of the particular darray results in an empty block on some MPI process. Programs written in an SPMD style will not check for this special case and may want to use `MPI_GET_COUNT` to check the status. (*End of rationale.*)

*Advice to users.* The buffer size required for the receive can be affected by data conversions and by the stride of the receive datatype. In most cases, the safest approach is to use the same datatype with `MPI_GET_COUNT` and the receive. (*End of advice to users.*)

All send and receive operations use the `buf`, `count`, `datatype`, `source`, `dest`, `tag`, `comm`, and `status` arguments in the same way as the blocking `MPI_SEND` and `MPI_RECV` operations described in this section.

### 3.2.6 Passing `MPI_STATUS_IGNORE` for Status

Every call to `MPI_RECV` includes a `status` argument, wherein the system can return details about the message received. There are also a number of other MPI calls where `status` is returned. An object of type `MPI_Status` is not an MPI opaque object; its structure is declared in `mpi.h` and `mpif.h`, and it exists in the user's program. In many cases, application programs are constructed so that it is unnecessary for them to examine the `status` fields. In these cases, it is a waste for the user to allocate a status object, and it is particularly wasteful for the MPI implementation to fill in fields in this object.

To cope with this problem, there are two predefined constants, `MPI_STATUS_IGNORE` and `MPI_STATUSES_IGNORE`, which when passed to a receive, probe, wait, or test function, inform the implementation that the status fields are not to be filled in. Note that `MPI_STATUS_IGNORE` is not a special type of `MPI_Status` object; rather, it is a special value for the argument. In C one would expect it to be `NULL`, not the address of a special `MPI_Status`.

`MPI_STATUS_IGNORE`, and the array version `MPI_STATUSES_IGNORE`, can be used everywhere a status argument is passed to a receive, wait, or test function. `MPI_STATUS_IGNORE` cannot be used when status is an IN argument. Note that in Fortran `MPI_STATUS_IGNORE` and `MPI_STATUSES_IGNORE` are objects like `MPI_BOTTOM` (not usable for initialization or assignment). See Section 2.5.4.

In general, this optimization can apply to all functions for which `status` or an array of statuses is an OUT argument. Note that this converts `status` into an INOUT argument. The functions that can be passed `MPI_STATUS_IGNORE` are all the various forms of `MPI_RECV`, `MPI_PROBE`, `MPI_TEST`, and `MPI_WAIT`, as well as `MPI_REQUEST_GET_STATUS`. When an array is passed, as in the `MPI_{TEST|WAIT}{ALL|SOME}` functions, a separate constant, `MPI_STATUSES_IGNORE`, is passed for the array argument. It is possible for an MPI function to return `MPI_ERR_IN_STATUS` even when `MPI_STATUS_IGNORE` or `MPI_STATUSES_IGNORE` has been passed to that function.

`MPI_STATUS_IGNORE` and `MPI_STATUSES_IGNORE` are not required to have the same values in C and Fortran.

1 It is not allowed to have some of the statuses in an array of statuses for  
 2 `MPI_{TEST|WAIT}{ALL|SOME}` functions set to `MPI_STATUS_IGNORE`; one either specifies  
 3 ignoring *all* of the statuses in such a call with `MPI_STATUSES_IGNORE`, or *none* of them by  
 4 passing normal statuses in all positions in the array of statuses.

### 6 3.2.7 Send-Receive

7 The **send-receive** operations combine in one call the sending of a message to one desti-  
 8 nation and the receiving of another message, from another process. The two (source and  
 9 destination) are possibly the same. A send-receive operation is very useful for executing  
 10 a shift operation across a chain of processes. If blocking sends and receives are used for  
 11 such a shift, then one needs to order the sends and receives correctly (for example, even  
 12 processes send, then receive, odd processes receive first, then send) so as to prevent cyclic  
 13 dependencies that may lead to deadlock. When a send-receive operation is used, the com-  
 14 munication subsystem takes care of these issues. The send-receive operation can be used  
 15 in conjunction with the functions described in Chapter 8 in order to perform shifts on var-  
 16 ious logical topologies. Also, a send-receive operation is useful for implementing remote  
 17 procedure calls.

18 A message sent by a send-receive operation can be received by a regular receive oper-  
 19 ation or probed by a probe operation; a send-receive operation can receive a message sent  
 20 by a regular send operation.

21  
 22  
 23 `MPI_SENDRECV`(`sendbuf`, `sendcount`, `sendtype`, `dest`, `sendtag`, `recvbuf`, `recvcount`, `recvtype`,  
 24 `source`, `recvtag`, `comm`, `status`)

25			
26	IN	<code>sendbuf</code>	initial address of send buffer (choice)
27	IN	<code>sendcount</code>	number of elements in send buffer (non-negative integer)
28			
29	IN	<code>sendtype</code>	type of elements in send buffer (handle)
30			
31	IN	<code>dest</code>	rank of destination (integer)
32	IN	<code>sendtag</code>	send tag (integer)
33	OUT	<code>recvbuf</code>	initial address of receive buffer (choice)
34	IN	<code>recvcount</code>	number of elements in receive buffer (non-negative integer)
35			
36	IN	<code>recvtype</code>	type of elements receive buffer element (handle)
37	IN	<code>source</code>	rank of source or <code>MPI_ANY_SOURCE</code> (integer)
38	IN	<code>recvtag</code>	receive tag or <code>MPI_ANY_TAG</code> (integer)
39	IN	<code>comm</code>	communicator (handle)
40	OUT	<code>status</code>	status object (status)
41			
42			
43			

#### 44 C binding

45 `int MPI_Sendrecv`(`const void *sendbuf`, `int sendcount`, `MPI_Datatype sendtype`,  
 46 `int dest`, `int sendtag`, `void *recvbuf`, `int recvcount`,  
 47  
 48

```

        MPI_Datatype recvtype, int source, int recvtag, MPI_Comm comm,
        MPI_Status *status)
int MPI_Sendrecv(const void *sendbuf, MPI_Count sendcount,
        MPI_Datatype sendtype, int dest, int sendtag, void *recvbuf,
        MPI_Count recvcount, MPI_Datatype recvtype, int source,
        int recvtag, MPI_Comm comm, MPI_Status *status)

```

**Fortran 2008 binding**

```

MPI_Sendrecv(sendbuf, sendcount, sendtype, dest, sendtag, recvbuf,
        recvcount, recvtype, source, recvtag, comm, status, ierror)
TYPE(*), DIMENSION(..), INTENT(IN) :: sendbuf
INTEGER, INTENT(IN) :: sendcount, dest, sendtag, recvcount, source,
        recvtag
TYPE(MPI_Datatype), INTENT(IN) :: sendtype, recvtype
TYPE(*), DIMENSION(..) :: recvbuf
TYPE(MPI_Comm), INTENT(IN) :: comm
TYPE(MPI_Status) :: status
INTEGER, OPTIONAL, INTENT(OUT) :: ierror

```

```

MPI_Sendrecv(sendbuf, sendcount, sendtype, dest, sendtag, recvbuf,
        recvcount, recvtype, source, recvtag, comm, status, ierror)
TYPE(*), DIMENSION(..), INTENT(IN) :: sendbuf
INTEGER(KIND=MPI_COUNT_KIND), INTENT(IN) :: sendcount, recvcount
TYPE(MPI_Datatype), INTENT(IN) :: sendtype, recvtype
INTEGER, INTENT(IN) :: dest, sendtag, source, recvtag
TYPE(*), DIMENSION(..) :: recvbuf
TYPE(MPI_Comm), INTENT(IN) :: comm
TYPE(MPI_Status) :: status
INTEGER, OPTIONAL, INTENT(OUT) :: ierror

```

**Fortran binding**

```

MPI_SENDRECV(SENDBUF, SENDCOUNT, SENDTYPE, DEST, SENDTAG, RECVBUF,
        RECVCOUNT, RECVTYPE, SOURCE, RECVTAG, COMM, STATUS, IERROR)
<type> SENDBUF(*), RECVBUF(*)
INTEGER SENDCOUNT, SENDTYPE, DEST, SENDTAG, RECVCOUNT, RECVTYPE,
        SOURCE, RECVTAG, COMM, STATUS(MPI_STATUS_SIZE), IERROR

```

Execute a blocking send and receive operation. Both send and receive use the same communicator, but possibly different tags. The send buffer and receive buffers must be disjoint, and may have different lengths and datatypes.

The semantics of a send-receive operation is what would be obtained if the caller forked two concurrent threads, one to execute the send, and one to execute the receive, followed by a join of these two threads.



```

1 MPI_SENDRECV_REPLACE(buf, count, datatype, dest, sendtag, source, recvtag, comm,
2     status)
3
4     INOUT   buf           initial address of send and receive buffer (choice)
5
6     IN      count        number of elements in send and receive buffer
7                             (non-negative integer)
8
9     IN      datatype     type of elements in send and receive buffer (handle)
10
11     IN      dest         rank of destination (integer)
12
13     IN      sendtag      send message tag (integer)
14
15     IN      source       rank of source or MPI_ANY_SOURCE (integer)
16
17     IN      recvtag      receive message tag or MPI_ANY_TAG (integer)
18
19     IN      comm         communicator (handle)
20
21     OUT     status       status object (status)

```

**C binding**

```

18 int MPI_Sendrecv_replace(void *buf, int count, MPI_Datatype datatype,
19     int dest, int sendtag, int source, int recvtag, MPI_Comm comm,
20     MPI_Status *status)
21
22 int MPI_Sendrecv_replace_c(void *buf, MPI_Count count,
23     MPI_Datatype datatype, int dest, int sendtag, int source,
24     int recvtag, MPI_Comm comm, MPI_Status *status)

```

**Fortran 2008 binding**

```

26 MPI_Sendrecv_replace(buf, count, datatype, dest, sendtag, source, recvtag,
27     comm, status, ierror)
28     TYPE(*), DIMENSION(..) :: buf
29     INTEGER, INTENT(IN) :: count, dest, sendtag, source, recvtag
30     TYPE(MPI_Datatype), INTENT(IN) :: datatype
31     TYPE(MPI_Comm), INTENT(IN) :: comm
32     TYPE(MPI_Status) :: status
33     INTEGER, OPTIONAL, INTENT(OUT) :: ierror
34
35 MPI_Sendrecv_replace(buf, count, datatype, dest, sendtag, source, recvtag,
36     comm, status, ierror)
37     TYPE(*), DIMENSION(..) :: buf
38     INTEGER(KIND=MPI_COUNT_KIND), INTENT(IN) :: count
39     TYPE(MPI_Datatype), INTENT(IN) :: datatype
40     INTEGER, INTENT(IN) :: dest, sendtag, source, recvtag
41     TYPE(MPI_Comm), INTENT(IN) :: comm
42     TYPE(MPI_Status) :: status
43     INTEGER, OPTIONAL, INTENT(OUT) :: ierror

```

**Fortran binding**

```

45 MPI_SENDRECV_REPLACE(BUF, COUNT, DATATYPE, DEST, SENDTAG, SOURCE, RECVTAG,
46     COMM, STATUS, IERROR)
47     <type> BUF(*)
48

```



```

INTEGER COUNT, DATATYPE, DEST, SENDTAG, SOURCE, RECVTAG, COMM,
STATUS(MPI_STATUS_SIZE), IERROR

```

Execute a blocking send and receive. The same buffer is used both for the send and for the receive, so that the message sent is replaced by the message received.

*Advice to implementors.* Additional intermediate buffering is needed for the “replace” variant. (*End of advice to implementors.*)

### 3.3 Datatype Matching and Data Conversion

#### 3.3.1 Type Matching Rules

One can think of message transfer as consisting of the following three phases.

1. Data is pulled out of the send buffer and a message is assembled.
2. A message is transferred from sender to receiver.
3. Data is pulled from the incoming message and disassembled into the receive buffer.

Type matching has to be observed at each of these three phases: The type of each variable in the sender buffer has to match the type specified for that entry by the send operation; the type specified by the send operation has to match the type specified by the receive operation; and the type of each variable in the receive buffer has to match the type specified for that entry by the receive operation. A program that fails to observe these three rules is erroneous.

To define type matching more precisely, we need to deal with two issues: matching of types of the host language with types specified in communication operations; and matching of types at sender and receiver.

The types of a send and receive match (phase two) if both operations use identical names. That is, MPI\_INTEGER matches MPI\_INTEGER, MPI\_REAL matches MPI\_REAL, and so on. There is one exception to this rule, discussed in Section 5.2: the type MPI\_PACKED can match any other type.

The type of a variable in a host program matches the type specified in the communication operation if the datatype name used by that operation corresponds to the basic type of the host program variable. For example, an entry with type name MPI\_INTEGER matches a Fortran variable of type INTEGER. A table giving this correspondence for Fortran and C appears in Section 3.2.2. There are two exceptions to this last rule: an entry with type name MPI\_BYTE or MPI\_PACKED can be used to match any byte of storage (on a byte-addressable machine), irrespective of the datatype of the variable that contains this byte. The type MPI\_PACKED is used to send data that has been explicitly packed, or receive data that will be explicitly unpacked, see Section 5.2. The type MPI\_BYTE allows one to transfer the binary value of a byte in memory unchanged.

To summarize, the type matching rules fall into the three categories below.

- Communication of typed values (e.g., with datatype different from MPI\_BYTE), where the datatypes of the corresponding entries in the sender program, in the send call, in the receive call and in the receiver program must all match.

- 1 • Communication of untyped values (e.g., of datatype MPI\_BYTE), where both sender  
2 and receiver use the datatype MPI\_BYTE. In this case, there are no requirements on  
3 the types of the corresponding entries in the sender and the receiver programs, nor is  
4 it required that they be the same.
- 5 • Communication involving packed data, where MPI\_PACKED is used.

7 The following examples illustrate the first two cases.  
8

9 **Example 3.2** Sender and receiver specify matching types.

```
10 CALL MPI_COMM_RANK(comm, rank, ierr)
11 IF (rank .EQ. 0) THEN
12     CALL MPI_SEND(a(1), 10, MPI_REAL, 1, tag, comm, ierr)
13 ELSE IF (rank .EQ. 1) THEN
14     CALL MPI_RECV(b(1), 15, MPI_REAL, 0, tag, comm, status, ierr)
15 END IF
16
```

17 This code is correct if both **a** and **b** are real arrays of size  $\geq 10$ . (In Fortran, it might be  
18 correct to use this code even if **a** or **b** have size  $< 10$ : e.g., when **a**(1) can be equivalenced  
19 to an array with ten reals.)  
20

21 **Example 3.3** Sender and receiver do not specify matching types.

```
22
23 /* ----- THIS EXAMPLE IS ERRONEOUS ----- */
24 CALL MPI_COMM_RANK(comm, rank, ierr)
25 IF (rank .EQ. 0) THEN
26     CALL MPI_SEND(a(1), 10, MPI_REAL, 1, tag, comm, ierr)
27 ELSE IF (rank .EQ. 1) THEN
28     CALL MPI_RECV(b(1), 40, MPI_BYTE, 0, tag, comm, status, ierr)
29 END IF
30
```

31 This code is erroneous, since sender and receiver do not provide matching datatype  
32 arguments.  
33

34 **Example 3.4** Sender and receiver specify communication of untyped values.

```
35 CALL MPI_COMM_RANK(comm, rank, ierr)
36 IF (rank .EQ. 0) THEN
37     CALL MPI_SEND(a(1), 40, MPI_BYTE, 1, tag, comm, ierr)
38 ELSE IF (rank .EQ. 1) THEN
39     CALL MPI_RECV(b(1), 60, MPI_BYTE, 0, tag, comm, status, ierr)
40 END IF
41
```

42 This code is correct, irrespective of the type and size of **a** and **b** (unless this results in  
43 an out of bounds memory access).  
44

45 *Advice to users.* If a buffer of type MPI\_BYTE is passed as an argument to MPI\_SEND,  
46 then MPI will send the data stored at contiguous locations, starting from the address  
47 indicated by the **buf** argument. This may have unexpected results when the data  
48 layout is not as a casual user would expect it to be. For example, some Fortran

compilers implement variables of type `CHARACTER` as a structure that contains the character length and a pointer to the actual string. In such an environment, sending and receiving a Fortran `CHARACTER` variable using the `MPI_BYTE` type will not have the anticipated result of transferring the character string. For this reason, the user is advised to use typed communications whenever possible. (*End of advice to users.*)

#### Type `MPI_CHARACTER`

The type `MPI_CHARACTER` matches one character of a Fortran variable of type `CHARACTER`, rather than the entire character string stored in the variable. Fortran variables of type `CHARACTER` or substrings are transferred as if they were arrays of characters. This is illustrated in the example below.

#### Example 3.5 Transfer of Fortran `CHARACTER`s.

```
CHARACTER*10 a
CHARACTER*10 b

CALL MPI_COMM_RANK(comm, rank, ierr)
IF (rank .EQ. 0) THEN
  CALL MPI_SEND(a, 5, MPI_CHARACTER, 1, tag, comm, ierr)
ELSE IF (rank .EQ. 1) THEN
  CALL MPI_RECV(b(6:10), 5, MPI_CHARACTER, 0, tag, comm, status, ierr)
END IF
```

The last five characters of string `b` at process 1 are replaced by the first five characters of string `a` at process 0.

*Rationale.* The alternative choice would be for `MPI_CHARACTER` to match a character of arbitrary length. This runs into problems.

A Fortran character variable is a constant length string, with no special termination symbol. There is no fixed convention on how to represent characters, and how to store their length. Some compilers pass a character argument to a routine as a pair of arguments, one holding the address of the string and the other holding the length of string. Consider the case of an MPI communication call that is passed a communication buffer with type defined by a derived datatype (Section 5.1). If this communicator buffer contains variables of type `CHARACTER` then the information on their length will not be passed to the MPI routine.

This problem forces us to provide explicit information on character length with the MPI call. One could add a length parameter to the type `MPI_CHARACTER`, but this does not add much convenience and the same functionality can be achieved by defining a suitable derived datatype. (*End of rationale.*)

*Advice to implementors.* Some compilers pass Fortran `CHARACTER` arguments as a structure with a length and a pointer to the actual string. In such an environment, the MPI call needs to dereference the pointer in order to reach the string. (*End of advice to implementors.*)

### 3.3.2 Data Conversion

One of the goals of MPI is to support parallel computations across heterogeneous environments. Communication in a heterogeneous environment may require data conversions. We use the following terminology.

**type conversion** changes the datatype of a value, e.g., by rounding a `REAL` to an `INTEGER`.

**representation conversion** changes the binary representation of a value, e.g., from Hex floating point to IEEE floating point.

The type matching rules imply that MPI communication never entails type conversion. On the other hand, MPI requires that a representation conversion be performed when a typed value is transferred across environments that use different representations for the datatype of this value. MPI does not specify rules for representation conversion. Such conversion is expected to preserve integer, logical and character values, and to convert a floating point value to the nearest value that can be represented on the target system.

Overflow and underflow exceptions may occur during floating point conversions. Conversion of integers or characters may also lead to exceptions when a value that can be represented in one system cannot be represented in the other system. An exception occurring during representation conversion results in a failure of the communication. An error occurs either in the send operation, or the receive operation, or both.

If a value sent in a message is untyped (i.e., of type `MPI_BYTE`), then the binary representation of the byte stored at the receiver is identical to the binary representation of the byte loaded at the sender. This holds true, whether sender and receiver run in the same or in distinct environments. No representation conversion is required. (Note that representation conversion may occur when values of type `MPI_CHARACTER` or `MPI_CHAR` are transferred, for example, from an EBCDIC encoding to an ASCII encoding.)

No conversion need occur when an MPI program executes in a homogeneous system, where all processes run in the same environment.

Consider the three examples, 3.2–3.4. The first program is correct, assuming that `a` and `b` are `REAL` arrays of size  $\geq 10$ . If the sender and receiver execute in different environments, then the ten real values that are fetched from the send buffer will be converted to the representation for reals on the receiver site before they are stored in the receive buffer. While the number of real elements fetched from the send buffer equal the number of real elements stored in the receive buffer, the number of bytes stored need not equal the number of bytes loaded. For example, the sender may use a four byte representation and the receiver an eight byte representation for reals.

The second program is erroneous, and its behavior is undefined.

The third program is correct. The exact same sequence of forty bytes that were loaded from the send buffer will be stored in the receive buffer, even if sender and receiver run in a different environment. The message sent has exactly the same length (in bytes) and the same binary representation as the message received. If `a` and `b` are of different types, or if they are of the same type but different data representations are used, then the bits stored in the receive buffer may encode values that are different from the values they encoded in the send buffer.

Data representation conversion also applies to the envelope of a message: source, destination and tag are all integers that may need to be converted.

*Advice to implementors.* The current definition does not require messages to carry data type information. Both sender and receiver provide complete data type information. In a heterogeneous environment, one can either use a machine independent encoding such as XDR, or have the receiver convert from the sender representation to its own, or even have the sender do the conversion.

Additional type information might be added to messages in order to allow the system to detect mismatches between datatype at sender and receiver. This might be particularly useful in a slower but safer debug mode. (*End of advice to implementors.*)

MPI requires support for inter-language communication, e.g., if messages are sent using an MPI procedure from the MPI C language interface and received using an MPI procedure from one of the MPI Fortran language interfaces. The behavior is defined in Section 19.3.

### 3.4 Communication Modes

The send call described in Section 3.2.1 is **blocking**: it does not return until the message data and envelope have been safely stored away so that the sender is free to modify the send buffer. The message might be copied directly into the matching receive buffer, or it might be copied into a temporary system buffer.

Message buffering decouples the send and receive operations. A blocking send can complete as soon as the message was buffered, even if no matching receive has been executed by the receiver. On the other hand, message buffering can be expensive, as it entails additional memory-to-memory copying, and it requires the allocation of memory for buffering. MPI offers the choice of several communication modes that allow one to control the choice of the communication protocol.

The send call described in Section 3.2.1 uses the **standard** communication mode. In this mode, it is up to MPI to decide whether outgoing messages will be buffered. MPI may buffer outgoing messages. In such a case, the send call may complete before a matching receive is invoked. On the other hand, buffer space may be unavailable, or MPI may choose not to buffer outgoing messages, for performance reasons. In this case, the send call will not complete until a matching receive has been posted, and the data has been moved to the receiver.

Thus, a send in standard mode can be started whether or not a matching receive has been posted. It may complete before a matching receive is posted. The standard mode send is *non-local*: successful completion of the send operation may depend on the occurrence of a matching receive.

*Rationale.* The reluctance of MPI to mandate whether standard sends are buffering or not stems from the desire to achieve portable programs. Since any system will run out of buffer resources as message sizes are increased, and some implementations may want to provide little buffering, MPI takes the position that correct (and therefore, portable) programs do not rely on system buffering in standard mode. Buffering may improve the performance of a correct program, but it doesn't affect the result of the program. If the user wishes to guarantee a certain amount of buffering, the user-provided buffer system of Section 3.6 should be used, along with the buffered-mode send. (*End of rationale.*)

There are three additional communication modes.

1 A **buffered** mode send operation can be started whether or not a matching receive  
2 has been posted. It may complete before a matching receive is posted. However, unlike the  
3 standard send, this operation is *local*, and its completion does not depend on the occurrence  
4 of a matching receive. Thus, if a send is executed and no matching receive is posted, then  
5 MPI must buffer the outgoing message, so as to allow the send call to complete. An error will  
6 occur if there is insufficient buffer space. The amount of available buffer space is controlled  
7 by the user—see Section 3.6. Buffer allocation by the user may be required for the buffered  
8 mode to be effective.

9 According to the definitions in Section 2.4.2, MPI\_BSEND is a completing procedure  
10 and the user can re-use all resources given as arguments, including the message data buffer.  
11 It is also a local procedure because it returns immediately without depending on the execu-  
12 tion of any MPI procedure in any other MPI process.

13  
14 *Advice to users.* This is one of the exceptions in which a completing and therefore  
15 blocking operation-related procedure is local. (*End of advice to users.*)

16 A send that uses the **synchronous** mode can be started whether or not a matching  
17 receive was posted. However, the send will complete successfully only if a matching receive is  
18 posted, and the receive operation has started to receive the message sent by the synchronous  
19 send. Thus, the completion of a synchronous send not only indicates that the send buffer  
20 can be reused, but it also indicates that the receiver has reached a certain point in its  
21 execution, namely that it has started executing the matching receive. If both sends and  
22 receives are blocking operations then the use of the synchronous mode provides synchronous  
23 communication semantics: a communication does not complete at either end before both  
24 processes rendezvous at the communication. A send executed in this mode is *non-local*.

25 A send that uses the **ready** communication mode may be started *only* if the matching  
26 receive is already posted. Otherwise, the operation is erroneous and its outcome is unde-  
27 fined. On some systems, this allows the removal of a hand-shake operation that is otherwise  
28 required and results in improved performance. The completion of the send operation does  
29 not depend on the status of a matching receive, and merely indicates that the send buffer  
30 can be reused. A send operation that uses the ready mode has the same semantics as a  
31 standard send operation, or a synchronous send operation; it is merely that the sender  
32 provides additional information to the system (namely that a matching receive is already  
33 posted), that can save some overhead. In a correct program, therefore, a ready send could  
34 be replaced by a standard send with no effect on the behavior of the program other than  
35 performance.

36 Three additional send functions are provided for the three additional communication  
37 modes. The communication mode is indicated by a one letter prefix: B for buffered, S for  
38 synchronous, and R for ready.  
39  
40  
41  
42  
43  
44  
45  
46  
47  
48

MPI_BSEND(buf, count, datatype, dest, tag, comm)			1
IN	buf	initial address of send buffer (choice)	2
IN	count	number of elements in send buffer (non-negative integer)	3
			4
			5
IN	datatype	datatype of each send buffer element (handle)	6
IN	dest	rank of destination (integer)	7
IN	tag	message tag (integer)	8
IN	comm	communicator (handle)	9
			10
			11

**C binding**

```
int MPI_Bsend(const void *buf, int count, MPI_Datatype datatype, int dest,
             int tag, MPI_Comm comm)
```

```
int MPI_Bsend_c(const void *buf, MPI_Count count, MPI_Datatype datatype,
               int dest, int tag, MPI_Comm comm)
```

**Fortran 2008 binding**

```
MPI_Bsend(buf, count, datatype, dest, tag, comm, ierror)
```

```
TYPE(*), DIMENSION(..), INTENT(IN) :: buf
```

```
INTEGER, INTENT(IN) :: count, dest, tag
```

```
TYPE(MPI_Datatype), INTENT(IN) :: datatype
```

```
TYPE(MPI_Comm), INTENT(IN) :: comm
```

```
INTEGER, OPTIONAL, INTENT(OUT) :: ierror
```

```
MPI_Bsend(buf, count, datatype, dest, tag, comm, ierror)
```

```
TYPE(*), DIMENSION(..), INTENT(IN) :: buf
```

```
INTEGER(KIND=MPI_COUNT_KIND), INTENT(IN) :: count
```

```
TYPE(MPI_Datatype), INTENT(IN) :: datatype
```

```
INTEGER, INTENT(IN) :: dest, tag
```

```
TYPE(MPI_Comm), INTENT(IN) :: comm
```

```
INTEGER, OPTIONAL, INTENT(OUT) :: ierror
```

**Fortran binding**

```
MPI_BSEND(BUF, COUNT, DATATYPE, DEST, TAG, COMM, IERROR)
```

```
<type> BUF(*)
```

```
INTEGER COUNT, DATATYPE, DEST, TAG, COMM, IERROR
```

```
Send in buffered mode.
```

```

1 MPI_SSEND(buf, count, datatype, dest, tag, comm)
2     IN      buf                initial address of send buffer (choice)
3
4     IN      count              number of elements in send buffer (non-negative
5                                 integer)
6
7     IN      datatype           datatype of each send buffer element (handle)
8
9     IN      dest                rank of destination (integer)
10
11    IN      tag                  message tag (integer)
12
13    IN      comm                 communicator (handle)

```

**C binding**

```

14 int MPI_Ssend(const void *buf, int count, MPI_Datatype datatype, int dest,
15              int tag, MPI_Comm comm)
16
17 int MPI_Ssend_c(const void *buf, MPI_Count count, MPI_Datatype datatype,
18                int dest, int tag, MPI_Comm comm)

```

**Fortran 2008 binding**

```

19 MPI_Ssend(buf, count, datatype, dest, tag, comm, ierror)
20     TYPE(*), DIMENSION(..), INTENT(IN) :: buf
21     INTEGER, INTENT(IN) :: count, dest, tag
22     TYPE(MPI_Datatype), INTENT(IN) :: datatype
23     TYPE(MPI_Comm), INTENT(IN) :: comm
24     INTEGER, OPTIONAL, INTENT(OUT) :: ierror
25
26 MPI_Ssend(buf, count, datatype, dest, tag, comm, ierror)
27     TYPE(*), DIMENSION(..), INTENT(IN) :: buf
28     INTEGER(KIND=MPI_COUNT_KIND), INTENT(IN) :: count
29     TYPE(MPI_Datatype), INTENT(IN) :: datatype
30     INTEGER, INTENT(IN) :: dest, tag
31     TYPE(MPI_Comm), INTENT(IN) :: comm
32     INTEGER, OPTIONAL, INTENT(OUT) :: ierror

```

**Fortran binding**

```

34 MPI_SSEND(BUF, COUNT, DATATYPE, DEST, TAG, COMM, IERROR)
35     <type> BUF(*)
36     INTEGER COUNT, DATATYPE, DEST, TAG, COMM, IERROR
37
38     Send in synchronous mode.

```



MPI_RSEND(buf, count, datatype, dest, tag, comm)			1
IN	buf	initial address of send buffer (choice)	2
			3
IN	count	number of elements in send buffer (non-negative integer)	4
			5
IN	datatype	datatype of each send buffer element (handle)	6
			7
IN	dest	rank of destination (integer)	8
			9
IN	tag	message tag (integer)	9
			10
IN	comm	communicator (handle)	11

**C binding**

```
int MPI_Rsend(const void *buf, int count, MPI_Datatype datatype, int dest,
             int tag, MPI_Comm comm)
```

```
int MPI_Rsend_c(const void *buf, MPI_Count count, MPI_Datatype datatype,
               int dest, int tag, MPI_Comm comm)
```

**Fortran 2008 binding**

```
MPI_Rsend(buf, count, datatype, dest, tag, comm, ierror)
```

```
TYPE(*), DIMENSION(..), INTENT(IN) :: buf
```

```
INTEGER, INTENT(IN) :: count, dest, tag
```

```
TYPE(MPI_Datatype), INTENT(IN) :: datatype
```

```
TYPE(MPI_Comm), INTENT(IN) :: comm
```

```
INTEGER, OPTIONAL, INTENT(OUT) :: ierror
```

```
MPI_Rsend(buf, count, datatype, dest, tag, comm, ierror)
```

```
TYPE(*), DIMENSION(..), INTENT(IN) :: buf
```

```
INTEGER(KIND=MPI_COUNT_KIND), INTENT(IN) :: count
```

```
TYPE(MPI_Datatype), INTENT(IN) :: datatype
```

```
INTEGER, INTENT(IN) :: dest, tag
```

```
TYPE(MPI_Comm), INTENT(IN) :: comm
```

```
INTEGER, OPTIONAL, INTENT(OUT) :: ierror
```

**Fortran binding**

```
MPI_RSEND(BUF, COUNT, DATATYPE, DEST, TAG, COMM, IERROR)
```

```
<type> BUF(*)
```

```
INTEGER COUNT, DATATYPE, DEST, TAG, COMM, IERROR
```

Send in ready mode.

There is only one receive operation, but it matches any of the send modes. The receive operation described in the last section is *blocking*: it returns only after the receive buffer contains the newly received message. A receive can complete before the matching send has completed (of course, it can complete only after the matching send has started).

In a multithreaded implementation of MPI, the system may de-schedule a thread that is blocked on a send or receive operation, and schedule another thread for execution in the same address space. In such a case it is the user's responsibility not to modify a communication buffer until the communication completes. Otherwise, the outcome of the computation is undefined.

1 *Advice to implementors.* Since a synchronous send cannot complete before a matching  
2 receive is posted, one will not normally buffer messages sent by such an operation.

3 It is recommended to choose buffering over blocking the sender, whenever possible,  
4 for standard sends. The programmer can signal his or her preference for blocking the  
5 sender until a matching receive occurs by using the synchronous send mode.

6 A possible communication protocol for the various communication modes is outlined  
7 below.

8 *ready send:* The message is sent as soon as possible.

9 *synchronous send:* The sender sends a request-to-send message. The receiver stores  
10 this request. When a matching receive is posted, the receiver sends back a permission-  
11 to-send message, and the sender now sends the message.

12 *standard send:* First protocol may be used for short messages, and second protocol  
13 for long messages.

14 *buffered send:* The sender copies the message into a buffer and then sends it with a  
15 nonblocking send (using the same protocol as for standard send).

16 Additional control messages might be needed for flow control and error recovery. Of  
17 course, there are many other possible protocols.

18 Ready send can be implemented as a standard send. In this case there will be no  
19 performance advantage (or disadvantage) for the use of ready send.

20 A standard send can be implemented as a synchronous send. In such a case, no data  
21 buffering is needed. However, users may expect some buffering.

22 In a multithreaded environment, the execution of a blocking communication should  
23 block only the executing thread, allowing the thread scheduler to de-schedule this  
24 thread and schedule another thread for execution. (*End of advice to implementors.*)

## 25 3.5 Semantics of Point-to-Point Communication

26 A valid MPI implementation guarantees certain general properties of point-to-point com-  
27 munication, which are described in this section.

28 **Order** Messages are *non-overtaking*: If a sender sends two messages in succession to the  
29 same destination, and both match the same receive, then this operation cannot receive the  
30 second message if the first one is still pending. If a receiver posts two receives in succession,  
31 and both match the same message, then the second receive operation cannot be satisfied  
32 by this message, if the first one is still pending. This requirement facilitates matching of  
33 sends to receives. It guarantees that message-passing code is deterministic, if processes are  
34 single-threaded and the wildcard MPI\_ANY\_SOURCE is not used in receives. (Some of the  
35 calls described later, such as MPI\_CANCEL or MPI\_WAITANY, are additional sources of  
36 nondeterminism.)

37 If a process has a single thread of execution, then any two communications executed  
38 by this process are ordered. On the other hand, if the process is multithreaded, then the  
39 semantics of thread execution may not define a relative order between two send operations  
40 executed by two distinct threads. The operations are logically concurrent, even if one  
41 physically precedes the other. In such a case, the two messages sent can be received in  
42

any order. Similarly, if two receive operations that are logically concurrent receive two successively sent messages, then the two messages can match the two receives in either order.

**Example 3.6** An example of non-overtaking messages.

```
CALL MPI_COMM_RANK(comm, rank, ierr)
IF (rank .EQ. 0) THEN
  CALL MPI_BSEND(buf1, count, MPI_REAL, 1, tag, comm, ierr)
  CALL MPI_BSEND(buf2, count, MPI_REAL, 1, tag, comm, ierr)
ELSE IF (rank .EQ. 1) THEN
  CALL MPI_RECV(buf1, count, MPI_REAL, 0, MPI_ANY_TAG, comm, status, ierr)
  CALL MPI_RECV(buf2, count, MPI_REAL, 0, tag, comm, status, ierr)
END IF
```

The message sent by the first send must be received by the first receive, and the message sent by the second send must be received by the second receive.

**Progress** If a pair of matching send and receives have been initiated on two processes, then at least one of these two operations will complete, independently of other actions in the system: the send operation will complete, unless the receive is satisfied by another message, and completes; the receive operation will complete, unless the message sent is consumed by another matching receive that was posted at the same destination process.

**Example 3.7** An example of two, intertwined matching pairs.

```
CALL MPI_COMM_RANK(comm, rank, ierr)
IF (rank .EQ. 0) THEN
  CALL MPI_BSEND(buf1, count, MPI_REAL, 1, tag1, comm, ierr)
  CALL MPI_SSEND(buf2, count, MPI_REAL, 1, tag2, comm, ierr)
ELSE IF (rank .EQ. 1) THEN
  CALL MPI_RECV(buf1, count, MPI_REAL, 0, tag2, comm, status, ierr)
  CALL MPI_RECV(buf2, count, MPI_REAL, 0, tag1, comm, status, ierr)
END IF
```

Both processes invoke their first communication call. Since the first send of process zero uses the buffered mode, it must complete, irrespective of the state of process one. Since no matching receive is posted, the message will be copied into buffer space. (If insufficient buffer space is available, then the program will fail.) The second send is then invoked. At that point, a matching pair of send and receive operation is enabled, and both operations must complete. Process one next invokes its second receive call, which will be satisfied by the buffered message. Note that process one received the messages in the reverse order they were sent.

**Fairness** MPI makes no guarantee of *fairness* in the handling of communication. Suppose that a send is posted. Then it is possible that the destination process repeatedly posts a receive that matches this send, yet the message is never received, because it is each time overtaken by another message, sent from another source. Similarly, suppose that a receive was posted by a multithreaded process. Then it is possible that messages that match this

1 receive are repeatedly received, yet the receive is never satisfied, because it is overtaken  
 2 by other receives posted at this node (by other executing threads). It is the programmer's  
 3 responsibility to prevent starvation in such situations.  
 4

5 **Resource limitations** Any pending communication operation consumes system resources  
 6 that are limited. Errors may occur when lack of resources prevent the execution of an MPI  
 7 call. A quality implementation will use a (small) fixed amount of resources for each pending  
 8 send in the ready or synchronous mode and for each pending receive. However, buffer space  
 9 may be consumed to store messages sent in standard mode, and must be consumed to store  
 10 messages sent in buffered mode, when no matching receive is available. The amount of space  
 11 available for buffering will be much smaller than program data memory on many systems.  
 12 Then, it will be easy to write programs that overrun available buffer space.

13 MPI allows the user to provide buffer memory for messages sent in the buffered mode.  
 14 Furthermore, MPI specifies a detailed operational model for the use of this buffer. An MPI  
 15 implementation is required to do no worse than implied by this model. This allows users to  
 16 avoid buffer overflows when they use buffered sends. Buffer allocation and use is described  
 17 in Section 3.6.

18 A buffered send operation that cannot complete because of a lack of buffer space is  
 19 erroneous. When such a situation is detected, an error is signaled that may cause the  
 20 program to terminate abnormally. On the other hand, a standard send operation that  
 21 cannot complete because of lack of buffer space will merely block, waiting for buffer space  
 22 to become available or for a matching receive to be posted. This behavior is preferable in  
 23 many situations. Consider a situation where a producer repeatedly produces new values  
 24 and sends them to a consumer. Assume that the producer produces new values faster  
 25 than the consumer can consume them. If buffered sends are used, then a buffer overflow  
 26 will result. Additional synchronization has to be added to the program so as to prevent  
 27 this from occurring. If standard sends are used, then the producer will be automatically  
 28 throttled, as its send operations will block when buffer space is unavailable.

29 In some situations, a lack of buffer space leads to deadlock situations. This is illustrated  
 30 by the examples below.  
 31

32 **Example 3.8** An exchange of messages.

```
33
34 CALL MPI_COMM_RANK(comm, rank, ierr)
35 IF (rank .EQ. 0) THEN
36   CALL MPI_SEND(sendbuf, count, MPI_REAL, 1, tag, comm, ierr)
37   CALL MPI_RECV(recvbuf, count, MPI_REAL, 1, tag, comm, status, ierr)
38 ELSE IF (rank .EQ. 1) THEN
39   CALL MPI_RECV(recvbuf, count, MPI_REAL, 0, tag, comm, status, ierr)
40   CALL MPI_SEND(sendbuf, count, MPI_REAL, 0, tag, comm, ierr)
41 END IF
42
```

43 This program will succeed even if no buffer space for data is available. The standard send  
 44 operation can be replaced, in this example, with a synchronous send.

45 **Example 3.9** An errant attempt to exchange messages.  
 46  
 47  
 48

```

/* ----- THIS EXAMPLE IS ERRONEOUS ----- */
CALL MPI_COMM_RANK(comm, rank, ierr)
IF (rank .EQ. 0) THEN
    CALL MPI_RECV(recvbuf, count, MPI_REAL, 1, tag, comm, status, ierr)
    CALL MPI_SEND(sendbuf, count, MPI_REAL, 1, tag, comm, ierr)
ELSE IF (rank .EQ. 1) THEN
    CALL MPI_RECV(recvbuf, count, MPI_REAL, 0, tag, comm, status, ierr)
    CALL MPI_SEND(sendbuf, count, MPI_REAL, 0, tag, comm, ierr)
END IF

```

The receive operation of the first process must complete before its send, and can complete only if the matching send of the second processor is executed. The receive operation of the second process must complete before its send and can complete only if the matching send of the first process is executed. This program will always deadlock. The same holds for any other send mode.

**Example 3.10** An exchange that relies on buffering.

```

/* ----- THIS EXAMPLE IS ERRONEOUS ----- */
CALL MPI_COMM_RANK(comm, rank, ierr)
IF (rank .EQ. 0) THEN
    CALL MPI_SEND(sendbuf, count, MPI_REAL, 1, tag, comm, ierr)
    CALL MPI_RECV(recvbuf, count, MPI_REAL, 1, tag, comm, status, ierr)
ELSE IF (rank .EQ. 1) THEN
    CALL MPI_SEND(sendbuf, count, MPI_REAL, 0, tag, comm, ierr)
    CALL MPI_RECV(recvbuf, count, MPI_REAL, 0, tag, comm, status, ierr)
END IF

```

The message sent by each process has to be copied out before the send operation returns and the receive operation starts. For the program to complete, it is necessary that at least one of the two messages sent be buffered. Thus, this program can succeed only if the communication system can buffer at least count words of data.

*Advice to users.* When standard send operations are used, then a deadlock situation may occur where both processes are blocked because buffer space is not available. The same will certainly happen, if the synchronous mode is used. If the buffered mode is used, and not enough buffer space is available, then the program will not complete either. However, rather than a deadlock situation, we shall have a buffer overflow error.

A program is “safe” if no message buffering is required for the program to complete. One can replace all sends in such program with synchronous sends, and the program will still run correctly. This conservative programming style provides the best portability, since program completion does not depend on the amount of buffer space available or on the communication protocol used.

Many programmers prefer to have more leeway and opt to use the “unsafe” programming style shown in Example 3.10. In such cases, the use of standard sends is likely to provide the best compromise between performance and robustness: quality implementations will provide sufficient buffering so that “common practice” programs will not deadlock. The buffered send mode can be used for programs that require more

buffering, or in situations where the programmer wants more control. This mode might also be used for debugging purposes, as buffer overflow conditions are easier to diagnose than deadlock conditions.

Nonblocking message-passing operations, as described in Section 3.7, can be used to avoid the need for buffering outgoing messages. This prevents deadlocks due to lack of buffer space, and improves performance, by allowing overlap of computation and communication, and avoiding the overheads of allocating buffers and copying messages into buffers. (*End of advice to users.*)

### 3.6 Buffer Allocation and Usage

A user may specify a buffer to be used for buffering messages sent in buffered mode. Buffering is done by the sender.

`MPI_BUFFER_ATTACH(buffer, size)`

IN	buffer	initial buffer address (choice)
IN	size	buffer size, in bytes (non-negative integer)

#### C binding

```
int MPI_Buffer_attach(void *buffer, int size)
```

```
int MPI_Buffer_attach_c(void *buffer, MPI_Count size)
```

#### Fortran 2008 binding

```
MPI_Buffer_attach(buffer, size, ierror)
```

```
TYPE(*), DIMENSION(..), ASYNCHRONOUS :: buffer
```

```
INTEGER, INTENT(IN) :: size
```

```
INTEGER, OPTIONAL, INTENT(OUT) :: ierror
```

```
MPI_Buffer_attach(buffer, size, ierror)
```

```
TYPE(*), DIMENSION(..), ASYNCHRONOUS :: buffer
```

```
INTEGER(KIND=MPI_COUNT_KIND), INTENT(IN) :: size
```

```
INTEGER, OPTIONAL, INTENT(OUT) :: ierror
```

#### Fortran binding

```
MPI_BUFFER_ATTACH(BUFFER, SIZE, IERROR)
```

```
<type> BUFFER(*)
```

```
INTEGER SIZE, IERROR
```

Provides to MPI a buffer in the user's memory to be used for buffering outgoing messages. The buffer is used only by messages sent in buffered mode. Only one buffer can be attached to a process at a time. In C, `buffer` is the starting address of a memory region. In Fortran, one can pass the first element of a memory region or a whole array, which must be 'simply contiguous' (for 'simply contiguous,' see also Section 19.1.12).

```
MPI_BUFFER_DETACH(buffer_addr, size)
```

```
OUT    buffer_addr          initial buffer address (choice)
OUT    size                 buffer size, in bytes (integer)
```

### C binding

```
int MPI_Buffer_detach(void *buffer_addr, int *size)
```

```
int MPI_Buffer_detach_c(void *buffer_addr, MPI_Count *size)
```

### Fortran 2008 binding

```
MPI_Buffer_detach(buffer_addr, size, ierror)
USE, INTRINSIC :: ISO_C_BINDING, ONLY : C_PTR
TYPE(C_PTR), INTENT(OUT) :: buffer_addr
INTEGER, INTENT(OUT) :: size
INTEGER, OPTIONAL, INTENT(OUT) :: ierror
```

```
MPI_Buffer_detach(buffer_addr, size, ierror)
USE, INTRINSIC :: ISO_C_BINDING, ONLY : C_PTR
TYPE(C_PTR), INTENT(OUT) :: buffer_addr
INTEGER(KIND=MPI_COUNT_KIND), INTENT(OUT) :: size
INTEGER, OPTIONAL, INTENT(OUT) :: ierror
```

### Fortran binding

```
MPI_BUFFER_DETACH(BUFFER_ADDR, SIZE, IERROR)
<type> BUFFER_ADDR(*)
INTEGER SIZE, IERROR
```

Detach the buffer currently associated with MPI. The call returns the address and the size of the detached buffer. This operation will block until all messages currently in the buffer have been transmitted. Upon return of this function, the user may reuse or deallocate the space taken by the buffer.

If the size of the detached buffer cannot be represented in `size`, it is set to `MPI_UNDEFINED`.

**Example 3.11** Calls to attach and detach buffers.

```
#define BUFFSIZE 10000
int size;
char *buff;
MPI_Buffer_attach(malloc(BUFFSIZE), BUFFSIZE);
/* a buffer of 10000 bytes can now be used by MPI_Bsend */
MPI_Buffer_detach(&buff, &size);
/* Buffer size reduced to zero */
MPI_Buffer_attach(buff, size);
/* Buffer of 10000 bytes available again */
```

*Advice to users.* Even though the C functions `MPI_Buffer_attach` and `MPI_Buffer_detach` both have a first argument of type `void*`, these arguments are used differently: A pointer to the buffer is passed to `MPI_Buffer_attach`; the address of the pointer is passed to `MPI_Buffer_detach`, so that this call can return the pointer

1 value. In Fortran with the `mpi` module or `mpif.h`, the type of the `buffer_addr` argument  
 2 is wrongly defined and the argument is therefore unused. In Fortran with the `mpi_f08`  
 3 module, the address of the buffer is returned as `TYPE(C_PTR)`, see also Example 9.1  
 4 about the use of `C_PTR` pointers. (*End of advice to users.*)

5  
 6 *Rationale.* Both arguments are defined to be of type `void*` (rather than `void*` and  
 7 `void**`, respectively), so as to avoid complex type casts. E.g., in the last example,  
 8 `&buff`, which is of type `char**`, can be passed as argument to `MPI_Buffer_detach`  
 9 without type casting. If the formal parameter had type `void**` then we would need  
 10 a type cast before and after the call. (*End of rationale.*)

11  
 12 The statements made in this section describe the behavior of MPI for buffered-mode  
 13 sends. When no buffer is currently associated, MPI behaves as if a zero-sized buffer is  
 14 associated with the process.

15 MPI must provide as much buffering for outgoing messages *as if* outgoing message  
 16 data were buffered by the sending process, in the specified buffer space, using a circular,  
 17 contiguous-space allocation policy. We outline below a model implementation that defines  
 18 this policy. MPI may provide more buffering, and may use a better buffer allocation algo-  
 19 rithm than described below. On the other hand, MPI may signal an error whenever the  
 20 simple buffering allocator described below would run out of space. In particular, if no buffer  
 21 is explicitly associated with the process, then any buffered send may cause an error.

22 MPI does not provide mechanisms for querying or controlling buffering done by standard  
 23 mode sends. It is expected that vendors will provide such information for their implemen-  
 24 tations.

25  
 26 *Rationale.* There is a wide spectrum of possible implementations of buffered com-  
 27 munication: buffering can be done at sender, at receiver, or both; buffers can be  
 28 dedicated to one sender-receiver pair, or be shared by all communications; buffering  
 29 can be done in real or in virtual memory; it can use dedicated memory, or memory  
 30 shared by other processes; buffer space may be allocated statically or be changed dy-  
 31 namically; etc. It does not seem feasible to provide a portable mechanism for querying  
 32 or controlling buffering that would be compatible with all these choices, yet provide  
 33 meaningful information. (*End of rationale.*)

### 34 35 3.6.1 Model Implementation of Buffered Mode

36 The model implementation uses the packing and unpacking functions described in Sec-  
 37 tion 5.2 and the nonblocking communication functions described in Section 3.7.

38 We assume that a circular queue of pending message entries (PME) is maintained.  
 39 Each entry contains a communication request handle that identifies a pending nonblocking  
 40 send, a pointer to the next entry and the packed message data. The entries are stored in  
 41 successive locations in the buffer. Free space is available between the queue tail and the  
 42 queue head.

43 A buffered send call results in the execution of the following code.

- 44
- 45 • Traverse sequentially the PME queue from head towards the tail, deleting all entries  
 46 for communications that have completed, up to the first entry with an uncompleted  
 47 request; update queue head to point to that entry.
- 48



- Compute the number,  $n$ , of bytes needed to store an entry for the new message. An upper bound on  $n$  can be computed as follows: A call to the function `MPI_PACK_SIZE(count, datatype, comm, size)`, with the `count`, `datatype` and `comm` arguments used in the `MPI_BSEND` call, returns an upper bound on the amount of space needed to buffer the message data (see Section 5.2). The MPI constant `MPI_BSEND_OVERHEAD` provides an upper bound on the additional space consumed by the entry (e.g., for pointers or envelope information).
- Find the next contiguous empty space of  $n$  bytes in buffer (space following queue tail, or space at start of buffer if queue tail is too close to end of buffer). If space is not found then raise buffer overflow error.
- Append to end of PME queue in contiguous space the new entry that contains request handle, next pointer and packed message data; `MPI_PACK` is used to pack data.
- Post nonblocking send (standard mode) for packed data.
- Return

### 3.7 Nonblocking Communication

**Nonblocking communication** is important both for reasons of correctness and performance. For complex communication patterns, the use of only blocking communication (without buffering) is difficult because the programmer must ensure that each send is matched with a receive in an order that avoids *deadlock*. For communication patterns that are determined only at run time, this is even more difficult. Nonblocking communication can be used to avoid this problem, allowing programmers to express complex and possibly dynamic communication patterns without needing to ensure that all sends and receives are issued in an order that prevents deadlock (see Section 3.5 and the discussion of “safe” programs). Nonblocking communication also allows for the overlap of communication with different communication operations, e.g., to prevent the *serialization* of such operations, and for the *overlap* of communication with computation. Whether an implementation is able to accomplish an effective (from a performance standpoint) overlap of operations depends on the implementation itself and the system on which the implementation is running. Using nonblocking operations *permits* an implementation to overlap communication with computation, but does not require it to do so.

A nonblocking **send start** call initiates the send operation, but does not complete it. The send start call can return before the message was copied out of the send buffer. A separate **send complete** call is needed to complete the communication, i.e., to verify that the data has been copied out of the send buffer. With suitable hardware, the transfer of data out of the sender memory may proceed concurrently with computations done at the sender after the send was initiated and before it completed. Similarly, a nonblocking **receive start call** initiates the receive operation, but does not complete it. The call can return before a message is stored into the receive buffer. A separate **receive complete** call is needed to complete the receive operation and verify that the data has been received into the receive buffer. With suitable hardware, the transfer of data into the receiver memory may proceed concurrently with computations done after the receive was initiated and before it completed. The use of nonblocking receives may also avoid system buffering and memory-to-memory copying, as information is provided early on the location of the receive buffer.

1 Nonblocking send start calls can use the same four modes as blocking sends: *standard*,  
2 *buffered*, *synchronous* and *ready*. These carry the same meaning. Sends of all modes, *ready*  
3 excepted, can be started whether a matching receive has been posted or not; a nonblocking  
4 **ready** send can be started only if a matching receive is posted. In all cases, the send start  
5 call is local: it returns immediately, irrespective of the status of other processes. If the call  
6 causes some system resource to be exhausted, then it will fail and return an error code.  
7 Quality implementations of MPI should ensure that this happens only in “pathological”  
8 cases. That is, an MPI implementation should be able to support a large number of pending  
9 nonblocking operations.

10 The send-complete call returns when data has been copied out of the send buffer. It  
11 may carry additional meaning, depending on the send mode.

12 If the send mode is **synchronous**, then the send can complete only if a matching receive  
13 has started. That is, a receive has been posted, and has been matched with the send. In  
14 this case, the send-complete call is non-local. Note that a synchronous, nonblocking send  
15 may complete, if matched by a nonblocking receive, before the receive complete call occurs.  
16 (It can complete as soon as the sender “knows” the transfer will complete, but before the  
17 receiver “knows” the transfer will complete.)

18 If the send mode is **buffered** then the message must be buffered if there is no pending  
19 receive. In this case, the send-complete call is local, and must succeed irrespective of the  
20 status of a matching receive.

21 If the send mode is **standard** then the send-complete call may return before a matching  
22 receive is posted, if the message is buffered. On the other hand, the receive-complete may  
23 not complete until a matching receive is posted, and the message was copied into the receive  
24 buffer.

25 Nonblocking sends can be matched with blocking receives, and vice-versa.

26  
27 *Advice to users.* The completion of a send operation may be delayed, for standard  
28 mode, and must be delayed, for synchronous mode, until a matching receive is posted.  
29 The use of nonblocking sends in these two cases allows the sender to proceed ahead  
30 of the receiver, so that the computation is more tolerant of fluctuations in the speeds  
31 of the two processes.

32 Nonblocking sends in the buffered and ready modes have a more limited impact, e.g.,  
33 the blocking version of buffered send is capable of completing regardless of when a  
34 matching receive call is made. However, separating the start from the completion  
35 of these sends still gives some opportunity for optimization within the MPI library.  
36 For example, starting a buffered send gives an implementation more flexibility in  
37 determining if and how the message is buffered. There are also advantages for both  
38 nonblocking buffered and ready modes when data copying can be done concurrently  
39 with computation.

40 The message-passing model implies that communication is initiated by the sender.  
41 The communication will generally have lower overhead if a receive is already posted  
42 when the sender initiates the communication (data can be moved directly to the  
43 receive buffer, and there is no need to queue a pending send request). However, a  
44 receive operation can complete only after the matching send has occurred. The use  
45 of nonblocking receives allows one to achieve lower communication overheads without  
46 blocking the receiver while it waits for the send. (*End of advice to users.*)  
47  
48

### 3.7.1 Communication Request Objects

Nonblocking communications use opaque **request** objects to identify communication operations and match the operation that initiates the communication with the operation that terminates it. These are system objects that are accessed via a handle. A request object identifies various properties of a communication operation, such as the send mode, the communication buffer that is associated with it, its context, the tag and destination arguments to be used for a send, or the tag and source arguments to be used for a receive. In addition, this object stores information about the status of the pending communication operation.

### 3.7.2 Communication Initiation

For the functions defined in this section, we use the same naming conventions as for blocking communication: a prefix of B, S, or R is used for **buffered**, **synchronous** or **ready** mode. In addition, for these functions a prefix of I (for **immediate** and **incomplete**) indicates that the call is nonblocking.

`MPI_ISEND(buf, count, datatype, dest, tag, comm, request)`

IN	buf	initial address of send buffer (choice)
IN	count	number of elements in send buffer (non-negative integer)
IN	datatype	datatype of each send buffer element (handle)
IN	dest	rank of destination (integer)
IN	tag	message tag (integer)
IN	comm	communicator (handle)
OUT	request	communication request (handle)

#### C binding

```
int MPI_Isend(const void *buf, int count, MPI_Datatype datatype, int dest,
             int tag, MPI_Comm comm, MPI_Request *request)
```

```
int MPI_Isend_c(const void *buf, MPI_Count count, MPI_Datatype datatype,
               int dest, int tag, MPI_Comm comm, MPI_Request *request)
```

#### Fortran 2008 binding

```
MPI_Isend(buf, count, datatype, dest, tag, comm, request, ierror)
  TYPE(*), DIMENSION(..), INTENT(IN), ASYNCHRONOUS :: buf
  INTEGER, INTENT(IN) :: count, dest, tag
  TYPE(MPI_Datatype), INTENT(IN) :: datatype
  TYPE(MPI_Comm), INTENT(IN) :: comm
  TYPE(MPI_Request), INTENT(OUT) :: request
  INTEGER, OPTIONAL, INTENT(OUT) :: ierror
```

```
MPI_Isend(buf, count, datatype, dest, tag, comm, request, ierror)
  TYPE(*), DIMENSION(..), INTENT(IN), ASYNCHRONOUS :: buf
  INTEGER(KIND=MPI_COUNT_KIND), INTENT(IN) :: count
  TYPE(MPI_Datatype), INTENT(IN) :: datatype
```

```

1     INTEGER, INTENT(IN) :: dest, tag
2     TYPE(MPI_Comm), INTENT(IN) :: comm
3     TYPE(MPI_Request), INTENT(OUT) :: request
4     INTEGER, OPTIONAL, INTENT(OUT) :: ierror

```

### Fortran binding

```

6 MPI_ISEND(BUF, COUNT, DATATYPE, DEST, TAG, COMM, REQUEST, IERROR)
7     <type> BUF(*)
8     INTEGER COUNT, DATATYPE, DEST, TAG, COMM, REQUEST, IERROR

```

10 Start a standard mode, nonblocking send.

```

12
13 MPI_IBSEND(buf, count, datatype, dest, tag, comm, request)

```

14	IN	buf	initial address of send buffer (choice)
15	IN	count	number of elements in send buffer (non-negative integer)
16			
17			
18	IN	datatype	datatype of each send buffer element (handle)
19	IN	dest	rank of destination (integer)
20	IN	tag	message tag (integer)
21			
22	IN	comm	communicator (handle)
23	OUT	request	communication request (handle)
24			

### C binding

```

25
26 int MPI_Ibsend(const void *buf, int count, MPI_Datatype datatype, int dest,
27               int tag, MPI_Comm comm, MPI_Request *request)
28
29 int MPI_Ibsend_c(const void *buf, MPI_Count count, MPI_Datatype datatype,
30                 int dest, int tag, MPI_Comm comm, MPI_Request *request)

```

### Fortran 2008 binding

```

31
32 MPI_Ibsend(buf, count, datatype, dest, tag, comm, request, ierror)
33     TYPE(*), DIMENSION(..), INTENT(IN), ASYNCHRONOUS :: buf
34     INTEGER, INTENT(IN) :: count, dest, tag
35     TYPE(MPI_Datatype), INTENT(IN) :: datatype
36     TYPE(MPI_Comm), INTENT(IN) :: comm
37     TYPE(MPI_Request), INTENT(OUT) :: request
38     INTEGER, OPTIONAL, INTENT(OUT) :: ierror

```

```

39
40 MPI_Ibsend(buf, count, datatype, dest, tag, comm, request, ierror)
41     TYPE(*), DIMENSION(..), INTENT(IN), ASYNCHRONOUS :: buf
42     INTEGER(KIND=MPI_COUNT_KIND), INTENT(IN) :: count
43     TYPE(MPI_Datatype), INTENT(IN) :: datatype
44     INTEGER, INTENT(IN) :: dest, tag
45     TYPE(MPI_Comm), INTENT(IN) :: comm
46     TYPE(MPI_Request), INTENT(OUT) :: request
47     INTEGER, OPTIONAL, INTENT(OUT) :: ierror

```

48

**Fortran binding**

```
MPI_IBSEND(BUF, COUNT, DATATYPE, DEST, TAG, COMM, REQUEST, IERROR)
  <type> BUF(*)
  INTEGER COUNT, DATATYPE, DEST, TAG, COMM, REQUEST, IERROR
```

Start a buffered mode, nonblocking send.

```
MPI_ISSEND(buf, count, datatype, dest, tag, comm, request)
```

IN	buf	initial address of send buffer (choice)
IN	count	number of elements in send buffer (non-negative integer)
IN	datatype	datatype of each send buffer element (handle)
IN	dest	rank of destination (integer)
IN	tag	message tag (integer)
IN	comm	communicator (handle)
OUT	request	communication request (handle)

**C binding**

```
int MPI_Issend(const void *buf, int count, MPI_Datatype datatype, int dest,
              int tag, MPI_Comm comm, MPI_Request *request)
```

```
int MPI_Issend_c(const void *buf, MPI_Count count, MPI_Datatype datatype,
                int dest, int tag, MPI_Comm comm, MPI_Request *request)
```

**Fortran 2008 binding**

```
MPI_Issend(buf, count, datatype, dest, tag, comm, request, ierror)
  TYPE(*), DIMENSION(..), INTENT(IN), ASYNCHRONOUS :: buf
  INTEGER, INTENT(IN) :: count, dest, tag
  TYPE(MPI_Datatype), INTENT(IN) :: datatype
  TYPE(MPI_Comm), INTENT(IN) :: comm
  TYPE(MPI_Request), INTENT(OUT) :: request
  INTEGER, OPTIONAL, INTENT(OUT) :: ierror
```

```
MPI_Issend(buf, count, datatype, dest, tag, comm, request, ierror)
  TYPE(*), DIMENSION(..), INTENT(IN), ASYNCHRONOUS :: buf
  INTEGER(KIND=MPI_COUNT_KIND), INTENT(IN) :: count
  TYPE(MPI_Datatype), INTENT(IN) :: datatype
  INTEGER, INTENT(IN) :: dest, tag
  TYPE(MPI_Comm), INTENT(IN) :: comm
  TYPE(MPI_Request), INTENT(OUT) :: request
  INTEGER, OPTIONAL, INTENT(OUT) :: ierror
```

**Fortran binding**

```
MPI_ISSEND(BUF, COUNT, DATATYPE, DEST, TAG, COMM, REQUEST, IERROR)
  <type> BUF(*)
  INTEGER COUNT, DATATYPE, DEST, TAG, COMM, REQUEST, IERROR
```

1 Start a synchronous mode, nonblocking send.

2  
3  
4 **MPI\_IRSEND**(buf, count, datatype, dest, tag, comm, request)  
5     IN     buf                     initial address of send buffer (choice)  
6     IN     count                 number of elements in send buffer (non-negative  
7                                     integer)  
8  
9     IN     datatype               datatype of each send buffer element (handle)  
10    IN     dest                   rank of destination (integer)  
11    IN     tag                    message tag (integer)  
12    IN     comm                   communicator (handle)  
13  
14    OUT    request                 communication request (handle)  
15

### 16 C binding

17 `int MPI_Irsend(const void *buf, int count, MPI_Datatype datatype, int dest,`  
18 `int tag, MPI_Comm comm, MPI_Request *request)`  
19  
20 `int MPI_Irsend_c(const void *buf, MPI_Count count, MPI_Datatype datatype,`  
21 `int dest, int tag, MPI_Comm comm, MPI_Request *request)`  
22

### 23 Fortran 2008 binding

24 `MPI_Irsend(buf, count, datatype, dest, tag, comm, request, ierror)`  
25 `TYPE(*), DIMENSION(..), INTENT(IN), ASYNCHRONOUS :: buf`  
26 `INTEGER, INTENT(IN) :: count, dest, tag`  
27 `TYPE(MPI_Datatype), INTENT(IN) :: datatype`  
28 `TYPE(MPI_Comm), INTENT(IN) :: comm`  
29 `TYPE(MPI_Request), INTENT(OUT) :: request`  
30 `INTEGER, OPTIONAL, INTENT(OUT) :: ierror`  
31  
32 `MPI_Irsend(buf, count, datatype, dest, tag, comm, request, ierror)`  
33 `TYPE(*), DIMENSION(..), INTENT(IN), ASYNCHRONOUS :: buf`  
34 `INTEGER(KIND=MPI_COUNT_KIND), INTENT(IN) :: count`  
35 `TYPE(MPI_Datatype), INTENT(IN) :: datatype`  
36 `INTEGER, INTENT(IN) :: dest, tag`  
37 `TYPE(MPI_Comm), INTENT(IN) :: comm`  
38 `TYPE(MPI_Request), INTENT(OUT) :: request`  
39 `INTEGER, OPTIONAL, INTENT(OUT) :: ierror`

### 40 Fortran binding

41 `MPI_IRSEND(BUF, COUNT, DATATYPE, DEST, TAG, COMM, REQUEST, IERROR)`  
42 `<type> BUF(*)`  
43 `INTEGER COUNT, DATATYPE, DEST, TAG, COMM, REQUEST, IERROR`  
44

45 Start a ready mode nonblocking send.  
46  
47  
48

MPI_Irecv(buf, count, datatype, source, tag, comm, request)			1
OUT	buf	initial address of receive buffer (choice)	2
			3
IN	count	number of elements in receive buffer (non-negative integer)	4
			5
IN	datatype	datatype of each receive buffer element (handle)	6
			7
IN	source	rank of source or MPI_ANY_SOURCE (integer)	8
			9
IN	tag	message tag or MPI_ANY_TAG (integer)	9
			10
IN	comm	communicator (handle)	10
			11
OUT	request	communication request (handle)	11
			12

**C binding**

```

int MPI_Irecv(void *buf, int count, MPI_Datatype datatype, int source,
              int tag, MPI_Comm comm, MPI_Request *request)
int MPI_Irecv_c(void *buf, MPI_Count count, MPI_Datatype datatype,
                int source, int tag, MPI_Comm comm, MPI_Request *request)

```

**Fortran 2008 binding**

```

MPI_Irecv(buf, count, datatype, source, tag, comm, request, ierror)
  TYPE(*), DIMENSION(..), ASYNCHRONOUS :: buf
  INTEGER, INTENT(IN) :: count, source, tag
  TYPE(MPI_Datatype), INTENT(IN) :: datatype
  TYPE(MPI_Comm), INTENT(IN) :: comm
  TYPE(MPI_Request), INTENT(OUT) :: request
  INTEGER, OPTIONAL, INTENT(OUT) :: ierror
MPI_Irecv(buf, count, datatype, source, tag, comm, request, ierror)
  TYPE(*), DIMENSION(..), ASYNCHRONOUS :: buf
  INTEGER(KIND=MPI_COUNT_KIND), INTENT(IN) :: count
  TYPE(MPI_Datatype), INTENT(IN) :: datatype
  INTEGER, INTENT(IN) :: source, tag
  TYPE(MPI_Comm), INTENT(IN) :: comm
  TYPE(MPI_Request), INTENT(OUT) :: request
  INTEGER, OPTIONAL, INTENT(OUT) :: ierror

```

**Fortran binding**

```

MPI_Irecv(BUF, COUNT, DATATYPE, SOURCE, TAG, COMM, REQUEST, IERROR)
  <type> BUF(*)
  INTEGER COUNT, DATATYPE, SOURCE, TAG, COMM, REQUEST, IERROR

```

Start a nonblocking receive.

1	MPI_ISENDRECV(sendbuf, sendcount, sendtype, dest, sendtag, recvbuf, recvcount, recvtype,		
2	source, recvtag, comm, request)		
3	IN	sendbuf	initial address of send buffer (choice)
4	IN	sendcount	number of elements in send buffer (non-negative integer)
5			
6			
7	IN	sendtype	datatype of each send buffer element (handle)
8	IN	dest	rank of destination (integer)
9			
10	IN	sendtag	send tag (integer)
11	OUT	recvbuf	initial address of receive buffer (choice)
12	IN	recvcount	number of elements in receive buffer (non-negative integer)
13			
14			
15	IN	recvtype	datatype of each receive buffer element (handle)
16	IN	source	rank of source or MPI_ANY_SOURCE (integer)
17	IN	recvtag	receive tag or MPI_ANY_TAG (integer)
18			
19	IN	comm	communicator (handle)
20	OUT	request	communication request (handle)
21			

### C binding

```

23 int MPI_Isendrecv(const void *sendbuf, int sendcount,
24                 MPI_Datatype sendtype, int dest, int sendtag, void *recvbuf,
25                 int recvcount, MPI_Datatype recvtype, int source, int recvtag,
26                 MPI_Comm comm, MPI_Request *request)
27
28 int MPI_Isendrecv_c(const void *sendbuf, MPI_Count sendcount,
29                   MPI_Datatype sendtype, int dest, int sendtag, void *recvbuf,
30                   MPI_Count recvcount, MPI_Datatype recvtype, int source,
31                   int recvtag, MPI_Comm comm, MPI_Request *request)

```

### Fortran 2008 binding

```

33 MPI_Isendrecv(sendbuf, sendcount, sendtype, dest, sendtag, recvbuf,
34              recvcount, recvtype, source, recvtag, comm, request, ierror)
35 TYPE(*), DIMENSION(..), INTENT(IN), ASYNCHRONOUS :: sendbuf
36 INTEGER, INTENT(IN) :: sendcount, dest, sendtag, recvcount, source,
37   recvtag
38 TYPE(MPI_Datatype), INTENT(IN) :: sendtype, recvtype
39 TYPE(*), DIMENSION(..), ASYNCHRONOUS :: recvbuf
40 TYPE(MPI_Comm), INTENT(IN) :: comm
41 TYPE(MPI_Request), INTENT(OUT) :: request
42 INTEGER, OPTIONAL, INTENT(OUT) :: ierror
43
44 MPI_Isendrecv(sendbuf, sendcount, sendtype, dest, sendtag, recvbuf,
45              recvcount, recvtype, source, recvtag, comm, request, ierror)
46 TYPE(*), DIMENSION(..), INTENT(IN), ASYNCHRONOUS :: sendbuf
47 INTEGER(KIND=MPI_COUNT_KIND), INTENT(IN) :: sendcount, recvcount
48 TYPE(MPI_Datatype), INTENT(IN) :: sendtype, recvtype

```



```

INTEGER, INTENT(IN) :: dest, sendtag, source, recvtag
TYPE(*), DIMENSION(..), ASYNCHRONOUS :: recvbuf
TYPE(MPI_Comm), INTENT(IN) :: comm
TYPE(MPI_Request), INTENT(OUT) :: request
INTEGER, OPTIONAL, INTENT(OUT) :: ierror

```

**Fortran binding**

```

MPI_ISENDRECV(SENDBUF, SENDCOUNT, SENDTYPE, DEST, SENDTAG, RECVBUF,
              RECVCOUNT, RECVTYPE, SOURCE, RECVTAG, COMM, REQUEST, IERROR)
<type> SENDBUF(*), RECVBUF(*)
INTEGER SENDCOUNT, SENDTYPE, DEST, SENDTAG, RECVCOUNT, RECVTYPE,
SOURCE, RECVTAG, COMM, REQUEST, IERROR

```

Initiate a nonblocking communication request for a *send and receive* operation.

```

MPI_ISENDRECV_REPLACE(buf, count, datatype, dest, sendtag, source, recvtag, comm,
                      request)

```

INOUT	buf	initial address of send and receive buffer (choice)
IN	count	number of elements in send and receive buffer (non-negative integer)
IN	datatype	type of elements in send and receive buffer (handle)
IN	dest	rank of destination (integer)
IN	sendtag	send message tag (integer)
IN	source	rank of source or MPI_ANY_SOURCE (integer)
IN	recvtag	receive message tag or MPI_ANY_TAG (integer)
IN	comm	communicator (handle)
OUT	request	communication request (handle)

**C binding**

```

int MPI_Isendrecv_replace(void *buf, int count, MPI_Datatype datatype,
                          int dest, int sendtag, int source, int recvtag, MPI_Comm comm,
                          MPI_Request *request)
int MPI_Isendrecv_replace_c(void *buf, MPI_Count count,
                             MPI_Datatype datatype, int dest, int sendtag, int source,
                             int recvtag, MPI_Comm comm, MPI_Request *request)

```

**Fortran 2008 binding**

```

MPI_Isendrecv_replace(buf, count, datatype, dest, sendtag, source, recvtag,
                      comm, request, ierror)
TYPE(*), DIMENSION(..), ASYNCHRONOUS :: buf
INTEGER, INTENT(IN) :: count, dest, sendtag, source, recvtag
TYPE(MPI_Datatype), INTENT(IN) :: datatype
TYPE(MPI_Comm), INTENT(IN) :: comm
TYPE(MPI_Request), INTENT(OUT) :: request
INTEGER, OPTIONAL, INTENT(OUT) :: ierror

```

```

1 MPI_Isendrecv_replace(buf, count, datatype, dest, sendtag, source, recvtag,
2     comm, request, ierror)
3     TYPE(*), DIMENSION(..), ASYNCHRONOUS :: buf
4     INTEGER(KIND=MPI_COUNT_KIND), INTENT(IN) :: count
5     TYPE(MPI_Datatype), INTENT(IN) :: datatype
6     INTEGER, INTENT(IN) :: dest, sendtag, source, recvtag
7     TYPE(MPI_Comm), INTENT(IN) :: comm
8     TYPE(MPI_Request), INTENT(OUT) :: request
9     INTEGER, OPTIONAL, INTENT(OUT) :: ierror

```

### Fortran binding

```

11 MPI_ISENDRECV_REPLACE(BUF, COUNT, DATATYPE, DEST, SENDTAG, SOURCE, RECVTAG,
12     COMM, REQUEST, IERROR)
13     <type> BUF(*)
14     INTEGER COUNT, DATATYPE, DEST, SENDTAG, SOURCE, RECVTAG, COMM, REQUEST,
15     IERROR

```

Initiate a nonblocking communication request for a *send and receive* operation. The same buffer is used both for the send and for the receive, so that the message sent is replaced by the message received.

These calls allocate a communication request object and associate it with the request handle (the argument `request`). The request can be used later to query the status of the communication or wait for its completion.

A nonblocking send call indicates that the system may start copying data out of the send buffer. The sender should not modify any part of the send buffer after a nonblocking send operation is called, until the send completes.

A nonblocking receive call indicates that the system may start writing data into the receive buffer. The receiver should not access any part of the receive buffer after a nonblocking receive operation is called, until the receive completes.

*Advice to users.* To prevent problems with the argument copying and register optimization done by Fortran compilers, please note the hints in Sections [19.1.10–19.1.20](#). (*End of advice to users.*)

### 3.7.3 Communication Completion

The functions `MPI_WAIT` and `MPI_TEST` are used to complete a nonblocking communication. The completion of a send operation indicates that the sender is now free to update the locations in the send buffer (the send operation itself leaves the content of the send buffer unchanged). It does not indicate that the message has been received, rather, it may have been buffered by the communication subsystem. However, if a **synchronous** mode send was used, the completion of the send operation indicates that a matching receive was initiated, and that the message will eventually be received by this matching receive.

The completion of a receive operation indicates that the receive buffer contains the received message, the receiver is now free to access it, and that the status object is set. It does not indicate that the matching send operation has completed (but indicates, of course, that the send was initiated).

We shall use the following terminology: A **null handle** is a handle with value `MPI_REQUEST_NULL`. A persistent request and the handle to it are **inactive** if the request

is not associated with any ongoing communication (see Section 3.9). A handle is **active** if it is neither null nor inactive. An **empty** status is a status which is set to return `tag = MPI_ANY_TAG`, `source = MPI_ANY_SOURCE`, `error = MPI_SUCCESS`, and is also internally configured so that calls to `MPI_GET_COUNT`, `MPI_GET_ELEMENTS`, and `MPI_GET_ELEMENTS_X` return `count = 0` and `MPI_TEST_CANCELLED` returns false. We set a status variable to empty when the value returned by it is not significant. Status is set in this way so as to prevent errors due to accesses of stale information.

The fields in a status object returned by a call to `MPI_WAIT`, `MPI_TEST`, or any of the other derived functions (`MPI_{TEST|WAIT}{ALL|SOME|ANY}`), where the request corresponds to a send call, are undefined, with two exceptions: The error status field will contain valid information if the wait or test call returned with `MPI_ERR_IN_STATUS`; and the returned status can be queried by the call `MPI_TEST_CANCELLED`.

Error codes belonging to the error class `MPI_ERR_IN_STATUS` should be returned only by the MPI completion functions that take arrays of `MPI_Status`. For the functions that take a single `MPI_Status` argument, the error code is returned by the function, and the value of the `MPI_ERROR` field in the `MPI_Status` argument is undefined (see 3.2.5).

`MPI_WAIT(request, status)`

INOUT	request	request (handle)
OUT	status	status object (status)

### C binding

```
int MPI_Wait(MPI_Request *request, MPI_Status *status)
```

### Fortran 2008 binding

```
MPI_Wait(request, status, ierror)
  TYPE(MPI_Request), INTENT(INOUT) :: request
  TYPE(MPI_Status) :: status
  INTEGER, OPTIONAL, INTENT(OUT) :: ierror
```

### Fortran binding

```
MPI_WAIT(REQUEST, STATUS, IERROR)
  INTEGER REQUEST, STATUS(MPI_STATUS_SIZE), IERROR
```

A call to `MPI_WAIT` returns when the operation identified by `request` is complete. If the request is an active persistent request, it is marked inactive. Any other type of request is deallocated and the request handle is set to `MPI_REQUEST_NULL`. `MPI_WAIT` is a non-local operation.

The call returns, in `status`, information on the completed operation. The content of the status object for a receive operation can be accessed as described in Section 3.2.5. The status object for a send operation may be queried by a call to `MPI_TEST_CANCELLED` (see Section 3.8).

One is allowed to call `MPI_WAIT` with a null or inactive request argument. In this case the operation returns immediately with empty status.

*Advice to users.* Successful return of `MPI_WAIT` after a `MPI_IBSEND` implies that the user send buffer can be reused—i.e., data has been sent out or copied into a buffer attached with `MPI_BUFFER_ATTACH`. Note that, at this point, we can no longer

cancel the send (see Section 3.8). If a matching receive is never posted, then the buffer cannot be freed. This runs somewhat counter to the stated goal of MPI\_CANCEL (always being able to free program space that was committed to the communication subsystem). (*End of advice to users.*)

*Advice to implementors.* In a multithreaded environment, a call to MPI\_WAIT should block only the calling thread, allowing the thread scheduler to schedule another thread for execution. (*End of advice to implementors.*)

MPI\_TEST(request, flag, status)

INOUT	request	communication request (handle)
OUT	flag	true if operation completed (logical)
OUT	status	status object (status)

### C binding

```
int MPI_Test(MPI_Request *request, int *flag, MPI_Status *status)
```

### Fortran 2008 binding

```
MPI_Test(request, flag, status, ierror)
  TYPE(MPI_Request), INTENT(INOUT) :: request
  LOGICAL, INTENT(OUT) :: flag
  TYPE(MPI_Status) :: status
  INTEGER, OPTIONAL, INTENT(OUT) :: ierror
```

### Fortran binding

```
MPI_TEST(REQUEST, FLAG, STATUS, IERROR)
  INTEGER REQUEST, STATUS(MPI_STATUS_SIZE), IERROR
  LOGICAL FLAG
```

A call to MPI\_TEST returns flag = true if the operation identified by request is complete. In such a case, the status object is set to contain information on the completed operation. If the request is an active persistent request, it is marked as inactive. Any other type of request is deallocated and the request handle is set to MPI\_REQUEST\_NULL. The call returns flag = false if the operation identified by request is not complete. In this case, the value of the status object is undefined. MPI\_TEST is a local operation.

The return status object for a receive operation carries information that can be accessed as described in Section 3.2.5. The status object for a send operation carries information that can be accessed by a call to MPI\_TEST\_CANCELLED (see Section 3.8).

One is allowed to call MPI\_TEST with a null or inactive request argument. In such a case the operation returns with flag = true and empty status.

The functions MPI\_WAIT and MPI\_TEST can be used to complete any request-based nonblocking or persistent operation.

*Advice to users.* The use of the nonblocking MPI\_TEST call allows the user to schedule alternative activities within a single thread of execution. An event-driven thread scheduler can be emulated with periodic calls to MPI\_TEST. (*End of advice to users.*)

**Example 3.12** Simple usage of nonblocking operations and MPI\_WAIT.

```

CALL MPI_COMM_RANK(comm, rank, ierr)
IF (rank .EQ. 0) THEN
  CALL MPI_ISEND(a(1), 10, MPI_REAL, 1, tag, comm, request, ierr)
  **** do some computation to mask latency ****
  CALL MPI_WAIT(request, status, ierr)
ELSE IF (rank .EQ. 1) THEN
  CALL MPI_Irecv(a(1), 15, MPI_REAL, 0, tag, comm, request, ierr)
  **** do some computation to mask latency ****
  CALL MPI_WAIT(request, status, ierr)
END IF

```

A request object can be freed using the following MPI procedure.

```

MPI_REQUEST_FREE(request)
  INOUT    request          communication request (handle)

```

### C binding

```
int MPI_Request_free(MPI_Request *request)
```

### Fortran 2008 binding

```

MPI_Request_free(request, ierror)
  TYPE(MPI_Request), INTENT(INOUT) :: request
  INTEGER, OPTIONAL, INTENT(OUT) :: ierror

```

### Fortran binding

```

MPI_REQUEST_FREE(REQUEST, IERROR)
  INTEGER REQUEST, IERROR

```

MPI\_REQUEST\_FREE is a local operation. Upon successful return, MPI\_REQUEST\_FREE sets request to MPI\_REQUEST\_NULL. For an inactive request representing any type of MPI operation, MPI\_REQUEST\_FREE shall do the freeing stage of the associated operation during its execution.

For a request representing a nonblocking point-to-point or a persistent point-to-point operation, it is permitted (although strongly discouraged) to call MPI\_REQUEST\_FREE when the request is active. In this special case, MPI\_REQUEST\_FREE will only mark the request for freeing and MPI will actually do the freeing stage of the associated operation later.

The use of this routine for generalized requests is described in Section 13.2.

Calling MPI\_REQUEST\_FREE with an active request representing any other type of MPI operation (e.g., any partitioned operation (see Chapter 4), any collective operation (see Chapter 6), any I/O operation (see Chapter 14), or any request-based RMA operation (see Chapter 12)) is erroneous.

*Rationale.* For point-to-point operations, the MPI\_REQUEST\_FREE mechanism is provided for reasons of performance and convenience on the sending side. (*End of rationale.*)

*Advice to users.* Once a request is freed by a call to `MPI_REQUEST_FREE`, it is not possible to check for the successful completion of the associated communication with calls to `MPI_WAIT` or `MPI_TEST`. Also, if an error occurs subsequently during the communication, an error code cannot be returned to the user—such an error must be treated as fatal. An active receive request should never be freed as the receiver will have no way to verify that the receive has completed and the receive buffer can be reused. (*End of advice to users.*)

**Example 3.13** An example using `MPI_REQUEST_FREE`.

```

11 CALL MPI_COMM_RANK(MPI_COMM_WORLD, rank, ierr)
12 IF (rank .EQ. 0) THEN
13   DO i=1,n
14     CALL MPI_ISEND(outval, 1, MPI_REAL, 1, 0, MPI_COMM_WORLD, req, ierr)
15     CALL MPI_REQUEST_FREE(req, ierr)
16     CALL MPI_Irecv(inval, 1, MPI_REAL, 1, 0, MPI_COMM_WORLD, req, ierr)
17     CALL MPI_WAIT(req, status, ierr)
18   END DO
19 ELSE IF (rank .EQ. 1) THEN
20   CALL MPI_Irecv(inval, 1, MPI_REAL, 0, 0, MPI_COMM_WORLD, req, ierr)
21   CALL MPI_WAIT(req, status, ierr)
22   DO I=1,n-1
23     CALL MPI_ISEND(outval, 1, MPI_REAL, 0, 0, MPI_COMM_WORLD, req, ierr)
24     CALL MPI_REQUEST_FREE(req, ierr)
25     CALL MPI_Irecv(inval, 1, MPI_REAL, 0, 0, MPI_COMM_WORLD, req, ierr)
26     CALL MPI_WAIT(req, status, ierr)
27   END DO
28   CALL MPI_ISEND(outval, 1, MPI_REAL, 0, 0, MPI_COMM_WORLD, req, ierr)
29   CALL MPI_WAIT(req, status, ierr)
30 END IF

```

### 3.7.4 Semantics of Nonblocking Communications

The semantics of nonblocking communication is defined by suitably extending the definitions in Section 3.5.

**Order** Nonblocking communication operations are ordered according to the execution order of the calls that initiate the communication. The non-overtaking requirement of Section 3.5 is extended to nonblocking communication, with this definition of order being used.

**Example 3.14** Message ordering for nonblocking operations.

```

CALL MPI_COMM_RANK(comm, rank, ierr) 1
IF (RANK .EQ. 0) THEN 2
    CALL MPI_ISEND(a, 1, MPI_REAL, 1, 0, comm, r1, ierr) 3
    CALL MPI_ISEND(b, 1, MPI_REAL, 1, 0, comm, r2, ierr) 4
ELSE IF (rank .EQ. 1) THEN 5
    CALL MPI_Irecv(a, 1, MPI_REAL, 0, MPI_ANY_TAG, comm, r1, ierr) 6
    CALL MPI_Irecv(b, 1, MPI_REAL, 0, 0, comm, r2, ierr) 7
END IF 8
CALL MPI_WAIT(r1, status, ierr) 9
CALL MPI_WAIT(r2, status, ierr) 10

```

The first send of process zero will match the first receive of process one, even if both messages are sent before process one executes either receive.

**Progress** A call to `MPI_WAIT` that completes a receive will eventually terminate and return if a matching send has been started, unless the send is satisfied by another receive. In particular, if the matching send is nonblocking, then the receive should complete even if no call is executed by the sender to complete the send. Similarly, a call to `MPI_WAIT` that completes a send will eventually return if a matching receive has been started, unless the receive is satisfied by another send, and even if no call is executed to complete the receive.

**Example 3.15** An illustration of progress semantics.

```

CALL MPI_COMM_RANK(comm, rank, ierr) 23
IF (RANK .EQ. 0) THEN 24
    CALL MPI_SSEND(a, 1, MPI_REAL, 1, 0, comm, ierr) 25
    CALL MPI_SEND(b, 1, MPI_REAL, 1, 1, comm, ierr) 26
ELSE IF (rank .EQ. 1) THEN 27
    CALL MPI_Irecv(a, 1, MPI_REAL, 0, 0, comm, r, ierr) 28
    CALL MPI_RECV(b, 1, MPI_REAL, 0, 1, comm, status, ierr) 29
    CALL MPI_WAIT(r, status, ierr) 30
END IF 31

```

This code should not deadlock in a correct MPI implementation. The first synchronous send of process zero must complete after process one posts the matching (nonblocking) receive even if process one has not yet reached the completing wait call. Thus, process zero will continue and execute the second send, allowing process one to complete execution.

If an `MPI_TEST` that completes a receive is repeatedly called with the same arguments, and a matching send has been started, then the call will eventually return `flag = true`, unless the send is satisfied by another receive. If an `MPI_TEST` that completes a send is repeatedly called with the same arguments, and a matching receive has been started, then the call will eventually return `flag = true`, unless the receive is satisfied by another send.

### 3.7.5 Multiple Completions

It is convenient to be able to wait for the completion of any, some, or all the operations in a list, rather than having to wait for a specific message. A call to `MPI_WAITANY` or `MPI_TESTANY` can be used to wait for the completion of one out of several operations. A call to `MPI_WAITALL` or `MPI_TESTALL` can be used to wait for all pending operations in

1 a list. A call to `MPI_WAIT SOME` or `MPI_TEST SOME` can be used to complete all enabled  
 2 operations in a list.

3  
 4  
 5 `MPI_WAIT ANY(count, array_of_requests, index, status)`

6	IN	count	list length (non-negative integer)
7	INOUT	array_of_requests	array of requests (array of handles)
8			
9	OUT	index	index of handle for operation that completed (integer)
10			
11	OUT	status	status object (status)

### 12 13 C binding

14 `int MPI_Waitany(int count, MPI_Request array_of_requests[], int *index,`  
 15 `MPI_Status *status)`

### 16 17 Fortran 2008 binding

18 `MPI_Waitany(count, array_of_requests, index, status, ierror)`  
 19 `INTEGER, INTENT(IN) :: count`  
 20 `TYPE(MPI_Request), INTENT(INOUT) :: array_of_requests(count)`  
 21 `INTEGER, INTENT(OUT) :: index`  
 22 `TYPE(MPI_Status) :: status`  
 23 `INTEGER, OPTIONAL, INTENT(OUT) :: ierror`

### 24 25 Fortran binding

26 `MPI_WAIT ANY(COUNT, ARRAY_OF_REQUESTS, INDEX, STATUS, IERROR)`  
 27 `INTEGER COUNT, ARRAY_OF_REQUESTS(*), INDEX, STATUS(MPI_STATUS_SIZE),`  
 28 `IERROR`

29  
 30 Blocks until one of the operations associated with the active requests in the array has  
 31 completed. If more than one operation is enabled and can terminate, one is arbitrarily  
 32 chosen. Returns in `index` the index of that request in the array and returns in `status` the  
 33 status of the completing operation. (The array is indexed from zero in C, and from one in  
 34 Fortran.) If the request is an active persistent request, it is marked inactive. Any other  
 35 type of request is deallocated and the request handle is set to `MPI_REQUEST_NULL`.

36 The `array_of_requests` list may contain null or inactive handles. If the list contains no  
 37 active handles (list has length zero or all entries are null or inactive), then the call returns  
 38 immediately with `index = MPI_UNDEFINED`, and an empty `status`.

39 The execution of `MPI_WAIT ANY` with an array containing multiple entries has the  
 40 same effect as the execution of `MPI_WAIT` with the array entry indicated by the output  
 41 value of `index` (unless the output value of `index` is `MPI_UNDEFINED`). `MPI_WAIT ANY` with  
 42 an array containing one active entry is equivalent to `MPI_WAIT`.



`MPI_TESTANY(count, array_of_requests, index, flag, status)`

IN	count	list length (non-negative integer)	1
INOUT	array_of_requests	array of requests (array of handles)	2
OUT	index	index of operation that completed or MPI_UNDEFINED if none completed (integer)	3
OUT	flag	true if one of the operations is complete (logical)	4
OUT	status	status object (status)	5

### C binding

```
int MPI_Testany(int count, MPI_Request array_of_requests[], int *index,
               int *flag, MPI_Status *status)
```

### Fortran 2008 binding

```
MPI_Testany(count, array_of_requests, index, flag, status, ierror)
  INTEGER, INTENT(IN) :: count
  TYPE(MPI_Request), INTENT(INOUT) :: array_of_requests(count)
  INTEGER, INTENT(OUT) :: index
  LOGICAL, INTENT(OUT) :: flag
  TYPE(MPI_Status) :: status
  INTEGER, OPTIONAL, INTENT(OUT) :: ierror
```

### Fortran binding

```
MPI_TESTANY(COUNT, ARRAY_OF_REQUESTS, INDEX, FLAG, STATUS, IERROR)
  INTEGER COUNT, ARRAY_OF_REQUESTS(*), INDEX, STATUS(MPI_STATUS_SIZE),
  IERROR
  LOGICAL FLAG
```

Tests for completion of either one or none of the operations associated with active handles. In the former case, it returns `flag = true`, returns in `index` the index of this request in the array, and returns in `status` the status of that operation. If the request is an active persistent request, it is marked as inactive. Any other type of request is deallocated and the handle is set to `MPI_REQUEST_NULL`. (The array is indexed from zero in C, and from one in Fortran.) In the latter case (no operation completed), it returns `flag = false`, returns a value of `MPI_UNDEFINED` in `index` and `status` is undefined.

The array may contain null or inactive handles. If the array contains no active handles then the call returns immediately with `flag = true`, `index = MPI_UNDEFINED`, and an empty `status`.

If the array of requests contains active handles then the execution of `MPI_TESTANY` has the same effect as the execution of `MPI_TEST` with each of the array elements in some arbitrary order, until one call returns `flag = true`, or all fail. In the former case, `index` is set to indicate which array element returned `flag = true` and in the latter case, it is set to `MPI_UNDEFINED`. `MPI_TESTANY` with an array containing one active entry is equivalent to `MPI_TEST`.

```

1 MPI_WAITALL(count, array_of_requests, array_of_statuses)
2     IN      count                list length (non-negative integer)
3
4     INOUT  array_of_requests     array of requests (array of handles)
5
6     OUT    array_of_statuses     array of status objects (array of status)

```

### C binding

```

8 int MPI_Waitall(int count, MPI_Request array_of_requests[],
9                MPI_Status array_of_statuses[])

```

### Fortran 2008 binding

```

12 MPI_Waitall(count, array_of_requests, array_of_statuses, ierror)
13     INTEGER, INTENT(IN) :: count
14     TYPE(MPI_Request), INTENT(INOUT) :: array_of_requests(count)
15     TYPE(MPI_Status) :: array_of_statuses(*)
16     INTEGER, OPTIONAL, INTENT(OUT) :: ierror

```

### Fortran binding

```

18 MPI_WAITALL(COUNT, ARRAY_OF_REQUESTS, ARRAY_OF_STATUSES, IERROR)
19     INTEGER COUNT, ARRAY_OF_REQUESTS(*), ARRAY_OF_STATUSES(MPI_STATUS_SIZE,
20     *), IERROR

```

Blocks until all communication operations associated with active handles in the list complete, and return the status of all these operations (this includes the case where no handle in the list is active). Both arrays have the same number of valid entries. The *i*-th entry in `array_of_statuses` is set to the return status of the *i*-th operation. Active persistent requests are marked inactive. Requests of any other type are deallocated and the corresponding handles in the array are set to `MPI_REQUEST_NULL`. The list may contain null or inactive handles. The call sets to empty the status of each such entry.

The error-free execution of `MPI_WAITALL` has the same effect as the execution of `MPI_WAIT` for each of the array elements in some arbitrary order. `MPI_WAITALL` with an array of length one is equivalent to `MPI_WAIT`.

When one or more of the communications completed by a call to `MPI_WAITALL` fail, it is desirable to return specific information on each communication. The function `MPI_WAITALL` will return in such case the error code `MPI_ERR_IN_STATUS` and will set the error field of each status to a specific error code. This code will be `MPI_SUCCESS`, if the specific communication completed; it will be another specific error code, if it failed; or it can be `MPI_ERR_PENDING` if it has neither failed nor completed. The function `MPI_WAITALL` will return `MPI_SUCCESS` if no request had an error, or will return another error code if it failed for other reasons (such as invalid arguments). In such cases, it will not update the error fields of the statuses.

*Rationale.* This design streamlines error handling in the application. The application code need only test the (single) function result to determine if an error has occurred. It needs to check each individual status only when an error occurred. (*End of rationale.*)

MPI\_TESTALL(count, array\_of\_requests, flag, array\_of\_statuses)

IN	count	list length (non-negative integer)	1
			2
INOUT	array_of_requests	array of requests (array of handles)	3
			4
OUT	flag	true if all of the operations are complete (logical)	5
			6
OUT	array_of_statuses	array of status objects (array of status)	7
			8

### C binding

```
int MPI_Testall(int count, MPI_Request array_of_requests[], int *flag,
               MPI_Status array_of_statuses[])
```

### Fortran 2008 binding

```
MPI_Testall(count, array_of_requests, flag, array_of_statuses, ierror)
  INTEGER, INTENT(IN) :: count
  TYPE(MPI_Request), INTENT(INOUT) :: array_of_requests(count)
  LOGICAL, INTENT(OUT) :: flag
  TYPE(MPI_Status) :: array_of_statuses(*)
  INTEGER, OPTIONAL, INTENT(OUT) :: ierror
```

### Fortran binding

```
MPI_TESTALL(COUNT, ARRAY_OF_REQUESTS, FLAG, ARRAY_OF_STATUSES, IERROR)
  INTEGER COUNT, ARRAY_OF_REQUESTS(*), ARRAY_OF_STATUSES(MPI_STATUS_SIZE,
  *), IERROR
  LOGICAL FLAG
```

Returns `flag = true` if all communications associated with active handles in the array have completed (this includes the case where no handle in the list is active). In this case, each status entry that corresponds to an active request is set to the status of the corresponding operation. Active persistent requests are marked inactive. Requests of any other type are deallocated and the corresponding handles in the array are set to `MPI_REQUEST_NULL`. Each status entry that corresponds to a null or inactive handle is set to empty.

Otherwise, `flag = false` is returned, no request is modified and the values of the status entries are undefined. This is a local operation.

Errors that occurred during the execution of `MPI_TESTALL` are handled in the same manner as errors in `MPI_WAITALL`.

```

1 MPI_WAITSOME(incount, array_of_requests, outcount, array_of_indices, array_of_statuses)
2
3     IN        incount                length of array_of_requests (non-negative integer)
4
5     INOUT    array_of_requests       array of requests (array of handles)
6
7     OUT      outcount                number of completed requests (integer)
8
9     OUT      array_of_indices        array of indices of operations that completed (array
10                                          of integers)
11
12     OUT      array_of_statuses       array of status objects for operations that completed
13                                          (array of status)

```

**C binding**

```

14 int MPI_Waitsome(int incount, MPI_Request array_of_requests[],
15                 int *outcount, int array_of_indices[],
16                 MPI_Status array_of_statuses[])

```

**Fortran 2008 binding**

```

17 MPI_Waitsome(incount, array_of_requests, outcount, array_of_indices,
18             array_of_statuses, ierror)
19     INTEGER, INTENT(IN) :: incount
20     TYPE(MPI_Request), INTENT(INOUT) :: array_of_requests(incount)
21     INTEGER, INTENT(OUT) :: outcount, array_of_indices(*)
22     TYPE(MPI_Status) :: array_of_statuses(*)
23     INTEGER, OPTIONAL, INTENT(OUT) :: ierror

```

**Fortran binding**

```

24 MPI_WAITSOME(INCOUNT, ARRAY_OF_REQUESTS, OUTCOUNT, ARRAY_OF_INDICES,
25             ARRAY_OF_STATUSES, IERROR)
26     INTEGER INCOUNT, ARRAY_OF_REQUESTS(*), OUTCOUNT, ARRAY_OF_INDICES(*),
27             ARRAY_OF_STATUSES(MPI_STATUS_SIZE, *), IERROR

```

Waits until at least one of the operations associated with active handles in the list have completed. Returns in `outcount` the number of requests from the list `array_of_requests` that have completed. Returns in the first `outcount` locations of the array `array_of_indices` the indices of these operations (index within the array `array_of_requests`; the array is indexed from zero in C and from one in Fortran). Returns in the first `outcount` locations of the array `array_of_statuses` the status for these completed operations. Completed active persistent requests are marked as inactive. Any other type or request that completed is deallocated, and the associated handle is set to `MPI_REQUEST_NULL`.

If the list contains no active handles, then the call returns immediately with `outcount = MPI_UNDEFINED`.

When one or more of the communications completed by `MPI_WAITSOME` fails, then it is desirable to return specific information on each communication. The arguments `outcount`, `array_of_indices` and `array_of_statuses` will be adjusted to indicate completion of all communications that have succeeded or failed. The call will return the error code `MPI_ERR_IN_STATUS` and the error field of each status returned will be set to indicate success or to indicate the specific error that occurred. The call will return `MPI_SUCCESS` if no request resulted in an error, and will return another error code if it failed for other

reasons (such as invalid arguments). In such cases, it will not update the error fields of the statuses.

`MPI_TESTSOME`(`incount`, `array_of_requests`, `outcount`, `array_of_indices`, `array_of_statuses`)

IN	<code>incount</code>	length of <code>array_of_requests</code> (non-negative integer)
INOUT	<code>array_of_requests</code>	array of requests (array of handles)
OUT	<code>outcount</code>	number of completed requests (integer)
OUT	<code>array_of_indices</code>	array of indices of operations that completed (array of integers)
OUT	<code>array_of_statuses</code>	array of status objects for operations that completed (array of status)

### C binding

```
int MPI_Testsome(int incount, MPI_Request array_of_requests[],
                int *outcount, int array_of_indices[],
                MPI_Status array_of_statuses[])
```

### Fortran 2008 binding

```
MPI_Testsome(incount, array_of_requests, outcount, array_of_indices,
             array_of_statuses, ierror)
INTEGER, INTENT(IN) :: incount
TYPE(MPI_Request), INTENT(INOUT) :: array_of_requests(incount)
INTEGER, INTENT(OUT) :: outcount, array_of_indices(*)
TYPE(MPI_Status) :: array_of_statuses(*)
INTEGER, OPTIONAL, INTENT(OUT) :: ierror
```

### Fortran binding

```
MPI_TESTSOME(INCOUNT, ARRAY_OF_REQUESTS, OUTCOUNT, ARRAY_OF_INDICES,
             ARRAY_OF_STATUSES, IERROR)
INTEGER INCOUNT, ARRAY_OF_REQUESTS(*), OUTCOUNT, ARRAY_OF_INDICES(*),
             ARRAY_OF_STATUSES(MPI_STATUS_SIZE, *), IERROR
```

Behaves like `MPI_WAITSSOME`, except that it returns immediately. If no operation has completed it returns `outcount = 0`. If there is no active handle in the list it returns `outcount = MPI_UNDEFINED`.

`MPI_TESTSOME` is a local operation, which returns immediately, whereas `MPI_WAITSSOME` will block until a communication completes, if it was passed a list that contains at least one active handle. Both calls fulfill a **fairness** requirement: If a request for a receive repeatedly appears in a list of requests passed to `MPI_WAITSSOME` or `MPI_TESTSOME`, and a matching send has been posted, then the receive will eventually succeed, unless the send is satisfied by another receive; and similarly for send requests.

Errors that occur during the execution of `MPI_TESTSOME` are handled as for `MPI_WAITSSOME`.

*Advice to users.* The use of `MPI_TESTSOME` is likely to be more efficient than the use of `MPI_TESTANY`. The former returns information on all completed communications,

with the latter, a new call is required for each communication that completes.

A server with multiple clients can use `MPI_WAITSSOME` so as not to starve any client. Clients send messages to the server with service requests. The server calls `MPI_WAITSSOME` with one receive request for each client, and then handles all receives that completed. If a call to `MPI_WAITANY` is used instead, then one client could starve while requests from another client always sneak in first. (*End of advice to users.*)

*Advice to implementors.* `MPI_TESTSSOME` should complete as many pending communications as possible. (*End of advice to implementors.*)

**Example 3.16** Client-server code (starvation can occur).

```

13 CALL MPI_COMM_SIZE(comm, size, ierr)
14 CALL MPI_COMM_RANK(comm, rank, ierr)
15 IF (rank .GT. 0) THEN           ! client code
16   DO WHILE(.TRUE.)
17     CALL MPI_ISEND(a, n, MPI_REAL, 0, tag, comm, request, ierr)
18     CALL MPI_WAIT(request, status, ierr)
19   END DO
20 ELSE                           ! rank=0 -- server code
21   DO i=1,size-1
22     CALL MPI_Irecv(a(1,i), n, MPI_REAL, i, tag, &
23                  comm, request_list(i), ierr)
24   END DO
25   DO WHILE(.TRUE.)
26     CALL MPI_WAITANY(size-1, request_list, index, status, ierr)
27     CALL DO_SERVICE(a(1,index)) ! handle one message
28     CALL MPI_Irecv(a(1, index), n, MPI_REAL, index, tag, &
29                  comm, request_list(index), ierr)
30   END DO
31 END IF

```

**Example 3.17** Same code, using `MPI_WAITSSOME`.

```

35 CALL MPI_COMM_SIZE(comm, size, ierr)
36 CALL MPI_COMM_RANK(comm, rank, ierr)
37 IF (rank .GT. 0) THEN           ! client code
38   DO WHILE(.TRUE.)
39     CALL MPI_ISEND(a, n, MPI_REAL, 0, tag, comm, request, ierr)
40     CALL MPI_WAIT(request, status, ierr)
41   END DO
42 ELSE                           ! rank=0 -- server code
43   DO i=1,size-1
44     CALL MPI_Irecv(a(1,i), n, MPI_REAL, i, tag, &
45                  comm, request_list(i), ierr)
46   END DO
47   DO WHILE(.TRUE.)
48

```

```

CALL MPI_WAITSSOME(size, request_list, numdone, &
                   indices, statuses, ierr)
DO i=1,numdone
  CALL DO_SERVICE(a(1, indices(i)))
  CALL MPI_Irecv(a(1, indices(i)), n, MPI_REAL, 0, tag, &
                comm, request_list(indices(i)), ierr)
END DO
END DO
END IF

```

### 3.7.6 Non-Destructive Test of status

This call is useful for accessing the information associated with a request, without freeing the request (in case the user is expected to access it later). It allows one to layer libraries more conveniently, since multiple layers of software may access the same completed request and extract from it the status information.

**MPI\_REQUEST\_GET\_STATUS**(request, flag, status)

IN	request	request (handle)
OUT	flag	boolean flag, same as from MPI_TEST (logical)
OUT	status	status object if flag is true (status)

#### C binding

```
int MPI_Request_get_status(MPI_Request request, int *flag,
                          MPI_Status *status)
```

#### Fortran 2008 binding

```
MPI_Request_get_status(request, flag, status, ierror)
  TYPE(MPI_Request), INTENT(IN) :: request
  LOGICAL, INTENT(OUT) :: flag
  TYPE(MPI_Status) :: status
  INTEGER, OPTIONAL, INTENT(OUT) :: ierror
```

#### Fortran binding

```
MPI_REQUEST_GET_STATUS(REQUEST, FLAG, STATUS, IERROR)
  INTEGER REQUEST, STATUS(MPI_STATUS_SIZE), IERROR
  LOGICAL FLAG
```

Sets `flag = true` if the operation is complete, and, if so, returns in `status` the request status. However, unlike `test` or `wait`, it does not deallocate or inactivate the request; a subsequent call to `test`, `wait` or `free` should be executed with that request. It sets `flag = false` if the operation is not complete.

One is allowed to call `MPI_REQUEST_GET_STATUS` with a null or inactive request argument. In such a case the operation returns with `flag = true` and empty `status`.

## 3.8 Probe and Cancel

The `MPI_PROBE`, `MPI_IPROBE`, `MPI_MPROBE`, and `MPI_IMPROBE` operations allow incoming messages to be checked for, without actually receiving them. The user can then decide how to receive them, based on the information returned by the probe (basically, the information returned by `status`). In particular, the user may allocate memory for the receive buffer, according to the length of the probed message.

The `MPI_CANCEL` operation allows pending communications to be cancelled. This is required for cleanup. Posting a send or a receive ties up user resources (send or receive buffers), and a **cancel** may be needed to free these resources gracefully.

Cancelling a send request by calling `MPI_CANCEL` is deprecated. Cancelling a `sendrecv` request by calling `MPI_CANCEL` is not allowed.

### 3.8.1 Probe

`MPI_IPROBE(source, tag, comm, flag, status)`

IN	source	rank of source or <code>MPI_ANY_SOURCE</code> (integer)
IN	tag	message tag or <code>MPI_ANY_TAG</code> (integer)
IN	comm	communicator (handle)
OUT	flag	true if there is a matching message that can be received (logical)
OUT	status	status object (status)

#### C binding

```
int MPI_Iprobe(int source, int tag, MPI_Comm comm, int *flag,
              MPI_Status *status)
```

#### Fortran 2008 binding

```
MPI_Iprobe(source, tag, comm, flag, status, ierror)
  INTEGER, INTENT(IN) :: source, tag
  TYPE(MPI_Comm), INTENT(IN) :: comm
  LOGICAL, INTENT(OUT) :: flag
  TYPE(MPI_Status) :: status
  INTEGER, OPTIONAL, INTENT(OUT) :: ierror
```

#### Fortran binding

```
MPI_IPROBE(SOURCE, TAG, COMM, FLAG, STATUS, IERROR)
  INTEGER SOURCE, TAG, COMM, STATUS(MPI_STATUS_SIZE), IERROR
  LOGICAL FLAG
```

`MPI_IPROBE(source, tag, comm, flag, status)` returns `flag = true` if there is a message that can be received and that matches the pattern specified by the arguments `source`, `tag`, and `comm`. The call matches the same message that would have been received by a call to `MPI_RECV(..., source, tag, comm, status)` executed at the same point in the program, and returns in `status` the same value that would have been returned by `MPI_RECV()`. Otherwise, the call returns `flag = false`, and leaves `status` undefined.



If `MPI_Iprobe` returns `flag = true`, then the content of the status object can be subsequently accessed as described in Section 3.2.5 to find the source, tag, and length of the probed message.

`MPI_Iprobe` is a local procedure since its return does not depend on MPI calls in other MPI processes, which is marked with the prefix `I` (for immediate).

A subsequent receive executed with the same communicator, and the source and tag returned in status by `MPI_Iprobe` will receive the message that was matched by the probe, if no other intervening receive occurs after the probe, and the send is not successfully cancelled before the receive. If the receiving process is multithreaded, it is the user's responsibility to ensure that the last condition holds.

The `source` argument of `MPI_Probe` can be `MPI_ANY_SOURCE`, and the `tag` argument can be `MPI_ANY_TAG`, so that one can probe for messages from an arbitrary source and/or with an arbitrary tag. However, a specific communication context must be provided with the `comm` argument.

It is not necessary to receive a message immediately after it has been probed for, and the same message may be probed for several times before it is received.

A probe with `MPI_PROC_NULL` as source returns `flag = true`, and the status object returns `source = MPI_PROC_NULL`, `tag = MPI_ANY_TAG`, and `count = 0`; see Section 3.10.

`MPI_Probe(source, tag, comm, status)`

IN	source	rank of source or <code>MPI_ANY_SOURCE</code> (integer)
IN	tag	message tag or <code>MPI_ANY_TAG</code> (integer)
IN	comm	communicator (handle)
OUT	status	status object (status)

### C binding

```
int MPI_Probe(int source, int tag, MPI_Comm comm, MPI_Status *status)
```

### Fortran 2008 binding

```
MPI_Probe(source, tag, comm, status, ierror)
  INTEGER, INTENT(IN) :: source, tag
  TYPE(MPI_Comm), INTENT(IN) :: comm
  TYPE(MPI_Status) :: status
  INTEGER, OPTIONAL, INTENT(OUT) :: ierror
```

### Fortran binding

```
MPI_PROBE(SOURCE, TAG, COMM, STATUS, IERROR)
  INTEGER SOURCE, TAG, COMM, STATUS(MPI_STATUS_SIZE), IERROR
```

`MPI_Probe` behaves like `MPI_Iprobe` except that it is a non-local call that returns only after a matching message has been found.

The MPI implementation of `MPI_Probe` and `MPI_Iprobe` needs to guarantee progress: if a call to `MPI_Probe` has been issued by a process, and a send that matches the probe has been initiated by some process, then the call to `MPI_Probe` will return, unless the message is received by another concurrent receive operation (that is executed by another thread at the probing process). Similarly, if a process busy waits with `MPI_Iprobe` and a matching message has been issued, then the call to `MPI_Iprobe` will eventually return `flag`

1 = true unless the message is received by another concurrent receive operation or matched  
 2 by a concurrent matched probe.  
 3

4 **Example 3.18** Use probe to wait for an incoming message.

```

5     CALL MPI_COMM_RANK(comm, rank, ierr)
6     IF (rank .EQ. 0) THEN
7         CALL MPI_SEND(i, 1, MPI_INTEGER, 2, 0, comm, ierr)
8     ELSE IF (rank .EQ. 1) THEN
9         CALL MPI_SEND(x, 1, MPI_REAL, 2, 0, comm, ierr)
10    ELSE IF (rank .EQ. 2) THEN
11        DO i=1,2
12            CALL MPI_PROBE(MPI_ANY_SOURCE, 0, &
13                          comm, status, ierr)
14            IF (status(MPI_SOURCE) .EQ. 0) THEN
15100            CALL MPI_RECV(i, 1, MPI_INTEGER, 0, 0, comm, status, ierr)
16            ELSE
17200            CALL MPI_RECV(x, 1, MPI_REAL, 1, 0, comm, status, ierr)
18            END IF
19        END DO
20    END IF
21
```

22 Each message is received with the right type.  
 23

24 **Example 3.19** A similar program to the previous example, but now it has a problem.

```

25 /* ----- THIS EXAMPLE IS ERRONEOUS ----- */
26 CALL MPI_COMM_RANK(comm, rank, ierr)
27 IF (rank .EQ. 0) THEN
28     CALL MPI_SEND(i, 1, MPI_INTEGER, 2, 0, comm, ierr)
29 ELSE IF (rank .EQ. 1) THEN
30     CALL MPI_SEND(x, 1, MPI_REAL, 2, 0, comm, ierr)
31 ELSE IF (rank .EQ. 2) THEN
32     DO i=1,2
33         CALL MPI_PROBE(MPI_ANY_SOURCE, 0, &
34                       comm, status, ierr)
35         IF (status(MPI_SOURCE) .EQ. 0) THEN
36100         CALL MPI_RECV(i, 1, MPI_INTEGER, MPI_ANY_SOURCE, &
37                       0, comm, status, ierr)
38         ELSE
39200         CALL MPI_RECV(x, 1, MPI_REAL, MPI_ANY_SOURCE, &
40                       0, comm, status, ierr)
41         END IF
42     END DO
43 END IF
44
```

45 In Example 3.19, the two receive calls in statements labeled 100 and 200 in Example 3.18  
 46 are slightly modified, using MPI\_ANY\_SOURCE as the source argument. The program is now  
 47 incorrect: the receive operation may receive a message that is distinct from the message  
 48 probed by the preceding call to MPI\_PROBE.

*Advice to users.* In a multithreaded MPI program, MPI\_PROBE and MPI\_Iprobe might need special care. If a thread probes for a message and then immediately posts a matching receive, the receive may match a message other than that found by the probe since another thread could concurrently receive that original message [33]. MPI\_Mprobe and MPI\_Improbe solve this problem by matching the incoming message so that it may only be received with MPI\_Mrecv or MPI\_Irecv on the corresponding message handle. (*End of advice to users.*)

*Advice to implementors.* A call to MPI\_PROBE(source, tag, comm, status) will match the message that would have been received by a call to MPI\_RECV(..., source, tag, comm, status) executed at the same point. Suppose that this message has source *s*, tag *t* and communicator *c*. If the tag argument in the probe call has value MPI\_ANY\_TAG then the message probed will be the earliest pending message from source *s* with communicator *c* and any tag; in any case, the message probed will be the earliest pending message from source *s* with tag *t* and communicator *c* (this is the message that would have been received, so as to preserve message order). This message continues as the earliest pending message from source *s* with tag *t* and communicator *c*, until it is received. A receive operation subsequent to the probe that uses the same communicator as the probe and uses the tag and source values returned by the probe, must receive this message, unless it has already been received by another receive operation. (*End of advice to implementors.*)

### 3.8.2 Matching Probe

The function MPI\_PROBE checks for incoming messages without receiving them. Since the list of incoming messages is global among the threads of each MPI process, it can be hard to use this functionality in threaded environments [33, 30].

Like MPI\_PROBE and MPI\_Iprobe, the MPI\_Mprobe and MPI\_Improbe operations allow incoming messages to be queried without actually receiving them, except that MPI\_Mprobe and MPI\_Improbe provide a mechanism to receive the specific message that was matched regardless of other intervening probe or receive operations. This gives the application an opportunity to decide how to receive the message, based on the information returned by the probe. In particular, the user may allocate memory for the receive buffer, according to the length of the probed message.

MPI\_Improbe(source, tag, comm, flag, message, status)

IN	source	rank of source or MPI_ANY_SOURCE (integer)
IN	tag	message tag or MPI_ANY_TAG (integer)
IN	comm	communicator (handle)
OUT	flag	true if there is a matching message that can be received (logical)
OUT	message	returned message (handle)
OUT	status	status object (status)

#### C binding

```
int MPI_Improbe(int source, int tag, MPI_Comm comm, int *flag,
```

```
1 MPI_Message *message, MPI_Status *status)
```

### 2 Fortran 2008 binding

```
3 MPI_Improbe(source, tag, comm, flag, message, status, ierror)
4 INTEGER, INTENT(IN) :: source, tag
5 TYPE(MPI_Comm), INTENT(IN) :: comm
6 LOGICAL, INTENT(OUT) :: flag
7 TYPE(MPI_Message), INTENT(OUT) :: message
8 TYPE(MPI_Status) :: status
9 INTEGER, OPTIONAL, INTENT(OUT) :: ierror
10
```

### 11 Fortran binding

```
12 MPI_IMPROBE(SOURCE, TAG, COMM, FLAG, MESSAGE, STATUS, IERROR)
13 INTEGER SOURCE, TAG, COMM, MESSAGE, STATUS(MPI_STATUS_SIZE), IERROR
14 LOGICAL FLAG
15
```

16 MPI\_IMPROBE(source, tag, comm, flag, message, status) returns flag = true if there is  
 17 a message that can be received and that matches the pattern specified by the arguments  
 18 source, tag, and comm. The call matches the same message that would have been received  
 19 by a call to MPI\_RECV(..., source, tag, comm, status) executed at the same point in the  
 20 program and returns in status the same value that would have been returned by MPI\_RECV.  
 21 In addition, it returns in message a handle to the matched message. Otherwise, the call  
 22 returns flag = false, and leaves status and message undefined.

23 MPI\_IMPROBE is a local procedure. According to the definitions in Section 2.4.2 and  
 24 in contrast to MPI\_IPROBE, it is a nonblocking procedure because it is the initialization of  
 25 a matched receive operation.

26 A matched receive (MPI\_MRECV or MPI\_IMRECV) executed with the message han-  
 27 dle will receive the message that was matched by the probe. Unlike MPI\_IPROBE, no  
 28 other probe or receive operation may match the message returned by MPI\_IMPROBE.  
 29 Each message returned by MPI\_IMPROBE must be received with either MPI\_MRECV or  
 30 MPI\_IMRECV.

31 The source argument of MPI\_IMPROBE can be MPI\_ANY\_SOURCE, and the tag argu-  
 32 ment can be MPI\_ANY\_TAG, so that one can probe for messages from an arbitrary source  
 33 and/or with an arbitrary tag. However, a specific communication context must be provided  
 34 with the comm argument.

35 A synchronous send operation that is matched with MPI\_IMPROBE or MPI\_MPROBE  
 36 will complete successfully only if both a matching receive is posted with MPI\_MRECV or  
 37 MPI\_IMRECV, and the receive operation has started to receive the message sent by the  
 38 synchronous send.

39 There is a special predefined message: MPI\_MESSAGE\_NO\_PROC, which is a message  
 40 which has MPI\_PROC\_NULL as its source process. The predefined constant  
 41 MPI\_MESSAGE\_NULL is the value used for invalid message handles.

42 A matching probe with source = MPI\_PROC\_NULL returns flag = true, message =  
 43 MPI\_MESSAGE\_NO\_PROC, and the status object returns source = MPI\_PROC\_NULL, tag =  
 44 MPI\_ANY\_TAG, and count = 0; see Section 3.10. It is not necessary to call MPI\_MRECV or  
 45 MPI\_IMRECV with MPI\_MESSAGE\_NO\_PROC, but it is not erroneous to do so.

46 *Rationale.* MPI\_MESSAGE\_NO\_PROC was chosen instead of  
 47  
 48

MPI\_MESSAGE\_PROC\_NULL to avoid possible confusion as another null handle constant. (*End of rationale.*)

MPI\_MPROBE(source, tag, comm, message, status)

IN	source	rank of source or MPI_ANY_SOURCE (integer)
IN	tag	message tag or MPI_ANY_TAG (integer)
IN	comm	communicator (handle)
OUT	message	returned message (handle)
OUT	status	status object (status)

### C binding

```
int MPI_Mprobe(int source, int tag, MPI_Comm comm, MPI_Message *message,
               MPI_Status *status)
```

### Fortran 2008 binding

```
MPI_Mprobe(source, tag, comm, message, status, ierror)
  INTEGER, INTENT(IN) :: source, tag
  TYPE(MPI_Comm), INTENT(IN) :: comm
  TYPE(MPI_Message), INTENT(OUT) :: message
  TYPE(MPI_Status) :: status
  INTEGER, OPTIONAL, INTENT(OUT) :: ierror
```

### Fortran binding

```
MPI_MPROBE(SOURCE, TAG, COMM, MESSAGE, STATUS, IERROR)
  INTEGER SOURCE, TAG, COMM, MESSAGE, STATUS(MPI_STATUS_SIZE), IERROR
```

MPI\_MPROBE behaves like MPI\_IMPROBE except that it is a blocking call that returns only after a matching message has been found.

The implementation of MPI\_MPROBE and MPI\_IMPROBE needs to guarantee progress in the same way as in the case of MPI\_PROBE and MPI\_IPROBE.

According to the definitions in Section 2.4.2, MPI\_MPROBE is incomplete. It is also a non-local procedure.

*Advice to users.* This is one of the exceptions in which incomplete procedures are non-local. (*End of advice to users.*)

### 3.8.3 Matched Receives

The functions MPI\_MRECV and MPI\_IMRECV receive messages that have been previously matched by a matching probe (Section 3.8.2).

```

1 MPI_MRECV(buf, count, datatype, message, status)
2   OUT    buf                initial address of receive buffer (choice)
3
4   IN     count              number of elements in receive buffer (non-negative
5                               integer)
6
7   IN     datatype           datatype of each receive buffer element (handle)
8   INOUT  message            message (handle)
9   OUT    status              status object (status)

```

### C binding

```

12 int MPI_Mrecv(void *buf, int count, MPI_Datatype datatype,
13              MPI_Message *message, MPI_Status *status)
14
15 int MPI_Mrecv_c(void *buf, MPI_Count count, MPI_Datatype datatype,
16                MPI_Message *message, MPI_Status *status)

```

### Fortran 2008 binding

```

18 MPI_Mrecv(buf, count, datatype, message, status, ierror)
19   TYPE(*), DIMENSION(..) :: buf
20   INTEGER, INTENT(IN) :: count
21   TYPE(MPI_Datatype), INTENT(IN) :: datatype
22   TYPE(MPI_Message), INTENT(INOUT) :: message
23   TYPE(MPI_Status) :: status
24   INTEGER, OPTIONAL, INTENT(OUT) :: ierror
25
26 MPI_Mrecv(buf, count, datatype, message, status, ierror)
27   TYPE(*), DIMENSION(..) :: buf
28   INTEGER(KIND=MPI_COUNT_KIND), INTENT(IN) :: count
29   TYPE(MPI_Datatype), INTENT(IN) :: datatype
30   TYPE(MPI_Message), INTENT(INOUT) :: message
31   TYPE(MPI_Status) :: status
32   INTEGER, OPTIONAL, INTENT(OUT) :: ierror

```

### Fortran binding

```

34 MPI_MRECV(BUF, COUNT, DATATYPE, MESSAGE, STATUS, IERROR)
35   <type> BUF(*)
36   INTEGER COUNT, DATATYPE, MESSAGE, STATUS(MPI_STATUS_SIZE), IERROR

```

This call receives a message matched by a matching probe operation (Section 3.8.2).

The receive buffer consists of the storage containing `count` consecutive elements of the type specified by `datatype`, starting at address `buf`. The length of the received message must be less than or equal to the length of the receive buffer. An overflow error occurs if all incoming data does not fit, without truncation, into the receive buffer.

If the message is shorter than the receive buffer, then only those locations corresponding to the (shorter) message are modified.

On return from this function, the message handle is set to `MPI_MESSAGE_NULL`. All errors that occur during the execution of this operation are handled according to the error handler set for the communicator used in the matching probe call that produced the message handle.

If MPI\_MRECV is called with MPI\_MESSAGE\_NO\_PROC as the message argument, the call returns immediately with the status object set to source = MPI\_PROC\_NULL, tag = MPI\_ANY\_TAG, and count = 0. This is consistent with the status object produced by a call to MPI\_RECV or to MPI\_PROBE with source = MPI\_PROC\_NULL (see Section 3.10). A call to MPI\_MRECV with MPI\_MESSAGE\_NULL is erroneous.

MPI\_IMRECV(buf, count, datatype, message, request)

OUT	buf	initial address of receive buffer (choice)
IN	count	number of elements in receive buffer (non-negative integer)
IN	datatype	datatype of each receive buffer element (handle)
INOUT	message	message (handle)
OUT	request	communication request (handle)

### C binding

```
int MPI_Imrecv(void *buf, int count, MPI_Datatype datatype,
               MPI_Message *message, MPI_Request *request)
```

```
int MPI_Imrecv_c(void *buf, MPI_Count count, MPI_Datatype datatype,
                 MPI_Message *message, MPI_Request *request)
```

### Fortran 2008 binding

```
MPI_Imrecv(buf, count, datatype, message, request, ierror)
  TYPE(*), DIMENSION(..), ASYNCHRONOUS :: buf
  INTEGER, INTENT(IN) :: count
  TYPE(MPI_Datatype), INTENT(IN) :: datatype
  TYPE(MPI_Message), INTENT(INOUT) :: message
  TYPE(MPI_Request), INTENT(OUT) :: request
  INTEGER, OPTIONAL, INTENT(OUT) :: ierror
```

```
MPI_Imrecv(buf, count, datatype, message, request, ierror)
  TYPE(*), DIMENSION(..), ASYNCHRONOUS :: buf
  INTEGER(KIND=MPI_COUNT_KIND), INTENT(IN) :: count
  TYPE(MPI_Datatype), INTENT(IN) :: datatype
  TYPE(MPI_Message), INTENT(INOUT) :: message
  TYPE(MPI_Request), INTENT(OUT) :: request
  INTEGER, OPTIONAL, INTENT(OUT) :: ierror
```

### Fortran binding

```
MPI_IMRECV(BUF, COUNT, DATATYPE, MESSAGE, REQUEST, IERROR)
  <type> BUF(*)
  INTEGER COUNT, DATATYPE, MESSAGE, REQUEST, IERROR
```

MPI\_IMRECV is the nonblocking variant of MPI\_MRECV and starts a nonblocking receive of a matched message. Completion semantics are similar to MPI\_IRECV as described in Section 3.7.2. On return from this function, the message handle is set to MPI\_MESSAGE\_NULL.



1 If `MPI_IMRECV` is called with `MPI_MESSAGE_NO_PROC` as the message argument, the  
 2 call returns immediately with a request object which, when completed, will yield a status  
 3 object set to `source = MPI_PROC_NULL`, `tag = MPI_ANY_TAG`, and `count = 0`, as if a receive  
 4 from `MPI_PROC_NULL` was issued (see Section 3.10). A call to `MPI_IMRECV` with  
 5 `MPI_MESSAGE_NULL` is erroneous.

6  
 7 *Advice to implementors.* If reception of a matched message is started with  
 8 `MPI_IMRECV`, then it is possible to cancel the returned request with `MPI_CANCEL`. If  
 9 `MPI_CANCEL` succeeds, the matched message must be found by a subsequent message  
 10 probe (`MPI_PROBE`, `MPI_IPROBE`, `MPI_MPROBE`, or `MPI_IMPROBE`), received by  
 11 a subsequent receive operation or cancelled by the sender. See Section 3.8.4 for details  
 12 about `MPI_CANCEL`. The cancellation of operations initiated with `MPI_IMRECV` may  
 13 fail. (*End of advice to implementors.*)

### 14 3.8.4 Cancel

15  
 16  
 17  
 18 `MPI_CANCEL(request)`

19 IN request communication request (handle)

#### 21 C binding

22 `int MPI_Cancel(MPI_Request *request)`

#### 23 Fortran 2008 binding

24 `MPI_Cancel(request, ierror)`  
 25 `TYPE(MPI_Request), INTENT(IN) :: request`  
 26 `INTEGER, OPTIONAL, INTENT(OUT) :: ierror`

#### 27 Fortran binding

28 `MPI_CANCEL(REQUEST, IERROR)`  
 29 `INTEGER REQUEST, IERROR`

30  
 31  
 32 A call to `MPI_CANCEL` marks for cancellation a pending, nonblocking communica-  
 33 tion operation (send or receive). Cancelling a send request by calling `MPI_CANCEL` is  
 34 deprecated. The cancel call is local. It returns immediately, possibly before the communi-  
 35 cation is actually cancelled. It is still necessary to call `MPI_REQUEST_FREE`, `MPI_WAIT` or  
 36 `MPI_TEST` (or any of the derived operations) with the cancelled request as argument after  
 37 the call to `MPI_CANCEL`. If a communication is marked for cancellation, then a `MPI_WAIT`  
 38 call for that communication is guaranteed to return, irrespective of the activities of other  
 39 processes (i.e., `MPI_WAIT` behaves as a local function); similarly if `MPI_TEST` is repeatedly  
 40 called in a busy wait loop for a cancelled communication, then `MPI_TEST` will eventually  
 41 be successful.

42  
 43 `MPI_CANCEL` can be used to cancel a communication that uses a persistent request (see  
 44 Section 3.9), in the same way it is used for nonpersistent requests. Cancelling a persistent  
 45 send request by calling `MPI_CANCEL` is deprecated. A successful cancellation cancels the  
 46 active communication, but not the request itself. After the call to `MPI_CANCEL` and the  
 47 subsequent call to `MPI_WAIT` or `MPI_TEST`, the request becomes inactive and can be  
 48 activated for a new communication.



The successful cancellation of a buffered send frees the buffer space occupied by the pending message. Cancelling a buffered send request by calling `MPI_CANCEL` is deprecated.

Either the cancellation succeeds, or the communication succeeds, but not both. If a send is marked for cancellation, which is deprecated, then it must be the case that either the send completes normally, in which case the message sent was received at the destination process, or that the send is successfully cancelled, in which case no part of the message was received at the destination. Then, any matching receive has to be satisfied by another send. If a receive is marked for cancellation, then it must be the case that either the receive completes normally, or that the receive is successfully cancelled, in which case no part of the receive buffer is altered. Then, any matching send has to be satisfied by another receive.

If the operation has been cancelled, then information to that effect will be returned in the status argument of the operation that completes the communication.

*Rationale.* Although the IN request handle parameter should not need to be passed by reference, the C binding has listed the argument type as `MPI_Request*` since MPI-1.0. This function signature therefore cannot be changed without breaking existing MPI applications. (*End of rationale.*)

`MPI_TEST_CANCELLED(status, flag)`

IN	status	status object (status)
OUT	flag	true if the operation has been cancelled (logical)

#### C binding

```
int MPI_Test_cancelled(const MPI_Status *status, int *flag)
```

#### Fortran 2008 binding

```
MPI_Test_cancelled(status, flag, ierror)
  TYPE(MPI_Status), INTENT(IN) :: status
  LOGICAL, INTENT(OUT) :: flag
  INTEGER, OPTIONAL, INTENT(OUT) :: ierror
```

#### Fortran binding

```
MPI_TEST_CANCELLED(STATUS, FLAG, IERROR)
  INTEGER STATUS(MPI_STATUS_SIZE), IERROR
  LOGICAL FLAG
```

Returns `flag = true` if the communication associated with the status object was cancelled successfully. In such a case, all other fields of `status` (such as `count` or `tag`) are undefined. Returns `flag = false`, otherwise. If a receive operation might be cancelled then one should call `MPI_TEST_CANCELLED` first, to check whether the operation was cancelled, before checking on the other fields of the return status.

*Advice to users.* Cancel can be an expensive operation that should be used only exceptionally. (*End of advice to users.*)

*Advice to implementors.* If a send operation uses an “eager” protocol (data is transferred to the receiver before a matching receive is posted), then the cancellation

of this send may require communication with the intended receiver in order to free allocated buffers. On some systems this may require an interrupt to the intended receiver. Note that, while communication may be needed to implement `MPI_CANCEL`, this is still a local operation, since its completion does not depend on the code executed by other processes. If processing is required on another process, this should be transparent to the application (hence the need for an interrupt and an interrupt handler). (*End of advice to implementors.*)

### 3.9 Persistent Communication Requests

Often a communication with the same argument list (with the exception of the buffer contents) is repeatedly executed within the inner loop of a parallel computation. In such a situation, it may be possible to optimize the communication by binding the list of communication arguments to a **persistent** communication request once and then repeatedly using the request to initiate and complete operations. In the case of point-to-point communication, the persistent request thus created can be thought of as a communication port or a “half-channel.” It does not provide the full functionality of a conventional channel, since there is no binding of the send port to the receive port. This construct allows reduction of the overhead for communication between the process and communication controller, but not of the overhead for communication between one communication controller and another. It is not necessary that messages sent with a persistent point-to-point request be received by a receive operation using a persistent point-to-point request, or vice versa.

There are also persistent collective communication operations defined in Section 6.13 and Section 8.8. The remainder of this section covers the point-to-point persistent initialization operations and the start routines, which are used for both persistent point-to-point and persistent collective communication operations.

A persistent point-to-point communication request is created using one of the five following calls. These point-to-point persistent initialization calls involve no communication.

`MPI_SEND_INIT(buf, count, datatype, dest, tag, comm, request)`

IN	<code>buf</code>	initial address of send buffer (choice)
IN	<code>count</code>	number of elements sent (non-negative integer)
IN	<code>datatype</code>	type of each element (handle)
IN	<code>dest</code>	rank of destination (integer)
IN	<code>tag</code>	message tag (integer)
IN	<code>comm</code>	communicator (handle)
OUT	<code>request</code>	communication request (handle)

#### C binding

```
int MPI_Send_init(const void *buf, int count, MPI_Datatype datatype,
                 int dest, int tag, MPI_Comm comm, MPI_Request *request)
```

```
int MPI_Send_init_c(const void *buf, MPI_Count count,
                   MPI_Datatype datatype, int dest, int tag, MPI_Comm comm,
                   MPI_Request *request)
```

**Fortran 2008 binding**

```

MPI_Send_init(buf, count, datatype, dest, tag, comm, request, ierror)
  TYPE(*), DIMENSION(..), INTENT(IN), ASYNCHRONOUS :: buf
  INTEGER, INTENT(IN) :: count, dest, tag
  TYPE(MPI_Datatype), INTENT(IN) :: datatype
  TYPE(MPI_Comm), INTENT(IN) :: comm
  TYPE(MPI_Request), INTENT(OUT) :: request
  INTEGER, OPTIONAL, INTENT(OUT) :: ierror

```

```

MPI_Send_init(buf, count, datatype, dest, tag, comm, request, ierror)
  TYPE(*), DIMENSION(..), INTENT(IN), ASYNCHRONOUS :: buf
  INTEGER(KIND=MPI_COUNT_KIND), INTENT(IN) :: count
  TYPE(MPI_Datatype), INTENT(IN) :: datatype
  INTEGER, INTENT(IN) :: dest, tag
  TYPE(MPI_Comm), INTENT(IN) :: comm
  TYPE(MPI_Request), INTENT(OUT) :: request
  INTEGER, OPTIONAL, INTENT(OUT) :: ierror

```

**Fortran binding**

```

MPI_SEND_INIT(BUF, COUNT, DATATYPE, DEST, TAG, COMM, REQUEST, IERROR)
  <type> BUF(*)
  INTEGER COUNT, DATATYPE, DEST, TAG, COMM, REQUEST, IERROR

```

Creates a persistent communication request for a standard mode send operation.

```

MPI_BSEND_INIT(buf, count, datatype, dest, tag, comm, request)

```

IN	buf	initial address of send buffer (choice)
IN	count	number of elements sent (non-negative integer)
IN	datatype	type of each element (handle)
IN	dest	rank of destination (integer)
IN	tag	message tag (integer)
IN	comm	communicator (handle)
OUT	request	communication request (handle)

**C binding**

```

int MPI_Bsend_init(const void *buf, int count, MPI_Datatype datatype,
  int dest, int tag, MPI_Comm comm, MPI_Request *request)

```

```

int MPI_Bsend_init_c(const void *buf, MPI_Count count,
  MPI_Datatype datatype, int dest, int tag, MPI_Comm comm,
  MPI_Request *request)

```

**Fortran 2008 binding**

```

MPI_Bsend_init(buf, count, datatype, dest, tag, comm, request, ierror)
  TYPE(*), DIMENSION(..), INTENT(IN), ASYNCHRONOUS :: buf
  INTEGER, INTENT(IN) :: count, dest, tag
  TYPE(MPI_Datatype), INTENT(IN) :: datatype

```

```

1     TYPE(MPI_Comm), INTENT(IN) :: comm
2     TYPE(MPI_Request), INTENT(OUT) :: request
3     INTEGER, OPTIONAL, INTENT(OUT) :: ierror
4
5 MPI_Bsend_init(buf, count, datatype, dest, tag, comm, request, ierror)
6     TYPE(*), DIMENSION(..), INTENT(IN), ASYNCHRONOUS :: buf
7     INTEGER(KIND=MPI_COUNT_KIND), INTENT(IN) :: count
8     TYPE(MPI_Datatype), INTENT(IN) :: datatype
9     INTEGER, INTENT(IN) :: dest, tag
10    TYPE(MPI_Comm), INTENT(IN) :: comm
11    TYPE(MPI_Request), INTENT(OUT) :: request
12    INTEGER, OPTIONAL, INTENT(OUT) :: ierror

```

### 13 Fortran binding

```

14 MPI_BSEND_INIT(BUF, COUNT, DATATYPE, DEST, TAG, COMM, REQUEST, IERROR)
15     <type> BUF(*)
16     INTEGER COUNT, DATATYPE, DEST, TAG, COMM, REQUEST, IERROR

```

17 Creates a persistent communication request for a buffered mode send operation.

```

19
20 MPI_SSEND_INIT(buf, count, datatype, dest, tag, comm, request)
21
22     IN        buf                initial address of send buffer (choice)
23     IN        count              number of elements sent (non-negative integer)
24     IN        datatype           type of each element (handle)
25     IN        dest               rank of destination (integer)
26     IN        tag                message tag (integer)
27     IN        comm              communicator (handle)
28     IN        request            communication request (handle)
29
30     OUT       request

```

### 32 C binding

```

33 int MPI_Ssend_init(const void *buf, int count, MPI_Datatype datatype,
34                  int dest, int tag, MPI_Comm comm, MPI_Request *request)
35
36 int MPI_Ssend_init_c(const void *buf, MPI_Count count,
37                    MPI_Datatype datatype, int dest, int tag, MPI_Comm comm,
38                    MPI_Request *request)

```

### 39 Fortran 2008 binding

```

40 MPI_Ssend_init(buf, count, datatype, dest, tag, comm, request, ierror)
41     TYPE(*), DIMENSION(..), INTENT(IN), ASYNCHRONOUS :: buf
42     INTEGER, INTENT(IN) :: count, dest, tag
43     TYPE(MPI_Datatype), INTENT(IN) :: datatype
44     TYPE(MPI_Comm), INTENT(IN) :: comm
45     TYPE(MPI_Request), INTENT(OUT) :: request
46     INTEGER, OPTIONAL, INTENT(OUT) :: ierror
47
48 MPI_Ssend_init(buf, count, datatype, dest, tag, comm, request, ierror)

```

```

TYPE(*), DIMENSION(..), INTENT(IN), ASYNCHRONOUS :: buf           1
INTEGER(KIND=MPI_COUNT_KIND), INTENT(IN) :: count                2
TYPE(MPI_Datatype), INTENT(IN) :: datatype                       3
INTEGER, INTENT(IN) :: dest, tag                                4
TYPE(MPI_Comm), INTENT(IN) :: comm                              5
TYPE(MPI_Request), INTENT(OUT) :: request                       6
INTEGER, OPTIONAL, INTENT(OUT) :: ierror                        7
                                                                8
Fortran binding                                             9
MPI_SSEND_INIT(BUF, COUNT, DATATYPE, DEST, TAG, COMM, REQUEST, IERROR) 10
  <type> BUF(*)                                               11
  INTEGER COUNT, DATATYPE, DEST, TAG, COMM, REQUEST, IERROR    12
  Creates a persistent communication object for a synchronous mode send operation. 13
                                                                14
MPI_RSEND_INIT(buf, count, datatype, dest, tag, comm, request)    15
                                                                16
IN      buf              initial address of send buffer (choice) 17
IN      count            number of elements sent (non-negative integer) 18
IN      datatype         type of each element (handle)          19
IN      dest             rank of destination (integer)          20
IN      tag              message tag (integer)                  21
IN      comm             communicator (handle)                   22
OUT     request          communication request (handle)          23
                                                                24
                                                                25
                                                                26
C binding                                                 27
int MPI_Rsend_init(const void *buf, int count, MPI_Datatype datatype, 28
                  int dest, int tag, MPI_Comm comm, MPI_Request *request) 29
                                                                30
int MPI_Rsend_init_c(const void *buf, MPI_Count count, 31
                    MPI_Datatype datatype, int dest, int tag, MPI_Comm comm, 32
                    MPI_Request *request) 33
                                                                34
Fortran 2008 binding                                     35
MPI_Rsend_init(buf, count, datatype, dest, tag, comm, request, ierror) 36
  TYPE(*), DIMENSION(..), INTENT(IN), ASYNCHRONOUS :: buf           37
  INTEGER, INTENT(IN) :: count, dest, tag                            38
  TYPE(MPI_Datatype), INTENT(IN) :: datatype                       39
  TYPE(MPI_Comm), INTENT(IN) :: comm                              40
  TYPE(MPI_Request), INTENT(OUT) :: request                       41
  INTEGER, OPTIONAL, INTENT(OUT) :: ierror                        42
                                                                43
MPI_Rsend_init(buf, count, datatype, dest, tag, comm, request, ierror) 44
  TYPE(*), DIMENSION(..), INTENT(IN), ASYNCHRONOUS :: buf           45
  INTEGER(KIND=MPI_COUNT_KIND), INTENT(IN) :: count                46
  TYPE(MPI_Datatype), INTENT(IN) :: datatype                       47
  INTEGER, INTENT(IN) :: dest, tag                                48
  TYPE(MPI_Comm), INTENT(IN) :: comm

```

```

1     TYPE(MPI_Request), INTENT(OUT) :: request
2     INTEGER, OPTIONAL, INTENT(OUT) :: ierror

```

### Fortran binding

```

4 MPI_RSEND_INIT(BUF, COUNT, DATATYPE, DEST, TAG, COMM, REQUEST, IERROR)
5     <type> BUF(*)
6     INTEGER COUNT, DATATYPE, DEST, TAG, COMM, REQUEST, IERROR

```

Creates a persistent communication object for a ready mode send operation.

```

10 MPI_RECV_INIT(buf, count, datatype, source, tag, comm, request)

```

12	OUT	buf	initial address of receive buffer (choice)
13	IN	count	number of elements received (non-negative integer)
14	IN	datatype	type of each element (handle)
15	IN	source	rank of source or MPI_ANY_SOURCE (integer)
16	IN	source	rank of source or MPI_ANY_SOURCE (integer)
17	IN	tag	message tag or MPI_ANY_TAG (integer)
18	IN	comm	communicator (handle)
19	IN	comm	communicator (handle)
20	OUT	request	communication request (handle)

### C binding

```

23 int MPI_Recv_init(void *buf, int count, MPI_Datatype datatype, int source,
24                 int tag, MPI_Comm comm, MPI_Request *request)
25
26 int MPI_Recv_init_c(void *buf, MPI_Count count, MPI_Datatype datatype,
27                   int source, int tag, MPI_Comm comm, MPI_Request *request)

```

### Fortran 2008 binding

```

29 MPI_Recv_init(buf, count, datatype, source, tag, comm, request, ierror)
30     TYPE(*), DIMENSION(..), ASYNCHRONOUS :: buf
31     INTEGER, INTENT(IN) :: count, source, tag
32     TYPE(MPI_Datatype), INTENT(IN) :: datatype
33     TYPE(MPI_Comm), INTENT(IN) :: comm
34     TYPE(MPI_Request), INTENT(OUT) :: request
35     INTEGER, OPTIONAL, INTENT(OUT) :: ierror
36
37 MPI_Recv_init(buf, count, datatype, source, tag, comm, request, ierror)
38     TYPE(*), DIMENSION(..), ASYNCHRONOUS :: buf
39     INTEGER(KIND=MPI_COUNT_KIND), INTENT(IN) :: count
40     TYPE(MPI_Datatype), INTENT(IN) :: datatype
41     INTEGER, INTENT(IN) :: source, tag
42     TYPE(MPI_Comm), INTENT(IN) :: comm
43     TYPE(MPI_Request), INTENT(OUT) :: request
44     INTEGER, OPTIONAL, INTENT(OUT) :: ierror

```

### Fortran binding

```

46 MPI_RECV_INIT(BUF, COUNT, DATATYPE, SOURCE, TAG, COMM, REQUEST, IERROR)
47     <type> BUF(*)
48

```

INTEGER COUNT, DATATYPE, SOURCE, TAG, COMM, REQUEST, IERROR

Creates a persistent communication request for a receive operation. The argument `buf` is marked as `OUT` because the user gives permission to write on the receive buffer by passing the argument to `MPI_RECV_INIT`.

A persistent communication request is inactive after it was created—no active communication is attached to the request.

A communication that uses a persistent request is initiated by the function `MPI_START`.

`MPI_START(request)`

INOUT request communication request (handle)

#### C binding

```
int MPI_Start(MPI_Request *request)
```

#### Fortran 2008 binding

```
MPI_Start(request, ierror)
  TYPE(MPI_Request), INTENT(INOUT) :: request
  INTEGER, OPTIONAL, INTENT(OUT) :: ierror
```

#### Fortran binding

```
MPI_START(REQUEST, IERROR)
  INTEGER REQUEST, IERROR
```

The argument, `request`, is a handle returned by any of the initialization procedures for persistent point-to-point communication (the previous five procedures), or for persistent collective communication (see Sections 6.13 and 8.8). The associated request should be inactive. The request becomes active once the call is made.

If the request is for a ready mode send operation, then a matching receive operation should be posted before the call is made. The communication buffer should not be modified after the call, and until the operation completes.

The call is local, with similar semantics to the nonblocking communication operations described in Section 3.7. That is, a call to `MPI_START` with a request created by `MPI_SEND_INIT` starts a communication in the same manner as a call to `MPI_ISEND`; a call to `MPI_START` with a request created by `MPI_BSEND_INIT` starts a communication in the same manner as a call to `MPI_IBSEND`; and so on.

`MPI_STARTALL(count, array_of_requests)`

IN count list length (non-negative integer)  
INOUT array\_of\_requests array of requests (array of handles)

#### C binding

```
int MPI_Startall(int count, MPI_Request array_of_requests[])
```

#### Fortran 2008 binding

```
MPI_Startall(count, array_of_requests, ierror)
```

```

1     INTEGER, INTENT(IN) :: count
2     TYPE(MPI_Request), INTENT(INOUT) :: array_of_requests(count)
3     INTEGER, OPTIONAL, INTENT(OUT) :: ierror

```

### Fortran binding

```

6     MPI_STARTALL(COUNT, ARRAY_OF_REQUESTS, IERROR)
7         INTEGER COUNT, ARRAY_OF_REQUESTS(*), IERROR

```

The execution of `MPI_STARTALL` has the same effect as the execution of `MPI_START` for each of the array elements in some arbitrary order. `MPI_STARTALL` with an array of length one is equivalent to `MPI_START`.

A communication started with a call to `MPI_START` or `MPI_STARTALL` is completed by a call to `MPI_WAIT`, `MPI_TEST`, or one of the derived functions described in Section 3.7.5. The request becomes inactive after successful completion of such call. The request is not deallocated and it can be activated anew by an `MPI_START` or `MPI_STARTALL` call.

A persistent request is deallocated by a call to `MPI_REQUEST_FREE` (Section 3.7.3). The call to `MPI_REQUEST_FREE` can occur at any point in the program after the persistent request was created. However, the request will be deallocated only after it becomes inactive. Active receive requests should not be freed. Otherwise, it will not be possible to check that the receive has completed. Collective operation requests (defined in Section 6.12 and Section 8.7 for nonblocking collective operations, and Section 6.13 and Section 8.8 for persistent collective operations) must not be freed while active. It is preferable, in general, to free requests when they are inactive. If this rule is followed, then the functions described in this section will be invoked in a sequence of the form,

**Create (Start Complete)\* Free**

where `*` indicates zero or more repetitions. If the same communication object is used in several concurrent threads, it is the user's responsibility to coordinate calls so that the correct sequence is obeyed.

A send operation initiated with `MPI_START` can be matched with any receive operation and, likewise, a receive operation initiated with `MPI_START` can receive messages generated by any send operation.

*Advice to users.* To prevent problems with the argument copying and register optimization done by Fortran compilers, please note the hints in Sections 19.1.10–19.1.20. (*End of advice to users.*)

## 3.10 Null Processes

In many instances, it is convenient to specify a “dummy” source or destination for communication. This simplifies the code that is needed for dealing with boundaries, for example, in the case of a non-circular shift done with calls to send-receive.

The special value `MPI_PROC_NULL` can be used instead of a rank wherever a source or a destination argument is required in a call. A communication with process `MPI_PROC_NULL` has no effect. A send to `MPI_PROC_NULL` succeeds and returns as soon as possible. A receive from `MPI_PROC_NULL` succeeds and returns as soon as possible with no modifications to the receive buffer. When a receive with `source = MPI_PROC_NULL` is executed then the



status object returns `source = MPI_PROC_NULL`, `tag = MPI_ANY_TAG` and `count = 0`. A probe or matching probe with `source = MPI_PROC_NULL` succeeds and returns as soon as possible, and the status object returns `source = MPI_PROC_NULL`, `tag = MPI_ANY_TAG` and `count = 0`. A matching probe (cf. Section 3.8.2) with `source = MPI_PROC_NULL` returns `flag = true`, `message = MPI_MESSAGE_NO_PROC`, and the status object returns `source = MPI_PROC_NULL`, `tag = MPI_ANY_TAG`, and `count = 0`.

DRAFT

1  
2  
3  
4  
5  
6  
7  
8  
9  
10  
11  
12  
13  
14  
15  
16  
17  
18  
19  
20  
21  
22  
23  
24  
25  
26  
27  
28  
29  
30  
31  
32  
33  
34  
35  
36  
37  
38  
39  
40  
41  
42  
43  
44  
45  
46  
47  
48

1  
2  
3  
4  
5  
6  
7  
8  
9  
10  
11  
12  
13  
14  
15  
16  
17  
18  
19  
20  
21  
22  
23  
24  
25  
26  
27  
28  
29  
30  
31  
32  
33  
34  
35  
36  
37  
38  
39  
40  
41  
42  
43  
44  
45  
46  
47  
48

DRAFT

1  
2  
3  
4  
5  
6  
7  
8  
9  
10  
11  
12  
13  
14  
15  
16  
17  
18  
19  
20  
21  
22  
23  
24  
25  
26  
27  
28  
29  
30  
31  
32  
33  
34  
35  
36  
37  
38  
39  
40  
41  
42  
43  
44  
45  
46  
47  
48

## Chapter 4

# Partitioned Point-to-Point Communication

### 4.1 Introduction

Partitioned communication extends persistent point-to-point communication as defined in Chapter 3. Partitioned communication operations are matched based on the order in which the local initialization calls are performed. Partitioned communication is “partitioned” because it allows for multiple contributions of data to be made, potentially, from multiple actors (e.g., threads or tasks) in an MPI process to a single communication operation.

*Advice to users.* The techniques of partitioned communication were known as “fine-points” before their adoption into the MPI standard. We refer the interested reader to the original literature describing the design goals, functioning, initial implementation and performance improvements [28, 29]. (*End of advice to users.*)

Partitioned communication operations use a persistent communication style that involves a sequence of start and test or wait operations. For this sequence, partitioned communications use `MPI_START` or `MPI_STARTALL` calls and completion mechanisms (`MPI_TEST` or `MPI_WAIT`). Partitioned communication is different in three fundamental ways from persistent point-to-point operations in MPI. First, partitioned communication allows additional partitioned test function calls that can expose partial completion of the operation. Second, partitioned communication may perform all of the initialization required to enable data transfer as early as its initialization phase. Third, partitioned communication allows for MPI to be independently notified of multiple contributions from the send-side to a single data buffer of a single MPI message.

*Rationale.* The rationale behind having different initialization behavior allowed for partitioned communication as opposed to persistent point-to-point communication is to enable flexibility and optimization possibilities in implementations. Buffer setup can occur in the partitioned communication initialization functions (see Section 4.2.1). However, such negotiation can be deferred until data is to be moved between two processes. This means that partitioned communication can lazily negotiate as late as testing for completion of the operation on the first iteration of a sequence of partitioned communication start and test or wait operations. Matching still occurs as if matching happened at the partitioned communication initialization functions as noted in the function descriptions. (*End of rationale.*)

## 4.2 Semantics of Partitioned Point-to-Point Communication

MPI guarantees certain general properties of partitioned point-to-point communication progress, which are described in this section.

Persistent communications use opaque `MPI_REQUEST` objects as described in Section 3. Partitioned communication uses these same semantics for `MPI_REQUEST` objects.

Partitioned communication provides fine-grained transfers on either or both sides of a send-receive operation described by requests. Persistent communication semantics are ideal for partitioned communication: they provide `MPI_PSEND_INIT` and `MPI_PRECV_INIT` functions that allow partitioned communication setup to occur prior to message transfers. Partitioned communication initialization functions are local. The partitioned communication initialization includes inputs on the number of user-visible partitions on the send-side and receive-side, which may differ. Valid partitioned communication operations must have one or more partitions specified.

Once an `MPI_PSEND_INIT` call has been made, the user may start the operation with a call to a starting procedure and complete the operation with a number of `MPI_PREADY` calls equal to the requested number of send partitions followed by a call to a completing procedure. A call to `MPI_PREADY` notifies the MPI library that a specified portion of the data buffer (a specific partition) is ready to be sent. Notification of partial completion can be done via fine-grained `MPI_PARRIVED` calls at the receiver before a final `MPI_TEST/MPI_WAIT` on the request itself; the latter represents overall operation completion upon success. A full set of methods for starting and completing partitioned communication is given in the following sections.

*Advice to users.* Having a large number of receiver-side partitions can increase overheads as the completion mechanism may need to work with finer-grained notifications. Using a small number of receiver-side partitions *may* provide higher performance.

A large number of sender-side partitions may be aggregated by an MPI implementation, making performance concerns of a large number of sender-side partitions potentially less impactful than receiver-side granularity. (*End of advice to users.*)

*Advice to implementors.* It is expected that an MPI implementation will attempt to balance latency and aggregation for data transfers for the requested partition counts on the sender-side and receiver-side to allow optimization for different hardware. A high quality implementation may perform significant optimizations to enhance performance in this way; they may, for example, resize the data transfers of the partitions to combine partitions in fractional partition sizes (e.g., 2.5 partitions in a single data transfer). (*End of advice to implementors.*)

Example 4.1 shows a simple partitioned transfer in which the sender-side and receiver-side partitioning is identical in partition count.

**Example 4.1** Simple partitioned communication example.

```

#include "mpi.h" 1
#define PARTITIONS 8 2
#define COUNT 5 3
int main(int argc, char *argv[]) 4
{ 5
    double message[PARTITIONS*COUNT]; 6
    MPI_Count partitions = PARTITIONS; 7
    int source = 0, dest = 1, tag = 1, flag = 0; 8
    int myrank, i; 9
    int provided; 10
    MPI_Request request; 11
    MPI_Init_thread(&argc, &argv, MPI_THREAD_SERIALIZED, &provided); 12
    if (provided < MPI_THREAD_SERIALIZED) 13
        MPI_Abort(MPI_COMM_WORLD, EXIT_FAILURE); 14
    MPI_Comm_rank(MPI_COMM_WORLD, &myrank); 15
    if (myrank == 0) 16
    { 17
        MPI_Psend_init(message, partitions, COUNT, MPI_DOUBLE, dest, tag, 18
            MPI_COMM_WORLD, MPI_INFO_NULL, &request); 19
        MPI_Start(&request); 20
        for(i = 0; i < partitions; ++i) 21
        { 22
            /* compute and fill partition #i, then mark ready: */ 23
            MPI_Pready(i, &request); 24
        } 25
        while(!flag) 26
        { 27
            /* do useful work #1 */ 28
            MPI_Test(&request, &flag, MPI_STATUS_IGNORE); 29
            /* do useful work #2 */ 30
        } 31
        MPI_Request_free(&request); 32
    } 33
    else if (myrank == 1) 34
    { 35
        MPI_Precv_init(message, partitions, COUNT, MPI_DOUBLE, source, tag, 36
            MPI_COMM_WORLD, MPI_INFO_NULL, &request); 37
        MPI_Start(&request); 38
        while(!flag) 39
        { 40
            /* do useful work #1 */ 41
            MPI_Test(&request, &flag, MPI_STATUS_IGNORE); 42
            /* do useful work #2 */ 43
        } 44
        MPI_Request_free(&request); 45
    } 46
    MPI_Finalize(); 47
    return 0; 48
}

```

1 }  
 2  
 3

4 *Rationale.* Partitioned communication is designed to provide opportunities for MPI  
 5 implementations to optimize data transfers. MPI is free to choose how many transfers  
 6 to do within a partitioned communication send independent of how many partitions  
 7 are reported as ready to MPI through MPI\_PREADY calls. Aggregation of partitions  
 8 is permitted but not required. Ordering of partitions is permitted but not required.  
 9 A naive implementation can simply wait for the entire message buffer to be marked  
 10 ready before any transfer(s) occur and could wait until the completion function is  
 11 called on a request before transferring data. However, this modality of communication  
 12 gives MPI implementations far more flexibility in data movement than non-partitioned  
 13 communications. (*End of rationale.*)  
 14

#### 15 4.2.1 Communication Initialization and Starting with Partitioning

16 Initialization of partitioned communication operations use the initialization calls described  
 17 below. Subsequent to initialization, MPI\_START/MPI\_STARTALL are used as the first  
 18 indication to MPI that a message transfer will occur. For send-side operations, neither  
 19 initializing nor starting the operation enables transfer of any part of the user buffer. Freeing  
 20 or canceling a partitioned communication request that is active (i.e., initialized and started)  
 21 and not completed is erroneous. After the partitioned communication operation is started,  
 22 individual partitions of a message are indicated as ready to be sent by MPI via the  
 23 MPI\_PREADY function, described below.  
 24

25  
 26 MPI\_PSEND\_INIT(buf, partitions, count, datatype, dest, tag, comm, info, request)  
 27     IN     buf                     initial address of send buffer (choice)  
 28     IN     partitions             number of partitions (non-negative integer)  
 29     IN     count                 number of elements sent per partition (non-negative  
 30                                     integer)  
 31     IN     datatype             type of each element (handle)  
 32     IN     dest                 rank of destination (integer)  
 33     IN     tag                 message tag (integer)  
 34     IN     comm                 communicator (handle)  
 35     IN     info                 info argument (handle)  
 36     OUT    request               communication request (handle)  
 37  
 38  
 39  
 40

#### 41 C binding

42 int MPI\_Psend\_init(const void \*buf, int partitions, MPI\_Count count,  
 43                    MPI\_Datatype datatype, int dest, int tag, MPI\_Comm comm,  
 44                    MPI\_Info info, MPI\_Request \*request)  
 45

#### 46 Fortran 2008 binding

47 MPI\_Psend\_init(buf, partitions, count, datatype, dest, tag, comm, info,  
 48                 request, ierror)

```

TYPE(*), DIMENSION(..), INTENT(IN) :: buf
INTEGER, INTENT(IN) :: partitions, dest, tag
INTEGER(KIND=MPI_COUNT_KIND), INTENT(IN) :: count
TYPE(MPI_Datatype), INTENT(IN) :: datatype
TYPE(MPI_Comm), INTENT(IN) :: comm
TYPE(MPI_Info), INTENT(IN) :: info
TYPE(MPI_Request), INTENT(OUT) :: request
INTEGER, OPTIONAL, INTENT(OUT) :: ierror

```

**Fortran binding**

```

MPI_PSEND_INIT(BUF, PARTITIONS, COUNT, DATATYPE, DEST, TAG, COMM, INFO,
               REQUEST, IERROR)
<type> BUF(*)
INTEGER PARTITIONS, DATATYPE, DEST, TAG, COMM, INFO, REQUEST, IERROR
INTEGER(KIND=MPI_COUNT_KIND) COUNT

```

MPI\_PSEND\_INIT creates a partitioned communication request and binds to it all the arguments of a partitioned send operation. Matching follows the same MPI matching rules as for point-to-point communication (see Chapter 3) with communicator, tag, and source dictating message matching. In the event that the communicator, tag, and source do not uniquely identify a message, the order in which partitioned communication *initialization* calls are made is the order in which they will eventually match. This operation can only match with partitioned communication initialization operations, therefore it is required to be matched with a corresponding MPI\_PRECV\_INIT call. Partitioned communication initialization calls are local. It is erroneous to provide a `partitions` value  $\leq 0$ . Send-side and receive-side buffers must be identical in size.

*Advice to implementors.* Unlike MPI\_SEND\_INIT, MPI\_PSEND\_INIT can be matched as early as the initialization call. Also, unlike MPI\_SEND\_INIT, MPI\_PSEND\_INIT takes an `info` argument. (*End of advice to implementors.*)

```

MPI_PRECV_INIT(buf, partitions, count, datatype, dest, tag, comm, info, request)

```

IN	buf	initial address of recv buffer (choice)
IN	partitions	number of partitions (non-negative integer)
IN	count	number of elements sent per partition (non-negative integer)
IN	datatype	type of each element (handle)
IN	dest	rank of source (integer)
IN	tag	message tag (integer)
IN	comm	communicator (handle)
IN	info	info argument (handle)
OUT	request	communication request (handle)

**C binding**

```

int MPI_Precv_init(void *buf, int partitions, MPI_Count count,

```

```

1      MPI_Datatype datatype, int dest, int tag, MPI_Comm comm,
2      MPI_Info info, MPI_Request *request)

```

### Fortran 2008 binding

```

4 MPI_Precv_init(buf, partitions, count, datatype, dest, tag, comm, info,
5               request, ierror)
6
7     TYPE(*), DIMENSION(..), INTENT(IN) :: buf
8     INTEGER, INTENT(IN) :: partitions, dest, tag
9     INTEGER(KIND=MPI_COUNT_KIND), INTENT(IN) :: count
10    TYPE(MPI_Datatype), INTENT(IN) :: datatype
11    TYPE(MPI_Comm), INTENT(IN) :: comm
12    TYPE(MPI_Info), INTENT(IN) :: info
13    TYPE(MPI_Request), INTENT(OUT) :: request
14    INTEGER, OPTIONAL, INTENT(OUT) :: ierror

```

### Fortran binding

```

15 MPI_PRECV_INIT(BUF, PARTITIONS, COUNT, DATATYPE, DEST, TAG, COMM, INFO,
16               REQUEST, IERROR)
17
18     <type> BUF(*)
19     INTEGER PARTITIONS, DATATYPE, DEST, TAG, COMM, INFO, REQUEST, IERROR
20     INTEGER(KIND=MPI_COUNT_KIND) COUNT

```

*Rationale.* The info argument is provided in order to support per-operation implementation-defined info keys. (*End of rationale.*)

MPI\_PRECV\_INIT creates a partitioned communication receive request and binds to it all the arguments of a partitioned receive operation. This operation can only match with partitioned communication initialization operations, therefore the MPI library is required to match MPI\_PRECV\_INIT calls only with a corresponding MPI\_PSEND\_INIT call. Matching follows the same MPI matching rules as for point-to-point communication (see Chapter 3) with communicator, tag, and source dictating message matching. In the event that the communicator, tag, and source do not uniquely identify a message, the order in which partitioned communication initialization calls are made is the order in which they will eventually match. Partitioned communication initialization calls are local. That is, MPI\_PRECV\_INIT may return before the operation completes. It is erroneous to provide a partitions value  $\leq 0$ . Wildcards for source and tag are not allowed.

*Advice to implementors.* Unlike MPI\_RECV\_INIT, MPI\_PRECV\_INIT may communicate. Also unlike MPI\_RECV\_INIT, MPI\_PRECV\_INIT takes an info argument. (*End of advice to implementors.*)

```

41 MPI_PREADY(partition, request)

```

42	IN	partition	partition to mark ready for transfer (non-negative integer)
43			
44			
45	INOUT	request	partitioned communication request (handle)
46			

### C binding

```

47 int MPI_Pready(int partition, MPI_Request *request)

```



**Fortran 2008 binding**

```

MPI_Pready(partition, request, ierror)
  INTEGER, INTENT(IN) :: partition
  TYPE(MPI_Request), INTENT(INOUT) :: request
  INTEGER, OPTIONAL, INTENT(OUT) :: ierror

```

**Fortran binding**

```

MPI_PREADY(PARTITION, REQUEST, IERROR)
  INTEGER PARTITION, REQUEST, IERROR

```

MPI\_PREADY is a send-side call that indicates that a given `partition` is ready to be transferred. It is erroneous to use MPI\_PREADY on any request object that does not correspond to a partitioned send operation. The partitioning is defined by the MPI\_PSEND\_INIT call. Partition numbering starts at zero and ranges to one less than the number of partitions declared in the MPI\_PSEND\_INIT call. Specifying a partition number that is equal to or larger than the number of partitions is erroneous. After a call to MPI\_START/MPI\_STARTALL, all partitions associated with that operation are inactive. A call to MPI\_PREADY marks the indicated partition as active. Calling MPI\_PREADY on an active partition is erroneous.

```

MPI_PREADY_RANGE(partition_low, partition_high, request)

```

IN	partition_low	lowest partition ready for transfer (non-negative integer)
IN	partition_high	highest partition ready for transfer (non-negative integer)
INOUT	request	partitioned communication request (handle)

**C binding**

```

int MPI_Pready_range(int partition_low, int partition_high,
  MPI_Request *request)

```

**Fortran 2008 binding**

```

MPI_Pready_range(partition_low, partition_high, request, ierror)
  INTEGER, INTENT(IN) :: partition_low, partition_high
  TYPE(MPI_Request), INTENT(INOUT) :: request
  INTEGER, OPTIONAL, INTENT(OUT) :: ierror

```

**Fortran binding**

```

MPI_PREADY_RANGE(PARTITION_LOW, PARTITION_HIGH, REQUEST, IERROR)
  INTEGER PARTITION_LOW, PARTITION_HIGH, REQUEST, IERROR

```

A call to MPI\_PREADY\_RANGE has the same effect as calls to MPI\_PREADY, executed for `i=partition_low, ..., partition_high`, in some arbitrary order. Calls to MPI\_PREADY\_RANGE follow the same rules as those for MPI\_PREADY calls.

```

1 MPI_PREADY_LIST(length, array_of_partitions, request)
2     IN          length                list length (integer)
3
4     IN          array_of_partitions   array of partitions (array of non-negative integers)
5
6     INOUT       request               partitioned communication request (handle)

```

### C binding

```

8 int MPI_Pready_list(int length, const int array_of_partitions[],
9                    MPI_Request *request)

```

### Fortran 2008 binding

```

10 MPI_Pready_list(length, array_of_partitions, request, ierror)
11     INTEGER, INTENT(IN) :: length, array_of_partitions(length)
12     TYPE(MPI_Request), INTENT(INOUT) :: request
13     INTEGER, OPTIONAL, INTENT(OUT) :: ierror

```

### Fortran binding

```

14 MPI_PREADY_LIST(LENGTH, ARRAY_OF_PARTITIONS, REQUEST, IERROR)
15     INTEGER LENGTH, ARRAY_OF_PARTITIONS(*), REQUEST, IERROR

```

A call to `MPI_PREADY_LIST` has the same effect as calls to `MPI_PREADY`, executed for the partitions specified in the range `array_of_partitions[0]`, ..., `array_of_partitions[count - 1]` of the `array_of_partitions`, executed in some arbitrary order. Calls to `MPI_PREADY_LIST` follow the same rules as those for `MPI_PREADY` calls.

## 4.2.2 Communication Completion under Partitioning

The functions `MPI_WAIT` and `MPI_TEST` (and variants) are used to complete a partitioned communication operation. The completion of a partitioned send operation indicates that the sender is now free to call `MPI_START/MPI_STARTALL` to restart the operation and subsequently `MPI_PREADY`, `MPI_PREADY_RANGE` or `MPI_PREADY_LIST`. Alternatively, the user can safely free the partitioned communication request after the completion of the partitioned operation. For the sending process, completion of the partitioned send operation does not indicate that the partitions of the message have all been received.

The completion of a partitioned receive operation through `MPI_WAIT` or `MPI_TEST` indicates that the receive buffer contains all of the partitions. A function for probing the partial reception of the receive buffer is provided by `MPI_PARRIVED`. The `MPI_PARRIVED` function can be used to determine if the message data for the indicated partition has been received into the receive buffer. Upon success, the receiver becomes free to access the indicated partition (as well as any others that previously completed for that operation).

MPI_PARRIVED(request, partition, flag)			1
INOUT	request	partitioned communication request (handle)	2
IN	partition	partition to be tested (non-negative integer)	3
OUT	flag	true if operation completed on the specified partition, false if not (logical)	4

**C binding**

```
int MPI_Parrived(MPI_Request *request, int partition, int *flag)
```

**Fortran 2008 binding**

```
MPI_Parrived(request, partition, flag, ierror)
  TYPE(MPI_Request), INTENT(INOUT) :: request
  INTEGER, INTENT(IN) :: partition
  LOGICAL, INTENT(OUT) :: flag
  INTEGER, OPTIONAL, INTENT(OUT) :: ierror
```

**Fortran binding**

```
MPI_PARRIVED(REQUEST, PARTITION, FLAG, IERROR)
  INTEGER REQUEST, PARTITION, IERROR
  LOGICAL FLAG
```

The function `MPI_PARRIVED` can be used to test partial completion of partitioned receive operations. A call to `MPI_PARRIVED` on an active partitioned communication request returns `flag = true` if the operation identified by `request` for the specified `partition` is complete. The request is not marked as complete/inactive by this operation. A subsequent `MPI_TEST/MPI_WAIT` operation is required to complete the message, as described in Chapter 3. `MPI_PARRIVED` may be called multiple times for a partition. `MPI_PARRIVED` may be called with a null or inactive `request` argument. In either case, the operation returns with `flag = true`. Calling `MPI_PARRIVED` on a request that does not correspond to a partitioned receive operation is erroneous.

**4.2.3 Semantics of Communications in Partitioned Mode**

The semantics of nonblocking partitioned communication are defined by suitably extending the definitions in Section 3.5.

**Interpretation of count and datatype for partitioned communication** Partitioned communication uses the `count` and `datatype` arguments in the partitioned communication initialization functions to describe a single partition. The argument `partitions` specifies how many equal partitions of a number (`count`) of objects of `datatypes` make up the entire buffer to be transferred in the partitioned communication. As partitioned communication describes many partitions, using absolute displacements in datatypes (e.g., `MPI_BOTTOM`) is not supported. Partitions are contiguous in memory, there is no padding in between them. Once a partitioned send operation is started, each partition must be marked as ready using `MPI_PREADY` and the operation must be completed using a completion function, such as `MPI_TEST` or `MPI_WAIT`.

Order Matching follows the same MPI matching rules as for point-to-point communication (see Chapter 3) with communicator, tag, and source dictating message matching. In the event that the communicator, tag, and source do not uniquely identify the message, the order in which partitioned communication initialization calls are made is the order in which they will eventually match.

## 4.3 Partitioned Communication Examples

This section provides concrete examples of the utility of partitioned communication in realistic settings.

### 4.3.1 Partition Communication with Threads/Tasks Using OpenMP 4.0 or later

The equal partitioning on send-side and receive-side in Example 4.1 is shown using threads. In this case, the receive-side uses the same number of partitions as the send-side like in the previous example, but this example uses multiple threads on the send-side. Note that the `MPI_PSEND_INIT` and `MPI_PRECV_INIT` functions match each other like in the previous example.

**Example 4.2** Equal partitioning on send-side and receive-side using threads.

```

#include "mpi.h"
#define NUM_THREADS 8
#define PARTITIONS 8
#define PARTLENGTH 16
int main(int argc, char *argv[]) /* same send/recv partitioning */
{
    double message[PARTITIONS*PARTLENGTH];
    int partitions = PARTITIONS;
    int partlength = PARTLENGTH;
    int count = 1, source = 0, dest = 1, tag = 1, flag = 0;
    int myrank;
    int provided;
    MPI_Request request;
    MPI_Info info = MPI_INFO_NULL;
    MPI_Datatype xfer_type;
    MPI_Init_thread(&argc, &argv, MPI_THREAD_MULTIPLE, &provided);
    if (provided < MPI_THREAD_MULTIPLE)
        MPI_Abort(MPI_COMM_WORLD, EXIT_FAILURE);
    MPI_Comm_rank(MPI_COMM_WORLD, &myrank);
    MPI_Type_contiguous(partlength, MPI_DOUBLE, &xfer_type);
    MPI_Type_commit(&xfer_type);
    if (myrank == 0) /* code for process zero */
    {
        MPI_Psend_init(message, partitions, count, xfer_type, dest, tag,
            info, MPI_COMM_WORLD, &request);
        MPI_Start(&request);
    }
}

```

```

1
2 #pragma omp parallel for shared(request) num_threads(NUM_THREADS)
3 for (int i=0; i<partitions; i++)
4 {
5     /* compute and fill partition #i, then mark ready: */
6     MPI_Pready(i, &request);
7 }
8 while(!flag)
9 {
10     /* Do useful work */
11     MPI_Test(&request, &flag, MPI_STATUS_IGNORE);
12     /* Do useful work */
13 }
14 MPI_Request_free(&request);
15 }
16 else if (myrank == 1) /* code for process one */
17 {
18     MPI_Precv_init(message, partitions, count, xfer_type, source, tag,
19                   info, MPI_COMM_WORLD, &request);
20     MPI_Start(&request);
21     while(!flag)
22     {
23         /* Do useful work */
24         MPI_Test(&request, &flag, MPI_STATUS_IGNORE);
25         /* Do useful work */
26     }
27     MPI_Request_free(&request);
28 }
29 MPI_Finalize();
30 return 0;
31 }
32

```

### 4.3.2 Send-only Partitioning Example with Tasks and OpenMP version 4.0 or later

The previous example is tailored specifically for send-side partitioning using threads. This is an example where parallel task producers produce input to part of an overall buffer; they complete in any order and contribute to the overall buffer.

**Example 4.3** Parallel task producers for partitioned communication using threads.

```

33
34
35
36
37
38
39
40
41 #include "mpi.h"
42 #define NUM_THREADS 8
43 #define NUM_TASKS 64
44 #define PARTITIONS NUM_TASKS
45 #define PARTLENGTH 16
46 #define MESSAGE_LENGTH PARTITIONS*PARTLENGTH
47 int main(int argc, char *argv[]) /* send-side partitioning */
48 {

```

```

1  double message[MESSAGE_LENGTH];
2  int send_partitions = PARTITIONS,
3      send_partlength = PARTLENGTH,
4      recv_partitions = 1,
5      recv_partlength = PARTITIONS*PARTLENGTH;
6  int count = 1, source = 0, dest = 1, tag = 1, flag = 0;
7  int myrank;
8  int provided;
9  MPI_Request request;
10 MPI_Info info = MPI_INFO_NULL;
11 MPI_Datatype send_type;
12 MPI_Init_thread(&argc, &argv, MPI_THREAD_MULTIPLE, &provided);
13 if (provided < MPI_THREAD_MULTIPLE)
14     MPI_Abort(MPI_COMM_WORLD, EXIT_FAILURE);
15 MPI_Comm_rank(MPI_COMM_WORLD, &myrank);
16 MPI_Type_contiguous(send_partlength, MPI_DOUBLE, &send_type);
17 MPI_Type_commit(&send_type);
18
19 if (myrank == 0)    /* code for process zero */
20 {
21     MPI_Psend_init(message, send_partitions, count, send_type, dest, tag,
22                   info, MPI_COMM_WORLD, &request);
23     MPI_Start(&request);
24
25     #pragma omp parallel shared(request) num_threads(NUM_THREADS)
26     {
27         #pragma omp single
28         {
29             /* single thread creates 64 tasks to be executed by 8 threads */
30             for (int partition_num=0;partition_num<NUM_TASKS;partition_num++)
31             {
32                 #pragma omp task firstprivate(partition_num)
33                 {
34                     /* compute and fill partition #partition_num, then mark
35                     ready: */
36                     /* buffer is filled in arbitrary order from each task */
37                     MPI_Pready(partition_num, &request);
38                 } /*end task*/
39             } /* end for */
40         } /* end single */
41     } /* end parallel */
42     while(!flag)
43     {
44         /* Do useful work */
45         MPI_Test(&request, &flag, MPI_STATUS_IGNORE);
46         /* Do useful work */
47     }
48     MPI_Request_free(&request);

```

```

}
else if (myrank == 1) /* code for process one */
{
    MPI_Precv_init(message, recv_partitions, recv_partlength, MPI_DOUBLE,
                  source, tag, info, MPI_COMM_WORLD, &request);

    MPI_Start(&request);
    while(!flag)
    {
        /* Do useful work */
        MPI_Test(&request, &flag, MPI_STATUS_IGNORE);
        /* Do useful work */
    }
    MPI_Request_free(&request);
}
MPI_Finalize();
return 0;
}

```

#### 4.3.3 Send and Receive Partitioning Example with OpenMP version 4.0 or later

This example demonstrates receive-side partial completion notification using more than one partition per receive-side thread. It uses a naive flag based method to test for multiple completed partitions per thread. Note that this means that some threads may be busy polling for completion of assigned partitions when partitions are available to work on that were not assigned to the polling threads in this example. More advanced work stealing methods could be employed for greater efficiency. Like previous examples, it also demonstrates send-side production of input to part of an overall buffer. This example also uses different send-side and receive-side partitioning.

**Example 4.4** Partitioned communication receive-side partial completion.

```

#include "mpi.h"
#define NUM_THREADS 64
#define PARTITIONS NUM_THREADS
#define PARTLENGTH 16
#define MESSAGE_LENGTH PARTITIONS*PARTLENGTH
int main(int argc, char *argv[]) /* send-side partitioning */
{
    double message[MESSAGE_LENGTH];
    int send_partitions = PARTITIONS,
        send_partlength = PARTLENGTH,
        recv_partitions = PARTITIONS*2,
        recv_partlength = PARTLENGTH/2;
    int source = 0, dest = 1, tag = 1, flag = 0;
    int myrank;
    int provided;
    MPI_Request request;
}

```

```

1  MPI_Info info = MPI_INFO_NULL;
2  MPI_Datatype send_type;
3  MPI_Init_thread(&argc, &argv, MPI_THREAD_MULTIPLE, &provided);
4  if (provided < MPI_THREAD_MULTIPLE)
5      MPI_Abort(MPI_COMM_WORLD, EXIT_FAILURE);
6  MPI_Comm_rank(MPI_COMM_WORLD, &myrank);
7  MPI_Type_contiguous(send_partlength, MPI_DOUBLE, &send_type);
8  MPI_Type_commit(&send_type);
9
10 if (myrank == 0) /* code for process zero */
11 {
12     MPI_Psend_init(message, send_partitions, 1, send_type, dest, tag,
13                   info, MPI_COMM_WORLD, &request);
14     MPI_Start(&request);
15     #pragma omp parallel for shared(request) num_threads(NUM_THREADS)
16     for (int i=0; i<send_partitions; i++)
17     {
18         /* compute and fill partition #i, then mark ready: */
19         MPI_Pready(i, &request);
20     }
21     while(!flag)
22     {
23         /* Do useful work */
24         MPI_Test(&request, &flag, MPI_STATUS_IGNORE);
25         /* Do useful work */
26     }
27     MPI_Request_free(&request);
28 }
29 else if (myrank == 1) /* code for process one */
30 {
31     MPI_Precv_init(message, recv_partitions, recv_partlength, MPI_DOUBLE,
32                  source, tag, info, MPI_COMM_WORLD, &request);
33     MPI_Start(&request);
34     #pragma omp parallel for shared(request) num_threads(NUM_THREADS)
35     for (int j=0; j<recv_partitions; j+=2)
36     {
37         int part1_complete = 0;
38         int part2_complete = 0;
39         while(part1_complete == 0 || part2_complete == 0)
40         {
41             /* test partition #j and #j+1 */
42             MPI_Parrived(&request, j, &flag);
43             if(flag && part1_complete == 0)
44             {
45                 part1_complete++;
46                 /* Do work using partition j data */
47             }
48             if (j+1 < recv_partitions) {

```



```
        MPI_Parrived(&request, j+1, &flag);           1
        if(flag && part2_complete == 0)               2
        {                                             3
            part2_complete++;                          4
            /* Do work using partition j+1 */         5
        }                                             6
    }                                             7
    else {                                           8
        part2_complete++;                             9
    }                                             10
}                                             11
}                                             12
while(!flag)                                       13
{                                             14
    /* Do useful work */                             15
    MPI_Test(&request, &flag, MPI_STATUS_IGNORE);   16
    /* Do useful work */                             17
}                                             18
MPI_Request_free(&request);                       19
}                                             20
MPI_Finalize();                                    21
return 0;                                          22
}                                             23
}                                             24
}                                             25
}                                             26
}                                             27
}                                             28
}                                             29
}                                             30
}                                             31
}                                             32
}                                             33
}                                             34
}                                             35
}                                             36
}                                             37
}                                             38
}                                             39
}                                             40
}                                             41
}                                             42
}                                             43
}                                             44
}                                             45
}                                             46
}                                             47
}                                             48
```

1  
2  
3  
4  
5  
6  
7  
8  
9  
10  
11  
12  
13  
14  
15  
16  
17  
18  
19  
20  
21  
22  
23  
24  
25  
26  
27  
28  
29  
30  
31  
32  
33  
34  
35  
36  
37  
38  
39  
40  
41  
42  
43  
44  
45  
46  
47  
48

DRAFT

1  
2  
3  
4  
5  
6  
7  
8  
9  
10  
11  
12  
13  
14  
15  
16  
17  
18  
19  
20  
21  
22  
23  
24  
25  
26  
27  
28  
29  
30  
31  
32  
33  
34  
35  
36  
37  
38  
39  
40  
41  
42  
43  
44  
45  
46  
47  
48

## Chapter 5

# Datatypes

Basic datatypes were introduced in Section 3.2.2 and in Section 3.3. In this chapter, this model is extended to describe any data layout. We consider general datatypes that allow one to transfer efficiently heterogeneous and noncontiguous data. We conclude with the description of calls for explicit packing and unpacking of messages.

### 5.1 Derived Datatypes

Up to here, all point-to-point communications have involved only buffers containing a sequence of identical basic datatypes. This is too constraining on two accounts. One often wants to pass messages that contain values with different datatypes (e.g., an integer count, followed by a sequence of real numbers); and one often wants to send noncontiguous data (e.g., a sub-block of a matrix). One solution is to pack noncontiguous data into a contiguous buffer at the sender site and unpack it at the receiver site. This has the disadvantage of requiring additional memory-to-memory copy operations at both sites, even when the communication subsystem has scatter-gather capabilities. Instead, MPI provides mechanisms to specify more general, mixed, and noncontiguous communication buffers. It is up to the implementation to decide whether data should be first packed in a contiguous buffer before being transmitted, or whether it can be collected directly from where it resides.

The general mechanisms provided here allow one to transfer directly, without copying, objects of various shapes and sizes. It is not assumed that the MPI library is cognizant of the objects declared in the host language. Thus, if one wants to transfer a structure, or an array section, it will be necessary to provide in MPI a definition of a communication buffer that mimics the definition of the structure or array section in question. These facilities can be used by library designers to define communication functions that can transfer objects defined in the host language—by decoding their definitions as available in a symbol table or a dope vector. Such higher-level communication functions are not part of MPI.

More general communication buffers are specified by replacing the basic datatypes that have been used so far with derived datatypes that are constructed from basic datatypes using the constructors described in this section. These methods of constructing derived datatypes can be applied recursively.

A **general datatype** is an opaque object that specifies two things:

- A sequence of basic datatypes
- A sequence of integer (byte) displacements

The displacements are not required to be positive, distinct, or in increasing order. Therefore, the order of items need not coincide with their order in store, and an item may appear more than once. We call such a pair of sequences (or sequence of pairs) a **type map**. The sequence of basic datatypes (displacements ignored) is the **type signature** of the datatype.

Let

$$Typemap = \{(type_0, disp_0), \dots, (type_{n-1}, disp_{n-1})\},$$

be such a type map, where  $type_i$  are basic types, and  $disp_i$  are displacements. Let

$$Typesig = \{type_0, \dots, type_{n-1}\}$$

be the associated type signature. This type map, together with a base address `buf`, specifies a communication buffer: the communication buffer that consists of  $n$  entries, where the  $i$ -th entry is at address `buf + dispi` and has type  $type_i$ . A message assembled from such a communication buffer will consist of  $n$  values, of the types defined by  $Typesig$ .

Most datatype constructors have replication count or block length arguments. Allowed values are non-negative integers. If the value is zero, no elements are generated in the type map and there is no effect on datatype bounds or extent.

We can use a handle to a general datatype as an argument in a send or receive operation, instead of a basic datatype argument. The operation `MPI_SEND(buf, 1, datatype, ...)` will use the send buffer defined by the base address `buf` and the general datatype associated with `datatype`; it will generate a message with the type signature determined by the `datatype` argument. `MPI_RECV(buf, 1, datatype, ...)` will use the receive buffer defined by the base address `buf` and the general datatype associated with `datatype`.

General datatypes can be used in all send and receive operations. We discuss, in Section 5.1.11, the case where the second argument `count` has value  $> 1$ .

The basic datatypes presented in Section 3.2.2 are particular cases of a general datatype, and are predefined. Thus, `MPI_INT` is a predefined handle to a datatype with type map  $\{(int, 0)\}$ , with one entry of type `int` and displacement zero. The other basic datatypes are similar.

The **extent** of a datatype is defined to be the span from the first byte to the last byte occupied by entries in this datatype, rounded up to satisfy alignment requirements. That is, if

$$Typemap = \{(type_0, disp_0), \dots, (type_{n-1}, disp_{n-1})\},$$

then

$$\begin{aligned} lb(Typemap) &= \min_j disp_j, \\ ub(Typemap) &= \max_j (disp_j + sizeof(type_j)) + \epsilon, \text{ and} \\ extent(Typemap) &= ub(Typemap) - lb(Typemap). \end{aligned} \tag{5.1}$$

If  $type_j$  requires alignment to a byte address that is a multiple of  $k_j$ , then  $\epsilon$  is the least non-negative increment needed to round  $extent(Typemap)$  to the next multiple of  $\max_j k_j$ . In Fortran, it is implementation dependent whether the MPI implementation computes the alignments  $k_j$  according to the alignments used by the compiler in common blocks, SEQUENCE derived types, BIND(C) derived types, or derived types that are neither SEQUENCE nor BIND(C). The complete definition of **extent** is given by Equation 5.1 Section 5.1.

**Example 5.1** Assume that  $Type = \{(double, 0), (char, 8)\}$  (a `double` at displacement zero, followed by a `char` at displacement eight). Assume, furthermore, that doubles have to be strictly aligned at addresses that are multiples of eight. Then, the extent of this datatype is 16 (9 rounded to the next multiple of 8). A datatype that consists of a character immediately followed by a double will also have an extent of 16.

*Rationale.* The definition of extent is motivated by the assumption that the amount of padding added at the end of each structure in an array of structures is the least needed to fulfill alignment constraints. More explicit control of the extent is provided in Section 5.1.6. Such explicit control is needed in cases where the assumption does not hold, for example, where union types are used. In Fortran, structures can be expressed with several language features, e.g., common blocks, `SEQUENCE` derived types, or `BIND(C)` derived types. The compiler may use different alignments, and therefore, it is recommended to use `MPI_TYPE_CREATE_RESIZED` for arrays of structures if an alignment may cause an alignment-gap at the end of a structure as described in Section 5.1.6 and in Section 19.1.15. (*End of rationale.*)

### 5.1.1 Type Constructors with Explicit Addresses

In Fortran, the functions `MPI_TYPE_CREATE_HVECTOR`, `MPI_TYPE_CREATE_HINDEXED`, `MPI_TYPE_CREATE_HINDEXED_BLOCK`, `MPI_TYPE_CREATE_STRUCT`, and `MPI_GET_ADDRESS` accept arguments of type `INTEGER(KIND=MPI_ADDRESS_KIND)`, wherever arguments of type `MPI_Aint` are used in C. For Fortran compilers that do not support the Fortran 90 `KIND` notation, and where addresses are 64 bits whereas default `INTEGERs` are 32 bits, these arguments will be of type `INTEGER*8` (assuming the Fortran compiler accepts the common extension of `INTEGER*8` for eight-byte integers).

For the large count versions of three datatype constructors with explicit addresses, `MPI_TYPE_CREATE_HINDEXED`, `MPI_TYPE_CREATE_HINDEXED_BLOCK`, and `MPI_TYPE_CREATE_STRUCT`, absolute addresses shall not be used to specify byte displacements since the parameter is of type `MPI_COUNT` instead of type `MPI_AINT`.

### 5.1.2 Datatype Constructors

**Contiguous** The simplest datatype constructor is `MPI_TYPE_CONTIGUOUS` which allows replication of a datatype into contiguous locations.

`MPI_TYPE_CONTIGUOUS(count, oldtype, newtype)`

IN	count	replication count (non-negative integer)
IN	oldtype	old datatype (handle)
OUT	newtype	new datatype (handle)

#### C binding

```
int MPI_Type_contiguous(int count, MPI_Datatype oldtype,
                        MPI_Datatype *newtype)
```

```

1 int MPI_Type_contiguous_c(MPI_Count count, MPI_Datatype oldtype,
2     MPI_Datatype *newtype)

```

### Fortran 2008 binding

```

4 MPI_Type_contiguous(count, oldtype, newtype, ierror)
5     INTEGER, INTENT(IN) :: count
6     TYPE(MPI_Datatype), INTENT(IN) :: oldtype
7     TYPE(MPI_Datatype), INTENT(OUT) :: newtype
8     INTEGER, OPTIONAL, INTENT(OUT) :: ierror
9

```

```

10 MPI_Type_contiguous(count, oldtype, newtype, ierror)
11     INTEGER(KIND=MPI_COUNT_KIND), INTENT(IN) :: count
12     TYPE(MPI_Datatype), INTENT(IN) :: oldtype
13     TYPE(MPI_Datatype), INTENT(OUT) :: newtype
14     INTEGER, OPTIONAL, INTENT(OUT) :: ierror
15

```

### Fortran binding

```

16 MPI_TYPE_CONTIGUOUS(COUNT, OLDTYPE, NEWTYPE, IERROR)
17     INTEGER COUNT, OLDTYPE, NEWTYPE, IERROR
18

```

newtype is the datatype obtained by concatenating count copies of oldtype. Concatenation is defined using *extent* as the size of the concatenated copies.

**Example 5.2** Let oldtype have type map  $\{(\text{double}, 0), (\text{char}, 8)\}$ , with extent 16, and let  $\text{count} = 3$ . The type map of the datatype returned by newtype is

$$\{(\text{double}, 0), (\text{char}, 8), (\text{double}, 16), (\text{char}, 24), (\text{double}, 32), (\text{char}, 40)\};$$

i.e., alternating double and char elements, with displacements 0, 8, 16, 24, 32, 40.

In general, assume that the type map of oldtype is

$$\{(type_0, disp_0), \dots, (type_{n-1}, disp_{n-1})\},$$

with extent  $ex$ . Then newtype has a type map with  $\text{count} \cdot n$  entries defined by:

$$\{(type_0, disp_0), \dots, (type_{n-1}, disp_{n-1}), (type_0, disp_0 + ex), \dots, (type_{n-1}, disp_{n-1} + ex), \\ \dots, (type_0, disp_0 + ex \cdot (\text{count} - 1)), \dots, (type_{n-1}, disp_{n-1} + ex \cdot (\text{count} - 1))\}.$$

**Vector** The function `MPI_TYPE_VECTOR` is a more general constructor that allows replication of a datatype into locations that consist of equally spaced blocks. Each block is obtained by concatenating the same number of copies of the old datatype. The spacing between blocks is a multiple of the extent of the old datatype.

MPI_TYPE_VECTOR(count, blocklength, stride, oldtype, newtype)			1
IN	count	number of blocks (non-negative integer)	2
			3
IN	blocklength	number of elements in each block (non-negative integer)	4
			5
IN	stride	number of elements between start of each block (integer)	6
			7
IN	oldtype	old datatype (handle)	8
			9
OUT	newtype	new datatype (handle)	10

**C binding**

```

int MPI_Type_vector(int count, int blocklength, int stride,
                   MPI_Datatype oldtype, MPI_Datatype *newtype)
int MPI_Type_vector_c(MPI_Count count, MPI_Count blocklength,
                    MPI_Count stride, MPI_Datatype oldtype, MPI_Datatype *newtype)

```

**Fortran 2008 binding**

```

MPI_Type_vector(count, blocklength, stride, oldtype, newtype, ierror)
  INTEGER, INTENT(IN) :: count, blocklength, stride
  TYPE(MPI_Datatype), INTENT(IN) :: oldtype
  TYPE(MPI_Datatype), INTENT(OUT) :: newtype
  INTEGER, OPTIONAL, INTENT(OUT) :: ierror
MPI_Type_vector(count, blocklength, stride, oldtype, newtype, ierror)
  INTEGER(KIND=MPI_COUNT_KIND), INTENT(IN) :: count, blocklength, stride
  TYPE(MPI_Datatype), INTENT(IN) :: oldtype
  TYPE(MPI_Datatype), INTENT(OUT) :: newtype
  INTEGER, OPTIONAL, INTENT(OUT) :: ierror

```

**Fortran binding**

```

MPI_TYPE_VECTOR(COUNT, BLOCKLENGTH, STRIDE, OLDDTYPE, NEWTYPE, IERROR)
  INTEGER COUNT, BLOCKLENGTH, STRIDE, OLDDTYPE, NEWTYPE, IERROR

```

**Example 5.3** Assume, again, that oldtype has type map  $\{(double, 0), (char, 8)\}$ , with extent 16. A call to MPI\_TYPE\_VECTOR(2, 3, 4, oldtype, newtype) will create the datatype with type map,

$$\{(double, 0), (char, 8), (double, 16), (char, 24), (double, 32), (char, 40), (double, 64), (char, 72), (double, 80), (char, 88), (double, 96), (char, 104)\}.$$

That is, two blocks with three copies each of the old type, with a stride of 4 elements (4 · 16 bytes) between the the start of each block.

**Example 5.4** A call to MPI\_TYPE\_VECTOR(3, 1, -2, oldtype, newtype) will create the datatype,

$$\{(double, 0), (char, 8), (double, -32), (char, -24), (double, -64), (char, -56)\}.$$

In general, assume that `oldtype` has type map,

$$\{(type_0, disp_0), \dots, (type_{n-1}, disp_{n-1})\},$$

with extent  $ex$ . Let `bl` be the `blocklength`. The newly created datatype has a type map with  $count \cdot bl \cdot n$  entries:

$$\begin{aligned} &\{(type_0, disp_0), \dots, (type_{n-1}, disp_{n-1}), \\ &(type_0, disp_0 + ex), \dots, (type_{n-1}, disp_{n-1} + ex), \dots, \\ &(type_0, disp_0 + (bl - 1) \cdot ex), \dots, (type_{n-1}, disp_{n-1} + (bl - 1) \cdot ex), \\ &(type_0, disp_0 + stride \cdot ex), \dots, (type_{n-1}, disp_{n-1} + stride \cdot ex), \dots, \\ &(type_0, disp_0 + (stride + bl - 1) \cdot ex), \dots, (type_{n-1}, disp_{n-1} + (stride + bl - 1) \cdot ex), \dots, \\ &(type_0, disp_0 + stride \cdot (count - 1) \cdot ex), \dots, \\ &(type_{n-1}, disp_{n-1} + stride \cdot (count - 1) \cdot ex), \dots, \\ &(type_0, disp_0 + (stride \cdot (count - 1) + bl - 1) \cdot ex), \dots, \\ &(type_{n-1}, disp_{n-1} + (stride \cdot (count - 1) + bl - 1) \cdot ex)\}. \end{aligned}$$

A call to `MPI_TYPE_CONTIGUOUS(count, oldtype, newtype)` is equivalent to a call to `MPI_TYPE_VECTOR(count, 1, 1, oldtype, newtype)`, or to a call to `MPI_TYPE_VECTOR(1, count, n, oldtype, newtype)`, where `n` is an arbitrary integer value.

**Hvector** The function `MPI_TYPE_CREATE_HVECTOR` is identical to `MPI_TYPE_VECTOR`, except that `stride` is given in bytes, rather than in elements. The use for both types of vector constructors is illustrated in Section 5.1.14. (H stands for “heterogeneous”).

`MPI_TYPE_CREATE_HVECTOR(count, blocklength, stride, oldtype, newtype)`

IN	<code>count</code>	number of blocks (non-negative integer)
IN	<code>blocklength</code>	number of elements in each block (non-negative integer)
IN	<code>stride</code>	number of bytes between start of each block (integer)
IN	<code>oldtype</code>	old datatype (handle)
OUT	<code>newtype</code>	new datatype (handle)

### C binding

```
int MPI_Type_create_hvector(int count, int blocklength, MPI_Aint stride,
                           MPI_Datatype oldtype, MPI_Datatype *newtype)
```

```
int MPI_Type_create_hvector_c(MPI_Count count, MPI_Count blocklength,
                              MPI_Count stride, MPI_Datatype oldtype, MPI_Datatype *newtype)
```



**Fortran 2008 binding**

```

MPI_Type_create_hvector(count, blocklength, stride, oldtype, newtype,
    ierror)
    INTEGER, INTENT(IN) :: count, blocklength
    INTEGER(KIND=MPI_ADDRESS_KIND), INTENT(IN) :: stride
    TYPE(MPI_Datatype), INTENT(IN) :: oldtype
    TYPE(MPI_Datatype), INTENT(OUT) :: newtype
    INTEGER, OPTIONAL, INTENT(OUT) :: ierror

MPI_Type_create_hvector(count, blocklength, stride, oldtype, newtype,
    ierror)
    INTEGER(KIND=MPI_COUNT_KIND), INTENT(IN) :: count, blocklength, stride
    TYPE(MPI_Datatype), INTENT(IN) :: oldtype
    TYPE(MPI_Datatype), INTENT(OUT) :: newtype
    INTEGER, OPTIONAL, INTENT(OUT) :: ierror

```

**Fortran binding**

```

MPI_TYPE_CREATE_HVECTOR(COUNT, BLOCKLENGTH, STRIDE, OLDTYPE, NEWTYPE,
    IERROR)
    INTEGER COUNT, BLOCKLENGTH, OLDTYPE, NEWTYPE, IERROR
    INTEGER(KIND=MPI_ADDRESS_KIND) STRIDE

```

Assume that *oldtype* has type map,

$$\{(type_0, disp_0), \dots, (type_{n-1}, disp_{n-1})\},$$

with extent *ex*. Let *bl* be the blocklength. The newly created datatype has a type map with  $count \cdot bl \cdot n$  entries:

$$\begin{aligned}
& \{(type_0, disp_0), \dots, (type_{n-1}, disp_{n-1}), \\
& (type_0, disp_0 + ex), \dots, (type_{n-1}, disp_{n-1} + ex), \dots, \\
& (type_0, disp_0 + (bl - 1) \cdot ex), \dots, (type_{n-1}, disp_{n-1} + (bl - 1) \cdot ex), \\
& (type_0, disp_0 + stride), \dots, (type_{n-1}, disp_{n-1} + stride), \dots, \\
& (type_0, disp_0 + stride + (bl - 1) \cdot ex), \dots, \\
& (type_{n-1}, disp_{n-1} + stride + (bl - 1) \cdot ex), \dots, \\
& (type_0, disp_0 + stride \cdot (count - 1)), \dots, (type_{n-1}, disp_{n-1} + stride \cdot (count - 1)), \dots, \\
& (type_0, disp_0 + stride \cdot (count - 1) + (bl - 1) \cdot ex), \dots, \\
& (type_{n-1}, disp_{n-1} + stride \cdot (count - 1) + (bl - 1) \cdot ex)\}.
\end{aligned}$$

1 Indexed The function `MPI_TYPE_INDEXED` allows replication of an old datatype into a  
 2 sequence of blocks (each block is a concatenation of the old datatype), where each block  
 3 can contain a different number of copies and have a different displacement. All block  
 4 displacements are multiples of the old type extent.  
 5

6  
 7 `MPI_TYPE_INDEXED(count, array_of_blocklengths, array_of_displacements, oldtype,`  
 8 `newtype)`

9	IN	count	number of blocks—also number of entries in
10			<code>array_of_displacements</code> and <code>array_of_blocklengths</code>
11			(non-negative integer)
12	IN	<code>array_of_blocklengths</code>	number of elements per block (array of non-negative
13			integers)
14	IN	<code>array_of_displacements</code>	displacement for each block, in multiples of <code>oldtype</code>
15			(array of integers)
16	IN	<code>oldtype</code>	old datatype (handle)
17	OUT	<code>newtype</code>	new datatype (handle)
18			
19			

### 20 C binding

21  
 22 `int MPI_Type_indexed(int count, const int array_of_blocklengths[],`  
 23 `const int array_of_displacements[], MPI_Datatype oldtype,`  
 24 `MPI_Datatype *newtype)`

25  
 26 `int MPI_Type_indexed_c(MPI_Count count,`  
 27 `const MPI_Count array_of_blocklengths[],`  
 28 `const MPI_Count array_of_displacements[],`  
 29 `MPI_Datatype oldtype, MPI_Datatype *newtype)`

### 30 Fortran 2008 binding

31 `MPI_Type_indexed(count, array_of_blocklengths, array_of_displacements,`  
 32 `oldtype, newtype, ierror)`

33 `INTEGER, INTENT(IN) :: count, array_of_blocklengths(count),`  
 34 `array_of_displacements(count)`

35 `TYPE(MPI_Datatype), INTENT(IN) :: oldtype`

36 `TYPE(MPI_Datatype), INTENT(OUT) :: newtype`

37 `INTEGER, OPTIONAL, INTENT(OUT) :: ierror`

38  
 39 `MPI_Type_indexed(count, array_of_blocklengths, array_of_displacements,`  
 40 `oldtype, newtype, ierror)`

41 `INTEGER(KIND=MPI_COUNT_KIND), INTENT(IN) :: count,`

42 `array_of_blocklengths(count), array_of_displacements(count)`

43 `TYPE(MPI_Datatype), INTENT(IN) :: oldtype`

44 `TYPE(MPI_Datatype), INTENT(OUT) :: newtype`

45 `INTEGER, OPTIONAL, INTENT(OUT) :: ierror`

### 46 Fortran binding

47 `MPI_TYPE_INDEXED(COUNT, ARRAY_OF_BLOCKLENGTHS, ARRAY_OF_DISPLACEMENTS,`  
 48 `OLDTYPE, NEWTYPE, IERROR)`

INTEGER COUNT, ARRAY\_OF\_BLOCKLENGTHS(\*), ARRAY\_OF\_DISPLACEMENTS(\*),  
 OLDTYPE, NEWTYPE, IERROR

**Example 5.5** Let `oldtype` have type map  $\{(\text{double}, 0), (\text{char}, 8)\}$ , with extent 16. Let  $\mathbf{B} = (3, 1)$  and let  $\mathbf{D} = (4, 0)$ . A call to `MPI_TYPE_INDEXED(2, B, D, oldtype, newtype)` returns a datatype with type map,

$$\{(\text{double}, 64), (\text{char}, 72), (\text{double}, 80), (\text{char}, 88), (\text{double}, 96), (\text{char}, 104),$$

$$(\text{double}, 0), (\text{char}, 8)\}.$$

That is, three copies of the old type starting at displacement 64, and one copy starting at displacement 0.

In general, assume that `oldtype` has type map,

$$\{(type_0, disp_0), \dots, (type_{n-1}, disp_{n-1})\},$$

with extent  $ex$ . Let  $\mathbf{B}$  be the `array_of_blocklengths` argument and  $\mathbf{D}$  be the `array_of_displacements` argument. The newly created datatype has  $n \cdot \sum_{i=0}^{\text{count}-1} \mathbf{B}[i]$  entries:

$$\{(type_0, disp_0 + \mathbf{D}[0] \cdot ex), \dots, (type_{n-1}, disp_{n-1} + \mathbf{D}[0] \cdot ex), \dots,$$

$$(type_0, disp_0 + (\mathbf{D}[0] + \mathbf{B}[0] - 1) \cdot ex), \dots,$$

$$(type_{n-1}, disp_{n-1} + (\mathbf{D}[0] + \mathbf{B}[0] - 1) \cdot ex), \dots,$$

$$(type_0, disp_0 + \mathbf{D}[\text{count}-1] \cdot ex), \dots, (type_{n-1}, disp_{n-1} + \mathbf{D}[\text{count}-1] \cdot ex), \dots,$$

$$(type_0, disp_0 + (\mathbf{D}[\text{count}-1] + \mathbf{B}[\text{count}-1] - 1) \cdot ex), \dots,$$

$$(type_{n-1}, disp_{n-1} + (\mathbf{D}[\text{count}-1] + \mathbf{B}[\text{count}-1] - 1) \cdot ex)\}.$$

A call to `MPI_TYPE_VECTOR(count, blocklength, stride, oldtype, newtype)` is equivalent to a call to `MPI_TYPE_INDEXED(count, B, D, oldtype, newtype)` where

$$\mathbf{D}[j] = j \cdot \text{stride}, \quad j = 0, \dots, \text{count} - 1,$$

and

$$\mathbf{B}[j] = \text{blocklength}, \quad j = 0, \dots, \text{count} - 1.$$

**Hindexed** The function `MPI_TYPE_CREATE_HINDEXED` is identical to `MPI_TYPE_INDEXED`, except that block displacements in `array_of_displacements` are specified in bytes, rather than in multiples of the `oldtype` extent.

```

1 MPI_TYPE_CREATE_HINDEXED(count, array_of_blocklengths, array_of_displacements,
2     oldtype, newtype)
3
4     IN     count           number of blocks—also number of entries in
5                       array_of_displacements and array_of_blocklengths
6                       (non-negative integer)
7
8     IN     array_of_blocklengths  number of elements in each block (array of
9                       non-negative integers)
10
11    IN     array_of_displacements  byte displacement of each block (array of integers)
12
13    IN     oldtype                old datatype (handle)
14
15    OUT    newtype                new datatype (handle)

```

**C binding**

```

15 int MPI_Type_create_hindexed(int count, const int array_of_blocklengths[],
16     const MPI_Aint array_of_displacements[], MPI_Datatype oldtype,
17     MPI_Datatype *newtype)
18
19 int MPI_Type_create_hindexed_c(MPI_Count count,
20     const MPI_Count array_of_blocklengths[],
21     const MPI_Count array_of_displacements[],
22     MPI_Datatype oldtype, MPI_Datatype *newtype)

```

**Fortran 2008 binding**

```

24 MPI_Type_create_hindexed(count, array_of_blocklengths,
25     array_of_displacements, oldtype, newtype, ierror)
26     INTEGER, INTENT(IN) :: count, array_of_blocklengths(count)
27     INTEGER(KIND=MPI_ADDRESS_KIND), INTENT(IN) ::
28     array_of_displacements(count)
29     TYPE(MPI_Datatype), INTENT(IN) :: oldtype
30     TYPE(MPI_Datatype), INTENT(OUT) :: newtype
31     INTEGER, OPTIONAL, INTENT(OUT) :: ierror
32
33 MPI_Type_create_hindexed(count, array_of_blocklengths,
34     array_of_displacements, oldtype, newtype, ierror)
35     INTEGER(KIND=MPI_COUNT_KIND), INTENT(IN) :: count,
36     array_of_blocklengths(count), array_of_displacements(count)
37     TYPE(MPI_Datatype), INTENT(IN) :: oldtype
38     TYPE(MPI_Datatype), INTENT(OUT) :: newtype
39     INTEGER, OPTIONAL, INTENT(OUT) :: ierror

```

**Fortran binding**

```

41 MPI_TYPE_CREATE_HINDEXED(COUNT, ARRAY_OF_BLOCKLENGTHS,
42     ARRAY_OF_DISPLACEMENTS, OLDTYPE, NEWTYPE, IERROR)
43     INTEGER COUNT, ARRAY_OF_BLOCKLENGTHS(*), OLDTYPE, NEWTYPE, IERROR
44     INTEGER(KIND=MPI_ADDRESS_KIND) ARRAY_OF_DISPLACEMENTS(*)

```

Assume that oldtype has type map,

$$\{(type_0, disp_0), \dots, (type_{n-1}, disp_{n-1})\},$$

with extent  $ex$ . Let  $B$  be the `array_of_blocklengths` argument and  $D$  be the `array_of_displacements` argument. The newly created datatype has a type map with  $n \cdot \sum_{i=0}^{\text{count}-1} B[i]$  entries:

$$\{(type_0, disp_0 + D[0]), \dots, (type_{n-1}, disp_{n-1} + D[0]), \dots, \\ (type_0, disp_0 + D[0] + (B[0] - 1) \cdot ex), \dots, \\ (type_{n-1}, disp_{n-1} + D[0] + (B[0] - 1) \cdot ex), \dots, \\ (type_0, disp_0 + D[\text{count}-1]), \dots, (type_{n-1}, disp_{n-1} + D[\text{count}-1]), \dots, \\ (type_0, disp_0 + D[\text{count}-1] + (B[\text{count}-1] - 1) \cdot ex), \dots, \\ (type_{n-1}, disp_{n-1} + D[\text{count}-1] + (B[\text{count}-1] - 1) \cdot ex)\}.$$

**Indexed\_block** This function is the same as `MPI_TYPE_INDEXED` except that the blocklength is the same for all blocks. There are many codes using indirect addressing arising from unstructured grids where the blocksize is always 1 (gather/scatter). The following convenience function allows for constant blocksize and arbitrary displacements.

`MPI_TYPE_CREATE_INDEXED_BLOCK(count, blocklength, array_of_displacements, oldtype, newtype)`

IN	count	number of blocks—also number of entries in <code>array_of_displacements</code> (non-negative integer)
IN	blocklength	number of elements in each block (non-negative integer)
IN	array_of_displacements	array of displacements, in multiples of oldtype (array of integers)
IN	oldtype	old datatype (handle)
OUT	newtype	new datatype (handle)

### C binding

```
int MPI_Type_create_indexed_block(int count, int blocklength,
    const int array_of_displacements[], MPI_Datatype oldtype,
    MPI_Datatype *newtype)
```

```
int MPI_Type_create_indexed_block_c(MPI_Count count, MPI_Count blocklength,
    const MPI_Count array_of_displacements[],
    MPI_Datatype oldtype, MPI_Datatype *newtype)
```

### Fortran 2008 binding

```
MPI_Type_create_indexed_block(count, blocklength, array_of_displacements,
    oldtype, newtype, ierror)
    INTEGER, INTENT(IN) :: count, blocklength,
        array_of_displacements(count)
    TYPE(MPI_Datatype), INTENT(IN) :: oldtype
```

```

1     TYPE(MPI_Datatype), INTENT(OUT) :: newtype
2     INTEGER, OPTIONAL, INTENT(OUT) :: ierror
3
4 MPI_Type_create_indexed_block(count, blocklength, array_of_displacements,
5                             oldtype, newtype, ierror)
6     INTEGER(KIND=MPI_COUNT_KIND), INTENT(IN) :: count, blocklength,
7         array_of_displacements(count)
8     TYPE(MPI_Datatype), INTENT(IN) :: oldtype
9     TYPE(MPI_Datatype), INTENT(OUT) :: newtype
10    INTEGER, OPTIONAL, INTENT(OUT) :: ierror

```

### Fortran binding

```

11 MPI_TYPE_CREATE_INDEXED_BLOCK(COUNT, BLOCKLENGTH, ARRAY_OF_DISPLACEMENTS,
12                               OLDTYPE, NEWTYPE, IERROR)
13     INTEGER COUNT, BLOCKLENGTH, ARRAY_OF_DISPLACEMENTS(*), OLDTYPE,
14         NEWTYPE, IERROR

```

17  
18 **Hindexed\_block** The function `MPI_TYPE_CREATE_HINDEXED_BLOCK` is identical to  
19 `MPI_TYPE_CREATE_INDEXED_BLOCK`, except that block displacements in  
20 `array_of_displacements` are specified in bytes, rather than in multiples of the oldtype extent.

```

21
22 MPI_TYPE_CREATE_HINDEXED_BLOCK(count, blocklength, array_of_displacements,
23                               oldtype, newtype)
24
25 IN     count                number of blocks—also number of entries in
26                               array_of_displacements (non-negative integer)
27 IN     blocklength          number of elements in each block (non-negative
28                               integer)
29 IN     array_of_displacements byte displacement of each block (array of integers)
30 IN     oldtype              old datatype (handle)
31 OUT    newtype              new datatype (handle)

```

### C binding

```

34
35 int MPI_Type_create_hindexed_block(int count, int blocklength,
36     const MPI_Aint array_of_displacements[], MPI_Datatype oldtype,
37     MPI_Datatype *newtype)
38
39 int MPI_Type_create_hindexed_block_c(MPI_Count count,
40     MPI_Count blocklength,
41     const MPI_Count array_of_displacements[],
42     MPI_Datatype oldtype, MPI_Datatype *newtype)

```

### Fortran 2008 binding

```

43
44 MPI_Type_create_hindexed_block(count, blocklength, array_of_displacements,
45                               oldtype, newtype, ierror)
46     INTEGER, INTENT(IN) :: count, blocklength

```

48

```

INTEGER(KIND=MPI_ADDRESS_KIND), INTENT(IN) ::
    array_of_displacements(count)
TYPE(MPI_Datatype), INTENT(IN) :: oldtype
TYPE(MPI_Datatype), INTENT(OUT) :: newtype
INTEGER, OPTIONAL, INTENT(OUT) :: ierror

MPI_Type_create_hindexed_block(count, blocklength, array_of_displacements,
    oldtype, newtype, ierror)
INTEGER(KIND=MPI_COUNT_KIND), INTENT(IN) :: count, blocklength,
    array_of_displacements(count)
TYPE(MPI_Datatype), INTENT(IN) :: oldtype
TYPE(MPI_Datatype), INTENT(OUT) :: newtype
INTEGER, OPTIONAL, INTENT(OUT) :: ierror

```

**Fortran binding**

```

MPI_TYPE_CREATE_HINDEXED_BLOCK(COUNT, BLOCKLENGTH, ARRAY_OF_DISPLACEMENTS,
    OLDTYPE, NEWTYPE, IERROR)
INTEGER COUNT, BLOCKLENGTH, OLDTYPE, NEWTYPE, IERROR
INTEGER(KIND=MPI_ADDRESS_KIND) ARRAY_OF_DISPLACEMENTS(*)

```

Struct `MPI_TYPE_CREATE_STRUCT` is the most general type constructor. It further generalizes `MPI_TYPE_CREATE_HINDEXED` in that it allows each block to consist of replications of different datatypes.

```

MPI_TYPE_CREATE_STRUCT(count, array_of_blocklengths, array_of_displacements,
    array_of_types, newtype)

```

IN	count	number of blocks—also number of entries in arrays array_of_types, array_of_displacements, and array_of_blocklengths (non-negative integer)
IN	array_of_blocklengths	number of elements in each block (array of non-negative integers)
IN	array_of_displacements	byte displacement of each block (array of integers)
IN	array_of_types	type of elements in each block (array of handles)
OUT	newtype	new datatype (handle)

**C binding**

```

int MPI_Type_create_struct(int count, const int array_of_blocklengths[],
    const MPI_Aint array_of_displacements[],
    const MPI_Datatype array_of_types[], MPI_Datatype *newtype)

int MPI_Type_create_struct_c(MPI_Count count,
    const MPI_Count array_of_blocklengths[],
    const MPI_Count array_of_displacements[],
    const MPI_Datatype array_of_types[], MPI_Datatype *newtype)

```

**Fortran 2008 binding**

```

1 MPI_Type_create_struct(count, array_of_blocklengths,
2     array_of_displacements, array_of_types, newtype, ierror)
3     INTEGER, INTENT(IN) :: count, array_of_blocklengths(count)
4     INTEGER(KIND=MPI_ADDRESS_KIND), INTENT(IN) ::
5     array_of_displacements(count)
6     TYPE(MPI_Datatype), INTENT(IN) :: array_of_types(count)
7     TYPE(MPI_Datatype), INTENT(OUT) :: newtype
8     INTEGER, OPTIONAL, INTENT(OUT) :: ierror
9
10 MPI_Type_create_struct(count, array_of_blocklengths,
11     array_of_displacements, array_of_types, newtype, ierror)
12     INTEGER(KIND=MPI_COUNT_KIND), INTENT(IN) :: count,
13     array_of_blocklengths(count), array_of_displacements(count)
14     TYPE(MPI_Datatype), INTENT(IN) :: array_of_types(count)
15     TYPE(MPI_Datatype), INTENT(OUT) :: newtype
16     INTEGER, OPTIONAL, INTENT(OUT) :: ierror
17

```

**Fortran binding**

```

18 MPI_TYPE_CREATE_STRUCT(COUNT, ARRAY_OF_BLOCKLENGTHS,
19     ARRAY_OF_DISPLACEMENTS, ARRAY_OF_TYPES, NEWTYPE, IERROR)
20     INTEGER COUNT, ARRAY_OF_BLOCKLENGTHS(*), ARRAY_OF_TYPES(*), NEWTYPE,
21     IERROR
22     INTEGER(KIND=MPI_ADDRESS_KIND) ARRAY_OF_DISPLACEMENTS(*)
23
24

```

**Example 5.6** Let `type1` have type map,

$$\{(\text{double}, 0), (\text{char}, 8)\},$$

with extent 16. Let  $B = (2, 1, 3)$ ,  $D = (0, 16, 26)$ , and  $T = (\text{MPI\_FLOAT}, \text{type1}, \text{MPI\_CHAR})$ . Then a call to `MPI_TYPE_CREATE_STRUCT(3, B, D, T, newtype)` returns a datatype with type map,

$$\{(\text{float}, 0), (\text{float}, 4), (\text{double}, 16), (\text{char}, 24), (\text{char}, 26), (\text{char}, 27), (\text{char}, 28)\}.$$

That is, two copies of `MPI_FLOAT` starting at 0, followed by one copy of `type1` starting at 16, followed by three copies of `MPI_CHAR`, starting at 26. In this example, we assume that a float occupies four bytes.

In general, let  $T$  be the `array_of_types` argument, where  $T[i]$  is a handle to,

$$\text{typemap}_i = \{(type_0^i, disp_0^i), \dots, (type_{n_i-1}^i, disp_{n_i-1}^i)\},$$

with extent  $ex_i$ . Let  $B$  be the `array_of_blocklength` argument and  $D$  be the `array_of_displacements` argument. Let  $c$  be the count argument. Then the newly created datatype has a type map with  $\sum_{i=0}^{c-1} B[i] \cdot n_i$  entries:

$$\begin{aligned} &\{(type_0^0, disp_0^0 + D[0]), \dots, (type_{n_0}^0, disp_{n_0}^0 + D[0]), \dots, \\ &(type_0^0, disp_0^0 + D[0] + (B[0] - 1) \cdot ex_0), \dots, (type_{n_0}^0, disp_{n_0}^0 + D[0] + (B[0]-1) \cdot ex_0), \dots, \\ &(type_0^{c-1}, disp_0^{c-1} + D[c-1]), \dots, (type_{n_{c-1}-1}^{c-1}, disp_{n_{c-1}-1}^{c-1} + D[c-1]), \dots, \end{aligned}$$



$$(type_0^{c-1}, disp_0^{c-1} + D[c-1] + (B[c-1] - 1) \cdot ex_{c-1}), \dots,$$

$$(type_{n_{c-1}-1}^{c-1}, disp_{n_{c-1}-1}^{c-1} + D[c-1] + (B[c-1]-1) \cdot ex_{c-1}).$$

A call to `MPI_TYPE_CREATE_HINDEXED(count, B, D, oldtype, newtype)` is equivalent to a call to `MPI_TYPE_CREATE_STRUCT(count, B, D, T, newtype)`, where each entry of `T` is equal to `oldtype`.

### 5.1.3 Subarray Datatype Constructor

`MPI_TYPE_CREATE_SUBARRAY(ndims, array_of_sizes, array_of_subsizes, array_of_starts, order, oldtype, newtype)`

IN	<code>ndims</code>	number of array dimensions (positive integer)
IN	<code>array_of_sizes</code>	number of elements of type <code>oldtype</code> in each dimension of the full array (array of positive integers)
IN	<code>array_of_subsizes</code>	number of elements of type <code>oldtype</code> in each dimension of the subarray (array of positive integers)
IN	<code>array_of_starts</code>	starting coordinates of the subarray in each dimension (array of non-negative integers)
IN	<code>order</code>	array storage order flag (state)
IN	<code>oldtype</code>	old datatype (handle)
OUT	<code>newtype</code>	new datatype (handle)

#### C binding

```
int MPI_Type_create_subarray(int ndims, const int array_of_sizes[],
                             const int array_of_subsizes[], const int array_of_starts[],
                             int order, MPI_Datatype oldtype, MPI_Datatype *newtype)

int MPI_Type_create_subarray_c(int ndims, const MPI_Count array_of_sizes[],
                               const MPI_Count array_of_subsizes[],
                               const MPI_Count array_of_starts[], int order,
                               MPI_Datatype oldtype, MPI_Datatype *newtype)
```

#### Fortran 2008 binding

```
MPI_Type_create_subarray(ndims, array_of_sizes, array_of_subsizes,
                          array_of_starts, order, oldtype, newtype, ierror)
  INTEGER, INTENT(IN) :: ndims, array_of_sizes(ndims),
                          array_of_subsizes(ndims), array_of_starts(ndims), order
  TYPE(MPI_Datatype), INTENT(IN) :: oldtype
  TYPE(MPI_Datatype), INTENT(OUT) :: newtype
  INTEGER, OPTIONAL, INTENT(OUT) :: ierror

MPI_Type_create_subarray(ndims, array_of_sizes, array_of_subsizes,
                          array_of_starts, order, oldtype, newtype, ierror)
  INTEGER, INTENT(IN) :: ndims, order
```

```

1     INTEGER(KIND=MPI_COUNT_KIND), INTENT(IN) :: array_of_sizes(ndims),
2         array_of_subsizes(ndims), array_of_starts(ndims)
3     TYPE(MPI_Datatype), INTENT(IN) :: oldtype
4     TYPE(MPI_Datatype), INTENT(OUT) :: newtype
5     INTEGER, OPTIONAL, INTENT(OUT) :: ierror

```

### Fortran binding

```

7 MPI_TYPE_CREATE_SUBARRAY(NDIMS, ARRAY_OF_SIZES, ARRAY_OF_SUBSIZES,
8     ARRAY_OF_STARTS, ORDER, OLDTYPE, NEWTYPE, IERROR)
9     INTEGER NDIMS, ARRAY_OF_SIZES(*), ARRAY_OF_SUBSIZES(*),
10     ARRAY_OF_STARTS(*), ORDER, OLDTYPE, NEWTYPE, IERROR

```

The subarray type constructor creates an MPI datatype describing an  $n$ -dimensional subarray of an  $n$ -dimensional array. The subarray may be situated anywhere within the full array, and may be of any nonzero size up to the size of the larger array as long as it is confined within this array. This type constructor facilitates creating filetypes to access arrays distributed in blocks among processes to a single file that contains the global array, see MPI I/O, especially Section 14.1.1.

This type constructor can handle arrays with an arbitrary number of dimensions and works for both C and Fortran ordered matrices (i.e., row-major or column-major). Note that a C program may use Fortran order and a Fortran program may use C order.

The `ndims` parameter specifies the number of dimensions in the full data array and gives the number of elements in `array_of_sizes`, `array_of_subsizes`, and `array_of_starts`.

The number of elements of type `oldtype` in each dimension of the  $n$ -dimensional array and the requested subarray are specified by `array_of_sizes` and `array_of_subsizes`, respectively. For any dimension  $i$ , it is erroneous to specify `array_of_subsizes[i] < 1` or `array_of_subsizes[i] > array_of_sizes[i]`.

The `array_of_starts` contains the starting coordinates of each dimension of the subarray. Arrays are assumed to be indexed starting from zero. For any dimension  $i$ , it is erroneous to specify `array_of_starts[i] < 0` or `array_of_starts[i] > (array_of_sizes[i] - array_of_subsizes[i])`.

*Advice to users.* In a Fortran program with arrays indexed starting from 1, if the starting coordinate of a particular dimension of the subarray is  $n$ , then the entry in `array_of_starts` for that dimension is  $n-1$ . (*End of advice to users.*)

The `order` argument specifies the storage order for the subarray as well as the full array. It must be set to one of the following:

**MPI\_ORDER\_C** The ordering used by C arrays, (i.e., row-major order)

**MPI\_ORDER\_FORTRAN** The ordering used by Fortran arrays, (i.e., column-major order)

A  $ndims$ -dimensional subarray (`newtype`) with no extra padding can be defined by the function `Subarray()` as follows:

```

42     newtype = Subarray(ndims, {size0, size1, ..., sizendims-1},
43         {subsize0, subsize1, ..., subsizendims-1},
44         {start0, start1, ..., startndims-1}, oldtype)

```

Let the typemap of `oldtype` have the form:

```

48     {(type0, disp0), (type1, disp1), ..., (typen-1, dispn-1)}

```

where  $type_i$  is a predefined MPI datatype, and let  $ex$  be the extent of `oldtype`. Then we define the `Subarray()` function recursively using the following three equations. Equation 5.2 defines the base step. Equation 5.3 defines the recursion step when `order = MPI_ORDER_FORTRAN`, and Equation 5.4 defines the recursion step when `order = MPI_ORDER_C`. These equations use the conceptual datatypes `lb_marker` and `ub_marker`; see Section 5.1.6 for details.

$$\begin{aligned}
 & \text{Subarray}(1, \{size_0\}, \{subsize_0\}, \{start_0\}, \\
 & \quad \{(type_0, disp_0), (type_1, disp_1), \dots, (type_{n-1}, disp_{n-1})\}) \\
 = & \{(\text{lb\_marker}, 0), \\
 & (type_0, disp_0 + start_0 \times ex), \dots, (type_{n-1}, disp_{n-1} + start_0 \times ex), \\
 & (type_0, disp_0 + (start_0 + 1) \times ex), \dots, (type_{n-1}, \\
 & \quad disp_{n-1} + (start_0 + 1) \times ex), \dots \\
 & (type_0, disp_0 + (start_0 + subsize_0 - 1) \times ex), \dots, \\
 & \quad (type_{n-1}, disp_{n-1} + (start_0 + subsize_0 - 1) \times ex), \\
 & (\text{ub\_marker}, size_0 \times ex)\}
 \end{aligned} \tag{5.2}$$

$$\begin{aligned}
 & \text{Subarray}(ndims, \{size_0, size_1, \dots, size_{ndims-1}\}, \\
 & \quad \{subsize_0, subsize_1, \dots, subsize_{ndims-1}\}, \\
 & \quad \{start_0, start_1, \dots, start_{ndims-1}\}, \text{oldtype}) \\
 = & \text{Subarray}(ndims - 1, \{size_1, size_2, \dots, size_{ndims-1}\}, \\
 & \quad \{subsize_1, subsize_2, \dots, subsize_{ndims-1}\}, \\
 & \quad \{start_1, start_2, \dots, start_{ndims-1}\}, \\
 & \quad \text{Subarray}(1, \{size_0\}, \{subsize_0\}, \{start_0\}, \text{oldtype}))
 \end{aligned} \tag{5.3}$$

$$\begin{aligned}
 & \text{Subarray}(ndims, \{size_0, size_1, \dots, size_{ndims-1}\}, \\
 & \quad \{subsize_0, subsize_1, \dots, subsize_{ndims-1}\}, \\
 & \quad \{start_0, start_1, \dots, start_{ndims-1}\}, \text{oldtype}) \\
 = & \text{Subarray}(ndims - 1, \{size_0, size_1, \dots, size_{ndims-2}\}, \\
 & \quad \{subsize_0, subsize_1, \dots, subsize_{ndims-2}\}, \\
 & \quad \{start_0, start_1, \dots, start_{ndims-2}\}, \\
 & \quad \text{Subarray}(1, \{size_{ndims-1}\}, \{subsize_{ndims-1}\}, \{start_{ndims-1}\}, \text{oldtype}))
 \end{aligned} \tag{5.4}$$

For an example use of `MPI_TYPE_CREATE_SUBARRAY` in the context of I/O see Section 14.9.2.

#### 5.1.4 Distributed Array Datatype Constructor

The distributed array type constructor supports HPF-like [47] data distributions. However, unlike in HPF, the storage order may be specified for C arrays as well as for Fortran arrays.

*Advice to users.* One can create an HPF-like file view using this type constructor as follows. Complementary filetypes are created by having every process of a group call

1 this constructor with identical arguments (with the exception of rank which should be  
 2 set appropriately). These filetypes (along with identical disp and etype) are then used  
 3 to define the view (via MPI\_FILE\_SET\_VIEW), see MPI I/O, especially Section 14.1.1  
 4 and Section 14.3. Using this view, a collective data access operation (with identical  
 5 offsets) will yield an HPF-like distribution pattern. (*End of advice to users.*)  
 6  
 7

```

8 MPI_TYPE_CREATE_DARRAY(size, rank, ndims, array_of_gsizes, array_of_distribs,
9     array_of_dargs, array_of_psizes, order, oldtype, newtype)
10
11 IN     size                size of process group (positive integer)
12 IN     rank                rank in process group (non-negative integer)
13 IN     ndims              number of array dimensions as well as process grid
14                          dimensions (positive integer)
15
16 IN     array_of_gsizes    number of elements of type oldtype in each dimension
17                          of global array (array of positive integers)
18 IN     array_of_distribs  distribution of array in each dimension (array of
19                          states)
20
21 IN     array_of_dargs     distribution argument in each dimension (array of
22                          positive integers)
23 IN     array_of_psizes    size of process grid in each dimension (array of
24                          positive integers)
25
26 IN     order              array storage order flag (state)
27 IN     oldtype            old datatype (handle)
28 OUT    newtype            new datatype (handle)
29

```

### 30 C binding

```

31 int MPI_Type_create_darray(int size, int rank, int ndims,
32     const int array_of_gsizes[], const int array_of_distribs[],
33     const int array_of_dargs[], const int array_of_psizes[],
34     int order, MPI_Datatype oldtype, MPI_Datatype *newtype)
35
36 int MPI_Type_create_darray_c(int size, int rank, int ndims,
37     const MPI_Count array_of_gsizes[],
38     const int array_of_distribs[], const int array_of_dargs[],
39     const int array_of_psizes[], int order, MPI_Datatype oldtype,
40     MPI_Datatype *newtype)

```

### 41 Fortran 2008 binding

```

42 MPI_Type_create_darray(size, rank, ndims, array_of_gsizes,
43     array_of_distribs, array_of_dargs, array_of_psizes, order,
44     oldtype, newtype, ierror)
45 INTEGER, INTENT(IN) :: size, rank, ndims, array_of_gsizes(ndims),
46     array_of_distribs(ndims), array_of_dargs(ndims),
47     array_of_psizes(ndims), order
48 TYPE(MPI_Datatype), INTENT(IN) :: oldtype

```

```

TYPE(MPI_Datatype), INTENT(OUT) :: newtype
INTEGER, OPTIONAL, INTENT(OUT) :: ierror
MPI_Type_create_darray(size, rank, ndims, array_of_gsizes,
    array_of_distribs, array_of_dargs, array_of_psizes, order,
    oldtype, newtype, ierror)
INTEGER, INTENT(IN) :: size, rank, ndims, array_of_distribs(ndims),
    array_of_dargs(ndims), array_of_psizes(ndims), order
INTEGER(KIND=MPI_COUNT_KIND), INTENT(IN) :: array_of_gsizes(ndims)
TYPE(MPI_Datatype), INTENT(IN) :: oldtype
TYPE(MPI_Datatype), INTENT(OUT) :: newtype
INTEGER, OPTIONAL, INTENT(OUT) :: ierror

```

### Fortran binding

```

MPI_TYPE_CREATE_DARRAY(SIZE, RANK, NDIMS, ARRAY_OF_GSIZES,
    ARRAY_OF_DISTRIBS, ARRAY_OF_DARGS, ARRAY_OF_PSIZEs, ORDER,
    OLDTYPE, NEWTYPE, IERROR)
INTEGER SIZE, RANK, NDIMS, ARRAY_OF_GSIZES(*), ARRAY_OF_DISTRIBS(*),
    ARRAY_OF_DARGS(*), ARRAY_OF_PSIZEs(*), ORDER, OLDTYPE,
    NEWTYPE, IERROR

```

`MPI_TYPE_CREATE_DARRAY` can be used to generate the datatypes corresponding to the distribution of an `ndims`-dimensional array of `oldtype` elements onto an `ndims`-dimensional grid of logical processes. Unused dimensions of `array_of_psize`s should be set to 1 (see Example 5.7). For a call to `MPI_TYPE_CREATE_DARRAY` to be correct, the equation  $\prod_{i=0}^{ndims-1} array\_of\_psizes[i] = size$  must be satisfied. The ordering of processes in the process grid is assumed to be row-major, as in the case of virtual Cartesian process topologies.

*Advice to users.* For both Fortran and C arrays, the ordering of processes in the process grid is assumed to be row-major. This is consistent with the ordering used in virtual Cartesian process topologies in MPI. To create such virtual process topologies, or to find the coordinates of a process in the process grid, etc., users may use the corresponding process topology functions, see Chapter 8. (*End of advice to users.*)

Each dimension of the array can be distributed in one of three ways:

- `MPI_DISTRIBUTE_BLOCK` - Block distribution
- `MPI_DISTRIBUTE_CYCLIC` - Cyclic distribution
- `MPI_DISTRIBUTE_NONE` - Dimension not distributed

The constant `MPI_DISTRIBUTE_DFLT_DARG` specifies a default distribution argument. The distribution argument for a dimension that is not distributed is ignored. For any dimension `i` in which the distribution is `MPI_DISTRIBUTE_BLOCK`, it is erroneous to specify `array_of_dargs[i] * array_of_psize[i] < array_of_gsize[i]`.

For example, the HPF layout `ARRAY(CYCLIC(15))` corresponds to `MPI_DISTRIBUTE_CYCLIC` with a distribution argument of 15, and the HPF layout `ARRAY(BLOCK)` corresponds to `MPI_DISTRIBUTE_BLOCK` with a distribution argument of `MPI_DISTRIBUTE_DFLT_DARG`.

1 The `order` argument is used as in `MPI_TYPE_CREATE_SUBARRAY` to specify the stor-  
 2 age order. Therefore, arrays described by this type constructor may be stored in Fortran  
 3 (column-major) or C (row-major) order. Valid values for `order` are `MPI_ORDER_FORTRAN`  
 4 and `MPI_ORDER_C`.

5 This routine creates a new MPI datatype with a typemap defined in terms of a function  
 6 called “`cyclic()`” (see below).

7 Without loss of generality, it suffices to define the typemap for the  
 8 `MPI_DISTRIBUTE_CYCLIC` case where `MPI_DISTRIBUTE_DFLT_DARG` is not used.

9 `MPI_DISTRIBUTE_BLOCK` and `MPI_DISTRIBUTE_NONE` can be reduced to the  
 10 `MPI_DISTRIBUTE_CYCLIC` case for dimension `i` as follows.

11 `MPI_DISTRIBUTE_BLOCK` with `array_of_dargs[i]` equal to `MPI_DISTRIBUTE_DFLT_DARG`  
 12 is equivalent to `MPI_DISTRIBUTE_CYCLIC` with `array_of_dargs[i]` set to

$$(array\_of\_gsizes[i] + array\_of\_psizes[i] - 1) / array\_of\_psizes[i].$$

15 If `array_of_dargs[i]` is not `MPI_DISTRIBUTE_DFLT_DARG`, then `MPI_DISTRIBUTE_BLOCK` and  
 16 `MPI_DISTRIBUTE_CYCLIC` are equivalent.

17 `MPI_DISTRIBUTE_NONE` is equivalent to `MPI_DISTRIBUTE_CYCLIC` with  
 18 `array_of_dargs[i]` set to `array_of_gsizes[i]`.

19 Finally, `MPI_DISTRIBUTE_CYCLIC` with `array_of_dargs[i]` equal to  
 20 `MPI_DISTRIBUTE_DFLT_DARG` is equivalent to `MPI_DISTRIBUTE_CYCLIC` with  
 21 `array_of_dargs[i]` set to 1.

22 For `MPI_ORDER_FORTRAN`, an `ndims`-dimensional distributed array (`newtype`) is defined  
 23 by the following code fragment:

```
24
25     oldtypes[0] = oldtype;
26     for (i = 0; i < ndims; i++) {
27         oldtypes[i+1] = cyclic(array_of_dargs[i],
28                               array_of_gsizes[i],
29                               r[i],
30                               array_of_psize[i],
31                               oldtypes[i]);
32     }
33     newtype = oldtypes[ndims];
```

34 For `MPI_ORDER_C`, the code is:

```
35
36     oldtypes[0] = oldtype;
37     for (i = 0; i < ndims; i++) {
38         oldtypes[i + 1] = cyclic(array_of_dargs[ndims - i - 1],
39                                 array_of_gsizes[ndims - i - 1],
40                                 r[ndims - i - 1],
41                                 array_of_psize[ndims - i - 1],
42                                 oldtypes[i]);
43     }
44     newtype = oldtypes[ndims];
```

47 where `r[i]` is the position of the process (with rank `rank`) in the process grid at dimension  
 48 `i`. The values of `r[i]` are given by the following code fragment:

```

t_rank = rank;
t_size = 1;
for (i = 0; i < ndims; i++)
    t_size *= array_of_psize[i];
for (i = 0; i < ndims; i++) {
    t_size = t_size / array_of_psize[i];
    r[i] = t_rank / t_size;
    t_rank = t_rank % t_size;
}

```

Let the typemap of oldtype have the form:

$$\{(type_0, disp_0), (type_1, disp_1), \dots, (type_{n-1}, disp_{n-1})\}$$

where  $type_i$  is a predefined MPI datatype, and let  $ex$  be the extent of oldtype. The following function uses the conceptual datatypes `lb_marker` and `ub_marker`, see Section 5.1.6 for details.

Given the above, the function `cyclic()` is defined as follows:

```

cyclic(darg, gsize, r, psize, oldtype)
= { (lb_marker, 0),
    (type_0, disp_0 + r × darg × ex), ...,
    (type_{n-1}, disp_{n-1} + r × darg × ex),
    (type_0, disp_0 + (r × darg + 1) × ex), ...,
    (type_{n-1}, disp_{n-1} + (r × darg + 1) × ex),
    ...
    (type_0, disp_0 + ((r + 1) × darg - 1) × ex), ...,
    (type_{n-1}, disp_{n-1} + ((r + 1) × darg - 1) × ex),
    ...
    (type_0, disp_0 + r × darg × ex + psize × darg × ex), ...,
    (type_{n-1}, disp_{n-1} + r × darg × ex + psize × darg × ex),
    (type_0, disp_0 + (r × darg + 1) × ex + psize × darg × ex), ...,
    (type_{n-1}, disp_{n-1} + (r × darg + 1) × ex + psize × darg × ex),
    ...
    (type_0, disp_0 + ((r + 1) × darg - 1) × ex + psize × darg × ex), ...,
    (type_{n-1}, disp_{n-1} + ((r + 1) × darg - 1) × ex + psize × darg × ex),
    ...
    (type_0, disp_0 + r × darg × ex + psize × darg × ex × (count - 1)), ...,
    (type_{n-1}, disp_{n-1} + r × darg × ex + psize × darg × ex × (count - 1)),
    (type_0, disp_0 + (r × darg + 1) × ex + psize × darg × ex × (count - 1)), ...,
    (type_{n-1}, disp_{n-1} + (r × darg + 1) × ex
    + psize × darg × ex × (count - 1)),
    ...
    (type_0, disp_0 + (r × darg + darg_{last} - 1) × ex

```

```

1          +psize × darg × ex × (count − 1)), ...,
2          (typen−1, dispn−1 + (r × darg + darglast − 1) × ex
3          +psize × darg × ex × (count − 1)),
4          (ub_marker, gsize × ex)}
5

```

where *count* is defined by this code fragment:

```

8      nblocks = (gsize + (darg - 1)) / darg;
9      count = nblocks / psize;
10     left_over = nblocks - count * psize;
11     if (r < left_over)
12         count = count + 1;

```

Here, *nblocks* is the number of blocks that must be distributed among the processors. Finally, *darg<sub>last</sub>* is defined by this code fragment:

```

16     if ((num_in_last_cyclic = gsize % (psize * darg)) == 0)
17         darg_last = darg;
18     else {
19         darg_last = num_in_last_cyclic - darg * r;
20         if (darg_last > darg)
21             darg_last = darg;
22         if (darg_last <= 0)
23             darg_last = darg;
24     }

```

**Example 5.7** Consider generating the filetypes corresponding to the HPF distribution:

```

28     <oldtype> FILEARRAY(100, 200, 300)
29     !HPF$ PROCESSORS PROCESSES(2, 3)
30     !HPF$ DISTRIBUTE FILEARRAY(CYCLIC(10), *, BLOCK) ONTO PROCESSES

```

This can be achieved by the following Fortran code, assuming there will be six processes attached to the run:

```

34     ndims = 3
35     array_of_gsizes(1) = 100
36     array_of_distrib(1) = MPI_DISTRIBUTE_CYCLIC
37     array_of_dargs(1) = 10
38     array_of_gsizes(2) = 200
39     array_of_distrib(2) = MPI_DISTRIBUTE_NONE
40     array_of_dargs(2) = 0
41     array_of_gsizes(3) = 300
42     array_of_distrib(3) = MPI_DISTRIBUTE_BLOCK
43     array_of_dargs(3) = MPI_DISTRIBUTE_DFLT_DARG
44     array_of_psize(1) = 2
45     array_of_psize(2) = 1
46     array_of_psize(3) = 3
47     call MPI_COMM_SIZE(MPI_COMM_WORLD, size, ierr)

```



```

call MPI_COMM_RANK(MPI_COMM_WORLD, rank, ierr)
call MPI_TYPE_CREATE_DARRAY(size, rank, ndims, array_of_gsizes, &
    array_of_distribs, array_of_dargs, array_of_psize, &
    MPI_ORDER_FORTRAN, oldtype, newtype, ierr)

```

### 5.1.5 Address and Size Functions

The displacements in a general datatype are relative to some initial buffer address. **Absolute addresses** can be substituted for these displacements: we treat them as displacements relative to “address zero,” the start of the address space. This initial address zero is indicated by the constant `MPI_BOTTOM`. Thus, a datatype can specify the absolute address of the entries in the communication buffer, in which case the `buf` argument is passed the value `MPI_BOTTOM`. Note that in Fortran `MPI_BOTTOM` is not usable for initialization or assignment, see Section 2.5.4.

The address of a location in memory can be found by invoking the function `MPI_GET_ADDRESS`. The **relative displacement** between two absolute addresses can be calculated with the function `MPI_AINT_DIFF`. A new absolute address as sum of an absolute base address and a relative displacement can be calculated with the function `MPI_AINT_ADD`. To ensure portability, arithmetic on absolute addresses should not be performed with the intrinsic operators “-” and “+”. See also Sections 2.5.6 and 5.1.12 on pages 20 and 154.

*Rationale.* Address sized integer values, i.e., `MPI_Aint` or `INTEGER(KIND=MPI_ADDRESS_KIND)` values, are signed integers, while absolute addresses are unsigned quantities. Direct arithmetic on addresses stored in address sized signed variables can cause overflows, resulting in undefined behavior. (*End of rationale.*)

```
MPI_GET_ADDRESS(location, address)
```

IN	location	location in caller memory (choice)
OUT	address	address of location (integer)

#### C binding

```
int MPI_Get_address(const void *location, MPI_Aint *address)
```

#### Fortran 2008 binding

```

MPI_Get_address(location, address, ierror)
    TYPE(*), DIMENSION(..), ASYNCHRONOUS :: location
    INTEGER(KIND=MPI_ADDRESS_KIND), INTENT(OUT) :: address
    INTEGER, OPTIONAL, INTENT(OUT) :: ierror

```

#### Fortran binding

```

MPI_GET_ADDRESS(LOCATION, ADDRESS, IERROR)
    <type> LOCATION(*)
    INTEGER(KIND=MPI_ADDRESS_KIND) ADDRESS
    INTEGER IERROR

```

Returns the (byte) address of location.

1       *Rationale.* In the `mpi_f08` module, the `location` argument is not defined with  
 2       `INTENT(IN)` because existing applications may use `MPI_GET_ADDRESS` as a substi-  
 3       tute for `MPI_F_SYNC_REG`, which was not defined before MPI-3.0. (*End of rationale.*)

6       **Example 5.8** Using `MPI_GET_ADDRESS` for an array.

```
7
8 REAL A(100,100)
9 INTEGER(KIND=MPI_ADDRESS_KIND) I1, I2, DIFF
10 CALL MPI_GET_ADDRESS(A(1,1), I1, IERROR)
11 CALL MPI_GET_ADDRESS(A(10,10), I2, IERROR)
12 DIFF = MPI_AINT_DIFF(I2, I1)
13 ! The value of DIFF is 909*SIZEOF(REAL); the values of I1 and I2 are
14 ! implementation dependent.
```

15       *Advice to users.* C users may be tempted to avoid the usage of  
 16       `MPI_GET_ADDRESS` and rely on the availability of the address operator `&`. Note,  
 17       however, that *& cast-expression* is a pointer, not an address. ISO C does not require  
 18       that the value of a pointer (or the pointer cast to `int`) be the absolute address of  
 19       the object pointed at—although this is commonly the case. Furthermore, referencing  
 20       may not have a unique definition on machines with a segmented address space. The  
 21       use of `MPI_GET_ADDRESS` to “reference” C variables guarantees portability to such  
 22       machines as well. (*End of advice to users.*)

24       *Advice to users.* To prevent problems with the argument copying and register  
 25       optimization done by Fortran compilers, please note the hints in Sections 19.1.10–  
 26       19.1.20. (*End of advice to users.*)

28       To ensure portability, arithmetic on MPI addresses must be performed using the  
 29       `MPI_AINT_ADD` and `MPI_AINT_DIFF` functions.

```
30
31
32 MPI_AINT_ADD(base, disp)
33   IN      base                base address (integer)
34
35   IN      disp               displacement (integer)
```

### 37 C binding

```
38 MPI_Aint MPI_Aint_add(MPI_Aint base, MPI_Aint disp)
```

### 39 Fortran 2008 binding

```
40 INTEGER(KIND=MPI_ADDRESS_KIND) MPI_Aint_add(base, disp)
41     INTEGER(KIND=MPI_ADDRESS_KIND), INTENT(IN) :: base, disp
```

### 43 Fortran binding

```
44 INTEGER(KIND=MPI_ADDRESS_KIND) MPI_AINT_ADD(BASE, DISP)
45     INTEGER(KIND=MPI_ADDRESS_KIND) BASE, DISP
```

46       `MPI_AINT_ADD` produces a new `MPI_Aint` value that is equivalent to the sum of  
 47       the `base` and `disp` arguments, where `base` represents a base address returned by a call to  
 48

MPI\_GET\_ADDRESS and disp represents a signed integer displacement. The resulting address is valid only at the process that generated base, and it must correspond to a location in the same object referenced by base, as described in Section 5.1.12. The addition is performed in a manner that results in the correct MPI\_Aint representation of the output address, as if the process that originally produced base had called:

```
MPI_Get_address((char *) base + disp, &result);
```

```
MPI_AINT_DIFF(addr1, addr2)
```

IN	addr1	minuend address (integer)
IN	addr2	subtrahend address (integer)

### C binding

```
MPI_Aint MPI_Aint_diff(MPI_Aint addr1, MPI_Aint addr2)
```

### Fortran 2008 binding

```
INTEGER(KIND=MPI_ADDRESS_KIND) MPI_Aint_diff(addr1, addr2)
      INTEGER(KIND=MPI_ADDRESS_KIND), INTENT(IN) :: addr1, addr2
```

### Fortran binding

```
INTEGER(KIND=MPI_ADDRESS_KIND) MPI_AINT_DIFF(ADDR1, ADDR2)
      INTEGER(KIND=MPI_ADDRESS_KIND) ADDR1, ADDR2
```

MPI\_AINT\_DIFF produces a new MPI\_Aint value that is equivalent to the difference between addr1 and addr2 arguments, where addr1 and addr2 represent addresses returned by calls to MPI\_GET\_ADDRESS. The resulting address is valid only at the process that generated addr1 and addr2, and addr1 and addr2 must correspond to locations in the same object in the same process, as described in Section 5.1.12. The difference is calculated in a manner that results in the signed difference from addr1 to addr2, as if the process that originally produced the addresses had called (char \*) addr1 - (char \*) addr2 on the addresses initially passed to MPI\_GET\_ADDRESS.

The following auxiliary functions provide useful information on derived datatypes.

```
MPI_TYPE_SIZE(datatype, size)
```

IN	datatype	datatype to get information on (handle)
OUT	size	datatype size (integer)

### C binding

```
int MPI_Type_size(MPI_Datatype datatype, int *size)
```

```
int MPI_Type_size_c(MPI_Datatype datatype, MPI_Count *size)
```

### Fortran 2008 binding

```
MPI_Type_size(datatype, size, ierror)
      TYPE(MPI_Datatype), INTENT(IN) :: datatype
      INTEGER, INTENT(OUT) :: size
      INTEGER, OPTIONAL, INTENT(OUT) :: ierror
```

```

1 MPI_Type_size(datatype, size, ierror)
2     TYPE(MPI_Datatype), INTENT(IN) :: datatype
3     INTEGER(KIND=MPI_COUNT_KIND), INTENT(OUT) :: size
4     INTEGER, OPTIONAL, INTENT(OUT) :: ierror

```

#### Fortran binding

```

6 MPI_TYPE_SIZE(DATATYPE, SIZE, IERROR)
7     INTEGER DATATYPE, SIZE, IERROR

```

```

10 MPI_TYPE_SIZE_X(datatype, size)

```

```

12     IN      datatype          datatype to get information on (handle)
13     OUT     size              datatype size (integer)

```

#### C binding

```

16 int MPI_Type_size_x(MPI_Datatype datatype, MPI_Count *size)

```

#### Fortran 2008 binding

```

19 MPI_Type_size_x(datatype, size, ierror)
20     TYPE(MPI_Datatype), INTENT(IN) :: datatype
21     INTEGER(KIND=MPI_COUNT_KIND), INTENT(OUT) :: size
22     INTEGER, OPTIONAL, INTENT(OUT) :: ierror

```

#### Fortran binding

```

24 MPI_TYPE_SIZE_X(DATATYPE, SIZE, IERROR)
25     INTEGER DATATYPE, IERROR
26     INTEGER(KIND=MPI_COUNT_KIND) SIZE

```

MPI\_TYPE\_SIZE and MPI\_TYPE\_SIZE\_X set the value of `size` to the total size, in bytes, of the entries in the type signature associated with `datatype`; i.e., the total size of the data in a message that would be created with this datatype. Entries that occur multiple times in the datatype are counted with their multiplicity. For both functions, if the OUT parameter cannot express the value to be returned (e.g., if the parameter is too small to hold the output value), it is set to MPI\_UNDEFINED.

### 5.1.6 Lower-Bound and Upper-Bound Markers

It is often convenient to define explicitly the lower bound and upper bound of a type map, and override the definition given on page 143. This allows one to define a datatype that has “holes” at its beginning or its end, or a datatype with entries that extend above the upper bound or below the lower bound. Examples of such usage are provided in Section 5.1.14. Also, the user may want to override the alignment rules that are used to compute upper bounds and extents. E.g., a C compiler may allow the user to override default alignment rules for some of the structures within a program. The user has to specify explicitly the bounds of the datatypes that match these structures.

To achieve this, we add two additional conceptual datatypes, `lb_marker` and `ub_marker`, that represent the lower bound and upper bound of a datatype. These conceptual datatypes occupy no space ( $extent(lb\_marker) = extent(ub\_marker) = 0$ ). They do not affect the size or count of a datatype, and do not affect the content of a message created

with this datatype. However, they do affect the definition of the extent of a datatype and, therefore, affect the outcome of a replication of this datatype by a datatype constructor.

**Example 5.9** A call to `MPI_TYPE_CREATE_RESIZED(MPI_INT, -3, 9, type1)` creates a new datatype that has an extent of 9 (from -3 to 5, 5 included), and contains an integer at displacement 0. This is the datatype defined by the typemap  $\{(lb\_marker, -3), (int, 0), (ub\_marker, 6)\}$ . If this type is replicated twice by a call to `MPI_TYPE_CONTIGUOUS(2, type1, type2)` then the newly created type can be described by the typemap  $\{(lb\_marker, -3), (int, 0), (int, 9), (ub\_marker, 15)\}$ . (An entry of type `ub\_marker` can be deleted if there is another entry of type `ub\_marker` with a higher displacement; an entry of type `lb\_marker` can be deleted if there is another entry of type `lb\_marker` with a lower displacement.)

In general, if

$$Typemap = \{(type_0, disp_0), \dots, (type_{n-1}, disp_{n-1})\},$$

then the **lower bound** of  $Typemap$  is defined to be

$$lb(Typemap) = \begin{cases} \min_j disp_j & \text{if no entry has type } lb\_marker \\ \min_j \{disp_j \text{ such that } type_j = lb\_marker\} & \text{otherwise} \end{cases}$$

Similarly, the **upper bound** of  $Typemap$  is defined to be

$$ub(Typemap) = \begin{cases} \max_j (disp_j + sizeof(type_j)) + \epsilon & \text{if no entry has type } ub\_marker \\ \max_j \{disp_j \text{ such that } type_j = ub\_marker\} & \text{otherwise} \end{cases}$$

Then

$$extent(Typemap) = ub(Typemap) - lb(Typemap)$$

If  $type_i$  requires alignment to a byte address that is a multiple of  $k_i$ , then  $\epsilon$  is the least non-negative increment needed to round  $extent(Typemap)$  to the next multiple of  $\max_i k_i$ . In Fortran, it is implementation dependent whether the MPI implementation computes the alignments  $k_i$  according to the alignments used by the compiler in common blocks, `SEQUENCE` derived types, `BIND(C)` derived types, or derived types that are neither `SEQUENCE` nor `BIND(C)`.

The formal definitions given for the various datatype constructors apply now, with the amended definition of **extent**.

*Rationale.* Before Fortran 2003, `MPI_TYPE_CREATE_STRUCT` could be applied to Fortran common blocks and `SEQUENCE` derived types. With Fortran 2003, this list was extended by `BIND(C)` derived types and MPI implementors have implemented the alignments  $k_i$  differently, i.e., some based on the alignments used in `SEQUENCE` derived types, and others according to `BIND(C)` derived types. (*End of rationale.*)

*Advice to implementors.* In Fortran, it is generally recommended to use `BIND(C)` derived types instead of common blocks or `SEQUENCE` derived types. Therefore it is recommended to calculate the alignments  $k_i$  based on `BIND(C)` derived types. (*End of advice to implementors.*)

*Advice to users.* Structures combining different basic datatypes should be defined so that there will be no gaps based on alignment rules. If such a datatype is used to create an array of structures, users should also avoid an alignment-gap at the end of the structure. In MPI communication, the content of such gaps would not be communicated into the receiver's buffer. For example, such an alignment-gap may occur between an odd number of `floats` or `REALs` before a `double` or `DOUBLE PRECISION` data. Such gaps may be added explicitly to both the structure and the MPI derived datatype handle because the communication of a contiguous derived datatype may be significantly faster than the communication of one that is non-contiguous because of such alignment-gaps.

As an example, instead of

```

TYPE, BIND(C) :: my_data
  REAL, DIMENSION(3) :: x
  ! there may be a gap of the size of one REAL
  ! if the alignment of a DOUBLE PRECISION is
  ! two times the size of a REAL
  DOUBLE PRECISION :: p
END TYPE

```

one should define

```

TYPE, BIND(C) :: my_data
  REAL, DIMENSION(3) :: x
  REAL :: gap1
  DOUBLE PRECISION :: p
END TYPE

```

and also include `gap1` in the matching MPI derived datatype. It is required that all processes in a communication add the same gaps, i.e., defined with the same basic datatype. Both the original and the modified structures are portable, but may have different performance implications for the communication and memory accesses during computation on systems with different alignment values.

In principle, a compiler may define an additional alignment rule for structures, e.g., to use at least 4 or 8 byte alignment, although the content may have a  $max_i k_i$  alignment less than this structure alignment. To maintain portability, users should always resize structure derived datatype handles if used in an array of structures, see the Example in Section 19.1.15. (*End of advice to users.*)

## 5.1.7 Extent and Bounds of Datatypes

MPI\_TYPE\_GET\_EXTENT(datatype, lb, extent)

IN	datatype	datatype to get information on (handle)
OUT	lb	lower bound of datatype (integer)
OUT	extent	extent of datatype (integer)

**C binding**

```
int MPI_Type_get_extent(MPI_Datatype datatype, MPI_Aint *lb,
                       MPI_Aint *extent)
```

```
int MPI_Type_get_extent_c(MPI_Datatype datatype, MPI_Count *lb,
                          MPI_Count *extent)
```

**Fortran 2008 binding**

```
MPI_Type_get_extent(datatype, lb, extent, ierror)
  TYPE(MPI_Datatype), INTENT(IN) :: datatype
  INTEGER(KIND=MPI_ADDRESS_KIND), INTENT(OUT) :: lb, extent
  INTEGER, OPTIONAL, INTENT(OUT) :: ierror
```

```
MPI_Type_get_extent(datatype, lb, extent, ierror)
  TYPE(MPI_Datatype), INTENT(IN) :: datatype
  INTEGER(KIND=MPI_COUNT_KIND), INTENT(OUT) :: lb, extent
  INTEGER, OPTIONAL, INTENT(OUT) :: ierror
```

**Fortran binding**

```
MPI_TYPE_GET_EXTENT(DATATYPE, LB, EXTENT, IERROR)
  INTEGER DATATYPE, IERROR
  INTEGER(KIND=MPI_ADDRESS_KIND) LB, EXTENT
```

MPI\_TYPE\_GET\_EXTENT\_X(datatype, lb, extent)

IN	datatype	datatype to get information on (handle)
OUT	lb	lower bound of datatype (integer)
OUT	extent	extent of datatype (integer)

**C binding**

```
int MPI_Type_get_extent_x(MPI_Datatype datatype, MPI_Count *lb,
                          MPI_Count *extent)
```

**Fortran 2008 binding**

```
MPI_Type_get_extent_x(datatype, lb, extent, ierror)
  TYPE(MPI_Datatype), INTENT(IN) :: datatype
  INTEGER(KIND=MPI_COUNT_KIND), INTENT(OUT) :: lb, extent
  INTEGER, OPTIONAL, INTENT(OUT) :: ierror
```

**Fortran binding**

```

1 MPI_TYPE_GET_EXTENT_X(DATATYPE, LB, EXTENT, IERROR)
2   INTEGER DATATYPE, IERROR
3   INTEGER(KIND=MPI_COUNT_KIND) LB, EXTENT

```

Returns the lower bound and the extent of `datatype` (as defined in Equation 5.1).

For both functions, if either `OUT` parameter cannot express the value to be returned (e.g., if the parameter is too small to hold the output value), it is set to `MPI_UNDEFINED`.

MPI allows one to change the extent of a datatype, using lower bound and upper bound markers. This provides control over the stride of successive datatypes that are replicated by datatype constructors, or are replicated by the count argument in a send or receive call.

```

13 MPI_TYPE_CREATE_RESIZED(oldtype, lb, extent, newtype)

```

14	IN	oldtype	input datatype (handle)
15			
16	IN	lb	new lower bound of datatype (integer)
17	IN	extent	new extent of datatype (integer)
18			
19	OUT	newtype	output datatype (handle)

**C binding**

```

22 int MPI_Type_create_resized(MPI_Datatype oldtype, MPI_Aint lb,
23   MPI_Aint extent, MPI_Datatype *newtype)
24
25 int MPI_Type_create_resized_c(MPI_Datatype oldtype, MPI_Count lb,
26   MPI_Count extent, MPI_Datatype *newtype)

```

**Fortran 2008 binding**

```

28 MPI_Type_create_resized(oldtype, lb, extent, newtype, ierror)
29   TYPE(MPI_Datatype), INTENT(IN) :: oldtype
30   INTEGER(KIND=MPI_ADDRESS_KIND), INTENT(IN) :: lb, extent
31   TYPE(MPI_Datatype), INTENT(OUT) :: newtype
32   INTEGER, OPTIONAL, INTENT(OUT) :: ierror
33
34 MPI_Type_create_resized(oldtype, lb, extent, newtype, ierror)
35   TYPE(MPI_Datatype), INTENT(IN) :: oldtype
36   INTEGER(KIND=MPI_COUNT_KIND), INTENT(IN) :: lb, extent
37   TYPE(MPI_Datatype), INTENT(OUT) :: newtype
38   INTEGER, OPTIONAL, INTENT(OUT) :: ierror

```

**Fortran binding**

```

40 MPI_TYPE_CREATE_RESIZED(OLDTYPE, LB, EXTENT, NEWTYPE, IERROR)
41   INTEGER OLDTYPE, NEWTYPE, IERROR
42   INTEGER(KIND=MPI_ADDRESS_KIND) LB, EXTENT

```

Returns in `newtype` a handle to a new datatype that is identical to `oldtype`, except that the lower bound of this new datatype is set to be `lb`, and its upper bound is set to be `lb + extent`. Any previous `lb` and `ub` markers are erased, and a new pair of lower bound and upper bound markers are put in the positions indicated by the `lb` and `extent` arguments.



This affects the behavior of the datatype when used in communication operations, with count > 1, and when used in the construction of new derived datatypes.

### 5.1.8 True Extent of Datatypes

Suppose we implement gather (see also Section 6.5) as a spanning tree implemented on top of point-to-point routines. Since the receive buffer is only valid on the root process, one will need to allocate some temporary space for receiving data on intermediate nodes. However, the datatype extent cannot be used as an estimate of the amount of space that needs to be allocated, if the user has modified the extent, for example by using MPI\_TYPE\_CREATE\_RESIZED. The functions MPI\_TYPE\_GET\_TRUE\_EXTENT and MPI\_TYPE\_GET\_TRUE\_EXTENT\_X are provided which return the true extent of the datatype.

MPI\_TYPE\_GET\_TRUE\_EXTENT(datatype, true\_lb, true\_extent)

IN	datatype	datatype to get information on (handle)
OUT	true_lb	true lower bound of datatype (integer)
OUT	true_extent	true extent of datatype (integer)

#### C binding

```
int MPI_Type_get_true_extent(MPI_Datatype datatype, MPI_Aint *true_lb,
    MPI_Aint *true_extent)
```

```
int MPI_Type_get_true_extent_c(MPI_Datatype datatype, MPI_Count *true_lb,
    MPI_Count *true_extent)
```

#### Fortran 2008 binding

```
MPI_Type_get_true_extent(datatype, true_lb, true_extent, ierror)
    TYPE(MPI_Datatype), INTENT(IN) :: datatype
    INTEGER(KIND=MPI_ADDRESS_KIND), INTENT(OUT) :: true_lb, true_extent
    INTEGER, OPTIONAL, INTENT(OUT) :: ierror
```

```
MPI_Type_get_true_extent(datatype, true_lb, true_extent, ierror)
    TYPE(MPI_Datatype), INTENT(IN) :: datatype
    INTEGER(KIND=MPI_COUNT_KIND), INTENT(OUT) :: true_lb, true_extent
    INTEGER, OPTIONAL, INTENT(OUT) :: ierror
```

#### Fortran binding

```
MPI_TYPE_GET_TRUE_EXTENT(DATATYPE, TRUE_LB, TRUE_EXTENT, IERROR)
    INTEGER DATATYPE, IERROR
    INTEGER(KIND=MPI_ADDRESS_KIND) TRUE_LB, TRUE_EXTENT
```

```

1 MPI_TYPE_GET_TRUE_EXTENT_X(datatype, true_lb, true_extent)
2     IN      datatype          datatype to get information on (handle)
3
4     OUT     true_lb           true lower bound of datatype (integer)
5
6     OUT     true_extent       true extent of datatype (integer)

```

### C binding

```

8 int MPI_Type_get_true_extent_x(MPI_Datatype datatype, MPI_Count *true_lb,
9                               MPI_Count *true_extent)

```

### Fortran 2008 binding

```

12 MPI_Type_get_true_extent_x(datatype, true_lb, true_extent, ierror)
13     TYPE(MPI_Datatype), INTENT(IN) :: datatype
14     INTEGER(KIND=MPI_COUNT_KIND), INTENT(OUT) :: true_lb, true_extent
15     INTEGER, OPTIONAL, INTENT(OUT) :: ierror

```

### Fortran binding

```

17 MPI_TYPE_GET_TRUE_EXTENT_X(DATATYPE, TRUE_LB, TRUE_EXTENT, IERROR)
18     INTEGER DATATYPE, IERROR
19     INTEGER(KIND=MPI_COUNT_KIND) TRUE_LB, TRUE_EXTENT

```

21 `true_lb` returns the offset of the lowest unit of store which is addressed by the datatype,
22 i.e., the lower bound of the corresponding typemap, ignoring explicit lower bound markers.
23 `true_extent` returns the true size of the datatype, i.e., the extent of the corresponding
24 typemap, ignoring explicit lower bound and upper bound markers, and performing no
25 rounding for alignment. If the typemap associated with `datatype` is

$$26 \text{Typemap} = \{(type_0, disp_0), \dots, (type_{n-1}, disp_{n-1})\}$$

28 Then

$$30 \text{true\_lb}(\text{Typemap}) = \min_j \{disp_j : type_j \neq \text{lb\_marker}, \text{ub\_marker}\},$$

$$32 \text{true\_ub}(\text{Typemap}) = \max_j \{disp_j + \text{sizeof}(type_j) : type_j \neq \text{lb\_marker}, \text{ub\_marker}\},$$

33 and

$$35 \text{true\_extent}(\text{Typemap}) = \text{true\_ub}(\text{Typemap}) - \text{true\_lb}(\text{typemap}).$$

37 (Readers should compare this with the definitions in Section 5.1.6 and Section 5.1.7, which
38 describe the function `MPI_TYPE_GET_EXTENT`.)

39 The `true_extent` is the minimum number of bytes of memory necessary to hold a
40 datatype, uncompressed.

41 For both functions, if either OUT parameter cannot express the value to be returned
42 (e.g., if the parameter is too small to hold the output value), it is set to `MPI_UNDEFINED`.

### 5.1.9 Commit and Free

44 A datatype object has to be **committed** before it can be used in a communication. As
45 an argument in datatype constructors, uncommitted and also committed datatypes can be
46 used. There is no need to commit basic datatypes. They are “pre-committed.”

MPI\_TYPE\_COMMIT(datatype) 1

INOUT datatype datatype that is committed (handle) 2

**C binding** 4

int MPI\_Type\_commit(MPI\_Datatype \*datatype) 5

**Fortran 2008 binding** 7

MPI\_Type\_commit(datatype, ierror) 8

TYPE(MPI\_Datatype), INTENT(INOUT) :: datatype 9

INTEGER, OPTIONAL, INTENT(OUT) :: ierror 10

**Fortran binding** 12

MPI\_TYPE\_COMMIT(DATATYPE, IERROR) 13

INTEGER DATATYPE, IERROR 14

The commit operation commits the datatype, that is, the formal description of a communication buffer, not the content of that buffer. Thus, after a datatype has been committed, it can be repeatedly reused to communicate the changing content of a buffer or, indeed, the content of different buffers, with different starting addresses. 15-19

*Advice to implementors.* The system may “compile” at commit time an internal representation for the datatype that facilitates communication, e.g., change from a compacted representation to a flat representation of the datatype, and select the most convenient transfer mechanism. (*End of advice to implementors.*) 20-24

MPI\_TYPE\_COMMIT will accept a committed datatype; in this case, it is equivalent to a no-op. 25-26

**Example 5.10** The following code fragment gives examples of using MPI\_TYPE\_COMMIT. 27-28

```
INTEGER type1, type2 29
```

```
CALL MPI_TYPE_CONTIGUOUS(5, MPI_REAL, type1, ierr) 30
```

```
! new type object created 31
```

```
CALL MPI_TYPE_COMMIT(type1, ierr) 32
```

```
! now type1 can be used for communication 33
```

```
type2 = type1 34
```

```
! type2 can be used for communication 35
```

```
! (it is a handle to same object as type1) 36
```

```
CALL MPI_TYPE_VECTOR(3, 5, 4, MPI_REAL, type1, ierr) 37
```

```
! new uncommitted type object created 38
```

```
CALL MPI_TYPE_COMMIT(type1, ierr) 39
```

```
! now type1 can be used anew for communication 40
```

MPI\_TYPE\_FREE(datatype) 43

INOUT datatype datatype that is freed (handle) 44

**C binding** 47

int MPI\_Type\_free(MPI\_Datatype \*datatype) 48

**Fortran 2008 binding**

```

MPI_Type_free(datatype, ierror)
    TYPE(MPI_Datatype), INTENT(INOUT) :: datatype
    INTEGER, OPTIONAL, INTENT(OUT) :: ierror

```

**Fortran binding**

```

MPI_TYPE_FREE(DATATYPE, IERROR)
    INTEGER DATATYPE, IERROR

```

Marks the datatype object associated with `datatype` for deallocation and sets `datatype` to `MPI_DATATYPE_NULL`. Any communication that is currently using this datatype will complete normally. Freeing a datatype does not affect any other datatype that was built from the freed datatype. The system behaves as if input datatype arguments to derived datatype constructors are passed by value.

*Advice to implementors.* The implementation may keep a reference count of active communications that use the datatype, in order to decide when to free it. Also, one may implement constructors of derived datatypes so that they keep pointers to their datatype arguments, rather than copying them. In this case, one needs to keep track of active datatype definition references in order to know when a datatype object can be freed. (*End of advice to implementors.*)

**5.1.10 Duplicating a Datatype**

```

MPI_Type_dup(oldtype, newtype)

```

IN	oldtype	datatype (handle)
OUT	newtype	copy of oldtype (handle)

**C binding**

```

int MPI_Type_dup(MPI_Datatype oldtype, MPI_Datatype *newtype)

```

**Fortran 2008 binding**

```

MPI_Type_dup(oldtype, newtype, ierror)
    TYPE(MPI_Datatype), INTENT(IN) :: oldtype
    TYPE(MPI_Datatype), INTENT(OUT) :: newtype
    INTEGER, OPTIONAL, INTENT(OUT) :: ierror

```

**Fortran binding**

```

MPI_TYPE_DUP(OLDTYPE, NEWTYPE, IERROR)
    INTEGER OLDTYPE, NEWTYPE, IERROR

```

`MPI_TYPE_DUP` is a type constructor which duplicates the existing `oldtype` with associated key values. For each key value, the respective copy callback function determines the attribute value associated with this key in the new communicator; one particular action that a copy callback may take is to delete the attribute from the new datatype. Returns in `newtype` a new datatype with exactly the same properties as `oldtype` and any copied cached information, see Section 7.7.4. The new datatype has identical upper bound and

lower bound and yields the same net result when fully decoded with the functions in Section 5.1.13. The newtype has the same committed state as the old oldtype.

### 5.1.11 Use of General Datatypes in Communication

Handles to derived datatypes can be passed to a communication call wherever a datatype argument is required. A call of the form `MPI_SEND(buf, count, datatype, ...)`, where `count > 1`, is interpreted as if the call was passed a new datatype which is the concatenation of `count` copies of `datatype`. Thus, `MPI_SEND(buf, count, datatype, dest, tag, comm)` is equivalent to,

```
MPI_TYPE_CONTIGUOUS(count, datatype, newtype)
MPI_TYPE_COMMIT(newtype)
MPI_SEND(buf, 1, newtype, dest, tag, comm)
MPI_TYPE_FREE(newtype).
```

Similar statements apply to all other communication functions that have a `count` and `datatype` argument.

Suppose that a send operation `MPI_SEND(buf, count, datatype, dest, tag, comm)` is executed, where `datatype` has type map,

$$\{(type_0, disp_0), \dots, (type_{n-1}, disp_{n-1})\},$$

and extent *extent*. (Explicit lower bound and upper bound markers are not listed in the type map, but they affect the value of *extent*.) The send operation sends  $n \cdot \text{count}$  entries, where entry  $i \cdot n + j$  is at location  $addr_{i,j} = \text{buf} + \text{extent} \cdot i + disp_j$  and has type  $type_j$ , for  $i = 0, \dots, \text{count} - 1$  and  $j = 0, \dots, n - 1$ . These entries need not be contiguous, nor distinct; their order can be arbitrary.

The variable stored at address  $addr_{i,j}$  in the calling program should be of a type that matches  $type_j$ , where type matching is defined as in Section 3.3.1. The message sent contains  $n \cdot \text{count}$  entries, where entry  $i \cdot n + j$  has type  $type_j$ .

Similarly, suppose that a receive operation `MPI_RECV(buf, count, datatype, source, tag, comm, status)` is executed, where `datatype` has type map,

$$\{(type_0, disp_0), \dots, (type_{n-1}, disp_{n-1})\},$$

with extent *extent*. (Again, explicit lower bound and upper bound markers are not listed in the type map, but they affect the value of *extent*.) This receive operation receives  $n \cdot \text{count}$  entries, where entry  $i \cdot n + j$  is at location  $\text{buf} + \text{extent} \cdot i + disp_j$  and has type  $type_j$ . If the incoming message consists of  $k$  elements, then we must have  $k \leq n \cdot \text{count}$ ; the  $i \cdot n + j$ -th element of the message should have a type that matches  $type_j$ .

**Type matching** is defined according to the type signature of the corresponding datatypes, that is, the sequence of basic type components. Type matching does not depend on some aspects of the datatype definition, such as the displacements (layout in memory) or the intermediate types used.

**Example 5.11** This example shows that type matching is defined in terms of the basic types that a derived type consists of.

```

1  ...
2  CALL MPI_TYPE_CONTIGUOUS(2, MPI_REAL, type2, ...)
3  CALL MPI_TYPE_CONTIGUOUS(4, MPI_REAL, type4, ...)
4  CALL MPI_TYPE_CONTIGUOUS(2, type2, type22, ...)
5  ...
6  CALL MPI_SEND(a, 4, MPI_REAL, ...)
7  CALL MPI_SEND(a, 2, type2, ...)
8  CALL MPI_SEND(a, 1, type22, ...)
9  CALL MPI_SEND(a, 1, type4, ...)
10 ...
11 CALL MPI_RECV(a, 4, MPI_REAL, ...)
12 CALL MPI_RECV(a, 2, type2, ...)
13 CALL MPI_RECV(a, 1, type22, ...)
14 CALL MPI_RECV(a, 1, type4, ...)

```

Each of the sends matches any of the receives.

A datatype may specify overlapping entries. The use of such a datatype in any communication in association with a buffer updated by the operation is erroneous. (This is erroneous even if the actual message received is short enough not to write any entry more than once.)

Suppose that `MPI_RECV(buf, count, datatype, dest, tag, comm, status)` is executed, where `datatype` has type map,

$$\{(type_0, disp_0), \dots, (type_{n-1}, disp_{n-1})\}.$$

The received message need not fill all the receive buffer, nor does it need to fill a number of locations which is a multiple of  $n$ . Any number,  $k$ , of basic elements can be received, where  $0 \leq k \leq count \cdot n$ . The number of basic elements received can be retrieved from `status` using the query functions `MPI_GET_ELEMENTS` or `MPI_GET_ELEMENTS_X`.

`MPI_GET_ELEMENTS(status, datatype, count)`

IN	<code>status</code>	return status of receive operation (status)
IN	<code>datatype</code>	datatype used by receive operation (handle)
OUT	<code>count</code>	number of received basic elements (integer)

### C binding

```

38 int MPI_Get_elements(const MPI_Status *status, MPI_Datatype datatype,
39                    int *count)

```

```

40 int MPI_Get_elements_c(const MPI_Status *status, MPI_Datatype datatype,
41                      MPI_Count *count)

```

### Fortran 2008 binding

```

44 MPI_Get_elements(status, datatype, count, ierror)
45     TYPE(MPI_Status), INTENT(IN) :: status
46     TYPE(MPI_Datatype), INTENT(IN) :: datatype
47     INTEGER, INTENT(OUT) :: count
48     INTEGER, OPTIONAL, INTENT(OUT) :: ierror

```

```

MPI_Get_elements(status, datatype, count, ierror)
    TYPE(MPI_Status), INTENT(IN) :: status
    TYPE(MPI_Datatype), INTENT(IN) :: datatype
    INTEGER(KIND=MPI_COUNT_KIND), INTENT(OUT) :: count
    INTEGER, OPTIONAL, INTENT(OUT) :: ierror

```

**Fortran binding**

```

MPI_GET_ELEMENTS(STATUS, DATATYPE, COUNT, IERROR)
    INTEGER STATUS(MPI_STATUS_SIZE), DATATYPE, COUNT, IERROR

```

```

MPI_GET_ELEMENTS_X(status, datatype, count)

```

IN	status	return status of receive operation (status)
IN	datatype	datatype used by receive operation (handle)
OUT	count	number of received basic elements (integer)

**C binding**

```

int MPI_Get_elements_x(const MPI_Status *status, MPI_Datatype datatype,
    MPI_Count *count)

```

**Fortran 2008 binding**

```

MPI_Get_elements_x(status, datatype, count, ierror)
    TYPE(MPI_Status), INTENT(IN) :: status
    TYPE(MPI_Datatype), INTENT(IN) :: datatype
    INTEGER(KIND=MPI_COUNT_KIND), INTENT(OUT) :: count
    INTEGER, OPTIONAL, INTENT(OUT) :: ierror

```

**Fortran binding**

```

MPI_GET_ELEMENTS_X(STATUS, DATATYPE, COUNT, IERROR)
    INTEGER STATUS(MPI_STATUS_SIZE), DATATYPE, IERROR
    INTEGER(KIND=MPI_COUNT_KIND) COUNT

```

The datatype argument should match the argument provided by the receive call that set the status variable. For both functions, if the OUT parameter cannot express the value to be returned (e.g., if the parameter is too small to hold the output value), it is set to MPI\_UNDEFINED.

The previously defined function MPI\_GET\_COUNT (Section 3.2.5), has a different behavior. It returns the number of “top-level entries” received, i.e. the number of “copies” of type datatype. In the previous example, MPI\_GET\_COUNT may return any integer value  $k$ , where  $0 \leq k \leq \text{count}$ . If MPI\_GET\_COUNT returns  $k$ , then the number of basic elements received (and the value returned by MPI\_GET\_ELEMENTS or MPI\_GET\_ELEMENTS\_X) is  $n \cdot k$ . If the number of basic elements received is not a multiple of  $n$ , that is, if the receive operation has not received an integral number of datatype “copies,” then MPI\_GET\_COUNT sets the value of count to MPI\_UNDEFINED.

**Example 5.12** Usage of MPI\_GET\_COUNT and MPI\_GET\_ELEMENTS.

```

1  ...
2  CALL MPI_TYPE_CONTIGUOUS(2, MPI_REAL, Type2, ierr)
3  CALL MPI_TYPE_COMMIT(Type2, ierr)
4  ...
5  CALL MPI_COMM_RANK(comm, rank, ierr)
6  IF (rank.EQ.0) THEN
7      CALL MPI_SEND(a, 2, MPI_REAL, 1, 0, comm, ierr)
8      CALL MPI_SEND(a, 3, MPI_REAL, 1, 0, comm, ierr)
9  ELSE IF (rank.EQ.1) THEN
10     CALL MPI_RECV(a, 2, Type2, 0, 0, comm, stat, ierr)
11     CALL MPI_GET_COUNT(stat, Type2, i, ierr)      ! returns i=1
12     CALL MPI_GET_ELEMENTS(stat, Type2, i, ierr) ! returns i=2
13     CALL MPI_RECV(a, 2, Type2, 0, 0, comm, stat, ierr)
14     CALL MPI_GET_COUNT(stat, Type2, i, ierr)      ! returns i=MPI_UNDEFINED
15     CALL MPI_GET_ELEMENTS(stat, Type2, i, ierr) ! returns i=3
16 END IF

```

The functions `MPI_GET_ELEMENTS` and `MPI_GET_ELEMENTS_X` can also be used after a probe to find the number of elements in the probed message. Note that the `MPI_GET_COUNT`, `MPI_GET_ELEMENTS`, and `MPI_GET_ELEMENTS_X` return the same values when they are used with basic datatypes as long as the limits of their respective `count` arguments are not exceeded.

*Rationale.* The extension given to the definition of `MPI_GET_COUNT` seems natural: one would expect this function to return the value of the `count` argument, when the receive buffer is filled. Sometimes `datatype` represents a basic unit of data one wants to transfer, for example, a record in an array of records (structures). One should be able to find out how many components were received without bothering to divide by the number of elements in each component. However, on other occasions, `datatype` is used to define a complex layout of data in the receiver memory, and does not represent a basic unit of data for transfers. In such cases, one needs to use the function `MPI_GET_ELEMENTS` or `MPI_GET_ELEMENTS_X`. (*End of rationale.*)

*Advice to implementors.* The definition implies that a receive cannot change the value of storage outside the entries defined to compose the communication buffer. In particular, the definition implies that padding space in a structure should not be modified when such a structure is copied from one process to another. This would prevent the obvious optimization of copying the structure, together with the padding, as one contiguous block. The implementation is free to do this optimization when it does not impact the outcome of the computation. The user can “force” this optimization by explicitly including padding as part of the message. (*End of advice to implementors.*)

### 5.1.12 Correct Use of Addresses

Successively declared variables in C or Fortran are not necessarily stored at contiguous locations. Thus, care must be exercised that displacements do not cross from one variable to another. Also, in machines with a segmented address space, addresses are not unique and address arithmetic has some peculiar properties. Thus, the use of **addresses**, that is, displacements relative to the start address `MPI_BOTTOM`, has to be restricted.



Variables belong to the same **sequential storage** if they belong to the same array, to the same COMMON block in Fortran, or to the same structure in C. Valid addresses are defined recursively as follows:

1. The function `MPI_GET_ADDRESS` returns a valid address, when passed as argument a variable of the calling program.
2. The `buf` argument of a communication function evaluates to a valid address, when passed as argument a variable of the calling program.
3. If `v` is a valid address, and `i` is an integer, then `v+i` is a valid address, provided `v` and `v+i` are in the same sequential storage.

A correct program uses only valid addresses to identify the locations of entries in communication buffers. Furthermore, if `u` and `v` are two valid addresses, then the (integer) difference `u - v` can be computed only if both `u` and `v` are in the same sequential storage. No other arithmetic operations can be meaningfully Aexecuted on addresses.

The rules above impose no constraints on the use of derived datatypes, as long as they are used to define a communication buffer that is wholly contained within the same sequential storage. However, the construction of a communication buffer that contains variables that are not within the same sequential storage must obey certain restrictions. Basically, a communication buffer with variables that are not within the same sequential storage can be used only by specifying in the communication call `buf = MPI_BOTTOM`, `count = 1`, and using a `datatype` argument where all displacements are valid (absolute) addresses.

*Advice to users.* It is not expected that MPI implementations will be able to detect erroneous, “out of bound” displacements—unless those overflow the user address space—since the MPI call may not know the extent of the arrays and records in the host program. (*End of advice to users.*)

*Advice to implementors.* There is no need to distinguish (absolute) addresses and (relative) displacements on a machine with contiguous address space: `MPI_BOTTOM` is zero, and both addresses and displacements are integers. On machines where the distinction is required, addresses are recognized as expressions that involve `MPI_BOTTOM`. (*End of advice to implementors.*)

### 5.1.13 Decoding a Datatype

MPI datatype objects allow users to specify an arbitrary layout of data in memory. There are several cases where accessing the layout information in opaque datatype objects would be useful. The opaque datatype object has found a number of uses outside MPI. Furthermore, a number of tools wish to display internal information about a datatype. To achieve this, datatype decoding functions are provided. The two functions in this section are used together to decode datatypes to recreate the calling sequence used in their initial definition. These can be used to allow a user to determine the type map and type signature of a datatype.

```

1 MPI_TYPE_GET_ENVELOPE(datatype, num_integers, num_addresses, num_large_counts,
2   num_datatypes, combiner)

```

3	IN	datatype	datatype to decode (handle)
4			
5	OUT	num_integers	number of input integers used in call constructing combiner (non-negative integer)
6			
7	OUT	num_addresses	number of input addresses used in call constructing combiner (non-negative integer)
8			
9	OUT	num_large_counts	number of input large counts used in call constructing combiner (non-negative integer, <b>only present for large count variants</b> )
10			
11			
12			
13	OUT	num_datatypes	number of input datatypes used in call constructing combiner (non-negative integer)
14			
15	OUT	combiner	combiner (state)
16			

### 17 C binding

```

18 int MPI_Type_get_envelope(MPI_Datatype datatype, int *num_integers,
19   int *num_addresses, int *num_datatypes, int *combiner)
20
21 int MPI_Type_get_envelope_c(MPI_Datatype datatype, MPI_Count *num_integers,
22   MPI_Count *num_addresses, MPI_Count *num_large_counts,
23   MPI_Count *num_datatypes, int *combiner)

```

### 24 Fortran 2008 binding

```

25 MPI_Type_get_envelope(datatype, num_integers, num_addresses, num_datatypes,
26   combiner, ierror)
27   TYPE(MPI_Datatype), INTENT(IN) :: datatype
28   INTEGER, INTENT(OUT) :: num_integers, num_addresses, num_datatypes,
29     combiner
30   INTEGER, OPTIONAL, INTENT(OUT) :: ierror
31
32 MPI_Type_get_envelope(datatype, num_integers, num_addresses,
33   num_large_counts, num_datatypes, combiner, ierror)
34   TYPE(MPI_Datatype), INTENT(IN) :: datatype
35   INTEGER(KIND=MPI_COUNT_KIND), INTENT(OUT) :: num_integers,
36     num_addresses, num_large_counts, num_datatypes
37   INTEGER, INTENT(OUT) :: combiner
38   INTEGER, OPTIONAL, INTENT(OUT) :: ierror

```

### 39 Fortran binding

```

40 MPI_TYPE_GET_ENVELOPE(DATATYPE, NUM_INTEGERS, NUM_ADDRESSES, NUM_DATATYPES,
41   COMBINER, IERROR)
42   INTEGER DATATYPE, NUM_INTEGERS, NUM_ADDRESSES, NUM_DATATYPES, COMBINER,
43     IERROR
44

```

45 For the given datatype, MPI\_TYPE\_GET\_ENVELOPE returns information on the number and type of input arguments used in the call that created the datatype. The number-of-arguments values returned can be used to provide sufficiently large arrays in the decoding routine MPI\_TYPE\_GET\_CONTENTS. This call and the meaning of the returned values is

described below. The combiner reflects the MPI datatype constructor call that was used in creating datatype.

*Rationale.* By requiring that the combiner reflect the constructor used in the creation of the datatype, the decoded information can be used to effectively recreate the calling sequence used in the original creation. This is the most useful information and was felt to be reasonable even though it constrains implementations to remember the original constructor sequence even if the internal representation is different.

The decoded information keeps track of datatype duplications. This is important as one needs to distinguish between a predefined datatype and a dup of a predefined datatype. The former is a constant object that cannot be freed, while the latter is a derived datatype that can be freed. (*End of rationale.*)

The list in Table 5.1 has the values that can be returned in combiner on the left and the call associated with them on the right.

MPI_COMBINER_NAMED	a named predefined datatype
MPI_COMBINER_DUP	MPI_TYPE_DUP
MPI_COMBINER_CONTIGUOUS	MPI_TYPE_CONTIGUOUS
MPI_COMBINER_VECTOR	MPI_TYPE_VECTOR
MPI_COMBINER_HVECTOR	MPI_TYPE_CREATE_HVECTOR
MPI_COMBINER_INDEXED	MPI_TYPE_INDEXED
MPI_COMBINER_HINDEXED	MPI_TYPE_CREATE_HINDEXED
MPI_COMBINER_INDEXED_BLOCK	MPI_TYPE_CREATE_INDEXED_BLOCK
MPI_COMBINER_HINDEXED_BLOCK	MPI_TYPE_CREATE_HINDEXED_BLOCK
MPI_COMBINER_STRUCT	MPI_TYPE_CREATE_STRUCT
MPI_COMBINER_SUBARRAY	MPI_TYPE_CREATE_SUBARRAY
MPI_COMBINER_DARRAY	MPI_TYPE_CREATE_DARRAY
MPI_COMBINER_F90_REAL	MPI_TYPE_CREATE_F90_REAL
MPI_COMBINER_F90_COMPLEX	MPI_TYPE_CREATE_F90_COMPLEX
MPI_COMBINER_F90_INTEGER	MPI_TYPE_CREATE_F90_INTEGER
MPI_COMBINER_RESIZED	MPI_TYPE_CREATE_RESIZED

Table 5.1: combiner values returned from MPI\_TYPE\_GET\_ENVELOPE

If combiner is MPI\_COMBINER\_NAMED then datatype is a named predefined datatype.

If the MPI\_TYPE\_GET\_ENVELOPE variant without num\_large\_counts is invoked with a datatype that requires an output value of num\_large\_counts > 0, then an error of class MPI\_ERR\_TYPE is raised.

*Rationale.* The large count variant of this MPI procedure was added in MPI-4. It contains a new num\_large\_counts parameter. The other variant—the variant that existed before MPI-4—was not changed in order to preserve backwards compatibility. (*End of rationale.*)

The actual arguments used in the creation call for a datatype can be obtained using MPI\_TYPE\_GET\_CONTENTS.

MPI\_TYPE\_GET\_ENVELOPE and MPI\_TYPE\_GET\_CONTENTS also support large count types in separate additional MPI procedures in C (suffixed with the “\_c”) and interface polymorphism in Fortran when using USE mpi\_f08.

```

1 MPI_TYPE_GET_CONTENTS(datatype, max_integers, max_addresses, max_large_counts,
2     max_datatypes, array_of_integers, array_of_addresses,
3     array_of_large_counts, array_of_datatypes)
4
5     IN     datatype           datatype to decode (handle)
6
7     IN     max_integers      number of elements in array_of_integers
8                               (non-negative integer)
9
10    IN     max_addresses     number of elements in array_of_addresses
11                               (non-negative integer)
12
13    IN     max_large_counts   number of elements in array_of_large_counts
14                               (non-negative integer, only present for large
15                               count variants)
16
17    IN     max_datatypes     number of elements in array_of_datatypes
18                               (non-negative integer)
19
20    OUT    array_of_integers  contains integer arguments used in constructing
21                               datatype (array of integers)
22
23    OUT    array_of_addresses contains address arguments used in constructing
24                               datatype (array of integers)
25
26    OUT    array_of_large_counts contains large count arguments used in constructing
27                               datatype (array of integers, only present for large
28                               count variants)
29
30    OUT    array_of_datatypes contains datatype arguments used in constructing
31                               datatype (array of handles)

```

### C binding

```

28 int MPI_Type_get_contents(MPI_Datatype datatype, int max_integers,
29     int max_addresses, int max_datatypes, int array_of_integers[],
30     MPI_Aint array_of_addresses[],
31     MPI_Datatype array_of_datatypes[])
32
33 int MPI_Type_get_contents_c(MPI_Datatype datatype, MPI_Count max_integers,
34     MPI_Count max_addresses, MPI_Count max_large_counts,
35     MPI_Count max_datatypes, int array_of_integers[],
36     MPI_Aint array_of_addresses[],
37     MPI_Count array_of_large_counts[],
38     MPI_Datatype array_of_datatypes[])

```

### Fortran 2008 binding

```

39 MPI_Type_get_contents(datatype, max_integers, max_addresses, max_datatypes,
40     array_of_integers, array_of_addresses, array_of_datatypes,
41     ierror)
42
43     TYPE(MPI_Datatype), INTENT(IN) :: datatype
44     INTEGER, INTENT(IN) :: max_integers, max_addresses, max_datatypes
45     INTEGER, INTENT(OUT) :: array_of_integers(max_integers)
46     INTEGER(KIND=MPI_ADDRESS_KIND), INTENT(OUT) ::
47         array_of_addresses(max_addresses)
48

```

```

TYPE(MPI_Datatype), INTENT(OUT) :: array_of_datatypes(max_datatypes) 1
INTEGER, OPTIONAL, INTENT(OUT) :: ierror 2
3
MPI_Type_get_contents(datatype, max_integers, max_addresses, 4
    max_large_counts, max_datatypes, array_of_integers, 5
    array_of_addresses, array_of_large_counts, array_of_datatypes, 6
    ierror) 7
TYPE(MPI_Datatype), INTENT(IN) :: datatype 8
INTEGER(KIND=MPI_COUNT_KIND), INTENT(IN) :: max_integers, 9
    max_addresses, max_large_counts, max_datatypes 10
INTEGER, INTENT(OUT) :: array_of_integers(max_integers) 11
INTEGER(KIND=MPI_ADDRESS_KIND), INTENT(OUT) :: 12
    array_of_addresses(max_addresses) 13
INTEGER(KIND=MPI_COUNT_KIND), INTENT(OUT) :: 14
    array_of_large_counts(max_large_counts) 15
TYPE(MPI_Datatype), INTENT(OUT) :: array_of_datatypes(max_datatypes) 16
INTEGER, OPTIONAL, INTENT(OUT) :: ierror 17

```

### Fortran binding

```

MPI_TYPE_GET_CONTENTS(DATATYPE, MAX_INTEGERS, MAX_ADDRESSES, MAX_DATATYPES, 19
    ARRAY_OF_INTEGERS, ARRAY_OF_ADDRESSES, ARRAY_OF_DATATYPES, 20
    IERROR) 21
INTEGER DATATYPE, MAX_INTEGERS, MAX_ADDRESSES, MAX_DATATYPES, 22
    ARRAY_OF_INTEGERS(*), ARRAY_OF_DATATYPES(*), IERROR 23
INTEGER(KIND=MPI_ADDRESS_KIND) ARRAY_OF_ADDRESSES(*) 24

```

datatype must be a predefined unnamed or a derived datatype; the call is erroneous if datatype is a predefined named datatype.

The values given for max\_integers, max\_addresses, max\_large\_counts, and max\_datatypes must be at least as large as the value returned in num\_integers, num\_addresses, num\_large\_counts, and num\_datatypes, respectively, in the call MPI\_TYPE\_GET\_ENVELOPE for the same datatype argument.

*Rationale.* The arguments max\_integers, max\_addresses, max\_large\_counts, and max\_datatypes allow for error checking in the call. (*End of rationale.*)

If the MPI\_TYPE\_GET\_CONTENTS variant without max\_large\_counts is invoked with a datatype that requires > 0 values in array\_of\_large\_counts, then an error of class MPI\_ERR\_TYPE is raised.

*Rationale.* The large count variant of this MPI procedure was added in MPI-4. It contains new max\_large\_counts and array\_of\_large\_counts parameters. The other variant—the variant that existed before MPI-4—was not changed in order to preserve backwards compatibility. (*End of rationale.*)

The datatypes returned in array\_of\_datatypes are handles to datatype objects that are equivalent to the datatypes used in the original construction call. If these were derived datatypes, then the returned datatypes are new datatype objects, and the user is responsible for freeing these datatypes with MPI\_TYPE\_FREE. If these were predefined datatypes, then the returned datatype is equal to that (constant) predefined datatype and cannot be freed.

1 The committed state of returned derived datatypes is undefined, i.e., the datatypes may  
 2 or may not be committed. Furthermore, the content of attributes of returned datatypes is  
 3 undefined.

4 Note that `MPI_TYPE_GET_CONTENTS` can be invoked with a  
 5 datatype argument that was constructed using `MPI_TYPE_CREATE_F90_REAL`,  
 6 `MPI_TYPE_CREATE_F90_INTEGER`, or `MPI_TYPE_CREATE_F90_COMPLEX` (an unnamed  
 7 predefined datatype). In such a case, an empty `array_of_datatypes` is returned.  
 8

9 *Rationale.* The definition of datatype equivalence implies that equivalent predefined  
 10 datatypes are equal. By requiring the same handle for named predefined datatypes,  
 11 it is possible to use the `==` or `.EQ.` comparison operator to determine the datatype  
 12 involved. (*End of rationale.*)  
 13

14 *Advice to implementors.* The datatypes returned in `array_of_datatypes` must appear  
 15 to the user as if each is an equivalent copy of the datatype used in the type constructor  
 16 call. Whether this is done by creating a new datatype or via another mechanism such  
 17 as a reference count mechanism is up to the implementation as long as the semantics  
 18 are preserved. (*End of advice to implementors.*)  
 19

20 *Rationale.* The committed state and attributes of the returned datatype is delib-  
 21 erately left vague. The datatype used in the original construction may have been  
 22 modified since its use in the constructor call. Attributes can be added, removed, or  
 23 modified as well as having the datatype committed. The semantics given allow for  
 24 a reference count implementation without having to track these changes. (*End of*  
 25 *rationale.*)  
 26

27 In the deprecated datatype constructor calls, the address arguments in Fortran are  
 28 of type `INTEGER`. In the preferred calls, the address arguments are of type  
 29 `INTEGER(KIND=MPI_ADDRESS_KIND)`. The call `MPI_TYPE_GET_CONTENTS` returns all ad-  
 30 dresses in an argument of type `INTEGER(KIND=MPI_ADDRESS_KIND)`. This is true even if the  
 31 deprecated calls were used. Thus, the location of values returned can be thought of as being  
 32 returned by the C bindings. It can also be determined by examining the preferred calls for  
 33 datatype constructors for the deprecated calls that involve addresses.  
 34

35 *Rationale.* By having all address arguments returned in the  
 36 `array_of_addresses` argument, the result from a C and Fortran decoding of a datatype  
 37 gives the result in the same argument. It is assumed that an integer of type  
 38 `INTEGER(KIND=MPI_ADDRESS_KIND)` will be at least as large as the `INTEGER` argument  
 39 used in datatype construction with the old MPI-1 calls so no loss of information will  
 40 occur. (*End of rationale.*)  
 41

42 The following defines what values are placed in each entry of the returned arrays  
 43 depending on the datatype constructor used for `datatype`. It also specifies the size of the  
 44 arrays needed which is the values returned by `MPI_TYPE_GET_ENVELOPE`. In Fortran,  
 45 the following calls were made:

```
46 PARAMETER (LARGE = 1000)
47 INTEGER TYPE, NI, NA, ND, COMBINER, I(LARGE), D(LARGE), IERROR
48 INTEGER (KIND=MPI_ADDRESS_KIND) A(LARGE)
```

```

! CONSTRUCT DATATYPE TYPE (NOT SHOWN)
CALL MPI_TYPE_GET_ENVELOPE(TYPE, NI, NA, ND, COMBINER, IERROR)
IF ((NI .GT. LARGE) .OR. (NA .GT. LARGE) .OR. (ND .GT. LARGE)) THEN
    WRITE (*, *) "NI, NA, OR ND = ", NI, NA, ND, &
        " RETURNED BY MPI_TYPE_GET_ENVELOPE IS LARGER THAN LARGE = ", LARGE
    CALL MPI_ABORT(MPI_COMM_WORLD, 99, IERROR)
ENDIF
CALL MPI_TYPE_GET_CONTENTS(TYPE, NI, NA, ND, I, A, D, IERROR)

```

or in C the analogous calls of:

```

#define LARGE 1000
int ni, na, nd, combiner, i[LARGE];
MPI_Aint a[LARGE];
MPI_Datatype type, d[LARGE];
/* construct datatype type (not shown) */
MPI_Type_get_envelope(type, &ni, &na, &nd, &combiner);
if ((ni > LARGE) || (na > LARGE) || (nd > LARGE)) {
    fprintf(stderr, "ni, na, or nd = %d %d %d returned by ", ni, na, nd);
    fprintf(stderr, "MPI_Type_get_envelope is larger than LARGE = %d\n",
        LARGE);
    MPI_Abort(MPI_COMM_WORLD, 99);
};
MPI_Type_get_contents(type, ni, na, nd, i, a, d);

```

The following describes the values of the arguments for each combiner. The lower case name of arguments is used.

**MPI\_COMBINER\_NAMED** the datatype represent a predefined type and therefore it is erroneous to call `MPI_TYPE_GET_CONTENTS`.

**MPI\_COMBINER\_DUP** `ni = 0, na = 0, nd = 1`, and

Constructor argument	C	Fortran location
oldtype	d[0]	D(1)

**MPI\_COMBINER\_CONTIGUOUS** `ni = 1, na = 0, nd = 1`, and

Constructor argument	C	Fortran location
count	i[0]	I(1)
oldtype	d[0]	D(1)

**MPI\_COMBINER\_VECTOR** `ni = 3, na = 0, nd = 1`, and

Constructor argument	C	Fortran location
count	i[0]	I(1)
blocklength	i[1]	I(2)
stride	i[2]	I(3)
oldtype	d[0]	D(1)

1 **MPI\_COMBINER\_HVECTOR** ni = 2, na = 1, nd = 1, and

Constructor argument	C	Fortran location
count	i[0]	I(1)
blocklength	i[1]	I(2)
stride	a[0]	A(1)
oldtype	d[0]	D(1)

9 **MPI\_COMBINER\_INDEXED** ni = 2\*count+1, na = 0, nd = 1, and

Constructor argument	C	Fortran location
count	i[0]	I(1)
array_of_blocklengths	i[1] to i[i[0]]	I(2) to I(I(1)+1)
array_of_displacements	i[i[0]+1] to i[2*i[0]]	I(I(1)+2) to I(2*I(1)+1)
oldtype	d[0]	D(1)

17 **MPI\_COMBINER\_HINDEXED** ni = count+1, na = count, nd = 1, and

Constructor argument	C	Fortran location
count	i[0]	I(1)
array_of_blocklengths	i[1] to i[i[0]]	I(2) to I(I(1)+1)
array_of_displacements	a[0] to a[i[0]-1]	A(1) to A(I(1))
oldtype	d[0]	D(1)

25 **MPI\_COMBINER\_INDEXED\_BLOCK** ni = count+2, na = 0, nd = 1, and

Constructor argument	C	Fortran location
count	i[0]	I(1)
blocklength	i[1]	I(2)
array_of_displacements	i[2] to i[i[0]+1]	I(3) to I(I(1)+2)
oldtype	d[0]	D(1)

33 **MPI\_COMBINER\_HINDEXED\_BLOCK** ni = 2, na = count, nd = 1, and

Constructor argument	C	Fortran location
count	i[0]	I(1)
blocklength	i[1]	I(2)
array_of_displacements	a[0] to a[i[0]-1]	A(1) to A(I(1))
oldtype	d[0]	D(1)

41 **MPI\_COMBINER\_STRUCT** ni = count+1, na = count, nd = count, and

Constructor argument	C	Fortran location
count	i[0]	I(1)
array_of_blocklengths	i[1] to i[i[0]]	I(2) to I(I(1)+1)
array_of_displacements	a[0] to a[i[0]-1]	A(1) to A(I(1))
array_of_types	d[0] to d[i[0]-1]	D(1) to D(I(1))



**MPI\_COMBINER\_SUBARRAY**  $ni = 3*ndims+2$ ,  $na = 0$ ,  $nd = 1$ , and

Constructor argument	C	Fortran location
ndims	$i[0]$	I(1)
array_of_sizes	$i[1]$ to $i[i[0]]$	I(2) to I(I(1)+1)
array_of_subsizes	$i[i[0]+1]$ to $i[2*i[0]]$	I(I(1)+2) to I(2*I(1)+1)
array_of_starts	$i[2*i[0]+1]$ to $i[3*i[0]]$	I(2*I(1)+2) to I(3*I(1)+1)
order	$i[3*i[0]+1]$	I(3*I(1)+2)
oldtype	$d[0]$	D(1)

**MPI\_COMBINER\_DARRAY**  $ni = 4*ndims+4$ ,  $na = 0$ ,  $nd = 1$ , and

Constructor argument	C	Fortran location
size	$i[0]$	I(1)
rank	$i[1]$	I(2)
ndims	$i[2]$	I(3)
array_of_gsizes	$i[3]$ to $i[i[2]+2]$	I(4) to I(I(3)+3)
array_of_distribs	$i[i[2]+3]$ to $i[2*i[2]+2]$	I(I(3)+4) to I(2*I(3)+3)
array_of_dargs	$i[2*i[2]+3]$ to $i[3*i[2]+2]$	I(2*I(3)+4) to I(3*I(3)+3)
array_of_psizes	$i[3*i[2]+3]$ to $i[4*i[2]+2]$	I(3*I(3)+4) to I(4*I(3)+3)
order	$i[4*i[2]+3]$	I(4*I(3)+4)
oldtype	$d[0]$	D(1)

**MPI\_COMBINER\_F90\_REAL**  $ni = 2$ ,  $na = 0$ ,  $nd = 0$ , and

Constructor argument	C	Fortran location
p	$i[0]$	I(1)
r	$i[1]$	I(2)

**MPI\_COMBINER\_F90\_COMPLEX**  $ni = 2$ ,  $na = 0$ ,  $nd = 0$ , and

Constructor argument	C	Fortran location
p	$i[0]$	I(1)
r	$i[1]$	I(2)

**MPI\_COMBINER\_F90\_INTEGER**  $ni = 1$ ,  $na = 0$ ,  $nd = 0$ , and

Constructor argument	C	Fortran location
r	$i[0]$	I(1)

**MPI\_COMBINER\_RESIZED**  $ni = 0$ ,  $na = 2$ ,  $nd = 1$ , and

Constructor argument	C	Fortran location
lb	$a[0]$	A(1)
extent	$a[1]$	A(2)
oldtype	$d[0]$	D(1)

### 5.1.14 Examples

The following examples illustrate the use of derived datatypes.

**Example 5.13** Send and receive a section of a 3D array.

```

6 REAL a(100,100,100), e(9,9,9)
7 INTEGER oneslice, twoslice, threeslice, myrank, ierr
8 INTEGER (KIND=MPI_ADDRESS_KIND) lb, sizeofreal
9 INTEGER status(MPI_STATUS_SIZE)
10
11 ! extract the section a(1:17:2, 3:11, 2:10)
12 ! and store it in e(:, :, :).
13
14 CALL MPI_COMM_RANK(MPI_COMM_WORLD, myrank, ierr)
15
16 CALL MPI_TYPE_GET_EXTENT(MPI_REAL, lb, sizeofreal, ierr)
17
18 ! create datatype for a 1D section
19 CALL MPI_TYPE_VECTOR(9, 1, 2, MPI_REAL, oneslice, ierr)
20
21 ! create datatype for a 2D section
22 CALL MPI_TYPE_CREATE_HVECTOR(9, 1, 100*sizeofreal, oneslice, &
23                               twoslice, ierr)
24
25 ! create datatype for the entire section
26 CALL MPI_TYPE_CREATE_HVECTOR(9, 1, 100*100*sizeofreal, twoslice, &
27                               threeslice, ierr)
28
29 CALL MPI_TYPE_COMMIT(threeslice, ierr)
30 CALL MPI_SENDRECV(a(1,3,2), 1, threeslice, myrank, 0, e, 9*9*9, &
31                   MPI_REAL, myrank, 0, MPI_COMM_WORLD, status, ierr)
32
33

```

**Example 5.14** Copy the (strictly) lower triangular part of a matrix.

```

35 REAL a(100,100), b(100,100)
36 INTEGER disp(100), blocklen(100), ltype, myrank, ierr
37 INTEGER status(MPI_STATUS_SIZE)
38
39 ! copy lower triangular part of array a
40 ! onto lower triangular part of array b
41
42
43 CALL MPI_COMM_RANK(MPI_COMM_WORLD, myrank, ierr)
44
45 ! compute start and size of each column
46 DO i=1,100
47     disp(i) = 100*(i-1) + i
48     blocklen(i) = 100-i

```

```

END DO
1
2
! create datatype for lower triangular part
3
CALL MPI_TYPE_INDEXED(100, blocklen, disp, MPI_REAL, ltype, ierr)
4
5
CALL MPI_TYPE_COMMIT(ltype, ierr)
6
CALL MPI_SENDRECV(a, 1, ltype, myrank, 0, b, 1, &
7
8
9
10
11
12
13
14
15
16
17
18
19
20
21
22
23
24
25
26
27
28
29
30
31
32
33
34
35
36
37
38
39
40
41
42
43
44
45
46
47
48

```

**Example 5.15** Transpose a matrix.

```

REAL a(100,100), b(100,100)
INTEGER row, xpose, myrank, ierr
INTEGER (KIND=MPI_ADDRESS_KIND) lb, sizeofreal
INTEGER status(MPI_STATUS_SIZE)

! transpose matrix a onto b

CALL MPI_COMM_RANK(MPI_COMM_WORLD, myrank, ierr)

CALL MPI_TYPE_GET_EXTENT(MPI_REAL, lb, sizeofreal, ierr)

! create datatype for one row
CALL MPI_TYPE_VECTOR(100, 1, 100, MPI_REAL, row, ierr)

! create datatype for matrix in row-major order
CALL MPI_TYPE_CREATE_HVECTOR(100, 1, sizeofreal, row, xpose, ierr)

CALL MPI_TYPE_COMMIT(xpose, ierr)

! send matrix in row-major order and receive in column major order
CALL MPI_SENDRECV(a, 1, xpose, myrank, 0, b, 100*100, &
MPI_REAL, myrank, 0, MPI_COMM_WORLD, status, ierr)

```

**Example 5.16** Another approach to the transpose problem:

```

REAL a(100,100), b(100,100)
INTEGER row, row1
INTEGER (KIND=MPI_ADDRESS_KIND) disp(2), lb, sizeofreal
INTEGER myrank, ierr
INTEGER status(MPI_STATUS_SIZE)

CALL MPI_COMM_RANK(MPI_COMM_WORLD, myrank, ierr)

! transpose matrix a onto b

CALL MPI_TYPE_GET_EXTENT(MPI_REAL, lb, sizeofreal, ierr)

```

```

1
2 ! create datatype for one row
3 CALL MPI_TYPE_VECTOR(100, 1, 100, MPI_REAL, row, ierr)
4
5 ! create datatype for one row, with the extent of one real number
6 lb = 0
7 CALL MPI_TYPE_CREATE_RESIZED(row, lb, sizeofreal, row1, ierr)
8
9 CALL MPI_TYPE_COMMIT(row1, ierr)
10
11 ! send 100 rows and receive in column major order
12 CALL MPI_SENDRECV(a, 100, row1, myrank, 0, b, 100*100, &
13                 MPI_REAL, myrank, 0, MPI_COMM_WORLD, status, ierr)
14

```

**Example 5.17** Use of MPI datatypes to manipulate an array of structures.

```

17 struct Partstruct
18 {
19     int    type; /* particle type */
20     double d[6]; /* particle coordinates */
21     char   b[7]; /* some additional information */
22 };
23
24 struct Partstruct    particle[1000];
25
26 int                i, dest, tag;
27 MPI_Comm           comm;
28
29
30 /* build datatype describing structure */
31
32 MPI_Datatype Particlestruct, Particletype;
33 MPI_Datatype type[3] = {MPI_INT, MPI_DOUBLE, MPI_CHAR};
34 int    blocklen[3] = {1, 6, 7};
35 MPI_Aint    disp[3];
36 MPI_Aint    base, lb, sizeofentry;
37
38
39 /* compute displacements of structure components */
40
41 MPI_Get_address(particle, disp);
42 MPI_Get_address(particle[0].d, disp+1);
43 MPI_Get_address(particle[0].b, disp+2);
44 base = disp[0];
45 for (i=0; i < 3; i++) disp[i] = MPI_Aint_diff(disp[i], base);
46
47 MPI_Type_create_struct(3, blocklen, disp, type, &Particlestruct);
48

```

```
/* Since the compiler may pad the structure, it is best to explicitly
   set the extent of the MPI datatype for a structure element using
   MPI_Type_create_resized */

/* compute extent of the structure */
MPI_Get_address(particle+1, &sizeofentry);
sizeofentry = MPI_Aint_diff(sizeofentry, base);

/* build datatype describing structure */
MPI_Type_create_resized(Particlestruct, 0, sizeofentry, &Particletype);

/* 4.1: send the entire array */

MPI_Type_commit(&Particletype);
MPI_Send(particle, 1000, Particletype, dest, tag, comm);

/* 4.2: send only the entries of type zero particles,
   preceded by the number of such entries */

MPI_Datatype Zparticles; /* datatype describing all particles
                           with type zero (needs to be recomputed
                           if types change) */

MPI_Datatype Ztype;

int      zdisp[1000];
int      zblock[1000], j, k;
int      zzblock[2] = {1,1};
MPI_Aint zzdisp[2];
MPI_Datatype zztype[2];

/* compute displacements of type zero particles */
j = 0;
for (i=0; i < 1000; i++)
    if (particle[i].type == 0)
    {
        zdisp[j] = i;
        zblock[j] = 1;
        j++;
    }

/* create datatype for type zero particles */
MPI_Type_indexed(j, zblock, zdisp, Particletype, &Zparticles);

/* prepend particle count */
MPI_Get_address(&j, zzdisp);
MPI_Get_address(particle, zzdisp+1);
```

```

1  zztype[0] = MPI_INT;
2  zztype[1] = Zparticles;
3  MPI_Type_create_struct(2, zzbblock, zzdisp, zztype, &Ztype);
4
5  MPI_Type_commit(&Ztype);
6  MPI_Send(MPI_BOTTOM, 1, Ztype, dest, tag, comm);
7
8
9  /* A probably more efficient way of defining Zparticles */
10
11 /* consecutive particles with index zero are handled as one block */
12 j=0;
13 for (i=0; i < 1000; i++)
14     if (particle[i].type == 0)
15         {
16             for (k=i+1; (k < 1000)&&(particle[k].type == 0); k++);
17             zdisp[j] = i;
18             zblock[j] = k-i;
19             j++;
20             i = k;
21         }
22 MPI_Type_indexed(j, zblock, zdisp, Particletype, &Zparticles);
23
24
25 /* 4.3: send the first two coordinates of all entries */
26
27 MPI_Datatype Allpairs; /* datatype for all pairs of coordinates */
28
29 MPI_Type_get_extent(Particletype, &lb, &sizeofentry);
30
31 /* sizeofentry can also be computed by subtracting the address
32    of particle[0] from the address of particle[1] */
33
34 MPI_Type_create_hvector(1000, 2, sizeofentry, MPI_DOUBLE, &Allpairs);
35 MPI_Type_commit(&Allpairs);
36 MPI_Send(particle[0].d, 1, Allpairs, dest, tag, comm);
37
38 /* an alternative solution to 4.3 */
39
40 MPI_Datatype Twodouble;
41
42 MPI_Type_contiguous(2, MPI_DOUBLE, &Twodouble);
43
44 MPI_Datatype Onepair; /* datatype for one pair of coordinates, with
45                       the extent of one particle entry */
46
47 MPI_Type_create_resized(Twodouble, 0, sizeofentry, &Onepair );
48 MPI_Type_commit(&Onepair);

```

```
MPI_Send(particle[0].d, 1000, Onepair, dest, tag, comm);
```

**Example 5.18** The same manipulations as in the previous example, but use absolute addresses in datatypes.

```
struct Partstruct
{
    int    type;
    double d[6];
    char   b[7];
};

struct Partstruct particle[1000];

/* build datatype describing first array entry */

MPI_Datatype Particletype;
MPI_Datatype type[3] = {MPI_INT, MPI_DOUBLE, MPI_CHAR};
int          block[3] = {1, 6, 7};
MPI_Aint     disp[3];

MPI_Get_address(particle, disp);
MPI_Get_address(particle[0].d, disp+1);
MPI_Get_address(particle[0].b, disp+2);
MPI_Type_create_struct(3, block, disp, type, &Particletype);

/* Particletype describes first array entry -- using absolute
   addresses */

/* 5.1: send the entire array */

MPI_Type_commit(&Particletype);
MPI_Send(MPI_BOTTOM, 1000, Particletype, dest, tag, comm);

/* 5.2: send the entries of type zero,
   preceded by the number of such entries */

MPI_Datatype Zparticles, Ztype;

int          zdisp[1000];
int          zblock[1000], i, j, k;
int          zzblock[2] = {1,1};
MPI_Datatype zztype[2];
MPI_Aint     zzdisp[2];
```

```

1  j=0;
2  for (i=0; i < 1000; i++)
3      if (particle[i].type == 0)
4          {
5              for (k=i+1; (k < 1000)&&(particle[k].type == 0); k++);
6              zdisp[j] = i;
7              zblock[j] = k-i;
8              j++;
9              i = k;
10         }
11     MPI_Type_indexed(j, zblock, zdisp, Particletype, &Zparticles);
12     /* Zparticles describe particles with type zero, using
13        their absolute addresses*/
14
15     /* prepend particle count */
16     MPI_Get_address(&j, zzdisp);
17     zzdisp[1] = (MPI_Aint)0;
18     zztype[0] = MPI_INT;
19     zztype[1] = Zparticles;
20     MPI_Type_create_struct(2, zblock, zzdisp, zztype, &Ztype);
21
22     MPI_Type_commit(&Ztype);
23     MPI_Send(MPI_BOTTOM, 1, Ztype, dest, tag, comm);
24
25
26

```

**Example 5.19** This example shows how datatypes can be used to handle unions.

```

27
28
29     union {
30         int    ival;
31         float fval;
32     } u[1000];
33
34     int    i, utype;
35
36     /* All entries of u have identical type; variable
37        utype keeps track of their current type */
38
39     MPI_Datatype  mpi_utype[2];
40     MPI_Aint      ubase, extent;
41
42     /* compute an MPI datatype for each possible union type;
43        assume values are left-aligned in union storage. */
44
45     MPI_Get_address(u, &ubase);
46     MPI_Get_address(u+1, &extent);
47     extent = MPI_Aint_diff(extent, ubase);
48

```



```

MPI_Type_create_resized(MPI_INT, 0, extent, &mpi_utype[0]);
MPI_Type_create_resized(MPI_FLOAT, 0, extent, &mpi_utype[1]);
for(i=0; i<2; i++) MPI_Type_commit(&mpi_utype[i]);

/* actual communication */
MPI_Send(u, 1000, mpi_utype[utype], dest, tag, comm);

```

**Example 5.20** This example shows how a datatype can be decoded. The routine `printdatatype` prints out the elements of the datatype. Note the use of `MPI_Type_free` for datatypes that are not predefined.

```

/*
  Example of decoding a datatype.

  Returns 0 if the datatype is predefined, 1 otherwise
*/
#include <stdio.h>
#include <stdlib.h>
#include "mpi.h"
int printdatatype(MPI_Datatype datatype)
{
    int *array_of_ints;
    MPI_Aint *array_of_adds;
    MPI_Datatype *array_of_dtypes;
    int num_ints, num_adds, num_dtypes, combiner;
    int i;

    MPI_Type_get_envelope(datatype,
                          &num_ints, &num_adds, &num_dtypes, &combiner);

    switch (combiner) {
    case MPI_COMBINER_NAMED:
        printf("Datatype is named:");
        /* To print the specific type, we can match against the
           predefined forms. We can NOT use a switch statement here
           We could also use MPI_TYPE_GET_NAME if we preferred to use
           names that the user may have changed.
        */
        if (datatype == MPI_INT) printf("MPI_INT\n");
        else if (datatype == MPI_DOUBLE) printf("MPI_DOUBLE\n");
        ... else test for other types ...
        return 0;
        break;
    case MPI_COMBINER_STRUCT:
    case MPI_COMBINER_STRUCT_INTEGER:
        printf("Datatype is struct containing");
        array_of_ints = (int *)malloc(num_ints * sizeof(int));

```

```

1     array_of_adds    =
2         (MPI_Aint *) malloc(num_adds * sizeof(MPI_Aint));
3     array_of_dtypes = (MPI_Datatype *)
4         malloc(num_dtypes * sizeof(MPI_Datatype));
5     MPI_Type_get_contents(datatype, num_ints, num_adds, num_dtypes,
6         array_of_ints, array_of_adds, array_of_dtypes);
7     printf(" %d datatypes:\n", array_of_ints[0]);
8     for (i=0; i<array_of_ints[0]; i++) {
9         printf("blocklength %d, displacement %ld, type:\n",
10            array_of_ints[i+1], (long)array_of_adds[i]);
11        if (printdatatype(array_of_dtypes[i])) {
12            /* Note that we free the type ONLY if it
13               is not predefined */
14            MPI_Type_free(&array_of_dtypes[i]);
15        }
16    }
17    free(array_of_ints);
18    free(array_of_adds);
19    free(array_of_dtypes);
20    break;
21    ... other combiner values ...
22 default:
23     printf("Unrecognized combiner type\n");
24 }
25 return 1;
26 }

```

## 5.2 Pack and Unpack

Some existing communication libraries provide pack/unpack functions for sending noncontiguous data. In these, the user explicitly packs data into a contiguous buffer before sending it, and unpacks it from a contiguous buffer after receiving it. Derived datatypes, which are described in Section 5.1, allow one, in most cases, to avoid explicit packing and unpacking. The user specifies the layout of the data to be sent or received, and the communication library directly accesses a noncontiguous buffer. The pack/unpack routines are provided for compatibility with previous libraries. Also, they provide some functionality that is not otherwise available in MPI. For instance, a message can be received in several parts, where the receive operation done on a later part may depend on the content of a former part. Another use is that outgoing messages may be explicitly buffered in user supplied space, thus overriding the system buffering policy. Finally, the availability of pack and unpack operations facilitates the development of additional communication libraries layered on top of MPI.

MPI_PACK(inbuf, incount, datatype, outbuf, outsize, position, comm)			1
IN	inbuf	input buffer start (choice)	2
IN	incount	number of input data items (non-negative integer)	3
IN	datatype	datatype of each input data item (handle)	4
OUT	outbuf	output buffer start (choice)	5
IN	outsize	output buffer size, in bytes (non-negative integer)	6
INOUT	position	current position in buffer, in bytes (integer)	7
IN	comm	communicator for packed message (handle)	8
			9
			10
			11

**C binding**

```
int MPI_Pack(const void *inbuf, int incount, MPI_Datatype datatype,
            void *outbuf, int outsize, int *position, MPI_Comm comm)
```

```
int MPI_Pack_c(const void *inbuf, MPI_Count incount, MPI_Datatype datatype,
              void *outbuf, MPI_Count outsize, MPI_Count *position,
              MPI_Comm comm)
```

**Fortran 2008 binding**

```
MPI_Pack(inbuf, incount, datatype, outbuf, outsize, position, comm, ierror)
  TYPE(*), DIMENSION(..), INTENT(IN) :: inbuf
  INTEGER, INTENT(IN) :: incount, outsize
  TYPE(MPI_Datatype), INTENT(IN) :: datatype
  TYPE(*), DIMENSION(..) :: outbuf
  INTEGER, INTENT(INOUT) :: position
  TYPE(MPI_Comm), INTENT(IN) :: comm
  INTEGER, OPTIONAL, INTENT(OUT) :: ierror
```

```
MPI_Pack(inbuf, incount, datatype, outbuf, outsize, position, comm, ierror)
  TYPE(*), DIMENSION(..), INTENT(IN) :: inbuf
  INTEGER(KIND=MPI_COUNT_KIND), INTENT(IN) :: incount, outsize
  TYPE(MPI_Datatype), INTENT(IN) :: datatype
  TYPE(*), DIMENSION(..) :: outbuf
  INTEGER(KIND=MPI_COUNT_KIND), INTENT(INOUT) :: position
  TYPE(MPI_Comm), INTENT(IN) :: comm
  INTEGER, OPTIONAL, INTENT(OUT) :: ierror
```

**Fortran binding**

```
MPI_PACK(INBUF, INCOUNT, DATATYPE, OUTBUF, OUTSIZE, POSITION, COMM, IERROR)
  <type> INBUF(*), OUTBUF(*)
  INTEGER INCOUNT, DATATYPE, OUTSIZE, POSITION, COMM, IERROR
```

Packs the message in the send buffer specified by *inbuf*, *incount*, *datatype* into the buffer space specified by *outbuf* and *outsize*. The input buffer can be any communication buffer allowed in `MPI_SEND`. The output buffer is a contiguous storage area containing *outsize* bytes, starting at the address *outbuf* (length is counted in *bytes*, not elements, as if it were a communication buffer for a message of type `MPI_PACKED`).

The input value of *position* is the first location in the output buffer to be used for packing. *position* is incremented by the size of the packed message, and the output value

1 of position is the first location in the output buffer following the locations occupied by the  
 2 packed message. The comm argument is the communicator that will be subsequently used  
 3 for sending the packed message.  
 4

5  
 6 **MPI\_UNPACK**(inbuf, insize, position, outbuf, outcount, datatype, comm)

7	IN	inbuf	input buffer start (choice)
8	IN	insize	size of input buffer, in bytes (non-negative integer)
9			
10	INOUT	position	current position in bytes (integer)
11	OUT	outbuf	output buffer start (choice)
12			
13	IN	outcount	number of items to be unpacked (integer)
14	IN	datatype	datatype of each output data item (handle)
15	IN	comm	communicator for packed message (handle)

### 17 C binding

18 `int MPI_Unpack(const void *inbuf, int insize, int *position, void *outbuf,`  
 19 `int outcount, MPI_Datatype datatype, MPI_Comm comm)`

20  
 21 `int MPI_Unpack_c(const void *inbuf, MPI_Count insize, MPI_Count *position,`  
 22 `void *outbuf, MPI_Count outcount, MPI_Datatype datatype,`  
 23 `MPI_Comm comm)`

### 24 Fortran 2008 binding

25 `MPI_Unpack(inbuf, insize, position, outbuf, outcount, datatype, comm,`  
 26 `ierror)`

27 `TYPE(*), DIMENSION(..), INTENT(IN) :: inbuf`  
 28 `INTEGER, INTENT(IN) :: insize, outcount`  
 29 `INTEGER, INTENT(INOUT) :: position`  
 30 `TYPE(*), DIMENSION(..) :: outbuf`  
 31 `TYPE(MPI_Datatype), INTENT(IN) :: datatype`  
 32 `TYPE(MPI_Comm), INTENT(IN) :: comm`  
 33 `INTEGER, OPTIONAL, INTENT(OUT) :: ierror`

34  
 35 `MPI_Unpack(inbuf, insize, position, outbuf, outcount, datatype, comm,`  
 36 `ierror)`

37 `TYPE(*), DIMENSION(..), INTENT(IN) :: inbuf`  
 38 `INTEGER(KIND=MPI_COUNT_KIND), INTENT(IN) :: insize, outcount`  
 39 `INTEGER(KIND=MPI_COUNT_KIND), INTENT(INOUT) :: position`  
 40 `TYPE(*), DIMENSION(..) :: outbuf`  
 41 `TYPE(MPI_Datatype), INTENT(IN) :: datatype`  
 42 `TYPE(MPI_Comm), INTENT(IN) :: comm`  
 43 `INTEGER, OPTIONAL, INTENT(OUT) :: ierror`

### 44 Fortran binding

45 `MPI_UNPACK(INBUF, INSIZE, POSITION, OUTBUF, OUTCOUNT, DATATYPE, COMM,`  
 46 `IERROR)`

47 `<type> INBUF(*), OUTBUF(*)`  
 48

INTEGER INSIZE, POSITION, OUTCOUNT, DATATYPE, COMM, IERROR

Unpacks a message into the receive buffer specified by `outbuf`, `outcount`, `datatype` from the buffer space specified by `inbuf` and `insize`. The output buffer can be any communication buffer allowed in `MPI_RECV`. The input buffer is a contiguous storage area containing `insize` bytes, starting at address `inbuf`. The input value of `position` is the first location in the input buffer occupied by the packed message. `position` is incremented by the size of the packed message, so that the output value of `position` is the first location in the input buffer after the locations occupied by the message that was unpacked. `comm` is the communicator used to receive the packed message.

*Advice to users.* Note the difference between `MPI_RECV` and `MPI_UNPACK`: in `MPI_RECV`, the `count` argument specifies the maximum number of items that can be received. The actual number of items received is determined by the length of the incoming message. In `MPI_UNPACK`, the `count` argument specifies the actual number of items that are unpacked; the “size” of the corresponding message is the increment in `position`. The reason for this change is that the “incoming message size” is not predetermined since the user decides how much to unpack; nor is it easy to determine the “message size” from the number of items to be unpacked. In fact, in a heterogeneous system, this number may not be determined *a priori*. (*End of advice to users.*)

To understand the behavior of `pack` and `unpack`, it is convenient to think of the data part of a message as being the sequence obtained by concatenating the successive values sent in that message. The `pack` operation stores this sequence in the buffer space, as if sending the message to that buffer. The `unpack` operation retrieves this sequence from buffer space, as if receiving a message from that buffer. (It is helpful to think of internal Fortran files or `sscanf` in C, for a similar function.)

Several messages can be successively packed into one **packing unit**. This is effected by several successive **related** calls to `MPI_PACK`, where the first call provides `position = 0`, and each successive call inputs the value of `position` that was output by the previous call, and the same values for `outbuf`, `outcount` and `comm`. This packing unit now contains the equivalent information that would have been stored in a message by one send call with a send buffer that is the “concatenation” of the individual send buffers.

A packing unit can be sent using type `MPI_PACKED`. Any point-to-point or collective communication function can be used to move the sequence of bytes that forms the packing unit from one process to another. This packing unit can now be received using any receive operation, with any `datatype`: the type matching rules are relaxed for messages sent with type `MPI_PACKED`.

A message sent with any type (including `MPI_PACKED`) can be received using the type `MPI_PACKED`. Such a message can then be unpacked by calls to `MPI_UNPACK`.

A packing unit (or a message created by a regular, “typed” send) can be unpacked into several successive messages. This is effected by several successive related calls to `MPI_UNPACK`, where the first call provides `position = 0`, and each successive call inputs the value of `position` that was output by the previous call, and the same values for `inbuf`, `insize` and `comm`.

The concatenation of two packing units is not necessarily a packing unit; nor is a substring of a packing unit necessarily a packing unit. Thus, one cannot concatenate two packing units and then unpack the result as one packing unit; nor can one unpack a substring

1 of a packing unit as a separate packing unit. Each packing unit, that was created by a related  
 2 sequence of pack calls, or by a regular send, must be unpacked as a unit, by a sequence of  
 3 related unpack calls.

4  
 5 *Rationale.* The restriction on “atomic” packing and unpacking of packing units  
 6 allows the implementation to add at the head of packing units additional information,  
 7 such as a description of the sender architecture (to be used for type conversion, in a  
 8 heterogeneous environment) (*End of rationale.*)

9 The following call allows the user to find out how much space is needed to pack a  
 10 message and, thus, manage space allocation for buffers.

11  
 12  
 13 MPI\_PACK\_SIZE(incount, datatype, comm, size)

14	IN	incount	count argument to packing call (non-negative integer)
15	IN	datatype	datatype argument to packing call (handle)
16	IN	comm	communicator argument to packing call (handle)
17	OUT	size	upper bound on size of packed message, in bytes (non-negative integer)

#### 21 C binding

22 int MPI\_Pack\_size(int incount, MPI\_Datatype datatype, MPI\_Comm comm,  
 23 int \*size)

24  
 25 int MPI\_Pack\_size\_c(MPI\_Count incount, MPI\_Datatype datatype,  
 26 MPI\_Comm comm, MPI\_Count \*size)

#### 27 Fortran 2008 binding

28 MPI\_Pack\_size(incount, datatype, comm, size, ierror)  
 29 INTEGER, INTENT(IN) :: incount  
 30 TYPE(MPI\_Datatype), INTENT(IN) :: datatype  
 31 TYPE(MPI\_Comm), INTENT(IN) :: comm  
 32 INTEGER, INTENT(OUT) :: size  
 33 INTEGER, OPTIONAL, INTENT(OUT) :: ierror

34  
 35 MPI\_Pack\_size(incount, datatype, comm, size, ierror)  
 36 INTEGER(KIND=MPI\_COUNT\_KIND), INTENT(IN) :: incount  
 37 TYPE(MPI\_Datatype), INTENT(IN) :: datatype  
 38 TYPE(MPI\_Comm), INTENT(IN) :: comm  
 39 INTEGER(KIND=MPI\_COUNT\_KIND), INTENT(OUT) :: size  
 40 INTEGER, OPTIONAL, INTENT(OUT) :: ierror

#### 41 Fortran binding

42 MPI\_PACK\_SIZE(INCOUNT, DATATYPE, COMM, SIZE, IERROR)  
 43 INTEGER INCOUNT, DATATYPE, COMM, SIZE, IERROR

44  
 45 A call to MPI\_PACK\_SIZE(incount, datatype, comm, size) returns in size an upper bound  
 46 on the increment in position that is effected by a call to MPI\_PACK(inbuf, incount, datatype,  
 47 outbuf, outcount, position, comm). If the packed size of the datatype cannot be expressed  
 48 by the size parameter, then MPI\_PACK\_SIZE sets the value of size to MPI\_UNDEFINED.

*Rationale.* The call returns an upper bound, rather than an exact bound, since the exact amount of space needed to pack the message may depend on the context (e.g., first message packed in a packing unit may take more space). (*End of rationale.*)

**Example 5.21** An example using MPI\_PACK.

```

int      position, i, j, a[2];
char     buff[1000];

MPI_Comm_rank(MPI_COMM_WORLD, &myrank);
if (myrank == 0)
{
    /* SENDER CODE */

    position = 0;
    MPI_Pack(&i, 1, MPI_INT, buff, 1000, &position, MPI_COMM_WORLD);
    MPI_Pack(&j, 1, MPI_INT, buff, 1000, &position, MPI_COMM_WORLD);
    MPI_Send(buff, position, MPI_PACKED, 1, 0, MPI_COMM_WORLD);
}
else /* RECEIVER CODE */
    MPI_Recv(a, 2, MPI_INT, 0, 0, MPI_COMM_WORLD, MPI_STATUS_IGNORE);

```

**Example 5.22** An elaborate example.

```

int      position, i = 200;
float    a[200];
char     buff[1000]; /* larger than sizeof(int) + 200 * sizeof(float) */

MPI_Comm_rank(MPI_COMM_WORLD, &myrank);
if (myrank == 0)
{
    /* SENDER CODE */

    int len[2];
    MPI_Aint disp[2];
    MPI_Datatype type[2], newtype;

    /* build datatype for i followed by a[0]...a[i-1] */

    len[0] = 1;
    len[1] = i;
    MPI_Get_address(&i, disp);
    MPI_Get_address(a, disp+1);
    type[0] = MPI_INT;
    type[1] = MPI_FLOAT;
    MPI_Type_create_struct(2, len, disp, type, &newtype);
    MPI_Type_commit(&newtype);
}

```

```

1      /* Pack i followed by a[0]...a[i-1]*/
2
3      position = 0;
4      MPI_Pack(MPI_BOTTOM, 1, newtype, buff, 1000, &position, MPI_COMM_WORLD);
5
6      /* Send */
7
8      MPI_Send(buff, position, MPI_PACKED, 1, 0,
9              MPI_COMM_WORLD);
10
11     /* *****
12      One can replace the last three lines with
13      MPI_Send(MPI_BOTTOM, 1, newtype, 1, 0, MPI_COMM_WORLD);
14      ***** */
15     }
16     else if (myrank == 1)
17     {
18         /* RECEIVER CODE */
19
20         MPI_Status status;
21
22         /* Receive */
23
24         MPI_Recv(buff, 1000, MPI_PACKED, 0, 0, MPI_COMM_WORLD, &status);
25
26         /* Unpack i */
27
28         position = 0;
29         MPI_Unpack(buff, 1000, &position, &i, 1, MPI_INT, MPI_COMM_WORLD);
30
31         /* Unpack a[0]...a[i-1] */
32         MPI_Unpack(buff, 1000, &position, a, i, MPI_FLOAT, MPI_COMM_WORLD);
33     }
34

```

**Example 5.23** Each process sends a count, followed by count characters to the root; the root concatenates all characters into one string.

```

38     int count, gsize, counts[64], totalcount, k1, k2, k,
39         displs[64], position, concat_pos;
40     char chr[100], *lbuf, *rbuf, *cbuf;
41
42     MPI_Comm_size(comm, &gsiz);
43     MPI_Comm_rank(comm, &myrank);
44
45     /* allocate local pack buffer */
46     MPI_Pack_size(1, MPI_INT, comm, &k1);
47     MPI_Pack_size(count, MPI_CHAR, comm, &k2);
48     k = k1+k2;

```



```
lbuf = (char *)malloc(k);
1
2
    /* pack count, followed by count characters */
3
    position = 0;
4
    MPI_Pack(&count, 1, MPI_INT, lbuf, k, &position, comm);
5
    MPI_Pack(chr, count, MPI_CHAR, lbuf, k, &position, comm);
6
7
if (myrank != root) {
8
    /* gather at root sizes of all packed messages */
9
    MPI_Gather(&position, 1, MPI_INT, NULL, 0,
10
              MPI_DATATYPE_NULL, root, comm);
11
12
    /* gather at root packed messages */
13
    MPI_Gatherv(lbuf, position, MPI_PACKED, NULL,
14
               NULL, NULL, MPI_DATATYPE_NULL, root, comm);
15
16
} else { /* root code */
17
    /* gather sizes of all packed messages */
18
    MPI_Gather(&position, 1, MPI_INT, counts, 1,
19
              MPI_INT, root, comm);
20
21
    /* gather all packed messages */
22
    displs[0] = 0;
23
    for (i=1; i < gsize; i++)
24
        displs[i] = displs[i-1] + counts[i-1];
25
    totalcount = displs[gsiz-1] + counts[gsiz-1];
26
    rbuf = (char *)malloc(totalcount);
27
    cbuf = (char *)malloc(totalcount);
28
    MPI_Gatherv(lbuf, position, MPI_PACKED, rbuf,
29
               counts, displs, MPI_PACKED, root, comm);
30
31
    /* unpack all messages and concatenate strings */
32
    concat_pos = 0;
33
    for (i=0; i < gsize; i++) {
34
        position = 0;
35
        MPI_Unpack(rbuf+displs[i], totalcount-displs[i],
36
                  &position, &count, 1, MPI_INT, comm);
37
        MPI_Unpack(rbuf+displs[i], totalcount-displs[i],
38
                  &position, cbuf+concat_pos, count, MPI_CHAR, comm);
39
        concat_pos += count;
40
    }
41
    cbuf[concat_pos] = '\0';
42
}
43
44
45
46
47
48
```

### 5.3 Canonical MPI\_PACK and MPI\_UNPACK

These functions read/write data to/from the buffer in the "external32" data format specified in Section 14.5.2, and calculate the size needed for packing. Their first arguments specify the data format, for future extensibility, but currently the only valid value of the `datarep` argument is "external32".

*Advice to users.* These functions could be used, for example, to send typed data in a portable format from one MPI implementation to another. (*End of advice to users.*)

The buffer will contain exactly the packed data, without headers. `MPI_BYTE` should be used to send and receive data that is packed using `MPI_PACK_EXTERNAL`.

*Rationale.* `MPI_PACK_EXTERNAL` specifies that there is no header on the message and further specifies the exact format of the data. Since `MPI_PACK` may (and is allowed to) use a header, the datatype `MPI_PACKED` cannot be used for data packed with `MPI_PACK_EXTERNAL`. (*End of rationale.*)

`MPI_PACK_EXTERNAL(datarep, inbuf, incount, datatype, outbuf, outsize, position)`

IN	<code>datarep</code>	data representation (string)
IN	<code>inbuf</code>	input buffer start (choice)
IN	<code>incount</code>	number of input data items (integer)
IN	<code>datatype</code>	datatype of each input data item (handle)
OUT	<code>outbuf</code>	output buffer start (choice)
IN	<code>outsize</code>	output buffer size, in bytes (integer)
INOUT	<code>position</code>	current position in buffer, in bytes (integer)

#### C binding

```
int MPI_Pack_external(const char datarep[], const void *inbuf, int incount,
                    MPI_Datatype datatype, void *outbuf, MPI_Aint outsize,
                    MPI_Aint *position)
```

```
int MPI_Pack_external_c(const char datarep[], const void *inbuf,
                      MPI_Count incount, MPI_Datatype datatype, void *outbuf,
                      MPI_Count outsize, MPI_Count *position)
```

#### Fortran 2008 binding

```
MPI_Pack_external(datarep, inbuf, incount, datatype, outbuf, outsize,
                 position, ierror)
CHARACTER(LEN=*), INTENT(IN) :: datarep
TYPE(*), DIMENSION(..), INTENT(IN) :: inbuf
INTEGER, INTENT(IN) :: incount
TYPE(MPI_Datatype), INTENT(IN) :: datatype
TYPE(*), DIMENSION(..) :: outbuf
INTEGER(KIND=MPI_ADDRESS_KIND), INTENT(IN) :: outsize
INTEGER(KIND=MPI_ADDRESS_KIND), INTENT(INOUT) :: position
```

```

    INTEGER, OPTIONAL, INTENT(OUT) :: ierror
1
MPI_Pack_external(datarep, inbuf, incount, datatype, outbuf, outsize,
2
    position, ierror)
3
    CHARACTER(LEN=*), INTENT(IN) :: datarep
4
    TYPE(*), DIMENSION(..), INTENT(IN) :: inbuf
5
    INTEGER(KIND=MPI_COUNT_KIND), INTENT(IN) :: incount, outsize
6
    TYPE(MPI_Datatype), INTENT(IN) :: datatype
7
    TYPE(*), DIMENSION(..) :: outbuf
8
    INTEGER(KIND=MPI_COUNT_KIND), INTENT(INOUT) :: position
9
    INTEGER, OPTIONAL, INTENT(OUT) :: ierror
10
11
Fortran binding
12
MPI_PACK_EXTERNAL(DATAREP, INBUF, INCOUNT, DATATYPE, OUTBUF, OUTSIZE,
13
    POSITION, IERROR)
14
    CHARACTER*(*) DATAREP
15
    <type> INBUF(*), OUTBUF(*)
16
    INTEGER INCOUNT, DATATYPE, IERROR
17
    INTEGER(KIND=MPI_ADDRESS_KIND) OUTSIZE, POSITION
18
19
20
MPI_UNPACK_EXTERNAL(datarep, inbuf, insize, position, outbuf, outcount, datatype)
21
    IN      datarep      data representation (string)
22
    IN      inbuf        input buffer start (choice)
23
    IN      insize       input buffer size, in bytes (integer)
24
    INOUT   position     current position in buffer, in bytes (integer)
25
    OUT     outbuf       output buffer start (choice)
26
    IN      outcount     number of output data items (integer)
27
    IN      datatype     datatype of output data item (handle)
28
29
30
31
32
C binding
33
int MPI_Unpack_external(const char datarep[], const void *inbuf,
34
    MPI_Aint insize, MPI_Aint *position, void *outbuf,
35
    int outcount, MPI_Datatype datatype)
36
37
int MPI_Unpack_external_c(const char datarep[], const void *inbuf,
38
    MPI_Count insize, MPI_Count *position, void *outbuf,
39
    MPI_Count outcount, MPI_Datatype datatype)
40
41
Fortran 2008 binding
42
MPI_Unpack_external(datarep, inbuf, insize, position, outbuf, outcount,
43
    datatype, ierror)
44
    CHARACTER(LEN=*), INTENT(IN) :: datarep
45
    TYPE(*), DIMENSION(..), INTENT(IN) :: inbuf
46
    INTEGER(KIND=MPI_ADDRESS_KIND), INTENT(IN) :: insize
47
    INTEGER(KIND=MPI_ADDRESS_KIND), INTENT(INOUT) :: position
48
    TYPE(*), DIMENSION(..) :: outbuf

```

```

1     INTEGER, INTENT(IN) :: outcount
2     TYPE(MPI_Datatype), INTENT(IN) :: datatype
3     INTEGER, OPTIONAL, INTENT(OUT) :: ierror
4
5 MPI_Unpack_external(datarep, inbuf, insize, position, outbuf, outcount,
6     datatype, ierror)
7     CHARACTER(LEN=*), INTENT(IN) :: datarep
8     TYPE(*), DIMENSION(..), INTENT(IN) :: inbuf
9     INTEGER(KIND=MPI_COUNT_KIND), INTENT(IN) :: insize, outcount
10    INTEGER(KIND=MPI_COUNT_KIND), INTENT(INOUT) :: position
11    TYPE(*), DIMENSION(..) :: outbuf
12    TYPE(MPI_Datatype), INTENT(IN) :: datatype
13    INTEGER, OPTIONAL, INTENT(OUT) :: ierror

```

#### Fortran binding

```

14 MPI_UNPACK_EXTERNAL(DATAREP, INBUF, INSIZE, POSITION, OUTBUF, OUTCOUNT,
15     DATATYPE, IERROR)
16     CHARACTER*(*) DATAREP
17     <type> INBUF(*), OUTBUF(*)
18     INTEGER(KIND=MPI_ADDRESS_KIND) INSIZE, POSITION
19     INTEGER OUTCOUNT, DATATYPE, IERROR
20
21
22

```

#### MPI\_PACK\_EXTERNAL\_SIZE(datarep, incount, datatype, size)

24	IN	datarep	data representation (string)
25	IN	incount	number of input data items (integer)
26	IN	datatype	datatype of each input data item (handle)
27	IN	datatype	datatype of each input data item (handle)
28	IN	datatype	datatype of each input data item (handle)
29	OUT	size	output buffer size, in bytes (integer)

#### C binding

```

30
31
32 int MPI_Pack_external_size(const char datarep[], int incount,
33     MPI_Datatype datatype, MPI_Aint *size)
34
35 int MPI_Pack_external_size_c(const char datarep[], MPI_Count incount,
36     MPI_Datatype datatype, MPI_Count *size)

```

#### Fortran 2008 binding

```

37
38 MPI_Pack_external_size(datarep, incount, datatype, size, ierror)
39     CHARACTER(LEN=*), INTENT(IN) :: datarep
40     INTEGER, INTENT(IN) :: incount
41     TYPE(MPI_Datatype), INTENT(IN) :: datatype
42     INTEGER(KIND=MPI_ADDRESS_KIND), INTENT(OUT) :: size
43     INTEGER, OPTIONAL, INTENT(OUT) :: ierror
44
45 MPI_Pack_external_size(datarep, incount, datatype, size, ierror)
46     CHARACTER(LEN=*), INTENT(IN) :: datarep
47     INTEGER(KIND=MPI_COUNT_KIND), INTENT(IN) :: incount
48     TYPE(MPI_Datatype), INTENT(IN) :: datatype

```

```
INTEGER(KIND=MPI_COUNT_KIND), INTENT(OUT) :: size  
INTEGER, OPTIONAL, INTENT(OUT) :: ierror
```

**Fortran binding**

```
MPI_PACK_EXTERNAL_SIZE(DATAREP, INCOUNT, DATATYPE, SIZE, IERROR)  
CHARACTER*(*) DATAREP  
INTEGER INCOUNT, DATATYPE, IERROR  
INTEGER(KIND=MPI_ADDRESS_KIND) SIZE
```

1  
2  
3  
4  
5  
6  
7  
8  
9  
10  
11  
12  
13  
14  
15  
16  
17  
18  
19  
20  
21  
22  
23  
24  
25  
26  
27  
28  
29  
30  
31  
32  
33  
34  
35  
36  
37  
38  
39  
40  
41  
42  
43  
44  
45  
46  
47  
48

1  
2  
3  
4  
5  
6  
7  
8  
9  
10  
11  
12  
13  
14  
15  
16  
17  
18  
19  
20  
21  
22  
23  
24  
25  
26  
27  
28  
29  
30  
31  
32  
33  
34  
35  
36  
37  
38  
39  
40  
41  
42  
43  
44  
45  
46  
47  
48

DRAFT

1  
2  
3  
4  
5  
6  
7  
8  
9  
10  
11  
12  
13  
14  
15  
16  
17  
18  
19  
20  
21  
22  
23  
24  
25  
26  
27  
28  
29  
30  
31  
32  
33  
34  
35  
36  
37  
38  
39  
40  
41  
42  
43  
44  
45  
46  
47  
48

## Chapter 6

# Collective Communication

### 6.1 Introduction and Overview

Collective communication is defined as communication that involves a group or groups of processes. The functions of this type provided by MPI are the following:

- `MPI_BARRIER`, `MPI_IBARRIER`: Barrier synchronization across all members of a group (Section 6.3 and Section 6.12.1).
- `MPI_BCAST`, `MPI_IBCAST`: Broadcast from one member to all members of a group (Section 6.4 and Section 6.12.2). This is shown as “broadcast” in Figure 6.1.
- `MPI_GATHER`, `MPI_IGATHER`, `MPI_GATHERV`, `MPI_IGATHERV`: Gather data from all members of a group to one member (Section 6.5 and Section 6.12.3). This is shown as “gather” in Figure 6.1.
- `MPI_SCATTER`, `MPI_ISCATTER`, `MPI_SCATTERV`, `MPI_ISCATTERV`: Scatter data from one member to all members of a group (Section 6.6 and Section 6.12.4). This is shown as “scatter” in Figure 6.1.
- `MPI_ALLGATHER`, `MPI_IALLGATHER`, `MPI_ALLGATHERV`, `MPI_IALLGATHERV`: A variation on Gather where all members of a group receive the result (Section 6.7 and Section 6.12.5). This is shown as “allgather” in Figure 6.1.
- `MPI_ALLTOALL`, `MPI_IALLTOALL`, `MPI_ALLTOALLV`, `MPI_IALLTOALLV`, `MPI_ALLTOALLW`, `MPI_IALLTOALLW`: Scatter/Gather data from all members to all members of a group (also called complete exchange) (Section 6.8 and Section 6.12.6). This is shown as “complete exchange” in Figure 6.1.
- `MPI_ALLREDUCE`, `MPI_IALLREDUCE`, `MPI_REDUCE`, `MPI_IREDUCE`: Global reduction operations such as sum, max, min, or user-defined functions, where the result is returned to all members of a group (Section 6.9.6 and Section 6.12.8) and a variation where the result is returned to only one member (Section 6.9 and Section 6.12.7).
- `MPI_REDUCE_SCATTER_BLOCK`, `MPI_IREDUCE_SCATTER_BLOCK`, `MPI_REDUCE_SCATTER`, `MPI_IREDUCE_SCATTER`: A combined reduction and scatter operation (Section 6.10, Section 6.12.9, and Section 6.12.10).

- `MPI_SCAN`, `MPI_ISCAN`, `MPI_EXSCAN`, `MPI_IEXSCAN`: Scan across all members of a group (also called prefix) (Section 6.11, Section 6.11.2, Section 6.12.11, and Section 6.12.12).

One of the key arguments in a call to a collective routine is a communicator that defines the group or groups of participating processes and provides a context for the operation. This is discussed further in Section 6.2. The syntax and semantics of the collective operations are defined to be consistent with the syntax and semantics of the point-to-point operations. Thus, general datatypes are allowed and must match between sending and receiving processes as specified in Chapter 5. Several collective routines such as broadcast and gather have a single originating or receiving process. Such a process is called the *root*. Some arguments in the collective functions are specified as “significant only at root,” and are ignored for all participants except the root. The reader is referred to Chapter 5 for information concerning communication buffers, general datatypes and type matching rules, and to Chapter 7 for information on how to define groups and create communicators.

The type-matching conditions for the collective operations are more strict than the corresponding conditions between sender and receiver in point-to-point. Namely, for collective operations, the amount of data sent must exactly match the amount of data specified by the receiver. Different type maps (the layout in memory, see Section 5.1) between sender and receiver are still allowed.

Collective operations can (but are not required to) complete as soon as the caller’s participation in the collective communication is finished. A blocking operation is complete as soon as the call returns. A nonblocking (immediate) call requires a separate completion call (cf. Section 3.7). The completion of a collective operation indicates that the caller is free to modify locations in the communication buffer. It does not indicate that other processes in the group have completed or even started the operation (unless otherwise implied by the description of the operation). Thus, a collective communication operation may, or may not, have the effect of synchronizing all participating MPI processes.

Collective communication calls may use the same communicators as point-to-point communication; MPI guarantees that messages generated on behalf of collective communication calls will not be confused with messages generated by point-to-point communication. The collective operations do not have a message tag argument. A more detailed discussion of correct use of collective routines is found in Section 6.14.

*Rationale.* The equal-data restriction (on type matching) was made so as to avoid the complexity of providing a facility analogous to the status argument of `MPI_RECV` for discovering the amount of data sent. Some of the collective routines would require an array of status values.

The statements about synchronization are made so as to allow a variety of implementations of the collective functions.

*(End of rationale.)*

*Advice to users.* It is dangerous to rely on synchronization side-effects of the collective operations for program correctness. For example, even though a particular implementation may provide a broadcast routine with a side-effect of synchronization, the standard does not require this, and a program that relies on this will not be portable.



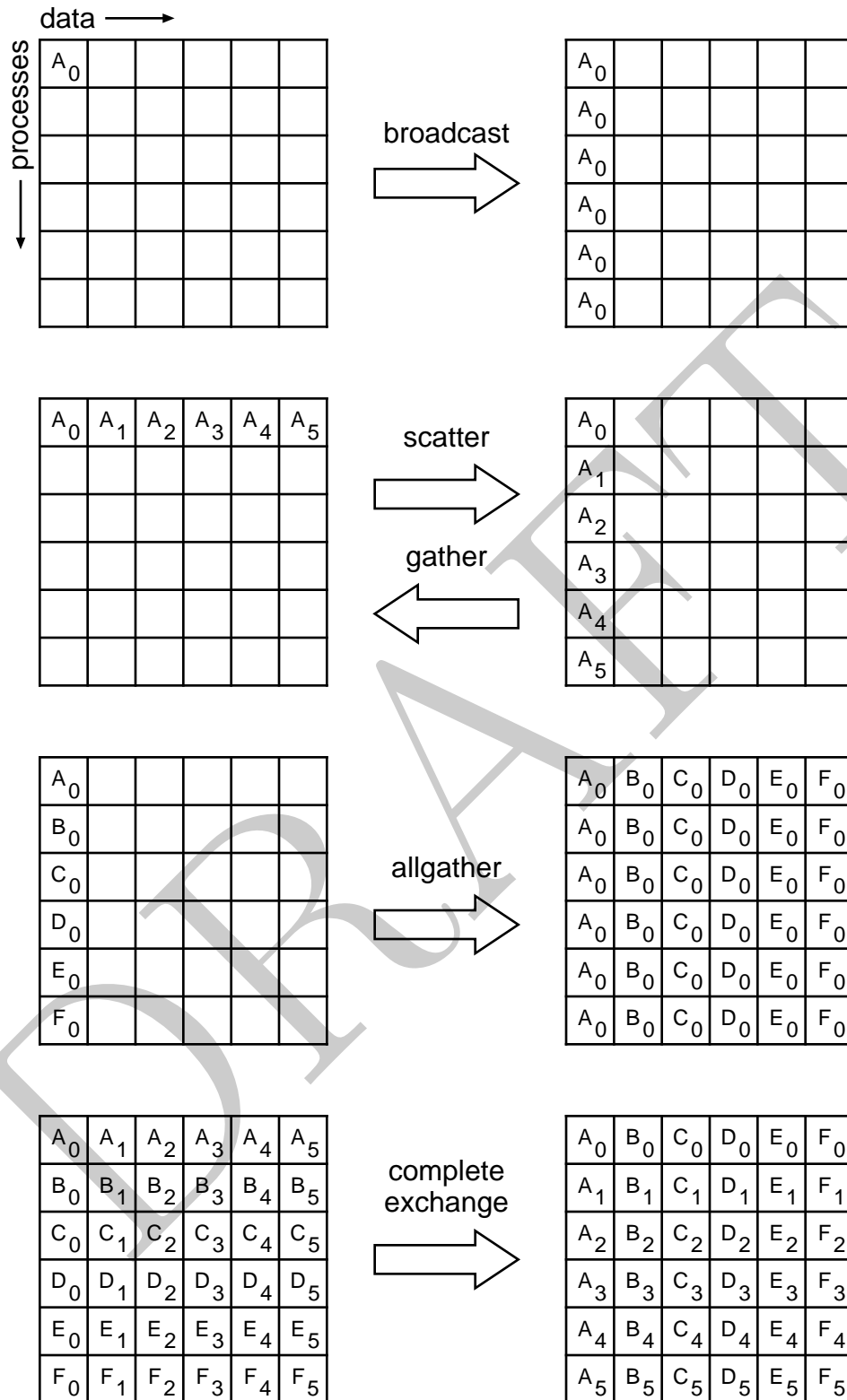

Figure 6.1: Collective move functions illustrated for a group of six processes. In each case, each row of boxes represents data locations in one process. Thus, in the broadcast, initially just the first process contains the data  $A_0$ , but after the broadcast all processes contain it.

1  
2  
3  
4  
5  
6  
7  
8  
9  
10  
11  
12  
13  
14  
15  
16  
17  
18  
19  
20  
21  
22  
23  
24  
25  
26  
27  
28  
29  
30  
31  
32  
33  
34  
35  
36  
37  
38  
39  
40  
41  
42  
43  
44  
45  
46  
47  
48

1 On the other hand, a correct, portable program must allow for the fact that a collective  
2 call *may* be synchronizing. Though one cannot rely on any synchronization side-effect,  
3 one must program so as to allow it. These issues are discussed further in Section 6.14.  
4 (*End of advice to users.*)

5 *Advice to implementors.* While vendors may write optimized collective routines  
6 matched to their architectures, a complete library of the collective communication  
7 routines can be written entirely using the MPI point-to-point communication func-  
8 tions and a few auxiliary functions. If implementing on top of point-to-point, a hidden,  
9 special communicator might be created for the collective operation so as to avoid inter-  
10 ference with any on-going point-to-point communication at the time of the collective  
11 call. This is discussed further in Section 6.14. (*End of advice to implementors.*)

12  
13 Many of the descriptions of the collective routines provide illustrations in terms of  
14 blocking MPI point-to-point routines. These are intended solely to indicate what data is  
15 sent or received by what process. Many of these examples are *not* correct MPI programs;  
16 for purposes of simplicity, they often assume infinite buffering.

## 17 18 6.2 Communicator Argument

19  
20 The key concept of the collective functions is to have a group or groups of participating  
21 processes. The routines do not have group identifiers as explicit arguments. Instead, there  
22 is a communicator argument. Groups and communicators are discussed in full detail in  
23 Chapter 7. For the purposes of this chapter, it is sufficient to know that there are two types  
24 of communicators: *intra-communicators* and *inter-communicators*. An intra-communicator  
25 can be thought of as an identifier for a single group of processes linked with a context. An  
26 inter-communicator identifies two distinct groups of processes linked with a context.

### 27 28 6.2.1 Specifics for Intra-Communicator Collective Operations

29  
30 All processes in the group identified by the intra-communicator must call the collective  
31 routine.

32 In many cases, collective communication can occur “in place” for intra-communicators,  
33 with the output buffer being identical to the input buffer. This is specified by providing  
34 a special argument value, `MPI_IN_PLACE`, instead of the send buffer or the receive buffer  
35 argument, depending on the operation performed.

36 *Rationale.* The “in place” operations are provided to reduce unnecessary memory  
37 motion by both the MPI implementation and by the user. Note that while the simple  
38 check of testing whether the send and receive buffers have the same address will  
39 work for some cases (e.g., `MPI_ALLREDUCE`), they are inadequate in others (e.g.,  
40 `MPI_GATHER`, with root not equal to zero). Further, Fortran explicitly prohibits  
41 aliasing of arguments; the approach of using a special value to denote “in place”  
42 operation eliminates that difficulty. (*End of rationale.*)

43  
44 *Advice to users.* By allowing the “in place” option, the receive buffer in many of the  
45 collective calls becomes a send-and-receive buffer. For this reason, a Fortran binding  
46 that includes `INTENT` must mark these as `INOUT`, not `OUT`.

47 Note that `MPI_IN_PLACE` is a special kind of value; it has the same restrictions on its  
48 use that `MPI_BOTTOM` has. (*End of advice to users.*)

### 6.2.2 Applying Collective Operations to Inter-Communicators

To understand how collective operations apply to inter-communicators, we can view most MPI intra-communicator collective operations as fitting one of the following categories (see, for instance, [63]):

**All-To-All** All processes contribute to the result. All processes receive the result.

- MPI\_ALLGATHER, MPI\_IALLGATHER, MPI\_ALLGATHERV, MPI\_IALLGATHERV
- MPI\_ALLTOALL, MPI\_IALLTOALL, MPI\_ALLTOALLV, MPI\_IALLTOALLV, MPI\_ALLTOALLW, MPI\_IALLTOALLW
- MPI\_ALLREDUCE, MPI\_IALLREDUCE, MPI\_REDUCE\_SCATTER\_BLOCK, MPI\_IREDUCE\_SCATTER\_BLOCK, MPI\_REDUCE\_SCATTER, MPI\_IREDUCE\_SCATTER
- MPI\_BARRIER, MPI\_IBARRIER

**All-To-One** All processes contribute to the result. One process receives the result.

- MPI\_GATHER, MPI\_IGATHER, MPI\_GATHERV, MPI\_IGATHERV
- MPI\_REDUCE, MPI\_IREDUCE

**One-To-All** One process contributes to the result. All processes receive the result.

- MPI\_BCAST, MPI\_IBCAST
- MPI\_SCATTER, MPI\_ISCATTER, MPI\_SCATTERV, MPI\_ISCATTERV

**Other** Collective operations that do not fit into one of the above categories.

- MPI\_SCAN, MPI\_ISCAN, MPI\_EXSCAN, MPI\_IEXSCAN

The data movement patterns of MPI\_SCAN, MPI\_ISCAN, MPI\_EXSCAN, and MPI\_IEXSCAN do not fit this taxonomy.

The application of collective communication to inter-communicators is best described in terms of two groups. For example, an all-to-all MPI\_ALLGATHER operation can be described as collecting data from all members of one group with the result appearing in all members of the other group (see Figure 6.2). As another example, a one-to-all MPI\_BCAST operation sends data from one member of one group to all members of the other group. Collective computation operations such as MPI\_REDUCE\_SCATTER have a similar interpretation (see Figure 6.3). For intra-communicators, these two groups are the same. For inter-communicators, these two groups are distinct. For the all-to-all operations, each such operation is described in two phases, so that it has a symmetric, full-duplex behavior.

The following collective operations also apply to inter-communicators:

- MPI\_BARRIER, MPI\_IBARRIER
- MPI\_BCAST, MPI\_IBCAST
- MPI\_GATHER, MPI\_IGATHER, MPI\_GATHERV, MPI\_IGATHERV,
- MPI\_SCATTER, MPI\_ISCATTER, MPI\_SCATTERV, MPI\_ISCATTERV,

- 1 • MPI\_ALLGATHER, MPI\_IALLGATHER, MPI\_ALLGATHERV, MPI\_IALLGATHERV,
- 2 • MPI\_ALLTOALL, MPI\_IALLTOALL, MPI\_ALLTOALLV, MPI\_IALLTOALLV,
- 3 MPI\_ALLTOALLW, MPI\_IALLTOALLW,
- 4
- 5 • MPI\_ALLREDUCE, MPI\_IALLREDUCE, MPI\_REDUCE, MPI\_IREDUCE,
- 6
- 7 • MPI\_REDUCE\_SCATTER\_BLOCK, MPI\_IREDUCE\_SCATTER\_BLOCK,
- 8 MPI\_REDUCE\_SCATTER, MPI\_IREDUCE\_SCATTER.
- 9

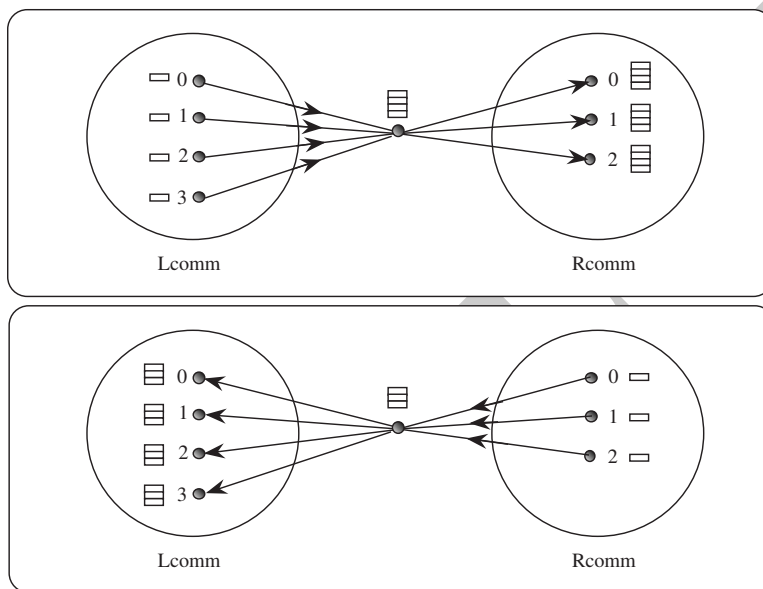

Figure 6.2: Inter-communicator allgather. The focus of data to one process is represented, not mandated by the semantics. The two phases do allgathers in both directions.

### 6.2.3 Specifics for Inter-Communicator Collective Operations

All processes in both groups identified by the inter-communicator must call the collective routine.

Note that the “in place” option for intra-communicators does not apply to inter-communicators since in the inter-communicator case there is no communication from a process to itself.

For inter-communicator collective communication, if the operation is in the All-To-One or One-To-All categories, then the transfer is unidirectional. The direction of the transfer is indicated by a special value of the root argument. In this case, for the group containing the root process, all processes in the group must call the routine using a special argument for the root. For this, the root process uses the special root value `MPI_ROOT`; all other processes in the same group as the root use `MPI_PROC_NULL`. All processes in the other group (the group that is the remote group relative to the root process) must call the collective routine and provide the rank of the root. If the operation is in the All-To-All category, then the transfer is bidirectional.

*Rationale.* Operations in the All-To-One and One-To-All categories are unidirectional by nature, and there is a clear way of specifying direction. Operations in the All-To-All

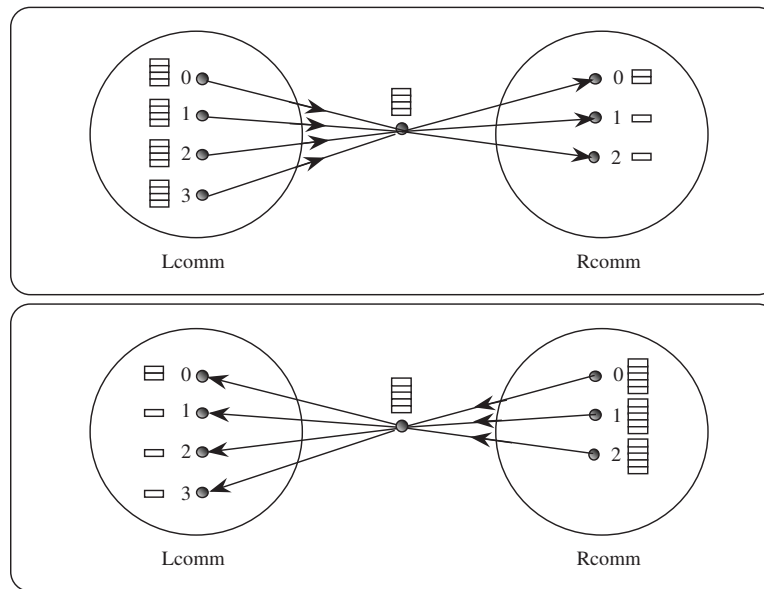

Figure 6.3: Inter-communicator reduce-scatter. The focus of data to one process is represented, not mandated by the semantics. The two phases do reduce-scatters in both directions.

category will often occur as part of an exchange, where it makes sense to communicate in both directions at once. (*End of rationale.*)

### 6.3 Barrier Synchronization

`MPI_BARRIER(comm)`

IN `comm` communicator (handle)

#### C binding

`int MPI_Barrier(MPI_Comm comm)`

#### Fortran 2008 binding

`MPI_Barrier(comm, ierror)`

TYPE(MPI\_Comm), INTENT(IN) :: comm

INTEGER, OPTIONAL, INTENT(OUT) :: ierror

#### Fortran binding

`MPI_BARRIER(COMM, IERROR)`

INTEGER COMM, IERROR

If `comm` is an intra-communicator, `MPI_BARRIER` blocks the caller until all group members have called it. The call returns at any process only after all group members have entered the call.

If `comm` is an inter-communicator, `MPI_BARRIER` involves two groups. The call returns at processes in one group (group A) of the inter-communicator only after all members of

the other group (group B) have entered the call (and vice versa). A process may return from the call before all processes in its own group have entered the call.

## 6.4 Broadcast

`MPI_BCAST(buffer, count, datatype, root, comm)`

INOUT	buffer	starting address of buffer (choice)
IN	count	number of entries in buffer (non-negative integer)
IN	datatype	datatype of buffer (handle)
IN	root	rank of broadcast root (integer)
IN	comm	communicator (handle)

### C binding

```
int MPI_Bcast(void *buffer, int count, MPI_Datatype datatype, int root,
             MPI_Comm comm)
```

```
int MPI_Bcast_c(void *buffer, MPI_Count count, MPI_Datatype datatype,
               int root, MPI_Comm comm)
```

### Fortran 2008 binding

```
MPI_Bcast(buffer, count, datatype, root, comm, ierror)
  TYPE(*), DIMENSION(..) :: buffer
  INTEGER, INTENT(IN) :: count, root
  TYPE(MPI_Datatype), INTENT(IN) :: datatype
  TYPE(MPI_Comm), INTENT(IN) :: comm
  INTEGER, OPTIONAL, INTENT(OUT) :: ierror
```

```
MPI_Bcast(buffer, count, datatype, root, comm, ierror)
  TYPE(*), DIMENSION(..) :: buffer
  INTEGER(KIND=MPI_COUNT_KIND), INTENT(IN) :: count
  TYPE(MPI_Datatype), INTENT(IN) :: datatype
  INTEGER, INTENT(IN) :: root
  TYPE(MPI_Comm), INTENT(IN) :: comm
  INTEGER, OPTIONAL, INTENT(OUT) :: ierror
```

### Fortran binding

```
MPI_BCAST(BUFFER, COUNT, DATATYPE, ROOT, COMM, IERROR)
  <type> BUFFER(*)
  INTEGER COUNT, DATATYPE, ROOT, COMM, IERROR
```

If `comm` is an intra-communicator, `MPI_BCAST` broadcasts a message from the process with rank `root` to all processes of the group, itself included. It is called by all members of the group using the same arguments for `comm` and `root`. On return, the content of `root`'s buffer is copied to all other processes.

General, derived datatypes are allowed for `datatype`. The type signature of `count`, `datatype` on any process must be equal to the type signature of `count`, `datatype` at the root.

This implies that the amount of data sent must be equal to the amount received, pairwise between each process and the root. `MPI_BCAST` and all other data-movement collective routines make this restriction. Distinct type maps between sender and receiver are still allowed.

The “in place” option is not meaningful here.

If `comm` is an inter-communicator, then the call involves all processes in the inter-communicator, but with one group (group A) defining the root process. All processes in the other group (group B) pass the same value in argument `root`, which is the rank of the root in group A. The root passes the value `MPI_ROOT` in `root`. All other processes in group A pass the value `MPI_PROC_NULL` in `root`. Data is broadcast from the root to all processes in group B. The buffer arguments of the processes in group B must be consistent with the buffer argument of the root.

#### 6.4.1 Example using `MPI_BCAST`

The examples in this section use intra-communicators.

**Example 6.1** Broadcast 100 ints from process 0 to every process in the group.

```
MPI_Comm comm;
int array[100];
int root=0;
...
MPI_Bcast(array, 100, MPI_INT, root, comm);
```

As in many of our example code fragments, we assume that some of the variables (such as `comm` in the above) have been assigned appropriate values.

## 6.5 Gather

```

1 MPI_GATHER(sendbuf, sendcount, sendtype, recvbuf, recvcount, recvtype, root, comm)
2
3
4
5 MPI_GATHER(sendbuf, sendcount, sendtype, recvbuf, recvcount, recvtype, root, comm)
6     IN     sendbuf     starting address of send buffer (choice)
7     IN     sendcount   number of elements in send buffer (non-negative
8                          integer)
9
10    IN     sendtype    datatype of send buffer elements (handle)
11    OUT    recvbuf     address of receive buffer (choice, significant only at
12                          root)
13
14    IN     recvcount    number of elements for any single receive
15                          (non-negative integer, significant only at root)
16
17    IN     recvtype     datatype of recv buffer elements (handle, significant
18                          only at root)
19
20    IN     root         rank of receiving process (integer)
21
22    IN     comm         communicator (handle)

```

### C binding

```

23 int MPI_Gather(const void *sendbuf, int sendcount, MPI_Datatype sendtype,
24               void *recvbuf, int recvcount, MPI_Datatype recvtype, int root,
25               MPI_Comm comm)

```

```

26 int MPI_Gather_c(const void *sendbuf, MPI_Count sendcount,
27                 MPI_Datatype sendtype, void *recvbuf, MPI_Count recvcount,
28                 MPI_Datatype recvtype, int root, MPI_Comm comm)

```

### Fortran 2008 binding

```

30 MPI_Gather(sendbuf, sendcount, sendtype, recvbuf, recvcount, recvtype,
31           root, comm, ierror)
32     TYPE(*), DIMENSION(..), INTENT(IN) :: sendbuf
33     INTEGER, INTENT(IN) :: sendcount, recvcount, root
34     TYPE(MPI_Datatype), INTENT(IN) :: sendtype, recvtype
35     TYPE(*), DIMENSION(..) :: recvbuf
36     TYPE(MPI_Comm), INTENT(IN) :: comm
37     INTEGER, OPTIONAL, INTENT(OUT) :: ierror

```

```

39 MPI_Gather(sendbuf, sendcount, sendtype, recvbuf, recvcount, recvtype,
40           root, comm, ierror)
41     TYPE(*), DIMENSION(..), INTENT(IN) :: sendbuf
42     INTEGER(KIND=MPI_COUNT_KIND), INTENT(IN) :: sendcount, recvcount
43     TYPE(MPI_Datatype), INTENT(IN) :: sendtype, recvtype
44     TYPE(*), DIMENSION(..) :: recvbuf
45     INTEGER, INTENT(IN) :: root
46     TYPE(MPI_Comm), INTENT(IN) :: comm
47     INTEGER, OPTIONAL, INTENT(OUT) :: ierror

```



**Fortran binding**

```

MPI_GATHER(SENDBUF, SENDCOUNT, SENDTYPE, RECVBUF, REVCOUNT, RECVTYPE,
           ROOT, COMM, IERROR)
<type> SENDBUF(*), RECVBUF(*)
INTEGER SENDCOUNT, SENDTYPE, REVCOUNT, RECVTYPE, ROOT, COMM, IERROR

```

If `comm` is an intra-communicator, each process (root process included) sends the contents of its send buffer to the root process. The root process receives the messages and stores them in rank order. The outcome is *as if* each of the `n` processes in the group (including the root process) had executed a call to

```
MPI_Send(sendbuf, sendcount, sendtype, root , ...),
```

and the root had executed `n` calls to

```
MPI_Recv(recvbuf+i·recvcount·extent(recvtype), recvcount, recvtype, i,...),
```

where `extent(recvtype)` is the type extent obtained from a call to `MPI_Type_get_extent`.

An alternative description is that the `n` messages sent by the processes in the group are concatenated in rank order, and the resulting message is received by the root as if by a call to `MPI_RECV(recvbuf, recvcount·n, recvtype, ...)`.

The receive buffer is ignored for all non-root processes.

General, derived datatypes are allowed for both `sendtype` and `recvtype`. The type signature of `sendcount`, `sendtype` on each process must be equal to the type signature of `recvcount`, `recvtype` at the root. This implies that the amount of data sent must be equal to the amount of data received, pairwise between each process and the root. Distinct type maps between sender and receiver are still allowed.

All arguments to the function are significant on process `root`, while on other processes, only arguments `sendbuf`, `sendcount`, `sendtype`, `root`, and `comm` are significant. The arguments `root` and `comm` must have identical values on all processes.

The specification of counts and types should not cause any location on the root to be written more than once. Such a call is erroneous.

Note that the `recvcount` argument at the root indicates the number of items it receives from *each* process, not the total number of items it receives.

The “in place” option for intra-communicators is specified by passing `MPI_IN_PLACE` as the value of `sendbuf` at the root. In such a case, `sendcount` and `sendtype` are ignored, and the contribution of the root to the gathered vector is assumed to be already in the correct place in the receive buffer.

If `comm` is an inter-communicator, then the call involves all processes in the inter-communicator, but with one group (group A) defining the root process. All processes in the other group (group B) pass the same value in argument `root`, which is the rank of the root in group A. The root passes the value `MPI_ROOT` in `root`. All other processes in group A pass the value `MPI_PROC_NULL` in `root`. Data is gathered from all processes in group B to the root. The send buffer arguments of the processes in group B must be consistent with the receive buffer argument of the root.

```

1 MPI_GATHERV(sendbuf, sendcount, sendtype, recvbuf, recvcnts, displs, recvtype, root,
2             comm)
3
4   IN      sendbuf      starting address of send buffer (choice)
5
6   IN      sendcount    number of elements in send buffer (non-negative
7                       integer)
8
9   IN      sendtype     datatype of send buffer elements (handle)
10
11  OUT     recvbuf      address of receive buffer (choice, significant only at
12                       root)
13
14  IN      recvcnts     non-negative integer array (of length group size)
15                       containing the number of elements that are received
16                       from each process (significant only at root)
17
18  IN      displs      integer array (of length group size). Entry i specifies
19                       the displacement relative to recvbuf at which to place
20                       the incoming data from process i (significant only at
21                       root)
22
23  IN      recvtype     datatype of recv buffer elements (handle, significant
24                       only at root)
25
26  IN      root         rank of receiving process (integer)
27
28  IN      comm         communicator (handle)

```

**C binding**

```

29 int MPI_Gatherv(const void *sendbuf, int sendcount, MPI_Datatype sendtype,
30               void *recvbuf, const int recvcnts[], const int displs[],
31               MPI_Datatype recvtype, int root, MPI_Comm comm)
32
33 int MPI_Gatherv_c(const void *sendbuf, MPI_Count sendcount,
34                 MPI_Datatype sendtype, void *recvbuf,
35                 const MPI_Count recvcnts[], const MPI_Aint displs[],
36                 MPI_Datatype recvtype, int root, MPI_Comm comm)

```

**Fortran 2008 binding**

```

37 MPI_Gatherv(sendbuf, sendcount, sendtype, recvbuf, recvcnts, displs,
38             recvtype, root, comm, ierror)
39
40   TYPE(*), DIMENSION(..), INTENT(IN) :: sendbuf
41   INTEGER, INTENT(IN) :: sendcount, recvcnts(*), displs(*), root
42   TYPE(MPI_Datatype), INTENT(IN) :: sendtype, recvtype
43   TYPE(*), DIMENSION(..) :: recvbuf
44   TYPE(MPI_Comm), INTENT(IN) :: comm
45   INTEGER, OPTIONAL, INTENT(OUT) :: ierror
46
47 MPI_Gatherv(sendbuf, sendcount, sendtype, recvbuf, recvcnts, displs,
48             recvtype, root, comm, ierror)
49
50   TYPE(*), DIMENSION(..), INTENT(IN) :: sendbuf
51   INTEGER(KIND=MPI_COUNT_KIND), INTENT(IN) :: sendcount, recvcnts(*)
52   TYPE(MPI_Datatype), INTENT(IN) :: sendtype, recvtype
53   TYPE(*), DIMENSION(..) :: recvbuf

```

```

INTEGER(KIND=MPI_ADDRESS_KIND), INTENT(IN) :: displs(*)
INTEGER, INTENT(IN) :: root
TYPE(MPI_Comm), INTENT(IN) :: comm
INTEGER, OPTIONAL, INTENT(OUT) :: ierror

```

### Fortran binding

```

MPI_GATHERV(SENDBUF, SENDCOUNT, SENDTYPE, RECVBUF, RECVCOUNTS, DISPLS,
            RECVTYPE, ROOT, COMM, IERROR)
<type> SENDBUF(*), RECVBUF(*)
INTEGER SENDCOUNT, SENDTYPE, RECVCOUNTS(*), DISPLS(*), RECVTYPE, ROOT,
COMM, IERROR

```

MPI\_GATHERV extends the functionality of MPI\_GATHER by allowing a varying count of data from each process, since `recvcounts` is now an array. It also allows more flexibility as to where the data is placed on the root, by providing the new argument, `displs`.

If `comm` is an intra-communicator, the outcome is *as if* each process, including the root process, sends a message to the root,

```
MPI_Send(sendbuf, sendcount, sendtype, root, ...),
```

and the root executes `n` receives,

```
MPI_Recv(recvbuf+displs[j]·extent(recvtype), recvcounts[j], recvtype, i, ...).
```

The data received from process `j` is placed into `recvbuf` of the root process beginning at offset `displs[j]` elements (in terms of the `recvtype`).

The receive buffer is ignored for all non-root processes.

The type signature implied by `sendcount`, `sendtype` on process `i` must be equal to the type signature implied by `recvcounts[i]`, `recvtype` at the root. This implies that the amount of data sent must be equal to the amount of data received, pairwise between each process and the root. Distinct type maps between sender and receiver are still allowed, as illustrated in Example 6.6.

All arguments to the function are significant on process `root`, while on other processes, only arguments `sendbuf`, `sendcount`, `sendtype`, `root`, and `comm` are significant. The arguments `root` and `comm` must have identical values on all processes.

The specification of counts, types, and displacements should not cause any location on the root to be written more than once. Such a call is erroneous.

The “in place” option for intra-communicators is specified by passing `MPI_IN_PLACE` as the value of `sendbuf` at the root. In such a case, `sendcount` and `sendtype` are ignored, and the contribution of the root to the gathered vector is assumed to be already in the correct place in the receive buffer.

If `comm` is an inter-communicator, then the call involves all processes in the inter-communicator, but with one group (group A) defining the root process. All processes in the other group (group B) pass the same value in argument `root`, which is the rank of the root in group A. The root passes the value `MPI_ROOT` in `root`. All other processes in group A pass the value `MPI_PROC_NULL` in `root`. Data is gathered from all processes in group B to the root. The send buffer arguments of the processes in group B must be consistent with the receive buffer argument of the root.

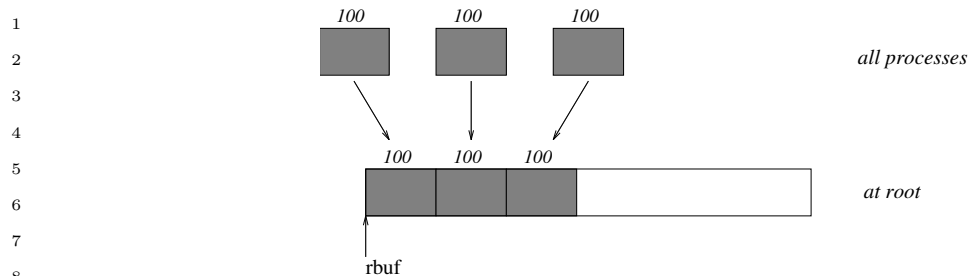

Figure 6.4: The root process gathers 100 ints from each process in the group.

### 6.5.1 Examples using MPI\_GATHER, MPI\_GATHERV

The examples in this section use intra-communicators.

**Example 6.2** Gather 100 ints from every process in group to root. See Figure 6.4.

```

17 MPI_Comm comm;
18 int gsize, sendarray[100];
19 int root, *rbuf;
20 ...
21 MPI_Comm_size(comm, &gsize);
22 rbuf = (int *)malloc(gsize*100*sizeof(int));
23 MPI_Gather(sendarray, 100, MPI_INT, rbuf, 100, MPI_INT, root, comm);

```

**Example 6.3** Previous example modified—only the root allocates memory for the receive buffer.

```

29 MPI_Comm comm;
30 int gsize, sendarray[100];
31 int root, myrank, *rbuf;
32 ...
33 MPI_Comm_rank(comm, &myrank);
34 if (myrank == root) {
35     MPI_Comm_size(comm, &gsize);
36     rbuf = (int *)malloc(gsize*100*sizeof(int));
37 }
38 MPI_Gather(sendarray, 100, MPI_INT, rbuf, 100, MPI_INT, root, comm);

```

**Example 6.4** Do the same as the previous example, but use a derived datatype. Note that the type cannot be the entire set of `gsize*100` ints since type matching is defined pairwise between the root and each process in the gather.

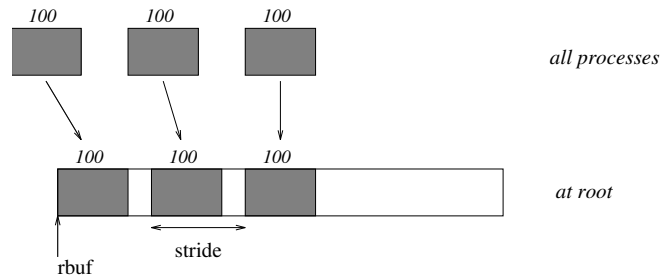

Figure 6.5: The root process gathers 100 ints from each process in the group, each set is placed `stride` ints apart.

```

MPI_Comm comm;
int gsize, sendarray[100];
int root, *rbuf;
MPI_Datatype rtype;
...
MPI_Comm_size(comm, &gsize);
MPI_Type_contiguous(100, MPI_INT, &rtype);
MPI_Type_commit(&rtype);
rbuf = (int *)malloc(gsize*100*sizeof(int));
MPI_Gather(sendarray, 100, MPI_INT, rbuf, 1, rtype, root, comm);

```

**Example 6.5** Now have each process send 100 ints to root, but place each set (of 100) `stride` ints apart at receiving end. Use `MPI_GATHERV` and the `displs` argument to achieve this effect. Assume `stride ≥ 100`. See Figure 6.5.

```

MPI_Comm comm;
int gsize, sendarray[100];
int root, *rbuf, stride;
int *displs, i, *rcounts;
...
MPI_Comm_size(comm, &gsize);
rbuf = (int *)malloc(gsize*stride*sizeof(int));
displs = (int *)malloc(gsize*sizeof(int));
rcounts = (int *)malloc(gsize*sizeof(int));
for (i=0; i<gsize; ++i) {
    displs[i] = i*stride;
    rcounts[i] = 100;
}
MPI_Gatherv(sendarray, 100, MPI_INT, rbuf, rcounts, displs, MPI_INT,
            root, comm);

```

Note that the program is erroneous if `stride < 100`.

**Example 6.6** Same as Example 6.5 on the receiving side, but send the 100 ints from the 0th column of a 100×150 int array, in C. See Figure 6.6.

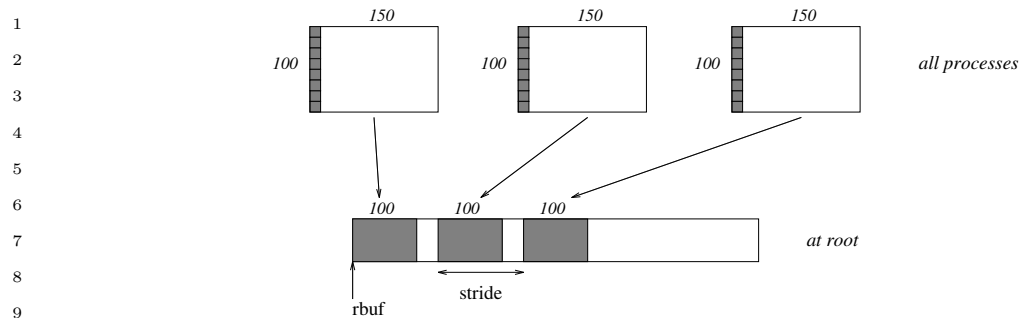

Figure 6.6: The root process gathers column 0 of a  $100 \times 150$  C array, and each set is placed `stride` ints apart.

```

14 MPI_Comm comm;
15 int gsize,sendarray[100][150];
16 int root, *rbuf, stride;
17 MPI_Datatype stype;
18 int *displs,i,*rcounts;
19 ...
20
21
22 MPI_Comm_size(comm, &gsize);
23 rbuf = (int *)malloc(gsize*stride*sizeof(int));
24 displs = (int *)malloc(gsize*sizeof(int));
25 rcounts = (int *)malloc(gsize*sizeof(int));
26 for (i=0; i<gsize; ++i) {
27     displs[i] = i*stride;
28     rcounts[i] = 100;
29 }
30 /* Create datatype for 1 column of array
31 */
32 MPI_Type_vector(100, 1, 150, MPI_INT, &stype);
33 MPI_Type_commit(&stype);
34 MPI_Gatherv(sendarray, 1, stype, rbuf, rcounts, displs, MPI_INT,
35             root, comm);
36

```

**Example 6.7** Process  $i$  sends  $(100-i)$  ints from the  $i$ -th column of a  $100 \times 150$  int array, in C. It is received into a buffer with stride, as in the previous two examples. See Figure 6.7.

```

41 MPI_Comm comm;
42 int gsize,sendarray[100][150],*sptr;
43 int root, *rbuf, stride, myrank;
44 MPI_Datatype stype;
45 int *displs,i,*rcounts;
46 ...
47
48

```

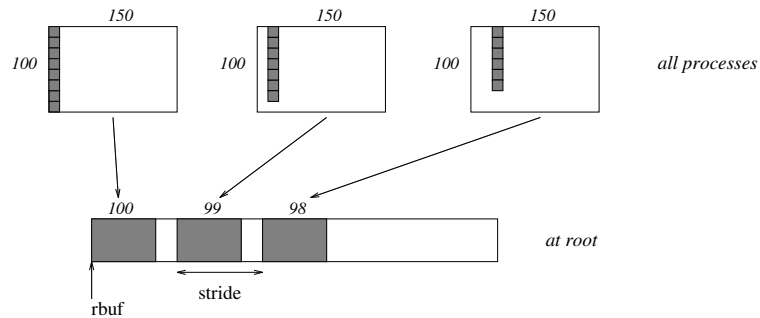

Figure 6.7: The root process gathers  $100-i$  ints from column  $i$  of a  $100 \times 150$  C-array, and each set is placed `stride` ints apart.

```

MPI_Comm_size(comm, &gsize);
MPI_Comm_rank(comm, &myrank);
rbuf = (int *)malloc(gsize*stride*sizeof(int));
displs = (int *)malloc(gsize*sizeof(int));
rcounts = (int *)malloc(gsize*sizeof(int));
for (i=0; i<gsize; ++i) {
    displs[i] = i*stride;
    rcounts[i] = 100-i;    /* note change from previous example */
}
/* Create datatype for the column we are sending
*/
MPI_Type_vector(100-myrank, 1, 150, MPI_INT, &stype);
MPI_Type_commit(&stype);
/* sptr is the address of start of "myrank" column
*/
sptr = &sendarray[0][myrank];
MPI_Gatherv(sptr, 1, stype, rbuf, rcounts, displs, MPI_INT,
            root, comm);

```

Note that a different amount of data is received from each process.

**Example 6.8** Same as Example 6.7, but done in a different way at the sending end. We create a datatype that causes the correct striding at the sending end so that we read a column of a C array. A similar thing was done in Example 5.16, Section 5.1.14.

```

MPI_Comm comm;
int gsize, sendarray[100][150], *sptr;
int root, *rbuf, stride, myrank;
MPI_Datatype stype;
int *displs, i, *rcounts;
...

MPI_Comm_size(comm, &gsize);
MPI_Comm_rank(comm, &myrank);
rbuf = (int *)malloc(gsize*stride*sizeof(int));

```

```

1  displs = (int *)malloc(gsize*sizeof(int));
2  rcounts = (int *)malloc(gsize*sizeof(int));
3  for (i=0; i<gsize; ++i) {
4      displs[i] = i*stride;
5      rcounts[i] = 100-i;
6  }
7  /* Create datatype for one int, with extent of entire row
8     */
9  MPI_Type_create_resized(MPI_INT, 0, 150*sizeof(int), &stype);
10 MPI_Type_commit(&stype);
11 sptr = &sendarray[0][myrank];
12 MPI_Gatherv(sptr, 100-myrank, stype, rbuf, rcounts, displs, MPI_INT,
13            root, comm);
14
15

```

**Example 6.9** Same as Example 6.7 at sending side, but at receiving side we make the stride between received blocks vary from block to block. See Figure 6.8.

```

18
19 MPI_Comm comm;
20 int gsize, sendarray[100][150], *sptr;
21 int root, *rbuf, *stride, myrank, bufsize;
22 MPI_Datatype stype;
23 int *displs, i, *rcounts, offset;
24
25 ...
26
27 MPI_Comm_size(comm, &gsize);
28 MPI_Comm_rank(comm, &myrank);
29
30 stride = (int *)malloc(gsize*sizeof(int));
31 ...
32 /* stride[i] for i = 0 to gsize-1 is set somehow
33    */
34
35 /* set up displs and rcounts vectors first
36    */
37 displs = (int *)malloc(gsize*sizeof(int));
38 rcounts = (int *)malloc(gsize*sizeof(int));
39 offset = 0;
40 for (i=0; i<gsize; ++i) {
41     displs[i] = offset;
42     offset += stride[i];
43     rcounts[i] = 100-i;
44 }
45 /* the required buffer size for rbuf is now easily obtained
46    */
47 bufsize = displs[gsize-1]+rcounts[gsize-1];
48 rbuf = (int *)malloc(bufsize*sizeof(int));

```



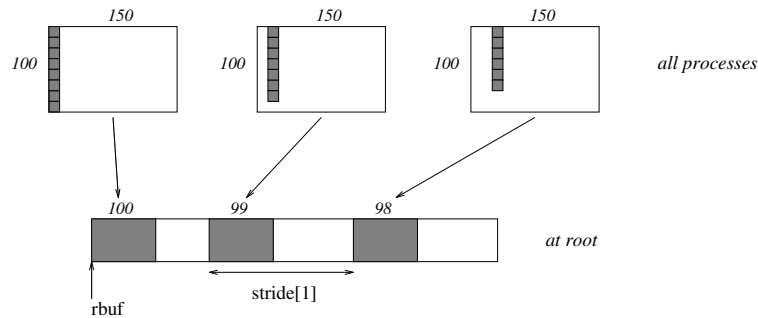

Figure 6.8: The root process gathers  $100-i$  ints from column  $i$  of a  $100 \times 150$  C-array, and each set is placed  $\text{stride}[i]$  ints apart (a varying stride).

```

/* Create datatype for the column we are sending
 */
MPI_Type_vector(100-myrank, 1, 150, MPI_INT, &stype);
MPI_Type_commit(&stype);
sptr = &sendarray[0][myrank];
MPI_Gatherv(sptr, 1, stype, rbuf, rcounts, displs, MPI_INT,
            root, comm);

```

**Example 6.10** Process  $i$  sends  $\text{num}$  ints from the  $i$ -th column of a  $100 \times 150$  int array, in C. The complicating factor is that the various values of  $\text{num}$  are not known to `root`, so a separate gather must first be run to find these out. The data is placed contiguously at the receiving end.

```

MPI_Comm comm;
int gsize, sendarray[100][150], *sptr;
int root, *rbuf, myrank;
MPI_Datatype stype;
int *displs, i, *rcounts, num;
...

MPI_Comm_size(comm, &gsize);
MPI_Comm_rank(comm, &myrank);

/* First, gather nums to root
 */
rcounts = (int *)malloc(gsize*sizeof(int));
MPI_Gather(&num, 1, MPI_INT, rcounts, 1, MPI_INT, root, comm);
/* root now has correct rcounts, using these we set displs[] so
 * that data is placed contiguously (or concatenated) at receive end
 */
displs = (int *)malloc(gsize*sizeof(int));
displs[0] = 0;
for (i=1; i<gsize; ++i) {
    displs[i] = displs[i-1]+rcounts[i-1];
}

```

```

1     }
2     /* And, create receive buffer
3     */
4     rbuf = (int *)malloc(gsize*(displs[gsize-1]+rcounts[gsize-1])
5                               *sizeof(int));
6
7     /* Create datatype for one int, with extent of entire row
8     */
9     MPI_Type_create_resized(MPI_INT, 0, 150*sizeof(int), &stype);
10    MPI_Type_commit(&stype);
11    sptr = &sendarray[0][myrank];
12    MPI_Gatherv(sptr, num, stype, rbuf, rcounts, displs, MPI_INT,
13              root, comm);

```

## 6.6 Scatter

```

18 MPI_SCATTER(sendbuf, sendcount, sendtype, recvbuf, recvcount, recvtype, root, comm)
19
20 IN      sendbuf      address of send buffer (choice, significant only at
21                          root)
22 IN      sendcount    number of elements sent to each process
23                          (non-negative integer, significant only at root)
24 IN      sendtype     datatype of send buffer elements (handle, significant
25                          only at root)
26 OUT     recvbuf      address of receive buffer (choice)
27 IN      recvcount    number of elements in receive buffer (non-negative
28                          integer)
29 IN      recvtype     datatype of receive buffer elements (handle)
30 IN      root         rank of sending process (integer)
31 IN      comm         communicator (handle)

```

### C binding

```

36 int MPI_Scatter(const void *sendbuf, int sendcount, MPI_Datatype sendtype,
37                void *recvbuf, int recvcount, MPI_Datatype recvtype, int root,
38                MPI_Comm comm)
39
40 int MPI_Scatter_c(const void *sendbuf, MPI_Count sendcount,
41                  MPI_Datatype sendtype, void *recvbuf, MPI_Count recvcount,
42                  MPI_Datatype recvtype, int root, MPI_Comm comm)

```

### Fortran 2008 binding

```

44 MPI_Scatter(sendbuf, sendcount, sendtype, recvbuf, recvcount, recvtype,
45            root, comm, ierror)
46     TYPE(*), DIMENSION(..), INTENT(IN) :: sendbuf
47     INTEGER, INTENT(IN) :: sendcount, recvcount, root
48     TYPE(MPI_Datatype), INTENT(IN) :: sendtype, recvtype

```

```

TYPE(*), DIMENSION(..) :: recvbuf      1
TYPE(MPI_Comm), INTENT(IN) :: comm      2
INTEGER, OPTIONAL, INTENT(OUT) :: ierror 3
MPI_Scatter(sendbuf, sendcount, sendtype, recvbuf, recvcnt, recvtype,      4
            root, comm, ierror)        5
TYPE(*), DIMENSION(..), INTENT(IN) :: sendbuf      6
INTEGER(KIND=MPI_COUNT_KIND), INTENT(IN) :: sendcount, recvcnt      7
TYPE(MPI_Datatype), INTENT(IN) :: sendtype, recvtype 8
TYPE(*), DIMENSION(..) :: recvbuf      9
INTEGER, INTENT(IN) :: root            10
TYPE(MPI_Comm), INTENT(IN) :: comm     11
INTEGER, OPTIONAL, INTENT(OUT) :: ierror 12

```

**Fortran binding**

```

MPI_SCATTER(SENDBUF, SENDCOUNT, SENDTYPE, RECVBUF, REVCOUNT, RECVTYPE,    13
            ROOT, COMM, IERROR)                                           14
<type> SENDBUF(*), RECVBUF(*)                                           15
INTEGER SENDCOUNT, SENDTYPE, REVCOUNT, RECVTYPE, ROOT, COMM, IERROR    16

```

MPI\_SCATTER is the inverse operation to MPI\_GATHER.

If *comm* is an intra-communicator, the outcome is *as if* the root executed *n* send operations,

```

MPI_Send(sendbuf+i·sendcount·extent(sendtype), sendcount, sendtype, i,...), 17

```

and each process executed a receive,

```

MPI_Recv(recvbuf, recvcnt, recvtype, i,...).                               18

```

An alternative description is that the root sends a message with MPI\_Send(*sendbuf*, *sendcount*·*n*, *sendtype*, ...). This message is split into *n* equal segments, the *i*-th segment is sent to the *i*-th process in the group, and each process receives this message as above.

The send buffer is ignored for all non-root processes.

The type signature associated with *sendcount*, *sendtype* at the root must be equal to the type signature associated with *recvcnt*, *recvtype* at all processes (however, the type maps may be different). This implies that the amount of data sent must be equal to the amount of data received, pairwise between each process and the root. Distinct type maps between sender and receiver are still allowed.

All arguments to the function are significant on process *root*, while on other processes, only arguments *recvbuf*, *recvcnt*, *recvtype*, *root*, and *comm* are significant. The arguments *root* and *comm* must have identical values on all processes.

The specification of counts and types should not cause any location on the root to be read more than once.

*Rationale.* Though not needed, the last restriction is imposed so as to achieve symmetry with MPI\_GATHER, where the corresponding restriction (a multiple-write restriction) is necessary. (*End of rationale.*)

The “in place” option for intra-communicators is specified by passing MPI\_IN\_PLACE as the value of *recvbuf* at the root. In such a case, *recvcnt* and *recvtype* are ignored, and

1 root “sends” no data to itself. The scattered vector is still assumed to contain  $n$  segments,  
 2 where  $n$  is the group size; the  $root$ -th segment, which root should “send to itself,” is not  
 3 moved.

4 If `comm` is an inter-communicator, then the call involves all processes in the inter-  
 5 communicator, but with one group (group A) defining the root process. All processes in  
 6 the other group (group B) pass the same value in argument `root`, which is the rank of the  
 7 root in group A. The root passes the value `MPI_ROOT` in `root`. All other processes in group  
 8 A pass the value `MPI_PROC_NULL` in `root`. Data is scattered from the root to all processes  
 9 in group B. The receive buffer arguments of the processes in group B must be consistent  
 10 with the send buffer argument of the root.

11  
 12  
 13 `MPI_SCATTERV(sendbuf, sendcounts, displs, sendtype, recvbuf, recvcount, recvtype, root,`  
 14 `comm)`

15	IN	<code>sendbuf</code>	address of send buffer (choice, significant only at 16 root)
17	IN	<code>sendcounts</code>	non-negative integer array (of length group size) 18 specifying the number of elements to send to each 19 rank (significant only at root)
20	IN	<code>displs</code>	integer array (of length group size). Entry $i$ specifies 21 the displacement (relative to <code>sendbuf</code> ) from which to 22 take the outgoing data to process $i$ (significant only 23 at root)
24	IN	<code>sendtype</code>	datatype of send buffer elements (handle, significant 25 only at root)
26	OUT	<code>recvbuf</code>	address of receive buffer (choice)
27	IN	<code>recvcount</code>	number of elements in receive buffer (non-negative 28 integer)
29	IN	<code>recvtype</code>	datatype of receive buffer elements (handle)
30	IN	<code>root</code>	rank of sending process (integer)
31	IN	<code>comm</code>	communicator (handle)

### 36 C binding

37 `int MPI_Scatterv(const void *sendbuf, const int sendcounts[],`  
 38 `const int displs[], MPI_Datatype sendtype, void *recvbuf,`  
 39 `int recvcount, MPI_Datatype recvtype, int root, MPI_Comm comm)`

40 `int MPI_Scatterv_c(const void *sendbuf, const MPI_Count sendcounts[],`  
 41 `const MPI_Aint displs[], MPI_Datatype sendtype, void *recvbuf,`  
 42 `MPI_Count recvcount, MPI_Datatype recvtype, int root,`  
 43 `MPI_Comm comm)`

### 45 Fortran 2008 binding

46 `MPI_Scatterv(sendbuf, sendcounts, displs, sendtype, recvbuf, recvcount,`  
 47 `recvtype, root, comm, ierror)`  
 48 `TYPE(*), DIMENSION(..), INTENT(IN) :: sendbuf`

```

INTEGER, INTENT(IN) :: sendcounts(*), displs(*), recvcount, root      1
TYPE(MPI_Datatype), INTENT(IN) :: sendtype, recvtype                 2
TYPE(*), DIMENSION(..) :: recvbuf                                   3
TYPE(MPI_Comm), INTENT(IN) :: comm                                  4
INTEGER, OPTIONAL, INTENT(OUT) :: ierror                            5
                                                                    6
MPI_Scatterv(sendbuf, sendcounts, displs, sendtype, recvbuf, recvcount,  7
             recvtype, root, comm, ierror)                           8
TYPE(*), DIMENSION(..), INTENT(IN) :: sendbuf                       9
INTEGER(KIND=MPI_COUNT_KIND), INTENT(IN) :: sendcounts(*), recvcount 10
INTEGER(KIND=MPI_ADDRESS_KIND), INTENT(IN) :: displs(*)             11
TYPE(MPI_Datatype), INTENT(IN) :: sendtype, recvtype               12
TYPE(*), DIMENSION(..) :: recvbuf                                   13
INTEGER, INTENT(IN) :: root                                         14
TYPE(MPI_Comm), INTENT(IN) :: comm                                  15
INTEGER, OPTIONAL, INTENT(OUT) :: ierror                            16

```

### Fortran binding

```

MPI_SCATTERV(SENDBUF, SENDCOUNTS, DISPLS, SENDTYPE, RECVBUF, REVCOUNT,  18
            RECVTYPE, ROOT, COMM, IERROR)                             19
<type> SENDBUF(*), RECVBUF(*)                                         20
INTEGER SENDCOUNTS(*), DISPLS(*), SENDTYPE, REVCOUNT, RECVTYPE, ROOT,  21
            COMM, IERROR                                               22

```

MPI\_SCATTERV is the inverse operation to MPI\_GATHERV.

MPI\_SCATTERV extends the functionality of MPI\_SCATTER by allowing a varying count of data to be sent to each process, since `sendcounts` is now an array. It also allows more flexibility as to where the data is taken from on the root, by providing an additional argument, `displs`.

If `comm` is an intra-communicator, the outcome is as if the root executed `n` send operations,

```
MPI_Send(sendbuf+displs[i].extent(sendtype), sendcounts[i], sendtype, i,...),
```

and each process executed a receive,

```
MPI_Recv(recvbuf, recvcount, recvtype, i,...).
```

The send buffer is ignored for all non-root processes.

The type signature implied by `sendcount[i]`, `sendtype` at the root must be equal to the type signature implied by `recvcount`, `recvtype` at process `i` (however, the type maps may be different). This implies that the amount of data sent must be equal to the amount of data received, pairwise between each process and the root. Distinct type maps between sender and receiver are still allowed.

All arguments to the function are significant on process `root`, while on other processes, only arguments `recvbuf`, `recvcount`, `recvtype`, `root`, and `comm` are significant. The arguments `root` and `comm` must have identical values on all processes.

The specification of counts, types, and displacements should not cause any location on the root to be read more than once.

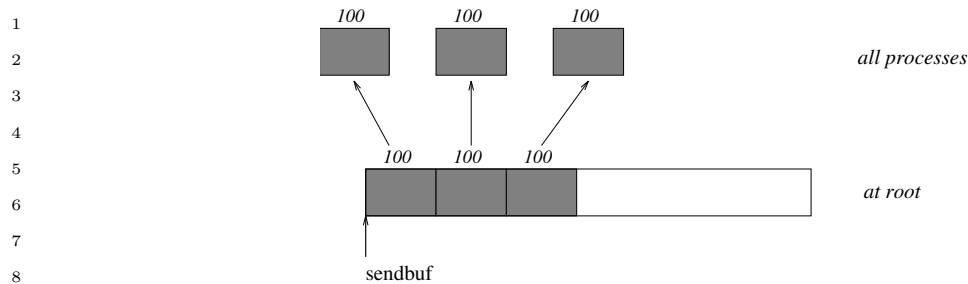

Figure 6.9: The root process scatters sets of 100 ints to each process in the group.

The “in place” option for intra-communicators is specified by passing `MPI_IN_PLACE` as the value of `recvbuf` at the root. In such a case, `recvcount` and `recvtype` are ignored, and root “sends” no data to itself. The scattered vector is still assumed to contain  $n$  segments, where  $n$  is the group size; the *root*-th segment, which root should “send to itself,” is not moved.

If `comm` is an inter-communicator, then the call involves all processes in the inter-communicator, but with one group (group A) defining the root process. All processes in the other group (group B) pass the same value in argument `root`, which is the rank of the root in group A. The root passes the value `MPI_ROOT` in `root`. All other processes in group A pass the value `MPI_PROC_NULL` in `root`. Data is scattered from the root to all processes in group B. The receive buffer arguments of the processes in group B must be consistent with the send buffer argument of the root.

### 6.6.1 Examples using `MPI_SCATTER`, `MPI_SCATTERV`

The examples in this section use intra-communicators.

**Example 6.11** The reverse of Example 6.2. Scatter sets of 100 ints from the root to each process in the group. See Figure 6.9.

```

31 MPI_Comm comm;
32 int gsize,*sendbuf;
33 int root, rbuf[100];
34 ...
35 MPI_Comm_size(comm, &gsize);
36 sendbuf = (int *)malloc(gsize*100*sizeof(int));
37 ...
38 MPI_Scatter(sendbuf, 100, MPI_INT, rbuf, 100, MPI_INT, root, comm);
39

```

**Example 6.12** The reverse of Example 6.5. The root process scatters sets of 100 ints to the other processes, but the sets of 100 are *stride ints* apart in the sending buffer. Requires use of `MPI_SCATTERV`. Assume  $stride \geq 100$ . See Figure 6.10.

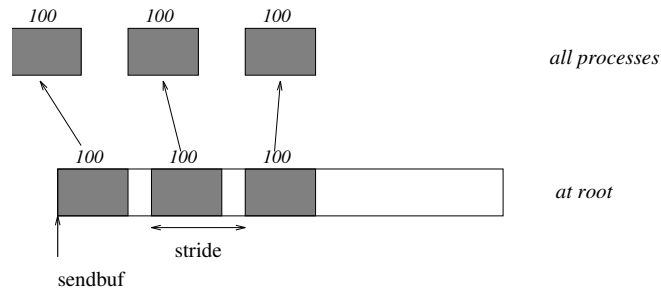

Figure 6.10: The root process scatters sets of 100 ints, moving by `stride` ints from send to send in the scatter.

```

MPI_Comm comm;
int gsize,*sendbuf;
int root, rbuf[100], i, *displs, *scounts;

...

MPI_Comm_size(comm, &gsize);
sendbuf = (int *)malloc(gsize*stride*sizeof(int));
...
displs = (int *)malloc(gsize*sizeof(int));
scount = (int *)malloc(gsize*sizeof(int));
for (i=0; i<gsize; ++i) {
    displs[i] = i*stride;
    scounts[i] = 100;
}
MPI_Scatterv(sendbuf, scounts, displs, MPI_INT, rbuf, 100, MPI_INT,
            root, comm);

```

**Example 6.13** The reverse of Example 6.9. We have a varying stride between blocks at sending (root) side, at the receiving side we receive into the  $i$ -th column of a  $100 \times 150$  C array. See Figure 6.11.

```

MPI_Comm comm;
int gsize,recvarray[100][150],*rptr;
int root, *sendbuf, myrank, *stride;
MPI_Datatype rtype;
int i, *displs, *scounts, offset;

...
MPI_Comm_size(comm, &gsize);
MPI_Comm_rank(comm, &myrank);

stride = (int *)malloc(gsize*sizeof(int));
...
/* stride[i] for i = 0 to gsize-1 is set somehow
 * sendbuf comes from elsewhere
 */

```

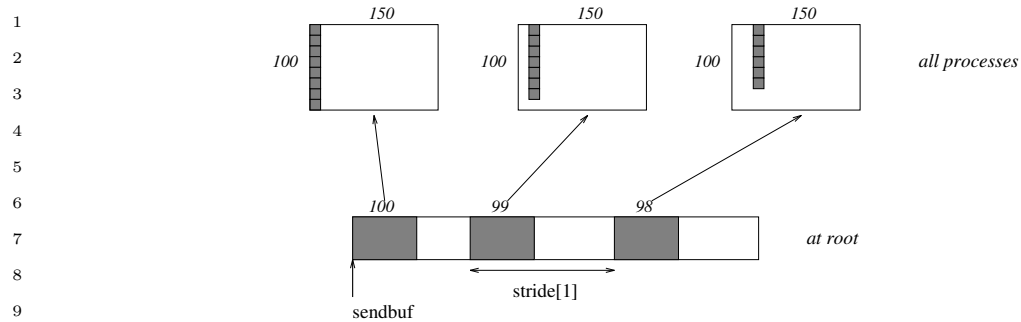

Figure 6.11: The root scatters blocks of  $100-i$  ints into column  $i$  of a  $100 \times 150$  C array. At the sending side, the blocks are  $\text{stride}[i]$  ints apart.

```

14  ...
15  displs = (int *)malloc(gsize*sizeof(int));
16  counts = (int *)malloc(gsize*sizeof(int));
17  offset = 0;
18  for (i=0; i<gsize; ++i) {
19      displs[i] = offset;
20      offset += stride[i];
21      counts[i] = 100 - i;
22  }
23  /* Create datatype for the column we are receiving
24   */
25  MPI_Type_vector(100-myrank, 1, 150, MPI_INT, &rtype);
26  MPI_Type_commit(&rtype);
27  rptr = &recvarray[0][myrank];
28  MPI_Scatterv(sendbuf, counts, displs, MPI_INT, rptr, 1, rtype,
29              root, comm);

```



## 6.7 Gather-to-all

MPI\_ALLGATHER(sendbuf, sendcount, sendtype, recvbuf, recvcount, recvtype, comm)

IN	sendbuf	starting address of send buffer (choice)
IN	sendcount	number of elements in send buffer (non-negative integer)
IN	sendtype	datatype of send buffer elements (handle)
OUT	recvbuf	address of receive buffer (choice)
IN	recvcount	number of elements received from any process (non-negative integer)
IN	recvtype	datatype of receive buffer elements (handle)
IN	comm	communicator (handle)

**C binding**

```
int MPI_Allgather(const void *sendbuf, int sendcount,
                 MPI_Datatype sendtype, void *recvbuf, int recvcount,
                 MPI_Datatype recvtype, MPI_Comm comm)
```

```
int MPI_Allgather_c(const void *sendbuf, MPI_Count sendcount,
                   MPI_Datatype sendtype, void *recvbuf, MPI_Count recvcount,
                   MPI_Datatype recvtype, MPI_Comm comm)
```

**Fortran 2008 binding**

```
MPI_Allgather(sendbuf, sendcount, sendtype, recvbuf, recvcount, recvtype,
              comm, ierror)
    TYPE(*), DIMENSION(..), INTENT(IN) :: sendbuf
    INTEGER, INTENT(IN) :: sendcount, recvcount
    TYPE(MPI_Datatype), INTENT(IN) :: sendtype, recvtype
    TYPE(*), DIMENSION(..) :: recvbuf
    TYPE(MPI_Comm), INTENT(IN) :: comm
    INTEGER, OPTIONAL, INTENT(OUT) :: ierror
```

```
MPI_Allgather(sendbuf, sendcount, sendtype, recvbuf, recvcount, recvtype,
              comm, ierror)
    TYPE(*), DIMENSION(..), INTENT(IN) :: sendbuf
    INTEGER(KIND=MPI_COUNT_KIND), INTENT(IN) :: sendcount, recvcount
    TYPE(MPI_Datatype), INTENT(IN) :: sendtype, recvtype
    TYPE(*), DIMENSION(..) :: recvbuf
    TYPE(MPI_Comm), INTENT(IN) :: comm
    INTEGER, OPTIONAL, INTENT(OUT) :: ierror
```

**Fortran binding**

```
MPI_ALLGATHER(SENDBUF, SENDCOUNT, SENDTYPE, RECVBUF, RECVCOUNT, RECVTYPE,
              COMM, IERROR)
    <type> SENDBUF(*), RECVBUF(*)
    INTEGER SENDCOUNT, SENDTYPE, RECVCOUNT, RECVTYPE, COMM, IERROR
```

1 MPI\_ALLGATHER can be thought of as MPI\_GATHER, but where all processes receive  
2 the result, instead of just the root. The block of data sent from the  $j$ -th process is received  
3 by every process and placed in the  $j$ -th block of the buffer `recvbuf`.

4 The type signature associated with `sendcount`, `sendtype`, at a process must be equal to  
5 the type signature associated with `recvcount`, `recvtype` at any other process.

6 If `comm` is an intra-communicator, the outcome of a call to `MPI_ALLGATHER(...)` is  
7 as if all processes executed  $n$  calls to

```
8  
9 MPI_Gather(sendbuf, sendcount, sendtype, recvbuf, recvcount,  
10                                     recvtype, root, comm)
```

11 for `root = 0, ..., n-1`. The rules for correct usage of `MPI_ALLGATHER` are easily found  
12 from the corresponding rules for `MPI_GATHER`.

13 The “in place” option for intra-communicators is specified by passing the value  
14 `MPI_IN_PLACE` to the argument `sendbuf` at all processes. `sendcount` and `sendtype` are ignored.  
15 Then the input data of each process is assumed to be in the area where that process would  
16 receive its own contribution to the receive buffer.

17 If `comm` is an inter-communicator, then each process of one group (group A) contributes  
18 `sendcount` data items; these data are concatenated and the result is stored at each process  
19 in the other group (group B). Conversely the concatenation of the contributions of the  
20 processes in group B is stored at each process in group A. The send buffer arguments in  
21 group A must be consistent with the receive buffer arguments in group B, and vice versa.  
22

23 *Advice to users.* The communication pattern of `MPI_ALLGATHER` executed on an  
24 intercommunication domain need not be symmetric. The number of items sent by  
25 processes in group A (as specified by the arguments `sendcount`, `sendtype` in group A  
26 and the arguments `recvcount`, `recvtype` in group B), need not equal the number of  
27 items sent by processes in group B (as specified by the arguments `sendcount`, `sendtype`  
28 in group B and the arguments `recvcount`, `recvtype` in group A). In particular, one can  
29 move data in only one direction by specifying `sendcount = 0` for the communication  
30 in the reverse direction. (*End of advice to users.*)  
31  
32  
33  
34  
35  
36  
37  
38  
39  
40  
41  
42  
43  
44  
45  
46  
47  
48

MPI_ALLGATHERV(sendbuf, sendcount, sendtype, recvbuf, recvcnts, displs, recvtype,		1	
comm)		2	
IN	sendbuf	starting address of send buffer (choice)	3
IN	sendcount	number of elements in send buffer (non-negative integer)	4
IN	sendtype	datatype of send buffer elements (handle)	5
OUT	recvbuf	address of receive buffer (choice)	6
IN	recvcnts	non-negative integer array (of length group size) containing the number of elements that are received from each process	7
IN	displs	integer array (of length group size). Entry i specifies the displacement (relative to recvbuf) at which to place the incoming data from process i	8
IN	recvtype	datatype of receive buffer elements (handle)	9
IN	comm	communicator (handle)	10

**C binding**

```

int MPI_Allgatherv(const void *sendbuf, int sendcount,
                  MPI_Datatype sendtype, void *recvbuf, const int recvcnts[],
                  const int displs[], MPI_Datatype recvtype, MPI_Comm comm)
int MPI_Allgatherv_c(const void *sendbuf, MPI_Count sendcount,
                    MPI_Datatype sendtype, void *recvbuf,
                    const MPI_Count recvcnts[], const MPI_Aint displs[],
                    MPI_Datatype recvtype, MPI_Comm comm)

```

**Fortran 2008 binding**

```

MPI_Allgatherv(sendbuf, sendcount, sendtype, recvbuf, recvcnts, displs,
              recvtype, comm, ierror)
TYPE(*), DIMENSION(..), INTENT(IN) :: sendbuf
INTEGER, INTENT(IN) :: sendcount, recvcnts(*), displs(*)
TYPE(MPI_Datatype), INTENT(IN) :: sendtype, recvtype
TYPE(*), DIMENSION(..) :: recvbuf
TYPE(MPI_Comm), INTENT(IN) :: comm
INTEGER, OPTIONAL, INTENT(OUT) :: ierror
MPI_Allgatherv(sendbuf, sendcount, sendtype, recvbuf, recvcnts, displs,
              recvtype, comm, ierror)
TYPE(*), DIMENSION(..), INTENT(IN) :: sendbuf
INTEGER(KIND=MPI_COUNT_KIND), INTENT(IN) :: sendcount, recvcnts(*)
TYPE(MPI_Datatype), INTENT(IN) :: sendtype, recvtype
TYPE(*), DIMENSION(..) :: recvbuf
INTEGER(KIND=MPI_ADDRESS_KIND), INTENT(IN) :: displs(*)
TYPE(MPI_Comm), INTENT(IN) :: comm
INTEGER, OPTIONAL, INTENT(OUT) :: ierror

```

## 1 Fortran binding

```

2 MPI_ALLGATHERV(SENDBUF, SENDCOUNT, SENDTYPE, RECVBUF, RECVCOUNTS, DISPLS,
3               RECVTYPE, COMM, IERROR)
4   <type> SENDBUF(*), RECVBUF(*)
5   INTEGER SENDCOUNT, SENDTYPE, RECVCOUNTS(*), DISPLS(*), RECVTYPE, COMM,
6               IERROR

```

7  
8 MPI\_ALLGATHERV can be thought of as MPI\_GATHERV, but where all processes re-  
9 ceive the result, instead of just the root. The block of data sent from the j-th process is  
10 received by every process and placed in the j-th block of the buffer `recvbuf`. These blocks  
11 need not all be the same size.

12 The type signature associated with `sendcount`, `sendtype`, at process `j` must be equal to  
13 the type signature associated with `recvcounts[j]`, `recvtype` at any other process.

14 If `comm` is an intra-communicator, the outcome is as if all processes executed calls to

```

15 MPI_Gatherv(sendbuf, sendcount, sendtype, recvbuf, recvcounts, displs,
16             recvtype, root, comm),
17

```

18 for `root = 0, ..., n-1`. The rules for correct usage of MPI\_ALLGATHERV are easily  
19 found from the corresponding rules for MPI\_GATHERV.

20 The “in place” option for intra-communicators is specified by passing the value  
21 MPI\_IN\_PLACE to the argument `sendbuf` at all processes. In such a case, `sendcount` and  
22 `sendtype` are ignored, and the input data of each process is assumed to be in the area where  
23 that process would receive its own contribution to the receive buffer.

24 If `comm` is an inter-communicator, then each process of one group (group A) contributes  
25 `sendcount` data items; these data are concatenated and the result is stored at each process  
26 in the other group (group B). Conversely the concatenation of the contributions of the  
27 processes in group B is stored at each process in group A. The send buffer arguments in  
28 group A must be consistent with the receive buffer arguments in group B, and vice versa.

### 30 6.7.1 Example using MPI\_ALLGATHER

31 The example in this section uses intra-communicators.

32  
33 **Example 6.14** The all-gather version of Example 6.2. Using MPI\_ALLGATHER, we will  
34 gather 100 ints from every process in the group to every process.

```

35
36 MPI_Comm comm;
37 int gsize, sendarray[100];
38 int *rbuf;
39 ...
40 MPI_Comm_size(comm, &gsize);
41 rbuf = (int *)malloc(gsize*100*sizeof(int));
42 MPI_Allgather(sendarray, 100, MPI_INT, rbuf, 100, MPI_INT, comm);
43

```

44 After the call, every process has the group-wide concatenation of the sets of data.

## 6.8 All-to-All Scatter/Gather

MPI\_ALLTOALL(sendbuf, sendcount, sendtype, recvbuf, recvcount, recvtype, comm)

IN	sendbuf	starting address of send buffer (choice)
IN	sendcount	number of elements sent to each process (non-negative integer)
IN	sendtype	datatype of send buffer elements (handle)
OUT	recvbuf	address of receive buffer (choice)
IN	recvcount	number of elements received from any process (non-negative integer)
IN	recvtype	datatype of receive buffer elements (handle)
IN	comm	communicator (handle)

**C binding**

```
int MPI_Alltoall(const void *sendbuf, int sendcount, MPI_Datatype sendtype,
                void *recvbuf, int recvcount, MPI_Datatype recvtype,
                MPI_Comm comm)
```

```
int MPI_Alltoall_c(const void *sendbuf, MPI_Count sendcount,
                  MPI_Datatype sendtype, void *recvbuf, MPI_Count recvcount,
                  MPI_Datatype recvtype, MPI_Comm comm)
```

**Fortran 2008 binding**

```
MPI_Alltoall(sendbuf, sendcount, sendtype, recvbuf, recvcount, recvtype,
             comm, ierror)
```

```
TYPE(*), DIMENSION(..), INTENT(IN) :: sendbuf
INTEGER, INTENT(IN) :: sendcount, recvcount
TYPE(MPI_Datatype), INTENT(IN) :: sendtype, recvtype
TYPE(*), DIMENSION(..) :: recvbuf
TYPE(MPI_Comm), INTENT(IN) :: comm
INTEGER, OPTIONAL, INTENT(OUT) :: ierror
```

```
MPI_Alltoall(sendbuf, sendcount, sendtype, recvbuf, recvcount, recvtype,
             comm, ierror)
```

```
TYPE(*), DIMENSION(..), INTENT(IN) :: sendbuf
INTEGER(KIND=MPI_COUNT_KIND), INTENT(IN) :: sendcount, recvcount
TYPE(MPI_Datatype), INTENT(IN) :: sendtype, recvtype
TYPE(*), DIMENSION(..) :: recvbuf
TYPE(MPI_Comm), INTENT(IN) :: comm
INTEGER, OPTIONAL, INTENT(OUT) :: ierror
```

**Fortran binding**

```
MPI_ALLTOALL(SENDBUF, SENDCOUNT, SENDTYPE, RECVBUF, RECVCOUNT, RECVTYPE,
             COMM, IERROR)
```

```
<type> SENDBUF(*), RECVBUF(*)
INTEGER SENDCOUNT, SENDTYPE, RECVCOUNT, RECVTYPE, COMM, IERROR
```

1 MPI\_ALLTOALL is an extension of MPI\_ALLGATHER to the case where each process  
2 sends distinct data to each of the receivers. The  $j$ -th block sent from process  $i$  is received  
3 by process  $j$  and is placed in the  $i$ -th block of `recvbuf`.

4 The type signature associated with `sendcount`, `sendtype`, at a process must be equal to  
5 the type signature associated with `recvcount`, `recvtype` at any other process. This implies  
6 that the amount of data sent must be equal to the amount of data received, pairwise between  
7 every pair of processes. As usual, however, the type maps may be different.

8 If `comm` is an intra-communicator, the outcome is as if each process executed a send  
9 to each process (itself included) with a call to,

10  
11 `MPI_Send(sendbuf+i·sendcount·extent(sendtype),sendcount,sendtype,i, ...)`,

12  
13 and a receive from every other process with a call to,

14  
15 `MPI_Recv(recvbuf+i·recvcount·extent(recvtype),recvcount,recvtype,i,...)`.

16 All arguments on all processes are significant. The argument `comm` must have identical  
17 values on all processes.

18 The “in place” option for intra-communicators is specified by passing `MPI_IN_PLACE` to  
19 the argument `sendbuf` at *all* processes. In such a case, `sendcount` and `sendtype` are ignored.  
20 The data to be sent is taken from the `recvbuf` and replaced by the received data. Data sent  
21 and received must have the same type map as specified by `recvcount` and `recvtype`.

22  
23 *Rationale.* For large MPI\_ALLTOALL instances, allocating both send and receive  
24 buffers may consume too much memory. The “in place” option effectively halves the  
25 application memory consumption and is useful in situations where the data to be sent  
26 will not be used by the sending process after the MPI\_ALLTOALL exchange (e.g., in  
27 parallel Fast Fourier Transforms). (*End of rationale.*)

28  
29 *Advice to implementors.* Users may opt to use the “in place” option in order to  
30 conserve memory. Quality MPI implementations should thus strive to minimize system  
31 buffering. (*End of advice to implementors.*)

32  
33 If `comm` is an inter-communicator, then the outcome is as if each process in group A  
34 sends a message to each process in group B, and vice versa. The  $j$ -th send buffer of process  
35  $i$  in group A should be consistent with the  $i$ -th receive buffer of process  $j$  in group B, and  
36 vice versa.

37  
38 *Advice to users.* When a complete exchange is executed on an intercommunication  
39 domain, then the number of data items sent from processes in group A to processes  
40 in group B need not equal the number of items sent in the reverse direction. In  
41 particular, one can have unidirectional communication by specifying `sendcount = 0` in  
42 the reverse direction. (*End of advice to users.*)

	MPI_ALLTOALLV(sendbuf, sendcounts, sdispls, sendtype, recvbuf, recvcounts, rdispls, recvtype, comm)		1
			2
IN	sendbuf	starting address of send buffer (choice)	3
			4
IN	sendcounts	non-negative integer array (of length group size) specifying the number of elements to send to each rank	5
			6
			7
IN	sdispls	integer array (of length group size). Entry j specifies the displacement (relative to sendbuf) from which to take the outgoing data destined for process j	8
			9
			10
IN	sendtype	datatype of send buffer elements (handle)	11
OUT	recvbuf	address of receive buffer (choice)	12
			13
IN	recvcounts	non-negative integer array (of length group size) specifying the number of elements that can be received from each rank	14
			15
			16
IN	rdispls	integer array (of length group size). Entry i specifies the displacement (relative to recvbuf) at which to place the incoming data from process i	17
			18
			19
			20
IN	recvtype	datatype of receive buffer elements (handle)	21
IN	comm	communicator (handle)	22
			23

**C binding**

```

int MPI_Alltoallv(const void *sendbuf, const int sendcounts[],
                 const int sdispls[], MPI_Datatype sendtype, void *recvbuf,
                 const int recvcounts[], const int rdispls[],
                 MPI_Datatype recvtype, MPI_Comm comm)

```

```

int MPI_Alltoallv_c(const void *sendbuf, const MPI_Count sendcounts[],
                   const MPI_Aint sdispls[], MPI_Datatype sendtype,
                   void *recvbuf, const MPI_Count recvcounts[],
                   const MPI_Aint rdispls[], MPI_Datatype recvtype,
                   MPI_Comm comm)

```

**Fortran 2008 binding**

```

MPI_Alltoallv(sendbuf, sendcounts, sdispls, sendtype, recvbuf, recvcounts,
              rdispls, recvtype, comm, ierror)
  TYPE(*), DIMENSION(..), INTENT(IN) :: sendbuf
  INTEGER, INTENT(IN) :: sendcounts(*), sdispls(*), recvcounts(*),
    rdispls(*)
  TYPE(MPI_Datatype), INTENT(IN) :: sendtype, recvtype
  TYPE(*), DIMENSION(..) :: recvbuf
  TYPE(MPI_Comm), INTENT(IN) :: comm
  INTEGER, OPTIONAL, INTENT(OUT) :: ierror

MPI_Alltoallv(sendbuf, sendcounts, sdispls, sendtype, recvbuf, recvcounts,
              rdispls, recvtype, comm, ierror)
  TYPE(*), DIMENSION(..), INTENT(IN) :: sendbuf

```

```

1  INTEGER(KIND=MPI_COUNT_KIND), INTENT(IN) :: sendcounts(*),
2      recvcounts(*)
3  INTEGER(KIND=MPI_ADDRESS_KIND), INTENT(IN) :: sdispls(*), rdispls(*)
4  TYPE(MPI_Datatype), INTENT(IN) :: sendtype, recvtype
5  TYPE(*), DIMENSION(..) :: recvbuf
6  TYPE(MPI_Comm), INTENT(IN) :: comm
7  INTEGER, OPTIONAL, INTENT(OUT) :: ierror

```

### Fortran binding

```

9  MPI_ALLTOALLV(SENDBUF, SENDCOUNTS, SDISPLS, SENDTYPE, RECVBUF, RECVCOUNTS,
10     RDISPLS, RECVTYPE, COMM, IERROR)
11     <type> SENDBUF(*), RECVBUF(*)
12     INTEGER SENDCOUNTS(*), SDISPLS(*), SENDTYPE, RECVCOUNTS(*), RDISPLS(*),
13     RECVTYPE, COMM, IERROR

```

MPI\_ALLTOALLV adds flexibility to MPI\_ALLTOALL in that the location of data for the send is specified by `sdispls` and the location of the placement of the data on the receive side is specified by `rdispls`.

If `comm` is an intra-communicator, then the  $j$ -th block sent from process  $i$  is received by process  $j$  and is placed in the  $i$ -th block of `recvbuf`. These blocks need not all have the same size.

The type signature associated with `sendcounts[j]`, `sendtype` at process  $i$  must be equal to the type signature associated with `recvcounts[i]`, `recvtype` at process  $j$ . This implies that the amount of data sent must be equal to the amount of data received, pairwise between every pair of processes. Distinct type maps between sender and receiver are still allowed.

The outcome is as if each process sent a message to every other process with,

```
MPI_Send(sendbuf+sdispls[i]·extent(sendtype),sendcounts[i],sendtype,i,...),
```

and received a message from every other process with a call to

```
MPI_Recv(recvbuf+rdispls[i]·extent(recvtype),recvcounts[i],recvtype,i,...).
```

All arguments on all processes are significant. The argument `comm` must have identical values on all processes.

The “in place” option for intra-communicators is specified by passing `MPI_IN_PLACE` to the argument `sendbuf` at *all* processes. In such a case, `sendcounts`, `sdispls` and `sendtype` are ignored. The data to be sent is taken from the `recvbuf` and replaced by the received data. Data sent and received must have the same type map as specified by the `recvcounts` array and the `recvtype`, and is taken from the locations of the receive buffer specified by `rdispls`.

*Advice to users.* Specifying the “in place” option (which must be given on all processes) implies that the same amount and type of data is sent and received between any two processes in the group of the communicator. Different pairs of processes can exchange different amounts of data. Users must ensure that `recvcounts[j]` and `recvtype` on process  $i$  match `recvcounts[i]` and `recvtype` on process  $j$ . This symmetric exchange can be useful in applications where the data to be sent will not be used by the sending process after the MPI\_ALLTOALLV exchange. (*End of advice to users.*)



If `comm` is an inter-communicator, then the outcome is as if each process in group A sends a message to each process in group B, and vice versa. The  $j$ -th send buffer of process  $i$  in group A should be consistent with the  $i$ -th receive buffer of process  $j$  in group B, and vice versa.

*Rationale.* The definitions of `MPI_ALLTOALL` and `MPI_ALLTOALLV` give as much flexibility as one would achieve by specifying  $n$  independent, point-to-point communications, with two exceptions: all messages use the same datatype, and messages are scattered from (or gathered to) sequential storage. (*End of rationale.*)

*Advice to implementors.* Although the discussion of collective communication in terms of point-to-point operation implies that each message is transferred directly from sender to receiver, implementations may use a tree communication pattern. Messages can be forwarded by intermediate nodes where they are split (for scatter) or concatenated (for gather), if this is more efficient. (*End of advice to implementors.*)

`MPI_ALLTOALLW(sendbuf, sendcounts, sdispls, sendtypes, recvbuf, recvcoun-  
ts, rdispls, recvtypes, comm)`

IN	<code>sendbuf</code>	starting address of send buffer (choice)
IN	<code>sendcounts</code>	non-negative integer array (of length group size) specifying the number of elements to send to each rank
IN	<code>sdispls</code>	integer array (of length group size). Entry $j$ specifies the displacement in bytes (relative to <code>sendbuf</code> ) from which to take the outgoing data destined for process $j$ (array of integers)
IN	<code>sendtypes</code>	array of datatypes (of length group size). Entry $j$ specifies the type of data to send to process $j$ (array of handles)
OUT	<code>recvbuf</code>	address of receive buffer (choice)
IN	<code>recvcoun- ts</code>	non-negative integer array (of length group size) specifying the number of elements that can be received from each rank
IN	<code>rdispls</code>	integer array (of length group size). Entry $i$ specifies the displacement in bytes (relative to <code>recvbuf</code> ) at which to place the incoming data from process $i$ (array of integers)
IN	<code>recvtypes</code>	array of datatypes (of length group size). Entry $i$ specifies the type of data received from process $i$ (array of handles)
IN	<code>comm</code>	communicator (handle)

### C binding

```
int MPI_Alltoallw(const void *sendbuf, const int sendcounts[],
                 const int sdispls[], const MPI_Datatype sendtypes[],
```

```

1         void *recvbuf, const int recvcnts[], const int rdispls[],
2         const MPI_Datatype recvtypes[], MPI_Comm comm)
3
4     int MPI_Alltoallw_c(const void *sendbuf, const MPI_Count sendcounts[],
5         const MPI_Aint sdispls[], const MPI_Datatype sendtypes[],
6         void *recvbuf, const MPI_Count recvcnts[],
7         const MPI_Aint rdispls[], const MPI_Datatype recvtypes[],
8         MPI_Comm comm)

```

### Fortran 2008 binding

```

9     MPI_Alltoallw(sendbuf, sendcounts, sdispls, sendtypes, recvbuf, recvcnts,
10        rdispls, recvtypes, comm, ierror)
11
12        TYPE(*), DIMENSION(..), INTENT(IN) :: sendbuf
13        INTEGER, INTENT(IN) :: sendcounts(*), sdispls(*), recvcnts(*),
14        rdispls(*)
15        TYPE(MPI_Datatype), INTENT(IN) :: sendtypes(*), recvtypes(*)
16        TYPE(*), DIMENSION(..) :: recvbuf
17        TYPE(MPI_Comm), INTENT(IN) :: comm
18        INTEGER, OPTIONAL, INTENT(OUT) :: ierror
19
20    MPI_Alltoallw(sendbuf, sendcounts, sdispls, sendtypes, recvbuf, recvcnts,
21        rdispls, recvtypes, comm, ierror)
22        TYPE(*), DIMENSION(..), INTENT(IN) :: sendbuf
23        INTEGER(KIND=MPI_COUNT_KIND), INTENT(IN) :: sendcounts(*),
24        recvcnts(*)
25        INTEGER(KIND=MPI_ADDRESS_KIND), INTENT(IN) :: sdispls(*), rdispls(*)
26        TYPE(MPI_Datatype), INTENT(IN) :: sendtypes(*), recvtypes(*)
27        TYPE(*), DIMENSION(..) :: recvbuf
28        TYPE(MPI_Comm), INTENT(IN) :: comm
29        INTEGER, OPTIONAL, INTENT(OUT) :: ierror

```

### Fortran binding

```

30    MPI_ALLTOALLW(SENDBUF, SENDCOUNTS, SDISPLS, SENDTYPES, RECVBUF, RECVCOUNTS,
31        RDISPLS, RECVTYPES, COMM, IERROR)
32
33        <type> SENDBUF(*), RECVBUF(*)
34        INTEGER SENDCOUNTS(*), SDISPLS(*), SENDTYPES(*), RECVCOUNTS(*),
35        RDISPLS(*), RECVTYPES(*), COMM, IERROR

```

MPI\_ALLTOALLW is the most general form of complete exchange. Like MPI\_TYPE\_CREATE\_STRUCT, the most general type constructor, MPI\_ALLTOALLW allows separate specification of count, displacement and datatype. In addition, to allow maximum flexibility, the displacement of blocks within the send and receive buffers is specified in bytes.

If *comm* is an intra-communicator, then the *j*-th block sent from process *i* is received by process *j* and is placed in the *i*-th block of *recvbuf*. These blocks need not all have the same size.

The type signature associated with *sendcounts*[*j*], *sendtypes*[*j*] at process *i* must be equal to the type signature associated with *recvcnts*[*i*], *recvtypes*[*i*] at process *j*. This implies that the amount of data sent must be equal to the amount of data received, pairwise between every pair of processes. Distinct type maps between sender and receiver are still allowed.

The outcome is as if each process sent a message to every other process with

```
MPI_Send(sendbuf+sdispls[i],sendcounts[i],sendtypes[i] ,i,...),
```

and received a message from every other process with a call to

```
MPI_Recv(recvbuf+rdispls[i],recvcounts[i],recvtypes[i] ,i,...).
```

All arguments on all processes are significant. The argument `comm` must describe the same communicator on all processes.

Like for `MPI_ALLTOALLV`, the “in place” option for intra-communicators is specified by passing `MPI_IN_PLACE` to the argument `sendbuf` at *all* processes. In such a case, `sendcounts`, `sdispls` and `sendtypes` are ignored. The data to be sent is taken from the `recvbuf` and replaced by the received data. Data sent and received must have the same type map as specified by the `recvcounts` and `recvtypes` arrays, and is taken from the locations of the receive buffer specified by `rdispls`.

If `comm` is an inter-communicator, then the outcome is as if each process in group A sends a message to each process in group B, and vice versa. The *j*-th send buffer of process *i* in group A should be consistent with the *i*-th receive buffer of process *j* in group B, and vice versa.

*Rationale.* The `MPI_ALLTOALLW` function generalizes several MPI functions by carefully selecting the input arguments. For example, by making all but one process have `sendcounts[i] = 0`, this achieves an `MPI_SCATTERW` function. (*End of rationale.*)

## 6.9 Global Reduction Operations

The functions in this section perform a global reduce operation (for example sum, maximum, and logical and) across all members of a group. The reduction operation can be either one of a predefined list of operations, or a user-defined operation. The global reduction functions come in several flavors: a reduce that returns the result of the reduction to one member of a group, an all-reduce that returns this result to all members of a group, and two scan (parallel prefix) operations. In addition, a reduce-scatter operation combines the functionality of a reduce and of a scatter operation.

## 6.9.1 Reduce

MPI\_REDUCE(sendbuf, recvbuf, count, datatype, op, root, comm)

IN	sendbuf	address of send buffer (choice)
OUT	recvbuf	address of receive buffer (choice, significant only at root)
IN	count	number of elements in send buffer (non-negative integer)
IN	datatype	datatype of elements of send buffer (handle)
IN	op	reduce operation (handle)
IN	root	rank of root process (integer)
IN	comm	communicator (handle)

**C binding**

```
int MPI_Reduce(const void *sendbuf, void *recvbuf, int count,
              MPI_Datatype datatype, MPI_Op op, int root, MPI_Comm comm)
```

```
int MPI_Reduce_c(const void *sendbuf, void *recvbuf, MPI_Count count,
                MPI_Datatype datatype, MPI_Op op, int root, MPI_Comm comm)
```

**Fortran 2008 binding**

```
MPI_Reduce(sendbuf, recvbuf, count, datatype, op, root, comm, ierror)
  TYPE(*), DIMENSION(..), INTENT(IN) :: sendbuf
  TYPE(*), DIMENSION(..) :: recvbuf
  INTEGER, INTENT(IN) :: count, root
  TYPE(MPI_Datatype), INTENT(IN) :: datatype
  TYPE(MPI_Op), INTENT(IN) :: op
  TYPE(MPI_Comm), INTENT(IN) :: comm
  INTEGER, OPTIONAL, INTENT(OUT) :: ierror
```

```
MPI_Reduce(sendbuf, recvbuf, count, datatype, op, root, comm, ierror)
  TYPE(*), DIMENSION(..), INTENT(IN) :: sendbuf
  TYPE(*), DIMENSION(..) :: recvbuf
  INTEGER(KIND=MPI_COUNT_KIND), INTENT(IN) :: count
  TYPE(MPI_Datatype), INTENT(IN) :: datatype
  TYPE(MPI_Op), INTENT(IN) :: op
  INTEGER, INTENT(IN) :: root
  TYPE(MPI_Comm), INTENT(IN) :: comm
  INTEGER, OPTIONAL, INTENT(OUT) :: ierror
```

**Fortran binding**

```
MPI_REDUCE(SENDBUF, RECVBUF, COUNT, DATATYPE, OP, ROOT, COMM, IERROR)
  <type> SENDBUF(*), RECVBUF(*)
  INTEGER COUNT, DATATYPE, OP, ROOT, COMM, IERROR
```

If `comm` is an intra-communicator, `MPI_REDUCE` combines the elements provided in the input buffer of each process in the group, using the operation `op`, and returns the combined value in the output buffer of the process with rank `root`. The input buffer is defined by the arguments `sendbuf`, `count` and `datatype`; the output buffer is defined by the arguments `recvbuf`, `count` and `datatype`; both have the same number of elements, with the same type. The routine is called by all group members using the same arguments for `count`, `datatype`, `op`, `root` and `comm`. Thus, all processes provide input buffers of the same length, with elements of the same type as the output buffer at the root. Each process can provide one element, or a sequence of elements, in which case the combine operation is executed element-wise on each entry of the sequence. For example, if the operation is `MPI_MAX` and the send buffer contains two elements that are floating point numbers (`count = 2` and `datatype = MPI_FLOAT`), then `recvbuf(1) = global max(sendbuf(1))` and `recvbuf(2) = global max(sendbuf(2))`.

Section 6.9.2, lists the set of predefined operations provided by MPI. That section also enumerates the datatypes to which each operation can be applied.

In addition, users may define their own operations that can be overloaded to operate on several datatypes, either basic or derived. This is further explained in Section 6.9.5.

The operation `op` is always assumed to be associative. All predefined operations are also assumed to be commutative. Users may define operations that are assumed to be associative, but not commutative. The “canonical” evaluation order of a reduction is determined by the ranks of the processes in the group. However, the implementation can take advantage of associativity, or associativity and commutativity in order to change the order of evaluation. This may change the result of the reduction for operations that are not strictly associative and commutative, such as floating point addition.

*Advice to implementors.* It is strongly recommended that `MPI_REDUCE` be implemented so that the same result be obtained whenever the function is applied on the same arguments, appearing in the same order. Note that this may prevent optimizations that take advantage of the physical location of ranks. (*End of advice to implementors.*)

*Advice to users.* Some applications may not be able to ignore the non-associative nature of floating-point operations or may use user-defined operations (see Section 6.9.5) that require a special reduction order and cannot be treated as associative. Such applications should enforce the order of evaluation explicitly. For example, in the case of operations that require a strict left-to-right (or right-to-left) evaluation order, this could be done by gathering all operands at a single process (e.g., with `MPI_GATHER`), applying the reduction operation in the desired order (e.g., with `MPI_REDUCE_LOCAL`), and if needed, broadcast or scatter the result to the other processes (e.g., with `MPI_BCAST`). (*End of advice to users.*)

The `datatype` argument of `MPI_REDUCE` must be compatible with `op`. Predefined operators work only with the MPI types listed in Section 6.9.2 and Section 6.9.4. Furthermore, the `datatype` and `op` given for predefined operators must be the same on all processes.

Note that it is possible for users to supply different user-defined operations to `MPI_REDUCE` in each process. MPI does not define which operations are used on which operands in this case. User-defined operators may operate on general, derived datatypes. In this case, each argument that the reduce operation is applied to is one element described

by such a datatype, which may contain several basic values. This is further explained in Section 6.9.5.

*Advice to users.* Users should make no assumptions about how MPI\_REDUCE is implemented. It is safest to ensure that the same function is passed to MPI\_REDUCE by each process. (*End of advice to users.*)

Overlapping datatypes are permitted in “send” buffers. Overlapping datatypes in “receive” buffers are erroneous and may give unpredictable results.

The “in place” option for intra-communicators is specified by passing the value MPI\_IN\_PLACE to the argument `sendbuf` at the root. In such a case, the input data is taken at the root from the receive buffer, where it will be replaced by the output data.

If `comm` is an inter-communicator, then the call involves all processes in the inter-communicator, but with one group (group A) defining the root process. All processes in the other group (group B) pass the same value in argument `root`, which is the rank of the root in group A. The root passes the value MPI\_ROOT in `root`. All other processes in group A pass the value MPI\_PROC\_NULL in `root`. Only send buffer arguments are significant in group B and only receive buffer arguments are significant at the root.

## 6.9.2 Predefined Reduction Operations

The following predefined operations are supplied for MPI\_REDUCE and related functions MPI\_ALLREDUCE, MPI\_REDUCE\_SCATTER\_BLOCK, MPI\_REDUCE\_SCATTER, MPI\_SCAN, MPI\_EXSCAN, all nonblocking variants of those (see Section 6.12), and MPI\_REDUCE\_LOCAL. These operations are invoked by placing the following in `op`.

Name	Meaning
MPI_MAX	maximum
MPI_MIN	minimum
MPI_SUM	sum
MPI_PROD	product
MPI_LAND	logical and
MPI_BAND	bit-wise and
MPI_LOR	logical or
MPI BOR	bit-wise or
MPI_LXOR	logical exclusive or (xor)
MPI_BXOR	bit-wise exclusive or (xor)
MPI_MAXLOC	max value and location
MPI_MINLOC	min value and location

The two operations MPI\_MINLOC and MPI\_MAXLOC are discussed separately in Section 6.9.4. For the other predefined operations, we enumerate below the allowed combinations of `op` and `datatype` arguments. First, define groups of MPI basic datatypes in the following way.

C integer: MPI\_INT, MPI\_LONG, MPI\_SHORT,  
MPI\_UNSIGNED\_SHORT, MPI\_UNSIGNED,

	MPI_UNSIGNED_LONG,	1
	MPI_LONG_LONG_INT,	2
	MPI_LONG_LONG (as synonym),	3
	MPI_UNSIGNED_LONG_LONG,	4
	MPI_SIGNED_CHAR,	5
	MPI_UNSIGNED_CHAR,	6
	MPI_INT8_T, MPI_INT16_T,	7
	MPI_INT32_T, MPI_INT64_T,	8
	MPI_UINT8_T, MPI_UINT16_T,	9
	MPI_UINT32_T, and MPI_UINT64_T	10
Fortran integer:	MPI_INTEGER	11
	and handles returned from	12
	MPI_TYPE_CREATE_F90_INTEGER	13
	and, if available, MPI_INTEGER1,	14
	MPI_INTEGER2, MPI_INTEGER4,	15
	MPI_INTEGER8, and MPI_INTEGER16	16
Floating point:	MPI_FLOAT, MPI_DOUBLE, MPI_REAL,	17
	MPI_DOUBLE_PRECISION,	18
	MPI_LONG_DOUBLE,	19
	and handles returned from	20
	MPI_TYPE_CREATE_F90_REAL	21
	and, if available, MPI_REAL2,	22
	MPI_REAL4, MPI_REAL8, and MPI_REAL16	23
Logical:	MPI_LOGICAL, MPI_C_BOOL,	24
	and MPI_CXX_BOOL	25
Complex:	MPI_COMPLEX, MPI_C_COMPLEX,	26
	MPI_C_FLOAT_COMPLEX (as synonym),	27
	MPI_C_DOUBLE_COMPLEX,	28
	MPI_C_LONG_DOUBLE_COMPLEX,	29
	MPI_CXX_FLOAT_COMPLEX,	30
	MPI_CXX_DOUBLE_COMPLEX,	31
	MPI_CXX_LONG_DOUBLE_COMPLEX,	32
	and handles returned from	33
	MPI_TYPE_CREATE_F90_COMPLEX	34
	and, if available, MPI_DOUBLE_COMPLEX,	35
	MPI_COMPLEX4, MPI_COMPLEX8,	36
	MPI_COMPLEX16, and MPI_COMPLEX32	37
Byte:	MPI_BYTE	38
Multi-language types:	MPI_AINT, MPI_OFFSET, and MPI_COUNT	39

Now, the valid datatypes for each operation are specified below.

Op	Allowed Types	
MPI_MAX, MPI_MIN	C integer, Fortran integer, Floating point, Multi-language types	42 43 44 45
MPI_SUM, MPI_PROD	C integer, Fortran integer, Floating point, Complex, Multi-language types	46 47
MPI_LAND, MPI_LOR, MPI_LXOR	C integer, Logical	48

1 MPI\_BAND, MPI\_BOR, MPI\_BXOR C integer, Fortran integer, Byte, Multi-language types

2 These operations together with all listed datatypes are valid in all supported program-  
3 ming languages, see also Reduce Operations on page 838 in Section 19.3.6.

4 The following examples use intra-communicators.  
5

6 **Example 6.15** A routine that computes the dot product of two vectors that are distributed  
7 across a group of processes and returns the answer at node zero.  
8

```
9 SUBROUTINE PAR_BLAS1(m, a, b, c, comm)
10 REAL a(m), b(m) ! local slice of array
11 REAL c ! result (at node zero)
12 REAL sum
13 INTEGER m, comm, i, ierr
14
15 ! local sum
16 sum = 0.0
17 DO i = 1, m
18 sum = sum + a(i)*b(i)
19 END DO
20
21 ! global sum
22 CALL MPI_REDUCE(sum, c, 1, MPI_REAL, MPI_SUM, 0, comm, ierr)
23 RETURN
24 END
```

25  
26 **Example 6.16** A routine that computes the product of a vector and an array that are  
27 distributed across a group of processes and returns the answer at node zero.  
28

```
29 SUBROUTINE PAR_BLAS2(m, n, a, b, c, comm)
30 REAL a(m), b(m,n) ! local slice of array
31 REAL c(n) ! result
32 REAL sum(n)
33 INTEGER n, comm, i, j, ierr
34
35 ! local sum
36 DO j=1,n
37 sum(j) = 0.0
38 DO i=1,m
39 sum(j) = sum(j) + a(i)*b(i,j)
40 END DO
41 END DO
42
43 ! global sum
44 CALL MPI_REDUCE(sum, c, n, MPI_REAL, MPI_SUM, 0, comm, ierr)
45
46 ! return result at node zero (and garbage at the other nodes)
47 RETURN
48 END
```



### 6.9.3 Signed Characters and Reductions

The types `MPI_SIGNED_CHAR` and `MPI_UNSIGNED_CHAR` can be used in reduction operations. `MPI_CHAR`, `MPI_WCHAR`, and `MPI_CHARACTER` (which represent printable characters) cannot be used in reduction operations. In a heterogeneous environment, `MPI_CHAR`, `MPI_WCHAR`, and `MPI_CHARACTER` will be translated so as to preserve the printable character, whereas `MPI_SIGNED_CHAR` and `MPI_UNSIGNED_CHAR` will be translated so as to preserve the integer value.

*Advice to users.* The types `MPI_CHAR`, `MPI_WCHAR`, and `MPI_CHARACTER` are intended for characters, and so will be translated to preserve the printable representation, rather than the integer value, if sent between machines with different character codes. The types `MPI_SIGNED_CHAR` and `MPI_UNSIGNED_CHAR` should be used in C if the integer value should be preserved. (*End of advice to users.*)

### 6.9.4 MINLOC and MAXLOC

The operator `MPI_MINLOC` is used to compute a global minimum and also an index attached to the minimum value. `MPI_MAXLOC` similarly computes a global maximum and index. One application of these is to compute a global minimum (maximum) and the rank of the process containing this value.

The operation that defines `MPI_MAXLOC` is:

$$\begin{pmatrix} u \\ i \end{pmatrix} \circ \begin{pmatrix} v \\ j \end{pmatrix} = \begin{pmatrix} w \\ k \end{pmatrix}$$

where

$$w = \max(u, v)$$

and

$$k = \begin{cases} i & \text{if } u > v \\ \min(i, j) & \text{if } u = v \\ j & \text{if } u < v \end{cases}$$

`MPI_MINLOC` is defined similarly:

$$\begin{pmatrix} u \\ i \end{pmatrix} \circ \begin{pmatrix} v \\ j \end{pmatrix} = \begin{pmatrix} w \\ k \end{pmatrix}$$

where

$$w = \min(u, v)$$

and

$$k = \begin{cases} i & \text{if } u < v \\ \min(i, j) & \text{if } u = v \\ j & \text{if } u > v \end{cases}$$

Both operations are associative and commutative. Note that if `MPI_MAXLOC` is applied to reduce a sequence of pairs  $(u_0, 0), (u_1, 1), \dots, (u_{n-1}, n-1)$ , then the value returned is

1  $(u, r)$ , where  $u = \max_i u_i$  and  $r$  is the index of the first global maximum in the sequence.  
 2 Thus, if each process supplies a value and its rank within the group, then a reduce operation  
 3 with `op = MPI_MAXLOC` will return the maximum value and the rank of the first process with  
 4 that value. Similarly, `MPI_MINLOC` can be used to return a minimum and its index. More  
 5 generally, `MPI_MINLOC` computes a *lexicographic minimum*, where elements are ordered  
 6 according to the first component of each pair, and ties are resolved according to the second  
 7 component.

8 The reduce operation is defined to operate on arguments that consist of a pair: value  
 9 and index. For both Fortran and C, types are provided to describe the pair. The potentially  
 10 mixed-type nature of such arguments is a problem in Fortran. The problem is circumvented,  
 11 for Fortran, by having the MPI-provided type consist of a pair of the same type as value,  
 12 and coercing the index to this type also. In C, the MPI-provided pair type has distinct  
 13 types and the index is an `int`.

14 In order to use `MPI_MINLOC` and `MPI_MAXLOC` in a reduce operation, one must provide  
 15 a `datatype` argument that represents a pair (value and index). MPI provides nine such  
 16 predefined datatypes. The operations `MPI_MAXLOC` and `MPI_MINLOC` can be used with  
 17 each of the following datatypes.

18  
 19 Fortran:

20 Name	Description
21 <code>MPI_2REAL</code>	pair of REALs
22 <code>MPI_2DOUBLE_PRECISION</code>	pair of DOUBLE PRECISION variables
23 <code>MPI_2INTEGER</code>	pair of INTEGERS

24  
 25  
 26 C:

27 Name	Description
28 <code>MPI_FLOAT_INT</code>	float and int
29 <code>MPI_DOUBLE_INT</code>	double and int
30 <code>MPI_LONG_INT</code>	long and int
31 <code>MPI_2INT</code>	pair of int
32 <code>MPI_SHORT_INT</code>	short and int
33 <code>MPI_LONG_DOUBLE_INT</code>	long double and int

34 The datatype `MPI_2REAL` is *as if* defined by the following (see Section 5.1).  
 35

```
36 MPI_Type_contiguous(2, MPI_REAL, MPI_2REAL);
```

37  
 38 Similar statements apply for `MPI_2INTEGER`, `MPI_2DOUBLE_PRECISION`, and `MPI_2INT`.

39 The datatype `MPI_SHORT_INT` is *as if* defined by the following sequence of instructions.  
 40

```
41 struct mystruct {
42     short val;
43     int rank;
44 };
45 type[0] = MPI_SHORT;
46 type[1] = MPI_INT;
47 disp[0] = 0;
48 disp[1] = offsetof(struct mystruct, rank);
```

```

block[0] = 1;
block[1] = 1;
MPI_Type_create_struct(2, block, disp, type, MPI_SHORT_INT);

```

Similar statements apply for MPI\_FLOAT\_INT, MPI\_LONG\_INT and MPI\_DOUBLE\_INT.

The following examples use intra-communicators.

**Example 6.17** Each process has an array of 30 doubles, in C. For each of the 30 locations, compute the value and rank of the process containing the largest value.

```

...
/* each process has an array of 30 double: ain[30]
*/
double ain[30], aout[30];
int ind[30];
struct {
    double val;
    int rank;
} in[30], out[30];
int i, myrank, root;

MPI_Comm_rank(comm, &myrank);
for (i=0; i<30; ++i) {
    in[i].val = ain[i];
    in[i].rank = myrank;
}
MPI_Reduce(in, out, 30, MPI_DOUBLE_INT, MPI_MAXLOC, root, comm);
/* At this point, the answer resides on process root
*/
if (myrank == root) {
    /* read ranks out
    */
    for (i=0; i<30; ++i) {
        aout[i] = out[i].val;
        ind[i] = out[i].rank;
    }
}

```

**Example 6.18** Same example, in Fortran.

```

...
! each process has an array of 30 double: ain(30)

DOUBLE PRECISION ain(30), aout(30)
INTEGER ind(30)
DOUBLE PRECISION in(2,30), out(2,30)
INTEGER i, myrank, root, ierr

```

```

1 CALL MPI_COMM_RANK(comm, myrank, ierr)
2 DO i=1,30
3     in(1,i) = ain(i)
4     in(2,i) = myrank    ! myrank is coerced to a double
5 END DO
6
7 CALL MPI_REDUCE(in, out, 30, MPI_2DOUBLE_PRECISION, MPI_MAXLOC, root,&
8     comm, ierr)
9 ! At this point, the answer resides on process root
10
11 IF (myrank .EQ. root) THEN
12     ! read ranks out
13     DO i=1,30
14         aout(i) = out(1,i)
15         ind(i) = out(2,i) ! rank is coerced back to an integer
16     END DO
17 END IF
18
19

```

**Example 6.19** Each process has a non-empty array of values. Find the minimum global value, the rank of the process that holds it and its index on this process.

```

22 #define LEN 1000
23
24 float val[LEN];    /* local array of values */
25 int count;        /* local number of values */
26 int myrank, minrank, minindex;
27 float minval;
28
29 struct {
30     float value;
31     int index;
32 } in, out;
33
34 /* local minloc */
35 in.value = val[0];
36 in.index = 0;
37 for (i=1; i < count; i++)
38     if (in.value > val[i]) {
39         in.value = val[i];
40         in.index = i;
41     }
42
43 /* global minloc */
44 MPI_Comm_rank(comm, &myrank);
45 in.index = myrank*LEN + in.index;
46 MPI_Reduce(&in, &out, 1, MPI_FLOAT_INT, MPI_MINLOC, root, comm);
47 /* At this point, the answer resides on process root
48

```

```

    */
if (myrank == root) {
    /* read answer out
    */
    minval = out.value;
    minrank = out.index / LEN;
    minindex = out.index % LEN;
}

```

*Rationale.* The definition of MPI\_MINLOC and MPI\_MAXLOC given here has the advantage that it does not require any special-case handling of these two operations: they are handled like any other reduce operation. A programmer can provide his or her own definition of MPI\_MAXLOC and MPI\_MINLOC, if so desired. The disadvantage is that values and indices have to be first interleaved, and that indices and values have to be coerced to the same type, in Fortran. (*End of rationale.*)

### 6.9.5 User-Defined Reduction Operations

MPI\_OP\_CREATE(user\_fn, commute, op)

IN	user_fn	user defined function (function)
IN	commute	true if commutative; false otherwise.
OUT	op	operation (handle)

#### C binding

```
int MPI_Op_create(MPI_User_function *user_fn, int commute, MPI_Op *op)
```

```
int MPI_Op_create_c(MPI_User_function_c *user_fn, int commute, MPI_Op *op)
```

#### Fortran 2008 binding

```

MPI_Op_create(user_fn, commute, op, ierror)
  PROCEDURE(MPI_User_function), INTENT(IN) :: user_fn
  LOGICAL, INTENT(IN) :: commute
  TYPE(MPI_Op), INTENT(OUT) :: op
  INTEGER, OPTIONAL, INTENT(OUT) :: ierror

```

```

MPI_Op_create_c(user_fn, commute, op, ierror)
  PROCEDURE(MPI_User_function_c), INTENT(IN) :: user_fn
  LOGICAL, INTENT(IN) :: commute
  TYPE(MPI_Op), INTENT(OUT) :: op
  INTEGER, OPTIONAL, INTENT(OUT) :: ierror

```

#### Fortran binding

```

MPI_OP_CREATE(USER_FN, COMMUTE, OP, IERROR)
  EXTERNAL USER_FN
  LOGICAL COMMUTE
  INTEGER OP, IERROR

```

1 MPI\_OP\_CREATE binds a user-defined reduction operation to an  
 2 op handle that can subsequently be used in MPI\_REDUCE, MPI\_ALLREDUCE,  
 3 MPI\_REDUCE\_SCATTER\_BLOCK, MPI\_REDUCE\_SCATTER, MPI\_SCAN,  
 4 MPI\_EXSCAN, all nonblocking variants of those (see Section 6.12), and  
 5 MPI\_REDUCE\_LOCAL. The user-defined operation is assumed to be associative. If `commute`  
 6 `= true`, then the operation should be both commutative and associative. If `commute = false`,  
 7 then the order of operands is fixed and is defined to be in ascending, process rank order,  
 8 beginning with process zero. The order of evaluation can be changed, talking advantage of  
 9 the associativity of the operation. If `commute = true` then the order of evaluation can be  
 10 changed, taking advantage of commutativity and associativity.

11 The argument `user_fn` is the user-defined function, which must have the following four  
 12 arguments: `invec`, `inoutvec`, `len`, and `datatype`.

13 MPI\_USER\_FUNCTION also supports large count types in separate additional MPI  
 14 procedures in C (suffixed with the “\_c”) and interface polymorphism in Fortran when using  
 15 `USE mpi_f08`.

16 The ISO C prototypes for the functions are the following.

```
17 typedef void MPI_User_function(void *invec, void *inoutvec, int *len,
18                               MPI_Datatype *datatype);
19
20 typedef void MPI_User_function_c(void *invec, void *inoutvec,
21                                 MPI_Count *len, MPI_Datatype *datatype);
```

22 The Fortran declarations of the user-defined function `user_fn` appear below.

23 ABSTRACT INTERFACE

```
24 SUBROUTINE MPI_User_function(invec, inoutvec, len, datatype)
25   USE, INTRINSIC :: ISO_C_BINDING, ONLY : C_PTR
26   TYPE(C_PTR), VALUE :: invec, inoutvec
27   INTEGER :: len
28   TYPE(MPI_Datatype) :: datatype
```

29 ABSTRACT INTERFACE

```
30 SUBROUTINE MPI_User_function_c(invec, inoutvec, len, datatype)
31   USE, INTRINSIC :: ISO_C_BINDING, ONLY : C_PTR
32   TYPE(C_PTR), VALUE :: invec, inoutvec
33   INTEGER(KIND=MPI_COUNT_KIND) :: len
34   TYPE(MPI_Datatype) :: datatype
```

35 SUBROUTINE USER\_FUNCTION(INVEC, INOUTVEC, LEN, DATATYPE)

```
36   <type> INVEC(LEN), INOUTVEC(LEN)
37   INTEGER LEN, DATATYPE
```

38 The `datatype` argument is a handle to the datatype that was passed into the call to  
 39 MPI\_REDUCE. The user reduce function should be written such that the following holds:  
 40 Let `u[0], ..., u[len-1]` be the `len` elements in the communication buffer described by the  
 41 arguments `invec`, `len` and `datatype` when the function is invoked; let `v[0], ..., v[len-1]` be `len`  
 42 elements in the communication buffer described by the arguments `inoutvec`, `len` and `datatype`  
 43 when the function is invoked; let `w[0], ..., w[len-1]` be `len` elements in the communication  
 44 buffer described by the arguments `inoutvec`, `len` and `datatype` when the function returns;  
 45 then `w[i] = u[i] ◦ v[i]`, for `i=0, ..., len-1`, where `◦` is the reduce operation that the function  
 46 computes.  
 47  
 48

Informally, we can think of `invec` and `inoutvec` as arrays of `len` elements that `user_fn` is combining. The result of the reduction over-writes values in `inoutvec`, hence the name. Each invocation of the function results in the pointwise evaluation of the reduce operator on `len` elements: i.e., the function returns in `inoutvec[i]` the value `invec[i] o inoutvec[i]`, for `i=0, . . . , count-1`, where `o` is the combining operation computed by the function.

*Rationale.* The `len` argument allows `MPI_REDUCE` to avoid calling the function for each element in the input buffer. Rather, the system can choose to apply the function to chunks of input. In C, it is passed in as a reference for reasons of compatibility with Fortran.

By internally comparing the value of the `datatype` argument to known, global handles, it is possible to overload the use of a single user-defined function for several, different datatypes. (*End of rationale.*)

When calling any reduction or prefix scan MPI procedure with a user-defined MPI operator, the type of the `count` parameter in the call to the reduction or prefix scan MPI procedure does not need to be identical to the type of the `len` parameter in the user function associated with the user-defined MPI operator. If the `count` parameter has a type of `int` in C or `INTEGER` in Fortran and the `len` parameter has a type of `MPI_COUNT`, then MPI will perform the appropriate widening type conversion of the `len` parameter. If the `count` parameter has a type of `MPI_COUNT` and the `len` parameter has a type of `int` in C or `INTEGER` in Fortran, then MPI will perform the appropriate narrowing type conversion of the `len` parameter. If this narrowing conversion would result in truncation of the `len` value, then MPI will call the user function multiple times with a sequence of values for `len` that sum to the value of `count`.

*Advice to implementors.* If the number of data items cannot be represented in `len`, the implementation may need to invoke `user_fn` multiple times. (*End of advice to implementors.*)

General datatypes may be passed to the user function. However, use of datatypes that are not contiguous is likely to lead to inefficiencies.

No MPI communication function may be called inside the user function. `MPI_ABORT` may be called inside the function in case of an error.

*Advice to users.* Suppose one defines a library of user-defined reduce functions that are overloaded: the `datatype` argument is used to select the right execution path at each invocation, according to the types of the operands. The user-defined reduce function cannot “decode” the `datatype` argument that it is passed, and cannot identify, by itself, the correspondence between the datatype handles and the datatype they represent. This correspondence was established when the datatypes were created. Before the library is used, a library initialization preamble must be executed. This preamble code will define the datatypes that are used by the library, and store handles to these datatypes in global, static variables that are shared by the user code and the library code.

The Fortran version of `MPI_REDUCE` will invoke a user-defined reduce function using the Fortran calling conventions and will pass a Fortran-type datatype argument; the C version will use C calling convention and the C representation of a datatype handle.

1 Users who plan to mix languages should define their reduction functions accordingly.  
 2 (*End of advice to users.*)

3  
 4 *Advice to implementors.* We outline below a naive and inefficient implementation of  
 5 MPI\_REDUCE not supporting the “in place” option.

```

6     MPI_Comm_size(comm, &groupsize);
7     MPI_Comm_rank(comm, &rank);
8     if (rank > 0) {
9         MPI_Recv(tempbuf, count, datatype, rank-1,...);
10        User_reduce(tempbuf, sendbuf, count, datatype);
11    }
12    if (rank < groupsize-1) {
13        MPI_Send(sendbuf, count, datatype, rank+1, ...);
14    }
15    /* answer now resides in process groupsize-1 ... now send to root
16     */
17    if (rank == root) {
18        MPI_Irecv(recvbuf, count, datatype, groupsize-1,..., &req);
19    }
20    if (rank == groupsize-1) {
21        MPI_Send(sendbuf, count, datatype, root, ...);
22    }
23    if (rank == root) {
24        MPI_Wait(&req, &status);
25    }
26

```

27 The reduction computation proceeds, sequentially, from process 0 to process  
 28 `groupsize-1`. This order is chosen so as to respect the order of a possibly non-  
 29 commutative operator defined by the function `User_reduce()`. A more efficient im-  
 30 plementation is achieved by taking advantage of associativity and using a logarithmic  
 31 tree reduction. Commutativity can be used to advantage, for those cases in which  
 32 the `commute` argument to `MPI_OP_CREATE` is true. Also, the amount of temporary  
 33 buffer required can be reduced, and communication can be pipelined with computa-  
 34 tion, by transferring and reducing the elements in chunks of size `len < count`.  
 35

36 The predefined reduce operations can be implemented as a library of user-defined  
 37 operations. However, better performance might be achieved if MPI\_REDUCE handles  
 38 these functions as a special case. (*End of advice to implementors.*)

39  
 40 MPI\_OP\_FREE(op)

41     INOUT   op                             operation (handle)

#### 42 C binding

43  
 44 int MPI\_Op\_free(MPI\_Op \*op)

#### 45 Fortran 2008 binding

46  
 47 MPI\_Op\_free(op, ierror)



```

TYPE(MPI_Op), INTENT(INOUT) :: op
INTEGER, OPTIONAL, INTENT(OUT) :: ierror

```

**Fortran binding**

```

MPI_OP_FREE(OP, IERROR)
  INTEGER OP, IERROR

```

Marks a user-defined reduction operation for deallocation and sets `op` to `MPI_OP_NULL`.

**Example of User-Defined Reduce**

It is time for an example of user-defined reduction. The example in this section uses an intra-communicator.

**Example 6.20** Compute the product of an array of complex numbers, in C.

```

typedef struct {
    double real,imag;
} Complex;

/* the user-defined function
*/
void myProd(void *inP, void *inoutP, int *len, MPI_Datatype *dptr)
{
    int i;
    Complex c;
    Complex *in = (Complex *)inP, *inout = (Complex *)inoutP;

    for (i=0; i< *len; ++i) {
        c.real = inout->real*in->real -
                inout->imag*in->imag;
        c.imag = inout->real*in->imag +
                inout->imag*in->real;
        *inout = c;
        in++; inout++;
    }
}

/* and, to call it...
*/
...

/* each process has an array of 100 Complexes
*/
Complex a[100], answer[100];
MPI_Op myOp;
MPI_Datatype ctype;

/* explain to MPI how type Complex is defined
*/

```

```

1  MPI_Type_contiguous(2, MPI_DOUBLE, &ctype);
2  MPI_Type_commit(&ctype);
3  /* create the complex-product user-op
4   */
5  MPI_Op_create(myProd, 1, &myOp);
6
7  MPI_Reduce(a, answer, 100, ctype, myOp, root, comm);
8
9  /* At this point, the answer, which consists of 100 Complexes,
10   * resides on process root
11   */
12

```

**Example 6.21** How to use the `mpi_f08` interface of the Fortran `MPI_User_function`.

```

13
14 Example 6.21 How to use the mpi_f08 interface of the Fortran MPI_User_function.
15 subroutine my_user_function(invec, inoutvec, len, type)  bind(c)
16   use, intrinsic :: iso_c_binding, only : c_ptr, c_f_pointer
17   use mpi_f08
18   type(c_ptr), value :: invec, inoutvec
19   integer :: len
20   type(MPI_Datatype) :: type
21   real, pointer :: invec_r(:), inoutvec_r(:)
22   if (type%MPI_VAL == MPI_REAL%MPI_VAL) then
23     call c_f_pointer(invec, invec_r, (/ len /))
24     call c_f_pointer(inoutvec, inoutvec_r, (/ len /))
25     inoutvec_r = invec_r + inoutvec_r
26   end if
27 end subroutine
28

```

### 6.9.6 All-Reduce

MPI includes a variant of the reduce operations where the result is returned to all processes in a group. MPI requires that all processes from the same group participating in these operations receive identical results.

`MPI_ALLREDUCE(sendbuf, recvbuf, count, datatype, op, comm)`

IN	sendbuf	starting address of send buffer (choice)
OUT	recvbuf	starting address of receive buffer (choice)
IN	count	number of elements in send buffer (non-negative integer)
IN	datatype	datatype of elements of send buffer (handle)
IN	op	operation (handle)
IN	comm	communicator (handle)

#### C binding

```

46
47 int MPI_Allreduce(const void *sendbuf, void *recvbuf, int count,
48                 MPI_Datatype datatype, MPI_Op op, MPI_Comm comm)

```

```
int MPI_Allreduce_c(const void *sendbuf, void *recvbuf, MPI_Count count,
                   MPI_Datatype datatype, MPI_Op op, MPI_Comm comm)
```

**Fortran 2008 binding**

```
MPI_Allreduce(sendbuf, recvbuf, count, datatype, op, comm, ierror)
```

```
TYPE(*), DIMENSION(..), INTENT(IN) :: sendbuf
```

```
TYPE(*), DIMENSION(..) :: recvbuf
```

```
INTEGER, INTENT(IN) :: count
```

```
TYPE(MPI_Datatype), INTENT(IN) :: datatype
```

```
TYPE(MPI_Op), INTENT(IN) :: op
```

```
TYPE(MPI_Comm), INTENT(IN) :: comm
```

```
INTEGER, OPTIONAL, INTENT(OUT) :: ierror
```

```
MPI_Allreduce(sendbuf, recvbuf, count, datatype, op, comm, ierror)
```

```
TYPE(*), DIMENSION(..), INTENT(IN) :: sendbuf
```

```
TYPE(*), DIMENSION(..) :: recvbuf
```

```
INTEGER(KIND=MPI_COUNT_KIND), INTENT(IN) :: count
```

```
TYPE(MPI_Datatype), INTENT(IN) :: datatype
```

```
TYPE(MPI_Op), INTENT(IN) :: op
```

```
TYPE(MPI_Comm), INTENT(IN) :: comm
```

```
INTEGER, OPTIONAL, INTENT(OUT) :: ierror
```

**Fortran binding**

```
MPI_ALLREDUCE(SENDBUF, RECVBUF, COUNT, DATATYPE, OP, COMM, IERROR)
```

```
<type> SENDBUF(*), RECVBUF(*)
```

```
INTEGER COUNT, DATATYPE, OP, COMM, IERROR
```

If `comm` is an intra-communicator, `MPI_ALLREDUCE` behaves the same as `MPI_REDUCE` except that the result appears in the receive buffer of all the group members.

*Advice to implementors.* The all-reduce operations can be implemented as a reduce, followed by a broadcast. However, a direct implementation can lead to better performance. (*End of advice to implementors.*)

The “in place” option for intra-communicators is specified by passing the value `MPI_IN_PLACE` to the argument `sendbuf` at all processes. In this case, the input data is taken at each process from the receive buffer, where it will be replaced by the output data.

If `comm` is an inter-communicator, then the result of the reduction of the data provided by processes in group A is stored at each process in group B, and vice versa. Both groups should provide `count` and `datatype` arguments that specify the same type signature.

The following example uses an intra-communicator.

**Example 6.22** A routine that computes the product of a vector and an array that are distributed across a group of processes and returns the answer at all nodes (see also Example 6.16).

```

1  SUBROUTINE PAR_BLAS2(m, n, a, b, c, comm)
2  REAL a(m), b(m,n)    ! local slice of array
3  REAL c(n)           ! result
4  REAL sum(n)
5  INTEGER n, comm, i, j, ierr
6
7  ! local sum
8  DO j=1,n
9     sum(j) = 0.0
10    DO i=1,m
11       sum(j) = sum(j) + a(i)*b(i,j)
12    END DO
13 END DO
14
15 ! global sum
16 CALL MPI_ALLREDUCE(sum, c, n, MPI_REAL, MPI_SUM, comm, ierr)
17
18 ! return result at all nodes
19 RETURN
20 END

```

### 6.9.7 Process-Local Reduction

The functions in this section are of importance to library implementors who may want to implement special reduction patterns that are otherwise not easily covered by the standard MPI operations.

The following function applies a reduction operator to local arguments.

MPI\_REDUCE\_LOCAL(inbuf, inoutbuf, count, datatype, op)

IN	inbuf	input buffer (choice)
INOUT	inoutbuf	combined input and output buffer (choice)
IN	count	number of elements in inbuf and inoutbuf buffers (non-negative integer)
IN	datatype	datatype of elements of inbuf and inoutbuf buffers (handle)
IN	op	operation (handle)

#### C binding

```
int MPI_Reduce_local(const void *inbuf, void *inoutbuf, int count,
                    MPI_Datatype datatype, MPI_Op op)
```

```
int MPI_Reduce_local_c(const void *inbuf, void *inoutbuf, MPI_Count count,
                      MPI_Datatype datatype, MPI_Op op)
```

#### Fortran 2008 binding

```
MPI_Reduce_local(inbuf, inoutbuf, count, datatype, op, ierror)
```

```

TYPE(*), DIMENSION(..), INTENT(IN) :: inbuf           1
TYPE(*), DIMENSION(..) :: inoutbuf                   2
INTEGER, INTENT(IN) :: count                           3
TYPE(MPI_Datatype), INTENT(IN) :: datatype            4
TYPE(MPI_Op), INTENT(IN) :: op                         5
INTEGER, OPTIONAL, INTENT(OUT) :: ierror              6
                                                    7
MPI_Reduce_local(inbuf, inoutbuf, count, datatype, op, ierror)  8
TYPE(*), DIMENSION(..), INTENT(IN) :: inbuf           9
TYPE(*), DIMENSION(..) :: inoutbuf                   10
INTEGER(KIND=MPI_COUNT_KIND), INTENT(IN) :: count     11
TYPE(MPI_Datatype), INTENT(IN) :: datatype            12
TYPE(MPI_Op), INTENT(IN) :: op                         13
INTEGER, OPTIONAL, INTENT(OUT) :: ierror              14

```

**Fortran binding**

```

MPI_REDUCE_LOCAL(INBUF, INOUTBUF, COUNT, DATATYPE, OP, IERROR)  15
<type> INBUF(*), INOUTBUF(*)                                   16
INTEGER COUNT, DATATYPE, OP, IERROR                           17
                                                    18

```

The function applies the operation given by `op` element-wise to the elements of `inbuf` and `inoutbuf` with the result stored element-wise in `inoutbuf`, as explained for user-defined operations in Section 6.9.5. Both `inbuf` and `inoutbuf` (input as well as result) have the same number of elements given by `count` and the same datatype given by `datatype`. The `MPI_IN_PLACE` option is not allowed.

Reduction operations can be queried for their commutativity.

```

MPI_OP_COMMUTATIVE(op, commute)                               19
                                                    20
IN      op      operation (handle)                           21
OUT     commute  true if op is commutative, false otherwise (logical)  22
                                                    23

```

**C binding**

```

int MPI_Op_commutative(MPI_Op op, int *commute)             24

```

**Fortran 2008 binding**

```

MPI_Op_commutative(op, commute, ierror)                       25
TYPE(MPI_Op), INTENT(IN) :: op                               26
LOGICAL, INTENT(OUT) :: commute                              27
INTEGER, OPTIONAL, INTENT(OUT) :: ierror                     28

```

**Fortran binding**

```

MPI_OP_COMMUTATIVE(OP, COMMUTE, IERROR)                       29
INTEGER OP, IERROR                                           30
LOGICAL COMMUTE                                              31

```

## 6.10 Reduce-Scatter

MPI includes variants of the reduce operations where the result is scattered to all processes in a group on return. One variant scatters equal-sized blocks to all processes, while another variant scatters blocks that may vary in size for each process.

### 6.10.1 MPI\_REDUCE\_SCATTER\_BLOCK

`MPI_REDUCE_SCATTER_BLOCK(sendbuf, recvbuf, recvcount, datatype, op, comm)`

IN	sendbuf	starting address of send buffer (choice)
OUT	recvbuf	starting address of receive buffer (choice)
IN	recvcount	element count per block (non-negative integer)
IN	datatype	datatype of elements of send and receive buffers (handle)
IN	op	operation (handle)
IN	comm	communicator (handle)

#### C binding

```
int MPI_Reduce_scatter_block(const void *sendbuf, void *recvbuf,
    int recvcount, MPI_Datatype datatype, MPI_Op op,
    MPI_Comm comm)
```

```
int MPI_Reduce_scatter_block_c(const void *sendbuf, void *recvbuf,
    MPI_Count recvcount, MPI_Datatype datatype, MPI_Op op,
    MPI_Comm comm)
```

#### Fortran 2008 binding

```
MPI_Reduce_scatter_block(sendbuf, recvbuf, recvcount, datatype, op, comm,
    ierror)
```

```
TYPE(*), DIMENSION(..), INTENT(IN) :: sendbuf
```

```
TYPE(*), DIMENSION(..) :: recvbuf
```

```
INTEGER, INTENT(IN) :: recvcount
```

```
TYPE(MPI_Datatype), INTENT(IN) :: datatype
```

```
TYPE(MPI_Op), INTENT(IN) :: op
```

```
TYPE(MPI_Comm), INTENT(IN) :: comm
```

```
INTEGER, OPTIONAL, INTENT(OUT) :: ierror
```

```
MPI_Reduce_scatter_block(sendbuf, recvbuf, recvcount, datatype, op, comm,
    ierror)
```

```
TYPE(*), DIMENSION(..), INTENT(IN) :: sendbuf
```

```
TYPE(*), DIMENSION(..) :: recvbuf
```

```
INTEGER(KIND=MPI_COUNT_KIND), INTENT(IN) :: recvcount
```

```
TYPE(MPI_Datatype), INTENT(IN) :: datatype
```

```
TYPE(MPI_Op), INTENT(IN) :: op
```

```
TYPE(MPI_Comm), INTENT(IN) :: comm
```

```
INTEGER, OPTIONAL, INTENT(OUT) :: ierror
```

**Fortran binding**

```

MPI_REDUCE_SCATTER_BLOCK(SENDBUF, RECVBUF, RECVCOUNT, DATATYPE, OP, COMM,
    IERROR)
    <type> SENDBUF(*), RECVBUF(*)
    INTEGER RECVCOUNT, DATATYPE, OP, COMM, IERROR

```

If `comm` is an intra-communicator, `MPI_REDUCE_SCATTER_BLOCK` first performs a global, element-wise reduction on vectors of `count = n*recvcount` elements in the send buffers defined by `sendbuf`, `count` and `datatype`, using the operation `op`, where `n` is the number of processes in the group of `comm`. The routine is called by all group members using the same arguments for `recvcount`, `datatype`, `op` and `comm`. The resulting vector is treated as `n` consecutive blocks of `recvcount` elements that are scattered to the processes of the group. The `i`-th block is sent to process `i` and stored in the receive buffer defined by `recvbuf`, `recvcount`, and `datatype`.

*Advice to implementors.* The `MPI_REDUCE_SCATTER_BLOCK` routine is functionally equivalent to: an `MPI_REDUCE` collective operation with `count` equal to `recvcount*n`, followed by an `MPI_SCATTER` with `sendcount` equal to `recvcount`. However, a direct implementation may run faster. (*End of advice to implementors.*)

The “in place” option for intra-communicators is specified by passing `MPI_IN_PLACE` in the `sendbuf` argument on *all* processes. In this case, the input data is taken from the receive buffer.

If `comm` is an inter-communicator, then the result of the reduction of the data provided by processes in one group (group A) is scattered among processes in the other group (group B) and vice versa. Within each group, all processes provide the same value for the `recvcount` argument, and provide input vectors of `count = n*recvcount` elements stored in the send buffers, where `n` is the size of the group. The number of elements `count` must be the same for the two groups. The resulting vector from the other group is scattered in blocks of `recvcount` elements among the processes in the group.

*Rationale.* The last restriction is needed so that the length of the send buffer of one group can be determined by the local `recvcount` argument of the other group. Otherwise, a communication is needed to figure out how many elements are reduced. (*End of rationale.*)

**6.10.2 MPI\_REDUCE\_SCATTER**

`MPI_REDUCE_SCATTER` extends the functionality of `MPI_REDUCE_SCATTER_BLOCK` such that the scattered blocks can vary in size. Block sizes are determined by the `recvcounts` array, such that the `i`-th block contains `recvcounts[i]` elements.

```

1 MPI_REDUCE_SCATTER(sendbuf, recvbuf, recvcnts, datatype, op, comm)
2   IN      sendbuf          starting address of send buffer (choice)
3
4   OUT     recvbuf          starting address of receive buffer (choice)
5
6   IN      recvcnts         non-negative integer array (of length group size)
7                          specifying the number of elements of the result
8                          distributed to each process.
9
10  IN      datatype         datatype of elements of send and receive buffers
11                          (handle)
12
13  IN      op                operation (handle)
14
15  IN      comm              communicator (handle)

```

**C binding**

```

15 int MPI_Reduce_scatter(const void *sendbuf, void *recvbuf,
16                       const int recvcnts[], MPI_Datatype datatype, MPI_Op op,
17                       MPI_Comm comm)
18
19 int MPI_Reduce_scatter_c(const void *sendbuf, void *recvbuf,
20                          const MPI_Count recvcnts[], MPI_Datatype datatype,
21                          MPI_Op op, MPI_Comm comm)

```

**Fortran 2008 binding**

```

23 MPI_Reduce_scatter(sendbuf, recvbuf, recvcnts, datatype, op, comm,
24                   ierror)
25     TYPE(*), DIMENSION(..), INTENT(IN) :: sendbuf
26     TYPE(*), DIMENSION(..) :: recvbuf
27     INTEGER, INTENT(IN) :: recvcnts(*)
28     TYPE(MPI_Datatype), INTENT(IN) :: datatype
29     TYPE(MPI_Op), INTENT(IN) :: op
30     TYPE(MPI_Comm), INTENT(IN) :: comm
31     INTEGER, OPTIONAL, INTENT(OUT) :: ierror
32
33 MPI_Reduce_scatter(sendbuf, recvbuf, recvcnts, datatype, op, comm,
34                   ierror)
35     TYPE(*), DIMENSION(..), INTENT(IN) :: sendbuf
36     TYPE(*), DIMENSION(..) :: recvbuf
37     INTEGER(KIND=MPI_COUNT_KIND), INTENT(IN) :: recvcnts(*)
38     TYPE(MPI_Datatype), INTENT(IN) :: datatype
39     TYPE(MPI_Op), INTENT(IN) :: op
40     TYPE(MPI_Comm), INTENT(IN) :: comm
41     INTEGER, OPTIONAL, INTENT(OUT) :: ierror

```

**Fortran binding**

```

43 MPI_REDUCE_SCATTER(SENDBUF, RECVBUF, RECVCOUNTS, DATATYPE, OP, COMM,
44                   IERROR)
45     <type> SENDBUF(*), RECVBUF(*)
46     INTEGER REVCOUNTS(*), DATATYPE, OP, COMM, IERROR

```



If `comm` is an intra-communicator, `MPI_REDUCE_SCATTER` first performs a global, element-wise reduction on vectors of `count =  $\sum_{i=0}^{n-1} \text{recvcounts}[i]$`  elements in the send buffers defined by `sendbuf`, `count` and `datatype`, using the operation `op`, where `n` is the number of processes in the group of `comm`. The routine is called by all group members using the same arguments for `recvcounts`, `datatype`, `op` and `comm`. The resulting vector is treated as `n` consecutive blocks where the number of elements of the `i`-th block is `recvcounts[i]`. The blocks are scattered to the processes of the group. The `i`-th block is sent to process `i` and stored in the receive buffer defined by `recvbuf`, `recvcounts[i]` and `datatype`.

*Advice to implementors.* The `MPI_REDUCE_SCATTER` routine is functionally equivalent to: an `MPI_REDUCE` collective operation with `count` equal to the sum of `recvcounts[i]` followed by `MPI_SCATTERV` with `sendcounts` equal to `recvcounts`. However, a direct implementation may run faster. (*End of advice to implementors.*)

The “in place” option for intra-communicators is specified by passing `MPI_IN_PLACE` in the `sendbuf` argument. In this case, the input data is taken from the receive buffer. It is not required to specify the “in place” option on all processes, since the processes for which `recvcounts[i] == 0` may not have allocated a receive buffer.

If `comm` is an inter-communicator, then the result of the reduction of the data provided by processes in one group (group A) is scattered among processes in the other group (group B), and vice versa. Within each group, all processes provide the same `recvcounts` argument, and provide input vectors of `count =  $\sum_{i=0}^{n-1} \text{recvcounts}[i]$`  elements stored in the send buffers, where `n` is the size of the group. The resulting vector from the other group is scattered in blocks of `recvcounts[i]` elements among the processes in the group. The number of elements `count` must be the same for the two groups.

*Rationale.* The last restriction is needed so that the length of the send buffer can be determined by the sum of the local `recvcounts` entries. Otherwise, a communication is needed to figure out how many elements are reduced. (*End of rationale.*)

## 6.11 Scan

### 6.11.1 Inclusive Scan

`MPI_SCAN(sendbuf, recvbuf, count, datatype, op, comm)`

IN	<code>sendbuf</code>	starting address of send buffer (choice)
OUT	<code>recvbuf</code>	starting address of receive buffer (choice)
IN	<code>count</code>	number of elements in input buffer (non-negative integer)
IN	<code>datatype</code>	datatype of elements of input buffer (handle)
IN	<code>op</code>	operation (handle)
IN	<code>comm</code>	communicator (handle)

### C binding

```
int MPI_Scan(const void *sendbuf, void *recvbuf, int count,
            MPI_Datatype datatype, MPI_Op op, MPI_Comm comm)
```

```

1 int MPI_Scan_c(const void *sendbuf, void *recvbuf, MPI_Count count,
2               MPI_Datatype datatype, MPI_Op op, MPI_Comm comm)

```

### Fortran 2008 binding

```

4 MPI_Scan(sendbuf, recvbuf, count, datatype, op, comm, ierror)
5     TYPE(*), DIMENSION(..), INTENT(IN) :: sendbuf
6     TYPE(*), DIMENSION(..) :: recvbuf
7     INTEGER, INTENT(IN) :: count
8     TYPE(MPI_Datatype), INTENT(IN) :: datatype
9     TYPE(MPI_Op), INTENT(IN) :: op
10    TYPE(MPI_Comm), INTENT(IN) :: comm
11    INTEGER, OPTIONAL, INTENT(OUT) :: ierror
12
13 MPI_Scan(sendbuf, recvbuf, count, datatype, op, comm, ierror)
14    TYPE(*), DIMENSION(..), INTENT(IN) :: sendbuf
15    TYPE(*), DIMENSION(..) :: recvbuf
16    INTEGER(KIND=MPI_COUNT_KIND), INTENT(IN) :: count
17    TYPE(MPI_Datatype), INTENT(IN) :: datatype
18    TYPE(MPI_Op), INTENT(IN) :: op
19    TYPE(MPI_Comm), INTENT(IN) :: comm
20    INTEGER, OPTIONAL, INTENT(OUT) :: ierror

```

### Fortran binding

```

22 MPI_SCAN(SENDBUF, RECVBUF, COUNT, DATATYPE, OP, COMM, IERROR)
23     <type> SENDBUF(*), RECVBUF(*)
24     INTEGER COUNT, DATATYPE, OP, COMM, IERROR

```

If comm is an intra-communicator, MPI\_SCAN is used to perform a prefix reduction on data distributed across the group. The operation returns, in the receive buffer of the process with rank i, the reduction of the values in the send buffers of processes with ranks 0,...,i (inclusive). The routine is called by all group members using the same arguments for count, datatype, op and comm, except that for user-defined operations, the same rules apply as for MPI\_REDUCE. The type of operations supported, their semantics, and the constraints on send and receive buffers are as for MPI\_REDUCE.

The “in place” option for intra-communicators is specified by passing MPI\_IN\_PLACE in the sendbuf argument. In this case, the input data is taken from the receive buffer, and replaced by the output data.

This operation is invalid for inter-communicators.

## 6.11.2 Exclusive Scan

MPI\_EXSCAN(sendbuf, recvbuf, count, datatype, op, comm)

IN	sendbuf	starting address of send buffer (choice)
OUT	recvbuf	starting address of receive buffer (choice)
IN	count	number of elements in input buffer (non-negative integer)
IN	datatype	datatype of elements of input buffer (handle)
IN	op	operation (handle)
IN	comm	intra-communicator (handle)

**C binding**

```
int MPI_Exscan(const void *sendbuf, void *recvbuf, int count,
               MPI_Datatype datatype, MPI_Op op, MPI_Comm comm)
```

```
int MPI_Exscan_c(const void *sendbuf, void *recvbuf, MPI_Count count,
                  MPI_Datatype datatype, MPI_Op op, MPI_Comm comm)
```

**Fortran 2008 binding**

```
MPI_Exscan(sendbuf, recvbuf, count, datatype, op, comm, ierror)
  TYPE(*), DIMENSION(..), INTENT(IN) :: sendbuf
  TYPE(*), DIMENSION(..) :: recvbuf
  INTEGER, INTENT(IN) :: count
  TYPE(MPI_Datatype), INTENT(IN) :: datatype
  TYPE(MPI_Op), INTENT(IN) :: op
  TYPE(MPI_Comm), INTENT(IN) :: comm
  INTEGER, OPTIONAL, INTENT(OUT) :: ierror
```

```
MPI_Exscan(sendbuf, recvbuf, count, datatype, op, comm, ierror)
  TYPE(*), DIMENSION(..), INTENT(IN) :: sendbuf
  TYPE(*), DIMENSION(..) :: recvbuf
  INTEGER(KIND=MPI_COUNT_KIND), INTENT(IN) :: count
  TYPE(MPI_Datatype), INTENT(IN) :: datatype
  TYPE(MPI_Op), INTENT(IN) :: op
  TYPE(MPI_Comm), INTENT(IN) :: comm
  INTEGER, OPTIONAL, INTENT(OUT) :: ierror
```

**Fortran binding**

```
MPI_EXSCAN(SENDBUF, RECVBUF, COUNT, DATATYPE, OP, COMM, IERROR)
  <type> SENDBUF(*), RECVBUF(*)
  INTEGER COUNT, DATATYPE, OP, COMM, IERROR
```

If `comm` is an intra-communicator, `MPI_EXSCAN` is used to perform a prefix reduction on data distributed across the group. The value in `recvbuf` on the process with rank 0 is undefined, and `recvbuf` is not significant on process 0. The value in `recvbuf` on the process with rank 1 is defined as the value in `sendbuf` on the process with rank 0. For processes with rank  $i > 1$ , the operation returns, in the receive buffer of the process with rank  $i$ , the

reduction of the values in the send buffers of processes with ranks  $0, \dots, i-1$  (inclusive). The routine is called by all group members using the same arguments for count, datatype, op and comm, except that for user-defined operations, the same rules apply as for `MPI_REDUCE`. The type of operations supported, their semantics, and the constraints on send and receive buffers, are as for `MPI_REDUCE`.

The “in place” option for intra-communicators is specified by passing `MPI_IN_PLACE` in the `sendbuf` argument. In this case, the input data is taken from the receive buffer, and replaced by the output data. The receive buffer on rank 0 is not changed by this operation.

This operation is invalid for inter-communicators.

*Rationale.* The exclusive scan is more general than the inclusive scan. Any inclusive scan operation can be achieved by using the exclusive scan and then locally combining the local contribution. Note that for non-invertable operations such as `MPI_MAX`, the exclusive scan cannot be computed with the inclusive scan. (*End of rationale.*)

### 6.11.3 Example using `MPI_SCAN`

The example in this section uses an intra-communicator.

**Example 6.23** This example uses a user-defined operation to produce a *segmented scan*. A segmented scan takes, as input, a set of values and a set of logicals, and the logicals delineate the various segments of the scan. For example:

<i>values</i>	$v_1$	$v_2$	$v_3$	$v_4$	$v_5$	$v_6$	$v_7$	$v_8$
<i>logicals</i>	0	0	1	1	1	0	0	1
<i>result</i>	$v_1$	$v_1 + v_2$	$v_3$	$v_3 + v_4$	$v_3 + v_4 + v_5$	$v_6$	$v_6 + v_7$	$v_8$

The operator that produces this effect is

$$\begin{pmatrix} u \\ i \end{pmatrix} \circ \begin{pmatrix} v \\ j \end{pmatrix} = \begin{pmatrix} w \\ j \end{pmatrix},$$

where

$$w = \begin{cases} u + v & \text{if } i = j \\ v & \text{if } i \neq j \end{cases}.$$

Note that this is a non-commutative operator. C code that implements it is given below.

```

typedef struct {
    double val;
    int log;
} SegScanPair;

/* the user-defined function
*/
void segScan(SegScanPair *in, SegScanPair *inout, int *len,
             MPI_Datatype *dptr)
{
    int i;
    SegScanPair c;

    for (i=0; i < *len; ++i) {
        if (in->log == inout->log)
            c.val = in->val + inout->val;
        else
            c.val = inout->val;
        c.log = inout->log;
        *inout = c;
        in++; inout++;
    }
}

```

Note that the `inout` argument to the user-defined function corresponds to the right-hand operand of the operator. When using this operator, we must be careful to specify that it is non-commutative, as in the following.

```

int i, base;
SegScanPair a, answer;
MPI_Op myOp;
MPI_Datatype type[2] = {MPI_DOUBLE, MPI_INT};
MPI_Aint disp[2];
int blocklen[2] = { 1, 1};
MPI_Datatype sspair;

/* explain to MPI how type SegScanPair is defined
*/
MPI_Get_address(&a, disp);
MPI_Get_address(&a.log, disp+1);
base = disp[0];
for (i=0; i < 2; ++i) disp[i] -= base;
MPI_Type_create_struct(2, blocklen, disp, type, &sspair);
MPI_Type_commit(&sspair);
/* create the segmented-scan user-op
*/
MPI_Op_create(segScan, 0, &myOp);
...
MPI_Scan(&a, &answer, 1, sspair, myOp, comm);

```

## 6.12 Nonblocking Collective Operations

As described in Section 3.7, performance of many applications can be improved by overlapping communication and computation, and many systems enable this. Nonblocking collective operations combine the potential benefits of nonblocking point-to-point operations, to exploit overlap and to avoid synchronization, with the optimized implementation and message scheduling provided by collective operations [34, 38]. One way of doing this would be to perform a blocking collective operation in a separate thread. An alternative mechanism that often leads to better performance (e.g., avoids context switching, scheduler overheads, and thread management) is to use nonblocking collective communication [36].

The nonblocking collective communication model is similar to the model used for nonblocking point-to-point communication. A nonblocking call initiates a collective operation, which must be completed in a separate completion call. Once initiated, the operation may progress independently of any computation or other communication at participating processes. In this manner, nonblocking collective operations can mitigate possible synchronizing effects of collective operations by running them in the “background.” In addition to enabling communication-computation overlap, nonblocking collective operations can perform collective operations on overlapping communicators, which would lead to deadlocks with blocking operations. Their semantic advantages can also be useful in combination with point-to-point communication.

As in the nonblocking point-to-point case, all calls are local and return immediately, irrespective of the status of other processes. The call initiates the operation, which indicates that the system may start to copy data out of the send buffer and into the receive buffer. Once initiated, all associated send buffers and buffers associated with input arguments (such as arrays of counts, displacements, or datatypes in the vector versions of the collectives) should not be modified, and all associated receive buffers should not be accessed, until the collective operation completes. The call returns a request handle, which must be passed to a completion call.

All completion calls (e.g., `MPI_WAIT`) described in Section 3.7.3 are supported for nonblocking collective operations. Similarly to the blocking case, nonblocking collective operations are considered to be complete when the local part of the operation is finished, i.e., for the caller, the semantics of the operation are guaranteed and all buffers can be safely accessed and modified. Completion does not indicate that other processes have completed or even started the operation (unless otherwise implied by the description of the operation). Completion of a particular nonblocking collective operation also does not indicate completion of any other posted nonblocking collective (or send-receive) operations, whether they are posted before or after the completed operation.

*Advice to users.* Users should be aware that implementations are allowed, but not required (with exception of `MPI_IBARRIER`), to synchronize processes during the completion of a nonblocking collective operation. (*End of advice to users.*)

Upon returning from a completion call in which a nonblocking collective operation completes, the values of the `MPI_SOURCE` and `MPI_TAG` fields in the associated status object, if any, are undefined. The value of `MPI_ERROR` may be defined, if appropriate, according to the specification in Section 3.2.5. It is valid to mix different request types (i.e., any combination of collective requests, I/O requests, generalized requests, or point-to-point requests) in functions that enable multiple completions (e.g., `MPI_WAITALL`). It is erroneous

to call `MPI_REQUEST_FREE` or `MPI_CANCEL` for a request associated with a nonblocking collective operation. Nonblocking collective requests created using the APIs described in this section are not persistent. However, persistent collective requests can be created using persistent collective operations described in Sections 6.13 and 8.8.

*Rationale.* Freeing an active nonblocking collective request could cause similar problems as discussed for point-to-point requests (see Section 3.7.3). Cancelling a request is not supported because the semantics of this operation are not well-defined. (*End of rationale.*)

Multiple nonblocking collective operations can be outstanding on a single communicator. If the nonblocking call causes some system resource to be exhausted, then it will fail and raise an error. Quality implementations of MPI should ensure that this happens only in pathological cases. That is, an MPI implementation should be able to support a large number of pending nonblocking operations.

Unlike point-to-point operations, nonblocking collective operations do not match with blocking collective operations, and collective operations do not have a tag argument. All processes must call collective operations (blocking and nonblocking) in the same order per communicator. In particular, once a process calls a collective operation, all other processes in the communicator must eventually call the same collective operation, and no other collective operation with the same communicator in between. This is consistent with the ordering rules for blocking collective operations in threaded environments.

*Rationale.* Matching blocking and nonblocking collective operations is not allowed because the implementation might use different communication algorithms for the two cases. Blocking collective operations may be optimized for minimal time to completion, while nonblocking collective operations may balance time to completion with CPU overhead and asynchronous progression.

The use of tags for collective operations can prevent certain hardware optimizations. (*End of rationale.*)

*Advice to users.* If program semantics require matching blocking and nonblocking collective operations, then a nonblocking collective operation can be initiated and immediately completed with a blocking wait to emulate blocking behavior. (*End of advice to users.*)

In terms of data movement, each nonblocking collective operation has the same effect as its blocking counterpart for intra-communicators and inter-communicators after completion. Likewise, upon completion, nonblocking collective reduction operations have the same effect as their blocking counterparts, and the same restrictions and recommendations on reduction orders apply.

The use of the “in place” option is allowed exactly as described for the corresponding blocking collective operations. When using the “in place” option, message buffers function as both send and receive buffers. Such buffers should not be modified or accessed until the operation completes.

Progression rules for nonblocking collective operations are similar to progression of nonblocking point-to-point operations, refer to Section 3.7.4.

*Advice to implementors.* Nonblocking collective operations can be implemented with local execution schedules [37] using nonblocking point-to-point communication and a reserved tag-space. (*End of advice to implementors.*)

## 6.12.1 Nonblocking Barrier Synchronization

MPI\_IBARRIER(comm, request)

IN	comm	communicator (handle)
OUT	request	communication request (handle)

### C binding

```
int MPI_Ibarrier(MPI_Comm comm, MPI_Request *request)
```

### Fortran 2008 binding

```
MPI_Ibarrier(comm, request, ierror)
  TYPE(MPI_Comm), INTENT(IN) :: comm
  TYPE(MPI_Request), INTENT(OUT) :: request
  INTEGER, OPTIONAL, INTENT(OUT) :: ierror
```

### Fortran binding

```
MPI_IBARRIER(COMM, REQUEST, IERROR)
  INTEGER COMM, REQUEST, IERROR
```

MPI\_IBARRIER is a nonblocking version of MPI\_BARRIER. By calling MPI\_IBARRIER, a process notifies that it has reached the barrier. The call returns immediately, independent of whether other processes have called MPI\_IBARRIER. The usual barrier semantics are enforced at the corresponding completion operation (test or wait), which in the intra-communicator case will complete only after all other processes in the communicator have called MPI\_IBARRIER. In the inter-communicator case, it will complete when all processes in the remote group have called MPI\_IBARRIER.

*Advice to users.* A nonblocking barrier can be used to hide latency. Moving independent computations between the MPI\_IBARRIER and the subsequent completion call can overlap the barrier latency and therefore shorten possible waiting times. The semantic properties are also useful when mixing collective operations and point-to-point messages. (*End of advice to users.*)



## 6.12.2 Nonblocking Broadcast

`MPI_IBCAST(buffer, count, datatype, root, comm, request)`

INOUT	buffer	starting address of buffer (choice)
IN	count	number of entries in buffer (non-negative integer)
IN	datatype	datatype of buffer (handle)
IN	root	rank of broadcast root (integer)
IN	comm	communicator (handle)
OUT	request	communication request (handle)

**C binding**

```
int MPI_Ibcast(void *buffer, int count, MPI_Datatype datatype, int root,
              MPI_Comm comm, MPI_Request *request)
```

```
int MPI_Ibcast_c(void *buffer, MPI_Count count, MPI_Datatype datatype,
                 int root, MPI_Comm comm, MPI_Request *request)
```

**Fortran 2008 binding**

```
MPI_Ibcast(buffer, count, datatype, root, comm, request, ierror)
  TYPE(*), DIMENSION(..), ASYNCHRONOUS :: buffer
  INTEGER, INTENT(IN) :: count, root
  TYPE(MPI_Datatype), INTENT(IN) :: datatype
  TYPE(MPI_Comm), INTENT(IN) :: comm
  TYPE(MPI_Request), INTENT(OUT) :: request
  INTEGER, OPTIONAL, INTENT(OUT) :: ierror
```

```
MPI_Ibcast(buffer, count, datatype, root, comm, request, ierror)
  TYPE(*), DIMENSION(..), ASYNCHRONOUS :: buffer
  INTEGER(KIND=MPI_COUNT_KIND), INTENT(IN) :: count
  TYPE(MPI_Datatype), INTENT(IN) :: datatype
  INTEGER, INTENT(IN) :: root
  TYPE(MPI_Comm), INTENT(IN) :: comm
  TYPE(MPI_Request), INTENT(OUT) :: request
  INTEGER, OPTIONAL, INTENT(OUT) :: ierror
```

**Fortran binding**

```
MPI_IBCAST(BUFFER, COUNT, DATATYPE, ROOT, COMM, REQUEST, IERROR)
  <type> BUFFER(*)
  INTEGER COUNT, DATATYPE, ROOT, COMM, REQUEST, IERROR
```

This call starts a nonblocking variant of `MPI_BCAST` (see Section 6.4).

**Example using `MPI_IBCAST`**

The example in this section uses an intra-communicator.

**Example 6.24** Start a broadcast of 100 ints from process 0 to every process in the group, perform some computation on independent data, and then complete the outstanding broadcast operation.

```

5     MPI_Comm comm;
6     int array1[100], array2[100];
7     int root=0;
8     MPI_Request req;
9     ...
10    MPI_Ibcast(array1, 100, MPI_INT, root, comm, &req);
11    compute(array2, 100);
12    MPI_Wait(&req, MPI_STATUS_IGNORE);

```

### 6.12.3 Nonblocking Gather

```

17 MPI_IGATHER(sendbuf, sendcount, sendtype, recvbuf, recvcount, recvtype, root, comm,
18             request)
19
20 IN     sendbuf           starting address of send buffer (choice)
21 IN     sendcount        number of elements in send buffer (non-negative
22                               integer)
23 IN     sendtype         datatype of send buffer elements (handle)
24 OUT    recvbuf          address of receive buffer (choice, significant only at
25                               root)
26
27 IN     recvcount        number of elements for any single receive
28                               (non-negative integer, significant only at root)
29 IN     recvtype         datatype of recv buffer elements (handle, significant
30                               only at root)
31
32 IN     root             rank of receiving process (integer)
33 IN     comm             communicator (handle)
34 OUT    request          communication request (handle)

```

#### C binding

```

37 int MPI_Igather(const void *sendbuf, int sendcount, MPI_Datatype sendtype,
38               void *recvbuf, int recvcount, MPI_Datatype recvtype, int root,
39               MPI_Comm comm, MPI_Request *request)
40

```

```

41 int MPI_Igather_c(const void *sendbuf, MPI_Count sendcount,
42                 MPI_Datatype sendtype, void *recvbuf, MPI_Count recvcount,
43                 MPI_Datatype recvtype, int root, MPI_Comm comm,
44                 MPI_Request *request)
45

```

#### Fortran 2008 binding

```

46 MPI_Igather(sendbuf, sendcount, sendtype, recvbuf, recvcount, recvtype,
47             root, comm, request, ierror)
48

```

```

TYPE(*), DIMENSION(..), INTENT(IN), ASYNCHRONOUS :: sendbuf      1
INTEGER, INTENT(IN) :: sendcount, recvcount, root                2
TYPE(MPI_Datatype), INTENT(IN) :: sendtype, recvtype            3
TYPE(*), DIMENSION(..), ASYNCHRONOUS :: recvbuf                4
TYPE(MPI_Comm), INTENT(IN) :: comm                              5
TYPE(MPI_Request), INTENT(OUT) :: request                       6
INTEGER, OPTIONAL, INTENT(OUT) :: ierror                        7
                                                                8
MPI_Igather(sendbuf, sendcount, sendtype, recvbuf, recvcount, recvtype,
            root, comm, request, ierror)                          9
TYPE(*), DIMENSION(..), INTENT(IN), ASYNCHRONOUS :: sendbuf    10
INTEGER(KIND=MPI_COUNT_KIND), INTENT(IN) :: sendcount, recvcount 11
TYPE(MPI_Datatype), INTENT(IN) :: sendtype, recvtype            12
TYPE(*), DIMENSION(..), ASYNCHRONOUS :: recvbuf                13
INTEGER, INTENT(IN) :: root                                     14
TYPE(MPI_Comm), INTENT(IN) :: comm                              15
TYPE(MPI_Request), INTENT(OUT) :: request                       16
INTEGER, OPTIONAL, INTENT(OUT) :: ierror                        17
                                                                18
Fortran binding                                              19
MPI_IGATHER(SENDBUF, SENDCOUNT, SENDTYPE, RECVBUF, RECVCOUNT, RECVTYPE,
            ROOT, COMM, REQUEST, IERROR)                          20
<type> SENDBUF(*), RECVBUF(*)                                    21
INTEGER SENDCOUNT, SENDTYPE, RECVCOUNT, RECVTYPE, ROOT, COMM, REQUEST,
            IERROR                                               22
                                                                23
This call starts a nonblocking variant of MPI_GATHER (see Section 6.5).  24
                                                                25
                                                                26
                                                                27
                                                                28
                                                                29
                                                                30
                                                                31
                                                                32
                                                                33
                                                                34
                                                                35
                                                                36
                                                                37
                                                                38
                                                                39
                                                                40
                                                                41
                                                                42
                                                                43
                                                                44
                                                                45
                                                                46
                                                                47
                                                                48

```

```

1 MPI_IGATHERV(sendbuf, sendcount, sendtype, recvbuf, recvcnts, displs, recvtype, root,
2             comm, request)
3
4     IN      sendbuf      starting address of send buffer (choice)
5
6     IN      sendcount    number of elements in send buffer (non-negative
7                          integer)
8
9     IN      sendtype     datatype of send buffer elements (handle)
10
11    OUT     recvbuf      address of receive buffer (choice, significant only at
12                          root)
13
14    IN      recvcnts     non-negative integer array (of length group size)
15                          containing the number of elements that are received
16                          from each process (significant only at root)
17
18    IN      displs      integer array (of length group size). Entry i specifies
19                          the displacement relative to recvbuf at which to place
20                          the incoming data from process i (significant only at
21                          root)
22
23    IN      recvtype     datatype of recv buffer elements (handle, significant
24                          only at root)
25
26    IN      root         rank of receiving process (integer)
27
28    IN      comm         communicator (handle)
29
30    OUT     request      communication request (handle)

```

**C binding**

```

31 int MPI_Igatherv(const void *sendbuf, int sendcount, MPI_Datatype sendtype,
32                void *recvbuf, const int recvcnts[], const int displs[],
33                MPI_Datatype recvtype, int root, MPI_Comm comm,
34                MPI_Request *request)
35
36 int MPI_Igatherv_c(const void *sendbuf, MPI_Count sendcount,
37                   MPI_Datatype sendtype, void *recvbuf,
38                   const MPI_Count recvcnts[], const MPI_Aint displs[],
39                   MPI_Datatype recvtype, int root, MPI_Comm comm,
40                   MPI_Request *request)

```

**Fortran 2008 binding**

```

41 MPI_Igatherv(sendbuf, sendcount, sendtype, recvbuf, recvcnts, displs,
42             recvtype, root, comm, request, ierror)
43     TYPE(*), DIMENSION(..), INTENT(IN), ASYNCHRONOUS :: sendbuf
44     INTEGER, INTENT(IN) :: sendcount, root
45     TYPE(MPI_Datatype), INTENT(IN) :: sendtype, recvtype
46     TYPE(*), DIMENSION(..), ASYNCHRONOUS :: recvbuf
47     INTEGER, INTENT(IN), ASYNCHRONOUS :: recvcnts(*), displs(*)
48     TYPE(MPI_Comm), INTENT(IN) :: comm
49     TYPE(MPI_Request), INTENT(OUT) :: request
50     INTEGER, OPTIONAL, INTENT(OUT) :: ierror

```

```

MPI_Igatherv(sendbuf, sendcount, sendtype, recvbuf, recvcounts, displs,
             recvtype, root, comm, request, ierror)
TYPE(*), DIMENSION(..), INTENT(IN), ASYNCHRONOUS :: sendbuf
INTEGER(KIND=MPI_COUNT_KIND), INTENT(IN) :: sendcount
TYPE(MPI_Datatype), INTENT(IN) :: sendtype, recvtype
TYPE(*), DIMENSION(..), ASYNCHRONOUS :: recvbuf
INTEGER(KIND=MPI_COUNT_KIND), INTENT(IN), ASYNCHRONOUS :: recvcounts(*)
INTEGER(KIND=MPI_ADDRESS_KIND), INTENT(IN), ASYNCHRONOUS :: displs(*)
INTEGER, INTENT(IN) :: root
TYPE(MPI_Comm), INTENT(IN) :: comm
TYPE(MPI_Request), INTENT(OUT) :: request
INTEGER, OPTIONAL, INTENT(OUT) :: ierror

```

**Fortran binding**

```

MPI_IGATHERV(SENDBUF, SENDCOUNT, SENDTYPE, RECVBUF, RECVCOUNTS, DISPLS,
             RECVTYPE, ROOT, COMM, REQUEST, IERROR)
<type> SENDBUF(*), RECVBUF(*)
INTEGER SENDCOUNT, SENDTYPE, RECVCOUNTS(*), DISPLS(*), RECVTYPE, ROOT,
COMM, REQUEST, IERROR

```

This call starts a nonblocking variant of `MPI_GATHERV` (see Section 6.5).

## 6.12.4 Nonblocking Scatter

```

MPI_ISCATTER(sendbuf, sendcount, sendtype, recvbuf, recvcount, recvtype, root, comm,
             request)
IN      sendbuf      address of send buffer (choice, significant only at
                    root)
IN      sendcount    number of elements sent to each process
                    (non-negative integer, significant only at root)
IN      sendtype     datatype of send buffer elements (handle, significant
                    only at root)
OUT     recvbuf      address of receive buffer (choice)
IN      recvcount    number of elements in receive buffer (non-negative
                    integer)
IN      recvtype     datatype of receive buffer elements (handle)
IN      root         rank of sending process (integer)
IN      comm         communicator (handle)
OUT     request      communication request (handle)

```

**C binding**

```

int MPI_Iscatter(const void *sendbuf, int sendcount, MPI_Datatype sendtype,
                void *recvbuf, int recvcount, MPI_Datatype recvtype, int root,
                MPI_Comm comm, MPI_Request *request)

```

```

1 int MPI_Iscatter_c(const void *sendbuf, MPI_Count sendcount,
2                 MPI_Datatype sendtype, void *recvbuf, MPI_Count recvcount,
3                 MPI_Datatype recvtype, int root, MPI_Comm comm,
4                 MPI_Request *request)

```

#### Fortran 2008 binding

```

5
6 MPI_Iscatter(sendbuf, sendcount, sendtype, recvbuf, recvcount, recvtype,
7             root, comm, request, ierror)
8     TYPE(*), DIMENSION(..), INTENT(IN), ASYNCHRONOUS :: sendbuf
9     INTEGER, INTENT(IN) :: sendcount, recvcount, root
10    TYPE(MPI_Datatype), INTENT(IN) :: sendtype, recvtype
11    TYPE(*), DIMENSION(..), ASYNCHRONOUS :: recvbuf
12    TYPE(MPI_Comm), INTENT(IN) :: comm
13    TYPE(MPI_Request), INTENT(OUT) :: request
14    INTEGER, OPTIONAL, INTENT(OUT) :: ierror
15
16 MPI_Iscatter(sendbuf, sendcount, sendtype, recvbuf, recvcount, recvtype,
17             root, comm, request, ierror)
18    TYPE(*), DIMENSION(..), INTENT(IN), ASYNCHRONOUS :: sendbuf
19    INTEGER(KIND=MPI_COUNT_KIND), INTENT(IN) :: sendcount, recvcount
20    TYPE(MPI_Datatype), INTENT(IN) :: sendtype, recvtype
21    TYPE(*), DIMENSION(..), ASYNCHRONOUS :: recvbuf
22    INTEGER, INTENT(IN) :: root
23    TYPE(MPI_Comm), INTENT(IN) :: comm
24    TYPE(MPI_Request), INTENT(OUT) :: request
25    INTEGER, OPTIONAL, INTENT(OUT) :: ierror
26

```

#### Fortran binding

```

27 MPI_ISCATTER(SENDBUF, SENDCOUNT, SENDTYPE, RECVBUF, RECVCOUNT, RECVTYPE,
28             ROOT, COMM, REQUEST, IERROR)
29     <type> SENDBUF(*), RECVBUF(*)
30     INTEGER SENDCOUNT, SENDTYPE, RECVCOUNT, RECVTYPE, ROOT, COMM, REQUEST,
31     IERROR
32

```

This call starts a nonblocking variant of MPI\_SCATTER (see Section 6.6).

	MPI_ISCATTERV(sendbuf, sendcounts, displs, sendtype, recvbuf, recvcount, recvtype, root, comm, request)		1
			2
IN	sendbuf	address of send buffer (choice, significant only at root)	3
			4
			5
IN	sendcounts	non-negative integer array (of length group size) specifying the number of elements to send to each rank (significant only at root)	6
			7
			8
IN	displs	integer array (of length group size). Entry <i>i</i> specifies the displacement (relative to <code>sendbuf</code> ) from which to take the outgoing data to process <i>i</i> (significant only at root)	9
			10
			11
			12
IN	sendtype	datatype of send buffer elements (handle, significant only at root)	13
			14
OUT	recvbuf	address of receive buffer (choice)	15
			16
IN	recvcount	number of elements in receive buffer (non-negative integer)	17
			18
			19
IN	recvtype	datatype of receive buffer elements (handle)	20
			21
IN	root	rank of sending process (integer)	22
			23
IN	comm	communicator (handle)	24
			25
OUT	request	communication request (handle)	26

**C binding**

```
int MPI_Iscatterv(const void *sendbuf, const int sendcounts[],
                 const int displs[], MPI_Datatype sendtype, void *recvbuf,
                 int recvcount, MPI_Datatype recvtype, int root, MPI_Comm comm,
                 MPI_Request *request)
```

```
int MPI_Iscatterv_c(const void *sendbuf, const MPI_Count sendcounts[],
                   const MPI_Aint displs[], MPI_Datatype sendtype, void *recvbuf,
                   MPI_Count recvcount, MPI_Datatype recvtype, int root,
                   MPI_Comm comm, MPI_Request *request)
```

**Fortran 2008 binding**

```
MPI_Iscatterv(sendbuf, sendcounts, displs, sendtype, recvbuf, recvcount,
              recvtype, root, comm, request, ierror)
```

```
TYPE(*), DIMENSION(..), INTENT(IN), ASYNCHRONOUS :: sendbuf
INTEGER, INTENT(IN), ASYNCHRONOUS :: sendcounts(*), displs(*)
TYPE(MPI_Datatype), INTENT(IN) :: sendtype, recvtype
TYPE(*), DIMENSION(..), ASYNCHRONOUS :: recvbuf
INTEGER, INTENT(IN) :: recvcount, root
TYPE(MPI_Comm), INTENT(IN) :: comm
TYPE(MPI_Request), INTENT(OUT) :: request
INTEGER, OPTIONAL, INTENT(OUT) :: ierror
```

```
MPI_Iscatterv(sendbuf, sendcounts, displs, sendtype, recvbuf, recvcount,
              recvtype, root, comm, request, ierror)
```

```

1  TYPE(*), DIMENSION(..), INTENT(IN), ASYNCHRONOUS :: sendbuf
2  INTEGER(KIND=MPI_COUNT_KIND), INTENT(IN), ASYNCHRONOUS :: sendcounts(*)
3  INTEGER(KIND=MPI_ADDRESS_KIND), INTENT(IN), ASYNCHRONOUS :: displs(*)
4  TYPE(MPI_Datatype), INTENT(IN) :: sendtype, recvtype
5  TYPE(*), DIMENSION(..), ASYNCHRONOUS :: recvbuf
6  INTEGER(KIND=MPI_COUNT_KIND), INTENT(IN) :: recvcount
7  INTEGER, INTENT(IN) :: root
8  TYPE(MPI_Comm), INTENT(IN) :: comm
9  TYPE(MPI_Request), INTENT(OUT) :: request
10 INTEGER, OPTIONAL, INTENT(OUT) :: ierror

```

### Fortran binding

```

12 MPI_ISCATTERV(SENDBUF, SENDCOUNTS, DISPLS, SENDTYPE, RECVBUF, RECVCOUNT,
13              RECVTYPE, ROOT, COMM, REQUEST, IERROR)
14 <type> SENDBUF(*), RECVBUF(*)
15 INTEGER SENDCOUNTS(*), DISPLS(*), SENDTYPE, RECVCOUNT, RECVTYPE, ROOT,
16              COMM, REQUEST, IERROR

```

This call starts a nonblocking variant of `MPI_SCATTERV` (see Section 6.6).

### 6.12.5 Nonblocking Gather-to-all

```

23 MPI_IALLGATHER(sendbuf, sendcount, sendtype, recvbuf, recvcount, recvtype, comm,
24               request)

```

26	IN	sendbuf	starting address of send buffer (choice)
27	IN	sendcount	number of elements in send buffer (non-negative integer)
28			
29	IN	sendtype	datatype of send buffer elements (handle)
30			
31	OUT	recvbuf	address of receive buffer (choice)
32	IN	recvcount	number of elements received from any process (non-negative integer)
33			
34	IN	recvtype	datatype of receive buffer elements (handle)
35			
36	IN	comm	communicator (handle)
37	OUT	request	communication request (handle)

### C binding

```

39
40 int MPI_Iallgather(const void *sendbuf, int sendcount,
41                  MPI_Datatype sendtype, void *recvbuf, int recvcount,
42                  MPI_Datatype recvtype, MPI_Comm comm, MPI_Request *request)
43
44 int MPI_Iallgather_c(const void *sendbuf, MPI_Count sendcount,
45                     MPI_Datatype sendtype, void *recvbuf, MPI_Count recvcount,
46                     MPI_Datatype recvtype, MPI_Comm comm, MPI_Request *request)
47
48

```



**Fortran 2008 binding**

```

MPI_Iallgather(sendbuf, sendcount, sendtype, recvbuf, recvcount, recvtype,
               comm, request, ierror)
TYPE(*), DIMENSION(..), INTENT(IN), ASYNCHRONOUS :: sendbuf
INTEGER, INTENT(IN) :: sendcount, recvcount
TYPE(MPI_Datatype), INTENT(IN) :: sendtype, recvtype
TYPE(*), DIMENSION(..), ASYNCHRONOUS :: recvbuf
TYPE(MPI_Comm), INTENT(IN) :: comm
TYPE(MPI_Request), INTENT(OUT) :: request
INTEGER, OPTIONAL, INTENT(OUT) :: ierror

```

```

MPI_Iallgather(sendbuf, sendcount, sendtype, recvbuf, recvcount, recvtype,
               comm, request, ierror)
TYPE(*), DIMENSION(..), INTENT(IN), ASYNCHRONOUS :: sendbuf
INTEGER(KIND=MPI_COUNT_KIND), INTENT(IN) :: sendcount, recvcount
TYPE(MPI_Datatype), INTENT(IN) :: sendtype, recvtype
TYPE(*), DIMENSION(..), ASYNCHRONOUS :: recvbuf
TYPE(MPI_Comm), INTENT(IN) :: comm
TYPE(MPI_Request), INTENT(OUT) :: request
INTEGER, OPTIONAL, INTENT(OUT) :: ierror

```

**Fortran binding**

```

MPI_IALLGATHER(SENDBUF, SENDCOUNT, SENDTYPE, RECVBUF, RECVCOUNT, RECVTYP,
               COMM, REQUEST, IERROR)
<type> SENDBUF(*), RECVBUF(*)
INTEGER SENDCOUNT, SENDTYPE, RECVCOUNT, RECVTYP, COMM, REQUEST, IERROR

```

This call starts a nonblocking variant of MPI\_ALLGATHER (see Section 6.7).

```

1 MPI_IALLGATHERV(sendbuf, sendcount, sendtype, recvbuf, recvcounts, displs, recvtype,
2               comm, request)
3
4   IN      sendbuf      starting address of send buffer (choice)
5
6   IN      sendcount    number of elements in send buffer (non-negative
7                       integer)
8
9   IN      sendtype     datatype of send buffer elements (handle)
10
11  OUT     recvbuf      address of receive buffer (choice)
12
13  IN      recvcounts    non-negative integer array (of length group size)
14                       containing the number of elements that are received
15                       from each process
16
17  IN      displs       integer array (of length group size). Entry i specifies
18                       the displacement (relative to recvbuf) at which to
19                       place the incoming data from process i
20
21  IN      recvtype     datatype of receive buffer elements (handle)
22
23  IN      comm         communicator (handle)
24
25  OUT     request      communication request (handle)

```

**C binding**

```

22 int MPI_Iallgatherv(const void *sendbuf, int sendcount,
23                   MPI_Datatype sendtype, void *recvbuf, const int recvcounts[],
24                   const int displs[], MPI_Datatype recvtype, MPI_Comm comm,
25                   MPI_Request *request)
26
27 int MPI_Iallgatherv_c(const void *sendbuf, MPI_Count sendcount,
28                      MPI_Datatype sendtype, void *recvbuf,
29                      const MPI_Count recvcounts[], const MPI_Aint displs[],
30                      MPI_Datatype recvtype, MPI_Comm comm, MPI_Request *request)

```

**Fortran 2008 binding**

```

32 MPI_Iallgatherv(sendbuf, sendcount, sendtype, recvbuf, recvcounts, displs,
33               recvtype, comm, request, ierror)
34   TYPE(*), DIMENSION(..), INTENT(IN), ASYNCHRONOUS :: sendbuf
35   INTEGER, INTENT(IN) :: sendcount
36   TYPE(MPI_Datatype), INTENT(IN) :: sendtype, recvtype
37   TYPE(*), DIMENSION(..), ASYNCHRONOUS :: recvbuf
38   INTEGER, INTENT(IN), ASYNCHRONOUS :: recvcounts(*), displs(*)
39   TYPE(MPI_Comm), INTENT(IN) :: comm
40   TYPE(MPI_Request), INTENT(OUT) :: request
41   INTEGER, OPTIONAL, INTENT(OUT) :: ierror
42
43 MPI_Iallgatherv(sendbuf, sendcount, sendtype, recvbuf, recvcounts, displs,
44               recvtype, comm, request, ierror)
45   TYPE(*), DIMENSION(..), INTENT(IN), ASYNCHRONOUS :: sendbuf
46   INTEGER(KIND=MPI_COUNT_KIND), INTENT(IN) :: sendcount
47   TYPE(MPI_Datatype), INTENT(IN) :: sendtype, recvtype
48   TYPE(*), DIMENSION(..), ASYNCHRONOUS :: recvbuf

```

```

INTEGER(KIND=MPI_COUNT_KIND), INTENT(IN), ASYNCHRONOUS :: recvcounts(*)
INTEGER(KIND=MPI_ADDRESS_KIND), INTENT(IN), ASYNCHRONOUS :: displs(*)
TYPE(MPI_Comm), INTENT(IN) :: comm
TYPE(MPI_Request), INTENT(OUT) :: request
INTEGER, OPTIONAL, INTENT(OUT) :: ierror

```

**Fortran binding**

```

MPI_IALLGATHERV(SENDBUF, SENDCOUNT, SENDTYPE, RECVBUF, RECVCOUNTS, DISPLS,
                RECVTYPE, COMM, REQUEST, IERROR)
<type> SENDBUF(*), RECVBUF(*)
INTEGER SENDCOUNT, SENDTYPE, RECVCOUNTS(*), DISPLS(*), RECVTYPE, COMM,
                REQUEST, IERROR

```

This call starts a nonblocking variant of MPI\_ALLGATHERV (see Section 6.7).

## 6.12.6 Nonblocking All-to-All Scatter/Gather

```

MPI_IALLTOALL(sendbuf, sendcount, sendtype, recvbuf, recvcnt, recvtype, comm, request)

```

IN	sendbuf	starting address of send buffer (choice)
IN	sendcount	number of elements sent to each process (non-negative integer)
IN	sendtype	datatype of send buffer elements (handle)
OUT	recvbuf	address of receive buffer (choice)
IN	recvcnt	number of elements received from any process (non-negative integer)
IN	recvtype	datatype of receive buffer elements (handle)
IN	comm	communicator (handle)
OUT	request	communication request (handle)

**C binding**

```

int MPI_Ialltoall(const void *sendbuf, int sendcount,
                 MPI_Datatype sendtype, void *recvbuf, int recvcnt,
                 MPI_Datatype recvtype, MPI_Comm comm, MPI_Request *request)
int MPI_Ialltoall_c(const void *sendbuf, MPI_Count sendcount,
                   MPI_Datatype sendtype, void *recvbuf, MPI_Count recvcnt,
                   MPI_Datatype recvtype, MPI_Comm comm, MPI_Request *request)

```

**Fortran 2008 binding**

```

MPI_Ialltoall(sendbuf, sendcount, sendtype, recvbuf, recvcnt, recvtype,
              comm, request, ierror)
TYPE(*), DIMENSION(..), INTENT(IN), ASYNCHRONOUS :: sendbuf
INTEGER, INTENT(IN) :: sendcount, recvcnt
TYPE(MPI_Datatype), INTENT(IN) :: sendtype, recvtype

```

```

1     TYPE(*), DIMENSION(..), ASYNCHRONOUS :: recvbuf
2     TYPE(MPI_Comm), INTENT(IN) :: comm
3     TYPE(MPI_Request), INTENT(OUT) :: request
4     INTEGER, OPTIONAL, INTENT(OUT) :: ierror
5
6 MPI_Ialltoall(sendbuf, sendcount, sendtype, recvbuf, recvcount, recvtype,
7             comm, request, ierror)
8     TYPE(*), DIMENSION(..), INTENT(IN), ASYNCHRONOUS :: sendbuf
9     INTEGER(KIND=MPI_COUNT_KIND), INTENT(IN) :: sendcount, recvcount
10    TYPE(MPI_Datatype), INTENT(IN) :: sendtype, recvtype
11    TYPE(*), DIMENSION(..), ASYNCHRONOUS :: recvbuf
12    TYPE(MPI_Comm), INTENT(IN) :: comm
13    TYPE(MPI_Request), INTENT(OUT) :: request
14    INTEGER, OPTIONAL, INTENT(OUT) :: ierror
15
16 Fortran binding
17 MPI_IALLTOALL(SENDBUF, SENDCOUNT, SENDTYPE, RECVBUF, REVCOUNT, RECVTYPE,
18             COMM, REQUEST, IERROR)
19     <type> SENDBUF(*), RECVBUF(*)
20     INTEGER SENDCOUNT, SENDTYPE, REVCOUNT, RECVTYPE, COMM, REQUEST, IERROR
21
22 This call starts a nonblocking variant of MPI_ALLTOALL (see Section 6.8).
23
24
25
26
27
28
29
30
31
32
33
34
35
36
37
38
39
40
41
42
43
44
45
46
47
48

```

	<code>MPI_IALLTOALLV</code>	<code>(sendbuf, sendcounts, sdispls, sendtype, recvbuf, recvcounts, rdispls, recvtype, comm, request)</code>	1
			2
IN	<code>sendbuf</code>	starting address of send buffer (choice)	3
			4
IN	<code>sendcounts</code>	non-negative integer array (of length group size) specifying the number of elements to send to each rank	5
			6
			7
IN	<code>sdispls</code>	integer array (of length group size). Entry <code>j</code> specifies the displacement (relative to <code>sendbuf</code> ) from which to take the outgoing data destined for process <code>j</code>	8
			9
			10
IN	<code>sendtype</code>	datatype of send buffer elements (handle)	11
OUT	<code>recvbuf</code>	address of receive buffer (choice)	12
			13
IN	<code>recvcounts</code>	non-negative integer array (of length group size) specifying the number of elements that can be received from each rank	14
			15
			16
IN	<code>rdispls</code>	integer array (of length group size). Entry <code>i</code> specifies the displacement (relative to <code>recvbuf</code> ) at which to place the incoming data from process <code>i</code>	17
			18
			19
			20
IN	<code>recvtype</code>	datatype of receive buffer elements (handle)	21
IN	<code>comm</code>	communicator (handle)	22
OUT	<code>request</code>	communication request (handle)	23
			24
			25

**C binding**

```

int MPI_Ialltoallv(const void *sendbuf, const int sendcounts[],
                  const int sdispls[], MPI_Datatype sendtype, void *recvbuf,
                  const int recvcounts[], const int rdispls[],
                  MPI_Datatype recvtype, MPI_Comm comm, MPI_Request *request)

```

```

int MPI_Ialltoallv_c(const void *sendbuf, const MPI_Count sendcounts[],
                    const MPI_Aint sdispls[], MPI_Datatype sendtype,
                    void *recvbuf, const MPI_Count recvcounts[],
                    const MPI_Aint rdispls[], MPI_Datatype recvtype,
                    MPI_Comm comm, MPI_Request *request)

```

**Fortran 2008 binding**

```

MPI_Ialltoallv(sendbuf, sendcounts, sdispls, sendtype, recvbuf, recvcounts,
               rdispls, recvtype, comm, request, ierror)
  TYPE(*), DIMENSION(..), INTENT(IN), ASYNCHRONOUS :: sendbuf
  INTEGER, INTENT(IN), ASYNCHRONOUS :: sendcounts(*), sdispls(*),
    recvcounts(*), rdispls(*)
  TYPE(MPI_Datatype), INTENT(IN) :: sendtype, recvtype
  TYPE(*), DIMENSION(..), ASYNCHRONOUS :: recvbuf
  TYPE(MPI_Comm), INTENT(IN) :: comm
  TYPE(MPI_Request), INTENT(OUT) :: request
  INTEGER, OPTIONAL, INTENT(OUT) :: ierror

```

```

1 MPI_Ialltoallv(sendbuf, sendcounts, sdispls, sendtype, recvbuf, recvcounts,
2               rdispls, recvtype, comm, request, ierror)
3     TYPE(*), DIMENSION(..), INTENT(IN), ASYNCHRONOUS :: sendbuf
4     INTEGER(KIND=MPI_COUNT_KIND), INTENT(IN), ASYNCHRONOUS ::
5         sendcounts(*), recvcounts(*)
6     INTEGER(KIND=MPI_ADDRESS_KIND), INTENT(IN), ASYNCHRONOUS :: sdispls(*),
7         rdispls(*)
8     TYPE(MPI_Datatype), INTENT(IN) :: sendtype, recvtype
9     TYPE(*), DIMENSION(..), ASYNCHRONOUS :: recvbuf
10    TYPE(MPI_Comm), INTENT(IN) :: comm
11    TYPE(MPI_Request), INTENT(OUT) :: request
12    INTEGER, OPTIONAL, INTENT(OUT) :: ierror

```

### Fortran binding

```

14 MPI_IALLTOALLV(SENDBUF, SENDCOUNTS, SDISPLS, SENDTYPE, RECVBUF, RECVCOUNTS,
15               RDISPLS, RECVTYPE, COMM, REQUEST, IERROR)
16 <type> SENDBUF(*), RECVBUF(*)
17 INTEGER SENDCOUNTS(*), SDISPLS(*), SENDTYPE, RECVCOUNTS(*), RDISPLS(*),
18     RECVTYPE, COMM, REQUEST, IERROR

```

This call starts a nonblocking variant of `MPI_ALLTOALLV` (see Section 6.8).

21  
22  
23  
24  
25  
26  
27  
28  
29  
30  
31  
32  
33  
34  
35  
36  
37  
38  
39  
40  
41  
42  
43  
44  
45  
46  
47  
48

MPI_IALLTOALLW(sendbuf, sendcounts, sdispls, sendtypes, recvbuf, recvcoun- ts, rdispls, recvtypes, comm, request)			1
			2
IN	sendbuf	starting address of send buffer (choice)	3
			4
IN	sendcounts	integer array (of length group size) specifying the number of elements to send to each rank (array of non-negative integers)	5
			6
			7
IN	sdispls	integer array (of length group size). Entry j specifies the displacement in bytes (relative to sendbuf) from which to take the outgoing data destined for process j (array of integers)	8
			9
			10
			11
IN	sendtypes	array of datatypes (of length group size). Entry j specifies the type of data to send to process j (array of handles)	12
			13
			14
			15
OUT	recvbuf	address of receive buffer (choice)	16
IN	recvcoun- ts	integer array (of length group size) specifying the number of elements that can be received from each rank (array of non-negative integers)	17
			18
			19
IN	rdispls	integer array (of length group size). Entry i specifies the displacement in bytes (relative to recvbuf) at which to place the incoming data from process i (array of integers)	20
			21
			22
			23
			24
IN	recvtypes	array of datatypes (of length group size). Entry i specifies the type of data received from process i (array of handles)	25
			26
			27
IN	comm	communicator (handle)	28
OUT	request	communication request (handle)	29
			30
			31
<b>C binding</b>			32
int MPI_Ialltoallw(const void *sendbuf, const int sendcounts[], const int sdispls[], const MPI_Datatype sendtypes[], void *recvbuf, const int recvcoun- ts, const int rdispls[], const MPI_Datatype recvtypes[], MPI_Comm comm, MPI_Request *request)			33
			34
			35
			36
			37
int MPI_Ialltoallw_c(const void *sendbuf, const MPI_Count sendcounts[], const MPI_Aint sdispls[], const MPI_Datatype sendtypes[], void *recvbuf, const MPI_Count recvcoun- ts, const MPI_Aint rdispls[], const MPI_Datatype recvtypes[], MPI_Comm comm, MPI_Request *request)			38
			39
			40
			41
			42
			43
<b>Fortran 2008 binding</b>			44
MPI_Ialltoallw(sendbuf, sendcounts, sdispls, sendtypes, recvbuf, recvcoun- ts, rdispls, recvtypes, comm, request, ierror)			45
			46
		TYPE(*), DIMENSION(..), INTENT(IN), ASYNCHRONOUS :: sendbuf	47
			48

```

1     INTEGER, INTENT(IN), ASYNCHRONOUS :: sendcounts(*), sdispls(*),
2         recvcounts(*), rdispls(*)
3     TYPE(MPI_Datatype), INTENT(IN), ASYNCHRONOUS :: sendtypes(*),
4         recvtypes(*)
5     TYPE(*), DIMENSION(..), ASYNCHRONOUS :: recvbuf
6     TYPE(MPI_Comm), INTENT(IN) :: comm
7     TYPE(MPI_Request), INTENT(OUT) :: request
8     INTEGER, OPTIONAL, INTENT(OUT) :: ierror
9
10    MPI_Ialltoallw(sendbuf, sendcounts, sdispls, sendtypes, recvbuf,
11        recvcounts, rdispls, recvtypes, comm, request, ierror)
12    TYPE(*), DIMENSION(..), INTENT(IN), ASYNCHRONOUS :: sendbuf
13    INTEGER(KIND=MPI_COUNT_KIND), INTENT(IN), ASYNCHRONOUS ::
14        sendcounts(*), recvcounts(*)
15    INTEGER(KIND=MPI_ADDRESS_KIND), INTENT(IN), ASYNCHRONOUS :: sdispls(*),
16        rdispls(*)
17    TYPE(MPI_Datatype), INTENT(IN), ASYNCHRONOUS :: sendtypes(*),
18        recvtypes(*)
19    TYPE(*), DIMENSION(..), ASYNCHRONOUS :: recvbuf
20    TYPE(MPI_Comm), INTENT(IN) :: comm
21    TYPE(MPI_Request), INTENT(OUT) :: request
22    INTEGER, OPTIONAL, INTENT(OUT) :: ierror

```

### Fortran binding

```

24    MPI_IALLTOALLW(SENDBUF, SENDCOUNTS, SDISPLS, SENDTYPES, RECVBUF,
25        RECVCOUNTS, RDISPLS, RECVTYPES, COMM, REQUEST, IERROR)
26    <type> SENDBUF(*), RECVBUF(*)
27    INTEGER SENDCOUNTS(*), SDISPLS(*), SENDTYPES(*), RECVCOUNTS(*),
28        RDISPLS(*), RECVTYPES(*), COMM, REQUEST, IERROR

```

This call starts a nonblocking variant of MPI\_ALLTOALLW (see Section 6.8).

31  
32  
33  
34  
35  
36  
37  
38  
39  
40  
41  
42  
43  
44  
45  
46  
47  
48



## 6.12.7 Nonblocking Reduce

MPI\_IREDUCE(sendbuf, recvbuf, count, datatype, op, root, comm, request)

IN	sendbuf	address of send buffer (choice)	1
OUT	recvbuf	address of receive buffer (choice, significant only at root)	2
IN	count	number of elements in send buffer (non-negative integer)	3
IN	datatype	datatype of elements of send buffer (handle)	4
IN	op	reduce operation (handle)	5
IN	root	rank of root process (integer)	6
IN	comm	communicator (handle)	7
OUT	request	communication request (handle)	8

**C binding**

```
int MPI_Ireduce(const void *sendbuf, void *recvbuf, int count,
               MPI_Datatype datatype, MPI_Op op, int root, MPI_Comm comm,
               MPI_Request *request)
```

```
int MPI_Ireduce_c(const void *sendbuf, void *recvbuf, MPI_Count count,
                  MPI_Datatype datatype, MPI_Op op, int root, MPI_Comm comm,
                  MPI_Request *request)
```

**Fortran 2008 binding**

```
MPI_Ireduce(sendbuf, recvbuf, count, datatype, op, root, comm, request,
            ierror)
    TYPE(*), DIMENSION(..), INTENT(IN), ASYNCHRONOUS :: sendbuf
    TYPE(*), DIMENSION(..), ASYNCHRONOUS :: recvbuf
    INTEGER, INTENT(IN) :: count, root
    TYPE(MPI_Datatype), INTENT(IN) :: datatype
    TYPE(MPI_Op), INTENT(IN) :: op
    TYPE(MPI_Comm), INTENT(IN) :: comm
    TYPE(MPI_Request), INTENT(OUT) :: request
    INTEGER, OPTIONAL, INTENT(OUT) :: ierror
```

```
MPI_Ireduce(sendbuf, recvbuf, count, datatype, op, root, comm, request,
            ierror)
    TYPE(*), DIMENSION(..), INTENT(IN), ASYNCHRONOUS :: sendbuf
    TYPE(*), DIMENSION(..), ASYNCHRONOUS :: recvbuf
    INTEGER(KIND=MPI_COUNT_KIND), INTENT(IN) :: count
    TYPE(MPI_Datatype), INTENT(IN) :: datatype
    TYPE(MPI_Op), INTENT(IN) :: op
    INTEGER, INTENT(IN) :: root
    TYPE(MPI_Comm), INTENT(IN) :: comm
    TYPE(MPI_Request), INTENT(OUT) :: request
```

1       INTEGER, OPTIONAL, INTENT(OUT) :: ierror

### 2       **Fortran binding**

3       MPI\_IREDUCE(SENDBUF, RECVBUF, COUNT, DATATYPE, OP, ROOT, COMM, REQUEST,  
4                    IERROR)

5       <type> SENDBUF(\*), RECVBUF(\*)

6       INTEGER COUNT, DATATYPE, OP, ROOT, COMM, REQUEST, IERROR

7  
8       This call starts a nonblocking variant of MPI\_REDUCE (see Section 6.9.1).

9  
10      *Advice to implementors.* The implementation is explicitly allowed to use different  
11      algorithms for blocking and nonblocking reduction operations that might change the  
12      order of evaluation of the operations. However, as for MPI\_REDUCE, it is strongly  
13      recommended that MPI\_IREDUCE be implemented so that the same result be obtained  
14      whenever the function is applied on the same arguments, appearing in the same order.  
15      Note that this may prevent optimizations that take advantage of the physical location  
16      of processes. (*End of advice to implementors.*)

17      *Advice to users.* For operations which are not truly associative, the result delivered  
18      upon completion of the nonblocking reduction may not exactly equal the result deliv-  
19      ered by the blocking reduction, even when specifying the same arguments in the same  
20      order. (*End of advice to users.*)

### 21 22       6.12.8 Nonblocking All-Reduce

23  
24  
25       MPI\_IALLREDUCE(sendbuf, recvbuf, count, datatype, op, comm, request)

26       IN       sendbuf                   starting address of send buffer (choice)

27       OUT      recvbuf                  starting address of receive buffer (choice)

28       IN       count                    number of elements in send buffer (non-negative  
29                    integer)

30       IN       datatype                datatype of elements of send buffer (handle)

31       IN       op                       operation (handle)

32       IN       comm                    communicator (handle)

33       OUT      request                 communication request (handle)

### 34 35       **C binding**

36       int MPI\_Iallreduce(const void \*sendbuf, void \*recvbuf, int count,  
37                          MPI\_Datatype datatype, MPI\_Op op, MPI\_Comm comm,  
38                          MPI\_Request \*request)

39       int MPI\_Iallreduce\_c(const void \*sendbuf, void \*recvbuf, MPI\_Count count,  
40                          MPI\_Datatype datatype, MPI\_Op op, MPI\_Comm comm,  
41                          MPI\_Request \*request)

### 42 43       **Fortran 2008 binding**

44       MPI\_Iallreduce(sendbuf, recvbuf, count, datatype, op, comm, request,  
45                      ierror)

```

TYPE(*), DIMENSION(..), INTENT(IN), ASYNCHRONOUS :: sendbuf      1
TYPE(*), DIMENSION(..), ASYNCHRONOUS :: recvbuf                 2
INTEGER, INTENT(IN) :: count                                    3
TYPE(MPI_Datatype), INTENT(IN) :: datatype                      4
TYPE(MPI_Op), INTENT(IN) :: op                                  5
TYPE(MPI_Comm), INTENT(IN) :: comm                              6
TYPE(MPI_Request), INTENT(OUT) :: request                       7
INTEGER, OPTIONAL, INTENT(OUT) :: ierror                       8
MPI_Iallreduce(sendbuf, recvbuf, count, datatype, op, comm, request, 9
               ierror)                                         10
TYPE(*), DIMENSION(..), INTENT(IN), ASYNCHRONOUS :: sendbuf    11
TYPE(*), DIMENSION(..), ASYNCHRONOUS :: recvbuf                 12
INTEGER(KIND=MPI_COUNT_KIND), INTENT(IN) :: count               13
TYPE(MPI_Datatype), INTENT(IN) :: datatype                      14
TYPE(MPI_Op), INTENT(IN) :: op                                  15
TYPE(MPI_Comm), INTENT(IN) :: comm                              16
TYPE(MPI_Request), INTENT(OUT) :: request                       17
INTEGER, OPTIONAL, INTENT(OUT) :: ierror                       18

```

**Fortran binding**

```

MPI_IALLREDUCE(SENDBUF, RECVBUF, COUNT, DATATYPE, OP, COMM, REQUEST, 21
              IERROR)                                          22
<type> SENDBUF(*), RECVBUF(*)                                  23
INTEGER COUNT, DATATYPE, OP, COMM, REQUEST, IERROR           24

```

This call starts a nonblocking variant of MPI\_ALLREDUCE (see Section 6.9.6).

## 6.12.9 Nonblocking Reduce-Scatter with Equal Blocks

```

MPI_IREDUCE_SCATTER_BLOCK(sendbuf, recvbuf, recvcnt, datatype, op, comm, 31
                          request)                               32
IN      sendbuf          starting address of send buffer (choice) 33
OUT     recvbuf          starting address of receive buffer (choice) 34
IN      recvcnt          element count per block (non-negative integer) 35
IN      datatype         datatype of elements of send and receive buffers 36
                          (handle)                                     37
IN      op               operation (handle)                          38
IN      comm             communicator (handle)                        39
OUT     request          communication request (handle)               40

```

**C binding**

```

int MPI_Ireduce_scatter_block(const void *sendbuf, void *recvbuf, 45
                              int recvcnt, MPI_Datatype datatype, MPI_Op op,
                              MPI_Comm comm, MPI_Request *request) 46

```

```

1 int MPI_Ireduce_scatter_block_c(const void *sendbuf, void *recvbuf,
2     MPI_Count recvcnt, MPI_Datatype datatype, MPI_Op op,
3     MPI_Comm comm, MPI_Request *request)
4

```

#### Fortran 2008 binding

```

5 MPI_Ireduce_scatter_block(sendbuf, recvbuf, recvcnt, datatype, op, comm,
6     request, ierror)
7     TYPE(*), DIMENSION(..), INTENT(IN), ASYNCHRONOUS :: sendbuf
8     TYPE(*), DIMENSION(..), ASYNCHRONOUS :: recvbuf
9     INTEGER, INTENT(IN) :: recvcnt
10    TYPE(MPI_Datatype), INTENT(IN) :: datatype
11    TYPE(MPI_Op), INTENT(IN) :: op
12    TYPE(MPI_Comm), INTENT(IN) :: comm
13    TYPE(MPI_Request), INTENT(OUT) :: request
14    INTEGER, OPTIONAL, INTENT(OUT) :: ierror
15
16 MPI_Ireduce_scatter_block(sendbuf, recvbuf, recvcnt, datatype, op, comm,
17     request, ierror)
18    TYPE(*), DIMENSION(..), INTENT(IN), ASYNCHRONOUS :: sendbuf
19    TYPE(*), DIMENSION(..), ASYNCHRONOUS :: recvbuf
20    INTEGER(KIND=MPI_COUNT_KIND), INTENT(IN) :: recvcnt
21    TYPE(MPI_Datatype), INTENT(IN) :: datatype
22    TYPE(MPI_Op), INTENT(IN) :: op
23    TYPE(MPI_Comm), INTENT(IN) :: comm
24    TYPE(MPI_Request), INTENT(OUT) :: request
25    INTEGER, OPTIONAL, INTENT(OUT) :: ierror
26

```

#### Fortran binding

```

27 MPI_IREDUCE_SCATTER_BLOCK(SENDBUF, RECVBUF, RECVCOUNT, DATATYPE, OP, COMM,
28     REQUEST, IERROR)
29     <type> SENDBUF(*), RECVBUF(*)
30     INTEGER RECVCOUNT, DATATYPE, OP, COMM, REQUEST, IERROR
31

```

32 This call starts a nonblocking variant of MPI\_REDUCE\_SCATTER\_BLOCK (see Sec-  
33 tion [6.10.1](#)).

## 6.12.10 Nonblocking Reduce-Scatter

MPI\_IREDUCE\_SCATTER(sendbuf, recvbuf, recvcnts, datatype, op, comm, request)

IN	sendbuf	starting address of send buffer (choice)
OUT	recvbuf	starting address of receive buffer (choice)
IN	recvcnts	non-negative integer array specifying the number of elements in result distributed to each process. This array must be identical on all calling processes.
IN	datatype	datatype of elements of input buffer (handle)
IN	op	operation (handle)
IN	comm	communicator (handle)
OUT	request	communication request (handle)

**C binding**

```
int MPI_Ireduce_scatter(const void *sendbuf, void *recvbuf,
                       const int recvcnts[], MPI_Datatype datatype, MPI_Op op,
                       MPI_Comm comm, MPI_Request *request)
```

```
int MPI_Ireduce_scatter_c(const void *sendbuf, void *recvbuf,
                          const MPI_Count recvcnts[], MPI_Datatype datatype,
                          MPI_Op op, MPI_Comm comm, MPI_Request *request)
```

**Fortran 2008 binding**

```
MPI_Ireduce_scatter(sendbuf, recvbuf, recvcnts, datatype, op, comm,
                    request, ierror)
```

```
TYPE(*), DIMENSION(..), INTENT(IN), ASYNCHRONOUS :: sendbuf
```

```
TYPE(*), DIMENSION(..), ASYNCHRONOUS :: recvbuf
```

```
INTEGER, INTENT(IN), ASYNCHRONOUS :: recvcnts(*)
```

```
TYPE(MPI_Datatype), INTENT(IN) :: datatype
```

```
TYPE(MPI_Op), INTENT(IN) :: op
```

```
TYPE(MPI_Comm), INTENT(IN) :: comm
```

```
TYPE(MPI_Request), INTENT(OUT) :: request
```

```
INTEGER, OPTIONAL, INTENT(OUT) :: ierror
```

```
MPI_Ireduce_scatter(sendbuf, recvbuf, recvcnts, datatype, op, comm,
                    request, ierror)
```

```
TYPE(*), DIMENSION(..), INTENT(IN), ASYNCHRONOUS :: sendbuf
```

```
TYPE(*), DIMENSION(..), ASYNCHRONOUS :: recvbuf
```

```
INTEGER(KIND=MPI_COUNT_KIND), INTENT(IN), ASYNCHRONOUS :: recvcnts(*)
```

```
TYPE(MPI_Datatype), INTENT(IN) :: datatype
```

```
TYPE(MPI_Op), INTENT(IN) :: op
```

```
TYPE(MPI_Comm), INTENT(IN) :: comm
```

```
TYPE(MPI_Request), INTENT(OUT) :: request
```

```
INTEGER, OPTIONAL, INTENT(OUT) :: ierror
```

**Fortran binding**

```

1 MPI_IREDUCE_SCATTER(SENDBUF, RECVBUF, RECVCOUNTS, DATATYPE, OP, COMM,
2     REQUEST, IERROR)
3     <type> SENDBUF(*), RECVBUF(*)
4     INTEGER RECVCOUNTS(*), DATATYPE, OP, COMM, REQUEST, IERROR
5
6
7
8

```

This call starts a nonblocking variant of MPI\_REDUCE\_SCATTER (see Section 6.10.2).

**6.12.11 Nonblocking Inclusive Scan**

```

9
10
11
12 MPI_ISCAN(sendbuf, recvbuf, count, datatype, op, comm, request)
13
14
15
16
17
18
19
20
21
22
23

```

IN	sendbuf	starting address of send buffer (choice)
OUT	recvbuf	starting address of receive buffer (choice)
IN	count	number of elements in input buffer (non-negative integer)
IN	datatype	datatype of elements of input buffer (handle)
IN	op	operation (handle)
IN	comm	communicator (handle)
OUT	request	communication request (handle)

**C binding**

```

24
25 int MPI_Iscan(const void *sendbuf, void *recvbuf, int count,
26     MPI_Datatype datatype, MPI_Op op, MPI_Comm comm,
27     MPI_Request *request)
28
29
30
31
32

```

```

33 int MPI_Iscan_c(const void *sendbuf, void *recvbuf, MPI_Count count,
34     MPI_Datatype datatype, MPI_Op op, MPI_Comm comm,
35     MPI_Request *request)
36
37
38
39
40

```

**Fortran 2008 binding**

```

41 MPI_Iscan(sendbuf, recvbuf, count, datatype, op, comm, request, ierror)
42     TYPE(*), DIMENSION(..), INTENT(IN), ASYNCHRONOUS :: sendbuf
43     TYPE(*), DIMENSION(..), ASYNCHRONOUS :: recvbuf
44     INTEGER, INTENT(IN) :: count
45     TYPE(MPI_Datatype), INTENT(IN) :: datatype
46     TYPE(MPI_Op), INTENT(IN) :: op
47     TYPE(MPI_Comm), INTENT(IN) :: comm
48     TYPE(MPI_Request), INTENT(OUT) :: request
49     INTEGER, OPTIONAL, INTENT(OUT) :: ierror
50
51
52
53

```

```

54 MPI_Iscan(sendbuf, recvbuf, count, datatype, op, comm, request, ierror)
55     TYPE(*), DIMENSION(..), INTENT(IN), ASYNCHRONOUS :: sendbuf
56     TYPE(*), DIMENSION(..), ASYNCHRONOUS :: recvbuf
57     INTEGER(KIND=MPI_COUNT_KIND), INTENT(IN) :: count
58     TYPE(MPI_Datatype), INTENT(IN) :: datatype
59     TYPE(MPI_Op), INTENT(IN) :: op
60
61
62
63

```

```

TYPE(MPI_Comm), INTENT(IN) :: comm
TYPE(MPI_Request), INTENT(OUT) :: request
INTEGER, OPTIONAL, INTENT(OUT) :: ierror

```

**Fortran binding**

```

MPI_ISCAN(SENDBUF, RECVBUF, COUNT, DATATYPE, OP, COMM, REQUEST, IERROR)
  <type> SENDBUF(*), RECVBUF(*)
  INTEGER COUNT, DATATYPE, OP, COMM, REQUEST, IERROR

```

This call starts a nonblocking variant of MPI\_SCAN (see Section 6.11).

## 6.12.12 Nonblocking Exclusive Scan

```

MPI_IEXSCAN(sendbuf, recvbuf, count, datatype, op, comm, request)

```

IN	sendbuf	starting address of send buffer (choice)
OUT	recvbuf	starting address of receive buffer (choice)
IN	count	number of elements in input buffer (non-negative integer)
IN	datatype	datatype of elements of input buffer (handle)
IN	op	operation (handle)
IN	comm	intra-communicator (handle)
OUT	request	communication request (handle)

**C binding**

```

int MPI_Iexscan(const void *sendbuf, void *recvbuf, int count,
               MPI_Datatype datatype, MPI_Op op, MPI_Comm comm,
               MPI_Request *request)

```

```

int MPI_Iexscan_c(const void *sendbuf, void *recvbuf, MPI_Count count,
                 MPI_Datatype datatype, MPI_Op op, MPI_Comm comm,
                 MPI_Request *request)

```

**Fortran 2008 binding**

```

MPI_Iexscan(sendbuf, recvbuf, count, datatype, op, comm, request, ierror)
  TYPE(*), DIMENSION(..), INTENT(IN), ASYNCHRONOUS :: sendbuf
  TYPE(*), DIMENSION(..), ASYNCHRONOUS :: recvbuf
  INTEGER, INTENT(IN) :: count
  TYPE(MPI_Datatype), INTENT(IN) :: datatype
  TYPE(MPI_Op), INTENT(IN) :: op
  TYPE(MPI_Comm), INTENT(IN) :: comm
  TYPE(MPI_Request), INTENT(OUT) :: request
  INTEGER, OPTIONAL, INTENT(OUT) :: ierror

```

```

MPI_Iexscan(sendbuf, recvbuf, count, datatype, op, comm, request, ierror)
  TYPE(*), DIMENSION(..), INTENT(IN), ASYNCHRONOUS :: sendbuf
  TYPE(*), DIMENSION(..), ASYNCHRONOUS :: recvbuf

```

```

1  INTEGER(KIND=MPI_COUNT_KIND), INTENT(IN) :: count
2  TYPE(MPI_Datatype), INTENT(IN) :: datatype
3  TYPE(MPI_Op), INTENT(IN) :: op
4  TYPE(MPI_Comm), INTENT(IN) :: comm
5  TYPE(MPI_Request), INTENT(OUT) :: request
6  INTEGER, OPTIONAL, INTENT(OUT) :: ierror

```

### Fortran binding

```

8  MPI_IEXSCAN(SENDBUF, RECVBUF, COUNT, DATATYPE, OP, COMM, REQUEST, IERROR)
9  <type> SENDBUF(*), RECVBUF(*)
10  INTEGER COUNT, DATATYPE, OP, COMM, REQUEST, IERROR

```

This call starts a nonblocking variant of MPI\_EXSCAN (see Section 6.11.2).

## 6.13 Persistent Collective Operations

Many parallel computation algorithms involve repetitively executing a collective communication operation with the same arguments each time. As with persistent point-to-point operations (see Section 3.9), persistent collective operations allow the MPI programmer to specify operations that will be reused frequently (with fixed arguments). MPI can be designed to select a more efficient way to perform the collective operation based on the parameters specified when the operation is initialized. This “planned-transfer” approach [52, 41] can offer significant performance benefits for programs with repetitive communication patterns.

In terms of data movement, each persistent collective operation has the same effect as its blocking and nonblocking counterparts for intra-communicators and inter-communicators after completion. Likewise, upon completion, persistent collective reduction operations perform the same operation as their blocking and nonblocking counterparts, and the same restrictions and recommendations on reduction orders apply (see also Section 6.9.1).

Initialization calls for MPI persistent collective operations are non-local and follow all the existing rules for collective operations, in particular ordering; programs that do not conform to these restrictions are erroneous. After initialization, all arrays associated with input arguments (such as arrays of counts, displacements, and datatypes in the vector versions of the collectives) must not be modified until the corresponding persistent request is freed with MPI\_REQUEST\_FREE.

According to the definitions in Section 2.4.2, the persistent collective initialization procedures are incomplete. They are also non-local procedures because they may or may not return before they are called in all MPI processes of the process group associated with the specified communicator.

*Advice to users.* This is one of the exceptions in which incomplete procedures are non-local and therefore blocking. (*End of advice to users.*)

The `request` argument is an output argument that can be used zero or more times with MPI\_START or MPI\_STARTALL in order to start the collective operation. The `request` is initially inactive after the initialization call. Once initialized, persistent collective operations can be started in any order and the order can differ among processes in the communicator.

*Rationale.* All ordering requirements that an implementation may need to match up collective operations across the communicator are achieved through the ordering



requirements of the initialization functions. This enables out-of-order starts for the persistent operations, and particularly supports their use in MPI\_STARTALL. (*End of rationale.*)

*Advice to implementors.* An MPI implementation should do no worse than duplicating the communicator during the initialization function, caching the input arguments, and calling the appropriate nonblocking collective function, using the cached arguments, during MPI\_START. High-quality implementations should be able to amortize setup costs and further optimize by taking advantage of early-binding, such as efficient and effective pre-allocation of certain resources and algorithm selection. (*End of advice to implementors.*)

A request must be inactive when it is started. Starting the operation makes the request active. Once any process starts a persistent collective operation, it must complete that operation and all other processes in the communicator must eventually start (and complete) the same persistent collective operation. Persistent collective operations cannot be matched with blocking or nonblocking collective operations. Completion of a persistent collective operation makes the corresponding request inactive. After starting a persistent collective operation, all associated send buffers must not be modified and all associated receive buffers must not be accessed until the corresponding persistent request is completed.

Completing a persistent collective request, for example using MPI\_TEST or MPI\_WAIT, makes it inactive, but does not free the request. This is the same behavior as for persistent point-to-point requests. Inactive persistent collective requests can be freed using MPI\_REQUEST\_FREE. It is erroneous to free an active persistent collective request. Persistent collective operations cannot be canceled; it is erroneous to use MPI\_CANCEL on a persistent collective request.

For every nonblocking collective communication operation in MPI, there is a corresponding persistent collective operation with the analogous API signature.

The collective persistent API signatures include an info object in order to support optimization hints and other information that may be non-standard. Persistent collective operations may be optimized during communicator creation or by the initialization operation of an individual persistent collective. Note that communicator-scoped hints should be provided using MPI\_COMM\_SET\_INFO while, for operation-scoped hints, they are supplied to the persistent collective communication initialization functions using the info argument.

### 6.13.1 Persistent Barrier Synchronization

MPI\_BARRIER\_INIT(comm, info, request)

IN	comm	communicator (handle)
IN	info	info argument (handle)
OUT	request	communication request (handle)

#### C binding

```
int MPI_Barrier_init(MPI_Comm comm, MPI_Info info, MPI_Request *request)
```

#### Fortran 2008 binding

```
MPI_Barrier_init(comm, info, request, ierror)
```

```

1     TYPE(MPI_Comm), INTENT(IN) :: comm
2     TYPE(MPI_Info), INTENT(IN) :: info
3     TYPE(MPI_Request), INTENT(OUT) :: request
4     INTEGER, OPTIONAL, INTENT(OUT) :: ierror

```

### Fortran binding

```

7 MPI_BARRIER_INIT(COMM, INFO, REQUEST, IERROR)
8     INTEGER COMM, INFO, REQUEST, IERROR

```

Creates a persistent collective communication request for the barrier operation.

### 6.13.2 Persistent Broadcast

```

14 MPI_BCAST_INIT(buffer, count, datatype, root, comm, info, request)

```

16	INOUT	buffer	starting address of buffer (choice)
17	IN	count	number of entries in buffer (non-negative integer)
18	IN	datatype	datatype of buffer (handle)
20	IN	root	rank of broadcast root (integer)
21	IN	comm	communicator (handle)
22	IN	info	info argument (handle)
24	OUT	request	communication request (handle)

### C binding

```

27 int MPI_Bcast_init(void *buffer, int count, MPI_Datatype datatype,
28                   int root, MPI_Comm comm, MPI_Info info, MPI_Request *request)

```

```

29 int MPI_Bcast_init_c(void *buffer, MPI_Count count, MPI_Datatype datatype,
30                     int root, MPI_Comm comm, MPI_Info info, MPI_Request *request)

```

### Fortran 2008 binding

```

33 MPI_Bcast_init(buffer, count, datatype, root, comm, info, request, ierror)

```

```

34     TYPE(*), DIMENSION(..), ASYNCHRONOUS :: buffer

```

```

35     INTEGER, INTENT(IN) :: count, root

```

```

36     TYPE(MPI_Datatype), INTENT(IN) :: datatype

```

```

37     TYPE(MPI_Comm), INTENT(IN) :: comm

```

```

38     TYPE(MPI_Info), INTENT(IN) :: info

```

```

39     TYPE(MPI_Request), INTENT(OUT) :: request

```

```

40     INTEGER, OPTIONAL, INTENT(OUT) :: ierror

```

```

42 MPI_Bcast_init(buffer, count, datatype, root, comm, info, request, ierror)

```

```

43     TYPE(*), DIMENSION(..), ASYNCHRONOUS :: buffer

```

```

44     INTEGER(KIND=MPI_COUNT_KIND), INTENT(IN) :: count

```

```

45     TYPE(MPI_Datatype), INTENT(IN) :: datatype

```

```

46     INTEGER, INTENT(IN) :: root

```

```

47     TYPE(MPI_Comm), INTENT(IN) :: comm

```

```

48     TYPE(MPI_Info), INTENT(IN) :: info

```

```

TYPE(MPI_Request), INTENT(OUT) :: request
INTEGER, OPTIONAL, INTENT(OUT) :: ierror

```

**Fortran binding**

```

MPI_BCAST_INIT(BUFFER, COUNT, DATATYPE, ROOT, COMM, INFO, REQUEST, IERROR)
  <type> BUFFER(*)
  INTEGER COUNT, DATATYPE, ROOT, COMM, INFO, REQUEST, IERROR

```

Creates a persistent collective communication request for the broadcast operation.

## 6.13.3 Persistent Gather

```

MPI_GATHER_INIT(sendbuf, sendcount, sendtype, recvbuf, recvcnt, recvtpe, root, comm,
  info, request)

```

IN	sendbuf	starting address of send buffer (choice)
IN	sendcount	number of elements in send buffer (non-negative integer)
IN	sendtype	datatype of send buffer elements (handle)
OUT	recvbuf	address of receive buffer (choice, significant only at root)
IN	recvcnt	number of elements for any single receive (non-negative integer, significant only at root)
IN	recvtpe	datatype of recv buffer elements (handle, significant only at root)
IN	root	rank of receiving process (integer)
IN	comm	communicator (handle)
IN	info	info argument (handle)
OUT	request	communication request (handle)

**C binding**

```

int MPI_Gather_init(const void *sendbuf, int sendcount,
  MPI_Datatype sendtype, void *recvbuf, int recvcnt,
  MPI_Datatype recvtpe, int root, MPI_Comm comm, MPI_Info info,
  MPI_Request *request)

```

```

int MPI_Gather_init_c(const void *sendbuf, MPI_Count sendcount,
  MPI_Datatype sendtype, void *recvbuf, MPI_Count recvcnt,
  MPI_Datatype recvtpe, int root, MPI_Comm comm, MPI_Info info,
  MPI_Request *request)

```

**Fortran 2008 binding**

```

MPI_Gather_init(sendbuf, sendcount, sendtype, recvbuf, recvcnt, recvtpe,
  root, comm, info, request, ierror)
  TYPE(*), DIMENSION(..), INTENT(IN), ASYNCHRONOUS :: sendbuf
  INTEGER, INTENT(IN) :: sendcount, recvcnt, root

```

```

1     TYPE(MPI_Datatype), INTENT(IN) :: sendtype, recvtype
2     TYPE(*), DIMENSION(..), ASYNCHRONOUS :: recvbuf
3     TYPE(MPI_Comm), INTENT(IN) :: comm
4     TYPE(MPI_Info), INTENT(IN) :: info
5     TYPE(MPI_Request), INTENT(OUT) :: request
6     INTEGER, OPTIONAL, INTENT(OUT) :: ierror
7
8     MPI_Gather_init(sendbuf, sendcount, sendtype, recvbuf, recvcount, recvtype,
9                   root, comm, info, request, ierror)
10    TYPE(*), DIMENSION(..), INTENT(IN), ASYNCHRONOUS :: sendbuf
11    INTEGER(KIND=MPI_COUNT_KIND), INTENT(IN) :: sendcount, recvcount
12    TYPE(MPI_Datatype), INTENT(IN) :: sendtype, recvtype
13    TYPE(*), DIMENSION(..), ASYNCHRONOUS :: recvbuf
14    INTEGER, INTENT(IN) :: root
15    TYPE(MPI_Comm), INTENT(IN) :: comm
16    TYPE(MPI_Info), INTENT(IN) :: info
17    TYPE(MPI_Request), INTENT(OUT) :: request
18    INTEGER, OPTIONAL, INTENT(OUT) :: ierror

```

### Fortran binding

```

19
20    MPI_GATHER_INIT(SENDBUF, SENDCOUNT, SENDTYPE, RECVBUF, RECVCOUNT, RECVTYPE,
21                  ROOT, COMM, INFO, REQUEST, IERROR)
22    <type> SENDBUF(*), RECVBUF(*)
23    INTEGER SENDCOUNT, SENDTYPE, RECVCOUNT, RECVTYPE, ROOT, COMM, INFO,
24          REQUEST, IERROR

```

Creates a persistent collective communication request for the gather operation.

25  
26  
27  
28  
29  
30  
31  
32  
33  
34  
35  
36  
37  
38  
39  
40  
41  
42  
43  
44  
45  
46  
47  
48

MPI_GATHERV_INIT(sendbuf, sendcount, sendtype, recvbuf, recvcnts, displs, recvtype,			1
root, comm, info, request)			2
IN	sendbuf	starting address of send buffer (choice)	3
			4
IN	sendcount	number of elements in send buffer (non-negative integer)	5
			6
IN	sendtype	datatype of send buffer elements (handle)	7
OUT	recvbuf	address of receive buffer (choice, significant only at root)	8
			9
IN	recvcnts	non-negative integer array (of length group size) containing the number of elements that are received from each process (significant only at root)	10
			11
			12
IN	displs	integer array (of length group size). Entry i specifies the displacement relative to recvbuf at which to place the incoming data from process i (significant only at root)	13
			14
			15
			16
IN	recvtype	datatype of recv buffer elements (handle, significant only at root)	17
			18
			19
IN	root	rank of receiving process (integer)	20
			21
IN	comm	communicator (handle)	22
			23
IN	info	info argument (handle)	24
			25
OUT	request	communication request (handle)	26

**C binding**

```

int MPI_Gatherv_init(const void *sendbuf, int sendcount,
    MPI_Datatype sendtype, void *recvbuf, const int recvcnts[],
    const int displs[], MPI_Datatype recvtype, int root,
    MPI_Comm comm, MPI_Info info, MPI_Request *request)
int MPI_Gatherv_init_c(const void *sendbuf, MPI_Count sendcount,
    MPI_Datatype sendtype, void *recvbuf,
    const MPI_Count recvcnts[], const MPI_Aint displs[],
    MPI_Datatype recvtype, int root, MPI_Comm comm, MPI_Info info,
    MPI_Request *request)

```

**Fortran 2008 binding**

```

MPI_Gatherv_init(sendbuf, sendcount, sendtype, recvbuf, recvcnts, displs,
    recvtype, root, comm, info, request, ierror)
TYPE(*), DIMENSION(..), INTENT(IN), ASYNCHRONOUS :: sendbuf
INTEGER, INTENT(IN) :: sendcount, root
TYPE(MPI_Datatype), INTENT(IN) :: sendtype, recvtype
TYPE(*), DIMENSION(..), ASYNCHRONOUS :: recvbuf
INTEGER, INTENT(IN), ASYNCHRONOUS :: recvcnts(*), displs(*)
TYPE(MPI_Comm), INTENT(IN) :: comm
TYPE(MPI_Info), INTENT(IN) :: info
TYPE(MPI_Request), INTENT(OUT) :: request

```

```

1     INTEGER, OPTIONAL, INTENT(OUT) :: ierror
2
3     MPI_Gatherv_init(sendbuf, sendcount, sendtype, recvbuf, recvcounts, displs,
4         recvtype, root, comm, info, request, ierror)
5     TYPE(*), DIMENSION(..), INTENT(IN), ASYNCHRONOUS :: sendbuf
6     INTEGER(KIND=MPI_COUNT_KIND), INTENT(IN) :: sendcount
7     TYPE(MPI_Datatype), INTENT(IN) :: sendtype, recvtype
8     TYPE(*), DIMENSION(..), ASYNCHRONOUS :: recvbuf
9     INTEGER(KIND=MPI_COUNT_KIND), INTENT(IN), ASYNCHRONOUS :: recvcounts(*)
10    INTEGER(KIND=MPI_ADDRESS_KIND), INTENT(IN), ASYNCHRONOUS :: displs(*)
11    INTEGER, INTENT(IN) :: root
12    TYPE(MPI_Comm), INTENT(IN) :: comm
13    TYPE(MPI_Info), INTENT(IN) :: info
14    TYPE(MPI_Request), INTENT(OUT) :: request
15    INTEGER, OPTIONAL, INTENT(OUT) :: ierror

```

### Fortran binding

```

17    MPI_GATHERV_INIT(SENDBUF, SENDCOUNT, SENDTYPE, RECVBUF, RECVCOUNTS, DISPLS,
18        RECVTYPE, ROOT, COMM, INFO, REQUEST, IERROR)
19    <type> SENDBUF(*), RECVBUF(*)
20    INTEGER SENDCOUNT, SENDTYPE, RECVCOUNTS(*), DISPLS(*), RECVTYPE, ROOT,
21        COMM, INFO, REQUEST, IERROR

```

Creates a persistent collective communication request for the gatherv operation.

22  
23  
24  
25  
26  
27  
28  
29  
30  
31  
32  
33  
34  
35  
36  
37  
38  
39  
40  
41  
42  
43  
44  
45  
46  
47  
48

## 6.13.4 Persistent Scatter

			1
			2
			3
			4
			5
			6
IN	sendbuf	address of send buffer (choice, significant only at root)	7
			8
IN	sendcount	number of elements sent to each process (non-negative integer, significant only at root)	9
			10
IN	sendtype	datatype of send buffer elements (handle, significant only at root)	11
			12
OUT	recvbuf	address of receive buffer (choice)	13
			14
IN	recvcount	number of elements in receive buffer (non-negative integer)	15
			16
IN	recvtype	datatype of receive buffer elements (handle)	17
			18
IN	root	rank of sending process (integer)	19
			20
IN	comm	communicator (handle)	21
			22
IN	info	info argument (handle)	23
			24
OUT	request	communication request (handle)	25

**C binding**

```
int MPI_Scatter_init(const void *sendbuf, int sendcount,
    MPI_Datatype sendtype, void *recvbuf, int recvcount,
    MPI_Datatype recvtype, int root, MPI_Comm comm, MPI_Info info,
    MPI_Request *request)
```

```
int MPI_Scatter_init_c(const void *sendbuf, MPI_Count sendcount,
    MPI_Datatype sendtype, void *recvbuf, MPI_Count recvcount,
    MPI_Datatype recvtype, int root, MPI_Comm comm, MPI_Info info,
    MPI_Request *request)
```

**Fortran 2008 binding**

```
MPI_Scatter_init(sendbuf, sendcount, sendtype, recvbuf, recvcount,
    recvtype, root, comm, info, request, ierror)
    TYPE(*), DIMENSION(..), INTENT(IN), ASYNCHRONOUS :: sendbuf
    INTEGER, INTENT(IN) :: sendcount, recvcount, root
    TYPE(MPI_Datatype), INTENT(IN) :: sendtype, recvtype
    TYPE(*), DIMENSION(..), ASYNCHRONOUS :: recvbuf
    TYPE(MPI_Comm), INTENT(IN) :: comm
    TYPE(MPI_Info), INTENT(IN) :: info
    TYPE(MPI_Request), INTENT(OUT) :: request
    INTEGER, OPTIONAL, INTENT(OUT) :: ierror
```

```
MPI_Scatter_init(sendbuf, sendcount, sendtype, recvbuf, recvcount,
    recvtype, root, comm, info, request, ierror)
```

```

1  TYPE(*), DIMENSION(..), INTENT(IN), ASYNCHRONOUS :: sendbuf
2  INTEGER(KIND=MPI_COUNT_KIND), INTENT(IN) :: sendcount, recvcnt
3  TYPE(MPI_Datatype), INTENT(IN) :: sendtype, recvtype
4  TYPE(*), DIMENSION(..), ASYNCHRONOUS :: recvbuf
5  INTEGER, INTENT(IN) :: root
6  TYPE(MPI_Comm), INTENT(IN) :: comm
7  TYPE(MPI_Info), INTENT(IN) :: info
8  TYPE(MPI_Request), INTENT(OUT) :: request
9  INTEGER, OPTIONAL, INTENT(OUT) :: ierror

```

### Fortran binding

```

10 MPI_SCATTER_INIT(SENDBUF, SENDCOUNT, SENDTYPE, RECVBUF, RECVCOUNT,
11                 RECVTYPE, ROOT, COMM, INFO, REQUEST, IERROR)
12 <type> SENDBUF(*), RECVBUF(*)
13 INTEGER SENDCOUNT, SENDTYPE, RECVCOUNT, RECVTYPE, ROOT, COMM, INFO,
14 REQUEST, IERROR

```

Creates a persistent collective communication request for the scatter operation.

```

15 MPI_SCATTERV_INIT(sendbuf, sendcounts, displs, sendtype, recvbuf, recvcnt, recvtype,
16                 root, comm, info, request)

```

17	IN	sendbuf	address of send buffer (choice, significant only at root)
18			
19	IN	sendcounts	non-negative integer array (of length group size) specifying the number of elements to send to each rank (significant only at root)
20			
21	IN	displs	integer array (of length group size). Entry <i>i</i> specifies the displacement (relative to <code>sendbuf</code> ) from which to take the outgoing data to process <i>i</i> (significant only at root)
22			
23	IN	sendtype	datatype of send buffer elements (handle, significant only at root)
24			
25	OUT	recvbuf	address of receive buffer (choice, significant only at root)
26			
27	IN	recvcnt	number of elements in receive buffer (non-negative integer)
28			
29	IN	recvtype	datatype of receive buffer elements (handle)
30			
31	IN	root	rank of sending process (integer)
32			
33	IN	comm	communicator (handle)
34			
35	IN	info	info argument (handle)
36			
37	OUT	request	communication request (handle)
38			

### C binding

```

39 int MPI_Scatterv_init(const void *sendbuf, const int sendcounts[],
40                     const int displs[], MPI_Datatype sendtype, void *recvbuf,

```



```

        int recvcount, MPI_Datatype recvtype, int root, MPI_Comm comm,
        MPI_Info info, MPI_Request *request)
int MPI_Scatterv_init_c(const void *sendbuf, const MPI_Count sendcounts[],
        const MPI_Aint displs[], MPI_Datatype sendtype, void *recvbuf,
        MPI_Count recvcount, MPI_Datatype recvtype, int root,
        MPI_Comm comm, MPI_Info info, MPI_Request *request)
Fortran 2008 binding
MPI_Scatterv_init(sendbuf, sendcounts, displs, sendtype, recvbuf,
        recvcount, recvtype, root, comm, info, request, ierror)
TYPE(*), DIMENSION(..), INTENT(IN), ASYNCHRONOUS :: sendbuf
INTEGER, INTENT(IN), ASYNCHRONOUS :: sendcounts(*), displs(*)
TYPE(MPI_Datatype), INTENT(IN) :: sendtype, recvtype
TYPE(*), DIMENSION(..), ASYNCHRONOUS :: recvbuf
INTEGER, INTENT(IN) :: recvcount, root
TYPE(MPI_Comm), INTENT(IN) :: comm
TYPE(MPI_Info), INTENT(IN) :: info
TYPE(MPI_Request), INTENT(OUT) :: request
INTEGER, OPTIONAL, INTENT(OUT) :: ierror
MPI_Scatterv_init(sendbuf, sendcounts, displs, sendtype, recvbuf,
        recvcount, recvtype, root, comm, info, request, ierror)
TYPE(*), DIMENSION(..), INTENT(IN), ASYNCHRONOUS :: sendbuf
INTEGER(KIND=MPI_COUNT_KIND), INTENT(IN), ASYNCHRONOUS :: sendcounts(*)
INTEGER(KIND=MPI_ADDRESS_KIND), INTENT(IN), ASYNCHRONOUS :: displs(*)
TYPE(MPI_Datatype), INTENT(IN) :: sendtype, recvtype
TYPE(*), DIMENSION(..), ASYNCHRONOUS :: recvbuf
INTEGER(KIND=MPI_COUNT_KIND), INTENT(IN) :: recvcount
INTEGER, INTENT(IN) :: root
TYPE(MPI_Comm), INTENT(IN) :: comm
TYPE(MPI_Info), INTENT(IN) :: info
TYPE(MPI_Request), INTENT(OUT) :: request
INTEGER, OPTIONAL, INTENT(OUT) :: ierror
Fortran binding
MPI_SCATTERV_INIT(SENDBUF, SENDCOUNTS, DISPLS, SENDTYPE, RECVBUF,
        RECVCOUNT, RECVTYPE, ROOT, COMM, INFO, REQUEST, IERROR)
<type> SENDBUF(*), RECVBUF(*)
INTEGER SENDCOUNTS(*), DISPLS(*), SENDTYPE, RECVCOUNT, RECVTYPE, ROOT,
        COMM, INFO, REQUEST, IERROR

```

Creates a persistent collective communication request for the scatterv operation.

## 6.13.5 Persistent Gather-to-all

```

4 MPI_ALLGATHER_INIT(sendbuf, sendcount, sendtype, recvbuf, recvcount, recvtype, comm,
5 info, request)

```

7	IN	sendbuf	starting address of send buffer (choice)
8	IN	sendcount	number of elements in send buffer (non-negative integer)
10	IN	sendtype	datatype of send buffer elements (handle)
12	OUT	recvbuf	address of receive buffer (choice)
13	IN	recvcount	number of elements received from any process (non-negative integer)
15	IN	recvtype	datatype of receive buffer elements (handle)
17	IN	comm	communicator (handle)
18	IN	info	info argument (handle)
19	OUT	request	communication request (handle)

**C binding**

```

22 int MPI_Allgather_init(const void *sendbuf, int sendcount,
23 MPI_Datatype sendtype, void *recvbuf, int recvcount,
24 MPI_Datatype recvtype, MPI_Comm comm, MPI_Info info,
25 MPI_Request *request)
26
27 int MPI_Allgather_init_c(const void *sendbuf, MPI_Count sendcount,
28 MPI_Datatype sendtype, void *recvbuf, MPI_Count recvcount,
29 MPI_Datatype recvtype, MPI_Comm comm, MPI_Info info,
30 MPI_Request *request)

```

**Fortran 2008 binding**

```

32 MPI_Allgather_init(sendbuf, sendcount, sendtype, recvbuf, recvcount,
33 recvtype, comm, info, request, ierror)
34 TYPE(*), DIMENSION(..), INTENT(IN), ASYNCHRONOUS :: sendbuf
35 INTEGER, INTENT(IN) :: sendcount, recvcount
36 TYPE(MPI_Datatype), INTENT(IN) :: sendtype, recvtype
37 TYPE(*), DIMENSION(..), ASYNCHRONOUS :: recvbuf
38 TYPE(MPI_Comm), INTENT(IN) :: comm
39 TYPE(MPI_Info), INTENT(IN) :: info
40 TYPE(MPI_Request), INTENT(OUT) :: request
41 INTEGER, OPTIONAL, INTENT(OUT) :: ierror
42
43 MPI_Allgather_init(sendbuf, sendcount, sendtype, recvbuf, recvcount,
44 recvtype, comm, info, request, ierror)
45 TYPE(*), DIMENSION(..), INTENT(IN), ASYNCHRONOUS :: sendbuf
46 INTEGER(KIND=MPI_COUNT_KIND), INTENT(IN) :: sendcount, recvcount
47 TYPE(MPI_Datatype), INTENT(IN) :: sendtype, recvtype
48 TYPE(*), DIMENSION(..), ASYNCHRONOUS :: recvbuf

```

```

TYPE(MPI_Comm), INTENT(IN) :: comm
TYPE(MPI_Info), INTENT(IN) :: info
TYPE(MPI_Request), INTENT(OUT) :: request
INTEGER, OPTIONAL, INTENT(OUT) :: ierror

```

**Fortran binding**

```

MPI_ALLGATHER_INIT(SENDBUF, SENDCOUNT, SENDTYPE, RECVBUF, RECVCOUNT,
                   RECVTYPE, COMM, INFO, REQUEST, IERROR)
<type> SENDBUF(*), RECVBUF(*)
INTEGER SENDCOUNT, SENDTYPE, RECVCOUNT, RECVTYPE, COMM, INFO, REQUEST,
                   IERROR

```

Creates a persistent collective communication request for the allgather operation.

```

MPI_ALLGATHERV_INIT(sendbuf, sendcount, sendtype, recvbuf, recvcoun-
                    t, displs, recvtype,
                    comm, info, request)

```

IN	sendbuf	starting address of send buffer (choice)
IN	sendcount	number of elements in send buffer (non-negative integer)
IN	sendtype	datatype of send buffer elements (handle)
OUT	recvbuf	address of receive buffer (choice)
IN	recvcoun-	non-negative integer array (of length group size)
	ts	containing the number of elements that are received from each process
IN	displs	integer array (of length group size). Entry <i>i</i> specifies the displacement (relative to <i>recvbuf</i> ) at which to place the incoming data from process <i>i</i>
IN	recvtype	datatype of receive buffer elements (handle)
IN	comm	communicator (handle)
IN	info	info argument (handle)
OUT	request	communication request (handle)

**C binding**

```

int MPI_Allgatherv_init(const void *sendbuf, int sendcount,
                       MPI_Datatype sendtype, void *recvbuf, const int recvcoun-
                       ts[],
                       const int displs[], MPI_Datatype recvtype, MPI_Comm comm,
                       MPI_Info info, MPI_Request *request)

```

```

int MPI_Allgatherv_init_c(const void *sendbuf, MPI_Count sendcount,
                          MPI_Datatype sendtype, void *recvbuf,
                          const MPI_Count recvcoun-
                          ts[], const MPI_Aint displs[],
                          MPI_Datatype recvtype, MPI_Comm comm, MPI_Info info,
                          MPI_Request *request)

```

**Fortran 2008 binding**

```

1 MPI_Allgatherv_init(sendbuf, sendcount, sendtype, recvbuf, recvcoun
2     displs, recvtype, comm, info, request, ierror)
3     TYPE(*), DIMENSION(..), INTENT(IN), ASYNCHRONOUS :: sendbuf
4     INTEGER, INTENT(IN) :: sendcount
5     TYPE(MPI_Datatype), INTENT(IN) :: sendtype, recvtype
6     TYPE(*), DIMENSION(..), ASYNCHRONOUS :: recvbuf
7     INTEGER, INTENT(IN), ASYNCHRONOUS :: recvcoun(*), displs(*)
8     TYPE(MPI_Comm), INTENT(IN) :: comm
9     TYPE(MPI_Info), INTENT(IN) :: info
10    TYPE(MPI_Request), INTENT(OUT) :: request
11    INTEGER, OPTIONAL, INTENT(OUT) :: ierror
12
13 MPI_Allgatherv_init(sendbuf, sendcount, sendtype, recvbuf, recvcoun
14     displs, recvtype, comm, info, request, ierror)
15     TYPE(*), DIMENSION(..), INTENT(IN), ASYNCHRONOUS :: sendbuf
16     INTEGER(KIND=MPI_COUNT_KIND), INTENT(IN) :: sendcount
17     TYPE(MPI_Datatype), INTENT(IN) :: sendtype, recvtype
18     TYPE(*), DIMENSION(..), ASYNCHRONOUS :: recvbuf
19     INTEGER(KIND=MPI_COUNT_KIND), INTENT(IN), ASYNCHRONOUS :: recvcoun(*)
20     INTEGER(KIND=MPI_ADDRESS_KIND), INTENT(IN), ASYNCHRONOUS :: displs(*)
21     TYPE(MPI_Comm), INTENT(IN) :: comm
22     TYPE(MPI_Info), INTENT(IN) :: info
23     TYPE(MPI_Request), INTENT(OUT) :: request
24     INTEGER, OPTIONAL, INTENT(OUT) :: ierror
25

```

**Fortran binding**

```

26 MPI_ALLGATHERV_INIT(SENDBUF, SENDCOUNT, SENDTYPE, RECVBUF, REVCOUNTS,
27     DISPLS, RECVTYPE, COMM, INFO, REQUEST, IERROR)
28     <type> SENDBUF(*), RECVBUF(*)
29     INTEGER SENDCOUNT, SENDTYPE, REVCOUNTS(*), DISPLS(*), RECVTYPE, COMM,
30     INFO, REQUEST, IERROR
31

```

Creates a persistent collective communication request for the allgatherv operation.

## 6.13.6 Persistent All-to-All Scatter/Gather

MPI\_ALLTOALL\_INIT(sendbuf, sendcount, sendtype, recvbuf, recvcount, recvtype, comm, info, request)

IN	sendbuf	starting address of send buffer (choice)
IN	sendcount	number of elements sent to each process (non-negative integer)
IN	sendtype	datatype of send buffer elements (handle)
OUT	recvbuf	address of receive buffer (choice)
IN	recvcount	number of elements received from any process (non-negative integer)
IN	recvtype	datatype of receive buffer elements (handle)
IN	comm	communicator (handle)
IN	info	info argument (handle)
OUT	request	communication request (handle)

**C binding**

```
int MPI_Alltoall_init(const void *sendbuf, int sendcount,
    MPI_Datatype sendtype, void *recvbuf, int recvcount,
    MPI_Datatype recvtype, MPI_Comm comm, MPI_Info info,
    MPI_Request *request)
```

```
int MPI_Alltoall_init_c(const void *sendbuf, MPI_Count sendcount,
    MPI_Datatype sendtype, void *recvbuf, MPI_Count recvcount,
    MPI_Datatype recvtype, MPI_Comm comm, MPI_Info info,
    MPI_Request *request)
```

**Fortran 2008 binding**

```
MPI_Alltoall_init(sendbuf, sendcount, sendtype, recvbuf, recvcount,
    recvtype, comm, info, request, ierror)
TYPE(*), DIMENSION(..), INTENT(IN), ASYNCHRONOUS :: sendbuf
INTEGER, INTENT(IN) :: sendcount, recvcount
TYPE(MPI_Datatype), INTENT(IN) :: sendtype, recvtype
TYPE(*), DIMENSION(..), ASYNCHRONOUS :: recvbuf
TYPE(MPI_Comm), INTENT(IN) :: comm
TYPE(MPI_Info), INTENT(IN) :: info
TYPE(MPI_Request), INTENT(OUT) :: request
INTEGER, OPTIONAL, INTENT(OUT) :: ierror
```

```
MPI_Alltoall_init(sendbuf, sendcount, sendtype, recvbuf, recvcount,
    recvtype, comm, info, request, ierror)
TYPE(*), DIMENSION(..), INTENT(IN), ASYNCHRONOUS :: sendbuf
INTEGER(KIND=MPI_COUNT_KIND), INTENT(IN) :: sendcount, recvcount
TYPE(MPI_Datatype), INTENT(IN) :: sendtype, recvtype
TYPE(*), DIMENSION(..), ASYNCHRONOUS :: recvbuf
```

```

1     TYPE(MPI_Comm), INTENT(IN) :: comm
2     TYPE(MPI_Info), INTENT(IN) :: info
3     TYPE(MPI_Request), INTENT(OUT) :: request
4     INTEGER, OPTIONAL, INTENT(OUT) :: ierror

```

### Fortran binding

```

6 MPI_ALLTOALL_INIT(SENDBUF, SENDCOUNT, SENDTYPE, RECVBUF, REVCOUNT,
7                   RECVTYPE, COMM, INFO, REQUEST, IERROR)
8   <type> SENDBUF(*), RECVBUF(*)
9   INTEGER SENDCOUNT, SENDTYPE, REVCOUNT, RECVTYPE, COMM, INFO, REQUEST,
10  IERROR

```

Creates a persistent collective communication request for the alltoall operation.

```

14 MPI_ALLTOALLV_INIT(sendbuf, sendcounts, sdispls, sendtype, recvbuf, recvcoun
15  ts, rdispls,
16  recvtype, comm, info, request)

```

17	IN	sendbuf	starting address of send buffer (choice)
18	IN	sendcounts	non-negative integer array (of length group size) specifying the number of elements to send to each rank
19			
20			
21			
22	IN	sdispls	Integer array (of length group size). Entry j specifies the displacement (relative to sendbuf) from which to take the outgoing data destined for process j
23			
24			
25	IN	sendtype	datatype of send buffer elements (handle)
26	OUT	recvbuf	address of receive buffer (choice)
27	IN	recvcoun	non-negative integer array (of length group size) specifying the number of elements that can be received from each rank
28			
29			
30			
31	IN	rdispls	integer array (of length group size). Entry i specifies the displacement (relative to recvbuf) at which to place the incoming data from process i
32			
33			
34	IN	recvtype	datatype of receive buffer elements (handle)
35	IN	comm	communicator (handle)
36	IN	info	info argument (handle)
37	OUT	request	communication request (handle)
38			
39			

### C binding

```

41 int MPI_Alltoallv_init(const void *sendbuf, const int sendcounts[],
42                       const int sdispls[], MPI_Datatype sendtype, void *recvbuf,
43                       const int recvcoun
44  ts, const int rdispls[],
45                       MPI_Datatype recvtype, MPI_Comm comm, MPI_Info info,
46                       MPI_Request *request)

```

```

47 int MPI_Alltoallv_init_c(const void *sendbuf, const MPI_Count sendcounts[],
48                          const MPI_Aint sdispls[], MPI_Datatype sendtype,

```

```

void *recvbuf, const MPI_Count recvcounts[],
const MPI_Aint rdispls[], MPI_Datatype recvtype,
MPI_Comm comm, MPI_Info info, MPI_Request *request)

```

**Fortran 2008 binding**

```

MPI_Alltoallv_init(sendbuf, sendcounts, sdispls, sendtype, recvbuf,
    recvcounts, rdispls, recvtype, comm, info, request, ierror)
TYPE(*), DIMENSION(..), INTENT(IN), ASYNCHRONOUS :: sendbuf
INTEGER, INTENT(IN), ASYNCHRONOUS :: sendcounts(*), sdispls(*),
    recvcounts(*), rdispls(*)
TYPE(MPI_Datatype), INTENT(IN) :: sendtype, recvtype
TYPE(*), DIMENSION(..), ASYNCHRONOUS :: recvbuf
TYPE(MPI_Comm), INTENT(IN) :: comm
TYPE(MPI_Info), INTENT(IN) :: info
TYPE(MPI_Request), INTENT(OUT) :: request
INTEGER, OPTIONAL, INTENT(OUT) :: ierror

```

```

MPI_Alltoallv_init(sendbuf, sendcounts, sdispls, sendtype, recvbuf,
    recvcounts, rdispls, recvtype, comm, info, request, ierror)
TYPE(*), DIMENSION(..), INTENT(IN), ASYNCHRONOUS :: sendbuf
INTEGER(KIND=MPI_COUNT_KIND), INTENT(IN), ASYNCHRONOUS ::
    sendcounts(*), recvcounts(*)
INTEGER(KIND=MPI_ADDRESS_KIND), INTENT(IN), ASYNCHRONOUS :: sdispls(*),
    rdispls(*)
TYPE(MPI_Datatype), INTENT(IN) :: sendtype, recvtype
TYPE(*), DIMENSION(..), ASYNCHRONOUS :: recvbuf
TYPE(MPI_Comm), INTENT(IN) :: comm
TYPE(MPI_Info), INTENT(IN) :: info
TYPE(MPI_Request), INTENT(OUT) :: request
INTEGER, OPTIONAL, INTENT(OUT) :: ierror

```

**Fortran binding**

```

MPI_ALLTOALLV_INIT(SENDBUF, SENDCOUNTS, SDISPLS, SENDTYPE, RECVBUF,
    RECVCOUNTS, RDISPLS, RECVTYPE, COMM, INFO, REQUEST, IERROR)
<type> SENDBUF(*), RECVBUF(*)
INTEGER SENDCOUNTS(*), SDISPLS(*), SENDTYPE, RECVCOUNTS(*), RDISPLS(*),
    RECVTYPE, COMM, INFO, REQUEST, IERROR

```

Creates a persistent collective communication request for the alltoallv operation.

```

1 MPI_ALLTOALLW_INIT(sendbuf, sendcounts, sdispls, sendtypes, recvbuf, recvcoun
2     recvtypes, comm, info, request)
3
4     IN     sendbuf     starting address of send buffer (choice)
5
6     IN     sendcounts  integer array (of length group size) specifying the
7     number of elements to send to each rank (array of
8     non-negative integers)
9
10    IN     sdispls     integer array (of length group size). Entry j specifies
11    the displacement in bytes (relative to sendbuf) from
12    which to take the outgoing data destined for process
13    j (array of integers)
14
15    IN     sendtypes   Array of datatypes (of length group size). Entry j
16    specifies the type of data to send to process j (array
17    of handles)
18
19    OUT    recvbuf     address of receive buffer (choice)
20
21    IN     recvcoun
22    ts               integer array (of length group size) specifying the
23    number of elements that can be received from each
24    rank (array of non-negative integers)
25
26    IN     rdispls     integer array (of length group size). Entry i specifies
27    the displacement in bytes (relative to recvbuf) at
28    which to place the incoming data from process i
29    (array of integers)
30
31    IN     recvtypes   array of datatypes (of length group size). Entry i
32    specifies the type of data received from process i
33    (array of handles)
34
35    IN     comm        communicator (handle)
36
37    IN     info        info argument (handle)
38
39    OUT    request     communication request (handle)

```

**C binding**

```

34 int MPI_Alltoallw_init(const void *sendbuf, const int sendcounts[],
35     const int sdispls[], const MPI_Datatype sendtypes[],
36     void *recvbuf, const int recvcoun
37     ts[], const MPI_Datatype recvtypes[], MPI_Comm comm, MPI_Info info,
38     MPI_Request *request)
39
40 int MPI_Alltoallw_init_c(const void *sendbuf, const MPI_Count sendcounts[],
41     const MPI_Aint sdispls[], const MPI_Datatype sendtypes[],
42     void *recvbuf, const MPI_Count recvcoun
43     ts[], const MPI_Aint rdispls[], const MPI_Datatype recvtypes[],
44     MPI_Comm comm, MPI_Info info, MPI_Request *request)

```

**Fortran 2008 binding**

```

46 MPI_Alltoallw_init(sendbuf, sendcounts, sdispls, sendtypes, recvbuf,
47     recvcoun
48     ts, rdispls, recvtypes, comm, info, request, ierror)
49     TYPE(*), DIMENSION(..), INTENT(IN), ASYNCHRONOUS :: sendbuf

```



```

INTEGER, INTENT(IN), ASYNCHRONOUS :: sendcounts(*), sdispls(*),
    recvcounts(*), rdispls(*)
TYPE(MPI_Datatype), INTENT(IN), ASYNCHRONOUS :: sendtypes(*),
    recvtypes(*)
TYPE(*), DIMENSION(..), ASYNCHRONOUS :: recvbuf
TYPE(MPI_Comm), INTENT(IN) :: comm
TYPE(MPI_Info), INTENT(IN) :: info
TYPE(MPI_Request), INTENT(OUT) :: request
INTEGER, OPTIONAL, INTENT(OUT) :: ierror

MPI_Alltoallw_init(sendbuf, sendcounts, sdispls, sendtypes, recvbuf,
    recvcounts, rdispls, recvtypes, comm, info, request, ierror)
TYPE(*), DIMENSION(..), INTENT(IN), ASYNCHRONOUS :: sendbuf
INTEGER(KIND=MPI_COUNT_KIND), INTENT(IN), ASYNCHRONOUS ::
    sendcounts(*), recvcounts(*)
INTEGER(KIND=MPI_ADDRESS_KIND), INTENT(IN), ASYNCHRONOUS :: sdispls(*),
    rdispls(*)
TYPE(MPI_Datatype), INTENT(IN), ASYNCHRONOUS :: sendtypes(*),
    recvtypes(*)
TYPE(*), DIMENSION(..), ASYNCHRONOUS :: recvbuf
TYPE(MPI_Comm), INTENT(IN) :: comm
TYPE(MPI_Info), INTENT(IN) :: info
TYPE(MPI_Request), INTENT(OUT) :: request
INTEGER, OPTIONAL, INTENT(OUT) :: ierror

Fortran binding
MPI_ALLTOALLW_INIT(SENDBUF, SENDCOUNTS, SDISPLS, SENDTYPES, RECVBUF,
    RECVCOUNTS, RDISPLS, RECVTYPES, COMM, INFO, REQUEST, IERROR)
<type> SENDBUF(*), RECVBUF(*)
INTEGER SENDCOUNTS(*), SDISPLS(*), SENDTYPES(*), RECVCOUNTS(*),
    RDISPLS(*), RECVTYPES(*), COMM, INFO, REQUEST, IERROR

Creates a persistent collective communication request for the alltoallw operation.

```

## 6.13.7 Persistent Reduce

```

1 MPI_REDUCE_INIT(sendbuf, recvbuf, count, datatype, op, root, comm, info, request)
2
3
4 MPI_REDUCE_INIT(sendbuf, recvbuf, count, datatype, op, root, comm, info, request)
5
6     IN        sendbuf          address of send buffer (choice)
7
8     OUT       recvbuf          address of receive buffer (choice, significant only at
9                                root)
10
11     IN        count            number of elements in send buffer (non-negative
12                                integer)
13
14     IN        datatype         datatype of elements of send buffer (handle)
15
16     IN        op                reduce operation (handle)
17
18     IN        root              rank of root process (integer)
19
20     IN        comm              communicator (handle)
21
22     IN        info              info argument (handle)
23
24     OUT       request           communication request (handle)

```

**C binding**

```

21 int MPI_Reduce_init(const void *sendbuf, void *recvbuf, int count,
22                   MPI_Datatype datatype, MPI_Op op, int root, MPI_Comm comm,
23                   MPI_Info info, MPI_Request *request)
24
25 int MPI_Reduce_init_c(const void *sendbuf, void *recvbuf, MPI_Count count,
26                      MPI_Datatype datatype, MPI_Op op, int root, MPI_Comm comm,
27                      MPI_Info info, MPI_Request *request)

```

**Fortran 2008 binding**

```

29 MPI_Reduce_init(sendbuf, recvbuf, count, datatype, op, root, comm, info,
30               request, ierror)
31     TYPE(*), DIMENSION(..), INTENT(IN), ASYNCHRONOUS :: sendbuf
32     TYPE(*), DIMENSION(..), ASYNCHRONOUS :: recvbuf
33     INTEGER, INTENT(IN) :: count, root
34     TYPE(MPI_Datatype), INTENT(IN) :: datatype
35     TYPE(MPI_Op), INTENT(IN) :: op
36     TYPE(MPI_Comm), INTENT(IN) :: comm
37     TYPE(MPI_Info), INTENT(IN) :: info
38     TYPE(MPI_Request), INTENT(OUT) :: request
39     INTEGER, OPTIONAL, INTENT(OUT) :: ierror
40
41 MPI_Reduce_init(sendbuf, recvbuf, count, datatype, op, root, comm, info,
42               request, ierror)
43     TYPE(*), DIMENSION(..), INTENT(IN), ASYNCHRONOUS :: sendbuf
44     TYPE(*), DIMENSION(..), ASYNCHRONOUS :: recvbuf
45     INTEGER(KIND=MPI_COUNT_KIND), INTENT(IN) :: count
46     TYPE(MPI_Datatype), INTENT(IN) :: datatype
47     TYPE(MPI_Op), INTENT(IN) :: op
48     INTEGER, INTENT(IN) :: root

```

```

TYPE(MPI_Comm), INTENT(IN) :: comm
TYPE(MPI_Info), INTENT(IN) :: info
TYPE(MPI_Request), INTENT(OUT) :: request
INTEGER, OPTIONAL, INTENT(OUT) :: ierror

```

**Fortran binding**

```

MPI_REDUCE_INIT(SENDBUF, RECVBUF, COUNT, DATATYPE, OP, ROOT, COMM, INFO,
               REQUEST, IERROR)

```

```

<type> SENDBUF(*), RECVBUF(*)

```

```

INTEGER COUNT, DATATYPE, OP, ROOT, COMM, INFO, REQUEST, IERROR

```

Creates a persistent collective communication request for the reduce operation.

## 6.13.8 Persistent All-Reduce

```

MPI_ALLREDUCE_INIT(sendbuf, recvbuf, count, datatype, op, comm, info, request)

```

IN	sendbuf	starting address of send buffer (choice)
OUT	recvbuf	starting address of receive buffer (choice)
IN	count	number of elements in send buffer (non-negative integer)
IN	datatype	datatype of elements of send buffer (handle)
IN	op	operation (handle)
IN	comm	communicator (handle)
IN	info	info argument (handle)
OUT	request	communication request (handle)

**C binding**

```

int MPI_Allreduce_init(const void *sendbuf, void *recvbuf, int count,
                      MPI_Datatype datatype, MPI_Op op, MPI_Comm comm,
                      MPI_Info info, MPI_Request *request)

```

```

int MPI_Allreduce_init_c(const void *sendbuf, void *recvbuf,
                        MPI_Count count, MPI_Datatype datatype, MPI_Op op,
                        MPI_Comm comm, MPI_Info info, MPI_Request *request)

```

**Fortran 2008 binding**

```

MPI_Allreduce_init(sendbuf, recvbuf, count, datatype, op, comm, info,
                  request, ierror)

```

```

TYPE(*), DIMENSION(..), INTENT(IN), ASYNCHRONOUS :: sendbuf

```

```

TYPE(*), DIMENSION(..), ASYNCHRONOUS :: recvbuf

```

```

INTEGER, INTENT(IN) :: count

```

```

TYPE(MPI_Datatype), INTENT(IN) :: datatype

```

```

TYPE(MPI_Op), INTENT(IN) :: op

```

```

TYPE(MPI_Comm), INTENT(IN) :: comm

```

```

TYPE(MPI_Info), INTENT(IN) :: info

```

```

1     TYPE(MPI_Request), INTENT(OUT) :: request
2     INTEGER, OPTIONAL, INTENT(OUT) :: ierror
3
4 MPI_Allreduce_init(sendbuf, recvbuf, count, datatype, op, comm, info,
5                   request, ierror)
6     TYPE(*), DIMENSION(..), INTENT(IN), ASYNCHRONOUS :: sendbuf
7     TYPE(*), DIMENSION(..), ASYNCHRONOUS :: recvbuf
8     INTEGER(KIND=MPI_COUNT_KIND), INTENT(IN) :: count
9     TYPE(MPI_Datatype), INTENT(IN) :: datatype
10    TYPE(MPI_Op), INTENT(IN) :: op
11    TYPE(MPI_Comm), INTENT(IN) :: comm
12    TYPE(MPI_Info), INTENT(IN) :: info
13    TYPE(MPI_Request), INTENT(OUT) :: request
14    INTEGER, OPTIONAL, INTENT(OUT) :: ierror

```

### Fortran binding

```

15 MPI_ALLREDUCE_INIT(SENDBUF, RECVBUFF, COUNT, DATATYPE, OP, COMM, INFO,
16                   REQUEST, IERROR)
17     <type> SENDBUF(*), RECVBUFF(*)
18     INTEGER COUNT, DATATYPE, OP, COMM, INFO, REQUEST, IERROR

```

Creates a persistent collective communication request for the allreduce operation.

### 6.13.9 Persistent Reduce-Scatter with Equal Blocks

```

26 MPI_REDUCE_SCATTER_BLOCK_INIT(sendbuf, recvbuf, recvcnt, datatype, op, comm,
27                               info, request)
28
29 IN     sendbuf      starting address of send buffer (choice)
30 OUT   recvbuf      starting address of receive buffer (choice)
31 IN     recvcnt      element count per block (non-negative integer)
32 IN     datatype     datatype of elements of send and receive buffers
33                               (handle)
34
35 IN     op           operation (handle)
36 IN     comm         communicator (handle)
37 IN     info         info argument (handle)
38
39 OUT   request      communication request (handle)

```

### C binding

```

42 int MPI_Reduce_scatter_block_init(const void *sendbuf, void *recvbuf,
43                                 int recvcnt, MPI_Datatype datatype, MPI_Op op,
44                                 MPI_Comm comm, MPI_Info info, MPI_Request *request)
45
46 int MPI_Reduce_scatter_block_init_c(const void *sendbuf, void *recvbuf,
47                                    MPI_Count recvcnt, MPI_Datatype datatype, MPI_Op op,
48                                    MPI_Comm comm, MPI_Info info, MPI_Request *request)

```

**Fortran 2008 binding**

```

MPI_Reduce_scatter_block_init(sendbuf, recvbuf, recvcount, datatype, op,
    comm, info, request, ierror)
    TYPE(*), DIMENSION(..), INTENT(IN), ASYNCHRONOUS :: sendbuf
    TYPE(*), DIMENSION(..), ASYNCHRONOUS :: recvbuf
    INTEGER, INTENT(IN) :: recvcount
    TYPE(MPI_Datatype), INTENT(IN) :: datatype
    TYPE(MPI_Op), INTENT(IN) :: op
    TYPE(MPI_Comm), INTENT(IN) :: comm
    TYPE(MPI_Info), INTENT(IN) :: info
    TYPE(MPI_Request), INTENT(OUT) :: request
    INTEGER, OPTIONAL, INTENT(OUT) :: ierror

```

```

MPI_Reduce_scatter_block_init(sendbuf, recvbuf, recvcount, datatype, op,
    comm, info, request, ierror)
    TYPE(*), DIMENSION(..), INTENT(IN), ASYNCHRONOUS :: sendbuf
    TYPE(*), DIMENSION(..), ASYNCHRONOUS :: recvbuf
    INTEGER(KIND=MPI_COUNT_KIND), INTENT(IN) :: recvcount
    TYPE(MPI_Datatype), INTENT(IN) :: datatype
    TYPE(MPI_Op), INTENT(IN) :: op
    TYPE(MPI_Comm), INTENT(IN) :: comm
    TYPE(MPI_Info), INTENT(IN) :: info
    TYPE(MPI_Request), INTENT(OUT) :: request
    INTEGER, OPTIONAL, INTENT(OUT) :: ierror

```

**Fortran binding**

```

MPI_REDUCE_SCATTER_BLOCK_INIT(SENDBUF, RECVBUF, RECVCOUNT, DATATYPE, OP,
    COMM, INFO, REQUEST, IERROR)
    <type> SENDBUF(*), RECVBUF(*)
    INTEGER RECVCOUNT, DATATYPE, OP, COMM, INFO, REQUEST, IERROR

```

Creates a persistent collective communication request for the reduce-scatter with equal blocks operation.

## 6.13.10 Persistent Reduce-Scatter

```

MPI_REDUCE_SCATTER_INIT(sendbuf, recvbuf, recvcnts, datatype, op, comm, info,
                        request)

```

IN	sendbuf	starting address of send buffer (choice)
OUT	recvbuf	starting address of receive buffer (choice)
IN	recvcnts	non-negative integer array specifying the number of elements in result distributed to each process. This array must be identical on all calling processes.
IN	datatype	datatype of elements of input buffer (handle)
IN	op	operation (handle)
IN	comm	communicator (handle)
IN	info	info argument (handle)
OUT	request	communication request (handle)

**C binding**

```

int MPI_Reduce_scatter_init(const void *sendbuf, void *recvbuf,
                          const int recvcnts[], MPI_Datatype datatype, MPI_Op op,
                          MPI_Comm comm, MPI_Info info, MPI_Request *request)

int MPI_Reduce_scatter_init_c(const void *sendbuf, void *recvbuf,
                             const MPI_Count recvcnts[], MPI_Datatype datatype,
                             MPI_Op op, MPI_Comm comm, MPI_Info info, MPI_Request *request)

```

**Fortran 2008 binding**

```

MPI_Reduce_scatter_init(sendbuf, recvbuf, recvcnts, datatype, op, comm,
                       info, request, ierror)
  TYPE(*), DIMENSION(..), INTENT(IN), ASYNCHRONOUS :: sendbuf
  TYPE(*), DIMENSION(..), ASYNCHRONOUS :: recvbuf
  INTEGER, INTENT(IN), ASYNCHRONOUS :: recvcnts(*)
  TYPE(MPI_Datatype), INTENT(IN) :: datatype
  TYPE(MPI_Op), INTENT(IN) :: op
  TYPE(MPI_Comm), INTENT(IN) :: comm
  TYPE(MPI_Info), INTENT(IN) :: info
  TYPE(MPI_Request), INTENT(OUT) :: request
  INTEGER, OPTIONAL, INTENT(OUT) :: ierror

MPI_Reduce_scatter_init(sendbuf, recvbuf, recvcnts, datatype, op, comm,
                       info, request, ierror)
  TYPE(*), DIMENSION(..), INTENT(IN), ASYNCHRONOUS :: sendbuf
  TYPE(*), DIMENSION(..), ASYNCHRONOUS :: recvbuf
  INTEGER(KIND=MPI_COUNT_KIND), INTENT(IN), ASYNCHRONOUS :: recvcnts(*)
  TYPE(MPI_Datatype), INTENT(IN) :: datatype
  TYPE(MPI_Op), INTENT(IN) :: op
  TYPE(MPI_Comm), INTENT(IN) :: comm

```

```

TYPE(MPI_Info), INTENT(IN) :: info
TYPE(MPI_Request), INTENT(OUT) :: request
INTEGER, OPTIONAL, INTENT(OUT) :: ierror

```

**Fortran binding**

```

MPI_REDUCE_SCATTER_INIT(SENDBUF, RECVBUF, RECVCOUNTS, DATATYPE, OP, COMM,
    INFO, REQUEST, IERROR)

```

```

<type> SENDBUF(*), RECVBUF(*)

```

```

INTEGER RECVCOUNTS(*), DATATYPE, OP, COMM, INFO, REQUEST, IERROR

```

Creates a persistent collective communication request for the reduce-scatter operation.

## 6.13.11 Persistent Inclusive Scan

```

MPI_SCAN_INIT(sendbuf, recvbuf, count, datatype, op, comm, info, request)

```

IN	sendbuf	starting address of send buffer (choice)
OUT	recvbuf	starting address of receive buffer (choice)
IN	count	number of elements in input buffer (non-negative integer)
IN	datatype	datatype of elements of input buffer (handle)
IN	op	operation (handle)
IN	comm	communicator (handle)
IN	info	info argument (handle)
OUT	request	communication request (handle)

**C binding**

```

int MPI_Scan_init(const void *sendbuf, void *recvbuf, int count,
    MPI_Datatype datatype, MPI_Op op, MPI_Comm comm,
    MPI_Info info, MPI_Request *request)

```

```

int MPI_Scan_init_c(const void *sendbuf, void *recvbuf, MPI_Count count,
    MPI_Datatype datatype, MPI_Op op, MPI_Comm comm,
    MPI_Info info, MPI_Request *request)

```

**Fortran 2008 binding**

```

MPI_Scan_init(sendbuf, recvbuf, count, datatype, op, comm, info, request,
    ierror)

```

```

TYPE(*), DIMENSION(..), INTENT(IN), ASYNCHRONOUS :: sendbuf

```

```

TYPE(*), DIMENSION(..), ASYNCHRONOUS :: recvbuf

```

```

INTEGER, INTENT(IN) :: count

```

```

TYPE(MPI_Datatype), INTENT(IN) :: datatype

```

```

TYPE(MPI_Op), INTENT(IN) :: op

```

```

TYPE(MPI_Comm), INTENT(IN) :: comm

```

```

TYPE(MPI_Info), INTENT(IN) :: info

```

```

TYPE(MPI_Request), INTENT(OUT) :: request

```

```

1     INTEGER, OPTIONAL, INTENT(OUT) :: ierror
2
3     MPI_Scan_init(sendbuf, recvbuf, count, datatype, op, comm, info, request,
4         ierror)
5     TYPE(*), DIMENSION(..), INTENT(IN), ASYNCHRONOUS :: sendbuf
6     TYPE(*), DIMENSION(..), ASYNCHRONOUS :: recvbuf
7     INTEGER(KIND=MPI_COUNT_KIND), INTENT(IN) :: count
8     TYPE(MPI_Datatype), INTENT(IN) :: datatype
9     TYPE(MPI_Op), INTENT(IN) :: op
10    TYPE(MPI_Comm), INTENT(IN) :: comm
11    TYPE(MPI_Info), INTENT(IN) :: info
12    TYPE(MPI_Request), INTENT(OUT) :: request
13    INTEGER, OPTIONAL, INTENT(OUT) :: ierror

```

#### Fortran binding

```

14    MPI_SCAN_INIT(SENDBUF, RECVBUFF, COUNT, DATATYPE, OP, COMM, INFO, REQUEST,
15        IERROR)
16
17    <type> SENDBUF(*), RECVBUFF(*)
18    INTEGER COUNT, DATATYPE, OP, COMM, INFO, REQUEST, IERROR

```

Creates a persistent collective communication request for the inclusive scan operation.

#### 6.13.12 Persistent Exclusive Scan

```

25    MPI_EXSCAN_INIT(sendbuf, recvbuf, count, datatype, op, comm, info, request)
26
27    IN     sendbuf      starting address of send buffer (choice)
28    OUT    recvbuf     starting address of receive buffer (choice)
29    IN     count       number of elements in input buffer (non-negative
30        integer)
31    IN     datatype    datatype of elements of input buffer (handle)
32    IN     op          operation (handle)
33    IN     comm        intra-communicator (handle)
34    IN     info        info argument (handle)
35    IN     request     communication request (handle)
36
37    OUT    request     communication request (handle)

```

#### C binding

```

39    int MPI_Exscan_init(const void *sendbuf, void *recvbuf, int count,
40        MPI_Datatype datatype, MPI_Op op, MPI_Comm comm,
41        MPI_Info info, MPI_Request *request)
42
43    int MPI_Exscan_init_c(const void *sendbuf, void *recvbuf, MPI_Count count,
44        MPI_Datatype datatype, MPI_Op op, MPI_Comm comm,
45        MPI_Info info, MPI_Request *request)

```



**Fortran 2008 binding**

```

MPI_Exscan_init(sendbuf, recvbuf, count, datatype, op, comm, info, request,
                ierror)
    TYPE(*), DIMENSION(..), INTENT(IN), ASYNCHRONOUS :: sendbuf
    TYPE(*), DIMENSION(..), ASYNCHRONOUS :: recvbuf
    INTEGER, INTENT(IN) :: count
    TYPE(MPI_Datatype), INTENT(IN) :: datatype
    TYPE(MPI_Op), INTENT(IN) :: op
    TYPE(MPI_Comm), INTENT(IN) :: comm
    TYPE(MPI_Info), INTENT(IN) :: info
    TYPE(MPI_Request), INTENT(OUT) :: request
    INTEGER, OPTIONAL, INTENT(OUT) :: ierror

MPI_Exscan_init(sendbuf, recvbuf, count, datatype, op, comm, info, request,
                ierror)
    TYPE(*), DIMENSION(..), INTENT(IN), ASYNCHRONOUS :: sendbuf
    TYPE(*), DIMENSION(..), ASYNCHRONOUS :: recvbuf
    INTEGER(KIND=MPI_COUNT_KIND), INTENT(IN) :: count
    TYPE(MPI_Datatype), INTENT(IN) :: datatype
    TYPE(MPI_Op), INTENT(IN) :: op
    TYPE(MPI_Comm), INTENT(IN) :: comm
    TYPE(MPI_Info), INTENT(IN) :: info
    TYPE(MPI_Request), INTENT(OUT) :: request
    INTEGER, OPTIONAL, INTENT(OUT) :: ierror

```

**Fortran binding**

```

MPI_EXSCAN_INIT(SENDBUF, RECVBUFF, COUNT, DATATYPE, OP, COMM, INFO, REQUEST,
                IERROR)
    <type> SENDBUF(*), RECVBUFF(*)
    INTEGER COUNT, DATATYPE, OP, COMM, INFO, REQUEST, IERROR

```

Creates a persistent collective communication request for the exclusive scan operation.

**6.14 Correctness**

A correct, portable program must invoke collective communications so that deadlock will not occur, whether collective communications are synchronizing or not. The following examples illustrate dangerous use of collective routines on intra-communicators.

**Example 6.25** The following is erroneous.

```

switch(rank) {
    case 0:
        MPI_Bcast(buf1, count, type, 0, comm);
        MPI_Bcast(buf2, count, type, 1, comm);
        break;
    case 1:
        MPI_Bcast(buf2, count, type, 1, comm);
        MPI_Bcast(buf1, count, type, 0, comm);

```

```

1         break;
2     }
3

```

We assume that the group of `comm` is  $\{0,1\}$ . Two processes execute two broadcast operations in reverse order. If the operation is synchronizing then a deadlock will occur.

Collective operations must be executed in the same order at all members of the communication group.

**Example 6.26** The following is erroneous.

```

10 switch(rank) {
11     case 0:
12         MPI_Bcast(buf1, count, type, 0, comm0);
13         MPI_Bcast(buf2, count, type, 2, comm2);
14         break;
15     case 1:
16         MPI_Bcast(buf1, count, type, 1, comm1);
17         MPI_Bcast(buf2, count, type, 0, comm0);
18         break;
19     case 2:
20         MPI_Bcast(buf1, count, type, 2, comm2);
21         MPI_Bcast(buf2, count, type, 1, comm1);
22         break;
23 }
24

```

Assume that the group of `comm0` is  $\{0,1\}$ , of `comm1` is  $\{1, 2\}$  and of `comm2` is  $\{2,0\}$ . If the broadcast is a synchronizing operation, then there is a cyclic dependency: the broadcast in `comm2` completes only after the broadcast in `comm0`; the broadcast in `comm0` completes only after the broadcast in `comm1`; and the broadcast in `comm1` completes only after the broadcast in `comm2`. Thus, the code will deadlock.

Collective operations must be executed in an order so that no cyclic dependencies occur. Nonblocking collective operations can alleviate this issue.

**Example 6.27** The following is erroneous.

```

35 switch(rank) {
36     case 0:
37         MPI_Bcast(buf1, count, type, 0, comm);
38         MPI_Send(buf2, count, type, 1, tag, comm);
39         break;
40     case 1:
41         MPI_Recv(buf2, count, type, 0, tag, comm, status);
42         MPI_Bcast(buf1, count, type, 0, comm);
43         break;
44 }
45
46
47
48

```

Process zero executes a broadcast, followed by a blocking send operation. Process one first executes a blocking receive that matches the send, followed by broadcast call that matches the broadcast of process zero. This program may deadlock. The broadcast call on process zero *may* block until process one executes the matching broadcast call, so that the send is not executed. Process one will definitely block on the receive and so, in this case, never executes the broadcast.

The relative order of execution of collective operations and point-to-point operations should be such, so that even if the collective operations and the point-to-point operations are synchronizing, no deadlock will occur.

**Example 6.28** An unsafe, non-deterministic program.

```
switch(rank) {
  case 0:
    MPI_Bcast(buf1, count, type, 0, comm);
    MPI_Send(buf2, count, type, 1, tag, comm);
    break;
  case 1:
    MPI_Recv(buf2, count, type, MPI_ANY_SOURCE, tag, comm, status);
    MPI_Bcast(buf1, count, type, 0, comm);
    MPI_Recv(buf2, count, type, MPI_ANY_SOURCE, tag, comm, status);
    break;
  case 2:
    MPI_Send(buf2, count, type, 1, tag, comm);
    MPI_Bcast(buf1, count, type, 0, comm);
    break;
}
```

All three processes participate in a broadcast. Process 0 sends a message to process 1 after the broadcast, and process 2 sends a message to process 1 before the broadcast. Process 1 receives before and after the broadcast, with a wildcard source argument.

Two possible executions of this program, with different matchings of sends and receives, are illustrated in Figure 6.12. Note that the second execution has the peculiar effect that a send executed after the broadcast is received at another node before the broadcast. This example illustrates the fact that one should not rely on collective communication functions to have particular synchronization effects. A program that works correctly only when the first execution occurs (only when broadcast is synchronizing) is erroneous.

Finally, in multithreaded implementations, one can have more than one, concurrently executing, collective communication call at a process. In these situations, it is the user's responsibility to ensure that the same communicator is not used concurrently by two different collective communication calls at the same process.

*Advice to implementors.* Assume that broadcast is implemented using point-to-point MPI communication. Suppose the following two rules are followed.

1. All receives specify their source explicitly (no wildcards).
2. Each process sends all messages that pertain to one collective call before sending any message that pertain to a subsequent collective call.

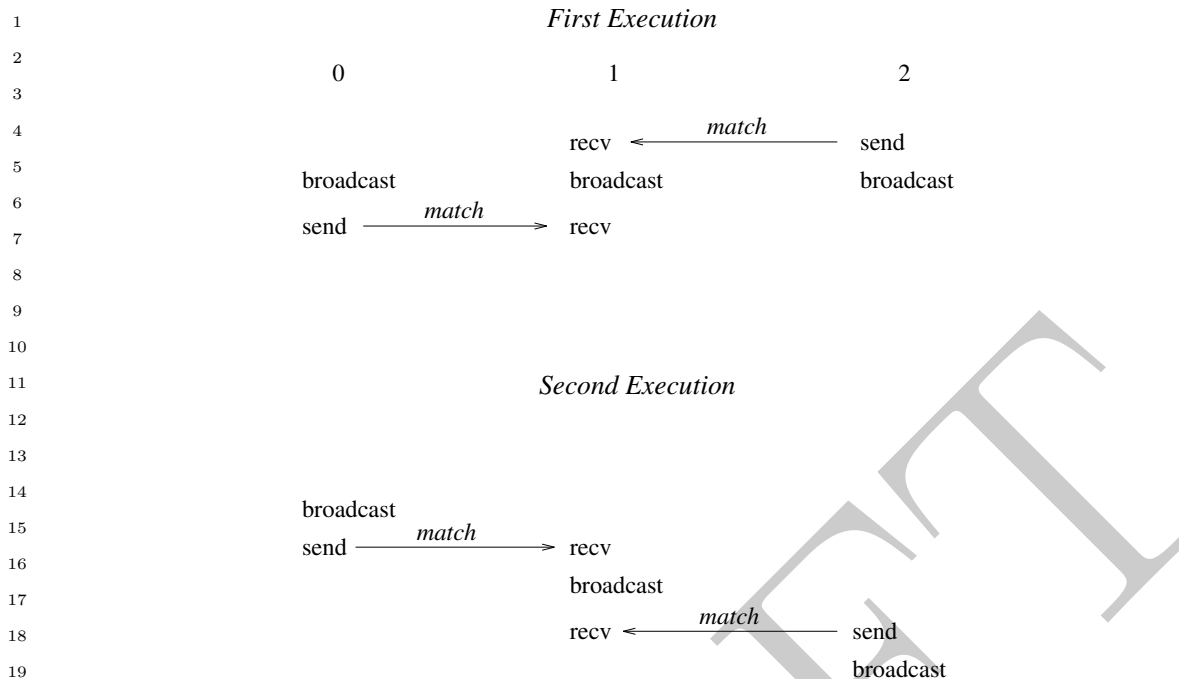

Figure 6.12: A race condition causes non-deterministic matching of sends and receives. One cannot rely on synchronization from a broadcast to make the program deterministic.

Then, messages belonging to successive broadcasts cannot be confused, as the order of point-to-point messages is preserved.

It is the implementor’s responsibility to ensure that point-to-point messages are not confused with collective messages. One way to accomplish this is, whenever a communicator is created, to also create a “hidden communicator” for collective communication. One could achieve a similar effect more cheaply, for example, by using a hidden tag or context bit to indicate whether the communicator is used for point-to-point or collective communication. (*End of advice to implementors.*)

**Example 6.29** Blocking and nonblocking collective operations can be interleaved, i.e., a blocking collective operation can be posted even if there is a nonblocking collective operation outstanding.

```
MPI_Request req;

MPI_Ibarrier(comm, &req);
MPI_Bcast(buf1, count, type, 0, comm);
MPI_Wait(&req, MPI_STATUS_IGNORE);
```

Each process starts a nonblocking barrier operation, participates in a blocking broadcast and then waits until every other process started the barrier operation. This effectively turns the broadcast into a synchronizing broadcast with possible communication/communication overlap (MPI\_Bcast is allowed, but not required to synchronize).

**Example 6.30** The starting order of collective operations on a particular communicator defines their matching. The following example shows an erroneous matching of different collective operations on the same communicator.

```
MPI_Request req;
switch(rank) {
    case 0:
        /* erroneous matching */
        MPI_Ibarrier(comm, &req);
        MPI_Bcast(buf1, count, type, 0, comm);
        MPI_Wait(&req, MPI_STATUS_IGNORE);
        break;
    case 1:
        /* erroneous matching */
        MPI_Bcast(buf1, count, type, 0, comm);
        MPI_Ibarrier(comm, &req);
        MPI_Wait(&req, MPI_STATUS_IGNORE);
        break;
}
```

This ordering would match `MPI_Ibarrier` on rank 0 with `MPI_Bcast` on rank 1 which is erroneous and the program behavior is undefined. However, if such an order is required, the user must create different duplicate communicators and perform the operations on them. If started with two processes, the following program would be correct:

```
MPI_Request req;
MPI_Comm dupcomm;
MPI_Comm_dup(comm, &dupcomm);
switch(rank) {
    case 0:
        MPI_Ibarrier(comm, &req);
        MPI_Bcast(buf1, count, type, 0, dupcomm);
        MPI_Wait(&req, MPI_STATUS_IGNORE);
        break;
    case 1:
        MPI_Bcast(buf1, count, type, 0, dupcomm);
        MPI_Ibarrier(comm, &req);
        MPI_Wait(&req, MPI_STATUS_IGNORE);
        break;
}
```

*Advice to users.* The use of different communicators offers some flexibility regarding the matching of nonblocking collective operations. In this sense, communicators could be used as an equivalent to tags. However, communicator construction might induce overheads so that this should be used carefully. (*End of advice to users.*)

**Example 6.31** Nonblocking collective operations can rely on the same progression rules as nonblocking point-to-point messages. Thus, if started with two processes, the following program is a valid MPI program and is guaranteed to terminate:

```

1 MPI_Request req;
2
3 switch(rank) {
4     case 0:
5         MPI_Ibarrier(comm, &req);
6         MPI_Wait(&req, MPI_STATUS_IGNORE);
7         MPI_Send(buf, count, dtype, 1, tag, comm);
8         break;
9     case 1:
10        MPI_Ibarrier(comm, &req);
11        MPI_Recv(buf, count, dtype, 0, tag, comm, MPI_STATUS_IGNORE);
12        MPI_Wait(&req, MPI_STATUS_IGNORE);
13        break;
14 }

```

The MPI library must progress the barrier in the MPI\_Recv call. Thus, the MPI\_Wait call in rank 0 will eventually complete, which enables the matching MPI\_Send so all calls eventually return.

**Example 6.32** Blocking and nonblocking collective operations do not match. The following example is erroneous.

```

22 MPI_Request req;
23
24 switch(rank) {
25     case 0:
26         /* erroneous false matching of Alltoall and Ialltoall */
27         MPI_Ialltoall(sbuf, scnt, stype, rbuf, rcnt, rtype, comm, &req);
28         MPI_Wait(&req, MPI_STATUS_IGNORE);
29         break;
30     case 1:
31         /* erroneous false matching of Alltoall and Ialltoall */
32         MPI_Alltoall(sbuf, scnt, stype, rbuf, rcnt, rtype, comm);
33         break;
34 }

```

**Example 6.33** Collective and point-to-point requests can be mixed in functions that enable multiple completions. If started with two processes, the following program is valid.

```

40 MPI_Request reqs[2];
41
42 switch(rank) {
43     case 0:
44         MPI_Ibarrier(comm, &reqs[0]);
45         MPI_Send(buf, count, dtype, 1, tag, comm);
46         MPI_Wait(&reqs[0], MPI_STATUS_IGNORE);
47         break;
48     case 1:

```

```

    MPI_Irecv(buf, count, dtype, 0, tag, comm, &reqs[0]);
    MPI_Ibcast(comm, &reqs[1]);
    MPI_Waitall(2, reqs, MPI_STATUSES_IGNORE);
    break;
}

```

The MPI\_Waitall call returns only after the barrier and the receive completed.

**Example 6.34** Multiple nonblocking collective operations can be outstanding on a single communicator and match in order.

```

MPI_Request reqs[3];

compute(buf1);
MPI_Ibcast(buf1, count, type, 0, comm, &reqs[0]);
compute(buf2);
MPI_Ibcast(buf2, count, type, 0, comm, &reqs[1]);
compute(buf3);
MPI_Ibcast(buf3, count, type, 0, comm, &reqs[2]);
MPI_Waitall(3, reqs, MPI_STATUSES_IGNORE);

```

*Advice to users.* Pipelining and double-buffering techniques can efficiently be used to overlap computation and communication. However, having too many outstanding requests might have a negative impact on performance. (*End of advice to users.*)

*Advice to implementors.* The use of pipelining may generate many outstanding requests. A high-quality hardware-supported implementation with limited resources should be able to fall back to a software implementation if its resources are exhausted. In this way, the implementation could limit the number of outstanding requests only by the available memory. (*End of advice to implementors.*)

**Example 6.35** Nonblocking collective operations can also be used to enable simultaneous collective operations on multiple overlapping communicators (see Figure 6.13). The following example is started with three processes and three communicators. The first communicator `comm1` includes ranks 0 and 1, `comm2` includes ranks 1 and 2, and `comm3` spans ranks 0 and 2. It is not possible to perform a blocking collective operation on all communicators because there exists no deadlock-free order to invoke them. However, nonblocking collective operations can easily be used to achieve this task.

```

MPI_Request reqs[2];

switch(rank) {
    case 0:
        MPI_Iallreduce(sbuf1, rbuf1, count, dtype, MPI_SUM, comm1, &reqs[0]);
        MPI_Iallreduce(sbuf3, rbuf3, count, dtype, MPI_SUM, comm3, &reqs[1]);
        break;
    case 1:
        MPI_Iallreduce(sbuf1, rbuf1, count, dtype, MPI_SUM, comm1, &reqs[0]);

```

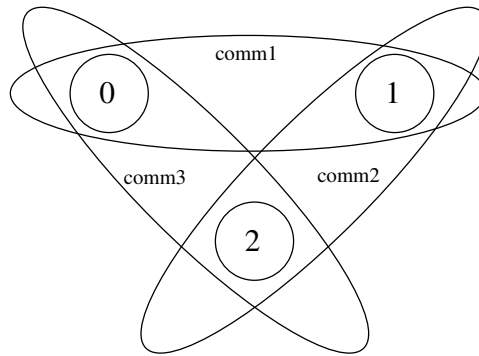

Figure 6.13: Example with overlapping communicators.

```

14     MPI_Iallreduce(sbuf2, rbuf2, count, dtype, MPI_SUM, comm2, &reqs[1]);
15     break;
16 case 2:
17     MPI_Iallreduce(sbuf2, rbuf2, count, dtype, MPI_SUM, comm2, &reqs[0]);
18     MPI_Iallreduce(sbuf3, rbuf3, count, dtype, MPI_SUM, comm3, &reqs[1]);
19     break;
20 }
21 MPI_Waitall(2, reqs, MPI_STATUSES_IGNORE);

```

*Advice to users.* This method can be useful if overlapping neighboring regions (halo or ghost zones) are used in collective operations. The sequence of the two calls in each process is irrelevant because the two nonblocking operations are performed on different communicators. (*End of advice to users.*)

**Example 6.36** The progress of multiple outstanding nonblocking collective operations is completely independent.

```

31 MPI_Request reqs[2];
32
33 compute(buf1);
34 MPI_Ibcast(buf1, count, type, 0, comm, &reqs[0]);
35 compute(buf2);
36 MPI_Ibcast(buf2, count, type, 0, comm, &reqs[1]);
37 MPI_Wait(&reqs[1], MPI_STATUS_IGNORE);
38 /* nothing is known about the status of the first bcast here */
39 MPI_Wait(&reqs[0], MPI_STATUS_IGNORE);
40

```

Finishing the second MPI\_IBCAST is completely independent of the first one. This means that it is not guaranteed that the first broadcast operation is finished or even started after the second one is completed via reqs[1].



1  
2  
3  
4  
5  
6  
7  
8  
9  
10  
11  
12  
13  
14  
15  
16  
17  
18  
19  
20  
21  
22  
23  
24  
25  
26  
27  
28  
29  
30  
31  
32  
33  
34  
35  
36  
37  
38  
39  
40  
41  
42  
43  
44  
45  
46  
47  
48

## Chapter 7

# Groups, Contexts, Communicators, and Caching

### 7.1 Introduction

This chapter introduces MPI features that support the development of parallel libraries. Parallel libraries are needed to encapsulate the distracting complications inherent in parallel implementations of key algorithms. They help to ensure consistent correctness of such procedures, and provide a “higher level” of portability than MPI itself can provide. As such, libraries prevent each programmer from repeating the work of defining consistent data structures, data layouts, and methods that implement key algorithms (such as matrix operations). Since the best libraries come with several variations on parallel systems (different data layouts, different strategies depending on the size of the system or problem, or type of floating point), this too needs to be hidden from the user.

We refer the reader to [4] and [62] for further information on writing libraries in MPI, using the features described in this chapter.

#### 7.1.1 Features Needed to Support Libraries

The key features needed to support the creation of robust parallel libraries are as follows:

- Safe communication space, that guarantees that libraries can communicate as they need to, without conflicting with communication extraneous to the library,
- Group scope for collective operations, that allow libraries to avoid unnecessarily synchronizing uninvolved processes (potentially running unrelated code),
- Abstract process naming to allow libraries to describe their communication in terms suitable to their own data structures and algorithms,
- The ability to “adorn” a set of communicating processes with additional user-defined attributes, such as extra collective operations. This mechanism should provide a means for the user or library writer effectively to extend a message-passing notation.

In addition, a unified mechanism or object is needed for conveniently denoting communication context, the group of communicating processes, to house abstract process naming, and to store adornments.

## 7.1.2 MPI's Support for Libraries

The corresponding concepts that MPI provides, specifically to support robust libraries, are as follows:

- **Contexts** of communication,
- **Groups** of processes,
- **Virtual topologies**,
- **Attribute caching**,
- **Communicators**.

**Communicators** (see [22, 60, 64]) encapsulate all of these ideas in order to provide the appropriate scope for all communication operations in MPI. Communicators are divided into two kinds: intra-communicators for operations within a single group of processes and inter-communicators for operations between two groups of processes.

**Caching.** Communicators (see below) provide a “caching” mechanism that allows one to associate new attributes with communicators, on par with MPI built-in features. This can be used by advanced users to adorn communicators further, and by MPI to implement some communicator functions. For example, the virtual-topology functions described in Chapter 8 are likely to be supported this way.

**Groups.** Groups define an ordered collection of processes, each with a rank, and it is this group that defines the low-level names for inter-process communication (ranks are used for sending and receiving). Thus, groups define a scope for process names in point-to-point communication. In addition, groups define the scope of collective operations. Groups may be manipulated separately from communicators in MPI, but only communicators can be used in communication operations.

**Intra-Communicators.** The most commonly used means for message-passing in MPI is via intra-communicators. Intra-communicators contain an instance of a group, contexts of communication for both point-to-point and collective communication, and the ability to include virtual topology and other attributes. These features work as follows:

- **Contexts** provide the ability to have separate safe “universes” of message-passing in MPI. A context is akin to an additional tag that differentiates messages. The system manages this differentiation process. The use of separate communication contexts by distinct libraries (or distinct library invocations) insulates communication internal to the library execution from external communication. This allows the invocation of the library even if there are pending communications on “other” communicators, and avoids the need to synchronize entry or exit into library code. Pending point-to-point communications are also guaranteed not to interfere with collective communications within a single communicator.
- **Groups** define the participants in the communication (see above) of a communicator.

- A **virtual topology** defines a special mapping of the ranks in a group to and from a topology. Special constructors for communicators are defined in Chapter 8 to provide this feature. Intra-communicators as described in this chapter do not have topologies.
- **Attributes** define the local information that the user or library has added to a communicator for later reference.

*Advice to users.* The practice in many communication libraries is that there is a unique, predefined communication universe that includes all processes available when the parallel program is initiated; the processes are assigned consecutive ranks. Participants in a point-to-point communication are identified by their rank; a collective communication (such as broadcast) always involves all processes. When using the World Model (Section 11.2), this practice can be followed in MPI by using the predefined communicator `MPI_COMM_WORLD`. *Users who are satisfied with this practice can plug in `MPI_COMM_WORLD` wherever a communicator argument is required, and can consequently disregard the rest of this chapter. (End of advice to users.)*

**Inter-Communicators.** The discussion has dealt so far with **intra-communication**: communication within a group. MPI also supports **inter-communication**: communication between two non-overlapping groups. When an application is built by composing several parallel modules, it is convenient to allow one module to communicate with another using local ranks for addressing within the second module. This is especially convenient in a client-server computing paradigm, where either client or server are parallel. The support of inter-communication also provides a mechanism for the extension of MPI to a dynamic model where not all processes are preallocated at initialization time. In such a situation, it becomes necessary to support communication across “universes.” Inter-communication is supported by objects called **inter-communicators**. These objects bind two groups together with communication contexts shared by both groups. For inter-communicators, these features work as follows:

- Contexts provide the ability to have a separate safe “universe” of message-passing between the two groups. A send in the local group is always a receive in the remote group, and vice versa. The system manages this differentiation process. The use of separate communication contexts by distinct libraries (or distinct library invocations) insulates communication internal to the library execution from external communication. This allows the invocation of the library even if there are pending communications on “other” communicators, and avoids the need to synchronize entry or exit into library code.
- A local and remote group specify the recipients and destinations for an inter-communicator.
- Virtual topology is undefined for an inter-communicator.
- As before, attributes cache defines the local information that the user or library has added to a communicator for later reference.

MPI provides mechanisms for creating and manipulating inter-communicators. They are used for point-to-point and collective communication in a related manner to intra-communicators. Users who do not need inter-communication in their applications can safely

1 ignore this extension. Users who require inter-communication between overlapping groups  
 2 must layer this capability on top of MPI.  
 3

## 4 7.2 Basic Concepts 5

6 In this section, we turn to a more formal definition of the concepts introduced above.  
 7

### 8 7.2.1 Groups 9

10 A **group** is an ordered set of process identifiers (henceforth processes); processes are imple-  
 11 mentation-dependent objects. Each process in a group is associated with an integer **rank**.  
 12 Ranks are contiguous and start from zero. Groups are represented by opaque **group ob-**  
 13 **jects**, and hence cannot be directly transferred from one process to another. A group is  
 14 used within a communicator to describe the participants in a communication “universe”  
 15 and to rank such participants (thus giving them unique names within that “universe” of  
 16 communication).

17 There is a special pre-defined group: `MPI_GROUP_EMPTY`, which is a group with no  
 18 members. The predefined constant `MPI_GROUP_NULL` is the value used for invalid group  
 19 handles.  
 20

21 *Advice to users.* `MPI_GROUP_EMPTY`, which is a valid handle to an empty group,  
 22 should not be confused with `MPI_GROUP_NULL`, which in turn is an invalid handle.  
 23 The former may be used as an argument to group operations; the latter, which is  
 24 returned when a group is freed, is not a valid argument. (*End of advice to users.*)  
 25

26 *Advice to implementors.* A group may be represented by a virtual-to-real process-  
 27 address-translation table. Each communicator object (see below) would have a pointer  
 28 to such a table.

29 Simple implementations of MPI will enumerate groups, such as in a table. However,  
 30 more advanced data structures make sense in order to improve scalability and memory  
 31 usage with large numbers of processes. Such implementations are possible with MPI.  
 32 (*End of advice to implementors.*)  
 33

### 34 7.2.2 Contexts 35

36 A **context** is a property of communicators (defined next) that allows partitioning of the  
 37 communication space. A message sent in one context cannot be received in another context.  
 38 Furthermore, where permitted, collective operations are independent of pending point-to-  
 39 point operations. Contexts are not explicit MPI objects; they appear only as part of the  
 40 realization of communicators (below).  
 41

42 *Advice to implementors.* Distinct communicators in the same process have distinct  
 43 contexts. A context is essentially a system-managed tag (or tags) needed to make  
 44 a communicator safe for point-to-point and MPI-defined collective communication.  
 45 Safety means that collective and point-to-point communication within one commu-  
 46 nicator do not interfere, and that communication over distinct communicators don’t  
 47 interfere.  
 48

A possible implementation for a context is as a supplemental tag attached to messages on send and matched on receive. Each intra-communicator stores the value of its two tags (one for point-to-point and one for collective communication). Communicator-generating functions use a collective communication to agree on a new group-wide unique context.

Analogously, in inter-communication, two context tags are stored per communicator, one used by group A to send and group B to receive, and a second used by group B to send and for group A to receive.

Since contexts are not explicit objects, other implementations are also possible. (*End of advice to implementors.*)

### 7.2.3 Intra-Communicators

Intra-communicators bring together the concepts of group and context. To support implementation-specific optimizations, and application topologies (defined in the next chapter, Chapter 8), communicators may also “cache” additional information (see Section 7.7). MPI communication operations reference communicators to determine the scope and the “communication universe” in which a point-to-point or collective operation is to operate.

Each communicator contains a group of valid participants; this group always includes the local process. The source and destination of a message are identified by process ranks within that group.

For collective communication, the intra-communicator specifies the set of processes that participate in the collective operation (and their order, when significant). Thus, the communicator restricts the “spatial” scope of communication, and provides machine-independent process addressing through ranks.

Intra-communicators are represented by opaque **intra-communicator objects**, and hence cannot be directly transferred from one process to another.

### 7.2.4 Predefined Intra-Communicators

When using the World Model for MPI initialization, an initial intra-communicator `MPI_COMM_WORLD` of all processes the local process can communicate with after initialization (itself included) is defined once `MPI_INIT` or `MPI_INIT_THREAD` has been called. In addition, the communicator `MPI_COMM_SELF` is provided, which includes only the process itself. When using the Sessions Model (Section 11.3) for initialization of MPI resources, `MPI_COMM_WORLD` and `MPI_COMM_SELF` are not valid for use as a communicator. See the discussion concerning use of MPI named constants in 2.5.4 for valid uses of `MPI_COMM_WORLD` and `MPI_COMM_SELF` prior to initialization of MPI.

The predefined constant `MPI_COMM_NULL` is the value used for invalid communicator handles.

In a static-process-model implementation of MPI, all processes that participate in the computation are available after MPI is initialized. For this case, `MPI_COMM_WORLD` is a communicator of all processes available for the computation; this communicator has the same value in all processes. In an implementation of MPI where processes can dynamically join an MPI execution, it may be the case that a process starts an MPI computation without having access to all other processes. In such situations, `MPI_COMM_WORLD` is a communicator incorporating all processes with which the joining process can immediately

1 communicate. Therefore, `MPI_COMM_WORLD` may simultaneously represent disjoint groups  
 2 in different processes.

3 All MPI implementations are required to provide the `MPI_COMM_WORLD` communi-  
 4 cator. It cannot be deallocated during the life of a process. The group corresponding to  
 5 this communicator does not appear as a pre-defined constant, but it may be accessed using  
 6 `MPI_COMM_GROUP` (see below). MPI does not specify the correspondence between the  
 7 process rank in `MPI_COMM_WORLD` and its (machine-dependent) absolute address. Neither  
 8 does MPI specify the function of the host process, if any. Other implementation-dependent,  
 9 predefined communicators may also be provided.

## 11 7.3 Group Management

12 This section describes the manipulation of process groups in MPI. These operations are  
 13 local and their execution does not require interprocess communication.

### 16 7.3.1 Group Accessors

17 `MPI_GROUP_SIZE(group, size)`

21	IN	group	group (handle)
22	OUT	size	number of processes in the group (integer)

#### 24 C binding

25 `int MPI_Group_size(MPI_Group group, int *size)`

#### 27 Fortran 2008 binding

28 `MPI_Group_size(group, size, ierror)`  
 29 `TYPE(MPI_Group), INTENT(IN) :: group`  
 30 `INTEGER, INTENT(OUT) :: size`  
 31 `INTEGER, OPTIONAL, INTENT(OUT) :: ierror`

#### 33 Fortran binding

34 `MPI_GROUP_SIZE(GROUP, SIZE, IERROR)`  
 35 `INTEGER GROUP, SIZE, IERROR`

37 `MPI_GROUP_RANK(group, rank)`

39	IN	group	group (handle)
40	OUT	rank	rank of the calling process in group, or
41			<code>MPI_UNDEFINED</code> if the process is not a member
42			(integer)

#### 45 C binding

46 `int MPI_Group_rank(MPI_Group group, int *rank)`

**Fortran 2008 binding**

```

MPI_Group_rank(group, rank, ierror)
    TYPE(MPI_Group), INTENT(IN) :: group
    INTEGER, INTENT(OUT) :: rank
    INTEGER, OPTIONAL, INTENT(OUT) :: ierror

```

**Fortran binding**

```

MPI_GROUP_RANK(GROUP, RANK, IERROR)
    INTEGER GROUP, RANK, IERROR

```

```

MPI_GROUP_TRANSLATE_RANKS(group1, n, ranks1, group2, ranks2)

```

IN	group1	group1 (handle)
IN	n	number of ranks in ranks1 and ranks2 arrays (integer)
IN	ranks1	array of zero or more valid ranks in group1
IN	group2	group2 (handle)
OUT	ranks2	array of corresponding ranks in group2, MPI_UNDEFINED when no correspondence exists.

**C binding**

```

int MPI_Group_translate_ranks(MPI_Group group1, int n, const int ranks1[],
    MPI_Group group2, int ranks2[])

```

**Fortran 2008 binding**

```

MPI_Group_translate_ranks(group1, n, ranks1, group2, ranks2, ierror)
    TYPE(MPI_Group), INTENT(IN) :: group1, group2
    INTEGER, INTENT(IN) :: n, ranks1(n)
    INTEGER, INTENT(OUT) :: ranks2(n)
    INTEGER, OPTIONAL, INTENT(OUT) :: ierror

```

**Fortran binding**

```

MPI_GROUP_TRANSLATE_RANKS(GROUP1, N, RANKS1, GROUP2, RANKS2, IERROR)
    INTEGER GROUP1, N, RANKS1(*), GROUP2, RANKS2(*), IERROR

```

This function is important for determining the relative numbering of the same processes in two different groups. For instance, if one knows the ranks of certain processes in the group of MPI\_COMM\_WORLD, one might want to know their ranks in a subset of that group.

MPI\_PROC\_NULL is a valid rank for input to MPI\_GROUP\_TRANSLATE\_RANKS, which returns MPI\_PROC\_NULL as the translated rank.

```

1 MPI_GROUP_COMPARE(group1, group2, result)
2     IN      group1          first group (handle)
3     IN      group2          second group (handle)
4     OUT     result          result (integer)
5
6

```

**C binding**

```

8 int MPI_Group_compare(MPI_Group group1, MPI_Group group2, int *result)
9

```

**Fortran 2008 binding**

```

10 MPI_Group_compare(group1, group2, result, ierror)
11     TYPE(MPI_Group), INTENT(IN) :: group1, group2
12     INTEGER, INTENT(OUT) :: result
13     INTEGER, OPTIONAL, INTENT(OUT) :: ierror
14

```

**Fortran binding**

```

15 MPI_GROUP_COMPARE(GROUP1, GROUP2, RESULT, IERROR)
16     INTEGER GROUP1, GROUP2, RESULT, IERROR
17
18

```

MPI\_IDENT results if the group members and group order are exactly the same in both groups. This happens for instance if `group1` and `group2` are the same handle. MPI\_SIMILAR results if the group members are the same but the order is different. MPI\_UNEQUAL results otherwise.

**7.3.2 Group Constructors**

MPI provides two approaches to constructing groups. In the first approach, MPI procedures are provided to subset and superset existing groups. These constructors construct new groups from existing groups. In the second approach, a group is created using a session handle and associated process set. This second approach is available when using the Sessions Model. With both approaches, these are local operations, and distinct groups may be defined on different processes; a process may also define a group that does not include itself. Consistent definitions are required when groups are used as arguments in communicator creation functions. When using the World Model for initializing MPI, the base group, upon which all other groups are defined, is the group associated with the initial communicator MPI\_COMM\_WORLD (accessible through the function MPI\_COMM\_GROUP).

*Rationale.* In what follows, there is no group duplication function analogous to MPI\_COMM\_DUP, defined later in this chapter. There is no need for a group duplicator. A group, once created, can have several references to it by making copies of the handle. The following constructors address the need for subsets and supersets of existing groups. (*End of rationale.*)

*Advice to implementors.* Each group constructor behaves as if it returned a new group object. When this new group is a copy of an existing group, then one can avoid creating such new objects, using a reference-count mechanism. (*End of advice to implementors.*)



MPI\_COMM\_GROUP(comm, group)

IN	comm	communicator (handle)
OUT	group	group corresponding to comm (handle)

#### C binding

```
int MPI_Comm_group(MPI_Comm comm, MPI_Group *group)
```

#### Fortran 2008 binding

```
MPI_Comm_group(comm, group, ierror)
  TYPE(MPI_Comm), INTENT(IN) :: comm
  TYPE(MPI_Group), INTENT(OUT) :: group
  INTEGER, OPTIONAL, INTENT(OUT) :: ierror
```

#### Fortran binding

```
MPI_COMM_GROUP(COMM, GROUP, IERROR)
  INTEGER COMM, GROUP, IERROR
```

MPI\_COMM\_GROUP returns in group a handle to the group of comm.

MPI\_GROUP\_UNION(group1, group2, newgroup)

IN	group1	first group (handle)
IN	group2	second group (handle)
OUT	newgroup	union group (handle)

#### C binding

```
int MPI_Group_union(MPI_Group group1, MPI_Group group2,
  MPI_Group *newgroup)
```

#### Fortran 2008 binding

```
MPI_Group_union(group1, group2, newgroup, ierror)
  TYPE(MPI_Group), INTENT(IN) :: group1, group2
  TYPE(MPI_Group), INTENT(OUT) :: newgroup
  INTEGER, OPTIONAL, INTENT(OUT) :: ierror
```

#### Fortran binding

```
MPI_GROUP_UNION(GROUP1, GROUP2, NEWGROUP, IERROR)
  INTEGER GROUP1, GROUP2, NEWGROUP, IERROR
```

MPI\_GROUP\_INTERSECTION(group1, group2, newgroup)

IN	group1	first group (handle)
IN	group2	second group (handle)
OUT	newgroup	intersection group (handle)

#### C binding

```
int MPI_Group_intersection(MPI_Group group1, MPI_Group group2,
```

```

1         MPI_Group *newgroup)
2
3     Fortran 2008 binding
4     MPI_Group_intersection(group1, group2, newgroup, ierror)
5         TYPE(MPI_Group), INTENT(IN) :: group1, group2
6         TYPE(MPI_Group), INTENT(OUT) :: newgroup
7         INTEGER, OPTIONAL, INTENT(OUT) :: ierror
8
9     Fortran binding
10    MPI_GROUP_INTERSECTION(GROUP1, GROUP2, NEWGROUP, IERROR)
11        INTEGER GROUP1, GROUP2, NEWGROUP, IERROR
12
13    MPI_GROUP_DIFFERENCE(group1, group2, newgroup)
14
15    IN        group1            first group (handle)
16    IN        group2            second group (handle)
17    OUT       newgroup          difference group (handle)
18
19    C binding
20    int MPI_Group_difference(MPI_Group group1, MPI_Group group2,
21        MPI_Group *newgroup)
22
23    Fortran 2008 binding
24    MPI_Group_difference(group1, group2, newgroup, ierror)
25        TYPE(MPI_Group), INTENT(IN) :: group1, group2
26        TYPE(MPI_Group), INTENT(OUT) :: newgroup
27        INTEGER, OPTIONAL, INTENT(OUT) :: ierror
28
29    Fortran binding
30    MPI_GROUP_DIFFERENCE(GROUP1, GROUP2, NEWGROUP, IERROR)
31        INTEGER GROUP1, GROUP2, NEWGROUP, IERROR

```

32 The set-like operations are defined as follows:

33  
34 **union** All elements of the first group (group1), followed by all elements of second group  
35 (group2) not in the first group.

36  
37 **intersect** All elements of the first group that are also in the second group, ordered as in  
38 the first group.

39  
40 **difference** All elements of the first group that are not in the second group, ordered as in  
41 the first group.

42 Note that for these operations the order of processes in the output group is determined  
43 primarily by order in the first group (if possible) and then, if necessary, by order in the  
44 second group. Neither union nor intersection are commutative, but both are associative.  
45 The new group can be empty, that is, equal to MPI\_GROUP\_EMPTY.

46  
47  
48

MPI_GROUP_INCL(group, n, ranks, newgroup)			1
IN	group	group (handle)	2
IN	n	number of elements in array ranks (and size of newgroup) (integer)	3
IN	ranks	ranks of processes in group to appear in newgroup (array of integers)	4
OUT	newgroup	new group derived from above, in the order defined by ranks (handle)	5

**C binding**

```
int MPI_Group_incl(MPI_Group group, int n, const int ranks[],
                  MPI_Group *newgroup)
```

**Fortran 2008 binding**

```
MPI_Group_incl(group, n, ranks, newgroup, ierror)
  TYPE(MPI_Group), INTENT(IN) :: group
  INTEGER, INTENT(IN) :: n, ranks(n)
  TYPE(MPI_Group), INTENT(OUT) :: newgroup
  INTEGER, OPTIONAL, INTENT(OUT) :: ierror
```

**Fortran binding**

```
MPI_GROUP_INCL(GROUP, N, RANKS, NEWGROUP, IERROR)
  INTEGER GROUP, N, RANKS(*), NEWGROUP, IERROR
```

The function MPI\_GROUP\_INCL creates a group `newgroup` that consists of the `n` processes in `group` with ranks `ranks[0]`, ..., `ranks[n-1]`; the process with rank `i` in `newgroup` is the process with rank `ranks[i]` in `group`. Each of the `n` elements of `ranks` must be a valid rank in `group` and all elements must be distinct, or else the program is erroneous. If `n = 0`, then `newgroup` is `MPI_GROUP_EMPTY`. This function can, for instance, be used to reorder the elements of a group. See also `MPI_GROUP_COMPARE`.

MPI_GROUP_EXCL(group, n, ranks, newgroup)			31
IN	group	group (handle)	32
IN	n	number of elements in array ranks (integer)	33
IN	ranks	array of integer ranks of processes in group not to appear in newgroup	34
OUT	newgroup	new group derived from above, preserving the order defined by group (handle)	35

**C binding**

```
int MPI_Group_excl(MPI_Group group, int n, const int ranks[],
                  MPI_Group *newgroup)
```

**Fortran 2008 binding**

```
MPI_Group_excl(group, n, ranks, newgroup, ierror)
  TYPE(MPI_Group), INTENT(IN) :: group
```

```

1     INTEGER, INTENT(IN) :: n, ranks(n)
2     TYPE(MPI_Group), INTENT(OUT) :: newgroup
3     INTEGER, OPTIONAL, INTENT(OUT) :: ierror

```

#### Fortran binding

```

6     MPI_GROUP_EXCL(GROUP, N, RANKS, NEWGROUP, IERROR)
7     INTEGER GROUP, N, RANKS(*), NEWGROUP, IERROR

```

The function `MPI_GROUP_EXCL` creates a group of processes `newgroup` that is obtained by deleting from `group` those processes with ranks `ranks[0], ..., ranks[n-1]`. The ordering of processes in `newgroup` is identical to the ordering in `group`. Each of the `n` elements of `ranks` must be a valid rank in `group` and all elements must be distinct; otherwise, the program is erroneous. If `n = 0`, then `newgroup` is identical to `group`.

```

15    MPI_GROUP_RANGE_INCL(group, n, ranges, newgroup)

```

16	IN	group	group (handle)
17	IN	n	number of triplets in array <code>ranges</code> (integer)
18	IN	ranges	a one-dimensional array of integer triplets, of the form (first rank, last rank, stride) indicating ranks in <code>group</code> of processes to be included in <code>newgroup</code>
19	OUT	newgroup	new group derived from above, in the order defined by <code>ranges</code> (handle)

#### C binding

```

26    int MPI_Group_range_incl(MPI_Group group, int n, int ranges[][3],
27                             MPI_Group *newgroup)

```

#### Fortran 2008 binding

```

30    MPI_Group_range_incl(group, n, ranges, newgroup, ierror)
31    TYPE(MPI_Group), INTENT(IN) :: group
32    INTEGER, INTENT(IN) :: n, ranges(3, n)
33    TYPE(MPI_Group), INTENT(OUT) :: newgroup
34    INTEGER, OPTIONAL, INTENT(OUT) :: ierror

```

#### Fortran binding

```

36    MPI_GROUP_RANGE_INCL(GROUP, N, RANGES, NEWGROUP, IERROR)
37    INTEGER GROUP, N, RANGES(3, *), NEWGROUP, IERROR

```

If `ranges` consists of the triplets

$$(first_1, last_1, stride_1), \dots, (first_n, last_n, stride_n)$$

then `newgroup` consists of the sequence of processes in `group` with ranks

$$first_1, first_1 + stride_1, \dots, first_1 + \left\lfloor \frac{last_1 - first_1}{stride_1} \right\rfloor stride_1, \dots,$$

$$first_n, first_n + stride_n, \dots, first_n + \left\lfloor \frac{last_n - first_n}{stride_n} \right\rfloor stride_n.$$

Each computed rank must be a valid rank in `group` and all computed ranks must be distinct, or else the program is erroneous. Note that we may have  $first_i > last_i$ , and  $stride_i$  may be negative, but cannot be zero.

The functionality of this routine is specified to be equivalent to expanding the array of ranges to an array of the included ranks and passing the resulting array of ranks and other arguments to `MPI_GROUP_INCL`. A call to `MPI_GROUP_INCL` is equivalent to a call to `MPI_GROUP_RANGE_INCL` with each rank `i` in `ranks` replaced by the triplet `(i,i,1)` in the argument `ranges`.

`MPI_GROUP_RANGE_EXCL(group, n, ranges, newgroup)`

IN	<code>group</code>	group (handle)
IN	<code>n</code>	number of triplets in array <code>ranges</code> (integer)
IN	<code>ranges</code>	a one-dimensional array of integer triplets, of the form (first rank, last rank, stride) indicating ranks in <code>group</code> of processes to be excluded from the output group <code>newgroup</code> (array of integers)
OUT	<code>newgroup</code>	new group derived from above, preserving the order in <code>group</code> (handle)

#### C binding

```
int MPI_Group_range_excl(MPI_Group group, int n, int ranges[][3],
                        MPI_Group *newgroup)
```

#### Fortran 2008 binding

```
MPI_Group_range_excl(group, n, ranges, newgroup, ierror)
  TYPE(MPI_Group), INTENT(IN) :: group
  INTEGER, INTENT(IN) :: n, ranges(3, n)
  TYPE(MPI_Group), INTENT(OUT) :: newgroup
  INTEGER, OPTIONAL, INTENT(OUT) :: ierror
```

#### Fortran binding

```
MPI_GROUP_RANGE_EXCL(GROUP, N, RANGES, NEWGROUP, IERROR)
  INTEGER GROUP, N, RANGES(3, *), NEWGROUP, IERROR
```

Each computed rank must be a valid rank in `group` and all computed ranks must be distinct, or else the program is erroneous.

The functionality of this routine is specified to be equivalent to expanding the array of ranges to an array of the excluded ranks and passing the resulting array of ranks and other arguments to `MPI_GROUP_EXCL`. A call to `MPI_GROUP_EXCL` is equivalent to a call to `MPI_GROUP_RANGE_EXCL` with each rank `i` in `ranks` replaced by the triplet `(i,i,1)` in the argument `ranges`.

*Advice to users.* The range operations do not explicitly enumerate ranks, and therefore are more scalable if implemented efficiently. Hence, we recommend MPI programmers to use them whenever possible, as high-quality implementations will take advantage of this fact. (*End of advice to users.*)

1 *Advice to implementors.* The range operations should be implemented, if possible,  
 2 without enumerating the group members, in order to obtain better scalability (time  
 3 and space). (*End of advice to implementors.*)  
 4  
 5

6  
 7 **MPI\_GROUP\_FROM\_SESSION\_PSET**(session, pset\_name, newgroup)

8	IN	session	session (handle)
9	IN	pset_name	name of process set to use to create the new group (string)
10			
11	OUT	newgroup	new group derived from supplied session and process set (handle)
12			
13			

14  
 15 **C binding**

16 `int MPI_Group_from_session_pset(MPI_Session session, const char *pset_name,`  
 17 `MPI_Group *newgroup)`

18 **Fortran 2008 binding**

19 `MPI_Group_from_session_pset(session, pset_name, newgroup, ierror)`  
 20 `TYPE(MPI_Session), INTENT(IN) :: session`  
 21 `CHARACTER(LEN=*), INTENT(IN) :: pset_name`  
 22 `TYPE(MPI_Group), INTENT(OUT) :: newgroup`  
 23 `INTEGER, OPTIONAL, INTENT(OUT) :: ierror`  
 24

25 **Fortran binding**

26 `MPI_GROUP_FROM_SESSION_PSET(SESSION, PSET_NAME, NEWGROUP, IERROR)`  
 27 `INTEGER SESSION, NEWGROUP, IERROR`  
 28 `CHARACTER*(*) PSET_NAME`

29  
 30 The function `MPI_GROUP_FROM_SESSION_PSET` creates a group `newgroup` using the  
 31 provided session handle and process set. The process set name must be one returned from  
 32 an invocation of `MPI_SESSION_GET_NTH_PSET` using the supplied session handle. If the  
 33 `pset_name` does not exist, `MPI_GROUP_NULL` will be returned in the `newgroup` argument.  
 34 As with other group constructors, `MPI_GROUP_FROM_SESSION_PSET` is a local function.  
 35 See Section 11.3 for more information on sessions and process sets.  
 36

37 **7.3.3 Group Destructors**

38  
 39  
 40 **MPI\_GROUP\_FREE**(group)

41	INOUT	group	group (handle)
42			

43 **C binding**

44 `int MPI_Group_free(MPI_Group *group)`

45 **Fortran 2008 binding**

46 `MPI_Group_free(group, ierror)`  
 47 `TYPE(MPI_Group), INTENT(INOUT) :: group`  
 48

INTEGER, OPTIONAL, INTENT(OUT) :: ierror

### Fortran binding

MPI\_GROUP\_FREE(GROUP, IERROR)

INTEGER GROUP, IERROR

This operation marks a group object for deallocation. The handle `group` is set to `MPI_GROUP_NULL` by the call. Any on-going operation using this group will complete normally.

*Advice to implementors.* One can keep a reference count that is incremented for each call to `MPI_COMM_GROUP`, `MPI_COMM_CREATE`, `MPI_COMM_DUP`, and `MPI_COMM_IDUP`, and decremented for each call to `MPI_GROUP_FREE` or `MPI_COMM_FREE`; the group object is ultimately deallocated when the reference count drops to zero. (*End of advice to implementors.*)

## 7.4 Communicator Management

This section describes the manipulation of communicators in MPI. Operations that access communicators are local and their execution does not require interprocess communication. Operations that create communicators are collective and may require interprocess communication.

*Advice to implementors.* High-quality implementations should amortize the overheads associated with the creation of communicators (for the same group, or subsets thereof) over several calls, by allocating multiple contexts with one collective communication. (*End of advice to implementors.*)

### 7.4.1 Communicator Accessors

The following are all local operations.

MPI\_COMM\_SIZE(comm, size)

IN	comm	communicator (handle)
OUT	size	number of processes in the group of comm (integer)

### C binding

int MPI\_Comm\_size(MPI\_Comm comm, int \*size)

### Fortran 2008 binding

MPI\_Comm\_size(comm, size, ierror)

TYPE(MPI\_Comm), INTENT(IN) :: comm

INTEGER, INTENT(OUT) :: size

INTEGER, OPTIONAL, INTENT(OUT) :: ierror

### Fortran binding

MPI\_COMM\_SIZE(COMM, SIZE, IERROR)

INTEGER COMM, SIZE, IERROR

*Rationale.* This function is equivalent to accessing the communicator's group with `MPI_COMM_GROUP` (see above), computing the size using `MPI_GROUP_SIZE`, and then freeing the temporary group via `MPI_GROUP_FREE`. However, this function is so commonly used that this shortcut was introduced. (*End of rationale.*)

*Advice to users.* This function indicates the number of processes involved in a communicator. For `MPI_COMM_WORLD`, it indicates the total number of processes available unless the number of processes has been changed by using the functions described in Chapter 11; note that the number of processes in `MPI_COMM_WORLD` does not change during the life of an MPI program.

This call is often used with the next call to determine the amount of concurrency available for a specific library or program. The following call, `MPI_COMM_RANK` indicates the rank of the process that calls it in the range from 0, ..., `size-1`, where `size` is the return value of `MPI_COMM_SIZE`. (*End of advice to users.*)

`MPI_COMM_RANK(comm, rank)`

IN	<code>comm</code>	communicator (handle)
OUT	<code>rank</code>	rank of the calling process in group of <code>comm</code> (integer)

### C binding

```
int MPI_Comm_rank(MPI_Comm comm, int *rank)
```

### Fortran 2008 binding

```
MPI_Comm_rank(comm, rank, ierror)
  TYPE(MPI_Comm), INTENT(IN) :: comm
  INTEGER, INTENT(OUT) :: rank
  INTEGER, OPTIONAL, INTENT(OUT) :: ierror
```

### Fortran binding

```
MPI_COMM_RANK(COMM, RANK, IERROR)
  INTEGER COMM, RANK, IERROR
```

*Rationale.* This function is equivalent to accessing the communicator's group with `MPI_COMM_GROUP` (see above), computing the rank using `MPI_GROUP_RANK`, and then freeing the temporary group via `MPI_GROUP_FREE`. However, this function is so commonly used that this shortcut was introduced. (*End of rationale.*)

*Advice to users.* This function gives the rank of the process in the particular communicator's group. It is useful, as noted above, in conjunction with `MPI_COMM_SIZE`.

Many programs will be written with the supervisor/executor or manager/worker model, where one process (such as the rank-zero process) will play a supervisory role, and the other processes will serve as compute nodes. In this framework, the two preceding calls are useful for determining the roles of the various processes of a communicator. (*End of advice to users.*)



MPI\_COMM\_COMPARE(comm1, comm2, result)

IN	comm1	first communicator (handle)
IN	comm2	second communicator (handle)
OUT	result	result (integer)

#### C binding

```
int MPI_Comm_compare(MPI_Comm comm1, MPI_Comm comm2, int *result)
```

#### Fortran 2008 binding

```
MPI_Comm_compare(comm1, comm2, result, ierror)
  TYPE(MPI_Comm), INTENT(IN) :: comm1, comm2
  INTEGER, INTENT(OUT) :: result
  INTEGER, OPTIONAL, INTENT(OUT) :: ierror
```

#### Fortran binding

```
MPI_COMM_COMPARE(COMM1, COMM2, RESULT, IERROR)
  INTEGER COMM1, COMM2, RESULT, IERROR
```

MPI\_IDENT results if and only if comm1 and comm2 are handles for the same object (identical groups and same contexts). MPI\_CONGRUENT results if the underlying groups are identical in constituents and rank order; these communicators differ only by context. MPI\_SIMILAR results if the group members of both communicators are the same but the rank order differs. MPI\_UNEQUAL results otherwise.

### 7.4.2 Communicator Constructors

The following are collective functions that are invoked by all processes in the group or groups associated with comm, with the exception of MPI\_COMM\_CREATE\_GROUP, MPI\_COMM\_CREATE\_FROM\_GROUP, and MPI\_INTERCOMM\_CREATE\_FROM\_GROUPS. MPI\_COMM\_CREATE\_GROUP and MPI\_COMM\_CREATE\_FROM\_GROUP are invoked only by the processes in the group of the new communicator being constructed. MPI\_INTERCOMM\_CREATE\_FROM\_GROUPS is invoked by all the processes in the local and remote groups of the new communicator being constructed. See the discussion below for the definition of local and remote groups.

*Rationale.* Note that, when using the World Model, there is a chicken-and-egg aspect to MPI in that a communicator is needed to create a new communicator. In the World Model, the base communicator for all MPI communicators is predefined outside of MPI, and is MPI\_COMM\_WORLD. The World Model was arrived at after considerable debate, and was chosen to increase “safety” of programs written in MPI. (End of rationale.)

This chapter presents the following communicator construction routines: MPI\_COMM\_CREATE, MPI\_COMM\_DUP, MPI\_COMM\_IDUP, MPI\_COMM\_DUP\_WITH\_INFO, MPI\_COMM\_IDUP\_WITH\_INFO, MPI\_COMM\_SPLIT and MPI\_COMM\_SPLIT\_TYPE can be used to create both intra-communicators and inter-communicators; MPI\_COMM\_CREATE\_GROUP, MPI\_COMM\_CREATE\_FROM\_GROUP and MPI\_INTERCOMM\_MERGE (see Section 7.6.2) can be used to create intra-communicators;

1 MPI\_INTERCOMM\_CREATE and MPI\_INTERCOMM\_CREATE\_FROM\_GROUPS (see Sec-  
 2 tion 7.6.2) can be used to create inter-communicators.

3 An intra-communicator involves a single group while an inter-communicator involves  
 4 two groups. Where the following discussions address inter-communicator semantics, the  
 5 two groups in an inter-communicator are called the *left* and *right* groups. A process in an  
 6 inter-communicator is a member of either the left or the right group. From the point of  
 7 view of that process, the group that the process is a member of is called the *local group*; the  
 8 other group (relative to that process) is the *remote group*. The left and right group labels  
 9 give us a way to describe the two groups in an inter-communicator that is not relative to  
 10 any particular process (as the local and remote groups are).  
 11

12  
 13 MPI\_COMM\_DUP(comm, newcomm)

14	IN	comm	communicator (handle)
15	OUT	newcomm	copy of comm (handle)
16			

### 17 C binding

18 int MPI\_Comm\_dup(MPI\_Comm comm, MPI\_Comm \*newcomm)  
 19

### 20 Fortran 2008 binding

21 MPI\_Comm\_dup(comm, newcomm, ierror)  
 22     TYPE(MPI\_Comm), INTENT(IN) :: comm  
 23     TYPE(MPI\_Comm), INTENT(OUT) :: newcomm  
 24     INTEGER, OPTIONAL, INTENT(OUT) :: ierror  
 25

### 26 Fortran binding

27 MPI\_COMM\_DUP(COMM, NEWCOMM, IERROR)  
 28     INTEGER COMM, NEWCOMM, IERROR  
 29

30 MPI\_COMM\_DUP duplicates the existing communicator `comm` with associated key  
 31 values and topology information. For each key value, the respective copy callback function  
 32 determines the attribute value associated with this key in the new communicator; one  
 33 particular action that a copy callback may take is to delete the attribute from the new  
 34 communicator. MPI\_COMM\_DUP returns in `newcomm` a new communicator with the same  
 35 group or groups, same topology, and any copied cached information, but a new context (see  
 36 Section 7.7.1).

37 *Advice to users.* This operation is used to provide a parallel library with a duplicate  
 38 communication space that has the same properties as the original communicator. This  
 39 includes any attributes (see below) and topologies (see Chapter 8). This call is valid  
 40 even if there are pending point-to-point communications involving the communicator  
 41 `comm`. A typical call might involve a MPI\_COMM\_DUP at the beginning of the  
 42 parallel call, and an MPI\_COMM\_FREE of that duplicated communicator at the end  
 43 of the call. Other models of communicator management are also possible.

44 This call applies to both intra- and inter-communicators. (*End of advice to users.*)

45  
 46 *Advice to implementors.* One need not actually copy the group information, but only  
 47 add a new reference and increment the reference count. Copy on write can be used  
 48 for the cached information. (*End of advice to implementors.*)

MPI\_COMM\_DUP\_WITH\_INFO(comm, info, newcomm) 1

IN	comm	communicator (handle)	2
IN	info	info object (handle)	3
OUT	newcomm	copy of comm (handle)	4

#### C binding

```
int MPI_Comm_dup_with_info(MPI_Comm comm, MPI_Info info, MPI_Comm *newcomm) 5
```

#### Fortran 2008 binding

```
MPI_Comm_dup_with_info(comm, info, newcomm, ierror) 6
  TYPE(MPI_Comm), INTENT(IN) :: comm 7
  TYPE(MPI_Info), INTENT(IN) :: info 8
  TYPE(MPI_Comm), INTENT(OUT) :: newcomm 9
  INTEGER, OPTIONAL, INTENT(OUT) :: ierror 10
```

#### Fortran binding

```
MPI_COMM_DUP_WITH_INFO(COMM, INFO, NEWCOMM, IERROR) 11
  INTEGER COMM, INFO, NEWCOMM, IERROR 12
```

MPI\_COMM\_DUP\_WITH\_INFO behaves exactly as MPI\_COMM\_DUP except that the hints provided by the argument info are associated with the output communicator newcomm. 13

*Rationale.* It is expected that some hints will only be valid at communicator creation time. However, for legacy reasons, most communicator creation calls do not provide an info argument. One may associate info hints with a duplicate of any communicator at creation time through a call to MPI\_COMM\_DUP\_WITH\_INFO. (*End of rationale.*) 14

MPI\_COMM\_IDUP(comm, newcomm, request) 15

IN	comm	communicator (handle)	16
OUT	newcomm	copy of comm (handle)	17
OUT	request	communication request (handle)	18

#### C binding

```
int MPI_Comm_idup(MPI_Comm comm, MPI_Comm *newcomm, MPI_Request *request) 19
```

#### Fortran 2008 binding

```
MPI_Comm_idup(comm, newcomm, request, ierror) 20
  TYPE(MPI_Comm), INTENT(IN) :: comm 21
  TYPE(MPI_Comm), INTENT(OUT), ASYNCHRONOUS :: newcomm 22
  TYPE(MPI_Request), INTENT(OUT) :: request 23
  INTEGER, OPTIONAL, INTENT(OUT) :: ierror 24
```

#### Fortran binding

```
MPI_COMM_IDUP(COMM, NEWCOMM, REQUEST, IERROR) 25
  INTEGER COMM, NEWCOMM, REQUEST, IERROR 26
```

1 MPI\_COMM\_IDUP is a nonblocking variant of MPI\_COMM\_DUP. With the exception  
 2 of its nonblocking behavior, the semantics of MPI\_COMM\_IDUP are as if MPI\_COMM\_DUP  
 3 was executed at the time that MPI\_COMM\_IDUP is called. For example, attributes changed  
 4 after MPI\_COMM\_IDUP will not be copied to the new communicator. All restrictions and  
 5 assumptions for nonblocking collective operations (see Section 6.12) apply to  
 6 MPI\_COMM\_IDUP and the returned request.

7 It is erroneous to use the communicator `newcomm` as an input argument to other MPI  
 8 functions before the MPI\_COMM\_IDUP operation completes.

9  
 10  
 11 MPI\_COMM\_IDUP\_WITH\_INFO(comm, info, newcomm, request)

12	IN	comm	communicator (handle)
13	IN	info	info object (handle)
14	OUT	newcomm	copy of comm (handle)
15	OUT	request	communication request (handle)

### 18 C binding

```
19 int MPI_Comm_idup_with_info(MPI_Comm comm, MPI_Info info,
20                             MPI_Comm *newcomm, MPI_Request *request)
21
```

### 22 Fortran 2008 binding

```
23 MPI_Comm_idup_with_info(comm, info, newcomm, request, ierror)
24     TYPE(MPI_Comm), INTENT(IN) :: comm
25     TYPE(MPI_Info), INTENT(IN) :: info
26     TYPE(MPI_Comm), INTENT(OUT), ASYNCHRONOUS :: newcomm
27     TYPE(MPI_Request), INTENT(OUT) :: request
28     INTEGER, OPTIONAL, INTENT(OUT) :: ierror
29
```

### 29 Fortran binding

```
30 MPI_COMM_IDUP_WITH_INFO(COMM, INFO, NEWCOMM, REQUEST, IERROR)
31     INTEGER COMM, INFO, NEWCOMM, REQUEST, IERROR
32
```

33 MPI\_COMM\_IDUP\_WITH\_INFO is a nonblocking variant of  
 34 MPI\_COMM\_DUP\_WITH\_INFO. With the exception of its nonblocking behavior, the se-  
 35 mantics of MPI\_COMM\_IDUP\_WITH\_INFO are as if MPI\_COMM\_DUP\_WITH\_INFO was  
 36 executed at the time that MPI\_COMM\_IDUP\_WITH\_INFO is called. For example, attributes  
 37 or info hints changed after MPI\_COMM\_IDUP\_WITH\_INFO will not be copied to the new  
 38 communicator. All restrictions and assumptions for nonblocking collective operations (see  
 39 Section 6.12) apply to MPI\_COMM\_IDUP\_WITH\_INFO and the returned request.

40 It is erroneous to use the communicator `newcomm` as an input argument to other MPI  
 41 functions before the MPI\_COMM\_IDUP\_WITH\_INFO operation completes.

42  
 43 *Rationale.* The MPI\_COMM\_IDUP and MPI\_COMM\_IDUP\_WITH\_INFO functions  
 44 are crucial for the development of purely nonblocking libraries (see [40]). (*End of*  
 45 *rationale.*)

MPI\_COMM\_CREATE(comm, group, newcomm) 1

IN comm communicator (handle) 2

IN group group, which is a subset of the group of comm  
(handle) 3 4 5

OUT newcomm new communicator (handle) 6 7

### C binding 8

int MPI\_Comm\_create(MPI\_Comm comm, MPI\_Group group, MPI\_Comm \*newcomm) 9

### Fortran 2008 binding 11

MPI\_Comm\_create(comm, group, newcomm, ierror) 12

TYPE(MPI\_Comm), INTENT(IN) :: comm 13

TYPE(MPI\_Group), INTENT(IN) :: group 14

TYPE(MPI\_Comm), INTENT(OUT) :: newcomm 15

INTEGER, OPTIONAL, INTENT(OUT) :: ierror 16

### Fortran binding 17

MPI\_COMM\_CREATE(COMM, GROUP, NEWCOMM, IERROR) 18

INTEGER COMM, GROUP, NEWCOMM, IERROR 19

If `comm` is an intra-communicator, this function returns a new communicator `newcomm` with communication group defined by the `group` argument. No cached information propagates from `comm` to `newcomm` and no virtual topology information is added to the created communicator. Each process must call `MPI_COMM_CREATE` with a `group` argument that is a subgroup of the `group` associated with `comm`; this could be `MPI_GROUP_EMPTY`. The processes may specify different values for the `group` argument. If a process calls with a non-empty `group` then all processes in that `group` must call the function with the same `group` as argument, that is the same processes in the same order. Otherwise, the call is erroneous. This implies that the set of groups specified across the processes must be disjoint. If the calling process is a member of the group given as `group` argument, then `newcomm` is a communicator with `group` as its associated group. In the case that a process calls with a `group` to which it does not belong, e.g., `MPI_GROUP_EMPTY`, then `MPI_COMM_NULL` is returned as `newcomm`. The function is collective and must be called by all processes in the group of `comm`. 21 22 23 24 25 26 27 28 29 30 31 32 33 34

*Rationale.* The interface supports the original mechanism from MPI-1.1, which required the same `group` in all processes of `comm`. It was extended in MPI-2.2 to allow the use of disjoint subgroups in order to allow implementations to eliminate unnecessary communication that `MPI_COMM_SPLIT` would incur when the user already knows the membership of the disjoint subgroups. (*End of rationale.*) 35 36 37 38 39 40

*Rationale.* The requirement that the entire group of `comm` participate in the call stems from the following considerations: 41 42

- It allows the implementation to layer `MPI_COMM_CREATE` on top of regular collective communications. 44 45 46
- It provides additional safety, in particular in the case where partially overlapping groups are used to create new communicators. 47 48

- It permits implementations to sometimes avoid communication related to context creation.

(*End of rationale.*)

*Advice to users.* MPI\_COMM\_CREATE provides a means to subset a group of processes for the purpose of separate MIMD computation, with separate communication space. newcomm, which emerges from MPI\_COMM\_CREATE, can be used in subsequent calls to MPI\_COMM\_CREATE (or other communicator constructors) to further subdivide a computation into parallel sub-computations. A more general service is provided by MPI\_COMM\_SPLIT, below. (*End of advice to users.*)

*Advice to implementors.* When calling MPI\_COMM\_DUP, all processes call with the same group (the group associated with the communicator). When calling MPI\_COMM\_CREATE, the processes provide the same group or disjoint subgroups. For both calls, it is theoretically possible to agree on a group-wide unique context with no communication. However, local execution of these functions requires use of a larger context name space and reduces error checking. Implementations may strike various compromises between these conflicting goals, such as bulk allocation of multiple contexts in one collective operation.

Important: If new communicators are created without synchronizing the processes involved then the communication system must be able to cope with messages arriving in a context that has not yet been allocated at the receiving process. (*End of advice to implementors.*)

If comm is an inter-communicator, then the output communicator is also an inter-communicator where the local group consists only of those processes contained in group (see Figure 7.1). The group argument should only contain those processes in the local group of the input inter-communicator that are to be a part of newcomm. All processes in the same local group of comm must specify the same value for group, i.e., the same members in the same order. If either group does not specify at least one process in the local group of the inter-communicator, or if the calling process is not included in the group, MPI\_COMM\_NULL is returned.

*Rationale.* In the case where either the left or right group is empty, a null communicator is returned instead of an inter-communicator with MPI\_GROUP\_EMPTY because the side with the empty group must return MPI\_COMM\_NULL. (*End of rationale.*)

### Example 7.1 Inter-communicator creation.

The following example illustrates how the first node in the left side of an inter-communicator could be joined with all members on the right side of an inter-communicator to form a new inter-communicator.

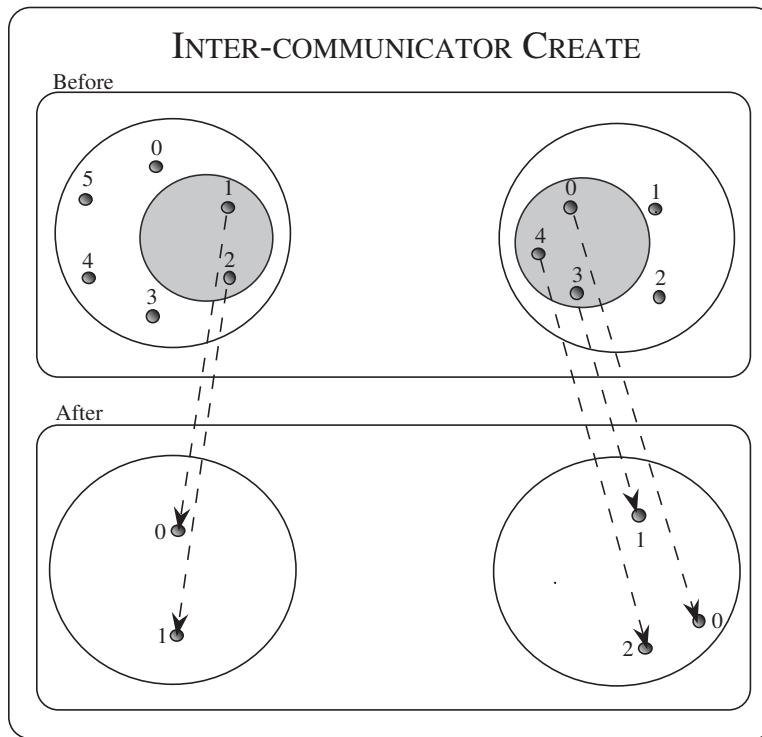

Figure 7.1: Inter-communicator creation using `MPI_COMM_CREATE` extended to inter-communicators. The input groups are those in the grey circle.

```

MPI_Comm inter_comm, new_inter_comm;
MPI_Group local_group, group;
int      rank = 0; /* rank on left side to include in
                  new inter-comm */

/* Construct the original inter-communicator: "inter_comm" */
...

/* Construct the group of processes to be in new
inter-communicator */
if (/* I'm on the left side of the inter-communicator */) {
    MPI_Comm_group(inter_comm, &local_group);
    MPI_Group_incl(local_group, 1, &rank, &group);
    MPI_Group_free(&local_group);
}
else
    MPI_Comm_group(inter_comm, &group);

MPI_Comm_create(inter_comm, group, &new_inter_comm);
MPI_Group_free(&group);

```

```

1 MPI_COMM_CREATE_GROUP(comm, group, tag, newcomm)
2     IN      comm      intra-communicator (handle)
3
4     IN      group     group, which is a subset of the group of comm
5                      (handle)
6
7     IN      tag       tag (integer)
8
9     OUT     newcomm   new communicator (handle)

```

**C binding**

```

10 int MPI_Comm_create_group(MPI_Comm comm, MPI_Group group, int tag,
11                          MPI_Comm *newcomm)
12

```

**Fortran 2008 binding**

```

13 MPI_Comm_create_group(comm, group, tag, newcomm, ierror)
14     TYPE(MPI_Comm), INTENT(IN) :: comm
15     TYPE(MPI_Group), INTENT(IN) :: group
16     INTEGER, INTENT(IN) :: tag
17     TYPE(MPI_Comm), INTENT(OUT) :: newcomm
18     INTEGER, OPTIONAL, INTENT(OUT) :: ierror
19
20

```

**Fortran binding**

```

21 MPI_COMM_CREATE_GROUP(COMM, GROUP, TAG, NEWCOMM, IERROR)
22     INTEGER COMM, GROUP, TAG, NEWCOMM, IERROR
23

```

MPI\_COMM\_CREATE\_GROUP is similar to MPI\_COMM\_CREATE; however, MPI\_COMM\_CREATE must be called by all processes in the group of `comm`, whereas MPI\_COMM\_CREATE\_GROUP must be called by all processes in `group`, which is a subgroup of the group of `comm`. In addition, MPI\_COMM\_CREATE\_GROUP requires that `comm` is an intra-communicator. MPI\_COMM\_CREATE\_GROUP returns a new intra-communicator, `newcomm`, for which the `group` argument defines the communication group. No cached information propagates from `comm` to `newcomm` and no virtual topology information is added to the created communicator. Each process must provide a `group` argument that is a subgroup of the group associated with `comm`; this could be MPI\_GROUP\_EMPTY. If a non-empty group is specified, then all processes in that group must call the function, and each of these processes must provide the same arguments, including a `group` that contains the same members with the same ordering. Otherwise the call is erroneous. If the calling process is a member of the group given as the `group` argument, then `newcomm` is a communicator with `group` as its associated group. If the calling process is not a member of `group`, e.g., `group` is MPI\_GROUP\_EMPTY, then the call is a local operation and MPI\_COMM\_NULL is returned as `newcomm`.

*Rationale.* Functionality similar to MPI\_COMM\_CREATE\_GROUP can be implemented through repeated MPI\_INTERCOMM\_CREATE and MPI\_INTERCOMM\_MERGE calls that start with the MPI\_COMM\_SELF communicators at each process in `group` and build up an intra-communicator with group `group` [17]. Such an algorithm requires the creation of many intermediate communicators; MPI\_COMM\_CREATE\_GROUP can provide a more efficient implementation that avoids this overhead. (*End of rationale.*)



*Advice to users.* An inter-communicator can be created collectively over processes in the union of the local and remote groups by creating the local communicator using `MPI_COMM_CREATE_GROUP` and using that communicator as the local communicator argument to `MPI_INTERCOMM_CREATE`. (*End of advice to users.*)

The `tag` argument does not conflict with tags used in point-to-point communication and is not permitted to be a wildcard. If multiple threads at a given process perform concurrent `MPI_COMM_CREATE_GROUP` operations, the user must distinguish these operations by providing different `tag` or `comm` arguments.

*Advice to users.* `MPI_COMM_CREATE` may provide lower overhead than `MPI_COMM_CREATE_GROUP` because it can take advantage of collective communication on `comm` when constructing `newcomm`. (*End of advice to users.*)

`MPI_COMM_SPLIT(comm, color, key, newcomm)`

IN	<code>comm</code>	communicator (handle)
IN	<code>color</code>	control of subset assignment (integer)
IN	<code>key</code>	control of rank assignment (integer)
OUT	<code>newcomm</code>	new communicator (handle)

### C binding

```
int MPI_Comm_split(MPI_Comm comm, int color, int key, MPI_Comm *newcomm)
```

### Fortran 2008 binding

```
MPI_Comm_split(comm, color, key, newcomm, ierror)
  TYPE(MPI_Comm), INTENT(IN) :: comm
  INTEGER, INTENT(IN) :: color, key
  TYPE(MPI_Comm), INTENT(OUT) :: newcomm
  INTEGER, OPTIONAL, INTENT(OUT) :: ierror
```

### Fortran binding

```
MPI_COMM_SPLIT(COMM, COLOR, KEY, NEWCOMM, IERROR)
  INTEGER COMM, COLOR, KEY, NEWCOMM, IERROR
```

This function partitions the group associated with `comm` into disjoint subgroups, one for each value of `color`. Each subgroup contains all processes of the same `color`. Within each subgroup, the processes are ranked in the order defined by the value of the argument `key`, with ties broken according to their rank in the old group. A new communicator is created for each subgroup and returned in `newcomm`. A process may supply the `color` value `MPI_UNDEFINED`, in which case `newcomm` returns `MPI_COMM_NULL`. This is a collective call, but each process is permitted to provide different values for `color` and `key`. No cached information propagates from `comm` to `newcomm` and no virtual topology information is added to the created communicators.

With an intra-communicator `comm`, a call to `MPI_COMM_CREATE(comm, group, newcomm)` is equivalent to a call to `MPI_COMM_SPLIT(comm, color, key, newcomm)`, where processes that are members of their `group` argument provide `color = number of the group`

(based on a unique numbering of all disjoint groups) and `key = rank in group`, and all processes that are not members of their `group` argument provide `color = MPI_UNDEFINED`. The value of `color` must be non-negative or `MPI_UNDEFINED`.

*Advice to users.* This is an extremely powerful mechanism for dividing a single communicating group of processes into  $k$  subgroups, with  $k$  chosen implicitly by the user (by the number of colors asserted over all the processes). Each resulting communicator will be non-overlapping. Such a division could be useful for defining a hierarchy of computations, such as for multigrid, or linear algebra. For intra-communicators, `MPI_COMM_SPLIT` provides similar capability as `MPI_COMM_CREATE` to split a communicating group into disjoint subgroups. `MPI_COMM_SPLIT` is useful when some processes do not have complete information of the other members in their group, but all processes know (the color of) the group to which they belong. In this case, the MPI implementation discovers the other group members via communication. `MPI_COMM_CREATE` is useful when all processes have complete information of the members of their group. In this case, MPI can avoid the extra communication required to discover group membership. `MPI_COMM_CREATE_GROUP` is useful when all processes in a given group have complete information of the members of their group and synchronization with processes outside the group can be avoided.

Multiple calls to `MPI_COMM_SPLIT` can be used to overcome the requirement that any call have no overlap of the resulting communicators (each process is of only one color per call). In this way, multiple overlapping communication structures can be created. Creative use of the `color` and `key` in such splitting operations is encouraged.

Note that, for a fixed color, the keys need not be unique. It is `MPI_COMM_SPLIT`'s responsibility to sort processes in ascending order according to this key, and to break ties in a consistent way. If all the keys are specified in the same way, then all the processes in a given color will have the relative rank order as they did in their parent group.

Essentially, making the key value zero for all processes of a given color means that one does not really care about the rank-order of the processes in the new communicator. (*End of advice to users.*)

*Rationale.* `color` is restricted to be non-negative, so as not to conflict with the value assigned to `MPI_UNDEFINED`. (*End of rationale.*)

The result of `MPI_COMM_SPLIT` on an inter-communicator is that those processes on the left with the same `color` as those processes on the right combine to create a new inter-communicator. The `key` argument describes the relative rank of processes on each side of the inter-communicator (see Figure 7.2). For those colors that are specified only on one side of the inter-communicator, `MPI_COMM_NULL` is returned. `MPI_COMM_NULL` is also returned to those processes that specify `MPI_UNDEFINED` as the color.

*Advice to users.* For inter-communicators, `MPI_COMM_SPLIT` is more general than `MPI_COMM_CREATE`. A single call to `MPI_COMM_SPLIT` can create a set of disjoint inter-communicators, while a call to `MPI_COMM_CREATE` creates only one. (*End of advice to users.*)

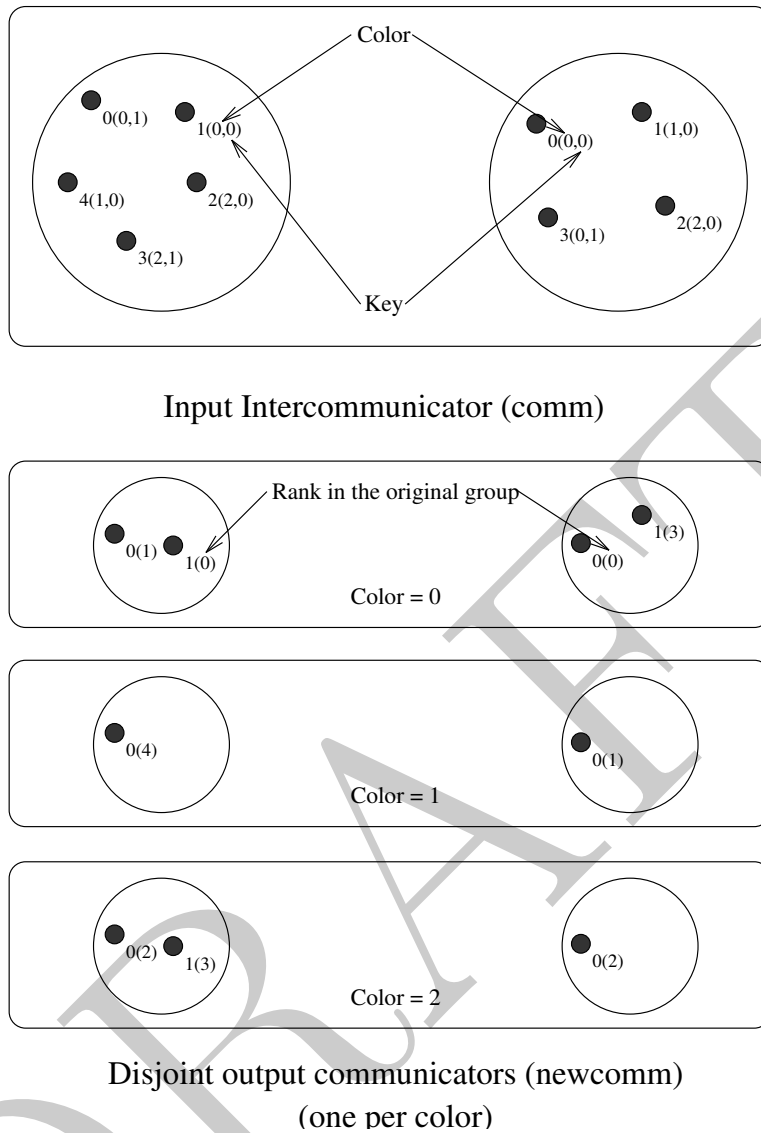

Figure 7.2: Inter-communicator construction achieved by splitting an existing inter-communicator with `MPI_COMM_SPLIT` extended to inter-communicators.

1  
2  
3  
4  
5  
6  
7  
8  
9  
10  
11  
12  
13  
14  
15  
16  
17  
18  
19  
20  
21  
22  
23  
24  
25  
26  
27  
28  
29  
30  
31  
32  
33  
34  
35  
36  
37  
38  
39  
40  
41  
42  
43  
44  
45  
46  
47  
48

1 **Example 7.2** Parallel client-server model.

2 The following client code illustrates how clients on the left side of an inter-communicator  
3 could be assigned to a single server from a pool of servers on the right side of an inter-communicator.  
4

```
5
6     /* Client code */
7     MPI_Comm multiple_server_comm;
8     MPI_Comm single_server_comm;
9     int      color, rank, num_servers;
10
11    /* Create inter-communicator with clients and servers:
12       multiple_server_comm */
13    ...
14
15    /* Find out the number of servers available */
16    MPI_Comm_remote_size(multiple_server_comm, &num_servers);
17
18    /* Determine my color */
19    MPI_Comm_rank(multiple_server_comm, &rank);
20    color = rank % num_servers;
21
22    /* Split the inter-communicator */
23    MPI_Comm_split(multiple_server_comm, color, rank,
24                  &single_server_comm);
```

25 The following is the corresponding server code:

```
26
27    /* Server code */
28    MPI_Comm multiple_client_comm;
29    MPI_Comm single_server_comm;
30    int      rank;
31
32    /* Create inter-communicator with clients and servers:
33       multiple_client_comm */
34    ...
35
36    /* Split the inter-communicator for a single server per group
37       of clients */
38    MPI_Comm_rank(multiple_client_comm, &rank);
39    MPI_Comm_split(multiple_client_comm, rank, 0,
40                  &single_server_comm);
41
42
43
44
45
46
47
48
```

MPI\_COMM\_SPLIT\_TYPE(comm, split\_type, key, info, newcomm)

IN	comm	communicator (handle)	1
IN	split_type	type of processes to be grouped together (integer)	2
IN	key	control of rank assignment (integer)	3
INOUT	info	info argument (handle)	4
OUT	newcomm	new communicator (handle)	5

### C binding

```
int MPI_Comm_split_type(MPI_Comm comm, int split_type, int key,
                        MPI_Info info, MPI_Comm *newcomm)
```

### Fortran 2008 binding

```
MPI_Comm_split_type(comm, split_type, key, info, newcomm, ierror)
  TYPE(MPI_Comm), INTENT(IN) :: comm
  INTEGER, INTENT(IN) :: split_type, key
  TYPE(MPI_Info), INTENT(IN) :: info
  TYPE(MPI_Comm), INTENT(OUT) :: newcomm
  INTEGER, OPTIONAL, INTENT(OUT) :: ierror
```

### Fortran binding

```
MPI_COMM_SPLIT_TYPE(COMM, SPLIT_TYPE, KEY, INFO, NEWCOMM, IERROR)
  INTEGER COMM, SPLIT_TYPE, KEY, INFO, NEWCOMM, IERROR
```

This function partitions the group associated with `comm` into disjoint subgroups such that each subgroup contains all MPI processes in the same grouping referred to by `split_type`. Within each subgroup, the MPI processes are ranked in the order defined by the value of the argument `key`, with ties broken according to their rank in the old group. A new communicator is created for each subgroup and returned in `newcomm`. This is a collective call. All MPI processes in the group associated with `comm` must provide the same `split_type`, but each MPI process is permitted to provide different values for `key`. An exception to this rule is that an MPI process may supply the type value `MPI_UNDEFINED`, in which case `MPI_COMM_NULL` is returned in `newcomm` for such MPI process. No cached information propagates from `comm` to `newcomm` and no virtual topology information is added to the created communicators.

For `split_type`, the following values are defined by MPI:

`MPI_COMM_TYPE_SHARED`—all MPI processes in `newcomm` can create a shared memory segment (e.g., with a successful call to `MPI_WIN_ALLOCATE_SHARED`). This segment can subsequently be used for load/store accesses by all MPI processes in `newcomm`.

*Advice to users.* Since the location of some of the MPI processes may change during the application execution, the communicators created with the value `MPI_COMM_TYPE_SHARED` before this change may not reflect an actual ability to share memory between MPI processes after this change. (*End of advice to users.*)

`MPI_COMM_TYPE_HW_GUIDED`—this value specifies that the communicator `comm` is split according to a **hardware resource type** (for example a computing core or an L3

1 cache) specified by the "mpi\_hw\_resource\_type" info key. Each output communicator  
2 `newcomm` corresponds to a single instance of the specified hardware resource type.  
3 The MPI processes in the group associated with the output communicator `newcomm`  
4 utilize that specific hardware resource type instance, and no other instance of the  
5 same hardware resource type.

6 If an MPI process does not meet the above criteria, then `MPI_COMM_NULL` is returned  
7 in `newcomm` for such process.

8 `MPI_COMM_NULL` is also returned in `newcomm` in the following cases:

- 9 • No info key is provided.
- 10 • The info handle does not include the key "mpi\_hw\_resource\_type".
- 11 • The MPI implementation neither recognizes nor supports the info key  
12 "mpi\_hw\_resource\_type".
- 13 • The MPI implementation does not recognize the value associated with the info  
14 key "mpi\_hw\_resource\_type".

15 The MPI implementation will return in the group of the output communicator  
16 `newcomm` the largest subset of MPI processes that match the splitting criterion.

17 The processes in the group associated with `newcomm` are ranked in the order defined  
18 by the value of the argument key with ties broken according to their rank in the group  
19 associated with `comm`.

20 *Advice to users.* The set of hardware resources that an MPI process is able to  
21 utilize may change during the application execution (e.g., because of the reloca-  
22 tion of an MPI process), in which case the communicators created with the value  
23 `MPI_COMM_TYPE_HW_GUIDED` before this change may not reflect the utiliza-  
24 tion of hardware resources of such process at any time after the communicator  
25 creation. (*End of advice to users.*)

26 The user explicitly constrains with the info argument the splitting of the input com-  
27 municator `comm`. To this end, the info key "mpi\_hw\_resource\_type" is reserved and  
28 its associated value is an implementation-defined string designating the type of the  
29 requested hardware resource (e.g., "NUMANode", "Package" or "L3Cache").

30 The value "mpi\_shared\_memory" is reserved and its use is equivalent to using  
31 `MPI_COMM_TYPE_SHARED` for the `split_type` parameter.

32 *Rationale.* The value "mpi\_shared\_memory" is defined in order to ensure consis-  
33 tency between the use of `MPI_COMM_TYPE_SHARED` and the use of  
34 `MPI_COMM_TYPE_HW_GUIDED`. (*End of rationale.*)

35 All MPI processes must provide the same value for the info key "mpi\_hw\_resource\_type".

36 `MPI_COMM_TYPE_HW_UNGUIDED`—the group of MPI processes associated with `newcomm`  
37 must be a *strict* subset of the group associated with `comm` and each  
38 `newcomm` corresponds to a single instance of a **hardware resource type** (for example  
39 a computing core or an L3 cache).

**Example 7.3** Splitting MPI\_COMM\_WORLD into NUMANode subcommunicators.

```
MPI_Info info;
MPI_Comm hwcomm;
int rank;

MPI_Comm_rank(MPI_COMM_WORLD, &rank);
MPI_Info_create(&info);
MPI_Info_set(info, "mpi_hw_resource_type", "NUMANode");
MPI_Comm_split_type(MPI_COMM_WORLD,
                    MPI_COMM_TYPE_HW_GUIDED,
                    rank, info, &hwcomm);
```

All MPI processes in the group associated with `comm` which utilize that specific hardware resource type instance—and no other instance of the same hardware resource type—are included in the group of `newcomm`.

If a given MPI process cannot be a member of a communicator that forms such a strict subset, or does not meet the above criteria, then MPI\_COMM\_NULL is returned in `newcomm` for this process.

*Advice to implementors.* In a high-quality MPI implementation, the number of different new valid communicators `newcomm` produced by this splitting operation should be minimal unless the user provides a key/value pair that modifies this behavior. The sets of hardware resource types used for the splitting operation are implementation-dependent, but should reflect the hardware of the actual system on which the application is currently executing. (*End of advice to implementors.*)

*Rationale.* If the hardware resources are hierarchically organized, calling this routine several times using as its input communicator `comm` the output communicator `newcomm` of the previous call creates a sequence of `newcomm` communicators in each MPI process, which exposes a hierarchical view of the hardware platform, as shown in Example 7.4. This sequence of returned `newcomm` communicators may differ from the sets of hardware resource types, as shown in the second splitting operation in Figure 7.3. (*End of rationale.*)

*Advice to users.* Each output communicator `newcomm` can represent a different hardware resource type (see Figure 7.3 for an example). The set of hardware resources an MPI process utilizes may change during the application execution (e.g., because of process relocation), in which case the communicators created with the value MPI\_COMM\_TYPE\_HW\_UNGUIDED before this change may not reflect the utilization of hardware resources for such process at any time after the communicator creation. (*End of advice to users.*)

If a valid info handle is provided as an argument, the MPI implementation sets the info key "mpi\_hw\_resource\_type" for each MPI process in the group associated with a returned `newcomm` communicator and the info key value is an implementation-defined

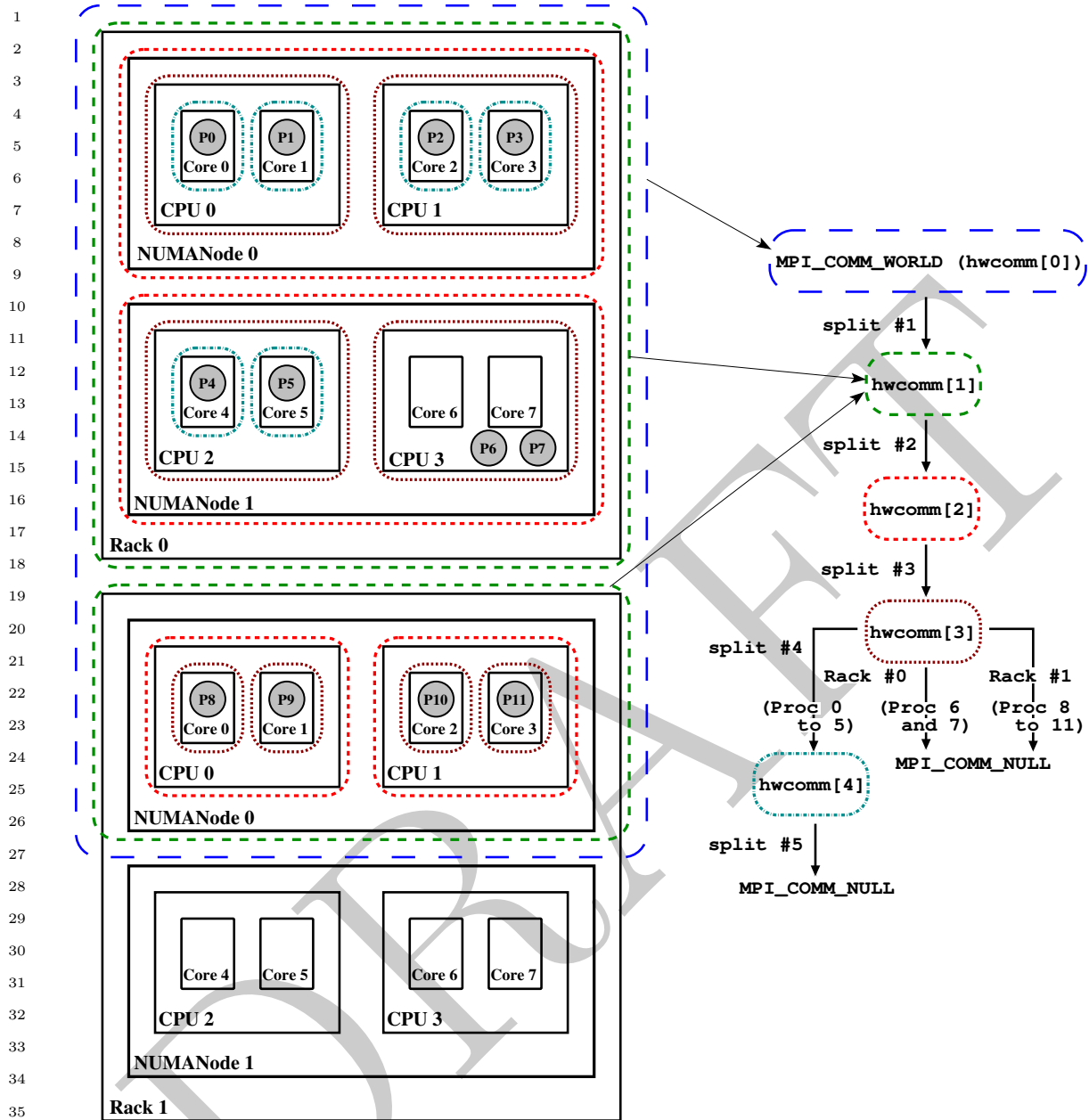

Figure 7.3: Recursive splitting of `MPI_COMM_WORLD` with `MPI_COMM_SPLIT_TYPE` and `MPI_COMM_TYPE_HW_UNGUIDED`. Dashed lines represent communicators whilst solid lines represent hardware resources. MPI processes (P0 to P11) utilize exclusively their respective core, except for P6 and P7 which utilize CPU #3 of Rack #0 and can therefore use Cores #6 and #7 indifferently. The second splitting operation yields two subcommunicators corresponding to NUMANodes in Rack #0 and to CPUs in Rack #1 because Rack #1 features only one NUMANode, which corresponds to the whole portion of the Rack that is included in `MPI_COMM_WORLD` and `hwcomm[1]`. For the first splitting operation, the hardware resource type returned in the info argument is “Rack” on the processes on Rack #0, whereas on Rack #1, it can be either “Rack” or “NUMANode”.



string that indicates the hardware resource type represented by `newcomm`. The same hardware resource type must be set in all MPI processes in the group associated with `newcomm`.

**Example 7.4** Recursive splitting of `MPI_COMM_WORLD`.

```
#define MAX_NUM_LEVELS 32

MPI_Comm hwcomm[MAX_NUM_LEVELS];
int      rank, level_num = 0;

hwcomm[level_num] = MPI_COMM_WORLD;

while((hwcomm[level_num] != MPI_COMM_NULL)
      && (level_num < MAX_NUM_LEVELS-1)){
    MPI_Comm_rank(hwcomm[level_num], &rank);
    MPI_Comm_split_type(hwcomm[level_num],
                       MPI_COMM_TYPE_HW_UNGUIDED,
                       rank,
                       MPI_INFO_NULL,
                       &hwcomm[level_num+1]);

    level_num++;
}
```

*Advice to implementors.* Implementations can define their own `split_type` values, or use the `info` argument, to assist in creating communicators that help expose platform-specific information to the application. The concept of hardware-based communicators was first described by Träff [67] for SMP systems. Guided and unguided modes description as well as an implementation path are introduced by Goglin *et al.* [27]. (*End of advice to implementors.*)

`MPI_COMM_CREATE_FROM_GROUP(group, stringtag, info, errhandler, newcomm)`

IN	<code>group</code>	group (handle)
IN	<code>stringtag</code>	unique identifier for this operation (string)
IN	<code>info</code>	info object (handle)
IN	<code>errhandler</code>	error handler to be attached to new intra-communicator (handle)
OUT	<code>newcomm</code>	new communicator (handle)

### C binding

```
int MPI_Comm_create_from_group(MPI_Group group, const char *stringtag,
                              MPI_Info info, MPI_Errhandler errhandler, MPI_Comm *newcomm)
```

**Fortran 2008 binding**

```

1 MPI_Comm_create_from_group(group, stringtag, info, errhandler, newcomm,
2     ierror)
3     TYPE(MPI_Group), INTENT(IN) :: group
4     CHARACTER(LEN=*), INTENT(IN) :: stringtag
5     TYPE(MPI_Info), INTENT(IN) :: info
6     TYPE(MPI_Errhandler), INTENT(IN) :: errhandler
7     TYPE(MPI_Comm), INTENT(OUT) :: newcomm
8     INTEGER, OPTIONAL, INTENT(OUT) :: ierror

```

**Fortran binding**

```

11 MPI_COMM_CREATE_FROM_GROUP(GROUP, STRINGTAG, INFO, ERRHANDLER, NEWCOMM,
12     IERROR)
13     INTEGER GROUP, INFO, ERRHANDLER, NEWCOMM, IERROR
14     CHARACTER*(*) STRINGTAG

```

MPI\_COMM\_CREATE\_FROM\_GROUP is similar to MPI\_COMM\_CREATE\_GROUP, except that the set of MPI processes involved in the creation of the new intra-communicator is specified by a **group** argument, rather than the group associated with a pre-existing communicator. If a non-empty **group** is specified, then all MPI processes in that group must call the function and each of these MPI processes must provide the same arguments, including a group that contains the same members with the same ordering, and identical **stringtag** value. In the event that MPI\_GROUP\_EMPTY is supplied as the **group** argument, then the call is a local operation and MPI\_COMM\_NULL is returned as **newcomm**. The **stringtag** argument is analogous to the **tag** used for MPI\_COMM\_CREATE\_GROUP. If multiple threads at a given MPI process perform concurrent MPI\_COMM\_CREATE\_FROM\_GROUP operations, the user must distinguish these operations by providing different **stringtag** arguments. The **stringtag** shall not exceed MPI\_MAX\_FROM\_GROUP\_TAG characters in length. For C, this includes space for a null terminating character. The **errhandler** argument specifies an error handler to be attached to the new intra-communicator. This error handler will also be invoked if the MPI\_COMM\_CREATE\_FROM\_GROUP function encounters an error. The **info** argument provides hints and assertions, possibly MPI implementation dependent, which indicate desired characteristics and guide communicator creation.

*Advice to users.* The **stringtag** argument is used to distinguish concurrent communicator construction operations issued by different entities. As such, it is important to ensure that this argument is unique for each concurrent call to MPI\_COMM\_CREATE\_FROM\_GROUP. Reverse domain name notation convention [1] is one approach to constructing unique **stringtag** arguments. See also example 11.8. (*End of advice to users.*)

## 7.4.3 Communicator Destructors

MPI\_COMM\_FREE(comm)

INOUT comm communicator to be destroyed (handle)

**C binding**

```
int MPI_Comm_free(MPI_Comm *comm)
```

**Fortran 2008 binding**

```
MPI_Comm_free(comm, ierror)
  TYPE(MPI_Comm), INTENT(INOUT) :: comm
  INTEGER, OPTIONAL, INTENT(OUT) :: ierror
```

**Fortran binding**

```
MPI_COMM_FREE(COMM, IERROR)
  INTEGER COMM, IERROR
```

This collective operation marks the communication object for deallocation. The handle is set to MPI\_COMM\_NULL. Any pending operations that use this communicator will complete normally; the object is actually deallocated only if there are no other active references to it. This call applies to intra- and inter-communicators. The delete callback functions for all cached attributes (see Section 7.7) are called in arbitrary order.

*Advice to implementors.* Though collective, it is anticipated that this operation will normally be implemented to be local, though a debugging version of an MPI library might choose to synchronize. (*End of advice to implementors.*)

## 7.4.4 Communicator Info

Hints specified via info (see Chapter 10) allow a user to provide information to direct optimization. Providing hints may enable an implementation to deliver increased performance or minimize use of system resources. An implementation is free to ignore all hints; however, applications must comply with any info hints they provide that are used by the MPI implementation (i.e., are returned by a call to MPI\_COMM\_GET\_INFO) and that place a restriction on the behavior of the application. Hints are specified on a per communicator basis, in MPI\_COMM\_DUP\_WITH\_INFO, MPI\_COMM\_IDUP\_WITH\_INFO, MPI\_COMM\_SET\_INFO, MPI\_COMM\_SPLIT\_TYPE, MPI\_DIST\_GRAPH\_CREATE, and MPI\_DIST\_GRAPH\_CREATE\_ADJACENT, via the opaque info object. When an info object that specifies a subset of valid hints is passed to MPI\_COMM\_SET\_INFO, there will be no effect on previously set or defaulted hints that the info does not specify.

*Advice to implementors.* It may happen that a program is coded with hints for one system, and later executes on another system that does not support these hints. In general, unsupported hints should simply be ignored. Needless to say, no hint can be mandatory. However, for each hint used by a specific implementation, a default value must be provided when the user does not specify a value for this hint. (*End of advice to implementors.*)

1 Info hints are not propagated by MPI from one communicator to another. The following  
2 info keys are valid for all communicators.

3  
4 **"mpi\_assert\_no\_any\_tag" (boolean, default: "false"):** If set to "true", then the implemen-  
5 tation may assume that the process will not use the MPI\_ANY\_TAG wildcard on the  
6 given communicator.

7  
8 **"mpi\_assert\_no\_any\_source" (boolean, default: "false"):** If set to "true", then the imple-  
9 mentation may assume that the process will not use the MPI\_ANY\_SOURCE wildcard  
10 on the given communicator.

11  
12 **"mpi\_assert\_exact\_length" (boolean, default: "false"):** If set to "true", then the imple-  
13 mentation may assume that the lengths of messages received by the process are equal  
14 to the lengths of the corresponding receive buffers, for point-to-point communication  
15 operations on the given communicator.

16  
17 **"mpi\_assert\_allow\_overtaking" (boolean, default: "false"):** If set to "true", then the im-  
18 plementation may assume that point-to-point communications on the given commu-  
19 nicator do not rely on the non-overtaking rule specified in Section 3.5. In other words,  
20 the application asserts that send operations are not required to be matched at the  
21 receiver in the order in which the send operations were posted by the sender, and  
22 receive operations are not required to be matched in the order in which they were  
23 posted by the receiver.

24 *Advice to users.* Use of the "mpi\_assert\_allow\_overtaking" info key can result in nonde-  
25 terminism in the message matching order. (*End of advice to users.*)

26  
27 *Advice to users.* Some optimizations may only be possible when all processes in the  
28 group of the communicator provide a given info key with the same value. (*End of*  
29 *advice to users.*)

30  
31  
32 MPI\_COMM\_SET\_INFO(comm, info)

33 INOUT comm communicator (handle)  
34 IN info info object (handle)

### 37 C binding

38 int MPI\_Comm\_set\_info(MPI\_Comm comm, MPI\_Info info)

### 39 Fortran 2008 binding

40 MPI\_Comm\_set\_info(comm, info, ierror)  
41 TYPE(MPI\_Comm), INTENT(IN) :: comm  
42 TYPE(MPI\_Info), INTENT(IN) :: info  
43 INTEGER, OPTIONAL, INTENT(OUT) :: ierror

### 45 Fortran binding

46 MPI\_COMM\_SET\_INFO(COMM, INFO, IERROR)  
47 INTEGER COMM, INFO, IERROR

MPI\_COMM\_SET\_INFO updates the hints of the communicator associated with `comm` using the hints provided in `info`. This operation has no effect on previously set or defaulted hints that are not specified by `info`. It also has no effect on previously set or defaulted hints that are specified by `info`, but are ignored by the MPI implementation in this call to MPI\_COMM\_SET\_INFO. MPI\_COMM\_SET\_INFO is a collective routine. The `info` object may be different on each process, but any `info` entries that an implementation requires to be the same on all processes must appear with the same value in each process's `info` object.

*Advice to users.* Some `info` items that an implementation can use when it creates a communicator cannot easily be changed once the communicator has been created. Thus, an implementation may ignore hints issued in this call that it would have accepted in a creation call. An implementation may also be unable to update certain `info` hints in a call to MPI\_COMM\_SET\_INFO. MPI\_COMM\_GET\_INFO can be used to determine whether updates to existing `info` hints were ignored by the implementation. (*End of advice to users.*)

*Advice to users.* Setting `info` hints on the predefined communicators MPI\_COMM\_WORLD and MPI\_COMM\_SELF may have unintended effects, as changes to these global objects may affect all components of the application, including libraries and tools. Users must ensure that all components of the application that use a given communicator, including libraries and tools, can comply with any `info` hints associated with that communicator. (*End of advice to users.*)

MPI\_COMM\_GET\_INFO(`comm`, `info_used`)

IN	<code>comm</code>	communicator object (handle)
OUT	<code>info_used</code>	new <code>info</code> object (handle)

#### C binding

```
int MPI_Comm_get_info(MPI_Comm comm, MPI_Info *info_used)
```

#### Fortran 2008 binding

```
MPI_Comm_get_info(comm, info_used, ierror)
  TYPE(MPI_Comm), INTENT(IN) :: comm
  TYPE(MPI_Info), INTENT(OUT) :: info_used
  INTEGER, OPTIONAL, INTENT(OUT) :: ierror
```

#### Fortran binding

```
MPI_COMM_GET_INFO(COMM, INFO_USED, IERROR)
  INTEGER COMM, INFO_USED, IERROR
```

MPI\_COMM\_GET\_INFO returns a new `info` object containing the hints of the communicator associated with `comm`. The current setting of all hints related to this communicator is returned in `info_used`. An MPI implementation is required to return all hints that are supported by the implementation and have default values specified; any user-supplied hints that were not ignored by the implementation; and any additional hints that were set by the implementation. If no such hints exist, a handle to a newly created `info` object is returned that contains no key/value pair. The user is responsible for freeing `info_used` via MPI\_INFO\_FREE.

## 7.5 Motivating Examples

### 7.5.1 Current Practice #1

Example #1a:

```

1  int main(int argc, char *argv[])
2  {
3      int me, size;
4      ...
5      MPI_Init(&argc, &argv);
6      MPI_Comm_rank(MPI_COMM_WORLD, &me);
7      MPI_Comm_size(MPI_COMM_WORLD, &size);
8
9      (void)printf("Process %d size %d\n", me, size);
10     ...
11     MPI_Finalize();
12     return 0;
13 }

```

Example #1a is a do-nothing program that initializes itself, and refers to the “all” communicator, and prints a message. It terminates itself too. This example does not imply that MPI supports `printf`-like communication itself.

Example #1b: Message exchange (supposing that `size` is even)

```

24  int main(int argc, char *argv[])
25  {
26     int me, size;
27     int SOME_TAG = 0;
28     ...
29     MPI_Init(&argc, &argv);
30
31     MPI_Comm_rank(MPI_COMM_WORLD, &me); /* local */
32     MPI_Comm_size(MPI_COMM_WORLD, &size); /* local */
33
34     if((me % 2) == 0)
35     {
36         /* send unless highest-numbered process */
37         if((me + 1) < size)
38             MPI_Send(..., me + 1, SOME_TAG, MPI_COMM_WORLD);
39     }
40     else
41         MPI_Recv(..., me - 1, SOME_TAG, MPI_COMM_WORLD, &status);
42
43     ...
44     MPI_Finalize();
45     return 0;
46 }

```

Example #1b schematically illustrates message exchanges between “even” and “odd” processes in the “all” communicator.

## 7.5.2 Current Practice #2

```

1
2
3
4
5
6
7
8
9
10
11
12
13
14
15
16
17
18
19
20
21
22
23
int main(int argc, char *argv[])
{
    int me, count;
    void *data;
    ...

    MPI_Init(&argc, &argv);
    MPI_Comm_rank(MPI_COMM_WORLD, &me);

    if(me == 0)
    {
        /* get input, create buffer "data" */
        ...
    }

    MPI_Bcast(data, count, MPI_BYTE, 0, MPI_COMM_WORLD);
    ...
    MPI_Finalize();
    return 0;
}

```

This example illustrates the use of a collective communication.

## 7.5.3 (Approximate) Current Practice #3

```

24
25
26
27
28
29
30
31
32
33
34
35
36
37
38
39
40
41
42
43
44
45
46
47
48
int main(int argc, char *argv[])
{
    int me, count, count2;
    void *send_buf, *recv_buf, *send_buf2, *recv_buf2;
    MPI_Group group_world, grpem;
    MPI_Comm commWorker;
    static int ranks[] = {0};
    ...
    MPI_Init(&argc, &argv);
    MPI_Comm_group(MPI_COMM_WORLD, &group_world);
    MPI_Comm_rank(MPI_COMM_WORLD, &me); /* local */

    MPI_Group_excl(group_world, 1, ranks, &grpem); /* local */
    MPI_Comm_create(MPI_COMM_WORLD, grpem, &commWorker);

    if(me != 0)
    {
        /* compute on worker */
        ...
        MPI_Reduce(send_buf, recv_buf, count, MPI_INT, MPI_SUM, 1, commWorker);
        ...
    }
}

```

```

1     MPI_Comm_free(&commWorker);
2 }
3 /* zero falls through immediately to this reduce, others do later... */
4 MPI_Reduce(send_buf2, recv_buf2, count2,
5           MPI_INT, MPI_SUM, 0, MPI_COMM_WORLD);
6
7     MPI_Group_free(&group_world);
8     MPI_Group_free(&grpem);
9     MPI_Finalize();
10    return 0;
11 }

```

This example illustrates how a group consisting of all but the zeroth process of the “all” group is created, and then how a communicator is formed (`commWorker`) for that new group. The new communicator is used in a collective call, and all processes execute a collective call in the `MPI_COMM_WORLD` context. This example illustrates how the two communicators (that inherently possess distinct contexts) protect communication. That is, communication in `MPI_COMM_WORLD` is insulated from communication in `commWorker`, and vice versa.

In summary, “group safety” is achieved via communicators because distinct contexts within communicators are enforced to be unique on any process.

#### 7.5.4 Example #4

The following example is meant to illustrate “safety” between point-to-point and collective communication. MPI guarantees that a single communicator can do safe point-to-point and collective communication.

```

27     #define TAG_ARBITRARY 12345
28     #define SOME_COUNT    50
29
30     int main(int argc, char *argv[])
31     {
32         int me;
33         MPI_Request request[2];
34         MPI_Status status[2];
35         MPI_Group group_world, subgroup;
36         int ranks[] = {2, 4, 6, 8};
37         MPI_Comm the_comm;
38         ...
39         MPI_Init(&argc, &argv);
40         MPI_Comm_group(MPI_COMM_WORLD, &group_world);
41
42         MPI_Group_incl(group_world, 4, ranks, &subgroup); /* local */
43         MPI_Group_rank(subgroup, &me); /* local */
44
45         MPI_Comm_create(MPI_COMM_WORLD, subgroup, &the_comm);
46
47         if(me != MPI_UNDEFINED)
48         {

```



```

    MPI_Irecv(buff1, count, MPI_DOUBLE, MPI_ANY_SOURCE, TAG_ARBITRARY,
              the_comm, request);
    MPI_Isend(buff2, count, MPI_DOUBLE, (me+1)%4, TAG_ARBITRARY,
              the_comm, request+1);
    for(i = 0; i < SOME_COUNT; i++)
        MPI_Reduce(..., the_comm);
    MPI_Waitall(2, request, status);

    MPI_Comm_free(&the_comm);
}

MPI_Group_free(&group_world);
MPI_Group_free(&subgroup);
MPI_Finalize();
return 0;
}

```

### 7.5.5 Library Example #1

The main program:

```

int main(int argc, char *argv[])
{
    int done = 0;
    user_lib_t *libh_a, *libh_b;
    void *dataset1, *dataset2;
    ...
    MPI_Init(&argc, &argv);
    ...
    init_user_lib(MPI_COMM_WORLD, &libh_a);
    init_user_lib(MPI_COMM_WORLD, &libh_b);
    ...
    user_start_op(libh_a, dataset1);
    user_start_op(libh_b, dataset2);
    ...
    while(!done)
    {
        /* work */
        ...
        MPI_Reduce(..., MPI_COMM_WORLD);
        ...
        /* see if done */
        ...
    }
    user_end_op(libh_a);
    user_end_op(libh_b);

    uninit_user_lib(libh_a);
}

```

```

1     uninit_user_lib(libh_b);
2     MPI_Finalize();
3     return 0;
4 }

```

5  
6 The user library initialization code:

```

7     void init_user_lib(MPI_Comm comm, user_lib_t **handle)
8     {
9         user_lib_t *save;
10
11        user_lib_initsave(&save); /* local */
12        MPI_Comm_dup(comm, &(save->comm));
13
14        /* other inits */
15        ...
16
17        *handle = save;
18    }

```

19  
20 User start-up code:

```

21
22    void user_start_op(user_lib_t *handle, void *data)
23    {
24        MPI_Irecv( ..., handle->comm, &(handle->irecv_handle) );
25        MPI_Isend( ..., handle->comm, &(handle->isend_handle) );
26    }

```

27  
28 User communication clean-up code:

```

29    void user_end_op(user_lib_t *handle)
30    {
31        MPI_Status status;
32        MPI_Wait(&handle->isend_handle, &status);
33        MPI_Wait(&handle->irecv_handle, &status);
34    }

```

35  
36 User object clean-up code:

```

37    void uninit_user_lib(user_lib_t *handle)
38    {
39        MPI_Comm_free(&(handle->comm));
40        free(handle);
41    }

```

## 42 43 7.5.6 Library Example #2

44  
45 The main program:

```

46
47    int main(int argc, char *argv[])
48    {

```

```
int ma, mb;
MPI_Group group_world, group_a, group_b;
MPI_Comm comm_a, comm_b;

static int list_a[] = {0, 1};
#if defined(EXAMPLE_2B) || defined(EXAMPLE_2C)
static int list_b[] = {0, 2, 3};
#else/* EXAMPLE_2A */
static int list_b[] = {0, 2};
#endif
int size_list_a = sizeof(list_a)/sizeof(int);
int size_list_b = sizeof(list_b)/sizeof(int);

...
MPI_Init(&argc, &argv);
MPI_Comm_group(MPI_COMM_WORLD, &group_world);

MPI_Group_incl(group_world, size_list_a, list_a, &group_a);
MPI_Group_incl(group_world, size_list_b, list_b, &group_b);

MPI_Comm_create(MPI_COMM_WORLD, group_a, &comm_a);
MPI_Comm_create(MPI_COMM_WORLD, group_b, &comm_b);

if(comm_a != MPI_COMM_NULL)
    MPI_Comm_rank(comm_a, &ma);
if(comm_b != MPI_COMM_NULL)
    MPI_Comm_rank(comm_b, &mb);

if(comm_a != MPI_COMM_NULL)
    lib_call(comm_a);

if(comm_b != MPI_COMM_NULL)
{
    lib_call(comm_b);
    lib_call(comm_b);
}

if(comm_a != MPI_COMM_NULL)
    MPI_Comm_free(&comm_a);
if(comm_b != MPI_COMM_NULL)
    MPI_Comm_free(&comm_b);
MPI_Group_free(&group_a);
MPI_Group_free(&group_b);
MPI_Group_free(&group_world);
MPI_Finalize();
return 0;
}
```

1 The library:

```

2
3 void lib_call(MPI_Comm comm)
4 {
5     int me, done = 0;
6     MPI_Status status;
7     MPI_Comm_rank(comm, &me);
8     if(me == 0)
9         while(!done)
10            {
11                MPI_Recv(..., MPI_ANY_SOURCE, MPI_ANY_TAG, comm, &status);
12                ...
13            }
14     else
15     {
16         /* work */
17         MPI_Send(..., 0, ARBITRARY_TAG, comm);
18         ...
19     }
20 #ifdef EXAMPLE_2C
21     /* include (resp, exclude) for safety (resp, no safety): */
22     MPI_Barrier(comm);
23 #endif
24 }

```

25 The above example is really three examples, depending on whether or not one includes rank  
26 3 in `list_b`, and whether or not a synchronize is included in `lib_call`. This example illustrates  
27 that, despite contexts, subsequent calls to `lib_call` with the same context need not be safe  
28 from one another (colloquially, “back-masking”). Safety is realized if the `MPI_Barrier`  
29 is added. What this demonstrates is that libraries have to be written carefully, even with  
30 contexts. When rank 3 is excluded, then the synchronize is not needed to get safety from  
31 back-masking.

32 Algorithms like “reduce” and “allreduce” have strong enough source selectivity prop-  
33 erties so that they are inherently okay (no back-masking), provided that MPI provides basic  
34 guarantees. So are multiple calls to a typical tree-broadcast algorithm with the same root  
35 or different roots (see [64]). Here we rely on two guarantees of MPI: pairwise ordering  
36 of messages between processes in the same context, and source selectivity—deleting either  
37 feature removes the guarantee that back-masking cannot be required.

38 Algorithms that try to do non-deterministic broadcasts or other calls that include wild-  
39 card operations will not generally have the good properties of the deterministic implemen-  
40 tations of “reduce,” “allreduce,” and “broadcast.” Such algorithms would have to utilize  
41 the monotonically increasing tags (within a communicator scope) to keep things straight.

42 All of the foregoing is a supposition of “collective calls” implemented with point-to-  
43 point operations. MPI implementations may or may not implement collective calls using  
44 point-to-point operations. These algorithms are used to illustrate the issues of correctness  
45 and safety, independent of how MPI implements its collective calls. See also Section 7.9.

## 7.6 Inter-Communication

This section introduces the concept of inter-communication and describes the portions of MPI that support it. It describes support for writing programs that contain user-level servers.

All communication described thus far has involved communication between processes that are members of the same group. This type of communication is called “**intra-communication**” and the communicator used is called an “**intra-communicator**,” as we have noted earlier in the chapter.

In modular and multi-disciplinary applications, different process groups execute distinct modules and processes within different modules communicate with one another in a pipeline or a more general module graph. In these applications, the most natural way for a process to specify a target process is by the rank of the target process within the target group. In applications that contain internal user-level servers, each server may be a process group that provides services to one or more clients, and each client may be a process group that uses the services of one or more servers. It is again most natural to specify the target process by rank within the target group in these applications. This type of communication is called “**inter-communication**” and the communicator used is called an “**inter-communicator**,” as introduced earlier.

An **inter-communication** is a point-to-point communication between processes in different groups. The group containing a process that initiates an inter-communication operation is called the “local group,” that is, the sender in a send and the receiver in a receive. The group containing the target process is called the “remote group,” that is, the receiver in a send and the sender in a receive. As in intra-communication, the target process is specified using a (communicator, rank) pair. Unlike intra-communication, the rank is relative to a second, remote group.

All inter-communicator constructors are blocking except for `MPI_COMM_IDUP` and require that the local and remote groups be disjoint.

*Advice to users.* The groups must be disjoint for several reasons. Primarily, this is the intent of the inter-communicators—to provide a communicator for communication between disjoint groups. This is reflected in the definition of `MPI_INTERCOMM_MERGE`, which allows the user to control the ranking of the processes in the created intra-communicator; this ranking makes little sense if the groups are not disjoint. In addition, the natural extension of collective operations to inter-communicators makes the most sense when the groups are disjoint. (*End of advice to users.*)

Here is a summary of the properties of inter-communication and inter-communicators:

- The syntax of point-to-point and collective communication is the same for both inter- and intra-communication. The same communicator can be used both for send and for receive operations.
- A target process is addressed by its rank in the remote group, both for sends and for receives.
- Communications using an inter-communicator are guaranteed not to conflict with any communications that use a different communicator.
- A communicator will provide either intra- or inter-communication, never both.

The routine `MPI_COMM_TEST_INTER` may be used to determine if a communicator is an inter- or intra-communicator. Inter-communicators can be used as arguments to some of the other communicator access routines. Inter-communicators cannot be used as input to some of the constructor routines for intra-communicators (for instance, `MPI_CART_CREATE`).

*Advice to implementors.* For the purpose of point-to-point communication, communicators can be represented in each process by a tuple consisting of:

**group**  
**send\_context**  
**receive\_context**  
**source**

For inter-communicators, *group* describes the remote group, and *source* is the rank of the process in the local group. For intra-communicators, *group* is the communicator group (remote=local), *source* is the rank of the process in this group, and *send context* and *receive context* are identical. A group can be represented by a rank-to-absolute-address translation table.

The inter-communicator cannot be discussed sensibly without considering processes in both the local and remote groups. Imagine a process **P** in group  $\mathcal{P}$ , which has an inter-communicator  $C_{\mathcal{P}}$ , and a process **Q** in group  $\mathcal{Q}$ , which has an inter-communicator  $C_{\mathcal{Q}}$ . Then

- $C_{\mathcal{P}}.\mathbf{group}$  describes the group  $\mathcal{Q}$  and  $C_{\mathcal{Q}}.\mathbf{group}$  describes the group  $\mathcal{P}$ .
- $C_{\mathcal{P}}.\mathbf{send\_context} = C_{\mathcal{Q}}.\mathbf{receive\_context}$  and the context is unique in  $\mathcal{Q}$ ;  
 $C_{\mathcal{P}}.\mathbf{receive\_context} = C_{\mathcal{Q}}.\mathbf{send\_context}$  and this context is unique in  $\mathcal{P}$ .
- $C_{\mathcal{P}}.\mathbf{source}$  is rank of **P** in  $\mathcal{P}$  and  $C_{\mathcal{Q}}.\mathbf{source}$  is rank of **Q** in  $\mathcal{Q}$ .

Assume that **P** sends a message to **Q** using the inter-communicator. Then **P** uses the **group** table to find the absolute address of **Q**; **source** and **send\_context** are appended to the message.

Assume that **Q** posts a receive with an explicit source argument using the inter-communicator. Then **Q** matches **receive\_context** to the message context and source argument to the message source.

The same algorithm is appropriate for intra-communicators as well.

In order to support inter-communicator accessors and constructors, it is necessary to supplement this model with additional structures, that store information about the local communication group, and additional safe contexts. (*End of advice to implementors.*)

## 7.6.1 Inter-Communicator Accessors

MPI\_COMM\_TEST\_INTER(comm, flag)

IN	comm	communicator (handle)
OUT	flag	true if comm is an inter-communicator (logical)

**C binding**

```
int MPI_Comm_test_inter(MPI_Comm comm, int *flag)
```

**Fortran 2008 binding**

```
MPI_Comm_test_inter(comm, flag, ierror)
  TYPE(MPI_Comm), INTENT(IN) :: comm
  LOGICAL, INTENT(OUT) :: flag
  INTEGER, OPTIONAL, INTENT(OUT) :: ierror
```

**Fortran binding**

```
MPI_COMM_TEST_INTER(COMM, FLAG, IERROR)
  INTEGER COMM, IERROR
  LOGICAL FLAG
```

This local routine allows the calling process to determine if a communicator is an inter-communicator or an intra-communicator. It returns true if it is an inter-communicator, otherwise false.

When an inter-communicator is used as an input argument to the communicator accessors described above under intra-communication, the following table describes behavior.

MPI_COMM_SIZE	returns the size of the local group.
MPI_COMM_GROUP	returns the local group.
MPI_COMM_RANK	returns the rank in the local group

Table 7.1: MPI\_COMM\_\* Function Behavior (in Inter-Communication Mode)

Furthermore, the operation MPI\_COMM\_COMPARE is valid for inter-communicators. Both communicators must be either intra- or inter-communicators, or else MPI\_UNEQUAL results. Both corresponding local and remote groups must compare correctly to get the results MPI\_CONGRUENT or MPI\_SIMILAR. In particular, it is possible for MPI\_SIMILAR to result because either the local or remote groups were similar but not identical.

The following accessors provide consistent access to the remote group of an inter-communicator. The following are all local operations.

1 MPI\_COMM\_REMOTE\_SIZE(comm, size)

2 IN comm inter-communicator (handle)

3  
4 OUT size number of processes in the remote group of comm  
5 (integer)

6  
7 **C binding**

8 int MPI\_Comm\_remote\_size(MPI\_Comm comm, int \*size)

9  
10 **Fortran 2008 binding**

11 MPI\_Comm\_remote\_size(comm, size, ierror)  
12 TYPE(MPI\_Comm), INTENT(IN) :: comm  
13 INTEGER, INTENT(OUT) :: size  
14 INTEGER, OPTIONAL, INTENT(OUT) :: ierror

15 **Fortran binding**

16 MPI\_COMM\_REMOTE\_SIZE(COMM, SIZE, IERROR)  
17 INTEGER COMM, SIZE, IERROR

18  
19  
20 MPI\_COMM\_REMOTE\_GROUP(comm, group)

21 IN comm inter-communicator (handle)

22  
23 OUT group remote group corresponding to comm (handle)

24  
25 **C binding**

26 int MPI\_Comm\_remote\_group(MPI\_Comm comm, MPI\_Group \*group)

27  
28 **Fortran 2008 binding**

29 MPI\_Comm\_remote\_group(comm, group, ierror)  
30 TYPE(MPI\_Comm), INTENT(IN) :: comm  
31 TYPE(MPI\_Group), INTENT(OUT) :: group  
32 INTEGER, OPTIONAL, INTENT(OUT) :: ierror

33 **Fortran binding**

34 MPI\_COMM\_REMOTE\_GROUP(COMM, GROUP, IERROR)  
35 INTEGER COMM, GROUP, IERROR

36  
37  
38 *Rationale.* Symmetric access to both the local and remote groups of an inter-  
39 communicator is important, so this function, as well as MPI\_COMM\_REMOTE\_SIZE  
40 have been provided. (*End of rationale.*)

41  
42 **7.6.2 Inter-Communicator Operations**

43 This section introduces five blocking inter-communicator operations.

44 MPI\_INTERCOMM\_CREATE is used to bind two intra-communicators into an inter-com-  
45 municator; the function MPI\_INTERCOMM\_CREATE\_FROM\_GROUPS constructs an inter-  
46 communicator from two previously defined disjoint groups; the function  
47 MPI\_INTERCOMM\_MERGE creates an intra-communicator by merging the local and remote  
48



groups of an inter-communicator. The functions `MPI_COMM_DUP` and `MPI_COMM_FREE`, introduced previously, duplicate and free an inter-communicator, respectively.

Overlap of local and remote groups that are bound into an inter-communicator is prohibited. If there is overlap, then the program is erroneous and is likely to deadlock.

The function `MPI_INTERCOMM_CREATE` can be used to create an inter-communicator from two existing intra-communicators, in the following situation: At least one selected member from each group (the “group leader”) has the ability to communicate with the selected member from the other group; that is, a “peer” communicator exists to which both leaders belong, and each leader knows the rank of the other leader in this peer communicator. Furthermore, members of each group know the rank of their leader.

Construction of an inter-communicator from two intra-communicators requires separate collective operations in the local group and in the remote group, as well as a point-to-point communication between a process in the local group and a process in the remote group.

When using the World Model, the `MPI_COMM_WORLD` communicator (or preferably a dedicated duplicate thereof) can be this peer communicator. For applications that use the Sessions Model, or the spawn or join operations, it may be necessary to first create an intra-communicator to be used as the peer communicator.

The application topology functions described in Chapter 8 do not apply to inter-communicators. Users that require this capability should utilize `MPI_INTERCOMM_MERGE` to build an intra-communicator, then apply the graph or cartesian topology capabilities to that intra-communicator, creating an appropriate topology-oriented intra-communicator. Alternatively, it may be reasonable to devise one’s own application topology mechanisms for this case, without loss of generality.

```
MPI_INTERCOMM_CREATE(local_comm, local_leader, peer_comm, remote_leader, tag,
                    newintercomm)
```

IN	<code>local_comm</code>	local intra-communicator (handle)
IN	<code>local_leader</code>	rank of local group leader in <code>local_comm</code> (integer)
IN	<code>peer_comm</code>	“peer” communicator; significant only at the <code>local_leader</code> (handle)
IN	<code>remote_leader</code>	rank of remote group leader in <code>peer_comm</code> ; significant only at the <code>local_leader</code> (integer)
IN	<code>tag</code>	tag (integer)
OUT	<code>newintercomm</code>	new inter-communicator (handle)

### C binding

```
int MPI_Intercomm_create(MPI_Comm local_comm, int local_leader,
                        MPI_Comm peer_comm, int remote_leader, int tag,
                        MPI_Comm *newintercomm)
```

### Fortran 2008 binding

```
MPI_Intercomm_create(local_comm, local_leader, peer_comm, remote_leader,
                    tag, newintercomm, ierror)
TYPE(MPI_Comm), INTENT(IN) :: local_comm, peer_comm
INTEGER, INTENT(IN) :: local_leader, remote_leader, tag
```

```

1     TYPE(MPI_Comm), INTENT(OUT) :: newintercomm
2     INTEGER, OPTIONAL, INTENT(OUT) :: ierror

```

### Fortran binding

```

4 MPI_INTERCOMM_CREATE(LOCAL_COMM, LOCAL_LEADER, PEER_COMM, REMOTE_LEADER,
5     TAG, NEWINTERCOMM, IERROR)
6     INTEGER LOCAL_COMM, LOCAL_LEADER, PEER_COMM, REMOTE_LEADER, TAG,
7     NEWINTERCOMM, IERROR

```

This call creates an inter-communicator. It is collective over the union of the local and remote groups. MPI processes should provide identical `local_comm` and `local_leader` arguments within each group. Wildcards are not permitted for `remote_leader`, `local_leader`, and `tag`.

```

15 MPI_INTERCOMM_CREATE_FROM_GROUPS(local_group, local_leader, remote_group,
16     remote_leader, stringtag, info, errhandler, newintercomm)

```

17	IN	<code>local_group</code>	local group (handle)
18	IN	<code>local_leader</code>	rank of local group leader in <code>local_group</code> (integer)
19	IN	<code>remote_group</code>	remote group, significant only at <code>local_leader</code> (handle)
20	IN	<code>remote_leader</code>	rank of remote group leader in <code>remote_group</code> , significant only at <code>local_leader</code> (integer)
21	IN	<code>stringtag</code>	unique identifier for this operation (string)
22	IN	<code>info</code>	info object (handle)
23	IN	<code>errhandler</code>	error handler to be attached to new inter-communicator (handle)
24	OUT	<code>newintercomm</code>	new inter-communicator (handle)

### C binding

```

31 int MPI_Intercomm_create_from_groups(MPI_Group local_group,
32     int local_leader, MPI_Group remote_group, int remote_leader,
33     const char *stringtag, MPI_Info info,
34     MPI_Errhandler errhandler, MPI_Comm *newintercomm)

```

### Fortran 2008 binding

```

37 MPI_Intercomm_create_from_groups(local_group, local_leader, remote_group,
38     remote_leader, stringtag, info, errhandler, newintercomm,
39     ierror)
40     TYPE(MPI_Group), INTENT(IN) :: local_group, remote_group
41     INTEGER, INTENT(IN) :: local_leader, remote_leader
42     CHARACTER(LEN=*), INTENT(IN) :: stringtag
43     TYPE(MPI_Info), INTENT(IN) :: info
44     TYPE(MPI_Errhandler), INTENT(IN) :: errhandler
45     TYPE(MPI_Comm), INTENT(OUT) :: newintercomm
46     INTEGER, OPTIONAL, INTENT(OUT) :: ierror

```

**Fortran binding**

```

MPI_INTERCOMM_CREATE_FROM_GROUPS(LOCAL_GROUP, LOCAL_LEADER, REMOTE_GROUP,
    REMOTE_LEADER, STRINGTAG, INFO, ERRHANDLER, NEWINTERCOMM,
    IERROR)
    INTEGER LOCAL_GROUP, LOCAL_LEADER, REMOTE_GROUP, REMOTE_LEADER, INFO,
        ERRHANDLER, NEWINTERCOMM, IERROR
    CHARACTER*(*) STRINGTAG

```

This call creates an inter-communicator. Unlike `MPI_INTERCOMM_CREATE`, this function uses as input previously defined, disjoint local and remote groups. The calling MPI process must be a member of the local group. The call is collective over the union of the local and remote groups. All involved MPI processes shall provide an identical value for the `stringtag` argument. Within each group, all MPI processes shall provide identical `local_group`, `local_leader` arguments. Wildcards are not permitted for the `remote_leader` or `local_leader` arguments. The `stringtag` argument serves the same purpose as the `stringtag` used in the `MPI_COMM_CREATE_FROM_GROUP` function; it differentiates concurrent calls in a multithreaded environment. The `stringtag` shall not exceed `MPI_MAX_FROM_GROUP_STRINGTAG` characters in length. For C, this includes space for a null terminating character. In the event that `MPI_GROUP_EMPTY` is supplied as the `local_group` or `remote_group` or both, then the call is a local operation and `MPI_COMM_NULL` is returned as the `newintercomm`.

```

MPI_INTERCOMM_MERGE(intercomm, high, newintracomm)

```

IN	intercomm	inter-communicator (handle)
IN	high	ordering of the local and remote groups in the new intra-communicator (logical)
OUT	newintracomm	new intra-communicator (handle)

**C binding**

```

int MPI_Intercomm_merge(MPI_Comm intercomm, int high,
    MPI_Comm *newintracomm)

```

**Fortran 2008 binding**

```

MPI_Intercomm_merge(intercomm, high, newintracomm, ierror)
    TYPE(MPI_Comm), INTENT(IN) :: intercomm
    LOGICAL, INTENT(IN) :: high
    TYPE(MPI_Comm), INTENT(OUT) :: newintracomm
    INTEGER, OPTIONAL, INTENT(OUT) :: ierror

```

**Fortran binding**

```

MPI_INTERCOMM_MERGE(INTERCOMM, HIGH, NEWINTRACOMM, IERROR)
    INTEGER INTERCOMM, NEWINTRACOMM, IERROR
    LOGICAL HIGH

```

This function creates an intra-communicator from the union of the two groups that are associated with `intercomm`. All processes should provide the same `high` value within each of the two groups. If processes in one group provided the value `high = false` and processes in the other group provided the value `high = true` then the union orders the “low” group

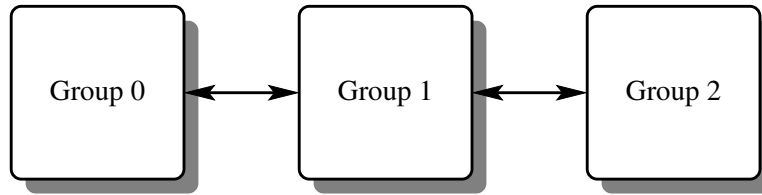

Figure 7.4: Three-group pipeline

before the “high” group. If all processes provided the same high argument then the order of the union is arbitrary. This call is blocking and collective within the union of the two groups.

The error handler on the new inter-communicator in each process is inherited from the communicator that contributes the local group. Note that this can result in different processes in the same communicator having different error handlers.

*Advice to implementors.* The implementation of `MPI_INTERCOMM_MERGE`, `MPI_COMM_FREE`, and `MPI_COMM_DUP` are similar to the implementation of `MPI_INTERCOMM_CREATE`, except that contexts private to the input inter-communicator are used for communication between group leaders rather than contexts inside a bridge communicator. (*End of advice to implementors.*)

### 7.6.3 Inter-Communication Examples

#### Example 1: Three-Group “Pipeline”

As shown in Figure 7.4, groups 0 and 1 communicate. Groups 1 and 2 communicate. Therefore, group 0 requires one inter-communicator, group 1 requires two inter-communicators, and group 2 requires 1 inter-communicator.

```

int main(int argc, char *argv[])
{
    MPI_Comm    myComm;        /* intra-communicator of local sub-group */
    MPI_Comm    myFirstComm;   /* inter-communicator */
    MPI_Comm    mySecondComm; /* second inter-communicator (group 1 only) */
    int membershipKey;
    int rank;

    MPI_Init(&argc, &argv);
    MPI_Comm_rank(MPI_COMM_WORLD, &rank);

    /* User code must generate membershipKey in the range [0, 1, 2] */
    membershipKey = rank % 3;

    /* Build intra-communicator for local sub-group */
    MPI_Comm_split(MPI_COMM_WORLD, membershipKey, rank, &myComm);

    /* Build inter-communicators. Tags are hard-coded. */
    if (membershipKey == 0)
  
```

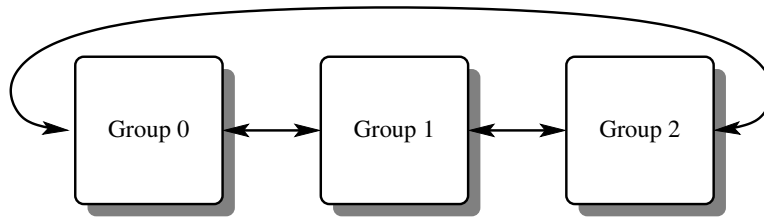

Figure 7.5: Three-group ring

```

1
2
3
4
5
6
7
8
9
10
11
12
13
14
15
16
17
18
19
20
21
22
23
24
25
26
27
28
29
30
31
32
33
34
35
36
37
38
39
40
41
42
43
44
45
46
47
48
{
    /* Group 0 communicates with group 1. */
    MPI_Intercomm_create(myComm, 0, MPI_COMM_WORLD, 1,
        1, &myFirstComm);
}
else if (membershipKey == 1)
{
    /* Group 1 communicates with groups 0 and 2. */
    MPI_Intercomm_create(myComm, 0, MPI_COMM_WORLD, 0,
        1, &myFirstComm);
    MPI_Intercomm_create(myComm, 0, MPI_COMM_WORLD, 2,
        12, &mySecondComm);
}
else if (membershipKey == 2)
{
    /* Group 2 communicates with group 1. */
    MPI_Intercomm_create(myComm, 0, MPI_COMM_WORLD, 1,
        12, &myFirstComm);
}

/* Do work ... */

switch(membershipKey) /* free communicators appropriately */
{
case 1:
    MPI_Comm_free(&mySecondComm);
case 0:
case 2:
    MPI_Comm_free(&myFirstComm);
    break;
}

MPI_Finalize();
return 0;
}

```

#### Example 2: Three-Group “Ring”

As shown in Figure 7.5, groups 0 and 1 communicate. Groups 1 and 2 communicate. Groups 0 and 2 communicate. Therefore, each requires two inter-communicators.

```
int main(int argc, char *argv[])
```

```

1  {
2      MPI_Comm  myComm;      /* intra-communicator of local sub-group */
3      MPI_Comm  myFirstComm; /* inter-communicators */
4      MPI_Comm  mySecondComm;
5      int membershipKey;
6      int rank;
7
8      MPI_Init(&argc, &argv);
9      MPI_Comm_rank(MPI_COMM_WORLD, &rank);
10     ...
11
12     /* User code must generate membershipKey in the range [0, 1, 2] */
13     membershipKey = rank % 3;
14
15     /* Build intra-communicator for local sub-group */
16     MPI_Comm_split(MPI_COMM_WORLD, membershipKey, rank, &myComm);
17
18     /* Build inter-communicators. Tags are hard-coded. */
19     if (membershipKey == 0)
20     {
21         /* Group 0 communicates with groups 1 and 2. */
22         MPI_Intercomm_create(myComm, 0, MPI_COMM_WORLD, 1,
23                             1, &myFirstComm);
24         MPI_Intercomm_create(myComm, 0, MPI_COMM_WORLD, 2,
25                             2, &mySecondComm);
26     }
27     else if (membershipKey == 1)
28     {
29         /* Group 1 communicates with groups 0 and 2. */
30         MPI_Intercomm_create(myComm, 0, MPI_COMM_WORLD, 0,
31                             1, &myFirstComm);
32         MPI_Intercomm_create(myComm, 0, MPI_COMM_WORLD, 2,
33                             12, &mySecondComm);
34     }
35     else if (membershipKey == 2)
36     {
37         /* Group 2 communicates with groups 0 and 1. */
38         MPI_Intercomm_create(myComm, 0, MPI_COMM_WORLD, 0,
39                             2, &myFirstComm);
40         MPI_Intercomm_create(myComm, 0, MPI_COMM_WORLD, 1,
41                             12, &mySecondComm);
42     }
43
44     /* Do some work ... */
45
46     /* Then free communicators before terminating... */
47     MPI_Comm_free(&myFirstComm);
48     MPI_Comm_free(&mySecondComm);
49     MPI_Comm_free(&myComm);
50     MPI_Finalize();
51     return 0;

```

```
}

```

## 7.7 Caching

MPI provides a “caching” facility that allows an application to attach arbitrary pieces of information, called **attributes**, to three kinds of MPI objects: communicators, windows, and datatypes. More precisely, the caching facility allows a portable library to do the following:

- pass information between calls by associating it with an MPI intra- or inter-communicator, window, or datatype,
- quickly retrieve that information, and
- be guaranteed that out-of-date information is never retrieved, even if the object is freed and its handle subsequently reused by MPI.

The caching capabilities, in some form, are required by built-in MPI routines such as collective communication and application topology. Defining an interface to these capabilities as part of the MPI standard is valuable because it permits routines like collective communication and application topologies to be implemented as portable code, and also because it makes MPI more extensible by allowing user-written routines to use standard MPI calling sequences.

*Advice to users.* The communicator `MPI_COMM_SELF` is a suitable choice for posting process-local attributes, via this attribute-caching mechanism. (*End of advice to users.*)

*Rationale.* In one extreme one can allow caching on all opaque handles. The other extreme is to only allow it on communicators. Caching has a cost associated with it and should only be allowed when it is clearly needed and the increased cost is modest. This is the reason that windows and datatypes were added but not other handles. (*End of rationale.*)

One difficulty is the potential for size differences between Fortran integers and C pointers. For this reason, the Fortran versions of these routines use integers of kind `MPI_ADDRESS_KIND`.

*Advice to implementors.* High-quality implementations should raise an error when a keyval that was created by a call to `MPI_XXX_CREATE_KEYVAL` is used with an object of the wrong type with a call to `MPI_YYY_GET_ATTR`, `MPI_YYY_SET_ATTR`, `MPI_YYY_DELETE_ATTR`, or `MPI_YYY_FREE_KEYVAL`. To do so, it is necessary to maintain, with each keyval, information on the type of the associated user function. (*End of advice to implementors.*)

### 7.7.1 Functionality

Attributes can be attached to communicators, windows, and datatypes. Attributes are local to the process and specific to the communicator to which they are attached. Attributes are not propagated by MPI from one communicator to another except when the communicator is duplicated using `MPI_COMM_DUP` or `MPI_COMM_IDUP` (and even then the application must give specific permission through callback functions for the attribute to be copied).

*Advice to users.* Attributes in C are of type `void*`. Typically, such an attribute will be a pointer to a structure that contains further information, or a handle to an MPI object. In Fortran, attributes are of type `INTEGER`. Such attribute can be a handle to an MPI object, or just an integer-valued attribute. (*End of advice to users.*)

*Advice to implementors.* Attributes are scalar values, equal in size to, or larger than a C-language pointer. Attributes can always hold an MPI handle. (*End of advice to implementors.*)

The caching interface defined here requires that attributes be stored by MPI opaquely within a communicator, window, or datatype. Accessor functions include the following:

- obtain a key value (used to identify an attribute); the user specifies “callback” functions by which MPI informs the application when the communicator is destroyed or copied.
- store and retrieve the value of an attribute;

*Advice to implementors.* Caching and callback functions are only called synchronously, in response to explicit application requests. This avoids problems that result from repeated crossings between user and system space. (This synchronous calling rule is a general property of MPI.)

The choice of key values is under control of MPI. This allows MPI to optimize its implementation of attribute sets. It also avoids conflict between independent modules caching information on the same communicators.

A much smaller interface, consisting of just a callback facility, would allow the entire caching facility to be implemented by portable code. However, with the minimal callback interface, some form of table searching is implied by the need to handle arbitrary communicators. In contrast, the more complete interface defined here permits rapid access to attributes through the use of pointers in communicators (to find the attribute table) and cleverly chosen key values (to retrieve individual attributes). In light of the efficiency “hit” inherent in the minimal interface, the more complete interface defined here is seen to be superior. (*End of advice to implementors.*)

MPI provides the following services related to caching. They are all process local.

### 7.7.2 Communicators

Functions for caching on communicators are:

```
MPI_COMM_CREATE_KEYVAL(comm_copy_attr_fn, comm_delete_attr_fn, comm_keyval,
                        extra_state)
```

IN	<code>comm_copy_attr_fn</code>	copy callback function for <code>comm_keyval</code> (function)
IN	<code>comm_delete_attr_fn</code>	delete callback function for <code>comm_keyval</code> (function)
OUT	<code>comm_keyval</code>	key value for future access (integer)
IN	<code>extra_state</code>	extra state for callback function

### C binding

```
int MPI_Comm_create_keyval(MPI_Comm_copy_attr_function *comm_copy_attr_fn,
```



```

MPI_Comm_delete_attr_function *comm_delete_attr_fn,
int *comm_keyval, void *extra_state)

```

**Fortran 2008 binding**

```

MPI_Comm_create_keyval(comm_copy_attr_fn, comm_delete_attr_fn, comm_keyval,
extra_state, ierror)
PROCEDURE(MPI_Comm_copy_attr_function), INTENT(IN) :: comm_copy_attr_fn
PROCEDURE(MPI_Comm_delete_attr_function), INTENT(IN) ::
comm_delete_attr_fn
INTEGER, INTENT(OUT) :: comm_keyval
INTEGER(KIND=MPI_ADDRESS_KIND), INTENT(IN) :: extra_state
INTEGER, OPTIONAL, INTENT(OUT) :: ierror

```

**Fortran binding**

```

MPI_COMM_CREATE_KEYVAL(COMM_COPY_ATTR_FN, COMM_DELETE_ATTR_FN, COMM_KEYVAL,
EXTRA_STATE, IERROR)
EXTERNAL COMM_COPY_ATTR_FN, COMM_DELETE_ATTR_FN
INTEGER COMM_KEYVAL, IERROR
INTEGER(KIND=MPI_ADDRESS_KIND) EXTRA_STATE

```

Generates a new attribute key. Keys are locally unique in a process, and opaque to user, though they are explicitly stored in integers. Once allocated, the key value can be used to associate attributes and access them on any locally defined communicator.

The C callback functions are:

```

typedef int MPI_Comm_copy_attr_function(MPI_Comm oldcomm, int comm_keyval,
void *extra_state, void *attribute_val_in,
void *attribute_val_out, int *flag);

```

and

```

typedef int MPI_Comm_delete_attr_function(MPI_Comm comm, int comm_keyval,
void *attribute_val, void *extra_state);

```

which are the same as the MPI-1.1 calls but with a new name. The old names are deprecated.

With the `mpi_f08` module, the Fortran callback functions are:

```

ABSTRACT INTERFACE
SUBROUTINE MPI_Comm_copy_attr_function(oldcomm, comm_keyval, extra_state,
attribute_val_in, attribute_val_out, flag, ierror)
TYPE(MPI_Comm) :: oldcomm
INTEGER :: comm_keyval, ierror
INTEGER(KIND=MPI_ADDRESS_KIND) :: extra_state, attribute_val_in,
attribute_val_out
LOGICAL :: flag

```

and

```

ABSTRACT INTERFACE
SUBROUTINE MPI_Comm_delete_attr_function(comm, comm_keyval,
attribute_val, extra_state, ierror)
TYPE(MPI_Comm) :: comm
INTEGER :: comm_keyval, ierror
INTEGER(KIND=MPI_ADDRESS_KIND) :: attribute_val, extra_state

```

1 With the `mpi` module and `mpif.h`, the Fortran callback functions are:

```
2 SUBROUTINE COMM_COPY_ATTR_FUNCTION(OLDCOMM, COMM_KEYVAL, EXTRA_STATE,
3     ATTRIBUTE_VAL_IN, ATTRIBUTE_VAL_OUT, FLAG, IERROR)
4     INTEGER OLDCOMM, COMM_KEYVAL, IERROR
5     INTEGER(KIND=MPI_ADDRESS_KIND) EXTRA_STATE, ATTRIBUTE_VAL_IN,
6     ATTRIBUTE_VAL_OUT
7     LOGICAL FLAG
```

8 and

```
9 SUBROUTINE COMM_DELETE_ATTR_FUNCTION(COMM, COMM_KEYVAL, ATTRIBUTE_VAL,
10     EXTRA_STATE, IERROR)
11     INTEGER COMM, COMM_KEYVAL, IERROR
12     INTEGER(KIND=MPI_ADDRESS_KIND) ATTRIBUTE_VAL, EXTRA_STATE
```

14 The `comm_copy_attr_fn` function is invoked when a communicator is duplicated by  
15 `MPI_COMM_DUP` or `MPI_COMM_IDUP`. `comm_copy_attr_fn` should be of type  
16 `MPI_Comm_copy_attr_function`. The copy callback function is invoked for each key value in  
17 `oldcomm` in arbitrary order. Each call to the copy callback is made with a key value and its  
18 corresponding attribute. If it returns `flag = 0` or `.FALSE.`, then the attribute is deleted in  
19 the duplicated communicator. Otherwise (`flag = 1` or `.TRUE.`), the new attribute value is  
20 set to the value returned in `attribute_val_out`. The function returns `MPI_SUCCESS` on success  
21 and an error code on failure (in which case `MPI_COMM_DUP` or `MPI_COMM_IDUP` will  
22 fail).

23 The argument `comm_copy_attr_fn` may be specified as `MPI_COMM_NULL_COPY_FN`  
24 or `MPI_COMM_DUP_FN` from either C or Fortran. `MPI_COMM_NULL_COPY_FN` is a  
25 function that does nothing other than returning `flag = 0` or `.FALSE.` (depending on whether  
26 the keyval was created with a C or Fortran binding to `MPI_COMM_CREATE_KEYVAL`) and  
27 `MPI_SUCCESS`. `MPI_COMM_DUP_FN` is a simple copy function that sets `flag = 1` or `.TRUE.`,  
28 returns the value of `attribute_val_in` in `attribute_val_out`, and returns `MPI_SUCCESS`. These  
29 replace the MPI-1 predefined callbacks `MPI_NULL_COPY_FN` and `MPI_DUP_FN`, whose  
30 use is deprecated.

32 *Advice to users.* Even though both formal arguments `attribute_val_in` and  
33 `attribute_val_out` are of type `void*`, their usage differs. The C copy function is passed  
34 by MPI in `attribute_val_in` the *value* of the attribute, and in `attribute_val_out` the  
35 *address* of the attribute, so as to allow the function to return the (new) attribute  
36 value. The use of type `void*` for both is to avoid messy type casts.

37 A valid copy function is one that completely duplicates the information by making  
38 a full duplicate copy of the data structures implied by an attribute; another might  
39 just make another reference to that data structure, while using a reference-count  
40 mechanism. Other types of attributes might not copy at all (they might be specific  
41 to `oldcomm` only). (*End of advice to users.*)

43 *Advice to implementors.* A C interface should be assumed for copy and delete  
44 functions associated with key values created in C; a Fortran calling interface should  
45 be assumed for key values created in Fortran. (*End of advice to implementors.*)

47 Analogous to `comm_copy_attr_fn` is a callback deletion function, defined as follows.  
48 The `comm_delete_attr_fn` function is invoked when a communicator is deleted by

MPI\_COMM\_FREE or when a call is made explicitly to MPI\_COMM\_DELETE\_ATTR. comm\_delete\_attr\_fn should be of type MPI\_Comm\_delete\_attr\_function.

This function is called by MPI\_COMM\_FREE, MPI\_COMM\_DELETE\_ATTR, and MPI\_COMM\_SET\_ATTR to do whatever is needed to remove an attribute. The function returns MPI\_SUCCESS on success and an error code on failure (in which case MPI\_COMM\_FREE will fail).

The argument comm\_delete\_attr\_fn may be specified as MPI\_COMM\_NULL\_DELETE\_FN from either C or Fortran.

MPI\_COMM\_NULL\_DELETE\_FN is a function that does nothing, other than returning MPI\_SUCCESS. MPI\_COMM\_NULL\_DELETE\_FN replaces MPI\_NULL\_DELETE\_FN, whose use is deprecated.

If an attribute copy function or attribute delete function returns other than MPI\_SUCCESS, then the call that caused it to be invoked (for example, MPI\_COMM\_FREE), is erroneous.

The special key value MPI\_KEYVAL\_INVALID is never returned by MPI\_COMM\_CREATE\_KEYVAL. Therefore, it can be used for static initialization of key values.

*Advice to implementors.* The predefined Fortran functions MPI\_COMM\_NULL\_COPY\_FN, MPI\_COMM\_DUP\_FN, and MPI\_COMM\_NULL\_DELETE\_FN are defined in the mpi module (and mpif.h) and the mpi\_f08 module with the same name, but with different interfaces. Each function can coexist twice with the same name in the same MPI library, one routine as an implicit interface outside of the mpi module, i.e., declared as EXTERNAL, and the other routine within mpi\_f08 declared with CONTAINS. These routines have different link names, which are also different to the link names used for the routines used in C. (End of advice to implementors.)

*Advice to users.* Callbacks, including the predefined Fortran functions MPI\_COMM\_NULL\_COPY\_FN, MPI\_COMM\_DUP\_FN, and MPI\_COMM\_NULL\_DELETE\_FN should not be passed from one application routine that uses the mpi\_f08 module to another application routine that uses the mpi module or mpif.h, and vice versa; see also the advice to users on page 840. (End of advice to users.)

MPI\_COMM\_FREE\_KEYVAL(comm\_keyval)

INOUT comm\_keyval key value (integer)

### C binding

int MPI\_Comm\_free\_keyval(int \*comm\_keyval)

### Fortran 2008 binding

MPI\_Comm\_free\_keyval(comm\_keyval, ierror)  
 INTEGER, INTENT(INOUT) :: comm\_keyval  
 INTEGER, OPTIONAL, INTENT(OUT) :: ierror

### Fortran binding

MPI\_COMM\_FREE\_KEYVAL(COMM\_KEYVAL, IERROR)

1 INTEGER COMM\_KEYVAL, IERROR

2  
3 Frees an extant attribute key. This function sets the value of `keyval` to  
4 `MPI_KEYVAL_INVALID`. Note that it is not erroneous to free an attribute key that is in use,  
5 because the actual free does not transpire until after all references (in other communicators  
6 on the process) to the key have been freed. These references need to be explicitly freed by the  
7 program, either via calls to `MPI_COMM_DELETE_ATTR` that free one attribute instance,  
8 or by calls to `MPI_COMM_FREE` that free all attribute instances associated with the freed  
9 communicator.

10  
11 `MPI_COMM_SET_ATTR(comm, comm_keyval, attribute_val)`

12	INOUT	<code>comm</code>	communicator to which attribute will be attached (handle)
13			
14			
15	IN	<code>comm_keyval</code>	key value (integer)
16	IN	<code>attribute_val</code>	attribute value
17			

18 **C binding**

19 `int MPI_Comm_set_attr(MPI_Comm comm, int comm_keyval, void *attribute_val)`

20  
21 **Fortran 2008 binding**

22 `MPI_Comm_set_attr(comm, comm_keyval, attribute_val, ierror)`  
23 `TYPE(MPI_Comm), INTENT(IN) :: comm`  
24 `INTEGER, INTENT(IN) :: comm_keyval`  
25 `INTEGER(KIND=MPI_ADDRESS_KIND), INTENT(IN) :: attribute_val`  
26 `INTEGER, OPTIONAL, INTENT(OUT) :: ierror`

27  
28 **Fortran binding**

29 `MPI_COMM_SET_ATTR(COMM, COMM_KEYVAL, ATTRIBUTE_VAL, IERROR)`  
30 `INTEGER COMM, COMM_KEYVAL, IERROR`  
31 `INTEGER(KIND=MPI_ADDRESS_KIND) ATTRIBUTE_VAL`

32 This function stores the stipulated attribute value `attribute_val` for subsequent retrieval  
33 by `MPI_COMM_GET_ATTR`. If the value is already present, then the outcome is as if  
34 `MPI_COMM_DELETE_ATTR` was first called to delete the previous value (and the callback  
35 function `comm_delete_attr_fn` was executed), and a new value was next stored. The call  
36 is erroneous if there is no key with value `keyval`; in particular `MPI_KEYVAL_INVALID` is an  
37 erroneous key value. The call will fail if the `comm_delete_attr_fn` function returned an error  
38 code other than `MPI_SUCCESS`.

MPI\_COMM\_GET\_ATTR(comm, comm\_keyval, attribute\_val, flag) 1

IN	comm	communicator to which the attribute is attached (handle)	2 3 4
IN	comm_keyval	key value (integer)	5
OUT	attribute_val	attribute value, unless flag = false	6 7
OUT	flag	false if no attribute is associated with the key (logical)	8 9 10

### C binding 11

```
int MPI_Comm_get_attr(MPI_Comm comm, int comm_keyval, void *attribute_val,
                    int *flag) 12
```

### Fortran 2008 binding 14

```
MPI_Comm_get_attr(comm, comm_keyval, attribute_val, flag, ierror) 15
  TYPE(MPI_Comm), INTENT(IN) :: comm 16
  INTEGER, INTENT(IN) :: comm_keyval 17
  INTEGER(KIND=MPI_ADDRESS_KIND), INTENT(OUT) :: attribute_val 18
  LOGICAL, INTENT(OUT) :: flag 19
  INTEGER, OPTIONAL, INTENT(OUT) :: ierror 20
```

### Fortran binding 22

```
MPI_COMM_GET_ATTR(COMM, COMM_KEYVAL, ATTRIBUTE_VAL, FLAG, IERROR) 23
  INTEGER COMM, COMM_KEYVAL, IERROR 24
  INTEGER(KIND=MPI_ADDRESS_KIND) ATTRIBUTE_VAL 25
  LOGICAL FLAG 26
```

Retrieves attribute value by key. The call is erroneous if there is no key with value keyval. On the other hand, the call is correct if the key value exists, but no attribute is attached on comm for that key; in such case, the call returns flag = false. In particular MPI\_KEYVAL\_INVALID is an erroneous key value. 27-31

*Advice to users.* The call to MPI\_Comm\_set\_attr passes in attribute\_val the *value* of the attribute; the call to MPI\_Comm\_get\_attr passes in attribute\_val the *address* of the location where the attribute value is to be returned. Thus, if the attribute value itself is a pointer of type void\*, then the actual attribute\_val parameter to MPI\_Comm\_set\_attr will be of type void\* and the actual attribute\_val parameter to MPI\_Comm\_get\_attr will be of type void\*\*. (*End of advice to users.*) 32-38

*Rationale.* The use of a formal parameter attribute\_val of type void\* (rather than void\*\*) avoids the messy type casting that would be needed if the attribute value is declared with a type other than void\*. (*End of rationale.*) 39-41

```

1 MPI_COMM_DELETE_ATTR(comm, comm_keyval)
2     INOUT    comm                communicator from which the attribute is deleted
3                                     (handle)
4
5     IN      comm_keyval          key value (integer)
6

```

**C binding**

```

8 int MPI_Comm_delete_attr(MPI_Comm comm, int comm_keyval)
9

```

**Fortran 2008 binding**

```

10 MPI_Comm_delete_attr(comm, comm_keyval, ierror)
11     TYPE(MPI_Comm), INTENT(IN) :: comm
12     INTEGER, INTENT(IN) :: comm_keyval
13     INTEGER, OPTIONAL, INTENT(OUT) :: ierror
14

```

**Fortran binding**

```

15 MPI_COMM_DELETE_ATTR(COMM, COMM_KEYVAL, IERROR)
16     INTEGER COMM, COMM_KEYVAL, IERROR
17

```

18 Delete attribute from cache by key. This function invokes the attribute delete function
19 `comm_delete_attr_fn` specified when the `keyval` was created. The call will fail if the
20 `comm_delete_attr_fn` function returns an error code other than `MPI_SUCCESS`.
21

22 Whenever a communicator is replicated using the function `MPI_COMM_DUP` or
23 `MPI_COMM_IDUP`, all call-back copy functions for attributes that are currently set are
24 invoked (in arbitrary order). Whenever a communicator is deleted using the function
25 `MPI_COMM_FREE` all callback delete functions for attributes that are currently set are
26 invoked.
27

**7.7.3 Windows**

28 The functions for caching on windows are:
29

```

30
31
32 MPI_WIN_CREATE_KEYVAL(win_copy_attr_fn, win_delete_attr_fn, win_keyval,
33     extra_state)
34     IN      win_copy_attr_fn      copy callback function for win_keyval (function)
35     IN      win_delete_attr_fn    delete callback function for win_keyval (function)
36     OUT     win_keyval            key value for future access (integer)
37     IN      extra_state           extra state for callback function
38
39

```

**C binding**

```

40
41 int MPI_Win_create_keyval(MPI_Win_copy_attr_function *win_copy_attr_fn,
42     MPI_Win_delete_attr_function *win_delete_attr_fn,
43     int *win_keyval, void *extra_state)
44

```

**Fortran 2008 binding**

```

45 MPI_Win_create_keyval(win_copy_attr_fn, win_delete_attr_fn, win_keyval,
46     extra_state, ierror)
47     PROCEDURE(MPI_Win_copy_attr_function), INTENT(IN) :: win_copy_attr_fn
48

```

```

PROCEDURE(MPI_Win_delete_attr_function), INTENT(IN) ::
    win_delete_attr_fn
INTEGER, INTENT(OUT) :: win_keyval
INTEGER(KIND=MPI_ADDRESS_KIND), INTENT(IN) :: extra_state
INTEGER, OPTIONAL, INTENT(OUT) :: ierror

```

**Fortran binding**

```

MPI_WIN_CREATE_KEYVAL(WIN_COPY_ATTR_FN, WIN_DELETE_ATTR_FN, WIN_KEYVAL,
    EXTRA_STATE, IERROR)
EXTERNAL WIN_COPY_ATTR_FN, WIN_DELETE_ATTR_FN
INTEGER WIN_KEYVAL, IERROR
INTEGER(KIND=MPI_ADDRESS_KIND) EXTRA_STATE

```

The argument `win_copy_attr_fn` may be specified as `MPI_WIN_NULL_COPY_FN` or `MPI_WIN_DUP_FN` from either C or Fortran. `MPI_WIN_NULL_COPY_FN` is a function that does nothing other than returning `flag = 0` and `MPI_SUCCESS`. `MPI_WIN_DUP_FN` is a simple copy function that sets `flag = 1`, returns the value of `attribute_val_in` in `attribute_val_out`, and returns `MPI_SUCCESS`.

The argument `win_delete_attr_fn` may be specified as `MPI_WIN_NULL_DELETE_FN` from either C or Fortran. `MPI_WIN_NULL_DELETE_FN` is a function that does nothing, other than returning `MPI_SUCCESS`.

The C callback functions are:

```

typedef int MPI_Win_copy_attr_function(MPI_Win oldwin, int win_keyval,
    void *extra_state, void *attribute_val_in,
    void *attribute_val_out, int *flag);

```

and

```

typedef int MPI_Win_delete_attr_function(MPI_Win win, int win_keyval,
    void *attribute_val, void *extra_state);

```

With the `mpi_f08` module, the Fortran callback functions are:

```

ABSTRACT INTERFACE
    SUBROUTINE MPI_Win_copy_attr_function(oldwin, win_keyval, extra_state,
        attribute_val_in, attribute_val_out, flag, ierror)
        TYPE(MPI_Win) :: oldwin
        INTEGER :: win_keyval, ierror
        INTEGER(KIND=MPI_ADDRESS_KIND) :: extra_state, attribute_val_in,
            attribute_val_out
        LOGICAL :: flag

```

and

```

ABSTRACT INTERFACE
    SUBROUTINE MPI_Win_delete_attr_function(win, win_keyval, attribute_val,
        extra_state, ierror)
        TYPE(MPI_Win) :: win
        INTEGER :: win_keyval, ierror
        INTEGER(KIND=MPI_ADDRESS_KIND) :: attribute_val, extra_state

```

With the `mpi` module and `mpif.h`, the Fortran callback functions are:

```

1  SUBROUTINE WIN_COPY_ATTR_FUNCTION(OLDWIN, WIN_KEYVAL, EXTRA_STATE,
2      ATTRIBUTE_VAL_IN, ATTRIBUTE_VAL_OUT, FLAG, IERROR)
3      INTEGER OLDWIN, WIN_KEYVAL, IERROR
4      INTEGER(KIND=MPI_ADDRESS_KIND) EXTRA_STATE, ATTRIBUTE_VAL_IN,
5          ATTRIBUTE_VAL_OUT
6      LOGICAL FLAG

```

7 and

```

8  SUBROUTINE WIN_DELETE_ATTR_FUNCTION(WIN, WIN_KEYVAL, ATTRIBUTE_VAL,
9      EXTRA_STATE, IERROR)
10     INTEGER WIN, WIN_KEYVAL, IERROR
11     INTEGER(KIND=MPI_ADDRESS_KIND) ATTRIBUTE_VAL, EXTRA_STATE

```

13 If an attribute copy function or attribute delete function returns other than  
14 MPI\_SUCCESS, then the call that caused it to be invoked (for example, MPI\_WIN\_FREE), is  
15 erroneous.

```

16
17 MPI_WIN_FREE_KEYVAL(win_keyval)

```

```

18     INOUT    win_keyval                key value (integer)

```

#### 21 C binding

```

22 int MPI_Win_free_keyval(int *win_keyval)

```

#### 24 Fortran 2008 binding

```

25 MPI_Win_free_keyval(win_keyval, ierror)
26     INTEGER, INTENT(INOUT) :: win_keyval
27     INTEGER, OPTIONAL, INTENT(OUT) :: ierror

```

#### 28 Fortran binding

```

29 MPI_WIN_FREE_KEYVAL(WIN_KEYVAL, IERROR)
30     INTEGER WIN_KEYVAL, IERROR

```

```

31
32
33 MPI_WIN_SET_ATTR(win, win_keyval, attribute_val)

```

```

34     INOUT    win                window to which attribute will be attached (handle)

```

```

35     IN      win_keyval          key value (integer)

```

```

36     IN      attribute_val       attribute value

```

#### 39 C binding

```

40 int MPI_Win_set_attr(MPI_Win win, int win_keyval, void *attribute_val)

```

#### 42 Fortran 2008 binding

```

43 MPI_Win_set_attr(win, win_keyval, attribute_val, ierror)
44     TYPE(MPI_Win), INTENT(IN) :: win
45     INTEGER, INTENT(IN) :: win_keyval
46     INTEGER(KIND=MPI_ADDRESS_KIND), INTENT(IN) :: attribute_val
47     INTEGER, OPTIONAL, INTENT(OUT) :: ierror

```



**Fortran binding**

```

MPI_WIN_SET_ATTR(WIN, WIN_KEYVAL, ATTRIBUTE_VAL, IERROR)
    INTEGER WIN, WIN_KEYVAL, IERROR
    INTEGER(KIND=MPI_ADDRESS_KIND) ATTRIBUTE_VAL

```

```

MPI_WIN_GET_ATTR(win, win_keyval, attribute_val, flag)

```

IN	win	window to which the attribute is attached (handle)
IN	win_keyval	key value (integer)
OUT	attribute_val	attribute value, unless flag = false
OUT	flag	false if no attribute is associated with the key (logical)

**C binding**

```

int MPI_Win_get_attr(MPI_Win win, int win_keyval, void *attribute_val,
    int *flag)

```

**Fortran 2008 binding**

```

MPI_Win_get_attr(win, win_keyval, attribute_val, flag, ierror)
    TYPE(MPI_Win), INTENT(IN) :: win
    INTEGER, INTENT(IN) :: win_keyval
    INTEGER(KIND=MPI_ADDRESS_KIND), INTENT(OUT) :: attribute_val
    LOGICAL, INTENT(OUT) :: flag
    INTEGER, OPTIONAL, INTENT(OUT) :: ierror

```

**Fortran binding**

```

MPI_WIN_GET_ATTR(WIN, WIN_KEYVAL, ATTRIBUTE_VAL, FLAG, IERROR)
    INTEGER WIN, WIN_KEYVAL, IERROR
    INTEGER(KIND=MPI_ADDRESS_KIND) ATTRIBUTE_VAL
    LOGICAL FLAG

```

```

MPI_WIN_DELETE_ATTR(win, win_keyval)

```

INOUT	win	window from which the attribute is deleted (handle)
IN	win_keyval	key value (integer)

**C binding**

```

int MPI_Win_delete_attr(MPI_Win win, int win_keyval)

```

**Fortran 2008 binding**

```

MPI_Win_delete_attr(win, win_keyval, ierror)
    TYPE(MPI_Win), INTENT(IN) :: win
    INTEGER, INTENT(IN) :: win_keyval
    INTEGER, OPTIONAL, INTENT(OUT) :: ierror

```

**Fortran binding**

```

MPI_WIN_DELETE_ATTR(WIN, WIN_KEYVAL, IERROR)

```

```
1     INTEGER WIN, WIN_KEYVAL, IERROR
```

#### 7.7.4 Datatypes

The new functions for caching on datatypes are:

```
8 MPI_TYPE_CREATE_KEYVAL(type_copy_attr_fn, type_delete_attr_fn, type_keyval,
9     extra_state)
10  IN     type_copy_attr_fn     copy callback function for type_keyval (function)
11  IN     type_delete_attr_fn  delete callback function for type_keyval (function)
12  OUT    type_keyval          key value for future access (integer)
13  IN     extra_state          extra state for callback function
```

#### C binding

```
17 int MPI_Type_create_keyval(MPI_Type_copy_attr_function *type_copy_attr_fn,
18     MPI_Type_delete_attr_function *type_delete_attr_fn,
19     int *type_keyval, void *extra_state)
```

#### Fortran 2008 binding

```
22 MPI_Type_create_keyval(type_copy_attr_fn, type_delete_attr_fn, type_keyval,
23     extra_state, ierror)
24     PROCEDURE(MPI_Type_copy_attr_function), INTENT(IN) :: type_copy_attr_fn
25     PROCEDURE(MPI_Type_delete_attr_function), INTENT(IN) ::
26         type_delete_attr_fn
27     INTEGER, INTENT(OUT) :: type_keyval
28     INTEGER(KIND=MPI_ADDRESS_KIND), INTENT(IN) :: extra_state
29     INTEGER, OPTIONAL, INTENT(OUT) :: ierror
```

#### Fortran binding

```
31 MPI_TYPE_CREATE_KEYVAL(TYPE_COPY_ATTR_FN, TYPE_DELETE_ATTR_FN, TYPE_KEYVAL,
32     EXTRA_STATE, IERROR)
33     EXTERNAL TYPE_COPY_ATTR_FN, TYPE_DELETE_ATTR_FN
34     INTEGER TYPE_KEYVAL, IERROR
35     INTEGER(KIND=MPI_ADDRESS_KIND) EXTRA_STATE
```

The argument `type_copy_attr_fn` may be specified as `MPI_TYPE_NULL_COPY_FN` or `MPI_TYPE_DUP_FN` from either C or Fortran. `MPI_TYPE_NULL_COPY_FN` is a function that does nothing other than returning `flag = 0` and `MPI_SUCCESS`. `MPI_TYPE_DUP_FN` is a simple copy function that sets `flag = 1`, returns the value of `attribute_val_in` in `attribute_val_out`, and returns `MPI_SUCCESS`.

The argument `type_delete_attr_fn` may be specified as `MPI_TYPE_NULL_DELETE_FN` from either C or Fortran. `MPI_TYPE_NULL_DELETE_FN` is a function that does nothing, other than returning `MPI_SUCCESS`.

The C callback functions are:

```
46 typedef int MPI_Type_copy_attr_function(MPI_Datatype oldtype,
47     int type_keyval, void *extra_state, void *attribute_val_in,
48     void *attribute_val_out, int *flag);
```

and

```
typedef int MPI_Type_delete_attr_function(MPI_Datatype datatype,
                                         int type_keyval, void *attribute_val, void *extra_state);
```

With the `mpi_f08` module, the Fortran callback functions are:

ABSTRACT INTERFACE

```
  SUBROUTINE MPI_Type_copy_attr_function(oldtype, type_keyval, extra_state,
                                         attribute_val_in, attribute_val_out, flag, ierror)
```

```
  TYPE(MPI_Datatype) :: oldtype
```

```
  INTEGER :: type_keyval, ierror
```

```
  INTEGER(KIND=MPI_ADDRESS_KIND) :: extra_state, attribute_val_in,
                                         attribute_val_out
```

```
  LOGICAL :: flag
```

and

ABSTRACT INTERFACE

```
  SUBROUTINE MPI_Type_delete_attr_function(datatype, type_keyval,
                                         attribute_val, extra_state, ierror)
```

```
  TYPE(MPI_Datatype) :: datatype
```

```
  INTEGER :: type_keyval, ierror
```

```
  INTEGER(KIND=MPI_ADDRESS_KIND) :: attribute_val, extra_state
```

With the `mpi` module and `mpif.h`, the Fortran callback functions are:

```
SUBROUTINE TYPE_COPY_ATTR_FUNCTION(OLDTYPE, TYPE_KEYVAL, EXTRA_STATE,
                                     ATTRIBUTE_VAL_IN, ATTRIBUTE_VAL_OUT, FLAG, IERROR)
```

```
  INTEGER OLDTYPE, TYPE_KEYVAL, IERROR
```

```
  INTEGER(KIND=MPI_ADDRESS_KIND) EXTRA_STATE, ATTRIBUTE_VAL_IN,
                                     ATTRIBUTE_VAL_OUT
```

```
  LOGICAL FLAG
```

and

```
SUBROUTINE TYPE_DELETE_ATTR_FUNCTION(DATATYPE, TYPE_KEYVAL, ATTRIBUTE_VAL,
                                       EXTRA_STATE, IERROR)
```

```
  INTEGER DATATYPE, TYPE_KEYVAL, IERROR
```

```
  INTEGER(KIND=MPI_ADDRESS_KIND) ATTRIBUTE_VAL, EXTRA_STATE
```

If an attribute copy function or attribute delete function returns other than `MPI_SUCCESS`, then the call that caused it to be invoked (for example, `MPI_TYPE_FREE`), is erroneous.

`MPI_TYPE_FREE_KEYVAL`(`type_keyval`)

INOUT `type_keyval` key value (integer)

### C binding

```
int MPI_Type_free_keyval(int *type_keyval)
```

### Fortran 2008 binding

```
MPI_Type_free_keyval(type_keyval, ierror)
```

```
  INTEGER, INTENT(INOUT) :: type_keyval
```

```

1     INTEGER, OPTIONAL, INTENT(OUT) :: ierror
2
3     Fortran binding
4     MPI_TYPE_FREE_KEYVAL(TYPE_KEYVAL, IERROR)
5         INTEGER TYPE_KEYVAL, IERROR
6
7
8     MPI_TYPE_SET_ATTR(datatype, type_keyval, attribute_val)
9         INOUT    datatype                datatype to which attribute will be attached (handle)
10        IN       type_keyval             key value (integer)
11        IN       attribute_val           attribute value
12
13
14    C binding
15    int MPI_Type_set_attr(MPI_Datatype datatype, int type_keyval,
16                          void *attribute_val)
17
18    Fortran 2008 binding
19    MPI_Type_set_attr(datatype, type_keyval, attribute_val, ierror)
20        TYPE(MPI_Datatype), INTENT(IN) :: datatype
21        INTEGER, INTENT(IN) :: type_keyval
22        INTEGER(KIND=MPI_ADDRESS_KIND), INTENT(IN) :: attribute_val
23        INTEGER, OPTIONAL, INTENT(OUT) :: ierror
24
25    Fortran binding
26    MPI_TYPE_SET_ATTR(DATATYPE, TYPE_KEYVAL, ATTRIBUTE_VAL, IERROR)
27        INTEGER DATATYPE, TYPE_KEYVAL, IERROR
28        INTEGER(KIND=MPI_ADDRESS_KIND) ATTRIBUTE_VAL
29
30    MPI_TYPE_GET_ATTR(datatype, type_keyval, attribute_val, flag)
31
32    IN    datatype                datatype to which the attribute is attached (handle)
33    IN    type_keyval             key value (integer)
34    OUT   attribute_val           attribute value, unless flag = false
35    OUT   flag                    false if no attribute is associated with the key
36                                     (logical)
37
38
39    C binding
40    int MPI_Type_get_attr(MPI_Datatype datatype, int type_keyval,
41                          void *attribute_val, int *flag)
42
43    Fortran 2008 binding
44    MPI_Type_get_attr(datatype, type_keyval, attribute_val, flag, ierror)
45        TYPE(MPI_Datatype), INTENT(IN) :: datatype
46        INTEGER, INTENT(IN) :: type_keyval
47        INTEGER(KIND=MPI_ADDRESS_KIND), INTENT(OUT) :: attribute_val
48        LOGICAL, INTENT(OUT) :: flag

```

```
INTEGER, OPTIONAL, INTENT(OUT) :: ierror
```

### Fortran binding

```
MPI_TYPE_GET_ATTR(DATATYPE, TYPE_KEYVAL, ATTRIBUTE_VAL, FLAG, IERROR)
  INTEGER DATATYPE, TYPE_KEYVAL, IERROR
  INTEGER(KIND=MPI_ADDRESS_KIND) ATTRIBUTE_VAL
  LOGICAL FLAG
```

```
MPI_TYPE_DELETE_ATTR(datatype, type_keyval)
```

```
INOUT datatype          datatype from which the attribute is deleted (handle)
IN      type_keyval      key value (integer)
```

### C binding

```
int MPI_Type_delete_attr(MPI_Datatype datatype, int type_keyval)
```

### Fortran 2008 binding

```
MPI_Type_delete_attr(datatype, type_keyval, ierror)
  TYPE(MPI_Datatype), INTENT(IN) :: datatype
  INTEGER, INTENT(IN) :: type_keyval
  INTEGER, OPTIONAL, INTENT(OUT) :: ierror
```

### Fortran binding

```
MPI_TYPE_DELETE_ATTR(DATATYPE, TYPE_KEYVAL, IERROR)
  INTEGER DATATYPE, TYPE_KEYVAL, IERROR
```

#### 7.7.5 Error Class for Invalid Keyval

Key values for attributes are system-allocated, by `MPI_{XXX}_CREATE_KEYVAL`. Only such values can be passed to the functions that use key values as input arguments. In order to signal that an erroneous key value has been passed to one of these functions, there is a new MPI error class: `MPI_ERR_KEYVAL`. It can be returned by `MPI_ATTR_PUT`, `MPI_ATTR_GET`, `MPI_ATTR_DELETE`, `MPI_KEYVAL_FREE`, `MPI_{XXX}_DELETE_ATTR`, `MPI_{XXX}_SET_ATTR`, `MPI_{XXX}_GET_ATTR`, `MPI_{XXX}_FREE_KEYVAL`, `MPI_COMM_DUP`, `MPI_COMM_IDUP`, `MPI_COMM_DISCONNECT`, and `MPI_COMM_FREE`. The last four are included because `keyval` is an argument to the copy and delete functions for attributes.

#### 7.7.6 Attributes Example

*Advice to users.* This example shows how to write a collective communication operation that uses caching to be more efficient after the first call. (*End of advice to users.*)

```

1  /* key for this module's stuff: */
2  static int gop_key = MPI_KEYVAL_INVALID;
3
4  typedef struct
5  {
6      int ref_count;          /* reference count */
7      /* other stuff, whatever else we want */
8  } gop_stuff_type;
9
10 void Efficient_Collective_Op(MPI_Comm comm, ...)
11 {
12     gop_stuff_type *gop_stuff;
13     MPI_Group      group;
14     int            foundflag;
15
16     MPI_Comm_group(comm, &group);
17
18     if (gop_key == MPI_KEYVAL_INVALID) /* get a key on first call ever */
19     {
20         if ( ! MPI_Comm_create_keyval(gop_stuff_copier,
21                                     gop_stuff_destructor,
22                                     &gop_key, NULL) {
23             /* get the key while assigning its copy and delete callback
24              behavior. */
25         } else
26             MPI_Abort(comm, 99);
27     }
28
29     MPI_Comm_get_attr(comm, gop_key, &gop_stuff, &foundflag);
30     if (foundflag)
31     { /* This module has executed in this group before.
32        We will use the cached information */
33     }
34     else
35     { /* This is a group that we have not yet cached anything in.
36        We will now do so.
37        */
38
39         /* First, allocate storage for the stuff we want,
40          and initialize the reference count */
41
42         gop_stuff = (gop_stuff_type *) malloc(sizeof(gop_stuff_type));
43         if (gop_stuff == NULL) { /* abort on out-of-memory error */ }
44
45         gop_stuff->ref_count = 1;
46
47         /* Second, fill in *gop_stuff with whatever we want.
48          This part isn't shown here */

```

```

1
2     /* Third, store gop_stuff as the attribute value */
3     MPI_Comm_set_attr(comm, gop_key, gop_stuff);
4 }
5 /* Then, in any case, use contents of *gop_stuff
6    to do the global op ... */
7 }
8
9 /* The following routine is called by MPI when a group is freed */
10
11 int gop_stuff_destructor(MPI_Comm comm, int keyval, void *gop_stuffP,
12                          void *extra)
13 {
14     gop_stuff_type *gop_stuff = (gop_stuff_type *)gop_stuffP;
15     if (keyval != gop_key) { /* abort -- programming error */ }
16
17     /* The group's being freed removes one reference to gop_stuff */
18     gop_stuff->ref_count -= 1;
19
20     /* If no references remain, then free the storage */
21     if (gop_stuff->ref_count == 0) {
22         free((void *)gop_stuff);
23     }
24     return MPI_SUCCESS;
25 }
26
27 /* The following routine is called by MPI when a group is copied */
28 int gop_stuff_copier(MPI_Comm comm, int keyval, void *extra,
29                      void *gop_stuff_inP, void *gop_stuff_outP, int *flag)
30 {
31     gop_stuff_type *gop_stuff_in = (gop_stuff_type *)gop_stuff_inP;
32     gop_stuff_type **gop_stuff_out = (gop_stuff_type **)gop_stuff_outP;
33     if (keyval != gop_key) { /* abort -- programming error */ }
34
35     /* The new group adds one reference to this gop_stuff */
36     gop_stuff_in->ref_count += 1;
37     *gop_stuff_out = gop_stuff_in;
38     return MPI_SUCCESS;
39 }
40
41
42
43
44
45
46
47
48

```

## 7.8 Naming Objects

There are many occasions on which it would be useful to allow a user to associate a printable identifier with an MPI communicator, window, or datatype, for instance error reporting, debugging, and profiling. The names attached to opaque objects do not propagate when the object is duplicated or copied by MPI routines. For communicators this can be achieved using the following two functions.

```

1 MPI_COMM_SET_NAME(comm, comm_name)
2     INOUT    comm                communicator whose identifier is to be set (handle)
3
4     IN      comm_name           the character string which is remembered as the
5                                 name (string)
6

```

**C binding**

```

8 int MPI_Comm_set_name(MPI_Comm comm, const char *comm_name)
9

```

**Fortran 2008 binding**

```

10 MPI_Comm_set_name(comm, comm_name, ierror)
11     TYPE(MPI_Comm), INTENT(IN) :: comm
12     CHARACTER(LEN=*), INTENT(IN) :: comm_name
13     INTEGER, OPTIONAL, INTENT(OUT) :: ierror
14

```

**Fortran binding**

```

15 MPI_COMM_SET_NAME(COMM, COMM_NAME, IERROR)
16     INTEGER COMM, IERROR
17     CHARACTER*(*) COMM_NAME
18

```

20 MPI\_COMM\_SET\_NAME allows a user to associate a name string with a communicator.
21 The character string which is passed to MPI\_COMM\_SET\_NAME will be saved inside the
22 MPI library (so it can be freed by the caller immediately after the call, or allocated on the
23 stack). Leading spaces in `name` are significant but trailing ones are not.

24 MPI\_COMM\_SET\_NAME is a local (non-collective) operation, which only affects the
25 name of the communicator as seen in the process which made the MPI\_COMM\_SET\_NAME
26 call. There is no requirement that the same (or any) name be assigned to a communicator
27 in every process where it exists.

28 *Advice to users.* Since MPI\_COMM\_SET\_NAME is provided to help debug code, it
29 is sensible to give the same name to a communicator in all of the processes where it
30 exists, to avoid confusion. (*End of advice to users.*)

32 The length of the name which can be stored is limited to the value of
33 MPI\_MAX\_OBJECT\_NAME in Fortran and MPI\_MAX\_OBJECT\_NAME-1 in C to allow for the
34 null terminator. Attempts to put names longer than this will result in truncation of the
35 name. MPI\_MAX\_OBJECT\_NAME must have a value of at least 64.

37 *Advice to users.* Under circumstances of store exhaustion an attempt to put a name
38 of any length could fail, therefore the value of MPI\_MAX\_OBJECT\_NAME should be
39 viewed only as a strict upper bound on the name length, not a guarantee that setting
40 names of less than this length will always succeed. (*End of advice to users.*)

42 *Advice to implementors.* Implementations which pre-allocate a fixed size space for a
43 name should use the length of that allocation as the value of MPI\_MAX\_OBJECT\_NAME.
44 Implementations which allocate space for the name from the heap should still define
45 MPI\_MAX\_OBJECT\_NAME to be a relatively small value, since the user has to allocate
46 space for a string of up to this size when calling MPI\_COMM\_GET\_NAME. (*End of
47 advice to implementors.*)



MPI\_COMM\_GET\_NAME(comm, comm\_name, resultlen) 1

IN comm communicator whose name is to be returned (handle) 2

OUT comm\_name the name previously stored on the communicator, or  
an empty string if no such name exists (string) 3

OUT resultlen length of returned name (integer) 4

### C binding 5

```
int MPI_Comm_get_name(MPI_Comm comm, char *comm_name, int *resultlen) 6
```

### Fortran 2008 binding 7

```
MPI_Comm_get_name(comm, comm_name, resultlen, ierror) 8
```

```
TYPE(MPI_Comm), INTENT(IN) :: comm 9
```

```
CHARACTER(LEN=MPI_MAX_OBJECT_NAME), INTENT(OUT) :: comm_name 10
```

```
INTEGER, INTENT(OUT) :: resultlen 11
```

```
INTEGER, OPTIONAL, INTENT(OUT) :: ierror 12
```

### Fortran binding 13

```
MPI_COMM_GET_NAME(COMM, COMM_NAME, RESULTLEN, IERROR) 14
```

```
INTEGER COMM, RESULTLEN, IERROR 15
```

```
CHARACTER*(*) COMM_NAME 16
```

MPI\_COMM\_GET\_NAME returns the last name which has previously been associated with the given communicator. The name may be set and retrieved from any language. The same name will be returned independent of the language used. `comm_name` should be allocated so that it can hold a resulting string of length `MPI_MAX_OBJECT_NAME` characters. MPI\_COMM\_GET\_NAME returns a copy of the set name in `comm_name`. 17

In C, a null character is additionally stored at `comm_name[resultlen]`. The value of `resultlen` cannot be larger than `MPI_MAX_OBJECT_NAME-1`. In Fortran, `comm_name` is padded on the right with blank characters. The value of `resultlen` cannot be larger than `MPI_MAX_OBJECT_NAME`. 18

If the user has not associated a name with a communicator, or an error occurs, MPI\_COMM\_GET\_NAME will return an empty string (all spaces in Fortran, "" in C). The three predefined communicators will have predefined names associated with them. Thus, the names of `MPI_COMM_WORLD`, `MPI_COMM_SELF`, and the communicator returned by `MPI_COMM_GET_PARENT` (if not `MPI_COMM_NULL`) will have the default of `MPI_COMM_WORLD`, `MPI_COMM_SELF`, and `MPI_COMM_PARENT`. The fact that the system may have chosen to give a default name to a communicator does not prevent the user from setting a name on the same communicator; doing this removes the old name and assigns the new one. 19

*Rationale.* We provide separate functions for setting and getting the name of a communicator, rather than simply providing a predefined attribute key for the following reasons: 20

- It is not, in general, possible to store a string as an attribute from Fortran. 21
- It is not easy to set up the delete function for a string attribute unless it is known to have been allocated from the heap. 22

- To make the attribute key useful additional code to call `strdup` is necessary. If this is not standardized then users have to write it. This is extra unneeded work which we can easily eliminate.
- The Fortran binding is not trivial to write (it will depend on details of the Fortran compilation system), and will not be portable. Therefore it should be in the library rather than in user code.

(*End of rationale.*)

*Advice to users.* The above definition means that it is safe simply to print the string returned by `MPI_COMM_GET_NAME`, as it is always a valid string even if there was no name.

Note that associating a name with a communicator has no effect on the semantics of an MPI program, and will (necessarily) increase the store requirement of the program, since the names must be saved. Therefore there is no requirement that users use these functions to associate names with communicators. However debugging and profiling MPI applications may be made easier if names are associated with communicators, since the debugger or profiler should then be able to present information in a less cryptic manner. (*End of advice to users.*)

The following functions are used for setting and getting names of datatypes. The constant `MPI_MAX_OBJECT_NAME` also applies to these names.

`MPI_TYPE_SET_NAME(datatype, type_name)`

INOUT	datatype	datatype whose identifier is to be set (handle)
IN	type_name	the character string which is remembered as the name (string)

### C binding

```
int MPI_Type_set_name(MPI_Datatype datatype, const char *type_name)
```

### Fortran 2008 binding

```
MPI_Type_set_name(datatype, type_name, ierror)
  TYPE(MPI_Datatype), INTENT(IN) :: datatype
  CHARACTER(LEN=*), INTENT(IN) :: type_name
  INTEGER, OPTIONAL, INTENT(OUT) :: ierror
```

### Fortran binding

```
MPI_TYPE_SET_NAME(DATATYPE, TYPE_NAME, IERROR)
  INTEGER DATATYPE, IERROR
  CHARACTER*(*) TYPE_NAME
```

MPI\_TYPE\_GET\_NAME(datatype, type\_name, resultlen) 1

IN	datatype	datatype whose name is to be returned (handle) <span style="float: right;">2</span>
OUT	type_name	the name previously stored on the datatype, or an empty string if no such name exists (string) <span style="float: right;">3</span>
OUT	resultlen	length of returned name (integer) <span style="float: right;">4</span>

### C binding 5

```
int MPI_Type_get_name(MPI_Datatype datatype, char *type_name,
                    int *resultlen) 6
```

### Fortran 2008 binding 7

```
MPI_Type_get_name(datatype, type_name, resultlen, ierror) 8
  TYPE(MPI_Datatype), INTENT(IN) :: datatype 9
  CHARACTER(LEN=MPI_MAX_OBJECT_NAME), INTENT(OUT) :: type_name 10
  INTEGER, INTENT(OUT) :: resultlen 11
  INTEGER, OPTIONAL, INTENT(OUT) :: ierror 12
```

### Fortran binding 13

```
MPI_TYPE_GET_NAME(DATATYPE, TYPE_NAME, RESULTLEN, IERROR) 14
  INTEGER DATATYPE, RESULTLEN, IERROR 15
  CHARACTER*(*) TYPE_NAME 16
```

Named predefined datatypes have the default names of the datatype name. For example, MPI\_WCHAR has the default name of "MPI\_WCHAR". 17

The following functions are used for setting and getting names of windows. The constant MPI\_MAX\_OBJECT\_NAME also applies to these names. 18

MPI\_WIN\_SET\_NAME(win, win\_name) 19

INOUT	win	window whose identifier is to be set (handle) <span style="float: right;">20</span>
IN	win_name	the character string which is remembered as the name (string) <span style="float: right;">21</span>

### C binding 22

```
int MPI_Win_set_name(MPI_Win win, const char *win_name) 23
```

### Fortran 2008 binding 24

```
MPI_Win_set_name(win, win_name, ierror) 25
  TYPE(MPI_Win), INTENT(IN) :: win 26
  CHARACTER(LEN=*), INTENT(IN) :: win_name 27
  INTEGER, OPTIONAL, INTENT(OUT) :: ierror 28
```

### Fortran binding 29

```
MPI_WIN_SET_NAME(WIN, WIN_NAME, IERROR) 30
  INTEGER WIN, IERROR 31
  CHARACTER*(*) WIN_NAME 32
```

```

1 MPI_WIN_GET_NAME(win, win_name, resultlen)
2     IN        win                window whose name is to be returned (handle)
3
4     OUT       win_name           the name previously stored on the window, or an
5                                 empty string if no such name exists (string)
6
7     OUT       resultlen         length of returned name (integer)

```

**C binding**

```

9 int MPI_Win_get_name(MPI_Win win, char *win_name, int *resultlen)

```

**Fortran 2008 binding**

```

12 MPI_Win_get_name(win, win_name, resultlen, ierror)
13     TYPE(MPI_Win), INTENT(IN) :: win
14     CHARACTER(LEN=MPI_MAX_OBJECT_NAME), INTENT(OUT) :: win_name
15     INTEGER, INTENT(OUT) :: resultlen
16     INTEGER, OPTIONAL, INTENT(OUT) :: ierror

```

**Fortran binding**

```

18 MPI_WIN_GET_NAME(WIN, WIN_NAME, RESULTLEN, IERROR)
19     INTEGER WIN, RESULTLEN, IERROR
20     CHARACTER*(*) WIN_NAME

```

## 7.9 Formalizing the Loosely Synchronous Model

In this section, we make further statements about the loosely synchronous model, with particular attention to intra-communication.

### 7.9.1 Basic Statements

When a caller passes a communicator (that contains a context and group) to a callee, that communicator must be free of side effects throughout execution of the subprogram: there should be no active operations on that communicator that might involve the process. This provides one model in which libraries can be written, and work “safely.” For libraries so designated, the callee has permission to do whatever communication it likes with the communicator, and under the above guarantee knows that no other communications will interfere. Since we permit good implementations to create new communicators without synchronization (such as by preallocated contexts on communicators), this does not impose a significant overhead.

This form of safety is analogous to other common computer-science usages, such as passing a descriptor of an array to a library routine. The library routine has every right to expect such a descriptor to be valid and modifiable.

### 7.9.2 Models of Execution

In the loosely synchronous model, transfer of control to a **parallel procedure** is effected by having each executing process invoke the procedure. The invocation is a collective operation: it is executed by all processes in the execution group, and invocations are similarly ordered at all processes. However, the invocation need not be synchronized.

We say that a parallel procedure is *active* in a process if the process belongs to a group that may collectively execute the procedure, and some member of that group is currently executing the procedure code. If a parallel procedure is active in a process, then this process may be receiving messages pertaining to this procedure, even if it does not currently execute the code of this procedure.

### Static Communicator Allocation

This covers the case where, at any point in time, at most one invocation of a parallel procedure can be active at any process, and the group of executing processes is fixed. For example, all invocations of parallel procedures involve all processes, processes are single-threaded, and there are no recursive invocations.

In such a case, a communicator can be statically allocated to each procedure. The static allocation can be done in a preamble, as part of initialization code. If the parallel procedures can be organized into libraries, so that only one procedure of each library can be concurrently active in each processor, then it is sufficient to allocate one communicator per library.

### Dynamic Communicator Allocation

Calls of parallel procedures are well-nested if a new parallel procedure is always invoked in a subset of a group executing the same parallel procedure. Thus, processes that execute the same parallel procedure have the same execution stack.

In such a case, a new communicator needs to be dynamically allocated for each new invocation of a parallel procedure. The allocation is done by the caller. A new communicator can be generated by a call to `MPI_COMM_DUP`, if the callee execution group is identical to the caller execution group, or by a call to `MPI_COMM_SPLIT` if the caller execution group is split into several subgroups executing distinct parallel routines. The new communicator is passed as an argument to the invoked routine.

The need for generating a new communicator at each invocation can be alleviated or avoided altogether in some cases: If the execution group is not split, then one can allocate a stack of communicators in a preamble, and next manage the stack in a way that mimics the stack of recursive calls.

One can also take advantage of the well-ordering property of communication to avoid confusing caller and callee communication, even if both use the same communicator. To do so, one needs to abide by the following two rules:

- messages sent before a procedure call (or before a return from the procedure) are also received before the matching call (or return) at the receiving end;
- messages are always selected by source (no use is made of `MPI_ANY_SOURCE`).

### The General Case

In the general case, there may be multiple concurrently active invocations of the same parallel procedure within the same group; invocations may not be well-nested. A new communicator needs to be created for each invocation. It is the user's responsibility to make sure that, should two distinct parallel procedures be invoked concurrently on overlapping sets of processes, communicator creation is properly coordinated.

1  
2  
3  
4  
5  
6  
7  
8  
9  
10  
11  
12  
13  
14  
15  
16  
17  
18  
19  
20  
21  
22  
23  
24  
25  
26  
27  
28  
29  
30  
31  
32  
33  
34  
35  
36  
37  
38  
39  
40  
41  
42  
43  
44  
45  
46  
47  
48

DRAFT

1  
2  
3  
4  
5  
6  
7  
8  
9  
10  
11  
12  
13  
14  
15  
16  
17  
18  
19  
20  
21  
22  
23  
24  
25  
26  
27  
28  
29  
30  
31  
32  
33  
34  
35  
36  
37  
38  
39  
40  
41  
42  
43  
44  
45  
46  
47  
48

# Chapter 8

## Process Topologies

### 8.1 Introduction

This chapter discusses the MPI topology mechanism. A topology is an extra, optional attribute that one can give to an intra-communicator; topologies cannot be added to inter-communicators. A topology can provide a convenient naming mechanism for the processes of a group (within a communicator), and additionally, may assist the runtime system in mapping the processes onto hardware.

As stated in Chapter 7, a process group in MPI is a collection of  $n$  processes. Each process in the group is assigned a rank between 0 and  $n-1$ . In many parallel applications a linear ranking of processes does not adequately reflect the logical communication pattern of the processes (which is usually determined by the underlying problem geometry and the numerical algorithm used). Often the processes are arranged in topological patterns such as two- or three-dimensional grids. More generally, the logical process arrangement is described by a graph. In this chapter we will refer to this logical process arrangement as the “virtual topology.”

A clear distinction must be made between the virtual process topology and the topology of the underlying, physical hardware. The virtual topology can be exploited by the system in the assignment of processes to physical processors, if this helps to improve the communication performance on a given machine. How this mapping is done, however, is outside the scope of MPI. The description of the virtual topology, on the other hand, depends only on the application, and is machine-independent. The functions that are described in this chapter deal with machine-independent mapping and communication on virtual process topologies.

*Rationale.* Though physical mapping is not discussed, the existence of the virtual topology information may be used as advice by the runtime system. There are well-known techniques for mapping grid/torus structures to hardware topologies such as hypercubes or grids. For more complicated graph structures good heuristics often yield nearly optimal results [49]. On the other hand, if there is no way for the user to specify the logical process arrangement as a “virtual topology,” a random mapping is most likely to result. On some machines, this will lead to unnecessary contention in the interconnection network. Some details about predicted and measured performance improvements that result from good process-to-processor mapping on modern wormhole-routing architectures can be found in [12, 13].

Besides possible performance benefits, the virtual topology can function as a convenient, process-naming structure, with significant benefits for program readability and notational power in message-passing programming. (*End of rationale.*)

## 8.2 Virtual Topologies

The communication pattern of a set of processes can be represented by a graph. The nodes represent processes, and the edges connect processes that communicate with each other. MPI provides message-passing between any pair of processes in a group. There is no requirement for opening a channel explicitly. Therefore, a “missing link” in the user-defined process graph does not prevent the corresponding processes from exchanging messages. It means rather that this connection is neglected in the virtual topology. This strategy implies that the topology gives no convenient way of naming this pathway of communication. Another possible consequence is that an automatic mapping tool (if one exists for the runtime environment) will not take account of this edge when mapping.

Specifying the virtual topology in terms of a graph is sufficient for all applications. However, in many applications the graph structure is regular, and the detailed set-up of the graph would be inconvenient for the user and might be less efficient at run time. A large fraction of all parallel applications use process topologies like rings, two- or higher-dimensional grids, or tori. These structures are completely defined by the number of dimensions and the numbers of processes in each coordinate direction. Also, the mapping of grids and tori is generally an easier problem than that of general graphs. Thus, it is desirable to address these cases explicitly.

Process coordinates in a Cartesian structure begin their numbering at 0. Row-major numbering is always used for the processes in a Cartesian structure. This means that, for example, the relation between group rank and coordinates for four processes in a  $(2 \times 2)$  grid is as follows.

coord (0,0):	rank 0
coord (0,1):	rank 1
coord (1,0):	rank 2
coord (1,1):	rank 3

## 8.3 Embedding in MPI

The support for virtual topologies as defined in this chapter is consistent with other parts of MPI, and, whenever possible, makes use of functions that are defined elsewhere. Topology information is associated with communicators. It is added to communicators using the caching mechanism described in Chapter 7.

Information representing an MPI virtual topology may be added to a communicator at the time of its creation. If a communicator creation function adds information representing an MPI virtual topology to the output communicator it creates, then it either propagates the topology representation from the input communicator to the output communicator, or adds a new topology representation generated from the input parameters that describe a virtual topology. The description of every MPI communicator creation function explicitly states how topology information is handled. Communicator creation functions that create new topology representations are described in Section 8.5.



## 8.4 Overview of the Functions

MPI supports three topology types: **Cartesian**, **graph**, and **distributed graph**. The function `MPI_CART_CREATE` can be used to create Cartesian topologies, the function `MPI_GRAPH_CREATE` can be used to create graph topologies, and the functions `MPI_DIST_GRAPH_CREATE_ADJACENT` and `MPI_DIST_GRAPH_CREATE` can be used to create distributed graph topologies. These topology creation functions are collective. As with other collective calls, the program must be written to work correctly, whether the call synchronizes or not.

The above topology creation functions take as input an existing communicator `comm_old`, which defines the set of processes on which the topology is to be mapped. For `MPI_GRAPH_CREATE` and `MPI_CART_CREATE`, all input arguments must have identical values on all processes of the group of `comm_old`. When calling `MPI_GRAPH_CREATE`, each process specifies all nodes and edges in the graph. In contrast, the functions `MPI_DIST_GRAPH_CREATE_ADJACENT` or `MPI_DIST_GRAPH_CREATE` are used to specify the graph in a distributed fashion, whereby each process only specifies a subset of the edges in the graph such that the entire graph structure is defined collectively across the set of processes. Therefore the processes provide different values for the arguments specifying the graph. However, all processes must give the same value for `reorder` and the `info` argument. In all cases, a new communicator `comm_topol` is created that carries the topological structure as cached information (see Chapter 7). In analogy to function `MPI_COMM_CREATE`, no cached information propagates from `comm_old` to `comm_topol`.

`MPI_CART_CREATE` can be used to describe Cartesian structures of arbitrary dimension. For each coordinate direction one specifies whether the process structure is periodic or not. Note that an  $n$ -dimensional hypercube is an  $n$ -dimensional torus with 2 processes per coordinate direction. Thus, special support for hypercube structures is not necessary. The local auxiliary function `MPI_DIMS_CREATE` can be used to compute a balanced distribution of processes among a given number of dimensions.

MPI defines functions to query a communicator for topology information. The function `MPI_TOPO_TEST` is used to query for the type of topology associated with a communicator. Depending on the topology type, different information can be extracted. For a graph topology, the functions `MPI_GRAPHDIMS_GET` and `MPI_GRAPH_GET` retrieve the graph-topology information that is associated with the communicator. Additionally, the functions `MPI_GRAPH_NEIGHBORS_COUNT` and `MPI_GRAPH_NEIGHBORS` can be used to obtain the neighbors of an arbitrary node in the graph. For a distributed graph topology, the functions `MPI_DIST_GRAPH_NEIGHBORS_COUNT` and `MPI_DIST_GRAPH_NEIGHBORS` can be used to obtain the neighbors of the calling process. For a Cartesian topology, the function `MPI_CARTDIM_GET` returns the number of dimensions and `MPI_CART_GET` returns the numbers of MPI processes in each dimension and periodicity of the associated Cartesian topology. Additionally, the functions `MPI_CART_RANK` and `MPI_CART_COORDS` translate Cartesian coordinates into a group rank, and vice-versa. The function `MPI_CART_SHIFT` provides the information needed to communicate with neighbors along a Cartesian dimension. All of these query functions are local.

For Cartesian topologies, the function `MPI_CART_SUB` can be used to extract a Cartesian subspace (analogous to `MPI_COMM_SPLIT`). This function is collective over the input communicator's group.

The two additional functions, `MPI_GRAPH_MAP` and `MPI_CART_MAP`, are, in general, not called by the user directly. However, together with the communicator manipulation

functions presented in Chapter 7, they are sufficient to implement all other topology functions. Section 8.5.8 outlines such an implementation.

The neighborhood collective communication routines `MPI_NEIGHBOR_ALLGATHER`, `MPI_NEIGHBOR_ALLGATHERV`, `MPI_NEIGHBOR_ALLTOALL`, `MPI_NEIGHBOR_ALLTOALLV`, and `MPI_NEIGHBOR_ALLTOALLW` communicate with the nearest neighbors on the topology associated with the communicator. The nonblocking variants are `MPI_INEIGHBOR_ALLGATHER`, `MPI_INEIGHBOR_ALLGATHERV`, `MPI_INEIGHBOR_ALLTOALL`, `MPI_INEIGHBOR_ALLTOALLV`, and `MPI_INEIGHBOR_ALLTOALLW`.

## 8.5 Topology Constructors

### 8.5.1 Cartesian Constructor

<code>MPI_CART_CREATE(comm_old, ndims, dims, periods, reorder, comm_cart)</code>	
IN	<code>comm_old</code> input communicator (handle)
IN	<code>ndims</code> number of dimensions of Cartesian grid (integer)
IN	<code>dims</code> integer array of size <code>ndims</code> specifying the number of processes in each dimension
IN	<code>periods</code> logical array of size <code>ndims</code> specifying whether the grid is periodic ( <code>true</code> ) or not ( <code>false</code> ) in each dimension
IN	<code>reorder</code> ranking may be reordered ( <code>true</code> ) or not ( <code>false</code> ) (logical)
OUT	<code>comm_cart</code> communicator with new Cartesian topology (handle)

#### C binding

```
int MPI_Cart_create(MPI_Comm comm_old, int ndims, const int dims[],
                   const int periods[], int reorder, MPI_Comm *comm_cart)
```

#### Fortran 2008 binding

```
MPI_Cart_create(comm_old, ndims, dims, periods, reorder, comm_cart, ierror)
  TYPE(MPI_Comm), INTENT(IN) :: comm_old
  INTEGER, INTENT(IN) :: ndims, dims(ndims)
  LOGICAL, INTENT(IN) :: periods(ndims), reorder
  TYPE(MPI_Comm), INTENT(OUT) :: comm_cart
  INTEGER, OPTIONAL, INTENT(OUT) :: ierror
```

#### Fortran binding

```
MPI_CART_CREATE(COMM_OLD, NDIMS, DIMS, PERIODS, REORDER, COMM_CART, IERROR)
  INTEGER COMM_OLD, NDIMS, DIMS(*), COMM_CART, IERROR
  LOGICAL PERIODS(*), REORDER
```

`MPI_CART_CREATE` returns a handle to a new communicator to which the Cartesian topology information is attached. If `reorder = false` then the rank of each process in the new group is identical to its rank in the old group. Otherwise, the function may reorder

the processes (possibly so as to choose a good embedding of the virtual topology onto the physical machine). If the total size of the Cartesian grid is smaller than the size of the group of `comm_old`, then some processes are returned `MPI_COMM_NULL`, in analogy to `MPI_COMM_SPLIT`. If `ndims` is zero then a zero-dimensional Cartesian topology is created. The call is erroneous if it specifies a grid that is larger than the group size or if `ndims` is negative. `MPI_CART_CREATE` will associate information representing a Cartesian topology with the specified number of dimensions, numbers of MPI processes in each coordinate direction, and periodicity with the new communicator.

### 8.5.2 Cartesian Convenience Function: `MPI_DIMS_CREATE`

For Cartesian topologies, the function `MPI_DIMS_CREATE` helps the user select a balanced distribution of processes per coordinate direction, depending on the number of processes in the group to be balanced and optional constraints that can be specified by the user. One use is to partition all the processes (the size of `MPI_COMM_WORLD`'s group) into an  $n$ -dimensional topology.

`MPI_DIMS_CREATE`(`nnodes`, `ndims`, `dims`)

IN	<code>nnodes</code>	number of nodes in a grid (integer)
IN	<code>ndims</code>	number of Cartesian dimensions (integer)
INOUT	<code>dims</code>	integer array of size <code>ndims</code> specifying the number of nodes in each dimension

#### C binding

```
int MPI_Dims_create(int nnodes, int ndims, int dims[])
```

#### Fortran 2008 binding

```
MPI_Dims_create(nnodes, ndims, dims, ierror)
  INTEGER, INTENT(IN) :: nnodes, ndims
  INTEGER, INTENT(INOUT) :: dims(ndims)
  INTEGER, OPTIONAL, INTENT(OUT) :: ierror
```

#### Fortran binding

```
MPI_DIMS_CREATE(NNODES, NDIMS, DIMS, IERROR)
  INTEGER NNODES, NDIMS, DIMS(*), IERROR
```

The entries in the array `dims` are set to describe a Cartesian grid with `ndims` dimensions and a total of `nnodes` nodes. The dimensions are set to be as close to each other as possible, using an appropriate divisibility algorithm. The caller may further constrain the operation of this routine by specifying elements of array `dims`. If `dims[i]` is set to a positive number, the routine will not modify the number of nodes in dimension  $i$ ; only those entries where `dims[i] = 0` are modified by the call.

Negative input values of `dims[i]` are erroneous. An error will occur if `nnodes` is not a multiple of

$$\prod_{i, \text{dims}[i] \neq 0} \text{dims}[i].$$

For `dims[i]` set by the call, `dims[i]` will be ordered in non-increasing order. Array `dims` is suitable for use as input to routine `MPI_CART_CREATE`. `MPI_DIMS_CREATE` is local. If `ndims` is zero and `nnodes` is one, `MPI_DIMS_CREATE` returns `MPI_SUCCESS`.

### Example 8.1

dims before call	function call	dims on return
(0,0)	<code>MPI_DIMS_CREATE(6, 2, dims)</code>	(3,2)
(0,0)	<code>MPI_DIMS_CREATE(7, 2, dims)</code>	(7,1)
(0,3,0)	<code>MPI_DIMS_CREATE(6, 3, dims)</code>	(2,3,1)
(0,3,0)	<code>MPI_DIMS_CREATE(7, 3, dims)</code>	erroneous call

### 8.5.3 Graph Constructor

`MPI_GRAPH_CREATE(comm_old, nnodes, index, edges, reorder, comm_graph)`

IN	<code>comm_old</code>	input communicator (handle)
IN	<code>nnodes</code>	number of nodes in graph (integer)
IN	<code>index</code>	array of integers describing node degrees (see below)
IN	<code>edges</code>	array of integers describing graph edges (see below)
IN	<code>reorder</code>	ranking may be reordered (true) or not (false) (logical)
OUT	<code>comm_graph</code>	communicator with graph topology added (handle)

#### C binding

```
int MPI_Graph_create(MPI_Comm comm_old, int nnodes, const int index[],
                    const int edges[], int reorder, MPI_Comm *comm_graph)
```

#### Fortran 2008 binding

```
MPI_Graph_create(comm_old, nnodes, index, edges, reorder, comm_graph,
                 ierror)
    TYPE(MPI_Comm), INTENT(IN) :: comm_old
    INTEGER, INTENT(IN) :: nnodes, index(nnodes), edges(*)
    LOGICAL, INTENT(IN) :: reorder
    TYPE(MPI_Comm), INTENT(OUT) :: comm_graph
    INTEGER, OPTIONAL, INTENT(OUT) :: ierror
```

#### Fortran binding

```
MPI_GRAPH_CREATE(COMM_OLD, NNODES, INDEX, EDGES, REORDER, COMM_GRAPH,
                 IERROR)
    INTEGER COMM_OLD, NNODES, INDEX(*), EDGES(*), COMM_GRAPH, IERROR
    LOGICAL REORDER
```

`MPI_GRAPH_CREATE` returns a handle to a new communicator to which the graph topology information is attached. If `reorder = false` then the rank of each process in the new group is identical to its rank in the old group. Otherwise, the function may reorder the

processes. If the size, `nnodes`, of the graph is smaller than the size of the group of `comm_old`, then some processes are returned `MPI_COMM_NULL`, in analogy to `MPI_CART_CREATE` and `MPI_COMM_SPLIT`. If the graph is empty, i.e., `nnodes == 0`, then `MPI_COMM_NULL` is returned in all processes. The call is erroneous if it specifies a graph that is larger than the group size of the input communicator.

The three parameters `nnodes`, `index` and `edges` define the graph structure. `nnodes` is the number of nodes of the graph. The nodes are numbered from 0 to `nnodes-1`. The  $i$ -th entry of array `index` stores the total number of neighbors of the first  $i$  graph nodes. The lists of neighbors of nodes 0, 1, ..., `nnodes-1` are stored in consecutive locations in array `edges`. The array `edges` is a flattened representation of the edge lists. The total number of entries in `index` is `nnodes` and the total number of entries in `edges` is equal to the number of graph edges.

The definitions of the arguments `nnodes`, `index`, and `edges` are illustrated with the following simple example.

**Example 8.2** Assume there are four processes 0, 1, 2, 3 with the following adjacency matrix:

process	neighbors
0	1, 3
1	0
2	3
3	0, 2

Then, the input arguments are:

```
nnodes = 4
index = 2, 3, 4, 6
edges = 1, 3, 0, 3, 0, 2
```

Thus, in C, `index[0]` is the degree of node zero, and `index[i] - index[i-1]` is the degree of node  $i$ ,  $i=1, \dots, \text{nnodes}-1$ ; the list of neighbors of node zero is stored in `edges[j]`, for  $0 \leq j \leq \text{index}[0] - 1$  and the list of neighbors of node  $i$ ,  $i > 0$ , is stored in `edges[j]`,  $\text{index}[i-1] \leq j \leq \text{index}[i] - 1$ .

In Fortran, `index(1)` is the degree of node zero, and `index(i+1) - index(i)` is the degree of node  $i$ ,  $i=1, \dots, \text{nnodes}-1$ ; the list of neighbors of node zero is stored in `edges(j)`, for  $1 \leq j \leq \text{index}(1)$  and the list of neighbors of node  $i$ ,  $i > 0$ , is stored in `edges(j)`,  $\text{index}(i)+1 \leq j \leq \text{index}(i+1)$ .

A single process is allowed to be defined multiple times in the list of neighbors of a process (i.e., there may be multiple edges between two processes). A process is also allowed to be a neighbor to itself (i.e., a self loop in the graph). The adjacency matrix is allowed to be non-symmetric.

*Advice to users.* Performance implications of using multiple edges or a non-symmetric adjacency matrix are not defined. The definition of a node-neighbor edge does not imply a direction of the communication. (*End of advice to users.*)

*Advice to implementors.* The following topology information is likely to be stored with a communicator:

- 1       • Type of topology (Cartesian/graph),
- 2       • For a Cartesian topology:
- 3           1. `ndims` (number of dimensions),
- 4           2. `dims` (numbers of processes per coordinate direction),
- 5           3. `periods` (periodicity information),
- 6           4. `own_position` (own position in grid, could also be computed from rank and
- 7                `dims`)
- 8       • For a graph topology:
- 9           1. `index`,
- 10          2. `edges`,
- 11                which are the vectors defining the graph structure.
- 12
- 13
- 14

15       For a graph structure the number of nodes is equal to the number of processes in  
16       the group. Therefore, the number of nodes does not have to be stored explicitly.  
17       An additional zero entry at the start of array `index` simplifies access to the topology  
18       information. (*End of advice to implementors.*)

#### 19

#### 20 8.5.4 Distributed Graph Constructor

21       MPI\_GRAPH\_CREATE requires that each process passes the full (global) communication  
22       graph to the call. This limits the scalability of this constructor. With the distributed graph  
23       interface, the communication graph is specified in a fully distributed fashion. Each process  
24       specifies only the part of the communication graph of which it is aware. Typically, this  
25       could be the set of processes from which the process will eventually receive or get data,  
26       or the set of processes to which the process will send or put data, or some combination of  
27       such edges. Two different interfaces can be used to create a distributed graph topology.  
28       MPI\_DIST\_GRAPH\_CREATE\_ADJACENT creates a distributed graph communicator with  
29       each process specifying each of its incoming and outgoing (adjacent) edges in the logical  
30       communication graph and thus requires minimal communication during creation.

31       MPI\_DIST\_GRAPH\_CREATE provides full flexibility such that any process can indicate that  
32       communication will occur between any pair of processes in the graph.

33       To provide better possibilities for optimization by the MPI library, the distributed  
34       graph constructors permit weighted communication edges and take an `info` argument that  
35       can further influence process reordering or other optimizations performed by the MPI library.  
36       For example, hints can be provided on how edge weights are to be interpreted, the quality  
37       of the reordering, and/or the time permitted for the MPI library to process the graph.  
38

MPI_DIST_GRAPH_CREATE_ADJACENT(comm_old, indegree, sources, sourceweights,			1
outdegree, destinations, destweights, info, reorder, comm_dist_graph)			2
IN	comm_old	input communicator (handle)	3
IN	indegree	size of sources and sourceweights arrays (non-negative integer)	4
IN	sources	ranks of processes for which the calling process is a destination (array of non-negative integers)	5
IN	sourceweights	weights of the edges into the calling process (array of non-negative integers)	6
IN	outdegree	size of destinations and destweights arrays (non-negative integer)	7
IN	destinations	ranks of processes for which the calling process is a source (array of non-negative integers)	8
IN	destweights	weights of the edges out of the calling process (array of non-negative integers)	9
IN	info	hints on optimization and interpretation of weights (handle)	10
IN	reorder	the ranks may be reordered (true) or not (false) (logical)	11
OUT	comm_dist_graph	communicator with distributed graph topology (handle)	12

**C binding**

```

int MPI_Dist_graph_create_adjacent(MPI_Comm comm_old, int indegree,
    const int sources[], const int sourceweights[], int outdegree,
    const int destinations[], const int destweights[],
    MPI_Info info, int reorder, MPI_Comm *comm_dist_graph)

```

**Fortran 2008 binding**

```

MPI_Dist_graph_create_adjacent(comm_old, indegree, sources, sourceweights,
    outdegree, destinations, destweights, info, reorder,
    comm_dist_graph, ierror)
TYPE(MPI_Comm), INTENT(IN) :: comm_old
INTEGER, INTENT(IN) :: indegree, sources(indegree), sourceweights(*),
    outdegree, destinations(outdegree), destweights(*)
TYPE(MPI_Info), INTENT(IN) :: info
LOGICAL, INTENT(IN) :: reorder
TYPE(MPI_Comm), INTENT(OUT) :: comm_dist_graph
INTEGER, OPTIONAL, INTENT(OUT) :: ierror

```

**Fortran binding**

```

MPI_DIST_GRAPH_CREATE_ADJACENT(COMM_OLD, INDEGREE, SOURCES, SOURCEWEIGHTS,
    OUTDEGREE, DESTINATIONS, DESTWEIGHTS, INFO, REORDER,
    COMM_DIST_GRAPH, IERROR)

```

```

1     INTEGER COMM_OLD, INDEGREE, SOURCES(*), SOURCEWEIGHTS(*), OUTDEGREE,
2         DESTINATIONS(*), DESTWEIGHTS(*), INFO, COMM_DIST_GRAPH,
3         IERROR
4     LOGICAL REORDER

```

MPI\_DIST\_GRAPH\_CREATE\_ADJACENT returns a handle to a new communicator to which the distributed graph topology information is attached. Each process passes all information about its incoming and outgoing edges in the virtual distributed graph topology. The calling processes must ensure that each edge of the graph is described in the source and in the destination process with the same weights. If there are multiple edges for a given (source,dest) pair, then the sequence of the weights of these edges does not matter. The complete communication topology is the combination of all edges shown in the sources arrays of all processes in comm\_old, which must be identical to the combination of all edges shown in the destinations arrays. Source and destination ranks must be process ranks of comm\_old. This allows a fully distributed specification of the communication graph. Isolated processes (i.e., processes with no outgoing or incoming edges, that is, processes that have specified indegree and outdegree as zero and thus do not occur as source or destination rank in the graph specification) are allowed.

The call creates a new communicator comm\_dist\_graph of distributed graph topology type to which topology information has been attached. The number of processes in comm\_dist\_graph is identical to the number of processes in comm\_old. The call to MPI\_DIST\_GRAPH\_CREATE\_ADJACENT is collective.

Weights are specified as non-negative integers and can be used to influence the process remapping strategy and other internal MPI optimizations. For instance, approximate count arguments of later communication calls along specific edges could be used as their edge weights. Multiplicity of edges can likewise indicate more intense communication between pairs of processes. However, the exact meaning of edge weights is not specified by the MPI standard and is left to the implementation. In C or Fortran, an application can supply the special value MPI\_UNWEIGHTED for the weight array to indicate that all edges have the same (effectively no) weight. It is erroneous to supply MPI\_UNWEIGHTED for some but not all processes of comm\_old. If the graph is weighted but indegree or outdegree is zero, then MPI\_WEIGHTS\_EMPTY or any arbitrary array may be passed to sourceweights or destweights respectively. Note that MPI\_UNWEIGHTED and MPI\_WEIGHTS\_EMPTY are not special weight values; rather they are special values for the total array argument. In Fortran, MPI\_UNWEIGHTED and MPI\_WEIGHTS\_EMPTY are objects like MPI\_BOTTOM (not usable for initialization or assignment). See Section 2.5.4.

*Advice to users.* In the case of an empty weights array argument passed while constructing a weighted graph, one should not pass NULL because the value of MPI\_UNWEIGHTED may be equal to NULL. The value of this argument would then be indistinguishable from MPI\_UNWEIGHTED to the implementation. In this case MPI\_WEIGHTS\_EMPTY should be used instead. (*End of advice to users.*)

*Advice to implementors.* It is recommended that MPI\_UNWEIGHTED not be implemented as NULL. (*End of advice to implementors.*)

*Rationale.* To ensure backward compatibility, MPI\_UNWEIGHTED may still be implemented as NULL. See Annex B.3. (*End of rationale.*)



The meaning of the `info` and `reorder` arguments is defined in the description of the following routine.

`MPI_DIST_GRAPH_CREATE(comm_old, n, sources, degrees, destinations, weights, info, reorder, comm_dist_graph)`

IN	<code>comm_old</code>	input communicator (handle)
IN	<code>n</code>	number of source nodes for which this process specifies edges (non-negative integer)
IN	<code>sources</code>	array containing the <code>n</code> source nodes for which this process specifies edges (array of non-negative integers)
IN	<code>degrees</code>	array specifying the number of destinations for each source node in the source node array (array of non-negative integers)
IN	<code>destinations</code>	destination nodes for the source nodes in the source node array (array of non-negative integers)
IN	<code>weights</code>	weights for source to destination edges (array of non-negative integers)
IN	<code>info</code>	hints on optimization and interpretation of weights (handle)
IN	<code>reorder</code>	the ranks may be reordered (true) or not (false) (logical)
OUT	<code>comm_dist_graph</code>	communicator with distributed graph topology added (handle)

#### C binding

```
int MPI_Dist_graph_create(MPI_Comm comm_old, int n, const int sources[],
    const int degrees[], const int destinations[],
    const int weights[], MPI_Info info, int reorder,
    MPI_Comm *comm_dist_graph)
```

#### Fortran 2008 binding

```
MPI_Dist_graph_create(comm_old, n, sources, degrees, destinations, weights,
    info, reorder, comm_dist_graph, ierror)
TYPE(MPI_Comm), INTENT(IN) :: comm_old
INTEGER, INTENT(IN) :: n, sources(n), degrees(n), destinations(*),
    weights(*)
TYPE(MPI_Info), INTENT(IN) :: info
LOGICAL, INTENT(IN) :: reorder
TYPE(MPI_Comm), INTENT(OUT) :: comm_dist_graph
INTEGER, OPTIONAL, INTENT(OUT) :: ierror
```

#### Fortran binding

```
MPI_DIST_GRAPH_CREATE(COMM_OLD, N, SOURCES, DEGREES, DESTINATIONS, WEIGHTS,
    INFO, REORDER, COMM_DIST_GRAPH, IERROR)
```

```

1     INTEGER COMM_OLD, N, SOURCES(*), DEGREES(*), DESTINATIONS(*),
2         WEIGHTS(*), INFO, COMM_DIST_GRAPH, IERROR
3     LOGICAL REORDER

```

MPI\_DIST\_GRAPH\_CREATE returns a handle to a new communicator to which the distributed graph topology information is attached. Concretely, each process calls the constructor with a set of directed (source,destination) communication edges as described below. Every process passes an array of  $n$  source nodes in the `sources` array. For each source node, a non-negative number of destination nodes is specified in the `degrees` array. The destination nodes are stored in the corresponding consecutive segment of the `destinations` array. More precisely, if the  $i$ -th node in `sources` is  $s$ , this specifies `degrees[i]` edges  $(s,d)$  with  $d$  of the  $j$ -th such edge stored in `destinations[degrees[0]+...+degrees[i-1]+j]`. The weight of this edge is stored in `weights[degrees[0]+...+degrees[i-1]+j]`. Both the `sources` and the `destinations` arrays may contain the same node more than once, and the order in which nodes are listed as destinations or sources is not significant. Similarly, different processes may specify edges with the same source and destination nodes. Source and destination nodes must be process ranks of `comm_old`. Different processes may specify different numbers of source and destination nodes, as well as different source to destination edges. This allows a fully distributed specification of the communication graph. Isolated processes (i.e., processes with no outgoing or incoming edges, that is, processes that do not occur as source or destination node in the graph specification) are allowed.

The call creates a new communicator `comm_dist_graph` of distributed graph topology type to which topology information has been attached. The number of processes in `comm_dist_graph` is identical to the number of processes in `comm_old`. The call to MPI\_DIST\_GRAPH\_CREATE is collective.

If `reorder = false`, all processes will have the same rank in `comm_dist_graph` as in `comm_old`. If `reorder = true` then the MPI library is free to remap to other processes (of `comm_old`) in order to improve communication on the edges of the communication graph. The weight associated with each edge is a hint to the MPI library about the amount or intensity of communication on that edge, and may be used to compute a “best” reordering.

Weights are specified as non-negative integers and can be used to influence the process remapping strategy and other internal MPI optimizations. For instance, approximate count arguments of later communication calls along specific edges could be used as their edge weights. Multiplicity of edges can likewise indicate more intense communication between pairs of processes. However, the exact meaning of edge weights is not specified by the MPI standard and is left to the implementation. In C or Fortran, an application can supply the special value `MPI_UNWEIGHTED` for the weight array to indicate that all edges have the same (effectively no) weight. It is erroneous to supply `MPI_UNWEIGHTED` for some but not all processes of `comm_old`. If the graph is weighted but  $n = 0$ , then `MPI_WEIGHTS_EMPTY` or any arbitrary array may be passed to `weights`. Note that `MPI_UNWEIGHTED` and `MPI_WEIGHTS_EMPTY` are not special weight values; rather they are special values for the total array argument. In Fortran, `MPI_UNWEIGHTED` and `MPI_WEIGHTS_EMPTY` are objects like `MPI_BOTTOM` (not usable for initialization or assignment). See Section 2.5.4.

*Advice to users.* In the case of an empty weights array argument passed while constructing a weighted graph, one should not pass `NULL` because the value of `MPI_UNWEIGHTED` may be equal to `NULL`. The value of this argument would then be indistinguishable from `MPI_UNWEIGHTED` to the implementation. `MPI_WEIGHTS_EMPTY` should be used instead. (*End of advice to users.*)

*Advice to implementors.* It is recommended that `MPI_UNWEIGHTED` not be implemented as `NULL`. (*End of advice to implementors.*)

*Rationale.* To ensure backward compatibility, `MPI_UNWEIGHTED` may still be implemented as `NULL`. See Annex B.3. (*End of rationale.*)

The meaning of the `weights` argument can be influenced by the `info` argument. `Info` arguments can be used to guide the mapping; possible options include minimizing the maximum number of edges between processes on different SMP nodes, or minimizing the sum of all such edges. An MPI implementation is not obliged to follow specific hints, and it is valid for an MPI implementation not to do any reordering. An MPI implementation may specify more `info` key-value pairs. All processes must specify the same set of key-value `info` pairs.

*Advice to implementors.* MPI implementations must document any additionally supported key-value `info` pairs. `MPI_INFO_NULL` is always valid, and may indicate the default creation of the distributed graph topology to the MPI library.

An implementation does not explicitly need to construct the topology from its distributed parts. However, all processes can construct the full topology from the distributed specification and use this in a call to `MPI_GRAPH_CREATE` to create the topology. This may serve as a reference implementation of the functionality, and may be acceptable for small communicators. However, a scalable high-quality implementation would save the topology graph in a distributed way. (*End of advice to implementors.*)

**Example 8.3** As for Example 8.2, assume there are four processes 0, 1, 2, 3 with the following adjacency matrix and unit edge weights:

process	neighbors
0	1, 3
1	0
2	3
3	0, 2

With `MPI_DIST_GRAPH_CREATE`, this graph could be constructed in many different ways. One way would be that each process specifies its outgoing edges. The arguments per process would be:

process	n	sources	degrees	destinations	weights
0	1	0	2	1,3	1,1
1	1	1	1	0	1
2	1	2	1	3	1
3	1	3	2	0,2	1,1

Another way would be to pass the whole graph on process 0, which could be done with the following arguments per process:

process	n	sources	degrees	destinations	weights
0	4	0,1,2,3	2,1,1,2	1,3,0,3,0,2	1,1,1,1,1,1
1	0	-	-	-	-
2	0	-	-	-	-
3	0	-	-	-	-

In both cases above, the application could supply `MPI_UNWEIGHTED` instead of explicitly providing identical weights.

`MPI_DIST_GRAPH_CREATE_ADJACENT` could be used to specify this graph using the following arguments:

process	indegree	sources	sourceweights	outdegree	destinations	destweights
0	2	1,3	1,1	2	1,3	1,1
1	1	0	1	1	0	1
2	1	3	1	1	3	1
3	2	0,2	1,1	2	0,2	1,1

**Example 8.4** A two-dimensional  $P \times Q$  torus where all processes communicate along the dimensions and along the diagonal edges. This cannot be modeled with Cartesian topologies, but can easily be captured with `MPI_DIST_GRAPH_CREATE` as shown in the following code. In this example, the communication along the dimensions is twice as heavy as the communication along the diagonals:

```

/*
Input:      dimensions P, Q
Condition:  number of processes equal to P*Q; otherwise only
            ranks smaller than P*Q participate
*/
int rank, x, y;
int sources[1], degrees[1];
int destinations[8], weights[8];
MPI_Comm comm_dist_graph;

MPI_Comm_rank(MPI_COMM_WORLD, &rank);

/* get x and y dimension */
y=rank/P; x=rank%P;

/* get my communication partners along x dimension */
destinations[0] = P*y+(x+1)%P; weights[0] = 2;
destinations[1] = P*y+(P+x-1)%P; weights[1] = 2;

/* get my communication partners along y dimension */
destinations[2] = P*((y+1)%Q)+x; weights[2] = 2;
destinations[3] = P*((Q+y-1)%Q)+x; weights[3] = 2;

/* get my communication partners along diagonals */
destinations[4] = P*((y+1)%Q)+(x+1)%P; weights[4] = 1;
destinations[5] = P*((Q+y-1)%Q)+(x+1)%P; weights[5] = 1;
destinations[6] = P*((y+1)%Q)+(P+x-1)%P; weights[6] = 1;
destinations[7] = P*((Q+y-1)%Q)+(P+x-1)%P; weights[7] = 1;

sources[0] = rank;
degrees[0] = 8;

```

```
MPI_Dist_graph_create(MPI_COMM_WORLD, 1, sources, degrees, destinations,
                    weights, MPI_INFO_NULL, 1, &comm_dist_graph);
```

### 8.5.5 Topology Inquiry Functions

If a topology has been defined with one of the above functions, then the topology information can be looked up using inquiry functions. They all are local calls.

**MPI\_TOPO\_TEST(comm, status)**

IN	comm	communicator (handle)
OUT	status	topology type of communicator comm (state)

#### C binding

```
int MPI_Topo_test(MPI_Comm comm, int *status)
```

#### Fortran 2008 binding

```
MPI_Topo_test(comm, status, ierror)
  TYPE(MPI_Comm), INTENT(IN) :: comm
  INTEGER, INTENT(OUT) :: status
  INTEGER, OPTIONAL, INTENT(OUT) :: ierror
```

#### Fortran binding

```
MPI_TOPO_TEST(COMM, STATUS, IERROR)
  INTEGER COMM, STATUS, IERROR
```

The function `MPI_TOPO_TEST` returns the type of topology that is assigned to a communicator.

The output value `status` is one of the following:

<code>MPI_GRAPH</code>	graph topology
<code>MPI_CART</code>	Cartesian topology
<code>MPI_DIST_GRAPH</code>	distributed graph topology
<code>MPI_UNDEFINED</code>	no topology

**MPI\_GRAPHDIMS\_GET(comm, nnodes, nedges)**

IN	comm	communicator for group with graph structure (handle)
OUT	nnodes	number of nodes in graph (same as number of processes in the group) (integer)
OUT	nedges	number of edges in graph (integer)

#### C binding

```
int MPI_Graphdims_get(MPI_Comm comm, int *nnodes, int *nedges)
```

#### Fortran 2008 binding

```
MPI_Graphdims_get(comm, nnodes, nedges, ierror)
```

```

1     TYPE(MPI_Comm), INTENT(IN) :: comm
2     INTEGER, INTENT(OUT) :: nnodes, nedges
3     INTEGER, OPTIONAL, INTENT(OUT) :: ierror

```

#### Fortran binding

```

4
5 MPI_GRAPHDIMS_GET(COMM, NNODES, NEDGES, IERROR)
6     INTEGER COMM, NNODES, NEDGES, IERROR
7

```

8 The functions `MPI_GRAPHDIMS_GET` and `MPI_GRAPH_GET` retrieve the graph-topology information that is associated with the communicator.

9 The information provided by `MPI_GRAPHDIMS_GET` can be used to dimension the vectors `index` and `edges` correctly for the following call to `MPI_GRAPH_GET`.

```

10
11 MPI_GRAPH_GET(comm, maxindex, maxedges, index, edges)
12
13
14 MPI_GRAPH_GET(comm, maxindex, maxedges, index, edges)
15     IN         comm                communicator with graph structure (handle)
16     IN         maxindex            length of vector index in the calling program (integer)
17     IN         maxedges           length of vector edges in the calling program (integer)
18     OUT        index              array of integers containing the graph structure (for
19                                     details see the definition of MPI_GRAPH_CREATE)
20
21     OUT        edges              array of integers containing the graph structure
22

```

#### C binding

```

23
24 int MPI_Graph_get(MPI_Comm comm, int maxindex, int maxedges, int index[],
25                 int edges[])
26

```

#### Fortran 2008 binding

```

27 MPI_Graph_get(comm, maxindex, maxedges, index, edges, ierror)
28     TYPE(MPI_Comm), INTENT(IN) :: comm
29     INTEGER, INTENT(IN) :: maxindex, maxedges
30     INTEGER, INTENT(OUT) :: index(maxindex), edges(maxedges)
31     INTEGER, OPTIONAL, INTENT(OUT) :: ierror
32

```

#### Fortran binding

```

33
34 MPI_GRAPH_GET(COMM, MAXINDEX, MAXEDGES, INDEX, EDGES, IERROR)
35     INTEGER COMM, MAXINDEX, MAXEDGES, INDEX(*), EDGES(*), IERROR
36

```

```

37
38 MPI_CARTDIM_GET(comm, ndims)
39

```

```

40     IN         comm                communicator with Cartesian structure (handle)
41     OUT        ndims              number of dimensions of the Cartesian structure
42                                     (integer)
43

```

#### C binding

```

44
45 int MPI_Cartdim_get(MPI_Comm comm, int *ndims)
46

```

#### Fortran 2008 binding

```

47 MPI_Cartdim_get(comm, ndims, ierror)
48

```

```

TYPE(MPI_Comm), INTENT(IN) :: comm
INTEGER, INTENT(OUT) :: ndims
INTEGER, OPTIONAL, INTENT(OUT) :: ierror

```

**Fortran binding**

```

MPI_CARTDIM_GET(COMM, NDIMS, IERROR)
INTEGER COMM, NDIMS, IERROR

```

The functions `MPI_CARTDIM_GET` and `MPI_CART_GET` return the Cartesian topology information that is associated with the communicator. If `comm` is associated with a zero-dimensional Cartesian topology, `MPI_CARTDIM_GET` returns `ndims = 0` and `MPI_CART_GET` will keep all output arguments unchanged.

```

MPI_CART_GET(comm, maxdims, dims, periods, coords)

```

IN	comm	communicator with Cartesian structure (handle)
IN	maxdims	length of vectors <code>dims</code> , <code>periods</code> , and <code>coords</code> in the calling program (integer)
OUT	dims	number of processes for each Cartesian dimension (array of integers)
OUT	periods	periodicity (true/false) for each Cartesian dimension (array of logicals)
OUT	coords	coordinates of calling process in Cartesian structure (array of integers)

**C binding**

```

int MPI_Cart_get(MPI_Comm comm, int maxdims, int dims[], int periods[],
                int coords[])

```

**Fortran 2008 binding**

```

MPI_Cart_get(comm, maxdims, dims, periods, coords, ierror)
TYPE(MPI_Comm), INTENT(IN) :: comm
INTEGER, INTENT(IN) :: maxdims
INTEGER, INTENT(OUT) :: dims(maxdims), coords(maxdims)
LOGICAL, INTENT(OUT) :: periods(maxdims)
INTEGER, OPTIONAL, INTENT(OUT) :: ierror

```

**Fortran binding**

```

MPI_CART_GET(COMM, MAXDIMS, DIMS, PERIODS, COORDS, IERROR)
INTEGER COMM, MAXDIMS, DIMS(*), COORDS(*), IERROR
LOGICAL PERIODS(*)

```

```

1 MPI_CART_RANK(comm, coords, rank)
2     IN      comm      communicator with Cartesian structure (handle)
3
4     IN      coords    integer array (of size ndims) specifying the Cartesian
5                          coordinates of a process
6
7     OUT     rank      rank of specified process (integer)

```

**C binding**

```

9 int MPI_Cart_rank(MPI_Comm comm, const int coords[], int *rank)

```

**Fortran 2008 binding**

```

12 MPI_Cart_rank(comm, coords, rank, ierror)
13     TYPE(MPI_Comm), INTENT(IN) :: comm
14     INTEGER, INTENT(IN) :: coords(*)
15     INTEGER, INTENT(OUT) :: rank
16     INTEGER, OPTIONAL, INTENT(OUT) :: ierror

```

**Fortran binding**

```

18 MPI_CART_RANK(COMM, COORDS, RANK, IERROR)
19     INTEGER COMM, COORDS(*), RANK, IERROR

```

For a communicator with an associated Cartesian topology, the function `MPI_CART_RANK` translates the logical process coordinates to process ranks as they are used by the point-to-point routines.

For dimension  $i$  with `periods(i) = true`, if the coordinate, `coords(i)`, is out of range, that is, `coords(i) < 0` or `coords(i) ≥ dims(i)`, it is shifted back to the interval  $0 ≤ \text{coords}(i) < \text{dims}(i)$  automatically. Out-of-range coordinates are erroneous for non-periodic dimensions.

If `comm` is associated with a zero-dimensional Cartesian topology, `coords` is not significant and 0 is returned in `rank`.

```

31 MPI_CART_COORDS(comm, rank, maxdims, coords)
32
33     IN      comm      communicator with Cartesian structure (handle)
34
35     IN      rank      rank of a process within group of comm (integer)
36
37     IN      maxdims   length of vector coords in the calling program
38                          (integer)
39
40     OUT     coords    integer array (of size maxdims) containing the
41                          Cartesian coordinates of specified process (array of
42                          integers)

```

**C binding**

```

43 int MPI_Cart_coords(MPI_Comm comm, int rank, int maxdims, int coords[])

```

**Fortran 2008 binding**

```

46 MPI_Cart_coords(comm, rank, maxdims, coords, ierror)
47     TYPE(MPI_Comm), INTENT(IN) :: comm
48     INTEGER, INTENT(IN) :: rank, maxdims

```



```

INTEGER, INTENT(OUT) :: coords(maxdims)
INTEGER, OPTIONAL, INTENT(OUT) :: ierror

```

**Fortran binding**

```

MPI_CART_COORDS(COMM, RANK, MAXDIMS, COORDS, IERROR)
  INTEGER COMM, RANK, MAXDIMS, COORDS(*), IERROR

```

The inverse mapping, rank-to-coordinates translation is provided by MPI\_CART\_COORDS.

If comm is associated with a zero-dimensional Cartesian topology, coords will be unchanged.

```

MPI_GRAPH_NEIGHBORS_COUNT(comm, rank, nneighbors)

```

IN	comm	communicator with graph topology (handle)
IN	rank	rank of process in group of comm (integer)
OUT	nneighbors	number of neighbors of specified process (integer)

**C binding**

```

int MPI_Graph_neighbors_count(MPI_Comm comm, int rank, int *nneighbors)

```

**Fortran 2008 binding**

```

MPI_Graph_neighbors_count(comm, rank, nneighbors, ierror)
  TYPE(MPI_Comm), INTENT(IN) :: comm
  INTEGER, INTENT(IN) :: rank
  INTEGER, INTENT(OUT) :: nneighbors
  INTEGER, OPTIONAL, INTENT(OUT) :: ierror

```

**Fortran binding**

```

MPI_GRAPH_NEIGHBORS_COUNT(COMM, RANK, NNEIGHBORS, IERROR)
  INTEGER COMM, RANK, NNEIGHBORS, IERROR

```

```

MPI_GRAPH_NEIGHBORS(comm, rank, maxneighbors, neighbors)

```

IN	comm	communicator with graph topology (handle)
IN	rank	rank of process in group of comm (integer)
IN	maxneighbors	size of array neighbors (integer)
OUT	neighbors	ranks of processes that are neighbors to specified process (array of integers)

**C binding**

```

int MPI_Graph_neighbors(MPI_Comm comm, int rank, int maxneighbors,
  int neighbors[])

```

**Fortran 2008 binding**

```

MPI_Graph_neighbors(comm, rank, maxneighbors, neighbors, ierror)
  TYPE(MPI_Comm), INTENT(IN) :: comm

```

```

1     INTEGER, INTENT(IN) :: rank, maxneighbors
2     INTEGER, INTENT(OUT) :: neighbors(maxneighbors)
3     INTEGER, OPTIONAL, INTENT(OUT) :: ierror

```

#### Fortran binding

```

5     MPI_GRAPH_NEIGHBORS(COMM, RANK, MAXNEIGHBORS, NEIGHBORS, IERROR)
6     INTEGER COMM, RANK, MAXNEIGHBORS, NEIGHBORS(*), IERROR

```

MPI\_GRAPH\_NEIGHBORS\_COUNT and MPI\_GRAPH\_NEIGHBORS provide adjacency information for a graph topology. The returned count and array of neighbors for the queried rank will both include *all* neighbors and reflect the same edge ordering as was specified by the original call to MPI\_GRAPH\_CREATE. Specifically, MPI\_GRAPH\_NEIGHBORS\_COUNT and MPI\_GRAPH\_NEIGHBORS will return values based on the original index and edges array passed to MPI\_GRAPH\_CREATE (for the purpose of this example, we assume that index[-1] is zero):

- The number of neighbors (nneighbors) returned from MPI\_GRAPH\_NEIGHBORS\_COUNT will be (index[rank] - index[rank-1]).
- The neighbors array returned from MPI\_GRAPH\_NEIGHBORS will be edges[index[rank-1]] through edges[index[rank]-1].

**Example 8.5** Assume there are four processes 0, 1, 2, 3 with the following adjacency matrix (note that some neighbors are listed multiple times):

process	neighbors
0	1, 1, 3
1	0, 0
2	3
3	0, 2, 2

Thus, the input arguments to MPI\_GRAPH\_CREATE are:

```

32     nnodes = 4
33     index = 3, 5, 6, 9
34     edges = 1, 1, 3, 0, 0, 3, 0, 2, 2

```

Therefore, calling MPI\_GRAPH\_NEIGHBORS\_COUNT and MPI\_GRAPH\_NEIGHBORS for each of the 4 processes will return:

Input rank	Count	Neighbors
0	3	1, 1, 3
1	2	0, 0
2	1	3
3	3	0, 2, 2

**Example 8.6** Suppose that comm is a communicator with a shuffle-exchange topology. The group has  $2^n$  members. Each process is labeled by  $a_1, \dots, a_n$  with  $a_i \in \{0, 1\}$ , and has three neighbors:  $\text{exchange}(a_1, \dots, a_n) = a_1, \dots, a_{n-1}, \bar{a}_n$  ( $\bar{a} = 1 - a$ ),  $\text{shuffle}(a_1, \dots, a_n) = a_2, \dots, a_n, a_1$ , and  $\text{unshuffle}(a_1, \dots, a_n) = a_n, a_1, \dots, a_{n-1}$ . The graph adjacency list is illustrated below for  $n = 3$ .

node	exchange neighbors(1)	shuffle neighbors(2)	unshuffle neighbors(3)
0 (000)	1	0	0
1 (001)	0	2	4
2 (010)	3	4	1
3 (011)	2	6	5
4 (100)	5	1	2
5 (101)	4	3	6
6 (110)	7	5	3
7 (111)	6	7	7

Suppose that the communicator `comm` has this topology associated with it. The following code fragment cycles through the three types of neighbors and performs an appropriate permutation for each.

```

! assume: each process has stored a real number A.
! extract neighborhood information
CALL MPI_COMM_RANK(comm, myrank, ierr)
CALL MPI_GRAPH_NEIGHBORS(comm, myrank, 3, neighbors, ierr)
! perform exchange permutation
CALL MPI_SENDRECV_REPLACE(A, 1, MPI_REAL, neighbors(1), 0, &
                        neighbors(1), 0, comm, status, ierr)
! perform shuffle permutation
CALL MPI_SENDRECV_REPLACE(A, 1, MPI_REAL, neighbors(2), 0, &
                        neighbors(3), 0, comm, status, ierr)
! perform unshuffle permutation
CALL MPI_SENDRECV_REPLACE(A, 1, MPI_REAL, neighbors(3), 0, &
                        neighbors(2), 0, comm, status, ierr)

```

`MPI_DIST_GRAPH_NEIGHBORS_COUNT` and `MPI_DIST_GRAPH_NEIGHBORS` provide adjacency information for a distributed graph topology.

`MPI_DIST_GRAPH_NEIGHBORS_COUNT(comm, indegree, outdegree, weighted)`

IN	<code>comm</code>	communicator with distributed graph topology (handle)
OUT	<code>indegree</code>	number of edges into this process (non-negative integer)
OUT	<code>outdegree</code>	number of edges out of this process (non-negative integer)
OUT	<code>weighted</code>	false if <code>MPI_UNWEIGHTED</code> was supplied during creation, true otherwise (logical)

### C binding

```

int MPI_Dist_graph_neighbors_count(MPI_Comm comm, int *indegree,
                                int *outdegree, int *weighted)

```

**Fortran 2008 binding**

```

1 MPI_Dist_graph_neighbors_count(comm, indegree, outdegree, weighted, ierror)
2   TYPE(MPI_Comm), INTENT(IN) :: comm
3   INTEGER, INTENT(OUT) :: indegree, outdegree
4   LOGICAL, INTENT(OUT) :: weighted
5   INTEGER, OPTIONAL, INTENT(OUT) :: ierror

```

**Fortran binding**

```

8 MPI_DIST_GRAPH_NEIGHBORS_COUNT(COMM, INDEGREE, OUTDEGREE, WEIGHTED, IERROR)
9   INTEGER COMM, INDEGREE, OUTDEGREE, IERROR
10  LOGICAL WEIGHTED

```

```

14 MPI_DIST_GRAPH_NEIGHBORS(comm, maxindegree, sources, sourceweights,
15   maxoutdegree, destinations, destweights)

```

16	IN	comm	communicator with distributed graph topology (handle)
17			
18	IN	maxindegree	size of sources and sourceweights arrays (non-negative integer)
19			
20			
21	OUT	sources	processes for which the calling process is a destination (array of non-negative integers)
22			
23	OUT	sourceweights	weights of the edges into the calling process (array of non-negative integers)
24			
25	IN	maxoutdegree	size of destinations and destweights arrays (non-negative integer)
26			
27			
28	OUT	destinations	processes for which the calling process is a source (array of non-negative integers)
29			
30	OUT	destweights	weights of the edges out of the calling process (array of non-negative integers)
31			
32			

**C binding**

```

34 int MPI_Dist_graph_neighbors(MPI_Comm comm, int maxindegree, int sources[],
35   int sourceweights[], int maxoutdegree, int destinations[],
36   int destweights[])

```

**Fortran 2008 binding**

```

39 MPI_Dist_graph_neighbors(comm, maxindegree, sources, sourceweights,
40   maxoutdegree, destinations, destweights, ierror)
41   TYPE(MPI_Comm), INTENT(IN) :: comm
42   INTEGER, INTENT(IN) :: maxindegree, maxoutdegree
43   INTEGER, INTENT(OUT) :: sources(maxindegree),
44   destinations(maxoutdegree)
45   INTEGER :: sourceweights(*), destweights(*)
46   INTEGER, OPTIONAL, INTENT(OUT) :: ierror

```

**Fortran binding**

```

MPI_DIST_GRAPH_NEIGHBORS(COMM, MAXINDEGREE, SOURCES, SOURCEWEIGHTS,
                          MAXOUTDEGREE, DESTINATIONS, DESTWEIGHTS, IERROR)
      INTEGER COMM, MAXINDEGREE, SOURCES(*), SOURCEWEIGHTS(*), MAXOUTDEGREE,
      DESTINATIONS(*), DESTWEIGHTS(*), IERROR

```

These calls are local. The number of edges into and out of the process returned by `MPI_DIST_GRAPH_NEIGHBORS_COUNT` are the total number of such edges given in the call to `MPI_DIST_GRAPH_CREATE_ADJACENT` or `MPI_DIST_GRAPH_CREATE` (potentially by processes other than the calling process in the case of `MPI_DIST_GRAPH_CREATE`). Multiply defined edges are all counted and returned by `MPI_DIST_GRAPH_NEIGHBORS` in some order. If `MPI_UNWEIGHTED` is supplied for sourceweights or destweights or both, or if `MPI_UNWEIGHTED` was supplied during the construction of the graph then no weight information is returned in that array or those arrays. If the communicator was created with `MPI_DIST_GRAPH_CREATE_ADJACENT` then for each rank in `comm`, the order of the values in `sources` and `destinations` is identical to the input that was used by the process with the same rank in `comm_old` in the creation call. If the communicator was created with `MPI_DIST_GRAPH_CREATE` then the only requirement on the order of values in `sources` and `destinations` is that two calls to the routine with same input argument `comm` will return the same sequence of edges. If `maxindegree` or `maxoutdegree` is smaller than the numbers returned by `MPI_DIST_GRAPH_NEIGHBORS_COUNT`, then only the first part of the full list is returned.

*Advice to implementors.* Since the query calls are defined to be local, each process needs to store the list of its neighbors with incoming and outgoing edges. Communication is required at the collective `MPI_DIST_GRAPH_CREATE` call in order to compute the neighbor lists for each process from the distributed graph specification. (*End of advice to implementors.*)

**8.5.6 Cartesian Shift Coordinates**

If the process topology is a Cartesian structure, an `MPI_SENDRECV` operation may be used along a coordinate direction to perform a shift of data. As input, `MPI_SENDRECV` takes the rank of a source process for the receive, and the rank of a destination process for the send. If the function `MPI_CART_SHIFT` is called for a Cartesian process group, it provides the calling process with the above identifiers, which then can be passed to `MPI_SENDRECV`. The user specifies the coordinate direction and the size of the step (positive or negative). The function is local.

```

1 MPI_CART_SHIFT(comm, direction, disp, rank_source, rank_dest)
2     IN      comm      communicator with Cartesian structure (handle)
3     IN      direction  coordinate dimension of shift (integer)
4     IN      disp      displacement (> 0: upwards shift, < 0: downwards
5                          shift) (integer)
6
7     OUT     rank_source rank of source process (integer)
8     OUT     rank_dest   rank of destination process (integer)
9

```

### C binding

```

12 int MPI_Cart_shift(MPI_Comm comm, int direction, int disp,
13                  int *rank_source, int *rank_dest)

```

### Fortran 2008 binding

```

15 MPI_Cart_shift(comm, direction, disp, rank_source, rank_dest, ierror)
16     TYPE(MPI_Comm), INTENT(IN) :: comm
17     INTEGER, INTENT(IN) :: direction, disp
18     INTEGER, INTENT(OUT) :: rank_source, rank_dest
19     INTEGER, OPTIONAL, INTENT(OUT) :: ierror
20

```

### Fortran binding

```

22 MPI_CART_SHIFT(COMM, DIRECTION, DISP, RANK_SOURCE, RANK_DEST, IERROR)
23     INTEGER COMM, DIRECTION, DISP, RANK_SOURCE, RANK_DEST, IERROR

```

The direction argument indicates the coordinate dimension to be traversed by the shift. The dimensions are numbered from 0 to `ndims-1`, where `ndims` is the number of dimensions.

Depending on the periodicity of the Cartesian group in the specified coordinate direction, `MPI_CART_SHIFT` provides the identifiers for a circular or an end-off shift. In the case of an end-off shift, the value `MPI_PROC_NULL` may be returned in `rank_source` or `rank_dest`, indicating that the source or the destination for the shift is out of range.

It is erroneous to call `MPI_CART_SHIFT` with a direction that is either negative or greater than or equal to the number of dimensions in the Cartesian communicator. This implies that it is erroneous to call `MPI_CART_SHIFT` with a `comm` that is associated with a zero-dimensional Cartesian topology.

**Example 8.7** The communicator, `comm`, has a two-dimensional, periodic, Cartesian topology associated with it. A two-dimensional array of `REALs` is stored one element per process, in variable `A`. One wishes to skew this array, by shifting column `i` (vertically, i.e., along the column) by `i` steps.

```

40 ...
41 ! find process rank
42 CALL MPI_COMM_RANK(comm, rank, ierr)
43 ! find Cartesian coordinates
44 CALL MPI_CART_COORDS(comm, rank, maxdims, coords, ierr)
45 ! compute shift source and destination
46 CALL MPI_CART_SHIFT(comm, 0, coords(2), source, dest, ierr)
47 ! skew array
48 CALL MPI_SENDRECV_REPLACE(A, 1, MPI_REAL, dest, 0, source, 0, comm, &

```

```
status, ierr)
```

*Advice to users.* In Fortran, the dimension indicated by `DIRECTION = i` has `DIMS(i+1)` nodes, where `DIMS` is the array that was used to create the grid. In C, the dimension indicated by `direction = i` is the dimension specified by `dims[i]`. (*End of advice to users.*)

### 8.5.7 Partitioning of Cartesian Structures

```
MPI_CART_SUB(comm, remain_dims, newcomm)
```

IN	comm	communicator with Cartesian structure (handle)
IN	remain_dims	the i-th entry of <code>remain_dims</code> specifies whether the i-th dimension is kept in the subgrid ( <code>true</code> ) or is dropped ( <code>false</code> ) (array of logicals)
OUT	newcomm	communicator containing the subgrid that includes the calling process (handle)

#### C binding

```
int MPI_Cart_sub(MPI_Comm comm, const int remain_dims[], MPI_Comm *newcomm)
```

#### Fortran 2008 binding

```
MPI_Cart_sub(comm, remain_dims, newcomm, ierror)
  TYPE(MPI_Comm), INTENT(IN) :: comm
  LOGICAL, INTENT(IN) :: remain_dims(*)
  TYPE(MPI_Comm), INTENT(OUT) :: newcomm
  INTEGER, OPTIONAL, INTENT(OUT) :: ierror
```

#### Fortran binding

```
MPI_CART_SUB(COMM, REMAIN_DIMS, NEWCOMM, IERROR)
  INTEGER COMM, NEWCOMM, IERROR
  LOGICAL REMAIN_DIMS(*)
```

`MPI_CART_SUB` can be used to partition the group associated with a communicator that has an associated Cartesian topology into subgroups that form lower-dimensional Cartesian subgrids, and to build for each subgroup a communicator with the associated subgrid Cartesian topology. The topologies of the new communicators describe the subgrids. The number of dimensions of the subgrids is the number of remaining dimensions, i.e., the number of true values in `remain_dims`. The numbers of MPI processes in each coordinate direction of the subgrids are the remaining numbers of MPI processes in each coordinate direction of the grid associated with the original communicator, i.e., the values of the original grid dimensions for which the corresponding entry in `remain_dims` is true. The periodicity for the remaining dimensions in the new communicator is preserved from the original communicator. If all entries in `remain_dims` are false or `comm` is already associated with a zero-dimensional Cartesian topology then `newcomm` is associated with a zero-dimensional Cartesian topology. (This function is closely related to `MPI_COMM_SPLIT`.)

**Example 8.8** Assume that `MPI_Cart_create(..., comm)` has defined a  $(2 \times 3 \times 4)$  grid. Let `remain_dims = (true, false, true)`. Then a call to

```
MPI_Cart_sub(comm, remain_dims, newcomm)
```

will create three communicators each with eight processes in a  $2 \times 4$  Cartesian topology. If `remain_dims = (false, false, true)` then the call to

```
MPI_Cart_sub(comm, remain_dims, newcomm)
```

will create six non-overlapping communicators, each with four processes, in a one-dimensional Cartesian topology.

### 8.5.8 Low-Level Topology Functions

The two additional functions introduced in this section can be used to implement all other topology functions. In general they will not be called by the user directly, unless he or she is creating additional virtual topology capability other than that provided by MPI. The two calls are both local.

```
MPI_CART_MAP(comm, ndims, dims, periods, newrank)
```

IN	comm	input communicator (handle)
IN	ndims	number of dimensions of Cartesian structure (integer)
IN	dims	integer array of size ndims specifying the number of processes in each coordinate direction
IN	periods	logical array of size ndims specifying the periodicity specification in each coordinate direction
OUT	newrank	reordered rank of the calling process; MPI_UNDEFINED if calling process does not belong to grid (integer)

#### C binding

```
int MPI_Cart_map(MPI_Comm comm, int ndims, const int dims[],
                const int periods[], int *newrank)
```

#### Fortran 2008 binding

```
MPI_Cart_map(comm, ndims, dims, periods, newrank, ierror)
  TYPE(MPI_Comm), INTENT(IN) :: comm
  INTEGER, INTENT(IN) :: ndims, dims(ndims)
  LOGICAL, INTENT(IN) :: periods(ndims)
  INTEGER, INTENT(OUT) :: newrank
  INTEGER, OPTIONAL, INTENT(OUT) :: ierror
```

#### Fortran binding

```
MPI_CART_MAP(COMM, NDIMS, DIMS, PERIODS, NEWRANK, IERROR)
  INTEGER COMM, NDIMS, DIMS(*), NEWRANK, IERROR
  LOGICAL PERIODS(*)
```



MPI\_CART\_MAP computes an “optimal” placement for the calling process on the physical machine. A possible implementation of this function is to always return the rank of the calling process, that is, not to perform any reordering.

*Advice to implementors.* The function MPI\_CART\_CREATE(comm, ndims, dims, periods, reorder, comm\_cart), with reorder = true can be implemented by calling MPI\_CART\_MAP(comm, ndims, dims, periods, newrank), then calling MPI\_COMM\_SPLIT(comm, color, key, comm\_cart), with color = 0 if newrank  $\neq$  MPI\_UNDEFINED, color = MPI\_UNDEFINED otherwise, and key = newrank. If ndims is zero then a zero-dimensional Cartesian topology is created.

The function MPI\_CART\_SUB(comm, remain\_dims, comm\_new) can be implemented by a call to MPI\_COMM\_SPLIT(comm, color, key, comm\_new), using a single number encoding of the lost dimensions as color and a single number encoding of the preserved dimensions as key.

All other Cartesian topology functions can be implemented locally, using the topology information that is cached with the communicator. (*End of advice to implementors.*)

The corresponding function for graph structures is as follows.

MPI\_GRAPH\_MAP(comm, nnodes, index, edges, newrank)

IN	comm	input communicator (handle)
IN	nnodes	number of graph nodes (integer)
IN	index	integer array specifying the graph structure, see MPI_GRAPH_CREATE
IN	edges	integer array specifying the graph structure
OUT	newrank	reordered rank of the calling process; MPI_UNDEFINED if the calling process does not belong to graph (integer)

### C binding

```
int MPI_Graph_map(MPI_Comm comm, int nnodes, const int index[],
                 const int edges[], int *newrank)
```

### Fortran 2008 binding

```
MPI_Graph_map(comm, nnodes, index, edges, newrank, ierror)
  TYPE(MPI_Comm), INTENT(IN) :: comm
  INTEGER, INTENT(IN) :: nnodes, index(nnodes), edges(*)
  INTEGER, INTENT(OUT) :: newrank
  INTEGER, OPTIONAL, INTENT(OUT) :: ierror
```

### Fortran binding

```
MPI_GRAPH_MAP(COMM, NNODES, INDEX, EDGES, NEWRANK, IERROR)
  INTEGER COMM, NNODES, INDEX(*), EDGES(*), NEWRANK, IERROR
```

*Advice to implementors.* The function MPI\_GRAPH\_CREATE(comm, nnodes, index, edges, reorder, comm\_graph), with reorder = true can be implemented by calling

1 MPI\_GRAPH\_MAP(comm, nnodes, index, edges, newrank), then calling  
 2 MPI\_COMM\_SPLIT(comm, color, key, comm\_graph), with color = 0 if newrank  $\neq$   
 3 MPI\_UNDEFINED, color = MPI\_UNDEFINED otherwise, and key = newrank.

4 All other graph topology functions can be implemented locally, using the topology  
 5 information that is cached with the communicator. (*End of advice to implementors.*)  
 6

## 7 8.6 Neighborhood Collective Communication on Process Topologies

9 MPI process topologies specify a communication graph, but they implement no commu-  
 10 nication function themselves. Many applications require sparse nearest neighbor commu-  
 11 nications that can be expressed as graph topologies. We now describe several collective  
 12 operations that perform communication along the edges of a process topology. All of these  
 13 functions are collective; i.e., they must be called by all processes in the specified commu-  
 14 nicator. See Section 6 for an overview of other dense (global) collective communication  
 15 operations and the semantics of collective operations.  
 16

17 If the graph was created with MPI\_DIST\_GRAPH\_CREATE\_ADJACENT with sources  
 18 and destinations containing 0, ..., n-1, where n is the number of processes in the group  
 19 of comm\_old (i.e., the graph is fully connected and also includes an edge from each node  
 20 to itself), then the sparse neighborhood communication routine performs the same data  
 21 exchange as the corresponding dense (fully-connected) collective operation. In the case of a  
 22 Cartesian communicator, only nearest neighbor communication is provided, corresponding  
 23 to rank\_source and rank\_dest in MPI\_CART\_SHIFT with input disp = 1.

24 *Rationale.* Neighborhood collective communications enable communication on a  
 25 process topology. This high-level specification of data exchange among neighboring  
 26 processes enables optimizations in the MPI library because the communication pattern  
 27 is known statically (the topology). Thus, the implementation can compute optimized  
 28 message schedules during creation of the topology [39]. This functionality can signif-  
 29 icantly simplify the implementation of neighbor exchanges [35]. (*End of rationale.*)  
 30

31 For a distributed graph topology, created with MPI\_DIST\_GRAPH\_CREATE, the se-  
 32 quence of neighbors in the send and receive buffers at each process is defined as the sequence  
 33 returned by MPI\_DIST\_GRAPH\_NEIGHBORS for destinations and sources, respectively. For  
 34 a general graph topology, created with MPI\_GRAPH\_CREATE, the use of neighborhood col-  
 35 lective communication is restricted to adjacency matrices, where the number of edges be-  
 36 tween any two processes is defined to be the same for both processes (i.e., with a symmetric  
 37 adjacency matrix). In this case, the order of neighbors in the send and receive buffers is  
 38 defined as the sequence of neighbors as returned by MPI\_GRAPH\_NEIGHBORS. Note that  
 39 general graph topologies should generally be replaced by the distributed graph topologies.  
 40

41 For a Cartesian topology, created with MPI\_CART\_CREATE, the sequence of neigh-  
 42 bors in the send and receive buffers at each process is defined by order of the dimensions,  
 43 first the neighbor in the negative direction and then in the positive direction with dis-  
 44 placement 1. The numbers of sources and destinations in the communication routines are  
 45 2\*ndims with ndims defined in MPI\_CART\_CREATE. If a neighbor does not exist, i.e., at  
 46 the border of a Cartesian topology in the case of a non-periodic virtual grid dimension (i.e.,  
 47 periods[. . .]=false), then this neighbor is defined to be MPI\_PROC\_NULL.  
 48

If a neighbor in any of the functions is MPI\_PROC\_NULL, then the neighborhood collec-  
 tive communication behaves like a point-to-point communication with MPI\_PROC\_NULL in

this direction. That is, the buffer is still part of the sequence of neighbors but it is neither communicated nor updated.

### 8.6.1 Neighborhood Gather

In this function, each process  $i$  gathers data items from each process  $j$  if an edge  $(j, i)$  exists in the topology graph, and each process  $i$  sends the same data items to all processes  $j$  where an edge  $(i, j)$  exists. The send buffer is sent to each neighboring process and the  $l$ -th block in the receive buffer is received from the  $l$ -th neighbor.

`MPI_NEIGHBOR_ALLGATHER`(sendbuf, sendcount, sendtype, recvbuf, recvcount, recvtype, comm)

IN	sendbuf	starting address of send buffer (choice)
IN	sendcount	number of elements sent to each neighbor (non-negative integer)
IN	sendtype	datatype of send buffer elements (handle)
OUT	recvbuf	starting address of receive buffer (choice)
IN	recvcount	number of elements received from each neighbor (non-negative integer)
IN	recvtype	datatype of receive buffer elements (handle)
IN	comm	communicator with topology structure (handle)

#### C binding

```
int MPI_Neighbor_allgather(const void *sendbuf, int sendcount,
    MPI_Datatype sendtype, void *recvbuf, int recvcount,
    MPI_Datatype recvtype, MPI_Comm comm)
```

```
int MPI_Neighbor_allgather_c(const void *sendbuf, MPI_Count sendcount,
    MPI_Datatype sendtype, void *recvbuf, MPI_Count recvcount,
    MPI_Datatype recvtype, MPI_Comm comm)
```

#### Fortran 2008 binding

```
MPI_Neighbor_allgather(sendbuf, sendcount, sendtype, recvbuf, recvcount,
    recvtype, comm, ierror)
```

```
TYPE(*), DIMENSION(..), INTENT(IN) :: sendbuf
INTEGER, INTENT(IN) :: sendcount, recvcount
TYPE(MPI_Datatype), INTENT(IN) :: sendtype, recvtype
TYPE(*), DIMENSION(..) :: recvbuf
TYPE(MPI_Comm), INTENT(IN) :: comm
INTEGER, OPTIONAL, INTENT(OUT) :: ierror
```

```
MPI_Neighbor_allgather(sendbuf, sendcount, sendtype, recvbuf, recvcount,
    recvtype, comm, ierror)
```

```
TYPE(*), DIMENSION(..), INTENT(IN) :: sendbuf
INTEGER(KIND=MPI_COUNT_KIND), INTENT(IN) :: sendcount, recvcount
TYPE(MPI_Datatype), INTENT(IN) :: sendtype, recvtype
```

```

1     TYPE(*), DIMENSION(..) :: recvbuf
2     TYPE(MPI_Comm), INTENT(IN) :: comm
3     INTEGER, OPTIONAL, INTENT(OUT) :: ierror

```

#### Fortran binding

```

6 MPI_NEIGHBOR_ALLGATHER(SENDBUF, SENDCOUNT, SENDTYPE, RECVBUF, RECVCOUNT,
7     RECVTYPE, COMM, IERROR)
8     <type> SENDBUF(*), RECVBUF(*)
9     INTEGER SENDCOUNT, SENDTYPE, RECVCOUNT, RECVTYPE, COMM, IERROR

```

This function supports Cartesian communicators, graph communicators, and distributed graph communicators as described in Section 8.6. If `comm` is a distributed graph communicator, the outcome is as if each process executed sends to each of its outgoing neighbors and receives from each of its incoming neighbors:

```

15 MPI_Dist_graph_neighbors_count(comm, &indegree, &outdegree, &weighted);
16 int *srcs=(int*)malloc(indegree*sizeof(int));
17 int *dsts=(int*)malloc(outdegree*sizeof(int));
18 MPI_Dist_graph_neighbors(comm, indegree, srcs, MPI_UNWEIGHTED,
19     outdegree, dsts, MPI_UNWEIGHTED);
20 int k;
21
22 /* assume sendbuf and recvbuf are of type (char*) */
23 for(k=0; k<outdegree; ++k)
24     MPI_Isend(sendbuf, sendcount, sendtype,dsts[k],...);
25
26 for(k=0; k<indegree; ++k)
27     MPI_Irecv(recvbuf+k*recvcount*extent(recvtype), recvcount, recvtype,
28     srcs[k],...);
29
30 MPI_Waitall(...);
31

```

Figure 8.1 shows the neighborhood gather communication of one process with outgoing neighbors  $d_0 \dots d_3$  and incoming neighbors  $s_0 \dots s_5$ . The process will send its `sendbuf` to all four destinations (outgoing neighbors) and it will receive the contribution from all six sources (incoming neighbors) into separate locations of its receive buffer.

All arguments are significant on all processes and the argument `comm` must have identical values on all processes.

The type signature associated with `sendcount`, `sendtype`, at a process must be equal to the type signature associated with `recvcount`, `recvtype` at all other processes. This implies that the amount of data sent must be equal to the amount of data received, pairwise between every pair of communicating processes. Distinct type maps between sender and receiver are still allowed.

*Rationale.* For optimization reasons, the same type signature is required independently of whether the topology graph is connected or not. (*End of rationale.*)

The “in place” option is not meaningful for this operation.

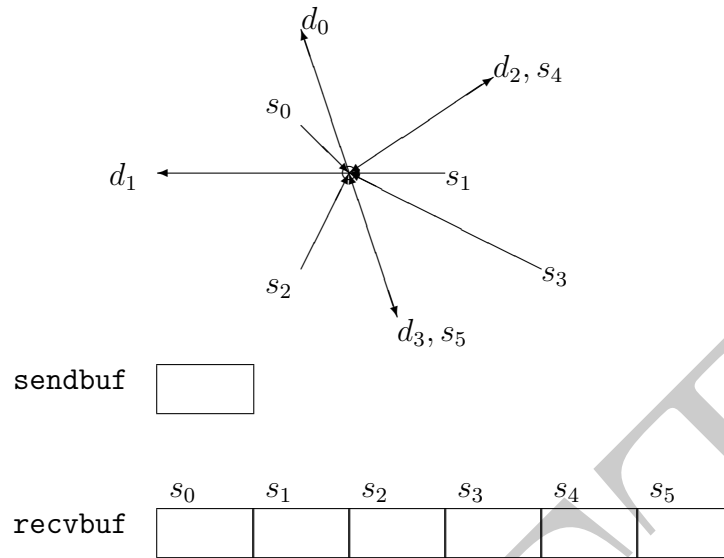

Figure 8.1: Neighborhood gather communication example

**Example 8.9** On a Cartesian virtual grid, the buffer usage in a given direction  $d$  with  $\text{dims}[d]=3$  and 1, respectively during creation of the communicator is described in Figure 8.2.

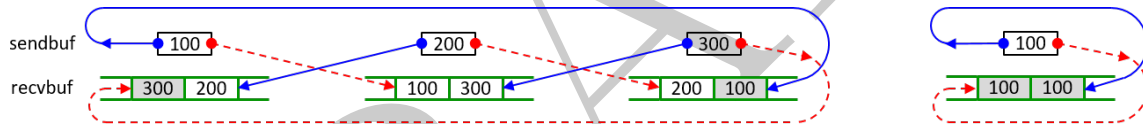

Figure 8.2: Cartesian neighborhood allgather example for 3 and 1 processes in a dimension

The figure may apply to any (or multiple) directions in the Cartesian topology. The grey buffers are required in all cases but are only accessed if during creation of the communicator,  $\text{periods}[d]$  was defined as 1 (in C) or `.TRUE.` (in Fortran).

The vector variant of `MPI_NEIGHBOR_ALLGATHER` allows one to gather different numbers of elements from each neighbor.

```

1 MPI_NEIGHBOR_ALLGATHERV(sendbuf, sendcount, sendtype, recvbuf, recvcoun
2     recvtype, comm)
3
4     IN     sendbuf           starting address of send buffer (choice)
5
6     IN     sendcount        number of elements sent to each neighbor
7                               (non-negative integer)
8
9     IN     sendtype         datatype of send buffer elements (handle)
10
11    OUT    recvbuf          starting address of receive buffer (choice)
12
13    IN     recvcoun
14           counts          non-negative integer array (of length indegree)
15                           containing the number of elements that are received
16                           from each neighbor
17
18    IN     displs           integer array (of length indegree). Entry i specifies
19                           the displacement (relative to recvbuf) at which to
20                           place the incoming data from neighbor i
21
22    IN     recvtype         datatype of receive buffer elements (handle)
23
24    IN     comm             communicator with topology structure (handle)

```

### C binding

```

21 int MPI_Neighbor_allgatherv(const void *sendbuf, int sendcount,
22     MPI_Datatype sendtype, void *recvbuf, const int recvcoun
23     ts[], MPI_Datatype recvtype, MPI_Comm comm)
24
25 int MPI_Neighbor_allgatherv_c(const void *sendbuf, MPI_Count sendcount,
26     MPI_Datatype sendtype, void *recvbuf,
27     const MPI_Count recvcoun
28     ts[], const MPI_Aint displs[],
29     MPI_Datatype recvtype, MPI_Comm comm)

```

### Fortran 2008 binding

```

30 MPI_Neighbor_allgatherv(sendbuf, sendcount, sendtype, recvbuf, recvcoun
31     ts, displs, recvtype, comm, ierror)
32     TYPE(*), DIMENSION(..), INTENT(IN) :: sendbuf
33     INTEGER, INTENT(IN) :: sendcount, recvcoun
34     ts(*), displs(*)
35     TYPE(MPI_Datatype), INTENT(IN) :: sendtype, recvtype
36     TYPE(*), DIMENSION(..) :: recvbuf
37     TYPE(MPI_Comm), INTENT(IN) :: comm
38     INTEGER, OPTIONAL, INTENT(OUT) :: ierror
39
40 MPI_Neighbor_allgatherv(sendbuf, sendcount, sendtype, recvbuf, recvcoun
41     ts, displs, recvtype, comm, ierror)
42     TYPE(*), DIMENSION(..), INTENT(IN) :: sendbuf
43     INTEGER(KIND=MPI_COUNT_KIND), INTENT(IN) :: sendcount, recvcoun
44     ts(*)
45     TYPE(MPI_Datatype), INTENT(IN) :: sendtype, recvtype
46     TYPE(*), DIMENSION(..) :: recvbuf
47     INTEGER(KIND=MPI_ADDRESS_KIND), INTENT(IN) :: displs(*)
48     TYPE(MPI_Comm), INTENT(IN) :: comm
49     INTEGER, OPTIONAL, INTENT(OUT) :: ierror

```

**Fortran binding**

```

MPI_NEIGHBOR_ALLGATHERV(SENDBUF, SENDCOUNT, SENDTYPE, RECVBUF, RECVCOUNTS,
    DISPLS, RECVMODE, COMM, IERROR)
    <type> SENDBUF(*), RECVBUF(*)
    INTEGER SENDCOUNT, SENDTYPE, RECVCOUNTS(*), DISPLS(*), RECVMODE, COMM,
    IERROR

```

This function supports Cartesian communicators, graph communicators, and distributed graph communicators as described in Section 8.6. If `comm` is a distributed graph communicator, the outcome is as if each process executed sends to each of its outgoing neighbors and receives from each of its incoming neighbors:

```

MPI_Dist_graph_neighbors_count(comm, &indegree, &outdegree, &weighted);
int *srcs=(int*)malloc(indegree*sizeof(int));
int *dsts=(int*)malloc(outdegree*sizeof(int));
MPI_Dist_graph_neighbors(comm, indegree, srcs, MPI_UNWEIGHTED,
    outdegree, dsts, MPI_UNWEIGHTED);

int k;

/* assume sendbuf and recvbuf are of type (char*) */
for(k=0; k<outdegree; ++k)
    MPI_Isend(sendbuf, sendcount, sendtype, dsts[k],...);

for(k=0; k<indegree; ++k)
    MPI_Irecv(recvbuf+displs[k]*extent(recvtype), recvcounts[k], recvtype,
        srcs[k],...);

MPI_Waitall(...);

```

The type signature associated with `sendcount`, `sendtype`, at process  $j$  must be equal to the type signature associated with `recvcounts[l]`, `recvtype` at any other process with `srcs[l]==j`. This implies that the amount of data sent must be equal to the amount of data received, pairwise between every pair of communicating processes. Distinct type maps between sender and receiver are still allowed. The data received from the  $l$ -th neighbor is placed into `recvbuf` beginning at offset `displs[l]` elements (in terms of the `recvtype`).

The “in place” option is not meaningful for this operation.

All arguments are significant on all processes and the argument `comm` must have identical values on all processes.

**8.6.2 Neighbor Alltoall**

In this function, each process  $i$  receives data items from each process  $j$  if an edge  $(j, i)$  exists in the topology graph or Cartesian topology. Similarly, each process  $i$  sends data items to all processes  $j$  where an edge  $(i, j)$  exists. This call is more general than `MPI_NEIGHBOR_ALLGATHER` in that different data items can be sent to each neighbor. The  $k$ -th block in send buffer is sent to the  $k$ -th neighboring process and the  $l$ -th block in the receive buffer is received from the  $l$ -th neighbor.

```

1 MPI_NEIGHBOR_ALLTOALL(sendbuf, sendcount, sendtype, recvbuf, recvcount, recvtype,
2     comm)
3
4     IN     sendbuf           starting address of send buffer (choice)
5
6     IN     sendcount        number of elements sent to each neighbor
7                               (non-negative integer)
8
9     IN     sendtype         datatype of send buffer elements (handle)
10
11    OUT    recvbuf          starting address of receive buffer (choice)
12
13    IN     recvcount        number of elements received from each neighbor
14                               (non-negative integer)
15
16    IN     recvtype         datatype of receive buffer elements (handle)
17
18    IN     comm             communicator with topology structure (handle)

```

**C binding**

```

16 int MPI_Neighbor_alltoall(const void *sendbuf, int sendcount,
17     MPI_Datatype sendtype, void *recvbuf, int recvcount,
18     MPI_Datatype recvtype, MPI_Comm comm)
19
20 int MPI_Neighbor_alltoall_c(const void *sendbuf, MPI_Count sendcount,
21     MPI_Datatype sendtype, void *recvbuf, MPI_Count recvcount,
22     MPI_Datatype recvtype, MPI_Comm comm)
23

```

**Fortran 2008 binding**

```

24 MPI_Neighbor_alltoall(sendbuf, sendcount, sendtype, recvbuf, recvcount,
25     recvtype, comm, ierror)
26     TYPE(*), DIMENSION(..), INTENT(IN) :: sendbuf
27     INTEGER, INTENT(IN) :: sendcount, recvcount
28     TYPE(MPI_Datatype), INTENT(IN) :: sendtype, recvtype
29     TYPE(*), DIMENSION(..) :: recvbuf
30     TYPE(MPI_Comm), INTENT(IN) :: comm
31     INTEGER, OPTIONAL, INTENT(OUT) :: ierror
32
33 MPI_Neighbor_alltoall(sendbuf, sendcount, sendtype, recvbuf, recvcount,
34     recvtype, comm, ierror)
35     TYPE(*), DIMENSION(..), INTENT(IN) :: sendbuf
36     INTEGER(KIND=MPI_COUNT_KIND), INTENT(IN) :: sendcount, recvcount
37     TYPE(MPI_Datatype), INTENT(IN) :: sendtype, recvtype
38     TYPE(*), DIMENSION(..) :: recvbuf
39     TYPE(MPI_Comm), INTENT(IN) :: comm
40     INTEGER, OPTIONAL, INTENT(OUT) :: ierror
41

```

**Fortran binding**

```

42 MPI_NEIGHBOR_ALLTOALL(SENDBUF, SENDCOUNT, SENDTYPE, RECVBUF, RECVCOUNT,
43     RECVTYPE, COMM, IERROR)
44     <type> SENDBUF(*), RECVBUF(*)
45     INTEGER SENDCOUNT, SENDTYPE, RECVCOUNT, RECVTYPE, COMM, IERROR
46
47
48

```



This function supports Cartesian communicators, graph communicators, and distributed graph communicators as described in Section 8.6. If `comm` is a distributed graph communicator, the outcome is as if each process executed sends to each of its outgoing neighbors and receives from each of its incoming neighbors:

```

MPI_Dist_graph_neighbors_count(comm, &indegree, &outdegree, &weighted);
int *srcs=(int*)malloc(indegree*sizeof(int));
int *dsts=(int*)malloc(outdegree*sizeof(int));
MPI_Dist_graph_neighbors(comm, indegree, srcs, MPI_UNWEIGHTED,
                        outdegree, dsts, MPI_UNWEIGHTED);

int k;

/* assume sendbuf and recvbuf are of type (char*) */
for(k=0; k<outdegree; ++k)
    MPI_Isend(sendbuf+k*sendcount*extent(sendtype), sendcount, sendtype,
             dsts[k],...);

for(k=0; k<indegree; ++k)
    MPI_Irecv(recvbuf+k*recvcount*extent(recvtype), recvcount, recvtype,
             srcs[k],...);

MPI_Waitall(...);

```

The type signature associated with `sendcount`, `sendtype`, at a process must be equal to the type signature associated with `recvcount`, `recvtype` at any other process. This implies that the amount of data sent must be equal to the amount of data received, pairwise between every pair of communicating processes. Distinct type maps between sender and receiver are still allowed.

The “in place” option is not meaningful for this operation.

All arguments are significant on all processes and the argument `comm` must have identical values on all processes.

**Example 8.10** For a halo communication on a Cartesian grid, the buffer usage in a given direction `d` with `dims[d]==3` and `1`, respectively during creation of the communicator is described in Figure 8.3.

The figure may apply to any (or multiple) directions in the Cartesian topology. The grey buffers are required in all cases but are only accessed if during creation of the communicator, `periods[d]` was defined as `1` (in C) or `.TRUE.` (in Fortran).

If each array element of `sendbuf` and `recvbuf` are described by `sendcount`, `sendtype` and `recvbuf`, `recvtype`, then after `MPI_NEIGHBOR_ALLTOALL` on a Cartesian communicator returned, the content of the `recvbuf` is as if the following code is executed:

```

MPI_Cartdim_get(comm, &ndims);
for( /*direction*/ d=0; d < ndims; d++) {
    MPI_Cart_shift(comm, /*direction*/ d, /*disp*/ 1, &rank_source, &rank_dest);
    MPI_Sendrecv(sendbuf[d*2+0], sendcount, sendtype, rank_source, /*sendtag*/ d*2,
                recvbuf[d*2+1], recvcount, recvtype, rank_dest, /*recvtag*/ d*2,
                comm, &status); /*communication in direction of displacement -1*/
    MPI_Sendrecv(sendbuf[d*2+1], sendcount, sendtype, rank_dest, /*sendtag*/ d*2+1,

```

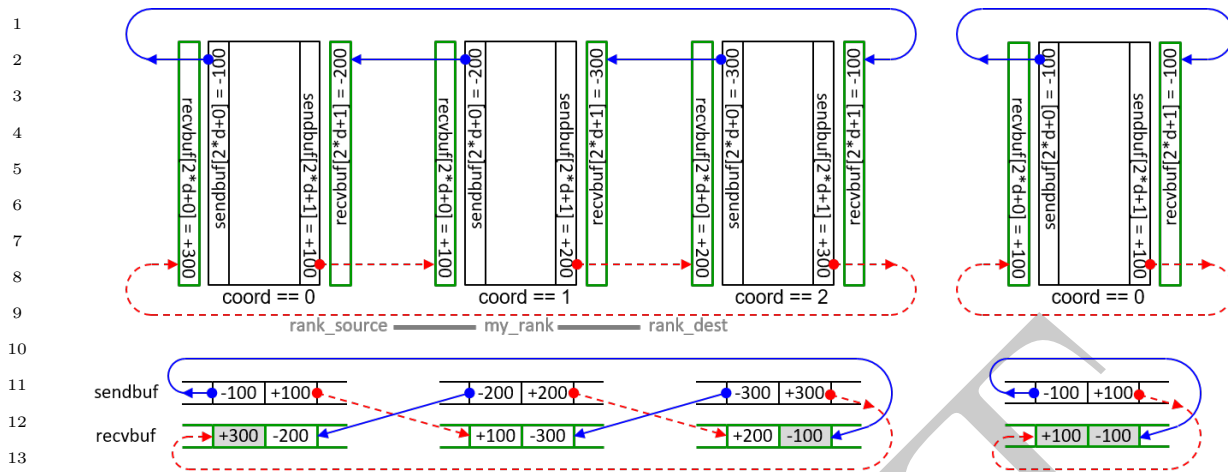

Figure 8.3: Cartesian neighborhood alltoall example for 3 and 1 processes in a dimension

```

17     recvbuf[d*2+0],recvcount,recvtype,rank_source,/*recvtag*/d*2+1,
18     comm,&status);/*communication in direction of displacment +1*/
19 }

```

The first call to `MPI_Sendrecv` implements the upper (solid arrows) communication pattern in each diagram of Figure 8.3, whereas the second call is for the lower (dashed arrows) pattern.

*Advice to implementors.* For a Cartesian topology, if the virtual grid in a direction `d` is periodic and `dims[d]` is equal to 0 or 1, then `rank_source` and `rank_dest` are identical, but still all `ndims` send and `ndims` receive operations use different buffers. If in this case, the two send and receive operations per direction or of all directions are internally parallelized, then the several send and receive operations for the same sender-receiver process pair must be initiated in the same sequence on sender and receiver side or they shall be distinguished by different tags. The code above shows a valid sequence of operations and tags. (*End of advice to implementors.*)

The vector variant of `MPI_NEIGHBOR_ALLTOALL` allows sending/receiving different numbers of elements to and from each neighbor.

MPI_NEIGHBOR_ALLTOALLV(sendbuf, sendcounts, sdispls, sendtype, recvbuf, recvcoun-			1
ts, rdispls, recvtype, comm)			2
IN	sendbuf	starting address of send buffer (choice)	3
			4
IN	sendcounts	non-negative integer array (of length outdegree)	5
		specifying the number of elements to send to each	6
		neighbor	7
IN	sdispls	integer array (of length outdegree). Entry j specifies	8
		the displacement (relative to sendbuf) from which to	9
		send the outgoing data to neighbor j	10
IN	sendtype	datatype of send buffer elements (handle)	11
OUT	recvbuf	starting address of receive buffer (choice)	12
IN	recvcoun-	non-negative integer array (of length indegree)	14
		ts specifying the number of elements that are received	15
		from each neighbor	16
IN	rdispls	integer array (of length indegree). Entry i specifies	17
		the displacement (relative to recvbuf) at which to	18
		place the incoming data from neighbor i	19
IN	recvtype	datatype of receive buffer elements (handle)	20
IN	comm	communicator with topology structure (handle)	21
			22
			23

**C binding**

```

int MPI_Neighbor_alltoallv(const void *sendbuf, const int sendcounts[],
                           const int sdispls[], MPI_Datatype sendtype, void *recvbuf,
                           const int recvcoun-
```

```

ts, MPI_Datatype recvtype, MPI_Comm comm)
int MPI_Neighbor_alltoallv_c(const void *sendbuf,
                             const MPI_Count sendcounts[], const MPI_Aint sdispls[],
                             MPI_Datatype sendtype, void *recvbuf,
                             const MPI_Count recvcoun-
```

**Fortran 2008 binding**

```

MPI_Neighbor_alltoallv(sendbuf, sendcounts, sdispls, sendtype, recvbuf,
                       recvcoun-
```

```

ts, rdispls, recvtype, comm, ierror)
TYPE(*), DIMENSION(..), INTENT(IN) :: sendbuf
INTEGER, INTENT(IN) :: sendcounts(*), sdispls(*), recvcoun-
```

```

ts, rdispls(*)
TYPE(MPI_Datatype), INTENT(IN) :: sendtype, recvtype
TYPE(*), DIMENSION(..) :: recvbuf
TYPE(MPI_Comm), INTENT(IN) :: comm
INTEGER, OPTIONAL, INTENT(OUT) :: ierror
```

```

MPI_Neighbor_alltoallv(sendbuf, sendcounts, sdispls, sendtype, recvbuf,
                       recvcoun-
```

```

ts, rdispls, recvtype, comm, ierror)
TYPE(*), DIMENSION(..), INTENT(IN) :: sendbuf
```

```

1  INTEGER(KIND=MPI_COUNT_KIND), INTENT(IN) :: sendcounts(*),
2      recvcounts(*)
3  INTEGER(KIND=MPI_ADDRESS_KIND), INTENT(IN) :: sdispls(*), rdispls(*)
4  TYPE(MPI_Datatype), INTENT(IN) :: sendtype, recvtype
5  TYPE(*), DIMENSION(..) :: recvbuf
6  TYPE(MPI_Comm), INTENT(IN) :: comm
7  INTEGER, OPTIONAL, INTENT(OUT) :: ierror

```

### Fortran binding

```

9  MPI_NEIGHBOR_ALLTOALLV(SENDBUF, SENDCOUNTS, SDISPLS, SENDTYPE, RECVBUF,
10     RECVCOUNTS, RDISPLS, RECVTYPE, COMM, IERROR)
11     <type> SENDBUF(*), RECVBUF(*)
12     INTEGER SENDCOUNTS(*), SDISPLS(*), SENDTYPE, RECVCOUNTS(*), RDISPLS(*),
13     RECVTYPE, COMM, IERROR

```

This function supports Cartesian communicators, graph communicators, and distributed graph communicators as described in Section 8.6. If `comm` is a distributed graph communicator, the outcome is as if each process executed sends to each of its outgoing neighbors and receives from each of its incoming neighbors:

```

15
16
17
18
19
20 MPI_Dist_graph_neighbors_count(comm, &indegree, &outdegree, &weighted);
21 int *srcs=(int*)malloc(indegree*sizeof(int));
22 int *dsts=(int*)malloc(outdegree*sizeof(int));
23 MPI_Dist_graph_neighbors(comm, indegree, srcs, MPI_UNWEIGHTED,
24     outdegree, dsts, MPI_UNWEIGHTED);
25 int k;
26
27 /* assume sendbuf and recvbuf are of type (char*) */
28 for(k=0; k<outdegree; ++k)
29     MPI_Isend(sendbuf+sdispls[k]*extent(sendtype), sendcounts[k], sendtype,
30     dsts[k],...);
31
32 for(k=0; k<indegree; ++k)
33     MPI_Irecv(recvbuf+rdispls[k]*extent(recvtype), recvcounts[k], recvtype,
34     srcs[k],...);
35
36 MPI_Waitall(...);
37

```

The type signature associated with `sendcounts[k]`, `sendtype` with `dsts[k]==j` at process `i` must be equal to the type signature associated with `recvcounts[l]`, `recvtype` with `srcs[l]==i` at process `j`. This implies that the amount of data sent must be equal to the amount of data received, pairwise between every pair of communicating processes. Distinct type maps between sender and receiver are still allowed. The data in the `sendbuf` beginning at offset `sdispls[k]` elements (in terms of the `sendtype`) is sent to the `k`-th outgoing neighbor. The data received from the `l`-th incoming neighbor is placed into `recvbuf` beginning at offset `rdispls[l]` elements (in terms of the `recvtype`).

The “in place” option is not meaningful for this operation.

All arguments are significant on all processes and the argument `comm` must have identical values on all processes.

`MPI_NEIGHBOR_ALLTOALLW` allows one to send and receive with different datatypes to and from each neighbor.

`MPI_NEIGHBOR_ALLTOALLW(sendbuf, sendcounts, sdispls, sendtypes, recvbuf, recvcoun-`  
`ts, rdispls, recvtypes, comm)`

IN	<code>sendbuf</code>	starting address of send buffer (choice)	9
IN	<code>sendcounts</code>	non-negative integer array (of length <code>outdegree</code> ) specifying the number of elements to send to each neighbor	10 11 12
IN	<code>sdispls</code>	integer array (of length <code>outdegree</code> ). Entry <code>j</code> specifies the displacement in bytes (relative to <code>sendbuf</code> ) from which to take the outgoing data destined for neighbor <code>j</code> (array of integers)	13 14 15 16 17
IN	<code>sendtypes</code>	array of datatypes (of length <code>outdegree</code> ). Entry <code>j</code> specifies the type of data to send to neighbor <code>j</code> (array of handles)	18 19 20
OUT	<code>recvbuf</code>	starting address of receive buffer (choice)	21
IN	<code>recvcoun-</code> <code>ts</code>	non-negative integer array (of length <code>indegree</code> ) specifying the number of elements that are received from each neighbor	22 23 24 25
IN	<code>rdispls</code>	integer array (of length <code>indegree</code> ). Entry <code>i</code> specifies the displacement in bytes (relative to <code>recvbuf</code> ) at which to place the incoming data from neighbor <code>i</code> (array of integers)	26 27 28 29
IN	<code>recvtypes</code>	array of datatypes (of length <code>indegree</code> ). Entry <code>i</code> specifies the type of data received from neighbor <code>i</code> (array of handles)	30 31 32
IN	<code>comm</code>	communicator with topology structure (handle)	33 34

### C binding

```
int MPI_Neighbor_alltoallw(const void *sendbuf, const int sendcounts[],
    const MPI_Aint sdispls[], const MPI_Datatype sendtypes[],
    void *recvbuf, const int recvcoun-
```

```
ts, const MPI_Aint rdispls[], const MPI_Datatype recvtypes[],
    MPI_Comm comm)

int MPI_Neighbor_alltoallw_c(const void *sendbuf,
    const MPI_Count sendcounts[], const MPI_Aint sdispls[],
    const MPI_Datatype sendtypes[], void *recvbuf,
    const MPI_Count recvcoun-
```

**Fortran 2008 binding**

```

1 MPI_Neighbor_alltoallw(sendbuf, sendcounts, sdispls, sendtypes, recvbuf,
2   recvcounts, rdispls, recvtypes, comm, ierror)
3   TYPE(*), DIMENSION(..), INTENT(IN) :: sendbuf
4   INTEGER, INTENT(IN) :: sendcounts(*), recvcounts(*)
5   INTEGER(KIND=MPI_ADDRESS_KIND), INTENT(IN) :: sdispls(*), rdispls(*)
6   TYPE(MPI_Datatype), INTENT(IN) :: sendtypes(*), recvtypes(*)
7   TYPE(*), DIMENSION(..) :: recvbuf
8   TYPE(MPI_Comm), INTENT(IN) :: comm
9   INTEGER, OPTIONAL, INTENT(OUT) :: ierror

```

```

11 MPI_Neighbor_alltoallw(sendbuf, sendcounts, sdispls, sendtypes, recvbuf,
12   recvcounts, rdispls, recvtypes, comm, ierror)
13   TYPE(*), DIMENSION(..), INTENT(IN) :: sendbuf
14   INTEGER(KIND=MPI_COUNT_KIND), INTENT(IN) :: sendcounts(*),
15   recvcounts(*)
16   INTEGER(KIND=MPI_ADDRESS_KIND), INTENT(IN) :: sdispls(*), rdispls(*)
17   TYPE(MPI_Datatype), INTENT(IN) :: sendtypes(*), recvtypes(*)
18   TYPE(*), DIMENSION(..) :: recvbuf
19   TYPE(MPI_Comm), INTENT(IN) :: comm
20   INTEGER, OPTIONAL, INTENT(OUT) :: ierror

```

**Fortran binding**

```

23 MPI_NEIGHBOR_ALLTOALLW(SENDBUF, SENDCOUNTS, SDISPLS, SENDTYPES, RECVBUF,
24   RECVCOUNTS, RDISPLS, RECVTYPES, COMM, IERROR)
25   <type> SENDBUF(*), RECVBUF(*)
26   INTEGER SENDCOUNTS(*), SENDTYPES(*), RECVCOUNTS(*), RECVTYPES(*), COMM,
27   IERROR
28   INTEGER(KIND=MPI_ADDRESS_KIND) SDISPLS(*), RDISPLS(*)

```

This function supports Cartesian communicators, graph communicators, and distributed graph communicators as described in Section 8.6. If `comm` is a distributed graph communicator, the outcome is as if each process executed sends to each of its outgoing neighbors and receives from each of its incoming neighbors:

```

34 MPI_Dist_graph_neighbors_count(comm, &indegree, &outdegree, &weighted);
35 int *srcs=(int*)malloc(indegree*sizeof(int));
36 int *dsts=(int*)malloc(outdegree*sizeof(int));
37 MPI_Dist_graph_neighbors(comm, indegree, srcs, MPI_UNWEIGHTED,
38   outdegree, dsts, MPI_UNWEIGHTED);
39 int k;
40
41 /* assume sendbuf and recvbuf are of type (char*) */
42 for(k=0; k<outdegree; ++k)
43   MPI_Isend(sendbuf+sdispls[k], sendcounts[k], sendtypes[k], dsts[k],...);
44
45 for(k=0; k<indegree; ++k)
46   MPI_Irecv(recvbuf+rdispls[k], recvcounts[k], recvtypes[k], srcs[k],...);
47
48

```

```
MPI_Waitall(...);
```

The type signature associated with `sendcounts[k]`, `sendtypes[k]` with `dsts[k]==j` at process `i` must be equal to the type signature associated with `recvcounts[l]`, `recvtypes[l]` with `srcs[l]==i` at process `j`. This implies that the amount of data sent must be equal to the amount of data received, pairwise between every pair of communicating processes. Distinct type maps between sender and receiver are still allowed.

The “in place” option is not meaningful for this operation.

All arguments are significant on all processes and the argument `comm` must have identical values on all processes.

## 8.7 Nonblocking Neighborhood Communication on Process Topologies

Nonblocking variants of the neighborhood collective operations allow relaxed synchronization and overlapping of computation and communication. The semantics are similar to nonblocking collective operations as described in Section 6.12.

### 8.7.1 Nonblocking Neighborhood Gather

```
MPI_INEIGHBOR_ALLGATHER(sendbuf, sendcount, sendtype, recvbuf, recvcount, recvtype,
                        comm, request)
```

IN	<code>sendbuf</code>	starting address of send buffer (choice)
IN	<code>sendcount</code>	number of elements sent to each neighbor (non-negative integer)
IN	<code>sendtype</code>	datatype of send buffer elements (handle)
OUT	<code>recvbuf</code>	starting address of receive buffer (choice)
IN	<code>recvcount</code>	number of elements received from each neighbor (non-negative integer)
IN	<code>recvtype</code>	datatype of receive buffer elements (handle)
IN	<code>comm</code>	communicator with topology structure (handle)
OUT	<code>request</code>	communication request (handle)

#### C binding

```
int MPI_Ineighbor_allgather(const void *sendbuf, int sendcount,
                          MPI_Datatype sendtype, void *recvbuf, int recvcount,
                          MPI_Datatype recvtype, MPI_Comm comm, MPI_Request *request)
```

```
int MPI_Ineighbor_allgather_c(const void *sendbuf, MPI_Count sendcount,
                              MPI_Datatype sendtype, void *recvbuf, MPI_Count recvcount,
                              MPI_Datatype recvtype, MPI_Comm comm, MPI_Request *request)
```

#### Fortran 2008 binding

```
MPI_Ineighbor_allgather(sendbuf, sendcount, sendtype, recvbuf, recvcount,
                        recvtype, comm, request, ierror)
```

```

1  TYPE(*), DIMENSION(..), INTENT(IN), ASYNCHRONOUS :: sendbuf
2  INTEGER, INTENT(IN) :: sendcount, recvcount
3  TYPE(MPI_Datatype), INTENT(IN) :: sendtype, recvtype
4  TYPE(*), DIMENSION(..), ASYNCHRONOUS :: recvbuf
5  TYPE(MPI_Comm), INTENT(IN) :: comm
6  TYPE(MPI_Request), INTENT(OUT) :: request
7  INTEGER, OPTIONAL, INTENT(OUT) :: ierror
8
9  MPI_Ineighbor_allgather(sendbuf, sendcount, sendtype, recvbuf, recvcount,
10     recvtype, comm, request, ierror)
11  TYPE(*), DIMENSION(..), INTENT(IN), ASYNCHRONOUS :: sendbuf
12  INTEGER(KIND=MPI_COUNT_KIND), INTENT(IN) :: sendcount, recvcount
13  TYPE(MPI_Datatype), INTENT(IN) :: sendtype, recvtype
14  TYPE(*), DIMENSION(..), ASYNCHRONOUS :: recvbuf
15  TYPE(MPI_Comm), INTENT(IN) :: comm
16  TYPE(MPI_Request), INTENT(OUT) :: request
17  INTEGER, OPTIONAL, INTENT(OUT) :: ierror

```

### Fortran binding

```

19  MPI_INEIGHBOR_ALLGATHER(SENDBUF, SENDCOUNT, SENDTYPE, RECVBUF, RECVCOUNT,
20     RECVTYPE, COMM, REQUEST, IERROR)
21  <type> SENDBUF(*), RECVBUF(*)
22  INTEGER SENDCOUNT, SENDTYPE, RECVCOUNT, RECVTYPE, COMM, REQUEST, IERROR
23

```

This call starts a nonblocking variant of MPI\_NEIGHBOR\_ALLGATHER.

```

26  MPI_INEIGHBOR_ALLGATHERV(sendbuf, sendcount, sendtype, recvbuf, recvcounts, displs,
27     recvtype, comm, request)
28
29  IN      sendbuf      starting address of send buffer (choice)
30  IN      sendcount    number of elements sent to each neighbor
31                        (non-negative integer)
32  IN      sendtype     datatype of send buffer elements (handle)
33  OUT     recvbuf      starting address of receive buffer (choice)
34  IN      recvcounts    non-negative integer array (of length indegree)
35                        containing the number of elements that are received
36                        from each neighbor
37
38  IN      displs       integer array (of length indegree). Entry i specifies
39                        the displacement (relative to recvbuf) at which to
40                        place the incoming data from neighbor i
41  IN      recvtype     datatype of receive buffer elements (handle)
42  IN      comm         communicator with topology structure (handle)
43  OUT     request      communication request (handle)
44

```

### C binding

```

47  int MPI_Ineighbor_allgatherv(const void *sendbuf, int sendcount,
48     MPI_Datatype sendtype, void *recvbuf, const int recvcounts[],

```



```

        const int displs[], MPI_Datatype recvtype, MPI_Comm comm,
        MPI_Request *request)
int MPI_Ineighbor_allgatherv_c(const void *sendbuf, MPI_Count sendcount,
        MPI_Datatype sendtype, void *recvbuf,
        const MPI_Count recvcounts[], const MPI_Aint displs[],
        MPI_Datatype recvtype, MPI_Comm comm, MPI_Request *request)

```

**Fortran 2008 binding**

```

MPI_Ineighbor_allgatherv(sendbuf, sendcount, sendtype, recvbuf, recvcounts,
        displs, recvtype, comm, request, ierror)
TYPE(*), DIMENSION(..), INTENT(IN), ASYNCHRONOUS :: sendbuf
INTEGER, INTENT(IN) :: sendcount
TYPE(MPI_Datatype), INTENT(IN) :: sendtype, recvtype
TYPE(*), DIMENSION(..), ASYNCHRONOUS :: recvbuf
INTEGER, INTENT(IN), ASYNCHRONOUS :: recvcounts(*), displs(*)
TYPE(MPI_Comm), INTENT(IN) :: comm
TYPE(MPI_Request), INTENT(OUT) :: request
INTEGER, OPTIONAL, INTENT(OUT) :: ierror

```

```

MPI_Ineighbor_allgatherv(sendbuf, sendcount, sendtype, recvbuf, recvcounts,
        displs, recvtype, comm, request, ierror)
TYPE(*), DIMENSION(..), INTENT(IN), ASYNCHRONOUS :: sendbuf
INTEGER(KIND=MPI_COUNT_KIND), INTENT(IN) :: sendcount
TYPE(MPI_Datatype), INTENT(IN) :: sendtype, recvtype
TYPE(*), DIMENSION(..), ASYNCHRONOUS :: recvbuf
INTEGER(KIND=MPI_COUNT_KIND), INTENT(IN), ASYNCHRONOUS :: recvcounts(*)
INTEGER(KIND=MPI_ADDRESS_KIND), INTENT(IN), ASYNCHRONOUS :: displs(*)
TYPE(MPI_Comm), INTENT(IN) :: comm
TYPE(MPI_Request), INTENT(OUT) :: request
INTEGER, OPTIONAL, INTENT(OUT) :: ierror

```

**Fortran binding**

```

MPI_INEIGHBOR_ALLGATHERV(SENDBUF, SENDCOUNT, SENDTYPE, RECVBUF, RECVCOUNTS,
        DISPLS, RECVTYPE, COMM, REQUEST, IERROR)
<type> SENDBUF(*), RECVBUF(*)
INTEGER SENDCOUNT, SENDTYPE, RECVCOUNTS(*), DISPLS(*), RECVTYPE, COMM,
        REQUEST, IERROR

```

This call starts a nonblocking variant of MPI\_NEIGHBOR\_ALLGATHERV.

## 8.7.2 Nonblocking Neighborhood Alltoall

```

4 MPI_INEIGHBOR_ALLTOALL(sendbuf, sendcount, sendtype, recvbuf, recvcount, recvtype,
5     comm, request)

```

6	IN	sendbuf	starting address of send buffer (choice)
7			
8	IN	sendcount	number of elements sent to each neighbor (non-negative integer)
9			
10	IN	sendtype	datatype of send buffer elements (handle)
11			
12	OUT	recvbuf	starting address of receive buffer (choice)
13	IN	recvcount	number of elements received from each neighbor (non-negative integer)
14			
15	IN	recvtype	datatype of receive buffer elements (handle)
16			
17	IN	comm	communicator with topology structure (handle)
18	OUT	request	communication request (handle)

**C binding**

```

21 int MPI_Ineighbor_alltoall(const void *sendbuf, int sendcount,
22     MPI_Datatype sendtype, void *recvbuf, int recvcount,
23     MPI_Datatype recvtype, MPI_Comm comm, MPI_Request *request)

```

```

25 int MPI_Ineighbor_alltoall_c(const void *sendbuf, MPI_Count sendcount,
26     MPI_Datatype sendtype, void *recvbuf, MPI_Count recvcount,
27     MPI_Datatype recvtype, MPI_Comm comm, MPI_Request *request)

```

**Fortran 2008 binding**

```

29 MPI_Ineighbor_alltoall(sendbuf, sendcount, sendtype, recvbuf, recvcount,
30     recvtype, comm, request, ierror)
31     TYPE(*), DIMENSION(..), INTENT(IN), ASYNCHRONOUS :: sendbuf
32     INTEGER, INTENT(IN) :: sendcount, recvcount
33     TYPE(MPI_Datatype), INTENT(IN) :: sendtype, recvtype
34     TYPE(*), DIMENSION(..), ASYNCHRONOUS :: recvbuf
35     TYPE(MPI_Comm), INTENT(IN) :: comm
36     TYPE(MPI_Request), INTENT(OUT) :: request
37     INTEGER, OPTIONAL, INTENT(OUT) :: ierror

```

```

39 MPI_Ineighbor_alltoall(sendbuf, sendcount, sendtype, recvbuf, recvcount,
40     recvtype, comm, request, ierror)
41     TYPE(*), DIMENSION(..), INTENT(IN), ASYNCHRONOUS :: sendbuf
42     INTEGER(KIND=MPI_COUNT_KIND), INTENT(IN) :: sendcount, recvcount
43     TYPE(MPI_Datatype), INTENT(IN) :: sendtype, recvtype
44     TYPE(*), DIMENSION(..), ASYNCHRONOUS :: recvbuf
45     TYPE(MPI_Comm), INTENT(IN) :: comm
46     TYPE(MPI_Request), INTENT(OUT) :: request
47     INTEGER, OPTIONAL, INTENT(OUT) :: ierror

```

**Fortran binding**

```

MPI_INEIGHBOR_ALLTOALL(SENDBUF, SENDCOUNT, SENDTYPE, RECVBUF, RECVCOUNT,
    RECVTYPE, COMM, REQUEST, IERROR)
    <type> SENDBUF(*), RECVBUF(*)
    INTEGER SENDCOUNT, SENDTYPE, RECVCOUNT, RECVTYPE, COMM, REQUEST, IERROR

```

This call starts a nonblocking variant of MPI\_NEIGHBOR\_ALLTOALL.

```

MPI_INEIGHBOR_ALLTOALLV(sendbuf, sendcounts, sdispls, sendtype, recvbuf, recvcoun-
    ts, rdispls, recvtype, comm, request)

```

IN	sendbuf	starting address of send buffer (choice)
IN	sendcounts	non-negative integer array (of length outdegree) specifying the number of elements to send to each neighbor
IN	sdispls	integer array (of length outdegree). Entry j specifies the displacement (relative to sendbuf) from which send the outgoing data to neighbor j
IN	sendtype	datatype of send buffer elements (handle)
OUT	recvbuf	starting address of receive buffer (choice)
IN	recvcoun- ts	non-negative integer array (of length indegree) specifying the number of elements that are received from each neighbor
IN	rdispls	integer array (of length indegree). Entry i specifies the displacement (relative to recvbuf) at which to place the incoming data from neighbor i
IN	recvtype	datatype of receive buffer elements (handle)
IN	comm	communicator with topology structure (handle)
OUT	request	communication request (handle)

**C binding**

```

int MPI_Ineighbor_alltoallv(const void *sendbuf, const int sendcounts[],
    const int sdispls[], MPI_Datatype sendtype, void *recvbuf,
    const int recvcoun-
    ts[], const int rdispls[],
    MPI_Datatype recvtype, MPI_Comm comm, MPI_Request *request)

```

```

int MPI_Ineighbor_alltoallv_c(const void *sendbuf,
    const MPI_Count sendcounts[], const MPI_Aint sdispls[],
    MPI_Datatype sendtype, void *recvbuf,
    const MPI_Count recvcoun-
    ts[], const MPI_Aint rdispls[],
    MPI_Datatype recvtype, MPI_Comm comm, MPI_Request *request)

```

**Fortran 2008 binding**

```

MPI_Ineighbor_alltoallv(sendbuf, sendcounts, sdispls, sendtype, recvbuf,
    recvcoun-
    ts, rdispls, recvtype, comm, request, ierror)
    TYPE(*), DIMENSION(..), INTENT(IN), ASYNCHRONOUS :: sendbuf

```

```

1     INTEGER, INTENT(IN), ASYNCHRONOUS :: sendcounts(*), sdispls(*),
2         recvcounts(*), rdispls(*)
3     TYPE(MPI_Datatype), INTENT(IN) :: sendtype, recvtype
4     TYPE(*), DIMENSION(..), ASYNCHRONOUS :: recvbuf
5     TYPE(MPI_Comm), INTENT(IN) :: comm
6     TYPE(MPI_Request), INTENT(OUT) :: request
7     INTEGER, OPTIONAL, INTENT(OUT) :: ierror
8
9     MPI_Ineighbor_alltoallv(sendbuf, sendcounts, sdispls, sendtype, recvbuf,
10         recvcounts, rdispls, recvtype, comm, request, ierror)
11     TYPE(*), DIMENSION(..), INTENT(IN), ASYNCHRONOUS :: sendbuf
12     INTEGER(KIND=MPI_COUNT_KIND), INTENT(IN), ASYNCHRONOUS ::
13         sendcounts(*), recvcounts(*)
14     INTEGER(KIND=MPI_ADDRESS_KIND), INTENT(IN), ASYNCHRONOUS :: sdispls(*),
15         rdispls(*)
16     TYPE(MPI_Datatype), INTENT(IN) :: sendtype, recvtype
17     TYPE(*), DIMENSION(..), ASYNCHRONOUS :: recvbuf
18     TYPE(MPI_Comm), INTENT(IN) :: comm
19     TYPE(MPI_Request), INTENT(OUT) :: request
20     INTEGER, OPTIONAL, INTENT(OUT) :: ierror

```

### Fortran binding

```

21 MPI_INEIGHBOR_ALLTOALLV(SENDBUF, SENDCOUNTS, SDISPLS, SENDTYPE, RECVBUF,
22     RECVCOUNTS, RDISPLS, RECVTYPE, COMM, REQUEST, IERROR)
23     <type> SENDBUF(*), RECVBUF(*)
24     INTEGER SENDCOUNTS(*), SDISPLS(*), SENDTYPE, RECVCOUNTS(*), RDISPLS(*),
25         RECVTYPE, COMM, REQUEST, IERROR

```

This call starts a nonblocking variant of MPI\_NEIGHBOR\_ALLTOALLV.

29  
30  
31  
32  
33  
34  
35  
36  
37  
38  
39  
40  
41  
42  
43  
44  
45  
46  
47  
48

MPI_INEIGHBOR_ALLTOALLW(sendbuf, sendcounts, sdispls, sendtypes, recvbuf, recvcounts,			1
rdispls, recvtypes, comm, request)			2
IN	sendbuf	starting address of send buffer (choice)	3
			4
IN	sendcounts	non-negative integer array (of length outdegree)	5
		specifying the number of elements to send to each	6
		neighbor	7
IN	sdispls	integer array (of length outdegree). Entry j specifies	8
		the displacement in bytes (relative to sendbuf) from	9
		which to take the outgoing data destined for	10
		neighbor j (array of integers)	11
IN	sendtypes	array of datatypes (of length outdegree). Entry j	12
		specifies the type of data to send to neighbor j (array	13
		of handles)	14
OUT	recvbuf	starting address of receive buffer (choice)	15
			16
IN	recvcounts	non-negative integer array (of length indegree)	17
		specifying the number of elements that are received	18
		from each neighbor	19
IN	rdispls	integer array (of length indegree). Entry i specifies	20
		the displacement in bytes (relative to recvbuf) at	21
		which to place the incoming data from neighbor i	22
		(array of integers)	23
			24
IN	recvtypes	array of datatypes (of length indegree). Entry i	25
		specifies the type of data received from neighbor i	26
		(array of handles)	27
IN	comm	communicator with topology structure (handle)	28
OUT	request	communication request (handle)	29
			30
			31
<b>C binding</b>			32
int MPI_Ineighbor_alltoallw(const void *sendbuf, const int sendcounts[],			33
	const MPI_Aint sdispls[], const MPI_Datatype sendtypes[],		34
	void *recvbuf, const int recvcounts[],		35
	const MPI_Aint rdispls[], const MPI_Datatype recvtypes[],		36
	MPI_Comm comm, MPI_Request *request)		37
			38
int MPI_Ineighbor_alltoallw_c(const void *sendbuf,			39
	const MPI_Count sendcounts[], const MPI_Aint sdispls[],		40
	const MPI_Datatype sendtypes[], void *recvbuf,		41
	const MPI_Count recvcounts[], const MPI_Aint rdispls[],		42
	const MPI_Datatype recvtypes[], MPI_Comm comm,		43
	MPI_Request *request)		44
			45
<b>Fortran 2008 binding</b>			46
MPI_Ineighbor_alltoallw(sendbuf, sendcounts, sdispls, sendtypes, recvbuf,			47
	recvcounts, rdispls, recvtypes, comm, request, ierror)		48
	TYPE(*), DIMENSION(..), INTENT(IN), ASYNCHRONOUS :: sendbuf		

```

1  INTEGER, INTENT(IN), ASYNCHRONOUS :: sendcounts(*), recvcounts(*)
2  INTEGER(KIND=MPI_ADDRESS_KIND), INTENT(IN), ASYNCHRONOUS :: sdispls(*),
3     rdispls(*)
4  TYPE(MPI_Datatype), INTENT(IN), ASYNCHRONOUS :: sendtypes(*),
5     recvtypes(*)
6  TYPE(*), DIMENSION(..), ASYNCHRONOUS :: recvbuf
7  TYPE(MPI_Comm), INTENT(IN) :: comm
8  TYPE(MPI_Request), INTENT(OUT) :: request
9  INTEGER, OPTIONAL, INTENT(OUT) :: ierror
10
11 MPI_Ineighbor_alltoallw(sendbuf, sendcounts, sdispls, sendtypes, recvbuf,
12     recvcounts, rdispls, recvtypes, comm, request, ierror)
13 TYPE(*), DIMENSION(..), INTENT(IN), ASYNCHRONOUS :: sendbuf
14 INTEGER(KIND=MPI_COUNT_KIND), INTENT(IN), ASYNCHRONOUS ::
15     sendcounts(*), recvcounts(*)
16 INTEGER(KIND=MPI_ADDRESS_KIND), INTENT(IN), ASYNCHRONOUS :: sdispls(*),
17     rdispls(*)
18 TYPE(MPI_Datatype), INTENT(IN), ASYNCHRONOUS :: sendtypes(*),
19     recvtypes(*)
20 TYPE(*), DIMENSION(..), ASYNCHRONOUS :: recvbuf
21 TYPE(MPI_Comm), INTENT(IN) :: comm
22 TYPE(MPI_Request), INTENT(OUT) :: request
23 INTEGER, OPTIONAL, INTENT(OUT) :: ierror

```

#### Fortran binding

```

24 MPI_INEIGHBOR_ALLTOALLW(SENDBUF, SENDCOUNTS, SDISPLS, SENDTYPES, RECVBUF,
25     RECVCOUNTS, RDISPLS, RECVTYPES, COMM, REQUEST, IERROR)
26 <type> SENDBUF(*), RECVBUF(*)
27 INTEGER SENDCOUNTS(*), SENDTYPES(*), RECVCOUNTS(*), RECVTYPES(*), COMM,
28     REQUEST, IERROR
29 INTEGER(KIND=MPI_ADDRESS_KIND) SDISPLS(*), RDISPLS(*)

```

This call starts a nonblocking variant of MPI\_NEIGHBOR\_ALLTOALLW.

## 8.8 Persistent Neighborhood Communication on Process Topologies

Persistent variants of the neighborhood collective operations can offer significant performance benefits for programs with repetitive communication patterns. The semantics are similar to persistent collective operations as described in Section 6.13.

## 8.8.1 Persistent Neighborhood Gather

MPI\_NEIGHBOR\_ALLGATHER\_INIT(sendbuf, sendcount, sendtype, recvbuf, recvcnt,  
recvtype, comm, info, request)

IN	sendbuf	starting address of send buffer (choice)	1
IN	sendcount	number of elements sent to each neighbor (non-negative integer)	2
IN	sendtype	datatype of send buffer elements (handle)	3
OUT	recvbuf	starting address of receive buffer (choice)	4
IN	recvcnt	number of elements received from each neighbor (non-negative integer)	5
IN	recvtype	datatype of receive buffer elements (handle)	6
IN	comm	communicator with topology structure (handle)	7
IN	info	info argument (handle)	8
OUT	request	communication request (handle)	9

**C binding**

```
int MPI_Neighbor_allgather_init(const void *sendbuf, int sendcount,
    MPI_Datatype sendtype, void *recvbuf, int recvcnt,
    MPI_Datatype recvtype, MPI_Comm comm, MPI_Info info,
    MPI_Request *request)
```

```
int MPI_Neighbor_allgather_init_c(const void *sendbuf, MPI_Count sendcount,
    MPI_Datatype sendtype, void *recvbuf, MPI_Count recvcnt,
    MPI_Datatype recvtype, MPI_Comm comm, MPI_Info info,
    MPI_Request *request)
```

**Fortran 2008 binding**

```
MPI_Neighbor_allgather_init(sendbuf, sendcount, sendtype, recvbuf,
    recvcnt, recvtype, comm, info, request, ierror)
TYPE(*), DIMENSION(..), INTENT(IN), ASYNCHRONOUS :: sendbuf
INTEGER, INTENT(IN) :: sendcount, recvcnt
TYPE(MPI_Datatype), INTENT(IN) :: sendtype, recvtype
TYPE(*), DIMENSION(..), ASYNCHRONOUS :: recvbuf
TYPE(MPI_Comm), INTENT(IN) :: comm
TYPE(MPI_Info), INTENT(IN) :: info
TYPE(MPI_Request), INTENT(OUT) :: request
INTEGER, OPTIONAL, INTENT(OUT) :: ierror
```

```
MPI_Neighbor_allgather_init(sendbuf, sendcount, sendtype, recvbuf,
    recvcnt, recvtype, comm, info, request, ierror)
TYPE(*), DIMENSION(..), INTENT(IN), ASYNCHRONOUS :: sendbuf
INTEGER(KIND=MPI_COUNT_KIND), INTENT(IN) :: sendcount, recvcnt
TYPE(MPI_Datatype), INTENT(IN) :: sendtype, recvtype
TYPE(*), DIMENSION(..), ASYNCHRONOUS :: recvbuf
```

```

1     TYPE(MPI_Comm), INTENT(IN) :: comm
2     TYPE(MPI_Info), INTENT(IN) :: info
3     TYPE(MPI_Request), INTENT(OUT) :: request
4     INTEGER, OPTIONAL, INTENT(OUT) :: ierror

```

### Fortran binding

```

6 MPI_NEIGHBOR_ALLGATHER_INIT(SENDBUF, SENDCOUNT, SENDTYPE, RECVBUF,
7     RECVCOUNT, RECVTYPE, COMM, INFO, REQUEST, IERROR)
8     <type> SENDBUF(*), RECVBUF(*)
9     INTEGER SENDCOUNT, SENDTYPE, RECVCOUNT, RECVTYPE, COMM, INFO, REQUEST,
10    IERROR

```

Creates a persistent collective communication request for the neighborhood allgather operation.

```

15 MPI_NEIGHBOR_ALLGATHERV_INIT(sendbuf, sendcount, sendtype, recvbuf, recvcoun
16    ts, displs, recvtype, comm, info, request)
17
18 IN     sendbuf           starting address of send buffer (choice)
19 IN     sendcount        number of elements sent to each neighbor
20                               (non-negative integer)
21
22 IN     sendtype         datatype of send buffer elements (handle)
23 OUT    recvbuf          starting address of receive buffer (choice)
24 IN     recvcoun
25    ts                   non-negative integer array (of length indegree)
26                               containing the number of elements that are received
27                               from each neighbor
28 IN     displs           integer array (of length indegree). Entry i specifies
29                               the displacement (relative to recvbuf) at which to
30                               place the incoming data from neighbor i
31 IN     recvtype         datatype of receive buffer elements (handle)
32 IN     comm              communicator with topology structure (handle)
33 IN     info              info argument (handle)
34 OUT    request          communication request (handle)

```

### C binding

```

38 int MPI_Neighbor_allgatherv_init(const void *sendbuf, int sendcount,
39     MPI_Datatype sendtype, void *recvbuf, const int recvcoun
40    ts[], const int displs[], MPI_Datatype recvtype, MPI_Comm comm,
41     MPI_Info info, MPI_Request *request)
42
43 int MPI_Neighbor_allgatherv_init_c(const void *sendbuf,
44     MPI_Count sendcount, MPI_Datatype sendtype, void *recvbuf,
45     const MPI_Count recvcoun
46    ts[], const MPI_Aint displs[],
47     MPI_Datatype recvtype, MPI_Comm comm, MPI_Info info,
48     MPI_Request *request)

```



**Fortran 2008 binding**

```

MPI_Neighbor_allgatherv_init(sendbuf, sendcount, sendtype, recvbuf,
    recvcounts, displs, recvtype, comm, info, request, ierror)
    TYPE(*), DIMENSION(..), INTENT(IN), ASYNCHRONOUS :: sendbuf
    INTEGER, INTENT(IN) :: sendcount, displs(*)
    TYPE(MPI_Datatype), INTENT(IN) :: sendtype, recvtype
    TYPE(*), DIMENSION(..), ASYNCHRONOUS :: recvbuf
    INTEGER, INTENT(IN), ASYNCHRONOUS :: recvcounts(*)
    TYPE(MPI_Comm), INTENT(IN) :: comm
    TYPE(MPI_Info), INTENT(IN) :: info
    TYPE(MPI_Request), INTENT(OUT) :: request
    INTEGER, OPTIONAL, INTENT(OUT) :: ierror

```

```

MPI_Neighbor_allgatherv_init(sendbuf, sendcount, sendtype, recvbuf,
    recvcounts, displs, recvtype, comm, info, request, ierror)
    TYPE(*), DIMENSION(..), INTENT(IN), ASYNCHRONOUS :: sendbuf
    INTEGER(KIND=MPI_COUNT_KIND), INTENT(IN) :: sendcount
    TYPE(MPI_Datatype), INTENT(IN) :: sendtype, recvtype
    TYPE(*), DIMENSION(..), ASYNCHRONOUS :: recvbuf
    INTEGER(KIND=MPI_COUNT_KIND), INTENT(IN), ASYNCHRONOUS :: recvcounts(*)
    INTEGER(KIND=MPI_ADDRESS_KIND), INTENT(IN) :: displs(*)
    TYPE(MPI_Comm), INTENT(IN) :: comm
    TYPE(MPI_Info), INTENT(IN) :: info
    TYPE(MPI_Request), INTENT(OUT) :: request
    INTEGER, OPTIONAL, INTENT(OUT) :: ierror

```

**Fortran binding**

```

MPI_NEIGHBOR_ALLGATHERV_INIT(SENDBUF, SENDCOUNT, SENDTYPE, RECVBUF,
    RECVCOUNTS, DISPLS, RECVTYPE, COMM, INFO, REQUEST, IERROR)
    <type> SENDBUF(*), RECVBUF(*)
    INTEGER SENDCOUNT, SENDTYPE, RECVCOUNTS(*), DISPLS(*), RECVTYPE, COMM,
    INFO, REQUEST, IERROR

```

Creates a persistent collective communication request for the neighborhood allgatherv operation.

## 8.8.2 Persistent Neighborhood Alltoall

```

MPI_NEIGHBOR_ALLTOALL_INIT(sendbuf, sendcount, sendtype, recvbuf, recvcount,
    recvtype, comm, info, request)

```

IN	sendbuf	starting address of send buffer (choice)
IN	sendcount	number of elements sent to each neighbor (non-negative integer)
IN	sendtype	datatype of send buffer elements (handle)
OUT	recvbuf	starting address of receive buffer (choice)
IN	recvcount	number of elements received from each neighbor (non-negative integer)
IN	recvtype	datatype of receive buffer elements (handle)
IN	comm	communicator with topology structure (handle)
IN	info	info argument (handle)
OUT	request	communication request (handle)

**C binding**

```

int MPI_Neighbor_alltoall_init(const void *sendbuf, int sendcount,
    MPI_Datatype sendtype, void *recvbuf, int recvcount,
    MPI_Datatype recvtype, MPI_Comm comm, MPI_Info info,
    MPI_Request *request)

```

```

int MPI_Neighbor_alltoall_init_c(const void *sendbuf, MPI_Count sendcount,
    MPI_Datatype sendtype, void *recvbuf, MPI_Count recvcount,
    MPI_Datatype recvtype, MPI_Comm comm, MPI_Info info,
    MPI_Request *request)

```

**Fortran 2008 binding**

```

MPI_Neighbor_alltoall_init(sendbuf, sendcount, sendtype, recvbuf,
    recvcount, recvtype, comm, info, request, ierror)
    TYPE(*), DIMENSION(..), INTENT(IN), ASYNCHRONOUS :: sendbuf
    INTEGER, INTENT(IN) :: sendcount, recvcount
    TYPE(MPI_Datatype), INTENT(IN) :: sendtype, recvtype
    TYPE(*), DIMENSION(..), ASYNCHRONOUS :: recvbuf
    TYPE(MPI_Comm), INTENT(IN) :: comm
    TYPE(MPI_Info), INTENT(IN) :: info
    TYPE(MPI_Request), INTENT(OUT) :: request
    INTEGER, OPTIONAL, INTENT(OUT) :: ierror

```

```

MPI_Neighbor_alltoall_init(sendbuf, sendcount, sendtype, recvbuf,
    recvcount, recvtype, comm, info, request, ierror)
    TYPE(*), DIMENSION(..), INTENT(IN), ASYNCHRONOUS :: sendbuf
    INTEGER(KIND=MPI_COUNT_KIND), INTENT(IN) :: sendcount, recvcount
    TYPE(MPI_Datatype), INTENT(IN) :: sendtype, recvtype
    TYPE(*), DIMENSION(..), ASYNCHRONOUS :: recvbuf

```

```

TYPE(MPI_Comm), INTENT(IN) :: comm
TYPE(MPI_Info), INTENT(IN) :: info
TYPE(MPI_Request), INTENT(OUT) :: request
INTEGER, OPTIONAL, INTENT(OUT) :: ierror

```

**Fortran binding**

```

MPI_NEIGHBOR_ALLTOALL_INIT(SENDBUF, SENDCOUNT, SENDTYPE, RECVBUF,
    RECVCOUNT, RECVTYPE, COMM, INFO, REQUEST, IERROR)
<type> SENDBUF(*), RECVBUF(*)
INTEGER SENDCOUNT, SENDTYPE, RECVCOUNT, RECVTYPE, COMM, INFO, REQUEST,
    IERROR

```

Creates a persistent collective communication request for the neighborhood alltoall operation.

```

MPI_NEIGHBOR_ALLTOALLV_INIT(sendbuf, sendcounts, sdispls, sendtype, recvbuf,
    recvcounts, rdispls, recvtype, comm, info, request)

```

IN	sendbuf	starting address of send buffer (choice)
IN	sendcounts	non-negative integer array (of length outdegree) specifying the number of elements to send to each neighbor
IN	sdispls	integer array (of length outdegree). Entry j specifies the displacement (relative to sendbuf) from which send the outgoing data to neighbor j
IN	sendtype	datatype of send buffer elements (handle)
OUT	recvbuf	starting address of receive buffer (choice)
IN	recvcounts	non-negative integer array (of length indegree) specifying the number of elements that are received from each neighbor
IN	rdispls	integer array (of length indegree). Entry i specifies the displacement (relative to recvbuf) at which to place the incoming data from neighbor i
IN	recvtype	datatype of receive buffer elements (handle)
IN	comm	communicator with topology structure (handle)
IN	info	info argument (handle)
OUT	request	communication request (handle)

**C binding**

```

int MPI_Neighbor_alltoallv_init(const void *sendbuf,
    const int sendcounts[], const int sdispls[],
    MPI_Datatype sendtype, void *recvbuf, const int recvcounts[],
    const int rdispls[], MPI_Datatype recvtype, MPI_Comm comm,
    MPI_Info info, MPI_Request *request)

```

```

1  int MPI_Neighbor_alltoallv_init_c(const void *sendbuf,
2      const MPI_Count sendcounts[], const MPI_Aint sdispls[],
3      MPI_Datatype sendtype, void *recvbuf,
4      const MPI_Count recvcounts[], const MPI_Aint rdispls[],
5      MPI_Datatype recvtype, MPI_Comm comm, MPI_Info info,
6      MPI_Request *request)
7
8  Fortran 2008 binding
9  MPI_Neighbor_alltoallv_init(sendbuf, sendcounts, sdispls, sendtype,
10     recvbuf, recvcounts, rdispls, recvtype, comm, info, request,
11     ierror)
12     TYPE(*), DIMENSION(..), INTENT(IN), ASYNCHRONOUS :: sendbuf
13     INTEGER, INTENT(IN), ASYNCHRONOUS :: sendcounts(*), sdispls(*),
14     recvcounts(*), rdispls(*)
15     TYPE(MPI_Datatype), INTENT(IN) :: sendtype, recvtype
16     TYPE(*), DIMENSION(..), ASYNCHRONOUS :: recvbuf
17     TYPE(MPI_Comm), INTENT(IN) :: comm
18     TYPE(MPI_Info), INTENT(IN) :: info
19     TYPE(MPI_Request), INTENT(OUT) :: request
20     INTEGER, OPTIONAL, INTENT(OUT) :: ierror
21
22  MPI_Neighbor_alltoallv_init(sendbuf, sendcounts, sdispls, sendtype,
23     recvbuf, recvcounts, rdispls, recvtype, comm, info, request,
24     ierror)
25     TYPE(*), DIMENSION(..), INTENT(IN), ASYNCHRONOUS :: sendbuf
26     INTEGER(KIND=MPI_COUNT_KIND), INTENT(IN), ASYNCHRONOUS ::
27     sendcounts(*), recvcounts(*)
28     INTEGER(KIND=MPI_ADDRESS_KIND), INTENT(IN), ASYNCHRONOUS :: sdispls(*),
29     rdispls(*)
30     TYPE(MPI_Datatype), INTENT(IN) :: sendtype, recvtype
31     TYPE(*), DIMENSION(..), ASYNCHRONOUS :: recvbuf
32     TYPE(MPI_Comm), INTENT(IN) :: comm
33     TYPE(MPI_Info), INTENT(IN) :: info
34     TYPE(MPI_Request), INTENT(OUT) :: request
35     INTEGER, OPTIONAL, INTENT(OUT) :: ierror
36
37  Fortran binding
38  MPI_NEIGHBOR_ALLTOALLV_INIT(SENDBUF, SENDCOUNTS, SDISPLS, SENDTYPE,
39     RECVBUF, RECVCOUNTS, RDISPLS, RECVTYPE, COMM, INFO, REQUEST,
40     IERROR)
41     <type> SENDBUF(*), RECVBUF(*)
42     INTEGER SENDCOUNTS(*), SDISPLS(*), SENDTYPE, RECVCOUNTS(*), RDISPLS(*),
43     RECVTYPE, COMM, INFO, REQUEST, IERROR
44
45     Creates a persistent collective communication request for the neighborhood alltoallv
46     operation.
47
48

```

```

MPI_NEIGHBOR_ALLTOALLW_INIT(sendbuf, sendcounts, sdispls, sendtypes, recvbuf,
                             recvcounts, rdispls, recvtypes, comm, info, request)
1
2
3
IN    sendbuf                starting address of send buffer (choice)
4
IN    sendcounts             non-negative integer array (of length outdegree)
5
                             specifying the number of elements to send to each
6
                             neighbor
7
IN    sdispls                integer array (of length outdegree). Entry j specifies
8
                             the displacement in bytes (relative to sendbuf) from
9
                             which to take the outgoing data destined for
10
                             neighbor j (array of integers)
11
IN    sendtypes              array of datatypes (of length outdegree). Entry j
12
                             specifies the type of data to send to neighbor j (array
13
                             of handles)
14
OUT   recvbuf                starting address of receive buffer (choice)
15
IN    recvcounts             non-negative integer array (of length indegree)
16
                             specifying the number of elements that are received
17
                             from each neighbor
18
IN    rdispls                integer array (of length indegree). Entry i specifies
19
                             the displacement in bytes (relative to recvbuf) at
20
                             which to place the incoming data from neighbor i
21
                             (array of integers)
22
IN    recvtypes              array of datatypes (of length indegree). Entry i
23
                             specifies the type of data received from neighbor i
24
                             (array of handles)
25
IN    comm                   communicator with topology structure (handle)
26
IN    info                   info argument (handle)
27
OUT   request                communication request (handle)
28
29
30
31
32

```

**C binding**

```

int MPI_Neighbor_alltoallw_init(const void *sendbuf,
                                const int sendcounts[], const MPI_Aint sdispls[],
                                const MPI_Datatype sendtypes[], void *recvbuf,
                                const int recvcounts[], const MPI_Aint rdispls[],
                                const MPI_Datatype recvtypes[], MPI_Comm comm, MPI_Info info,
                                MPI_Request *request)
33
34
35
36
37
38
39
40

```

```

int MPI_Neighbor_alltoallw_init_c(const void *sendbuf,
                                   const MPI_Count sendcounts[], const MPI_Aint sdispls[],
                                   const MPI_Datatype sendtypes[], void *recvbuf,
                                   const MPI_Count recvcounts[], const MPI_Aint rdispls[],
                                   const MPI_Datatype recvtypes[], MPI_Comm comm, MPI_Info info,
                                   MPI_Request *request)
41
42
43
44
45
46

```

**Fortran 2008 binding**

```

MPI_Neighbor_alltoallw_init(sendbuf, sendcounts, sdispls, sendtypes,
                             recvcounts, rdispls, recvtypes, comm, info, request)
47
48

```

```

1         recvbuf, recvcounts, rdispls, recvtypes, comm, info, request,
2         ierror)
3     TYPE(*), DIMENSION(..), INTENT(IN), ASYNCHRONOUS :: sendbuf
4     INTEGER, INTENT(IN), ASYNCHRONOUS :: sendcounts(*), recvcounts(*)
5     INTEGER(KIND=MPI_ADDRESS_KIND), INTENT(IN), ASYNCHRONOUS :: sdispls(*),
6         rdispls(*)
7     TYPE(MPI_Datatype), INTENT(IN), ASYNCHRONOUS :: sendtypes(*),
8         recvtypes(*)
9     TYPE(*), DIMENSION(..), ASYNCHRONOUS :: recvbuf
10    TYPE(MPI_Comm), INTENT(IN) :: comm
11    TYPE(MPI_Info), INTENT(IN) :: info
12    TYPE(MPI_Request), INTENT(OUT) :: request
13    INTEGER, OPTIONAL, INTENT(OUT) :: ierror
14
15 MPI_Neighbor_alltoallw_init(sendbuf, sendcounts, sdispls, sendtypes,
16     recvbuf, recvcounts, rdispls, recvtypes, comm, info, request,
17     ierror)
18    TYPE(*), DIMENSION(..), INTENT(IN), ASYNCHRONOUS :: sendbuf
19    INTEGER(KIND=MPI_COUNT_KIND), INTENT(IN), ASYNCHRONOUS ::
20     sendcounts(*), recvcounts(*)
21    INTEGER(KIND=MPI_ADDRESS_KIND), INTENT(IN), ASYNCHRONOUS :: sdispls(*),
22     rdispls(*)
23    TYPE(MPI_Datatype), INTENT(IN), ASYNCHRONOUS :: sendtypes(*),
24     recvtypes(*)
25    TYPE(*), DIMENSION(..), ASYNCHRONOUS :: recvbuf
26    TYPE(MPI_Comm), INTENT(IN) :: comm
27    TYPE(MPI_Info), INTENT(IN) :: info
28    TYPE(MPI_Request), INTENT(OUT) :: request
29    INTEGER, OPTIONAL, INTENT(OUT) :: ierror

```

### Fortran binding

```

31 MPI_NEIGHBOR_ALLTOALLW_INIT(SENDBUF, SENDCOUNTS, SDISPLS, SENDTYPES,
32     RECVBUF, RECVCOUNTS, RDISPLS, RECVTYPES, COMM, INFO, REQUEST,
33     IERROR)
34 <type> SENDBUF(*), RECVBUF(*)
35 INTEGER SENDCOUNTS(*), SENDTYPES(*), RECVCOUNTS(*), RECVTYPES(*), COMM,
36     INFO, REQUEST, IERROR
37 INTEGER(KIND=MPI_ADDRESS_KIND) SDISPLS(*), RDISPLS(*)

```

Creates a persistent collective communication request for the neighborhood alltoallw operation.

## 8.9 An Application Example

**Example 8.11** The example in Figures 8.4-8.7 shows how the grid definition and inquiry functions can be used in an application program. A partial differential equation, for instance the Poisson equation, is to be solved on a rectangular domain. First, the processes organize themselves in a two-dimensional structure. Each process then inquires about the ranks of

its neighbors in the four directions (up, down, right, left). The numerical problem is solved by an iterative method, the details of which are hidden in the subroutine `relax`.

In each relaxation step each process computes new values for the solution grid function at the points `u(1:100,1:100)` owned by the process. Then the values at inter-process boundaries have to be exchanged with neighboring processes. For example, the newly calculated values in `u(1,1:100)` must be sent into the halo cells `u(101,1:100)` of the left-hand neighbor with coordinates `(own_coord(1)-1,own_coord(2))`.

DRAFT

1  
2  
3  
4  
5  
6  
7  
8  
9  
10  
11  
12  
13  
14  
15  
16  
17  
18  
19  
20  
21  
22  
23  
24  
25  
26  
27  
28  
29  
30  
31  
32  
33  
34  
35  
36  
37  
38  
39  
40  
41  
42  
43  
44  
45  
46  
47  
48

```

1  INTEGER ndims, num_neigh
2  LOGICAL reorder
3  PARAMETER (ndims=2, num_neigh=4, reorder=.true.)
4  INTEGER comm, comm_size, comm_cart, dims(ndims), ierr
5  INTEGER neigh_rank(num_neigh), own_coords(ndims), i, j, it
6  LOGICAL periods(ndims)
7  REAL u(0:101,0:101), f(0:101,0:101)
8  DATA dims / ndims * 0 /
9  comm = MPI_COMM_WORLD
10 CALL MPI_COMM_SIZE(comm, comm_size, ierr)
11 ! Set process grid size and periodicity
12 CALL MPI_DIMS_CREATE(comm_size, ndims, dims, ierr)
13 periods(1) = .TRUE.
14 periods(2) = .TRUE.
15 ! Create a grid structure in WORLD group and inquire about own position
16 CALL MPI_CART_CREATE(comm, ndims, dims, periods, reorder, &
17                      comm_cart, ierr)
18 CALL MPI_CART_GET(comm_cart, ndims, dims, periods, own_coords, ierr)
19 i = own_coords(1)
20 j = own_coords(2)
21 ! Look up the ranks for the neighbors. Own process coordinates are (i,j).
22 ! Neighbors are (i-1,j), (i+1,j), (i,j-1), (i,j+1) modulo (dims(1),dims(2))
23 CALL MPI_CART_SHIFT(comm_cart, 0,1, neigh_rank(1), neigh_rank(2), ierr)
24 CALL MPI_CART_SHIFT(comm_cart, 1,1, neigh_rank(3), neigh_rank(4), ierr)
25 ! Initialize the grid functions and start the iteration
26 CALL init(u, f)
27 DO it=1,100
28     CALL relax(u, f)
29     ! Exchange data with neighbor processes
30     CALL exchange(u, comm_cart, neigh_rank, num_neigh)
31 END DO
32 CALL output(u)
33
34
35
36
37
38
39
40
41
42
43
44
45
46
47
48

```

Figure 8.4: Set-up of process structure for two-dimensional parallel Poisson solver



```

SUBROUTINE exchange(u, comm_cart, neigh_rank, num_neigh) 1
REAL u(0:101,0:101) 2
INTEGER comm_cart, num_neigh, neigh_rank(num_neigh) 3
REAL sndbuf(100,num_neigh), rcvbuf(100,num_neigh) 4
INTEGER ierr 5
sndbuf(1:100,1) = u( 1,1:100) 6
sndbuf(1:100,2) = u(100,1:100) 7
sndbuf(1:100,3) = u(1:100, 1) 8
sndbuf(1:100,4) = u(1:100,100) 9
CALL MPI_NEIGHBOR_ALLTOALL(sndbuf, 100, MPI_REAL, rcvbuf, 100, MPI_REAL, & 10
                           comm_cart, ierr) 11
! instead of 12
! CALL MPI_Irecv(rcvbuf(1,1),100,MPI_REAL, neigh_rank(1),..., rq(1), ierr) 13
! CALL MPI_Isend(sndbuf(1,2),100,MPI_REAL, neigh_rank(2),..., rq(2), ierr) 14
! Always pairing a receive from rank_source with a send to rank_dest 15
! of the same direction in MPI_CART_SHIFT! 16
! CALL MPI_Irecv(rcvbuf(1,2),100,MPI_REAL, neigh_rank(2),..., rq(3), ierr) 17
! CALL MPI_Isend(sndbuf(1,1),100,MPI_REAL, neigh_rank(1),..., rq(4), ierr) 18
! CALL MPI_Irecv(rcvbuf(1,3),100,MPI_REAL, neigh_rank(3),..., rq(5), ierr) 19
! CALL MPI_Isend(sndbuf(1,4),100,MPI_REAL, neigh_rank(4),..., rq(6), ierr) 20
! CALL MPI_Irecv(rcvbuf(1,4),100,MPI_REAL, neigh_rank(4),..., rq(7), ierr) 21
! CALL MPI_Isend(sndbuf(1,3),100,MPI_REAL, neigh_rank(3),..., rq(8), ierr) 22
! Of course, one can first start all four Irecv and then all four Isend, 23
! Or vice versa, but both in the sequence shown above. Otherwise, the 24
! matching would be wrong for 2 or only 1 processes in a direction. 25
! CALL MPI_Waitall(2*num_neigh, rq, statuses, ierr) 26
u( 0,1:100) = rcvbuf(1:100,1) 27
u(101,1:100) = rcvbuf(1:100,2) 28
u(1:100, 0) = rcvbuf(1:100,3) 29
u(1:100,101) = rcvbuf(1:100,4) 30
END 31

```

Figure 8.5: Communication routine with local data copying and sparse neighborhood all-to-all

```

1  SUBROUTINE exchange(u, comm_cart, neigh_rank, num_neigh)
2  IMPLICIT NONE
3  USE MPI
4  REAL u(0:101,0:101)
5  INTEGER comm_cart, num_neigh, neigh_rank(num_neigh)
6  INTEGER sndcounts(num_neigh), sndtypes(num_neigh)
7  INTEGER rcvcounts(num_neigh), rcvtypes(num_neigh)
8  INTEGER (KIND=MPI_ADDRESS_KIND) lb, sizeofreal
9  INTEGER (KIND=MPI_ADDRESS_KIND) sdispls(num_neigh), rdispls(num_neigh)
10 INTEGER type_vec, ierr
11 ! The following initialization need to be done only once
12 ! before the first call of exchange.
13 CALL MPI_TYPE_GET_EXTENT(MPI_REAL, lb, sizeofreal, ierr)
14 CALL MPI_TYPE_VECTOR(100, 1, 102, MPI_REAL, type_vec, ierr)
15 CALL MPI_TYPE_COMMIT(type_vec, ierr)
16 sndtypes(1:2) = type_vec
17 sndcounts(1:2) = 1
18 sndtypes(3:4) = MPI_REAL
19 sndcounts(3:4) = 100
20 rcvtypes = sndtypes
21 rcvcounts = sndcounts
22 sdispls(1) = ( 1 + 1*102) * sizeofreal ! first element of u( 1 , 1:100)
23 sdispls(2) = (100 + 1*102) * sizeofreal ! first element of u(100 , 1:100)
24 sdispls(3) = ( 1 + 1*102) * sizeofreal ! first element of u( 1:100, 1 )
25 sdispls(4) = ( 1 + 100*102) * sizeofreal ! first element of u( 1:100,100 )
26 rdispls(1) = ( 0 + 1*102) * sizeofreal ! first element of u( 0 , 1:100)
27 rdispls(2) = (101 + 1*102) * sizeofreal ! first element of u(101 , 1:100)
28 rdispls(3) = ( 1 + 0*102) * sizeofreal ! first element of u( 1:100, 0 )
29 rdispls(4) = ( 1 + 101*102) * sizeofreal ! first element of u( 1:100,101 )
30 ! the following communication has to be done in each call of exchange
31 CALL MPI_NEIGHBOR_ALLTOALLW(u, sndcounts, sdispls, sndtypes, &
32 u, rcvcounts, rdispls, rcvtypes, &
33 comm_cart, ierr)
34 ! The following finalizing need to be done only once
35 ! after the last call of exchange.
36 CALL MPI_TYPE_FREE(type_vec, ierr)
37 END

```

Figure 8.6: Communication routine with sparse neighborhood all-to-all-w and without local data copying

```

INTEGER ndims, num_neigh
LOGICAL reorder
PARAMETER (ndims=2, num_neigh=4, reorder=.true.)
INTEGER comm, comm_size, comm_cart, dims(ndims), it, ierr
LOGICAL periods(ndims)
REAL u(0:101,0:101), f(0:101,0:101)
DATA dims / ndims * 0 /
INTEGER sndcounts(num_neigh), sndtypes(num_neigh)
INTEGER rcvcounts(num_neigh), rcvtypes(num_neigh)
INTEGER (KIND=MPI_ADDRESS_KIND) lb, sizeofreal
INTEGER (KIND=MPI_ADDRESS_KIND) sdispls(num_neigh), rdispls(num_neigh)
INTEGER type_vec, request, status
comm = MPI_COMM_WORLD
CALL MPI_COMM_SIZE(comm, comm_size, ierr)
! Set process grid size and periodicity
CALL MPI_DIMS_CREATE(comm_size, ndims, dims, ierr)
periods(1) = .TRUE.
periods(2) = .TRUE.
! Create a grid structure in WORLD group
CALL MPI_CART_CREATE(comm, ndims, dims, periods, reorder, &
                    comm_cart, ierr)
! Create datatypes for the neighborhood communication
!
! Insert code from example in Figure 7.4 to create and initialize
! sndcounts, sdispls, sndtypes, rcvcounts, rdispls, and rcvtypes
!
! Initialize the neighborhood all-to-all-w operation
CALL MPI_NEIGHBOR_ALLTOALLW_INIT(u, sndcounts, sdispls, sndtypes, &
                                u, rcvcounts, rdispls, rcvtypes, &
                                comm_cart, info, request, ierr)
! Initialize the grid functions and start the iteration
CALL init(u, f)
DO it=1,100
! Start data exchange with neighbor processes
CALL MPI_START(request, ierr)
! Compute inner cells
CALL relax_inner (u, f)
! Check on completion of neighbor exchange
CALL MPI_WAIT(request, status, ierr)
! Compute edge cells
CALL relax_edges(u, f)
END DO
CALL output(u)
CALL MPI_REQUEST_FREE(request, ierr)
CALL MPI_TYPE_FREE(type_vec, ierr)

```

Figure 8.7: Two-dimensional parallel Poisson solver with persistent sparse neighborhood all-to-all-w and without local data copying

1  
2  
3  
4  
5  
6  
7  
8  
9  
10  
11  
12  
13  
14  
15  
16  
17  
18  
19  
20  
21  
22  
23  
24  
25  
26  
27  
28  
29  
30  
31  
32  
33  
34  
35  
36  
37  
38  
39  
40  
41  
42  
43  
44  
45  
46  
47  
48

DRAFT

1  
2  
3  
4  
5  
6  
7  
8  
9  
10  
11  
12  
13  
14  
15  
16  
17  
18  
19  
20  
21  
22  
23  
24  
25  
26  
27  
28  
29  
30  
31  
32  
33  
34  
35  
36  
37  
38  
39  
40  
41  
42  
43  
44  
45  
46  
47  
48

## Chapter 9

# MPI Environmental Management

This chapter discusses routines for getting and, where appropriate, setting various parameters that relate to the MPI implementation and the execution environment (such as error handling). The procedures for entering and leaving the MPI execution environment are also described here.

### 9.1 Implementation Information

#### 9.1.1 Version Inquiries

In order to cope with changes to the MPI Standard, there are both compile-time and run-time ways to determine which version of the standard is in use in the environment one is using.

The “version” will be represented by two separate integers, for the version and subversion: In C,

```
#define MPI_VERSION    3  
#define MPI_SUBVERSION 1
```

in Fortran,

```
INTEGER :: MPI_VERSION, MPI_SUBVERSION  
PARAMETER (MPI_VERSION    = 3)  
PARAMETER (MPI_SUBVERSION = 1)
```

For runtime determination,

`MPI_GET_VERSION(version, subversion)`

OUT	version	version number (integer)
OUT	subversion	subversion number (integer)

#### C binding

```
int MPI_Get_version(int *version, int *subversion)
```

#### Fortran 2008 binding

```
MPI_Get_version(version, subversion, ierror)
```

```

1     INTEGER, INTENT(OUT) :: version, subversion
2     INTEGER, OPTIONAL, INTENT(OUT) :: ierror

```

### Fortran binding

```

4 MPI_GET_VERSION(VERSION, SUBVERSION, IERROR)
5     INTEGER VERSION, SUBVERSION, IERROR

```

MPI\_GET\_VERSION can be called at any time in an MPI program. This function must always be thread-safe, as defined in Section 11.6. Valid (MPI\_VERSION, MPI\_SUBVERSION) pairs in this and previous versions of the MPI standard are (4,0), (3,1), (3,0), (2,2), (2,1), (2,0), and (1,2).

```

13 MPI_GET_LIBRARY_VERSION(version, resultlen)

```

14	OUT	version	version number (string)
15	OUT	resultlen	Length (in printable characters) of the result
16			returned in version (integer)

### C binding

```

19 int MPI_Get_library_version(char *version, int *resultlen)

```

### Fortran 2008 binding

```

22 MPI_Get_library_version(version, resultlen, ierror)
23     CHARACTER(LEN=MPI_MAX_LIBRARY_VERSION_STRING), INTENT(OUT) :: version
24     INTEGER, INTENT(OUT) :: resultlen
25     INTEGER, OPTIONAL, INTENT(OUT) :: ierror

```

### Fortran binding

```

28 MPI_GET_LIBRARY_VERSION(VERSION, RESULTLEN, IERROR)
29     CHARACTER*(*) VERSION
30     INTEGER RESULTLEN, IERROR

```

This routine returns a string representing the version of the MPI library. The version argument is a character string for maximum flexibility.

*Advice to implementors.* An implementation of MPI should return a different string for every change to its source code or build that could be visible to the user. (*End of advice to implementors.*)

The argument `version` must represent storage that is MPI\_MAX\_LIBRARY\_VERSION\_STRING characters long. MPI\_GET\_LIBRARY\_VERSION may write up to this many characters into `version`.

The number of characters actually written is returned in the output argument, `resultlen`. In C, a null character is additionally stored at `version[resultlen]`. The value of `resultlen` cannot be larger than MPI\_MAX\_LIBRARY\_VERSION\_STRING - 1. In Fortran, `version` is padded on the right with blank characters. The value of `resultlen` cannot be larger than MPI\_MAX\_LIBRARY\_VERSION\_STRING.

MPI\_GET\_LIBRARY\_VERSION can be called at any time in an MPI program. This function must always be thread-safe, as defined in Section 11.6.

### 9.1.2 Environmental Inquiries

When using the World Model (Section 11.2), a set of attributes that describe the execution environment is attached to the communicator `MPI_COMM_WORLD` when MPI is initialized. The values of these attributes can be inquired by using the function `MPI_COMM_GET_ATTR` described in Section 7.7 and in Section 19.3.7. It is erroneous to delete these attributes, free their keys, or change their values.

The list of predefined attribute keys include

**MPI\_TAG\_UB** Upper bound for tag value.

**MPI\_HOST** Host process rank, if such exists, `MPI_PROC_NULL`, otherwise.

**MPI\_IO** rank of a node that has regular I/O facilities (possibly myrank). Nodes in the same communicator may return different values for this parameter.

**MPI\_WTIME\_IS\_GLOBAL** Boolean variable that indicates whether clocks are synchronized.

When using the Sessions Model (Section 11.3), only the `MPI_TAG_UB` attribute is available.

Vendors may add implementation-specific parameters (such as node number, real memory size, virtual memory size, etc.)

These predefined attributes do not change value between MPI initialization (`MPI_INIT`) and MPI completion (`MPI_FINALIZE`), and cannot be updated or deleted by users.

*Advice to users.* Note that in the C binding, the value returned by these attributes is a *pointer* to an `int` containing the requested value. (*End of advice to users.*)

The required parameter values are discussed in more detail below:

#### Tag Values

Tag values range from 0 to the value returned for `MPI_TAG_UB`, inclusive. These values are guaranteed to be unchanging during the execution of an MPI program. In addition, the tag upper bound value must be *at least* 32767. An MPI implementation is free to make the value of `MPI_TAG_UB` larger than this; for example, the value  $2^{30} - 1$  is also a valid value for `MPI_TAG_UB`.

In the Sessions Model, the attribute `MPI_TAG_UB` is attached to all communicators created by `MPI_COMM_CREATE_FROM_GROUP` and `MPI_INTERCOMM_CREATE_FROM_GROUPS`, with the same value on all MPI processes in the communicator. In the World Model, the attribute `MPI_TAG_UB` has the same value on all processes of `MPI_COMM_WORLD`.

#### Host Rank

The value returned for `MPI_HOST` gets the rank of the *HOST* process in the group associated with communicator `MPI_COMM_WORLD`, if there is such. `MPI_PROC_NULL` is returned if there is no host. MPI does not specify what it means for a process to be a *HOST*, nor does it require that a *HOST* exists.

The attribute `MPI_HOST` has the same value on all processes of `MPI_COMM_WORLD`.

## IO Rank

The value returned for `MPI_IO` is the rank of a processor that can provide language-standard I/O facilities. For Fortran, this means that all of the Fortran I/O operations are supported (e.g., `OPEN`, `REWIND`, `WRITE`). For C, this means that all of the ISO C I/O operations are supported (e.g., `fopen`, `fprintf`, `lseek`).

If every process can provide language-standard I/O, then the value `MPI_ANY_SOURCE` will be returned. Otherwise, if the calling process can provide language-standard I/O, then its rank will be returned. Otherwise, if some process can provide language-standard I/O then the rank of one such process will be returned. The same value need not be returned by all processes. If no process can provide language-standard I/O, then the value `MPI_PROC_NULL` will be returned.

*Advice to users.* Note that input is not collective, and this attribute does *not* indicate which process can or does provide input. (*End of advice to users.*)

## Clock Synchronization

The value returned for `MPI_WTIME_IS_GLOBAL` is 1 if clocks at all processes in `MPI_COMM_WORLD` are synchronized, 0 otherwise. A collection of clocks is considered synchronized if explicit effort has been taken to synchronize them. The expectation is that the variation in time, as measured by calls to `MPI_WTIME`, will be less than one half the round-trip time for an MPI message of length zero. If time is measured at a process just before a send and at another process just after a matching receive, the second time should be always higher than the first one.

The attribute `MPI_WTIME_IS_GLOBAL` need not be present when the clocks are not synchronized (however, the attribute key `MPI_WTIME_IS_GLOBAL` is always valid). This attribute may be associated with communicators other than `MPI_COMM_WORLD`.

The attribute `MPI_WTIME_IS_GLOBAL` has the same value on all processes of `MPI_COMM_WORLD`.

## Inquire Processor Name

`MPI_GET_PROCESSOR_NAME(name, resultlen)`

OUT	<code>name</code>	A unique specifier for the actual (as opposed to virtual) node.
OUT	<code>resultlen</code>	Length (in printable characters) of the result returned in <code>name</code>

## C binding

```
int MPI_Get_processor_name(char *name, int *resultlen)
```

## Fortran 2008 binding

```
MPI_Get_processor_name(name, resultlen, ierror)
CHARACTER(LEN=MPI_MAX_PROCESSOR_NAME), INTENT(OUT) :: name
INTEGER, INTENT(OUT) :: resultlen
INTEGER, OPTIONAL, INTENT(OUT) :: ierror
```



**Fortran binding**

```

MPI_GET_PROCESSOR_NAME(NAME, RESULTLEN, IERROR)
  CHARACTER*(*) NAME
  INTEGER RESULTLEN, IERROR

```

This routine returns the name of the processor on which it was called at the moment of the call. The name is a character string for maximum flexibility. From this value it must be possible to identify a specific piece of hardware; possible values include “processor 9 in rack 4 of mpp.cs.org” and “231” (where 231 is the actual processor number in the running homogeneous system). The argument `name` must represent storage that is at least `MPI_MAX_PROCESSOR_NAME` characters long. `MPI_GET_PROCESSOR_NAME` may write up to this many characters into `name`.

The number of characters actually written is returned in the output argument, `resultlen`. In C, a null character is additionally stored at `name[resultlen]`. The value of `resultlen` cannot be larger than `MPI_MAX_PROCESSOR_NAME-1`. In Fortran, `name` is padded on the right with blank characters. The value of `resultlen` cannot be larger than `MPI_MAX_PROCESSOR_NAME`.

*Rationale.* This function allows MPI implementations that do process migration to return the current processor. Note that nothing in MPI *requires* or defines process migration; this definition of `MPI_GET_PROCESSOR_NAME` simply allows such an implementation. (*End of rationale.*)

*Advice to users.* The user must provide at least `MPI_MAX_PROCESSOR_NAME` space to write the processor name—processor names can be this long. The user should examine the output argument, `resultlen`, to determine the actual length of the name. (*End of advice to users.*)

**9.2 Memory Allocation**

In some systems, message-passing and remote-memory-access (RMA) operations run faster when accessing specially allocated memory (e.g., memory that is shared by the other processes in the communicating group on an SMP). MPI provides a mechanism for allocating and freeing such special memory. The use of such memory for message-passing or RMA is not mandatory, and this memory can be used without restrictions as any other dynamically allocated memory. However, implementations may restrict the use of some RMA functionality as defined in Section [12.5.3](#).

```

MPI_ALLOC_MEM(size, info, baseptr)

```

IN	size	size of memory segment in bytes (non-negative integer)
IN	info	info argument (handle)
OUT	baseptr	pointer to beginning of memory segment allocated

**C binding**

```

int MPI_Alloc_mem(MPI_Aint size, MPI_Info info, void *baseptr)

```

**Fortran 2008 binding**

```

1 MPI_Alloc_mem(size, info, baseptr, ierror)
2   USE, INTRINSIC :: ISO_C_BINDING, ONLY : C_PTR
3   INTEGER(KIND=MPI_ADDRESS_KIND), INTENT(IN) :: size
4   TYPE(MPI_Info), INTENT(IN) :: info
5   TYPE(C_PTR), INTENT(OUT) :: baseptr
6   INTEGER, OPTIONAL, INTENT(OUT) :: ierror

```

**Fortran binding**

```

9 MPI_ALLOC_MEM(SIZE, INFO, BASEPTR, IERROR)
10  INTEGER(KIND=MPI_ADDRESS_KIND) SIZE, BASEPTR
11  INTEGER INFO, IERROR

```

If the Fortran compiler provides `TYPE(C_PTR)`, then the following generic interface must be provided in the `mpi` module and should be provided in `mpif.h` through overloading, i.e., with the same routine name as the routine with `INTEGER(KIND=MPI_ADDRESS_KIND)` `BASEPTR`, but with a different specific procedure name:

```

17
18 INTERFACE MPI_ALLOC_MEM
19   SUBROUTINE MPI_ALLOC_MEM(SIZE, INFO, BASEPTR, IERROR)
20     IMPORT :: MPI_ADDRESS_KIND
21     INTEGER INFO, IERROR
22     INTEGER(KIND=MPI_ADDRESS_KIND) SIZE, BASEPTR
23   END SUBROUTINE
24   SUBROUTINE MPI_ALLOC_MEM_CPTR(SIZE, INFO, BASEPTR, IERROR)
25     USE, INTRINSIC :: ISO_C_BINDING, ONLY : C_PTR
26     IMPORT :: MPI_ADDRESS_KIND
27     INTEGER :: INFO, IERROR
28     INTEGER(KIND=MPI_ADDRESS_KIND) :: SIZE
29     TYPE(C_PTR) :: BASEPTR
30   END SUBROUTINE
31 END INTERFACE

```

The base procedure name of this overloaded function is `MPI_ALLOC_MEM_CPTR`. The implied specific procedure names are described in Section 19.1.5.

By default, the allocated memory shall be aligned to at least the alignment required for load/store accesses of any datatype corresponding to a predefined MPI datatype. The `info` argument may be used to specify a desired alternative minimum alignment in bytes for the allocated memory by setting the value of the key "mpi\_minimum\_memory\_alignment" to an integral number equal to a power of two. An implementation may ignore values smaller than the default required alignment. The `info` argument can also be used to provide directives that control the desired location of the allocated memory. Such a directive does not affect the semantics of the call. The corresponding `info` values are implementation-dependent. A null directive value of `info = MPI_INFO_NULL` is always valid.

The function `MPI_ALLOC_MEM` may return an error code of class `MPI_ERR_NO_MEM` to indicate it failed because memory is exhausted.

MPI\_FREE\_MEM(base)

IN            base                            initial address of memory segment allocated by  
MPI\_ALLOC\_MEM (choice)

### C binding

```
int MPI_Free_mem(void *base)
```

### Fortran 2008 binding

```
MPI_Free_mem(base, ierror)
   TYPE(*), DIMENSION(..), INTENT(IN), ASYNCHRONOUS :: base
   INTEGER, OPTIONAL, INTENT(OUT) :: ierror
```

### Fortran binding

```
MPI_FREE_MEM(BASE, IERROR)
   <type> BASE(*)
   INTEGER IERROR
```

The function MPI\_FREE\_MEM may return an error code of class MPI\_ERR\_BASE to indicate an invalid base argument.

*Rationale.* The C bindings of MPI\_ALLOC\_MEM and MPI\_FREE\_MEM are similar to the bindings for the `malloc` and `free` C library calls: a call to `MPI_Alloc_mem(..., &base)` should be paired with a call to `MPI_Free_mem(base)` (one less level of indirection). Both arguments are declared to be of same type `void*` so as to facilitate type casting. The Fortran binding is consistent with the C bindings: the Fortran MPI\_ALLOC\_MEM call returns in `baseptr` the `TYPE(C_PTR)` pointer or the (integer valued) address of the allocated memory. The `base` argument of MPI\_FREE\_MEM is a choice argument, which passes (a reference to) the variable stored at that location. (*End of rationale.*)

*Advice to implementors.* If MPI\_ALLOC\_MEM allocates special memory, then a design similar to the design of C `malloc` and `free` functions has to be used, in order to find out the size of a memory segment, when the segment is freed. If no special memory is used, MPI\_ALLOC\_MEM simply invokes `malloc`, and MPI\_FREE\_MEM invokes `free`.

A call to MPI\_ALLOC\_MEM can be used in shared memory systems to allocate memory in a shared memory segment. (*End of advice to implementors.*)

**Example 9.1** Example of use of MPI\_ALLOC\_MEM, in Fortran with `TYPE(C_PTR)` pointers. We assume 4-byte REALs.

```
USE mpi_f08 ! or USE mpi (not guaranteed with INCLUDE 'mpif.h')
USE, INTRINSIC :: ISO_C_BINDING
TYPE(C_PTR) :: p
REAL, DIMENSION(:,,:), POINTER :: a ! no memory is allocated
INTEGER, DIMENSION(2) :: shape
INTEGER(KIND=MPI_ADDRESS_KIND) :: size
shape = (/100,100/)
```

```

1  size = 4 * shape(1) * shape(2)           ! assuming 4 bytes per REAL
2  CALL MPI_Alloc_mem(size,MPI_INFO_NULL,p,ierr) ! memory is allocated and
3  CALL C_F_POINTER(p, a, shape) ! intrinsic    ! now accessible via a(i,j)
4  ...                                     ! in ISO_C_BINDING
5  a(3,5) = 2.71
6  ...
7  CALL MPI_Free_mem(a, ierr)              ! memory is freed
8

```

**Example 9.2** Example of use of `MPI_ALLOC_MEM`, in Fortran with non-standard *Cray-pointers*. We assume 4-byte REALs, and assume that these pointers are address-sized.

```

12  REAL A
13  POINTER (P, A(100,100)) ! no memory is allocated
14  INTEGER(KIND=MPI_ADDRESS_KIND) SIZE
15  SIZE = 4*100*100
16  CALL MPI_ALLOC_MEM(SIZE, MPI_INFO_NULL, P, IERR)
17  ! memory is allocated
18  ...
19  A(3,5) = 2.71
20  ...
21  CALL MPI_FREE_MEM(A, IERR) ! memory is freed
22

```

This code is not Fortran 77 or Fortran 90 code. Some compilers may not support this code or need a special option, e.g., the GNU gFortran compiler needs `-fcray-pointer`.

*Advice to implementors.* Some compilers map Cray-pointers to address-sized integers, some to `TYPE(C_PTR)` pointers (e.g., Cray Fortran, version 7.3.3). From the user's viewpoint, this mapping is irrelevant because Examples 9.2 should work correctly with an MPI-3.0 (or later) library if Cray-pointers are available. (*End of advice to implementors.*)

**Example 9.3** Same example, in C.

```

34  float (* f)[100][100];
35  /* no memory is allocated */
36  MPI_Alloc_mem(sizeof(float)*100*100, MPI_INFO_NULL, &f);
37  /* memory allocated */
38  ...
39  (*f)[5][3] = 2.71;
40  ...
41  MPI_Free_mem(f);
42

```

### 9.3 Error Handling

An MPI implementation may be unable or choose not to handle some failures that occur during MPI calls. These can include failures that generate exceptions or traps, such as floating point errors or access violations. The set of failures that are handled by MPI is implementation-dependent. Each such failure causes an error to be raised.

The above text takes precedence over any text on error handling within this document. Specifically, text that states that errors *will* be handled should be read as *may* be handled. More background information about how MPI treats errors can be found in Section 2.8.

A user can associate error handlers to four types of objects: communicators, windows, files, and sessions. The specified error handling routine will be used for any error that occurs during a call to MPI for the respective object. MPI calls that are not related to any MPI objects are considered to be attached to the communicator MPI\_COMM\_SELF. When MPI\_COMM\_SELF is not initialized (i.e., before MPI\_INIT / MPI\_INIT\_THREAD or after MPI\_FINALIZE) the error raises the initial error handler (set during the launch operation, see 11.8.4). The attachment of error handlers to objects is purely local: different processes may attach different error handlers to corresponding objects.

Several predefined error handlers are available in MPI:

**MPI\_ERRORS\_ARE\_FATAL** The handler, when called, causes the program to abort all connected MPI processes. This is similar to calling MPI\_ABORT using a communicator containing all connected processes with an implementation-specific value as the errorcode argument.

**MPI\_ERRORS\_ABORT** The handler, when called, is invoked on a communicator in a manner similar to calling MPI\_ABORT on that communicator. If the error handler is invoked on an window or file, it is similar to calling MPI\_ABORT using a communicator containing the group of MPI processes associated with the window or file, respectively. If the error handler is invoked on a session, the operation aborts only the local MPI process. In all cases, the value that would be provided as the errorcode argument to MPI\_ABORT is implementation-specific.

**MPI\_ERRORS\_RETURN** The handler has no effect other than returning the error code to the user.

*Advice to implementors.* The implementation-specific error information resulting from MPI\_ERRORS\_ARE\_FATAL and MPI\_ERRORS\_ABORT provided to the invoking environment should be meaningful to the end-user, for example a predefined error class. (*End of advice to implementors.*)

Implementations may provide additional predefined error handlers and programmers can code their own error handlers.

Unless otherwise requested, the error handler MPI\_ERRORS\_ARE\_FATAL is set as the default initial error handler and associated with predefined communicators. Thus, if the user chooses not to control error handling, every error that MPI handles is treated as fatal. Since (almost) all MPI calls return an error code, a user may choose to handle errors in its main code, by testing the return code of MPI calls and executing a suitable recovery code when the call was not successful. In this case, the error handler MPI\_ERRORS\_RETURN will be used. Usually it is more convenient and more efficient not to test for errors after each MPI call, and have such error handled by a non-trivial MPI error handler. Note that unlike predefined communicators, windows and files do not inherit from the initial error handler, as defined in Sections 12.6 and 14.7 respectively.

When an error is raised, MPI will provide the user information about that error using an error code. Some errors might prevent MPI from completing further API calls successfully and those functions will continue to report errors until the cause of the error is corrected

1 or the user terminates the application. The user can make the determination of whether or  
2 not to attempt to continue when handling such an error.

3  
4 *Advice to users.* For example, users may be unable to correct errors corresponding  
5 to some error classes, such as `MPI_ERR_INTERN`. Such errors may cause subsequent  
6 MPI calls to complete in error. (*End of advice to users.*)

7  
8 *Advice to implementors.* A high-quality implementation will, to the greatest possible  
9 extent, circumscribe the impact of an error, so that normal processing can continue  
10 after an error handler was invoked. The implementation documentation will provide  
11 information on the possible effect of each class of errors and available recovery actions.  
12 (*End of advice to implementors.*)

13  
14 An MPI error handler is an opaque object, which is accessed by a handle. MPI calls  
15 are provided to create new error handlers, to associate error handlers with objects, and to  
16 test which error handler is associated with an object. C has distinct typedefs for user de-  
17 fined error handling callback functions that accept communicator, file, window, and session  
18 arguments. In Fortran there are four user routines.

19 An error handler object is created by a call to `MPI_XXX_CREATE_ERRHANDLER`,  
20 where XXX is, respectively, `COMM`, `WIN`, `FILE`, or `SESSION`.

21 An error handler is attached to a communicator, window, file, or session by a call to  
22 `MPI_XXX_SET_ERRHANDLER`. The error handler must be either a predefined error han-  
23 dler, or an error handler that was created by a call to `MPI_XXX_CREATE_ERRHANDLER`,  
24 with matching XXX. An error handler can also be attached to a session using the `errorhandler`  
25 argument to `MPI_SESSION_INIT`. The predefined error handlers `MPI_ERRORS_RETURN` and  
26 `MPI_ERRORS_ARE_FATAL` can be attached to communicators, windows, files, or sessions.

27 The error handler currently associated with a communicator, window, file, or session  
28 can be retrieved by a call to `MPI_XXX_GET_ERRHANDLER`.

29 The MPI function `MPI_ERRHANDLER_FREE` can be used to free an error handler that  
30 was created by a call to `MPI_XXX_CREATE_ERRHANDLER`.

31 `MPI_XXX_GET_ERRHANDLER` behave as if a new error handler object is created. That  
32 is, once the error handler is no longer needed, `MPI_ERRHANDLER_FREE` should be called  
33 with the error handler returned from `MPI_XXX_GET_ERRHANDLER` to mark the error  
34 handler for deallocation. This provides behavior similar to that of `MPI_COMM_GROUP`  
35 and `MPI_GROUP_FREE`.

36  
37 *Advice to implementors.* High-quality implementations should raise an error when  
38 an error handler that was created by a call to `MPI_XXX_CREATE_ERRHANDLER` is  
39 attached to an object of the wrong type with a call to `MPI_YYY_SET_ERRHANDLER`.  
40 To do so, it is necessary to maintain, with each error handler, information on the  
41 typedef of the associated user function. (*End of advice to implementors.*)

42  
43 The syntax for these calls is given below.

## 9.3.1 Error Handlers for Communicators

`MPI_COMM_CREATE_ERRHANDLER(comm_errhandler_fn, errhandler)`

IN	<code>comm_errhandler_fn</code>	user defined error handling procedure (function)
OUT	<code>errhandler</code>	MPI error handler (handle)

**C binding**

```
int MPI_Comm_create_errhandler(
    MPI_Comm_errhandler_function *comm_errhandler_fn,
    MPI_Errhandler *errhandler)
```

**Fortran 2008 binding**

```
MPI_Comm_create_errhandler(comm_errhandler_fn, errhandler, ierror)
    PROCEDURE(MPI_Comm_errhandler_function), INTENT(IN) ::
        comm_errhandler_fn
    TYPE(MPI_Errhandler), INTENT(OUT) :: errhandler
    INTEGER, OPTIONAL, INTENT(OUT) :: ierror
```

**Fortran binding**

```
MPI_COMM_CREATE_ERRHANDLER(COMM_ERRHANDLER_FN, ERRHANDLER, IERROR)
    EXTERNAL COMM_ERRHANDLER_FN
    INTEGER ERRHANDLER, IERROR
```

Creates an error handler that can be attached to communicators.

The user routine should be, in C, a function of type `MPI_Comm_errhandler_function`, which is defined as

```
typedef void MPI_Comm_errhandler_function(MPI_Comm *comm, int *error_code,
    ...);
```

The first argument is the communicator in use. The second is the error code to be returned by the MPI routine that raised the error. If the routine would have returned `MPI_ERR_IN_STATUS`, it is the error code returned in the status for the request that caused the error handler to be invoked. The remaining arguments are “varargs” arguments whose number and meaning is implementation-dependent. An implementation should clearly document these arguments. Addresses are used so that the handler may be written in Fortran. With the Fortran `mpi_f08` module, the user routine `comm_errhandler_fn` should be of the form:

```
ABSTRACT INTERFACE
    SUBROUTINE MPI_Comm_errhandler_function(comm, error_code)
        TYPE(MPI_Comm) :: comm
        INTEGER :: error_code
```

With the Fortran `mpi` module and `mpif.h`, the user routine `COMM_ERRHANDLER_FN` should be of the form:

```
SUBROUTINE COMM_ERRHANDLER_FUNCTION(COMM, ERROR_CODE)
    INTEGER COMM, ERROR_CODE
```

1 *Rationale.* The variable argument list is provided because it provides an ISO-  
 2 standard hook for providing additional information to the error handler; without this  
 3 hook, ISO C prohibits additional arguments. (*End of rationale.*)

4  
 5 *Advice to users.* A newly created communicator inherits the error handler that  
 6 is associated with the “parent” communicator. In particular, the user can specify  
 7 a “global” error handler for all communicators by associating this handler with the  
 8 communicator MPI\_COMM\_WORLD immediately after initialization. (*End of advice to*  
 9 *users.*)

10  
 11  
 12 MPI\_COMM\_SET\_ERRHANDLER(comm, errhandler)

13 INOUT comm communicator (handle)  
 14 IN errhandler new error handler for communicator (handle)

15  
 16  
 17 **C binding**

18 int MPI\_Comm\_set\_errhandler(MPI\_Comm comm, MPI\_Errhandler errhandler)

19  
 20 **Fortran 2008 binding**

21 MPI\_Comm\_set\_errhandler(comm, errhandler, ierror)  
 22 TYPE(MPI\_Comm), INTENT(IN) :: comm  
 23 TYPE(MPI\_Errhandler), INTENT(IN) :: errhandler  
 24 INTEGER, OPTIONAL, INTENT(OUT) :: ierror

25 **Fortran binding**

26 MPI\_COMM\_SET\_ERRHANDLER(COMM, ERRHANDLER, IERROR)  
 27 INTEGER COMM, ERRHANDLER, IERROR

28  
 29 Attaches a new error handler to a communicator. The error handler must be either  
 30 a predefined error handler, or an error handler created by a call to  
 31 MPI\_COMM\_CREATE\_ERRHANDLER.

32  
 33 MPI\_COMM\_GET\_ERRHANDLER(comm, errhandler)

34 IN comm communicator (handle)  
 35 OUT errhandler error handler currently associated with  
 36 communicator (handle)

37  
 38  
 39 **C binding**

40 int MPI\_Comm\_get\_errhandler(MPI\_Comm comm, MPI\_Errhandler \*errhandler)

41  
 42 **Fortran 2008 binding**

43 MPI\_Comm\_get\_errhandler(comm, errhandler, ierror)  
 44 TYPE(MPI\_Comm), INTENT(IN) :: comm  
 45 TYPE(MPI\_Errhandler), INTENT(OUT) :: errhandler  
 46 INTEGER, OPTIONAL, INTENT(OUT) :: ierror

47 **Fortran binding**

48 MPI\_COMM\_GET\_ERRHANDLER(COMM, ERRHANDLER, IERROR)



INTEGER COMM, ERRHANDLER, IERROR

Retrieves the error handler currently associated with a communicator.

For example, a library function may register at its entry point the current error handler for a communicator, set its own private error handler for this communicator, and restore before exiting the previous error handler.

### 9.3.2 Error Handlers for Windows

MPI\_WIN\_CREATE\_ERRHANDLER(win\_errhandler\_fn, errhandler)

IN	win_errhandler_fn	user defined error handling procedure (function)
OUT	errhandler	MPI error handler (handle)

#### C binding

```
int MPI_Win_create_errhandler(
    MPI_Win_errhandler_function *win_errhandler_fn,
    MPI_Errhandler *errhandler)
```

#### Fortran 2008 binding

```
MPI_Win_create_errhandler(win_errhandler_fn, errhandler, ierror)
    PROCEDURE(MPI_Win_errhandler_function), INTENT(IN) :: win_errhandler_fn
    TYPE(MPI_Errhandler), INTENT(OUT) :: errhandler
    INTEGER, OPTIONAL, INTENT(OUT) :: ierror
```

#### Fortran binding

```
MPI_WIN_CREATE_ERRHANDLER(WIN_ERRHANDLER_FN, ERRHANDLER, IERROR)
    EXTERNAL WIN_ERRHANDLER_FN
    INTEGER ERRHANDLER, IERROR
```

Creates an error handler that can be attached to a window object. The user routine should be, in C, a function of type `MPI_Win_errhandler_function` which is defined as

```
typedef void MPI_Win_errhandler_function(MPI_Win *win, int *error_code,
    ...);
```

The first argument is the window in use, the second is the error code to be returned. The remaining arguments are “`varargs`” arguments whose number and meaning is implementation-dependent. An implementation should clearly document these arguments. With the Fortran `mpi_f08` module, the user routine `win_errhandler_fn` should be of the form:

```
ABSTRACT INTERFACE
    SUBROUTINE MPI_Win_errhandler_function(win, error_code)
        TYPE(MPI_Win) :: win
        INTEGER :: error_code
```

With the Fortran `mpi` module and `mpif.h`, the user routine `WIN_ERRHANDLER_FN` should be of the form:

```
SUBROUTINE WIN_ERRHANDLER_FUNCTION(WIN, ERROR_CODE)
    INTEGER WIN, ERROR_CODE
```

```

1 MPI_WIN_SET_ERRHANDLER(win, errhandler)
2     INOUT   win                window object (handle)
3
4     IN      errhandler         new error handler for window (handle)

```

### C binding

```

7 int MPI_Win_set_errhandler(MPI_Win win, MPI_Errhandler errhandler)

```

### Fortran 2008 binding

```

9 MPI_Win_set_errhandler(win, errhandler, ierror)
10     TYPE(MPI_Win), INTENT(IN) :: win
11     TYPE(MPI_Errhandler), INTENT(IN) :: errhandler
12     INTEGER, OPTIONAL, INTENT(OUT) :: ierror

```

### Fortran binding

```

14 MPI_WIN_SET_ERRHANDLER(WIN, ERRHANDLER, IERROR)
15     INTEGER WIN, ERRHANDLER, IERROR

```

Attaches a new error handler to a window. The error handler must be either a pre-defined error handler, or an error handler created by a call to `MPI_WIN_CREATE_ERRHANDLER`.

```

22 MPI_WIN_GET_ERRHANDLER(win, errhandler)
23
24     IN      win                window object (handle)
25
26     OUT    errhandler         error handler currently associated with window
27                                (handle)

```

### C binding

```

29 int MPI_Win_get_errhandler(MPI_Win win, MPI_Errhandler *errhandler)

```

### Fortran 2008 binding

```

31 MPI_Win_get_errhandler(win, errhandler, ierror)
32     TYPE(MPI_Win), INTENT(IN) :: win
33     TYPE(MPI_Errhandler), INTENT(OUT) :: errhandler
34     INTEGER, OPTIONAL, INTENT(OUT) :: ierror

```

### Fortran binding

```

36 MPI_WIN_GET_ERRHANDLER(WIN, ERRHANDLER, IERROR)
37     INTEGER WIN, ERRHANDLER, IERROR

```

Retrieves the error handler currently associated with a window.

## 9.3.3 Error Handlers for Files

MPI\_FILE\_CREATE\_ERRHANDLER(file\_errhandler\_fn, errhandler)

IN	file_errhandler_fn	user defined error handling procedure (function)
OUT	errhandler	MPI error handler (handle)

**C binding**

```
int MPI_File_create_errhandler(
    MPI_File_errhandler_function *file_errhandler_fn,
    MPI_Errhandler *errhandler)
```

**Fortran 2008 binding**

```
MPI_File_create_errhandler(file_errhandler_fn, errhandler, ierror)
    PROCEDURE(MPI_File_errhandler_function), INTENT(IN) ::
        file_errhandler_fn
    TYPE(MPI_Errhandler), INTENT(OUT) :: errhandler
    INTEGER, OPTIONAL, INTENT(OUT) :: ierror
```

**Fortran binding**

```
MPI_FILE_CREATE_ERRHANDLER(FILE_ERRHANDLER_FN, ERRHANDLER, IERROR)
    EXTERNAL FILE_ERRHANDLER_FN
    INTEGER ERRHANDLER, IERROR
```

Creates an error handler that can be attached to a file object. The user routine should be, in C, a function of type `MPI_File_errhandler_function`, which is defined as

```
typedef void MPI_File_errhandler_function(MPI_File *file, int *error_code,
    ...);
```

The first argument is the file in use, the second is the error code to be returned. The remaining arguments are “varargs” arguments whose number and meaning is implementation-dependent. An implementation should clearly document these arguments.

With the Fortran `mpi_f08` module, the user routine `file_errhandler_fn` should be of the form:

```
ABSTRACT INTERFACE
    SUBROUTINE MPI_File_errhandler_function(file, error_code)
        TYPE(MPI_File) :: file
        INTEGER :: error_code
```

With the Fortran `mpi` module and `mpif.h`, the user routine `FILE_ERRHANDLER_FN` should be of the form:

```
SUBROUTINE FILE_ERRHANDLER_FUNCTION(FILE, ERROR_CODE)
    INTEGER FILE, ERROR_CODE
```

1 MPI\_FILE\_SET\_ERRHANDLER(file, errhandler)

2     INOUT   file                             file (handle)

3     IN       errhandler                    new error handler for file (handle)

5  
6 **C binding**

7 int MPI\_File\_set\_errhandler(MPI\_File file, MPI\_Errhandler errhandler)

8  
9 **Fortran 2008 binding**

10 MPI\_File\_set\_errhandler(file, errhandler, ierror)

11     TYPE(MPI\_File), INTENT(IN) :: file

12     TYPE(MPI\_Errhandler), INTENT(IN) :: errhandler

13     INTEGER, OPTIONAL, INTENT(OUT) :: ierror

14 **Fortran binding**

15 MPI\_FILE\_SET\_ERRHANDLER(FILE, ERRHANDLER, IERROR)

16     INTEGER FILE, ERRHANDLER, IERROR

17     Attaches a new error handler to a file. The error handler must be either a predefined  
18 error handler, or an error handler created by a call to MPI\_FILE\_CREATE\_ERRHANDLER.

21 MPI\_FILE\_GET\_ERRHANDLER(file, errhandler)

22     IN       file                             file (handle)

23     OUT      errhandler                    error handler currently associated with file (handle)

25  
26 **C binding**

27 int MPI\_File\_get\_errhandler(MPI\_File file, MPI\_Errhandler \*errhandler)

28  
29 **Fortran 2008 binding**

30 MPI\_File\_get\_errhandler(file, errhandler, ierror)

31     TYPE(MPI\_File), INTENT(IN) :: file

32     TYPE(MPI\_Errhandler), INTENT(OUT) :: errhandler

33     INTEGER, OPTIONAL, INTENT(OUT) :: ierror

34 **Fortran binding**

35 MPI\_FILE\_GET\_ERRHANDLER(FILE, ERRHANDLER, IERROR)

36     INTEGER FILE, ERRHANDLER, IERROR

37     Retrieves the error handler currently associated with a file.

## 9.3.4 Error Handlers for Sessions

MPI_SESSION_CREATE_ERRHANDLER(session_errhandler_fn, errhandler)			
IN	session_errhandler_fn	user defined error handling procedure (function)	
OUT	errhandler	MPI error handler (handle)	

**C binding**

```
int MPI_Session_create_errhandler(
    MPI_Session_errhandler_function *session_errhandler_fn,
    MPI_Errhandler *errhandler)
```

**Fortran 2008 binding**

```
MPI_Session_create_errhandler(session_errhandler_fn, errhandler, ierror)
    PROCEDURE(MPI_Session_errhandler_function), INTENT(IN) ::
        session_errhandler_fn
    TYPE(MPI_Errhandler), INTENT(OUT) :: errhandler
    INTEGER, OPTIONAL, INTENT(OUT) :: ierror
```

**Fortran binding**

```
MPI_SESSION_CREATE_ERRHANDLER(SESSION_ERRHANDLER_FN, ERRHANDLER, IERROR)
    EXTERNAL SESSION_ERRHANDLER_FN
    INTEGER ERRHANDLER, IERROR
```

Creates an error handler that can be attached to a session object. In C, the `session_errhandler_fn` argument should be a function of type `MPI_Session_errhandler_function`, which is defined as

```
typedef void MPI_Session_errhandler_function(MPI_Session *session,
    int *error_code, ...);
```

The first argument is the session in use, the second is the error code to be returned. The remaining arguments are “`varargs`” arguments whose number and meaning is implementation-dependent. An implementation should clearly document these arguments.

With the Fortran `mpi_f08` module, the `session_errhandler_fn` argument should be of the form:

```
ABSTRACT INTERFACE
    SUBROUTINE MPI_Session_errhandler_function(session, error_code)
        TYPE(MPI_Session) :: session
        INTEGER :: error_code
```

With the Fortran `mpi` module and `mpif.h`, the `SESSION_ERRHANDLER_FN` argument should be of the form:

```
SUBROUTINE SESSION_ERRHANDLER_FUNCTION(SESSION, ERROR_CODE)
    INTEGER SESSION, ERROR_CODE
```

```

1 MPI_SESSION_SET_ERRHANDLER(session, errhandler)
2     INOUT    session                session (handle)
3
4     IN      errhandler              new error handler for session (handle)

```

**C binding**

```

7 int MPI_Session_set_errhandler(MPI_Session session,
8                               MPI_Errhandler errhandler)

```

**Fortran 2008 binding**

```

10 MPI_Session_set_errhandler(session, errhandler, ierror)
11     TYPE(MPI_Session), INTENT(IN) :: session
12     TYPE(MPI_Errhandler), INTENT(IN) :: errhandler
13     INTEGER, OPTIONAL, INTENT(OUT) :: ierror

```

**Fortran binding**

```

16 MPI_SESSION_SET_ERRHANDLER(SESSION, ERRHANDLER, IERROR)
17     INTEGER SESSION, ERRHANDLER, IERROR

```

Attaches a new error handler to a session. The error handler must be either a pre-defined error handler, or an error handler created by a call to MPI\_SESSION\_CREATE\_ERRHANDLER.

```

23 MPI_SESSION_GET_ERRHANDLER(session, errhandler)
24
25     IN      session                session (handle)
26
27     OUT    errhandler              error handler currently associated with session
28                                     (handle)

```

**C binding**

```

30 int MPI_Session_get_errhandler(MPI_Session session,
31                               MPI_Errhandler *errhandler)

```

**Fortran 2008 binding**

```

34 MPI_Session_get_errhandler(session, errhandler, ierror)
35     TYPE(MPI_Session), INTENT(IN) :: session
36     TYPE(MPI_Errhandler), INTENT(OUT) :: errhandler
37     INTEGER, OPTIONAL, INTENT(OUT) :: ierror

```

**Fortran binding**

```

39 MPI_SESSION_GET_ERRHANDLER(SESSION, ERRHANDLER, IERROR)
40     INTEGER SESSION, ERRHANDLER, IERROR

```

Retrieves the error handler currently associated with a session.

## 9.3.5 Freeing Errorhandlers and Retrieving Error Strings

`MPI_ERRHANDLER_FREE(errhandler)`

INOUT errhandler MPI error handler (handle)

**C binding**

```
int MPI_Errhandler_free(MPI_Errhandler *errhandler)
```

**Fortran 2008 binding**

```
MPI_Errhandler_free(errhandler, ierror)
  TYPE(MPI_Errhandler), INTENT(INOUT) :: errhandler
  INTEGER, OPTIONAL, INTENT(OUT) :: ierror
```

**Fortran binding**

```
MPI_ERRHANDLER_FREE(ERRHANDLER, IERROR)
  INTEGER ERRHANDLER, IERROR
```

Marks the error handler associated with `errhandler` for deallocation and sets `errhandler` to `MPI_ERRHANDLER_NULL`. The error handler will be deallocated after all the objects associated with it (communicator, window, or file) have been deallocated.

`MPI_ERROR_STRING(errorcode, string, resultlen)`

IN	errorcode	Error code returned by an MPI routine
OUT	string	Text that corresponds to the errorcode
OUT	resultlen	Length (in printable characters) of the result returned in string

**C binding**

```
int MPI_Error_string(int errorcode, char *string, int *resultlen)
```

**Fortran 2008 binding**

```
MPI_Error_string(errorcode, string, resultlen, ierror)
  INTEGER, INTENT(IN) :: errorcode
  CHARACTER(LEN=MPI_MAX_ERROR_STRING), INTENT(OUT) :: string
  INTEGER, INTENT(OUT) :: resultlen
  INTEGER, OPTIONAL, INTENT(OUT) :: ierror
```

**Fortran binding**

```
MPI_ERROR_STRING(ERRORCODE, STRING, RESULTLEN, IERROR)
  INTEGER ERRORCODE, RESULTLEN, IERROR
  CHARACTER*(*) STRING
```

Returns the error string associated with an error code or class. The argument `string` must represent storage that is at least `MPI_MAX_ERROR_STRING` characters long.

The number of characters actually written is returned in the output argument, `resultlen`.

This function must always be thread-safe, as defined in Section 11.6. It is one of the few routines that may be called before MPI is initialized or after MPI is finalized.

*Rationale.* The form of this function was chosen to make the Fortran and C bindings similar. A version that returns a pointer to a string has two difficulties. First, the return string must be statically allocated and different for each error message (allowing the pointers returned by successive calls to `MPI_ERROR_STRING` to point to the correct message). Second, in Fortran, a function declared as returning `CHARACTER*(*)` can not be referenced in, for example, a `PRINT` statement. (*End of rationale.*)

## 9.4 Error Codes and Classes

The error codes returned by MPI are left entirely to the implementation (with the exception of `MPI_SUCCESS`). This is done to allow an implementation to provide as much information as possible in the error code (for use with `MPI_ERROR_STRING`).

All MPI function calls shall return `MPI_SUCCESS` if and only if the specification of that function has been fulfilled at the point of return. For multiple completion functions, if the function returns `MPI_ERR_IN_STATUS`, the error code in each status object shall be set to `MPI_SUCCESS` if and only if the specification of the operation represented by the corresponding `MPI_Request` has been fulfilled at the point of return.

When an operation raises an error, it may not satisfy its specification (for example, a synchronizing operation may not have synchronized) and the content of the output buffers, targeted memory, or output parameters is undefined. However, a valid error code shall always be set when an operation raises an error, whether in the return value, error field in the status object, or element in an array of error codes.

To make it possible for an application to interpret an error code, the routine `MPI_ERROR_CLASS` converts any error code into one of a small set of standard error codes, called *error classes*. Valid error classes are shown in Table 9.1 and Table 9.2.

The error classes are a subset of the error codes: an MPI function may return an error class number; and the function `MPI_ERROR_STRING` can be used to compute the error string associated with an error class. The values defined for MPI error classes are valid MPI error codes.

The error codes satisfy,

$$0 = \text{MPI\_SUCCESS} < \text{MPI\_ERR\_}\dots \leq \text{MPI\_ERR\_LASTCODE}.$$

*Rationale.* The difference between `MPI_ERR_UNKNOWN` and `MPI_ERR_OTHER` is that `MPI_ERROR_STRING` can return useful information about `MPI_ERR_OTHER`.

Note that `MPI_SUCCESS = 0` is necessary to be consistent with C practice; the separation of error classes and error codes allows us to define the error classes this way. Having a known `LASTCODE` is often a nice sanity check as well. (*End of rationale.*)

`MPI_ERROR_CLASS(errorcode, errorclass)`

IN	errorcode	Error code returned by an MPI routine
OUT	errorclass	Error class associated with errorcode

### C binding

```
int MPI_Error_class(int errorcode, int *errorclass)
```



MPI_SUCCESS	No error	1
MPI_ERR_ACCESS	Permission denied	2
MPI_ERR_AMODE	Error related to the amode passed to MPI_FILE_OPEN	3 4
MPI_ERR_ARG	Invalid argument of some other kind	5
MPI_ERR_ASSERT	Invalid assertion argument	6
MPI_ERR_BAD_FILE	Invalid file name (e.g., path name too long)	7
MPI_ERR_BASE	Invalid base passed to MPI_FREE_MEM	8
MPI_ERR_BUFFER	Invalid buffer pointer argument	9
MPI_ERR_COMM	Invalid communicator argument	10
MPI_ERR_CONVERSION	An error occurred in a user supplied data conversion function	11 12
MPI_ERR_COUNT	Invalid count argument	13
MPI_ERR_DIMS	Invalid dimension argument	14
MPI_ERR_DISP	Invalid displacement argument	15
MPI_ERR_DUP_DATAREP	Conversion functions could not be regis- tered because a data representation identi- fier that was already defined was passed to MPI_REGISTER_DATAREP	16 17 18 19
MPI_ERR_FILE	Invalid file handle argument	20
MPI_ERR_FILE_EXISTS	File exists	21
MPI_ERR_FILE_IN_USE	File operation could not be completed, as the file is currently open by some process	22 23
MPI_ERR_GROUP	Invalid group argument	24
MPI_ERR_INFO	Invalid info argument	25
MPI_ERR_INFO_KEY	Key longer than MPI_MAX_INFO_KEY	26
MPI_ERR_INFO_NOKEY	Invalid key passed to MPI_INFO_DELETE	27
MPI_ERR_INFO_VALUE	Value longer than MPI_MAX_INFO_VAL	28
MPI_ERR_IN_STATUS	Error code is in status	29
MPI_ERR_INTERN	Internal MPI (implementation) error	30
MPI_ERR_IO	Other I/O error	31
MPI_ERR_KEYVAL	Invalid keyval argument	32
MPI_ERR_LOCKTYPE	Invalid locktype argument	33
MPI_ERR_NAME	Invalid service name passed to MPI_LOOKUP_NAME	34 35
MPI_ERR_NO_MEM	MPI_ALLOC_MEM failed because memory is exhausted	36 37
MPI_ERR_NO_SPACE	Not enough space	38
MPI_ERR_NO_SUCH_FILE	File does not exist	39
MPI_ERR_NOT_SAME	Collective argument not identical on all processes, or collective routines called in a different order by different processes	40 41 42 43 44

Table 9.1: Error classes (Part 1)

1	MPI_ERR_OP	Invalid operation argument
2	MPI_ERR_OTHER	Known error not in this list
3	MPI_ERR_PENDING	Pending request
4	MPI_ERR_PORT	Invalid port name passed to
5		MPI_COMM_CONNECT
6	MPI_ERR_PROC_ABORTED	Operation failed because a peer process has
7		aborted
8	MPI_ERR_QUOTA	Quota exceeded
9	MPI_ERR_RANK	Invalid rank argument
10	MPI_ERR_READ_ONLY	Read-only file or file system
11	MPI_ERR_REQUEST	Invalid request argument
12	MPI_ERR_RMA_ATTACH	Memory cannot be attached (e.g., because
13		of resource exhaustion)
14	MPI_ERR_RMA_CONFLICT	Conflicting accesses to window
15	MPI_ERR_RMA_FLAVOR	Passed window has the wrong flavor for the
16		called function
17	MPI_ERR_RMA_RANGE	Target memory is not part of the win-
18		dow (in the case of a window created
19		with MPI_WIN_CREATE_DYNAMIC, tar-
20		get memory is not attached)
21	MPI_ERR_RMA_SHARED	Memory cannot be shared (e.g., some pro-
22		cess in the group of the specified commu-
23		nicator cannot expose shared memory)
24	MPI_ERR_RMA_SYNC	Wrong synchronization of RMA calls
25	MPI_ERR_ROOT	Invalid root argument
26	MPI_ERR_SERVICE	Invalid service name passed to
27		MPI_UNPUBLISH_NAME
28	MPI_ERR_SESSION	Invalid session argument
29	MPI_ERR_SIZE	Invalid size argument
30	MPI_ERR_SPAWN	Error in spawning processes
31	MPI_ERR_TAG	Invalid tag argument
32	MPI_ERR_TOPOLOGY	Invalid topology argument
33	MPI_ERR_TRUNCATE	Message truncated on receive
34	MPI_ERR_TYPE	Invalid datatype argument
35	MPI_ERR_UNKNOWN	Unknown error
36	MPI_ERR_UNSUPPORTED_DATAREP	Unsupported <code>datarep</code> passed to
37		MPI_FILE_SET_VIEW
38	MPI_ERR_UNSUPPORTED_OPERATION	Unsupported operation, such as seeking on
39		a file which supports sequential access only
40	MPI_ERR_VALUE_TOO_LARGE	Value is too large to store
41	MPI_ERR_WIN	Invalid window argument
42	MPI_ERR_LASTCODE	Last error code

Table 9.2: Error classes (Part 2)

**Fortran 2008 binding**

```

MPI_Error_class(errorcode, errorclass, ierror)
    INTEGER, INTENT(IN) :: errorcode
    INTEGER, INTENT(OUT) :: errorclass
    INTEGER, OPTIONAL, INTENT(OUT) :: ierror

```

**Fortran binding**

```

MPI_ERROR_CLASS(ERRORCODE, ERRORCLASS, IERROR)
    INTEGER ERRORCODE, ERRORCLASS, IERROR

```

The function `MPI_ERROR_CLASS` maps each standard error code (error class) onto itself.

This function must always be thread-safe, as defined in Section 11.6. It is one of the few routines that may be called before MPI is initialized or after MPI is finalized.

## 9.5 Error Classes, Error Codes, and Error Handlers

Users may want to write a layered library on top of an existing MPI implementation, and this library may have its own set of error codes and classes. An example of such a library is an I/O library based on MPI, see Chapter 14. For this purpose, functions are needed to:

1. add a new error class to the ones an MPI implementation already knows.
2. associate error codes with this error class, so that `MPI_ERROR_CLASS` works.
3. associate strings with these error codes, so that `MPI_ERROR_STRING` works.
4. invoke the error handler associated with a communicator, window, or object.

Several functions are provided to do this. They are all local. No functions are provided to free error classes or codes: it is not expected that an application will generate them in significant numbers.

```

MPI_ADD_ERROR_CLASS(errorclass)

```

```

    OUT    errorclass          value for the new error class (integer)

```

**C binding**

```

int MPI_Add_error_class(int *errorclass)

```

**Fortran 2008 binding**

```

MPI_Add_error_class(errorclass, ierror)
    INTEGER, INTENT(OUT) :: errorclass
    INTEGER, OPTIONAL, INTENT(OUT) :: ierror

```

**Fortran binding**

```

MPI_ADD_ERROR_CLASS(ERRORCLASS, IERROR)
    INTEGER ERRORCLASS, IERROR

```

Creates a new error class and returns the value for it.

1 *Rationale.* To avoid conflicts with existing error codes and classes, the value is set  
 2 by the implementation and not by the user. (*End of rationale.*)

3  
 4 *Advice to users.* Since a call to `MPI_ADD_ERROR_CLASS` is local, the same `errorclass`  
 5 may not be returned on all processes that make this call. Thus, it is not safe to assume  
 6 that registering a new error on a set of processes at the same time will yield the same  
 7 `errorclass` on all of the processes. Getting the “same” error on multiple processes may  
 8 not cause the same value of error code to be generated. (*End of advice to users.*)

9  
 10 The value of `MPI_ERR_LASTCODE` is a constant value and is not affected by new user-  
 11 defined error codes and classes. Instead, a predefined attribute key `MPI_LASTUSED` is  
 12 associated with `MPI_COMM_WORLD`. The attribute value corresponding to this key is the  
 13 current maximum error class including the user-defined ones. This is a local value and may  
 14 be different on different processes. The value returned by this key is always greater than or  
 15 equal to `MPI_ERR_LASTCODE`.

16  
 17 *Advice to users.* The value returned by the key `MPI_LASTUSED` will not change  
 18 unless the user calls a function to explicitly add an error class/code. In a multithreaded  
 19 environment, the user must take extra care in assuming this value has not changed.  
 20 Note that error codes and error classes are not necessarily dense. A user may not  
 21 assume that each error class below `MPI_LASTUSED` is valid. (*End of advice to*  
 22 *users.*)

23  
 24  
 25 `MPI_ADD_ERROR_CODE(errorclass, errorcode)`

26	IN	<code>errorclass</code>	error class (integer)
27			
28	OUT	<code>errorcode</code>	new error code to be associated with <code>errorclass</code>
29			(integer)

### 30 C binding

31  
 32 `int MPI_Add_error_code(int errorclass, int *errorcode)`

### 33 Fortran 2008 binding

34  
 35 `MPI_Add_error_code(errorclass, errorcode, ierror)`  
 36 `INTEGER, INTENT(IN) :: errorclass`  
 37 `INTEGER, INTENT(OUT) :: errorcode`  
 38 `INTEGER, OPTIONAL, INTENT(OUT) :: ierror`

### 39 Fortran binding

40  
 41 `MPI_ADD_ERROR_CODE(ERRORCLASS, ERRORCODE, IERROR)`  
 42 `INTEGER ERRORCLASS, ERRORCODE, IERROR`

43 Creates new error code associated with `errorclass` and returns its value in `errorcode`.

44  
 45 *Rationale.* To avoid conflicts with existing error codes and classes, the value of the  
 46 new error code is set by the implementation and not by the user. (*End of rationale.*)

```

MPI_ADD_ERROR_STRING(errorcode, string) 1
    IN      errorcode      error code or class (integer) 2
    IN      string         text corresponding to errorcode (string) 3

```

**C binding**

```
int MPI_Add_error_string(int errorcode, const char *string) 4
```

**Fortran 2008 binding**

```

MPI_Add_error_string(errorcode, string, ierror) 5
    INTEGER, INTENT(IN) :: errorcode 6
    CHARACTER(LEN=*), INTENT(IN) :: string 7
    INTEGER, OPTIONAL, INTENT(OUT) :: ierror 8

```

**Fortran binding**

```

MPI_ADD_ERROR_STRING(ERRORCODE, STRING, IERROR) 9
    INTEGER ERRORCODE, IERROR 10
    CHARACTER*(*) STRING 11

```

Associates an error string with an error code or class. The string must be no more than `MPI_MAX_ERROR_STRING` characters long. The length of the string is as defined in the calling language. The length of the string does not include the null terminator in C. Trailing blanks will be stripped in Fortran. Calling `MPI_ADD_ERROR_STRING` for an errorcode that already has a string will replace the old string with the new string. It is erroneous to call `MPI_ADD_ERROR_STRING` for an error code or class with a value  $\leq$  `MPI_ERR_LASTCODE`.

If `MPI_ERROR_STRING` is called when no string has been set, it will return a empty string (all spaces in Fortran, "" in C).

Section 9.3 describes the methods for creating and associating error handlers with communicators, files, windows, and sessions.

```

MPI_COMM_CALL_ERRHANDLER(comm, errorcode) 12
    IN      comm          communicator with error handler (handle) 13
    IN      errorcode     error code (integer) 14

```

**C binding**

```
int MPI_Comm_call_errhandler(MPI_Comm comm, int errorcode) 15
```

**Fortran 2008 binding**

```

MPI_Comm_call_errhandler(comm, errorcode, ierror) 16
    TYPE(MPI_Comm), INTENT(IN) :: comm 17
    INTEGER, INTENT(IN) :: errorcode 18
    INTEGER, OPTIONAL, INTENT(OUT) :: ierror 19

```

**Fortran binding**

```

MPI_COMM_CALL_ERRHANDLER(COMM, ERRORCODE, IERROR) 20
    INTEGER COMM, ERRORCODE, IERROR 21

```

This function invokes the error handler assigned to the communicator with the error code supplied. This function returns `MPI_SUCCESS` in C and the same value in `IERROR` if

1 the error handler was successfully called (assuming the process is not aborted and the error  
 2 handler returns).

3  
 4  
 5 **MPI\_WIN\_CALL\_ERRHANDLER**(win, errorcode)

6     IN        win                            window with error handler (handle)  
 7     IN        errorcode                    error code (integer)

9  
 10 **C binding**

11 int MPI\_Win\_call\_errhandler(MPI\_Win win, int errorcode)

12 **Fortran 2008 binding**

13 MPI\_Win\_call\_errhandler(win, errorcode, ierror)  
 14     TYPE(MPI\_Win), INTENT(IN) :: win  
 15     INTEGER, INTENT(IN) :: errorcode  
 16     INTEGER, OPTIONAL, INTENT(OUT) :: ierror

17  
 18 **Fortran binding**

19 MPI\_WIN\_CALL\_ERRHANDLER(WIN, ERRORCODE, IERROR)  
 20     INTEGER WIN, ERRORCODE, IERROR

21     This function invokes the error handler assigned to the window with the error code  
 22 supplied. This function returns MPI\_SUCCESS in C and the same value in IERROR if the  
 23 error handler was successfully called (assuming the process is not aborted and the error  
 24 handler returns).

25  
 26     *Advice to users.* In contrast to communicators, the error handler  
 27 MPI\_ERRORS\_ARE\_FATAL is associated with a window when it is created. (*End of*  
 28 *advice to users.*)

29  
 30  
 31  
 32 **MPI\_FILE\_CALL\_ERRHANDLER**(fh, errorcode)

33     IN        fh                            file with error handler (handle)  
 34     IN        errorcode                    error code (integer)

35  
 36  
 37 **C binding**

38 int MPI\_File\_call\_errhandler(MPI\_File fh, int errorcode)

39 **Fortran 2008 binding**

40 MPI\_File\_call\_errhandler(fh, errorcode, ierror)  
 41     TYPE(MPI\_File), INTENT(IN) :: fh  
 42     INTEGER, INTENT(IN) :: errorcode  
 43     INTEGER, OPTIONAL, INTENT(OUT) :: ierror

44  
 45 **Fortran binding**

46 MPI\_FILE\_CALL\_ERRHANDLER(FH, ERRORCODE, IERROR)  
 47     INTEGER FH, ERRORCODE, IERROR

This function invokes the error handler assigned to the file with the error code supplied. This function returns `MPI_SUCCESS` in C and the same value in `IERROR` if the error handler was successfully called (assuming the process is not aborted and the error handler returns).

*Advice to users.* The default error handler for files is `MPI_ERRORS_RETURN`. (*End of advice to users.*)

`MPI_SESSION_CALL_ERRHANDLER(session, errorcode)`

IN	session	session with error handler (handle)
IN	errorcode	error code (integer)

### C binding

`int MPI_Session_call_errhandler(MPI_Session session, int errorcode)`

### Fortran 2008 binding

```
MPI_Session_call_errhandler(session, errorcode, ierror)
  TYPE(MPI_Session), INTENT(IN) :: session
  INTEGER, INTENT(IN) :: errorcode
  INTEGER, OPTIONAL, INTENT(OUT) :: ierror
```

### Fortran binding

```
MPI_SESSION_CALL_ERRHANDLER(SESSION, ERRORCODE, IERROR)
  INTEGER SESSION, ERRORCODE, IERROR
```

This function invokes the error handler assigned to the session with the error code supplied. This function returns `MPI_SUCCESS` in C and the same value in `IERROR` if the error handler was successfully called (assuming the process is not aborted and the error handler returns).

*Advice to users.* Users are warned that handlers should not be called recursively with `MPI_COMM_CALL_ERRHANDLER`, `MPI_FILE_CALL_ERRHANDLER`, `MPI_WIN_CALL_ERRHANDLER`, or `MPI_SESSION_CALL_ERRHANDLER`. Doing this can create a situation where an infinite recursion is created. This can occur if `MPI_COMM_CALL_ERRHANDLER`, `MPI_FILE_CALL_ERRHANDLER`, `MPI_WIN_CALL_ERRHANDLER`, or `MPI_SESSION_CALL_ERRHANDLER` is called inside an error handler.

Error codes and classes are associated with a process. As a result, they may be used in any error handler. Error handlers should be prepared to deal with any error code they are given. Furthermore, it is good practice to only call an error handler with the appropriate error codes. For example, file errors would normally be sent to the file error handler. (*End of advice to users.*)

## 9.6 Timers and Synchronization

MPI defines a timer. A timer is specified even though it is not “message-passing,” because timing parallel programs is important in “performance debugging” and because existing

timers (both in POSIX 1003.1-1988 and 1003.4D 14.1 and in Fortran 90) are either inconvenient or do not provide adequate access to high resolution timers. See also Section 2.6.4.

MPI\_WTIME()

### C binding

```
double MPI_Wtime(void)
```

### Fortran 2008 binding

```
DOUBLE PRECISION MPI_Wtime()
```

### Fortran binding

```
DOUBLE PRECISION MPI_WTIME()
```

MPI\_WTIME returns a floating-point number of seconds, representing elapsed wall-clock time since some time in the past.

The “time in the past” is guaranteed not to change during the life of the process. The user is responsible for converting large numbers of seconds to other units if they are preferred.

This function is portable (it returns seconds, not “ticks”), and it allows high-resolution. One would use it like this:

```
{
  double starttime, endtime;
  starttime = MPI_Wtime();
  ... stuff to be timed ...
  endtime = MPI_Wtime();
  printf("That took %f seconds\n", endtime-starttime);
}
```

The times returned are local to the node that called them. There is no requirement that different nodes return “the same time.” (But see also the discussion of MPI\_WTIME\_IS\_GLOBAL in Section 9.1.2).

MPI\_WTICK()

### C binding

```
double MPI_Wtick(void)
```

### Fortran 2008 binding

```
DOUBLE PRECISION MPI_Wtick()
```

### Fortran binding

```
DOUBLE PRECISION MPI_WTICK()
```

MPI\_WTICK returns the resolution of MPI\_WTIME in seconds. That is, it returns, as a double precision value, the number of seconds between successive clock ticks. For example, if the clock is implemented by the hardware as a counter that is incremented every millisecond, the value returned by MPI\_WTICK should be  $(10^{-3})$ .



1  
2  
3  
4  
5  
6  
7  
8  
9  
10  
11  
12  
13  
14  
15  
16  
17  
18  
19  
20  
21  
22  
23  
24  
25  
26  
27  
28  
29  
30  
31  
32  
33  
34  
35  
36  
37  
38  
39  
40  
41  
42  
43  
44  
45  
46  
47  
48

## Chapter 10

# The Info Object

Many of the routines in MPI take an argument `info`. `info` is an opaque object with a handle of type `MPI_Info` in C and Fortran with the `mpi_f08` module, and `INTEGER` in Fortran with the `mpi` module or the include file `mpif.h`. It stores an unordered set of (key,value) pairs (both key and value are strings). A key can have only one value. MPI reserves several keys and requires that if an implementation uses a reserved key, it must provide the specified functionality. An implementation is not required to support these keys and may support any others not reserved by MPI.

Some info hints allow the MPI library to restrict its support for certain operations in order to improve performance or resource utilization. If an application provides such an info hint, it must be compatible with any changes in the behavior of the MPI library that are allowed by the info hint.

An implementation must support info objects as caches for arbitrary (key,value) pairs, regardless of whether it recognizes the key. Each function that takes hints in the form of an `MPI_Info` must be prepared to ignore any key it does not recognize. This description of info objects does not attempt to define how a particular function should react if it recognizes a key but not the associated value. `MPI_INFO_GET_NKEYS`, `MPI_INFO_GET_NTHKEY`, `MPI_INFO_GET_VALUELEN`, `MPI_INFO_GET`, and `MPI_INFO_GET_STRING` must retain all (key,value) pairs so that layered functionality can also use the Info object.

Keys have an implementation-defined maximum length of `MPI_MAX_INFO_KEY`, which is at least 32 and at most 255. Values have an implementation-defined maximum length of `MPI_MAX_INFO_VAL`. In Fortran, leading and trailing spaces are stripped from both. Returned values will never be larger than these maximum lengths. Both key and value are case sensitive.

*Rationale.* Keys have a maximum length because the set of known keys will always be finite and known to the implementation and because there is no reason for keys to be complex. The small maximum size allows applications to declare keys of size `MPI_MAX_INFO_KEY`. The limitation on value sizes is so that an implementation is not forced to deal with arbitrarily long strings. (*End of rationale.*)

*Advice to users.* `MPI_MAX_INFO_VAL` might be very large, so it might not be wise to declare a string of that size. (*End of advice to users.*)

When `info` is used as an IN or INOUT argument to any MPI routine, it is parsed before that routine returns, so that it may be read, modified or freed immediately after return.

When the descriptions refer to a key or value as being a boolean, an integer, or a list, they mean the string representation of these types. An implementation may define its own rules for how info value strings are converted to other types, but to ensure portability, every implementation must support the following representations. Valid values for a boolean must include the strings “true” and “false” (all lowercase). For integers, valid values must include string representations of decimal values of integers that are within the range of a standard integer type in the program. (However it is possible that not every integer is a valid value for a given key.) On positive numbers, + signs are optional. No space may appear between a + or – sign and the leading digit of a number. For comma separated lists, the string must contain valid elements separated by commas. Leading and trailing spaces are stripped automatically from the types of info values described above and for each element of a comma separated list. These rules apply to all info values of these types. Implementations are free to specify a different interpretation for values of other info keys.

**MPI\_INFO\_CREATE**(info)

OUT info info object created (handle)

### C binding

```
int MPI_Info_create(MPI_Info *info)
```

### Fortran 2008 binding

```
MPI_Info_create(info, ierror)
  TYPE(MPI_Info), INTENT(OUT) :: info
  INTEGER, OPTIONAL, INTENT(OUT) :: ierror
```

### Fortran binding

```
MPI_INFO_CREATE(INFO, IERROR)
  INTEGER INFO, IERROR
```

MPI\_INFO\_CREATE creates a new info object. The newly created object contains no key/value pairs.

**MPI\_INFO\_SET**(info, key, value)

INOUT info info object (handle)  
 IN key key (string)  
 IN value value (string)

### C binding

```
int MPI_Info_set(MPI_Info info, const char *key, const char *value)
```

### Fortran 2008 binding

```
MPI_Info_set(info, key, value, ierror)
  TYPE(MPI_Info), INTENT(IN) :: info
  CHARACTER(LEN=*), INTENT(IN) :: key, value
  INTEGER, OPTIONAL, INTENT(OUT) :: ierror
```

**Fortran binding**

```
MPI_INFO_SET(INFO, KEY, VALUE, IERROR)
    INTEGER INFO, IERROR
    CHARACTER*(*) KEY, VALUE
```

MPI\_INFO\_SET adds the (key,value) pair to info, and overrides the value if a value for the same key was previously set. key and value are null-terminated strings in C. In Fortran, leading and trailing spaces in key and value are stripped. If either key or value are larger than the allowed maximums, the errors MPI\_ERR\_INFO\_KEY or MPI\_ERR\_INFO\_VALUE are raised, respectively.

```
MPI_INFO_DELETE(info, key)
```

INOUT	info	info object (handle)
IN	key	key (string)

**C binding**

```
int MPI_Info_delete(MPI_Info info, const char *key)
```

**Fortran 2008 binding**

```
MPI_Info_delete(info, key, ierror)
    TYPE(MPI_Info), INTENT(IN) :: info
    CHARACTER(LEN=*), INTENT(IN) :: key
    INTEGER, OPTIONAL, INTENT(OUT) :: ierror
```

**Fortran binding**

```
MPI_INFO_DELETE(INFO, KEY, IERROR)
    INTEGER INFO, IERROR
    CHARACTER*(*) KEY
```

MPI\_INFO\_DELETE deletes a (key,value) pair from info. If key is not defined in info, the call raises an error of class MPI\_ERR\_INFO\_NOKEY.

```
MPI_INFO_GET(info, key, valuelen, value, flag)
```

IN	info	info object (handle)
IN	key	key (string)
IN	valuelen	length of value arg (integer)
OUT	value	value (string)
OUT	flag	true if key defined, false if not (boolean)

**C binding**

```
int MPI_Info_get(MPI_Info info, const char *key, int valuelen, char *value,
    int *flag)
```

**Fortran 2008 binding**

```
MPI_Info_get(info, key, valuelen, value, flag, ierror)
    TYPE(MPI_Info), INTENT(IN) :: info
```

```

1     CHARACTER(LEN=*), INTENT(IN) :: key
2     INTEGER, INTENT(IN) :: valuelen
3     CHARACTER(LEN=valuelen), INTENT(OUT) :: value
4     LOGICAL, INTENT(OUT) :: flag
5     INTEGER, OPTIONAL, INTENT(OUT) :: ierror

```

### Fortran binding

```

7     MPI_INFO_GET(INFO, KEY, VALUELEN, VALUE, FLAG, IERROR)
8     INTEGER INFO, VALUELEN, IERROR
9     CHARACTER*(*) KEY, VALUE
10    LOGICAL FLAG

```

This function retrieves the value associated with key in a previous call to MPI\_INFO\_SET. If such a key exists, it sets flag to true and returns the value in value, otherwise it sets flag to false and leaves value unchanged. valuelen is the number of characters available in value. If it is less than the actual size of the value, the value is truncated. In C, valuelen should be one less than the amount of allocated space to allow for the null terminator.

If key is larger than MPI\_MAX\_INFO\_KEY, the call is erroneous.

```

21    MPI_INFO_GET_VALUELEN(info, key, valuelen, flag)

```

22	IN	info	info object (handle)
23	IN	key	key (string)
24	OUT	valuelen	length of value arg (integer)
25	OUT	flag	true if key defined, false if not (boolean)

### C binding

```

29    int MPI_Info_get_valuelen(MPI_Info info, const char *key, int *valuelen,
30                             int *flag)

```

### Fortran 2008 binding

```

33    MPI_Info_get_valuelen(info, key, valuelen, flag, ierror)
34    TYPE(MPI_Info), INTENT(IN) :: info
35    CHARACTER(LEN=*), INTENT(IN) :: key
36    INTEGER, INTENT(OUT) :: valuelen
37    LOGICAL, INTENT(OUT) :: flag
38    INTEGER, OPTIONAL, INTENT(OUT) :: ierror

```

### Fortran binding

```

40    MPI_INFO_GET_VALUELEN(INFO, KEY, VALUELEN, FLAG, IERROR)
41    INTEGER INFO, VALUELEN, IERROR
42    CHARACTER*(*) KEY
43    LOGICAL FLAG

```

Retrieves the length of the value associated with key. If key is defined, valuelen is set to the length of its associated value and flag is set to true. If key is not defined, valuelen is not touched and flag is set to false. The length returned in C does not include the end-of-string character.

If key is larger than MPI\_MAX\_INFO\_KEY, the call is erroneous.

MPI\_INFO\_GET\_STRING(info, key, buflen, value, flag)

IN	info	info object (handle)
IN	key	key (string)
INOUT	buflen	length of buffer (integer)
OUT	value	value (string)
OUT	flag	true if key defined, false if not (boolean)

### C binding

```
int MPI_Info_get_string(MPI_Info info, const char *key, int *buflen,
                       char *value, int *flag)
```

### Fortran 2008 binding

```
MPI_Info_get_string(info, key, buflen, value, flag, ierror)
  TYPE(MPI_Info), INTENT(IN) :: info
  CHARACTER(LEN=*), INTENT(IN) :: key
  INTEGER, INTENT(INOUT) :: buflen
  CHARACTER(LEN=*), INTENT(OUT) :: value
  LOGICAL, INTENT(OUT) :: flag
  INTEGER, OPTIONAL, INTENT(OUT) :: ierror
```

### Fortran binding

```
MPI_INFO_GET_STRING(INFO, KEY, BUFLen, VALUE, FLAG, IERROR)
  INTEGER INFO, BUFLen, IERROR
  CHARACTER*(*) KEY, VALUE
  LOGICAL FLAG
```

This function retrieves the value associated with key in a previous call to MPI\_INFO\_SET. If such a key exists, it sets flag to true and returns the value in value, otherwise it sets flag to false and leaves value unchanged. buflen on input is the size of the provided buffer, for the output of buflen it is the size of the buffer needed to store the value string. If the buflen passed into the function is less than the actual size needed to store the value string (including null terminator in C), the value is truncated. On return, the value of buflen will be set to the required buffer size to hold the value string. If buflen is set to 0, value is not changed. In C, buflen includes the required space for the null terminator. In C, this function returns a null terminated string in all cases where the buflen input value is greater than 0.

If key is larger than MPI\_MAX\_INFO\_KEY, the call is erroneous.

*Advice to users.* The MPI\_INFO\_GET\_STRING function can be used to obtain the size of the required buffer for a value string by setting the buflen to 0. The returned buflen can then be used to allocate memory before calling MPI\_INFO\_GET\_STRING again to obtain the value string. (*End of advice to users.*)

1 MPI\_INFO\_GET\_NKEYS(info, nkeys)

2     IN        info                    info object (handle)  
3  
4     OUT       nkeys                  number of defined keys (integer)

5  
6 **C binding**

7 int MPI\_Info\_get\_nkeys(MPI\_Info info, int \*nkeys)

8  
9 **Fortran 2008 binding**

10 MPI\_Info\_get\_nkeys(info, nkeys, ierror)  
11     TYPE(MPI\_Info), INTENT(IN) :: info  
12     INTEGER, INTENT(OUT) :: nkeys  
13     INTEGER, OPTIONAL, INTENT(OUT) :: ierror

14 **Fortran binding**

15 MPI\_INFO\_GET\_NKEYS(INFO, NKEYS, IERROR)  
16     INTEGER INFO, NKEYS, IERROR

17     MPI\_INFO\_GET\_NKEYS returns the number of currently defined keys in info.

18  
19  
20 MPI\_INFO\_GET\_NTHKEY(info, n, key)

21     IN        info                    info object (handle)  
22  
23     IN        n                      key number (integer)  
24     OUT       key                    key (string)

25  
26 **C binding**

27 int MPI\_Info\_get\_nthkey(MPI\_Info info, int n, char \*key)

28  
29 **Fortran 2008 binding**

30 MPI\_Info\_get\_nthkey(info, n, key, ierror)  
31     TYPE(MPI\_Info), INTENT(IN) :: info  
32     INTEGER, INTENT(IN) :: n  
33     CHARACTER(LEN=\*), INTENT(OUT) :: key  
34     INTEGER, OPTIONAL, INTENT(OUT) :: ierror

35  
36 **Fortran binding**

37 MPI\_INFO\_GET\_NTHKEY(INFO, N, KEY, IERROR)  
38     INTEGER INFO, N, IERROR  
39     CHARACTER\*(\*) KEY

40     This function returns the *n*th defined key in *info*. Keys are numbered  $0 \dots N - 1$  where  
41 *N* is the value returned by MPI\_INFO\_GET\_NKEYS. All keys between 0 and  $N - 1$  are  
42 guaranteed to be defined. The number of a given key does not change as long as *info* is not  
43 modified with MPI\_INFO\_SET or MPI\_INFO\_DELETE.

MPI_INFO_DUP(info, newinfo)	1
IN        info                    info object (handle)	2
OUT        newinfo                info object (handle)	3
	4
	5
<b>C binding</b>	6
int MPI_Info_dup(MPI_Info info, MPI_Info *newinfo)	7
	8
<b>Fortran 2008 binding</b>	9
MPI_Info_dup(info, newinfo, ierror)	10
TYPE(MPI_Info), INTENT(IN) :: info	11
TYPE(MPI_Info), INTENT(OUT) :: newinfo	12
INTEGER, OPTIONAL, INTENT(OUT) :: ierror	13
	14
<b>Fortran binding</b>	15
MPI_INFO_DUP(INFO, NEWINFO, IERROR)	16
INTEGER INFO, NEWINFO, IERROR	17
	18
MPI_INFO_DUP duplicates an existing info object, creating a new object, with the	19
same (key,value) pairs and the same ordering of keys.	20
	21
MPI_INFO_FREE(info)	22
INOUT    info                    info object (handle)	23
	24
<b>C binding</b>	25
int MPI_Info_free(MPI_Info *info)	26
	27
<b>Fortran 2008 binding</b>	28
MPI_Info_free(info, ierror)	29
TYPE(MPI_Info), INTENT(INOUT) :: info	30
INTEGER, OPTIONAL, INTENT(OUT) :: ierror	31
	32
<b>Fortran binding</b>	33
MPI_INFO_FREE(INFO, IERROR)	34
INTEGER INFO, IERROR	35
	36
This function frees info and sets it to MPI_INFO_NULL.	37
The value of an info argument is interpreted each time the info is passed to a routine.	38
Changes to an info after return from a routine do not affect that interpretation.	39
	40
MPI_INFO_CREATE_ENV(info)	41
OUT        info                    info object (handle)	42
	43
<b>C binding</b>	44
int MPI_Info_create_env(int argc, char argv[], MPI_Info *info)	45
	46
<b>Fortran 2008 binding</b>	47
MPI_Info_create_env(info, ierror)	48

```
1     TYPE(MPI_Info), INTENT(OUT) :: info
2     INTEGER, OPTIONAL, INTENT(OUT) :: ierror
```

### Fortran binding

```
4 MPI_INFO_CREATE_ENV(INFO, IERROR)
5     INTEGER INFO, IERROR
6
```

7 This routine produces an output object `info` with the same construction as  
8 `MPI_INFO_ENV` as created during `MPI_INIT` or `MPI_INIT_THREAD` when the same argu-  
9 ments are used. This construction is described in Section 11.2.1; however, this function can  
10 be called when not using the World Model, e.g., when using the Sessions Model. This object  
11 is not a direct copy or alias of the `MPI_INFO_ENV` object and could contain different values  
12 based on the input arguments and other sources. Multiple calls to this procedure that are  
13 given the same input arguments will produce `info` objects consistent with the definition of  
14 `MPI_INFO_ENV`. The version for ISO C accepts the `argc` and `argv` that are provided by the  
15 arguments to `main` or 0 for `argc` and `NULL` for `argv`. The user is responsible for freeing the  
16 `info` object via `MPI_INFO_FREE`. This procedure is local.

17 This procedure must always be thread-safe, as defined in Section 11.6. It is one of the  
18 few routines that may be called before MPI is initialized or after MPI is finalized.

#### *Advice to users.*

21 In some circumstances (e.g., when passing 0 to `argc` and `NULL` to `argv` in C or in Fortran  
22 where such arguments do not exist), the `info` object may not be populated or may be  
23 populated incompletely because this procedure is local and the implementation may  
24 not be able to determine the correct values. Note that this could result in different  
25 values in the resulting `info` object at different MPI processes.

26 (*End of advice to users.*)



1  
2  
3  
4  
5  
6  
7  
8  
9  
10  
11  
12  
13  
14  
15  
16  
17  
18  
19  
20  
21  
22  
23  
24  
25  
26  
27  
28  
29  
30  
31  
32  
33  
34  
35  
36  
37  
38  
39  
40  
41  
42  
43  
44  
45  
46  
47  
48

## Chapter 11

# Process Initialization, Creation, and Management

### 11.1 Introduction

MPI is primarily concerned with communication rather than process or resource management. However, it is necessary to address these issues to some degree in order to define a useful framework for communication. This chapter presents a set of MPI interfaces that allows for several approaches to MPI initialization and process management while placing minimal restrictions on the execution environment.

One goal of MPI is to achieve *source code portability*. By this we mean that a program written using MPI and complying with the relevant language standards is portable as written, and must not require any source code changes when moved from one system to another. This explicitly does *not* say anything about how an MPI program is started or launched from the command line, nor what the user must do to set up the environment in which an MPI program will run. However, an implementation may require some setup or initialization procedure to be performed before the complete set of MPI routines may be called.

To this end, MPI presents two models for **MPI process initialization**. In the World Model, an initial set of processes is created that are related by their membership in a common MPI\_COMM\_WORLD (see Section 11.2) communicator. In the Sessions Model (Section 11.3), an initial set of processes is also created, but the application must explicitly manage the creation of MPI groups, and hence MPI communicators. MPI\_COMM\_WORLD is only valid for use as a communicator in the World Model, i.e., after a successful call to MPI\_INIT or MPI\_INIT\_THREAD and before a call to MPI\_FINALIZE. An application can employ both of these Process Models concurrently. In multi-component MPI applications, for example, a component such as a library can make use of the Sessions Model to instantiate MPI resources without impacting the rest of the application.

Both of these models also support the *Dynamic Process Model* (see Section 11.7), which provides for the creation and management of additional processes after an MPI application has been started. A major impetus for the *Dynamic Process Model* comes from the PVM [25] research effort. This work has provided a wealth of experience with process management and resource control that illustrates their benefits and potential pitfalls.

In developing the *Dynamic Process Model*, the MPI Forum decided not to address resource control because it was not able to design a portable interface that would be ap-

1 appropriate for the broad spectrum of existing and potential resource and process controllers.  
 2 MPI assumes that resource control is provided externally.

3 Process management functionality is included in MPI to enable its use in classes of  
 4 message-passing applications requiring process control. These include task farms, serial  
 5 applications with parallel modules, and problems that require a run-time assessment of the  
 6 number and type of processes that should be started.

7 The following goals are central to the design of MPI process management:  
 8

- 9 • The MPI process model must apply to the vast majority of current parallel environ-  
 10 ments.
- 11 • MPI must not take over operating system responsibilities. It should instead provide a  
 12 clean interface between an application and system software.
- 13 • MPI must guarantee communication determinism in the presence of dynamic pro-  
 14 cesses, i.e., dynamic process management must not introduce unavoidable race condi-  
 15 tions.
- 16 • MPI must not contain features that compromise performance.

17  
 18  
 19  
 20 The *Dynamic Process Model* addresses these issues in two ways. First, MPI remains  
 21 primarily a communication library. It does not manage the parallel environment in which  
 22 a parallel program executes, though it provides a minimal interface between an application  
 23 and external resource and process managers.

24 Second, MPI maintains a consistent concept of a communicator, regardless of how its  
 25 members came into existence. A communicator is never changed once created, and it is  
 26 always created using deterministic collective operations.

## 27 11.2 The World Model

### 28 11.2.1 Starting MPI Processes

29  
 30 When using the World Model, MPI is initialized by calling either `MPI_INIT` or  
 31 `MPI_INIT_THREAD`.

32  
 33  
 34  
 35 `MPI_INIT()`

#### 36 **C binding**

37  
 38 `int MPI_Init(int *argc, char ***argv)`

#### 39 **Fortran 2008 binding**

40  
 41 `MPI_Init(ierror)`  
 42 `INTEGER, OPTIONAL, INTENT(OUT) :: ierror`

#### 43 **Fortran binding**

44  
 45 `MPI_INIT(IERROR)`  
 46 `INTEGER IERROR`

47 In the World Model, an MPI program must contain exactly one call to an MPI ini-  
 48 tialization routine: `MPI_INIT` or `MPI_INIT_THREAD`. `MPI_COMM_WORLD` and

MPI\_COMM\_SELF are not valid for use as communicators prior to invocation of MPI\_INIT or MPI\_INIT\_THREAD. Subsequent calls to either of these initialization routines are erroneous. A subset of MPI functions may be invoked before MPI initialization routines are called. See Section 11.4. MPI\_INIT accepts the argc and argv that are provided by the arguments to main or NULL:

```
int main(int argc, char *argv[])
{
    MPI_Init(&argc, &argv);

    /* parse arguments */
    /* main program */

    MPI_Finalize();    /* see below */
    return 0;
}
```

The Fortran version takes only IERROR.

Conforming implementations of MPI are required to allow applications to pass NULL for both the argc and argv arguments of main in C.

Failures may disrupt the execution of the program before or during MPI initialization. A high-quality implementation shall not deadlock during MPI initialization, even in the presence of failures. Except for functions with the MPI\_T\_ prefix, failures in MPI operations prior to or during MPI initialization are reported by invoking the initial error handler. Users can use the "mpi\_initial\_errhandler" info key during the launch of MPI processes (e.g., MPI\_COMM\_SPAWN / MPI\_COMM\_SPAWN\_MULTIPLE, or mpiexec) to set a non-fatal initial error handler before MPI initialization. When the initial error handler is set to MPI\_ERRORS\_ABORT, raising an error before or during initialization aborts the local MPI process (i.e., it is similar to calling MPI\_ABORT on MPI\_COMM\_SELF). An implementation may not always be capable of determining, before MPI initialization, what constitutes the local MPI process, or the set of connected processes. In this case, errors before initialization may cause a different set of MPI processes to abort than specified. During MPI initialization, the initial error handler is associated with MPI\_COMM\_WORLD, MPI\_COMM\_SELF, and the communicator returned by MPI\_COMM\_GET\_PARENT (if any).

*Advice to implementors.* Some failures may leave MPI in an undefined state, or raise an error before the error handling capabilities are fully operational, in which cases the implementation may be incapable of providing the desired error handling behavior. Of note, in some implementations, the notion of an MPI process is not clearly established in the early stages of MPI initialization (for example, when the implementation considers threads that called MPI\_INIT as independent MPI processes); in this case, before MPI is initialized, the MPI\_ERRORS\_ABORT error handler may abort what would have become multiple MPI processes.

When a failure occurs during MPI initialization, the implementation may decide to return MPI\_SUCCESS from the MPI initialization function instead of raising an error. It is recommended that an implementation masks an initialization error only when it expects that later MPI calls will result in well-specified behavior (i.e., barring additional failures, either the outcome of any call will be correct, or the call will raise an

appropriate error). For example, it may be difficult for an implementation to avoid unspecified behavior when the group of MPI\_COMM\_WORLD does not contain the same set of MPI processes at all members of the communicator, or if the communicator returned from MPI\_COMM\_GET\_PARENT was not initialized correctly. (*End of advice to implementors.*)

After MPI is initialized, the application can access information about the execution environment by querying the predefined info object MPI\_INFO\_ENV. The following keys are predefined for this object, corresponding to the arguments of MPI\_COMM\_SPAWN or of mpiexec:

"**command**" Name of program executed.

"**argv**" Space separated arguments to command.

"**maxprocs**" Maximum number of MPI processes to start.

"**mpi\_initial\_errhandler**" Name of the initial errhandler.

"**soft**" Allowed values for number of processors.

"**host**" Hostname.

"**arch**" Architecture name.

"**wdir**" Working directory of the MPI process.

"**file**" Value is the name of a file in which additional information is specified.

"**thread\_level**" Requested level of thread support, if requested before the program started execution.

Note that all values are strings. Thus, the maximum number of processes is represented by a string such as '1024' and the requested level is represented by a string such as 'MPI\_THREAD\_SINGLE'.

*Advice to users.* If one of the "argv" arguments contains a space, there is no way to tell from the value of the "argv" info key whether a space is part of the argument or is separating different arguments. (*End of advice to users.*)

The info object MPI\_INFO\_ENV need not contain a (key,value) pair for each of these predefined keys; the set of (key,value) pairs provided is implementation-dependent. Implementations may provide additional, implementation specific, (key,value) pairs.

In cases where the MPI processes were started with MPI\_COMM\_SPAWN\_MULTIPLE or, equivalently, with a startup mechanism that supports multiple process specifications, then the values stored in the info object MPI\_INFO\_ENV at a process are those values that affect the local MPI process.

**Example 11.1** If MPI is started with a call to

```
mpiexec -n 5 -arch x86_64 ocean : -n 10 -arch power9 atmos
```

Then the first 5 processes will have in their MPI\_INFO\_ENV object the pairs (command, ocean), (maxprocs, 5), and (arch, x86\_64). The next 10 processes will have in MPI\_INFO\_ENV (command, atmos), (maxprocs, 10), and (arch, power9)

*Advice to users.* The values passed in MPI\_INFO\_ENV are the values of the arguments passed to the mechanism that started the MPI execution—not the actual value provided. Thus, the value associated with "maxprocs" is the number of MPI processes requested; it can be larger than the actual number of processes obtained, if the soft option was used. (*End of advice to users.*)

*Advice to implementors.* High-quality implementations will provide a (key,value) pair for each parameter that can be passed to the command that starts an MPI program. (*End of advice to implementors.*)

The following function may be used to initialize MPI, and to initialize the MPI thread environment, instead of MPI\_INIT.

MPI\_INIT\_THREAD(required, provided)

IN	required	desired level of thread support (integer)
OUT	provided	provided level of thread support (integer)

### C binding

```
int MPI_Init_thread(int *argc, char ***argv, int required, int *provided)
```

### Fortran 2008 binding

```
MPI_Init_thread(required, provided, ierror)
  INTEGER, INTENT(IN) :: required
  INTEGER, INTENT(OUT) :: provided
  INTEGER, OPTIONAL, INTENT(OUT) :: ierror
```

### Fortran binding

```
MPI_INIT_THREAD(REQUIRED, PROVIDED, IERROR)
  INTEGER REQUIRED, PROVIDED, IERROR
```

This call initializes MPI in the same way that a call to MPI\_INIT would. In addition, it initializes the thread environment. The argument `required` is used to specify the desired level of thread support. The possible values are listed in increasing order of thread support.

**MPI\_THREAD\_SINGLE** Only one thread will execute.

**MPI\_THREAD\_FUNNELED** The process may be multithreaded, but the application must ensure that only the main thread makes MPI calls (for the definition of main thread, see MPI\_IS\_THREAD\_MAIN on page 489).

**MPI\_THREAD\_SERIALIZED** The process may be multithreaded, and multiple threads may make MPI calls, but only one at a time: MPI calls are not made concurrently from two distinct threads (all MPI calls are “serialized”).

**MPI\_THREAD\_MULTIPLE** Multiple threads may call MPI, with no restrictions.

1 These values are monotonic; i.e., `MPI_THREAD_SINGLE` < `MPI_THREAD_FUNNELED` <  
2 `MPI_THREAD_SERIALIZED` < `MPI_THREAD_MULTIPLE`.

3 Different processes in `MPI_COMM_WORLD` may require different levels of thread sup-  
4 port.

5 The call returns in provided information about the actual level of thread support that  
6 will be provided by MPI. It can be one of the four values listed above.

7 The level(s) of thread support that can be provided by `MPI_INIT_THREAD` will depend  
8 on the implementation, and may depend on information provided by the user before the  
9 program started to execute (e.g., with arguments to `mpiexec`). If possible, the call will  
10 return `provided = required`. Failing this, the call will return the least supported level such  
11 that `provided > required` (thus providing a stronger level of support than required by the  
12 user). Finally, if the user requirement cannot be satisfied, then the call will return in  
13 `provided` the highest supported level.

14 A **thread compliant** MPI implementation will be able to return `provided`  
15 = `MPI_THREAD_MULTIPLE`. Such an implementation may always return `provided`  
16 = `MPI_THREAD_MULTIPLE`, irrespective of the value of `required`.

17 An MPI library that is not thread compliant must always return `provided =`  
18 `MPI_THREAD_SINGLE`, even if `MPI_INIT_THREAD` is called on a multithreaded process.  
19 The library should also return correct values for the MPI calls that can be executed before  
20 initialization, even if multiple threads have been spawned.

21  
22 *Rationale.* Such code is erroneous, but if the MPI initialization is performed by a  
23 library, the error cannot be detected until `MPI_INIT_THREAD` is called. The require-  
24 ments in the previous paragraph ensure that the error can be properly detected. (*End*  
25 *of rationale.*)

26  
27 A call to `MPI_INIT` has the same effect as a call to `MPI_INIT_THREAD` with a `required`  
28 = `MPI_THREAD_SINGLE`.

29 Vendors may provide (implementation dependent) means to specify the level(s) of  
30 thread support available when the MPI program is started, e.g., with arguments to `mpiexec`.  
31 This will affect the outcome of calls to `MPI_INIT` and `MPI_INIT_THREAD`. Suppose, for  
32 example, that an MPI program has been started so that only `MPI_THREAD_MULTIPLE` is  
33 available. Then `MPI_INIT_THREAD` will return `provided = MPI_THREAD_MULTIPLE`, irre-  
34 spective of the value of `required`; a call to `MPI_INIT` will also initialize the MPI thread support  
35 level to `MPI_THREAD_MULTIPLE`. Suppose, instead, that an MPI program has been started  
36 so that all four levels of thread support are available. Then, a call to `MPI_INIT_THREAD`  
37 will return `provided = required`; alternatively, a call to `MPI_INIT` will initialize the MPI  
38 thread support level to `MPI_THREAD_SINGLE`.

39  
40 *Rationale.* Various optimizations are possible when MPI code is executed single-  
41 threaded, or is executed on multiple threads, but not concurrently: mutual exclusion  
42 code may be omitted. Furthermore, if only one thread executes, then the MPI library  
43 can use library functions that are not thread safe, without risking conflicts with user  
44 threads. Also, the model of one communication thread, multiple computation threads  
45 fits many applications well, e.g., if the process code is a sequential Fortran/C program  
46 with MPI calls that has been parallelized by a compiler for execution on an SMP node,  
47 in a cluster of SMPs, then the process computation is multithreaded, but MPI calls  
48 will likely execute on a single thread.

The design accommodates a static specification of the thread support level, for environments that require static binding of libraries, and for compatibility for current multithreaded MPI codes. (*End of rationale.*)

*Advice to implementors.* If `provided` is not `MPI_THREAD_SINGLE` then the MPI library should not invoke C or Fortran library calls that are not thread safe, e.g., in an environment where `malloc` is not thread safe, then `malloc` should not be used by the MPI library.

Some implementors may want to use different MPI libraries for different levels of thread support. They can do so using dynamic linking and selecting which library will be linked when `MPI_INIT_THREAD` is invoked. If this is not possible, then optimizations for lower levels of thread support will occur only when the level of thread support required is specified at link time.

Note that `required` need not be the same value on all processes of `MPI_COMM_WORLD`. (*End of advice to implementors.*)

As with `MPI_INIT`, discussed in Section 11.2.1, the version for ISO C accepts the `argc` and `argv` that are provided by the arguments to `main` or `NULL` for both arguments.

The following function can be used to query the current level of thread support.

`MPI_QUERY_THREAD(provided)`

OUT      `provided`                      `provided` level of thread support (integer)

#### C binding

```
int MPI_Query_thread(int *provided)
```

#### Fortran 2008 binding

```
MPI_Query_thread(provided, ierror)
  INTEGER, INTENT(OUT) :: provided
  INTEGER, OPTIONAL, INTENT(OUT) :: ierror
```

#### Fortran binding

```
MPI_QUERY_THREAD(PROVIDED, IERROR)
  INTEGER PROVIDED, IERROR
```

The call returns in `provided` the current level of thread support, which will be the value returned in `provided` by `MPI_INIT_THREAD`, if MPI was initialized by a call to `MPI_INIT_THREAD()`. This function is only applicable when using the World Model to initialize MPI. In the case of applications using both the World Model and the Sessions Model, this function only returns the thread support level returned in `provided` by `MPI_INIT_THREAD`.

1 MPI\_IS\_THREAD\_MAIN(flag)

2     OUT     flag                             true if calling thread is main thread, false otherwise  
3   (logical)  
4

### 5 C binding

6 int MPI\_Is\_thread\_main(int \*flag)

### 7 Fortran 2008 binding

8 MPI\_Is\_thread\_main(flag, ierror)  
9     LOGICAL, INTENT(OUT) :: flag  
10     INTEGER, OPTIONAL, INTENT(OUT) :: ierror  
11

### 12 Fortran binding

13 MPI\_IS\_THREAD\_MAIN(FLAG, IERROR)  
14     LOGICAL FLAG  
15     INTEGER IERROR  
16

17     This function can be called by a thread to determine if it is the main thread (the thread  
18     that called MPI\_INIT or MPI\_INIT\_THREAD). This function is only applicable when using  
19     the World Model to initialize MPI. In the case of applications using both the World Model  
20     and the Sessions Model, this function only returns the thread support level returned in  
21     provided by MPI\_INIT\_THREAD.

22     All routines listed in this section must be supported by all MPI implementations.

23  
24     *Rationale.* MPI libraries are required to provide these calls even if they do not  
25     support threads, so that portable code that contains invocations to these functions  
26     can link correctly. MPI\_INIT continues to be supported so as to provide compatibility  
27     with current MPI codes. (*End of rationale.*)  
28

29     *Advice to users.* It is possible to spawn threads before MPI is initialized, but  
30     MPI\_COMM\_WORLD and MPI\_COMM\_SELF cannot be used until the World Model is  
31     active, *i.e.* until MPI\_INIT\_THREAD is invoked by one thread (which, thereby, be-  
32     comes the main thread). In particular, it is possible to enter the MPI execution with  
33     a multithreaded process.

34     In the World Model, the level of thread support provided is a global property of the  
35     MPI process that can be specified only once, when MPI is initialized on that process (or  
36     before). Portable third party libraries have to be written so as to accommodate any  
37     provided level of thread support. Otherwise, their usage will be restricted to specific  
38     level(s) of thread support. If such a library can run only with specific level(s) of thread  
39     support, *e.g.*, only with MPI\_THREAD\_MULTIPLE, then MPI\_QUERY\_THREAD can be  
40     used to check whether the user initialized MPI to the correct level of thread support  
41     and. (*End of advice to users.*)  
42

## 43 11.2.2 Finalizing MPI

44  
45  
46 MPI\_FINALIZE()  
47  
48



**C binding**

```
int MPI_Finalize(void)
```

**Fortran 2008 binding**

```
MPI_Finalize(ierr)
    INTEGER, OPTIONAL, INTENT(OUT) :: ierr
```

**Fortran binding**

```
MPI_FINALIZE(IERROR)
    INTEGER IERROR
```

This routine cleans up all MPI state associated with the World Model. If an MPI program terminates normally (i.e., not due to a call to `MPI_ABORT` or an unrecoverable error) then each process must call `MPI_FINALIZE` before it exits.

Before an MPI process invokes `MPI_FINALIZE`, the process must perform all MPI calls needed to complete its involvement in MPI communications associated with the World Model. It must locally complete all MPI operations that it initiated and must execute matching calls needed to complete MPI communications initiated by other processes. For example, if the process executed a nonblocking send, it must eventually call `MPI_WAIT`, `MPI_TEST`, `MPI_REQUEST_FREE`, or any derived function; if the process is the target of a send, then it must post the matching receive; if it is part of a group executing a collective operation, then it must have completed its participation in the operation.

The call to `MPI_FINALIZE` does not clean up MPI state associated with objects created using `MPI_SESSION_INIT` and other Sessions Model methods, nor objects created using the communicator returned by `MPI_COMM_GET_PARENT`. See Sections 11.3 and 11.8.

The call to `MPI_FINALIZE` does not free objects created by MPI calls; these objects are freed using `MPI_XXX_FREE` calls.

`MPI_FINALIZE` is collective over all connected processes. If no processes were spawned, accepted or connected then this means over `MPI_COMM_WORLD`; otherwise it is collective over the union of all processes that have been and continue to be connected, as explained in Section 11.10.4.

The following examples illustrate these rules.

**Example 11.2** The following code is correct

<pre>Process 0 ----- MPI_Init(); MPI_Send(dest=1); MPI_Finalize();</pre>	<pre>Process 1 ----- MPI_Init(); MPI_Recv(src=0); MPI_Finalize();</pre>
--	---

**Example 11.3** Without a matching receive, the program is erroneous

<pre>Process 0 ----- MPI_Init(); MPI_Send (dest=1); MPI_Finalize();</pre>	<pre>Process 1 ----- MPI_Init(); MPI_Finalize();</pre>
---	--

**Example 11.4** This program is correct: Process 0 calls `MPI_Finalize` after it has executed the MPI calls that complete the send operation. Likewise, process 1 executes the MPI call that completes the matching receive operation before it calls `MPI_Finalize`.

```

5      Process 0                                Process 1
6      -----                                -----
7      MPI_Init();                             MPI_Init();
8      MPI_Isend(dest=1);                       MPI_Recv(src=0);
9      MPI_Request_free();                     MPI_Finalize();
10     MPI_Finalize();                          exit();
11     exit();

```

**Example 11.5** This program is correct. The attached buffer is a resource allocated by the user, not by MPI; it is available to the user after MPI is finalized.

```

16     Process 0                                Process 1
17     -----                                -----
18     MPI_Init();                             MPI_Init();
19     buffer = malloc(1000000);                MPI_Recv(src=0);
20     MPI_Buffer_attach();                    MPI_Finalize();
21     MPI_Send(dest=1));                      exit();
22     MPI_Finalize();
23     free(buffer);
24     exit();

```

**Example 11.6** This program is correct. The cancel operation must succeed, since the send cannot complete normally. The wait operation, after the call to `MPI_Cancel`, is local—no matching MPI call is required on process 1. Cancelling a send request by calling `MPI_CANCEL` is deprecated.

```

31     Process 0                                Process 1
32     -----                                -----
33     MPI_Issend(dest=1);                      MPI_Finalize();
34     MPI_Cancel();
35     MPI_Wait();
36     MPI_Finalize();

```

*Advice to implementors.* Even though a process has executed all MPI calls needed to complete the communications it is involved with, such communication may not yet be completed from the viewpoint of the underlying MPI system. For example, a blocking send may have returned, even though the data is still buffered at the sender in an MPI buffer; an MPI process may receive a cancel request for a message it has completed receiving. The MPI implementation must ensure that a process has completed any involvement in MPI communication before `MPI_FINALIZE` returns. Thus, if a process exits after the call to `MPI_FINALIZE`, this will not cause an ongoing communication to fail. The MPI implementation should also complete freeing all objects marked for deletion by MPI calls that freed them. (*End of advice to implementors.*)

Failures may disrupt MPI operations during and after MPI finalization. A high quality implementation shall not deadlock in MPI finalization, even in the presence of failures. The normal rules for MPI error handling continue to apply. After `MPI_COMM_SELF` has been “freed” (see Section 11.2.4), errors that are not associated with a communicator, window, or file raise the initial error handler (set during the launch operation, see 11.8.4).

Although it is not required that all processes return from `MPI_FINALIZE`, it is required that, when it has not failed or aborted, at least the MPI process that was assigned rank 0 in `MPI_COMM_WORLD` returns, so that users can know that the MPI portion of the computation is over. In addition, in a POSIX environment, users may desire to supply an exit code for each process that returns from `MPI_FINALIZE`.

Note that a failure may terminate the MPI process that was assigned rank 0 in `MPI_COMM_WORLD`, in which case it is possible that no MPI process returns from `MPI_FINALIZE`.

*Advice to users.* Applications that handle errors are encouraged to implement all rank-specific code before the call to `MPI_FINALIZE`. In Example 11.7 below, the process with rank 0 in `MPI_COMM_WORLD` may have been terminated before, during, or after the call to `MPI_FINALIZE`, possibly leading to the code after `MPI_FINALIZE` never being executed. (*End of advice to users.*)

**Example 11.7** The following illustrates the use of requiring that at least one process return and that it be known that process 0 is one of the processes that return. One wants code like the following to work no matter how many processes return.

```
...
MPI_Comm_rank(MPI_COMM_WORLD, &myrank);
...
MPI_Finalize();
if (myrank == 0) {
    resultfile = fopen("outfile", "w");
    dump_results(resultfile);
    fclose(resultfile);
}
exit(0);
```

### 11.2.3 Determining Whether MPI Has Been Initialized When Using the World Model

One of the goals of MPI is to allow for layered libraries. For a library using the World Model, it needs to know if MPI has been initialized using `MPI_INIT` or `MPI_INIT_THREAD`. In MPI the function `MPI_INITIALIZED` is provided to tell if MPI had been initialized using the World Model. In the World Model, once MPI has been finalized it cannot be restarted. A library needs to be able to determine this to act accordingly. To achieve this the function `MPI_FINALIZED` is needed.

1 MPI\_INITIALIZED(flag)

2     OUT     flag                             Flag is true if MPI\_INIT has been called and false  
3   otherwise (logical)  
4

5  
6 **C binding**

7 int MPI\_Initialized(int \*flag)

8 **Fortran 2008 binding**

9 MPI\_Initialized(flag, ierror)  
10     LOGICAL, INTENT(OUT) :: flag  
11     INTEGER, OPTIONAL, INTENT(OUT) :: ierror  
12

13 **Fortran binding**

14 MPI\_INITIALIZED(FLAG, IERROR)  
15     LOGICAL FLAG  
16     INTEGER IERROR  
17

18     This routine may be used to determine whether MPI\_INIT or MPI\_INIT\_THREAD has  
19     been called. MPI\_INITIALIZED returns true if the calling process has called either of these  
20     MPI procedures. Whether MPI\_FINALIZE has been called does not affect the behavior of  
21     MPI\_INITIALIZED. This function must always be thread-safe, as defined in Section 11.6.  
22     This function returns false for applications using the Sessions Model exclusively.  
23

24 MPI\_FINALIZED(flag)

25     OUT     flag                             true if MPI was finalized (logical)  
26

27 **C binding**

28 int MPI\_Finalized(int \*flag)

29 **Fortran 2008 binding**

30 MPI\_Finalized(flag, ierror)  
31     LOGICAL, INTENT(OUT) :: flag  
32     INTEGER, OPTIONAL, INTENT(OUT) :: ierror  
33

34 **Fortran binding**

35 MPI\_FINALIZED(FLAG, IERROR)  
36     LOGICAL FLAG  
37     INTEGER IERROR  
38

39     This routine returns true if MPI\_FINALIZE has completed. It is valid to call  
40     MPI\_FINALIZED before MPI\_INIT and after MPI\_FINALIZE. This function must always be  
41     thread-safe, as defined in Section 11.6.  
42

43 **11.2.4 Allowing User Functions at MPI Finalization**

44     In the context of the World Model, there are times in which it would be convenient to  
45     have actions happen when an MPI process finalizes MPI. For example, a routine may do  
46     initializations that are useful until the MPI job (or that part of the job that is being termi-  
47     nated in the case of dynamically created processes) finalizes MPI. This can be accomplished  
48

in MPI by attaching an attribute to `MPI_COMM_SELF` with a callback function. When `MPI_FINALIZE` is called, it will first execute the equivalent of an `MPI_COMM_FREE` on `MPI_COMM_SELF`. This will cause the delete callback function to be executed on all keys associated with `MPI_COMM_SELF`, in the reverse order that they were set on `MPI_COMM_SELF`. If no key has been attached to `MPI_COMM_SELF`, then no callback is invoked. The “freeing” of `MPI_COMM_SELF` occurs before any other parts of MPI are affected. Thus, for example, calling `MPI_FINALIZED` will return false in any of these callback functions. Once done with `MPI_COMM_SELF`, the order and rest of the actions taken by `MPI_FINALIZE` is not specified.

*Advice to implementors.* Since attributes can be added from any supported language, the MPI implementation needs to remember the creating language so the correct callback is made. Implementations that use the attribute delete callback on `MPI_COMM_SELF` internally should register their internal callbacks before returning from `MPI_INIT` / `MPI_INIT_THREAD`, so that libraries or applications will not have portions of the MPI implementation shut down before the application-level callbacks are made. (*End of advice to implementors.*)

### 11.3 The Sessions Model

There are a number of limitations with the World Model described in the preceding section. Among these are the following: MPI cannot be initialized from different application components without *a priori* knowledge or coordination; MPI cannot be initialized more than once; and MPI cannot be reinitialized after `MPI_FINALIZE` has been called. This section describes an alternative approach to MPI initialization—the Sessions Model. With this approach, an MPI application, or components of the application, can instantiate MPI resources for the specific communication needs of this component. `MPI_COMM_WORLD` is not valid for use as a communicator. `MPI_INFO_ENV` is not valid for use as an info object when only using the Sessions Model. As described in Section 11.2.1, MPI must be initialized using the World Model to use this info object.

In the Sessions Model, MPI resources can be allocated and freed multiple times in an MPI process.

As shown in Figure 11.1, when using the Sessions Model, an MPI process instantiates an *MPI Session handle*, which can be used to query the runtime system about characteristics of the job within which the process is running, as well as other system resources. Using this information, the MPI process can then create an MPI Group based on application requirements and available resources, which in turn can be used to create an MPI Communicator, Window, or File. By judicious creation of communicators, an application only needs to allocate MPI resources based on its communication requirements. Although there are existing MPI interfaces for creating communicators which can, in principle, allow for resource optimizations within an MPI implementation, this can only be done following initialization of MPI.

For multithreaded applications the Sessions Model provides fine-grain control of the thread support level for MPI objects. It is possible to specify different thread support levels when creating different *MPI Session handles*. Thus different components of an application can use different thread support levels.

The Sessions Model introduces a concept of isolation. MPI objects derived from different *MPI Session handles* shall not be intermixed with each other in a single MPI procedure call. MPI objects derived from the Sessions Model shall not be intermixed in a single MPI

1 procedure call with MPI objects derived from the World Model. MPI objects derived from  
2 the Sessions Model shall not be intermixed in a single MPI procedure call with MPI ob-  
3 jects derived from the communicator obtained from a call to `MPI_COMM_GET_PARENT`  
4 or `MPI_COMM_JOIN`.

5 This restriction does not apply to generalized requests (Section 13.2) as such requests  
6 are not associated directly with communicators or other MPI objects. Note however, the  
7 Sessions Model does not otherwise change the semantics or behavior of MPI objects.  
8

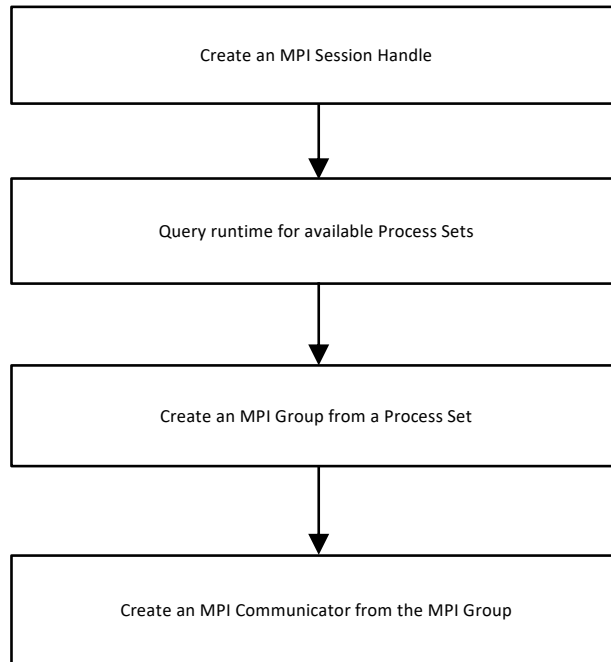

31  
32  
33  
34 Figure 11.1: Steps to creating an MPI Communicator from an MPI Session handle.  
35  
36  
37  
38  
39  
40  
41  
42  
43  
44  
45  
46  
47  
48

## 11.3.1 Session Creation and Destruction Methods

MPI\_SESSION\_INIT(info, errhandler, session)

IN	info	info object to specify thread support level and MPI implementation specific resources (handle)
IN	errhandler	error handler to invoke in the event that an error is encountered during this function call (handle)
OUT	session	new session (handle)

**C binding**

```
int MPI_Session_init(MPI_Info info, MPI_Errhandler errhandler,
                    MPI_Session *session)
```

**Fortran 2008 binding**

```
MPI_Session_init(info, errhandler, session, ierror)
  TYPE(MPI_Info), INTENT(IN) :: info
  TYPE(MPI_Errhandler), INTENT(IN) :: errhandler
  TYPE(MPI_Session), INTENT(OUT) :: session
  INTEGER, OPTIONAL, INTENT(OUT) :: ierror
```

**Fortran binding**

```
MPI_SESSION_INIT(INFO, ERRHANDLER, SESSION, IERROR)
  INTEGER INFO, ERRHANDLER, SESSION, IERROR
```

The info argument is used to request MPI functionality requirements and possible MPI implementation specific capabilities. The following info key is predefined:

**"thread\_level"** used to request the thread support level required for MPI objects derived from the Session. Allowed values are "MPI\_THREAD\_SINGLE", "MPI\_THREAD\_FUNNELED", "MPI\_THREAD\_SERIALIZED", and "MPI\_THREAD\_MULTIPLE". Note that the thread support value is specified by a string rather than the integer values supplied to MPI\_INIT\_THREAD. The thread support level actually provided by the MPI implementation can be determined via a subsequent call to MPI\_SESSION\_GET\_INFO to return the info object associated with the Session. The default thread support level is MPI implementation dependent.

The errhandler argument specifies an error handler to invoke in the event that the Session instantiation call encounters an error. The error handler shall be either a pre-defined error handler (see 9.3) or one created using MPI\_SESSION\_CREATE\_ERRHANDLER. Session instantiation is intended to be a lightweight operation. An MPI process may instantiate multiple Sessions. MPI\_SESSION\_INIT is always thread safe; multiple threads within an application may invoke it concurrently.

*Advice to users.* Requesting "MPI\_THREAD\_SINGLE" thread support level is generally not recommended, because this will conflict with other components of an application requesting higher levels of thread support. (*End of advice to users.*)

*Advice to implementors.* Owing to the restrictions of the MPI\_THREAD\_SINGLE thread support level, implementors are discouraged from making this the default thread support level for Sessions. (*End of advice to implementors.*)

MPI\_SESSION\_FINALIZE(session)

IN session session to be finalized (handle)

### C binding

```
int MPI_Session_finalize(MPI_Session *session)
```

### Fortran 2008 binding

```
MPI_Session_finalize(session, ierror)
    TYPE(MPI_Session), INTENT(INOUT) :: session
    INTEGER, OPTIONAL, INTENT(OUT) :: ierror
```

### Fortran binding

```
MPI_SESSION_FINALIZE(SESSION, IERROR)
    INTEGER SESSION, IERROR
```

This routine cleans up all MPI state associated with the supplied `session`. Every instantiated Session must be finalized using `MPI_SESSION_FINALIZE`. The handle `session` is set to `MPI_SESSION_NULL` by the call.

Before an MPI process invokes `MPI_SESSION_FINALIZE`, the process must perform all MPI calls needed to complete its involvement in MPI communications: it must locally complete all MPI operations that it initiated and it must execute matching calls needed to complete MPI communications initiated by other processes.

The call to `MPI_SESSION_FINALIZE` does not free objects created by MPI calls; these objects are freed using `MPI_XXX_FREE` calls.

`MPI_SESSION_FINALIZE` is collective over all MPI processes that are connected via MPI Communicators, Windows, or Files that were created as part of the Session and still exist. If processes were spawned, accepted, or connected using MPI Communicators created as part of this session, this operation is collective over the union of all processes that have been and continue to be connected via those objects, as explained in Section 11.10.4.

*Advice to implementors.* An MPI implementation should be able to implement the semantics of `MPI_SESSION_FINALIZE` without synchronization with other MPI processes, provided an application frees all MPI windows, closes all MPI files, and uses `MPI_COMM_DISCONNECT` to free all MPI communicators associated with a session prior to invoking `MPI_SESSION_FINALIZE` on the corresponding session handle. (*End of advice to implementors.*)

## 11.3.2 Processes Sets

Process sets are the mechanism for MPI applications to query the runtime. Process sets are identified by process set names. Process set names have a *Uniform Resource Identifier* (URI) format. Two process set names are mandated: "mpi://WORLD" and "mpi://SELF". Additional process set names may be defined, for example, "mpix://UNIVERSE" and "hwloc://L3Cache" may be defined by the MPI implementation. The



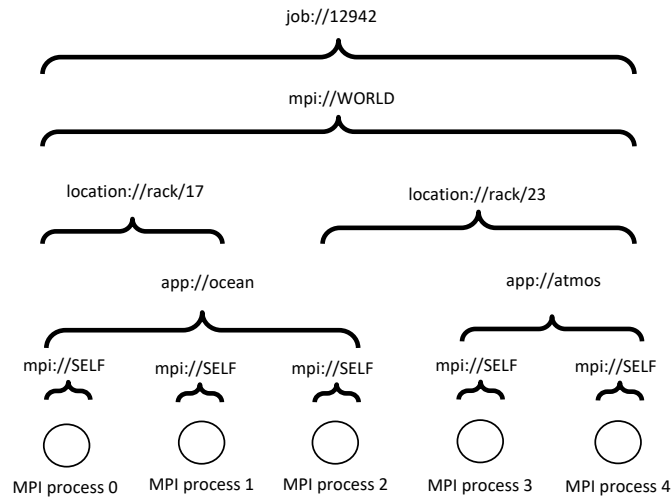

Figure 11.2: Examples of process sets. Illustrated are the two mandated process sets - "mpi://WORLD" and "mpi://SELF" - along with several optional ones that a runtime could define. In this example, `MPI_SESSION_GET_NUM_PSETS` would return five at each MPI process.

"mpi://" namespace is reserved for exclusive use by the MPI standard. Figure 11.2 depicts process sets that the runtime could associate with an instance of an MPI job. In this example, the two mandated process sets are defined, in addition to optional, implementation specific ones.

Mechanisms for defining process sets and how system resources are assigned to these sets is considered to be implementation dependent.

A process set caches key/value tuples that are accessible to the application via an `MPI_Info` object. The "mpi\_size" key is mandatory for all process sets.

### 11.3.3 Runtime Query Functions

`MPI_SESSION_GET_NUM_PSETS(session, info, npset_names)`

IN	session	session (handle)
IN	info	info object (handle)
OUT	npset_names	number of available process sets (non-negative integer)

#### C binding

```
int MPI_Session_get_num_psets(MPI_Session session, MPI_Info info,
                             int *npset_names)
```

**Fortran 2008 binding**

```

MPI_Session_get_num_psets(session, info, npset_names, ierror)
  TYPE(MPI_Session), INTENT(IN) :: session
  TYPE(MPI_Info), INTENT(IN) :: info
  INTEGER, INTENT(OUT) :: npset_names
  INTEGER, OPTIONAL, INTENT(OUT) :: ierror

```

**Fortran binding**

```

MPI_SESSION_GET_NUM_PSETS(SESSION, INFO, NPSET_NAMES, IERROR)
  INTEGER SESSION, INFO, NPSET_NAMES, IERROR

```

This function is used to query the runtime for the number of available process sets in which the calling MPI process is a member. An MPI implementation is allowed to increase the number of available process sets during the execution of an MPI application when new process sets become available. However, MPI implementations are not allowed to change the index of a particular process set name, or to change the name of the process set at a particular index, or to delete a process set name once it has been added. When a process set becomes invalid, for example, when some processes become unreachable due to failures in the communication system, subsequent usage of the process set name should raise an error. For example, creating an MPI\_Group from such a process set might succeed because it is a local operation, but creating an MPI\_Comm from that group and attempting collective communication should raise an error.

*Advice to implementors.* It is anticipated that an MPI implementation may be relying on an external runtime system to provide process sets. Such runtime systems may have the ability to dynamically create process sets during the course of application execution. Requiring the number of process sets returned by MPI\_SESSION\_GET\_NUM\_PSETS to be constant over the course of application execution would prevent an application from taking advantage of such capabilities. (*End of advice to implementors.*)

```

MPI_SESSION_GET_NTH_PSET(session, info, n, pset_len, pset_name)

```

IN	session	session (handle)
IN	info	info object (handle)
IN	n	index of the desired process set name (integer)
INOUT	pset_len	length of the pset_name argument (integer)
OUT	pset_name	name of the nth process set (string)

**C binding**

```

int MPI_Session_get_nth_pset(MPI_Session session, MPI_Info info, int n,
  int *pset_len, char *pset_name)

```

**Fortran 2008 binding**

```

MPI_Session_get_nth_pset(session, info, n, pset_len, pset_name, ierror)
  TYPE(MPI_Session), INTENT(IN) :: session
  TYPE(MPI_Info), INTENT(IN) :: info

```

```

INTEGER, INTENT(IN) :: n
INTEGER, INTENT(INOUT) :: pset_len
CHARACTER(LEN=*), INTENT(OUT) :: pset_name
INTEGER, OPTIONAL, INTENT(OUT) :: ierror

```

**Fortran binding**

```

MPI_SESSION_GET_NTH_PSET(SESSION, INFO, N, PSET_LEN, PSET_NAME, IERROR)
  INTEGER SESSION, INFO, N, PSET_LEN, IERROR
  CHARACTER*(*) PSET_NAME

```

This function returns the name of the *n*th process set in the supplied `pset_name` buffer. `pset_len` is the size of the buffer needed to store the *n*th process set name. If the `pset_len` passed into the function is less than the actual buffer size needed for the process set name, then the string value returned in `pset_name` is truncated. If `pset_len` is set to 0, `pset_name` is not changed. On return, the value of `pset_len` will be set to the required buffer size to hold the process set name. In C, `pset_len` includes the required space for the null terminator. In C, this function returns a null terminated string in all cases where the `pset_len` input value is greater than 0.

If two MPI processes get the same process set name, then the intersection of the two process sets shall either be the empty set or identical to the union of the two process sets.

After a successful call to `MPI_SESSION_GET_NTH_PSET`, subsequent calls to routines that query information about the same process set name and same session handle must return the same information. An MPI implementation is not allowed to alter any of the returned process set names.

Process set names have an implementation-defined maximum length of `MPI_MAX_PSET_NAME_LEN`.

*Advice to users.* `MPI_MAX_PSET_NAME_LEN` might be very large, so it might not be wise to declare a string of that size. Users are encouraged to use `MPI_SESSION_GET_NTH_PSET` both for obtaining the length of a `pset_name` and the process set name. (*End of advice to users.*)

```

MPI_SESSION_GET_INFO(session, info_used)

```

IN	session	session (handle)
OUT	info_used	see explanation below (handle)

**C binding**

```

int MPI_Session_get_info(MPI_Session session, MPI_Info *info_used)

```

**Fortran 2008 binding**

```

MPI_Session_get_info(session, info_used, ierror)
  TYPE(MPI_Session), INTENT(IN) :: session
  TYPE(MPI_Info), INTENT(OUT) :: info_used
  INTEGER, OPTIONAL, INTENT(OUT) :: ierror

```

**Fortran binding**

```

MPI_SESSION_GET_INFO(SESSION, INFO_USED, IERROR)

```

1       INTEGER SESSION, INFO\_USED, IERROR

2  
3       MPI\_SESSION\_GET\_INFO returns a new info object containing the hints of the MPI  
4 Session associated with *session*. The current setting of all hints related to this MPI Session  
5 is returned in *info\_used*. An MPI implementation is required to return all hints that are  
6 supported by the implementation and have default values specified; any user-supplied hints  
7 that were not ignored by the implementation; and any additional hints that were set by  
8 the implementation. If no such hints exist, a handle to a newly created info object is  
9 returned that contains no key/value pair. The user is responsible for freeing *info\_used* via  
10 MPI\_INFO\_FREE.

11  
12 MPI\_SESSION\_GET\_PSET\_INFO(*session*, *pset\_name*, *info*)

13	IN	<i>session</i>	<i>session</i> (handle)
14			
15	IN	<i>pset_name</i>	name of process set (string)
16			
17	OUT	<i>info</i>	info object containing information about the given 18 process set (handle)

### 19 C binding

20 int MPI\_Session\_get\_pset\_info(MPI\_Session *session*, const char \**pset\_name*,  
21 MPI\_Info \**info*)

### 22 Fortran 2008 binding

23 MPI\_Session\_get\_pset\_info(*session*, *pset\_name*, *info*, *ierror*)  
24 TYPE(MPI\_Session), INTENT(IN) :: *session*  
25 CHARACTER(LEN=\*), INTENT(IN) :: *pset\_name*  
26 TYPE(MPI\_Info), INTENT(OUT) :: *info*  
27 INTEGER, OPTIONAL, INTENT(OUT) :: *ierror*

### 28 Fortran binding

29  
30 MPI\_SESSION\_GET\_PSET\_INFO(SESSION, PSET\_NAME, INFO, IERROR)  
31 INTEGER SESSION, INFO, IERROR  
32 CHARACTER\*(\*) PSET\_NAME

33  
34 This function is used to query properties of a specific process set. The returned *info*  
35 object can be queried with existing MPI info object query functions. One key/value pair  
36 must be defined, "mpi\_size". The value of the "mpi\_size" key specifies the number of MPI  
37 processes in the process set. The user is responsible for freeing the returned MPI\_Info object.

### 38 11.3.4 Sessions Model Examples

39  
40 This section presents several examples of how to use MPI Sessions to create MPI Groups  
41 and MPI Communicators.

42  
43 **Example 11.8** Simple example illustrating creation of an MPI communicator using the  
44 Sessions Model.

```
#include <stdio.h> 1
#include <stdlib.h> 2
#include <string.h> 3
#include "mpi.h" 4
5
static MPI_Session lib_shandle = MPI_SESSION_NULL; 6
static MPI_Comm lib_comm = MPI_COMM_NULL; 7
8
int library_foo_init(void) 9
{ 10
    int rc, flag, valuelen; 11
    int ret = 0; 12
    const char pset_name[] = "mpi://WORLD"; 13
    const char mt_key[] = "thread_level"; 14
    const char mt_value[] = "MPI_THREAD_MULTIPLE"; 15
    char out_value[100]; /* large enough */ 16
    MPI_Group wgroup = MPI_GROUP_NULL; 17
    MPI_Info sinfo = MPI_INFO_NULL; 18
    MPI_Info tinfo = MPI_INFO_NULL; 19
20
    MPI_Info_create(&sinfo); 21
    MPI_Info_set(sinfo, mt_key, mt_value); 22
    rc = MPI_Session_init(sinfo, MPI_ERRORS_RETURN, 23
                          &lib_shandle); 24
    if (rc != MPI_SUCCESS) { 25
        ret = -1; 26
        goto fn_exit; 27
    } 28
29
    /* 30
     * check we got thread support level foo library needs 31
     */ 32
    rc = MPI_Session_get_info(lib_shandle, &tinfo); 33
    if (rc != MPI_SUCCESS) { 34
        ret = -1; 35
        goto fn_exit; 36
    } 37
38
    valuelen = sizeof(out_value); 39
    MPI_Info_get_string(tinfo, mt_key, &valuelen, 40
                       out_value, &flag); 41
    if (0 == flag) { 42
        printf("Could not find key %s\n", mt_key); 43
        ret = -1; 44
        goto fn_exit; 45
    } 46
47
    if (strcmp(out_value, mt_value)) { 48
```

```

1     printf("Did not get thread multiple support, got %s\n",
2           out_value);
3     ret = -1;
4     goto fn_exit;
5 }
6
7 /*
8  * create a group from the WORLD process set
9  */
10    rc = MPI_Group_from_session_pset(lib_shandle,
11                                   pset_name,
12                                   &wgroup);
13
14    if (rc != MPI_SUCCESS) {
15        ret = -1;
16        goto fn_exit;
17    }
18
19    /*
20     * get a communicator
21     */
22    rc = MPI_Comm_create_from_group(wgroup,
23                                   "org.mpi-forum.mpi-v4_0.example-ex10_8",
24                                   MPI_INFO_NULL,
25                                   MPI_ERRORS_RETURN,
26                                   &lib_comm);
27
28    if (rc != MPI_SUCCESS) {
29        ret = -1;
30        goto fn_exit;
31    }
32
33    /*
34     * free group, library doesn't need it.
35     */
36
37    fn_exit:
38    MPI_Group_free(&wgroup);
39
40    if (sinfo != MPI_INFO_NULL) {
41        MPI_Info_free(&sinfo);
42    }
43
44    if (tinfo != MPI_INFO_NULL) {
45        MPI_Info_free(&tinfo);
46    }
47
48    if (ret != 0) {
49        MPI_Session_finalize(&lib_shandle);
50    }

```

```
    return ret;
}
```

Example 11.8 shows how the pre-defined "mpi://WORLD" process set can be used to first create a local MPI group and then subsequently to create an MPI communicator from this group.

**Example 11.9** This example illustrates the use of Process Set query functions to select a Process Set to use for MPI Group creation.

```
#include <stdio.h>
#include <stdlib.h>
#include <string.h>
#include "mpi.h"

int main(int argc, char *argv[])
{
    int i, n_psets, psetlen, rc, ret;
    int valuelen;
    int flag = 0;
    char *pset_name = NULL;
    char *info_val = NULL;
    MPI_Session shandle = MPI_SESSION_NULL;
    MPI_Info sinfo = MPI_INFO_NULL;
    MPI_Group pgroup = MPI_GROUP_NULL;

    if (argc < 2) {
        fprintf(stderr, "A process set name fragment is required\n");
        return -1;
    }

    rc = MPI_Session_init(MPI_INFO_NULL, MPI_ERRORS_RETURN, &shandle);
    if (rc != MPI_SUCCESS) {
        fprintf(stderr, "Could not initialize session, bailing out\n");
        return -1;
    }

    MPI_Session_get_num_psets(shandle, MPI_INFO_NULL, &n_psets);

    for (i=0, pset_name=NULL; i<n_psets; i++) {
        psetlen = 0;
        MPI_Session_get_nth_pset(shandle, MPI_INFO_NULL, i,
                                &psetlen, NULL);
        pset_name = (char *)malloc(sizeof(char) * psetlen);
        MPI_Session_get_nth_pset(shandle, MPI_INFO_NULL, i,
                                &psetlen, pset_name);
        if (strstr(pset_name, argv[1]) != NULL) break;
    }
}
```

```

1      free(pset_name);
2      pset_name = NULL;
3  }
4
5  /*
6   * get instance of an info object for this Session
7   */
8
9  MPI_Session_get_pset_info(shandle, pset_name, &sinfo);
10 valuelen = 0;
11 MPI_Info_get_string(sinfo, "mpi_size", &valuelen, NULL, &flag);
12 if (flag) {
13     info_val = (char *)malloc(valuelen);
14     MPI_Info_get_string(sinfo, "mpi_size", &valuelen, info_val, &flag);
15     free(info_val);
16 }
17
18 /*
19 * create a group from the process set
20 */
21
22 rc = MPI_Group_from_session_pset(shandle, pset_name,
23                                &pgroup);
24 ret = (rc == MPI_SUCCESS) ? 0 : -1;
25
26 free(pset_name);
27 MPI_Group_free(&pgroup);
28 MPI_Info_free(&sinfo);
29 MPI_Session_finalize(&shandle);
30
31 fprintf(stderr, "Test completed ret = %d\n", ret);
32 return ret;
33
34 }

```

Example 11.9 illustrates several aspects of the Sessions Model. First, the default error handler can be specified when instantiating a Session instance. Second, there must be at least two process sets associated with a Session. Third, the example illustrates use of the Sessions info object and the one required key: "mpi\_size".

**Example 11.10** A Fortran 2008 example illustrating how to obtain information about available process sets, create an MPI Group from a process set, and subsequently create an MPI Communicator.

```

44 PROGRAM MAIN
45     USE mpi_f08
46     IMPLICIT NONE
47     INTEGER :: pset_len, ierror, n_psets
48     CHARACTER(LEN=:), ALLOCATABLE :: pset_name

```



```

TYPE(MPI_Session) :: shandle
TYPE(MPI_Group)  :: pgroup
TYPE(MPI_Comm)  :: pcomm

CALL MPI_Session_init(MPI_INFO_NULL, MPI_ERRORS_RETURN, &
                     shandle, ierror)
IF (ierror .NE. MPI_SUCCESS) THEN
  WRITE(*,*) "MPI_Session_init failed"
  ERROR STOP
END IF

CALL MPI_Session_get_num_psets(shandle, MPI_INFO_NULL, n_psets)
IF (n_psets .LT. 2) THEN
  WRITE(*,*) "MPI_Session_get_num_psets didn't return at least 2 psets"
  ERROR STOP
END IF

!
! Just get the second pset's length and name
! Note that index values are zero-based, even in Fortran
!

pset_len = 0
CALL MPI_Session_get_nth_pset(shandle, MPI_INFO_NULL, 1, &
                             pset_len, pset_name)
ALLOCATE(Character(len=pset_len)::pset_name)
CALL MPI_Session_get_nth_pset(shandle, MPI_INFO_NULL, 1, &
                             pset_len, pset_name)

!
! create a group from the pset
!
CALL MPI_Group_from_session_pset(shandle, pset_name, pgroup)
!
! free the buffer used for the pset name
!
DEALLOCATE(pset_name)

!
! create a MPI communicator from the group
!
CALL MPI_Comm_create_from_group(pgroup, "session_example", &
                               MPI_INFO_NULL, &
                               MPI_ERRORS_RETURN, &
                               pcomm)

CALL MPI_Barrier(pcomm, ierror)
IF (ierror .NE. MPI_SUCCESS) THEN

```

```

1      WRITE(*,*) "Barrier call on communicator failed"
2      ERROR STOP
3  END IF
4
5      CALL MPI_Comm_free(pcomm)
6      CALL MPI_Group_free(pgroup)
7      CALL MPI_Session_finalize(shandle, ierror)
8
9  END PROGRAM MAIN

```

Note in this example that the call to `MPI_SESSION_FINALIZE` may block in order to ensure that the calling MPI process has completed its involvement in the preceding `MPI_BARRIER` operation. If `MPI_COMM_DISCONNECT` had been used instead of `MPI_COMM_FREE`, the example would have blocked in `MPI_COMM_DISCONNECT` rather than `MPI_SESSION_FINALIZE`.

## 11.4 Common Elements of Both Process Models

### 11.4.1 MPI Functionality that is Always Available

Some MPI functions may be invoked at any time, including prior to calling `MPI_INIT` or `MPI_SESSION_INIT`, and following MPI finalization, independent of whether the World Model, Sessions Model, or both are used. These functions can be called concurrently by multiple threads within an MPI Process. Table 11.1 lists the applicable MPI functions.

In addition to the functions listed in Table 11.1, any function with the prefix `MPI_T_` (within the constraints for functions with this prefix listed in Section 15.3.4) may also be called prior to MPI initialization and after MPI finalization.

### 11.4.2 Aborting MPI Processes

`MPI_ABORT(comm, errorcode)`

IN	comm	communicator of tasks to abort (handle)
IN	errorcode	error code to return to invoking environment (integer)

#### C binding

```
int MPI_Abort(MPI_Comm comm, int errorcode)
```

#### Fortran 2008 binding

```

MPI_Abort(comm, errorcode, ierror)
  TYPE(MPI_Comm), INTENT(IN) :: comm
  INTEGER, INTENT(IN) :: errorcode
  INTEGER, OPTIONAL, INTENT(OUT) :: ierror

```

#### Fortran binding

```
MPI_ABORT(COMM, ERRORCODE, IERROR)
```

MPI_INITIALIZED	1
MPI_FINALIZED	2
MPI_GET_VERSION	3
MPI_GET_LIBRARY_VERSION	4
MPI_INFO_CREATE	5
MPI_INFO_CREATE_ENV	6
MPI_INFO_SET	7
MPI_INFO_DELETE	8
MPI_INFO_GET	9
MPI_INFO_GET_VALUELEN	10
MPI_INFO_GET_NKEYS	11
MPI_INFO_GET_NTHKEY	12
MPI_INFO_DUP	13
MPI_INFO_FREE	14
MPI_INFO_F2C	15
MPI_INFO_C2F	16
MPI_SESSION_CREATE_ERRHANDLER	17
MPI_SESSION_CALL_ERRHANDLER	18
MPI_ERRHANDLER_FREE	19
MPI_ERRHANDLER_F2C	20
MPI_ERRHANDLER_C2F	21
MPI_ERROR_STRING	22
MPI_ERROR_CLASS	23

Table 11.1: List of MPI Functions that can be called at any time within an MPI program, including prior to MPI initialization and following MPI finalization

INTEGER COMM, ERRORCODE, IERROR

This routine makes a “best attempt” to abort all MPI processes in the group of `comm`. This function does not require that the invoking environment take any action with the error code. However, a Unix or POSIX environment should handle this as a `return errorcode` from the main program.

It may not be possible for an MPI implementation to abort only the processes represented by `comm` if this is a subset of the processes. In this case, the MPI implementation should attempt to abort all the connected processes but should not abort any unconnected processes. When using the World Model, and if no processes were spawned, accepted, or connected then this has the effect of aborting all the processes associated with `MPI_COMM_WORLD`. In the case of the Sessions Model, if an MPI process has instantiated multiple sessions, the union of the process sets in these sessions are considered connected processes. Thus invoking `MPI_ABORT` on a communicator derived from one of these sessions will result in all MPI processes in this union being aborted.

*Advice to implementors.* After aborting a subset of processes, a high quality implementation should be able to provide error handling for communicators, windows, and files involving both aborted and non-aborted processes. As an example, if the user changes the error handler for `MPI_COMM_WORLD` to `MPI_ERRORS_RETURN` or a

1 custom error handler, when a subset of MPI\_COMM\_WORLD is aborted, the remaining  
 2 processes in MPI\_COMM\_WORLD should be able to continue communicating with each  
 3 other and receive an appropriate error code when attempting communication with  
 4 an aborted process (e.g., an error of class MPI\_ERR\_PROC\_ABORTED). A high quality  
 5 implementation should support equivalent behavior for communicators derived from  
 6 sessions. (*End of advice to implementors.*)

7  
 8 *Advice to users.* Whether the `errorcode` is returned from the executable or from the  
 9 MPI process startup mechanism (e.g., `mpirexec`), is an aspect of quality of the MPI  
 10 library but not mandatory. (*End of advice to users.*)

11  
 12  
 13 *Advice to implementors.* Where possible, a high-quality implementation will try  
 14 to return the `errorcode` from the MPI process startup mechanism (e.g. `mpirexec` or  
 15 singleton `init`). (*End of advice to implementors.*)

## 17 11.5 Portable MPI Process Startup

18  
 19 A number of implementations of MPI provide a startup command for MPI programs that  
 20 is of the form

```
21      mpirun <mpirun arguments> <program> <program arguments>
```

22  
 23 Separating the command to start the program from the program itself provides flexibility,  
 24 particularly for network and heterogeneous implementations. For example, the startup  
 25 script need not run on one of the machines that will be executing the MPI program itself.

26 Having a standard startup mechanism also extends the portability of MPI programs one  
 27 step further, to the command lines and scripts that manage them. For example, a validation  
 28 suite script that runs hundreds of programs can be a portable script if it is written using such  
 29 a standard startup mechanism. In order that the “standard” command not be confused  
 30 with existing practice, which is not standard and not portable among implementations,  
 31 instead of `mpirun MPI` specifies `mpirexec`.

32 While a standardized startup mechanism improves the usability of MPI, the range of  
 33 environments is so diverse (e.g., there may not even be a command line interface) that MPI  
 34 cannot mandate such a mechanism. Instead, MPI specifies an `mpirexec` startup command  
 35 and recommends but does not require it, as advice to implementors. However, if an im-  
 36 plementation does provide a command called `mpirexec`, it must be of the form described  
 37 below.

38 It is suggested that

```
39      mpiexec -n <numprocs> <program>
```

40  
 41 be at least one way to start `<program>` with an initial set of `<numprocs>` processes, which  
 42 will be accessible as the process set named “`mpi://WORLD`” in the Sessions Model and/or  
 43 used to the form the group associated with the built-in communicator, `MPI_COMM_WORLD`  
 44 in the World Model. Other arguments to `mpirexec` may be implementation-dependent.

45  
 46  
 47 *Advice to implementors.* Implementors, if they do provide a special startup command  
 48 for MPI programs, are advised to give it the following form. The syntax is chosen in

order that `mpiexec` be able to be viewed as a command-line version of `MPI_COMM_SPAWN` (See Section 11.8.4).

Analogous to `MPI_COMM_SPAWN`, we have

```

mpiexec -n                <maxprocs>
        -soft             <      >
        -host             <      >
        -arch             <      >
        -wdir             <      >
        -path             <      >
        -file             <      >
        -initial-errhandler <      >
        ...
        <command line>

```

for the case where a single command line for the application program and its arguments will suffice. See Section 11.8.4 for the meanings of these arguments. For the case corresponding to `MPI_COMM_SPAWN_MULTIPLE` there are two possible formats:

Form A:

```

mpiexec { <above arguments> } : { ... } : { ... } : ... : { ... }

```

As with `MPI_COMM_SPAWN`, all the arguments are optional. (Even the `-n x` argument is optional; the default is implementation dependent. It might be 1, it might be taken from an environment variable, or it might be specified at compile time.) The names and meanings of the arguments are taken from the keys in the `info` argument to `MPI_COMM_SPAWN`. There may be other, implementation-dependent arguments as well.

Note that Form A, though convenient to type, prevents colons from being program arguments. Therefore an alternate, file-based form is allowed:

Form B:

```

mpiexec -configfile <filename>

```

where the lines of `<filename>` are of the form separated by the colons in Form A. Lines beginning with `#` are comments, and lines may be continued by terminating the partial line with `\`.

**Example 11.11** Start 16 instances of `myprog` on the current or default machine:

```

mpiexec -n 16 myprog

```

**Example 11.12** Start 10 instances of `myprog` on the machine called `ferrari`:

```

mpiexec -n 10 -host ferrari myprog

```

1       **Example 11.13** Start 3 instances of the same program `myprog` with different com-  
 2       mand-line arguments:

```
3
4       mpirun myprog infile1 : myprog infile2 : myprog infile3
5
```

6  
 7       **Example 11.14** Start 5 instances of the `ocean` program on `x86_64` hosts and 10  
 8       instances of the `atmos` program on Power9 hosts (Form B):

```
9
10       mpirun -n 5 -arch x86_64 ocean : -n 10 -arch power9 atmos
11
```

12       It is assumed that the implementation in this case has a method for choosing hosts of  
 13       the appropriate type. Their ranks are in the order specified.

14  
 15       **Example 11.15** Start the `ocean` program on five Suns and the `atmos` program on  
 16       10 RS/6000's (Form B):

```
17
18       mpirun -configfile myfile
19
```

20       where `myfile` contains

```
21
22       -n 5 -arch sun     ocean
23       -n 10 -arch rs6000 atmos
24
```

25       (*End of advice to implementors.*)

## 26 27 11.6 MPI and Threads

28  
 29       This section specifies the interaction between MPI calls and threads. Although thread com-  
 30       pliance is not required, the standard specifies how threads are to work if they are provided.  
 31       The section lists minimal requirements for **thread compliant** MPI implementations and  
 32       defines functions that can be used for initializing the thread environment. MPI may be im-  
 33       plemented in environments where threads are not supported or perform poorly. Therefore,  
 34       MPI implementations are not required to be thread compliant as defined in this section.  
 35       Regardless of whether or not the MPI implementation is thread compliant, a subset of MPI  
 36       functions must always be thread safe. A complete list of such MPI functions is given in Ta-  
 37       ble 11.1. When a thread is executing one of these routines, if another concurrently running  
 38       thread also makes an MPI call, the outcome will be as if the calls executed in some order.

39       This section generally assumes a thread package similar to POSIX threads [44], but  
 40       the syntax and semantics of thread calls are not specified here—these are beyond the scope  
 41       of this document.

### 42 43 11.6.1 General

44  
 45       In a thread-compliant implementation, an MPI process is a process that may be multi-  
 46       threaded. Each thread can issue MPI calls; however, threads are not separately addressable:  
 47       a rank in a send or receive call identifies a process, not a thread. A message sent to a process  
 48       can be received by any thread in this process.

*Rationale.* This model corresponds to the POSIX model of interprocess communication: the fact that a process is multithreaded, rather than single-threaded, does not affect the external interface of this process. MPI implementations in which MPI ‘processes’ are POSIX threads inside a single POSIX process are not thread-compliant by this definition (indeed, their “processes” are single-threaded). (*End of rationale.*)

*Advice to users.* It is the user’s responsibility to prevent races when threads within the same application post conflicting communication calls. The user can make sure that two threads in the same process will not issue conflicting communication calls by using distinct communicators at each thread. (*End of advice to users.*)

The two main requirements for a thread-compliant implementation are listed below.

1. All MPI calls are *thread-safe*, i.e., two concurrently running threads may make MPI calls and the outcome will be as if the calls executed in some order, even if their execution is interleaved.
2. Blocking MPI calls will block the calling thread only, allowing another thread to execute, if available. The calling thread will be blocked until the event on which it is waiting occurs. Once the blocked communication is enabled and can proceed, then the call will complete and the thread will be marked runnable, within a finite time. A blocked thread will not prevent progress of other runnable threads on the same process, and will not prevent them from executing MPI calls.

**Example 11.16** Process 0 consists of two threads. The first thread executes a blocking send call `MPI_Send(buff1, count, type, 0, 0, comm)`, whereas the second thread executes a blocking receive call `MPI_Recv(buff2, count, type, 0, 0, comm, &status)`, i.e., the first thread sends a message that is received by the second thread. This communication should always succeed. According to the first requirement, the execution will correspond to some interleaving of the two calls. According to the second requirement, a call can only block the calling thread and cannot prevent progress of the other thread. If the send call went ahead of the receive call, then the sending thread may block, but this will not prevent the receiving thread from executing. Thus, the receive call will occur. Once both calls occur, the communication is enabled and both calls will complete. On the other hand, a single-threaded process that posts a send, followed by a matching receive, may deadlock. The progress requirement for multithreaded implementations is stronger, as a blocked call cannot prevent progress in other threads.

*Advice to implementors.* MPI calls can be made thread-safe by executing only one at a time, e.g., by protecting MPI code with one process-global lock. However, blocked operations cannot hold the lock, as this would prevent progress of other threads in the process. The lock is held only for the duration of an atomic, locally-completing suboperation such as posting a send or completing a send, and is released in between. Finer locks can provide more concurrency, at the expense of higher locking overheads. Concurrency can also be achieved by having some of the MPI protocol executed by separate server threads. (*End of advice to implementors.*)

## 11.6.2 Clarifications

**Initialization and Completion** When using the World Model, the call to `MPI_FINALIZE` should occur on the same thread that initialized MPI. We call this thread the **main thread**. The call should occur only after all process threads have completed their MPI calls, and have no pending communications or I/O operations.

*Rationale.* This constraint simplifies implementation. (*End of rationale.*)

**Threads and the Sessions Model** The Sessions Model provides a finer-grain approach to controlling the interaction between MPI calls and threads. When using this model, the desired level of thread support is specified at Session initialization time. See Section 11.3. Thus it is possible for communicators and other MPI objects derived from one Session to provide a different level of thread support than those created from another Session for which a different level of thread support was requested. Depending on the level of thread support requested at Session initialization time, different threads in a MPI process can make concurrent calls to MPI when using MPI objects derived from different *session handles*. Note that the requested and provided level of thread support when creating a Session may influence the granted level of thread support in a subsequent invocation of `MPI_SESSION_INIT`. Likewise, if the application at some point calls `MPI_INIT_THREAD`, the requested and granted level of thread support may influence the granted level of thread support for subsequent calls to `MPI_SESSION_INIT`. Similarly, if the application calls `MPI_INIT_THREAD` after a call to `MPI_SESSION_INIT`, the level of thread support returned from `MPI_INIT_THREAD` may be similarly influenced by the requested level of thread support in the prior call to `MPI_SESSION_INIT`.

In addition, if an MPI application is only using the Sessions Model, the provided thread support level returned by `MPI_QUERY_THREAD` is the same as that returned prior to invocation of `MPI_INIT_THREAD` or `MPI_INIT`. If the application also used the World Model in some component of the application, `MPI_QUERY_THREAD` will return the level of thread support returned by the original call to `MPI_INIT_THREAD`.

**Multiple threads completing the same request.** A program in which two threads block, waiting on the same request, is erroneous. Similarly, the same request cannot appear in the array of requests of two concurrent `MPI_{WAIT|TEST}{ANY|SOME|ALL}` calls. In MPI, a request can only be completed once. Any combination of wait or test that violates this rule is erroneous.

*Rationale.* This restriction is consistent with the view that a multithreaded execution corresponds to an interleaving of the MPI calls. In a single threaded implementation, once a wait is posted on a request the request handle will be nullified before it is possible to post a second wait on the same handle. With threads, an `MPI_WAIT{ANY|SOME|ALL}` may be blocked without having nullified its request(s) so it becomes the user's responsibility to avoid using the same request in an `MPI_WAIT` on another thread. This constraint also simplifies implementation, as only one thread will be blocked on any communication or I/O event. (*End of rationale.*)

**Probe** A receive call that uses source and tag values returned by a preceding call to `MPI_PROBE` or `MPI_IPROBE` will receive the message matched by the probe call only



if there was no other matching receive after the probe and before that receive. In a multi-threaded environment, it is up to the user to enforce this condition using suitable mutual exclusion logic. This can be enforced by making sure that each communicator is used by only one thread on each process. Alternatively, `MPI_MPROBE` or `MPI_IMPROBE` can be used.

**Collective calls** Matching of collective calls on a communicator, window, or file handle is done according to the order in which the calls are issued at each process. If concurrent threads issue such calls on the same communicator, window or file handle, it is up to the user to make sure the calls are correctly ordered, using interthread synchronization.

*Advice to users.* With three concurrent threads in each MPI process of a communicator `comm`, it is allowed that thread A in each MPI process calls a collective operation on `comm`, thread B calls a file operation on an existing filehandle that was formerly opened on `comm`, and thread C invokes one-sided operations on an existing window handle that was also formerly created on `comm`. (*End of advice to users.*)

*Rationale.* As specified in `MPI_FILE_OPEN` and `MPI_WIN_CREATE`, a file handle and a window handle inherit only the group of processes of the underlying communicator, but not the communicator itself. Accesses to communicators, window handles and file handles cannot affect one another. (*End of rationale.*)

*Advice to implementors.* If the implementation of file or window operations internally uses MPI communication then a duplicated communicator may be cached on the file or window object. (*End of advice to implementors.*)

**Error handlers** An error handler does not necessarily execute in the context of the thread that made the error-raising MPI call; the error handler may be executed by a thread that is distinct from the thread that will return the error code.

*Rationale.* The MPI implementation may be multithreaded, so that part of the communication protocol may execute on a thread that is distinct from the thread that made the MPI call. The design allows the error handler to be executed on the thread where the error is raised. (*End of rationale.*)

**Interaction with signals and cancellations** The outcome is undefined if a thread that executes an MPI call is cancelled (by another thread), or if a thread catches a signal while executing an MPI call. However, a thread of an MPI process may terminate, and may catch signals or be cancelled by another thread when not executing MPI calls.

*Rationale.* Few C library functions are signal safe, and many have cancellation points—points at which the thread executing them may be cancelled. The above restriction simplifies implementation (no need for the MPI library to be “async-cancel-safe” or “async-signal-safe”). (*End of rationale.*)

*Advice to users.* Users can catch signals in separate, non-MPI threads (e.g., by masking signals on MPI calling threads, and unmasking them in one or more non-MPI threads). A good programming practice is to have a distinct thread blocked in a call to `sigwait` for each user expected signal that may occur. Users must not catch

1 signals used by the MPI implementation; as each MPI implementation is required to  
2 document the signals used internally, users can avoid these signals. (*End of advice to*  
3 *users.*)

4  
5 *Advice to implementors.* The MPI library should not invoke library calls that are  
6 not thread safe, if multiple threads execute. (*End of advice to implementors.*)

## 8 11.7 The Dynamic Process Model

9  
10 The dynamic process model allows for the creation and cooperative termination of processes  
11 after an MPI application has started. It provides a mechanism to establish communication  
12 between the newly created processes and the existing MPI application. It also provides a  
13 mechanism to establish communication between two existing MPI applications, even when  
14 one did not “start” the other.

### 16 11.7.1 Starting Processes

17  
18 MPI applications may start new processes through an interface to an external process man-  
19 ager.

20 MPI\_COMM\_SPAWN starts MPI processes and establishes communication with them,  
21 returning an inter-communicator. MPI\_COMM\_SPAWN\_MULTIPLE starts several different  
22 binaries (or the same binary with different arguments), placing them in the same  
23 MPI\_COMM\_WORLD and returning an inter-communicator.

24 MPI uses the group abstraction to represent processes. A process is identified by a  
25 (group, rank) pair.

### 27 11.7.2 The Runtime Environment

28  
29 The MPI\_COMM\_SPAWN and MPI\_COMM\_SPAWN\_MULTIPLE routines provide an inter-  
30 face between MPI and the *runtime environment* of an MPI application. The difficulty is  
31 that there is an enormous range of runtime environments and application requirements, and  
32 MPI must not be tailored to any particular one.

33 MPI assumes, implicitly, the existence of an environment in which an application runs.  
34 It does not provide “operating system” services, such as a general ability to query what  
35 processes are running, to kill arbitrary processes, to find out properties of the runtime  
36 environment (how many processors, how much memory, etc.). Complex interaction of an  
37 MPI application with its runtime environment should be done through an environment-  
38 specific API.

39 At some low level, obviously, MPI must be able to interact with the runtime system,  
40 but the interaction is not visible at the application level and the details of the interaction  
41 are not specified by the MPI standard.

42 In many cases, it is impossible to keep environment-specific information out of the MPI  
43 interface without seriously compromising MPI functionality. To permit applications to take  
44 advantage of environment-specific functionality, many MPI routines take an info argument  
45 that allows an application to specify environment-specific information. There is a tradeoff  
46 between functionality and portability: applications that make use of environment-specific  
47 info are not portable.

MPI does not require the existence of an underlying “virtual machine” model, in which there is a consistent global view of an MPI application and an implicit “operating system” managing resources and processes. For instance, processes spawned by one task may not be visible to another; additional hosts added to the runtime environment by one process may not be visible in another process; tasks spawned by different processes may not be automatically distributed over available resources.

Interaction between MPI and the runtime environment is limited to the following areas:

- A process may start new processes with `MPI_COMM_SPAWN` and `MPI_COMM_SPAWN_MULTIPLE`.
- When a process spawns a child process, it may optionally use an `info` argument to tell the runtime environment where or how to start the process. This extra information may be opaque to MPI.
- An attribute `MPI_UNIVERSE_SIZE` (See Section 11.10.1) on `MPI_COMM_WORLD` tells a program how “large” the initial runtime environment is, namely how many processes can usefully be started in all. One can subtract the size of `MPI_COMM_WORLD` from this value to find out how many processes might usefully be started in addition to those already running.

## 11.8 Process Manager Interface

### 11.8.1 Processes in MPI

A process is represented in MPI by a (group, rank) pair. A (group, rank) pair specifies a unique process but a process does not determine a unique (group, rank) pair, since a process may belong to several groups.

### 11.8.2 Starting Processes and Establishing Communication

The following routine starts a number of MPI processes and establishes communication with them, returning an inter-communicator.

*Advice to users.* It is possible in MPI to start an SPMD or MPMD application with a fixed number of processes after initialization by first starting one process and having that process start its siblings with `MPI_COMM_SPAWN`. This practice is discouraged primarily for reasons of performance. If possible, it is preferable to start all processes at once, as a single MPI application. (*End of advice to users.*)

```

1 MPI_COMM_SPAWN(command, argv, maxprocs, info, root, comm, intercomm,
2     array_of_errcodes)
3
4     IN     command           name of program to be spawned (string, significant
5                               only at root)
6
7     IN     argv              arguments to command (array of strings, significant
8                               only at root)
9
10    IN     maxprocs          maximum number of processes to start (integer,
11                               significant only at root)
12
13    IN     info              a set of key-value pairs telling the runtime system
14                               where and how to start the processes (handle,
15                               significant only at root)
16
17    IN     root              rank of process in which previous arguments are
18                               examined (integer)
19
20    IN     comm              intra-communicator containing group of spawning
21                               processes (handle)
22
23    OUT    intercomm         inter-communicator between original group and the
24                               newly spawned group (handle)
25
26    OUT    array_of_errcodes one code per process (array of integer)

```

**C binding**

```

27 int MPI_Comm_spawn(const char *command, char *argv[], int maxprocs,
28     MPI_Info info, int root, MPI_Comm comm, MPI_Comm *intercomm,
29     int array_of_errcodes[])

```

**Fortran 2008 binding**

```

30 MPI_Comm_spawn(command, argv, maxprocs, info, root, comm, intercomm,
31     array_of_errcodes, ierror)
32 CHARACTER(LEN=*), INTENT(IN) :: command, argv(*)
33 INTEGER, INTENT(IN) :: maxprocs, root
34 TYPE(MPI_Info), INTENT(IN) :: info
35 TYPE(MPI_Comm), INTENT(IN) :: comm
36 TYPE(MPI_Comm), INTENT(OUT) :: intercomm
37 INTEGER :: array_of_errcodes(*)
38 INTEGER, OPTIONAL, INTENT(OUT) :: ierror

```

**Fortran binding**

```

39 MPI_COMM_SPAWN(COMMAND, ARGV, MAXPROCS, INFO, ROOT, COMM, INTERCOMM,
40     ARRAY_OF_ERRCODES, IERROR)
41 CHARACTER*(*) COMMAND, ARGV(*)
42 INTEGER MAXPROCS, INFO, ROOT, COMM, INTERCOMM, ARRAY_OF_ERRCODES(*),
43     IERROR

```

MPI\_COMM\_SPAWN tries to start maxprocs identical copies of the MPI program specified by command, establishing communication with them and returning an inter-communicator. The spawned processes are referred to as children. The children have their own MPI\_COMM\_WORLD, which is separate from that of the parents. MPI\_COMM\_SPAWN is

collective over `comm`, and also may not return until `MPI_INIT` has been called in the children. Similarly, `MPI_INIT` in the children may not return until all parents have called `MPI_COMM_SPAWN`. In this sense, `MPI_COMM_SPAWN` in the parents and `MPI_INIT` in the children form a collective operation over the union of parent and child processes. The inter-communicator returned by `MPI_COMM_SPAWN` contains the parent processes in the local group and the child processes in the remote group. The ordering of processes in the local and remote groups is the same as the ordering of the group of the `comm` in the parents and of `MPI_COMM_WORLD` of the children, respectively. This inter-communicator can be obtained in the children through the function `MPI_COMM_GET_PARENT`.

*Advice to users.* An implementation may automatically establish communication before `MPI_INIT` is called by the children. Thus, completion of `MPI_COMM_SPAWN` in the parent does not necessarily mean that `MPI_INIT` has been called in the children (although the returned inter-communicator can be used immediately). (*End of advice to users.*)

**The command argument** The `command` argument is a string containing the name of a program to be spawned. The string is null-terminated in C. In Fortran, leading and trailing spaces are stripped. MPI does not specify how to find the executable or how the working directory is determined. These rules are implementation-dependent and should be appropriate for the runtime environment.

*Advice to implementors.* The implementation should use a natural rule for finding executables and determining working directories. For instance, a homogeneous system with a global file system might look first in the working directory of the spawning process, or might search the directories in a `PATH` environment variable as do Unix shells. An implementation should document its rules for finding executables and determining working directories, and a high-quality implementation should give the user some control over these rules. (*End of advice to implementors.*)

If the program named in `command` does not call `MPI_INIT`, but instead forks a process that calls `MPI_INIT`, the results are undefined. Implementations may allow this case to work but are not required to.

*Advice to users.* MPI does not say what happens if the program you start is a shell script and that shell script starts a program that calls `MPI_INIT`. Though some implementations may allow you to do this, they may also have restrictions, such as requiring that arguments supplied to the shell script be supplied to the program, or requiring that certain parts of the environment not be changed. (*End of advice to users.*)

**The argv argument** `argv` is an array of strings containing arguments that are passed to the program. The first element of `argv` is the first argument passed to `command`, not, as is conventional in some contexts, the command itself. The argument list is terminated by `NULL` in C and an empty string in Fortran. In Fortran, leading and trailing spaces are always stripped, so that a string consisting of all spaces is considered an empty string. The constant `MPI_ARGV_NULL` may be used in C and Fortran to indicate an empty argument list. In C this constant is the same as `NULL`.

1 **Example 11.17** Examples of `argv` in C and Fortran

2 To run the program “ocean” with arguments “-gridfile” and “ocean1.grd” in C:

```
3
4     char command[] = "ocean";
5     char *argv[] = {"-gridfile", "ocean1.grd", NULL};
6     MPI_Comm_spawn(command, argv, ...);
```

7 or, if not everything is known at compile time:

```
8
9     char *command;
10    char **argv;
11    command = "ocean";
12    argv=(char **)malloc(3 * sizeof(char *));
13    argv[0] = "-gridfile";
14    argv[1] = "ocean1.grd";
15    argv[2] = NULL;
16    MPI_Comm_spawn(command, argv, ...);
```

17 In Fortran:

```
18
19    CHARACTER*25 command, argv(3)
20    command = 'ocean'
21    argv(1) = '-gridfile'
22    argv(2) = 'ocean1.grd'
23    argv(3) = ' '
24    call MPI_COMM_SPAWN(command, argv, ...)
```

25  
26 Arguments are supplied to the program if this is allowed by the operating system. In  
27 C, the `MPI_COMM_SPAWN` argument `argv` differs from the `argv` argument of `main` in two  
28 respects. First, it is shifted by one element. Specifically, `argv[0]` of `main` is provided by the  
29 implementation and conventionally contains the name of the program (given by `command`).  
30 `argv[1]` of `main` corresponds to `argv[0]` in `MPI_COMM_SPAWN`, `argv[2]` of `main` to `argv[1]`  
31 of `MPI_COMM_SPAWN`, etc. Passing an `argv` of `MPI_ARGV_NULL` to `MPI_COMM_SPAWN`  
32 results in `main` receiving `argc` of 1 and an `argv` whose element 0 is (conventionally) the  
33 name of the program. Second, `argv` of `MPI_COMM_SPAWN` must be null-terminated, so  
34 that its length can be determined.

35 If a Fortran implementation supplies routines that allow a program to obtain its ar-  
36 guments, the arguments may be available through that mechanism. In C, if the operating  
37 system does not support arguments appearing in `argv` of `main()`, the MPI implementation  
38 may add the arguments to the `argv` that is passed to `MPI_INIT`.

39  
40 The `maxprocs` argument MPI tries to spawn `maxprocs` processes. If it is unable to spawn  
41 `maxprocs` processes, it raises an error of class `MPI_ERR_SPAWN`.

42 An implementation may allow the `info` argument to change the default behavior, such  
43 that if the implementation is unable to spawn all `maxprocs` processes, it may spawn a  
44 smaller number of processes instead of raising an error. In principle, the `info` argument  
45 may specify an arbitrary set  $\{m_i : 0 \leq m_i \leq \text{maxprocs}\}$  of allowed values for the number  
46 of processes spawned. The set  $\{m_i\}$  does not necessarily include the value `maxprocs`. If  
47 an implementation is able to spawn one of these allowed numbers of processes,  
48 `MPI_COMM_SPAWN` returns successfully and the number of spawned processes,  $m$ , is given

by the size of the remote group of `intercomm`. If  $m$  is less than `maxprocs`, reasons why the other processes were not spawned are given in `array_of_errcodes` as described below. If it is not possible to spawn one of the allowed numbers of processes, `MPI_COMM_SPAWN` raises an error of class `MPI_ERR_SPAWN`.

A spawn call with the default behavior is called *hard*. A spawn call for which fewer than `maxprocs` processes may be returned is called *soft*. See Section 11.8.4 for more information on the *soft* key for info.

*Advice to users.* By default, requests are hard and MPI errors are fatal. This means that by default there will be a fatal error if MPI cannot spawn all the requested processes. If you want the behavior “spawn as many processes as possible, up to  $N$ ,” you should do a soft spawn, where the set of allowed values  $\{m_i\}$  is  $\{0, \dots, N\}$ . However, this is not completely portable, as implementations are not required to support soft spawning. (*End of advice to users.*)

**The info argument** The info argument to all of the routines in this chapter is an opaque handle of type `MPI_Info` in C and Fortran with the `mpi_f08` module and `INTEGER` in Fortran with the `mpi` module or the include file `mpif.h`. It is a container for a number of user-specified (key,value) pairs. `key` and `value` are strings (null-terminated `char*` in C, `character*(*)` in Fortran). Routines to create and manipulate the info argument are described in Chapter 10.

For the `SPAWN` calls, info provides additional (and possibly implementation-dependent) instructions to MPI and the runtime system on how to start processes. An application may pass `MPI_INFO_NULL` in C or Fortran. Portable programs not requiring detailed control over process locations should use `MPI_INFO_NULL`.

MPI does not specify the content of the info argument, except to reserve a number of special key values (see Section 11.8.4). The info argument is quite flexible and could even be used, for example, to specify the executable and its command-line arguments. In this case the command argument to `MPI_COMM_SPAWN` could be empty. The ability to do this follows from the fact that MPI does not specify how an executable is found, and the info argument can tell the runtime system where to “find” the executable “” (empty string). Of course a program that does this will not be portable across MPI implementations.

**The root argument** All arguments before the root argument are examined only on the process whose rank in `comm` is equal to `root`. The value of these arguments on other processes is ignored.

**The array\_of\_errcodes argument** The `array_of_errcodes` is an array of length `maxprocs` in which MPI reports the status of each process that MPI was requested to start. If all `maxprocs` processes were spawned, `array_of_errcodes` is filled in with the value `MPI_SUCCESS`. If only  $m$  ( $0 \leq m < \text{maxprocs}$ ) processes are spawned,  $m$  of the entries will contain `MPI_SUCCESS` and the rest will contain an implementation-specific error code indicating the reason MPI could not start the process. MPI does not specify which entries correspond to failed processes. An implementation may, for instance, fill in error codes in one-to-one correspondence with a detailed specification in the info argument. These error codes all belong to the error class `MPI_ERR_SPAWN` if there was no error in the argument list. In C or Fortran, an application may pass `MPI_ERRCODES_IGNORE` if it is not interested in the error codes.

*Advice to implementors.* MPI\_ERRCODES\_IGNORE in Fortran is a special type of constant, like MPI\_BOTTOM. See the discussion in Section 2.5.4. (*End of advice to implementors.*)

MPI\_COMM\_GET\_PARENT(parent)

OUT parent the parent communicator (handle)

### C binding

```
int MPI_Comm_get_parent(MPI_Comm *parent)
```

### Fortran 2008 binding

```
MPI_Comm_get_parent(parent, ierror)
  TYPE(MPI_Comm), INTENT(OUT) :: parent
  INTEGER, OPTIONAL, INTENT(OUT) :: ierror
```

### Fortran binding

```
MPI_COMM_GET_PARENT(PARENT, IERROR)
  INTEGER PARENT, IERROR
```

If a process was started with MPI\_COMM\_SPAWN or MPI\_COMM\_SPAWN\_MULTIPLE, MPI\_COMM\_GET\_PARENT returns the “parent” inter-communicator of the current process. This parent inter-communicator is created implicitly inside of MPI\_INIT and is the same inter-communicator returned by SPAWN in the parents.

If the process was not spawned, MPI\_COMM\_GET\_PARENT returns MPI\_COMM\_NULL.

After the parent communicator is freed or disconnected, MPI\_COMM\_GET\_PARENT returns MPI\_COMM\_NULL.

*Advice to users.* MPI\_COMM\_GET\_PARENT returns a handle to a single inter-communicator. Calling MPI\_COMM\_GET\_PARENT a second time returns a handle to the same inter-communicator. Freeing the handle with MPI\_COMM\_DISCONNECT or MPI\_COMM\_FREE will cause other references to the inter-communicator to become invalid (dangling). Note that calling MPI\_COMM\_FREE on the parent communicator is not useful. (*End of advice to users.*)

*Rationale.* The desire of the Forum was to create a constant MPI\_COMM\_PARENT similar to MPI\_COMM\_WORLD. Unfortunately such a constant cannot be used (syntactically) as an argument to MPI\_COMM\_DISCONNECT, which is explicitly allowed. (*End of rationale.*)

### 11.8.3 Starting Multiple Executables and Establishing Communication

While MPI\_COMM\_SPAWN is sufficient for most cases, it does not allow the spawning of multiple binaries, or of the same binary with multiple sets of arguments. The following routine spawns multiple binaries or the same binary with multiple sets of arguments, establishing communication with them and placing them in the same MPI\_COMM\_WORLD.



MPI_COMM_SPAWN_MULTIPLE(count, array_of_commands, array_of_argv,			1
array_of_maxprocs, array_of_info, root, comm, intercomm,			2
array_of_errcodes)			3
IN	count	number of commands (positive integer, significant only at root)	4
			5
IN	array_of_commands	programs to be executed (array of strings, significant only at root)	6
			7
IN	array_of_argv	arguments for commands (array of array of strings, significant only at root)	8
			9
IN	array_of_maxprocs	maximum number of processes to start for each command (array of integers, significant only at root)	10
			11
IN	array_of_info	info objects telling the runtime system where and how to start processes (array of handles, significant only at root)	12
			13
IN	root	rank of process in which previous arguments are examined (integer)	14
			15
IN	comm	intra-communicator containing group of spawning processes (handle)	16
			17
OUT	intercomm	inter-communicator between original group and the newly spawned group (handle)	18
			19
OUT	array_of_errcodes	one error code per process (array of integers)	20
			21
			22
			23
			24
			25
			26
<b>C binding</b>			27
int	MPI_Comm_spawn_multiple(int count, char *array_of_commands[],		28
	char **array_of_argv[], const int array_of_maxprocs[],		29
	const MPI_Info array_of_info[], int root, MPI_Comm comm,		30
	MPI_Comm *intercomm, int array_of_errcodes[])		31
			32
<b>Fortran 2008 binding</b>			33
MPI_Comm_spawn_multiple(count, array_of_commands, array_of_argv,			34
array_of_maxprocs, array_of_info, root, comm, intercomm,			35
array_of_errcodes, ierror)			36
INTEGER, INTENT(IN) :: count, array_of_maxprocs(*), root			37
CHARACTER(LEN=*), INTENT(IN) :: array_of_commands(*),			38
array_of_argv(count, *)			39
TYPE(MPI_Info), INTENT(IN) :: array_of_info(*)			40
TYPE(MPI_Comm), INTENT(IN) :: comm			41
TYPE(MPI_Comm), INTENT(OUT) :: intercomm			42
INTEGER :: array_of_errcodes(*)			43
INTEGER, OPTIONAL, INTENT(OUT) :: ierror			44
			45
<b>Fortran binding</b>			46
MPI_COMM_SPAWN_MULTIPLE(COUNT, ARRAY_OF_COMMANDS, ARRAY_OF_ARGV,			47
ARRAY_OF_MAXPROCS, ARRAY_OF_INFO, ROOT, COMM, INTERCOMM,			48
ARRAY_OF_ERRCODES, IERROR)			

```

1  INTEGER COUNT, ARRAY_OF_MAXPROCS(*), ARRAY_OF_INFO(*), ROOT, COMM,
2      INTERCOMM, ARRAY_OF_ERRCODES(*), IERROR
3  CHARACTER*(*) ARRAY_OF_COMMANDS(*), ARRAY_OF_ARGV(COUNT, *)

```

4 MPI\_COMM\_SPAWN\_MULTIPLE is identical to MPI\_COMM\_SPAWN except that there
5 are multiple executable specifications. The first argument, `count`, gives the number of
6 specifications. Each of the next four arguments are simply arrays of the corresponding
7 arguments in MPI\_COMM\_SPAWN. For the Fortran version of `array_of_argv`, the element
8 `array_of_argv(i,j)` is the  $j$ -th argument to command number  $i$ .
9

10 *Rationale.* This may seem backwards to Fortran programmers who are familiar
11 with Fortran's column-major ordering. However, it is necessary to do it this way to
12 allow MPI\_COMM\_SPAWN to sort out arguments. Note that the leading dimension
13 of `array_of_argv` *must* be the same as `count`. Also note that Fortran rules for sequence
14 association allow a different value in the first dimension; in this case, the sequence of
15 array elements is interpreted by MPI\_COMM\_SPAWN\_MULTIPLE as if the sequence is
16 stored in an array defined with the first dimension set to `count`. This Fortran feature
17 allows an implementor to define MPI\_ARGVS\_NULL (see below) with fixed dimensions,
18 e.g., (1,1), or only with one dimension, e.g., (1). (*End of rationale.*)
19

20 *Advice to users.* The argument `count` is interpreted by MPI only at the root, as is
21 `array_of_argv`. Since the leading dimension of `array_of_argv` is `count`, a non-positive
22 value of `count` at a non-root node could theoretically cause a runtime bounds check
23 error, even though `array_of_argv` should be ignored by the subroutine. If this happens,
24 you should explicitly supply a reasonable value of `count` on the non-root nodes. (*End*
25 *of advice to users.*)
26

27 In any language, an application may use the constant MPI\_ARGVS\_NULL (which is likely
28 to be `(char ***)0` in C) to specify that no arguments should be passed to any commands.
29 The effect of setting individual elements of `array_of_argv` to MPI\_ARGV\_NULL is not defined.
30 To specify arguments for some commands but not others, the commands without arguments
31 should have a corresponding `argv` whose first element is null (`(char *)0` in C and empty
32 string in Fortran). In Fortran at non-root processes, the `count` argument must be set to
33 a value that is consistent with the provided `array_of_argv` although the content of these
34 arguments has no meaning for this operation.

35 All of the spawned processes have the same MPI\_COMM\_WORLD. Their ranks in
36 MPI\_COMM\_WORLD correspond directly to the order in which the commands are specified
37 in MPI\_COMM\_SPAWN\_MULTIPLE. Assume that  $m_1$  processes are generated by the first
38 command,  $m_2$  by the second, etc. The processes corresponding to the first command have
39 ranks  $0, 1, \dots, m_1 - 1$ . The processes in the second command have ranks  $m_1, m_1 + 1, \dots, m_1 +$ 
40  $m_2 - 1$ . The processes in the third have ranks  $m_1 + m_2, m_1 + m_2 + 1, \dots, m_1 + m_2 + m_3 - 1$ ,
41 etc.
42

43 *Advice to users.* Calling MPI\_COMM\_SPAWN multiple times would create many
44 sets of children with different MPI\_COMM\_WORLDS whereas
45 MPI\_COMM\_SPAWN\_MULTIPLE creates children with a single MPI\_COMM\_WORLD,
46 so the two methods are not completely equivalent. There are also two performance-
47 related reasons why, if you need to spawn multiple executables, you may want to
48 use MPI\_COMM\_SPAWN\_MULTIPLE instead of calling MPI\_COMM\_SPAWN several

times. First, spawning several things at once may be faster than spawning them sequentially. Second, in some implementations, communication between processes spawned at the same time may be faster than communication between processes spawned separately. (*End of advice to users.*)

The `array_of_errcodes` argument is a 1-dimensional array of size  $\sum_{i=1}^{count} n_i$ , where  $n_i$  is the  $i$ -th element of `array_of_maxprocs`. Command number  $i$  corresponds to the  $n_i$  contiguous slots in this array from element  $\sum_{j=1}^{i-1} n_j$  to  $[\sum_{j=1}^i n_j] - 1$ . Error codes are treated as for `MPI_COMM_SPAWN`.

**Example 11.18** Examples of `array_of_argv` in C and Fortran

To run the program “ocean” with arguments “-gridfile” and “ocean1.grd” and the program “atmos” with argument “atmos.grd” in C:

```
char *array_of_commands[2] = {"ocean", "atmos"};
char **array_of_argv[2];
char *argv0[] = {"-gridfile", "ocean1.grd", (char *)0};
char *argv1[] = {"atmos.grd", (char *)0};
array_of_argv[0] = argv0;
array_of_argv[1] = argv1;
MPI_Comm_spawn_multiple(2, array_of_commands, array_of_argv, ...);
```

Here is how you do it in Fortran:

```
CHARACTER*25 commands(2), array_of_argv(2, 3)
commands(1) = 'ocean'
array_of_argv(1, 1) = '-gridfile'
array_of_argv(1, 2) = 'ocean1.grd'
array_of_argv(1, 3) = ' '

commands(2) = 'atmos'
array_of_argv(2, 1) = 'atmos.grd'
array_of_argv(2, 2) = ' '

call MPI_COMM_SPAWN_MULTIPLE(2, commands, array_of_argv, ...)
```

#### 11.8.4 Reserved Keys

The following keys are reserved. An implementation is not required to interpret these keys, but if it does interpret the key, it must provide the functionality described.

**"host"** Value is a hostname. The format of the hostname is determined by the implementation.

**"arch"** Value is an architecture name. Valid architecture names and what they mean are determined by the implementation.

**"wdir"** Value is the name of a directory on a machine on which the spawned process(es) execute(s). This directory is made the working directory of the executing process(es). The format of the directory name is determined by the implementation.

1 **"path"** Value is a directory or set of directories where the implementation should look for  
 2 the executable. The format of "path" is determined by the implementation.

3  
 4 **"file"** Value is the name of a file in which additional information is specified. The format  
 5 of the filename and internal format of the file are determined by the implementation.

6  
 7 **"mpi\_initial\_errhandler"** Value is the name of an errhandler that will be set as the initial  
 8 error handler. The "mpi\_initial\_errhandler" key can take the case insensitive values  
 9 "mpi\_errors\_are\_fatal", "mpi\_errors\_abort", and "mpi\_errors\_return" representing the pre-  
 10 defined MPI error handlers (MPI\_ERRORS\_ARE\_FATAL—the default,  
 11 MPI\_ERRORS\_ABORT, and MPI\_ERRORS\_RETURN, respectively). Other, non-standard  
 12 values may be supported by the implementation, which should document the resultant  
 13 behavior.

14 **"soft"** Value specifies a set of numbers which are allowed values for the number of processes  
 15 that MPI\_COMM\_SPAWN (et al.) may create. The format of the value is a comma-  
 16 separated list of Fortran-90 triplets each of which specifies a set of integers and which  
 17 together specify the set formed by the union of these sets. Negative values in this set  
 18 and values greater than `maxprocs` are ignored. MPI will spawn the largest number of  
 19 processes it can, consistent with some number in the set. The order in which triplets  
 20 are given is not significant.

21 By Fortran-90 triplets, we mean:

- 22 1. `a` means  $a$
- 23 2. `a:b` means  $a, a + 1, a + 2, \dots, b$
- 24 3. `a:b:c` means  $a, a + c, a + 2c, \dots, a + ck$ , where for  $c > 0$ ,  $k$  is the largest integer  
 25 for which  $a + ck \leq b$  and for  $c < 0$ ,  $k$  is the largest integer for which  $a + ck \geq b$ .  
 26 If  $b > a$  then  $c$  must be positive. If  $b < a$  then  $c$  must be negative.

27  
 28  
 29 Examples:

- 30 1. `a:b` gives a range between  $a$  and  $b$
- 31 2. `0:N` gives full "soft" functionality
- 32 3. `1,2,4,8,16,32,64,128,256,512,1024,2048,4096` allows a power-of-two num-  
 33 ber of processes.
- 34 4. `2:10000:2` allows an even number of processes.
- 35 5. `2:10:2,7` allows 2, 4, 6, 7, 8, or 10 processes.

### 36 37 38 39 11.8.5 Spawn Example

40  
 41 **Example 11.19** Manager-worker Example Using MPI\_COMM\_SPAWN

```
/* manager */ 1
#include "mpi.h" 2
int main(int argc, char *argv[]) 3
{ 4
    int world_size, universe_size, *universe_sizep, flag; 5
    MPI_Comm everyone; /* inter-communicator */ 6
    char worker_program[100]; 7
    8
    MPI_Init(&argc, &argv); 9
    MPI_Comm_size(MPI_COMM_WORLD, &world_size); 10
    11
    if (world_size != 1) error("Top heavy with management"); 12
    13
    MPI_Comm_get_attr(MPI_COMM_WORLD, MPI_UNIVERSE_SIZE, 14
                      &universe_sizep, &flag); 15
    if (!flag) { 16
        printf("This MPI does not support UNIVERSE_SIZE. How many\n\ 17
processes total?"); 18
        scanf("%d", &universe_size); 19
    } else universe_size = *universe_sizep; 20
    if (universe_size == 1) error("No room to start workers"); 21
    22
    /* 23
    * Now spawn the workers. Note that there is a run-time determination 24
    * of what type of worker to spawn, and presumably this calculation must 25
    * be done at run time and cannot be calculated before starting 26
    * the program. If everything is known when the application is 27
    * first started, it is generally better to start them all at once 28
    * in a single MPI_COMM_WORLD. 29
    */ 30
    31
    choose_worker_program(worker_program); 32
    MPI_Comm_spawn(worker_program, MPI_ARGV_NULL, universe_size-1, 33
                  MPI_INFO_NULL, 0, MPI_COMM_SELF, &everyone, 34
                  MPI_ERRCODES_IGNORE); 35
    36
    /* 37
    * Parallel code here. The communicator "everyone" can be used 38
    * to communicate with the spawned processes, which have ranks 0,.. 39
    * MPI_UNIVERSE_SIZE-1 in the remote group of the inter-communicator 40
    * "everyone". 41
    */ 42
    43
    MPI_Finalize(); 44
    return 0; 45
} 46
/* worker */ 47
48
```

```

1  #include "mpi.h"
2  int main(int argc, char *argv[])
3  {
4      int size;
5      MPI_Comm parent;
6      MPI_Init(&argc, &argv);
7      MPI_Comm_get_parent(&parent);
8      if (parent == MPI_COMM_NULL) error("No parent!");
9      MPI_Comm_remote_size(parent, &size);
10     if (size != 1) error("Something's wrong with the parent");
11
12     /*
13      * Parallel code here.
14      * The manager is represented as the process with rank 0 in (the remote
15      * group of) the parent communicator. If the workers need to communicate
16      * among themselves, they can use MPI_COMM_WORLD.
17      */
18
19     MPI_Finalize();
20     return 0;
21 }

```

## 11.9 Establishing Communication

This section provides functions that establish communication between two sets of MPI processes that do not share a communicator.

Some situations in which these functions are useful are:

1. Two parts of an application that are started independently need to communicate.
2. A visualization tool wants to attach to a running process.
3. A server wants to accept connections from multiple clients. Both clients and server may be parallel programs.

In each of these situations, MPI must establish communication channels where none existed before, and there is no parent/child relationship. The routines described in this section establish communication between the two sets of processes by creating an MPI inter-communicator, where the two groups of the inter-communicator are the original sets of processes.

Establishing contact between two groups of processes that do not share an existing communicator is a collective but asymmetric process. One group of processes indicates its willingness to accept connections from other groups of processes. We will call this group the (parallel) *server*, even if this is not a client/server type of application. The other group connects to the server; we will call it the *client*.

*Advice to users.* While the names *client* and *server* are used throughout this section, MPI does not guarantee the traditional robustness of client/server systems. The functionality described in this section is intended to allow two cooperating parts of the same application to communicate with one another. For instance, a client that gets a segmentation fault and dies, or one that does not participate in a collective operation may cause a server to crash or hang. (*End of advice to users.*)

### 11.9.1 Names, Addresses, Ports, and All That

Almost all of the complexity in MPI client/server routines addresses the question “how does the client find out how to contact the server?” The difficulty, of course, is that there is no existing communication channel between them, yet they must somehow agree on a rendezvous point where they will establish communication.

Agreeing on a rendezvous point always involves a third party. The third party may itself provide the rendezvous point or may communicate rendezvous information from server to client. Complicating matters might be the fact that a client does not really care what server it contacts, only that it be able to get in touch with one that can handle its request.

Ideally, MPI can accommodate a wide variety of run-time systems while retaining the ability to write simple, portable code. The following should be compatible with MPI:

- The server resides at a well-known internet address `host:port`.
- The server prints out an address to the terminal; the user gives this address to the client program.
- The server places the address information on a nameserver, where it can be retrieved with an agreed-upon name.
- The server to which the client connects is actually a broker, acting as a middleman between the client and the real server.

MPI does not require a nameserver, so not all implementations will be able to support all of the above scenarios. However, MPI provides an optional nameserver interface, and is compatible with external name servers.

A `port_name` is a *system-supplied* string that encodes a low-level network address at which a server can be contacted. Typically this is an IP address and a port number, but an implementation is free to use any protocol. The server establishes a `port_name` with the `MPI_OPEN_PORT` routine. It accepts a connection to a given port with `MPI_COMM_ACCEPT`. A client uses `port_name` to connect to the server.

By itself, the `port_name` mechanism is completely portable, but it may be clumsy to use because of the necessity to communicate `port_name` to the client. It would be more convenient if a server could specify that it be known by an *application-supplied* `service_name` so that the client could connect to that `service_name` without knowing the `port_name`.

An MPI implementation may allow the server to publish a (`port_name`, `service_name`) pair with `MPI_PUBLISH_NAME` and the client to retrieve the port name from the service name with `MPI_LOOKUP_NAME`. This allows three levels of portability, with increasing levels of functionality.

1. Applications that do not rely on the ability to publish names are the most portable. Typically the `port_name` must be transferred “by hand” from server to client.

2. Applications that use the `MPI_PUBLISH_NAME` mechanism are completely portable among implementations that provide this service. To be portable among all implementations, these applications should have a fall-back mechanism that can be used when names are not published.
3. Applications may ignore MPI's name publishing functionality and use their own mechanism (possibly system-supplied) to publish names. This allows arbitrary flexibility but is not portable.

### 11.9.2 Server Routines

A server makes itself available with two routines. First it must call `MPI_OPEN_PORT` to establish a port at which it may be contacted. Secondly it must call `MPI_COMM_ACCEPT` to accept connections from clients.

`MPI_OPEN_PORT`(info, port\_name)

IN	info	implementation-specific information on how to establish an address (handle)
OUT	port_name	newly established port (string)

#### C binding

```
int MPI_Open_port(MPI_Info info, char *port_name)
```

#### Fortran 2008 binding

```
MPI_Open_port(info, port_name, ierror)
  TYPE(MPI_Info), INTENT(IN) :: info
  CHARACTER(LEN=MPI_MAX_PORT_NAME), INTENT(OUT) :: port_name
  INTEGER, OPTIONAL, INTENT(OUT) :: ierror
```

#### Fortran binding

```
MPI_OPEN_PORT(INFO, PORT_NAME, IERROR)
  INTEGER INFO, IERROR
  CHARACTER*(*) PORT_NAME
```

This function establishes a network address, encoded in the `port_name` string, at which the server will be able to accept connections from clients. `port_name` is supplied by the system, possibly using information in the `info` argument.

MPI copies a system-supplied port name into `port_name`. `port_name` identifies the newly opened port and can be used by a client to contact the server. The maximum size string that may be supplied by the system is `MPI_MAX_PORT_NAME`.

*Advice to users.* The system copies the port name into `port_name`. The application must pass a buffer of sufficient size to hold this value. (*End of advice to users.*)

`port_name` is essentially a network address. It is unique within the communication universe to which it belongs (determined by the implementation), and may be used by any client within that communication universe. For instance, if it is an internet (host:port) address, it will be unique on the internet. If it is a low level switch address on an IBM SP, it will be unique to that SP.



*Advice to implementors.* These examples are not meant to constrain implementations. A `port_name` could, for instance, contain a user name or the name of a batch job, as long as it is unique within some well-defined communication domain. The larger the communication domain, the more useful MPI's client/server functionality will be. (*End of advice to implementors.*)

The precise form of the address is implementation-defined. For instance, an internet address may be a host name or IP address, or anything that the implementation can decode into an IP address. A port name may be reused after it is freed with `MPI_CLOSE_PORT` and released by the system.

*Advice to implementors.* Since the user may type in `port_name` by hand, it is useful to choose a form that is easily readable and does not have embedded spaces. (*End of advice to implementors.*)

`info` may be used to tell the implementation how to establish the address. It may, and usually will, be `MPI_INFO_NULL` in order to get the implementation defaults.

`MPI_CLOSE_PORT(port_name)`

IN            `port_name`                            a port (string)

#### C binding

```
int MPI_Close_port(const char *port_name)
```

#### Fortran 2008 binding

```
MPI_Close_port(port_name, ierror)
CHARACTER(LEN=*), INTENT(IN) :: port_name
INTEGER, OPTIONAL, INTENT(OUT) :: ierror
```

#### Fortran binding

```
MPI_CLOSE_PORT(PORT_NAME, IERROR)
CHARACTER*(*) PORT_NAME
INTEGER IERROR
```

This function releases the network address represented by `port_name`.

```

1 MPI_COMM_ACCEPT(port_name, info, root, comm, newcomm)
2
3   IN      port_name      port name (string, significant only at root)
4   IN      info           implementation-dependent information (handle,
5                          significant only at root)
6   IN      root           rank in comm of root node (integer)
7   IN      comm           intra-communicator over which call is collective
8                          (handle)
9
10  OUT     newcomm        inter-communicator with client as remote group
11                          (handle)
12

```

**C binding**

```

14 int MPI_Comm_accept(const char *port_name, MPI_Info info, int root,
15                   MPI_Comm comm, MPI_Comm *newcomm)
16

```

**Fortran 2008 binding**

```

17 MPI_Comm_accept(port_name, info, root, comm, newcomm, ierror)
18   CHARACTER(LEN=*), INTENT(IN) :: port_name
19   TYPE(MPI_Info), INTENT(IN) :: info
20   INTEGER, INTENT(IN) :: root
21   TYPE(MPI_Comm), INTENT(IN) :: comm
22   TYPE(MPI_Comm), INTENT(OUT) :: newcomm
23   INTEGER, OPTIONAL, INTENT(OUT) :: ierror
24

```

**Fortran binding**

```

26 MPI_COMM_ACCEPT(PORT_NAME, INFO, ROOT, COMM, NEWCOMM, IERROR)
27   CHARACTER*(*) PORT_NAME
28   INTEGER INFO, ROOT, COMM, NEWCOMM, IERROR
29

```

MPI\_COMM\_ACCEPT establishes communication with a client. It is collective over the calling communicator. It returns an inter-communicator that allows communication with the client.

The `port_name` must have been established through a call to `MPI_OPEN_PORT`.

`info` can be used to provide directives that may influence the behavior of the ACCEPT call.

**11.9.3 Client Routines**

There is only one routine on the client side.

MPI_COMM_CONNECT(port_name, info, root, comm, newcomm)			1
IN	port_name	network address (string, significant only at root)	2
			3
IN	info	implementation-dependent information (handle, significant only at root)	4
			5
IN	root	rank in comm of root node (integer)	6
			7
IN	comm	intra-communicator over which call is collective (handle)	8
			9
OUT	newcomm	inter-communicator with server as remote group (handle)	10
			11

**C binding**

```
int MPI_Comm_connect(const char *port_name, MPI_Info info, int root,
                    MPI_Comm comm, MPI_Comm *newcomm)
```

**Fortran 2008 binding**

```
MPI_Comm_connect(port_name, info, root, comm, newcomm, ierror)
  CHARACTER(LEN=*) , INTENT(IN) :: port_name
  TYPE(MPI_Info), INTENT(IN) :: info
  INTEGER, INTENT(IN) :: root
  TYPE(MPI_Comm), INTENT(IN) :: comm
  TYPE(MPI_Comm), INTENT(OUT) :: newcomm
  INTEGER, OPTIONAL, INTENT(OUT) :: ierror
```

**Fortran binding**

```
MPI_COMM_CONNECT(PORT_NAME, INFO, ROOT, COMM, NEWCOMM, IERROR)
  CHARACTER*(*) PORT_NAME
  INTEGER INFO, ROOT, COMM, NEWCOMM, IERROR
```

This routine establishes communication with a server specified by `port_name`. It is collective over the calling communicator and returns an inter-communicator in which the remote group participated in an `MPI_COMM_ACCEPT`.

If the named port does not exist (or has been closed), `MPI_COMM_CONNECT` raises an error of class `MPI_ERR_PORT`.

If the port exists, but does not have a pending `MPI_COMM_ACCEPT`, the connection attempt will eventually time out after an implementation-defined time, or succeed when the server calls `MPI_COMM_ACCEPT`. In the case of a time out, `MPI_COMM_CONNECT` raises an error of class `MPI_ERR_PORT`.

*Advice to implementors.* The time out period may be arbitrarily short or long. However, a high-quality implementation will try to queue connection attempts so that a server can handle simultaneous requests from several clients. A high-quality implementation may also provide a mechanism, through the `info` arguments to `MPI_OPEN_PORT`, `MPI_COMM_ACCEPT`, and/or `MPI_COMM_CONNECT`, for the user to control timeout and queuing behavior. (*End of advice to implementors.*)

MPI provides no guarantee of fairness in servicing connection attempts. That is, connection attempts are not necessarily satisfied in the order they were initiated and competition

1 from other connection attempts may prevent a particular connection attempt from being  
 2 satisfied.

3 `port_name` is the address of the server. It must be the same as the name returned  
 4 by `MPI_OPEN_PORT` on the server. Some freedom is allowed here. If there are equivalent  
 5 forms of `port_name`, an implementation may accept them as well. For instance, if `port_name`  
 6 is `(hostname:port)`, an implementation may accept `(ip_address:port)` as well.

#### 8 11.9.4 Name Publishing

9  
 10 The routines in this section provide a mechanism for publishing names. A (`service_name`,  
 11 `port_name`) pair is published by the server, and may be retrieved by a client using the  
 12 `service_name` only. An MPI implementation defines the *scope* of the `service_name`, that  
 13 is, the domain over which the `service_name` can be retrieved. If the domain is the empty  
 14 set, that is, if no client can retrieve the information, then we say that name publishing  
 15 is not supported. Implementations should document how the scope is determined. High-  
 16 quality implementations will give some control to users through the `info` arguments to name  
 17 publishing functions. Examples are given in the descriptions of individual functions.

18  
 19 `MPI_PUBLISH_NAME(service_name, info, port_name)`

20  
 21 IN `service_name` a service name to associate with the port (string)  
 22 IN `info` implementation-specific information (handle)  
 23 IN `port_name` a port name (string)  
 24

#### 25 C binding

26 `int MPI_Publish_name(const char *service_name, MPI_Info info,`  
 27 `const char *port_name)`  
 28

#### 29 Fortran 2008 binding

30 `MPI_Publish_name(service_name, info, port_name, ierror)`  
 31 `CHARACTER(LEN=*)`, `INTENT(IN) :: service_name, port_name`  
 32 `TYPE(MPI_Info)`, `INTENT(IN) :: info`  
 33 `INTEGER`, `OPTIONAL`, `INTENT(OUT) :: ierror`  
 34

#### 35 Fortran binding

36 `MPI_PUBLISH_NAME(SERVICE_NAME, INFO, PORT_NAME, IERROR)`  
 37 `CHARACTER*(*) SERVICE_NAME, PORT_NAME`  
 38 `INTEGER INFO, IERROR`

39 This routine publishes the pair (`port_name`, `service_name`) so that an application may  
 40 retrieve a system-supplied `port_name` using a well-known `service_name`.

41 The implementation must define the *scope* of a published service name, that is, the  
 42 domain over which the service name is unique, and conversely, the domain over which the  
 43 (`port name`, `service name`) pair may be retrieved. For instance, a service name may be  
 44 unique to a job (where job is defined by a distributed operating system or batch scheduler),  
 45 unique to a machine, or unique to a Kerberos realm. The scope may depend on the `info`  
 46 argument to `MPI_PUBLISH_NAME`.

47 MPI permits publishing more than one `service_name` for a single `port_name`. On the  
 48 other hand, if `service_name` has already been published within the scope determined by `info`,

the behavior of `MPI_PUBLISH_NAME` is undefined. An MPI implementation may, through a mechanism in the `info` argument to `MPI_PUBLISH_NAME`, provide a way to allow multiple servers with the same service in the same scope. In this case, an implementation-defined policy will determine which of several port names is returned by `MPI_LOOKUP_NAME`.

Note that while `service_name` has a limited scope, determined by the implementation, `port_name` always has global scope within the communication universe used by the implementation (i.e., it is globally unique).

`port_name` should be the name of a port established by `MPI_OPEN_PORT` and not yet released by `MPI_CLOSE_PORT`. If it is not, the result is undefined.

*Advice to implementors.* In some cases, an MPI implementation may use a name service that a user can also access directly. In this case, a name published by MPI could easily conflict with a name published by a user. In order to avoid such conflicts, MPI implementations should mangle service names so that they are unlikely to conflict with user code that makes use of the same service. Such name mangling will of course be completely transparent to the user.

The following situation is problematic but unavoidable, if we want to allow implementations to use nameservers. Suppose there are multiple instances of “ocean” running on a machine. If the scope of a service name is confined to a job, then multiple oceans can coexist. If an implementation provides site-wide scope, however, multiple instances are not possible as all calls to `MPI_PUBLISH_NAME` after the first may fail. There is no universal solution to this.

To handle these situations, a high-quality implementation should make it possible to limit the domain over which names are published. (*End of advice to implementors.*)

`MPI_UNPUBLISH_NAME(service_name, info, port_name)`

IN	<code>service_name</code>	a service name (string)
IN	<code>info</code>	implementation-specific information (handle)
IN	<code>port_name</code>	a port name (string)

### C binding

```
int MPI_Unpublish_name(const char *service_name, MPI_Info info,
                      const char *port_name)
```

### Fortran 2008 binding

```
MPI_Unpublish_name(service_name, info, port_name, ierror)
  CHARACTER(LEN=*) INTENT(IN) :: service_name, port_name
  TYPE(MPI_Info), INTENT(IN) :: info
  INTEGER, OPTIONAL, INTENT(OUT) :: ierror
```

### Fortran binding

```
MPI_UNPUBLISH_NAME(SERVICE_NAME, INFO, PORT_NAME, IERROR)
  CHARACTER*(*) SERVICE_NAME, PORT_NAME
  INTEGER INFO, IERROR
```

This routine unpublishes a service name that has been previously published. Attempting to unpublish a name that has not been published or has already been unpublished is erroneous and is indicated by the error class `MPI_ERR_SERVICE`.

All published names must be unpublished before the corresponding port is closed and before the publishing process exits. The behavior of `MPI_UNPUBLISH_NAME` is implementation dependent when a process tries to unpublish a name that it did not publish.

If the `info` argument was used with `MPI_PUBLISH_NAME` to tell the implementation how to publish names, the implementation may require that `info` passed to `MPI_UNPUBLISH_NAME` contain information to tell the implementation how to unpublish a name.

`MPI_LOOKUP_NAME(service_name, info, port_name)`

IN	<code>service_name</code>	a service name (string)
IN	<code>info</code>	implementation-specific information (handle)
OUT	<code>port_name</code>	a port name (string)

### C binding

```
int MPI_Lookup_name(const char *service_name, MPI_Info info,
                  char *port_name)
```

### Fortran 2008 binding

```
MPI_Lookup_name(service_name, info, port_name, ierror)
  CHARACTER(LEN=*) INTENT(IN) :: service_name
  TYPE(MPI_Info), INTENT(IN) :: info
  CHARACTER(LEN=MPI_MAX_PORT_NAME), INTENT(OUT) :: port_name
  INTEGER, OPTIONAL, INTENT(OUT) :: ierror
```

### Fortran binding

```
MPI_LOOKUP_NAME(SERVICE_NAME, INFO, PORT_NAME, IERROR)
  CHARACTER*(*) SERVICE_NAME, PORT_NAME
  INTEGER INFO, IERROR
```

This function retrieves a `port_name` published by `MPI_PUBLISH_NAME` with `service_name`. If `service_name` has not been published, it raises an error in the error class `MPI_ERR_NAME`. The application must supply a `port_name` buffer large enough to hold the largest possible port name (see discussion above under `MPI_OPEN_PORT`).

If an implementation allows multiple entries with the same `service_name` within the same scope, a particular `port_name` is chosen in a way determined by the implementation.

If the `info` argument was used with `MPI_PUBLISH_NAME` to tell the implementation how to publish names, a similar `info` argument may be required for `MPI_LOOKUP_NAME`.

## 11.9.5 Reserved Key Values

The following key values are reserved. An implementation is not required to interpret these key values, but if it does interpret the key value, it must provide the functionality described.

**"ip\_port"** Value contains IP port number at which to establish a port. (Reserved for `MPI_OPEN_PORT` only).

"**ip\_address**" Value contains IP address at which to establish a port. If the address is not a valid IP address of the host on which the MPI\_OPEN\_PORT call is made, the results are undefined. (Reserved for MPI\_OPEN\_PORT only).

### 11.9.6 Client/Server Examples

#### **Example 11.20** Simplest Example—Completely Portable.

The following example shows the simplest way to use the client/server interface. It does not use service names at all.

On the server side:

```
char myport[MPI_MAX_PORT_NAME];
MPI_Comm intercomm;
/* ... */
MPI_Open_port(MPI_INFO_NULL, myport);
printf("port name is: %s\n", myport);

MPI_Comm_accept(myport, MPI_INFO_NULL, 0, MPI_COMM_SELF, &intercomm);
/* do something with intercomm */
```

The server prints out the port name to the terminal and the user must type it in when starting up the client (assuming the MPI implementation supports stdin such that this works). On the client side:

```
MPI_Comm intercomm;
char name[MPI_MAX_PORT_NAME];
printf("enter port name: ");
gets(name);
MPI_Comm_connect(name, MPI_INFO_NULL, 0, MPI_COMM_SELF, &intercomm);
```

#### **Example 11.21** Ocean/Atmosphere—Relies on Name Publishing

In this example, the “ocean” application is the “server” side of a coupled ocean-atmosphere climate model. It assumes that the MPI implementation publishes names.

```
MPI_Open_port(MPI_INFO_NULL, port_name);
MPI_Publish_name("ocean", MPI_INFO_NULL, port_name);

MPI_Comm_accept(port_name, MPI_INFO_NULL, 0, MPI_COMM_SELF, &intercomm);
/* do something with intercomm */
MPI_Unpublish_name("ocean", MPI_INFO_NULL, port_name);
```

On the client side:

```
MPI_Lookup_name("ocean", MPI_INFO_NULL, port_name);
MPI_Comm_connect(port_name, MPI_INFO_NULL, 0, MPI_COMM_SELF,
                 &intercomm);
```

**Example 11.22** Simple Client-Server Example

This is a simple example; the server accepts only a single connection at a time and serves that connection until the client requests to be disconnected. The server is a single process.

Here is the server. It accepts a single connection and then processes data until it receives a message with tag 1. A message with tag 0 tells the server to exit.

```

1  #include "mpi.h"
2  int main(int argc, char *argv[])
3  {
4      MPI_Comm client;
5      MPI_Status status;
6      char port_name[MPI_MAX_PORT_NAME];
7      double buf[MAX_DATA];
8      int size, again;
9
10     MPI_Init(&argc, &argv);
11     MPI_Comm_size(MPI_COMM_WORLD, &size);
12     if (size != 1) error(FATAL, "Server too big");
13     MPI_Open_port(MPI_INFO_NULL, port_name);
14     printf("server available at %s\n", port_name);
15     while (1) {
16         MPI_Comm_accept(port_name, MPI_INFO_NULL, 0, MPI_COMM_WORLD,
17                         &client);
18         again = 1;
19         while (again) {
20             MPI_Recv(buf, MAX_DATA, MPI_DOUBLE,
21                     MPI_ANY_SOURCE, MPI_ANY_TAG, client, &status);
22             switch (status.MPI_TAG) {
23                 case 0: MPI_Comm_free(&client);
24                         MPI_Close_port(port_name);
25                         MPI_Finalize();
26                         return 0;
27                 case 1: MPI_Comm_disconnect(&client);
28                         again = 0;
29                         break;
30                 case 2: /* do something */
31                         ...
32                 default:
33                         /* Unexpected message type */
34                         MPI_Abort(MPI_COMM_WORLD, 1);
35             }
36         }
37     }
38 }

```

Here is the client.



```
#include "mpi.h" 1
int main(int argc, char **argv) 2
{ 3
    MPI_Comm server; 4
    double buf[MAX_DATA]; 5
    char port_name[MPI_MAX_PORT_NAME]; 6
    7
    MPI_Init(&argc, &argv); 8
    strcpy(port_name, argv[1]); /* assume server's name is cmd-line arg */ 9
    10
    MPI_Comm_connect(port_name, MPI_INFO_NULL, 0, MPI_COMM_WORLD, 11
                     &server); 12
    13
    while (!done) { 14
        tag = 2; /* Action to perform */ 15
        MPI_Send(buf, n, MPI_DOUBLE, 0, tag, server); 16
        /* etc */ 17
    } 18
    MPI_Send(buf, 0, MPI_DOUBLE, 0, 1, server); 19
    MPI_Comm_disconnect(&server); 20
    MPI_Finalize(); 21
    return 0; 22
} 23
24
25
```

## 11.10 Other Functionality

### 11.10.1 Universe Size

Many “dynamic” MPI applications are expected to exist in a static runtime environment, in which resources have been allocated before the application is run. When a user (or possibly a batch system) runs one of these quasi-static applications, she will usually specify a number of processes to start and a total number of processes that are expected. An application simply needs to know how many slots there are, i.e., how many processes it should spawn.

MPI provides an attribute on `MPI_COMM_WORLD`, `MPI_UNIVERSE_SIZE`, that allows the application to obtain this information in a portable manner. This attribute indicates the total number of processes that are expected. In Fortran, the attribute is the integer value. In C, the attribute is a pointer to the integer value. An application typically subtracts the size of `MPI_COMM_WORLD` from `MPI_UNIVERSE_SIZE` to find out how many processes it should spawn. `MPI_UNIVERSE_SIZE` is initialized in `MPI_INIT` and is not changed by MPI. If defined, it has the same value on all processes of `MPI_COMM_WORLD`. `MPI_UNIVERSE_SIZE` is determined by the application startup mechanism in a way not specified by MPI. (The size of `MPI_COMM_WORLD` is another example of such a parameter.)

Possibilities for how `MPI_UNIVERSE_SIZE` might be set include

- A `-universe_size` argument to a program that starts MPI processes.
- Automatic interaction with a batch scheduler to figure out how many processors have been allocated to an application.

- 1     • An environment variable set by the user.
- 2
- 3     • Extra information passed to MPI\_COMM\_SPAWN through the info argument.

4     An implementation must document how MPI\_UNIVERSE\_SIZE is set. An implementation  
5 may not support the ability to set MPI\_UNIVERSE\_SIZE, in which case the attribute  
6 MPI\_UNIVERSE\_SIZE is not set.

7     MPI\_UNIVERSE\_SIZE is a recommendation, not necessarily a hard limit. For instance,  
8 some implementations may allow an application to spawn 50 processes per processor, if  
9 they are requested. However, it is likely that the user only wants to spawn one process per  
10 processor.

11     MPI\_UNIVERSE\_SIZE is assumed to have been specified when an application was started,  
12 and is in essence a portable mechanism to allow the user to pass to the application (through  
13 the MPI process startup mechanism, such as `mpixec`) a piece of critical runtime informa-  
14 tion. Note that no interaction with the runtime environment is required. If the runtime  
15 environment changes size while an application is running, MPI\_UNIVERSE\_SIZE is not up-  
16 dated, and the application must find out about the change through direct communication  
17 with the runtime system.

### 19 11.10.2 Singleton MPI Initialization

20  
21 A high-quality implementation will allow any process (including those not started with a  
22 “parallel application” mechanism) to become an MPI process by calling MPI\_INIT,  
23 MPI\_INIT\_THREAD, or MPI\_SESSION\_INIT. Such a process can then connect to other MPI  
24 processes using the MPI\_COMM\_ACCEPT and MPI\_COMM\_CONNECT routines, or spawn  
25 other MPI processes. MPI does not mandate this behavior, but strongly encourages it where  
26 technically feasible.

27  
28     *Advice to implementors.* Special coordination is required to start MPI processes  
29 belonging to the same MPI\_COMM\_WORLD in the case of the World Model, or the  
30 same “`mpi://WORLD`” process set in the Sessions Model. The processes must be  
31 started at the “same” time, they must have a mechanism to establish communication,  
32 etc. Either the user or the operating system must take special steps beyond simply  
33 starting processes.

34     Considering the World Model, when an application enters MPI\_INIT, clearly it must  
35 be able to determine if these special steps were taken. If a process enters MPI\_INIT and  
36 determines that no special steps were taken (i.e., it has not been given the information  
37 to form an MPI\_COMM\_WORLD with other processes) it succeeds and forms a singleton  
38 MPI program, that is, one in which MPI\_COMM\_WORLD has size 1.

39     In some implementations, MPI may not be able to function without an “MPI environ-  
40 ment.” For example, MPI may require that daemons be running or MPI may not be  
41 able to work at all on the front-end of an MPP. In this case, an MPI implementation  
42 may either

- 43
- 44     1. Create the environment (e.g., start a daemon) or
- 45     2. Raise an error if it cannot create the environment and the environment has not
- 46     been started independently.
- 47
- 48

A high-quality implementation will try to create a singleton MPI process and not raise an error.

*(End of advice to implementors.)*

### 11.10.3 MPI\_APPNUM

There is a predefined attribute MPI\_APPNUM of MPI\_COMM\_WORLD. In Fortran, the attribute is an integer value. In C, the attribute is a pointer to an integer value. If a process was spawned with MPI\_COMM\_SPAWN\_MULTIPLE, MPI\_APPNUM is the command number that generated the current process. Numbering starts from zero. If a process was spawned with MPI\_COMM\_SPAWN, it will have MPI\_APPNUM equal to zero.

Additionally, if the process was not started by a spawn call, but by an implementation-specific startup mechanism that can handle multiple process specifications, MPI\_APPNUM should be set to the number of the corresponding process specification. In particular, if it is started with

```
mpirexec spec0 [: spec1 : spec2 : ...]
```

MPI\_APPNUM should be set to the number of the corresponding specification.

If an application was not spawned with MPI\_COMM\_SPAWN or MPI\_COMM\_SPAWN\_MULTIPLE, and MPI\_APPNUM does not make sense in the context of the implementation-specific startup mechanism, MPI\_APPNUM is not set.

MPI implementations may optionally provide a mechanism to override the value of MPI\_APPNUM through the info argument. MPI reserves the following key for all SPAWN calls.

**"appnum"** Value contains an integer that overrides the default value for MPI\_APPNUM in the child.

*Rationale.* When a single application is started, it is able to figure out how many processes there are by looking at the size of MPI\_COMM\_WORLD. An application consisting of multiple SPMD sub-applications has no way to find out how many sub-applications there are and to which sub-application the process belongs. While there are ways to figure it out in special cases, there is no general mechanism. MPI\_APPNUM provides such a general mechanism. *(End of rationale.)*

### 11.10.4 Releasing Connections

Before a client and server connect, they are independent MPI applications. An error in one does not affect the other. After establishing a connection with MPI\_COMM\_CONNECT and MPI\_COMM\_ACCEPT, an error in one may affect the other. It is desirable for a client and server to be able to disconnect, so that an error in one will not affect the other. Similarly, it might be desirable for a parent and child to disconnect, so that errors in the child do not affect the parent, or vice-versa.

- Two processes are **connected** if there is a communication path (direct or indirect) between them. More precisely:
  1. Two processes are connected if

- 1 (a) they both belong to the same communicator (inter- or intra-, including  
2 MPI\_COMM\_WORLD) *or*  
3 (b) they have previously belonged to a communicator that was freed with  
4 MPI\_COMM\_FREE instead of MPI\_COMM\_DISCONNECT *or*  
5 (c) they both belong to the group of the same window or filehandle.  
6

7 2. If A is connected to B and B to C, then A is connected to C.

- 8
- 9 • Two processes are **disconnected** (also **independent**) if they are not connected.
  - 10 • By the above definitions, connectivity is a transitive property, and divides the uni-  
11 verse of MPI processes into disconnected (independent) sets (equivalence classes) of  
12 processes.
  - 13 • Processes which are connected, but do not share the same MPI\_COMM\_WORLD, may  
14 become disconnected (independent) if the communication path between them is bro-  
15 ken by using MPI\_COMM\_DISCONNECT.  
16

17 The following additional rules apply to MPI routines in other chapters:

- 18
- 19 • MPI\_FINALIZE is collective over a set of connected processes.
  - 20
  - 21 • MPI\_ABORT does not abort independent processes. It may abort all processes in  
22 the caller's MPI\_COMM\_WORLD (ignoring its `comm` argument). Additionally, it may  
23 abort connected processes as well, though it makes a “best attempt” to abort only  
24 the processes in `comm`.
  - 25 • If a process terminates without calling MPI\_FINALIZE, independent processes are not  
26 affected but the effect on connected processes is not defined.  
27

28 *Advice to implementors.* In practice, it may be difficult to distinguish between an  
29 MPI process failure and an erroneous program that terminates without calling an  
30 MPI finalization function: an implementation that defines semantics for process fail-  
31 ure management may have to exhibit the behavior defined for MPI process failures  
32 with such erroneous programs. A high quality implementation should exhibit a dif-  
33 ferent behavior for erroneous programs and MPI process failures. (*End of advice to*  
34 *implementors.*)  
35

36  
37  
38 MPI\_COMM\_DISCONNECT(comm)

39 INOUT comm communicator (handle)  
40

#### 41 C binding

42 int MPI\_Comm\_disconnect(MPI\_Comm \*comm)  
43

#### 44 Fortran 2008 binding

45 MPI\_Comm\_disconnect(comm, ierror)  
46 TYPE(MPI\_Comm), INTENT(INOUT) :: comm  
47 INTEGER, OPTIONAL, INTENT(OUT) :: ierror  
48

**Fortran binding**

```
MPI_COMM_DISCONNECT(COMM, IERROR)
    INTEGER COMM, IERROR
```

This function waits for all pending communication on `comm` to complete internally, deallocates the communicator object, and sets the handle to `MPI_COMM_NULL`. It is a collective operation.

It may not be called with the communicator `MPI_COMM_WORLD` or `MPI_COMM_SELF`.

`MPI_COMM_DISCONNECT` may be called only if all communication is complete and matched, so that buffered data can be delivered to its destination. This requirement is the same as for `MPI_FINALIZE`.

`MPI_COMM_DISCONNECT` has the same action as `MPI_COMM_FREE`, except that it waits for pending communication to finish internally and enables the guarantee about the behavior of disconnected processes.

*Advice to users.* To disconnect two processes you may need to call `MPI_COMM_DISCONNECT`, `MPI_WIN_FREE`, and `MPI_FILE_CLOSE` to remove all communication paths between the two processes. Note that it may be necessary to disconnect several communicators (or to free several windows or files) before two processes are completely independent. (*End of advice to users.*)

*Rationale.* It would be nice to be able to use `MPI_COMM_FREE` instead, but that function explicitly does not wait for pending communication to complete. (*End of rationale.*)

## 11.10.5 Another Way to Establish MPI Communication

```
MPI_COMM_JOIN(fd, intercomm)
```

IN	fd	socket file descriptor
OUT	intercomm	new inter-communicator (handle)

**C binding**

```
int MPI_Comm_join(int fd, MPI_Comm *intercomm)
```

**Fortran 2008 binding**

```
MPI_Comm_join(fd, intercomm, ierror)
    INTEGER, INTENT(IN) :: fd
    TYPE(MPI_Comm), INTENT(OUT) :: intercomm
    INTEGER, OPTIONAL, INTENT(OUT) :: ierror
```

**Fortran binding**

```
MPI_COMM_JOIN(FD, INTERCOMM, IERROR)
    INTEGER FD, INTERCOMM, IERROR
```

`MPI_COMM_JOIN` is intended for MPI implementations that exist in an environment supporting the Berkeley Socket interface [50, 56]. Implementations that exist in an environment not supporting Berkeley Sockets should provide the entry point for `MPI_COMM_JOIN` and should return `MPI_COMM_NULL`.

1 This call creates an inter-communicator from the union of two MPI processes which are  
 2 connected by a socket. MPI\_COMM\_JOIN should normally succeed if the local and remote  
 3 processes have access to the same implementation-defined MPI communication universe.

4  
 5 *Advice to users.* An MPI implementation may require a specific communication  
 6 medium for MPI communication, such as a shared memory segment or a special switch.  
 7 In this case, it may not be possible for two processes to successfully join even if there  
 8 is a socket connecting them and they are using the same MPI implementation. (*End*  
 9 *of advice to users.*)

10  
 11 *Advice to implementors.* A high-quality implementation will attempt to establish  
 12 communication over a slow medium if its preferred one is not available. If implemen-  
 13 tations do not do this, they must document why they cannot do MPI communication  
 14 over the medium used by the socket (especially if the socket is a TCP connection).  
 15 (*End of advice to implementors.*)

16 `fd` is a file descriptor representing a socket of type `SOCK_STREAM` (a two-way reliable  
 17 byte-stream connection). Nonblocking I/O and asynchronous notification via `SIGIO` must  
 18 not be enabled for the socket. The socket must be in a connected state. The socket must  
 19 be quiescent when `MPI_COMM_JOIN` is called (see below). It is the responsibility of the  
 20 application to create the socket using standard socket API calls.

21 `MPI_COMM_JOIN` must be called by the process at each end of the socket. It does not  
 22 return until both processes have called `MPI_COMM_JOIN`. The two processes are referred  
 23 to as the local and remote processes.

24 MPI uses the socket to bootstrap creation of the inter-communicator, and for nothing  
 25 else. Upon return from `MPI_COMM_JOIN`, the file descriptor will be open and quiescent  
 26 (see below).

27 If MPI is unable to create an inter-communicator, but is able to leave the socket in its  
 28 original state, with no pending communication, it succeeds and sets `intercomm` to  
 29 `MPI_COMM_NULL`.

30 The socket must be quiescent before `MPI_COMM_JOIN` is called and after  
 31 `MPI_COMM_JOIN` returns. More specifically, on entry to `MPI_COMM_JOIN`, a `read` on the  
 32 socket will not read any data that was written to the socket before the remote process called  
 33 `MPI_COMM_JOIN`. On exit from `MPI_COMM_JOIN`, a `read` will not read any data that was  
 34 written to the socket before the remote process returned from `MPI_COMM_JOIN`. It is the  
 35 responsibility of the application to ensure the first condition, and the responsibility of the  
 36 MPI implementation to ensure the second. In a multithreaded application, the application  
 37 must ensure that one thread does not access the socket while another is calling  
 38 `MPI_COMM_JOIN`, or call `MPI_COMM_JOIN` concurrently.

39  
 40 *Advice to implementors.* MPI is free to use any available communication path(s)  
 41 for MPI messages in the new communicator; the socket is only used for the initial  
 42 handshaking. (*End of advice to implementors.*)

43 `MPI_COMM_JOIN` uses non-MPI communication to do its work. The interaction of  
 44 non-MPI communication with pending MPI communication is not defined. Therefore, the  
 45 result of calling `MPI_COMM_JOIN` on two connected processes (see Section 11.10.4 for the  
 46 definition of connected) is undefined.

47 The returned communicator may be used to establish MPI communication with addi-  
 48 tional processes, through the usual MPI communicator creation mechanisms.

1  
2  
3  
4  
5  
6  
7  
8  
9  
10  
11  
12  
13  
14  
15  
16  
17  
18  
19  
20  
21  
22  
23  
24  
25  
26  
27  
28  
29  
30  
31  
32  
33  
34  
35  
36  
37  
38  
39  
40  
41  
42  
43  
44  
45  
46  
47  
48

## Chapter 12

# One-Sided Communications

### 12.1 Introduction

**Remote Memory Access (RMA)** extends the communication mechanisms of MPI by allowing one process to specify all communication parameters, both for the sending side and for the receiving side. This mode of communication facilitates the coding of some applications with dynamically changing data access patterns where the data distribution is fixed or slowly changing. In such a case, each process can compute what data it needs to access or to update at other processes. However, the programmer may not be able to easily determine which data in a process may need to be accessed or to be updated by operations executed by a different process, and may not even know which processes may perform such updates. Thus, the transfer parameters are all available only on one side. Regular send/receive communication requires matching operations by sender and receiver. In order to issue the matching operations, an application needs to distribute the transfer parameters. This distribution may require all processes to participate in a time-consuming global computation, or to poll for potential communication requests to receive and upon which to act periodically. The use of RMA communication mechanisms avoids the need for global computations or explicit polling. A generic example of this nature is the execution of an assignment of the form  $A = B(\text{map})$ , where `map` is a permutation vector, and `A`, `B`, and `map` are distributed in the same manner.

Message-passing communication achieves two effects: *communication* of data from sender to receiver and *synchronization* of sender with receiver. The RMA design separates these two functions. The following communication calls are provided:

- Remote write: `MPI_PUT`, `MPI_RPUT`
- Remote read: `MPI_GET`, `MPI_RGET`
- Remote update: `MPI_ACCUMULATE`, `MPI_RACCUMULATE`
- Remote read and update: `MPI_GET_ACCUMULATE`, `MPI_RGET_ACCUMULATE`, and `MPI_FETCH_AND_OP`
- Remote atomic swap operations: `MPI_COMPARE_AND_SWAP`

This chapter refers to an operations set that includes all remote update, remote read and update, and remote atomic swap operations as “accumulate” operations.

1 MPI supports two fundamentally different *memory models*: *separate* and *unified*. The  
2 separate model makes no assumption about memory consistency and is highly portable.  
3 This model is similar to that of weakly coherent memory systems: the user must impose  
4 correct ordering of memory accesses through synchronization calls. The unified model can  
5 exploit cache-coherent hardware and hardware-accelerated, one-sided operations that are  
6 commonly available in high-performance systems. The two different models are discussed  
7 in detail in Section 12.4. Both models support several synchronization calls to support  
8 different synchronization styles.

9 The design of the RMA functions allows implementors to take advantage of fast or  
10 asynchronous communication mechanisms provided by various platforms, such as coherent  
11 or noncoherent shared memory, DMA engines, hardware-supported put/get operations, and  
12 communication coprocessors. The most frequently used RMA communication mechanisms  
13 can be layered on top of message-passing. However, certain RMA functions might need  
14 support for asynchronous communication agents in software (handlers, threads, etc.) in a  
15 distributed memory environment.

16 We shall denote by **origin** the process that performs the call, and by **target** the  
17 process in which the memory is accessed. Thus, in a put operation, **source** = **origin** and  
18 **destination** = **target**; in a get operation, **source** = **target** and **destination** = **origin**.

19 The use of terms such as nonblocking and local in this chapter follow the usage in  
20 MPI-3.1, and this chapter has not been updated to follow the definitions in Section 2.4.  
21 The MPI Forum intends to update this chapter in a subsequent version of the MPI standard  
22 to follow the definitions in Section 2.4.

## 24 12.2 Initialization

26 MPI provides the following window initialization functions: `MPI_WIN_CREATE`,  
27 `MPI_WIN_ALLOCATE`, `MPI_WIN_ALLOCATE_SHARED`, and  
28 `MPI_WIN_CREATE_DYNAMIC`, which are collective on an intra-communicator.  
29 `MPI_WIN_CREATE` allows each process to specify a “window” in its memory that is made  
30 accessible to accesses by remote processes. The call returns an opaque object that represents  
31 the group of processes that own and access the set of windows, and the attributes of each  
32 window, as specified by the initialization call. `MPI_WIN_ALLOCATE` differs from  
33 `MPI_WIN_CREATE` in that the user does not pass allocated memory;  
34 `MPI_WIN_ALLOCATE` returns a pointer to memory allocated by the MPI implementation.  
35 `MPI_WIN_ALLOCATE_SHARED` differs from `MPI_WIN_ALLOCATE` in that the allocated  
36 memory can be accessed from all processes in the window’s group with direct load/store  
37 instructions. Some restrictions may apply to the specified communicator.  
38 `MPI_WIN_CREATE_DYNAMIC` creates a window that allows the user to dynamically control  
39 which memory is exposed by the window.



## 12.2.1 Window Creation

MPI\_WIN\_CREATE(base, size, disp\_unit, info, comm, win)

IN	base	initial address of window (choice)
IN	size	size of window in bytes (non-negative integer)
IN	disp_unit	local unit size for displacements, in bytes (positive integer)
IN	info	info argument (handle)
IN	comm	intra-communicator (handle)
OUT	win	window object (handle)

**C binding**

```
int MPI_Win_create(void *base, MPI_Aint size, int disp_unit, MPI_Info info,
                  MPI_Comm comm, MPI_Win *win)
```

```
int MPI_Win_create_c(void *base, MPI_Aint size, MPI_Aint disp_unit,
                    MPI_Info info, MPI_Comm comm, MPI_Win *win)
```

**Fortran 2008 binding**

```
MPI_Win_create(base, size, disp_unit, info, comm, win, ierror)
  TYPE(*), DIMENSION(..), ASYNCHRONOUS :: base
  INTEGER(KIND=MPI_ADDRESS_KIND), INTENT(IN) :: size
  INTEGER, INTENT(IN) :: disp_unit
  TYPE(MPI_Info), INTENT(IN) :: info
  TYPE(MPI_Comm), INTENT(IN) :: comm
  TYPE(MPI_Win), INTENT(OUT) :: win
  INTEGER, OPTIONAL, INTENT(OUT) :: ierror
```

```
MPI_Win_create(base, size, disp_unit, info, comm, win, ierror)
  TYPE(*), DIMENSION(..), ASYNCHRONOUS :: base
  INTEGER(KIND=MPI_ADDRESS_KIND), INTENT(IN) :: size, disp_unit
  TYPE(MPI_Info), INTENT(IN) :: info
  TYPE(MPI_Comm), INTENT(IN) :: comm
  TYPE(MPI_Win), INTENT(OUT) :: win
  INTEGER, OPTIONAL, INTENT(OUT) :: ierror
```

**Fortran binding**

```
MPI_WIN_CREATE(BASE, SIZE, DISP_UNIT, INFO, COMM, WIN, IERROR)
  <type> BASE(*)
  INTEGER(KIND=MPI_ADDRESS_KIND) SIZE
  INTEGER DISP_UNIT, INFO, COMM, WIN, IERROR
```

This is a collective call executed by all processes in the group of comm. It returns a window object that can be used by these processes to perform RMA operations. Each process specifies a window of existing memory that it exposes to RMA accesses by the processes in the group of comm. The window consists of size bytes, starting at address base. In C, base is the starting address of a memory region. In Fortran, one can pass the

1 first element of a memory region or a whole array, which must be ‘simply contiguous’ (for  
 2 ‘simply contiguous,’ see also Section 19.1.12). A process may elect to expose no memory  
 3 by specifying `size = 0`.

4 The displacement unit argument is provided to facilitate address arithmetic in RMA  
 5 operations: the target displacement argument of an RMA operation is scaled by the factor  
 6 `disp_unit` specified by the target process, at window creation.

7  
 8 *Rationale.* The window size is specified using an address-sized integer, rather than a  
 9 basic integer type, to allow windows that span more memory than can be described  
 10 with a basic integer type. (*End of rationale.*)

11  
 12 *Advice to users.* Common choices for `disp_unit` are 1 (no scaling), and (in C syntax)  
 13 `sizeof(type)`, for a window that consists of an array of elements of type `type`. The  
 14 latter choice will allow one to use array indices in RMA calls, and have those scaled  
 15 correctly to byte displacements, even in a heterogeneous environment. (*End of advice*  
 16 *to users.*)

17  
 18 The `info` argument provides optimization hints to the runtime about the expected usage  
 19 pattern of the window. The following info keys are predefined:

20  
 21 "no\_locks"—if set to true, then the implementation may assume that passive target synchrono-  
 22 zation (i.e., `MPI_WIN_LOCK`, `MPI_WIN_LOCK_ALL`) will not be used on the given  
 23 window. This implies that this window is not used for 3-party communication, and  
 24 RMA can be implemented with no (less) asynchronous agent activity at this process.

25  
 26 "accumulate\_ordering"—controls the ordering of accumulate operations at the target. See  
 27 Section 12.7.2 for details.

28  
 29 "accumulate\_ops"—if set to "same\_op", the implementation will assume that all concurrent  
 30 accumulate calls to the same target address will use the same operation. If set to  
 31 "same\_op\_no\_op", then the implementation will assume that all concurrent accumulate  
 32 calls to the same target address will use the same operation or `MPI_NO_OP`. This can  
 33 eliminate the need to protect access for certain operation types where the hardware  
 34 can guarantee atomicity. The default is "same\_op\_no\_op".

35  
 36 "same\_size"—if set to true, then the implementation may assume that the argument `size` is  
 37 identical on all processes, and that all processes have provided this info key with the  
 38 same value.

39  
 40 "same\_disp\_unit"—if set to true, then the implementation may assume that the argument  
 41 `disp_unit` is identical on all processes, and that all processes have provided this info  
 42 key with the same value.

43  
 44 *Advice to users.* The info query mechanism described in Section 12.2.7 can be used  
 45 to query the specified info arguments for windows that have been passed to a library.  
 46 It is recommended that libraries check attached info keys for each passed window.  
 47 (*End of advice to users.*)

48  
 49 The various processes in the group of `comm` may specify completely different target  
 windows, in location, size, displacement units, and info arguments. As long as all the get,

put and accumulate accesses to a particular process fit their specific target window this should pose no problem. The same area in memory may appear in multiple windows, each associated with a different window object. However, concurrent communications to distinct, overlapping windows may lead to undefined results.

*Rationale.* The reason for specifying the memory that may be accessed from another process in an RMA operation is to permit the programmer to specify what memory can be a target of RMA operations and for the implementation to enforce that specification. For example, with this definition, a server process can safely allow a client process to use RMA operations, knowing that (under the assumption that the MPI implementation does enforce the specified limits on the exposed memory) an error in the client cannot affect any memory other than what was explicitly exposed. (*End of rationale.*)

*Advice to users.* A window can be created in any part of the process memory. However, on some systems, the performance of windows in memory allocated by `MPI_ALLOC_MEM` (Section 9.2) will be better. Also, on some systems, performance is improved when window boundaries are aligned at “natural” boundaries (word, double-word, cache line, page frame, etc.). (*End of advice to users.*)

*Advice to implementors.* In cases where RMA operations use different mechanisms in different memory areas (e.g., load/store in a shared memory segment, and an asynchronous handler in private memory), the `MPI_WIN_CREATE` call needs to figure out which type of memory is used for the window. To do so, MPI maintains, internally, the list of memory segments allocated by `MPI_ALLOC_MEM`, or by other, implementation-specific, mechanisms, together with information on the type of memory segment allocated. When a call to `MPI_WIN_CREATE` occurs, then MPI checks which segment contains each window, and decides, accordingly, which mechanism to use for RMA operations.

Vendors may provide additional, implementation-specific mechanisms to allocate or to specify memory regions that are preferable for use in one-sided communication. In particular, such mechanisms can be used to place static variables into such preferred regions.

Implementors should document any performance impact of window alignment. (*End of advice to implementors.*)

## 12.2.2 Window That Allocates Memory

MPI\_WIN\_ALLOCATE(size, disp\_unit, info, comm, baseptr, win)

IN	size	size of window in bytes (non-negative integer)
IN	disp_unit	local unit size for displacements, in bytes (positive integer)
IN	info	info argument (handle)
IN	comm	intra-communicator (handle)
OUT	baseptr	initial address of window (choice)
OUT	win	window object returned by call (handle)

### C binding

```
int MPI_Win_allocate(MPI_Aint size, int disp_unit, MPI_Info info,
                    MPI_Comm comm, void *baseptr, MPI_Win *win)
```

```
int MPI_Win_allocate_c(MPI_Aint size, MPI_Aint disp_unit, MPI_Info info,
                    MPI_Comm comm, void *baseptr, MPI_Win *win)
```

### Fortran 2008 binding

```
MPI_Win_allocate(size, disp_unit, info, comm, baseptr, win, ierror)
  USE, INTRINSIC :: ISO_C_BINDING, ONLY : C_PTR
  INTEGER(KIND=MPI_ADDRESS_KIND), INTENT(IN) :: size
  INTEGER, INTENT(IN) :: disp_unit
  TYPE(MPI_Info), INTENT(IN) :: info
  TYPE(MPI_Comm), INTENT(IN) :: comm
  TYPE(C_PTR), INTENT(OUT) :: baseptr
  TYPE(MPI_Win), INTENT(OUT) :: win
  INTEGER, OPTIONAL, INTENT(OUT) :: ierror
```

```
MPI_Win_allocate(size, disp_unit, info, comm, baseptr, win, ierror)
  USE, INTRINSIC :: ISO_C_BINDING, ONLY : C_PTR
  INTEGER(KIND=MPI_ADDRESS_KIND), INTENT(IN) :: size, disp_unit
  TYPE(MPI_Info), INTENT(IN) :: info
  TYPE(MPI_Comm), INTENT(IN) :: comm
  TYPE(C_PTR), INTENT(OUT) :: baseptr
  TYPE(MPI_Win), INTENT(OUT) :: win
  INTEGER, OPTIONAL, INTENT(OUT) :: ierror
```

### Fortran binding

```
MPI_WIN_ALLOCATE(SIZE, DISP_UNIT, INFO, COMM, BASEPTR, WIN, IERROR)
  INTEGER(KIND=MPI_ADDRESS_KIND) SIZE, BASEPTR
  INTEGER DISP_UNIT, INFO, COMM, WIN, IERROR
```

This is a collective call executed by all processes in the group of `comm`. On each process, it allocates memory of at least `size` bytes, returns a pointer to it, and returns a window object that can be used by all processes in `comm` to perform RMA operations. The returned memory consists of `size` bytes local to each process, starting at address `baseptr`

and is associated with the window as if the user called `MPI_WIN_CREATE` on existing memory. The size argument may be different at each process and `size = 0` is valid; however, a library might allocate and expose more memory in order to create a fast, globally symmetric allocation. The discussion of and rationales for `MPI_ALLOC_MEM` and `MPI_FREE_MEM` in Section 9.2 also apply to `MPI_WIN_ALLOCATE`; in particular, see the rationale in Section 9.2 for an explanation of the type used for `baseptr`.

If the Fortran compiler provides `TYPE(C_PTR)`, then the following generic interface must be provided in the `mpi` module and should be provided in `mpif.h` through overloading, i.e., with the same routine name as the routine with `INTEGER(KIND=MPI_ADDRESS_KIND)` `BASEPTR`, but with a different specific procedure name:

```

INTERFACE MPI_WIN_ALLOCATE
  SUBROUTINE MPI_WIN_ALLOCATE(SIZE, DISP_UNIT, INFO, COMM, BASEPTR, &
                              WIN, IERROR)
    IMPORT :: MPI_ADDRESS_KIND
    INTEGER DISP_UNIT, INFO, COMM, WIN, IERROR
    INTEGER(KIND=MPI_ADDRESS_KIND) SIZE, BASEPTR
  END SUBROUTINE
  SUBROUTINE MPI_WIN_ALLOCATE_CPTR(SIZE, DISP_UNIT, INFO, COMM, BASEPTR, &
                                   WIN, IERROR)
    USE, INTRINSIC :: ISO_C_BINDING, ONLY : C_PTR
    IMPORT :: MPI_ADDRESS_KIND
    INTEGER :: DISP_UNIT, INFO, COMM, WIN, IERROR
    INTEGER(KIND=MPI_ADDRESS_KIND) :: SIZE
    TYPE(C_PTR) :: BASEPTR
  END SUBROUTINE
END INTERFACE

```

The base procedure name of this overloaded function is `MPI_WIN_ALLOCATE_CPTR`. The implied specific procedure names are described in Section 19.1.5.

*Rationale.* By allocating (potentially aligned) memory instead of allowing the user to pass in an arbitrary buffer, this call can improve the performance for systems with remote direct memory access. This also permits the collective allocation of memory and supports what is sometimes called the “symmetric allocation” model that can be more scalable (for example, the implementation can arrange to return an address for the allocated memory that is the same on all processes). (*End of rationale.*)

The `info` argument can be used to specify hints similar to the `info` argument for `MPI_WIN_CREATE` and `MPI_ALLOC_MEM`.

The default memory alignment requirements and the “`mpi_minimum_memory_alignment`” `info` key described for `MPI_ALLOC_MEM` in Section 9.2 apply to all processes with non-zero size argument.

### 12.2.3 Window That Allocates Shared Memory

MPI\_WIN\_ALLOCATE\_SHARED(size, disp\_unit, info, comm, baseptr, win)

IN	size	size of local window in bytes (non-negative integer)
IN	disp_unit	local unit size for displacements, in bytes (positive integer)
IN	info	info argument (handle)
IN	comm	intra-communicator (handle)
OUT	baseptr	address of local allocated window segment (choice)
OUT	win	window object returned by the call (handle)

#### C binding

```
int MPI_Win_allocate_shared(MPI_Aint size, int disp_unit, MPI_Info info,
    MPI_Comm comm, void *baseptr, MPI_Win *win)
```

```
int MPI_Win_allocate_shared_c(MPI_Aint size, MPI_Aint disp_unit,
    MPI_Info info, MPI_Comm comm, void *baseptr, MPI_Win *win)
```

#### Fortran 2008 binding

```
MPI_Win_allocate_shared(size, disp_unit, info, comm, baseptr, win, ierror)
    USE, INTRINSIC :: ISO_C_BINDING, ONLY : C_PTR
    INTEGER(KIND=MPI_ADDRESS_KIND), INTENT(IN) :: size
    INTEGER, INTENT(IN) :: disp_unit
    TYPE(MPI_Info), INTENT(IN) :: info
    TYPE(MPI_Comm), INTENT(IN) :: comm
    TYPE(C_PTR), INTENT(OUT) :: baseptr
    TYPE(MPI_Win), INTENT(OUT) :: win
    INTEGER, OPTIONAL, INTENT(OUT) :: ierror
```

```
MPI_Win_allocate_shared(size, disp_unit, info, comm, baseptr, win, ierror)
    USE, INTRINSIC :: ISO_C_BINDING, ONLY : C_PTR
    INTEGER(KIND=MPI_ADDRESS_KIND), INTENT(IN) :: size, disp_unit
    TYPE(MPI_Info), INTENT(IN) :: info
    TYPE(MPI_Comm), INTENT(IN) :: comm
    TYPE(C_PTR), INTENT(OUT) :: baseptr
    TYPE(MPI_Win), INTENT(OUT) :: win
    INTEGER, OPTIONAL, INTENT(OUT) :: ierror
```

#### Fortran binding

```
MPI_WIN_ALLOCATE_SHARED(SIZE, DISP_UNIT, INFO, COMM, BASEPTR, WIN, IERROR)
    INTEGER(KIND=MPI_ADDRESS_KIND) SIZE, BASEPTR
    INTEGER DISP_UNIT, INFO, COMM, WIN, IERROR
```

This is a collective call executed by all processes in the group of `comm`. On each process, it allocates memory of at least `size` bytes that is shared among all processes in `comm`, and returns a pointer to the locally allocated segment in `baseptr` that can be used for load/store accesses on the calling process. The locally allocated memory can be the

target of load/store accesses by remote processes; the base pointers for other processes can be queried using the function `MPI_WIN_SHARED_QUERY`. The call also returns a window object that can be used by all processes in `comm` to perform RMA operations. The size argument may be different at each process and `size = 0` is valid. It is the user's responsibility to ensure that the communicator `comm` represents a group of processes that can create a shared memory segment that can be accessed by all processes in the group. The discussions of rationales for `MPI_ALLOC_MEM` and `MPI_FREE_MEM` in Section 9.2 also apply to `MPI_WIN_ALLOCATE_SHARED`; in particular, see the rationale in Section 9.2 for an explanation of the type used for `baseptr`. The allocated memory is contiguous across process ranks unless the info key "alloc\_shared\_noncontig" is specified. Contiguous across process ranks means that the first address in the memory segment of process  $i$  is consecutive with the last address in the memory segment of process  $i - 1$ . This may enable the user to calculate remote address offsets with local information only.

If the Fortran compiler provides `TYPE(C_PTR)`, then the following generic interface must be provided in the `mpi` module and should be provided in `mpif.h` through overloading, i.e., with the same routine name as the routine with `INTEGER(KIND=MPI_ADDRESS_KIND)` `BASEPTR`, but with a different specific procedure name:

```

INTERFACE MPI_WIN_ALLOCATE_SHARED
  SUBROUTINE MPI_WIN_ALLOCATE_SHARED(SIZE, DISP_UNIT, INFO, COMM, &
                                     BASEPTR, WIN, IERROR)
    IMPORT :: MPI_ADDRESS_KIND
    INTEGER DISP_UNIT, INFO, COMM, WIN, IERROR
    INTEGER(KIND=MPI_ADDRESS_KIND) SIZE, BASEPTR
  END SUBROUTINE
  SUBROUTINE MPI_WIN_ALLOCATE_SHARED_CPTR(SIZE, DISP_UNIT, INFO, COMM, &
                                          BASEPTR, WIN, IERROR)
    USE, INTRINSIC :: ISO_C_BINDING, ONLY : C_PTR
    IMPORT :: MPI_ADDRESS_KIND
    INTEGER :: DISP_UNIT, INFO, COMM, WIN, IERROR
    INTEGER(KIND=MPI_ADDRESS_KIND) :: SIZE
    TYPE(C_PTR) :: BASEPTR
  END SUBROUTINE
END INTERFACE

```

The base procedure name of this overloaded function is `MPI_WIN_ALLOCATE_SHARED_CPTR`. The implied specific procedure names are described in Section 19.1.5.

The `info` argument can be used to specify hints similar to the `info` argument for `MPI_WIN_CREATE`, `MPI_WIN_ALLOCATE`, and `MPI_ALLOC_MEM`. The additional `info` key "alloc\_shared\_noncontig" allows the library to optimize the layout of the shared memory segments in memory.

*Advice to users.* If the `info` key "alloc\_shared\_noncontig" is not set to true, the allocation strategy is to allocate contiguous memory across process ranks. This may limit the performance on some architectures because it does not allow the implementation to modify the data layout (e.g., padding to reduce access latency). (*End of advice to users.*)

*Advice to implementors.* If the user sets the info key "alloc\_shared\_noncontig" to true, the implementation can allocate the memory requested by each process in a location that is close to this process. This can be achieved by padding or allocating memory in special memory segments. Both techniques may make the address space across consecutive ranks noncontiguous. (*End of advice to implementors.*)

For contiguous shared memory allocations, the default alignment requirements outlined for MPI\_ALLOC\_MEM in Section 9.2 and the "mpi\_minimum\_memory\_alignment" info key apply to the start of the contiguous memory that is returned in `baseptr` to the first process with non-zero size argument. For noncontiguous memory allocations, the default alignment requirements and the "mpi\_minimum\_memory\_alignment" info key apply to all processes with non-zero size argument.

*Advice to users.* If the info key "alloc\_shared\_noncontig" is not set to true (or ignored by the MPI implementation), the alignment of the memory returned in `baseptr` to all but the first process with non-zero size argument depends on the value of the size argument provided by other processes. It is thus the user's responsibility to control the alignment of contiguous memory allocated for these processes by ensuring that each process provides a size argument that is an integral multiple of the alignment required for the application. (*End of advice to users.*)

The consistency of load/store accesses from/to the shared memory as observed by the user program depends on the architecture. A consistent view can be created in the *unified memory model* (see Section 12.4) by utilizing the window synchronization functions (see Section 12.5) or explicitly completing outstanding store accesses (e.g., by calling MPI\_WIN\_FLUSH). MPI does not define semantics for accessing shared memory windows in the *separate memory model*.

MPI\_WIN\_SHARED\_QUERY(win, rank, size, disp\_unit, baseptr)

IN	win	shared memory window object (handle)
IN	rank	rank in the group of window win or MPI_PROC_NULL (non-negative integer)
OUT	size	size of the window segment (non-negative integer)
OUT	disp_unit	local unit size for displacements, in bytes (positive integer)
OUT	baseptr	address for load/store access to window segment (choice)

### C binding

```
int MPI_Win_shared_query(MPI_Win win, int rank, MPI_Aint *size,
                        int *disp_unit, void *baseptr)
```

```
int MPI_Win_shared_query_c(MPI_Win win, int rank, MPI_Aint *size,
                          MPI_Aint *disp_unit, void *baseptr)
```

### Fortran 2008 binding

```
MPI_Win_shared_query(win, rank, size, disp_unit, baseptr, ierror)
```



```

USE, INTRINSIC :: ISO_C_BINDING, ONLY : C_PTR           1
TYPE(MPI_Win), INTENT(IN) :: win                       2
INTEGER, INTENT(IN) :: rank                            3
INTEGER(KIND=MPI_ADDRESS_KIND), INTENT(OUT) :: size    4
INTEGER, INTENT(OUT) :: disp_unit                     5
TYPE(C_PTR), INTENT(OUT) :: baseptr                   6
INTEGER, OPTIONAL, INTENT(OUT) :: ierror              7
                                                       8
MPI_Win_shared_query(win, rank, size, disp_unit, baseptr, ierror) 9
USE, INTRINSIC :: ISO_C_BINDING, ONLY : C_PTR         10
TYPE(MPI_Win), INTENT(IN) :: win                       11
INTEGER, INTENT(IN) :: rank                            12
INTEGER(KIND=MPI_ADDRESS_KIND), INTENT(OUT) :: size, disp_unit 13
TYPE(C_PTR), INTENT(OUT) :: baseptr                   14
INTEGER, OPTIONAL, INTENT(OUT) :: ierror              15

```

### Fortran binding

```

MPI_WIN_SHARED_QUERY(WIN, RANK, SIZE, DISP_UNIT, BASEPTR, IERROR) 17
  INTEGER WIN, RANK, DISP_UNIT, IERROR                  18
  INTEGER(KIND=MPI_ADDRESS_KIND) SIZE, BASEPTR         19

```

This function queries the process-local address for remote memory segments created with `MPI_WIN_ALLOCATE_SHARED`. This function can return different process-local addresses for the same physical memory on different processes. The returned memory can be used for load/store accesses subject to the constraints defined in Section 12.7. This function can only be called with windows of flavor `MPI_WIN_FLAVOR_SHARED`. If the passed window is not of flavor `MPI_WIN_FLAVOR_SHARED`, the error `MPI_ERR_RMA_FLAVOR` is raised. When rank is `MPI_PROC_NULL`, the pointer, `disp_unit`, and `size` returned are the pointer, `disp_unit`, and `size` of the memory segment belonging the lowest rank that specified `size > 0`. If all processes in the group attached to the window specified `size = 0`, then the call returns `size = 0` and a `baseptr` as if `MPI_ALLOC_MEM` was called with `size = 0`.

If the Fortran compiler provides `TYPE(C_PTR)`, then the following generic interface must be provided in the `mpi` module and should be provided in `mpif.h` through overloading, i.e., with the same routine name as the routine with `INTEGER(KIND=MPI_ADDRESS_KIND) BASEPTR`, but with a different specific procedure name:

```

INTERFACE MPI_WIN_SHARED_QUERY                               35
  SUBROUTINE MPI_WIN_SHARED_QUERY(WIN, RANK, SIZE, DISP_UNIT, & 36
    BASEPTR, IERROR)                                       37
    IMPORT :: MPI_ADDRESS_KIND                               38
    INTEGER WIN, RANK, DISP_UNIT, IERROR                   39
    INTEGER (KIND=MPI_ADDRESS_KIND) SIZE, BASEPTR         40
  END SUBROUTINE                                           41
  SUBROUTINE MPI_WIN_SHARED_QUERY_CPTR(WIN, RANK, SIZE, DISP_UNIT, & 42
    BASEPTR, IERROR)                                       43
    USE, INTRINSIC :: ISO_C_BINDING, ONLY : C_PTR         44
    IMPORT :: MPI_ADDRESS_KIND                               45
    INTEGER :: WIN, RANK, DISP_UNIT, IERROR               46
    INTEGER(KIND=MPI_ADDRESS_KIND) :: SIZE                47
  END SUBROUTINE                                           48

```

```

1      TYPE(C_PTR) :: BASEPTR
2      END SUBROUTINE
3  END INTERFACE

```

The base procedure name of this overloaded function is `MPI_WIN_SHARED_QUERY_CPTR`. The implied specific procedure names are described in Section 19.1.5.

## 12.2.4 Window of Dynamically Attached Memory

The MPI-2 RMA model requires the user to identify the local memory that may be a target of RMA calls at the time the window is created. This has advantages for both the programmer (only this memory can be updated by one-sided operations and provides greater safety) and the MPI implementation (special steps may be taken to make one-sided access to such memory more efficient). However, consider implementing a modifiable linked list using RMA operations; as new items are added to the list, memory must be allocated. In a C or C++ program, this memory is typically allocated using `malloc` or `new` respectively. In MPI-2 RMA, the programmer must create a window with a predefined amount of memory and then implement routines for allocating memory from within the window's memory. In addition, there is no easy way to handle the situation where the predefined amount of memory turns out to be inadequate. To support this model, the routine `MPI_WIN_CREATE_DYNAMIC` creates a window that makes it possible to expose memory without remote synchronization. It must be used in combination with the local routines `MPI_WIN_ATTACH` and `MPI_WIN_DETACH`.

`MPI_WIN_CREATE_DYNAMIC`(info, comm, win)

IN	info	info argument (handle)
IN	comm	intra-communicator (handle)
OUT	win	window object returned by the call (handle)

### C binding

```
int MPI_Win_create_dynamic(MPI_Info info, MPI_Comm comm, MPI_Win *win)
```

### Fortran 2008 binding

```

MPI_Win_create_dynamic(info, comm, win, ierror)
  TYPE(MPI_Info), INTENT(IN) :: info
  TYPE(MPI_Comm), INTENT(IN) :: comm
  TYPE(MPI_Win), INTENT(OUT) :: win
  INTEGER, OPTIONAL, INTENT(OUT) :: ierror

```

### Fortran binding

```

MPI_WIN_CREATE_DYNAMIC(INFO, COMM, WIN, IERROR)
  INTEGER INFO, COMM, WIN, IERROR

```

This is a collective call executed by all processes in the group of `comm`. It returns a window `win` without memory attached. Existing process memory can be attached as described below. This routine returns a window object that can be used by these processes to

perform RMA operations on attached memory. Because this window has special properties, it will sometimes be referred to as a *dynamic* window.

The `info` argument can be used to specify hints similar to the `info` argument for `MPI_WIN_CREATE`.

In the case of a window created with `MPI_WIN_CREATE_DYNAMIC`, the `target_disp` for all RMA functions is the address at the target; i.e., the effective `window_base` is `MPI_BOTTOM` and the `disp_unit` is one. For dynamic windows, the `target_disp` argument to RMA communication operations is not restricted to non-negative values. Users should use `MPI_GET_ADDRESS` at the target process to determine the address of a target memory location and communicate this address to the origin process.

*Advice to users.* Users are cautioned that displacement arithmetic can overflow in variables of type `MPI_Aint` and result in unexpected values on some platforms. The `MPI_AINT_ADD` and `MPI_AINT_DIFF` functions can be used to safely perform address arithmetic with `MPI_Aint` displacements. (*End of advice to users.*)

*Advice to implementors.* In environments with heterogeneous data representations, care must be exercised in communicating addresses between processes. For example, it is possible that an address valid at the target process (for example, a 64-bit pointer) cannot be expressed as an address at the origin (for example, the origin uses 32-bit pointers). For this reason, a portable MPI implementation should ensure that the type `MPI_AINT` (see Table 3.3) is able to store addresses from any process. (*End of advice to implementors.*)

Memory at the target cannot be accessed with this window until that memory has been attached using the function `MPI_WIN_ATTACH`. That is, in addition to using `MPI_WIN_CREATE_DYNAMIC` to create an MPI window, the user must use `MPI_WIN_ATTACH` before any local memory may be the target of an MPI RMA operation. Only memory that is currently accessible may be attached.

`MPI_WIN_ATTACH(win, base, size)`

IN	<code>win</code>	window object (handle)
IN	<code>base</code>	initial address of memory to be attached (choice)
IN	<code>size</code>	size of memory to be attached in bytes (non-negative integer)

### C binding

```
int MPI_Win_attach(MPI_Win win, void *base, MPI_Aint size)
```

### Fortran 2008 binding

```
MPI_Win_attach(win, base, size, ierror)
  TYPE(MPI_Win), INTENT(IN) :: win
  TYPE(*), DIMENSION(..), ASYNCHRONOUS :: base
  INTEGER(KIND=MPI_ADDRESS_KIND), INTENT(IN) :: size
  INTEGER, OPTIONAL, INTENT(OUT) :: ierror
```

### Fortran binding

```
MPI_WIN_ATTACH(WIN, BASE, SIZE, IERROR)
```

```

1     INTEGER WIN, IERROR
2     <type> BASE(*)
3     INTEGER(KIND=MPI_ADDRESS_KIND) SIZE

```

Attaches a local memory region beginning at `base` for remote access within the given window. The memory region specified must not contain any part that is already attached to the window `win`, that is, attaching overlapping memory concurrently within the same window is erroneous. The argument `win` must be a window that was created with `MPI_WIN_CREATE_DYNAMIC`. The local memory region attached to the window consists of `size` bytes, starting at address `base`. In C, `base` is the starting address of a memory region. In Fortran, one can pass the first element of a memory region or a whole array, which must be ‘simply contiguous’ (for ‘simply contiguous,’ see Section 19.1.12). Multiple (but non-overlapping) memory regions may be attached to the same window.

*Rationale.* Requiring that memory be explicitly attached before it is exposed to one-sided access by other processes can simplify implementations and improve performance. The ability to make memory available for RMA operations without requiring a collective `MPI_WIN_CREATE` call is needed for some one-sided programming models. (*End of rationale.*)

*Advice to users.* Attaching memory to a window may require the use of scarce resources; thus, attaching large regions of memory is not recommended in portable programs. Attaching memory to a window may fail if sufficient resources are not available; this is similar to the behavior of `MPI_ALLOC_MEM`.

The user is also responsible for ensuring that `MPI_WIN_ATTACH` at the target has returned before a process attempts to target that memory with an MPI RMA call.

Performing an RMA operation to memory that has not been attached to a window created with `MPI_WIN_CREATE_DYNAMIC` is erroneous. (*End of advice to users.*)

*Advice to implementors.* A high-quality implementation will attempt to make as much memory available for attaching as possible. Any limitations should be documented by the implementor. (*End of advice to implementors.*)

Attaching memory is a local operation as defined by MPI, which means that the call is not collective and completes without requiring any MPI routine to be called in any other process. Memory may be detached with the routine `MPI_WIN_DETACH`. After memory has been detached, it may not be the target of an MPI RMA operation on that window (unless the memory is re-attached with `MPI_WIN_ATTACH`).

```

39 MPI_WIN_DETACH(win, base)

```

41	IN	win	window object (handle)
42	IN	base	initial address of memory to be detached (choice)

#### 44 C binding

```

45 int MPI_Win_detach(MPI_Win win, const void *base)

```

#### 47 Fortran 2008 binding

```

48 MPI_Win_detach(win, base, ierror)

```

```

TYPE(MPI_Win), INTENT(IN) :: win
TYPE(*), DIMENSION(..), ASYNCHRONOUS :: base
INTEGER, OPTIONAL, INTENT(OUT) :: ierror

```

**Fortran binding**

```

MPI_WIN_DETACH(WIN, BASE, IERROR)
  INTEGER WIN, IERROR
  <type> BASE(*)

```

Detaches a previously attached memory region beginning at `base`. The arguments `base` and `win` must match the arguments passed to a previous call to `MPI_WIN_ATTACH`.

*Advice to users.* Detaching memory may permit the implementation to make more efficient use of special memory or provide memory that may be needed by a subsequent `MPI_WIN_ATTACH`. Users are encouraged to detach memory that is no longer needed. Memory should be detached before it is freed by the user. (*End of advice to users.*)

Memory becomes detached when the associated dynamic memory window is freed, see Section [12.2.5](#).

## 12.2.5 Window Destruction

```

MPI_WIN_FREE(win)

```

```

  INOUT  win                window object (handle)

```

**C binding**

```

int MPI_Win_free(MPI_Win *win)

```

**Fortran 2008 binding**

```

MPI_Win_free(win, ierror)
  TYPE(MPI_Win), INTENT(INOUT) :: win
  INTEGER, OPTIONAL, INTENT(OUT) :: ierror

```

**Fortran binding**

```

MPI_WIN_FREE(WIN, IERROR)
  INTEGER WIN, IERROR

```

Frees the window object `win` and returns a null handle (equal to `MPI_WIN_NULL`). This is a collective call executed by all processes in the group associated with `win`.

`MPI_WIN_FREE(win)` can be invoked by a process only after it has completed its involvement in RMA communications on window `win`: e.g., the process has called `MPI_WIN_FENCE`, or called `MPI_WIN_WAIT` to match a previous call to `MPI_WIN_POST` or called `MPI_WIN_COMPLETE` to match a previous call to `MPI_WIN_START` or called `MPI_WIN_UNLOCK` to match a previous call to `MPI_WIN_LOCK`. The memory associated with windows created by a call to `MPI_WIN_CREATE` may be freed after the call returns. If the window was created with `MPI_WIN_ALLOCATE`, `MPI_WIN_FREE` will free the window memory that was allocated in `MPI_WIN_ALLOCATE`. If the window was created with `MPI_WIN_ALLOCATE_SHARED`, `MPI_WIN_FREE` will free the window memory that was allocated in `MPI_WIN_ALLOCATE_SHARED`.

Freeing a window that was created with a call to `MPI_WIN_CREATE_DYNAMIC` detaches all associated memory; i.e., it has the same effect as if all attached memory was detached by calls to `MPI_WIN_DETACH`.

*Advice to implementors.* `MPI_WIN_FREE` requires a barrier synchronization: no process can return from free until all processes in the group of win call free. This ensures that no process will attempt to access a remote window (e.g., with lock/unlock) after it was freed. The only exception to this rule is when the user sets the "no\_locks" info key to "true" when creating the window. In that case, an MPI implementation may free the local window without barrier synchronization. (*End of advice to implementors.*)

## 12.2.6 Window Attributes

The following attributes are cached with a window when the window is created.

<code>MPI_WIN_BASE</code>	window base address.
<code>MPI_WIN_SIZE</code>	window size, in bytes.
<code>MPI_WIN_DISP_UNIT</code>	displacement unit associated with the window.
<code>MPI_WIN_CREATE_FLAVOR</code>	how the window was created.
<code>MPI_WIN_MODEL</code>	memory model for window.

In C, calls to `MPI_Win_get_attr(win, MPI_WIN_BASE, &base, &flag)`, `MPI_Win_get_attr(win, MPI_WIN_SIZE, &size, &flag)`, `MPI_Win_get_attr(win, MPI_WIN_DISP_UNIT, &disp_unit, &flag)`, `MPI_Win_get_attr(win, MPI_WIN_CREATE_FLAVOR, &create_kind, &flag)`, and `MPI_Win_get_attr(win, MPI_WIN_MODEL, &memory_model, &flag)` will return in `base` a pointer to the start of the window `win`, and will return in `size`, `disp_unit`, `create_kind`, and `memory_model` pointers to the size, displacement unit of the window, the kind of routine used to create the window, and the memory model, respectively. A detailed listing of the type of the pointer in the attribute value argument to `MPI_WIN_GET_ATTR` and `MPI_WIN_SET_ATTR` is shown in Table 12.1.

Attribute	C Type
<code>MPI_WIN_BASE</code>	<code>void *</code>
<code>MPI_WIN_SIZE</code>	<code>MPI_Aint *</code>
<code>MPI_WIN_DISP_UNIT</code>	<code>int *</code>
<code>MPI_WIN_CREATE_FLAVOR</code>	<code>int *</code>
<code>MPI_WIN_MODEL</code>	<code>int *</code>

Table 12.1: C types of attribute value argument to `MPI_WIN_GET_ATTR` and `MPI_WIN_SET_ATTR`

In Fortran, calls to `MPI_WIN_GET_ATTR(win, MPI_WIN_BASE, base, flag, ierror)`, `MPI_WIN_GET_ATTR(win, MPI_WIN_SIZE, size, flag, ierror)`, `MPI_WIN_GET_ATTR(win, MPI_WIN_DISP_UNIT, disp_unit, flag, ierror)`, `MPI_WIN_GET_ATTR(win, MPI_WIN_CREATE_FLAVOR, create_kind, flag, ierror)`, and `MPI_WIN_GET_ATTR(win, MPI_WIN_MODEL, memory_model, flag, ierror)` will return in `base`, `size`, `disp_unit`, `create_kind`, and `memory_model` the (integer representation of) the

base address, the size, the displacement unit of the window `win`, the kind of routine used to create the window, and the memory model, respectively.

The values of `create_kind` are

<code>MPI_WIN_FLAVOR_CREATE</code>	Window was created with <code>MPI_WIN_CREATE</code> .
<code>MPI_WIN_FLAVOR_ALLOCATE</code>	Window was created with <code>MPI_WIN_ALLOCATE</code> .
<code>MPI_WIN_FLAVOR_DYNAMIC</code>	Window was created with <code>MPI_WIN_CREATE_DYNAMIC</code> .
<code>MPI_WIN_FLAVOR_SHARED</code>	Window was created with <code>MPI_WIN_ALLOCATE_SHARED</code> .

The values of `memory_model` are `MPI_WIN_SEPARATE` and `MPI_WIN_UNIFIED`. The meaning of these is described in Section 12.4.

In the case of windows created with `MPI_WIN_CREATE_DYNAMIC`, the base address is `MPI_BOTTOM` and the size is 0. In C, pointers are returned, and in Fortran, the values are returned, for the respective attributes. (The window attribute access functions are defined in Section 7.7.3.) The value returned for an attribute on a window is constant over the lifetime of the window.

The other “window attribute,” namely the group of processes attached to the window, can be retrieved using the call below.

`MPI_WIN_GET_GROUP(win, group)`

IN	<code>win</code>	window object (handle)
OUT	<code>group</code>	group of processes which share access to the window (handle)

### C binding

```
int MPI_Win_get_group(MPI_Win win, MPI_Group *group)
```

### Fortran 2008 binding

```
MPI_Win_get_group(win, group, ierror)
  TYPE(MPI_Win), INTENT(IN) :: win
  TYPE(MPI_Group), INTENT(OUT) :: group
  INTEGER, OPTIONAL, INTENT(OUT) :: ierror
```

### Fortran binding

```
MPI_WIN_GET_GROUP(WIN, GROUP, IERROR)
  INTEGER WIN, GROUP, IERROR
```

`MPI_WIN_GET_GROUP` returns a duplicate of the group of the communicator used to create the window associated with `win`. The group is returned in `group`.

## 12.2.7 Window Info

Hints specified via `info` (see Section 10) allow a user to provide information to direct optimization. Providing hints may enable an implementation to deliver increased performance or use system resources more efficiently. An implementation is free to ignore all hints; however, applications must comply with any `info` hints they provide that are used by the MPI implementation (i.e., are returned by a call to `MPI_WIN_GET_INFO`) and that place



a restriction on the behavior of the application. Hints are specified on a per window basis, in window creation functions and `MPI_WIN_SET_INFO`, via the opaque info object. When an info object that specifies a subset of valid hints is passed to `MPI_WIN_SET_INFO` there will be no effect on previously set or default hints that the info does not specify.

*Advice to implementors.* It may happen that a program is coded with hints for one system, and later executes on another system that does not support these hints. In general, unsupported hints should simply be ignored. Needless to say, no hint can be mandatory. However, for each hint used by a specific implementation, a default value must be provided when the user does not specify a value for the hint. (*End of advice to implementors.*)

`MPI_WIN_SET_INFO(win, info)`

INOUT	win	window object (handle)
IN	info	info argument (handle)

### C binding

```
int MPI_Win_set_info(MPI_Win win, MPI_Info info)
```

### Fortran 2008 binding

```
MPI_Win_set_info(win, info, ierror)
  TYPE(MPI_Win), INTENT(IN) :: win
  TYPE(MPI_Info), INTENT(IN) :: info
  INTEGER, OPTIONAL, INTENT(OUT) :: ierror
```

### Fortran binding

```
MPI_WIN_SET_INFO(WIN, INFO, IERROR)
  INTEGER WIN, INFO, IERROR
```

`MPI_WIN_SET_INFO` updates the hints of the window associated with `win` using the hints provided in `info`. This operation has no effect on previously set or defaulted hints that are not specified by `info`. It also has no effect on previously set or defaulted hints that are specified by `info`, but are ignored by the MPI implementation in this call to `MPI_WIN_SET_INFO`. The call is collective on the group of `win`. The info object may be different on each process, but any info entries that an implementation requires to be the same on all processes must appear with the same value in each process's info object.

*Advice to users.* Some info items that an implementation can use when it creates a window cannot easily be changed once the window has been created. Thus, an implementation may ignore hints issued in this call that it would have accepted in a creation call. An implementation may also be unable to update certain info hints in a call to `MPI_WIN_SET_INFO`. `MPI_WIN_GET_INFO` can be used to determine whether info changes were ignored by the implementation. (*End of advice to users.*)



```

MPI_WIN_GET_INFO(win, info_used)
    IN      win                window object (handle)
    OUT     info_used          new info object (handle)

```

**C binding**

```
int MPI_Win_get_info(MPI_Win win, MPI_Info *info_used)
```

**Fortran 2008 binding**

```

MPI_Win_get_info(win, info_used, ierror)
    TYPE(MPI_Win), INTENT(IN) :: win
    TYPE(MPI_Info), INTENT(OUT) :: info_used
    INTEGER, OPTIONAL, INTENT(OUT) :: ierror

```

**Fortran binding**

```

MPI_WIN_GET_INFO(WIN, INFO_USED, IERROR)
    INTEGER WIN, INFO_USED, IERROR

```

MPI\_WIN\_GET\_INFO returns a new info object containing the hints of the window associated with win. The current setting of all hints related to this window is returned in info\_used. An MPI implementation is required to return all hints that are supported by the implementation and have default values specified; any user-supplied hints that were not ignored by the implementation; and any additional hints that were set by the implementation. If no such hints exist, a handle to a newly created info object is returned that contains no key/value pair. The user is responsible for freeing info\_used via MPI\_INFO\_FREE.

## 12.3 Communication Calls

MPI supports the following RMA communication calls: MPI\_PUT and MPI\_RPUT transfer data from the caller memory (origin) to the target memory; MPI\_GET and MPI\_RGET transfer data from the target memory to the caller memory; MPI\_ACCUMULATE and MPI\_RACCUMULATE update locations in the target memory, e.g., by adding to these locations values sent from the caller memory; MPI\_GET\_ACCUMULATE, MPI\_RGET\_ACCUMULATE, and MPI\_FETCH\_AND\_OP perform atomic read-modify-write and return the data before the accumulate operation; and MPI\_COMPARE\_AND\_SWAP performs a remote atomic compare and swap operation. These operations are *nonblocking*: the call initiates the transfer, but the transfer may continue after the call returns. The transfer is completed, at the origin or both the origin and the target, when a subsequent *synchronization* call is issued by the caller on the involved window object. These synchronization calls are described in Section 12.5. Transfers can also be completed with calls to flush routines; see Section 12.5.4 for details. For the MPI\_RPUT, MPI\_RGET, MPI\_RACCUMULATE, and MPI\_RGET\_ACCUMULATE calls, the transfer can be locally completed by using the MPI test or wait operations described in Section 3.7.3.

The local communication buffer of an RMA call should not be updated, and the local communication buffer of a get call should not be accessed after the RMA call until the operation completes at the origin.

The resulting data values, or outcome, of concurrent conflicting accesses to the same memory locations is undefined; if a location is updated by a put or accumulate operation, then the outcome of loads or other RMA operations is undefined until the updating operation

has completed at the target. There is one exception to this rule; namely, the same location can be updated by several concurrent accumulate calls, the outcome being as if these updates occurred in some order. In addition, the outcome of concurrent load/store and RMA updates to the same memory location is undefined. These restrictions are described in more detail in Section 12.7.

The calls use general datatype arguments to specify communication buffers at the origin and at the target. Thus, a transfer operation may also gather data at the source and scatter it at the destination. However, all arguments specifying both communication buffers are provided by the caller.

For all RMA calls, the target process may be identical with the origin process; i.e., a process may use an RMA operation to move data in its memory.

*Rationale.* The choice of supporting “self-communication” is the same as for message-passing. It simplifies some coding, and is very useful with accumulate operations, to allow atomic updates of local variables. (*End of rationale.*)

MPI\_PROC\_NULL is a valid target rank in all MPI RMA communication calls. The effect is the same as for MPI\_PROC\_NULL in MPI point-to-point communication. After any RMA operation with rank MPI\_PROC\_NULL, it is still necessary to finish the RMA epoch with the synchronization method that started the epoch.

### 12.3.1 Put

The execution of a put operation is similar to the execution of a send by the origin process and a matching receive by the target process. The obvious difference is that all arguments are provided by one call—the call executed by the origin process.

```
MPI_PUT(origin_addr, origin_count, origin_datatype, target_rank, target_disp, target_count,
        target_datatype, win)
```

IN	origin_addr	initial address of origin buffer (choice)
IN	origin_count	number of entries in origin buffer (non-negative integer)
IN	origin_datatype	datatype of each entry in origin buffer (handle)
IN	target_rank	rank of target (non-negative integer)
IN	target_disp	displacement from start of window to target buffer (non-negative integer)
IN	target_count	number of entries in target buffer (non-negative integer)
IN	target_datatype	datatype of each entry in target buffer (handle)
IN	win	window object used for communication (handle)

#### C binding

```
int MPI_Put(const void *origin_addr, int origin_count,
           MPI_Datatype origin_datatype, int target_rank,
```

```

        MPI_Aint target_disp, int target_count,
        MPI_Datatype target_datatype, MPI_Win win)
int MPI_Put_c(const void *origin_addr, MPI_Count origin_count,
        MPI_Datatype origin_datatype, int target_rank,
        MPI_Aint target_disp, MPI_Count target_count,
        MPI_Datatype target_datatype, MPI_Win win)

```

**Fortran 2008 binding**

```

MPI_Put(origin_addr, origin_count, origin_datatype, target_rank,
        target_disp, target_count, target_datatype, win, ierror)
TYPE(*), DIMENSION(..), INTENT(IN), ASYNCHRONOUS :: origin_addr
INTEGER, INTENT(IN) :: origin_count, target_rank, target_count
TYPE(MPI_Datatype), INTENT(IN) :: origin_datatype, target_datatype
INTEGER(KIND=MPI_ADDRESS_KIND), INTENT(IN) :: target_disp
TYPE(MPI_Win), INTENT(IN) :: win
INTEGER, OPTIONAL, INTENT(OUT) :: ierror
MPI_Put(origin_addr, origin_count, origin_datatype, target_rank,
        target_disp, target_count, target_datatype, win, ierror)
TYPE(*), DIMENSION(..), INTENT(IN), ASYNCHRONOUS :: origin_addr
INTEGER(KIND=MPI_COUNT_KIND), INTENT(IN) :: origin_count, target_count
TYPE(MPI_Datatype), INTENT(IN) :: origin_datatype, target_datatype
INTEGER, INTENT(IN) :: target_rank
INTEGER(KIND=MPI_ADDRESS_KIND), INTENT(IN) :: target_disp
TYPE(MPI_Win), INTENT(IN) :: win
INTEGER, OPTIONAL, INTENT(OUT) :: ierror

```

**Fortran binding**

```

MPI_PUT(ORIGIN_ADDR, ORIGIN_COUNT, ORIGIN_DATATYPE, TARGET_RANK,
        TARGET_DISP, TARGET_COUNT, TARGET_DATATYPE, WIN, IERROR)
<type> ORIGIN_ADDR(*)
INTEGER ORIGIN_COUNT, ORIGIN_DATATYPE, TARGET_RANK, TARGET_COUNT,
        TARGET_DATATYPE, WIN, IERROR
INTEGER(KIND=MPI_ADDRESS_KIND) TARGET_DISP

```

Transfers `origin_count` successive entries of the type specified by the `origin_datatype`, starting at address `origin_addr` on the origin node, to the target node specified by the `win`, `target_rank` pair. The data are written in the target buffer at address `target_addr = window_base + target_disp × disp_unit`, where `window_base` and `disp_unit` are the base address and window displacement unit specified at window initialization, by the target process.

The target buffer is specified by the arguments `target_count` and `target_datatype`.

The data transfer is the same as that which would occur if the origin process executed a send operation with arguments `origin_addr`, `origin_count`, `origin_datatype`, `target_rank`, `tag`, `comm`, and the target process executed a receive operation with arguments `target_addr`, `target_count`, `target_datatype`, `source`, `tag`, `comm`, where `target_addr` is the target buffer address computed as explained above, the values of `tag` are arbitrary valid matching tag values, and `comm` is a communicator for the group of `win`.

The communication must satisfy the same constraints as for a similar message-passing communication. The `target_datatype` may not specify overlapping entries in the target

1 buffer. The message sent must fit, without truncation, in the target buffer. Furthermore,  
2 the target buffer must fit in the target window or in attached memory in a dynamic window.

3 The `target_datatype` argument is a handle to a datatype object defined at the origin  
4 process. However, this object is interpreted at the target process: the outcome is as if  
5 the target datatype object was defined at the target process by the same sequence of calls  
6 used to define it at the origin process. The target datatype must contain only relative  
7 displacements, not absolute addresses. The same holds for get and accumulate operations.  
8

9 *Advice to users.* The `target_datatype` argument is a handle to a datatype object that  
10 is defined at the origin process, even though it defines a data layout in the target  
11 process memory. This causes no problems in a homogeneous environment, or in a  
12 heterogeneous environment if only portable datatypes are used (portable datatypes  
13 are defined in Section 2.4).

14 The performance of a put transfer can be significantly affected, on some systems, by  
15 the choice of window location and the shape and location of the origin and target  
16 buffer: transfers to a target window in memory allocated by `MPI_ALLOC_MEM` or  
17 `MPI_WIN_ALLOCATE` may be much faster on shared memory systems; transfers from  
18 contiguous buffers will be faster on most, if not all, systems; the alignment of the  
19 communication buffers may also impact performance. (*End of advice to users.*)  
20

21 *Advice to implementors.* A high-quality implementation will attempt to prevent  
22 remote accesses to memory outside the window that was exposed by the process.  
23 This is important both for debugging purposes and for protection with client-server  
24 codes that use RMA. That is, a high-quality implementation will check, if possible,  
25 window bounds on each RMA call, and raise an error at the origin call if an out-of-  
26 bound situation occurs. Note that the condition can be checked at the origin. Of  
27 course, the added safety achieved by such checks has to be weighed against the added  
28 cost of such checks. (*End of advice to implementors.*)  
29  
30  
31  
32  
33  
34  
35  
36  
37  
38  
39  
40  
41  
42  
43  
44  
45  
46  
47  
48

## 12.3.2 Get

MPI\_GET(origin\_addr, origin\_count, origin\_datatype, target\_rank, target\_disp, target\_count, target\_datatype, win)

OUT	origin_addr	initial address of origin buffer (choice)
IN	origin_count	number of entries in origin buffer (non-negative integer)
IN	origin_datatype	datatype of each entry in origin buffer (handle)
IN	target_rank	rank of target (non-negative integer)
IN	target_disp	displacement from window start to the beginning of the target buffer (non-negative integer)
IN	target_count	number of entries in target buffer (non-negative integer)
IN	target_datatype	datatype of each entry in target buffer (handle)
IN	win	window object used for communication (handle)

**C binding**

```
int MPI_Get(void *origin_addr, int origin_count,
            MPI_Datatype origin_datatype, int target_rank,
            MPI_Aint target_disp, int target_count,
            MPI_Datatype target_datatype, MPI_Win win)
```

```
int MPI_Get_c(void *origin_addr, MPI_Count origin_count,
              MPI_Datatype origin_datatype, int target_rank,
              MPI_Aint target_disp, MPI_Count target_count,
              MPI_Datatype target_datatype, MPI_Win win)
```

**Fortran 2008 binding**

```
MPI_Get(origin_addr, origin_count, origin_datatype, target_rank,
        target_disp, target_count, target_datatype, win, ierror)
TYPE(*), DIMENSION(..), ASYNCHRONOUS :: origin_addr
INTEGER, INTENT(IN) :: origin_count, target_rank, target_count
TYPE(MPI_Datatype), INTENT(IN) :: origin_datatype, target_datatype
INTEGER(KIND=MPI_ADDRESS_KIND), INTENT(IN) :: target_disp
TYPE(MPI_Win), INTENT(IN) :: win
INTEGER, OPTIONAL, INTENT(OUT) :: ierror
```

```
MPI_Get(origin_addr, origin_count, origin_datatype, target_rank,
        target_disp, target_count, target_datatype, win, ierror)
TYPE(*), DIMENSION(..), ASYNCHRONOUS :: origin_addr
INTEGER(KIND=MPI_COUNT_KIND), INTENT(IN) :: origin_count, target_count
TYPE(MPI_Datatype), INTENT(IN) :: origin_datatype, target_datatype
INTEGER, INTENT(IN) :: target_rank
INTEGER(KIND=MPI_ADDRESS_KIND), INTENT(IN) :: target_disp
TYPE(MPI_Win), INTENT(IN) :: win
```

```
1     INTEGER, OPTIONAL, INTENT(OUT) :: ierror
```

### 2 Fortran binding

```
3 MPI_GET(ORIGIN_ADDR, ORIGIN_COUNT, ORIGIN_DATATYPE, TARGET_RANK,
4         TARGET_DISP, TARGET_COUNT, TARGET_DATATYPE, WIN, IERROR)
5     <type> ORIGIN_ADDR(*)
6     INTEGER ORIGIN_COUNT, ORIGIN_DATATYPE, TARGET_RANK, TARGET_COUNT,
7         TARGET_DATATYPE, WIN, IERROR
8     INTEGER(KIND=MPI_ADDRESS_KIND) TARGET_DISP
9
```

10 Similar to MPI\_PUT, except that the direction of data transfer is reversed. Data  
11 are copied from the target memory to the origin. The `origin_datatype` may not specify  
12 overlapping entries in the origin buffer. The target buffer must be contained within the  
13 target window or within attached memory in a dynamic window, and the copied data must  
14 fit, without truncation, in the origin buffer.

### 16 12.3.3 Examples for Communication Calls

17 These examples show the use of the MPI\_GET function. As all MPI RMA communication  
18 functions are nonblocking, they must be completed. In the following, this is accomplished  
19 with the routine MPI\_WIN\_FENCE, introduced in Section 12.5.

21 **Example 12.1** We show how to implement the generic indirect assignment  $A = B(\text{map})$ ,  
22 where  $A$ ,  $B$ , and  $\text{map}$  have the same distribution, and  $\text{map}$  is a permutation. To simplify, we  
23 assume a block distribution with equal size blocks.

```
24
25 SUBROUTINE MAPVALS(A, B, map, m, comm, p)
26 USE MPI
27 INTEGER m, map(m), comm, p
28 REAL A(m), B(m)
29
30 INTEGER otype(p), oindex(m), & ! used to construct origin datatypes
31     ttype(p), tindex(m), & ! used to construct target datatypes
32     count(p), total(p), &
33     disp_int, win, ierr
34 INTEGER (KIND=MPI_ADDRESS_KIND) lowerbound, size, realextent, disp_aint
35
36 ! This part does the work that depends on the locations of B.
37 ! Can be reused while this does not change
38
39 CALL MPI_TYPE_GET_EXTENT(MPI_REAL, lowerbound, realextent, ierr)
40 disp_int = realextent
41 size = m * realextent
42 CALL MPI_WIN_CREATE(B, size, disp_int, MPI_INFO_NULL, &
43     comm, win, ierr)
44
45 ! This part does the work that depends on the value of map and
46 ! the locations of the arrays.
47 ! Can be reused while these do not change
48
```

```

! Compute number of entries to be received from each process
DO i=1,p
  count(i) = 0
END DO
DO i=1,m
  j = map(i)/m+1
  count(j) = count(j)+1
END DO

total(1) = 0
DO i=2,p
  total(i) = total(i-1) + count(i-1)
END DO

DO i=1,p
  count(i) = 0
END DO

! compute origin and target indices of entries.
! entry i at current process is received from location
! k at process (j-1), where map(i) = (j-1)*m + (k-1),
! j = 1..p and k = 1..m

DO i=1,m
  j = map(i)/m+1
  k = MOD(map(i),m)+1
  count(j) = count(j)+1
  oindex(total(j) + count(j)) = i
  tindex(total(j) + count(j)) = k
END DO

! create origin and target datatypes for each get operation
DO i=1,p
  CALL MPI_TYPE_CREATE_INDEXED_BLOCK(count(i), 1, &
                                     oindex(total(i)+1:total(i)+count(i)), &
                                     MPI_REAL, otype(i), ierr)
  CALL MPI_TYPE_COMMIT(otype(i), ierr)
  CALL MPI_TYPE_CREATE_INDEXED_BLOCK(count(i), 1, &
                                     tindex(total(i)+1:total(i)+count(i)), &
                                     MPI_REAL, ttype(i), ierr)
  CALL MPI_TYPE_COMMIT(ttype(i), ierr)
END DO

! this part does the assignment itself
CALL MPI_WIN_FENCE(0, win, ierr)
disp_aint = 0

```

```

1 DO i=1,p
2   CALL MPI_GET(A, 1, otype(i), i-1, disp_aint, 1, ttype(i), win, ierr)
3 END DO
4 CALL MPI_WIN_FENCE(0, win, ierr)
5
6 CALL MPI_WIN_FREE(win, ierr)
7 DO i=1,p
8   CALL MPI_TYPE_FREE(otype(i), ierr)
9   CALL MPI_TYPE_FREE(ttype(i), ierr)
10 END DO
11 RETURN
12 END

```

**Example 12.2** A simpler version can be written that does not require that a datatype be built for the target buffer. But, one then needs a separate get call for each entry, as illustrated below. This code is much simpler, but usually much less efficient, for large arrays.

```

18 SUBROUTINE MAPVALS(A, B, map, m, comm, p)
19 USE MPI
20 INTEGER m, map(m), comm, p
21 REAL A(m), B(m)
22 INTEGER disp_int, win, ierr
23 INTEGER (KIND=MPI_ADDRESS_KIND) lowerbound, size, realextent, disp_aint
24
25 CALL MPI_TYPE_GET_EXTENT(MPI_REAL, lowerbound, realextent, ierr)
26 disp_int = realextent
27 size = m * realextent
28 CALL MPI_WIN_CREATE(B, size, disp_int, MPI_INFO_NULL, &
29   comm, win, ierr)
30
31 CALL MPI_WIN_FENCE(0, win, ierr)
32 DO i=1,m
33   j = map(i)/m
34   disp_aint = MOD(map(i),m)
35   CALL MPI_GET(A(i), 1, MPI_REAL, j, disp_aint, 1, MPI_REAL, win, ierr)
36 END DO
37 CALL MPI_WIN_FENCE(0, win, ierr)
38 CALL MPI_WIN_FREE(win, ierr)
39 RETURN
40 END

```

#### 12.3.4 Accumulate Functions

It is often useful in a put operation to combine the data moved to the target process with the data that resides at that process, rather than replacing it. This will allow, for example, the accumulation of a sum by having all involved processes add their contributions to the sum variable in the memory of one process. The accumulate functions have slightly different



semantics with respect to overlapping data accesses than the put and get functions; see Section 12.7 for details.

### Accumulate Function

MPI\_ACCUMULATE(origin\_addr, origin\_count, origin\_datatype, target\_rank, target\_disp, target\_count, target\_datatype, op, win)

IN	origin_addr	initial address of buffer (choice)
IN	origin_count	number of entries in buffer (non-negative integer)
IN	origin_datatype	datatype of each entry (handle)
IN	target_rank	rank of target (non-negative integer)
IN	target_disp	displacement from start of window to beginning of target buffer (non-negative integer)
IN	target_count	number of entries in target buffer (non-negative integer)
IN	target_datatype	datatype of each entry in target buffer (handle)
IN	op	reduce operation (handle)
IN	win	window object (handle)

### C binding

```
int MPI_Accumulate(const void *origin_addr, int origin_count,
                  MPI_Datatype origin_datatype, int target_rank,
                  MPI_Aint target_disp, int target_count,
                  MPI_Datatype target_datatype, MPI_Op op, MPI_Win win)
```

```
int MPI_Accumulate_c(const void *origin_addr, MPI_Count origin_count,
                    MPI_Datatype origin_datatype, int target_rank,
                    MPI_Aint target_disp, MPI_Count target_count,
                    MPI_Datatype target_datatype, MPI_Op op, MPI_Win win)
```

### Fortran 2008 binding

```
MPI_Accumulate(origin_addr, origin_count, origin_datatype, target_rank,
               target_disp, target_count, target_datatype, op, win, ierror)
  TYPE(*), DIMENSION(..), INTENT(IN), ASYNCHRONOUS :: origin_addr
  INTEGER, INTENT(IN) :: origin_count, target_rank, target_count
  TYPE(MPI_Datatype), INTENT(IN) :: origin_datatype, target_datatype
  INTEGER(KIND=MPI_ADDRESS_KIND), INTENT(IN) :: target_disp
  TYPE(MPI_Op), INTENT(IN) :: op
  TYPE(MPI_Win), INTENT(IN) :: win
  INTEGER, OPTIONAL, INTENT(OUT) :: ierror
```

```
MPI_Accumulate(origin_addr, origin_count, origin_datatype, target_rank,
               target_disp, target_count, target_datatype, op, win, ierror)
  TYPE(*), DIMENSION(..), INTENT(IN), ASYNCHRONOUS :: origin_addr
  INTEGER(KIND=MPI_COUNT_KIND), INTENT(IN) :: origin_count, target_count
```

```

1  TYPE(MPI_Datatype), INTENT(IN) :: origin_datatype, target_datatype
2  INTEGER, INTENT(IN) :: target_rank
3  INTEGER(KIND=MPI_ADDRESS_KIND), INTENT(IN) :: target_disp
4  TYPE(MPI_Op), INTENT(IN) :: op
5  TYPE(MPI_Win), INTENT(IN) :: win
6  INTEGER, OPTIONAL, INTENT(OUT) :: ierror

```

### Fortran binding

```

8  MPI_ACCUMULATE(ORIGIN_ADDR, ORIGIN_COUNT, ORIGIN_DATATYPE, TARGET_RANK,
9  TARGET_DISP, TARGET_COUNT, TARGET_DATATYPE, OP, WIN, IERROR)
10 <type> ORIGIN_ADDR(*)
11 INTEGER ORIGIN_COUNT, ORIGIN_DATATYPE, TARGET_RANK, TARGET_COUNT,
12 TARGET_DATATYPE, OP, WIN, IERROR
13 INTEGER(KIND=MPI_ADDRESS_KIND) TARGET_DISP

```

Accumulate the contents of the origin buffer (as defined by `origin_addr`, `origin_count`, and `origin_datatype`) to the buffer specified by arguments `target_count` and `target_datatype`, at offset `target_disp`, in the target window specified by `target_rank` and `win`, using the operation `op`. This is like `MPI_PUT` except that data is combined into the target area instead of overwriting it.

Any of the predefined operations for `MPI_REDUCE` can be used. User-defined functions cannot be used. For example, if `op` is `MPI_SUM`, each element of the origin buffer is added to the corresponding element in the target, replacing the former value in the target.

Each datatype argument must be a predefined datatype or a derived datatype, where all basic components are of the same predefined datatype. Both datatype arguments must be constructed from the same predefined datatype. The operation `op` applies to elements of that predefined type. The parameter `target_datatype` must not specify overlapping entries, and the target buffer must fit in the target window.

A new predefined operation, `MPI_REPLACE`, is defined. It corresponds to the associative function  $f(a, b) = b$ ; i.e., the current value in the target memory is replaced by the value supplied by the origin.

`MPI_REPLACE` can be used only in `MPI_ACCUMULATE`, `MPI_RACCUMULATE`, `MPI_GET_ACCUMULATE`, `MPI_FETCH_AND_OP`, and `MPI_RGET_ACCUMULATE`, but not in collective reduction operations such as `MPI_REDUCE`.

*Advice to users.* `MPI_PUT` is a special case of `MPI_ACCUMULATE`, with the operation `MPI_REPLACE`. Note, however, that `MPI_PUT` and `MPI_ACCUMULATE` have different constraints on concurrent updates. (*End of advice to users.*)

**Example 12.3** We want to compute  $B(j) = \sum_{\text{map}(i)=j} A(i)$ . The arrays `A`, `B`, and `map` are distributed in the same manner. We write the simple version.

```

42 SUBROUTINE SUM(A, B, map, m, comm, p)
43 USE MPI
44 INTEGER m, map(m), comm, p, win, ierr, disp_int
45 REAL A(m), B(m)
46 INTEGER (KIND=MPI_ADDRESS_KIND) lowerbound, size, realextent, disp_aint

```

48

```
CALL MPI_TYPE_GET_EXTENT(MPI_REAL, lowerbound, realextent, ierr) 1
size = m * realextent 2
disp_int = realextent 3
CALL MPI_WIN_CREATE(B, size, disp_int, MPI_INFO_NULL, & 4
                    comm, win, ierr) 5
6
CALL MPI_WIN_FENCE(0, win, ierr) 7
DO i=1,m 8
  j = map(i)/m 9
  disp_aint = MOD(map(i),m) 10
  CALL MPI_ACCUMULATE(A(i), 1, MPI_REAL, j, disp_aint, 1, MPI_REAL, & 11
                    MPI_SUM, win, ierr) 12
END DO 13
CALL MPI_WIN_FENCE(0, win, ierr) 14
15
CALL MPI_WIN_FREE(win, ierr) 16
RETURN 17
END 18
19
```

This code is identical to the code in Example 12.2, except that a call to get has been replaced by a call to accumulate. (Note that, if `map` is one-to-one, the code computes  $B = A(\text{map}^{-1})$ , which is the reverse assignment to the one computed in that previous example.) In a similar manner, we can replace in Example 12.1, the call to get by a call to accumulate, thus performing the computation with only one communication between any two processes.

### Get Accumulate Function

It is often useful to have fetch-and-accumulate semantics such that the remote data is returned to the caller before the sent data is accumulated into the remote data. The get and accumulate steps are executed atomically for each basic element in the datatype (see Section 12.7 for details). The predefined operation `MPI_REPLACE` provides fetch-and-set behavior.

```

1 MPI_GET_ACCUMULATE(origin_addr, origin_count, origin_datatype, result_addr,
2     result_count, result_datatype, target_rank, target_disp, target_count,
3     target_datatype, op, win)
4
5     IN     origin_addr     initial address of buffer (choice)
6     IN     origin_count    number of entries in origin buffer (non-negative
7                             integer)
8     IN     origin_datatype datatype of each entry in origin buffer (handle)
9     OUT    result_addr     initial address of result buffer (choice)
10    IN     result_count    number of entries in result buffer (non-negative
11                             integer)
12
13    IN     result_datatype  datatype of each entry in result buffer (handle)
14    IN     target_rank      rank of target (non-negative integer)
15    IN     target_disp      displacement from start of window to beginning of
16                             target buffer (non-negative integer)
17
18    IN     target_count     number of entries in target buffer (non-negative
19                             integer)
20    IN     target_datatype  datatype of each entry in target buffer (handle)
21    IN     op               reduce operation (handle)
22    IN     win              window object (handle)
23
24

```

**C binding**

```

25
26 int MPI_Get_accumulate(const void *origin_addr, int origin_count,
27     MPI_Datatype origin_datatype, void *result_addr,
28     int result_count, MPI_Datatype result_datatype,
29     int target_rank, MPI_Aint target_disp, int target_count,
30     MPI_Datatype target_datatype, MPI_Op op, MPI_Win win)
31
32 int MPI_Get_accumulate_c(const void *origin_addr, MPI_Count origin_count,
33     MPI_Datatype origin_datatype, void *result_addr,
34     MPI_Count result_count, MPI_Datatype result_datatype,
35     int target_rank, MPI_Aint target_disp, MPI_Count target_count,
36     MPI_Datatype target_datatype, MPI_Op op, MPI_Win win)
37

```

**Fortran 2008 binding**

```

38 MPI_Get_accumulate(origin_addr, origin_count, origin_datatype, result_addr,
39     result_count, result_datatype, target_rank, target_disp,
40     target_count, target_datatype, op, win, ierror)
41     TYPE(*), DIMENSION(..), INTENT(IN), ASYNCHRONOUS :: origin_addr
42     INTEGER, INTENT(IN) :: origin_count, result_count, target_rank,
43         target_count
44     TYPE(MPI_Datatype), INTENT(IN) :: origin_datatype, result_datatype,
45         target_datatype
46     TYPE(*), DIMENSION(..), ASYNCHRONOUS :: result_addr
47     INTEGER(KIND=MPI_ADDRESS_KIND), INTENT(IN) :: target_disp
48     TYPE(MPI_Op), INTENT(IN) :: op

```

```

TYPE(MPI_Win), INTENT(IN) :: win
INTEGER, OPTIONAL, INTENT(OUT) :: ierror
MPI_Get_accumulate(origin_addr, origin_count, origin_datatype, result_addr,
    result_count, result_datatype, target_rank, target_disp,
    target_count, target_datatype, op, win, ierror)
TYPE(*), DIMENSION(..), INTENT(IN), ASYNCHRONOUS :: origin_addr
INTEGER(KIND=MPI_COUNT_KIND), INTENT(IN) :: origin_count, result_count,
    target_count
TYPE(MPI_Datatype), INTENT(IN) :: origin_datatype, result_datatype,
    target_datatype
TYPE(*), DIMENSION(..), ASYNCHRONOUS :: result_addr
INTEGER, INTENT(IN) :: target_rank
INTEGER(KIND=MPI_ADDRESS_KIND), INTENT(IN) :: target_disp
TYPE(MPI_Op), INTENT(IN) :: op
TYPE(MPI_Win), INTENT(IN) :: win
INTEGER, OPTIONAL, INTENT(OUT) :: ierror

```

### Fortran binding

```

MPI_GET_ACCUMULATE(ORIGIN_ADDR, ORIGIN_COUNT, ORIGIN_DATATYPE, RESULT_ADDR,
    RESULT_COUNT, RESULT_DATATYPE, TARGET_RANK, TARGET_DISP,
    TARGET_COUNT, TARGET_DATATYPE, OP, WIN, IERROR)
<type> ORIGIN_ADDR(*), RESULT_ADDR(*)
INTEGER ORIGIN_COUNT, ORIGIN_DATATYPE, RESULT_COUNT, RESULT_DATATYPE,
    TARGET_RANK, TARGET_COUNT, TARGET_DATATYPE, OP, WIN, IERROR
INTEGER(KIND=MPI_ADDRESS_KIND) TARGET_DISP

```

Accumulate `origin_count` elements of type `origin_datatype` from the origin buffer (`origin_addr`) to the buffer at offset `target_disp`, in the target window specified by `target_rank` and `win`, using the operation `op` and return in the result buffer `result_addr` the content of the target buffer before the accumulation, specified by `target_disp`, `target_count`, and `target_datatype`. The data transferred from origin to target must fit, without truncation, in the target buffer. Likewise, the data copied from target to origin must fit, without truncation, in the result buffer.

The origin and result buffers (`origin_addr` and `result_addr`) must be disjoint. Each datatype argument must be a predefined datatype or a derived datatype where all basic components are of the same predefined datatype. All datatype arguments must be constructed from the same predefined datatype. The operation `op` applies to elements of that predefined type. `target_datatype` must not specify overlapping entries, and the target buffer must fit in the target window or in attached memory in a dynamic window. The operation is executed atomically for each basic datatype; see Section 12.7 for details.

Any of the predefined operations for `MPI_REDUCE`, as well as `MPI_NO_OP` or `MPI_REPLACE` can be specified as `op`. User-defined functions cannot be used. A new predefined operation, `MPI_NO_OP`, is defined. It corresponds to the associative function  $f(a, b) = a$ ; i.e., the current value in the target memory is returned in the result buffer at the origin and no operation is performed on the target buffer. When `MPI_NO_OP` is specified as the operation, the `origin_addr`, `origin_count`, and `origin_datatype` arguments are ignored. `MPI_NO_OP` can be used only in `MPI_GET_ACCUMULATE`, `MPI_RGET_ACCUMULATE`,

1 and MPI\_FETCH\_AND\_OP. MPI\_NO\_OP cannot be used in MPI\_ACCUMULATE,  
 2 MPI\_RACCUMULATE, or collective reduction operations, such as MPI\_REDUCE and others.

3  
 4 *Advice to users.* MPI\_GET is similar to MPI\_GET\_ACCUMULATE, with the opera-  
 5 tion MPI\_NO\_OP. Note, however, that MPI\_GET and MPI\_GET\_ACCUMULATE have  
 6 different constraints on concurrent updates. (*End of advice to users.*)

### 8 Fetch and Op Function

9 The generic functionality of MPI\_GET\_ACCUMULATE might limit the performance of fetch-  
 10 and-increment or fetch-and-add calls that might be supported by special hardware opera-  
 11 tions. MPI\_FETCH\_AND\_OP thus allows for a fast implementation of a commonly used  
 12 subset of the functionality of MPI\_GET\_ACCUMULATE.  
 13

15 MPI\_FETCH\_AND\_OP(origin\_addr, result\_addr, datatype, target\_rank, target\_disp, op, win)

17	IN	origin_addr	initial address of buffer (choice)
18	OUT	result_addr	initial address of result buffer (choice)
19			
20	IN	datatype	datatype of the entry in origin, result, and target
21			buffers (handle)
22			
23	IN	target_rank	rank of target (non-negative integer)
24	IN	target_disp	displacement from start of window to beginning of
25			target buffer (non-negative integer)
26	IN	op	reduce operation (handle)
27			
28	IN	win	window object (handle)

### 30 C binding

```
31 int MPI_Fetch_and_op(const void *origin_addr, void *result_addr,
32     MPI_Datatype datatype, int target_rank, MPI_Aint target_disp,
33     MPI_Op op, MPI_Win win)
```

### 34 Fortran 2008 binding

```
35 MPI_Fetch_and_op(origin_addr, result_addr, datatype, target_rank,
36     target_disp, op, win, ierror)
37     TYPE(*), DIMENSION(..), INTENT(IN), ASYNCHRONOUS :: origin_addr
38     TYPE(*), DIMENSION(..), ASYNCHRONOUS :: result_addr
39     TYPE(MPI_Datatype), INTENT(IN) :: datatype
40     INTEGER, INTENT(IN) :: target_rank
41     INTEGER(KIND=MPI_ADDRESS_KIND), INTENT(IN) :: target_disp
42     TYPE(MPI_Op), INTENT(IN) :: op
43     TYPE(MPI_Win), INTENT(IN) :: win
44     INTEGER, OPTIONAL, INTENT(OUT) :: ierror
```

### 46 Fortran binding

```
47 MPI_FETCH_AND_OP(ORIGIN_ADDR, RESULT_ADDR, DATATYPE, TARGET_RANK,
48     TARGET_DISP, OP, WIN, IERROR)
```

```

<type> ORIGIN_ADDR(*), RESULT_ADDR(*)
INTEGER DATATYPE, TARGET_RANK, OP, WIN, IERROR
INTEGER(KIND=MPI_ADDRESS_KIND) TARGET_DISP

```

Accumulate one element of type `datatype` from the origin buffer (`origin_addr`) to the buffer at offset `target_disp`, in the target window specified by `target_rank` and `win`, using the operation `op` and return in the result buffer `result_addr` the content of the target buffer before the accumulation.

The origin and result buffers (`origin_addr` and `result_addr`) must be disjoint. Any of the predefined operations for `MPI_REDUCE`, as well as `MPI_NO_OP` or `MPI_REPLACE`, can be specified as `op`; user-defined functions cannot be used. The `datatype` argument must be a predefined datatype. The operation is executed atomically.

### Compare and Swap Function

Another useful operation is an atomic compare and swap where the value at the origin is compared to the value at the target, which is atomically replaced by a third value only if the values at origin and target are equal.

```

MPI_COMPARE_AND_SWAP(origin_addr, compare_addr, result_addr, datatype,
                    target_rank, target_disp, win)

```

IN	<code>origin_addr</code>	initial address of buffer (choice)
IN	<code>compare_addr</code>	initial address of compare buffer (choice)
OUT	<code>result_addr</code>	initial address of result buffer (choice)
IN	<code>datatype</code>	datatype of the element in all buffers (handle)
IN	<code>target_rank</code>	rank of target (non-negative integer)
IN	<code>target_disp</code>	displacement from start of window to beginning of target buffer (non-negative integer)
IN	<code>win</code>	window object (handle)

### C binding

```

int MPI_Compare_and_swap(const void *origin_addr, const void *compare_addr,
                        void *result_addr, MPI_Datatype datatype, int target_rank,
                        MPI_Aint target_disp, MPI_Win win)

```

### Fortran 2008 binding

```

MPI_Compare_and_swap(origin_addr, compare_addr, result_addr, datatype,
                    target_rank, target_disp, win, ierror)
TYPE(*), DIMENSION(..), INTENT(IN), ASYNCHRONOUS :: origin_addr,
                    compare_addr
TYPE(*), DIMENSION(..), ASYNCHRONOUS :: result_addr
TYPE(MPI_Datatype), INTENT(IN) :: datatype
INTEGER, INTENT(IN) :: target_rank
INTEGER(KIND=MPI_ADDRESS_KIND), INTENT(IN) :: target_disp
TYPE(MPI_Win), INTENT(IN) :: win
INTEGER, OPTIONAL, INTENT(OUT) :: ierror

```

### 1 Fortran binding

```

2 MPI_COMPARE_AND_SWAP(ORIGIN_ADDR, COMPARE_ADDR, RESULT_ADDR, DATATYPE,
3     TARGET_RANK, TARGET_DISP, WIN, IERROR)
4     <type> ORIGIN_ADDR(*), COMPARE_ADDR(*), RESULT_ADDR(*)
5     INTEGER DATATYPE, TARGET_RANK, WIN, IERROR
6     INTEGER(KIND=MPI_ADDRESS_KIND) TARGET_DISP

```

7 This function compares one element of type `datatype` in the compare buffer  
8 `compare_addr` with the buffer at offset `target_disp` in the target window specified by  
9 `target_rank` and `win` and replaces the value at the target with the value in the origin buffer  
10 `origin_addr` if the compare buffer and the target buffer are identical. The original value at  
11 the target is returned in the buffer `result_addr`. The parameter `datatype` must belong to  
12 one of the following categories of predefined datatypes: C integer, Fortran integer, Logical,  
13 Multi-language types, or Byte as specified in Section 6.9.2. The origin and result buffers  
14 (`origin_addr` and `result_addr`) must be disjoint.

### 16 12.3.5 Request-based RMA Communication Operations

17 Request-based RMA communication operations allow the user to associate a request handle  
18 with the RMA operations and test or wait for the completion of these requests using the  
19 functions described in Section 3.7.3. Request-based RMA operations are only valid within  
20 a passive target epoch (see Section 12.5).

21 Upon returning from a completion call in which an RMA operation completes, all fields  
22 of the status object, if any, and the results of status query functions (e.g.,  
23 `MPI_GET_COUNT`) are undefined with the exception of `MPI_ERROR` if appropriate (see  
24 Section 3.2.5). It is valid to mix different request types (e.g., any combination of RMA  
25 requests, collective requests, I/O requests, generalized requests, or point-to-point requests)  
26 in functions that enable multiple completions (e.g., `MPI_WAITALL`). It is erroneous to call  
27 `MPI_REQUEST_FREE` or `MPI_CANCEL` for a request associated with an RMA operation.  
28 RMA requests are not persistent.

29 The end of the epoch, or explicit bulk synchronization using  
30 `MPI_WIN_FLUSH`, `MPI_WIN_FLUSH_ALL`, `MPI_WIN_FLUSH_LOCAL`, or  
31 `MPI_WIN_FLUSH_LOCAL_ALL`, also indicates completion of the RMA operations. How-  
32 ever, users must still wait or test on the request handle to allow the MPI implementation to  
33 clean up any resources associated with these requests; in such cases the wait operation will  
34 complete locally.



MPI_RPUT(origin_addr, origin_count, origin_datatype, target_rank, target_disp,		1	
target_count, target_datatype, win, request)		2	
IN	origin_addr	initial address of origin buffer (choice)	3
IN	origin_count	number of entries in origin buffer (non-negative integer)	4
IN	origin_datatype	datatype of each entry in origin buffer (handle)	5
IN	target_rank	rank of target (non-negative integer)	6
IN	target_disp	displacement from start of window to target buffer (non-negative integer)	7
IN	target_count	number of entries in target buffer (non-negative integer)	8
IN	target_datatype	datatype of each entry in target buffer (handle)	9
IN	win	window object used for communication (handle)	10
OUT	request	RMA request (handle)	11

**C binding**

```

int MPI_Rput(const void *origin_addr, int origin_count,
            MPI_Datatype origin_datatype, int target_rank,
            MPI_Aint target_disp, int target_count,
            MPI_Datatype target_datatype, MPI_Win win,
            MPI_Request *request)

```

```

int MPI_Rput_c(const void *origin_addr, MPI_Count origin_count,
              MPI_Datatype origin_datatype, int target_rank,
              MPI_Aint target_disp, MPI_Count target_count,
              MPI_Datatype target_datatype, MPI_Win win,
              MPI_Request *request)

```

**Fortran 2008 binding**

```

MPI_Rput(origin_addr, origin_count, origin_datatype, target_rank,
        target_disp, target_count, target_datatype, win, request,
        ierror)
TYPE(*), DIMENSION(..), INTENT(IN), ASYNCHRONOUS :: origin_addr
INTEGER, INTENT(IN) :: origin_count, target_rank, target_count
TYPE(MPI_Datatype), INTENT(IN) :: origin_datatype, target_datatype
INTEGER(KIND=MPI_ADDRESS_KIND), INTENT(IN) :: target_disp
TYPE(MPI_Win), INTENT(IN) :: win
TYPE(MPI_Request), INTENT(OUT) :: request
INTEGER, OPTIONAL, INTENT(OUT) :: ierror

```

```

MPI_Rput(origin_addr, origin_count, origin_datatype, target_rank,
        target_disp, target_count, target_datatype, win, request,
        ierror)
TYPE(*), DIMENSION(..), INTENT(IN), ASYNCHRONOUS :: origin_addr
INTEGER(KIND=MPI_COUNT_KIND), INTENT(IN) :: origin_count, target_count
TYPE(MPI_Datatype), INTENT(IN) :: origin_datatype, target_datatype

```

```

1     INTEGER, INTENT(IN) :: target_rank
2     INTEGER(KIND=MPI_ADDRESS_KIND), INTENT(IN) :: target_disp
3     TYPE(MPI_Win), INTENT(IN) :: win
4     TYPE(MPI_Request), INTENT(OUT) :: request
5     INTEGER, OPTIONAL, INTENT(OUT) :: ierror

```

### Fortran binding

```

7 MPI_RPUT(ORIGIN_ADDR, ORIGIN_COUNT, ORIGIN_DATATYPE, TARGET_RANK,
8         TARGET_DISP, TARGET_COUNT, TARGET_DATATYPE, WIN, REQUEST,
9         IERROR)
10
11 <type> ORIGIN_ADDR(*)
12 INTEGER ORIGIN_COUNT, ORIGIN_DATATYPE, TARGET_RANK, TARGET_COUNT,
13         TARGET_DATATYPE, WIN, REQUEST, IERROR
14 INTEGER(KIND=MPI_ADDRESS_KIND) TARGET_DISP

```

MPI\_RPUT is similar to MPI\_PUT (Section 12.3.1), except that it allocates a communication request object and associates it with the request handle (the argument `request`). The completion of an MPI\_RPUT operation (i.e., after the corresponding test or wait) indicates that the sender is now free to update the locations in the origin buffer. It does not indicate that the data is available at the target window. If remote completion is required, MPI\_WIN\_FLUSH, MPI\_WIN\_FLUSH\_ALL, MPI\_WIN\_UNLOCK, or MPI\_WIN\_UNLOCK\_ALL can be used.

```

24 MPI_RGET(origin_addr, origin_count, origin_datatype, target_rank, target_disp,
25         target_count, target_datatype, win, request)

```

26	OUT	origin_addr	initial address of origin buffer (choice)
27	IN	origin_count	number of entries in origin buffer (non-negative integer)
28			
29	IN	origin_datatype	datatype of each entry in origin buffer (handle)
30	IN	target_rank	rank of target (non-negative integer)
31	IN	target_disp	displacement from window start to the beginning of the target buffer (non-negative integer)
32	IN	target_count	number of entries in target buffer (non-negative integer)
33	IN	target_datatype	datatype of each entry in target buffer (handle)
34	IN	win	window object used for communication (handle)
35	OUT	request	RMA request (handle)

### C binding

```

43 int MPI_Rget(void *origin_addr, int origin_count,
44             MPI_Datatype origin_datatype, int target_rank,
45             MPI_Aint target_disp, int target_count,
46             MPI_Datatype target_datatype, MPI_Win win,
47             MPI_Request *request)
48

```

```

int MPI_Rget_c(void *origin_addr, MPI_Count origin_count,
               MPI_Datatype origin_datatype, int target_rank,
               MPI_Aint target_disp, MPI_Count target_count,
               MPI_Datatype target_datatype, MPI_Win win,
               MPI_Request *request)

```

#### Fortran 2008 binding

```

MPI_Rget(origin_addr, origin_count, origin_datatype, target_rank,
         target_disp, target_count, target_datatype, win, request,
         ierror)
TYPE(*), DIMENSION(..), ASYNCHRONOUS :: origin_addr
INTEGER, INTENT(IN) :: origin_count, target_rank, target_count
TYPE(MPI_Datatype), INTENT(IN) :: origin_datatype, target_datatype
INTEGER(KIND=MPI_ADDRESS_KIND), INTENT(IN) :: target_disp
TYPE(MPI_Win), INTENT(IN) :: win
TYPE(MPI_Request), INTENT(OUT) :: request
INTEGER, OPTIONAL, INTENT(OUT) :: ierror

MPI_Rget(origin_addr, origin_count, origin_datatype, target_rank,
         target_disp, target_count, target_datatype, win, request,
         ierror)
TYPE(*), DIMENSION(..), ASYNCHRONOUS :: origin_addr
INTEGER(KIND=MPI_COUNT_KIND), INTENT(IN) :: origin_count, target_count
TYPE(MPI_Datatype), INTENT(IN) :: origin_datatype, target_datatype
INTEGER, INTENT(IN) :: target_rank
INTEGER(KIND=MPI_ADDRESS_KIND), INTENT(IN) :: target_disp
TYPE(MPI_Win), INTENT(IN) :: win
TYPE(MPI_Request), INTENT(OUT) :: request
INTEGER, OPTIONAL, INTENT(OUT) :: ierror

```

#### Fortran binding

```

MPI_RGET(ORIGIN_ADDR, ORIGIN_COUNT, ORIGIN_DATATYPE, TARGET_RANK,
        TARGET_DISP, TARGET_COUNT, TARGET_DATATYPE, WIN, REQUEST,
        IERROR)
<type> ORIGIN_ADDR(*)
INTEGER ORIGIN_COUNT, ORIGIN_DATATYPE, TARGET_RANK, TARGET_COUNT,
        TARGET_DATATYPE, WIN, REQUEST, IERROR
INTEGER(KIND=MPI_ADDRESS_KIND) TARGET_DISP

```

MPI\_RGET is similar to MPI\_GET (Section 12.3.2), except that it allocates a communication request object and associates it with the request handle (the argument `request`) that can be used to wait or test for completion. The completion of an MPI\_RGET operation indicates that the data is available in the origin buffer. If `origin_addr` points to memory attached to a window, then the data becomes available in the private copy of this window.

```

1 MPI_RACCUMULATE(origin_addr, origin_count, origin_datatype, target_rank, target_disp,
2   target_count, target_datatype, op, win, request)
3
4   IN      origin_addr      initial address of buffer (choice)
5
6   IN      origin_count     number of entries in buffer (non-negative integer)
7
8   IN      origin_datatype  datatype of each entry in origin buffer (handle)
9
10  IN      target_rank       rank of target (non-negative integer)
11
12  IN      target_disp       displacement from start of window to beginning of
13                               target buffer (non-negative integer)
14
15  IN      target_count      number of entries in target buffer (non-negative
16                               integer)
17
18  IN      target_datatype   datatype of each entry in target buffer (handle)
19
20  IN      op                reduce operation (handle)
21
22  IN      win               window object (handle)
23
24  OUT     request           RMA request (handle)

```

### C binding

```

25 int MPI_Raccumulate(const void *origin_addr, int origin_count,
26   MPI_Datatype origin_datatype, int target_rank,
27   MPI_Aint target_disp, int target_count,
28   MPI_Datatype target_datatype, MPI_Op op, MPI_Win win,
29   MPI_Request *request)
30
31 int MPI_Raccumulate_c(const void *origin_addr, MPI_Count origin_count,
32   MPI_Datatype origin_datatype, int target_rank,
33   MPI_Aint target_disp, MPI_Count target_count,
34   MPI_Datatype target_datatype, MPI_Op op, MPI_Win win,
35   MPI_Request *request)

```

### Fortran 2008 binding

```

36 MPI_Raccumulate(origin_addr, origin_count, origin_datatype, target_rank,
37   target_disp, target_count, target_datatype, op, win, request,
38   ierror)
39
40   TYPE(*), DIMENSION(..), INTENT(IN), ASYNCHRONOUS :: origin_addr
41   INTEGER, INTENT(IN) :: origin_count, target_rank, target_count
42   TYPE(MPI_Datatype), INTENT(IN) :: origin_datatype, target_datatype
43   INTEGER(KIND=MPI_ADDRESS_KIND), INTENT(IN) :: target_disp
44   TYPE(MPI_Op), INTENT(IN) :: op
45   TYPE(MPI_Win), INTENT(IN) :: win
46   TYPE(MPI_Request), INTENT(OUT) :: request
47   INTEGER, OPTIONAL, INTENT(OUT) :: ierror
48
49 MPI_Raccumulate(origin_addr, origin_count, origin_datatype, target_rank,
50   target_disp, target_count, target_datatype, op, win, request,
51   ierror)
52
53   TYPE(*), DIMENSION(..), INTENT(IN), ASYNCHRONOUS :: origin_addr
54   INTEGER(KIND=MPI_COUNT_KIND), INTENT(IN) :: origin_count, target_count

```

```

TYPE(MPI_Datatype), INTENT(IN) :: origin_datatype, target_datatype
INTEGER, INTENT(IN) :: target_rank
INTEGER(KIND=MPI_ADDRESS_KIND), INTENT(IN) :: target_disp
TYPE(MPI_Op), INTENT(IN) :: op
TYPE(MPI_Win), INTENT(IN) :: win
TYPE(MPI_Request), INTENT(OUT) :: request
INTEGER, OPTIONAL, INTENT(OUT) :: ierror

```

**Fortran binding**

```

MPI_RACCUMULATE(ORIGIN_ADDR, ORIGIN_COUNT, ORIGIN_DATATYPE, TARGET_RANK,
                TARGET_DISP, TARGET_COUNT, TARGET_DATATYPE, OP, WIN, REQUEST,
                IERROR)
<type> ORIGIN_ADDR(*)
INTEGER ORIGIN_COUNT, ORIGIN_DATATYPE, TARGET_RANK, TARGET_COUNT,
        TARGET_DATATYPE, OP, WIN, REQUEST, IERROR
INTEGER(KIND=MPI_ADDRESS_KIND) TARGET_DISP

```

MPI\_RACCUMULATE is similar to MPI\_ACCUMULATE (Section 12.3.4), except that it allocates a communication request object and associates it with the request handle (the argument request) that can be used to wait or test for completion. The completion of an MPI\_RACCUMULATE operation indicates that the origin buffer is free to be updated. It does not indicate that the operation has completed at the target window.

```

1 MPI_RGET_ACCUMULATE(origin_addr, origin_count, origin_datatype, result_addr,
2     result_count, result_datatype, target_rank, target_disp, target_count,
3     target_datatype, op, win, request)
4
5     IN     origin_addr     initial address of buffer (choice)
6     IN     origin_count   number of entries in origin buffer (non-negative
7                             integer)
8     IN     origin_datatype datatype of each entry in origin buffer (handle)
9     OUT    result_addr    initial address of result buffer (choice)
10    IN     result_count   number of entries in result buffer (non-negative
11                             integer)
12
13    IN     result_datatype datatype of entries in result buffer (handle)
14    IN     target_rank    rank of target (non-negative integer)
15    IN     target_disp    displacement from start of window to beginning of
16                             target buffer (non-negative integer)
17
18    IN     target_count   number of entries in target buffer (non-negative
19                             integer)
20
21    IN     target_datatype datatype of each entry in target buffer (handle)
22    IN     op             reduce operation (handle)
23    IN     win            window object (handle)
24    OUT    request        RMA request (handle)
25

```

### C binding

```

27 int MPI_Rget_accumulate(const void *origin_addr, int origin_count,
28     MPI_Datatype origin_datatype, void *result_addr,
29     int result_count, MPI_Datatype result_datatype,
30     int target_rank, MPI_Aint target_disp, int target_count,
31     MPI_Datatype target_datatype, MPI_Op op, MPI_Win win,
32     MPI_Request *request)
33
34 int MPI_Rget_accumulate_c(const void *origin_addr, MPI_Count origin_count,
35     MPI_Datatype origin_datatype, void *result_addr,
36     MPI_Count result_count, MPI_Datatype result_datatype,
37     int target_rank, MPI_Aint target_disp, MPI_Count target_count,
38     MPI_Datatype target_datatype, MPI_Op op, MPI_Win win,
39     MPI_Request *request)
40

```

### Fortran 2008 binding

```

41 MPI_Rget_accumulate(origin_addr, origin_count, origin_datatype,
42     result_addr, result_count, result_datatype, target_rank,
43     target_disp, target_count, target_datatype, op, win, request,
44     ierror)
45
46     TYPE(*), DIMENSION(..), INTENT(IN), ASYNCHRONOUS :: origin_addr
47     INTEGER, INTENT(IN) :: origin_count, result_count, target_rank,
48     target_count

```

```

TYPE(MPI_Datatype), INTENT(IN) :: origin_datatype, result_datatype,
    target_datatype
TYPE(*), DIMENSION(..), ASYNCHRONOUS :: result_addr
INTEGER(KIND=MPI_ADDRESS_KIND), INTENT(IN) :: target_disp
TYPE(MPI_Op), INTENT(IN) :: op
TYPE(MPI_Win), INTENT(IN) :: win
TYPE(MPI_Request), INTENT(OUT) :: request
INTEGER, OPTIONAL, INTENT(OUT) :: ierror
MPI_Rget_accumulate(origin_addr, origin_count, origin_datatype,
    result_addr, result_count, result_datatype, target_rank,
    target_disp, target_count, target_datatype, op, win, request,
    ierror)
TYPE(*), DIMENSION(..), INTENT(IN), ASYNCHRONOUS :: origin_addr
INTEGER(KIND=MPI_COUNT_KIND), INTENT(IN) :: origin_count, result_count,
    target_count
TYPE(MPI_Datatype), INTENT(IN) :: origin_datatype, result_datatype,
    target_datatype
TYPE(*), DIMENSION(..), ASYNCHRONOUS :: result_addr
INTEGER, INTENT(IN) :: target_rank
INTEGER(KIND=MPI_ADDRESS_KIND), INTENT(IN) :: target_disp
TYPE(MPI_Op), INTENT(IN) :: op
TYPE(MPI_Win), INTENT(IN) :: win
TYPE(MPI_Request), INTENT(OUT) :: request
INTEGER, OPTIONAL, INTENT(OUT) :: ierror

```

### Fortran binding

```

MPI_RGET_ACCUMULATE(ORIGIN_ADDR, ORIGIN_COUNT, ORIGIN_DATATYPE,
    RESULT_ADDR, RESULT_COUNT, RESULT_DATATYPE, TARGET_RANK,
    TARGET_DISP, TARGET_COUNT, TARGET_DATATYPE, OP, WIN, REQUEST,
    IERROR)
<type> ORIGIN_ADDR(*), RESULT_ADDR(*)
INTEGER ORIGIN_COUNT, ORIGIN_DATATYPE, RESULT_COUNT, RESULT_DATATYPE,
    TARGET_RANK, TARGET_COUNT, TARGET_DATATYPE, OP, WIN, REQUEST,
    IERROR
INTEGER(KIND=MPI_ADDRESS_KIND) TARGET_DISP

```

MPI\_RGET\_ACCUMULATE is similar to MPI\_GET\_ACCUMULATE (Section 12.3.4), except that it allocates a communication request object and associates it with the request handle (the argument *request*) that can be used to wait or test for completion. The completion of an MPI\_RGET\_ACCUMULATE operation indicates that the data is available in the result buffer and the origin buffer is free to be updated. It does not indicate that the operation has been completed at the target window.

## 12.4 Memory Model

The memory semantics of RMA are best understood by using the concept of *public* and *private* window copies. We assume that systems have a public memory region that is addressable by all processes (e.g., the shared memory in shared memory machines or the

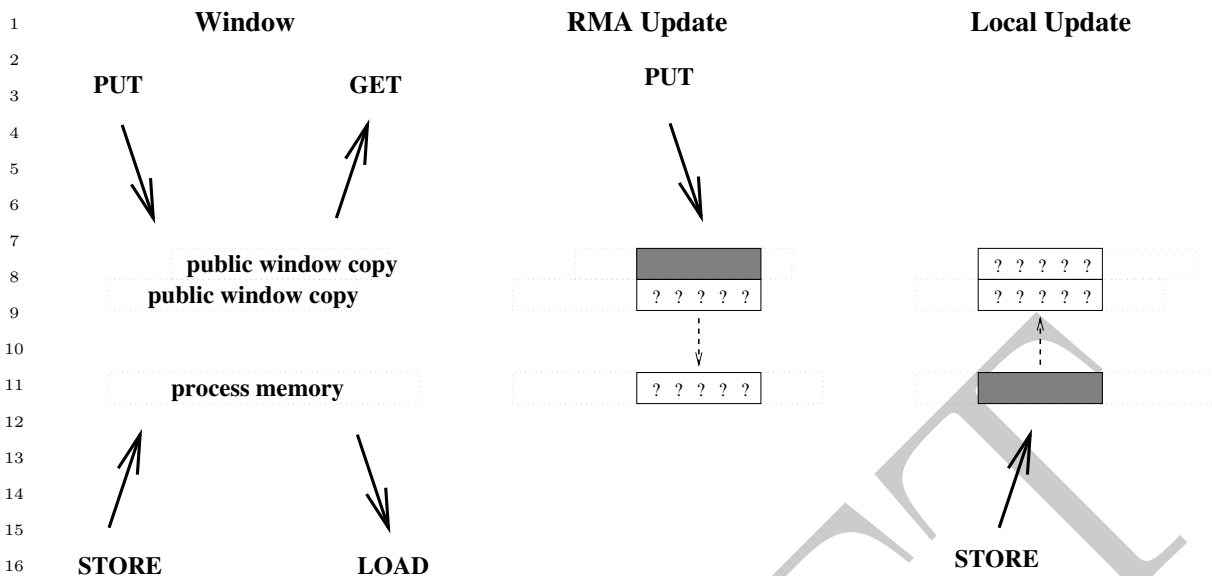

Figure 12.1: Schematic description of the public/private window operations in the MPI\_WIN\_SEPARATE memory model for two overlapping windows

exposed main memory in distributed memory machines). In addition, most machines have fast private buffers (e.g., transparent caches or explicit communication buffers) local to each process where copies of data elements from the main memory can be stored for faster access. Such buffers are either coherent, i.e., all updates to main memory are reflected in all private copies consistently, or non-coherent, i.e., conflicting accesses to main memory need to be synchronized and updated in all private copies explicitly. Coherent systems allow direct updates to remote memory without any participation of the remote side. Non-coherent systems, however, need to call RMA functions in order to reflect updates to the public window in their private memory. Thus, in coherent memory, the public and the private window are identical while they remain logically separate in the non-coherent case. MPI thus differentiates between two **memory models** called **RMA unified**, if public and private window are logically identical, and **RMA separate**, otherwise.

In the RMA separate model, there is only one instance of each variable in process memory, but a distinct *public* copy of the variable for each window that contains it. A load accesses the instance in process memory (this includes MPI sends). A local store accesses and updates the instance in process memory (this includes MPI receives), but the update may affect other public copies of the same locations. A get on a window accesses the public copy of that window. A put or accumulate on a window accesses and updates the public copy of that window, but the update may affect the private copy of the same locations in process memory, and public copies of other overlapping windows. This is illustrated in Figure 12.1.

In the RMA unified model, public and private copies are identical and updates via put or accumulate calls are eventually observed by load operations without additional RMA calls. A store access to a window is eventually visible to remote get or accumulate calls without additional RMA calls. These stronger semantics of the RMA unified model allow the user to omit some synchronization calls and potentially improve performance.

*Advice to users.* If accesses in the RMA unified model are not synchronized (with



locks or flushes, see Section 12.5.3), load and store operations might observe changes to the memory while they are in progress. The order in which data is written is not specified unless further synchronization is used. This might lead to inconsistent views on memory and programs that assume that a transfer is complete by only checking parts of the message are erroneous. (*End of advice to users.*)

The memory model for a particular RMA window can be determined by accessing the attribute `MPI_WIN_MODEL`. If the memory model is the unified model, the value of this attribute is `MPI_WIN_UNIFIED`; otherwise, the value is `MPI_WIN_SEPARATE`.

## 12.5 Synchronization Calls

RMA communications fall in two categories:

- **active target communication**, where data is moved from the memory of one process to the memory of another, and both are explicitly involved in the communication. This communication pattern is similar to message passing, except that all the data transfer arguments are provided by one process, and the second process only participates in the synchronization.
- **passive target communication**, where data is moved from the memory of one process to the memory of another, and only the origin process is explicitly involved in the transfer. Thus, two origin processes may communicate by accessing the same location in a target window. The process that owns the target window may be distinct from the two communicating processes, in which case it does not participate explicitly in the communication. This communication paradigm is closest to a shared memory model, where shared data can be accessed by all processes, irrespective of location.

RMA communication calls with argument `win` must occur at a process only within an **access epoch** for `win`. Such an epoch starts with an RMA synchronization call on `win`; it proceeds with zero or more RMA communication calls (e.g., `MPI_PUT`, `MPI_GET` or `MPI_ACCUMULATE`) on `win`; it completes with another synchronization call on `win`. This allows users to amortize one synchronization with multiple data transfers and provide implementors more flexibility in the implementation of RMA operations.

Distinct access epochs for `win` at the same process must be disjoint. On the other hand, epochs pertaining to different `win` arguments may overlap. Local operations or other MPI calls may also occur during an epoch.

In active target communication, a target window can be accessed by RMA operations only within an **exposure epoch**. Such an epoch is started and completed by RMA synchronization calls executed by the target process. Distinct exposure epochs at a process on the same window must be disjoint, but such an exposure epoch may overlap with exposure epochs on other windows or with access epochs for the same or other `win` arguments. There is a one-to-one matching between access epochs at origin processes and exposure epochs on target processes: RMA operations issued by an origin process for a target window will access that target window during the same exposure epoch if and only if they were issued during the same access epoch.

In passive target communication the target process does not execute RMA synchronization calls, and there is no concept of an exposure epoch.

MPI provides three synchronization mechanisms:

- 1 The `MPI_WIN_FENCE` collective synchronization call supports a simple synchroniza-  
2 tion pattern that is often used in parallel computations: namely a loosely-synchronous  
3 model, where global computation phases alternate with global communication phases.  
4 This mechanism is most useful for loosely synchronous algorithms where the graph  
5 of communicating processes changes very frequently, or where each process communi-  
6 cates with many others.

7 This call is used for active target communication. An access epoch at an origin  
8 process or an exposure epoch at a target process are started and completed by calls to  
9 `MPI_WIN_FENCE`. A process can access windows at all processes in the group of win  
10 during such an access epoch, and the local window can be accessed by all processes  
11 in the group of win during such an exposure epoch.

- 13 The four functions `MPI_WIN_START`, `MPI_WIN_COMPLETE`, `MPI_WIN_POST`, and  
14 `MPI_WIN_WAIT` can be used to restrict synchronization to the minimum: only pairs  
15 of communicating processes synchronize, and they do so only when a synchronization  
16 is needed to order correctly RMA accesses to a window with respect to local accesses  
17 to that same window. This mechanism may be more efficient when each process  
18 communicates with few (logical) neighbors, and the communication graph is fixed or  
19 changes infrequently.

20 These calls are used for active target communication. An access epoch is started  
21 at the origin process by a call to `MPI_WIN_START` and is terminated by a call to  
22 `MPI_WIN_COMPLETE`. The start call has a group argument that specifies the group  
23 of target processes for that epoch. An exposure epoch is started at the target process  
24 by a call to `MPI_WIN_POST` and is completed by a call to `MPI_WIN_WAIT`. The post  
25 call has a group argument that specifies the set of origin processes for that epoch.

- 27 Finally, shared lock access is provided by the functions `MPI_WIN_LOCK`,  
28 `MPI_WIN_LOCK_ALL`, `MPI_WIN_UNLOCK`, and `MPI_WIN_UNLOCK_ALL`.  
29 `MPI_WIN_LOCK` and `MPI_WIN_UNLOCK` also provide exclusive lock capability. Lock  
30 synchronization is useful for MPI applications that emulate a shared memory model  
31 via MPI calls; e.g., in a “bulletin board” model, where processes can, at random times,  
32 access or update different parts of the bulletin board.

33 These four calls provide passive target communication. An access epoch is started  
34 by a call to `MPI_WIN_LOCK` or `MPI_WIN_LOCK_ALL` and terminated by a call to  
35 `MPI_WIN_UNLOCK` or `MPI_WIN_UNLOCK_ALL`, respectively.

37 Figure 12.2 illustrates the general synchronization pattern for active target communi-  
38 cation. The synchronization between `post` and `start` ensures that the put call of the origin  
39 process does not start until the target process exposes the window (with the `post` call);  
40 the target process will expose the window only after preceding local accesses to the window  
41 have completed. The synchronization between `complete` and `wait` ensures that the put call  
42 of the origin process completes before the window is unexposed (with the `wait` call). The  
43 target process will execute following local accesses to the target window only after the `wait`  
44 returned.

45 Figure 12.2 shows operations occurring in the natural temporal order implied by the  
46 synchronizations: the `post` occurs before the matching `start`, and `complete` occurs be-  
47 fore the matching `wait`. However, such **strong synchronization** is more than needed for  
48

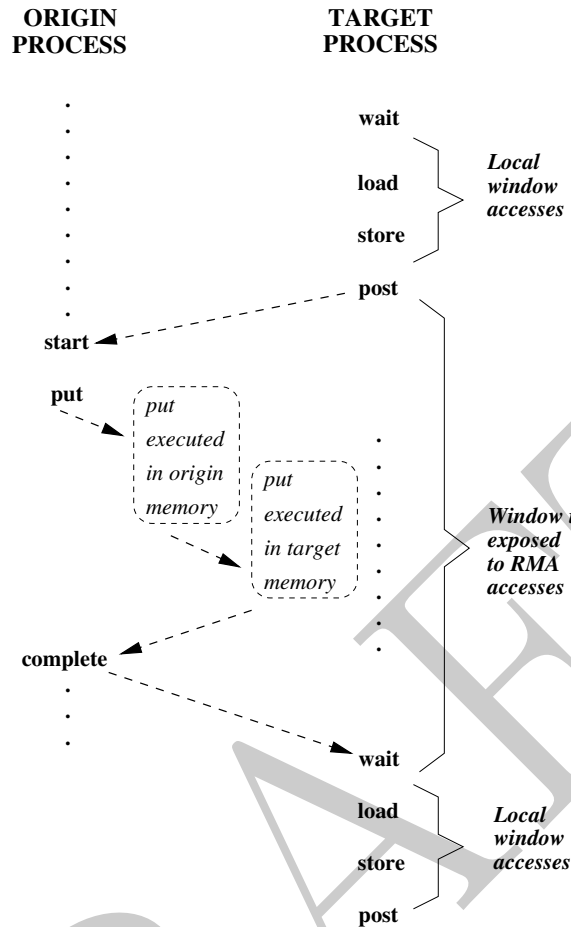

Figure 12.2: Active target communication. Dashed arrows represent synchronizations (ordering of events).

correct ordering of window accesses. The semantics of MPI calls allow **weak synchronization**, as illustrated in Figure 12.3. The access to the target window is delayed until the window is exposed, after the `post`. However the `start` may complete earlier; the `put` and `complete` may also terminate earlier, if put data is buffered by the implementation. The synchronization calls order correctly window accesses, but do not necessarily synchronize other operations. This weaker synchronization semantic allows for more efficient implementations.

Figure 12.4 illustrates the general synchronization pattern for passive target communication. The first origin process communicates data to the second origin process, through the memory of the target process; the target process is not explicitly involved in the communication. The `lock` and `unlock` calls ensure that the two RMA accesses do not occur concurrently. However, they do *not* ensure that the `put` by origin 1 will precede the `get` by origin 2.

*Rationale.* RMA does not define fine-grained mutexes in memory (only logical coarse-grained process locks). MPI provides the primitives (compare and swap, accumulate, send/receive, etc.) needed to implement high-level synchronization operations. (*End of rationale.*)

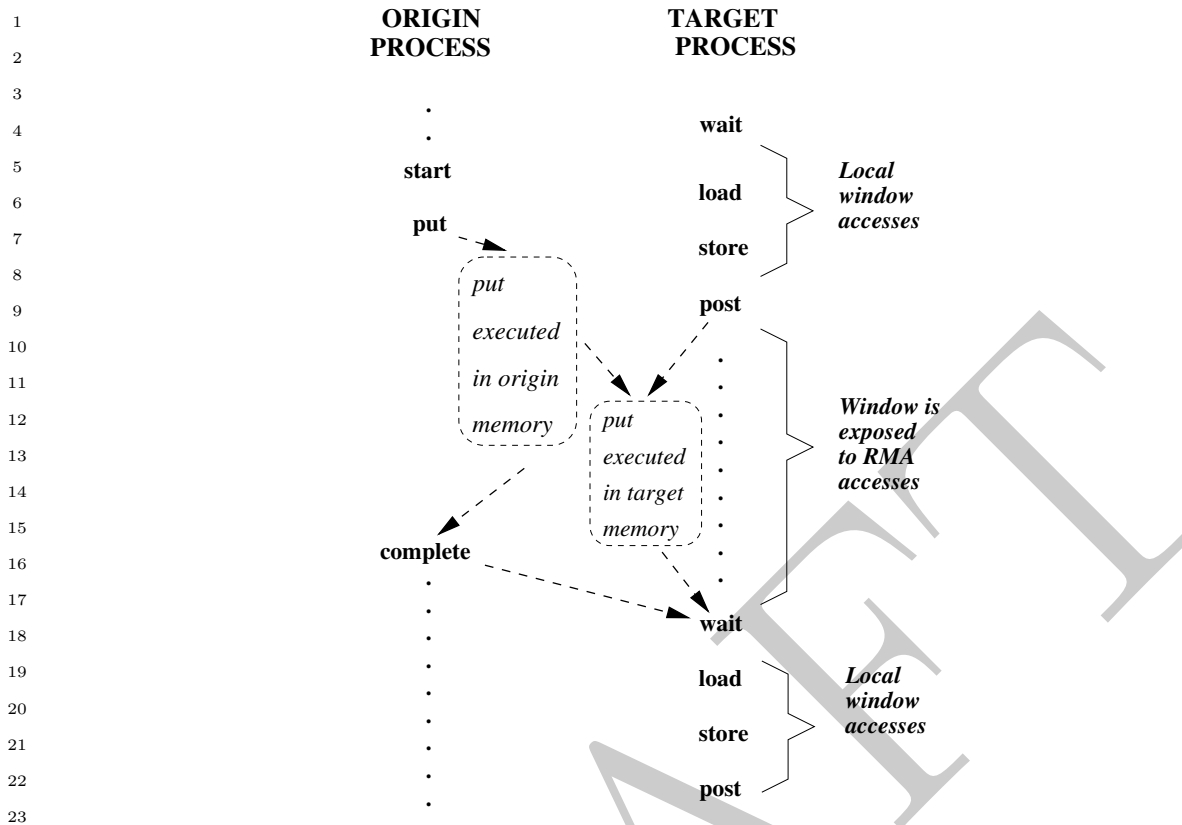

Figure 12.3: Active target communication, with weak synchronization. Dashed arrows represent synchronizations (ordering of events).

### 12.5.1 Fence

`MPI_WIN_FENCE(assert, win)`

IN	assert	program assertion (integer)
IN	win	window object (handle)

#### C binding

```
int MPI_Win_fence(int assert, MPI_Win win)
```

#### Fortran 2008 binding

```
MPI_Win_fence(assert, win, ierror)
  INTEGER, INTENT(IN) :: assert
  TYPE(MPI_Win), INTENT(IN) :: win
  INTEGER, OPTIONAL, INTENT(OUT) :: ierror
```

#### Fortran binding

```
MPI_WIN_FENCE(ASSERT, WIN, IERROR)
  INTEGER ASSERT, WIN, IERROR
```

The MPI call `MPI_WIN_FENCE(assert, win)` synchronizes RMA calls on `win`. The call

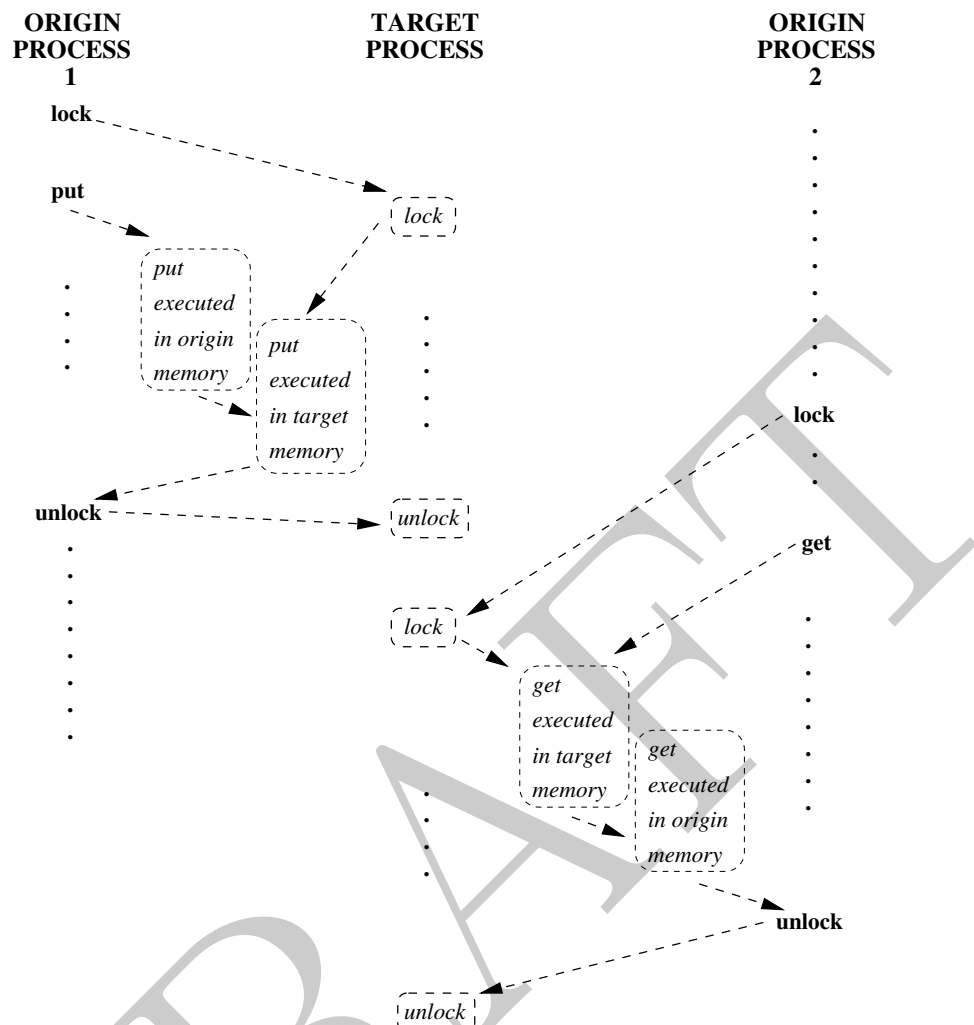

Figure 12.4: Passive target communication. Dashed arrows represent synchronizations (ordering of events).

is collective on the group of win. All RMA operations on win originating at a given process and started before the fence call will complete at that process before the fence call returns. They will be completed at their target before the fence call returns at the target. RMA operations on win started by a process after the fence call returns will access their target window only after MPI\_WIN\_FENCE has been called by the target process.

The call completes an RMA access epoch if it was preceded by another fence call and the local process issued RMA communication calls on win between these two calls. The call completes an RMA exposure epoch if it was preceded by another fence call and the local window was the target of RMA accesses between these two calls. The call starts an RMA access epoch if it is followed by another fence call and by RMA communication calls issued between these two fence calls. The call starts an exposure epoch if it is followed by another fence call and the local window is the target of RMA accesses between these two fence calls. Thus, the fence call is equivalent to calls to a subset of `post`, `start`, `complete`, `wait`.

A fence call usually entails a barrier synchronization: a process completes a call to MPI\_WIN\_FENCE only after all other processes in the group entered their matching call.

1 However, a call to `MPI_WIN_FENCE` that is known not to end any epoch (in particular, a  
 2 call with `assert` equal to `MPI_MODE_NOPRECEDE`) does not necessarily act as a barrier.

3 The `assert` argument is used to provide assertions on the context of the call that may  
 4 be used for various optimizations. This is described in Section 12.5.5. A value of `assert =`  
 5 `0` is always valid.

6  
 7 *Advice to users.* Calls to `MPI_WIN_FENCE` should both precede and follow calls to  
 8 RMA communication functions that are synchronized with fence calls. (*End of advice*  
 9 *to users.*)

## 10 12.5.2 General Active Target Synchronization

11 `MPI_WIN_START(group, assert, win)`

12  
 13  
 14  
 15     **IN**        **group**                    group of target processes (handle)  
 16     **IN**        **assert**                    program assertion (integer)  
 17     **IN**        **win**                        window object (handle)  
 18  
 19

### 20 **C binding**

21 `int MPI_Win_start(MPI_Group group, int assert, MPI_Win win)`

### 22 **Fortran 2008 binding**

23 `MPI_Win_start(group, assert, win, ierror)`  
 24     **TYPE**(MPI\_Group), **INTENT**(IN) :: group  
 25     **INTEGER**, **INTENT**(IN) :: assert  
 26     **TYPE**(MPI\_Win), **INTENT**(IN) :: win  
 27     **INTEGER**, **OPTIONAL**, **INTENT**(OUT) :: ierror  
 28

### 29 **Fortran binding**

30 `MPI_WIN_START(GROUP, ASSERT, WIN, IERROR)`  
 31     **INTEGER** GROUP, **ASSERT**, **WIN**, **IERROR**  
 32

33 Starts an RMA access epoch for `win`. RMA calls issued on `win` during this epoch must  
 34 access only windows at processes in `group`. Each process in `group` must issue a matching  
 35 call to `MPI_WIN_POST`. RMA accesses to each target window will be delayed, if necessary,  
 36 until the target process executed the matching call to `MPI_WIN_POST`. `MPI_WIN_START`  
 37 is allowed to block until the corresponding `MPI_WIN_POST` calls are executed, but is not  
 38 required to.

39 The `assert` argument is used to provide assertions on the context of the call that may  
 40 be used for various optimizations. This is described in Section 12.5.5. A value of `assert =`  
 41 `0` is always valid.

42  
 43  
 44 `MPI_WIN_COMPLETE(win)`

45     **IN**        **win**                        window object (handle)  
 46

### 47 **C binding**

48 `int MPI_Win_complete(MPI_Win win)`

**Fortran 2008 binding**

```
MPI_Win_complete(win, ierror)
    TYPE(MPI_Win), INTENT(IN) :: win
    INTEGER, OPTIONAL, INTENT(OUT) :: ierror
```

**Fortran binding**

```
MPI_WIN_COMPLETE(WIN, IERROR)
    INTEGER WIN, IERROR
```

Completes an RMA access epoch on win started by a call to MPI\_WIN\_START. All RMA communication calls issued on win during this epoch will have completed at the origin when the call returns.

MPI\_WIN\_COMPLETE enforces completion of preceding RMA calls at the origin, but not at the target. A put or accumulate call may not have completed at the target when it has completed at the origin.

Consider the sequence of calls in the example below.

**Example 12.4** Use of MPI\_WIN\_START and MPI\_WIN\_COMPLETE.

```
MPI_Win_start(group, flag, win);
MPI_Put(..., win);
MPI_Win_complete(win);
```

The call to MPI\_WIN\_COMPLETE does not return until the put call has completed at the origin; and the target window will be accessed by the put operation only after the call to MPI\_WIN\_START has matched a call to MPI\_WIN\_POST by the target process. This still leaves much choice to implementors. The call to MPI\_WIN\_START can block until the matching call to MPI\_WIN\_POST occurs at all target processes. One can also have implementations where the call to MPI\_WIN\_START is nonblocking, but the call to MPI\_PUT blocks until the matching call to MPI\_WIN\_POST occurs; or implementations where the first two calls are nonblocking, but the call to MPI\_WIN\_COMPLETE blocks until the call to MPI\_WIN\_POST occurred; or even implementations where all three calls can complete before any target process has called MPI\_WIN\_POST—the data put must be buffered, in this last case, so as to allow the put to complete at the origin ahead of its completion at the target. However, once the call to MPI\_WIN\_POST is issued, the sequence above must complete, without further dependencies.

```
MPI_WIN_POST(group, assert, win)
```

IN	group	group of origin processes (handle)
IN	assert	program assertion (integer)
IN	win	window object (handle)

**C binding**

```
int MPI_Win_post(MPI_Group group, int assert, MPI_Win win)
```

**Fortran 2008 binding**

```
MPI_Win_post(group, assert, win, ierror)
    TYPE(MPI_Group), INTENT(IN) :: group
```

```

1     INTEGER, INTENT(IN) :: assert
2     TYPE(MPI_Win), INTENT(IN) :: win
3     INTEGER, OPTIONAL, INTENT(OUT) :: ierror

```

#### Fortran binding

```

6 MPI_WIN_POST(GROUP, ASSERT, WIN, IERROR)
7     INTEGER GROUP, ASSERT, WIN, IERROR

```

Starts an RMA exposure epoch for the local window associated with win. Only processes in group should access the window with RMA calls on win during this epoch. Each process in group must issue a matching call to MPI\_WIN\_START. MPI\_WIN\_POST does not block.

```

13 MPI_WIN_WAIT(win)

```

```

14     IN      win                window object (handle)

```

#### C binding

```

17 int MPI_Win_wait(MPI_Win win)

```

#### Fortran 2008 binding

```

20 MPI_Win_wait(win, ierror)
21     TYPE(MPI_Win), INTENT(IN) :: win
22     INTEGER, OPTIONAL, INTENT(OUT) :: ierror

```

#### Fortran binding

```

24 MPI_WIN_WAIT(WIN, IERROR)
25     INTEGER WIN, IERROR

```

Completes an RMA exposure epoch started by a call to MPI\_WIN\_POST on win. This call matches calls to MPI\_WIN\_COMPLETE(win) issued by each of the origin processes that were granted access to the window during this epoch. The call to MPI\_WIN\_WAIT will block until all matching calls to MPI\_WIN\_COMPLETE have occurred. This guarantees that all these origin processes have completed their RMA accesses to the local window. When the call returns, all these RMA accesses will have completed at the target window.

Figure 12.5 illustrates the use of these four functions. Process 0 puts data in the windows of processes 1 and 2 and process 3 puts data in the window of process 2. Each start call lists the ranks of the processes whose windows will be accessed; each post call lists the ranks of the processes that access the local window. The figure illustrates a possible timing for the events, assuming strong synchronization; in a weak synchronization, the start, put or complete calls may occur ahead of the matching post calls.

```

40 MPI_WIN_TEST(win, flag)

```

```

42     IN      win                window object (handle)

```

```

43     OUT     flag                success flag (logical)

```

#### C binding

```

46 int MPI_Win_test(MPI_Win win, int *flag)

```



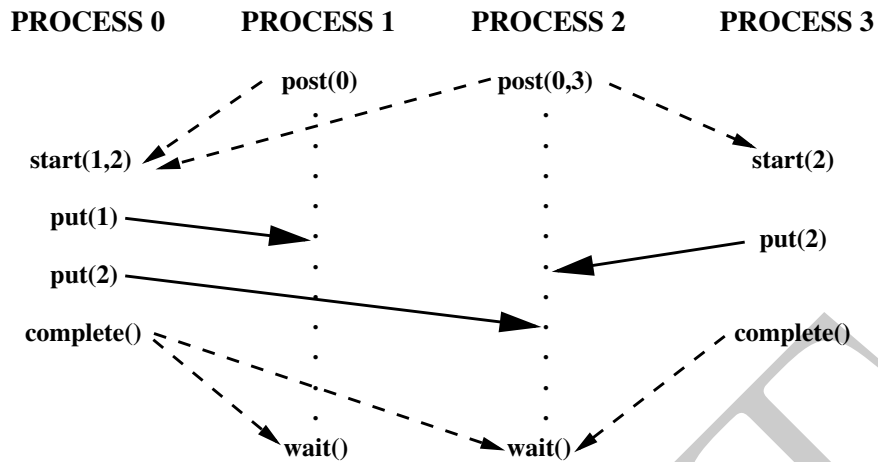

Figure 12.5: Active target communication. Dashed arrows represent synchronizations and solid arrows represent data transfer.

### Fortran 2008 binding

```
MPI_Win_test(win, flag, ierror)
  TYPE(MPI_Win), INTENT(IN) :: win
  LOGICAL, INTENT(OUT) :: flag
  INTEGER, OPTIONAL, INTENT(OUT) :: ierror
```

### Fortran binding

```
MPI_WIN_TEST(WIN, FLAG, IERROR)
  INTEGER WIN, IERROR
  LOGICAL FLAG
```

This is the nonblocking version of `MPI_WIN_WAIT`. It returns `flag = true` if all accesses to the local window by the group to which it was exposed by the corresponding `MPI_WIN_POST` call have been completed as signalled by matching `MPI_WIN_COMPLETE` calls, and `flag = false` otherwise. In the former case `MPI_WIN_WAIT` would have returned immediately. The effect of return of `MPI_WIN_TEST` with `flag = true` is the same as the effect of a return of `MPI_WIN_WAIT`. If `flag = false` is returned, then the call has no visible effect.

`MPI_WIN_TEST` should be invoked only where `MPI_WIN_WAIT` can be invoked. Once the call has returned `flag = true`, it must not be invoked anew, until the window is posted anew.

Assume that window `win` is associated with a “hidden” communicator `wincomm`, used for communication by the processes of `win`. The rules for matching of post and start calls and for matching complete and wait calls can be derived from the rules for matching sends and receives, by considering the following (partial) model implementation.

**`MPI_WIN_POST(group,0,win)`** initiates a nonblocking send with tag `tag0` to each process in `group`, using `wincomm`. There is no need to wait for the completion of these sends.

**`MPI_WIN_START(group,0,win)`** initiates a nonblocking receive with tag `tag0` from each process in `group`, using `wincomm`. An RMA access to a window in target process `i` is delayed until the receive from `i` is completed.

1 **MPI\_WIN\_COMPLETE(win)** initiates a nonblocking send with tag `tag1` to each process  
 2 in the group of the preceding start call. No need to wait for the completion of these  
 3 sends.

4  
 5 **MPI\_WIN\_WAIT(win)** initiates a nonblocking receive with tag `tag1` from each process in  
 6 the group of the preceding post call. Wait for the completion of all receives.

7  
 8 No races can occur in a correct program: each of the sends matches a unique receive,  
 9 and vice versa.

10  
 11 *Rationale.* The design for general active target synchronization requires the user to  
 12 provide complete information on the communication pattern, at each end of a com-  
 13 munication link: each origin specifies a list of targets, and each target specifies a list  
 14 of origins. This provides maximum flexibility (hence, efficiency) for the implementor:  
 15 each synchronization can be initiated by either side, since each “knows” the identity  
 16 of the other. This also provides maximum protection from possible races. On the  
 17 other hand, the design requires more information than RMA needs: in general, it is  
 18 sufficient for the origin to know the rank of the target, but not vice versa. Users  
 19 that want more “anonymous” communication will be required to use the fence or lock  
 20 mechanisms. (*End of rationale.*)

21  
 22 *Advice to users.* Assume a communication pattern that is represented by a directed  
 23 graph  $G = \langle V, E \rangle$ , where  $V = \{0, \dots, n - 1\}$  and  $ij \in E$  if origin process  $i$  accesses  
 24 the window at target process  $j$ . Then each process  $i$  issues a call to  
 25 `MPI_WIN_POST(ingroupi, ...)`, followed by a call to  
 26 `MPI_WIN_START(outgroupi, ...)`, where  $outgroup_i = \{j : ij \in E\}$  and  $ingroup_i =$   
 27  $\{j : ji \in E\}$ . A call is a noop, and can be skipped, if the `group` argument is empty.  
 28 After the communications calls, each process that issued a start will issue a complete.  
 29 Finally, each process that issued a post will issue a wait.

30 Note that each process may call with a `group` argument that has different members.  
 31 (*End of advice to users.*)

### 32 12.5.3 Lock

33  
 34  
 35  
 36 `MPI_WIN_LOCK(lock_type, rank, assert, win)`

37	IN	<code>lock_type</code>	either <code>MPI_LOCK_EXCLUSIVE</code> or <code>MPI_LOCK_SHARED</code> (state)
38			
39	IN	<code>rank</code>	rank of locked window (non-negative integer)
40			
41	IN	<code>assert</code>	program assertion (integer)
42			
43	IN	<code>win</code>	window object (handle)

#### 44 C binding

45 `int MPI_Win_lock(int lock_type, int rank, int assert, MPI_Win win)`

#### 46 Fortran 2008 binding

47 `MPI_Win_lock(lock_type, rank, assert, win, ierror)`

```

INTEGER, INTENT(IN) :: lock_type, rank, assert
TYPE(MPI_Win), INTENT(IN) :: win
INTEGER, OPTIONAL, INTENT(OUT) :: ierror

```

**Fortran binding**

```

MPI_WIN_LOCK(LOCK_TYPE, RANK, ASSERT, WIN, IERROR)
  INTEGER LOCK_TYPE, RANK, ASSERT, WIN, IERROR

```

Starts an RMA access epoch. The window at the process with rank `rank` can be accessed by RMA operations on `win` during that epoch. Multiple RMA access epochs (with calls to `MPI_WIN_LOCK`) can occur simultaneously; however, each access epoch must target a different process.

```

MPI_WIN_LOCK_ALL(assert, win)

```

```

IN      assert                program assertion (integer)
IN      win                   window object (handle)

```

**C binding**

```

int MPI_Win_lock_all(int assert, MPI_Win win)

```

**Fortran 2008 binding**

```

MPI_Win_lock_all(assert, win, ierror)
  INTEGER, INTENT(IN) :: assert
  TYPE(MPI_Win), INTENT(IN) :: win
  INTEGER, OPTIONAL, INTENT(OUT) :: ierror

```

**Fortran binding**

```

MPI_WIN_LOCK_ALL(ASSERT, WIN, IERROR)
  INTEGER ASSERT, WIN, IERROR

```

Starts an RMA access epoch to all processes in `win`, with a lock type of `MPI_LOCK_SHARED`. During the epoch, the calling process can access the window memory on all processes in `win` by using RMA operations. A window locked with `MPI_WIN_LOCK_ALL` must be unlocked with `MPI_WIN_UNLOCK_ALL`. This routine is not collective—the `ALL` refers to a lock on all members of the group of the window.

*Advice to users.* There may be additional overheads associated with using `MPI_WIN_LOCK` and `MPI_WIN_LOCK_ALL` concurrently on the same window. These overheads could be avoided by specifying the assertion `MPI_MODE_NOCHECK` when possible (see Section 12.5.5). (*End of advice to users.*)

```

MPI_WIN_UNLOCK(rank, win)

```

```

IN      rank                rank of window (non-negative integer)
IN      win                 window object (handle)

```

**C binding**

```

int MPI_Win_unlock(int rank, MPI_Win win)

```

**Fortran 2008 binding**

```

MPI_Win_unlock(rank, win, ierror)
    INTEGER, INTENT(IN) :: rank
    TYPE(MPI_Win), INTENT(IN) :: win
    INTEGER, OPTIONAL, INTENT(OUT) :: ierror

```

**Fortran binding**

```

MPI_WIN_UNLOCK(RANK, WIN, IERROR)
    INTEGER RANK, WIN, IERROR

```

Completes an RMA access epoch started by a call to `MPI_WIN_LOCK` on window `win`. RMA operations issued during this period will have completed both at the origin and at the target when the call returns.

**MPI\_WIN\_UNLOCK\_ALL(win)**

```

IN      win                window object (handle)

```

**C binding**

```

int MPI_Win_unlock_all(MPI_Win win)

```

**Fortran 2008 binding**

```

MPI_Win_unlock_all(win, ierror)
    TYPE(MPI_Win), INTENT(IN) :: win
    INTEGER, OPTIONAL, INTENT(OUT) :: ierror

```

**Fortran binding**

```

MPI_WIN_UNLOCK_ALL(WIN, IERROR)
    INTEGER WIN, IERROR

```

Completes a shared RMA access epoch started by a call to `MPI_WIN_LOCK_ALL` on window `win`. RMA operations issued during this epoch will have completed both at the origin and at the target when the call returns.

Locks are used to protect accesses to the locked target window effected by RMA calls issued between the lock and unlock calls, and to protect load/store accesses to a locked local or shared memory window executed between the lock and unlock calls. Accesses that are protected by an exclusive lock will not be concurrent at the window site with other accesses to the same window that are lock protected. Accesses that are protected by a shared lock will not be concurrent at the window site with accesses protected by an exclusive lock to the same window.

It is erroneous to have a window locked and exposed (in an exposure epoch) concurrently. For example, a process may not call `MPI_WIN_LOCK` to lock a target window if the target process has called `MPI_WIN_POST` and has not yet called `MPI_WIN_WAIT`; it is erroneous to call `MPI_WIN_POST` while the local window is locked.

*Rationale.* An alternative is to require MPI to enforce mutual exclusion between exposure epochs and locking periods. But this would entail additional overheads when locks or active target synchronization do not interact in support of those rare interactions between the two mechanisms. The programming style that we encourage

here is that a set of windows is used with only one synchronization mechanism at a time, with shifts from one mechanism to another being rare and involving global synchronization. (*End of rationale.*)

*Advice to users.* Users need to use explicit synchronization code in order to enforce mutual exclusion between locking periods and exposure epochs on a window. (*End of advice to users.*)

Implementors may restrict the use of RMA communication that is synchronized by lock calls to windows in memory allocated by `MPI_ALLOC_MEM` (Section 9.2), `MPI_WIN_ALLOCATE` (Section 12.2.2), `MPI_WIN_ALLOCATE_SHARED` (Section 12.2.3), or attached with `MPI_WIN_ATTACH` (Section 12.2.4). Locks can be used portably only in such memory.

*Rationale.* The implementation of passive target communication when memory is not shared may require an asynchronous software agent. Such an agent can be implemented more easily, and can achieve better performance, if restricted to specially allocated memory. It can be avoided altogether if shared memory is used. It seems natural to impose restrictions that allows one to use shared memory for third party communication in shared memory machines.

(*End of rationale.*)

Consider the sequence of calls in the example below.

**Example 12.5** Use of `MPI_WIN_LOCK` and `MPI_WIN_UNLOCK`.

```
MPI_Win_lock(MPI_LOCK_EXCLUSIVE, rank, assert, win);
MPI_Put(..., rank, ..., win);
MPI_Win_unlock(rank, win);
```

The call to `MPI_WIN_UNLOCK` will not return until the put transfer has completed at the origin and at the target. This still leaves much freedom to implementors. The call to `MPI_WIN_LOCK` may block until an exclusive lock on the window is acquired; or, the first two calls may not block, while `MPI_WIN_UNLOCK` blocks until a lock is acquired—the update of the target window is then postponed until the call to `MPI_WIN_UNLOCK` occurs. However, if the call to `MPI_WIN_LOCK` is used to lock a local window, then the call must block until the lock is acquired, since the lock may protect local load/store accesses to the window issued after the lock call returns.

#### 12.5.4 Flush and Sync

All flush and sync functions can be called only within passive target epochs.

```
MPI_WIN_FLUSH(rank, win)
```

IN	rank	rank of target window (non-negative integer)
IN	win	window object (handle)

#### C binding

```
int MPI_Win_flush(int rank, MPI_Win win)
```

**Fortran 2008 binding**

```

1 MPI_Win_flush(rank, win, ierror)
2     INTEGER, INTENT(IN) :: rank
3     TYPE(MPI_Win), INTENT(IN) :: win
4     INTEGER, OPTIONAL, INTENT(OUT) :: ierror

```

**Fortran binding**

```

7 MPI_WIN_FLUSH(RANK, WIN, IERROR)
8     INTEGER RANK, WIN, IERROR

```

MPI\_WIN\_FLUSH completes all outstanding RMA operations initiated by the calling process to the target rank on the specified window. The operations are completed both at the origin and at the target.

**MPI\_WIN\_FLUSH\_ALL(win)**

```

15     IN        win                window object (handle)

```

**C binding**

```

19 int MPI_Win_flush_all(MPI_Win win)

```

**Fortran 2008 binding**

```

22 MPI_Win_flush_all(win, ierror)
23     TYPE(MPI_Win), INTENT(IN) :: win
24     INTEGER, OPTIONAL, INTENT(OUT) :: ierror

```

**Fortran binding**

```

26 MPI_WIN_FLUSH_ALL(WIN, IERROR)
27     INTEGER WIN, IERROR

```

All RMA operations issued by the calling process to any target on the specified window prior to this call and in the specified window will have completed both at the origin and at the target when this call returns.

**MPI\_WIN\_FLUSH\_LOCAL(rank, win)**

```

35     IN        rank                rank of target window (non-negative integer)
36     IN        win                window object (handle)

```

**C binding**

```

39 int MPI_Win_flush_local(int rank, MPI_Win win)

```

**Fortran 2008 binding**

```

42 MPI_Win_flush_local(rank, win, ierror)
43     INTEGER, INTENT(IN) :: rank
44     TYPE(MPI_Win), INTENT(IN) :: win
45     INTEGER, OPTIONAL, INTENT(OUT) :: ierror

```

**Fortran binding**

```

47 MPI_WIN_FLUSH_LOCAL(RANK, WIN, IERROR)

```

INTEGER RANK, WIN, IERROR

Locally completes at the origin all outstanding RMA operations initiated by the calling process to the target process specified by rank on the specified window. For example, after this routine completes, the user may reuse any buffers provided to put, get, or accumulate operations.

`MPI_WIN_FLUSH_LOCAL_ALL(win)`

IN win window object (handle)

#### C binding

`int MPI_Win_flush_local_all(MPI_Win win)`

#### Fortran 2008 binding

`MPI_Win_flush_local_all(win, ierror)`  
 TYPE(MPI\_Win), INTENT(IN) :: win  
 INTEGER, OPTIONAL, INTENT(OUT) :: ierror

#### Fortran binding

`MPI_WIN_FLUSH_LOCAL_ALL(WIN, IERROR)`  
 INTEGER WIN, IERROR

All RMA operations issued to any target prior to this call in this window will have completed at the origin when `MPI_WIN_FLUSH_LOCAL_ALL` returns.

`MPI_WIN_SYNC(win)`

IN win window object (handle)

#### C binding

`int MPI_Win_sync(MPI_Win win)`

#### Fortran 2008 binding

`MPI_Win_sync(win, ierror)`  
 TYPE(MPI\_Win), INTENT(IN) :: win  
 INTEGER, OPTIONAL, INTENT(OUT) :: ierror

#### Fortran binding

`MPI_WIN_SYNC(WIN, IERROR)`  
 INTEGER WIN, IERROR

The call `MPI_WIN_SYNC` synchronizes the private and public window copies of `win`. For the purposes of synchronizing the private and public window, `MPI_WIN_SYNC` has the effect of ending and reopening an access and exposure epoch on the window (note that it does not actually end an epoch or complete any pending MPI RMA operations).

### 12.5.5 Assertions

The `assert` argument in the calls `MPI_WIN_POST`, `MPI_WIN_START`, `MPI_WIN_FENCE`, `MPI_WIN_LOCK`, and `MPI_WIN_LOCK_ALL` is used to provide assertions on the context of

1 the call that may be used to optimize performance. The `assert` argument does not change  
2 program semantics if it provides correct information on the program—it is erroneous to  
3 provide incorrect information. Users may always provide `assert = 0` to indicate a general  
4 case where no guarantees are made.

5  
6 *Advice to users.* Many implementations may not take advantage of the information  
7 in `assert`; some of the information is relevant only for noncoherent shared memory ma-  
8 chines. Users should consult their implementation’s manual to find which information  
9 is useful on each system. On the other hand, applications that provide correct asser-  
10 tions whenever applicable are portable and will take advantage of assertion specific  
11 optimizations whenever available. (*End of advice to users.*)

12  
13 *Advice to implementors.* Implementations can always ignore the `assert` argument.  
14 Implementors should document which `assert` values are significant on their implemen-  
15 tation. (*End of advice to implementors.*)

16 `assert` is the bit vector OR of zero or more of the following integer constants:  
17 `MPI_MODE_NOCHECK`, `MPI_MODE_NOSTORE`, `MPI_MODE_NOPUT`,  
18 `MPI_MODE_NOPRECEDE`, and `MPI_MODE_NOSUCCEED`. The significant options are listed  
19 below for each call.

20  
21 *Advice to users.* C/C++ users can use bit vector OR (`|`) to combine these constants;  
22 Fortran 90 users can use the bit vector `IOR` intrinsic. Alternatively, Fortran users can  
23 portably use integer addition to OR the constants (each constant should appear at  
24 most once in the addition!). (*End of advice to users.*)

#### 25 26 **MPI\_WIN\_START:**

27  
28 `MPI_MODE_NOCHECK`—the matching calls to `MPI_WIN_POST` have already com-  
29 pleted on all target processes when the call to `MPI_WIN_START` is made. The  
30 `nocheck` option can be specified in a start call if and only if it is specified in  
31 each matching post call. This is similar to the optimization of “ready-send” that  
32 may save a handshake when the handshake is implicit in the code. However,  
33 `ready-send` is matched by a regular receive, whereas both start and post must  
34 specify the `nocheck` option.

#### 35 36 **MPI\_WIN\_POST:**

37  
38 `MPI_MODE_NOCHECK`—the matching calls to `MPI_WIN_START` have not yet oc-  
39 curred on any origin processes when the call to `MPI_WIN_POST` is made. The  
40 `nocheck` option can be specified by a post call if and only if it is specified by each  
41 matching start call.

42  
43 `MPI_MODE_NOSTORE`—the local window was not updated by stores (or local get  
44 or receive calls) since last synchronization. This may avoid the need for cache  
45 synchronization at the post call.

46  
47 `MPI_MODE_NOPUT`—the local window will not be updated by put or accumulate calls  
48 after the post call, until the ensuing (wait) synchronization. This may avoid the  
need for cache synchronization at the wait call.

#### 49 50 **MPI\_WIN\_FENCE:**



MPI\_MODE\_NOSTORE—the local window was not updated by stores (or local get or receive calls) since last synchronization.

MPI\_MODE\_NOPUT—the local window will not be updated by put or accumulate calls after the fence call, until the ensuing (fence) synchronization.

MPI\_MODE\_NOPRECEDE—the fence does not complete any sequence of locally issued RMA calls. If this assertion is given by any process in the window group, then it must be given by all processes in the group.

MPI\_MODE\_NOSUCCEED—the fence does not start any sequence of locally issued RMA calls. If the assertion is given by any process in the window group, then it must be given by all processes in the group.

### **MPI\_WIN\_LOCK, MPI\_WIN\_LOCK\_ALL:**

MPI\_MODE\_NOCHECK—no other process holds, or will attempt to acquire, a conflicting lock, while the caller holds the window lock. This is useful when mutual exclusion is achieved by other means, but the coherence operations that may be attached to the lock and unlock calls are still required.

*Advice to users.* Note that the nostore and noprecede flags provide information on what happened *before* the call; the noput and nosucceed flags provide information on what will happen *after* the call. (*End of advice to users.*)

### 12.5.6 Miscellaneous Clarifications

Once an RMA routine completes, it is safe to free any opaque objects passed as arguments to that routine. For example, the datatype argument of a MPI\_PUT call can be freed as soon as the call returns, even though the communication may not be complete.

As in message-passing, datatypes must be committed before they can be used in RMA communication.

## 12.6 Error Handling

### 12.6.1 Error Handlers

Errors occurring during calls to routines that create MPI windows (e.g., MPI\_WIN\_CREATE (...comm,...)) cause the error handler currently associated with comm to be invoked. All other RMA calls have an input win argument. When an error occurs during such a call, the error handler currently associated with win is invoked.

The error handler MPI\_ERRORS\_ARE\_FATAL is associated with win during its creation. Users may change this default by explicitly associating a new error handler with win (see Section 9.3).

### 12.6.2 Error Classes

The error classes for one-sided communication are defined in Table 12.2. RMA routines may (and almost certainly will) use other MPI error classes, such as MPI\_ERR\_OP or MPI\_ERR\_RANK.

1	MPI_ERR_WIN	invalid win argument
2	MPI_ERR_BASE	invalid base argument
3	MPI_ERR_SIZE	invalid size argument
4	MPI_ERR_DISP	invalid disp argument
5	MPI_ERR_LOCKTYPE	invalid locktype argument
6	MPI_ERR_ASSERT	invalid assert argument
7	MPI_ERR_RMA_CONFLICT	conflicting accesses to window
8	MPI_ERR_RMA_SYNC	invalid synchronization of RMA calls
9	MPI_ERR_RMA_RANGE	target memory is not part of the window (in the case
10		of a window created with
11		MPI_WIN_CREATE_DYNAMIC, target memory is not
12		attached)
13	MPI_ERR_RMA_ATTACH	memory cannot be attached (e.g., because of resource
14		exhaustion)
15	MPI_ERR_RMA_SHARED	memory cannot be shared (e.g., some process in the
16		group of the specified communicator cannot expose
17		shared memory)
18	MPI_ERR_RMA_FLAVOR	passed window has the wrong flavor for the called
19		function
20		

Table 12.2: Error classes in one-sided communication routines

## 12.7 Semantics and Correctness

The following rules specify the latest time at which an operation must complete at the origin or the target. The update performed by a get call in the origin process memory is visible when the get operation is complete at the origin (or earlier); the update performed by a put or accumulate call in the public copy of the target window is visible when the put or accumulate has completed at the target (or earlier). The rules also specify the latest time at which an update of one window copy becomes visible in another overlapping copy.

1. An RMA operation is completed at the origin by the ensuing call to MPI\_WIN\_COMPLETE, MPI\_WIN\_FENCE, MPI\_WIN\_FLUSH, MPI\_WIN\_FLUSH\_ALL, MPI\_WIN\_FLUSH\_LOCAL, MPI\_WIN\_FLUSH\_LOCAL\_ALL, MPI\_WIN\_UNLOCK, or MPI\_WIN\_UNLOCK\_ALL that synchronizes this access at the origin.
2. If an RMA operation is completed at the origin by a call to MPI\_WIN\_FENCE then the operation is completed at the target by the matching call to MPI\_WIN\_FENCE by the target process.
3. If an RMA operation is completed at the origin by a call to MPI\_WIN\_COMPLETE then the operation is completed at the target by the matching call to MPI\_WIN\_WAIT by the target process.
4. If an RMA operation is completed at the origin by a call to MPI\_WIN\_UNLOCK, MPI\_WIN\_UNLOCK\_ALL, MPI\_WIN\_FLUSH(rank=target), or MPI\_WIN\_FLUSH\_ALL, then the operation is completed at the target by that same call.

5. An update of a location in a private window copy in process memory becomes visible in the public window copy at latest when an ensuing call to `MPI_WIN_POST`, `MPI_WIN_FENCE`, `MPI_WIN_UNLOCK`, `MPI_WIN_UNLOCK_ALL`, or `MPI_WIN_SYNC` is executed on that window by the window owner. In the RMA unified memory model, an update of a location in a private window in process memory becomes visible without additional RMA calls.
6. An update by a put or accumulate call to a public window copy becomes visible in the private copy in process memory at latest when an ensuing call to `MPI_WIN_WAIT`, `MPI_WIN_FENCE`, `MPI_WIN_LOCK`, `MPI_WIN_LOCK_ALL`, or `MPI_WIN_SYNC` is executed on that window by the window owner. In the RMA unified memory model, an update by a put or accumulate call to a public window copy eventually becomes visible in the private copy in process memory without additional RMA calls.

The `MPI_WIN_FENCE` or `MPI_WIN_WAIT` call that completes the transfer from public copy to private copy (6) is the same call that completes the put or accumulate operation in the window copy (2, 3). If a put or accumulate access was synchronized with a lock, then the update of the public window copy is complete as soon as the updating process executed `MPI_WIN_UNLOCK` or `MPI_WIN_UNLOCK_ALL`. In the RMA separate memory model, the update of a private copy in the process memory may be delayed until the target process executes a synchronization call on that window (6). Thus, updates to process memory can always be delayed in the RMA separate memory model until the process executes a suitable synchronization call, while they must complete in the RMA unified model without additional synchronization calls. If fence or post-start-complete-wait synchronization is used, updates to a public window copy can be delayed in both memory models until the window owner executes a synchronization call. When passive target synchronization is used, it is necessary to update the public window copy even if the window owner does not execute any related synchronization call.

The rules above also define, by implication, when an update to a public window copy becomes visible in another overlapping public window copy. Consider, for example, two overlapping windows, `win1` and `win2`. A call to `MPI_WIN_FENCE(0, win1)` by the window owner makes visible in the process memory previous updates to window `win1` by remote processes. A subsequent call to `MPI_WIN_FENCE(0, win2)` makes these updates visible in the public copy of `win2`.

The behavior of some MPI RMA operations may be *undefined* in certain situations. For example, the result of several origin processes performing concurrent `MPI_PUT` operations to the same target location is undefined. In addition, the result of a single origin process performing multiple `MPI_PUT` operations to the same target location within the same access epoch is also undefined. The result at the target may have all of the data from one of the `MPI_PUT` operations (the “last” one, in some sense), bytes from some of each of the operations, or something else. In MPI-2, such operations were *erroneous*. That meant that an MPI implementation was permitted to raise an error. Thus, user programs or tools that used MPI RMA could not portably permit such operations, even if the application code could function correctly with such an undefined result. Starting with MPI-3, these operations are not erroneous, but do not have a defined behavior.

*Rationale.* As discussed in [7], requiring operations such as overlapping puts to be erroneous makes it difficult to use MPI RMA to implement programming models—such as Unified Parallel C (UPC) or SHMEM—that permit these operations. Further,

1 while MPI-2 defined these operations as erroneous, the MPI Forum is unaware of any  
2 implementation that enforces this rule, as it would require significant overhead. Thus,  
3 relaxing this condition does not impact existing implementations or applications. (*End*  
4 *of rationale.*)

5  
6 *Advice to implementors.* Overlapping accesses are undefined. However, to assist  
7 users in debugging code, implementations may wish to provide a mode in which such  
8 operations are detected and reported to the user. Note, however, that starting with  
9 MPI-3, such operations must not raise an error. (*End of advice to implementors.*)

10  
11 A program with a well-defined outcome in the MPI\_WIN\_SEPARATE memory model  
12 must obey the following rules.

- 13  
14 S1. A location in a window must not be accessed with load/store operations once an  
15 update to that location has started, until the update becomes visible in the private  
16 window copy in process memory.
- 17  
18 S2. A location in a window must not be accessed as a target of an RMA operation once  
19 an update to that location has started, until the update becomes visible in the public  
20 window copy. There is one exception to this rule, in the case where the same variable  
21 is updated by two concurrent accumulates with the same predefined datatype, on  
22 the same window. Additional restrictions on the operation apply, see the info key  
23 `accumulate_ops` in Section 12.2.1.
- 24  
25 S3. A put or accumulate must not access a target window once a store or a put or accu-  
26 mulate update to another (overlapping) target window has started on a location in  
27 the target window, until the update becomes visible in the public copy of the win-  
28 dow. Conversely, a store to process memory to a location in a window must not start  
29 once a put or accumulate update to that target window has started, until the put or  
30 accumulate update becomes visible in process memory. In both cases, the restriction  
31 applies to operations even if they access disjoint locations in the window.

32  
33 *Rationale.* The last constraint on correct RMA accesses may seem unduly restric-  
34 tive, as it forbids concurrent accesses to nonoverlapping locations in a window. The  
35 reason for this constraint is that, on some architectures, explicit coherence restor-  
36 ing operations may be needed at synchronization points. A different operation may  
37 be needed for locations that were updated by stores and for locations that were re-  
38 motely updated by put or accumulate operations. Without this constraint, the MPI  
39 library would have to track precisely which locations in a window were updated by a  
40 put or accumulate call. The additional overhead of maintaining such information is  
41 considered prohibitive. (*End of rationale.*)

42  
43 Note that MPI\_WIN\_SYNC may be used within a passive target epoch to synchronize  
44 the private and public window copies (that is, updates to one are made visible to the other).

45 In the MPI\_WIN\_UNIFIED memory model, the rules are simpler because the public and  
46 private windows are the same. However, there are restrictions to avoid concurrent access  
47 to the same memory locations by different processes. The rules that a program with a  
48 well-defined outcome must obey in this case are:

- U1. A location in a window must not be accessed with load/store operations once an update to that location has started, until the update is complete, subject to the following special case.
- U2. Accessing a location in the window that is also the target of a remote update is valid (not erroneous) but the precise result will depend on the behavior of the implementation. Updates from a remote process will appear in the memory of the target, but there are no atomicity or ordering guarantees if more than one byte is updated. Updates are stable in the sense that once data appears in memory of the target, the data remains until replaced by another update. This permits polling on a location for a change from zero to non-zero or for a particular value, but not polling and comparing the relative magnitude of values. Users are cautioned that polling on one memory location and then accessing a different memory location has defined behavior only if the other rules given here and in this chapter are followed.

*Advice to users.* Some compiler optimizations can result in code that maintains the sequential semantics of the program, but violates this rule by introducing temporary values into locations in memory. Most compilers only apply such transformations under very high levels of optimization and users should be aware that such aggressive optimization may produce unexpected results. (*End of advice to users.*)

- U3. Updating a location in the window with a store operation that is also the target of a remote read (but not update) is valid (not erroneous) but the precise result will depend on the behavior of the implementation. Store updates will appear in memory, but there are no atomicity or ordering guarantees if more than one byte is updated. Updates are stable in the sense that once data appears in memory, the data remains until replaced by another update. This permits updates to memory with store operations without requiring an RMA epoch. Users are cautioned that remote accesses to a window that is updated by the local process has defined behavior only if the other rules given here and elsewhere in this chapter are followed.
- U4. A location in a window must not be accessed as a target of an RMA operation once an update to that location has started and until the update completes at the target. There is one exception to this rule: in the case where the same location is updated by two concurrent accumulates with the same predefined datatype on the same window. Additional restrictions on the operation apply; see the info key `accumulate_ops` in Section 12.2.1.
- U5. A put or accumulate must not access a target window once a store, put, or accumulate update to another (overlapping) target window has started on the same location in the target window and until the update completes at the target window. Conversely, a store operation to a location in a window must not start once a put or accumulate update to the same location in that target window has started and until the put or accumulate update completes at the target.

*Advice to users.* In the unified memory model, in the case where the window is in shared memory, `MPI_WIN_SYNC` can be used to order store operations and make store updates to the window visible to other processes and threads. Use of this

1 routine is necessary to ensure portable behavior when point-to-point, collective, or  
 2 shared memory synchronization is used in place of an RMA synchronization routine.  
 3 MPI\_WIN\_SYNC should be called by the writer before the non-RMA synchroniza-  
 4 tion operation and by the reader after the non-RMA synchronization, as shown in  
 5 Example 12.21. (*End of advice to users.*)

6 A program that violates these rules has undefined behavior.

7 *Advice to users.* A user can write correct programs by following the following rules:

8 **fence:** During each period between fence calls, each window is either updated by put  
 9 or accumulate calls, or updated by stores, but not both. Locations updated by  
 10 put or accumulate calls should not be accessed during the same period (with  
 11 the exception of concurrent updates to the same location by accumulate calls).  
 12 Locations accessed by get calls should not be updated during the same period.

13 **post-start-complete-wait:** A window should not be updated with store operations  
 14 while posted if it is being updated by put or accumulate calls. Locations updated  
 15 by put or accumulate calls should not be accessed while the window is posted  
 16 (with the exception of concurrent updates to the same location by accumulate  
 17 calls). Locations accessed by get calls should not be updated while the window  
 18 is posted.

19 With the post-start synchronization, the target process can tell the origin process  
 20 that its window is now ready for RMA access; with the complete-wait synchroni-  
 21 zation, the origin process can tell the target process that it has finished its  
 22 RMA accesses to the window.

23 **lock:** Updates to the window are protected by exclusive locks if they may conflict.  
 24 Nonconflicting accesses (such as read-only accesses or accumulate accesses) are  
 25 protected by shared locks, both for load/store accesses and for RMA accesses.

26 **changing window or synchronization mode:** One can change synchronization  
 27 mode, or change the window used to access a location that belongs to two over-  
 28 lapping windows, when the process memory and the window copy are guaranteed  
 29 to have the same values. This is true after a local call to MPI\_WIN\_FENCE, if  
 30 RMA accesses to the window are synchronized with fences; after a local call  
 31 to MPI\_WIN\_WAIT, if the accesses are synchronized with post-start-complete-  
 32 wait; after the call at the origin (local or remote) to MPI\_WIN\_UNLOCK or  
 33 MPI\_WIN\_UNLOCK\_ALL if the accesses are synchronized with locks.

34 In addition, a process should not access the local buffer of a get operation until the  
 35 operation is complete, and should not update the local buffer of a put or accumulate  
 36 operation until that operation is complete.

37 The RMA synchronization operations define when updates are guaranteed to become  
 38 visible in public and private windows. Updates may become visible earlier, but such  
 39 behavior is implementation dependent. (*End of advice to users.*)

40 The semantics are illustrated by the following examples:

41 **Example 12.6** The following example demonstrates updating a memory location inside  
 42 a window for the separate memory model, according to Rule 5. The MPI\_WIN\_LOCK  
 43 and MPI\_WIN\_UNLOCK calls around the store to X in process B are necessary to ensure  
 44 consistency between the public and private copies of the window.



```

Process A:                Process B:                1
                        window location X                2
                                                                3
                        MPI_Win_lock(EXCLUSIVE, B)        4
                        store X /* local update to private copy of B */ 5
                        MPI_Win_unlock(B)                 6
                        /* now visible in public window copy */ 7
                                                                8
MPI_Barrier                MPI_Barrier                9
                                                                10
MPI_Win_lock(EXCLUSIVE, B) 11
MPI_Get(X) /* ok, read from public window */             12
MPI_Win_unlock(B)                                           13
                                                                14

```

**Example 12.7** In the RMA unified model, although the public and private copies of the windows are synchronized, caution must be used when combining load/stores and multi-process synchronization. Although the following example appears correct, the compiler or hardware may delay the store to X after the barrier, possibly resulting in the MPI\_GET returning an incorrect value of X.

```

Process A:                Process B:                21
                        window location X                22
                                                                23
                        store X /* update to private & public copy of B */ 24
MPI_Barrier                MPI_Barrier                25
MPI_Win_lock_all          26
MPI_Get(X) /* ok, read from window */                   27
MPI_Win_flush_local(B)  28
/* read value in X */ 29
MPI_Win_unlock_all       30
                                                                31

```

MPI\_BARRIER provides process synchronization, but not memory synchronization. The example could potentially be made safe through the use of compiler- and hardware-specific notations to ensure the store to X occurs before process B enters the MPI\_BARRIER. The use of one-sided synchronization calls, as shown in Example 12.6, also ensures the correct result.

**Example 12.8** The following example demonstrates the reading of a memory location updated by a remote process (Rule 6) in the RMA separate memory model. Although the MPI\_WIN\_UNLOCK on process A and the MPI\_BARRIER ensure that the public copy on process B reflects the updated value of X, the call to MPI\_WIN\_LOCK by process B is necessary to synchronize the private copy with the public copy.

```

Process A:                Process B:                44
                        window location X                45
                                                                46
MPI_Win_lock(EXCLUSIVE, B) 47
MPI_Put(X) /* update to public window */                48
                                                                49

```

```

1 MPI_Win_unlock(B)
2
3 MPI_Barrier MPI_Barrier
4
5 MPI_Win_lock(EXCLUSIVE, B)
6 /* now visible in private copy of B */
7 load X
8 MPI_Win_unlock(B)
9

```

Note that in this example, the barrier is not critical to the semantic correctness. The use of exclusive locks guarantees a remote process will not modify the public copy after MPI\_WIN\_LOCK synchronizes the private and public copies. A polling implementation looking for changes in X on process B would be semantically correct. The barrier is required to ensure that process A performs the put operation before process B performs the load of X.

**Example 12.9** Similar to Example 12.7, the following example is unsafe even in the unified model, because the load of X can not be guaranteed to occur after the MPI\_BARRIER. While Process B does not need to explicitly synchronize the public and private copies through MPI\_WIN\_LOCK as the MPI\_PUT will update both the public and private copies of the window, the scheduling of the load could result in old values of X being returned. Compiler and hardware specific notations could ensure the load occurs after the data is updated, or explicit one-sided synchronization calls can be used to ensure the proper result.

```

24 Process A: Process B:
25 window location X
26
27 MPI_Win_lock_all
28 MPI_Put(X) /* update to window */
29 MPI_Win_flush(B)
30
31 MPI_Barrier MPI_Barrier
32 load X
33 MPI_Win_unlock_all
34

```

**Example 12.10** The following example further clarifies Rule 5. MPI\_WIN\_LOCK and MPI\_WIN\_LOCK\_ALL do *not* update the public copy of a window with changes to the private copy. Therefore, there is no guarantee that process A in the following sequence will see the value of X as updated by the local store by process B before the lock.

```

40 Process A: Process B:
41 window location X
42
43 store X /* update to private copy of B */
44 MPI_Win_lock(SHARED, B)
45 MPI_Barrier MPI_Barrier
46
47 MPI_Win_lock(SHARED, B)
48 MPI_Get(X) /* X may be the X before the store */

```



```
MPI_Win_unlock(B)
```

```

    MPI_Win_unlock(B)
    /* update on X now visible in public window */

```

The addition of an MPI\_WIN\_SYNC before the call to MPI\_BARRIER by process B would guarantee process A would see the updated value of X, as the public copy of the window would be explicitly synchronized with the private copy.

**Example 12.11** Similar to the previous example, Rule 5 can have unexpected implications for general active target synchronization with the RMA separate memory model. It is *not* guaranteed that process B reads the value of X as per the local update by process A, because neither MPI\_WIN\_WAIT nor MPI\_WIN\_COMPLETE calls by process A ensure visibility in the public window copy.

```
Process A:
```

```

window location X
window location Y

```

```
store Y
```

```
MPI_Win_post(A, B) /* Y visible in public window */
```

```
MPI_Win_start(A)      MPI_Win_start(A)
```

```
store X /* update to private window */
```

```
MPI_Win_complete
```

```
MPI_Win_complete
```

```
MPI_Win_wait
```

```
/* update on X may not yet visible in public window */
```

```
MPI_Barrier
```

```
MPI_Barrier
```

```
MPI_Win_lock(EXCLUSIVE, A)
```

```
MPI_Get(X) /* may return an obsolete value */
```

```
MPI_Get(Y)
```

```
MPI_Win_unlock(A)
```

To allow process B to read the value of X stored by A the local store must be replaced by a local MPI\_PUT that updates the public window copy. Note that by this replacement X may become visible in the private copy of process A only after the MPI\_WIN\_WAIT call in process A. The update to Y made before the MPI\_WIN\_POST call is visible in the public window after the MPI\_WIN\_POST call and therefore process B will read the proper value of Y. The MPI\_GET(Y) call could be moved to the epoch started by the MPI\_WIN\_START operation, and process B would still get the value stored by process A.

**Example 12.12** The following example demonstrates the interaction of general active target synchronization with local read operations with the RMA separate memory model. Rules 5 and 6 do *not* guarantee that the private copy of X at process B has been updated before the load takes place.

```

1 Process A:                Process B:
2                             window location X
3
4 MPI_Win_lock(EXCLUSIVE, B)
5 MPI_Put(X) /* update to public window */
6 MPI_Win_unlock(B)
7
8 MPI_Barrier                MPI_Barrier
9
10                             MPI_Win_post(B)
11                             MPI_Win_start(B)
12
13                             load X /* access to private window */
14                             /* may return an obsolete value */
15
16                             MPI_Win_complete
17                             MPI_Win_wait
18

```

19 To ensure that the value put by process A is read, the local load must be replaced with a  
20 local MPI\_GET operation, or must be placed after the call to MPI\_WIN\_WAIT.

### 21 12.7.1 Atomicity

22 The outcome of concurrent accumulate operations to the same location with the same  
23 predefined datatype is as if the accumulates were done at that location in some serial  
24 order. Additional restrictions on the operation apply; see the info key `accumulate_ops` in  
25 Section 12.2.1. Concurrent accumulate operations with different origin and target pairs are  
26 not ordered. Thus, there is no guarantee that the entire call to an accumulate operation is  
27 executed atomically. The effect of this lack of atomicity is limited: The previous correctness  
28 conditions imply that a location updated by a call to an accumulate operation cannot be  
29 accessed by a load or an RMA call other than accumulate until the accumulate operation has  
30 completed (at the target). Different interleavings can lead to different results only to the  
31 extent that computer arithmetics are not truly associative or commutative. The outcome  
32 of accumulate operations with overlapping types of different sizes or target displacements  
33 is undefined.

### 34 12.7.2 Ordering

35 Accumulate calls enable element-wise atomic read and write to remote memory locations.  
36 MPI specifies ordering between accumulate operations from an origin process to the same  
37 (or overlapping) memory locations at a target process on a per-datatype granularity. The  
38 default ordering is strict ordering, which guarantees that overlapping updates from the  
39 same origin to a remote location are committed in program order and that reads (e.g., with  
40 MPI\_GET\_ACCUMULATE) and writes (e.g., with MPI\_ACCUMULATE) are executed and  
41 committed in program order. Ordering only applies to operations originating at the same  
42 origin that access overlapping target memory regions. MPI does not provide any guarantees  
43 for accesses or updates from different origin processes to overlapping target memory regions.

44 The default strict ordering may incur a significant performance penalty. MPI specifies  
45 the info key "accumulate\_ordering" to allow relaxation of the ordering semantics when specified  
46

to any window creation function. The values for this key are as follows. If set to "none", then no ordering will be guaranteed for accumulate calls. This was the behavior for RMA in MPI-2 but has *not* been the default since MPI-3. The key can be set to a comma-separated list of required access orderings at the target. Allowed values in the comma-separated list are "rar", "war", "raw", and "waw" for read-after-read, write-after-read, read-after-write, and write-after-write ordering, respectively. These indicate whether operations of the specified type complete in the order they were issued. For example, "raw" means that any writes must complete at the target before subsequent reads. These ordering requirements apply only to operations issued by the same origin process and targeting the same target process. The default value for "accumulate\_ordering" is rar,raw,war,waw, which implies that writes complete at the target in the order in which they were issued, reads complete at the target before any writes that are issued after the reads, and writes complete at the target before any reads that are issued after the writes. Any subset of these four orderings can be specified. For example, if only read-after-read and write-after-write ordering is required, then the value of the "accumulate\_ordering" key could be set to rar,waw. The order of values is not significant.

Note that the above ordering semantics apply only to accumulate operations, not put and get. Put and get within an epoch are unordered.

### 12.7.3 Progress

One-sided communication has the same progress requirements as point-to-point communication: once a communication is enabled it is guaranteed to complete. RMA calls must have local semantics, except when required for synchronization with other RMA calls.

There is some fuzziness in the definition of the time when a RMA communication becomes enabled. This fuzziness provides to the implementor more flexibility than with point-to-point communication. Access to a target window becomes enabled once the corresponding synchronization (such as MPI\_WIN\_FENCE or MPI\_WIN\_POST) has executed. On the origin process, an RMA communication may become enabled as soon as the corresponding put, get or accumulate call has executed, or as late as when the ensuing synchronization call is issued. Once the communication is enabled both at the origin and at the target, the communication must complete.

Consider the code fragment in Example 12.4. Some of the calls may block if the target window is not posted. However, if the target window is posted, then the code fragment must complete. The data transfer may start as soon as the put call occurs, but may be delayed until the ensuing complete call occurs.

Consider the code fragment in Example 12.5. Some of the calls may block if another process holds a conflicting lock. However, if no conflicting lock is held, then the code fragment must complete.

Consider the code illustrated in Figure 12.6. Each process updates the window of the other process using a put operation, then accesses its own window. The post calls are nonblocking, and should complete. Once the post calls occur, RMA access to the windows is enabled, so that each process should complete the sequence of calls start-put-complete. Once these are done, the wait calls should complete at both processes. Thus, this communication should not deadlock, irrespective of the amount of data transferred.

Assume, in the last example, that the order of the post and start calls is reversed at each process. Then, the code may deadlock, as each process may block on the start call, waiting for the matching post to occur. Similarly, the program will deadlock if the order of the complete and wait calls is reversed at each process.

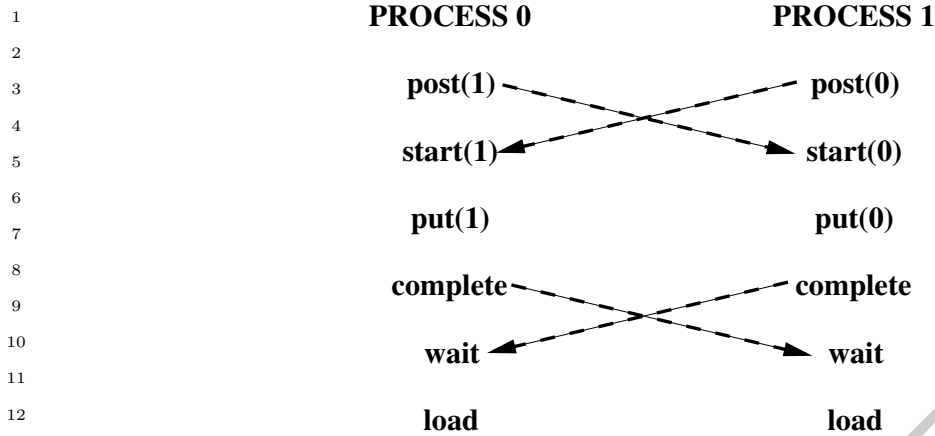

Figure 12.6: Symmetric communication

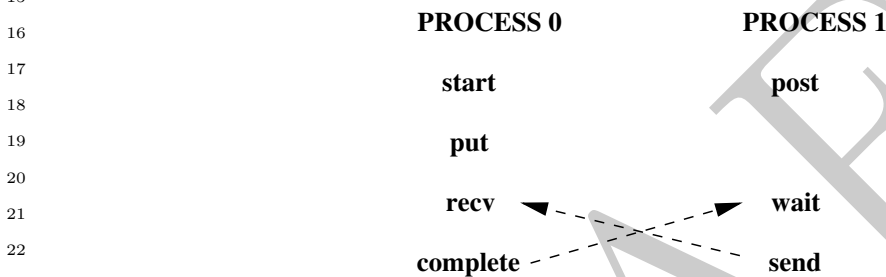

Figure 12.7: Deadlock situation

24  
25  
26  
27  
28  
29  
30  
31  
32  
33  
34

The following two examples illustrate the fact that the synchronization between complete and wait is not symmetric: the wait call blocks until the complete executes, but not vice versa. Consider the code illustrated in Figure 12.7. This code will deadlock: the wait of process 1 blocks until process 0 calls complete, and the receive of process 0 blocks until process 1 calls send. Consider, on the other hand, the code illustrated in Figure 12.8. This code will not deadlock. Once process 1 calls post, then the sequence start, put, complete on process 0 can proceed to completion. Process 0 will reach the send call, allowing the receive call of process 1 to complete.

35  
36  
37

*Rationale.* MPI implementations must guarantee that a process makes progress on all enabled communications it participates in, while blocked on an MPI call. This is true

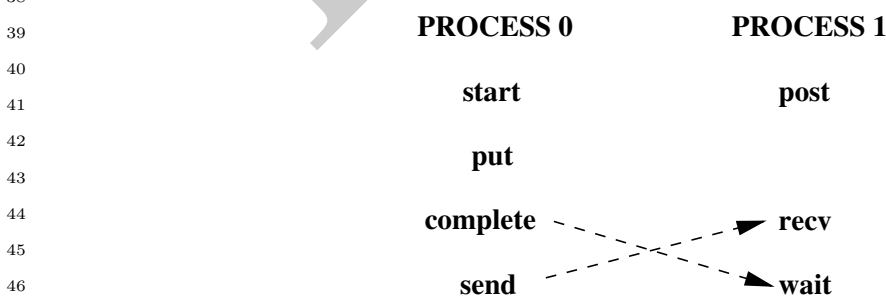

Figure 12.8: No deadlock

for send-receive communication and applies to RMA communication as well. Thus, in the example in Figure 12.8, the put and complete calls of process 0 should complete while process 1 is blocked on the receive call. This may require the involvement of process 1, e.g., to transfer the data put, while it is blocked on the receive call.

A similar issue is whether such progress must occur while a process is busy computing, or blocked in a non-MPI call. Suppose that in the last example the send-receive pair is replaced by a write-to-socket/read-from-socket pair. Then MPI does not specify whether deadlock is avoided. Suppose that the blocking receive of process 1 is replaced by a very long compute loop. Then, according to one interpretation of the MPI standard, process 0 must return from the complete call after a bounded delay, even if process 1 does not reach any MPI call in this period of time. According to another interpretation, the complete call may block until process 1 reaches the wait call, or reaches another MPI call. The qualitative behavior is the same, under both interpretations, unless a process is caught in an infinite compute loop, in which case the difference may not matter. However, the quantitative expectations are different. Different MPI implementations reflect these different interpretations. While this ambiguity is unfortunate, the MPI Forum decided not to define which interpretation of the standard is the correct one, since the issue is contentious. (*End of rationale.*)

#### 12.7.4 Registers and Compiler Optimizations

*Advice to users.* All the material in this section is an advice to users. (*End of advice to users.*)

A coherence problem exists between variables kept in registers and the memory values of these variables. An RMA call may access a variable in memory (or cache), while the up-to-date value of this variable is in register. A get will not return the latest variable value, and a put may be overwritten when the register is stored back in memory. Note that these issues are unrelated to the RMA memory model; that is, these issues apply even if the memory model is MPI\_WIN\_UNIFIED.

The problem is illustrated by the following code:

Source of Process 1	Source of Process 2	Executed in Process 2
bbbb = 777	buff = 999	reg_A:=999
call MPI_WIN_FENCE	call MPI_WIN_FENCE	
call MPI_PUT(bbbb into buff of process 2)		stop appl. thread
		buff:=777 in PUT handler
		continue appl. thread
call MPI_WIN_FENCE	call MPI_WIN_FENCE	
	ccc = buff	ccc:=reg_A

In this example, variable `buff` is allocated in the register `reg_A` and therefore `ccc` will have the old value of `buff` and not the new value `777`.

This problem, which also afflicts in some cases send/receive communication, is discussed more at length in Section 19.1.16.

Programs written in C avoid this problem, because of the semantics of C. Many Fortran compilers will avoid this problem, without disabling compiler optimizations. However, in order to avoid register coherence problems in a completely portable manner, users should

1 restrict their use of RMA windows to variables stored in modules or COMMON blocks. To  
 2 prevent problems with the argument copying and register optimization done by Fortran  
 3 compilers, please note the hints in Sections 19.1.10–19.1.20. Sections 19.1.17 to 19.1.17  
 4 discuss several solutions for the problem in this example.

## 6 12.8 Examples

9 **Example 12.13** The following example shows a generic loosely synchronous, iterative  
 10 code, using fence synchronization. The window at each process consists of array A, which  
 11 contains the origin and target buffers of the put calls.

```
12 ...
13
14 while (!converged(A)) {
15     update(A);
16     MPI_Win_fence(MPI_MODE_NOPRECEDE, win);
17     for(i=0; i < toneighbors; i++)
18         MPI_Put(&frombuf[i], 1, fromtype[i], toneighbor[i],
19               todisp[i], 1, totype[i], win);
20     MPI_Win_fence((MPI_MODE_NOSTORE | MPI_MODE_NOSUCCEED), win);
21 }
22
```

23 The same code could be written with get rather than put. Note that, during the commu-  
 24 nication phase, each window is concurrently read (as origin buffer of puts) and written (as  
 25 target buffer of puts). This is OK, provided that there is no overlap between the target  
 26 buffer of a put and another communication buffer.

27 **Example 12.14** Same generic example, with more computation/communication overlap.  
 28 We assume that the update phase is broken into two subphases: the first, where the “bound-  
 29 ary,” which is involved in communication, is updated, and the second, where the “core,”  
 30 which neither uses nor provides communicated data, is updated.

```
31 ...
32
33 while (!converged(A)) {
34     update_boundary(A);
35     MPI_Win_fence((MPI_MODE_NOPUT | MPI_MODE_NOPRECEDE), win);
36     for(i=0; i < fromneighbors; i++)
37         MPI_Get(&tobuf[i], 1, totype[i], fromneighbor[i],
38               fromdisp[i], 1, fromtype[i], win);
39     update_core(A);
40     MPI_Win_fence(MPI_MODE_NOSUCCEED, win);
41 }
42
```

43 The get communication can be concurrent with the core update, since they do not access the  
 44 same locations, and the local update of the origin buffer by the get call can be concurrent  
 45 with the local update of the core by the update\_core call. In order to get similar overlap  
 46 with put communication we would need to use separate windows for the core and for the  
 47 boundary. This is required because we do not allow local stores to be concurrent with puts  
 48 on the same, or on overlapping, windows.

**Example 12.15** Same code as in Example 12.13, rewritten using post-start-complete-wait.

```

...
while (!converged(A)) {
    update(A);
    MPI_Win_post(fromgroup, 0, win);
    MPI_Win_start(togroup, 0, win);
    for(i=0; i < toneighbors; i++)
        MPI_Put(&frombuf[i], 1, fromtype[i], toneighbor[i],
                todisp[i], 1, totype[i], win);
    MPI_Win_complete(win);
    MPI_Win_wait(win);
}

```

**Example 12.16** Same example, with split phases, as in Example 12.14.

```

...
while (!converged(A)) {
    update_boundary(A);
    MPI_Win_post(togroup, MPI_MODE_NOPUT, win);
    MPI_Win_start(fromgroup, 0, win);
    for(i=0; i < fromneighbors; i++)
        MPI_Get(&tobuf[i], 1, totype[i], fromneighbor[i],
                fromdisp[i], 1, fromtype[i], win);
    update_core(A);
    MPI_Win_complete(win);
    MPI_Win_wait(win);
}

```

**Example 12.17** A checkerboard, or double buffer communication pattern, that allows more computation/communication overlap. Array A0 is updated using values of array A1, and vice versa. We assume that communication is symmetric: if process A gets data from process B, then process B gets data from process A. Window win0 consists of array Ai.

```

...
if (!converged(A0,A1))
    MPI_Win_post(neighbors, (MPI_MODE_NOCHECK | MPI_MODE_NOPUT), win0);
MPI_Barrier(comm0);
/* the barrier is needed because the start call inside the
loop uses the nocheck option */
while (!converged(A0, A1)) {
    /* communication on A0 and computation on A1 */
    update2(A1, A0); /* local update of A1 that depends on A0 (and A1) */
    MPI_Win_start(neighbors, MPI_MODE_NOCHECK, win0);
    for(i=0; i < fromneighbors; i++)
        MPI_Get(&tobuf0[i], 1, totype0[i], neighbor[i],
                fromdisp0[i], 1, fromtype0[i], win0);
    update1(A1); /* local update of A1 that is

```

```

1          concurrent with communication that updates A0 */
2  MPI_Win_post(neighbors, (MPI_MODE_NOCHECK | MPI_MODE_NOPUT), win1);
3  MPI_Win_complete(win0);
4  MPI_Win_wait(win0);
5
6  /* communication on A1 and computation on A0 */
7  update2(A0, A1); /* local update of A0 that depends on A1 (and A0) */
8  MPI_Win_start(neighbors, MPI_MODE_NOCHECK, win1);
9  for(i=0; i < fromneighbors; i++)
10     MPI_Get(&tobuf1[i], 1, totype1[i], neighbor[i],
11            fromdisp1[i], 1, fromtype1[i], win1);
12  update1(A0); /* local update of A0 that depends on A0 only,
13              concurrent with communication that updates A1 */
14  if (!converged(A0,A1))
15     MPI_Win_post(neighbors, (MPI_MODE_NOCHECK | MPI_MODE_NOPUT), win0);
16  MPI_Win_complete(win1);
17  MPI_Win_wait(win1);
18  }

```

A process posts the local window associated with `win0` before it completes RMA accesses to the remote windows associated with `win1`. When the `wait(win1)` call returns, then all neighbors of the calling process have posted the windows associated with `win0`. Conversely, when the `wait(win0)` call returns, then all neighbors of the calling process have posted the windows associated with `win1`. Therefore, the `nocheck` option can be used with the calls to `MPI_WIN_START`.

Put calls can be used, instead of get calls, if the area of array `A0` (resp. `A1`) used by the `update(A1, A0)` (resp. `update(A0, A1)`) call is disjoint from the area modified by the RMA communication. On some systems, a put call may be more efficient than a get call, as it requires information exchange only in one direction.

In the next several examples, for conciseness, the expression

```
z = MPI_Get_accumulate(...)
```

means to perform an `MPI_GET_ACCUMULATE` with the result buffer (given by `result_addr` in the description of `MPI_GET_ACCUMULATE`) on the left side of the assignment, in this case, `z`. This format is also used with `MPI_COMPARE_AND_SWAP` and `MPI_COMM_SIZE`. Process B... refers to any process other than A.

**Example 12.18** The following example implements a naive, non-scalable counting semaphore. The example demonstrates the use of `MPI_WIN_SYNC` to manipulate the public copy of `X`, as well as `MPI_WIN_FLUSH` to complete operations without ending the access epoch opened with `MPI_WIN_LOCK_ALL`. To avoid the rules regarding synchronization of the public and private copies of windows, `MPI_ACCUMULATE` and `MPI_GET_ACCUMULATE` are used to write to or read from the local public copy.

Process A:	Process B...:
<code>MPI_Win_lock_all</code>	<code>MPI_Win_lock_all</code>
window location <code>X</code>	
<code>X=MPI_Comm_size()</code>	
<code>MPI_Win_sync</code>	



```

MPI_Barrier                               MPI_Barrier                               1
                                           2
MPI_Accumulate(X, MPI_SUM, -1)            MPI_Accumulate(X, MPI_SUM, -1)            3
                                           4
stack variable z                           stack variable z                           5
do                                           do                                           6
  z = MPI_Get_accumulate(X,                z = MPI_Get_accumulate(X,                7
    MPI_NO_OP, 0)                          MPI_NO_OP, 0)                          8
  MPI_Win_flush(A)                          MPI_Win_flush(A)                          9
while(z!=0)                                while(z!=0)                               10
                                           11
MPI_Win_unlock_all                         MPI_Win_unlock_all                         12
                                           13

```

**Example 12.19** Implementing a critical region between two processes (Peterson's algorithm). Despite their appearance in the following example, `MPI_WIN_LOCK_ALL` and `MPI_WIN_UNLOCK_ALL` are not collective calls, but it is frequently useful to start shared access epochs to all processes from all other processes in a window. Once the access epochs are established, accumulate communication operations and flush and sync synchronization operations can be used to read from or write to the public copy of the window.

```

Process A:                                Process B:                                21
window location X                          window location Y                          22
window location T                          23
                                           24
MPI_Win_lock_all                           MPI_Win_lock_all                           25
X=1                                         Y=1                                         26
MPI_Win_sync                               MPI_Win_sync                               27
MPI_Barrier                               MPI_Barrier                               28
MPI_Accumulate(T, MPI_REPLACE, 1)          MPI_Accumulate(T, MPI_REPLACE, 0)          29
stack variables t,y                       stack variable t,x                          30
t=1                                         t=0                                         31
y=MPI_Get_accumulate(Y,                   x=MPI_Get_accumulate(X,                   32
  MPI_NO_OP, 0)                            MPI_NO_OP, 0)                            33
while(y==1 && t==1) do                     while(x==1 && t==0) do                     34
  y=MPI_Get_accumulate(Y,                 x=MPI_Get_accumulate(X,                 35
    MPI_NO_OP, 0)                            MPI_NO_OP, 0)                            36
  t=MPI_Get_accumulate(T,                 t=MPI_Get_accumulate(T,                 37
    MPI_NO_OP, 0)                            MPI_NO_OP, 0)                            38
  MPI_Win_flush_all                       MPI_Win_flush(A)                          39
done                                       done                                       40
// critical region                         // critical region                         41
MPI_Accumulate(X, MPI_REPLACE, 0)          MPI_Accumulate(Y, MPI_REPLACE, 0)          42
MPI_Win_unlock_all                         MPI_Win_unlock_all                         43
                                           44

```

**Example 12.20** Implementing a critical region between multiple processes with compare and swap. The call to `MPI_WIN_SYNC` is necessary on Process A after local initialization of A to guarantee the public copy has been updated with the initialization value found in

1 the private copy. It would also be valid to call `MPI_ACCUMULATE` with `MPI_REPLACE` to  
 2 directly initialize the public copy. A call to `MPI_WIN_FLUSH` would be necessary to assure  
 3 A in the public copy of Process A had been updated before the barrier.

```

4
5 Process A:                               Process B...:
6 MPI_Win_lock_all                         MPI_Win_lock_all
7 atomic location A
8 A=0
9 MPI_Win_sync
10 MPI_Barrier                             MPI_Barrier
11 stack variable r=1                      stack variable r=1
12 while(r != 0) do                        while(r != 0) do
13   r = MPI_Compare_and_swap(A, 0, 1)      r = MPI_Compare_and_swap(A, 0, 1)
14   MPI_Win_flush(A)                      MPI_Win_flush(A)
15 done                                    done
16 // critical region                      // critical region
17 r = MPI_Compare_and_swap(A, 1, 0)        r = MPI_Compare_and_swap(A, 1, 0)
18 MPI_Win_unlock_all                      MPI_Win_unlock_all
19

```

20 **Example 12.21** The following example demonstrates the proper synchronization in the  
 21 unified memory model when a data transfer is implemented with load and store in the case  
 22 of windows in shared memory (instead of `MPI_PUT` or `MPI_GET`) and the synchronization  
 23 between processes is performed using point-to-point communication. The synchronization  
 24 between processes must be supplemented with a memory synchronization through calls to  
 25 `MPI_WIN_SYNC`, which act locally as a processor-memory barrier. In Fortran, if  
 26 `MPI_ASYNC_PROTECTS_NONBLOCKING` is `.FALSE.` or the variable X is not declared as  
 27 `ASYNCHRONOUS`, reordering of the accesses to the variable X must be prevented with  
 28 `MPI_F_SYNC_REG` operations. (No equivalent function is needed in C.)

29 The variable X is contained within a shared memory window and X corresponds to  
 30 the same memory location at both processes. The `MPI_WIN_SYNC` operation performed  
 31 by process A ensures completion of the load/store operations issued by process A. The  
 32 `MPI_WIN_SYNC` operation performed by process B ensures that process A's updates to X  
 33 are visible to process B.

```

34
35 Process A:                               Process B:
36 MPI_WIN_LOCK_ALL(                       MPI_WIN_LOCK_ALL(
37   MPI_MODE_NOCHECK,win)                 MPI_MODE_NOCHECK,win)
38
39 DO ...                                  DO ...
40   X=...
41
42   MPI_F_SYNC_REG(X)
43   MPI_WIN_SYNC(win)
44   MPI_SEND                               MPI_RECV
45                                           MPI_WIN_SYNC(win)
46                                           MPI_F_SYNC_REG(X)
47
48                                           print X

```

```

MPI_RECV                                MPI_F_SYNC_REG(X)
MPI_F_SYNC_REG(X)                      MPI_SEND
END DO                                  END DO

MPI_WIN_UNLOCK_ALL(win)                MPI_WIN_UNLOCK_ALL(win)

```

**Example 12.22** The following example shows how request-based operations can be used to overlap communication with computation. Each process fetches, processes, and writes the result for `NSTEPS` chunks of data. Instead of a single buffer, `M` local buffers are used to allow up to `M` communication operations to overlap with computation.

```

int          i, j;
MPI_Win     win;
MPI_Request  put_req[M] = { MPI_REQUEST_NULL };
MPI_Request  get_req;
double      *baseptr;
double      data[M][N];

MPI_Win_allocate(NSTEPS*N*sizeof(double), sizeof(double), MPI_INFO_NULL,
    MPI_COMM_WORLD, &baseptr, &win);

MPI_Win_lock_all(0, win);

for (i = 0; i < NSTEPS; i++) {
    if (i < M)
        j = i;
    else
        MPI_Waitany(M, put_req, &j, MPI_STATUS_IGNORE);

    MPI_Rget(data[j], N, MPI_DOUBLE, target, i*N, N, MPI_DOUBLE, win,
        &get_req);
    MPI_Wait(&get_req, MPI_STATUS_IGNORE);
    compute(i, data[j], ...);
    MPI_Rput(data[j], N, MPI_DOUBLE, target, i*N, N, MPI_DOUBLE, win,
        &put_req[j]);
}

MPI_Waitall(M, put_req, MPI_STATUSES_IGNORE);
MPI_Win_unlock_all(win);

```

**Example 12.23** The following example constructs a distributed shared linked list using dynamic windows. Initially process 0 creates the head of the list, attaches it to the window, and broadcasts the pointer to all processes. All processes then concurrently append `N` new elements to the list. When a process attempts to attach its element to the tail of the list it may discover that its tail pointer is stale and it must chase ahead to the new tail

1 before the element can be attached. This example requires some modification to work in  
 2 an environment where the layout of the structures is different on different processes.

```

3
4 ...
5 #define NUM_ELEMS 10
6
7 #define LLIST_ELEM_NEXT_RANK ( offsetof(llist_elem_t, next) + \
8                               offsetof(llist_ptr_t, rank) )
9 #define LLIST_ELEM_NEXT_DISP ( offsetof(llist_elem_t, next) + \
10                                offsetof(llist_ptr_t, disp) )
11
12 /* Linked list pointer */
13 typedef struct {
14     MPI_Aint disp;
15     int      rank;
16 } llist_ptr_t;
17
18 /* Linked list element */
19 typedef struct {
20     llist_ptr_t next;
21     int value;
22 } llist_elem_t;
23
24 const llist_ptr_t nil = { (MPI_Aint) MPI_BOTTOM, -1 };
25
26 /* List of locally allocated list elements. */
27 static llist_elem_t **my_elems = NULL;
28 static int my_elems_size = 0;
29 static int my_elems_count = 0;
30
31 /* Allocate a new shared linked list element */
32 MPI_Aint alloc_elem(int value, MPI_Win win) {
33     MPI_Aint disp;
34     llist_elem_t *elem_ptr;
35
36     /* Allocate the new element and register it with the window */
37     MPI_Alloc_mem(sizeof(llist_elem_t), MPI_INFO_NULL, &elem_ptr);
38     elem_ptr->value = value;
39     elem_ptr->next = nil;
40     MPI_Win_attach(win, elem_ptr, sizeof(llist_elem_t));
41
42     /* Add the element to the list of local elements so we can free
43        it later. */
44     if (my_elems_size == my_elems_count) {
45         my_elems_size += 100;
46         my_elems = realloc(my_elems, my_elems_size*sizeof(void*));
47     }
48     my_elems[my_elems_count] = elem_ptr;

```

```
my_elems_count++;
1
2
MPI_Get_address(elem_ptr, &disp);
3
return disp;
4
}
5
6
int main(int argc, char *argv[]) {
7
    int          procid, nproc, i;
8
    MPI_Win      llist_win;
9
    llist_ptr_t  head_ptr, tail_ptr;
10
11
    MPI_Init(&argc, &argv);
12
13
    MPI_Comm_rank(MPI_COMM_WORLD, &procid);
14
    MPI_Comm_size(MPI_COMM_WORLD, &nproc);
15
16
    MPI_Win_create_dynamic(MPI_INFO_NULL, MPI_COMM_WORLD, &llist_win);
17
18
    /* Process 0 creates the head node */
19
    if (procid == 0)
20
        head_ptr.disp = alloc_elem(-1, llist_win);
21
22
    /* Broadcast the head pointer to everyone */
23
    head_ptr.rank = 0;
24
    MPI_Bcast(&head_ptr.disp, 1, MPI_AINT, 0, MPI_COMM_WORLD);
25
    tail_ptr = head_ptr;
26
27
    /* Lock the window for shared access to all targets */
28
    MPI_Win_lock_all(0, llist_win);
29
30
    /* All processes concurrently append NUM_ELEMS elements to the list */
31
    for (i = 0; i < NUM_ELEMS; i++) {
32
        llist_ptr_t new_elem_ptr;
33
        int success;
34
35
        /* Create a new list element and attach it to the window */
36
        new_elem_ptr.rank = procid;
37
        new_elem_ptr.disp = alloc_elem(procid, llist_win);
38
39
        /* Append the new node to the list. This might take multiple
40
           attempts if others have already appended and our tail pointer
41
           is stale. */
42
        do {
43
            llist_ptr_t next_tail_ptr = nil;
44
45
            MPI_Compare_and_swap((void*) &new_elem_ptr.rank, (void*) &nil.rank,
46
                                (void*)&next_tail_ptr.rank, MPI_INT, tail_ptr.rank,
47
                                MPI_Aint_add(tail_ptr.disp, LLIST_ELEM_NEXT_RANK),
48
```

```
1         llist_win);
2
3     MPI_Win_flush(tail_ptr.rank, llist_win);
4     success = (next_tail_ptr.rank == nil.rank);
5
6     if (success) {
7         MPI_Accumulate(&new_elem_ptr.disp, 1, MPI_AINT, tail_ptr.rank,
8             MPI_Aint_add(tail_ptr.disp, LLIST_ELEM_NEXT_DISP), 1,
9             MPI_AINT, MPI_REPLACE, llist_win);
10
11         MPI_Win_flush(tail_ptr.rank, llist_win);
12         tail_ptr = new_elem_ptr;
13
14     } else {
15         /* Tail pointer is stale, fetch the displacement. May take
16            multiple tries if it is being updated. */
17         do {
18             MPI_Get_accumulate(NULL, 0, MPI_AINT, &next_tail_ptr.disp,
19                 1, MPI_AINT, tail_ptr.rank,
20                 MPI_Aint_add(tail_ptr.disp, LLIST_ELEM_NEXT_DISP),
21                 1, MPI_AINT, MPI_NO_OP, llist_win);
22
23             MPI_Win_flush(tail_ptr.rank, llist_win);
24         } while (next_tail_ptr.disp == nil.disp);
25         tail_ptr = next_tail_ptr;
26     }
27     } while (!success);
28 }
29
30 MPI_Win_unlock_all(llist_win);
31 MPI_Barrier(MPI_COMM_WORLD);
32
33 /* Free all the elements in the list */
34 for ( ; my_elems_count > 0; my_elems_count--) {
35     MPI_Win_detach(llist_win, my_elems[my_elems_count-1]);
36     MPI_Free_mem(my_elems[my_elems_count-1]);
37 }
38 MPI_Win_free(&llist_win);
39 ...
40
41
42
43
44
45
46
47
48
```

1  
2  
3  
4  
5  
6  
7  
8  
9  
10  
11  
12  
13  
14  
15  
16  
17  
18  
19  
20  
21  
22  
23  
24  
25  
26  
27  
28  
29  
30  
31  
32  
33  
34  
35  
36  
37  
38  
39  
40  
41  
42  
43  
44  
45  
46  
47  
48

# Chapter 13

## External Interfaces

### 13.1 Introduction

This chapter contains calls used to create **generalized requests**, which allow users to create new nonblocking operations with an interface similar to what is present in MPI. These calls can be used to layer new functionality on top of MPI. Next, Section 13.3 deals with setting the information found in `status`. This functionality is needed for generalized requests.

### 13.2 Generalized Requests

The goal of generalized requests is to allow users to define new nonblocking operations. Such an outstanding nonblocking operation is represented by a (generalized) request. A fundamental property of nonblocking operations is that progress toward the completion of this operation occurs asynchronously, i.e., concurrently with normal program execution. Typically, this requires execution of code concurrently with the execution of the user code, e.g., in a separate thread or in a signal handler. Operating systems provide a variety of mechanisms in support of concurrent execution. MPI does not attempt to standardize or to replace these mechanisms: it is assumed programmers who wish to define new asynchronous operations will use the mechanisms provided by the underlying operating system. Thus, the calls in this section only provide a means for defining the effect of MPI calls such as `MPI_WAIT` or `MPI_CANCEL` when they apply to generalized requests, and for signaling to MPI the completion of a generalized operation.

*Rationale.* It is tempting to also define an MPI standard mechanism for achieving concurrent execution of user-defined nonblocking operations. However, it is difficult to define such a mechanism without consideration of the specific mechanisms used in the operating system. The Forum feels that concurrency mechanisms are a proper part of the underlying operating system and should not be standardized by MPI; the MPI standard should only deal with the interaction of such mechanisms with MPI. (*End of rationale.*)

For a regular request, the operation associated with the request is performed by the MPI implementation, and the operation completes without intervention by the application. For a generalized request, the operation associated with the request is performed by the application; therefore, the application must notify MPI through a call to

1 MPI\_GREQUEST\_COMPLETE when the operation completes. MPI maintains the “completion”  
 2 status of generalized requests. Any other request state has to be maintained by the  
 3 user.

4 A new generalized request is started with

5  
 6  
 7 MPI\_GREQUEST\_START(query\_fn, free\_fn, cancel\_fn, extra\_state, request)

8	IN	query_fn	callback function invoked when request status is queried (function)
9			
10	IN	free_fn	callback function invoked when request is freed (function)
11			
12			
13	IN	cancel_fn	callback function invoked when request is cancelled (function)
14			
15	IN	extra_state	extra state
16	OUT	request	generalized request (handle)
17			

### 18 C binding

```
19 int MPI_Grequest_start(MPI_Grequest_query_function *query_fn,
20                       MPI_Grequest_free_function *free_fn,
21                       MPI_Grequest_cancel_function *cancel_fn, void *extra_state,
22                       MPI_Request *request)
23
```

### 24 Fortran 2008 binding

```
25 MPI_Grequest_start(query_fn, free_fn, cancel_fn, extra_state, request,
26                   ierror)
27     PROCEDURE(MPI_Grequest_query_function), INTENT(IN) :: query_fn
28     PROCEDURE(MPI_Grequest_free_function), INTENT(IN) :: free_fn
29     PROCEDURE(MPI_Grequest_cancel_function), INTENT(IN) :: cancel_fn
30     INTEGER(KIND=MPI_ADDRESS_KIND), INTENT(IN) :: extra_state
31     TYPE(MPI_Request), INTENT(OUT) :: request
32     INTEGER, OPTIONAL, INTENT(OUT) :: ierror
33
```

### 34 Fortran binding

```
35 MPI_GREQUEST_START(QUERY_FN, FREE_FN, CANCEL_FN, EXTRA_STATE, REQUEST,
36                   IERROR)
37     EXTERNAL QUERY_FN, FREE_FN, CANCEL_FN
38     INTEGER(KIND=MPI_ADDRESS_KIND) EXTRA_STATE
39     INTEGER REQUEST, IERROR
40
```

41 *Advice to users.* Note that a generalized request is of the same type as regular  
 42 requests, in C and Fortran. (*End of advice to users.*)

43  
 44 The call starts a generalized request and returns a handle to it in request.

45 The syntax and meaning of the callback functions are listed below. All callback func-  
 46 tions are passed the extra\_state argument that was associated with the request by the  
 47 starting call MPI\_GREQUEST\_START; extra\_state can be used to maintain user-defined  
 48 state for the request.



In C, the query function is

```
typedef int MPI_Grequest_query_function(void *extra_state,
                                       MPI_Status *status);
```

in Fortran with the `mpi_f08` module

```
ABSTRACT INTERFACE
```

```
  SUBROUTINE MPI_Grequest_query_function(extra_state, status, ierror)
    INTEGER(KIND=MPI_ADDRESS_KIND) :: extra_state
    TYPE(MPI_Status) :: status
    INTEGER :: ierror
```

in Fortran with the `mpi` module and `mpif.h`

```
SUBROUTINE GREQUEST_QUERY_FUNCTION(EXTRA_STATE, STATUS, IERROR)
  INTEGER(KIND=MPI_ADDRESS_KIND) EXTRA_STATE
  INTEGER STATUS(MPI_STATUS_SIZE), IERROR
```

The `query_fn` function computes the status that should be returned for the generalized request. The status also includes information about successful/unsuccessful cancellation of the request (result to be returned by `MPI_TEST_CANCELLED`).

The `query_fn` callback is invoked by the `MPI_{WAIT|TEST}{ANY|SOME|ALL}` call that completed the generalized request associated with this callback. The callback function is also invoked by calls to `MPI_REQUEST_GET_STATUS`, if the request is complete when the call occurs. In both cases, the callback is passed a reference to the corresponding status variable passed by the user to the MPI call; the status set by the callback function is returned by the MPI call. If the user provided `MPI_STATUS_IGNORE` or `MPI_STATUSES_IGNORE` to the MPI function that causes `query_fn` to be called, then MPI will pass a valid status object to `query_fn`, and this status will be ignored upon return of the callback function. Note that `query_fn` is invoked only after `MPI_GREQUEST_COMPLETE` is called on the request; it may be invoked several times for the same generalized request, e.g., if the user calls `MPI_REQUEST_GET_STATUS` several times for this request. Note also that a call to `MPI_{WAIT|TEST}{SOME|ALL}` may cause multiple invocations of `query_fn` callback functions, one for each generalized request that is completed by the MPI call. The order of these invocations is not specified by MPI.

In C, the free function is

```
typedef int MPI_Grequest_free_function(void *extra_state);
```

in Fortran with the `mpi_f08` module

```
ABSTRACT INTERFACE
```

```
  SUBROUTINE MPI_Grequest_free_function(extra_state, ierror)
    INTEGER(KIND=MPI_ADDRESS_KIND) :: extra_state
    INTEGER :: ierror
```

in Fortran with the `mpi` module and `mpif.h`

```
SUBROUTINE GREQUEST_FREE_FUNCTION(EXTRA_STATE, IERROR)
  INTEGER(KIND=MPI_ADDRESS_KIND) EXTRA_STATE
  INTEGER IERROR
```

The `free_fn` function is invoked to clean up user-allocated resources when the generalized request is freed.

The `free_fn` callback is invoked by the `MPI_{WAIT|TEST}{ANY|SOME|ALL}` call that completed the generalized request associated with this callback. `free_fn` is invoked after the call to `query_fn` for the same request. However, if the MPI call completed multiple generalized requests, the order in which `free_fn` callback functions are invoked is not specified by MPI.

The `free_fn` callback is also invoked for generalized requests that are freed by a call to `MPI_REQUEST_FREE` (no call to `MPI_{WAIT|TEST}{ANY|SOME|ALL}` will occur for such a request). In this case, the callback function will be called either in the MPI call `MPI_REQUEST_FREE(request)`, or in the MPI call `MPI_GREQUEST_COMPLETE(request)`, whichever happens last, i.e., in this case the actual freeing code is executed as soon as both calls `MPI_REQUEST_FREE` and `MPI_GREQUEST_COMPLETE` have occurred. The `request` is not deallocated until after `free_fn` completes. Note that `free_fn` will be invoked only once per request by a correct program.

*Advice to users.* Calling `MPI_REQUEST_FREE(request)` will cause the `request` handle to be set to `MPI_REQUEST_NULL`. This handle to the generalized request is no longer valid. However, user copies of this handle are valid until after `free_fn` completes since MPI does not deallocate the object until then. Since `free_fn` is not called until after `MPI_GREQUEST_COMPLETE`, the user copy of the handle can be used to make this call. Users should note that MPI will deallocate the object after `free_fn` executes. At this point, user copies of the `request` handle no longer point to a valid request. MPI will not set user copies to `MPI_REQUEST_NULL` in this case, so it is up to the user to avoid accessing this stale handle. This is a special case in which MPI defers deallocating the object until a later time that is known by the user. (*End of advice to users.*)

In C, the cancel function is

```
typedef int MPI_Grequest_cancel_function(void *extra_state, int complete);
```

in Fortran with the `mpi_f08` module

```
ABSTRACT INTERFACE
```

```
  SUBROUTINE MPI_Grequest_cancel_function(extra_state, complete, ierror)
    INTEGER(KIND=MPI_ADDRESS_KIND) :: extra_state
    LOGICAL :: complete
    INTEGER :: ierror
```

in Fortran with the `mpi` module and `mpif.h`

```
SUBROUTINE GREQUEST_CANCEL_FUNCTION(EXTRA_STATE, COMPLETE, IERROR)
  INTEGER(KIND=MPI_ADDRESS_KIND) EXTRA_STATE
  LOGICAL COMPLETE
  INTEGER IERROR
```

The `cancel_fn` function is invoked to start the cancelation of a generalized request. It is called by `MPI_CANCEL(request)`. MPI passes `complete = true` to the callback function if `MPI_GREQUEST_COMPLETE` was already called on the request, and `complete = false` otherwise.

All callback functions return an error code. The code is passed back and dealt with as appropriate for the error code by the MPI function that invoked the callback function. For example, if error codes are returned then the error code returned by the callback function will be returned by the MPI function that invoked the callback function. In the case of an `MPI_{WAIT|TEST}{ANY}` call that invokes both `query_fn` and `free_fn`, the MPI call will

return the error code returned by the last callback, namely `free_fn`. If one or more of the requests in a call to `MPI_{WAIT|TEST}{SOME|ALL}` failed, then the MPI call will return `MPI_ERR_IN_STATUS`. In such a case, if the MPI call was passed an array of statuses, then MPI will return in each of the statuses that correspond to a completed generalized request the error code returned by the corresponding invocation of its `free_fn` callback function. However, if the MPI function was passed `MPI_STATUSES_IGNORE`, then the individual error codes returned by each callback functions will be lost.

*Advice to users.* `query_fn` must *not* set the error field of `status` since `query_fn` may be called by `MPI_WAIT` or `MPI_TEST`, in which case the error field of `status` should not change. The MPI library knows the “context” in which `query_fn` is invoked and can decide correctly when to put the returned error code in the error field of `status`. (*End of advice to users.*)

`MPI_GREQUEST_COMPLETE(request)`

INOUT    `request`                                    generalized request (handle)

#### C binding

```
int MPI_Grequest_complete(MPI_Request request)
```

#### Fortran 2008 binding

```
MPI_Grequest_complete(request, ierror)
    TYPE(MPI_Request), INTENT(IN) :: request
    INTEGER, OPTIONAL, INTENT(OUT) :: ierror
```

#### Fortran binding

```
MPI_GREQUEST_COMPLETE(REQUEST, IERROR)
    INTEGER REQUEST, IERROR
```

The call informs MPI that the operations represented by the generalized request `request` are complete (see definitions in Section 2.4). A call to `MPI_WAIT(request, status)` will return and a call to `MPI_TEST(request, flag, status)` will return `flag = true` only after a call to `MPI_GREQUEST_COMPLETE` has declared that these operations are complete.

MPI imposes no restrictions on the code executed by the callback functions. However, new nonblocking operations should be defined so that the general semantic rules about MPI calls such as `MPI_TEST`, `MPI_REQUEST_FREE`, or `MPI_CANCEL` still hold. For example, these calls are supposed to be local and nonblocking. Therefore, the callback functions `query_fn`, `free_fn`, or `cancel_fn` should invoke blocking MPI communication calls only if the context is such that these calls are guaranteed to return in finite time. Once `MPI_CANCEL` is invoked, the cancelled operation should complete in finite time, irrespective of the state of other processes (the operation has acquired “local” semantics). It should either succeed, or fail without side-effects. The user should guarantee these same properties for newly defined operations.

*Advice to implementors.* A call to `MPI_GREQUEST_COMPLETE` may unblock a blocked user process/thread. The MPI library should ensure that the blocked user computation will resume. (*End of advice to implementors.*)

## 13.2.1 Examples

**Example 13.1** This example shows the code for a user-defined reduce operation on an `int` using a binary tree: each non-root node receives two messages, sums them, and sends them up. We assume that no status is returned and that the operation cannot be cancelled.

```

7 typedef struct {
8     MPI_Comm comm;
9     int tag;
10    int root;
11    int valin;
12    int *valout;
13    MPI_Request request;
14 } ARGS;
15
16
17 int myreduce(MPI_Comm comm, int tag, int root,
18             int valin, int *valout, MPI_Request *request)
19 {
20     ARGS *args;
21     pthread_t thread;
22
23     /* start request */
24     MPI_Grequest_start(query_fn, free_fn, cancel_fn, NULL, request);
25
26     args = (ARGS*)malloc(sizeof(ARGS));
27     args->comm = comm;
28     args->tag = tag;
29     args->root = root;
30     args->valin = valin;
31     args->valout = valout;
32     args->request = *request;
33
34     /* spawn thread to handle request */
35     /* The availability of the pthread_create call is system dependent */
36     pthread_create(&thread, NULL, reduce_thread, args);
37
38     return MPI_SUCCESS;
39 }
40
41 /* thread code */
42 void* reduce_thread(void *ptr)
43 {
44     int lchild, rchild, parent, lval, rval, val;
45     MPI_Request req[2];
46     ARGS *args;
47
48     args = (ARGS*)ptr;

```

```

1
2
3
4
5
6
7
8
9
10
11
12
13
14
15
16
17
18
19
20
21
22
23
24
25
26
27
28
29
30
31
32
33
34
35
36
37
38
39
40
41
42
43
44
45
46
47
48

```

```

/* compute left and right child and parent in tree; set
   to MPI_PROC_NULL if does not exist */
/* code not shown */
...

MPI_Irecv(&lval, 1, MPI_INT, lchild, args->tag, args->comm, &req[0]);
MPI_Irecv(&rval, 1, MPI_INT, rchild, args->tag, args->comm, &req[1]);
MPI_Waitall(2, req, MPI_STATUSES_IGNORE);
val = lval + args->valin + rval;
MPI_Send(&val, 1, MPI_INT, parent, args->tag, args->comm);
if (parent == MPI_PROC_NULL) *(args->valout) = val;
MPI_Grequest_complete((args->request));
free(ptr);
return(NULL);
}

int query_fn(void *extra_state, MPI_Status *status)
{
    /* always send just one int */
    MPI_Status_set_elements(status, MPI_INT, 1);
    /* can never cancel so always true */
    MPI_Status_set_cancelled(status, 0);
    /* choose not to return a value for this */
    status->MPI_SOURCE = MPI_UNDEFINED;
    /* tag has no meaning for this generalized request */
    status->MPI_TAG = MPI_UNDEFINED;
    /* this generalized request never fails */
    return MPI_SUCCESS;
}

int free_fn(void *extra_state)
{
    /* this generalized request does not need to do any freeing */
    /* as a result it never fails here */
    return MPI_SUCCESS;
}

int cancel_fn(void *extra_state, int complete)
{
    /* This generalized request does not support cancelling.
       Abort if not already done. If done then treat as if cancel failed.*/
    if (!complete) {
        fprintf(stderr,
            "Cannot cancel generalized request - aborting program\n");
        MPI_Abort(MPI_COMM_WORLD, 99);
    }
}

```

```

1     }
2     return MPI_SUCCESS;
3 }

```

### 13.3 Associating Information with Status

MPI supports several different types of requests besides those for point-to-point operations. These range from MPI calls for I/O to generalized requests. It is desirable to allow these calls to use the same request mechanism, which allows one to wait or test on different types of requests. However, `MPI_{TEST|WAIT}{ANY|SOME|ALL}` returns a status with information about the request. With the generalization of requests, one needs to define what information will be returned in the status object.

Each MPI call fills in the appropriate fields in the status object. Any unused fields will have undefined values. A call to `MPI_{TEST|WAIT}{ANY|SOME|ALL}` can modify any of the fields in the status object. Specifically, it can modify fields that are undefined. The fields with meaningful values for a given request are defined in the sections with the new request.

Generalized requests raise additional considerations. Here, the user provides the functions to deal with the request. Unlike other MPI calls, the user needs to provide the information to be returned in the status. The status argument is provided directly to the callback function where the status needs to be set. Users can directly set the values in 3 of the 5 status values. The count and cancel fields are opaque. To overcome this, these calls are provided:

`MPI_STATUS_SET_ELEMENTS(status, datatype, count)`

INOUT	status	status with which to associate count (status)
IN	datatype	datatype associated with count (handle)
IN	count	number of elements to associate with status (integer)

#### C binding

```

int MPI_Status_set_elements(MPI_Status *status, MPI_Datatype datatype,
    int count)

```

#### Fortran 2008 binding

```

MPI_Status_set_elements(status, datatype, count, ierror)
    TYPE(MPI_Status), INTENT(INOUT) :: status
    TYPE(MPI_Datatype), INTENT(IN) :: datatype
    INTEGER, INTENT(IN) :: count
    INTEGER, OPTIONAL, INTENT(OUT) :: ierror

```

#### Fortran binding

```

MPI_STATUS_SET_ELEMENTS(STATUS, DATATYPE, COUNT, IERROR)
    INTEGER STATUS(MPI_STATUS_SIZE), DATATYPE, COUNT, IERROR

```

MPI\_STATUS\_SET\_ELEMENTS\_X(status, datatype, count) 1

INOUT	status	status with which to associate count (status)	2
IN	datatype	datatype associated with count (handle)	3
IN	count	number of elements to associate with status (integer)	4

### C binding 7

```
int MPI_Status_set_elements_x(MPI_Status *status, MPI_Datatype datatype,
                             MPI_Count count) 8
9
10
```

### Fortran 2008 binding 11

```
MPI_Status_set_elements_x(status, datatype, count, ierror) 12
  TYPE(MPI_Status), INTENT(INOUT) :: status 13
  TYPE(MPI_Datatype), INTENT(IN) :: datatype 14
  INTEGER(KIND=MPI_COUNT_KIND), INTENT(IN) :: count 15
  INTEGER, OPTIONAL, INTENT(OUT) :: ierror 16
17
```

### Fortran binding 18

```
MPI_STATUS_SET_ELEMENTS_X(STATUS, DATATYPE, COUNT, IERROR) 18
  INTEGER STATUS(MPI_STATUS_SIZE), DATATYPE, IERROR 19
  INTEGER(KIND=MPI_COUNT_KIND) COUNT 20
21
```

These functions modify the opaque part of status so that a call to MPI\_GET\_ELEMENTS or MPI\_GET\_ELEMENTS\_X will return count. MPI\_GET\_COUNT will return a compatible value. 22  
23  
24

*Rationale.* The number of elements is set instead of the count because the former can deal with a nonintegral number of datatypes. (*End of rationale.*) 25  
26  
27

A subsequent call to MPI\_GET\_COUNT(status, datatype, count), MPI\_GET\_ELEMENTS(status, datatype, count), or MPI\_GET\_ELEMENTS\_X(status, datatype, count) must use a datatype argument that has the same type signature as the datatype argument that was used in the call to MPI\_STATUS\_SET\_ELEMENTS or MPI\_STATUS\_SET\_ELEMENTS\_X. 28  
29  
30  
31  
32  
33

*Rationale.* The requirement of matching type signatures for these calls is similar to the restriction that holds when count is set by a receive operation: in that case, the calls to MPI\_GET\_COUNT, MPI\_GET\_ELEMENTS, and MPI\_GET\_ELEMENTS\_X must use a datatype with the same signature as the datatype used in the receive call. (*End of rationale.*) 34  
35  
36  
37  
38  
39  
40  
41

MPI\_STATUS\_SET\_CANCELLED(status, flag) 42

INOUT	status	status with which to associate cancel flag (status)	43
IN	flag	if true, indicates request was cancelled (logical)	44

### C binding 47

```
int MPI_Status_set_cancelled(MPI_Status *status, int flag) 48
```

**Fortran 2008 binding**

```
MPI_Status_set_cancelled(status, flag, ierror)
  TYPE(MPI_Status), INTENT(INOUT) :: status
  LOGICAL, INTENT(IN) :: flag
  INTEGER, OPTIONAL, INTENT(OUT) :: ierror
```

**Fortran binding**

```
MPI_STATUS_SET_CANCELLED(STATUS, FLAG, IERROR)
  INTEGER STATUS(MPI_STATUS_SIZE), IERROR
  LOGICAL FLAG
```

If `flag` is set to true then a subsequent call to `MPI_TEST_CANCELLED(status, flag)` will also return `flag = true`, otherwise it will return false.

*Advice to users.* Users are advised not to reuse the status fields for values other than those for which they were intended. Doing so may lead to unexpected results when using the status object. For example, calling `MPI_GET_ELEMENTS` may cause an error if the value is out of range or it may be impossible to detect such an error. The `extra_state` argument provided with a generalized request can be used to return information that does not logically belong in status. Furthermore, modifying the values in a status set internally by MPI, e.g., `MPI_RECV`, may lead to unpredictable results and is strongly discouraged. (*End of advice to users.*)



1  
2  
3  
4  
5  
6  
7  
8  
9  
10  
11  
12  
13  
14  
15  
16  
17  
18  
19  
20  
21  
22  
23  
24  
25  
26  
27  
28  
29  
30  
31  
32  
33  
34  
35  
36  
37  
38  
39  
40  
41  
42  
43  
44  
45  
46  
47  
48

# Chapter 14

## I/O

### 14.1 Introduction

POSIX provides a model of a widely portable file system, but the portability and optimization needed for parallel I/O cannot be achieved with the POSIX interface.

The significant optimizations required for efficiency (e.g., grouping [54], collective buffering [8, 16, 55, 59, 66], and disk-directed I/O [48]) can only be implemented if the parallel I/O system provides a high-level interface supporting partitioning of file data among processes and a collective interface supporting complete transfers of global data structures between process memories and files. In addition, further efficiencies can be gained via support for asynchronous I/O, strided accesses, and control over physical file layout on storage devices (disks). The I/O environment described in this chapter provides these facilities.

Instead of defining I/O access modes to express the common patterns for accessing a shared file (broadcast, reduction, scatter, gather), we chose another approach in which data partitioning is expressed using derived datatypes. Compared to a limited set of predefined access patterns, this approach has the advantage of added flexibility and expressiveness.

#### 14.1.1 Definitions

**file** An MPI file is an ordered collection of typed data items. MPI supports random or sequential access to any integral set of these items. A file is opened collectively by a group of processes. All collective I/O calls on a file are collective over this group.

**displacement** A file *displacement* is an absolute byte position relative to the beginning of a file. The displacement defines the location where a *view* begins. Note that a “file displacement” is distinct from a “typemap displacement.”

**etype** An *etype* (*elementary* datatype) is the unit of data access and positioning. It can be any MPI predefined or derived datatype. Derived etypes can be constructed using any of the MPI datatype constructor routines, provided all resulting typemap displacements are non-negative and monotonically nondecreasing. Data access is performed in etype units, reading or writing whole data items of type etype. Offsets are expressed as a count of etypes; file pointers point to the beginning of etypes. Depending on context, the term “etype” is used to describe one of three aspects of an elementary datatype: a particular MPI type, a data item of that type, or the extent of that type.

**filetype** A *filetype* is the basis for partitioning a file among processes and defines a template for accessing the file. A filetype is either a single etype or a derived MPI datatype constructed from multiple instances of the same etype. In addition, the extent of any hole in the filetype must be a multiple of the etype's extent. The displacements in the typemap of the filetype are not required to be distinct, but they must be non-negative and monotonically nondecreasing.

**view** A *view* defines the current set of data visible and accessible from an open file as an ordered set of etypes. Each process has its own view of the file, defined by three quantities: a displacement, an etype, and a filetype. The pattern described by a filetype is repeated, beginning at the displacement, to define the view. The pattern of repetition is defined to be the same pattern that `MPI_TYPE_CONTIGUOUS` would produce if it were passed the filetype and an arbitrarily large count. Figure 14.1 shows how the tiling works; note that the filetype in this example must have explicit lower and upper bounds set in order for the initial and final holes to be repeated in the view. Views can be changed by the user during program execution. The default view is a linear byte stream (displacement is zero, etype and filetype equal to `MPI_BYTE`).

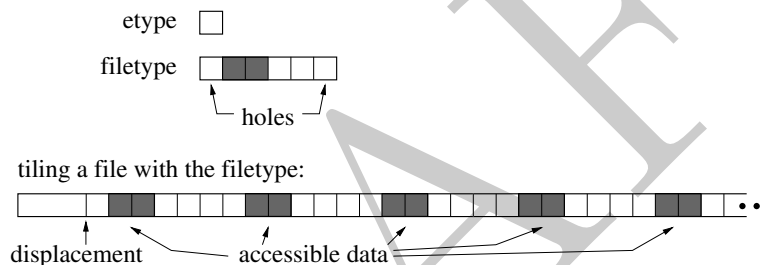

Figure 14.1: Etypes and filetypes

A group of processes can use complementary views to achieve a global data distribution such as a scatter/gather pattern (see Figure 14.2).



Figure 14.2: Partitioning a file among parallel processes

**offset** An *offset* is a position in the file relative to the current view, expressed as a count of etypes. Holes in the view's filetype are skipped when calculating this position. Offset 0 is the location of the first etype visible in the view (after skipping the displacement and any initial holes in the view). For example, an offset of 2 for process 1 in Figure 14.2 is the position of the eighth etype in the file after the displacement. An “explicit offset” is an offset that is used as an argument in explicit data access routines.

**file size and end of file** The *size* of an MPI file is measured in bytes from the beginning of the file. A newly created file has a size of zero bytes. Using the size as an absolute displacement gives the position of the byte immediately following the last byte in the file. For any given view, the *end of file* is the offset of the first etype accessible in the current view starting after the last byte in the file.

**file pointer** A *file pointer* is an implicit offset maintained by MPI. “Individual file pointers” are file pointers that are local to each process that opened the file. A “shared file pointer” is a file pointer that is shared by the group of processes that opened the file.

**file handle** A *file handle* is an opaque object created by `MPI_FILE_OPEN` and freed by `MPI_FILE_CLOSE`. All operations on an open file reference the file through the file handle.

## 14.2 File Manipulation

### 14.2.1 Opening a File

`MPI_FILE_OPEN(comm, filename, amode, info, fh)`

IN	comm	communicator (handle)
IN	filename	name of file to open (string)
IN	amode	file access mode (integer)
IN	info	info object (handle)
OUT	fh	new file handle (handle)

#### C binding

```
int MPI_File_open(MPI_Comm comm, const char *filename, int amode,
                 MPI_Info info, MPI_File *fh)
```

#### Fortran 2008 binding

```
MPI_File_open(comm, filename, amode, info, fh, ierror)
  TYPE(MPI_Comm), INTENT(IN) :: comm
  CHARACTER(LEN=*), INTENT(IN) :: filename
  INTEGER, INTENT(IN) :: amode
  TYPE(MPI_Info), INTENT(IN) :: info
  TYPE(MPI_File), INTENT(OUT) :: fh
  INTEGER, OPTIONAL, INTENT(OUT) :: ierror
```

#### Fortran binding

```
MPI_FILE_OPEN(COMM, FILENAME, AMODE, INFO, FH, IERROR)
  INTEGER COMM, AMODE, INFO, FH, IERROR
  CHARACTER*(*) FILENAME
```

`MPI_FILE_OPEN` opens the file identified by the file name `filename` on all processes in the `comm` communicator group. `MPI_FILE_OPEN` is a collective routine: all processes must provide the same value for `amode`, and all processes must provide `filenames` that reference

1 the same file. (Values for `info` may vary.) `comm` must be an intra-communicator; it is  
2 erroneous to pass an inter-communicator to `MPI_FILE_OPEN`. Errors in `MPI_FILE_OPEN`  
3 are raised using the default file error handler (see Section 14.7). When using the World  
4 Model (Section 11.1), a process can open a file independently of other processes by using  
5 the `MPI_COMM_SELF` communicator. Applications using the Sessions Model (Section 11.3)  
6 can achieve the same result using communicators created from the "mpi://SELF" process  
7 set. The file handle returned, `fh`, can be subsequently used to access the file until the file is  
8 closed using `MPI_FILE_CLOSE`. Before calling `MPI_FINALIZE`, the user is required to close  
9 (via `MPI_FILE_CLOSE`) all files that were opened with `MPI_FILE_OPEN`. Note that the  
10 communicator `comm` is unaffected by `MPI_FILE_OPEN` and continues to be usable in all  
11 MPI routines (e.g., `MPI_SEND`). Furthermore, the use of `comm` will not interfere with I/O  
12 behavior.

13 The format for specifying the file name in the `filename` argument is implementation  
14 dependent and must be documented by the implementation.

15  
16 *Advice to implementors.* An implementation may require that `filename` include a  
17 string or strings specifying additional information about the file. Examples include  
18 the type of filesystem (e.g., a prefix of `ufs:`), a remote hostname (e.g., a prefix of  
19 `machine.univ.edu:`), or a file password (e.g., a suffix of `/PASSWORD=SECRET`). (*End*  
20 *of advice to implementors.*)

21  
22 *Advice to users.* On some implementations of MPI, the file namespace may not be  
23 identical from all processes of all applications. For example, `"/tmp/foo"` may denote  
24 different files on different processes, or a single file may have many names, dependent  
25 on process location. The user is responsible for ensuring that a single file is referenced  
26 by the `filename` argument, as it may be impossible for an implementation to detect  
27 this type of namespace error. (*End of advice to users.*)

28  
29 Initially, all processes view the file as a linear byte stream, and each process views data  
30 in its own native representation (no data representation conversion is performed). (POSIX  
31 files are linear byte streams in the native representation.) The file view can be changed via  
32 the `MPI_FILE_SET_VIEW` routine.

33 The following access modes are supported (specified in `amode`, a bit vector OR of the  
34 following integer constants):

- 35 ● `MPI_MODE_RDONLY`—read only,
- 36 ● `MPI_MODE_RDWR`—reading and writing,
- 37 ● `MPI_MODE_WRONLY`—write only,
- 38 ● `MPI_MODE_CREATE`—create the file if it does not exist,
- 39 ● `MPI_MODE_EXCL`—error if creating file that already exists,
- 40 ● `MPI_MODE_DELETE_ON_CLOSE`—delete file on close,
- 41 ● `MPI_MODE_UNIQUE_OPEN`—file will not be concurrently opened elsewhere,
- 42 ● `MPI_MODE_SEQUENTIAL`—file will only be accessed sequentially,
- 43 ● `MPI_MODE_APPEND`—set initial position of all file pointers to end of file.
- 44
- 45
- 46
- 47
- 48

*Advice to users.* C users can use bit vector `OR (|)` to combine these constants; Fortran 90 users can use the bit vector `IOR` intrinsic. Fortran 77 users can use (nonportably) bit vector `IOR` on systems that support it. Alternatively, Fortran users can portably use integer addition to `OR` the constants (each constant should appear at most once in the addition.). (*End of advice to users.*)

*Advice to implementors.* The values of these constants must be defined such that the bitwise `OR` and the sum of any distinct set of these constants is equivalent. (*End of advice to implementors.*)

The modes `MPI_MODE_RDONLY`, `MPI_MODE_RDWR`, `MPI_MODE_WRONLY`, `MPI_MODE_CREATE`, and `MPI_MODE_EXCL` have identical semantics to their POSIX counterparts [44]. Exactly one of `MPI_MODE_RDONLY`, `MPI_MODE_RDWR`, or `MPI_MODE_WRONLY`, must be specified. It is erroneous to specify `MPI_MODE_CREATE` or `MPI_MODE_EXCL` in conjunction with `MPI_MODE_RDONLY`; it is erroneous to specify `MPI_MODE_SEQUENTIAL` together with `MPI_MODE_RDWR`.

The `MPI_MODE_DELETE_ON_CLOSE` mode causes the file to be deleted (equivalent to performing an `MPI_FILE_DELETE`) when the file is closed.

The `MPI_MODE_UNIQUE_OPEN` mode allows an implementation to optimize access by eliminating the overhead of file locking. It is erroneous to open a file in this mode unless the file will not be concurrently opened elsewhere.

*Advice to users.* For `MPI_MODE_UNIQUE_OPEN`, *not opened elsewhere* includes both inside and outside the MPI environment. In particular, one needs to be aware of potential external events which may open files (e.g., automated backup facilities). When `MPI_MODE_UNIQUE_OPEN` is specified, the user is responsible for ensuring that no such external events take place. (*End of advice to users.*)

The `MPI_MODE_SEQUENTIAL` mode allows an implementation to optimize access to some sequential devices (tapes and network streams). It is erroneous to attempt nonsequential access to a file that has been opened in this mode.

Specifying `MPI_MODE_APPEND` only guarantees that all shared and individual file pointers are positioned at the initial end of file when `MPI_FILE_OPEN` returns. Subsequent positioning of file pointers is application dependent. In particular, the implementation does not ensure that all writes are appended.

Errors related to the access mode are raised in the class `MPI_ERR_AMODE`.

The `info` argument is used to provide information regarding file access patterns and file system specifics (see Section 14.2.8). The constant `MPI_INFO_NULL` can be used when no `info` needs to be specified.

*Advice to users.* Some file attributes are inherently implementation dependent (e.g., file permissions). These attributes must be set using either the `info` argument or facilities outside the scope of MPI. (*End of advice to users.*)

Files are opened by default using nonatomic mode file consistency semantics (see Section 14.6.1). The more stringent atomic mode consistency semantics, required for atomicity of conflicting accesses, can be set using `MPI_FILE_SET_ATOMICITY`.

## 14.2.2 Closing a File

MPI\_FILE\_CLOSE(fh)

INOUT fh file handle (handle)

### C binding

```
int MPI_File_close(MPI_File *fh)
```

### Fortran 2008 binding

```
MPI_File_close(fh, ierror)
  TYPE(MPI_File), INTENT(INOUT) :: fh
  INTEGER, OPTIONAL, INTENT(OUT) :: ierror
```

### Fortran binding

```
MPI_FILE_CLOSE(FH, IERROR)
  INTEGER FH, IERROR
```

MPI\_FILE\_CLOSE first synchronizes file state (equivalent to performing an MPI\_FILE\_SYNC), then closes the file associated with fh. The file is deleted if it was opened with access mode MPI\_MODE\_DELETE\_ON\_CLOSE (equivalent to performing an MPI\_FILE\_DELETE). MPI\_FILE\_CLOSE is a collective routine.

*Advice to users.* If the file is deleted on close, and there are other processes currently accessing the file, the status of the file and the behavior of future accesses by these processes are implementation dependent. (*End of advice to users.*)

The user is responsible for ensuring that all outstanding nonblocking requests and split collective operations associated with fh made by a process have completed before that process calls MPI\_FILE\_CLOSE.

The MPI\_FILE\_CLOSE routine deallocates the file handle object and sets fh to MPI\_FILE\_NULL.

## 14.2.3 Deleting a File

MPI\_FILE\_DELETE(filename, info)

IN filename name of file to delete (string)  
IN info info object (handle)

### C binding

```
int MPI_File_delete(const char *filename, MPI_Info info)
```

### Fortran 2008 binding

```
MPI_File_delete(filename, info, ierror)
  CHARACTER(LEN=*), INTENT(IN) :: filename
  TYPE(MPI_Info), INTENT(IN) :: info
  INTEGER, OPTIONAL, INTENT(OUT) :: ierror
```

**Fortran binding**

```
MPI_FILE_DELETE(FILENAME, INFO, IERROR)
  CHARACTER*(*) FILENAME
  INTEGER INFO, IERROR
```

MPI\_FILE\_DELETE deletes the file identified by the file name `filename`. If the file does not exist, MPI\_FILE\_DELETE raises an error in the class MPI\_ERR\_NO\_SUCH\_FILE.

The `info` argument can be used to provide information regarding file system specifics (see Section 14.2.8). The constant MPI\_INFO\_NULL refers to the null info, and can be used when no info needs to be specified.

If a process currently has the file open, the behavior of any access to the file (as well as the behavior of any outstanding accesses) is implementation dependent. In addition, whether an open file is deleted or not is also implementation dependent. If the file is not deleted, an error in the class MPI\_ERR\_FILE\_IN\_USE or MPI\_ERR\_ACCESS will be raised. Errors are raised using the default file error handler (see Section 14.7).

## 14.2.4 Resizing a File

```
MPI_FILE_SET_SIZE(fh, size)
```

INOUT	fh	file handle (handle)
IN	size	size to truncate or expand file (integer)

**C binding**

```
int MPI_File_set_size(MPI_File fh, MPI_Offset size)
```

**Fortran 2008 binding**

```
MPI_File_set_size(fh, size, ierror)
  TYPE(MPI_File), INTENT(IN) :: fh
  INTEGER(KIND=MPI_OFFSET_KIND), INTENT(IN) :: size
  INTEGER, OPTIONAL, INTENT(OUT) :: ierror
```

**Fortran binding**

```
MPI_FILE_SET_SIZE(FH, SIZE, IERROR)
  INTEGER FH, IERROR
  INTEGER(KIND=MPI_OFFSET_KIND) SIZE
```

MPI\_FILE\_SET\_SIZE resizes the file associated with the file handle `fh`. `size` is measured in bytes from the beginning of the file. MPI\_FILE\_SET\_SIZE is collective; all processes in the group must pass identical values for `size`.

If `size` is smaller than the current file size, the file is truncated at the position defined by `size`. The implementation is free to deallocate file blocks located beyond this position.

If `size` is larger than the current file size, the file size becomes `size`. Regions of the file that have been previously written are unaffected. The values of data in the new regions in the file (those locations with displacements between old file size and `size`) are undefined. It is implementation dependent whether the MPI\_FILE\_SET\_SIZE routine allocates file space—use MPI\_FILE\_PREALLOCATE to force file space to be reserved.

MPI\_FILE\_SET\_SIZE does not affect the individual file pointers or the shared file

1 pointer. If `MPI_MODE_SEQUENTIAL` mode was specified when the file was opened, it is  
 2 erroneous to call this routine.

3  
 4 *Advice to users.* It is possible for the file pointers to point beyond the end of file  
 5 after a `MPI_FILE_SET_SIZE` operation truncates a file. This is valid, and equivalent  
 6 to seeking beyond the current end of file. (*End of advice to users.*)

7  
 8 All nonblocking requests and split collective operations on `fh` must be completed before  
 9 calling `MPI_FILE_SET_SIZE`. Otherwise, calling `MPI_FILE_SET_SIZE` is erroneous. As far  
 10 as consistency semantics are concerned, `MPI_FILE_SET_SIZE` is a write operation that  
 11 conflicts with operations that access bytes at displacements between the old and new file  
 12 sizes (see Section 14.6.1).

### 14 14.2.5 Preallocating Space for a File

17 `MPI_FILE_PREALLOCATE(fh, size)`

18     INOUT    `fh`                           file handle (handle)  
 19     IN        `size`                        size to preallocate file (integer)

#### 22 **C binding**

23 `int MPI_File_preallocate(MPI_File fh, MPI_Offset size)`

#### 25 **Fortran 2008 binding**

26 `MPI_File_preallocate(fh, size, ierror)`  
 27     `TYPE(MPI_File), INTENT(IN) :: fh`  
 28     `INTEGER(KIND=MPI_OFFSET_KIND), INTENT(IN) :: size`  
 29     `INTEGER, OPTIONAL, INTENT(OUT) :: ierror`

#### 30 **Fortran binding**

31 `MPI_FILE_PREALLOCATE(FH, SIZE, IERROR)`  
 32     `INTEGER FH, IERROR`  
 33     `INTEGER(KIND=MPI_OFFSET_KIND) SIZE`

34  
 35 `MPI_FILE_PREALLOCATE` ensures that storage space is allocated for the first `size` bytes  
 36 of the file associated with `fh`. `MPI_FILE_PREALLOCATE` is collective; all processes in the  
 37 group must pass identical values for `size`. Regions of the file that have previously been  
 38 written are unaffected. For newly allocated regions of the file, `MPI_FILE_PREALLOCATE`  
 39 has the same effect as writing undefined data. If `size` is larger than the current file size, the  
 40 file size increases to `size`. If `size` is less than or equal to the current file size, the file size is  
 41 unchanged.

42 The treatment of file pointers, pending nonblocking accesses, and file consistency is the  
 43 same as with `MPI_FILE_SET_SIZE`. If `MPI_MODE_SEQUENTIAL` mode was specified when  
 44 the file was opened, it is erroneous to call this routine.

45  
 46 *Advice to users.* In some implementations, file preallocation may be time-consuming.  
 47 (*End of advice to users.*)



## 14.2.6 Querying the Size of a File

`MPI_FILE_GET_SIZE(fh, size)`

IN	fh	file handle (handle)
OUT	size	size of the file in bytes (integer)

**C binding**

```
int MPI_File_get_size(MPI_File fh, MPI_Offset *size)
```

**Fortran 2008 binding**

```
MPI_File_get_size(fh, size, ierror)
  TYPE(MPI_File), INTENT(IN) :: fh
  INTEGER(KIND=MPI_OFFSET_KIND), INTENT(OUT) :: size
  INTEGER, OPTIONAL, INTENT(OUT) :: ierror
```

**Fortran binding**

```
MPI_FILE_GET_SIZE(FH, SIZE, IERROR)
  INTEGER FH, IERROR
  INTEGER(KIND=MPI_OFFSET_KIND) SIZE
```

`MPI_FILE_GET_SIZE` returns, in `size`, the current size in bytes of the file associated with the file handle `fh`. As far as consistency semantics are concerned, `MPI_FILE_GET_SIZE` is a data access operation (see Section 14.6.1).

## 14.2.7 Querying File Parameters

`MPI_FILE_GET_GROUP(fh, group)`

IN	fh	file handle (handle)
OUT	group	group which opened the file (handle)

**C binding**

```
int MPI_File_get_group(MPI_File fh, MPI_Group *group)
```

**Fortran 2008 binding**

```
MPI_File_get_group(fh, group, ierror)
  TYPE(MPI_File), INTENT(IN) :: fh
  TYPE(MPI_Group), INTENT(OUT) :: group
  INTEGER, OPTIONAL, INTENT(OUT) :: ierror
```

**Fortran binding**

```
MPI_FILE_GET_GROUP(FH, GROUP, IERROR)
  INTEGER FH, GROUP, IERROR
```

`MPI_FILE_GET_GROUP` returns a duplicate of the group of the communicator used to open the file associated with `fh`. The group is returned in `group`. The user is responsible for freeing `group`.

```
1 MPI_FILE_GET_AMODE(fh, amode)
```

```
2     IN      fh                file handle (handle)
```

```
3     OUT    amode            file access mode used to open the file (integer)
```

### 6 C binding

```
7 int MPI_File_get_amode(MPI_File fh, int *amode)
```

### 8 Fortran 2008 binding

```
9 MPI_File_get_amode(fh, amode, ierror)
```

```
10     TYPE(MPI_File), INTENT(IN) :: fh
```

```
11     INTEGER, INTENT(OUT) :: amode
```

```
12     INTEGER, OPTIONAL, INTENT(OUT) :: ierror
```

### 14 Fortran binding

```
15 MPI_FILE_GET_AMODE(FH, AMODE, IERROR)
```

```
16     INTEGER FH, AMODE, IERROR
```

17 MPI\_FILE\_GET\_AMODE returns, in amode, the access mode of the file associated with  
18 fh.

20 **Example 14.1** In Fortran 77, decoding an amode bit vector will require a routine such as  
21 the following:

```
23 SUBROUTINE BIT_QUERY(TEST_BIT, MAX_BIT, AMODE, BIT_FOUND)
```

```
24 !
```

```
25 ! TEST IF THE INPUT TEST_BIT IS SET IN THE INPUT AMODE
```

```
26 ! IF SET, RETURN 1 IN BIT_FOUND, 0 OTHERWISE
```

```
27 !
```

```
28     INTEGER TEST_BIT, AMODE, BIT_FOUND, CP_AMODE, HIFOUND
```

```
29     BIT_FOUND = 0
```

```
30     CP_AMODE = AMODE
```

```
31 100 CONTINUE
```

```
32     LBIT = 0
```

```
33     HIFOUND = 0
```

```
34     DO L = MAX_BIT, 0, -1
```

```
35         MATCHER = 2**L
```

```
36         IF (CP_AMODE .GE. MATCHER .AND. HIFOUND .EQ. 0) THEN
```

```
37             HIFOUND = 1
```

```
38             LBIT = MATCHER
```

```
39             CP_AMODE = CP_AMODE - MATCHER
```

```
40         END IF
```

```
41     END DO
```

```
42     IF (HIFOUND .EQ. 1 .AND. LBIT .EQ. TEST_BIT) BIT_FOUND = 1
```

```
43     IF (BIT_FOUND .EQ. 0 .AND. HIFOUND .EQ. 1 .AND. &
```

```
44         CP_AMODE .GT. 0) GO TO 100
```

```
45 END
```

47 This routine could be called successively to decode amode, one bit at a time. For  
48 example, the following code fragment would check for MPI\_MODE\_RDONLY.

```

CALL BIT_QUERY(MPI_MODE_RDONLY, 30, AMODE, BIT_FOUND)
IF (BIT_FOUND .EQ. 1) THEN
  PRINT *, ' FOUND READ-ONLY BIT IN AMODE=', AMODE
ELSE
  PRINT *, ' READ-ONLY BIT NOT FOUND IN AMODE=', AMODE
END IF

```

### 14.2.8 File Info

Hints specified via `info` (see Chapter 10) allow a user to provide information such as file access patterns and file system specifics to direct optimization. Providing hints may enable an implementation to deliver increased I/O performance or minimize the use of system resources. An implementation is free to ignore all hints; however, applications must comply with any `info` hints they provide that are used by the MPI implementation (i.e., are returned by a call to `MPI_FILE_GET_INFO`) and that place a restriction on the behavior of the application. Hints are specified on a per file basis, in `MPI_FILE_OPEN`, `MPI_FILE_DELETE`, `MPI_FILE_SET_VIEW`, and `MPI_FILE_SET_INFO`, via the opaque `info` object. When an `info` object that specifies a subset of valid hints is passed to `MPI_FILE_SET_VIEW` or `MPI_FILE_SET_INFO`, there will be no effect on previously set or defaulted hints that the `info` does not specify.

*Advice to implementors.* It may happen that a program is coded with hints for one system, and later executes on another system that does not support these hints. In general, unsupported hints should simply be ignored. Needless to say, no hint can be mandatory. However, for each hint used by a specific implementation, a default value must be provided when the user does not specify a value for this hint. (*End of advice to implementors.*)

#### MPI\_FILE\_SET\_INFO(fh, info)

INOUT	fh	file handle (handle)
IN	info	info object (handle)

#### C binding

```
int MPI_File_set_info(MPI_File fh, MPI_Info info)
```

#### Fortran 2008 binding

```

MPI_File_set_info(fh, info, ierror)
  TYPE(MPI_File), INTENT(IN) :: fh
  TYPE(MPI_Info), INTENT(IN) :: info
  INTEGER, OPTIONAL, INTENT(OUT) :: ierror

```

#### Fortran binding

```

MPI_FILE_SET_INFO(FH, INFO, IERROR)
  INTEGER FH, INFO, IERROR

```

`MPI_FILE_SET_INFO` updates the hints of the file associated with `fh` using the hints provided in `info`. This operation has no effect on previously set or defaulted hints that are not

1 specified by `info`. It also has no effect on previously set or defaulted hints that are specified  
 2 by `info`, but are ignored by the MPI implementation in this call to `MPI_FILE_SET_INFO`.  
 3 `MPI_FILE_SET_INFO` is a collective routine. The `info` object may be different on each  
 4 process, but any `info` entries that an implementation requires to be the same on all processes  
 5 must appear with the same value in each process's `info` object.

7 *Advice to users.* Many `info` items that an implementation can use when it creates or  
 8 opens a file cannot easily be changed once the file has been created or opened. Thus,  
 9 an implementation may ignore hints issued in this call that it would have accepted in  
 10 an open call. An implementation may also be unable to update certain `info` hints in a  
 11 call to `MPI_FILE_SET_VIEW` or `MPI_FILE_SET_INFO`. `MPI_FILE_GET_INFO` can be  
 12 used to determine whether `info` changes were ignored by the implementation. (*End of*  
 13 *advice to users.*)

16 `MPI_FILE_GET_INFO(fh, info_used)`

18     IN        fh                           file handle (handle)  
 19     OUT       info\_used                   new info object (handle)

### 21 C binding

22 `int MPI_File_get_info(MPI_File fh, MPI_Info *info_used)`

### 24 Fortran 2008 binding

25 `MPI_File_get_info(fh, info_used, ierror)`  
 26     TYPE(MPI\_File), INTENT(IN) :: fh  
 27     TYPE(MPI\_Info), INTENT(OUT) :: info\_used  
 28     INTEGER, OPTIONAL, INTENT(OUT) :: ierror

### 29 Fortran binding

30 `MPI_FILE_GET_INFO(FH, INFO_USED, IERROR)`  
 31     INTEGER FH, INFO\_USED, IERROR

33 `MPI_FILE_GET_INFO` returns a new `info` object containing the hints of the file associ-  
 34 ated with `fh`. The current setting of all hints related to this file is returned in `info_used`. An  
 35 MPI implementation is required to return all hints that are supported by the implementa-  
 36 tion and have default values specified; any user-supplied hints that were not ignored by the  
 37 implementation; and any additional hints that were set by the implementation. If no such  
 38 hints exist, a handle to a newly created `info` object is returned that contains no (key,value)  
 39 pairs. The user is responsible for freeing `info_used` via `MPI_INFO_FREE`.

### 41 Reserved File Hints

42 Some potentially useful hints (`info` key values) are outlined below. The following key values  
 43 are reserved. An implementation is not required to interpret these key values, but if it does  
 44 interpret the key value, it must provide the functionality described. (For more details on  
 45 “`info`,” see Chapter 10.)

47 These hints mainly affect access patterns and the layout of data on parallel I/O devices.  
 48 For each hint name introduced, we describe the purpose of the hint, and the type of the hint

value. The “[**SAME**]” annotation specifies that the hint values provided by all participating processes must be identical; otherwise the program is erroneous. In addition, some hints are context dependent, and are only used by an implementation at specific times (e.g., “file\_perm” is only useful during file creation).

**“access\_style” (comma separated list of strings):** This hint specifies the manner in which the file will be accessed until the file is closed or until the “access\_style” key value is altered. The hint value is a comma separated list of the following: “read\_once”, “write\_once”, “read\_mostly”, “write\_mostly”, “sequential”, “reverse\_sequential”, and “random”.

**“collective\_buffering” (boolean) [**SAME**]:** This hint specifies whether the application may benefit from collective buffering. Collective buffering is an optimization performed on collective accesses. Accesses to the file are performed on behalf of all processes in the group by a number of target nodes. These target nodes coalesce small requests into large disk accesses. Valid values for this key are “true” and “false”. Collective buffering parameters are further directed via additional hints: “cb\_block\_size”, “cb\_buffer\_size”, and “cb\_nodes”.

**“cb\_block\_size” (integer) [**SAME**]:** This hint specifies the block size to be used for collective buffering file access. *Target nodes* access data in chunks of this size. The chunks are distributed among target nodes in a round-robin (cyclic) pattern.

**“cb\_buffer\_size” (integer) [**SAME**]:** This hint specifies the total buffer space that can be used for collective buffering on each target node, usually a multiple of “cb\_block\_size”.

**“cb\_nodes” (integer) [**SAME**]:** This hint specifies the number of target nodes to be used for collective buffering.

**“chunked” (comma separated list of integers) [**SAME**]:** This hint specifies that the file consists of a multidimensional array that is often accessed by subarrays. The value for this hint is a comma separated list of array dimensions, starting from the most significant one (for an array stored in row-major order, as in C, the most significant dimension is the first one; for an array stored in column-major order, as in Fortran, the most significant dimension is the last one, and array dimensions should be reversed).

**“chunked\_item” (comma separated list of integers) [**SAME**]:** This hint specifies the size of each array entry, in bytes.

**“chunked\_size” (comma separated list of integers) [**SAME**]:** This hint specifies the dimensions of the subarrays. This is a comma separated list of array dimensions, starting from the most significant one.

**“filename” (string):** This hint specifies the file name used when the file was opened. If the implementation is capable of returning the file name of an open file, it will be returned using this key by MPI\_FILE\_GET\_INFO. This key is ignored when passed to MPI\_FILE\_OPEN, MPI\_FILE\_SET\_VIEW, MPI\_FILE\_SET\_INFO, and MPI\_FILE\_DELETE.

**“file\_perm” (string) [**SAME**]:** This hint specifies the file permissions to use for file creation. Setting this hint is only useful when passed to MPI\_FILE\_OPEN with an amode

that includes `MPI_MODE_CREATE`. The set of valid values for this key is implementation dependent.

**"io\_node\_list" (comma separated list of strings) [SAME]:** This hint specifies the list of I/O devices that should be used to store the file. This hint is most relevant when the file is created.

**"nb\_proc" (integer) [SAME]:** This hint specifies the number of parallel processes that will typically be assigned to run programs that access this file. This hint is most relevant when the file is created.

**"num\_io\_nodes" (integer) [SAME]:** This hint specifies the number of I/O devices in the system. This hint is most relevant when the file is created.

**"striping\_factor" (integer) [SAME]:** This hint specifies the number of I/O devices that the file should be striped across, and is relevant only when the file is created.

**"striping\_unit" (integer) [SAME]:** This hint specifies the suggested striping unit to be used for this file. The striping unit is the amount of consecutive data assigned to one I/O device before progressing to the next device, when striping across a number of devices. It is expressed in bytes. This hint is relevant only when the file is created.

## 14.3 File Views

`MPI_FILE_SET_VIEW(fh, disp, etype, filetype, datarep, info)`

INOUT	fh	file handle (handle)
IN	disp	displacement (integer)
IN	etype	elementary datatype (handle)
IN	filetype	filetype (handle)
IN	datarep	data representation (string)
IN	info	info object (handle)

### C binding

```
int MPI_File_set_view(MPI_File fh, MPI_Offset disp, MPI_Datatype etype,
                    MPI_Datatype filetype, const char *datarep, MPI_Info info)
```

### Fortran 2008 binding

```
MPI_File_set_view(fh, disp, etype, filetype, datarep, info, ierror)
    TYPE(MPI_File), INTENT(IN) :: fh
    INTEGER(KIND=MPI_OFFSET_KIND), INTENT(IN) :: disp
    TYPE(MPI_Datatype), INTENT(IN) :: etype, filetype
    CHARACTER(LEN=*), INTENT(IN) :: datarep
    TYPE(MPI_Info), INTENT(IN) :: info
    INTEGER, OPTIONAL, INTENT(OUT) :: ierror
```

### Fortran binding

```
MPI_FILE_SET_VIEW(FH, DISP, ETYPE, FILETYPE, DATAREP, INFO, IERROR)
```

```

INTEGER FH, ETYPE, FILETYPE, INFO, IERROR
INTEGER(KIND=MPI_OFFSET_KIND) DISP
CHARACTER*(*) DATAREP

```

The `MPI_FILE_SET_VIEW` routine changes the process's view of the data in the file. The start of the view is set to `disp`; the type of data is set to `etype`; the distribution of data to processes is set to `filetype`; and the representation of data in the file is set to `datarep`. In addition, `MPI_FILE_SET_VIEW` resets the individual file pointers and the shared file pointer to zero. `MPI_FILE_SET_VIEW` is collective; the values for `datarep` and the extents of `etype` in the file data representation must be identical on all processes in the group; values for `disp`, `filetype`, and `info` may vary. The datatypes passed in `etype` and `filetype` must be committed.

The `etype` always specifies the data layout in the file. If `etype` is a portable datatype (see Section 2.4), the extent of `etype` is computed by scaling any displacements in the datatype to match the file data representation. If `etype` is not a portable datatype, no scaling is done when computing the extent of `etype`. The user must be careful when using nonportable `etypes` in heterogeneous environments; see Section 14.5.1 for further details.

If `MPI_MODE_SEQUENTIAL` mode was specified when the file was opened, the special displacement `MPI_DISPLACEMENT_CURRENT` must be passed in `disp`. This sets the displacement to the current position of the shared file pointer. `MPI_DISPLACEMENT_CURRENT` is invalid unless the `amode` for the file has `MPI_MODE_SEQUENTIAL` set.

*Rationale.* For some sequential files, such as those corresponding to magnetic tapes or streaming network connections, the *displacement* may not be meaningful. `MPI_DISPLACEMENT_CURRENT` allows the view to be changed for these types of files. (*End of rationale.*)

*Advice to implementors.* It is expected that a call to `MPI_FILE_SET_VIEW` will immediately follow `MPI_FILE_OPEN` in numerous instances. A high-quality implementation will ensure that this behavior is efficient. (*End of advice to implementors.*)

The `disp` displacement argument specifies the position (absolute offset in bytes from the beginning of the file) where the view begins.

*Advice to users.* `disp` can be used to skip headers or when the file includes a sequence of data segments that are to be accessed in different patterns (see Figure 14.3). Separate views, each using a different displacement and `filetype`, can be used to access each segment.

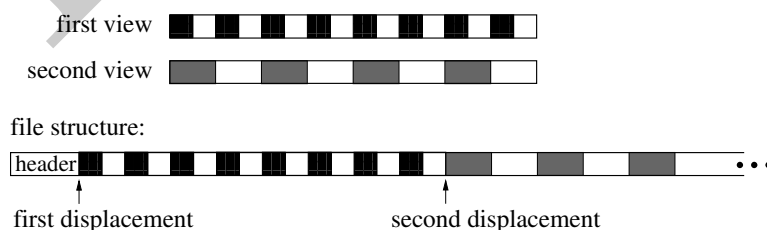

Figure 14.3: Displacements

(*End of advice to users.*)

1 An *etype* (*elementary datatype*) is the unit of data access and positioning. It can be  
 2 any MPI predefined or derived datatype. Derived etypes can be constructed by using any  
 3 of the MPI datatype constructor routines, provided all resulting typemap displacements are  
 4 non-negative and monotonically nondecreasing. Data access is performed in etype units,  
 5 reading or writing whole data items of type etype. Offsets are expressed as a count of  
 6 etypes; file pointers point to the beginning of etypes.

8 *Advice to users.* In order to ensure interoperability in a heterogeneous environ-  
 9 ment, additional restrictions must be observed when constructing the *etype* (see Sec-  
 10 tion 14.5). (*End of advice to users.*)

12 A filetype is either a single etype or a derived MPI datatype constructed from multiple  
 13 instances of the same etype. In addition, the extent of any hole in the filetype must be  
 14 a multiple of the etype’s extent. These displacements are not required to be distinct, but  
 15 they cannot be negative, and they must be monotonically nondecreasing.

16 If the file is opened for writing, neither the etype nor the filetype is permitted to  
 17 contain overlapping regions. This restriction is equivalent to the “datatype used in a receive  
 18 cannot specify overlapping regions” restriction for communication. Note that filetypes from  
 19 different processes may still overlap each other.

20 If a filetype has holes in it, then the data in the holes is inaccessible to the calling  
 21 process. However, the *disp*, *etype*, and *filetype* arguments can be changed via future calls to  
 22 `MPI_FILE_SET_VIEW` to access a different part of the file.

23 It is erroneous to use absolute addresses in the construction of the etype and filetype.

24 The *info* argument is used to provide information regarding file access patterns and file  
 25 system specifics to direct optimization (see Section 14.2.8). The constant `MPI_INFO_NULL`  
 26 refers to the null info and can be used when no info needs to be specified.

27 The *datarep* argument is a string that specifies the representation of data in the file.  
 28 See the file interoperability section (Section 14.5) for details and a discussion of valid values.

29 The user is responsible for ensuring that all nonblocking requests and split collective  
 30 operations on *fh* have been completed before calling `MPI_FILE_SET_VIEW`—otherwise, the  
 31 call to `MPI_FILE_SET_VIEW` is erroneous.

33 `MPI_FILE_GET_VIEW(fh, disp, etype, filetype, datarep)`

35	IN	<i>fh</i>	file handle (handle)
36	OUT	<i>disp</i>	displacement (integer)
37	OUT	<i>etype</i>	elementary datatype (handle)
38	OUT	<i>filetype</i>	filetype (handle)
39	OUT	<i>datarep</i>	data representation (string)

### 42 C binding

```
43 int MPI_File_get_view(MPI_File fh, MPI_Offset *disp, MPI_Datatype *etype,
44                     MPI_Datatype *filetype, char *datarep)
```

### 46 Fortran 2008 binding

```
47 MPI_File_get_view(fh, disp, etype, filetype, datarep, ierror)
48 TYPE(MPI_File), INTENT(IN) :: fh
```



```

INTEGER(KIND=MPI_OFFSET_KIND), INTENT(OUT) :: disp
TYPE(MPI_Datatype), INTENT(OUT) :: etype, filetype
CHARACTER(LEN=*), INTENT(OUT) :: datarep
INTEGER, OPTIONAL, INTENT(OUT) :: ierror

```

### Fortran binding

```

MPI_FILE_GET_VIEW(FH, DISP, ETYPE, FILETYPE, DATAREP, IERROR)
INTEGER FH, ETYPE, FILETYPE, IERROR
INTEGER(KIND=MPI_OFFSET_KIND) DISP
CHARACTER*(*) DATAREP

```

`MPI_FILE_GET_VIEW` returns the process's view of the data in the file. The current value of the displacement is returned in `disp`. The `etype` and `filetype` are new datatypes with typemaps equal to the typemaps of the current `etype` and `filetype`, respectively.

The data representation is returned in `datarep`. The user is responsible for ensuring that `datarep` is large enough to hold the returned data representation string. The length of a data representation string is limited to the value of `MPI_MAX_DATAREP_STRING`.

In addition, if a portable datatype was used to set the current view, then the corresponding datatype returned by `MPI_FILE_GET_VIEW` is also a portable datatype. If `etype` or `filetype` are derived datatypes, the user is responsible for freeing them. The `etype` and `filetype` returned are both in a committed state.

## 14.4 Data Access

### 14.4.1 Data Access Routines

Data is moved between files and processes by issuing read and write calls. There are three orthogonal aspects to data access: positioning (explicit offset *vs.* implicit file pointer), synchronism (blocking *vs.* nonblocking and split collective), and coordination (noncollective *vs.* collective). The following combinations of these data access routines, including two types of file pointers (individual and shared) are provided in Table 14.1.

positioning	synchronism	coordination	
		noncollective	collective
<i>explicit offsets</i>	<i>blocking</i>	MPI_FILE_READ_AT MPI_FILE_WRITE_AT	MPI_FILE_READ_AT_ALL MPI_FILE_WRITE_AT_ALL
	<i>nonblocking</i>	MPI_FILE_IREAD_AT MPI_FILE_IWRITE_AT	MPI_FILE_IREAD_AT_ALL MPI_FILE_IWRITE_AT_ALL
	<i>split collective</i>	N/A	MPI_FILE_READ_AT_ALL_BEGIN MPI_FILE_READ_AT_ALL_END MPI_FILE_WRITE_AT_ALL_BEGIN MPI_FILE_WRITE_AT_ALL_END
<i>individual file pointers</i>	<i>blocking</i>	MPI_FILE_READ MPI_FILE_WRITE	MPI_FILE_READ_ALL MPI_FILE_WRITE_ALL
	<i>nonblocking</i>	MPI_FILE_IREAD MPI_FILE_IWRITE	MPI_FILE_IREAD_ALL MPI_FILE_IWRITE_ALL
	<i>split collective</i>	N/A	MPI_FILE_READ_ALL_BEGIN MPI_FILE_READ_ALL_END MPI_FILE_WRITE_ALL_BEGIN MPI_FILE_WRITE_ALL_END
<i>shared file pointer</i>	<i>blocking</i>	MPI_FILE_READ_SHARED MPI_FILE_WRITE_SHARED	MPI_FILE_READ_ORDERED MPI_FILE_WRITE_ORDERED
	<i>nonblocking</i>	MPI_FILE_IREAD_SHARED MPI_FILE_IWRITE_SHARED	N/A
	<i>split collective</i>	N/A	MPI_FILE_READ_ORDERED_BEGIN MPI_FILE_READ_ORDERED_END MPI_FILE_WRITE_ORDERED_BEGIN MPI_FILE_WRITE_ORDERED_END

Table 14.1: Data access routines

1        POSIX `read()/fread()` and `write()/fwrite()` are blocking, noncollective operations  
 2 and use individual file pointers. The MPI equivalents are `MPI_FILE_READ` and  
 3 `MPI_FILE_WRITE`.

4        Implementations of data access routines may buffer data to improve performance. This  
 5 does not affect reads, as the data is always available in the user’s buffer after a read operation  
 6 completes. For writes, however, the `MPI_FILE_SYNC` routine provides the only guarantee  
 7 that data has been transferred to the storage device.  
 8

## 9 Positioning

10 MPI provides three types of positioning for data access routines: **explicit offsets**, **indi-**  
 11 **vidual file pointers**, and **shared file pointers**. The different positioning methods may  
 12 be mixed within the same program and do not affect each other.  
 13

14        The data access routines that accept explicit offsets contain `_AT` in their name (e.g.,  
 15 `MPI_FILE_WRITE_AT`). Explicit offset operations perform data access at the file position  
 16 given directly as an argument—no file pointer is used nor updated. Note that this is not  
 17 equivalent to an atomic seek-and-read or seek-and-write operation, as no “seek” is issued.  
 18 Operations with explicit offsets are described in Section 14.4.2.

19        The names of the individual file pointer routines contain no positional qualifier (e.g.,  
 20 `MPI_FILE_WRITE`). Operations with individual file pointers are described in Section 14.4.3.  
 21 The data access routines that use shared file pointers contain `_SHARED` or `_ORDERED`  
 22 in their name (e.g., `MPI_FILE_WRITE_SHARED`). Operations with shared file pointers are  
 23 described in Section 14.4.4.

24        The main semantic issues with MPI-maintained file pointers are how and when they are  
 25 updated by I/O operations. In general, each I/O operation leaves the file pointer pointing to  
 26 the next data item after the last one that is accessed by the operation. In a nonblocking or  
 27 split collective operation, the pointer is updated by the call that initiates the I/O, possibly  
 28 before the access completes.

29        More formally,

$$30 \quad \text{new\_file\_offset} = \text{old\_file\_offset} + \frac{\text{elements}(\text{datatype})}{\text{elements}(\text{etype})} \times \text{count}$$

31        where *count* is the number of *datatype* items to be accessed, *elements*(*X*) is the number of  
 32 predefined datatypes in the typemap of *X*, and *old\_file\_offset* is the value of the implicit  
 33 offset before the call. The file position, *new\_file\_offset*, is in terms of a count of etypes  
 34 relative to the current view.  
 35  
 36  
 37

## 38 Synchronism

39 MPI supports blocking and nonblocking I/O routines.

40        A *blocking* I/O call will not return until the I/O request is completed.

41        A *nonblocking* I/O call initiates an I/O operation, but does not wait for it to complete.  
 42 Given suitable hardware, this allows the transfer of data out of and into the user’s buffer  
 43 to proceed concurrently with computation. A separate *request complete* call (`MPI_WAIT`,  
 44 `MPI_TEST`, or any of their variants) is needed to complete the I/O request, i.e., to confirm  
 45 that the data has been read or written and that it is safe for the user to reuse the buffer.  
 46 The nonblocking versions of the routines are named `MPI_FILE_IXXX`, where the *I* stands  
 47 for immediate.  
 48

It is erroneous to access the local buffer of a nonblocking data access operation, or to use that buffer as the source or target of other communications, between the initiation and completion of the operation.

The split collective routines support a restricted form of “nonblocking” operations for collective data access (see Section 14.4.5).

### Coordination

Every noncollective data access routine `MPI_FILE_XXX` has a collective counterpart. For most routines, this counterpart is `MPI_FILE_XXX_ALL` or a pair of `MPI_FILE_XXX_BEGIN` and `MPI_FILE_XXX_END`. The counterparts to the `MPI_FILE_XXX_SHARED` routines are `MPI_FILE_XXX_ORDERED`.

The completion of a noncollective call only depends on the activity of the calling process. However, the completion of a collective call (which must be called by all members of the process group) may depend on the activity of the other processes participating in the collective call. See Section 14.6.4 for rules on semantics of collective calls.

Collective operations may perform much better than their noncollective counterparts, as global data accesses have significant potential for automatic optimization.

### Data Access Conventions

Data is moved between files and processes by calling read and write routines. Read routines move data from a file into memory. Write routines move data from memory into a file. The file is designated by a file handle, `fh`. The location of the file data is specified by an offset into the current view. The data in memory is specified by a triple: `buf`, `count`, and `datatype`. Upon completion, the amount of data accessed by the calling process is returned in a `status`.

An offset designates the starting position in the file for an access. The offset is always in `etype` units relative to the current view. Explicit offset routines pass `offset` as an argument (negative values are erroneous). The file pointer routines use implicit offsets maintained by MPI.

A data access routine attempts to transfer (read or write) `count` data items of type `datatype` between the user’s buffer `buf` and the file. The `datatype` passed to the routine must be a committed datatype. The layout of data in memory corresponding to `buf`, `count`, `datatype` is interpreted the same way as in MPI communication functions; see Section 3.2.2 and Section 5.1.11. The data is accessed from those parts of the file specified by the current view (Section 14.3). The type signature of `datatype` must match the type signature of some number of contiguous copies of the `etype` of the current view. As in a receive, it is erroneous to specify a `datatype` for reading that contains overlapping regions (areas of memory which would be stored into more than once).

The nonblocking data access routines indicate that MPI can start a data access and associate a request handle, `request`, with the I/O operation. Nonblocking operations are completed via `MPI_TEST`, `MPI_WAIT`, or any of their variants.

Data access operations, when completed, return the amount of data accessed in `status`.

*Advice to users.* To prevent problems with the argument copying and register optimization done by Fortran compilers, please note the hints in Sections 19.1.10–19.1.20. (*End of advice to users.*)

1 For blocking routines, `status` is returned directly. For nonblocking routines and split  
 2 collective routines, `status` is returned when the operation is completed. The number of  
 3 `datatype` entries and predefined elements accessed by the calling process can be extracted  
 4 from `status` by using `MPI_GET_COUNT` and `MPI_GET_ELEMENTS` (or  
 5 `MPI_GET_ELEMENTS_X`), respectively. The interpretation of the `MPI_ERROR` field is the  
 6 same as for other operations—normally undefined, but meaningful if an MPI routine returns  
 7 `MPI_ERR_IN_STATUS`. The user can pass (in C and Fortran) `MPI_STATUS_IGNORE` in the  
 8 `status` argument if the return value of this argument is not needed. The `status` can be  
 9 passed to `MPI_TEST_CANCELLED` to determine if the operation was cancelled. All other  
 10 fields of `status` are undefined.

11 When reading, a program can detect the end of file by noting that the amount of data  
 12 read is less than the amount requested. Writing past the end of file increases the file size.  
 13 The amount of data accessed will be the amount requested, unless an error is raised (or a  
 14 read reaches the end of file).

#### 16 14.4.2 Data Access with Explicit Offsets

17 If `MPI_MODE_SEQUENTIAL` mode was specified when the file was opened, it is erroneous to  
 18 call the routines in this section.  
 19

21 `MPI_FILE_READ_AT(fh, offset, buf, count, datatype, status)`

23	IN	<code>fh</code>	file handle (handle)
24	IN	<code>offset</code>	file offset (integer)
25	OUT	<code>buf</code>	initial address of buffer (choice)
26			
27	IN	<code>count</code>	number of elements in buffer (integer)
28	IN	<code>datatype</code>	datatype of each buffer element (handle)
29	OUT	<code>status</code>	status object (status)

#### 31 C binding

32 `int MPI_File_read_at(MPI_File fh, MPI_Offset offset, void *buf, int count,`  
 33 `MPI_Datatype datatype, MPI_Status *status)`

35 `int MPI_File_read_at_c(MPI_File fh, MPI_Offset offset, void *buf,`  
 36 `MPI_Count count, MPI_Datatype datatype, MPI_Status *status)`

#### 37 Fortran 2008 binding

38 `MPI_File_read_at(fh, offset, buf, count, datatype, status, ierror)`  
 39 `TYPE(MPI_File), INTENT(IN) :: fh`  
 40 `INTEGER(KIND=MPI_OFFSET_KIND), INTENT(IN) :: offset`  
 41 `TYPE(*), DIMENSION(..) :: buf`  
 42 `INTEGER, INTENT(IN) :: count`  
 43 `TYPE(MPI_Datatype), INTENT(IN) :: datatype`  
 44 `TYPE(MPI_Status) :: status`  
 45 `INTEGER, OPTIONAL, INTENT(OUT) :: ierror`

47 `MPI_File_read_at(fh, offset, buf, count, datatype, status, ierror)`  
 48 `TYPE(MPI_File), INTENT(IN) :: fh`

```

INTEGER(KIND=MPI_OFFSET_KIND), INTENT(IN) :: offset
TYPE(*), DIMENSION(..) :: buf
INTEGER(KIND=MPI_COUNT_KIND), INTENT(IN) :: count
TYPE(MPI_Datatype), INTENT(IN) :: datatype
TYPE(MPI_Status) :: status
INTEGER, OPTIONAL, INTENT(OUT) :: ierror

```

**Fortran binding**

```

MPI_FILE_READ_AT(FH, OFFSET, BUF, COUNT, DATATYPE, STATUS, IERROR)
  INTEGER FH, COUNT, DATATYPE, STATUS(MPI_STATUS_SIZE), IERROR
  INTEGER(KIND=MPI_OFFSET_KIND) OFFSET
  <type> BUF(*)

```

MPI\_FILE\_READ\_AT reads a file beginning at the position specified by offset.

```

MPI_FILE_READ_AT_ALL(fh, offset, buf, count, datatype, status)

```

IN	fh	file handle (handle)
IN	offset	file offset (integer)
OUT	buf	initial address of buffer (choice)
IN	count	number of elements in buffer (integer)
IN	datatype	datatype of each buffer element (handle)
OUT	status	status object (status)

**C binding**

```

int MPI_File_read_at_all(MPI_File fh, MPI_Offset offset, void *buf,
    int count, MPI_Datatype datatype, MPI_Status *status)
int MPI_File_read_at_all_c(MPI_File fh, MPI_Offset offset, void *buf,
    MPI_Count count, MPI_Datatype datatype, MPI_Status *status)

```

**Fortran 2008 binding**

```

MPI_File_read_at_all(fh, offset, buf, count, datatype, status, ierror)
  TYPE(MPI_File), INTENT(IN) :: fh
  INTEGER(KIND=MPI_OFFSET_KIND), INTENT(IN) :: offset
  TYPE(*), DIMENSION(..) :: buf
  INTEGER, INTENT(IN) :: count
  TYPE(MPI_Datatype), INTENT(IN) :: datatype
  TYPE(MPI_Status) :: status
  INTEGER, OPTIONAL, INTENT(OUT) :: ierror
MPI_File_read_at_all(fh, offset, buf, count, datatype, status, ierror)
  TYPE(MPI_File), INTENT(IN) :: fh
  INTEGER(KIND=MPI_OFFSET_KIND), INTENT(IN) :: offset
  TYPE(*), DIMENSION(..) :: buf
  INTEGER(KIND=MPI_COUNT_KIND), INTENT(IN) :: count
  TYPE(MPI_Datatype), INTENT(IN) :: datatype
  TYPE(MPI_Status) :: status

```

1       INTEGER, OPTIONAL, INTENT(OUT) :: ierror

2

### 3 Fortran binding

4 MPI\_FILE\_READ\_AT\_ALL(FH, OFFSET, BUF, COUNT, DATATYPE, STATUS, IERROR)

5       INTEGER FH, COUNT, DATATYPE, STATUS(MPI\_STATUS\_SIZE), IERROR

6       INTEGER(KIND=MPI\_OFFSET\_KIND) OFFSET

7       <type> BUF(\*)

8       MPI\_FILE\_READ\_AT\_ALL is a collective version of the blocking MPI\_FILE\_READ\_AT  
9 interface.

10

11

12

MPI\_FILE\_WRITE\_AT(fh, offset, buf, count, datatype, status)

13       INOUT fh                               file handle (handle)

14       IN       offset                       file offset (integer)

15       IN       buf                          initial address of buffer (choice)

16       IN       count                       number of elements in buffer (integer)

17       IN       datatype                   datatype of each buffer element (handle)

18       IN       status                      status object (status)

19

20

21

22

### 22 C binding

23 int MPI\_File\_write\_at(MPI\_File fh, MPI\_Offset offset, const void \*buf,  
24                       int count, MPI\_Datatype datatype, MPI\_Status \*status)

25 int MPI\_File\_write\_at\_c(MPI\_File fh, MPI\_Offset offset, const void \*buf,  
26                       MPI\_Count count, MPI\_Datatype datatype, MPI\_Status \*status)

27

28

### 28 Fortran 2008 binding

29 MPI\_File\_write\_at(fh, offset, buf, count, datatype, status, ierror)

30       TYPE(MPI\_File), INTENT(IN) :: fh

31       INTEGER(KIND=MPI\_OFFSET\_KIND), INTENT(IN) :: offset

32       TYPE(\*), DIMENSION(..), INTENT(IN) :: buf

33       INTEGER, INTENT(IN) :: count

34       TYPE(MPI\_Datatype), INTENT(IN) :: datatype

35       TYPE(MPI\_Status) :: status

36       INTEGER, OPTIONAL, INTENT(OUT) :: ierror

37

38

39

40

41

42

43

44

45

MPI\_File\_write\_at(fh, offset, buf, count, datatype, status, ierror)

38       TYPE(MPI\_File), INTENT(IN) :: fh

39       INTEGER(KIND=MPI\_OFFSET\_KIND), INTENT(IN) :: offset

40       TYPE(\*), DIMENSION(..), INTENT(IN) :: buf

41       INTEGER(KIND=MPI\_COUNT\_KIND), INTENT(IN) :: count

42       TYPE(MPI\_Datatype), INTENT(IN) :: datatype

43       TYPE(MPI\_Status) :: status

44       INTEGER, OPTIONAL, INTENT(OUT) :: ierror

45

46

### 46 Fortran binding

47 MPI\_FILE\_WRITE\_AT(FH, OFFSET, BUF, COUNT, DATATYPE, STATUS, IERROR)

48       INTEGER FH, COUNT, DATATYPE, STATUS(MPI\_STATUS\_SIZE), IERROR

```
INTEGER(KIND=MPI_OFFSET_KIND) OFFSET
```

```
<type> BUF(*)
```

MPI\_FILE\_WRITE\_AT writes a file beginning at the position specified by offset.

```
MPI_FILE_WRITE_AT_ALL(fh, offset, buf, count, datatype, status)
```

```
INOUT fh file handle (handle)
```

```
IN offset file offset (integer)
```

```
IN buf initial address of buffer (choice)
```

```
IN count number of elements in buffer (integer)
```

```
IN datatype datatype of each buffer element (handle)
```

```
OUT status status object (status)
```

### C binding

```
int MPI_File_write_at_all(MPI_File fh, MPI_Offset offset, const void *buf,
    int count, MPI_Datatype datatype, MPI_Status *status)
```

```
int MPI_File_write_at_all_c(MPI_File fh, MPI_Offset offset,
    const void *buf, MPI_Count count, MPI_Datatype datatype,
    MPI_Status *status)
```

### Fortran 2008 binding

```
MPI_File_write_at_all(fh, offset, buf, count, datatype, status, ierror)
    TYPE(MPI_File), INTENT(IN) :: fh
    INTEGER(KIND=MPI_OFFSET_KIND), INTENT(IN) :: offset
    TYPE(*), DIMENSION(..), INTENT(IN) :: buf
    INTEGER, INTENT(IN) :: count
    TYPE(MPI_Datatype), INTENT(IN) :: datatype
    TYPE(MPI_Status) :: status
    INTEGER, OPTIONAL, INTENT(OUT) :: ierror
```

```
MPI_File_write_at_all(fh, offset, buf, count, datatype, status, ierror)
    TYPE(MPI_File), INTENT(IN) :: fh
    INTEGER(KIND=MPI_OFFSET_KIND), INTENT(IN) :: offset
    TYPE(*), DIMENSION(..), INTENT(IN) :: buf
    INTEGER(KIND=MPI_COUNT_KIND), INTENT(IN) :: count
    TYPE(MPI_Datatype), INTENT(IN) :: datatype
    TYPE(MPI_Status) :: status
    INTEGER, OPTIONAL, INTENT(OUT) :: ierror
```

### Fortran binding

```
MPI_FILE_WRITE_AT_ALL(FH, OFFSET, BUF, COUNT, DATATYPE, STATUS, IERROR)
    INTEGER FH, COUNT, DATATYPE, STATUS(MPI_STATUS_SIZE), IERROR
    INTEGER(KIND=MPI_OFFSET_KIND) OFFSET
    <type> BUF(*)
```

MPI\_FILE\_WRITE\_AT\_ALL is a collective version of the blocking MPI\_FILE\_WRITE\_AT interface.

```

1 MPI_FILE_IREAD_AT(fh, offset, buf, count, datatype, request)
2     IN      fh                file handle (handle)
3
4     IN      offset            file offset (integer)
5
6     OUT     buf                initial address of buffer (choice)
7
8     IN      count             number of elements in buffer (integer)
9
10    IN      datatype           datatype of each buffer element (handle)
11
12    OUT     request            request object (handle)

```

**C binding**

```

13 int MPI_File_iread_at(MPI_File fh, MPI_Offset offset, void *buf, int count,
14                      MPI_Datatype datatype, MPI_Request *request)
15
16 int MPI_File_iread_at_c(MPI_File fh, MPI_Offset offset, void *buf,
17                        MPI_Count count, MPI_Datatype datatype, MPI_Request *request)

```

**Fortran 2008 binding**

```

18 MPI_File_iread_at(fh, offset, buf, count, datatype, request, ierror)
19     TYPE(MPI_File), INTENT(IN) :: fh
20     INTEGER(KIND=MPI_OFFSET_KIND), INTENT(IN) :: offset
21     TYPE(*), DIMENSION(..), ASYNCHRONOUS :: buf
22     INTEGER, INTENT(IN) :: count
23     TYPE(MPI_Datatype), INTENT(IN) :: datatype
24     TYPE(MPI_Request), INTENT(OUT) :: request
25     INTEGER, OPTIONAL, INTENT(OUT) :: ierror
26
27 MPI_File_iread_at(fh, offset, buf, count, datatype, request, ierror)
28     TYPE(MPI_File), INTENT(IN) :: fh
29     INTEGER(KIND=MPI_OFFSET_KIND), INTENT(IN) :: offset
30     TYPE(*), DIMENSION(..), ASYNCHRONOUS :: buf
31     INTEGER(KIND=MPI_COUNT_KIND), INTENT(IN) :: count
32     TYPE(MPI_Datatype), INTENT(IN) :: datatype
33     TYPE(MPI_Request), INTENT(OUT) :: request
34     INTEGER, OPTIONAL, INTENT(OUT) :: ierror

```

**Fortran binding**

```

35 MPI_FILE_IREAD_AT(FH, OFFSET, BUF, COUNT, DATATYPE, REQUEST, IERROR)
36     INTEGER FH, COUNT, DATATYPE, REQUEST, IERROR
37     INTEGER(KIND=MPI_OFFSET_KIND) OFFSET
38     <type> BUF(*)

```

MPI\_FILE\_IREAD\_AT is a nonblocking version of the MPI\_FILE\_READ\_AT interface.



MPI_FILE_IREAD_AT_ALL(fh, offset, buf, count, datatype, request)			1
IN	fh	file handle (handle)	2
IN	offset	file offset (integer)	3
OUT	buf	initial address of buffer (choice)	4
IN	count	number of elements in buffer (integer)	5
IN	datatype	datatype of each buffer element (handle)	6
OUT	request	request object (handle)	7
			8
			9
			10

**C binding**

```

int MPI_File_iread_at_all(MPI_File fh, MPI_Offset offset, void *buf,
                          int count, MPI_Datatype datatype, MPI_Request *request)
int MPI_File_iread_at_all_c(MPI_File fh, MPI_Offset offset, void *buf,
                             MPI_Count count, MPI_Datatype datatype, MPI_Request *request)

```

**Fortran 2008 binding**

```

MPI_File_iread_at_all(fh, offset, buf, count, datatype, request, ierror)
  TYPE(MPI_File), INTENT(IN) :: fh
  INTEGER(KIND=MPI_OFFSET_KIND), INTENT(IN) :: offset
  TYPE(*), DIMENSION(..), ASYNCHRONOUS :: buf
  INTEGER, INTENT(IN) :: count
  TYPE(MPI_Datatype), INTENT(IN) :: datatype
  TYPE(MPI_Request), INTENT(OUT) :: request
  INTEGER, OPTIONAL, INTENT(OUT) :: ierror
MPI_File_iread_at_all(fh, offset, buf, count, datatype, request, ierror)
  TYPE(MPI_File), INTENT(IN) :: fh
  INTEGER(KIND=MPI_OFFSET_KIND), INTENT(IN) :: offset
  TYPE(*), DIMENSION(..), ASYNCHRONOUS :: buf
  INTEGER(KIND=MPI_COUNT_KIND), INTENT(IN) :: count
  TYPE(MPI_Datatype), INTENT(IN) :: datatype
  TYPE(MPI_Request), INTENT(OUT) :: request
  INTEGER, OPTIONAL, INTENT(OUT) :: ierror

```

**Fortran binding**

```

MPI_FILE_IREAD_AT_ALL(FH, OFFSET, BUF, COUNT, DATATYPE, REQUEST, IERROR)
  INTEGER FH, COUNT, DATATYPE, REQUEST, IERROR
  INTEGER(KIND=MPI_OFFSET_KIND) OFFSET
  <type> BUF(*)

```

MPI\_FILE\_IREAD\_AT\_ALL is a nonblocking version of MPI\_FILE\_READ\_AT\_ALL. See Section 14.6.5 for semantics of nonblocking collective file operations.

```

1 MPI_FILE_IWRITE_AT(fh, offset, buf, count, datatype, request)
2     INOUT   fh                file handle (handle)
3
4     IN      offset            file offset (integer)
5
6     IN      buf               initial address of buffer (choice)
7
8     IN      count             number of elements in buffer (integer)
9
10    IN      datatype          datatype of each buffer element (handle)
11
12    OUT     request           request object (handle)

```

### C binding

```

13 int MPI_File_iwrite_at(MPI_File fh, MPI_Offset offset, const void *buf,
14                       int count, MPI_Datatype datatype, MPI_Request *request)
15
16 int MPI_File_iwrite_at_c(MPI_File fh, MPI_Offset offset, const void *buf,
17                          MPI_Count count, MPI_Datatype datatype, MPI_Request *request)

```

### Fortran 2008 binding

```

18 MPI_File_iwrite_at(fh, offset, buf, count, datatype, request, ierror)
19     TYPE(MPI_File), INTENT(IN) :: fh
20     INTEGER(KIND=MPI_OFFSET_KIND), INTENT(IN) :: offset
21     TYPE(*), DIMENSION(..), INTENT(IN), ASYNCHRONOUS :: buf
22     INTEGER, INTENT(IN) :: count
23     TYPE(MPI_Datatype), INTENT(IN) :: datatype
24     TYPE(MPI_Request), INTENT(OUT) :: request
25     INTEGER, OPTIONAL, INTENT(OUT) :: ierror
26
27 MPI_File_iwrite_at(fh, offset, buf, count, datatype, request, ierror)
28     TYPE(MPI_File), INTENT(IN) :: fh
29     INTEGER(KIND=MPI_OFFSET_KIND), INTENT(IN) :: offset
30     TYPE(*), DIMENSION(..), INTENT(IN), ASYNCHRONOUS :: buf
31     INTEGER(KIND=MPI_COUNT_KIND), INTENT(IN) :: count
32     TYPE(MPI_Datatype), INTENT(IN) :: datatype
33     TYPE(MPI_Request), INTENT(OUT) :: request
34     INTEGER, OPTIONAL, INTENT(OUT) :: ierror

```

### Fortran binding

```

35 MPI_FILE_IWRITE_AT(FH, OFFSET, BUF, COUNT, DATATYPE, REQUEST, IERROR)
36     INTEGER FH, COUNT, DATATYPE, REQUEST, IERROR
37     INTEGER(KIND=MPI_OFFSET_KIND) OFFSET
38     <type> BUF(*)

```

MPI\_FILE\_IWRITE\_AT is a nonblocking version of the MPI\_FILE\_WRITE\_AT interface.

MPI_FILE_IWRITE_AT_ALL(fh, offset, buf, count, datatype, request)			1
INOUT	fh	file handle (handle)	2
IN	offset	file offset (integer)	3
IN	buf	initial address of buffer (choice)	4
IN	count	number of elements in buffer (integer)	5
IN	datatype	datatype of each buffer element (handle)	6
OUT	request	request object (handle)	7

**C binding**

```
int MPI_File_irewrite_at_all(MPI_File fh, MPI_Offset offset, const void *buf,
    int count, MPI_Datatype datatype, MPI_Request *request)
```

```
int MPI_File_irewrite_at_all_c(MPI_File fh, MPI_Offset offset,
    const void *buf, MPI_Count count, MPI_Datatype datatype,
    MPI_Request *request)
```

**Fortran 2008 binding**

```
MPI_File_irewrite_at_all(fh, offset, buf, count, datatype, request, ierror)
    TYPE(MPI_File), INTENT(IN) :: fh
    INTEGER(KIND=MPI_OFFSET_KIND), INTENT(IN) :: offset
    TYPE(*), DIMENSION(..), INTENT(IN), ASYNCHRONOUS :: buf
    INTEGER, INTENT(IN) :: count
    TYPE(MPI_Datatype), INTENT(IN) :: datatype
    TYPE(MPI_Request), INTENT(OUT) :: request
    INTEGER, OPTIONAL, INTENT(OUT) :: ierror
```

```
MPI_File_irewrite_at_all(fh, offset, buf, count, datatype, request, ierror)
    TYPE(MPI_File), INTENT(IN) :: fh
    INTEGER(KIND=MPI_OFFSET_KIND), INTENT(IN) :: offset
    TYPE(*), DIMENSION(..), INTENT(IN), ASYNCHRONOUS :: buf
    INTEGER(KIND=MPI_COUNT_KIND), INTENT(IN) :: count
    TYPE(MPI_Datatype), INTENT(IN) :: datatype
    TYPE(MPI_Request), INTENT(OUT) :: request
    INTEGER, OPTIONAL, INTENT(OUT) :: ierror
```

**Fortran binding**

```
MPI_FILE_IWRITE_AT_ALL(FH, OFFSET, BUF, COUNT, DATATYPE, REQUEST, IERROR)
    INTEGER FH, COUNT, DATATYPE, REQUEST, IERROR
    INTEGER(KIND=MPI_OFFSET_KIND) OFFSET
    <type> BUF(*)
```

MPI\_FILE\_IWRITE\_AT\_ALL is a nonblocking version of MPI\_FILE\_WRITE\_AT\_ALL.

**14.4.3 Data Access with Individual File Pointers**

MPI maintains one individual file pointer per process per file handle. The current value of this pointer implicitly specifies the offset in the data access routines described in this

1 section. These routines only use and update the individual file pointers maintained by MPI.  
 2 The shared file pointer is not used nor updated.

3 The individual file pointer routines have the same semantics as the data access with  
 4 explicit offset routines described in Section 14.4.2, with the following modification:

- 5 • the offset is defined to be the current value of the MPI-maintained individual file  
 6 pointer.  
 7

8 After an individual file pointer operation is initiated, the individual file pointer is updated  
 9 to point to the next etype after the last one that will be accessed. The file pointer is updated  
 10 relative to the current view of the file.

11 If MPI\_MODE\_SEQUENTIAL mode was specified when the file was opened, it is erroneous  
 12 to call the routines in this section, with the exception of MPI\_FILE\_GET\_BYTE\_OFFSET.  
 13

14  
 15 MPI\_FILE\_READ(fh, buf, count, datatype, status)

16	INOUT	fh	file handle (handle)
17			
18	OUT	buf	initial address of buffer (choice)
19	IN	count	number of elements in buffer (integer)
20	IN	datatype	datatype of each buffer element (handle)
21			
22	OUT	status	status object (status)

### 23 C binding

24  
 25 int MPI\_File\_read(MPI\_File fh, void \*buf, int count, MPI\_Datatype datatype,  
 26 MPI\_Status \*status)

27  
 28 int MPI\_File\_read\_c(MPI\_File fh, void \*buf, MPI\_Count count,  
 29 MPI\_Datatype datatype, MPI\_Status \*status)

### 30 Fortran 2008 binding

31 MPI\_File\_read(fh, buf, count, datatype, status, ierror)  
 32 TYPE(MPI\_File), INTENT(IN) :: fh  
 33 TYPE(\*), DIMENSION(..) :: buf  
 34 INTEGER, INTENT(IN) :: count  
 35 TYPE(MPI\_Datatype), INTENT(IN) :: datatype  
 36 TYPE(MPI\_Status) :: status  
 37 INTEGER, OPTIONAL, INTENT(OUT) :: ierror

38  
 39 MPI\_File\_read(fh, buf, count, datatype, status, ierror)  
 40 TYPE(MPI\_File), INTENT(IN) :: fh  
 41 TYPE(\*), DIMENSION(..) :: buf  
 42 INTEGER(KIND=MPI\_COUNT\_KIND), INTENT(IN) :: count  
 43 TYPE(MPI\_Datatype), INTENT(IN) :: datatype  
 44 TYPE(MPI\_Status) :: status  
 45 INTEGER, OPTIONAL, INTENT(OUT) :: ierror

### 46 Fortran binding

47 MPI\_FILE\_READ(FH, BUF, COUNT, DATATYPE, STATUS, IERROR)  
 48 INTEGER FH, COUNT, DATATYPE, STATUS(MPI\_STATUS\_SIZE), IERROR

<type> BUF(\*)

MPI\_FILE\_READ reads a file using the individual file pointer.

**Example 14.2** The following Fortran code fragment is an example of reading a file until the end of file is reached:

```
! Read a preexisting input file until all data has been read.
! Call routine "process_input" if all requested data is read.
! The Fortran 90 "exit" statement exits the loop.

integer  bufsize, numread, totprocessed, status(MPI_STATUS_SIZE)
parameter (bufsize=100)
real     localbuffer(bufsize)
integer (kind=MPI_OFFSET_KIND) zero

zero = 0

call MPI_FILE_OPEN(MPI_COMM_WORLD, 'myoldfile', &
                   MPI_MODE_RDONLY, MPI_INFO_NULL, myfh, ierr)
call MPI_FILE_SET_VIEW(myfh, zero, MPI_REAL, MPI_REAL, 'native', &
                       MPI_INFO_NULL, ierr)

totprocessed = 0
do
  call MPI_FILE_READ(myfh, localbuffer, bufsize, MPI_REAL, &
                    status, ierr)
  call MPI_GET_COUNT(status, MPI_REAL, numread, ierr)
  call process_input(localbuffer, numread)
  totprocessed = totprocessed + numread
  if (numread < bufsize) exit
end do

write(6, 1001) numread, bufsize, totprocessed
1001 format("No more data:  read", I3, "and expected", I3, &
           "Processed total of", I6, "before terminating job.")

call MPI_FILE_CLOSE(myfh, ierr)
```

```

1 MPI_FILE_READ_ALL(fh, buf, count, datatype, status)
2     INOUT   fh                file handle (handle)
3
4     OUT     buf                initial address of buffer (choice)
5
6     IN      count              number of elements in buffer (integer)
7
8     IN      datatype           datatype of each buffer element (handle)
9
10    OUT     status              status object (status)

```

**C binding**

```

11 int MPI_File_read_all(MPI_File fh, void *buf, int count,
12                      MPI_Datatype datatype, MPI_Status *status)
13
14 int MPI_File_read_all_c(MPI_File fh, void *buf, MPI_Count count,
15                        MPI_Datatype datatype, MPI_Status *status)

```

**Fortran 2008 binding**

```

17 MPI_File_read_all(fh, buf, count, datatype, status, ierror)
18     TYPE(MPI_File), INTENT(IN) :: fh
19     TYPE(*), DIMENSION(..) :: buf
20     INTEGER, INTENT(IN) :: count
21     TYPE(MPI_Datatype), INTENT(IN) :: datatype
22     TYPE(MPI_Status) :: status
23     INTEGER, OPTIONAL, INTENT(OUT) :: ierror
24
25 MPI_File_read_all(fh, buf, count, datatype, status, ierror)
26     TYPE(MPI_File), INTENT(IN) :: fh
27     TYPE(*), DIMENSION(..) :: buf
28     INTEGER(KIND=MPI_COUNT_KIND), INTENT(IN) :: count
29     TYPE(MPI_Datatype), INTENT(IN) :: datatype
30     TYPE(MPI_Status) :: status
31     INTEGER, OPTIONAL, INTENT(OUT) :: ierror

```

**Fortran binding**

```

33 MPI_FILE_READ_ALL(FH, BUF, COUNT, DATATYPE, STATUS, IERROR)
34     INTEGER FH, COUNT, DATATYPE, STATUS(MPI_STATUS_SIZE), IERROR
35     <type> BUF(*)

```

MPI\_FILE\_READ\_ALL is a collective version of the blocking MPI\_FILE\_READ interface.

`MPI_FILE_WRITE(fh, buf, count, datatype, status)`

INOUT	fh	file handle (handle)
IN	buf	initial address of buffer (choice)
IN	count	number of elements in buffer (integer)
IN	datatype	datatype of each buffer element (handle)
OUT	status	status object (status)

### C binding

```
int MPI_File_write(MPI_File fh, const void *buf, int count,
                  MPI_Datatype datatype, MPI_Status *status)
int MPI_File_write_c(MPI_File fh, const void *buf, MPI_Count count,
                    MPI_Datatype datatype, MPI_Status *status)
```

### Fortran 2008 binding

```
MPI_File_write(fh, buf, count, datatype, status, ierror)
  TYPE(MPI_File), INTENT(IN) :: fh
  TYPE(*), DIMENSION(..), INTENT(IN) :: buf
  INTEGER, INTENT(IN) :: count
  TYPE(MPI_Datatype), INTENT(IN) :: datatype
  TYPE(MPI_Status) :: status
  INTEGER, OPTIONAL, INTENT(OUT) :: ierror
```

```
MPI_File_write(fh, buf, count, datatype, status, ierror)
  TYPE(MPI_File), INTENT(IN) :: fh
  TYPE(*), DIMENSION(..), INTENT(IN) :: buf
  INTEGER(KIND=MPI_COUNT_KIND), INTENT(IN) :: count
  TYPE(MPI_Datatype), INTENT(IN) :: datatype
  TYPE(MPI_Status) :: status
  INTEGER, OPTIONAL, INTENT(OUT) :: ierror
```

### Fortran binding

```
MPI_FILE_WRITE(FH, BUF, COUNT, DATATYPE, STATUS, IERROR)
  INTEGER FH, COUNT, DATATYPE, STATUS(MPI_STATUS_SIZE), IERROR
  <type> BUF(*)
```

`MPI_FILE_WRITE` writes a file using the individual file pointer.

```

1 MPI_FILE_WRITE_ALL(fh, buf, count, datatype, status)
2     INOUT   fh                file handle (handle)
3
4     IN      buf                initial address of buffer (choice)
5
6     IN      count              number of elements in buffer (integer)
7
8     IN      datatype           datatype of each buffer element (handle)
9
10    OUT     status              status object (status)

```

**C binding**

```

11 int MPI_File_write_all(MPI_File fh, const void *buf, int count,
12                       MPI_Datatype datatype, MPI_Status *status)
13
14 int MPI_File_write_all_c(MPI_File fh, const void *buf, MPI_Count count,
15                          MPI_Datatype datatype, MPI_Status *status)

```

**Fortran 2008 binding**

```

16 MPI_File_write_all(fh, buf, count, datatype, status, ierror)
17     TYPE(MPI_File), INTENT(IN) :: fh
18     TYPE(*), DIMENSION(..), INTENT(IN) :: buf
19     INTEGER, INTENT(IN) :: count
20     TYPE(MPI_Datatype), INTENT(IN) :: datatype
21     TYPE(MPI_Status) :: status
22     INTEGER, OPTIONAL, INTENT(OUT) :: ierror
23
24 MPI_File_write_all(fh, buf, count, datatype, status, ierror)
25     TYPE(MPI_File), INTENT(IN) :: fh
26     TYPE(*), DIMENSION(..), INTENT(IN) :: buf
27     INTEGER(KIND=MPI_COUNT_KIND), INTENT(IN) :: count
28     TYPE(MPI_Datatype), INTENT(IN) :: datatype
29     TYPE(MPI_Status) :: status
30     INTEGER, OPTIONAL, INTENT(OUT) :: ierror

```

**Fortran binding**

```

33 MPI_FILE_WRITE_ALL(FH, BUF, COUNT, DATATYPE, STATUS, IERROR)
34     INTEGER FH, COUNT, DATATYPE, STATUS(MPI_STATUS_SIZE), IERROR
35     <type> BUF(*)

```

MPI\_FILE\_WRITE\_ALL is a collective version of the blocking MPI\_FILE\_WRITE interface.



MPI\_FILE\_IREAD(fh, buf, count, datatype, request)

INOUT	fh	file handle (handle)
OUT	buf	initial address of buffer (choice)
IN	count	number of elements in buffer (integer)
IN	datatype	datatype of each buffer element (handle)
OUT	request	request object (handle)

### C binding

```
int MPI_File_iread(MPI_File fh, void *buf, int count,
                  MPI_Datatype datatype, MPI_Request *request)
```

```
int MPI_File_iread_c(MPI_File fh, void *buf, MPI_Count count,
                    MPI_Datatype datatype, MPI_Request *request)
```

### Fortran 2008 binding

```
MPI_File_iread(fh, buf, count, datatype, request, ierror)
  TYPE(MPI_File), INTENT(IN) :: fh
  TYPE(*), DIMENSION(..), ASYNCHRONOUS :: buf
  INTEGER, INTENT(IN) :: count
  TYPE(MPI_Datatype), INTENT(IN) :: datatype
  TYPE(MPI_Request), INTENT(OUT) :: request
  INTEGER, OPTIONAL, INTENT(OUT) :: ierror
```

```
MPI_File_iread(fh, buf, count, datatype, request, ierror)
  TYPE(MPI_File), INTENT(IN) :: fh
  TYPE(*), DIMENSION(..), ASYNCHRONOUS :: buf
  INTEGER(KIND=MPI_COUNT_KIND), INTENT(IN) :: count
  TYPE(MPI_Datatype), INTENT(IN) :: datatype
  TYPE(MPI_Request), INTENT(OUT) :: request
  INTEGER, OPTIONAL, INTENT(OUT) :: ierror
```

### Fortran binding

```
MPI_FILE_IREAD(FH, BUF, COUNT, DATATYPE, REQUEST, IERROR)
  INTEGER FH, COUNT, DATATYPE, REQUEST, IERROR
  <type> BUF(*)
```

MPI\_FILE\_IREAD is a nonblocking version of the MPI\_FILE\_READ interface.

**Example 14.3** The following Fortran code fragment illustrates file pointer update semantics:

```

1  ! Read the first twenty real words in a file into two local
2  ! buffers. Note that when the first MPI_FILE_IREAD returns,
3  ! the file pointer has been updated to point to the
4  ! eleventh real word in the file.
5
6  integer  bufsize, req1, req2
7  integer, dimension(MPI_STATUS_SIZE) :: status1, status2
8  parameter (bufsize=10)
9  real     buf1(bufsize), buf2(bufsize)
10 integer (kind=MPI_OFFSET_KIND) zero
11
12 zero = 0
13 call MPI_FILE_OPEN(MPI_COMM_WORLD, 'myoldfile', &
14                   MPI_MODE_RDONLY, MPI_INFO_NULL, myfh, ierr)
15 call MPI_FILE_SET_VIEW(myfh, zero, MPI_REAL, MPI_REAL, 'native', &
16                       MPI_INFO_NULL, ierr)
17 call MPI_FILE_IREAD(myfh, buf1, bufsize, MPI_REAL, &
18                   req1, ierr)
19 call MPI_FILE_IREAD(myfh, buf2, bufsize, MPI_REAL, &
20                   req2, ierr)
21
22 call MPI_WAIT(req1, status1, ierr)
23 call MPI_WAIT(req2, status2, ierr)
24
25 call MPI_FILE_CLOSE(myfh, ierr)
26
27
28
29 MPI_FILE_IREAD_ALL(fh, buf, count, datatype, request)
30     INOUT  fh                file handle (handle)
31     OUT    buf                initial address of buffer (choice)
32     IN     count              number of elements in buffer (integer)
33     IN     datatype           datatype of each buffer element (handle)
34     OUT    request            request object (handle)
35
36
37
38 C binding
39 int MPI_File_iread_all(MPI_File fh, void *buf, int count,
40                       MPI_Datatype datatype, MPI_Request *request)
41
42 int MPI_File_iread_all_c(MPI_File fh, void *buf, MPI_Count count,
43                          MPI_Datatype datatype, MPI_Request *request)
44
45 Fortran 2008 binding
46 MPI_File_iread_all(fh, buf, count, datatype, request, ierror)
47     TYPE(MPI_File), INTENT(IN) :: fh
48     TYPE(*), DIMENSION(..), ASYNCHRONOUS :: buf
49     INTEGER, INTENT(IN) :: count

```

```

    TYPE(MPI_Datatype), INTENT(IN) :: datatype
    TYPE(MPI_Request), INTENT(OUT) :: request
    INTEGER, OPTIONAL, INTENT(OUT) :: ierror
MPI_File_iread_all(fh, buf, count, datatype, request, ierror)
    TYPE(MPI_File), INTENT(IN) :: fh
    TYPE(*), DIMENSION(..), ASYNCHRONOUS :: buf
    INTEGER(KIND=MPI_COUNT_KIND), INTENT(IN) :: count
    TYPE(MPI_Datatype), INTENT(IN) :: datatype
    TYPE(MPI_Request), INTENT(OUT) :: request
    INTEGER, OPTIONAL, INTENT(OUT) :: ierror

Fortran binding
MPI_FILE_IREAD_ALL(FH, BUF, COUNT, DATATYPE, REQUEST, IERROR)
    INTEGER FH, COUNT, DATATYPE, REQUEST, IERROR
    <type> BUF(*)

    MPI_FILE_IREAD_ALL is a nonblocking version of MPI_FILE_READ_ALL.

MPI_FILE_IWRITE(fh, buf, count, datatype, request)
    INOUT   fh           file handle (handle)
    IN      buf          initial address of buffer (choice)
    IN      count        number of elements in buffer (integer)
    IN      datatype     datatype of each buffer element (handle)
    OUT     request      request object (handle)

C binding
int MPI_File_iread_all(MPI_File fh, void *buf, int count,
    MPI_Datatype datatype, MPI_Request *request)
int MPI_File_iread_all_c(MPI_File fh, const void *buf, MPI_Count count,
    MPI_Datatype datatype, MPI_Request *request)

Fortran 2008 binding
MPI_File_iread_all(fh, buf, count, datatype, request, ierror)
    TYPE(MPI_File), INTENT(IN) :: fh
    TYPE(*), DIMENSION(..), INTENT(IN), ASYNCHRONOUS :: buf
    INTEGER, INTENT(IN) :: count
    TYPE(MPI_Datatype), INTENT(IN) :: datatype
    TYPE(MPI_Request), INTENT(OUT) :: request
    INTEGER, OPTIONAL, INTENT(OUT) :: ierror

MPI_File_iread_all(fh, buf, count, datatype, request, ierror)
    TYPE(MPI_File), INTENT(IN) :: fh
    TYPE(*), DIMENSION(..), INTENT(IN), ASYNCHRONOUS :: buf
    INTEGER(KIND=MPI_COUNT_KIND), INTENT(IN) :: count
    TYPE(MPI_Datatype), INTENT(IN) :: datatype
    TYPE(MPI_Request), INTENT(OUT) :: request

```

1       INTEGER, OPTIONAL, INTENT(OUT) :: ierror

2

### 3 Fortran binding

4 MPI\_FILE\_IWRITE(FH, BUF, COUNT, DATATYPE, REQUEST, IERROR)

5       INTEGER FH, COUNT, DATATYPE, REQUEST, IERROR

6       <type> BUF(\*)

7       MPI\_FILE\_IWRITE is a nonblocking version of the MPI\_FILE\_WRITE interface.

8

9

10 MPI\_FILE\_IWRITE\_ALL(fh, buf, count, datatype, request)

11       INOUT fh                           file handle (handle)

12       IN buf                            initial address of buffer (choice)

13       IN count                         number of elements in buffer (integer)

14       IN datatype                     datatype of each buffer element (handle)

15       OUT request                     request object (handle)

16

17

18

### 19 C binding

20 int MPI\_File\_irewrite\_all(MPI\_File fh, const void \*buf, int count,

21       MPI\_Datatype datatype, MPI\_Request \*request)

22 int MPI\_File\_irewrite\_all\_c(MPI\_File fh, const void \*buf, MPI\_Count count,

23       MPI\_Datatype datatype, MPI\_Request \*request)

24

### 25 Fortran 2008 binding

26 MPI\_File\_irewrite\_all(fh, buf, count, datatype, request, ierror)

27       TYPE(MPI\_File), INTENT(IN) :: fh

28       TYPE(\*), DIMENSION(..), INTENT(IN), ASYNCHRONOUS :: buf

29       INTEGER, INTENT(IN) :: count

30       TYPE(MPI\_Datatype), INTENT(IN) :: datatype

31       TYPE(MPI\_Request), INTENT(OUT) :: request

32       INTEGER, OPTIONAL, INTENT(OUT) :: ierror

33

34 MPI\_File\_irewrite\_all(fh, buf, count, datatype, request, ierror)

35       TYPE(MPI\_File), INTENT(IN) :: fh

36       TYPE(\*), DIMENSION(..), INTENT(IN), ASYNCHRONOUS :: buf

37       INTEGER(KIND=MPI\_COUNT\_KIND), INTENT(IN) :: count

38       TYPE(MPI\_Datatype), INTENT(IN) :: datatype

39       TYPE(MPI\_Request), INTENT(OUT) :: request

40       INTEGER, OPTIONAL, INTENT(OUT) :: ierror

41

### 42 Fortran binding

43 MPI\_FILE\_IWRITE\_ALL(FH, BUF, COUNT, DATATYPE, REQUEST, IERROR)

44       INTEGER FH, COUNT, DATATYPE, REQUEST, IERROR

45       <type> BUF(\*)

46       MPI\_FILE\_IWRITE\_ALL is a nonblocking version of MPI\_FILE\_WRITE\_ALL.

47

48

MPI\_FILE\_SEEK(fh, offset, whence) 1

INOUT	fh	file handle (handle)	2
IN	offset	file offset (integer)	3
IN	whence	update mode (state)	4

### C binding 6

```
int MPI_File_seek(MPI_File fh, MPI_Offset offset, int whence) 7
```

### Fortran 2008 binding 8

```
MPI_File_seek(fh, offset, whence, ierror) 9
  TYPE(MPI_File), INTENT(IN) :: fh 10
  INTEGER(KIND=MPI_OFFSET_KIND), INTENT(IN) :: offset 11
  INTEGER, INTENT(IN) :: whence 12
  INTEGER, OPTIONAL, INTENT(OUT) :: ierror 13
```

### Fortran binding 14

```
MPI_FILE_SEEK(FH, OFFSET, WHENCE, IERROR) 15
  INTEGER FH, WHENCE, IERROR 16
  INTEGER(KIND=MPI_OFFSET_KIND) OFFSET 17
```

MPI\_FILE\_SEEK updates the individual file pointer according to whence, which has the following possible values: 18

- MPI\_SEEK\_SET: the pointer is set to offset 19
- MPI\_SEEK\_CUR: the pointer is set to the current pointer position plus offset 20
- MPI\_SEEK\_END: the pointer is set to the end of file plus offset 21

The offset can be negative, which allows seeking backwards. It is erroneous to seek to a negative position in the view. 22

MPI\_FILE\_GET\_POSITION(fh, offset) 23

IN	fh	file handle (handle)	24
OUT	offset	offset of individual pointer (integer)	25

### C binding 26

```
int MPI_File_get_position(MPI_File fh, MPI_Offset *offset) 27
```

### Fortran 2008 binding 28

```
MPI_File_get_position(fh, offset, ierror) 29
  TYPE(MPI_File), INTENT(IN) :: fh 30
  INTEGER(KIND=MPI_OFFSET_KIND), INTENT(OUT) :: offset 31
  INTEGER, OPTIONAL, INTENT(OUT) :: ierror 32
```

### Fortran binding 33

```
MPI_FILE_GET_POSITION(FH, OFFSET, IERROR) 34
  INTEGER FH, IERROR 35
  INTEGER(KIND=MPI_OFFSET_KIND) OFFSET 36
```

1 MPI\_FILE\_GET\_POSITION returns, in `offset`, the current position of the individual file  
 2 pointer in etype units relative to the current view.

3  
 4 *Advice to users.* The `offset` can be used in a future call to `MPI_FILE_SEEK` using  
 5 `whence = MPI_SEEK_SET` to return to the current position. To set the displacement to  
 6 the current file pointer position, first convert `offset` into an absolute byte position using  
 7 `MPI_FILE_GET_BYTE_OFFSET`, then call `MPI_FILE_SET_VIEW` with the resulting  
 8 displacement. (*End of advice to users.*)

9  
 10  
 11 MPI\_FILE\_GET\_BYTE\_OFFSET(fh, offset, disp)

12	IN	fh	file handle (handle)
13			
14	IN	offset	offset (integer)
15			
16	OUT	disp	absolute byte position of offset (integer)

### 17 C binding

18 `int MPI_File_get_byte_offset(MPI_File fh, MPI_Offset offset,`  
 19 `MPI_Offset *disp)`

### 21 Fortran 2008 binding

22 `MPI_File_get_byte_offset(fh, offset, disp, ierror)`  
 23 `TYPE(MPI_File), INTENT(IN) :: fh`  
 24 `INTEGER(KIND=MPI_OFFSET_KIND), INTENT(IN) :: offset`  
 25 `INTEGER(KIND=MPI_OFFSET_KIND), INTENT(OUT) :: disp`  
 26 `INTEGER, OPTIONAL, INTENT(OUT) :: ierror`

### 28 Fortran binding

29 `MPI_FILE_GET_BYTE_OFFSET(FH, OFFSET, DISP, IERROR)`  
 30 `INTEGER FH, IERROR`  
 31 `INTEGER(KIND=MPI_OFFSET_KIND) OFFSET, DISP`

32 MPI\_FILE\_GET\_BYTE\_OFFSET converts a view-relative offset into an absolute byte  
 33 position. The absolute byte position (from the beginning of the file) of `offset` relative to the  
 34 current view of `fh` is returned in `disp`.

## 36 14.4.4 Data Access with Shared File Pointers

37  
 38 MPI maintains exactly one shared file pointer per collective `MPI_FILE_OPEN` (shared among  
 39 processes in the communicator group). The current value of this pointer implicitly specifies  
 40 the offset in the data access routines described in this section. These routines only use and  
 41 update the shared file pointer maintained by MPI. The individual file pointers are not used  
 42 nor updated.

43 The shared file pointer routines have the same semantics as the data access with explicit  
 44 offset routines described in Section 14.4.2, with the following modifications:

- 45 • the `offset` is defined to be the current value of the MPI-maintained shared file pointer,
- 46
- 47 • the effect of multiple calls to shared file pointer routines is defined to behave as if the  
 48 calls were serialized, and

- the use of shared file pointer routines is erroneous unless all processes use the same file view.

For the noncollective shared file pointer routines, the serialization ordering is not deterministic. The user needs to use other synchronization means to enforce a specific order.

After a shared file pointer operation is initiated, the shared file pointer is updated to point to the next etype after the last one that will be accessed. The file pointer is updated relative to the current view of the file.

### Noncollective Operations

**MPI\_FILE\_READ\_SHARED**(fh, buf, count, datatype, status)

INOUT	fh	file handle (handle)
OUT	buf	initial address of buffer (choice)
IN	count	number of elements in buffer (integer)
IN	datatype	datatype of each buffer element (handle)
OUT	status	status object (status)

### C binding

```
int MPI_File_read_shared(MPI_File fh, void *buf, int count,
                        MPI_Datatype datatype, MPI_Status *status)
```

```
int MPI_File_read_shared_c(MPI_File fh, void *buf, MPI_Count count,
                          MPI_Datatype datatype, MPI_Status *status)
```

### Fortran 2008 binding

```
MPI_File_read_shared(fh, buf, count, datatype, status, ierror)
  TYPE(MPI_File), INTENT(IN) :: fh
  TYPE(*), DIMENSION(..) :: buf
  INTEGER, INTENT(IN) :: count
  TYPE(MPI_Datatype), INTENT(IN) :: datatype
  TYPE(MPI_Status) :: status
  INTEGER, OPTIONAL, INTENT(OUT) :: ierror
```

```
MPI_File_read_shared(fh, buf, count, datatype, status, ierror)
  TYPE(MPI_File), INTENT(IN) :: fh
  TYPE(*), DIMENSION(..) :: buf
  INTEGER(KIND=MPI_COUNT_KIND), INTENT(IN) :: count
  TYPE(MPI_Datatype), INTENT(IN) :: datatype
  TYPE(MPI_Status) :: status
  INTEGER, OPTIONAL, INTENT(OUT) :: ierror
```

### Fortran binding

```
MPI_FILE_READ_SHARED(FH, BUF, COUNT, DATATYPE, STATUS, IERROR)
  INTEGER FH, COUNT, DATATYPE, STATUS(MPI_STATUS_SIZE), IERROR
  <type> BUF(*)
```

1       MPI\_FILE\_READ\_SHARED reads a file using the shared file pointer.

2

3

4

MPI\_FILE\_WRITE\_SHARED(fh, buf, count, datatype, status)

5

INOUT fh file handle (handle)

6

IN buf initial address of buffer (choice)

7

8

IN count number of elements in buffer (integer)

9

IN datatype datatype of each buffer element (handle)

10

11

OUT status status object (status)

12

13

### C binding

14

```
int MPI_File_write_shared(MPI_File fh, const void *buf, int count,
    MPI_Datatype datatype, MPI_Status *status)
```

15

16

```
int MPI_File_write_shared_c(MPI_File fh, const void *buf, MPI_Count count,
    MPI_Datatype datatype, MPI_Status *status)
```

17

18

19

### Fortran 2008 binding

20

```
MPI_File_write_shared(fh, buf, count, datatype, status, ierror)
```

21

```
TYPE(MPI_File), INTENT(IN) :: fh
```

22

```
TYPE(*), DIMENSION(..), INTENT(IN) :: buf
```

23

```
INTEGER, INTENT(IN) :: count
```

24

```
TYPE(MPI_Datatype), INTENT(IN) :: datatype
```

25

```
TYPE(MPI_Status) :: status
```

26

```
INTEGER, OPTIONAL, INTENT(OUT) :: ierror
```

27

28

```
MPI_File_write_shared(fh, buf, count, datatype, status, ierror)
```

29

```
TYPE(MPI_File), INTENT(IN) :: fh
```

30

```
TYPE(*), DIMENSION(..), INTENT(IN) :: buf
```

31

```
INTEGER(KIND=MPI_COUNT_KIND), INTENT(IN) :: count
```

32

```
TYPE(MPI_Datatype), INTENT(IN) :: datatype
```

33

```
TYPE(MPI_Status) :: status
```

34

```
INTEGER, OPTIONAL, INTENT(OUT) :: ierror
```

35

36

### Fortran binding

37

```
MPI_FILE_WRITE_SHARED(FH, BUF, COUNT, DATATYPE, STATUS, IERROR)
```

38

```
INTEGER FH, COUNT, DATATYPE, STATUS(MPI_STATUS_SIZE), IERROR
```

39

```
<type> BUF(*)
```

40

MPI\_FILE\_WRITE\_SHARED writes a file using the shared file pointer.

41

42

43

44

45

46

47

48



MPI_FILE_IREAD_SHARED(fh, buf, count, datatype, request)			1
INOUT	fh	file handle (handle)	2
			3
OUT	buf	initial address of buffer (choice)	4
			5
IN	count	number of elements in buffer (integer)	6
			7
IN	datatype	datatype of each buffer element (handle)	8
			9
OUT	request	request object (handle)	10

**C binding**

```

int MPI_File_iread_shared(MPI_File fh, void *buf, int count,
                          MPI_Datatype datatype, MPI_Request *request)
int MPI_File_iread_shared_c(MPI_File fh, void *buf, MPI_Count count,
                            MPI_Datatype datatype, MPI_Request *request)

```

**Fortran 2008 binding**

```

MPI_File_iread_shared(fh, buf, count, datatype, request, ierror)
  TYPE(MPI_File), INTENT(IN) :: fh
  TYPE(*), DIMENSION(..), ASYNCHRONOUS :: buf
  INTEGER, INTENT(IN) :: count
  TYPE(MPI_Datatype), INTENT(IN) :: datatype
  TYPE(MPI_Request), INTENT(OUT) :: request
  INTEGER, OPTIONAL, INTENT(OUT) :: ierror
MPI_File_iread_shared(fh, buf, count, datatype, request, ierror)
  TYPE(MPI_File), INTENT(IN) :: fh
  TYPE(*), DIMENSION(..), ASYNCHRONOUS :: buf
  INTEGER(KIND=MPI_COUNT_KIND), INTENT(IN) :: count
  TYPE(MPI_Datatype), INTENT(IN) :: datatype
  TYPE(MPI_Request), INTENT(OUT) :: request
  INTEGER, OPTIONAL, INTENT(OUT) :: ierror

```

**Fortran binding**

```

MPI_FILE_IREAD_SHARED(FH, BUF, COUNT, DATATYPE, REQUEST, IERROR)
  INTEGER FH, COUNT, DATATYPE, REQUEST, IERROR
  <type> BUF(*)

```

MPI\_FILE\_IREAD\_SHARED is a nonblocking version of the MPI\_FILE\_READ\_SHARED interface.

```

1 MPI_FILE_IWRITE_SHARED(fh, buf, count, datatype, request)
2     INOUT   fh                file handle (handle)
3
4     IN      buf                initial address of buffer (choice)
5
6     IN      count              number of elements in buffer (integer)
7
8     IN      datatype           datatype of each buffer element (handle)
9
10    OUT     request            request object (handle)

```

### C binding

```

11 int MPI_File_iwrite_shared(MPI_File fh, const void *buf, int count,
12     MPI_Datatype datatype, MPI_Request *request)
13
14 int MPI_File_iwrite_shared_c(MPI_File fh, const void *buf, MPI_Count count,
15     MPI_Datatype datatype, MPI_Request *request)

```

### Fortran 2008 binding

```

17 MPI_File_iwrite_shared(fh, buf, count, datatype, request, ierror)
18     TYPE(MPI_File), INTENT(IN) :: fh
19     TYPE(*), DIMENSION(..), INTENT(IN), ASYNCHRONOUS :: buf
20     INTEGER, INTENT(IN) :: count
21     TYPE(MPI_Datatype), INTENT(IN) :: datatype
22     TYPE(MPI_Request), INTENT(OUT) :: request
23     INTEGER, OPTIONAL, INTENT(OUT) :: ierror
24
25 MPI_File_iwrite_shared(fh, buf, count, datatype, request, ierror)
26     TYPE(MPI_File), INTENT(IN) :: fh
27     TYPE(*), DIMENSION(..), INTENT(IN), ASYNCHRONOUS :: buf
28     INTEGER(KIND=MPI_COUNT_KIND), INTENT(IN) :: count
29     TYPE(MPI_Datatype), INTENT(IN) :: datatype
30     TYPE(MPI_Request), INTENT(OUT) :: request
31     INTEGER, OPTIONAL, INTENT(OUT) :: ierror

```

### Fortran binding

```

33 MPI_FILE_IWRITE_SHARED(FH, BUF, COUNT, DATATYPE, REQUEST, IERROR)
34     INTEGER FH, COUNT, DATATYPE, REQUEST, IERROR
35     <type> BUF(*)

```

MPI\_FILE\_IWRITE\_SHARED is a nonblocking version of the MPI\_FILE\_WRITE\_SHARED interface.

### Collective Operations

The semantics of a collective access using a shared file pointer is that the accesses to the file will be in the order determined by the ranks of the processes within the group. For each process, the location in the file at which data is accessed is the position at which the shared file pointer would be after all processes whose ranks within the group less than that of this process had accessed their data. In addition, in order to prevent subsequent shared offset accesses by the same processes from interfering with this collective access, the call might return only after all the processes within the group have initiated their accesses. When the

call returns, the shared file pointer points to the next etype accessible, according to the file view used by all processes, after the last etype requested.

*Advice to users.* There may be some programs in which all processes in the group need to access the file using the shared file pointer, but the program may not *require* that data be accessed in order of process rank. In such programs, using the shared ordered routines (e.g., `MPI_FILE_WRITE_ORDERED` rather than `MPI_FILE_WRITE_SHARED`) may enable an implementation to optimize access, improving performance. (*End of advice to users.*)

*Advice to implementors.* Accesses to the data requested by all processes do not have to be serialized. Once all processes have issued their requests, locations within the file for all accesses can be computed, and accesses can proceed independently from each other, possibly in parallel. (*End of advice to implementors.*)

`MPI_FILE_READ_ORDERED(fh, buf, count, datatype, status)`

INOUT	fh	file handle (handle)
OUT	buf	initial address of buffer (choice)
IN	count	number of elements in buffer (integer)
IN	datatype	datatype of each buffer element (handle)
OUT	status	status object (status)

#### C binding

```
int MPI_File_read_ordered(MPI_File fh, void *buf, int count,
    MPI_Datatype datatype, MPI_Status *status)
```

```
int MPI_File_read_ordered_c(MPI_File fh, void *buf, MPI_Count count,
    MPI_Datatype datatype, MPI_Status *status)
```

#### Fortran 2008 binding

```
MPI_File_read_ordered(fh, buf, count, datatype, status, ierror)
```

```
TYPE(MPI_File), INTENT(IN) :: fh
TYPE(*), DIMENSION(..) :: buf
INTEGER, INTENT(IN) :: count
TYPE(MPI_Datatype), INTENT(IN) :: datatype
TYPE(MPI_Status) :: status
INTEGER, OPTIONAL, INTENT(OUT) :: ierror
```

```
MPI_File_read_ordered(fh, buf, count, datatype, status, ierror)
```

```
TYPE(MPI_File), INTENT(IN) :: fh
TYPE(*), DIMENSION(..) :: buf
INTEGER(KIND=MPI_COUNT_KIND), INTENT(IN) :: count
TYPE(MPI_Datatype), INTENT(IN) :: datatype
TYPE(MPI_Status) :: status
INTEGER, OPTIONAL, INTENT(OUT) :: ierror
```

**Fortran binding**

```

MPI_FILE_READ_ORDERED(FH, BUF, COUNT, DATATYPE, STATUS, IERROR)
  INTEGER FH, COUNT, DATATYPE, STATUS(MPI_STATUS_SIZE), IERROR
  <type> BUF(*)

```

MPI\_FILE\_READ\_ORDERED is a collective version of the MPI\_FILE\_READ\_SHARED interface.

```

MPI_FILE_WRITE_ORDERED(fh, buf, count, datatype, status)

```

INOUT	fh	file handle (handle)
IN	buf	initial address of buffer (choice)
IN	count	number of elements in buffer (integer)
IN	datatype	datatype of each buffer element (handle)
OUT	status	status object (status)

**C binding**

```

int MPI_File_write_ordered(MPI_File fh, const void *buf, int count,
  MPI_Datatype datatype, MPI_Status *status)
int MPI_File_write_ordered_c(MPI_File fh, const void *buf, MPI_Count count,
  MPI_Datatype datatype, MPI_Status *status)

```

**Fortran 2008 binding**

```

MPI_File_write_ordered(fh, buf, count, datatype, status, ierror)
  TYPE(MPI_File), INTENT(IN) :: fh
  TYPE(*), DIMENSION(..), INTENT(IN) :: buf
  INTEGER, INTENT(IN) :: count
  TYPE(MPI_Datatype), INTENT(IN) :: datatype
  TYPE(MPI_Status) :: status
  INTEGER, OPTIONAL, INTENT(OUT) :: ierror
MPI_File_write_ordered(fh, buf, count, datatype, status, ierror)
  TYPE(MPI_File), INTENT(IN) :: fh
  TYPE(*), DIMENSION(..), INTENT(IN) :: buf
  INTEGER(KIND=MPI_COUNT_KIND), INTENT(IN) :: count
  TYPE(MPI_Datatype), INTENT(IN) :: datatype
  TYPE(MPI_Status) :: status
  INTEGER, OPTIONAL, INTENT(OUT) :: ierror

```

**Fortran binding**

```

MPI_FILE_WRITE_ORDERED(FH, BUF, COUNT, DATATYPE, STATUS, IERROR)
  INTEGER FH, COUNT, DATATYPE, STATUS(MPI_STATUS_SIZE), IERROR
  <type> BUF(*)

```

MPI\_FILE\_WRITE\_ORDERED is a collective version of the MPI\_FILE\_WRITE\_SHARED interface.

## Seek

If `MPI_MODE_SEQUENTIAL` mode was specified when the file was opened, it is erroneous to call the following two routines (`MPI_FILE_SEEK_SHARED` and `MPI_FILE_GET_POSITION_SHARED`).

`MPI_FILE_SEEK_SHARED(fh, offset, whence)`

INOUT	fh	file handle (handle)
IN	offset	file offset (integer)
IN	whence	update mode (state)

**C binding**

```
int MPI_File_seek_shared(MPI_File fh, MPI_Offset offset, int whence)
```

**Fortran 2008 binding**

```
MPI_File_seek_shared(fh, offset, whence, ierror)
  TYPE(MPI_File), INTENT(IN) :: fh
  INTEGER(KIND=MPI_OFFSET_KIND), INTENT(IN) :: offset
  INTEGER, INTENT(IN) :: whence
  INTEGER, OPTIONAL, INTENT(OUT) :: ierror
```

**Fortran binding**

```
MPI_FILE_SEEK_SHARED(FH, OFFSET, WHENCE, IERROR)
  INTEGER FH, WHENCE, IERROR
  INTEGER(KIND=MPI_OFFSET_KIND) OFFSET
```

`MPI_FILE_SEEK_SHARED` updates the shared file pointer according to `whence`, which has the following possible values:

- `MPI_SEEK_SET`: the pointer is set to `offset`
- `MPI_SEEK_CUR`: the pointer is set to the current pointer position plus `offset`
- `MPI_SEEK_END`: the pointer is set to the end of file plus `offset`

`MPI_FILE_SEEK_SHARED` is collective; all the processes in the communicator group associated with the file handle `fh` must call `MPI_FILE_SEEK_SHARED` with the same values for `offset` and `whence`.

The `offset` can be negative, which allows seeking backwards. It is erroneous to seek to a negative position in the view.

`MPI_FILE_GET_POSITION_SHARED(fh, offset)`

IN	fh	file handle (handle)
OUT	offset	offset of shared pointer (integer)

**C binding**

```
int MPI_File_get_position_shared(MPI_File fh, MPI_Offset *offset)
```

**Fortran 2008 binding**

```

MPI_File_get_position_shared(fh, offset, ierror)
  TYPE(MPI_File), INTENT(IN) :: fh
  INTEGER(KIND=MPI_OFFSET_KIND), INTENT(OUT) :: offset
  INTEGER, OPTIONAL, INTENT(OUT) :: ierror

```

**Fortran binding**

```

MPI_FILE_GET_POSITION_SHARED(FH, OFFSET, IERROR)
  INTEGER FH, IERROR
  INTEGER(KIND=MPI_OFFSET_KIND) OFFSET

```

`MPI_FILE_GET_POSITION_SHARED` returns, in `offset`, the current position of the shared file pointer in `etype` units relative to the current view.

*Advice to users.* The `offset` can be used in a future call to `MPI_FILE_SEEK_SHARED` using `whence = MPI_SEEK_SET` to return to the current position. To set the displacement to the current file pointer position, first convert `offset` into an absolute byte position using `MPI_FILE_GET_BYTE_OFFSET`, then call `MPI_FILE_SET_VIEW` with the resulting displacement. (*End of advice to users.*)

**14.4.5 Split Collective Data Access Routines**

MPI provides a restricted form of “nonblocking collective” I/O operations for all data accesses using split collective data access routines. These routines are referred to as “split” collective routines because a single collective operation is split in two: a begin routine and an end routine. The begin routine begins the operation, much like a nonblocking data access (e.g., `MPI_FILE_IREAD`). The end routine completes the operation, much like the matching test or wait (e.g., `MPI_WAIT`). As with nonblocking data access operations, the user must not use the buffer passed to a begin routine while the routine is outstanding; the operation must be completed with an end routine before it is safe to free buffers, etc.

Split collective data access operations on a file handle `fh` are subject to the semantic rules given below.

- On any MPI process, each file handle may have at most one active split collective operation at any time.
- Begin calls are collective over the group of processes that participated in the collective open and follow the ordering rules for collective calls.
- End calls are collective over the group of processes that participated in the collective open and follow the ordering rules for collective calls. Each end call matches the preceding begin call for the same collective operation. When an “end” call is made, exactly one unmatched “begin” call for the same operation must precede it.
- An implementation is free to implement any split collective data access routine using the corresponding blocking collective routine when either the begin call (e.g., `MPI_FILE_READ_ALL_BEGIN`) or the end call (e.g., `MPI_FILE_READ_ALL_END`) is issued. The begin and end calls are provided to allow the user and MPI implementation to optimize the collective operation.

According to the definitions in Section 2.4.2, the begin procedures are incomplete. They are also non-local procedures because they may or may not return before they are called in all MPI processes of the process group.

*Advice to users.* This is one of the exceptions in which incomplete procedures are non-local and therefore blocking. (*End of advice to users.*)

- Split collective operations do not match the corresponding regular collective operation. For example, in a single collective read operation, an `MPI_FILE_READ_ALL` on one process does not match an `MPI_FILE_READ_ALL_BEGIN/MPI_FILE_READ_ALL_END` pair on another process.
- Split collective routines must specify a buffer in both the begin and end routines. By specifying the buffer that receives data in the end routine, we can avoid the problems described in “A Problem with Code Movements and Register Optimization,” Section 19.1.17, but not all of the problems, such as those described in Sections 19.1.12, 19.1.13, and 19.1.16.
- No collective I/O operations are permitted on a file handle concurrently with a split collective access on that file handle (i.e., between the begin and end of the access). That is

```
MPI_File_read_all_begin(fh, ...);
...
MPI_File_read_all(fh, ...);
...
MPI_File_read_all_end(fh, ...);
```

is erroneous.

- In a multithreaded implementation, any split collective begin and end operation called by a process must be called from the same thread. This restriction is made to simplify the implementation in the multithreaded case. (Note that we have already disallowed having two threads begin a split collective operation on the same file handle since only one split collective operation can be active on a file handle at any time.)

The arguments for these routines have the same meaning as for the equivalent collective versions (e.g., the argument definitions for `MPI_FILE_READ_ALL_BEGIN` and `MPI_FILE_READ_ALL_END` are equivalent to the arguments for `MPI_FILE_READ_ALL`). The begin routine (e.g., `MPI_FILE_READ_ALL_BEGIN`) begins a split collective operation that, when completed with the matching end routine (i.e., `MPI_FILE_READ_ALL_END`) produces the result as defined for the equivalent collective routine (i.e., `MPI_FILE_READ_ALL`).

For the purpose of consistency semantics (Section 14.6.1), a matched pair of split collective data access operations (e.g., `MPI_FILE_READ_ALL_BEGIN` and `MPI_FILE_READ_ALL_END`) compose a single data access.

1 MPI\_FILE\_READ\_AT\_ALL\_BEGIN(fh, offset, buf, count, datatype)

2     IN     fh                     file handle (handle)  
 3  
 4     IN     offset                file offset (integer)  
 5     OUT    buf                   initial address of buffer (choice)  
 6     IN     count                 number of elements in buffer (integer)  
 7  
 8     IN     datatype              datatype of each buffer element (handle)

9  
 10 **C binding**

11 int MPI\_File\_read\_at\_all\_begin(MPI\_File fh, MPI\_Offset offset, void \*buf,  
 12                                int count, MPI\_Datatype datatype)

13  
 14 int MPI\_File\_read\_at\_all\_begin\_c(MPI\_File fh, MPI\_Offset offset, void \*buf,  
 15                                MPI\_Count count, MPI\_Datatype datatype)

16 **Fortran 2008 binding**

17 MPI\_File\_read\_at\_all\_begin(fh, offset, buf, count, datatype, ierror)  
 18     TYPE(MPI\_File), INTENT(IN) :: fh  
 19     INTEGER(KIND=MPI\_OFFSET\_KIND), INTENT(IN) :: offset  
 20     TYPE(\*), DIMENSION(..), ASYNCHRONOUS :: buf  
 21     INTEGER, INTENT(IN) :: count  
 22     TYPE(MPI\_Datatype), INTENT(IN) :: datatype  
 23     INTEGER, OPTIONAL, INTENT(OUT) :: ierror

24  
 25 MPI\_File\_read\_at\_all\_begin(fh, offset, buf, count, datatype, ierror)  
 26     TYPE(MPI\_File), INTENT(IN) :: fh  
 27     INTEGER(KIND=MPI\_OFFSET\_KIND), INTENT(IN) :: offset  
 28     TYPE(\*), DIMENSION(..), ASYNCHRONOUS :: buf  
 29     INTEGER(KIND=MPI\_COUNT\_KIND), INTENT(IN) :: count  
 30     TYPE(MPI\_Datatype), INTENT(IN) :: datatype  
 31     INTEGER, OPTIONAL, INTENT(OUT) :: ierror

32 **Fortran binding**

33 MPI\_FILE\_READ\_AT\_ALL\_BEGIN(FH, OFFSET, BUF, COUNT, DATATYPE, IERROR)  
 34     INTEGER FH, COUNT, DATATYPE, IERROR  
 35     INTEGER(KIND=MPI\_OFFSET\_KIND) OFFSET  
 36     <type> BUF(\*)

37  
 38  
 39 MPI\_FILE\_READ\_AT\_ALL\_END(fh, buf, status)

40     IN     fh                     file handle (handle)  
 41  
 42     OUT    buf                   initial address of buffer (choice)  
 43     OUT    status                status object (status)

44  
 45 **C binding**

46 int MPI\_File\_read\_at\_all\_end(MPI\_File fh, void \*buf, MPI\_Status \*status)

47  
 48



**Fortran 2008 binding**

```

MPI_File_read_at_all_end(fh, buf, status, ierror)
    TYPE(MPI_File), INTENT(IN) :: fh
    TYPE(*), DIMENSION(..), ASYNCHRONOUS :: buf
    TYPE(MPI_Status) :: status
    INTEGER, OPTIONAL, INTENT(OUT) :: ierror

```

**Fortran binding**

```

MPI_FILE_READ_AT_ALL_END(FH, BUF, STATUS, IERROR)
    INTEGER FH, STATUS(MPI_STATUS_SIZE), IERROR
    <type> BUF(*)

```

```

MPI_FILE_WRITE_AT_ALL_BEGIN(fh, offset, buf, count, datatype)

```

INOUT	fh	file handle (handle)
IN	offset	file offset (integer)
IN	buf	initial address of buffer (choice)
IN	count	number of elements in buffer (integer)
IN	datatype	datatype of each buffer element (handle)

**C binding**

```

int MPI_File_write_at_all_begin(MPI_File fh, MPI_Offset offset,
    const void *buf, int count, MPI_Datatype datatype)
int MPI_File_write_at_all_begin_c(MPI_File fh, MPI_Offset offset,
    const void *buf, MPI_Count count, MPI_Datatype datatype)

```

**Fortran 2008 binding**

```

MPI_File_write_at_all_begin(fh, offset, buf, count, datatype, ierror)
    TYPE(MPI_File), INTENT(IN) :: fh
    INTEGER(KIND=MPI_OFFSET_KIND), INTENT(IN) :: offset
    TYPE(*), DIMENSION(..), INTENT(IN), ASYNCHRONOUS :: buf
    INTEGER, INTENT(IN) :: count
    TYPE(MPI_Datatype), INTENT(IN) :: datatype
    INTEGER, OPTIONAL, INTENT(OUT) :: ierror

```

```

MPI_File_write_at_all_begin(fh, offset, buf, count, datatype, ierror)
    TYPE(MPI_File), INTENT(IN) :: fh
    INTEGER(KIND=MPI_OFFSET_KIND), INTENT(IN) :: offset
    TYPE(*), DIMENSION(..), INTENT(IN), ASYNCHRONOUS :: buf
    INTEGER(KIND=MPI_COUNT_KIND), INTENT(IN) :: count
    TYPE(MPI_Datatype), INTENT(IN) :: datatype
    INTEGER, OPTIONAL, INTENT(OUT) :: ierror

```

**Fortran binding**

```

MPI_FILE_WRITE_AT_ALL_BEGIN(FH, OFFSET, BUF, COUNT, DATATYPE, IERROR)
    INTEGER FH, COUNT, DATATYPE, IERROR
    INTEGER(KIND=MPI_OFFSET_KIND) OFFSET

```

```

1     <type> BUF(*)
2
3
4 MPI_FILE_WRITE_AT_ALL_END(fh, buf, status)
5
6     INOUT   fh                file handle (handle)
7     IN      buf                initial address of buffer (choice)
8     OUT     status            status object (status)
9
10
11 C binding
12 int MPI_File_write_at_all_end(MPI_File fh, const void *buf,
13                               MPI_Status *status)
14
15 Fortran 2008 binding
16 MPI_File_write_at_all_end(fh, buf, status, ierror)
17     TYPE(MPI_File), INTENT(IN) :: fh
18     TYPE(*), DIMENSION(..), INTENT(IN), ASYNCHRONOUS :: buf
19     TYPE(MPI_Status) :: status
20     INTEGER, OPTIONAL, INTENT(OUT) :: ierror
21
22 Fortran binding
23 MPI_FILE_WRITE_AT_ALL_END(FH, BUF, STATUS, IERROR)
24     INTEGER FH, STATUS(MPI_STATUS_SIZE), IERROR
25     <type> BUF(*)
26
27 MPI_FILE_READ_ALL_BEGIN(fh, buf, count, datatype)
28
29     INOUT   fh                file handle (handle)
30     OUT     buf                initial address of buffer (choice)
31     IN      count              number of elements in buffer (integer)
32     IN      datatype           datatype of each buffer element (handle)
33
34
35 C binding
36 int MPI_File_read_all_begin(MPI_File fh, void *buf, int count,
37                             MPI_Datatype datatype)
38
39 int MPI_File_read_all_begin_c(MPI_File fh, void *buf, MPI_Count count,
40                               MPI_Datatype datatype)
41
42 Fortran 2008 binding
43 MPI_File_read_all_begin(fh, buf, count, datatype, ierror)
44     TYPE(MPI_File), INTENT(IN) :: fh
45     TYPE(*), DIMENSION(..), ASYNCHRONOUS :: buf
46     INTEGER, INTENT(IN) :: count
47     TYPE(MPI_Datatype), INTENT(IN) :: datatype
48     INTEGER, OPTIONAL, INTENT(OUT) :: ierror
49
50 MPI_File_read_all_begin(fh, buf, count, datatype, ierror)

```

```

TYPE(MPI_File), INTENT(IN) :: fh
TYPE(*), DIMENSION(..), ASYNCHRONOUS :: buf
INTEGER(KIND=MPI_COUNT_KIND), INTENT(IN) :: count
TYPE(MPI_Datatype), INTENT(IN) :: datatype
INTEGER, OPTIONAL, INTENT(OUT) :: ierror

```

**Fortran binding**

```

MPI_FILE_READ_ALL_BEGIN(FH, BUF, COUNT, DATATYPE, IERROR)
  INTEGER FH, COUNT, DATATYPE, IERROR
  <type> BUF(*)

```

**MPI\_FILE\_READ\_ALL\_END(fh, buf, status)**

INOUT	fh	file handle (handle)
OUT	buf	initial address of buffer (choice)
OUT	status	status object (status)

**C binding**

```

int MPI_File_read_all_end(MPI_File fh, void *buf, MPI_Status *status)

```

**Fortran 2008 binding**

```

MPI_File_read_all_end(fh, buf, status, ierror)
  TYPE(MPI_File), INTENT(IN) :: fh
  TYPE(*), DIMENSION(..), ASYNCHRONOUS :: buf
  TYPE(MPI_Status) :: status
  INTEGER, OPTIONAL, INTENT(OUT) :: ierror

```

**Fortran binding**

```

MPI_FILE_READ_ALL_END(FH, BUF, STATUS, IERROR)
  INTEGER FH, STATUS(MPI_STATUS_SIZE), IERROR
  <type> BUF(*)

```

**MPI\_FILE\_WRITE\_ALL\_BEGIN(fh, buf, count, datatype)**

INOUT	fh	file handle (handle)
IN	buf	initial address of buffer (choice)
IN	count	number of elements in buffer (integer)
IN	datatype	datatype of each buffer element (handle)

**C binding**

```

int MPI_File_write_all_begin(MPI_File fh, const void *buf, int count,
  MPI_Datatype datatype)

int MPI_File_write_all_begin_c(MPI_File fh, const void *buf,
  MPI_Count count, MPI_Datatype datatype)

```

```

1  Fortran 2008 binding
2  MPI_File_write_all_begin(fh, buf, count, datatype, ierror)
3      TYPE(MPI_File), INTENT(IN) :: fh
4      TYPE(*), DIMENSION(..), INTENT(IN), ASYNCHRONOUS :: buf
5      INTEGER, INTENT(IN) :: count
6      TYPE(MPI_Datatype), INTENT(IN) :: datatype
7      INTEGER, OPTIONAL, INTENT(OUT) :: ierror
8
9  MPI_File_write_all_begin(fh, buf, count, datatype, ierror)
10     TYPE(MPI_File), INTENT(IN) :: fh
11     TYPE(*), DIMENSION(..), INTENT(IN), ASYNCHRONOUS :: buf
12     INTEGER(KIND=MPI_COUNT_KIND), INTENT(IN) :: count
13     TYPE(MPI_Datatype), INTENT(IN) :: datatype
14     INTEGER, OPTIONAL, INTENT(OUT) :: ierror
15
16 Fortran binding
17 MPI_FILE_WRITE_ALL_BEGIN(FH, BUF, COUNT, DATATYPE, IERROR)
18     INTEGER FH, COUNT, DATATYPE, IERROR
19     <type> BUF(*)
20
21 MPI_FILE_WRITE_ALL_END(fh, buf, status)
22
23     INOUT   fh                file handle (handle)
24     IN      buf               initial address of buffer (choice)
25     OUT     status            status object (status)
26
27 C binding
28 int MPI_File_write_all_end(MPI_File fh, const void *buf,
29                             MPI_Status *status)
30
31 Fortran 2008 binding
32 MPI_File_write_all_end(fh, buf, status, ierror)
33     TYPE(MPI_File), INTENT(IN) :: fh
34     TYPE(*), DIMENSION(..), INTENT(IN), ASYNCHRONOUS :: buf
35     TYPE(MPI_Status) :: status
36     INTEGER, OPTIONAL, INTENT(OUT) :: ierror
37
38 Fortran binding
39 MPI_FILE_WRITE_ALL_END(FH, BUF, STATUS, IERROR)
40     INTEGER FH, STATUS(MPI_STATUS_SIZE), IERROR
41     <type> BUF(*)
42
43
44
45
46
47
48

```

MPI_FILE_READ_ORDERED_BEGIN(fh, buf, count, datatype)			1
INOUT	fh	file handle (handle)	2
			3
OUT	buf	initial address of buffer (choice)	4
			5
IN	count	number of elements in buffer (integer)	6
			7
IN	datatype	datatype of each buffer element (handle)	8

**C binding**

```
int MPI_File_read_ordered_begin(MPI_File fh, void *buf, int count,
                               MPI_Datatype datatype)
```

```
int MPI_File_read_ordered_begin_c(MPI_File fh, void *buf, MPI_Count count,
                                  MPI_Datatype datatype)
```

**Fortran 2008 binding**

```
MPI_File_read_ordered_begin(fh, buf, count, datatype, ierror)
  TYPE(MPI_File), INTENT(IN) :: fh
  TYPE(*), DIMENSION(..), ASYNCHRONOUS :: buf
  INTEGER, INTENT(IN) :: count
  TYPE(MPI_Datatype), INTENT(IN) :: datatype
  INTEGER, OPTIONAL, INTENT(OUT) :: ierror
```

```
MPI_File_read_ordered_begin(fh, buf, count, datatype, ierror)
  TYPE(MPI_File), INTENT(IN) :: fh
  TYPE(*), DIMENSION(..), ASYNCHRONOUS :: buf
  INTEGER(KIND=MPI_COUNT_KIND), INTENT(IN) :: count
  TYPE(MPI_Datatype), INTENT(IN) :: datatype
  INTEGER, OPTIONAL, INTENT(OUT) :: ierror
```

**Fortran binding**

```
MPI_FILE_READ_ORDERED_BEGIN(FH, BUF, COUNT, DATATYPE, IERROR)
  INTEGER FH, COUNT, DATATYPE, IERROR
  <type> BUF(*)
```

```
MPI_FILE_READ_ORDERED_END(fh, buf, status)
```

INOUT	fh	file handle (handle)	36
			37
OUT	buf	initial address of buffer (choice)	38
			39
OUT	status	status object (status)	40

**C binding**

```
int MPI_File_read_ordered_end(MPI_File fh, void *buf, MPI_Status *status)
```

**Fortran 2008 binding**

```
MPI_File_read_ordered_end(fh, buf, status, ierror)
  TYPE(MPI_File), INTENT(IN) :: fh
  TYPE(*), DIMENSION(..), ASYNCHRONOUS :: buf
  TYPE(MPI_Status) :: status
```

```

1     INTEGER, OPTIONAL, INTENT(OUT) :: ierror
2
3     Fortran binding
4     MPI_FILE_READ_ORDERED_END(FH, BUF, STATUS, IERROR)
5         INTEGER FH, STATUS(MPI_STATUS_SIZE), IERROR
6         <type> BUF(*)
7
8
9     MPI_FILE_WRITE_ORDERED_BEGIN(fh, buf, count, datatype)
10
11     INOUT   fh                file handle (handle)
12
13     IN      buf                initial address of buffer (choice)
14
15     IN      count              number of elements in buffer (integer)
16
17     IN      datatype           datatype of each buffer element (handle)
18
19
20     C binding
21     int MPI_File_write_ordered_begin(MPI_File fh, const void *buf, int count,
22                                     MPI_Datatype datatype)
23
24     int MPI_File_write_ordered_begin_c(MPI_File fh, const void *buf,
25                                       MPI_Count count, MPI_Datatype datatype)
26
27     Fortran 2008 binding
28     MPI_File_write_ordered_begin(fh, buf, count, datatype, ierror)
29         TYPE(MPI_File), INTENT(IN) :: fh
30         TYPE(*), DIMENSION(..), INTENT(IN), ASYNCHRONOUS :: buf
31         INTEGER, INTENT(IN) :: count
32         TYPE(MPI_Datatype), INTENT(IN) :: datatype
33         INTEGER, OPTIONAL, INTENT(OUT) :: ierror
34
35     MPI_File_write_ordered_begin(fh, buf, count, datatype, ierror)
36         TYPE(MPI_File), INTENT(IN) :: fh
37         TYPE(*), DIMENSION(..), INTENT(IN), ASYNCHRONOUS :: buf
38         INTEGER(KIND=MPI_COUNT_KIND), INTENT(IN) :: count
39         TYPE(MPI_Datatype), INTENT(IN) :: datatype
40         INTEGER, OPTIONAL, INTENT(OUT) :: ierror
41
42     Fortran binding
43     MPI_FILE_WRITE_ORDERED_BEGIN(FH, BUF, COUNT, DATATYPE, IERROR)
44         INTEGER FH, COUNT, DATATYPE, IERROR
45         <type> BUF(*)
46
47
48

```

`MPI_FILE_WRITE_ORDERED_END(fh, buf, status)`

INOUT	fh	file handle (handle)
IN	buf	initial address of buffer (choice)
OUT	status	status object (status)

#### C binding

```
int MPI_File_write_ordered_end(MPI_File fh, const void *buf,
                               MPI_Status *status)
```

#### Fortran 2008 binding

```
MPI_File_write_ordered_end(fh, buf, status, ierror)
  TYPE(MPI_File), INTENT(IN) :: fh
  TYPE(*), DIMENSION(..), INTENT(IN), ASYNCHRONOUS :: buf
  TYPE(MPI_Status) :: status
  INTEGER, OPTIONAL, INTENT(OUT) :: ierror
```

#### Fortran binding

```
MPI_FILE_WRITE_ORDERED_END(FH, BUF, STATUS, IERROR)
  INTEGER FH, STATUS(MPI_STATUS_SIZE), IERROR
  <type> BUF(*)
```

## 14.5 File Interoperability

At the most basic level, file interoperability is the ability to read the information previously written to a file—not just the bits of data, but the actual information the bits represent. MPI guarantees full interoperability within a single MPI environment, and supports increased interoperability outside that environment through the external data representation (Section 14.5.2) as well as the data conversion functions (Section 14.5.3).

Interoperability within a single MPI environment (which could be considered “operability”) ensures that file data written by one MPI process can be read by any other MPI process, subject to the consistency constraints (see Section 14.6.1), provided that it would have been possible to start the two processes simultaneously and have them reside in a single MPI\_COMM\_WORLD. Furthermore, both processes must see the same data values at every absolute byte offset in the file for which data was written.

This single environment file interoperability implies that file data is accessible regardless of the number of processes.

There are three aspects to file interoperability:

- transferring the bits,
- converting between different file structures, and
- converting between different machine representations.

The first two aspects of file interoperability are beyond the scope of this standard, as both are highly machine dependent. However, transferring the bits of a file into and out of the MPI environment (e.g., by writing a file to tape) is required to be supported by all MPI implementations. In particular, an implementation must specify how familiar

1 operations similar to POSIX `cp`, `rm`, and `mv` can be performed on the file. Furthermore, it  
2 is expected that the facility provided maintains the correspondence between absolute byte  
3 offsets (e.g., after possible file structure conversion, the data bits at byte offset 102 in the  
4 MPI environment are at byte offset 102 outside the MPI environment). As an example,  
5 a simple off-line conversion utility that transfers and converts files between the native file  
6 system and the MPI environment would suffice, provided it maintained the offset coherence  
7 mentioned above. In a high-quality implementation of MPI, users will be able to manipulate  
8 MPI files using the same or similar tools that the native file system offers for manipulating  
9 its files.

10 The remaining aspect of file interoperability, converting between different machine  
11 representations, is supported by the typing information specified in the `etype` and `filetype`.  
12 This facility allows the information in files to be shared between any two applications,  
13 regardless of whether they use MPI, and regardless of the machine architectures on which  
14 they run.

15 MPI supports multiple data representations: "native", "internal", and "external32". An  
16 implementation may support additional data representations. MPI also supports user-  
17 defined data representations (see Section 14.5.3). The "native" and "internal" data repre-  
18 sentations are implementation dependent, while the "external32" representation is common  
19 to all MPI implementations and facilitates file interoperability. The data representation is  
20 specified in the `datarep` argument to `MPI_FILE_SET_VIEW`.

21  
22 *Advice to users.* MPI is not guaranteed to retain knowledge of what data representa-  
23 tion was used when a file is written. Therefore, to correctly retrieve file data, an MPI  
24 application is responsible for specifying the same data representation as was used to  
25 create the file. (*End of advice to users.*)

26 **"native"** Data in this representation is stored in a file exactly as it is in memory. The ad-  
27 vantage of this data representation is that data precision and I/O performance are not  
28 lost in type conversions with a purely homogeneous environment. The disadvantage  
29 is the loss of transparent interoperability within a heterogeneous MPI environment.

30  
31 *Advice to users.* This data representation should only be used in a homogeneous  
32 MPI environment, or when the MPI application is capable of performing the  
33 datatype conversions itself. (*End of advice to users.*)

34  
35 *Advice to implementors.* When implementing read and write operations on  
36 top of MPI message-passing, the message data should be typed as `MPI_BYTE` to  
37 ensure that the message routines do not perform any type conversions on the  
38 data. (*End of advice to implementors.*)

39 **"internal"** This data representation can be used for I/O operations in a homogeneous or  
40 heterogeneous environment; the implementation will perform type conversions if nec-  
41 essary. The implementation is free to store data in any format of its choice, with the  
42 restriction that it will maintain constant extents for all predefined datatypes in any  
43 one file. The environment in which the resulting file can be reused is implementa-  
44 tion-defined and must be documented by the implementation.

45  
46 *Rationale.* This data representation allows the implementation to perform I/O  
47 efficiently in a heterogeneous environment, though with implementation-defined  
48 restrictions on how the file can be reused. (*End of rationale.*)



*Advice to implementors.* Since "external32" is a superset of the functionality provided by "internal", an implementation may choose to implement "internal" as "external32". (*End of advice to implementors.*)

**"external32"** This data representation states that read and write operations convert all data from and to the "external32" representation defined in Section 14.5.2. The data conversion rules for communication also apply to these conversions (see Section 3.3.2). The data on the storage medium is always in this canonical representation, and the data in memory is always in the local process's native representation.

This data representation has several advantages. First, all processes reading the file in a heterogeneous MPI environment will automatically have the data converted to their respective native representations. Second, the file can be exported from one MPI environment and imported into any other MPI environment with the guarantee that the second environment will be able to read all the data in the file.

The disadvantage of this data representation is that data precision and I/O performance may be lost in datatype conversions.

*Advice to implementors.* When implementing read and write operations on top of MPI message-passing, the message data should be converted to and from the "external32" representation in the client, and sent as type MPI\_BYTE. This will avoid possible double datatype conversions and the associated further loss of precision and performance. (*End of advice to implementors.*)

### 14.5.1 Datatypes for File Interoperability

If the file data representation is other than "native", care must be taken in constructing etypes and filetypes. Any of the datatype constructor functions may be used; however, for those functions that accept displacements in bytes, the displacements must be specified in terms of their values in the file for the file data representation being used. MPI will interpret these byte displacements as is; no scaling will be done. The function MPI\_FILE\_GET\_TYPE\_EXTENT can be used to calculate the extents of datatypes in the file. For etypes and filetypes that are portable datatypes (see Section 2.4), MPI will scale any displacements in the datatypes to match the file data representation. Datatypes passed as arguments to read/write routines specify the data layout in memory; therefore, they must always be constructed using displacements corresponding to displacements in memory.

*Advice to users.* One can logically think of the file as if it were stored in the memory of a file server. The etype and filetype are interpreted as if they were defined at this file server, by the same sequence of calls used to define them at the calling process. If the data representation is "native", then this logical file server runs on the same architecture as the calling process, so that these types define the same data layout on the file as they would define in the memory of the calling process. If the etype and filetype are portable datatypes, then the data layout defined in the file is the same as would be defined in the calling process memory, up to a scaling factor. The routine MPI\_FILE\_GET\_TYPE\_EXTENT can be used to calculate this scaling factor. Thus, two equivalent, portable datatypes will define the same data layout in the file, even in a heterogeneous environment with "internal", "external32", or user defined data representations. Otherwise, the etype and filetype must be constructed

so that their typemap and extent are the same on any architecture. This can be achieved if they have an explicit upper bound and lower bound (defined using `MPI_TYPE_CREATE_RESIZED`). This condition must also be fulfilled by any datatype that is used in the construction of the `etype` and `filetype`, if this datatype is replicated contiguously, either explicitly, by a call to `MPI_TYPE_CONTIGUOUS`, or implicitly, by a `blocklength` argument that is greater than one. If an `etype` or `filetype` is not portable, and has a typemap or extent that is architecture dependent, then the data layout specified by it on a file is implementation dependent.

File data representations other than "native" may be different from corresponding data representations in memory. Therefore, for these file data representations, it is important not to use hardwired byte offsets for file positioning, including the initial displacement that specifies the view. When a portable datatype (see Section 2.4) is used in a data access operation, any holes in the datatype are scaled to match the data representation. However, note that this technique only works when all the processes that created the file view build their `etypes` from the same predefined datatypes. For example, if one process uses an `etype` built from `MPI_INT` and another uses an `etype` built from `MPI_FLOAT`, the resulting views may be nonportable because the relative sizes of these types may differ from one data representation to another. (*End of advice to users.*)

`MPI_FILE_GET_TYPE_EXTENT(fh, datatype, extent)`

IN	fh	file handle (handle)
IN	datatype	datatype (handle)
OUT	extent	datatype extent (integer)

### C binding

```
int MPI_File_get_type_extent(MPI_File fh, MPI_Datatype datatype,
                             MPI_Aint *extent)
```

```
int MPI_File_get_type_extent_c(MPI_File fh, MPI_Datatype datatype,
                               MPI_Count *extent)
```

### Fortran 2008 binding

```
MPI_File_get_type_extent(fh, datatype, extent, ierror)
    TYPE(MPI_File), INTENT(IN) :: fh
    TYPE(MPI_Datatype), INTENT(IN) :: datatype
    INTEGER(KIND=MPI_ADDRESS_KIND), INTENT(OUT) :: extent
    INTEGER, OPTIONAL, INTENT(OUT) :: ierror
```

```
MPI_File_get_type_extent(fh, datatype, extent, ierror)
    TYPE(MPI_File), INTENT(IN) :: fh
    TYPE(MPI_Datatype), INTENT(IN) :: datatype
    INTEGER(KIND=MPI_COUNT_KIND), INTENT(OUT) :: extent
    INTEGER, OPTIONAL, INTENT(OUT) :: ierror
```

### Fortran binding

```
MPI_FILE_GET_TYPE_EXTENT(FH, DATATYPE, EXTENT, IERROR)
```

```

INTEGER fh, datatype, ierror
INTEGER(KIND=MPI_ADDRESS_KIND) extent

```

Returns the extent of `datatype` in the file `fh`. This extent will be the same for all processes accessing the file `fh`. If the current view uses a user-defined data representation (see Section 14.5.3), MPI uses the `dtype_file_extent_fn` callback to calculate the extent.

If the `datatype` extent cannot be represented in `extent`, it is set to `MPI_UNDEFINED`.

*Advice to implementors.* In the case of user-defined data representations, the extent of a derived datatype can be calculated by first determining the extents of the predefined datatypes in this derived datatype using `dtype_file_extent_fn` (see Section 14.5.3).  
(*End of advice to implementors.*)

#### 14.5.2 External Data Representation: "external32"

All MPI implementations are required to support the data representation defined in this section. Support of optional datatypes (e.g., `MPI_INTEGER2`) is not required.

All floating point values are in big-endian IEEE format [42] of the appropriate size. Floating point values are represented by one of three IEEE formats. These are the IEEE “Single (binary32),” “Double (binary64),” and “Double Extended (binary128)” formats, requiring 4, 8, and 16 bytes of storage, respectively. For the IEEE “Double Extended (binary128)” formats, MPI specifies a Format Width of 16 bytes, with 15 exponent bits, bias = +16383, 112 fraction bits, and an encoding analogous to the “Double (binary64)” format. All integral values are in two’s complement big-endian format. Big-endian means most significant byte at lowest address byte. For C `_Bool`, Fortran `LOGICAL`, and C++ `bool`, 0 implies false and nonzero implies true. C `float`, `_Complex`, `double`, `_Complex`, and `long double`, `_Complex`, Fortran `COMPLEX` and `DOUBLE COMPLEX`, and other complex types are represented by a pair of floating point format values for the real and imaginary components. Characters are in ISO 8859-1 format [43]. Wide characters (of type `MPI_WCHAR`) are in Unicode format [68].

All signed numerals (e.g., `MPI_INT`, `MPI_REAL`) have the sign bit at the most significant bit. `MPI_COMPLEX` and `MPI_DOUBLE_COMPLEX` have the sign bit of the real and imaginary parts at the most significant bit of each part.

According to IEEE specifications [42], the “NaN” (not a number) is system dependent. It should not be interpreted within MPI as anything other than “NaN.”

*Advice to implementors.* The MPI treatment of “NaN” is similar to the approach used in XDR [65]. (*End of advice to implementors.*)

All data is byte aligned, regardless of type. All data items are stored contiguously in the file (if the file view is contiguous).

*Advice to implementors.* All bytes of `LOGICAL` and `bool` must be checked to determine the value. (*End of advice to implementors.*)

*Advice to users.* The type `MPI_PACKED` is treated as bytes and is not converted. The user should be aware that `MPI_PACK` has the option of placing a header in the beginning of the pack buffer. (*End of advice to users.*)

Predefined Type	Length
MPI_PACKED	1
MPI_BYTE	1
MPI_CHAR	1
MPI_UNSIGNED_CHAR	1
MPI_SIGNED_CHAR	1
MPI_WCHAR	2
MPI_SHORT	2
MPI_UNSIGNED_SHORT	2
MPI_INT	4
MPI_LONG	4
MPI_UNSIGNED	4
MPI_UNSIGNED_LONG	4
MPI_LONG_LONG_INT	8
MPI_UNSIGNED_LONG_LONG	8
MPI_FLOAT	4
MPI_DOUBLE	8
MPI_LONG_DOUBLE	16
MPI_C_BOOL	1
MPI_INT8_T	1
MPI_INT16_T	2
MPI_INT32_T	4
MPI_INT64_T	8
MPI_UINT8_T	1
MPI_UINT16_T	2
MPI_UINT32_T	4
MPI_UINT64_T	8
MPI_AINT	8
MPI_COUNT	8
MPI_OFFSET	8
MPI_C_COMPLEX	2*4
MPI_C_FLOAT_COMPLEX	2*4
MPI_C_DOUBLE_COMPLEX	2*8
MPI_C_LONG_DOUBLE_COMPLEX	2*16
MPI_CHARACTER	1
MPI_LOGICAL	4
MPI_INTEGER	4
MPI_REAL	4
MPI_DOUBLE_PRECISION	8
MPI_COMPLEX	2*4
MPI_DOUBLE_COMPLEX	2*8
MPI_CXX_BOOL	1
MPI_CXX_FLOAT_COMPLEX	2*4
MPI_CXX_DOUBLE_COMPLEX	2*8
MPI_CXX_LONG_DOUBLE_COMPLEX	2*16

Table 14.2: "external32" sizes of predefined datatypes

Predefined Type	Length
MPI_INTEGER1	1
MPI_INTEGER2	2
MPI_INTEGER4	4
MPI_INTEGER8	8
MPI_INTEGER16	16
MPI_REAL2	2
MPI_REAL4	4
MPI_REAL8	8
MPI_REAL16	16
MPI_COMPLEX4	2*2
MPI_COMPLEX8	2*4
MPI_COMPLEX16	2*8
MPI_COMPLEX32	2*16

Table 14.3: "external32" sizes of optional datatypes

C++ Types	Length
MPI_CXX_BOOL	1
MPI_CXX_FLOAT_COMPLEX	2*4
MPI_CXX_DOUBLE_COMPLEX	2*8
MPI_CXX_LONG_DOUBLE_COMPLEX	2*16

Table 14.4: "external32" sizes of C++ datatypes

The sizes of the predefined datatypes returned from `MPI_TYPE_CREATE_F90_REAL`, `MPI_TYPE_CREATE_F90_COMPLEX`, and `MPI_TYPE_CREATE_F90_INTEGER` are defined in Section 19.1.9, page 805.

*Advice to implementors.* When converting a larger size integer to a smaller size integer, only the least significant bytes are moved. Care must be taken to preserve the sign bit value. This allows no conversion errors if the data range is within the range of the smaller size integer. (*End of advice to implementors.*)

Table 14.2, 14.3, and 14.4 specify the sizes of predefined, optional, and C++ datatypes in "external32" format, respectively.

### 14.5.3 User-Defined Data Representations

There are two situations that cannot be handled by the required representations:

1. a user wants to write a file in a representation unknown to the implementation, and
2. a user wants to read a file written in a representation unknown to the implementation.

User-defined data representations allow the user to insert a third party converter into the I/O stream to do the data representation conversion.

```
MPI_REGISTER_DATAREP(datarep, read_conversion_fn, write_conversion_fn,
                    dtype_file_extent_fn, extra_state)
```

IN	datarep	data representation identifier (string)
IN	read_conversion_fn	function invoked to convert from file representation to native representation (function)
IN	write_conversion_fn	function invoked to convert from native representation to file representation (function)
IN	dtype_file_extent_fn	function invoked to get the extent of a datatype as represented in the file (function)
IN	extra_state	extra state

#### C binding

```
int MPI_Register_datarep(const char *datarep,
                       MPI_Datarep_conversion_function *read_conversion_fn,
                       MPI_Datarep_conversion_function *write_conversion_fn,
                       MPI_Datarep_extent_function *dtype_file_extent_fn,
                       void *extra_state)

int MPI_Register_datarep_c(const char *datarep,
                          MPI_Datarep_conversion_function_c *read_conversion_fn,
                          MPI_Datarep_conversion_function_c *write_conversion_fn,
                          MPI_Datarep_extent_function *dtype_file_extent_fn,
                          void *extra_state)
```

**Fortran 2008 binding**

```

MPI_Register_datarep(datarep, read_conversion_fn, write_conversion_fn,
    dtype_file_extent_fn, extra_state, ierror)
CHARACTER(LEN=*), INTENT(IN) :: datarep
PROCEDURE(MPI_Datarep_conversion_function), INTENT(IN) ::
    read_conversion_fn, write_conversion_fn
PROCEDURE(MPI_Datarep_extent_function) :: dtype_file_extent_fn
INTEGER(KIND=MPI_ADDRESS_KIND), INTENT(IN) :: extra_state
INTEGER, OPTIONAL, INTENT(OUT) :: ierror

MPI_Register_datarep_c(datarep, read_conversion_fn, write_conversion_fn,
    dtype_file_extent_fn, extra_state, ierror)
CHARACTER(LEN=*), INTENT(IN) :: datarep
PROCEDURE(MPI_Datarep_conversion_function_c), INTENT(IN) ::
    read_conversion_fn, write_conversion_fn
PROCEDURE(MPI_Datarep_extent_function) :: dtype_file_extent_fn
INTEGER(KIND=MPI_ADDRESS_KIND), INTENT(IN) :: extra_state
INTEGER, OPTIONAL, INTENT(OUT) :: ierror

```

**Fortran binding**

```

MPI_REGISTER_DATAREP(DATAREP, READ_CONVERSION_FN, WRITE_CONVERSION_FN,
    DTYPE_FILE_EXTENT_FN, EXTRA_STATE, IERROR)
CHARACTER*(*) DATAREP
EXTERNAL READ_CONVERSION_FN, WRITE_CONVERSION_FN, DTYPE_FILE_EXTENT_FN
INTEGER(KIND=MPI_ADDRESS_KIND) EXTRA_STATE
INTEGER IERROR

```

The call associates `read_conversion_fn`, `write_conversion_fn`, and `dtype_file_extent_fn` with the data representation identifier `datarep`. `datarep` can then be used as an argument to `MPI_FILE_SET_VIEW`, causing subsequent data access operations to call the conversion functions to convert all data items accessed between file data representation and native representation. `MPI_REGISTER_DATAREP` is a local operation and only registers the data representation for the calling MPI process. If `datarep` is already defined, an error in the error class `MPI_ERR_DUP_DATAREP` is raised using the default file error handler (see Section 14.7). The length of a data representation string is limited to the value of `MPI_MAX_DATAREP_STRING`. `MPI_MAX_DATAREP_STRING` must have a value of at least 64. No routines are provided to delete data representations and free the associated resources; it is not expected that an application will generate them in significant numbers.

**Extent Callback**

```

typedef int MPI_Datarep_extent_function(MPI_Datatype datatype,
    MPI_Aint *extent, void *extra_state);

ABSTRACT INTERFACE
SUBROUTINE MPI_Datarep_extent_function(datatype, extent, extra_state,
    ierror)
TYPE(MPI_Datatype) :: datatype
INTEGER(KIND=MPI_ADDRESS_KIND) :: extent, extra_state
INTEGER :: ierror

```

```

1  SUBROUTINE DATAREP_EXTENT_FUNCTION(DATATYPE, EXTENT, EXTRA_STATE, IERROR)
2      INTEGER DATATYPE, IERROR
3      INTEGER(KIND=MPI_ADDRESS_KIND) EXTENT, EXTRA_STATE

```

The function `dtype_file_extent_fn` must return, in `file_extent`, the number of bytes required to store `datatype` in the file representation. The function is passed, in `extra_state`, the argument that was passed to the `MPI_REGISTER_DATAREP` call. MPI will only call this routine with predefined datatypes employed by the user.

*Rationale.* This callback does not have a large count variant because it is anticipated that large counts will not be required to represent the extent output value. (*End of rationale.*)

`MPI_DATAREP_CONVERSION_FUNCTION` also supports large count types in separate additional MPI procedures in C (suffixed with the “\_c”) and interface polymorphism in Fortran when using `USE mpi_f08`.

If the extent cannot be represented in `extent`, the callback function shall set `extent` to `MPI_UNDEFINED`. The MPI implementation will then raise an error of class `MPI_ERR_VALUE_TOO_LARGE`.

#### Datarep Conversion Functions

```

22  typedef int MPI_Datarep_conversion_function(void *userbuf,
23      MPI_Datatype datatype, int count, void *filebuf,
24      MPI_Offset position, void *extra_state);
25
26  typedef int MPI_Datarep_conversion_function_c(void *userbuf,
27      MPI_Datatype datatype, MPI_Count count, void *filebuf,
28      MPI_Offset position, void *extra_state);
29
30  ABSTRACT INTERFACE
31      SUBROUTINE MPI_Datarep_conversion_function(userbuf, datatype, count,
32          filebuf, position, extra_state, ierror)
33          USE, INTRINSIC :: ISO_C_BINDING, ONLY : C_PTR
34          TYPE(C_PTR), VALUE :: userbuf, filebuf
35          TYPE(MPI_Datatype) :: datatype
36          INTEGER :: count, ierror
37          INTEGER(KIND=MPI_OFFSET_KIND) :: position
38          INTEGER(KIND=MPI_ADDRESS_KIND) :: extra_state
39
40  ABSTRACT INTERFACE
41      SUBROUTINE MPI_Datarep_conversion_function_c(userbuf, datatype, count,
42          filebuf, position, extra_state, ierror)
43          USE, INTRINSIC :: ISO_C_BINDING, ONLY : C_PTR
44          TYPE(C_PTR), VALUE :: userbuf, filebuf
45          TYPE(MPI_Datatype) :: datatype
46          INTEGER(KIND=MPI_COUNT_KIND) :: count
47          INTEGER(KIND=MPI_OFFSET_KIND) :: position
48          INTEGER(KIND=MPI_ADDRESS_KIND) :: extra_state
49          INTEGER :: ierror

```



```

SUBROUTINE DATAREP_CONVERSION_FUNCTION(USERBUF, DATATYPE, COUNT, FILEBUF,
    POSITION, EXTRA_STATE, IERROR)
<TYPE> USERBUF(*), FILEBUF(*)
INTEGER DATATYPE, COUNT, IERROR
INTEGER(KIND=MPI_OFFSET_KIND) POSITION
INTEGER(KIND=MPI_ADDRESS_KIND) EXTRA_STATE

```

The function `read_conversion_fn` must convert from file data representation to native representation. Before calling this routine, MPI allocates and fills `filebuf` with `count` contiguous data items. The type of each data item matches the corresponding entry for the predefined `datatype` in the type signature of `datatype`. The function is passed, in `extra_state`, the argument that was passed to the `MPI_REGISTER_DATAREP` call. The function must copy all `count` data items from `filebuf` to `userbuf` in the distribution described by `datatype`, converting each data item from file representation to native representation. `datatype` will be equivalent to the `datatype` that the user passed to the read function. If the size of `datatype` is less than the size of the `count` data items, the conversion function must treat `datatype` as being contiguously tiled over the `userbuf`. The conversion function must begin storing converted data at the location in `userbuf` specified by `position` into the (tiled) `datatype`.

*Advice to users.* Although the conversion functions have similarities to `MPI_PACK` and `MPI_UNPACK`, one should note the differences in the use of the arguments `count` and `position`. In the conversion functions, `count` is a count of data items (i.e., count of typemap entries of `datatype`), and `position` is an index into this typemap. In `MPI_PACK`, `incount` refers to the number of whole `datatypes`, and `position` is a number of bytes. (*End of advice to users.*)

*Advice to implementors.* A converted read operation could be implemented as follows:

1. Get file extent of all data items
2. Allocate a `filebuf` large enough to hold all `count` data items
3. Read data from file into `filebuf`
4. Call `read_conversion_fn` to convert data and place it into `userbuf`
5. Deallocate `filebuf`

(*End of advice to implementors.*)

If MPI cannot allocate a buffer large enough to hold all the data to be converted from a read operation, it may call the conversion function repeatedly using the same `datatype` and `userbuf`, and reading successive chunks of data to be converted in `filebuf`. For the first call (and in the case when all the data to be converted fits into `filebuf`), MPI will call the function with `position` set to zero. Data converted during this call will be stored in the `userbuf` according to the first `count` data items in `datatype`. Then in subsequent calls to the conversion function, MPI will increment the value in `position` by the count of items converted in the previous call, and the `userbuf` pointer will be unchanged.

*Rationale.* Passing the conversion function a `position` and one `datatype` for the transfer allows the conversion function to decode the `datatype` only once and cache an internal representation of it on the `datatype`. Then on subsequent calls, the conversion

1 function can use the `position` to quickly find its place in the datatype and continue  
2 storing converted data where it left off at the end of the previous call. (*End of*  
3 *rationale.*)

4  
5 *Advice to users.* Although the conversion function may usefully cache an internal  
6 representation on the datatype, it should not cache any state information specific to  
7 an ongoing conversion operation, since it is possible for the same datatype to be used  
8 concurrently in multiple conversion operations. (*End of advice to users.*)

9  
10 The function `write_conversion_fn` must convert from native representation to file data  
11 representation. Before calling this routine, MPI allocates `filebuf` of a size large enough to  
12 hold `count` contiguous data items. The type of each data item matches the corresponding  
13 entry for the predefined datatype in the type signature of `datatype`. The function must copy  
14 `count` data items from `userbuf` in the distribution described by `datatype`, to a contiguous  
15 distribution in `filebuf`, converting each data item from native representation to file repre-  
16 sentation. If the size of `datatype` is less than the size of `count` data items, the conversion  
17 function must treat `datatype` as being contiguously tiled over the `userbuf`.

18 The function must begin copying at the location in `userbuf` specified by `position` into  
19 the (tiled) `datatype`. `datatype` will be equivalent to the datatype that the user passed to the  
20 write function. The function is passed, in `extra_state`, the argument that was passed to the  
21 `MPI_REGISTER_DATAREP` call.

22 The predefined constant `MPI_CONVERSION_FN_NULL` may be used as either  
23 `write_conversion_fn` or `read_conversion_fn`. In that case, MPI will not attempt to invoke  
24 `write_conversion_fn` or `read_conversion_fn`, respectively, but will perform the requested data  
25 access using the native data representation.

26 An MPI implementation must ensure that all data accessed is converted, either by  
27 using a `filebuf` large enough to hold all the requested data items or else by making repeated  
28 calls to the conversion function with the same `datatype` argument and appropriate values  
29 for `position`.

30 An implementation will only invoke the callback routines in this section  
31 (`read_conversion_fn`, `write_conversion_fn`, and `dtype_file_extent_fn`) when one of the read or  
32 write routines in Section 14.4, or `MPI_FILE_GET_TYPE_EXTENT` is called by the user.  
33 `dtype_file_extent_fn` will only be passed predefined datatypes employed by the user. The  
34 conversion functions will only be passed datatypes equivalent to those that the user has  
35 passed to one of the routines noted above.

36 The conversion functions must be reentrant. User defined data representations are  
37 restricted to use byte alignment for all types. Furthermore, it is erroneous for the conversion  
38 functions to call any collective routines or to free `datatype`.

39 The conversion functions should return an error code. If the returned error code has  
40 a value other than `MPI_SUCCESS`, the implementation will raise an error in the class  
41 `MPI_ERR_CONVERSION`.

#### 42 14.5.4 Matching Data Representations

44 It is the user's responsibility to ensure that the data representation used to read data from  
45 a file is *compatible* with the data representation that was used to write that data to the file.

46 In general, using the same data representation name when writing and reading a file  
47 does not guarantee that the representation is compatible. Similarly, using different repre-  
48 sentation names on two different implementations may yield compatible representations.

Compatibility can be obtained when "external32" representation is used, although precision may be lost and the performance may be less than when "native" representation is used. Compatibility is guaranteed using "external32" provided at least one of the following conditions is met.

- The data access routines directly use types enumerated in Section 14.5.2, that are supported by all implementations participating in the I/O. The predefined type used to write a data item must also be used to read a data item.
- In the case of Fortran 90 programs, the programs participating in the data accesses obtain compatible datatypes using MPI routines that specify precision and/or range (Section 19.1.9).
- For any given data item, the programs participating in the data accesses use compatible predefined types to write and read the data item.

User-defined data representations may be used to provide an implementation compatibility with another implementation's "native" or "internal" representation.

*Advice to users.* Section 19.1.9 defines routines that support the use of matching datatypes in heterogeneous environments and contains examples illustrating their use. (*End of advice to users.*)

## 14.6 Consistency and Semantics

### 14.6.1 File Consistency

Consistency semantics define the outcome of multiple accesses to a single file. All file accesses in MPI are relative to a specific file handle created from a collective open. MPI provides three levels of consistency: sequential consistency among all accesses using a single file handle, sequential consistency among all accesses using file handles created from a single collective open with atomic mode enabled, and user-imposed consistency among accesses other than the above. Sequential consistency means the behavior of a set of operations will be as if the operations were performed in some serial order consistent with program order; each access appears atomic, although the exact ordering of accesses is unspecified. User-imposed consistency may be obtained using program order and calls to `MPI_FILE_SYNC`.

Let  $FH_1$  be the set of file handles created from one particular collective open of the file  $FOO$ , and  $FH_2$  be the set of file handles created from a different collective open of  $FOO$ . Note that nothing restrictive is said about  $FH_1$  and  $FH_2$ : the sizes of  $FH_1$  and  $FH_2$  may be different, the groups of processes used for each open may or may not intersect, the file handles in  $FH_1$  may be destroyed before those in  $FH_2$  are created, etc. Consider the following three cases: a single file handle (e.g.,  $fh_1 \in FH_1$ ), two file handles created from a single collective open (e.g.,  $fh_{1a} \in FH_1$  and  $fh_{1b} \in FH_1$ ), and two file handles from different collective opens (e.g.,  $fh_1 \in FH_1$  and  $fh_2 \in FH_2$ ).

For the purpose of consistency semantics, a matched pair (Section 14.4.5) of split collective data access operations (e.g., `MPI_FILE_READ_ALL_BEGIN` and `MPI_FILE_READ_ALL_END`) compose a single data access operation. Similarly, a non-blocking data access routine (e.g., `MPI_FILE_IREAD`) and the routine which completes the request (e.g., `MPI_WAIT`) also compose a single data access operation. For all cases below,

1 these data access operations are subject to the same constraints as blocking data access  
 2 operations.

3  
 4 *Advice to users.* For an `MPI_FILE_IREAD` and `MPI_WAIT` pair, the operation begins  
 5 when `MPI_FILE_IREAD` is called and ends when `MPI_WAIT` returns. (*End of advice*  
 6 *to users.*)

7  
 8 Assume that  $A_1$  and  $A_2$  are two data access operations. Let  $D_1$  ( $D_2$ ) be the set of  
 9 absolute byte displacements of every byte accessed in  $A_1$  ( $A_2$ ). The two data accesses  
 10 *overlap* if  $D_1 \cap D_2 \neq \emptyset$ . The two data accesses *conflict* if they overlap and at least one is a  
 11 write access.

12 Let  $SEQ_{fh}$  be a sequence of file operations on a single file handle, bracketed by  
 13 `MPI_FILE_SYNC`s on that file handle. (Both opening and closing a file implicitly perform  
 14 an `MPI_FILE_SYNC`.)  $SEQ_{fh}$  is a “write sequence” if any of the data access operations in  
 15 the sequence are writes or if any of the file manipulation operations in the sequence change  
 16 the state of the file (e.g., `MPI_FILE_SET_SIZE` or `MPI_FILE_PREALLOCATE`). Given two  
 17 sequences,  $SEQ_1$  and  $SEQ_2$ , we say they are not *concurrent* if one sequence is guaranteed  
 18 to completely precede the other (temporally).

19 The requirements for guaranteeing sequential consistency among all accesses to a par-  
 20 ticular file are divided into the three cases given below. If any of these requirements are  
 21 not met, then the value of all data in that file is implementation dependent.

22  
 23 **Case 1:**  $fh_1 \in FH_1$  All operations on  $fh_1$  are sequentially consistent if atomic mode is  
 24 set. If nonatomic mode is set, then all operations on  $fh_1$  are sequentially consistent if they  
 25 are either nonconcurrent, nonconflicting, or both.

26  
 27 **Case 2:**  $fh_{1a} \in FH_1$  and  $fh_{1b} \in FH_1$  Assume  $A_1$  is a data access operation using  $fh_{1a}$ ,  
 28 and  $A_2$  is a data access operation using  $fh_{1b}$ . If for any access  $A_1$ , there is no access  $A_2$   
 29 that conflicts with  $A_1$ , then MPI guarantees sequential consistency.

30 However, unlike POSIX semantics, the default MPI semantics for conflicting accesses  
 31 do not guarantee sequential consistency. If  $A_1$  and  $A_2$  conflict, sequential consistency can  
 32 be guaranteed by either enabling atomic mode via the `MPI_FILE_SET_ATOMICITY` routine,  
 33 or meeting the condition described in Case 3 below.

34  
 35 **Case 3:**  $fh_1 \in FH_1$  and  $fh_2 \in FH_2$  Consider access to a single file using file handles from  
 36 distinct collective opens. In order to guarantee sequential consistency, `MPI_FILE_SYNC`  
 37 must be used (both opening and closing a file implicitly perform an `MPI_FILE_SYNC`).

38 Sequential consistency is guaranteed among accesses to a single file if for any write  
 39 sequence  $SEQ_1$  to the file, there is no sequence  $SEQ_2$  to the file which is *concurrent* with  
 40  $SEQ_1$ . To guarantee sequential consistency when there are write sequences,  
 41 `MPI_FILE_SYNC` must be used together with a mechanism that guarantees nonconcurrency  
 42 of the sequences.

43 See the examples in Section 14.6.11 for further clarification of some of these consistency  
 44 semantics.

MPI\_FILE\_SET\_ATOMICITY(fh, flag) 1

	INOUT	fh	file handle (handle) <span style="float: right;">2</span>
			3
	IN	flag	true to set atomic mode, false to set nonatomic mode <span style="float: right;">4</span>
			5
			6

### C binding 7

```
int MPI_File_set_atomicity(MPI_File fh, int flag) 8
```

### Fortran 2008 binding 9

```
MPI_File_set_atomicity(fh, flag, ierror) 10
  TYPE(MPI_File), INTENT(IN) :: fh 11
  LOGICAL, INTENT(IN) :: flag 12
  INTEGER, OPTIONAL, INTENT(OUT) :: ierror 13
14
```

### Fortran binding 15

```
MPI_FILE_SET_ATOMICITY(FH, FLAG, IERROR) 16
  INTEGER FH, IERROR 17
  LOGICAL FLAG 18
19
```

Let  $FH$  be the set of file handles created by one collective open. The consistency semantics for data access operations using  $FH$  is set by collectively calling MPI\_FILE\_SET\_ATOMICITY on  $FH$ . MPI\_FILE\_SET\_ATOMICITY is collective; all processes in the group must pass identical values for  $fh$  and  $flag$ . If  $flag$  is true, atomic mode is set; if  $flag$  is false, nonatomic mode is set. 20-24

Changing the consistency semantics for an open file only affects new data accesses. All completed data accesses are guaranteed to abide by the consistency semantics in effect during their execution. Nonblocking data accesses and split collective operations that have not completed (e.g., via MPI\_WAIT) are only guaranteed to abide by nonatomic mode consistency semantics. 25-29

*Advice to implementors.* Since the semantics guaranteed by atomic mode are stronger than those guaranteed by nonatomic mode, an implementation is free to adhere to the more stringent atomic mode semantics for outstanding requests. (*End of advice to implementors.*) 30-34

MPI\_FILE\_GET\_ATOMICITY(fh, flag) 37

	IN	fh	file handle (handle) <span style="float: right;">38</span>
			39
	OUT	flag	true if atomic mode, false if nonatomic mode (logical) <span style="float: right;">40</span>
			41

### C binding 42

```
int MPI_File_get_atomicity(MPI_File fh, int *flag) 43
```

### Fortran 2008 binding 44

```
MPI_File_get_atomicity(fh, flag, ierror) 45
  TYPE(MPI_File), INTENT(IN) :: fh 46
  LOGICAL, INTENT(OUT) :: flag 47
48
```

1       INTEGER, OPTIONAL, INTENT(OUT) :: ierror

2       **Fortran binding**

3       MPI\_FILE\_GET\_ATOMICITY(FH, FLAG, IERROR)

4       INTEGER FH, IERROR

5       LOGICAL FLAG

6  
7       MPI\_FILE\_GET\_ATOMICITY returns the current consistency semantics for data access  
8       operations on the set of file handles created by one collective open. If *flag* is true, atomic  
9       mode is enabled; if *flag* is false, nonatomic mode is enabled.

10  
11  
12       MPI\_FILE\_SYNC(fh)

13       INOUT    fh                                   file handle (handle)

14  
15       **C binding**

16       int MPI\_File\_sync(MPI\_File fh)

17  
18       **Fortran 2008 binding**

19       MPI\_File\_sync(fh, ierror)

20       TYPE(MPI\_File), INTENT(IN) :: fh

21       INTEGER, OPTIONAL, INTENT(OUT) :: ierror

22       **Fortran binding**

23       MPI\_FILE\_SYNC(FH, IERROR)

24       INTEGER FH, IERROR

25  
26       Calling MPI\_FILE\_SYNC with *fh* causes all previous writes to *fh* by the calling process  
27       to be transferred to the storage device. If other processes have made updates to the storage  
28       device, then all such updates become visible to subsequent reads of *fh* by the calling process.  
29       MPI\_FILE\_SYNC may be necessary to ensure sequential consistency in certain cases (see  
30       above).

31       MPI\_FILE\_SYNC is a collective operation.

32       The user is responsible for ensuring that all nonblocking requests and split collective  
33       operations on *fh* have been completed before calling MPI\_FILE\_SYNC—otherwise, the call  
34       to MPI\_FILE\_SYNC is erroneous.

35  
36       **14.6.2 Random Access vs. Sequential Files**

37       MPI distinguishes ordinary random access files from sequential stream files, such as pipes  
38       and tape files. Sequential stream files must be opened with the MPI\_MODE\_SEQUENTIAL  
39       flag set in the *amode*. For these files, the only permitted data access operations are shared  
40       file pointer reads and writes. Filetypes and etypes with holes are erroneous. In addition, the  
41       notion of file pointer is not meaningful; therefore, calls to MPI\_FILE\_SEEK\_SHARED and  
42       MPI\_FILE\_GET\_POSITION\_SHARED are erroneous, and the pointer update rules specified  
43       for the data access routines do not apply. The amount of data accessed by a data access  
44       operation will be the amount requested unless the end of file is reached or an error is raised.

45  
46       *Rationale.* This implies that reading on a pipe will always wait until the requested  
47       amount of data is available or until the process writing to the pipe has issued an end  
48       of file. (*End of rationale.*)

Finally, for some sequential files, such as those corresponding to magnetic tapes or streaming network connections, writes to the file may be destructive. In other words, a write may act as a truncate (a `MPI_FILE_SET_SIZE` with size set to the current position) followed by the write.

### 14.6.3 Progress

The progress rules of MPI are both a promise to users and a set of constraints on implementors. In cases where the progress rules restrict possible implementation choices more than the interface specification alone, the progress rules take precedence.

All blocking routines must complete in finite time unless an exceptional condition (such as resource exhaustion) causes an error.

Nonblocking data access routines inherit the following progress rule from nonblocking point-to-point communication: a nonblocking write is equivalent to a nonblocking send for which a receive is eventually posted, and a nonblocking read is equivalent to a nonblocking receive for which a send is eventually posted.

Finally, an implementation is free to delay progress of collective routines until all processes in the group associated with the collective call have invoked the routine. Once all processes in the group have invoked the routine, the progress rule of the equivalent noncollective routine must be followed.

### 14.6.4 Collective File Operations

Collective file operations are subject to the same restrictions as collective communication operations. For a complete discussion, please refer to the semantics set forth in Section 6.14.

Collective file operations are collective over a duplicate of the communicator used to open the file—this duplicate communicator is implicitly specified via the file handle argument. Different processes can pass different values for other arguments of a collective routine unless specified otherwise.

### 14.6.5 Nonblocking Collective File Operations

Nonblocking collective file operations are defined only for data access routines with explicit offsets and individual file pointers but not with shared file pointers.

Nonblocking collective file operations are subject to the same restrictions as blocking collective I/O operations. All processes belonging to the group of the communicator that was used to open the file must call collective I/O operations (blocking and nonblocking) in the same order. This is consistent with the ordering rules for collective operations in threaded environments. For a complete discussion, please refer to the semantics set forth in Section 6.14.

Nonblocking collective I/O operations do not match with blocking collective I/O operations. Multiple nonblocking collective I/O operations can be outstanding on a single file handle. High quality MPI implementations should be able to support a large number of pending nonblocking I/O operations.

All nonblocking collective I/O calls are local and return immediately, irrespective of the status of other processes. The call initiates the operation which may progress independently of any communication, computation, or I/O. The call returns a request handle, which must be passed to a completion call. Input buffers should not be modified and output buffers should not be accessed before the completion call returns. The same progress rules described

1 for nonblocking collective operations apply for nonblocking collective I/O operations. For  
2 a complete discussion, please refer to the semantics set forth in Section 6.12.

### 3 4 14.6.6 Type Matching

5  
6 The type matching rules for I/O mimic the type matching rules for communication with one  
7 exception: if `etype` is `MPI_BYTE`, then this matches any `datatype` in a data access operation.  
8 In general, the `etype` of data items written must match the `etype` used to read the items,  
9 and for each data access operation, the current `etype` must also match the type declaration  
10 of the data access buffer.

11  
12 *Advice to users.* In most cases, use of `MPI_BYTE` as a wild card will defeat the  
13 file interoperability features of MPI. File interoperability can only perform automatic  
14 conversion between heterogeneous data representations when the exact `datatypes` ac-  
15 cessed are explicitly specified. (*End of advice to users.*)

### 16 17 14.6.7 Miscellaneous Clarifications

18  
19 Once an I/O routine completes, it is safe to free any opaque objects passed as arguments  
20 to that routine. For example, the `comm` and `info` used in an `MPI_FILE_OPEN`, or the `etype`  
21 and `filetype` used in an `MPI_FILE_SET_VIEW`, can be freed without affecting access to the  
22 file. Note that for nonblocking routines and split collective operations, the operation must  
23 be completed before it is safe to reuse data buffers passed as arguments.

24 As in communication, `datatypes` must be committed before they can be used in file  
25 manipulation or data access operations. For example, the `etype` and `filetype` must be com-  
26 mitted before calling `MPI_FILE_SET_VIEW`, and the `datatype` must be committed before  
27 calling `MPI_FILE_READ` or `MPI_FILE_WRITE`.

### 28 29 14.6.8 MPI\_Offset Type

30  
31 `MPI_Offset` is an integer type of size sufficient to represent the size (in bytes) of the largest  
32 file supported by MPI. Displacements and offsets are always specified as values of type  
33 `MPI_Offset`.

34 In Fortran, the corresponding integer is an integer with kind parameter  
35 `MPI_OFFSET_KIND`, which is defined in the `mpi_f08` module, the `mpi` module and the `mpif.h`  
36 include file.

37 In Fortran 77 environments that do not support `KIND` parameters, `MPI_Offset` arguments  
38 should be declared as an `INTEGER` of suitable size. The language interoperability implications  
39 for `MPI_Offset` are similar to those for addresses (see Section 19.3).

### 40 41 14.6.9 Logical vs. Physical File Layout

42  
43 MPI specifies how the data should be laid out in a virtual file structure (the view), not  
44 how that file structure is to be stored on one or more disks. Specification of the physical  
45 file structure was avoided because it is expected that the mapping of files to disks will be  
46 system specific, and any specific control over file layout would therefore restrict program  
47 portability. However, there are still cases where some information may be necessary to  
48 optimize file layout. This information can be provided as *hints* specified via `info` when a file  
is created (see Section 14.2.8).



### 14.6.10 File Size

The size of a file may be increased by writing to the file after the current end of file. The size may also be changed by calling MPI *size changing* routines, such as `MPI_FILE_SET_SIZE`. A call to a size changing routine does not necessarily change the file size. For example, calling `MPI_FILE_PREALLOCATE` with a size less than the current size does not change the size.

Consider a set of bytes that has been written to a file since the most recent call to a size changing routine, or since `MPI_FILE_OPEN` if no such routine has been called. Let the *high byte* be the byte in that set with the largest displacement. The file size is the larger of

- One plus the displacement of the high byte.
- The size immediately after the size changing routine, or `MPI_FILE_OPEN`, returned.

When applying consistency semantics, calls to `MPI_FILE_SET_SIZE` and `MPI_FILE_PREALLOCATE` are considered writes to the file (which conflict with operations that access bytes at displacements between the old and new file sizes), and `MPI_FILE_GET_SIZE` is considered a read of the file (which overlaps with all accesses to the file).

*Advice to users.* Any sequence of operations containing the collective routines `MPI_FILE_SET_SIZE` and `MPI_FILE_PREALLOCATE` is a write sequence. As such, sequential consistency in nonatomic mode is not guaranteed unless the conditions in Section 14.6.1 are satisfied. (*End of advice to users.*)

File pointer update semantics (i.e., file pointers are updated by the amount accessed) are only guaranteed if file size changes are sequentially consistent.

*Advice to users.* Consider the following example. Given two operations made by separate processes to a file containing 100 bytes: an `MPI_FILE_READ` of 10 bytes and an `MPI_FILE_SET_SIZE` to 0 bytes. If the user does not enforce sequential consistency between these two operations, the file pointer may be updated by the amount requested (10 bytes) even if the amount accessed is zero bytes. (*End of advice to users.*)

### 14.6.11 Examples

The examples in this section illustrate the application of the MPI consistency and semantics guarantees. These address

- conflicting accesses on file handles obtained from a single collective open, and
- all accesses on file handles obtained from two separate collective opens.

The simplest way to achieve consistency for conflicting accesses is to obtain sequential consistency by setting atomic mode. For the code below, process 1 will read either 0 or 10 integers. If the latter, every element of `b` will be 5. If nonatomic mode is set, the results of the read are undefined.

```

1  /* Process 0 */
2  int i, a[10];
3  int TRUE = 1;
4
5  for (i=0;i<10;i++)
6      a[i] = 5;
7
8  MPI_File_open(MPI_COMM_WORLD, "workfile",
9                MPI_MODE_RDWR | MPI_MODE_CREATE, MPI_INFO_NULL, &fh0);
10 MPI_File_set_view(fh0, 0, MPI_INT, MPI_INT, "native", MPI_INFO_NULL);
11 MPI_File_set_atomicity(fh0, TRUE);
12 MPI_File_write_at(fh0, 0, a, 10, MPI_INT, &status);
13 /* MPI_Barrier(MPI_COMM_WORLD); */
14
15 /* Process 1 */
16 int b[10];
17 int TRUE = 1;
18 MPI_File_open(MPI_COMM_WORLD, "workfile",
19                MPI_MODE_RDWR | MPI_MODE_CREATE, MPI_INFO_NULL, &fh1);
20 MPI_File_set_view(fh1, 0, MPI_INT, MPI_INT, "native", MPI_INFO_NULL);
21 MPI_File_set_atomicity(fh1, TRUE);
22 /* MPI_Barrier(MPI_COMM_WORLD); */
23 MPI_File_read_at(fh1, 0, b, 10, MPI_INT, &status);
24

```

A user may guarantee that the write on process 0 precedes the read on process 1 by imposing temporal order with, for example, calls to `MPI_BARRIER`.

*Advice to users.* Routines other than `MPI_BARRIER` may be used to impose temporal order. In the example above, process 0 could use `MPI_SEND` to send a 0 byte message, received by process 1 using `MPI_RECV`. (*End of advice to users.*)

Alternatively, a user can impose consistency with nonatomic mode set:

```

33 /* Process 0 */
34 int i, a[10];
35 for (i=0;i<10;i++)
36     a[i] = 5;
37
38 MPI_File_open(MPI_COMM_WORLD, "workfile",
39                MPI_MODE_RDWR | MPI_MODE_CREATE, MPI_INFO_NULL, &fh0);
40 MPI_File_set_view(fh0, 0, MPI_INT, MPI_INT, "native", MPI_INFO_NULL);
41 MPI_File_write_at(fh0, 0, a, 10, MPI_INT, &status );
42 MPI_File_sync(fh0);
43 MPI_Barrier(MPI_COMM_WORLD);
44 MPI_File_sync(fh0);
45
46 /* Process 1 */
47 int b[10];
48 MPI_File_open(MPI_COMM_WORLD, "workfile",

```

```

        MPI_MODE_RDWR | MPI_MODE_CREATE, MPI_INFO_NULL, &fh1);
MPI_File_set_view(fh1, 0, MPI_INT, MPI_INT, "native", MPI_INFO_NULL);
MPI_File_sync(fh1);
MPI_Barrier(MPI_COMM_WORLD);
MPI_File_sync(fh1);
MPI_File_read_at(fh1, 0, b, 10, MPI_INT, &status);

```

The “sync-barrier-sync” construct is required because:

- The barrier ensures that the write on process 0 occurs before the read on process 1.
- The first sync guarantees that the data written by all processes is transferred to the storage device.
- The second sync guarantees that all data which has been transferred to the storage device is visible to all processes. (This does not affect process 0 in this example.)

The following program represents an erroneous attempt to achieve consistency by eliminating the apparently superfluous second “sync” call for each process.

```

/* ----- THIS EXAMPLE IS ERRONEOUS ----- */
/* Process 0 */
int i, a[10];
for (i=0;i<10;i++)
    a[i] = 5;

MPI_File_open(MPI_COMM_WORLD, "workfile",
              MPI_MODE_RDWR | MPI_MODE_CREATE, MPI_INFO_NULL, &fh0);
MPI_File_set_view(fh0, 0, MPI_INT, MPI_INT, "native", MPI_INFO_NULL);
MPI_File_write_at(fh0, 0, a, 10, MPI_INT, &status);
MPI_File_sync(fh0);
MPI_Barrier(MPI_COMM_WORLD);

/* Process 1 */
int b[10];
MPI_File_open(MPI_COMM_WORLD, "workfile",
              MPI_MODE_RDWR | MPI_MODE_CREATE, MPI_INFO_NULL, &fh1);
MPI_File_set_view(fh1, 0, MPI_INT, MPI_INT, "native", MPI_INFO_NULL);
MPI_Barrier(MPI_COMM_WORLD);
MPI_File_sync(fh1);
MPI_File_read_at(fh1, 0, b, 10, MPI_INT, &status);

/* ----- THIS EXAMPLE IS ERRONEOUS ----- */

```

The above program also violates the MPI rule against out-of-order collective operations and will deadlock for implementations in which MPI\_FILE\_SYNC blocks.

*Advice to users.* Some implementations may choose to implement MPI\_FILE\_SYNC as a temporally synchronizing function. When using such an implementation, the “sync-barrier-sync” construct above can be replaced by a single “sync.” The results of using such code with an implementation for which MPI\_FILE\_SYNC is not temporally synchronizing is undefined. (*End of advice to users.*)

## 1 Asynchronous I/O

2 The behavior of asynchronous I/O operations is determined by applying the rules specified  
3 above for synchronous I/O operations.

4 The following examples all access a preexisting file “myfile.” Word 10 in myfile initially  
5 contains the integer 2. Each example writes and reads word 10.

6 First consider the following code fragment:

```
7
8 int a = 4, b, TRUE=1;
9 MPI_File_open(MPI_COMM_WORLD, "myfile",
10               MPI_MODE_RDWR, MPI_INFO_NULL, &fh);
11 MPI_File_set_view(fh, 0, MPI_INT, MPI_INT, "native", MPI_INFO_NULL);
12 /* MPI_File_set_atomicity(fh, TRUE); Use this to set atomic mode. */
13 MPI_File_iread_at(fh, 10, &a, 1, MPI_INT, &reqs[0]);
14 MPI_File_iwrite_at(fh, 10, &b, 1, MPI_INT, &reqs[1]);
15 MPI_Waitall(2, reqs, statuses);
16
```

17 For asynchronous data access operations, MPI specifies that the access occurs at any time  
18 between the call to the asynchronous data access routine and the return from the corre-  
19 sponding request complete routine. Thus, executing either the read before the write, or the  
20 write before the read is consistent with program order. If atomic mode is set, then MPI  
21 guarantees sequential consistency, and the program will read either 2 or 4 into b. If atomic  
22 mode is not set, then sequential consistency is not guaranteed and the program may read  
23 something other than 2 or 4 due to the conflicting data access.

24 Similarly, the following code fragment does not order file accesses:

```
25
26 int a = 4, b;
27 MPI_File_open(MPI_COMM_WORLD, "myfile",
28               MPI_MODE_RDWR, MPI_INFO_NULL, &fh);
29 MPI_File_set_view(fh, 0, MPI_INT, MPI_INT, "native", MPI_INFO_NULL);
30 /* MPI_File_set_atomicity(fh, TRUE); Use this to set atomic mode. */
31 MPI_File_iread_at(fh, 10, &a, 1, MPI_INT, &reqs[0]);
32 MPI_File_iwrite_at(fh, 10, &b, 1, MPI_INT, &reqs[1]);
33 MPI_Wait(&reqs[0], &status);
34 MPI_Wait(&reqs[1], &status);
35
```

36 If atomic mode is set, either 2 or 4 will be read into b. Again, MPI does not guarantee  
37 sequential consistency in nonatomic mode.

38 On the other hand, the following code fragment:

```
39
40 int a = 4, b;
41 MPI_File_open(MPI_COMM_WORLD, "myfile",
42               MPI_MODE_RDWR, MPI_INFO_NULL, &fh);
43 MPI_File_set_view(fh, 0, MPI_INT, MPI_INT, "native", MPI_INFO_NULL);
44 MPI_File_iread_at(fh, 10, &a, 1, MPI_INT, &reqs[0]);
45 MPI_Wait(&reqs[0], &status);
46 MPI_File_iwrite_at(fh, 10, &b, 1, MPI_INT, &reqs[1]);
47 MPI_Wait(&reqs[1], &status);
48
```

defines the same ordering as:

```

int a = 4, b;
MPI_File_open(MPI_COMM_WORLD, "myfile",
              MPI_MODE_RDWR, MPI_INFO_NULL, &fh);
MPI_File_set_view(fh, 0, MPI_INT, MPI_INT, "native", MPI_INFO_NULL);
MPI_File_write_at(fh, 10, &a, 1, MPI_INT, &status );
MPI_File_read_at(fh, 10, &b, 1, MPI_INT, &status );

```

Since

- nonconcurrent operations on a single file handle are sequentially consistent, and
- the program fragments specify an order for the operations,

MPI guarantees that both program fragments will read the value 4 into `b`. There is no need to set atomic mode for this example.

Similar considerations apply to conflicting accesses of the form:

```

MPI_File_iread_all(fh,...);
MPI_File_iwrite_all(fh,...);
MPI_Waitall(...);

```

In addition, as mentioned in Section 14.6.5, nonblocking collective I/O operations have to be called in the same order on the file handle by all processes.

Similar considerations apply to conflicting accesses of the form:

```

MPI_File_write_all_begin(fh,...);
MPI_File_iread(fh,...);
MPI_Wait(fh,...);
MPI_File_write_all_end(fh,...);

```

Recall that constraints governing consistency and semantics are not relevant to the following:

```

MPI_File_write_all_begin(fh,...);
MPI_File_read_all_begin(fh,...);
MPI_File_read_all_end(fh,...);
MPI_File_write_all_end(fh,...);

```

since split collective operations on the same file handle may not overlap (see Section 14.4.5).

## 14.7 I/O Error Handling

By default, communication errors are fatal—`MPI_ERRORS_ARE_FATAL` is the default error handler associated with `MPI_COMM_WORLD`. I/O errors are usually less catastrophic (e.g., “file not found”) than communication errors, and common practice is to catch these errors and continue executing. For this reason, MPI provides additional error facilities for I/O.

*Advice to users.* MPI does not specify the state of a computation after an erroneous MPI call has occurred. A high-quality implementation will support the I/O error handling facilities, allowing users to write programs using common practice for I/O. (*End of advice to users.*)

1 Like communicators, each file handle has an error handler associated with it. The MPI  
2 I/O error handling routines are defined in Section 9.3.

3 When MPI calls a user-defined error handler resulting from an error on a particular  
4 file handle, the first two arguments passed to the file error handler are the file handle and  
5 the error code. For I/O errors that are not associated with a valid file handle (e.g., in  
6 MPI\_FILE\_OPEN or MPI\_FILE\_DELETE), the first argument passed to the error handler is  
7 MPI\_FILE\_NULL.

8 I/O error handling differs from communication error handling in another important  
9 aspect. By default, the predefined error handler for file handles is MPI\_ERRORS\_RETURN.  
10 The **default file error** handler has two purposes: when a new file handle is created (by  
11 MPI\_FILE\_OPEN), the error handler for the new file handle is initially set to the default  
12 file error handler, and I/O routines that have no valid file handle on which to raise an  
13 error (e.g., MPI\_FILE\_OPEN or MPI\_FILE\_DELETE) use the default file error handler. The  
14 default file error handler can be changed by specifying MPI\_FILE\_NULL as the `fh` argument  
15 to MPI\_FILE\_SET\_ERRHANDLER. The current value of the default file error handler can  
16 be determined by passing MPI\_FILE\_NULL as the `fh` argument to  
17 MPI\_FILE\_GET\_ERRHANDLER.

18  
19 *Rationale.* For communication, the default error handler is inherited from  
20 MPI\_COMM\_WORLD when using the World Model. In I/O, there is no analogous  
21 “root” file handle from which default properties can be inherited. Rather than invent  
22 a new global file handle, the default file error handler is manipulated as if it were  
23 attached to MPI\_FILE\_NULL. (*End of rationale.*)

## 24 14.8 I/O Error Classes

25  
26 The implementation dependent error codes returned by the I/O routines can be converted  
27 into the error classes defined in Table 14.5.

28  
29 In addition, calls to routines in this chapter may raise errors in other MPI classes, such  
30 as MPI\_ERR\_TYPE.

## 31 14.9 Examples

### 32 14.9.1 Double Buffering with Split Collective I/O

33  
34 This example shows how to overlap computation and output. The computation is performed  
35 by the function `compute_buffer()`.

```
36 /*=====
```

```
37 *
```

```
38 * Function:          double_buffer
```

```
39 *
```

```
40 * Synopsis:
```

```
41 *   void double_buffer(
```

```
42 *       MPI_File fh,                ** IN
```

```
43 *       MPI_Datatype buftype,      ** IN
```

```
44 *       int bufcount                ** IN
```

```
45 *   )
```

```
46 *
```

```
47 *
```

```
48 *
```

MPI_ERR_FILE	Invalid file handle	1
MPI_ERR_NOT_SAME	Collective argument not identical on all processes, or collective routines called in a different order by different processes	2 3 4
MPI_ERR_AMODE	Error related to the <code>amode</code> passed to <code>MPI_FILE_OPEN</code>	5 6
MPI_ERR_UNSUPPORTED_DATAREP	Unsupported <code>datarep</code> passed to <code>MPI_FILE_SET_VIEW</code>	7 8
MPI_ERR_UNSUPPORTED_OPERATION	Unsupported operation, such as seeking on a file which supports sequential access only	9 10
MPI_ERR_NO_SUCH_FILE	File does not exist	11
MPI_ERR_FILE_EXISTS	File exists	12
MPI_ERR_BAD_FILE	Invalid file name (e.g., path name too long)	13
MPI_ERR_ACCESS	Permission denied	14
MPI_ERR_NO_SPACE	Not enough space	15
MPI_ERR_QUOTA	Quota exceeded	16
MPI_ERR_READ_ONLY	Read-only file or file system	17
MPI_ERR_FILE_IN_USE	File operation could not be completed, as the file is currently open by some process	18 19
MPI_ERR_DUP_DATAREP	Conversion functions could not be registered because a data representation identifier that was already defined was passed to <code>MPI_REGISTER_DATAREP</code>	20 21 22 23
MPI_ERR_CONVERSION	An error occurred in a user supplied data conversion function.	24 25
MPI_ERR_IO	Other I/O error	26 27

Table 14.5: I/O Error Classes

```

1      *
2      * Description:
3      *     Performs the steps to overlap computation with a collective write
4      *     by using a double-buffering technique.
5      *
6      * Parameters:
7      *     fh                previously opened MPI file handle
8      *     buftype           MPI datatype for memory layout
9      *                       (Assumes a compatible view has been set on fh)
10     *     bufcount          # buftype elements to transfer
11     *-----*/
12
13     /* this macro switches which buffer "x" is pointing to */
14     #define TOGGLE_PTR(x) (((x)==(buffer1)) ? (x=buffer2) : (x=buffer1))
15
16     void double_buffer(MPI_File fh, MPI_Datatype buftype, int bufcount)
17     {
18
19         MPI_Status status;        /* status for MPI calls */
20         float *buffer1, *buffer2; /* buffers to hold results */
21         float *compute_buf_ptr;   /* destination buffer */
22                                   /* for computing */
23         float *write_buf_ptr;     /* source for writing */
24         int done;                 /* determines when to quit */
25
26         /* buffer initialization */
27         buffer1 = (float *)
28                 malloc(bufcount*sizeof(float));
29         buffer2 = (float *)
30                 malloc(bufcount*sizeof(float));
31         compute_buf_ptr = buffer1; /* initially point to buffer1 */
32         write_buf_ptr   = buffer1; /* initially point to buffer1 */
33
34
35         /* DOUBLE-BUFFER prolog:
36          *   compute buffer1; then initiate writing buffer1 to disk
37          */
38         compute_buffer(compute_buf_ptr, bufcount, &done);
39         MPI_File_write_all_begin(fh, write_buf_ptr, bufcount, buftype);
40
41         /* DOUBLE-BUFFER steady state:
42          *   Overlap writing old results from buffer pointed to by write_buf_ptr
43          *   with computing new results into buffer pointed to by compute_buf_ptr.
44          *
45          *   There is always one write-buffer and one compute-buffer in use
46          *   during steady state.
47          */
48         while (!done) {

```



```

    TOGGLE_PTR(compute_buf_ptr);
    compute_buffer(compute_buf_ptr, bufcount, &done);
    MPI_File_write_all_end(fh, write_buf_ptr, &status);
    TOGGLE_PTR(write_buf_ptr);
    MPI_File_write_all_begin(fh, write_buf_ptr, bufcount, buftype);
}

/* DOUBLE-BUFFER epilog:
 *  wait for final write to complete.
 */
MPI_File_write_all_end(fh, write_buf_ptr, &status);

/* buffer cleanup */
free(buffer1);
free(buffer2);
}

```

14.9.2 Subarray Filetype Constructor

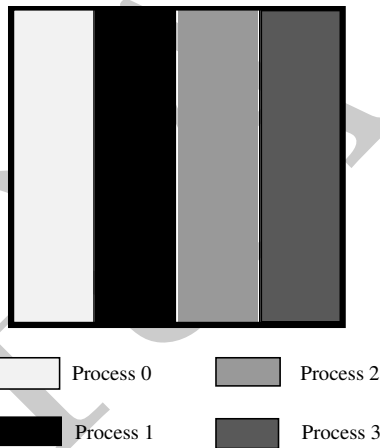

Figure 14.4: Example array file layout

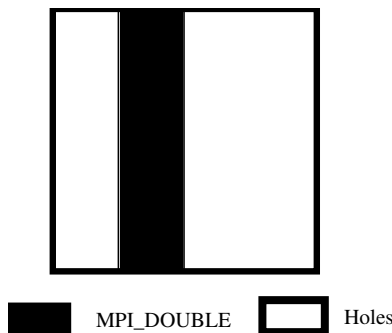

Figure 14.5: Example local array filetype for process 1

1 Assume we are writing out a  $100 \times 100$  2D array of double precision floating point  
 2 numbers that is distributed among 4 processes such that each process has a block of 25  
 3 columns (e.g., process 0 has columns 0–24, process 1 has columns 25–49, etc.; see Fig-  
 4 ure 14.4). To create the filetypes for each process one could use the following C program  
 5 (see Section 5.1.3):

```
6
7 double subarray[100][25];
8 MPI_Datatype filetype;
9 int sizes[2], subsizes[2], starts[2];
10 int rank;
11
12 MPI_Comm_rank(MPI_COMM_WORLD, &rank);
13 sizes[0]=100; sizes[1]=100;
14 subsizes[0]=100; subsizes[1]=25;
15 starts[0]=0; starts[1]=rank*subsizes[1];
16
17 MPI_Type_create_subarray(2, sizes, subsizes, starts, MPI_ORDER_C,
18 MPI_DOUBLE, &filetype);
19
```

20 Or, equivalently in Fortran:

```
21
22 double precision subarray(100,25)
23 integer filetype, rank, ierror
24 integer sizes(2), subsizes(2), starts(2)
25
26 call MPI_COMM_RANK(MPI_COMM_WORLD, rank, ierror)
27 sizes(1) = 100
28 sizes(2) = 100
29 subsizes(1) = 100
30 subsizes(2) = 25
31 starts(1) = 0
32 starts(2) = rank*subsizes(2)
33
34 call MPI_TYPE_CREATE_SUBARRAY(2, sizes, subsizes, starts, &
35 MPI_ORDER_FORTRAN, MPI_DOUBLE_PRECISION, &
36 filetype, ierror)
37
```

38 The generated filetype will then describe the portion of the file contained within the  
 39 process's subarray with holes for the space taken by the other processes. Figure 14.5 shows  
 40 the filetype created for process 1.

1  
2  
3  
4  
5  
6  
7  
8  
9  
10  
11  
12  
13  
14  
15  
16  
17  
18  
19  
20  
21  
22  
23  
24  
25  
26  
27  
28  
29  
30  
31  
32  
33  
34  
35  
36  
37  
38  
39  
40  
41  
42  
43  
44  
45  
46  
47  
48

# Chapter 15

## Tool Support

### 15.1 Introduction

This chapter discusses interfaces that allow debuggers, performance analyzers, and other tools to extract information about the operation of MPI processes. Specifically, this chapter defines both the MPI profiling interface (Section 15.2), which supports the transparent interception and inspection of MPI calls, and the MPI tool information interface (Section 15.3), which supports the inspection and manipulation of MPI control and performance variables, as well as the registration of callbacks for MPI library events. The interfaces described in this chapter are all defined in the context of an MPI process, i.e., are callable from the same code that invokes other MPI functions.

### 15.2 Profiling Interface

#### 15.2.1 Requirements

To meet the requirements for the MPI profiling interface, an implementation of the MPI functions *must*

1. provide a mechanism through which all of the MPI defined functions, except those allowed as macros (See Section 2.6.4), may be accessed with a name shift. This requires, in C and Fortran, an alternate entry point name, with the prefix `PMPI_` for each MPI function in each provided language binding and language support method. For routines implemented as macros, it is still required that the `PMPI_` version be supplied and work as expected, but it is not possible to replace at link time the `MPI_` version with a user-defined version.

For Fortran, the different support methods cause several specific procedure names. Therefore, several profiling routines (with these specific procedure names) are needed for each Fortran MPI routine, as described in Section 19.1.5.

2. ensure that those MPI functions that are not replaced may still be linked into an executable image without causing name clashes.
3. document the implementation of different language bindings of the MPI interface if they are layered on top of each other, so that the profiler developer knows whether she must implement the profile interface for each binding, or can economize by implementing it only for the lowest level routines.

- 1 4. where the implementation of different language bindings is done through a layered  
2 approach (e.g., the Fortran binding is a set of “wrapper” functions that call the C  
3 implementation), ensure that these wrapper functions are separable from the rest of  
4 the library.

5 This separability is necessary to allow a separate profiling library to be correctly  
6 implemented, since (at least with Unix linker semantics) the profiling library must  
7 contain these wrapper functions if it is to perform as expected. This requirement  
8 allows the person who builds the profiling library to extract these functions from the  
9 original MPI library and add them into the profiling library without bringing along  
10 any other unnecessary code.

- 11
- 12 5. provide a no-op routine `MPI_PCONTROL` in the MPI library.
- 13

## 14 15.2.2 Discussion

15 The objective of the MPI profiling interface is to ensure that it is relatively easy for authors  
16 of profiling (and other similar) tools to interface their codes to MPI implementations on  
17 different machines.

18 Since MPI is a machine independent standard with many different implementations,  
19 it is unreasonable to expect that the authors of profiling tools for MPI will have access to  
20 the source code that implements MPI on any particular machine. It is therefore necessary  
21 to provide a mechanism by which the implementors of such tools can collect whatever  
22 performance information they wish *without* access to the underlying implementation.

23 We believe that having such an interface is important if MPI is to be attractive to end  
24 users, since the availability of many different tools will be a significant factor in attracting  
25 users to the MPI standard.

26 The profiling interface is just that, an interface. It says *nothing* about the way in which  
27 it is used. There is therefore no attempt to lay down what information is collected through  
28 the interface, or how the collected information is saved, filtered, or displayed.

29 While the initial impetus for the development of this interface arose from the desire to  
30 permit the implementation of profiling tools, it is clear that an interface like that specified  
31 may also prove useful for other purposes, such as “internetworking” multiple MPI imple-  
32 mentations. Since all that is defined is an interface, there is no objection to it being used  
33 wherever it is useful.

34 As the issues being addressed here are intimately tied up with the way in which ex-  
35 ecutable images are built, which may differ greatly on different machines, the examples  
36 given below should be treated solely as one way of implementing the objective of the MPI  
37 profiling interface. The actual requirements made of an implementation are those detailed  
38 in the Requirements section above, the whole of the rest of this section is only present as  
39 justification and discussion of the logic for those requirements.

40 The examples below show one way in which an implementation could be constructed to  
41 meet the requirements on a Unix system (there are doubtless others that would be equally  
42 valid).

## 43 15.2.3 Logic of the Design

44 Provided that an MPI implementation meets the requirements above, it is possible for  
45 the implementor of the profiling system to intercept the MPI calls that are made by the  
46  
47  
48

user program. The profiling system implementor can then collect any required information before calling the underlying MPI implementation (through its name shifted entry points) to achieve the desired effects.

#### 15.2.4 Miscellaneous Control of Profiling

There is a clear requirement for the user code to be able to control the profiler dynamically at run time. This capability is normally used for (at least) the purposes of

- Enabling and disabling profiling depending on the state of the calculation.
- Flushing trace buffers at non-critical points in the calculation.
- Adding user events to a trace file.

These requirements are met by use of `MPI_PCONTROL`.

`MPI_PCONTROL(level, ...)`

IN            level                                    Profiling level (integer)

##### C binding

`int MPI_Pcontrol(const int level, ...)`

##### Fortran 2008 binding

`MPI_Pcontrol(level)`  
`INTEGER, INTENT(IN) :: level`

##### Fortran binding

`MPI_PCONTROL(LEVEL)`  
`INTEGER LEVEL`

MPI libraries themselves make no use of this routine, and simply return immediately to the user code. However the presence of calls to this routine allows a profiling package to be explicitly called by the user.

Since MPI has no control of the implementation of the profiling code, we are unable to specify precisely the semantics that will be provided by calls to `MPI_PCONTROL`. This vagueness extends to the number of arguments to the function, and their datatypes.

However to provide some level of portability of user codes to different profiling libraries, we request the following meanings for certain values of `level`.

- `level==0` Profiling is disabled.
- `level==1` Profiling is enabled at a normal default level of detail.
- `level==2` Profile buffers are flushed, which may be a no-op in some profilers.
- All other values of `level` have profile library defined effects and additional arguments.

We also request that the default state after MPI has been initialized is for profiling to be enabled at the normal default level. (i.e., as if `MPI_PCONTROL` had just been called with the argument 1). This allows users to link with a profiling library and to obtain profile output without having to modify their source code at all.

1       The provision of MPI\_PCONTROL as a no-op in the standard MPI library supports the  
 2 collection of more detailed profiling information with source code that can still link against  
 3 the standard MPI library.

4  
 5 **Example 15.1** A wrapper to accumulate the total amount of data sent by the MPI\_SEND  
 6 function, along with the total elapsed time spent in the function.

```

7
8 static int totalBytes = 0;
9 static double totalTime = 0.0;
10
11 int MPI_Send(const void* buffer, int count, MPI_Datatype datatype,
12             int dest, int tag, MPI_Comm comm)
13 {
14     double tstart = MPI_Wtime();      /* Pass on all arguments */
15     int size;
16     int result    = PMPI_Send(buffer, count, datatype, dest, tag, comm);
17
18     totalTime += MPI_Wtime() - tstart; /* and time */
19
20     MPI_Type_size(datatype, &size); /* Compute size */
21     totalBytes += count*size;
22
23     return result;
24 }
  
```

## 25 26 15.2.5 MPI Library Implementation

27 If the MPI library is implemented in C on a Unix system, then there are various options,  
 28 including the two presented here, for supporting the name-shift requirement. The choice  
 29 between these two options depends partly on whether the linker and compiler support weak  
 30 symbols.

31 If the compiler and linker support weak external symbols (e.g., Solaris 2.x, other System  
 32 V.4 machines), then only a single library is required as the following example shows:

33  
 34 **Example 15.2** Library implementation using weak symbols.

```

35 #pragma weak MPI_Example = PMPI_Example
36
37 int PMPI_Example(/* appropriate args */)
38 {
39     /* Useful content */
40 }
  
```

41  
 42 The effect of this #pragma is to define the external symbol MPI\_Example as a weak  
 43 definition. This means that the linker will not complain if there is another definition of the  
 44 symbol (for instance in the profiling library); however if no other definition exists, then the  
 45 linker will use the weak definition.

46 In the absence of weak symbols then one possible solution would be to use the C macro  
 47 preprocessor as the following example shows:  
 48

**Example 15.3** Library implementation using C pre-processor macros.

```

#ifdef PROFILELIB
#   ifdef __STDC__
#       define FUNCTION(name) P##name
#   else
#       define FUNCTION(name) P/**/name
#   endif
#else
#   define FUNCTION(name) name
#endif

```

Each of the user visible functions in the library would then be declared thus

```

int FUNCTION(MPI_Example)(/* appropriate args */)
{
    /* Useful content */
}

```

The same source file can then be compiled to produce both versions of the library, depending on the state of the PROFILELIB macro symbol.

It is required that the standard MPI library be built in such a way that the inclusion of MPI functions can be achieved one at a time. This is a somewhat unpleasant requirement, since it may mean that each external function has to be compiled from a separate file. However this is necessary so that the author of the profiling library need only define those MPI functions that she wishes to intercept, references to any others being fulfilled by the normal MPI library. Therefore the link step can look something like this

```
% cc ... -lmyprof -lpmpi -lmpi
```

Here libmyprof.a contains the profiler functions that intercept some of the MPI functions, libpmpi.a contains the “name shifted” MPI functions, and libmpi.a contains the normal definitions of the MPI functions.

## 15.2.6 Complications

### Multiple Counting

Since parts of the MPI library may themselves be implemented using more basic MPI functions (e.g., a portable implementation of the collective operations implemented using point-to-point communications), there is potential for profiling functions to be called from within an MPI function that was called from a profiling function. This could lead to “double counting” of the time spent in the inner routine. Since this effect could actually be useful under some circumstances (e.g., it might allow one to answer the question “How much time is spent in the point-to-point routines when they are called from collective functions?”), we have decided not to enforce any restrictions on the author of the MPI library that would overcome this. Therefore the author of the profiling library should be aware of this problem, and guard against it. In a single-threaded world this is easily achieved through use of a static variable in the profiling code that remembers if you are already inside a profiling routine. It becomes more complex in a multithreaded environment (as does the meaning of the times recorded).

## Linker Oddities

The Unix linker traditionally operates in one pass: the effect of this is that functions from libraries are only included in the image if they are needed at the time the library is scanned. When combined with weak symbols, or multiple definitions of the same function, this can cause odd (and unexpected) effects.

Consider, for instance, an implementation of MPI in which the Fortran binding is achieved by using wrapper functions on top of the C implementation. The author of the profile library then assumes that it is reasonable only to provide profile functions for the C binding, since Fortran will eventually call these, and the cost of the wrappers is assumed to be small. However, if the wrapper functions are not in the profiling library, then none of the profiled entry points will be undefined when the profiling library is called. Therefore none of the profiling code will be included in the image. When the standard MPI library is scanned, the Fortran wrappers will be resolved, and will also pull in the base versions of the MPI functions. The overall effect is that the code will link successfully, but will not be profiled.

To overcome this we must ensure that the Fortran wrapper functions are included in the profiling version of the library. We ensure that this is possible by requiring that these be separable from the rest of the base MPI library. This allows them to be copied out of the base library and into the profiling one using a tool such as `ar`.

## Fortran Support Methods

The different Fortran support methods and possible options for the support of subarrays (depending on whether the compiler can support `TYPE(*)`, `DIMENSION(..)` choice buffers) imply different specific procedure names for the same Fortran MPI routine. The rules and implications for the profiling interface are described in Section 19.1.5.

### 15.2.7 Multiple Levels of Interception

The scheme given here does not directly support the nesting of profiling functions, since it provides only a single alternative name for each MPI function. Consideration was given to an implementation that would allow multiple levels of call interception, however we were unable to construct an implementation of this that did not have the following disadvantages

- assuming a particular implementation language, and
- imposing a run time cost even when no profiling was taking place.

Since one of the objectives of MPI is to permit efficient, low latency implementations, and it is not the business of a standard to require a particular implementation language, we decided to accept the scheme outlined above.

Note, however, that it is possible to use the scheme above to implement a multi-level system, since the function called by the user may call many different profiling functions before calling the underlying MPI function. This capability has been demonstrated in the P<sup>N</sup>MPI tool infrastructure [58].



## 15.3 The MPI Tool Information Interface

MPI implementations often use internal variables to control their operation and performance and rely on internal events for their implementation. Understanding and manipulating these variables and tracking these events can provide a more efficient execution environment or improve performance for many applications. This section describes the MPI tool information interface, which provides a mechanism for MPI implementors to expose variables, each of which represents a particular property, setting, or performance measurement from within the MPI implementation, as well as expose events that can be tracked by tools. The interface is split into three parts: the first part provides information about, and supports the setting of, control variables through which the MPI implementation tunes its configuration. The second part provides access to performance variables that can provide insight into internal performance information of the MPI implementation. The third part enables tools to query available events within an MPI implementation and register callbacks for them.

To avoid restrictions on the MPI implementation, the MPI tool information interface allows the implementation to specify which control variables, performance variables, and events exist. Additionally, the user of the MPI tool information interface can obtain meta-data about each available variable or event, such as its datatype, and a textual description. The MPI tool information interface provides the necessary routines to find all variables and events that exist in a particular MPI implementation; to query their properties; to retrieve descriptions about their meaning; to access and, if appropriate, to alter their values; and (in case of events) set callbacks triggered by them.

Variables, events, and categories across connected MPI processes with equivalent names are required to have the same meaning (see the definition of “equivalent” as related to strings in Section 15.3.3). Furthermore, enumerations with equivalent names across connected MPI processes are required to have the same meaning, but are allowed to comprise different enumeration items. Enumeration items that have equivalent names across connected MPI processes in enumerations with the same meaning must also have the same meaning. In order for variables and categories to have the same meaning, routines in the tools information interface that return details for those variables and categories have requirements on what parameters must be identical. These requirements are specified in their respective sections.

*Rationale.* The intent of requiring the same meaning for entities with equivalent names is to enforce consistency across connected MPI processes. For example, variables describing the number of packets sent on different types of network devices should have different names to reflect their potentially different meanings. (*End of rationale.*)

The MPI tool information interface can be used independently from the MPI communication functionality. In particular, the routines of this interface can be called before MPI is initialized and after MPI is finalized. In order to support this behavior cleanly, the MPI tool information interface uses separate initialization and finalization routines. All identifiers used in the MPI tool information interface have the prefix `MPI_T_`.

On success, all MPI tool information interface routines return `MPI_SUCCESS`, otherwise they return an appropriate and unique return code indicating the reason why the call was not successfully completed. Details on return codes can be found in Section 15.3.10. However, unsuccessful calls to the MPI tool information interface are not fatal and do not impact the execution of subsequent MPI routines.

Since the MPI tool information interface primarily focuses on tools and support libraries, MPI implementations are only required to provide C bindings for functions and constants introduced in this section. Except where otherwise noted, all conventions and principles governing the C bindings of the MPI API also apply to the MPI tool information interface, which is available by including the `mpi.h` header file. All routines in this interface have local semantics.

*Advice to users.* The number and type of control variables, performance variables, and events can vary between MPI implementations, platforms and different builds of the same implementation on the same platform as well as between runs. Hence, any application relying on a particular variable will not be portable. Further, there is no guarantee that the number of variables and variable indices are the same across connected MPI processes.

This interface is primarily intended for performance monitoring tools, support tools, and libraries controlling the application's environment. When maximum portability is desired, application programmers should either avoid using the MPI tool information interface or avoid being dependent on the existence of a particular control or performance variable or of a particular event. (*End of advice to users.*)

### 15.3.1 Verbosity Levels

The MPI tool information interface provides access to internal configuration and performance information through a set of control and performance variables defined by the MPI implementation. Since some implementations may export a large number of variables, variables are classified by a verbosity level that categorizes both their intended audience (end users, performance tuners or MPI implementors) and a relative measure of level of detail (basic, detailed or all). These verbosity levels are described by a single integer. Table 15.1 lists the constants for all possible verbosity levels. The values of the constants are monotonic in the order listed in the table; i.e., `MPI_T_VERBOSITY_USER_BASIC` < `MPI_T_VERBOSITY_USER_DETAIL` < ... < `MPI_T_VERBOSITY_MPIDEV_ALL`.

<code>MPI_T_VERBOSITY_USER_BASIC</code>	Basic information of interest to users
<code>MPI_T_VERBOSITY_USER_DETAIL</code>	Detailed information of interest to users
<code>MPI_T_VERBOSITY_USER_ALL</code>	All remaining information of interest to users
<code>MPI_T_VERBOSITY_TUNER_BASIC</code>	Basic information required for tuning
<code>MPI_T_VERBOSITY_TUNER_DETAIL</code>	Detailed information required for tuning
<code>MPI_T_VERBOSITY_TUNER_ALL</code>	All remaining information required for tuning
<code>MPI_T_VERBOSITY_MPIDEV_BASIC</code>	Basic information for MPI implementors
<code>MPI_T_VERBOSITY_MPIDEV_DETAIL</code>	Detailed information for MPI implementors
<code>MPI_T_VERBOSITY_MPIDEV_ALL</code>	All remaining information for MPI implementors

Table 15.1: MPI tool information interface verbosity levels

### 15.3.2 Binding MPI Tool Information Interface Variables to MPI Objects

Each MPI tool information interface variable provides access to a particular control setting or performance property of the MPI implementation. A variable may refer to a specific

MPI object such as a communicator, datatype, or one-sided communication window, or the variable may refer more generally to the MPI environment of the process. Except for the last case, the variable must be bound to exactly one MPI object before it can be used. Table 15.2 lists all MPI object types to which an MPI tool information interface variable can be bound, together with the matching constant that MPI tool information interface routines return to identify the object type.

Constant	MPI object
MPI_T_BIND_NO_OBJECT	N/A; applies globally to entire MPI process
MPI_T_BIND_MPI_COMM	MPI communicators
MPI_T_BIND_MPI_DATATYPE	MPI datatypes
MPI_T_BIND_MPI_ERRHANDLER	MPI error handlers
MPI_T_BIND_MPI_FILE	MPI file handles
MPI_T_BIND_MPI_GROUP	MPI groups
MPI_T_BIND_MPI_OP	MPI reduction operators
MPI_T_BIND_MPI_REQUEST	MPI requests
MPI_T_BIND_MPI_WIN	MPI windows for one-sided communication
MPI_T_BIND_MPI_MESSAGE	MPI message object
MPI_T_BIND_MPI_INFO	MPI info object
MPI_T_BIND_MPI_SESSION	MPI session object

Table 15.2: Constants to identify associations of variables

*Rationale.* Some variables have meanings tied to a specific MPI object. Examples include the number of send or receive operations that use a particular datatype, the number of times a particular error handler has been called, or the communication protocol and “eager limit” used for a particular communicator. Creating a new MPI tool information interface variable for each MPI object would cause the number of variables to grow without bound, since they cannot be reused to avoid naming conflicts. By associating MPI tool information interface variables with a specific MPI object, the MPI implementation only must specify and maintain a single variable, which can then be applied to as many MPI objects of the respective type as created during the program’s execution. (*End of rationale.*)

### 15.3.3 Convention for Returning Strings

Several MPI tool information interface functions return one or more strings. These functions have two arguments for each string to be returned: an OUT parameter that identifies a pointer to the buffer in which the string will be returned, and an INOUT parameter to pass the length of the buffer. The user is responsible for the memory allocation of the buffer and must pass the size of the buffer ( $n$ ) as the length argument. Let  $n$  be the length value specified to the function. On return, the function writes at most  $n - 1$  of the string’s characters into the buffer, followed by a null terminator. If the returned string’s length is greater than or equal to  $n$ , the string will be truncated to  $n - 1$  characters. In this case, the length of the string plus one (for the terminating null character) is returned in the length argument. If the user passes the null pointer as the buffer argument or passes 0 as the length argument, the function does not return the string and only returns the length of the

1 string plus one in the length argument. If the user passes the null pointer as the length  
 2 argument, the buffer argument is ignored and nothing is returned.

3 MPI implementations behave as if they have an internal character array that is copied  
 4 to the output character array supplied by the user. Such output strings are only defined  
 5 to be equivalent if their notional source-internal character arrays are identical (up to and  
 6 including the null terminator), even if the output string is truncated due to a small input  
 7 length parameter  $n$ .

#### 9 15.3.4 Initialization and Finalization

10 The MPI tool information interface requires a separate set of initialization and finalization  
 11 routines.

12  
 13  
 14 MPI\_T\_INIT\_THREAD(required, provided)

15	IN	required	desired level of thread support (integer)
16			
17	OUT	provided	provided level of thread support (integer)
18			

#### 19 C binding

20 `int MPI_T_init_thread(int required, int *provided)`  
 21

22 All programs or tools that use the MPI tool information interface must initialize the  
 23 MPI tool information interface in the processes that will use the interface before calling  
 24 any other of its routines. A user can initialize the MPI tool information interface by calling  
 25 MPI\_T\_INIT\_THREAD, which can be called multiple times. In addition, this routine initial-  
 26 izes the thread environment for all routines in the MPI tool information interface. Calling  
 27 this routine when the MPI tool information interface is already initialized has no effect  
 28 beyond increasing the reference count of how often the interface has been initialized. The  
 29 argument `required` is used to specify the desired level of thread support. The possible values  
 30 and their semantics are identical to the ones that can be used with MPI\_INIT\_THREAD  
 31 listed in Section 11.6. The call returns in `provided` information about the actual level of  
 32 thread support that will be provided by the MPI implementation for calls to MPI tool  
 33 information interface routines. It can be one of the four values listed in Section 11.6.

34 The MPI specification does not require all MPI processes to exist before MPI is initial-  
 35 ized. If the MPI tool information interface is used before initialization of MPI, the user is  
 36 responsible for ensuring that the MPI tool information interface is initialized on all processes  
 37 it is used in. Processes created by the MPI implementation during initialization inherit the  
 38 status of the MPI tool information interface (whether it is initialized or not as well as all  
 39 active sessions and handles) from the process from which they are created.

40 Processes created at runtime as a result of calls to MPI's dynamic process management  
 41 require their own initialization before they can use the MPI tool information interface.

42  
 43 *Advice to users.* If MPI\_T\_INIT\_THREAD is called before MPI\_INIT\_THREAD, the  
 44 requested and provided thread level for MPI\_T\_INIT\_THREAD may influence the be-  
 45 havior and return value of MPI\_INIT\_THREAD. The same is true for the reverse order.  
 46 Likewise, when using the Sessions Model (Section 11.3), the requested and provided  
 47 thread level for MPI\_T\_INIT\_THREAD may influence the behavior and return values  
 48

of `MPI_SESSION_INIT` (see Section 11.3), with the same being true for the reverse order. (*End of advice to users.*)

*Advice to implementors.* MPI implementations should strive to make as many control or performance variables available before MPI initialization (instead of adding them during initialization) to allow tools the most flexibility. In particular, control variables should be available before MPI initialization if their value cannot be changed after MPI initialization. (*End of advice to implementors.*)

## `MPI_T_FINALIZE()`

### C binding

```
int MPI_T_finalize(void)
```

This routine finalizes the use of the MPI tool information interface and may be called as often as the corresponding `MPI_T_INIT_THREAD` routine up to the current point of execution. Calling it more times returns a corresponding error code. As long as the number of calls to `MPI_T_FINALIZE` is smaller than the number of calls to `MPI_T_INIT_THREAD` up to the current point of execution, the MPI tool information interface remains initialized and calls to its routines are permissible. Further, additional calls to `MPI_T_INIT_THREAD` after one or more calls to `MPI_T_FINALIZE` are permissible.

Once `MPI_T_FINALIZE` is called the same number of times as the routine `MPI_T_INIT_THREAD` up to the current point of execution, the MPI tool information interface is no longer initialized. The user can reinitialize the interface by a subsequent call to `MPI_T_INIT_THREAD`.

At the end of the program execution, unless `MPI_ABORT` is called, an application must have called `MPI_T_INIT_THREAD` and `MPI_T_FINALIZE` an equal number of times.

### 15.3.5 Datatype System

All variables managed through the MPI tool information interface represent their values through typed buffers of a given length and type using an MPI datatype (similar to regular send/receive buffers). Since the initialization of the MPI tool information interface is separate from the initialization of MPI, MPI tool information interface routines can be called before MPI initialization. Consequently, these routines can also use MPI datatypes before MPI initialization. Therefore, within the context of the MPI tool information interface, it is permissible to use a subset of MPI datatypes as specified below before MPI initialization.

*Rationale.* The MPI tool information interface relies mainly on unsigned datatypes for integer values since most variables are expected to represent counters or resource sizes. `MPI_INT` is provided for additional flexibility and is expected to be used mainly for control variables and enumeration types (see below).

Providing all basic datatypes, in particular providing all signed and unsigned variants of integer types, would lead to a larger number of types, which tools need to interpret. This would cause unnecessary complexity in the implementation of tools based on the MPI tool information interface. (*End of rationale.*)

1	MPI_INT
2	MPI_INT32_T
3	MPI_INT64_T
4	MPI_UNSIGNED
5	MPI_UNSIGNED_LONG
6	MPI_UNSIGNED_LONG_LONG
7	MPI_UINT32_T
8	MPI_UINT64_T
9	MPI_COUNT
10	MPI_CHAR
11	MPI_DOUBLE
12	

Table 15.3: MPI datatypes that can be used by the MPI tool information interface

The MPI tool information interface only relies on a subset of the basic MPI datatypes and does not use any derived MPI datatypes. Table 15.3 lists all MPI datatypes that can be returned by the MPI tool information interface to represent its variables.

The use of the datatype MPI\_CHAR in the MPI tool information interface implies a null-terminated character array, i.e., a string in the C language. If a variable has type MPI\_CHAR, the value of the `count` parameter returned by `MPI_T_CVAR_HANDLE_ALLOC` and `MPI_T_PVAR_HANDLE_ALLOC` must be large enough to include any valid value, including its terminating null character. The contents of returned MPI\_CHAR arrays are only defined from index 0 through the location of the first null character.

*Rationale.* The MPI tool information interface requires a significantly simpler type system than MPI itself. Therefore, only its required subset must be present before MPI initialization and MPI implementations do not need to initialize the complete MPI datatype system. (*End of rationale.*)

For variables of type MPI\_INT, an MPI implementation can provide additional information by associating names with a fixed number of values. We refer to this information in the following as an enumeration. In this case, the respective calls that provide additional metadata for each control or performance variable, i.e., `MPI_T_CVAR_GET_INFO` (Section 15.3.6), `MPI_T_PVAR_GET_INFO` (Section 15.3.7), and `MPI_T_EVENT_GET_INFO` (Section 15.3.8), return a handle of type `MPI_T_enum` that can be passed to the following functions to extract additional information. Thus, the MPI implementation can describe variables with a fixed set of values that each represents a particular state. Each enumeration type can have  $N$  different values, with a fixed  $N$  that can be queried using `MPI_T_ENUM_GET_INFO`.



MPI\_T\_ENUM\_GET\_INFO(enumtype, num, name, name\_len) 1

IN	enumtype	enumeration to be queried (handle)	2
OUT	num	number of discrete values represented by this enumeration (integer)	3
OUT	name	buffer to return the string containing the name of the enumeration item (string)	4
INOUT	name_len	length of the string and/or buffer for name (integer)	5

### C binding 6

```
int MPI_T_enum_get_info(MPI_T_enum enumtype, int *num, char *name,
                        int *name_len) 7
```

If `enumtype` is a valid enumeration, this routine returns the number of items represented by this enumeration type as well as its name.  $N$  must be greater than 0, i.e., the enumeration must represent at least one value. 8

The arguments `name` and `name_len` are used to return the name of the enumeration as described in Section 15.3.3. 9

The routine is required to return a name of at least length one. This name must be unique with respect to all other names for enumerations that the MPI implementation uses. 10

Names associated with individual values in each enumeration `enumtype` can be queried using `MPI_T_ENUM_GET_ITEM`. 11

MPI\_T\_ENUM\_GET\_ITEM(enumtype, index, value, name, name\_len) 12

IN	enumtype	enumeration to be queried (handle)	13
IN	index	number of the value to be queried in this enumeration (integer)	14
OUT	value	variable value (integer)	15
OUT	name	buffer to return the string containing the name of the enumeration item (string)	16
INOUT	name_len	length of the string and/or buffer for name (integer)	17

### C binding 18

```
int MPI_T_enum_get_item(MPI_T_enum enumtype, int index, int *value,
                        char *name, int *name_len) 19
```

The arguments `name` and `name_len` are used to return the name of the enumeration item as described in Section 15.3.3. 20

If completed successfully, the routine returns the name/value pair that describes the enumeration at the specified index. The call is further required to return a name of at least length one. This name must be unique with respect to all other names of items for the same enumeration. 21

### 15.3.6 Control Variables

The routines described in this section of the MPI tool information interface specification focus on the ability to list, query, and possibly set control variables exposed by the MPI implementation. These variables can typically be used by the user to fine tune properties and configuration settings of the MPI implementation. On many systems, such variables can be set using environment variables, although other configuration mechanisms may be available, such as configuration files or central configuration registries. A typical example that is available in several existing MPI implementations is the ability to specify an “eager limit,” i.e., an upper bound on the size of messages sent or received using an eager protocol.

#### Control Variable Query Functions

An MPI implementation exports a set of  $N$  control variables through the MPI tool information interface. If  $N$  is zero, then the MPI implementation does not export any control variables, otherwise the provided control variables are indexed from 0 to  $N - 1$ . This index number is used in subsequent calls to identify the individual variables.

An MPI implementation is allowed to increase the number of control variables during the execution of an MPI application when new variables become available through dynamic loading. However, MPI implementations are not allowed to change the index of a control variable or to delete a variable once it has been added to the set. When a variable becomes inactive, e.g., through dynamic unloading, accessing its value should return a corresponding error code.

*Advice to users.* While the MPI tool information interface guarantees that indices or variable properties do not change during a particular run of an MPI program, it does not provide a similar guarantee between runs. (*End of advice to users.*)

The following function can be used to query the number of control variables, `num_cvar`:

```
MPI_T_CVAR_GET_NUM(num_cvar)
```

```
OUT    num_cvar    returns number of control variables (integer)
```

#### C binding

```
int MPI_T_cvar_get_num(int *num_cvar)
```

The function `MPI_T_CVAR_GET_INFO` provides access to additional information for each variable.



MPI_T_CVAR_GET_INFO(cvar_index, name, name_len, verbosity, datatype, enumtype, desc,			1
desc_len, bind, scope)			2
IN	cvar_index	index of the control variable to be queried, value	3
		between 0 and num_cvar – 1 (integer)	4
OUT	name	buffer to return the string containing the name of the	5
		control variable (string)	6
INOUT	name_len	length of the string and/or buffer for name (integer)	7
OUT	verbosity	verbosity level of this variable (integer)	8
OUT	datatype	MPI datatype of the information stored in the	9
		control variable (handle)	10
OUT	enumtype	optional descriptor for enumeration information	11
		(handle)	12
OUT	desc	buffer to return the string containing a description of	13
		the control variable (string)	14
INOUT	desc_len	length of the string and/or buffer for desc (integer)	15
OUT	bind	type of MPI object to which this variable must be	16
		bound (integer)	17
OUT	scope	scope of when changes to this variable are possible	18
		(integer)	19

### C binding

```
int MPI_T_cvar_get_info(int cvar_index, char *name, int *name_len,
    int *verbosity, MPI_Datatype *datatype, MPI_T_enum *enumtype,
    char *desc, int *desc_len, int *bind, int *scope)
```

After a successful call to MPI\_T\_CVAR\_GET\_INFO for a particular variable, subsequent calls to this routine that query information about the same variable must return the same information. An MPI implementation is not allowed to alter any of the returned values.

If any OUT parameter to MPI\_T\_CVAR\_GET\_INFO is a NULL pointer, the implementation will ignore the parameter and not return a value for the parameter.

The arguments name and name\_len are used to return the name of the control variable as described in Section 15.3.3.

If completed successfully, the routine is required to return a name of at least length one. The name must be unique with respect to all other names for control variables used by the MPI implementation.

The argument verbosity returns the verbosity level of the variable (see Section 15.3.1).

The argument datatype returns the MPI datatype that is used to represent the control variable.

If the variable is of type MPI\_INT, MPI can optionally specify an enumeration for the values represented by this variable and return it in enumtype. In this case, MPI returns an enumeration identifier, which can then be used to gather more information as described in Section 15.3.5. Otherwise, enumtype is set to MPI\_T\_ENUM\_NULL. If the datatype is not MPI\_INT or the argument enumtype is the null pointer, no enumeration type is returned.

The arguments desc and desc\_len are used to return a description of the control variable as described in Section 15.3.3.

Returning a description is optional. If an MPI implementation does not return a description, the first character for `desc` must be set to the null character and `desc_len` must be set to one at the return of this call.

The parameter `bind` returns the type of the MPI object to which the variable must be bound or the value `MPI_T_BIND_NO_OBJECT` (see Section 15.3.2).

The scope of a variable determines whether changing a variable's value is either local to the MPI process or must be done by the user across multiple connected MPI processes. The latter is further split into variables that require changes in a group of MPI processes and those that require collective changes among all connected MPI processes. Both cases can require variables on all participating MPI processes either to be set to consistent (but potentially different) values or to equal values. The description provided with the variable must contain an explanation about the requirements and/or restrictions for setting the particular variable.

On successful return from `MPI_T_CVAR_GET_INFO`, the argument `scope` will be set to one of the constants listed in Table 15.4.

If the name of a control variable is equivalent across connected MPI processes, the following OUT parameters must be identical: `verbosity`, `datatype`, `enumtype`, `bind`, and `scope`. The returned description must be equivalent.

Scope Constant	Description
<code>MPI_T_SCOPE_CONSTANT</code>	read-only, value is constant
<code>MPI_T_SCOPE_READONLY</code>	read-only, cannot be written, but can change
<code>MPI_T_SCOPE_LOCAL</code>	may be writeable, writing is a local operation
<code>MPI_T_SCOPE_GROUP</code>	may be writeable, must be set to consistent values across a group of connected MPI processes
<code>MPI_T_SCOPE_GROUP_EQ</code>	may be writeable, must be set to the same value across a group of connected MPI processes
<code>MPI_T_SCOPE_ALL</code>	may be writeable, must be set to consistent values across all connected MPI processes
<code>MPI_T_SCOPE_ALL_EQ</code>	may be writeable, must be set to the same value across all connected MPI processes

Table 15.4: Scopes for control variables

*Advice to users.* The `scope` of a variable only indicates if a variable might be changeable; it is not a guarantee that it can be changed at any time. (*End of advice to users.*)

```
MPI_T_CVAR_GET_INDEX(name, cvar_index)
```

```
IN      name                name of the control variable (string)
```

```
OUT     cvar_index          index of the control variable (integer)
```

### C binding

```
int MPI_T_cvar_get_index(const char *name, int *cvar_index)
```

MPI\_T\_CVAR\_GET\_INDEX is a function for retrieving the index of a control variable given a known variable name. The name parameter is provided by the caller, and cvar\_index is returned by the MPI implementation. The name parameter is a string terminated with a null character.

This routine returns MPI\_SUCCESS on success and returns MPI\_T\_ERR\_INVALID\_NAME if name does not match the name of any control variable provided by the implementation at the time of the call.

*Rationale.* This routine is provided to enable fast retrieval of control variables by a tool, assuming it knows the name of the variable for which it is looking. The number of variables exposed by the implementation can change over time, so it is not possible for the tool to simply iterate over the list of variables once at initialization. Although using MPI implementation specific variable names is not portable across MPI implementations, tool developers may choose to take this route for lower overhead at runtime because the tool will not have to iterate over the entire set of variables to find a specific one. (*End of rationale.*)

**Example 15.4** Querying and printing the names of all available control variables.

```
#include <stdio.h>
#include <stdlib.h>
#include <mpi.h>

int main(int argc, char *argv[]) {
    int i, err, num, namelen, bind, verbose, scope;
    int threadsupport;
    char name[100];
    MPI_Datatype datatype;

    err=MPI_T_init_thread(MPI_THREAD_SINGLE,&threadsupport);
    if (err!=MPI_SUCCESS)
        return err;

    err=MPI_T_cvar_get_num(&num);
    if (err!=MPI_SUCCESS)
        return err;

    for (i=0; i<num; i++) {
        namelen=100;
        err=MPI_T_cvar_get_info(i, name, &namelen,
                               &verbose, &datatype, NULL,
                               NULL, NULL, /*no description */
                               &bind, &scope);
        if (err!=MPI_SUCCESS && err!=MPI_T_ERR_INVALID_INDEX) return err;
        printf("Var %i: %s\n", i, name);
    }

    err=MPI_T_finalize();
```

```

1   if (err!=MPI_SUCCESS)
2       return 1;
3   else
4       return 0;
5   }

```

## Handle Allocation and Deallocation

Before reading or writing the value of a variable, a user must first allocate a handle of type `MPI_T_cvar_handle` for the variable by binding it to an MPI object (see also Section 15.3.2).

*Rationale.* Handles used in the MPI tool information interface are distinct from handles used in the remaining parts of the MPI standard because they must be usable before MPI is initialized and after MPI is finalized. Further, accessing handles, in particular for performance variables, can be time critical and having a separate handle space enables optimizations. (*End of rationale.*)

### `MPI_T_CVAR_HANDLE_ALLOC(cvar_index, obj_handle, handle, count)`

IN	<code>cvar_index</code>	index of control variable for which handle is to be allocated (index)
IN	<code>obj_handle</code>	reference to a handle of the MPI object to which this variable is supposed to be bound (pointer)
OUT	<code>handle</code>	allocated handle (handle)
OUT	<code>count</code>	number of elements used to represent this variable (integer)

### C binding

```

30 int MPI_T_cvar_handle_alloc(int cvar_index, void *obj_handle,
31                             MPI_T_cvar_handle *handle, int *count)
32

```

This routine binds the control variable specified by the argument `index` to an MPI object. The object is passed in the argument `obj_handle` as an address to a local variable that stores the object's handle. The argument `obj_handle` is ignored if the `MPI_T_CVAR_GET_INFO` call for this control variable returned `MPI_T_BIND_NO_OBJECT` in the argument `bind`. The handle allocated to reference the variable is returned in the argument `handle`. Upon successful return, `count` contains the number of elements (of the datatype returned by a previous `MPI_T_CVAR_GET_INFO` call) used to represent this variable.

*Advice to users.* The `count` can be different based on the MPI object to which the control variable was bound. For example, variables bound to communicators could have a count that matches the size of the communicator.

It is not portable to pass references to predefined MPI object handles, such as `MPI_COMM_WORLD` to this routine, since their implementation depends on the MPI library. Instead, such object handles should be stored in a local variable and the address of this local variable should be passed into `MPI_T_CVAR_HANDLE_ALLOC`. (*End of advice to users.*)



1 returned datatype and count from prior corresponding calls to `MPI_T_CVAR_GET_INFO`  
 2 and `MPI_T_CVAR_HANDLE_ALLOC`, respectively).

3 If the variable has a global scope (as returned by a prior corresponding  
 4 `MPI_T_CVAR_GET_INFO` call), any write call to this variable must be issued by the user  
 5 in all connected (as defined in Section 11.10.4) MPI processes. If the variable has group  
 6 scope, any write call to this variable must be issued by the user in all MPI processes in  
 7 the group, which must be described by the MPI implementation in the description by the  
 8 `MPI_T_CVAR_GET_INFO`.

9 In both cases, the user must ensure that the writes in all participating MPI processes  
 10 are consistent. If the scope is either `MPI_T_SCOPE_ALL_EQ` or `MPI_T_SCOPE_GROUP_EQ`  
 11 this means that the variable in all connected MPI processes or MPI processes of the group,  
 12 respectively, must be set to the same value.

13 If it is not possible to change the variable at the time the call is made, the function  
 14 returns either `MPI_T_ERR_CVAR_SET_NOT_NOW`, if there may be a later time at which the  
 15 variable could be set, or `MPI_T_ERR_CVAR_SET_NEVER`, if the variable cannot be set for the  
 16 remainder of the application's execution.

17  
 18 **Example 15.5** Reading the value of a control variable.

```

19 int getValue_int_comm(int index, MPI_Comm comm, int *val) {
20     int err,count;
21     MPI_T_cvar_handle handle;
22
23     /* This example assumes that the variable index */
24     /* can be bound to a communicator */
25
26     err=MPI_T_cvar_handle_alloc(index, &comm, &handle, &count);
27     if (err!=MPI_SUCCESS) return err;
28
29     /* The following assumes that the variable is */
30     /* represented by a single integer */
31
32     err=MPI_T_cvar_read(handle,val);
33     if (err!=MPI_SUCCESS) return err;
34
35     err=MPI_T_cvar_handle_free(&handle);
36     return err;
37 }
38
39

```

### 40 15.3.7 Performance Variables

41 The following section focuses on the ability to list and to query performance variables  
 42 provided by the MPI implementation. Performance variables provide insight into MPI  
 43 implementation-specific internals and can represent information such as the state of the  
 44 MPI implementation (e.g., waiting blocked, receiving, not active), aggregated timing data  
 45 for submodules, or queue sizes and lengths.

46  
 47 *Rationale.* The interface for performance variables is separate from the interface for  
 48 control variables, since performance variables have different requirements and param-

eters. By keeping them separate, the interface provides cleaner semantics and allows for more performance optimization opportunities. (*End of rationale.*)

Some performance variables and classes refer to *events*. In general, such events describe state transitions within software or hardware related to the performance of an MPI application. The events offered through the callback-driven event-notification interface described in Section 15.3.8 also refer to such state transitions; however, the set of state transitions referred to by performance variables and events as described in Section 15.3.8 may not be identical.

### Performance Variable Classes

Each performance variable is associated with a class that describes its basic semantics, possible datatypes, basic behavior, its starting value, whether it can overflow, and when and how an MPI implementation can change the variable's value. The starting value is the value that is assigned to the variable the first time that it is used or whenever it is reset.

*Advice to users.* If a performance variable belongs to a class that can overflow, it is up to the user to protect against this overflow, e.g., by frequently reading and resetting the variable value. (*End of advice to users.*)

*Advice to implementors.* MPI implementations should use large enough datatypes for each performance variable to avoid overflows under normal circumstances. (*End of advice to implementors.*)

The classes are defined by the following constants:

- **MPI\_T\_PVAR\_CLASS\_STATE**  
A performance variable in this class represents a set of discrete states. Variables of this class are represented by `MPI_INT` and can be set by the MPI implementation at any time. Variables of this type should be described further using an enumeration, as discussed in Section 15.3.5. The starting value is the current state of the implementation at the time that the starting value is set. MPI implementations must ensure that variables of this class cannot overflow.
- **MPI\_T\_PVAR\_CLASS\_LEVEL**  
A performance variable in this class represents a value that describes the utilization level of a resource. The value of a variable of this class can change at any time to match the current utilization level of the resource. Values returned from variables in this class are non-negative and represented by one of the following datatypes: `MPI_UNSIGNED`, `MPI_UNSIGNED_LONG`, `MPI_UNSIGNED_LONG_LONG`, `MPI_DOUBLE`. The starting value is the current utilization level of the resource at the time that the starting value is set. MPI implementations must ensure that variables of this class cannot overflow.
- **MPI\_T\_PVAR\_CLASS\_SIZE**  
A performance variable in this class represents a value that is the size of a resource. Values returned from variables in this class are non-negative and represented by one of the following datatypes: `MPI_UNSIGNED`, `MPI_UNSIGNED_LONG`, `MPI_UNSIGNED_LONG_LONG`, `MPI_DOUBLE`. The starting value is the current size of the resource at the time that the starting value is set. MPI implementations must ensure that variables of this class cannot overflow.

- 1     • **MPI\_T\_PVAR\_CLASS\_PERCENTAGE**  
2       The value of a performance variable in this class represents the percentage utiliza-  
3       tion of a finite resource. The value of a variable of this class can change at any  
4       time to match the current utilization level of the resource. It will be returned as an  
5       MPI\_DOUBLE datatype. The value must always be between 0.0 (resource not used at  
6       all) and 1.0 (resource completely used). The starting value is the current percent-  
7       age utilization level of the resource at the time that the starting value is set. MPI  
8       implementations must ensure that variables of this class cannot overflow.  
9
- 10    • **MPI\_T\_PVAR\_CLASS\_HIGHWATERMARK**  
11      A performance variable in this class represents a value that describes the high water-  
12      mark utilization of a resource. The value of a variable of this class is non-negative  
13      and grows monotonically from the initialization or reset of the variable. It can be rep-  
14      resented by one of the following datatypes: MPI\_UNSIGNED, MPI\_UNSIGNED\_LONG,  
15      MPI\_UNSIGNED\_LONG\_LONG, MPI\_DOUBLE. The starting value is the current utiliza-  
16      tion level of the resource at the time that the variable is started or reset. MPI imple-  
17      mentations must ensure that variables of this class cannot overflow.  
18
- 19    • **MPI\_T\_PVAR\_CLASS\_LOWWATERMARK**  
20      A performance variable in this class represents a value that describes the low water-  
21      mark utilization of a resource. The value of a variable of this class is non-negative  
22      and decreases monotonically from the initialization or reset of the variable. It can be  
23      represented by one of the following datatypes: MPI\_UNSIGNED, MPI\_UNSIGNED\_LONG,  
24      MPI\_UNSIGNED\_LONG\_LONG, MPI\_DOUBLE. The starting value is the current utiliza-  
25      tion level of the resource at the time that the variable is started or reset. MPI imple-  
26      mentations must ensure that variables of this class cannot overflow.  
27
- 28    • **MPI\_T\_PVAR\_CLASS\_COUNTER**  
29      A performance variable in this class counts the number of occurrences of a specific  
30      event (e.g., the number of memory allocations within an MPI library). The value of  
31      a variable of this class increases monotonically from the initialization or reset of the  
32      performance variable by one for each specific event that is observed. Values must  
33      be non-negative and represented by one of the following datatypes: MPI\_UNSIGNED,  
34      MPI\_UNSIGNED\_LONG, MPI\_UNSIGNED\_LONG\_LONG. The starting value for variables  
35      of this class is 0. Variables of this class can overflow.  
36
- 37    • **MPI\_T\_PVAR\_CLASS\_AGGREGATE**  
38      The value of a performance variable in this class is an an aggregated value that  
39      represents a sum of arguments processed during a specific event (e.g., the amount  
40      of memory allocated by all memory allocations). This class is similar to the counter  
41      class, but instead of counting individual events, the value can be incremented by  
42      arbitrary amounts. The value of a variable of this class increases monotonically from  
43      the initialization or reset of the performance variable. It must be non-negative and  
44      represented by one of the following datatypes: MPI\_UNSIGNED, MPI\_UNSIGNED\_LONG,  
45      MPI\_UNSIGNED\_LONG\_LONG, MPI\_DOUBLE. The starting value for variables of this  
46      class is 0. Variables of this class can overflow.  
47
- 48    • **MPI\_T\_PVAR\_CLASS\_TIMER**  
    The value of a performance variable in this class represents the aggregated time that  
    the MPI implementation spends executing a particular event, type of event, or section



of the MPI library. This class has the same basic semantics as `MPI_T_PVAR_CLASS_AGGREGATE`, but explicitly records a timing value. The value of a variable of this class increases monotonically from the initialization or reset of the performance variable. It must be non-negative and represented by one of the following datatypes: `MPI_UNSIGNED`, `MPI_UNSIGNED_LONG`, `MPI_UNSIGNED_LONG_LONG`, `MPI_DOUBLE`. The starting value for variables of this class is 0. If the type `MPI_DOUBLE` is used, the units that represent time in this datatype must match the units used by `MPI_WTIME`. Otherwise, the time units should be documented, e.g., in the description returned by `MPI_T_PVAR_GET_INFO`. Variables of this class can overflow.

- `MPI_T_PVAR_CLASS_GENERIC`

This class can be used to describe a variable that does not fit into any of the other classes. For variables in this class, the starting value is variable-specific and implementation-defined.

### Performance Variable Query Functions

An MPI implementation exports a set of  $N$  performance variables through the MPI tool information interface. If  $N$  is zero, then the MPI implementation does not export any performance variables; otherwise the provided performance variables are indexed from 0 to  $N - 1$ . This index number is used in subsequent calls to identify the individual variables.

An MPI implementation is allowed to increase the number of performance variables during the execution of an MPI application when new variables become available through dynamic loading. However, MPI implementations are not allowed to change the index of a performance variable or to delete a variable once it has been added to the set. When a variable becomes inactive, e.g., through dynamic unloading, accessing its value should return a corresponding error code.

The following function can be used to query the number of performance variables, `num_pvar`:

```
MPI_T_PVAR_GET_NUM(num_pvar)
```

OUT      `num_pvar`                      returns number of performance variables (integer)

#### C binding

```
int MPI_T_pvar_get_num(int *num_pvar)
```

The function `MPI_T_PVAR_GET_INFO` provides access to additional information for each variable.

```

1 MPI_T_PVAR_GET_INFO(pvar_index, name, name_len, verbosity, var_class, datatype,
2     enumtype, desc, desc_len, bind, readonly, continuous, atomic)
3
4     IN     pvar_index     index of the performance variable to be queried
5                          between 0 and num_pvar - 1 (integer)
6
7     OUT    name          buffer to return the string containing the name of the
8                          performance variable (string)
9
10    INOUT  name_len      length of the string and/or buffer for name (integer)
11
12    OUT    verbosity     verbosity level of this variable (integer)
13
14    OUT    var_class     class of performance variable (integer)
15
16    OUT    datatype      MPI datatype of the information stored in the
17                          performance variable (handle)
18
19    OUT    enumtype     optional descriptor for enumeration information
20                          (handle)
21
22    OUT    desc          buffer to return the string containing a description of
23                          the performance variable (string)
24
25    INOUT  desc_len     length of the string and/or buffer for desc (integer)
26
27    OUT    bind          type of MPI object to which this variable must be
28                          bound (integer)
29
30    OUT    readonly     flag indicating whether the variable can be
31                          written/reset (integer)
32
33    OUT    continuous   flag indicating whether the variable can be started
34                          and stopped or is continuously active (integer)
35
36    OUT    atomic       flag indicating whether the variable can be
37                          atomically read and reset (integer)

```

### C binding

```

31 int MPI_T_pvar_get_info(int pvar_index, char *name, int *name_len,
32     int *verbosity, int *var_class, MPI_Datatype *datatype,
33     MPI_T_enum *enumtype, char *desc, int *desc_len, int *bind,
34     int *readonly, int *continuous, int *atomic)
35

```

After a successful call to `MPI_T_PVAR_GET_INFO` for a particular variable, subsequent calls to this routine that query information about the same variable must return the same information. An MPI implementation is not allowed to alter any of the returned values.

If any OUT parameter to `MPI_T_PVAR_GET_INFO` is a NULL pointer, the implementation will ignore the parameter and not return a value for the parameter.

The arguments `name` and `name_len` are used to return the name of the performance variable as described in Section 15.3.3. If completed successfully, the routine is required to return a name of at least length one.

The argument `verbosity` returns the verbosity level of the variable (see Section 15.3.1).

The class of the performance variable is returned in the parameter `var_class`. The class must be one of the constants defined in Section 15.3.7.

The combination of the name and the class of the performance variable must be unique with respect to all other names for performance variables used by the MPI implementation.

*Advice to implementors.* Groups of variables that belong closely together, but have different classes, can have the same name. This choice is useful, e.g., to refer to multiple variables that describe a single resource (like the level, the total size, as well as high and low watermarks). (*End of advice to implementors.*)

The argument `datatype` returns the MPI datatype that is used to represent the performance variable.

If the variable is of type `MPI_INT`, MPI can optionally specify an enumeration for the values represented by this variable and return it in `enumtype`. In this case, MPI returns an enumeration identifier, which can then be used to gather more information as described in Section 15.3.5. Otherwise, `enumtype` is set to `MPI_T_ENUM_NULL`. If the datatype is not `MPI_INT` or the argument `enumtype` is the null pointer, no enumeration type is returned.

Returning a description is optional. If an MPI implementation does not return a description, the first character for `desc` must be set to the null character and `desc_len` must be set to one at the return from this function.

The parameter `bind` returns the type of the MPI object to which the variable must be bound or the value `MPI_T_BIND_NO_OBJECT` (see Section 15.3.2).

Upon return, the argument `readonly` is set to zero if the variable can be written or reset by the user. It is set to one if the variable can only be read.

Upon return, the argument `continuous` is set to zero if the variable can be started and stopped by the user, i.e., it is possible for the user to control if and when the value of a variable is updated. It is set to one if the variable is always active and cannot be controlled by the user.

Upon return, the argument `atomic` is set to zero if the variable cannot be read and reset atomically. Only variables for which the call sets `atomic` to one can be used in a call to `MPI_T_PVAR_READRESET`.

If a performance variable has an equivalent name and has the same class across connected MPI processes, the following OUT parameters must be identical: `verbosity`, `varclass`, `datatype`, `enumtype`, `bind`, `readonly`, `continuous`, and `atomic`. The returned description must be equivalent.

`MPI_T_PVAR_GET_INDEX(name, var_class, pvar_index)`

IN	<code>name</code>	the name of the performance variable (string)
IN	<code>var_class</code>	the class of the performance variable (integer)
OUT	<code>pvar_index</code>	the index of the performance variable (integer)

### C binding

`int MPI_T_pvar_get_index(const char *name, int var_class, int *pvar_index)`

`MPI_T_PVAR_GET_INDEX` is a function for retrieving the index of a performance variable given a known variable name and class. The `name` and `var_class` parameters are provided by the caller, and `pvar_index` is returned by the MPI implementation. The `name` parameter is a string terminated with a null character.

This routine returns `MPI_SUCCESS` on success and returns `MPI_T_ERR_INVALID_NAME` if `name` does not match the name of any performance variable of the specified `var_class` provided by the implementation at the time of the call.

*Rationale.* This routine is provided to enable fast retrieval of performance variables by a tool, assuming it knows the name of the variable for which it is looking. The number of variables exposed by the implementation can change over time, so it is not possible for the tool to simply iterate over the list of variables once at initialization. Although using MPI implementation specific variable names is not portable across MPI implementations, tool developers may choose to take this route for lower overhead at runtime because the tool will not have to iterate over the entire set of variables to find a specific one. (*End of rationale.*)

## Performance Experiment Sessions

Within a single program, multiple components can use the MPI tool information interface. To avoid collisions with respect to accesses to performance variables, users of the MPI tool information interface must first create a performance experiment session. Subsequent calls that access performance variables can then be made within the context of this performance experiment session. Starting, stopping, reading, writing, or resetting a variable in one performance experiment session shall not influence whether a variable is started, stopped, read, written, or reset in another performance experiment session.

`MPI_T_PVAR_SESSION_CREATE(pe_session)`

OUT      `pe_session`                      identifier of performance experiment session (handle)

### C binding

`int MPI_T_pvar_session_create(MPI_T_pvar_session *pe_session)`

This call creates a new performance experiment session for accessing performance variables and returns a handle for this performance experiment session in the argument `pe_session` of type `MPI_T_pvar_session`.

`MPI_T_PVAR_SESSION_FREE(pe_session)`

INOUT    `pe_session`                      identifier of performance experiment session (handle)

### C binding

`int MPI_T_pvar_session_free(MPI_T_pvar_session *pe_session)`

This call frees an existing performance experiment session. Calls to the MPI tool information interface can no longer be made within the context of a performance experiment session after it is freed. On a successful return, MPI sets the performance experiment session identifier to `MPI_T_PVAR_SESSION_NULL`.

## Handle Allocation and Deallocation

Before using a performance variable, a user must first allocate a handle of type `MPI_T_pvar_handle` for the variable by binding it to an MPI object (see also Section 15.3.2).

<code>MPI_T_PVAR_HANDLE_ALLOC(pe_session, pvar_index, obj_handle, handle, count)</code>			1
IN	<code>pe_session</code>	identifier of performance experiment session (handle)	2
IN	<code>pvar_index</code>	index of performance variable for which handle is to be allocated (integer)	3
			4
IN	<code>obj_handle</code>	reference to a handle of the MPI object to which this variable is supposed to be bound (pointer)	5
			6
OUT	<code>handle</code>	allocated handle (handle)	7
			8
OUT	<code>count</code>	number of elements used to represent this variable (integer)	9
			10
			11

**C binding**

```
int MPI_T_pvar_handle_alloc(MPI_T_pvar_session pe_session, int pvar_index,
void *obj_handle, MPI_T_pvar_handle *handle, int *count)
```

This routine binds the performance variable specified by the argument `index` to an MPI object in the performance experiment session identified by the parameter `pe_session`. The object is passed in the argument `obj_handle` as an address to a local variable that stores the object's handle. The argument `obj_handle` is ignored if the `MPI_T_PVAR_GET_INFO` call for this performance variable returned `MPI_T_BIND_NO_OBJECT` in the argument `bind`. The handle allocated to reference the variable is returned in the argument `handle`. Upon successful return, `count` contains the number of elements (of the datatype returned by a previous `MPI_T_PVAR_GET_INFO` call) used to represent this variable.

*Advice to users.* The `count` can be different based on the MPI object to which the performance variable was bound. For example, variables bound to communicators could have a count that matches the size of the communicator.

It is not portable to pass references to predefined MPI object handles, such as `MPI_COMM_WORLD`, to this routine, since their implementation depends on the MPI library. Instead, such an object handle should be stored in a local variable and the address of this local variable should be passed into `MPI_T_PVAR_HANDLE_ALLOC`. (*End of advice to users.*)

The value of `index` should be in the range from 0 to `num_pvar - 1`, where `num_pvar` is the number of available performance variables as determined from a prior call to `MPI_T_PVAR_GET_NUM`. The type of the MPI object it references must be consistent with the type returned in the `bind` argument in a prior call to `MPI_T_PVAR_GET_INFO`.

For all routines in the rest of this section that take both `handle` and `pe_session` as IN or INOUT arguments, if the `handle` argument passed in is not associated with the `pe_session` argument, `MPI_T_ERR_INVALID_HANDLE` is returned.

<code>MPI_T_PVAR_HANDLE_FREE(pe_session, handle)</code>			42
IN	<code>pe_session</code>	identifier of performance experiment session (handle)	43
INOUT	<code>handle</code>	handle to be freed (handle)	44
			45
			46

**C binding**

```
int MPI_T_pvar_handle_free(MPI_T_pvar_session pe_session,
```

```
1 MPI_T_pvar_handle *handle)
```

2  
3 When a handle is no longer needed, a user of the MPI tool information interface should  
4 call `MPI_T_PVAR_HANDLE_FREE` to free the handle in the performance experiment session  
5 identified by the parameter `pe_session` and the associated resources in the MPI implemen-  
6 tation. On a successful return, MPI sets the handle to `MPI_T_PVAR_HANDLE_NULL`.

### 7 Starting and Stopping of Performance Variables

9 Performance variables that have the continuous flag set during the query operation are  
10 continuously operating once a handle has been allocated. Such variables may be queried at  
11 any time, but they cannot be started or stopped by the user. All other variables are in a  
12 stopped state after their handle has been allocated; their values are not updated until they  
13 have been started by the user.

```
14  
15  
16 MPI_T_PVAR_START(pe_session, handle)
```

```
17     IN     pe_session           identifier of performance experiment session (handle)
18     IN     handle              handle of a performance variable (handle)
```

### 20 C binding

```
21  
22 int MPI_T_pvar_start(MPI_T_pvar_session pe_session,
23                     MPI_T_pvar_handle handle)
```

24 This function starts the performance variable with the handle identified by the param-  
25 eter `handle` in the performance experiment session identified by the parameter `pe_session`.

26 If the constant `MPI_T_PVAR_ALL_HANDLES` is passed in `handle`, the MPI implementa-  
27 tion attempts to start all variables within the performance experiment session identified  
28 by the parameter `pe_session` for which handles have been allocated. In this case, the rou-  
29 tine returns `MPI_SUCCESS` if all variables are started successfully (even if there are no  
30 non-continuous variables to be started), otherwise `MPI_T_ERR_PVAR_NO_STARTSTOP` is  
31 returned. Continuous variables and variables that are already started are ignored when  
32 `MPI_T_PVAR_ALL_HANDLES` is specified.

```
33  
34  
35 MPI_T_PVAR_STOP(pe_session, handle)
```

```
36     IN     pe_session           identifier of performance experiment session (handle)
37     IN     handle              handle of a performance variable (handle)
```

### 39 C binding

```
40  
41 int MPI_T_pvar_stop(MPI_T_pvar_session pe_session,
42                    MPI_T_pvar_handle handle)
```

43 This function stops the performance variable with the handle identified by the param-  
44 eter `handle` in the performance experiment session identified by the parameter `pe_session`.

45 If the constant `MPI_T_PVAR_ALL_HANDLES` is passed in `handle`, the MPI implementa-  
46 tion attempts to stop all variables within the performance experiment session identified  
47

by the parameter `pe_session` for which handles have been allocated. In this case, the routine returns `MPI_SUCCESS` if all variables are stopped successfully (even if there are no non-continuous variables to be stopped), otherwise `MPI_T_ERR_PVAR_NO_STARTSTOP` is returned. Continuous variables and variables that are already stopped are ignored when `MPI_T_PVAR_ALL_HANDLES` is specified.

### Performance Variable Access Functions

`MPI_T_PVAR_READ(pe_session, handle, buf)`

IN	<code>pe_session</code>	identifier of performance experiment session (handle)
IN	<code>handle</code>	handle of a performance variable (handle)
OUT	<code>buf</code>	initial address of storage location for variable value (choice)

#### C binding

```
int MPI_T_pvar_read(MPI_T_pvar_session pe_session,
                   MPI_T_pvar_handle handle, void *buf)
```

The `MPI_T_PVAR_READ` call queries the value of the performance variable with the handle `handle` in the performance experiment session identified by the parameter `pe_session` and stores the result in the buffer identified by the parameter `buf`. The user is responsible to ensure that the buffer is of the appropriate size to hold the entire value of the performance variable (based on the datatype and count returned by the corresponding previous calls to `MPI_T_PVAR_GET_INFO` and `MPI_T_PVAR_HANDLE_ALLOC`, respectively).

The constant `MPI_T_PVAR_ALL_HANDLES` cannot be used as an argument for the function `MPI_T_PVAR_READ`.

`MPI_T_PVAR_WRITE(pe_session, handle, buf)`

IN	<code>pe_session</code>	identifier of performance experiment session (handle)
IN	<code>handle</code>	handle of a performance variable (handle)
IN	<code>buf</code>	initial address of storage location for variable value (choice)

#### C binding

```
int MPI_T_pvar_write(MPI_T_pvar_session pe_session,
                    MPI_T_pvar_handle handle, const void *buf)
```

The `MPI_T_PVAR_WRITE` call attempts to write the value of the performance variable with the handle identified by the parameter `handle` in the performance experiment session identified by the parameter `pe_session`. The value to be written is passed in the buffer identified by the parameter `buf`. The user must ensure that the buffer is of the appropriate size to hold the entire value of the performance variable (based on the datatype and count returned by the corresponding previous calls to `MPI_T_PVAR_GET_INFO` and `MPI_T_PVAR_HANDLE_ALLOC`, respectively).

1 If it is not possible to change the variable, the function returns  
 2 MPI\_T\_ERR\_PVAR\_NO\_WRITE.

3 The constant MPI\_T\_PVAR\_ALL\_HANDLES cannot be used as an argument for the func-  
 4 tion MPI\_T\_PVAR\_WRITE.

5  
 6  
 7 MPI\_T\_PVAR\_RESET(pe\_session, handle)

8 IN pe\_session identifier of performance experiment session (handle)  
 9 IN handle handle of a performance variable (handle)

### 11 C binding

12 int MPI\_T\_pvar\_reset(MPI\_T\_pvar\_session pe\_session,  
 13 MPI\_T\_pvar\_handle handle)

14  
 15 The MPI\_T\_PVAR\_RESET call sets the performance variable with the handle identified  
 16 by the parameter handle to its starting value specified in Section 15.3.7. If it is not possible  
 17 to change the variable, the function returns MPI\_T\_ERR\_PVAR\_NO\_WRITE.

18 If the constant MPI\_T\_PVAR\_ALL\_HANDLES is passed in handle, the MPI implementation  
 19 attempts to reset all variables within the performance experiment session identified by the  
 20 parameter pe\_session for which handles have been allocated. In this case, the routine returns  
 21 MPI\_SUCCESS if all variables are reset successfully (even if there are no valid handles or all  
 22 are read-only), otherwise MPI\_T\_ERR\_PVAR\_NO\_WRITE is returned. Read-only variables are  
 23 ignored when MPI\_T\_PVAR\_ALL\_HANDLES is specified.

24  
 25  
 26 MPI\_T\_PVAR\_READRESET(pe\_session, handle, buf)

27 IN pe\_session identifier of performance experiment session (handle)  
 28 IN handle handle of a performance variable (handle)  
 29 OUT buf initial address of storage location for variable value  
 30 (choice)

### 32 C binding

33 int MPI\_T\_pvar\_readreset(MPI\_T\_pvar\_session pe\_session,  
 34 MPI\_T\_pvar\_handle handle, void \*buf)

35  
 36 This call atomically combines the functionality of MPI\_T\_PVAR\_READ and  
 37 MPI\_T\_PVAR\_RESET with the same semantics as if these two calls were called separately.  
 38 If atomic operations on this variable are not supported, this routine returns  
 39 MPI\_T\_ERR\_PVAR\_NO\_ATOMIC.

40 The constant MPI\_T\_PVAR\_ALL\_HANDLES cannot be used as an argument for the func-  
 41 tion MPI\_T\_PVAR\_READRESET.

42  
 43 *Advice to implementors.* Sampling-based tools rely on the ability to call the MPI tool  
 44 information interface, in particular routines to start, stop, read, write, and reset per-  
 45 formance variables, from any program context, including asynchronous contexts such  
 46 as signal handlers. MPI implementations should strive, if possible in their particular  
 47 environment, to enable these usage scenarios for all or a subset of the routines men-  
 48 tioned above. If implementing only a subset, the read, write, and reset routines are



typically the most critical for sampling based tools. An MPI implementation should clearly document any restrictions on the program contexts in which the MPI tool information interface can be used. Restrictions might include guaranteeing usage outside of all signals or outside a specific set of signals. Any restrictions could be documented, for example, through the description returned by `MPI_T_PVAR_GET_INFO`. (*End of advice to implementors.*)

*Rationale.* All routines to read, to write or to reset performance variables require the performance experiment session argument. This requirement keeps the interface consistent and allows the use of `MPI_T_PVAR_ALL_HANDLES` where appropriate. Further, this opens up additional performance optimizations for the implementation of handles. (*End of rationale.*)

**Example 15.6** Detecting Receives with long unexpected message queues.

The following example shows a sample tool to identify receive operations that occur during times with long message queues. This examples assumes that the MPI implementation exports a variable with the name “`MPI_T_UMQ_LENGTH`” to represent the current length of the unexpected message queue. The tool is implemented as a PMPI tool using the MPI profiling interface.

The tool consists of three parts: (1) the initialization (by intercepting the call to `MPI_INIT`), (2) the test for long unexpected message queues (by intercepting calls to `MPI_RECV`), and (3) the clean-up phase (by intercepting the call to `MPI_FINALIZE`). To capture all receives, the example would have to be extended to have similar wrappers for all receive operations.

Part 1—Initialization: During initialization, the tool searches for the variable and, once the right index is found, allocates a performance experiment session and a handle for the variable with the found index, and starts the performance variable.

```
#include <stdio.h>
#include <stdlib.h>
#include <string.h>
#include <assert.h>
#include <mpi.h>

/* Global variables for the tool */
static MPI_T_pvar_session pe_session;
static MPI_T_pvar_handle handle;

int MPI_Init(int *argc, char ***argv ) {
    int err, num, i, index, namelen, verbosity;
    int var_class, bind, threadsup;
    int readonly, continuous, atomic, count;
    char name[18];
    MPI_Comm comm;
    MPI_Datatype datatype;
    MPI_T_enum enumtype;
```

```

1
2     err=PMPI_Init(argc, argv);
3     if (err!=MPI_SUCCESS) return err;
4
5     err=PMPI_T_init_thread(MPI_THREAD_SINGLE, &threadsup);
6     if (err!=MPI_SUCCESS) return err;
7
8     err=PMPI_T_pvar_get_num(&num);
9     if (err!=MPI_SUCCESS) return err;
10    index=-1;
11    i=0;
12    while ((i<num) && (index<0) && (err==MPI_SUCCESS)) {
13        /* Pass a buffer that is at least one character longer than */
14        /* the name of the variable being searched for to avoid */
15        /* finding variables that have a name that has a prefix */
16        /* equal to the name of the variable being searched. */
17        namelen=18;
18        err=PMPI_T_pvar_get_info(i, name, &namelen, &verbosity,
19                                &var_class, &datatype, &enumtype, NULL, NULL, &bind,
20                                &readonly, &continuous, &atomic);
21        if (strcmp(name,"MPI_T_UMQ_LENGTH")==0) index=i;
22        i++; }
23    if (err!=MPI_SUCCESS) return err;
24
25    /* this could be handled in a more flexible way for a generic tool */
26    assert(index>=0);
27    assert(var_class==MPI_T_PVAR_CLASS_LEVEL);
28    assert(datatype==MPI_INT);
29    assert(bind==MPI_T_BIND_MPI_COMM);
30
31    /* Create a session */
32    err=PMPI_T_pvar_session_create(&pe_session);
33    if (err!=MPI_SUCCESS) return err;
34
35    /* Get a handle and bind to MPI_COMM_WORLD */
36    comm=MPI_COMM_WORLD;
37    err=PMPI_T_pvar_handle_alloc(pe_session, index, &comm, &handle, &count);
38    if (err!=MPI_SUCCESS) return err;
39
40    /* this could be handled in a more flexible way for a generic tool */
41    assert(count==1);
42
43    /* Start variable */
44    err=PMPI_T_pvar_start(pe_session, handle);
45    if (err!=MPI_SUCCESS) return err;
46
47    return MPI_SUCCESS;
48 }

```

Part 2—Testing the Queue Lengths During Receives: During every receive operation, the tool reads the unexpected queue length through the matching performance variable and compares it against a predefined threshold.

```
#define THRESHOLD 5

int MPI_Recv(void *buf, int count, MPI_Datatype datatype, int source,
             int tag, MPI_Comm comm, MPI_Status *status)
{
    int value, err;

    if (comm==MPI_COMM_WORLD) {
        err=PMPI_T_pvar_read(pe_session, handle, &value);
        if ((err==MPI_SUCCESS) && (value>THRESHOLD))
        {
            /* tool identified receive called with long UMQ */
            /* execute tool functionality, */
            /* e.g., gather and print call stack */
        }
    }

    return PMPI_Recv(buf, count, datatype, source, tag, comm, status);
}
```

Part 3—Termination: In the wrapper for MPI\_FINALIZE, the MPI tool information interface is finalized.

```
int MPI_Finalize(void)
{
    int err;
    err=PMPI_T_pvar_handle_free(pe_session, &handle);
    err=PMPI_T_pvar_session_free(&pe_session);
    err=PMPI_T_finalize();
    return PMPI_Finalize();
}
```

### 15.3.8 Events

During the execution of an MPI application, the MPI implementation can raise *events* of a specific type to inform the user of a state change in the implementation. *Event types* describe specific state changes within the MPI implementation. In comparison to aggregate performance variables, events provide per-instance information on such state changes. The MPI implementation is said to *raise an event* when it invokes a callback function previously registered for the corresponding event type by the user. Each callback invocation for a specific event instance has a timestamp associated with it, which can be queried by the user, describing the time when the event was observed by the implementation. This decouples the observation of the state change from the communication of this information to the user. A timestamp in this context is a count of clock ticks elapsed since some time in the past and represented as a variable of type MPI\_Count.

## 1 Event Sources

2  
3 As a means to manage multiple state changes to be observed concurrently by different  
4 parts of the software and hardware system, the event interface of the MPI Tool Information  
5 Interface uses the concept of *sources*. A source in this context is a concept describing the  
6 logical entity raising the event. A source may or may not directly represent a concrete  
7 part of the software or hardware system. This concept is used primarily to describe partial  
8 ordering of events across different components where total ordering cannot necessarily be  
9 determined or is too costly to enforce.

10 The following function can be used to query the number of event sources, *num\_sources*:

11  
12 `MPI_T_SOURCE_GET_NUM(num_sources)`

13     OUT     *num\_sources*                     returns number of event sources (integer)

### 14 C binding

15  
16 `int MPI_T_source_get_num(int *num_sources)`

17  
18 The number of available event sources can be queried with a call to  
19 `MPI_T_SOURCE_GET_NUM`. An MPI implementation is allowed to increase the number of  
20 sources during the execution of an MPI process. However, MPI implementations are not  
21 allowed to change the index of an event source or to delete an event source once it has been  
22 made visible to the user (e.g., if new event sources become available via dynamic loading of  
23 additional components in the MPI implementation).  
24

25  
26 `MPI_T_SOURCE_GET_INFO(source_index, name, name_len, desc, desc_len, ordering,`  
27 `ticks_per_second, max_ticks, info)`

28     IN       *source\_index*                   index of the source to be queried between 0 and  
29   *num\_sources* - 1 (integer)

30     OUT     *name*                            buffer to return the string containing the name of the  
31   source (string)

32     INOUT   *name\_len*                     length of the string and/or buffer for *name* (integer)

33     OUT     *desc*                           buffer to return the string containing the description  
34   of the source (string)

35     INOUT   *desc\_len*                     length of the string and/or buffer for *desc* (integer)

36     OUT     *ordering*                     flag indicating chronological ordering guarantees  
37   given by the source (integer)

38     OUT     *ticks\_per\_second*             the number of ticks per second for the timer of this  
39   source (integer)

40     OUT     *max\_ticks*                    the maximum count of ticks reported by this source  
41   before overflow occurs (integer)

42     OUT     *info*                           optional info object (handle)

### 43 C binding

44  
45 `int MPI_T_source_get_info(int source_index, char *name, int *name_len,`  
46

```

char *desc, int *desc_len, MPI_T_source_order *ordering,
MPI_Count *ticks_per_second, MPI_Count *max_ticks,
MPI_Info *info)

```

A call to `MPI_T_SOURCE_GET_INFO` returns additional information on the source identified by the `source_index` argument.

The arguments `name` and `name_len` are used to return the name of the source as described in Section 15.3.3.

The arguments `desc` and `desc_len` are used to return the description of the source as described in Section 15.3.3.

The `ordering` argument returns whether event callbacks of this source will be invoked in chronological order, i.e., the timestamps reported by `MPI_T_EVENT_GET_TIMESTAMP` of subsequent events of the same source are monotonically increasing. The value of `ordering` can be `MPI_T_SOURCE_ORDERED` or `MPI_T_SOURCE_UNORDERED`.

The `ticks_per_seconds` argument returns the number of ticks elapsed in one second for the timer used for the specific source.

The `max_ticks` argument returns the largest number of ticks reported by this source as a timestamp before the value overflows.

*Advice to users.* As the size of `MPI_Count` is defined in relation to the types `MPI_Aint` and `MPI_Offset`, the effective size of `MPI_Count` may lead to overflows of the timestamp values reported. Users can use the argument `max_ticks` to mitigate resulting problems. (*End of advice to users.*)

MPI can optionally return an info object containing the default hints set for this source. If the argument to `info` provided by the user is the `NULL` pointer, this argument is ignored, otherwise an MPI implementation is required to return all hints that are supported by the implementation for this source and have default values specified; any user-supplied hints that were not ignored by the implementation; and any additional hints that were set by the implementation. If no such hints exist, a handle to a newly created info object is returned that contains no key/value pair. The user is responsible for freeing `info` via `MPI_INFO_FREE`.

`MPI_T_SOURCE_GET_TIMESTAMP(source_index, timestamp)`

IN	<code>source_index</code>	index of the source (integer)
OUT	<code>timestamp</code>	current timestamp from specified source (integer)

### C binding

`int MPI_T_source_get_timestamp(int source_index, MPI_Count *timestamp)`

To enable proper query of a reference timestamp for a specific source, a user can obtain a current timestamp using `MPI_T_SOURCE_GET_TIMESTAMP`. The argument `source_index` identifies the index of the source to query. The call returns `MPI_SUCCESS` and a current timestamp in the argument `timestamp` if the source supports ad-hoc generation of timestamps. The call returns `MPI_T_ERR_INVALID_INDEX` if the index does not identify a valid source. The call returns `MPI_T_ERR_NOT_SUPPORTED` if the source does not support the ad-hoc generation of timestamps.

## 1 Callback Safety Requirements

2 The actions a user is allowed to perform inside a callback function may vary with its  
 3 execution context. As the user has no control over the execution context of specific callback  
 4 function invocations, MPI provides a way to communicate this information using callback  
 5 safety levels.  
 6

Safety Requirement
MPI_T_CB_REQUIRE_NONE
MPI_T_CB_REQUIRE_MPI_RESTRICTED
MPI_T_CB_REQUIRE_THREAD_SAFE
MPI_T_CB_REQUIRE_ASYNC_SIGNAL_SAFE

7  
8  
9  
10  
11  
12  
13  
14 Table 15.5: Hierarchy of safety requirement levels for event callback routines

15 Table 15.5 provides the hierarchy of callback safety requirements levels within user-  
 16 defined callback functions. The MPI implementation provides the safety requirement as an  
 17 argument to the callback when it is invoked.  
 18

19 The level of `MPI_T_CB_REQUIRE_NONE` is the lowest level and does not impose any  
 20 restrictions on the callback function.

21 The level of `MPI_T_CB_REQUIRE_MPI_RESTRICTED` restricts the set of MPI functions  
 22 that can be called from inside the callback to all functions with the prefix `MPI_T` as well as  
 23 `MPI_WTICK` and `MPI_WTIME`.

24  
 25 *Advice to users.* While some MPI functions are safe to be called inside a callback  
 26 function used in the MPI tool information interface—which may in some implemen-  
 27 tations be issued from asynchronous contexts such as signal handlers—this does not  
 28 imply that those MPI functions are generally safe to be called in asynchronous contexts  
 29 such as signal handlers. (*End of advice to users.*)

30  
 31 The level of `MPI_T_CB_REQUIRE_THREAD_SAFE` includes all the limitations of  
 32 `MPI_T_CB_REQUIRE_MPI_RESTRICTED` and additionally requires the callback to be reen-  
 33 trant and thread-safe. This means the callback must allow its execution to be interrupted  
 34 by or happen concurrently with any other callback including itself.

35 The level of `MPI_T_CB_REQUIRE_ASYNC_SIGNAL_SAFE` includes all the limitations of  
 36 `MPI_T_CB_REQUIRE_THREAD_SAFE` and additionally requires the callback to meet the safety  
 37 requirements needed to support invocations from asynchronous contexts, such as signal  
 38 handlers.

39  
 40 *Advice to users.* It is always safe to assume the highest restrictions for a callback  
 41 invocation (i.e., `MPI_T_CB_REQUIRE_ASYNC_SIGNAL_SAFE`). By evaluating the spe-  
 42 cific requirements at runtime, a tool may obtain more freedom of action within the  
 43 callback. (*End of advice to users.*)

44  
 45 *Advice to implementors.* A high-quality implementation will strive to set callback  
 46 safety requirements to the most permissive level for a given callback invocation. (*End*  
 47 *of advice to implementors.*)  
 48

MPI_T_EVENT_COPY	PMPI_T_EVENT_COPY	1
MPI_T_EVENT_GET_SOURCE	PMPI_T_EVENT_GET_SOURCE	2
MPI_T_EVENT_GET_TIMESTAMP	PMPI_T_EVENT_GET_TIMESTAMP	3
MPI_T_EVENT_READ	PMPI_T_EVENT_READ	4
MPI_T_PVAR_READ	PMPI_T_PVAR_READ	5
MPI_T_PVAR_READRESET	PMPI_T_PVAR_READRESET	6
MPI_T_PVAR_RESET	PMPI_T_PVAR_RESET	7
MPI_T_PVAR_START	PMPI_T_PVAR_START	8
MPI_T_PVAR_STOP	PMPI_T_PVAR_STOP	9
MPI_T_PVAR_WRITE	PMPI_T_PVAR_WRITE	10
MPI_T_SOURCE_GET_TIMESTAMP	PMPI_T_SOURCE_GET_TIMESTAMP	11

Table 15.6: List of MPI functions that when called from within a callback function may not return MPI\_T\_ERR\_NOT\_ACCESSIBLE

All functions with the prefix MPI\_T, except those listed in Table 15.6, may return the error code MPI\_T\_ERR\_NOT\_ACCESSIBLE to indicate that the user may not access this function at this time.

*Rationale.* A call may be implemented in a way that is not safe for all execution contexts of a callback function, e.g., inside a signal handler. An MPI implementation therefore needs a way to communicate its inability to perform a certain action due to the execution context of a callback invocation. (*End of rationale.*)

*Advice to implementors.* A high-quality implementation shall not return MPI\_T\_ERR\_NOT\_ACCESSIBLE except where absolutely necessary. (*End of advice to implementors.*)

*Advice to users.* Users intercepting calls into the MPI tool information interface using the PMPI interface must ensure that the safety requirements for the calling context are met. This means that users may have to implement the wrapper with the highest safety level used by the MPI implementation. (*End of advice to users.*)

### Event Type Query Functions

An MPI implementation exports a set of  $N$  event types through the MPI tool information interface. If  $N$  is zero, then the MPI implementation does not export any event types; otherwise, the provided event types are indexed from 0 to  $N - 1$ . This index number is used in subsequent calls to identify a specific event type.

An MPI implementation is allowed to increase the number of event types during the execution of an MPI process. However, MPI implementations are not allowed to change the index of an event type or to delete an event type once it has been made visible to the user (e.g., if new event types become available via dynamic loading of additional components in the MPI implementation).

The following function can be used to query the number of event types, *num\_events*:

1 MPI\_T\_EVENT\_GET\_NUM(num\_events)

2     OUT     num\_events                    returns number of event types (integer)

4 **C binding**

5 `int MPI_T_event_get_num(int *num_events)`

7     The function MPI\_T\_EVENT\_GET\_INFO provides access to additional information  
8 about a specific event type.

10  
11 MPI\_T\_EVENT\_GET\_INFO(event\_index, name, name\_len, verbosity, array\_of\_datatypes,  
12                   array\_of\_displacements, num\_elements, enumtype, info, desc, desc\_len, bind)

13  
14     IN       event\_index                 index of the event type to be queried between 0 and  
15   num\_events - 1 (integer)

16     OUT       name                        buffer to return the string containing the name of the  
17   event type (string)

18     INOUT     name\_len                   length of the string and/or buffer for name (integer)

19     OUT       verbosity                  verbosity level of this event type (integer)

20     OUT       array\_of\_datatypes         array of MPI basic datatypes used to encode the  
21   event data (array of handles)

22     OUT       array\_of\_displacements     array of byte displacements of the elements in the  
23   event buffer (array of non-negative integers)

24     INOUT     num\_elements               length of array\_of\_datatypes and  
25   array\_of\_displacements arrays (non-negative integer)

26     OUT       enumtype                   optional descriptor for enumeration information  
27   (handle)

28     OUT       info                        optional info object (handle)

29     OUT       desc                        buffer to return the string containing a description of  
30   the event type (string)

31     INOUT     desc\_len                   length of the string and/or buffer for desc (integer)

32     OUT       bind                        type of MPI object to which an event of this type  
33   must be bound (integer)

34  
35  
36  
37  
38 **C binding**

39 `int MPI_T_event_get_info(int event_index, char *name, int *name_len,`  
40                    `int *verbosity, MPI_Datatype array_of_datatypes[],`  
41                    `MPI_Aint array_of_displacements[], int *num_elements,`  
42                    `MPI_T_enum *enumtype, MPI_Info *info, char *desc,`  
43                    `int *desc_len, int *bind)`

44  
45  
46     After a successful call to MPI\_T\_EVENT\_GET\_INFO for a particular event type, sub-  
47 sequent calls to this routine that query information about the same event type must return  
48 the same information. If any INOUT or OUT argument to MPI\_T\_EVENT\_GET\_INFO is a



NULL pointer, the implementation will ignore the argument and not return a value for the specific argument.

The arguments `name` and `name_len` are used to return the name of the event type as described in Section 15.3.3. If completed successfully, the routine is required to return a name of at least length one. The name of the event type must be unique with respect to all other names for event types used by the MPI implementation.

The argument `verbosity` returns the verbosity level of the event type (see Section 15.3.1).

The argument `array_of_datatypes` returns an array of MPI datatype handles that describe the elements returned for an instance of the event type with index `event_index`. The event data can either be queried element by element with `MPI_T_EVENT_READ` or copied into a contiguous event buffer with `MPI_T_EVENT_COPY`. For the latter case, the argument `array_of_displacements` returns an array of byte displacements in the event buffer in ascending order starting with zero.

The user is responsible for the memory allocation for the `array_of_datatypes` and `array_of_displacements` arrays. The number of elements in each array is supplied by the user in `num_elements`. If the number of elements used by the event type is larger than the value of `num_elements` provided by the user, the number of datatype handles and displacements returned in the corresponding arrays is truncated to the value of `num_elements` passed in by the user. If the user passes the NULL pointer for `array_of_datatypes` or `array_of_displacements`, the respective arguments are ignored. Unless the user passes the NULL pointer for `num_elements`, the function returns the number of elements required for this event type. If the user passes the NULL pointer for `num_elements`, the arguments `num_elements`, `array_of_datatypes`, and `array_of_displacements` are ignored.

MPI can optionally return an enumeration identifier in the `enumtype` argument, describing the individual elements in the `array_of_datatypes` argument. Otherwise, `enumtype` is set to `MPI_T_ENUM_NULL`. If the argument to `enumtype` provided by the user is the `MPI_T_ENUM_NULL` pointer, no enumeration type is returned.

MPI can optionally return an info object containing the default hints set for a registration handle for this event type. If the argument to `info` provided by the user is the NULL pointer, this argument is ignored, otherwise an MPI implementation is required to return all hints that are supported by the implementation for a registration handle for this event type and have default values specified; any user-supplied hints that were not ignored by the implementation; and any additional hints that were set by the implementation. If no such hints exist, a handle to a newly created info object is returned that contains no key/value pair. The user is responsible for freeing `info` via `MPI_INFO_FREE`.

The arguments `desc` and `desc_len` are used to return the description of the event type as described in Section 15.3.3. Returning a description is optional. If an MPI implementation does not return a description, the first character for `desc` must be set to the null character and `desc_len` must be set to one at the return from this function.

The parameter `bind` returns the type of the MPI object to which the event type must be bound or the value `MPI_T_BIND_NO_OBJECT` (see Section 15.3.2).

If an event type has an equivalent name across connected MPI processes, the following OUT parameters must be identical: `verbosity`, `array_of_datatypes`, `num_elements`, `enumtype`, and `bind`. The returned description must be equivalent. As the argument `array_of_displacements` is process dependent, it may differ across connected MPI processes.

This routine returns `MPI_SUCCESS` on success and returns `MPI_T_ERR_INVALID_INDEX` if `event_index` does not match a valid event type index provided by the implementation at the time of the call.

1 MPI\_T\_EVENT\_GET\_INDEX(name, event\_index)

2     IN        name                            name of the event type (string)  
3  
4     OUT       event\_index                    index of the event type (integer)

## 6 C binding

7 int MPI\_T\_event\_get\_index(const char \*name, int \*event\_index)

8  
9 MPI\_T\_EVENT\_GET\_INDEX returns the index of an event type identified by a known  
10 event type name. The name parameter is provided by the caller, and `event_index` is re-  
11 turned by the MPI implementation. The name parameter is a string terminated with a null  
12 character.

13 This routine returns `MPI_SUCCESS` on success and returns `MPI_T_ERR_INVALID_NAME`  
14 if name does not match the name of any event type provided by the implementation at the  
15 time of the call.

16 *Rationale.* This routine is provided to enable fast retrieval of an event index by  
17 a tool, assuming it knows the name of the event type for which it is looking. The  
18 number of event types exposed by the implementation can change over time, so it  
19 is not possible for the tool to simply iterate over the list of event types once at  
20 initialization. Although using MPI implementation specific event type names is not  
21 portable across MPI implementations, tool developers may choose to take this route  
22 for lower overhead at runtime because the tool will not have to iterate over the entire  
23 set of event types to find a specific one. (*End of rationale.*)

## 25 Handle Allocation and Deallocation

26  
27 Before the MPI implementation calls a callback function on the occurrence of a specific  
28 event, the user needs to register a callback function to be called for that event type and  
29 obtain a handle of type `MPI_T_event_registration`.

30  
31 MPI\_T\_EVENT\_HANDLE\_ALLOC(event\_index, obj\_handle, info, event\_registration)

32  
33     IN        event\_index                    index of event type for which the registration handle  
34    is to be allocated (integer)  
35  
36     IN        obj\_handle                    reference to a handle of the MPI object to which this  
37    event is supposed to be bound (pointer)  
38  
39     IN        info                          info object (handle)  
40  
41     OUT       event\_registration            event registration (handle)

## 41 C binding

42 int MPI\_T\_event\_handle\_alloc(int event\_index, void \*obj\_handle,  
43                               MPI\_Info info, MPI\_T\_event\_registration \*event\_registration)

44  
45 MPI\_T\_EVENT\_HANDLE\_ALLOC creates a *registration handle* for the event type iden-  
46 tified by `event_index`. Furthermore, if required by the event type, the registration handle  
47 is bound to the object referred to by the argument `obj_handle`. The argument `obj_handle`  
48 is ignored if the `MPI_T_EVENT_GET_INFO` call for this event type returned

MPI\_T\_BIND\_NO\_OBJECT in the argument `bind`. The user can pass hints for the handle allocation to the MPI implementation via the `info` argument. The allocated event-registration handle is returned in the argument `event_registration`.

MPI\_T\_EVENT\_HANDLE\_SET\_INFO(`event_registration`, `info`)

IN	<code>event_registration</code>	event registration (handle)
IN	<code>info</code>	info object (handle)

### C binding

```
int MPI_T_event_handle_set_info(
    MPI_T_event_registration event_registration, MPI_Info info)
```

MPI\_T\_EVENT\_HANDLE\_SET\_INFO updates the hints of the event-registration handle associated with `event_registration` using the hints provided in `info`. This operation has no effect on previously set or defaulted hints that are not specified by `info`. It also has no effect on previously set or defaulted hints that are specified by `info`, but are ignored by the MPI implementation in this call to MPI\_T\_EVENT\_HANDLE\_SET\_INFO.

*Advice to users.* Some info items that an implementation can use when it creates an event-registration handle cannot easily be changed once the registration handle is created. Thus, an implementation may ignore hints issued in this call that it would have accepted in a handle allocation call. An implementation may also be unable to update certain info hints in a call to MPI\_T\_EVENT\_HANDLE\_SET\_INFO. MPI\_T\_EVENT\_HANDLE\_GET\_INFO can be used to determine whether info changes were ignored by the implementation. (*End of advice to users.*)

MPI\_T\_EVENT\_HANDLE\_GET\_INFO(`event_registration`, `info_used`)

IN	<code>event_registration</code>	event registration (handle)
OUT	<code>info_used</code>	info object (handle)

### C binding

```
int MPI_T_event_handle_get_info(
    MPI_T_event_registration event_registration,
    MPI_Info *info_used)
```

MPI\_T\_EVENT\_HANDLE\_GET\_INFO returns a new info object containing the hints of the event-registration handle associated with `event_registration`. The current setting of all hints related to this registration handle is returned in `info_used`. An MPI implementation is required to return all hints that are supported by the implementation and have default values specified; any user-supplied hints that were not ignored by the implementation; and any additional hints that were set by the implementation. If no such hints exist, a handle to a newly created info object is returned that contains no key/value pairs. The user is responsible for freeing `info_used` via MPI\_INFO\_FREE.

```

1 MPI_T_EVENT_REGISTER_CALLBACK(event_registration, cb_safety, info, user_data,
2     event_cb_function)
3
4     IN     event_registration     event registration (handle)
5
6     IN     cb_safety             maximum callback safety level (integer)
7
8     IN     info                 info object (handle)
9
10    IN     user_data             pointer to a user-controlled buffer
11
12    IN     event_cb_function     pointer to user-defined callback function (function)

```

## C binding

```

13 int MPI_T_event_register_callback(
14     MPI_T_event_registration event_registration,
15     MPI_T_cb_safety cb_safety, MPI_Info info, void *user_data,
16     MPI_T_event_cb_function event_cb_function)

```

MPI\_T\_EVENT\_REGISTER\_CALLBACK associates a user-defined function pointed to by `event_cb_function` with an allocated event-registration handle. The maximum callback safety level supported by the callback function is passed in the argument `cb_safety`. The safety levels are defined in Table 15.5. A user can register multiple callback functions for a given event-registration handle, potentially specifying one for each callback safety level. Registering a callback function for a specific callback safety level overwrites any previously-registered callback function pointer and info object associated with the event registration for the specific callback safety level. If `event_cb_function` is the NULL pointer, an existing association of a callback function for that callback safety level is removed.

When an event is triggered, the implementation will select from all registered callbacks the callback with the lowest safety level valid in the context in which the callback is invoked. In situations where the required callback safety level exceeds the highest level for which a callback function is registered for a given registration handle, the event instance is dropped.

At callback invocation time, the implementation passes the pointer to a user-defined memory region specified during callback registration with the argument `user_data`.

The user can pass hints for the registration of the specified callback function to the MPI implementation via the `info` argument.

*Advice to users.* As event instances can be raised as soon as the registration handle is associated with the first callback function, the callback function with the highest callback safety guarantees should be registered before any further registrations for lower callback safety guarantees, to avoid dropped events due to insufficient callback safety guarantees. (*End of advice to users.*)

The callback function passed to MPI\_T\_EVENT\_REGISTER\_CALLBACK in the argument `event_cb_function` needs to have the following type:

```

43 typedef void (*MPI_T_event_cb_function)(
44     MPI_T_event_instance event_instance,
45     MPI_T_event_registration event_registration,
46     MPI_T_cb_safety cb_safety,
47     void *user_data);
48

```

The argument `event_instance` corresponds to a handle for the opaque event-instance object of type `MPI_T_event_instance`. This handle is only valid inside the corresponding invocation of the function to which it is passed. The argument `event_registration` corresponds to the event-registration handle returned by `MPI_T_EVENT_HANDLE_ALLOC` for the user function to the same event type and bound object combination. The handle can be used to identify the specific event registration information, such as event type and bound object, or even to deallocate the handle from within the callback invocation. The argument `cb_safety` describes the safety requirements the callback function must fulfill in the current invocation. The argument `user_data` is the pointer to user-allocated memory that was passed to the MPI implementation during callback registration.

`MPI_T_EVENT_CALLBACK_SET_INFO(event_registration, cb_safety, info)`

IN	<code>event_registration</code>	event registration (handle)
IN	<code>cb_safety</code>	callback safety level (integer)
IN	<code>info</code>	info object (handle)

### C binding

```
int MPI_T_event_callback_set_info(
    MPI_T_event_registration event_registration,
    MPI_T_cb_safety cb_safety, MPI_Info info)
```

`MPI_T_EVENT_CALLBACK_SET_INFO` updates the hints of the callback function registered for the callback safety level specified by `cb_safety` of the event-registration handle associated with `event_registration` using the hints provided in `info`. This operation has no effect on previously set or defaulted hints that are not specified by `info`. It also has no effect on previously set or defaulted hints that are specified by `info`, but are ignored by the MPI implementation in this call to `MPI_T_EVENT_CALLBACK_SET_INFO`.

`MPI_T_EVENT_CALLBACK_GET_INFO(event_registration, cb_safety, info_used)`

IN	<code>event_registration</code>	event registration (handle)
IN	<code>cb_safety</code>	callback safety level (integer)
OUT	<code>info_used</code>	info object (handle)

### C binding

```
int MPI_T_event_callback_get_info(
    MPI_T_event_registration event_registration,
    MPI_T_cb_safety cb_safety, MPI_Info *info_used)
```

`MPI_EVENT_CALLBACK_GET_INFO` returns a new info object containing the hints of the callback function registered for the callback safety level specified by `cb_safety` of the event-registration handle associated with `event_registration`. The current set of all hints related to this callback safety level of the event-registration handle is returned in `info_used`. An MPI implementation is required to return all hints that are supported by the implementation and have default values specified, any user-supplied hints that were not ignored by the implementation, and any additional hints that were set by the implementation. If

no such hints exist, a handle to a newly created info object is returned that contains no key/value pairs. The user is responsible for freeing `info_used` via `MPI_INFO_FREE`.

To stop the MPI implementation from raising events for a specific registration, a user needs to free the corresponding event-registration handle.

```
MPI_T_EVENT_HANDLE_FREE(event_registration, user_data, free_cb_function)
```

IN	<code>event_registration</code>	event registration (handle)
IN	<code>user_data</code>	pointer to a user-controlled buffer
IN	<code>free_cb_function</code>	pointer to user-defined callback function (function)

### C binding

```
int MPI_T_event_handle_free(MPI_T_event_registration event_registration,
    void *user_data,
    MPI_T_event_free_cb_function free_cb_function)
```

`MPI_T_EVENT_HANDLE_FREE` returns `MPI_SUCCESS` when deallocation of the handle was initiated successfully and returns `MPI_T_ERR_INVALID_HANDLE` if `event_registration` does not match a valid allocated event-registration handle at the time of the call. The callback function `free_cb_function` is called by the MPI implementation, when it is able to guarantee that no further event instances for the corresponding event-registration handle will be raised. If the pointer to `free_cb_function` is the `NULL` pointer, no user function is invoked after successful deallocation of the event registration handle. The pointer to user-controlled memory provided in the `user_data` argument will be passed to the function provided in the `free_cb_function` on invocation.

*Advice to users.* A free-callback function associated with a registration handle should always be prepared to postpone any pending actions, should the provided callback safety requirements exceed those required by the pending actions. (*End of advice to users.*)

The callback function passed to `MPI_T_EVENT_HANDLE_FREE` in the argument `free_cb_function` needs to have the following type:

```
typedef void (*MPI_T_event_free_cb_function)(
    MPI_T_event_registration event_registration,
    MPI_T_cb_safety cb_safety,
    void *user_data);
```

### Handling Dropped Events

Events may occur at times when the MPI implementation cannot invoke the user function corresponding to a matching event handle. An implementation is allowed to buffer such events and delay the callback invocation. If an event occurs at times when the corresponding callback function cannot be called and the corresponding data cannot be buffered, or no callback function meeting the required callback safety level is registered, the event data may be dropped. To discover such data loss, the user can set a handler function for a specific event-registration handle.

```

MPI_T_EVENT_SET_DROPPED_HANDLER(event_registration, dropped_cb_function)
    IN      event_registration      valid event registration (handle)
    IN      dropped_cb_function     pointer to user-defined callback function (function)

```

### C binding

```

int MPI_T_event_set_dropped_handler(
    MPI_T_event_registration event_registration,
    MPI_T_event_dropped_cb_function dropped_cb_function)

```

MPI\_T\_EVENT\_SET\_DROPPED\_HANDLER registers the function `dropped_cb_function` to be called by the MPI implementation when event information is dropped for the registration handle specified in `event_registration`. Subsequent calls to MPI\_T\_EVENT\_SET\_DROPPED\_HANDLER with the same registration handle will replace previously-registered callback functions for that registration handle. If the pointer to `dropped_cb_function` is the NULL pointer, no data loss is recorded or reported until a new valid callback function is registered.

*Advice to users.* The invocation of the dropped handler callback function may not necessarily occur close to the time the event was actually lost. (*End of advice to users.*)

The callback function passed to MPI\_T\_EVENT\_SET\_DROPPED\_HANDLER in the argument `dropped_cb_function` needs to have the following type:

```

typedef void (*MPI_T_event_dropped_cb_function)(int count,
    MPI_T_event_registration event_registration,
    int source_index,
    MPI_T_cb_safety cb_safety,
    void *user_data);

```

The argument `event_registration` corresponds to the event registration handle to which the dropped data corresponds. The argument `count` provides a best effort estimation of the number of invocations to a registered event callback corresponding to `event_registration` that were not executed since the registration of the dropped-callback handler or the last invocation of a registered dropped-callback handler. The `source_index` provides the index of the source that dropped the corresponding event information. The argument `cb_safety` describes the safety requirements the callback function must fulfill in the current invocation. The possible values for `cb_safety` are described in Table 15.5. The argument `user_data` is the pointer to user-allocated memory that was passed to the MPI implementation during callback registration.

*Advice to users.* A callback function for dropped events associated with a registration handle should always be prepared to postpone any pending actions, should the provided callback safety requirements exceed those required by the pending actions. (*End of advice to users.*)

*Advice to implementors.* A high-quality implementation will strive to invoke a callback function for dropped events associated with a registration handle at times that provide as much freedom of action to the function as possible. (*End of advice to implementors.*)

1 If events are dropped for a specific source, the corresponding handler callback function  
 2 must be called before other events are raised for this source. This means in a sequence of five  
 3 events E1 to E5 from the same source, where E3 and E4 were dropped, any handler func-  
 4 tion set through `MPI_T_EVENT_SET_DROPPED_HANDLER` for event-registration handles  
 5 associated with E3 or E4 must be called before E5 is raised.

## 7 Reading Event Data

8  
 9 In event callbacks, the parameter `event_instance` provides access to the per-instance event  
 10 data, i.e., the data encoded by the specific event type for this instance. The user can obtain  
 11 event data as well as event meta data, such as a time stamp and the source, by providing  
 12 this handle to the respective query functions. The event-instance handle is invalid beyond  
 13 the scope of the current invocation of the callback function to which it is provided.

14 The callback function argument `event_registration` identifies the registration handle that  
 15 was used to register the callback function.

16 The callback function argument `cb_safety` indicates the requirements for the specific  
 17 callback invocation. The value is one of the safety requirements levels described in Ta-  
 18 ble 15.5. The argument `user_data` passes the pointer provided by the user during callback  
 19 registration back to the function call.

20  
 21 *Advice to users.* Depending on the registered event and usage of MPI by the applica-  
 22 tion, a callback function may be invoked with high frequency. Users should therefore  
 23 strive to minimize the amount of work done inside callback functions. Furthermore,  
 24 the time spent in a callback function may influence the capability of an implemen-  
 25 tation to buffer events; long execution times may lead to an increased number of  
 26 dropped events. (*End of advice to users.*)

27 MPI provides the following function calls to access data of a specific event instance and  
 28 its corresponding meta data (such as its time and source).

29  
 30  
 31 `MPI_T_EVENT_READ(event_instance, element_index, buffer)`

32	IN	<code>event_instance</code>	event-instance handle provided to the callback function (handle)
33			
34	IN	<code>element_index</code>	index into the array of datatypes of the item to be queried (integer)
35			
36	OUT	<code>buffer</code>	pointer to a memory location to store the item data (choice)
37			
38			
39			

## 40 C binding

41 `int MPI_T_event_read(MPI_T_event_instance event_instance,`  
 42 `int element_index, void *buffer)`  
 43

44 `MPI_T_EVENT_READ` allows users to copy one element of the event data to a user-  
 45 specified buffer at a time.

46 The `event_instance` argument identifies the event instance to query. It is erroneous  
 47 to provide any other event-instance handle to the call than the one passed by the MPI  
 48 implementation to the callback function in which the data is read. The `buffer` argument



must point to a memory location the MPI implementation can copy the element of the event data to identified by `element_index`.

`MPI_T_EVENT_COPY(event_instance, buffer)`

IN	<code>event_instance</code>	event instance provided to the callback function (handle)
OUT	<code>buffer</code>	user-allocated buffer for event data (choice)

### C binding

```
int MPI_T_event_copy(MPI_T_event_instance event_instance, void *buffer)
```

`MPI_T_EVENT_COPY` copies the event data as a whole into the user-provided `buffer`. The user must assure that the buffer is of at least the size of the extent of the event type, which can be computed from the type and displacement information returned by the corresponding call to `MPI_T_EVENT_GET_INFO`. The data may include padding bytes between individual elements of the event data in the buffer. A user can reconstruct the location and size of the data contained in the buffer through the information returned by `MPI_T_EVENT_GET_INFO`.

*Advice to implementors.* An implementation should strive to use an appropriately compact representation when copying event instance data to a user buffer via `MPI_T_EVENT_COPY` to reduce the amount of memory required for the user buffer. *(End of advice to implementors.)*

### Reading Event Meta Data

Additional to the specific event data encoded by each event type, supplemental information available across all event types can be queried.

`MPI_T_EVENT_GET_TIMESTAMP(event_instance, event_timestamp)`

IN	<code>event_instance</code>	event instance provided to the callback function (handle)
OUT	<code>event_timestamp</code>	timestamp the event was observed (integer)

### C binding

```
int MPI_T_event_get_timestamp(MPI_T_event_instance event_instance,
                             MPI_Count *event_timestamp)
```

`MPI_T_EVENT_GET_TIMESTAMP` returns the timestamp of when the event was initially observed by the implementation. The `event_instance` argument identifies the event instance to query. It is erroneous to provide any other handle to the call than the one passed by the MPI implementation to the callback function in which the timestamp is read.

*Advice to users.* An MPI implementation may postpone the call to the user's callback function. In this case, the call to `MPI_T_EVENT_GET_TIMESTAMP` may yield a timestamp in the past that is closer to the time the event was initially observed, as

1       opposed to a timestamp captured during callback function invocation. (*End of advice*  
2       *to users.*)

3  
4       *Advice to implementors.* A high-quality implementation will return a timestamp as  
5       close as possible to the earliest time the event was observed by the MPI implementa-  
6       tion. (*End of advice to implementors.*)

7  
8       An event may be raised from different components acting as event sources in the MPI  
9       implementation. A source in this context is an abstract concept that helps to define partial  
10      ordering of raised events, as each source provides its own ordering guarantees. A source  
11      describes the entity that raises the event, rather than the origin of the data.

12      To identify the source of an event instance, the user can query the index of the source  
13      within the corresponding event callback function invocation.

14  
15      *Advice to implementors.* An excessive number of event sources may negatively impact  
16      performance of a tool due to per-source overhead in event handling. (*End of advice*  
17      *to implementors.*)

18  
19  
20      MPI\_T\_EVENT\_GET\_SOURCE(event\_instance, source\_index)

21      IN	event_instance	event instance provided to the callback function
		(handle)
22		
23		
24      OUT	source_index	index identifying the source (integer)
25		

## 26      C binding

```
27      int MPI_T_event_get_source(MPI_T_event_instance event_instance,
28                                int *source_index)
```

29  
30      The `event_instance` argument identifies the event instance to query. It is erroneous  
31      to provide any other event-instance handle to the call than the one passed by the MPI  
32      implementation to the callback function in which the source is queried.

33      The `source_index` argument returns the index of the source of the event instance. It  
34      can be used to query more information on the source using `MPI_T_SOURCE_GET_INFO`.

35  
36      *Rationale.* Event callback function invocations are associated with a source to enable  
37      chronological processing of events on the tool side, when required, while retaining low  
38      overhead on the side of the MPI implementation. (*End of rationale.*)

### 39      15.3.9 Variable Categorization

40  
41      MPI implementations can optionally group performance and control variables into categories  
42      to express logical relationships between various variables. For example, an MPI implemen-  
43      tation could group all control and performance variables that refer to message transfers in  
44      the MPI implementation and thereby distinguish them from variables that refer to local  
45      resources such as memory allocations or other interactions with the operating system.

46      Categories can also contain other categories to form a hierarchical grouping. Categories  
47      can never include themselves, either directly or transitively within other included categories.  
48      Expanding on the example above, this allows MPI to refine the grouping of variables referring

to message transfers into variables to control and to monitor message queues, message matching activities and communication protocols. Each of these groups of variables would be represented by a separate category and these categories would then be listed in a single category representing variables for message transfers.

The category information may be queried in a fashion similar to the mechanism for querying variable information. The MPI implementation exports a set of  $N$  categories via the MPI tool information interface. If  $N = 0$ , then the MPI implementation does not export any categories, otherwise the provided categories are indexed from 0 to  $N - 1$ . This index number is used in subsequent calls to functions of the MPI tool information interface to identify the individual categories.

An MPI implementation is permitted to increase the number of categories during the execution of an MPI program when new categories become available through dynamic loading. However, MPI implementations are not allowed to change the index of a category or delete it once it has been added to the set.

Similarly, MPI implementations are allowed to add variables to categories, but they are not allowed to remove variables from categories or change the order in which they are returned.

#### Category Query Functions

The following function can be used to query the number of categories, `num_cat`.

`MPI_T_CATEGORY_GET_NUM(num_cat)`

OUT      `num_cat`                      current number of categories (integer)

#### C binding

`int MPI_T_category_get_num(int *num_cat)`

Individual category information can then be queried by calling the following function:

```

1 MPI_T_CATEGORY_GET_INFO(cat_index, name, name_len, desc, desc_len, num_cvars,
2     num_pvars, num_categories)
3
4     IN      cat_index      index of the category to be queried (integer)
5     OUT     name           buffer to return the string containing the name of the
6                          category (string)
7     INOUT  name_len       length of the string and/or buffer for name (integer)
8     OUT     desc           buffer to return the string containing the description
9                          of the category (string)
10
11    INOUT  desc_len        length of the string and/or buffer for desc (integer)
12    OUT     num_cvars       number of control variables in the category (integer)
13    OUT     num_pvars       number of performance variables in the category
14                          (integer)
15
16    OUT     num_categories  number of categories contained in the category
17                          (integer)
18

```

### C binding

```

19 int MPI_T_category_get_info(int cat_index, char *name, int *name_len,
20     char *desc, int *desc_len, int *num_cvars, int *num_pvars,
21     int *num_categories)
22

```

The arguments `name` and `name_len` are used to return the name of the category as described in Section 15.3.3.

The routine is required to return a name of at least length one. This name must be unique with respect to all other names for categories used by the MPI implementation.

If any OUT parameter to `MPI_T_CATEGORY_GET_INFO` is the NULL pointer, the implementation will ignore the parameter and not return a value for the parameter.

The arguments `desc` and `desc_len` are used to return the description of the category as described in Section 15.3.3.

Returning a description is optional. If an MPI implementation decides not to return a description, the first character for `desc` must be set to the null character and `desc_len` must be set to one at the return of this call.

The function returns the number of control variables, performance variables and other categories contained in the queried category in the arguments `num_cvars`, `num_pvars`, and `num_categories`, respectively.

If the name of a category is equivalent across connected MPI processes, then the returned description must be equivalent.

```

41 MPI_T_CATEGORY_GET_NUM_EVENTS(cat_index, num_events)
42
43     IN      cat_index      index of the category to be queried (integer)
44     OUT     num_events     number of event types in the category (integer)
45

```

### C binding

```

46 int MPI_T_category_get_num_events(int cat_index, int *num_events)
47
48

```

MPI\_T\_CATEGORY\_GET\_NUM\_EVENTS returns the number of event types contained in the queried category.

MPI\_T\_CATEGORY\_GET\_INDEX(name, cat\_index)

IN	name	the name of the category (string)
OUT	cat_index	the index of the category (integer)

### C binding

```
int MPI_T_category_get_index(const char *name, int *cat_index)
```

MPI\_T\_CATEGORY\_GET\_INDEX is a function for retrieving the index of a category given a known category name. The name parameter is provided by the caller, and cat\_index is returned by the MPI implementation. The name parameter is a string terminated with a null character.

This routine returns MPI\_SUCCESS on success and returns MPI\_T\_ERR\_INVALID\_NAME if name does not match the name of any category provided by the implementation at the time of the call.

*Rationale.* This routine is provided to enable fast retrieval of a category index by a tool, assuming it knows the name of the category for which it is looking. The number of categories exposed by the implementation can change over time, so it is not possible for the tool to simply iterate over the list of categories once at initialization. Although using MPI implementation specific category names is not portable across MPI implementations, tool developers may choose to take this route for lower overhead at runtime because the tool will not have to iterate over the entire set of categories to find a specific one. (*End of rationale.*)

### Category Member Query Functions

MPI\_T\_CATEGORY\_GET\_CVARS(cat\_index, len, indices)

IN	cat_index	index of the category to be queried, in the range from 0 to num_cat - 1 (integer)
IN	len	the length of the indices array (integer)
OUT	indices	an integer array of size len, indicating control variable indices (array of integers)

### C binding

```
int MPI_T_category_get_cvars(int cat_index, int len, int indices[])
```

MPI\_T\_CATEGORY\_GET\_CVARS can be used to query which control variables are contained in a particular category. A category contains zero or more control variables.

1 MPI\_T\_CATEGORY\_GET\_PVARS(cat\_index, len, indices)

2     IN        cat\_index                    index of the category to be queried, in the range  
3    from 0 to num\_cat - 1 (integer)  
4  
5     IN        len                         the length of the indices array (integer)  
6  
7     OUT       indices                     an integer array of size len, indicating performance  
8    variable indices (array of integers)

9 **C binding**

10 int MPI\_T\_category\_get\_pvars(int cat\_index, int len, int indices[])

11  
12 MPI\_T\_CATEGORY\_GET\_PVARS can be used to query which performance variables  
13 are contained in a particular category. A category contains zero or more performance  
14 variables.

15  
16 MPI\_T\_CATEGORY\_GET\_EVENTS(cat\_index, len, indices)

17  
18     IN        cat\_index                    index of the category to be queried, in the range  
19    from 0 to num\_cat - 1 (integer)  
20  
21     IN        len                         the length of the indices array (integer)  
22  
23     OUT       indices                     an integer array of size len, indicating event type  
24    indices (array of integers)

25 **C binding**

26 int MPI\_T\_category\_get\_events(int cat\_index, int len, int indices[])

27  
28 MPI\_T\_CATEGORY\_GET\_EVENTS can be used to query which event types are con-  
29 tained in a particular category. A category contains zero or more event types.

30  
31 MPI\_T\_CATEGORY\_GET\_CATEGORIES(cat\_index, len, indices)

32     IN        cat\_index                    index of the category to be queried, in the range  
33    from 0 to num\_cat - 1 (integer)  
34  
35     IN        len                         the length of the indices array (integer)  
36  
37     OUT       indices                     an integer array of size len, indicating category  
38    indices (array of integers)

39 **C binding**

40 int MPI\_T\_category\_get\_categories(int cat\_index, int len, int indices[])

41  
42 MPI\_T\_CATEGORY\_GET\_CATEGORIES can be used to query which other categories  
43 are contained in a particular category. A category contains zero or more other categories.

44 As mentioned above, MPI implementations can grow the number of categories as well  
45 as the number of variables or other categories within a category. In order to allow users  
46 of the MPI tool information interface to check quickly whether new categories have been  
47 added or new variables or categories have been added to a category, MPI maintains a  
48

virtual timestamp. This timestamp is monotonically increasing during the execution and is returned by the following function:

`MPI_T_CATEGORY_CHANGED(stamp)`

OUT      `stamp`                      a virtual time stamp to indicate the last change to the categories (integer)

### C binding

`int MPI_T_category_changed(int *stamp)`

If two subsequent calls to this routine return the same timestamp, it is guaranteed that the category information has not changed between the two calls. If the timestamp retrieved from the second call is higher, then some categories have been added or expanded.

*Advice to users.* The timestamp value is purely virtual and only intended to check for changes in the category information. It should not be used for any other purpose. (*End of advice to users.*)

The index values returned in indices by `MPI_T_CATEGORY_GET_CVARS`, `MPI_T_CATEGORY_GET_PVARS`, `MPI_T_CATEGORY_GET_EVENTS`, and `MPI_T_CATEGORY_GET_CATEGORIES` can be used as input to `MPI_T_CVAR_GET_INFO`, `MPI_T_PVAR_GET_INFO`, `MPI_T_EVENT_GET_INFO`, and `MPI_T_CATEGORY_GET_INFO`, respectively.

The user is responsible for allocating the arrays passed into the functions `MPI_T_CATEGORY_GET_CVARS`, `MPI_T_CATEGORY_GET_PVARS`, `MPI_T_CATEGORY_GET_EVENTS`, and `MPI_T_CATEGORY_GET_CATEGORIES`. Starting from array index 0, each function writes up to `len` elements into the array. If the category contains more than `len` elements, the function returns an arbitrary subset of size `len`. Otherwise, the entire set of elements is returned in the beginning entries of the array, and any remaining array entries are not modified.

#### 15.3.10 Return Codes for the MPI Tool Information Interface

All functions defined as part of the MPI tool information interface return an integer error code (see Table 15.7) to indicate whether the function was completed successfully or was aborted. In the latter case, the error code indicates the reason for not completing the routine. Such errors neither impact the execution of the MPI process nor invoke MPI error handlers. The MPI process continues executing regardless of the return code from the call. The MPI implementation is not required to check all user-provided parameters; if a user passes invalid parameter values to any routine the behavior of the implementation is undefined.

All error codes with the prefix `MPI_T_` must be unique values and cannot overlap with any other error codes or error classes returned by the MPI implementation. Further, they shall be treated as MPI error classes as defined in Section 9.4 and follow the same rules and restrictions. In particular, they must satisfy:

$$0 = \text{MPI\_SUCCESS} < \text{MPI\_T\_ERR\_XXX} \leq \text{MPI\_ERR\_LASTCODE}.$$

### 15.3.11 Profiling Interface

All requirements for the profiling interfaces, as described in Section 15.2, also apply to the MPI tool information interface. All rules, guidelines, and recommendations from Section 15.2 apply equally to calls defined as part of the MPI tool information interface.

DRAFT



Return Code	Description
Return Codes for All Functions in the MPI Tool Information Interface	
MPI_SUCCESS	Call completed successfully
MPI_T_ERR_INVALID	Invalid or bad parameter value(s)
MPI_T_ERR_MEMORY	Out of memory
MPI_T_ERR_NOT_INITIALIZED	Interface not initialized
MPI_T_ERR_CANNOT_INIT	Interface not in the state to be initialized
MPI_T_ERR_NOT_ACCESSIBLE	Requested functionality not accessible
Return Codes for Datatype Functions: MPI_T_ENUM_*	
MPI_T_ERR_INVALID_INDEX	The enumeration index is invalid
Return Codes for Variable, Category, and Event Query Functions: MPI_T_*_GET_*	
MPI_T_ERR_INVALID_INDEX	The variable or category index is invalid
MPI_T_ERR_INVALID_NAME	The variable or category name is invalid
Return Codes for Handle Functions: MPI_T_*_{ALLOC FREE}	
MPI_T_ERR_INVALID_INDEX	The variable index is invalid
MPI_T_ERR_INVALID_HANDLE	The handle is invalid
MPI_T_ERR_OUT_OF_HANDLES	No more handles available
Return Codes for Performance Experiment Session Functions: MPI_T_PVAR_SESSION_*	
MPI_T_ERR_OUT_OF_SESSIONS	No more sessions available
MPI_T_ERR_INVALID_SESSION	Session argument is not a valid session
Return Codes for Control Variable Access Functions: MPI_T_CVAR_{READ WRITE}	
MPI_T_ERR_CVAR_SET_NOT_NOW	Variable cannot be set at this moment
MPI_T_ERR_CVAR_SET_NEVER	Variable cannot be set until end of execution
MPI_T_ERR_INVALID_HANDLE	The handle is invalid
Return Codes for Performance Variable Access and Control:	
MPI_T_PVAR_{START STOP READ WRITE RESET READREST}	
MPI_T_ERR_INVALID_HANDLE	The handle is invalid
MPI_T_ERR_INVALID_SESSION	Performance experiment session argument is not valid
MPI_T_ERR_PVAR_NO_STARTSTOP	Variable cannot be started or stopped (for MPI_T_PVAR_START and MPI_T_PVAR_STOP)
MPI_T_ERR_PVAR_NO_WRITE	Variable cannot be written or reset (for MPI_T_PVAR_WRITE and MPI_T_PVAR_RESET)
MPI_T_ERR_PVAR_NO_ATOMIC	Variable cannot be read and written atomically (for MPI_T_PVAR_READRESET)
Return Codes for Source Functions: MPI_T_SOURCE_*	
MPI_T_ERR_INVALID_INDEX	The source index is invalid
MPI_T_ERR_NOT_SUPPORTED	Requested functionality not supported
Return Codes for Category Functions: MPI_T_CATEGORY_*	
MPI_T_ERR_INVALID_INDEX	The category index is invalid

Table 15.7: Return codes used in functions of the MPI tool information interface

1  
2  
3  
4  
5  
6  
7  
8  
9  
10  
11  
12  
13  
14  
15  
16  
17  
18  
19  
20  
21  
22  
23  
24  
25  
26  
27  
28  
29  
30  
31  
32  
33  
34  
35  
36  
37  
38  
39  
40  
41  
42  
43  
44  
45  
46  
47  
48

DRAFT

# Chapter 16

## Deprecated Interfaces

### 16.1 Deprecated since MPI-2.0

The following function is deprecated and is superseded by `MPI_COMM_CREATE_KEYVAL` in MPI-2.0. The language independent definition of the deprecated function is the same as that of the new function, except for the function name and a different behavior in the C/Fortran language interoperability, see Section 19.3.7. The language bindings are modified.

`MPI_KEYVAL_CREATE(copy_fn, delete_fn, keyval, extra_state)`

IN	<code>copy_fn</code>	Copy callback function for <code>keyval</code>
IN	<code>delete_fn</code>	Delete callback function for <code>keyval</code>
OUT	<code>keyval</code>	key value for future access (integer)
IN	<code>extra_state</code>	Extra state for callback functions

#### C binding

```
int MPI_Keyval_create(MPI_Copy_function *copy_fn,  
                    MPI_Delete_function *delete_fn, int *keyval,  
                    void *extra_state)
```

For this routine, an interface within the `mpi_f08` module was never defined.

#### Fortran binding

```
MPI_KEYVAL_CREATE(COPY_FN, DELETE_FN, KEYVAL, EXTRA_STATE, IERROR)  
EXTERNAL COPY_FN, DELETE_FN  
INTEGER KEYVAL, EXTRA_STATE, IERROR
```

The `copy_fn` function is invoked when a communicator is duplicated by `MPI_COMM_DUP`. `copy_fn` should be of type `MPI_Copy_function`, which is defined as follows:

```
typedef int MPI_Copy_function(MPI_Comm oldcomm, int keyval,  
                             void *extra_state, void *attribute_val_in,  
                             void *attribute_val_out, int *flag);
```

A Fortran declaration for such a function is as follows:

For this routine, an interface within the `mpi_f08` module was never defined.

```

1  SUBROUTINE COPY_FUNCTION(OLDCOMM, KEYVAL, EXTRA_STATE, ATTRIBUTE_VAL_IN,
2      ATTRIBUTE_VAL_OUT, FLAG, IERR)
3      INTEGER OLDCOMM, KEYVAL, EXTRA_STATE, ATTRIBUTE_VAL_IN,
4      ATTRIBUTE_VAL_OUT, IERR
5      LOGICAL FLAG

```

copy\_fn may be specified as MPI\_NULL\_COPY\_FN or MPI\_DUP\_FN from either C or Fortran; MPI\_NULL\_COPY\_FN is a function that does nothing other than returning flag = 0 and MPI\_SUCCESS. MPI\_DUP\_FN is a simple-minded copy function that sets flag = 1, returns the value of attribute\_val\_in in attribute\_val\_out, and returns MPI\_SUCCESS. Note that MPI\_NULL\_COPY\_FN and MPI\_DUP\_FN are also deprecated.

Analogous to copy\_fn is a callback deletion function, defined as follows. The delete\_fn function is invoked when a communicator is deleted by MPI\_COMM\_FREE or when a call is made explicitly to MPI\_ATTR\_DELETE. delete\_fn should be of type MPI\_Delete\_function, which is defined as follows:

```

16  typedef int MPI_Delete_function(MPI_Comm comm, int keyval,
17      void *attribute_val, void *extra_state);

```

A Fortran declaration for such a function is as follows:

For this routine, an interface within the mpi\_f08 module was never defined.

```

21  SUBROUTINE DELETE_FUNCTION(COMM, KEYVAL, ATTRIBUTE_VAL, EXTRA_STATE, IERR)
22      INTEGER COMM, KEYVAL, ATTRIBUTE_VAL, EXTRA_STATE, IERR

```

delete\_fn may be specified as MPI\_NULL\_DELETE\_FN from either C or Fortran; MPI\_NULL\_DELETE\_FN is a function that does nothing, other than returning MPI\_SUCCESS. Note that MPI\_NULL\_DELETE\_FN is also deprecated.

The following function is deprecated and is superseded by MPI\_COMM\_FREE\_KEYVAL in MPI-2.0. The language independent definition of the deprecated function is the same as of the new function, except of the function name. The language bindings are modified.

```

31  MPI_KEYVAL_FREE(keyval)

```

```

32      INOUT  keyval           Frees the integer key value (integer)

```

### C binding

```

35  int MPI_Keyval_free(int *keyval)

```

For this routine, an interface within the mpi\_f08 module was never defined.

### Fortran binding

```

39  MPI_KEYVAL_FREE(KEYVAL, IERROR)
40      INTEGER KEYVAL, IERROR

```

The following function is deprecated and is superseded by MPI\_COMM\_SET\_ATTR in MPI-2.0. The language independent definition of the deprecated function is the same as of the new function, except of the function name. The language bindings are modified.

MPI\_ATTR\_PUT(comm, keyval, attribute\_val) 1

INOUT	comm	communicator to which attribute will be attached (handle)	2 3 4
IN	keyval	key value, as returned by MPI_KEYVAL_CREATE (integer)	5 6
IN	attribute_val	attribute value	7 8

### C binding 9

```
int MPI_Attr_put(MPI_Comm comm, int keyval, void *attribute_val) 10
```

For this routine, an interface within the `mpi_f08` module was never defined. 11  
12

### Fortran binding 13

```
MPI_ATTR_PUT(COMM, KEYVAL, ATTRIBUTE_VAL, IERROR) 14  
  INTEGER COMM, KEYVAL, ATTRIBUTE_VAL, IERROR 15  
16
```

The following function is deprecated and is superseded by `MPI_COMM_GET_ATTR` in MPI-2.0. The language independent definition of the deprecated function is the same as of the new function, except of the function name. The language bindings are modified. 17  
18  
19  
20

MPI\_ATTR\_GET(comm, keyval, attribute\_val, flag) 21

IN	comm	communicator to which attribute is attached (handle)	22 23
IN	keyval	key value (integer)	24 25
OUT	attribute_val	attribute value, unless flag = false	26
OUT	flag	true if an attribute value was extracted; false if no attribute is associated with the key	27 28 29

### C binding 30

```
int MPI_Attr_get(MPI_Comm comm, int keyval, void *attribute_val, int *flag) 31
```

For this routine, an interface within the `mpi_f08` module was never defined. 32  
33

### Fortran binding 34

```
MPI_ATTR_GET(COMM, KEYVAL, ATTRIBUTE_VAL, FLAG, IERROR) 35  
  INTEGER COMM, KEYVAL, ATTRIBUTE_VAL, IERROR 36  
  LOGICAL FLAG 37
```

The following function is deprecated and is superseded by `MPI_COMM_DELETE_ATTR` in MPI-2.0. The language independent definition of the deprecated function is the same as of the new function, except of the function name. The language bindings are modified. 38  
39  
40  
41  
42  
43  
44  
45  
46  
47  
48

```

1 MPI_ATTR_DELETE(comm, keyval)
2     INOUT    comm                communicator to which attribute is attached (handle)
3
4     IN      keyval              The key value of the deleted attribute (integer)

```

### C binding

```
int MPI_Attr_delete(MPI_Comm comm, int keyval)
```

For this routine, an interface within the `mpi_f08` module was never defined.

### Fortran binding

```
MPI_ATTR_DELETE(COMM, KEYVAL, IERROR)
      INTEGER COMM, KEYVAL, IERROR
```

## 16.2 Deprecated since MPI-2.2

The entire set of C++ language bindings have been removed. See Chapter 17, [Removed Interfaces](#) for more information.

The following function typedefs have been deprecated and are superseded by new names. Other than the typedef names, the function signatures are exactly the same; the names were updated to match conventions of other function typedef names.

Deprecated Name	New Name
<code>MPI_Comm_errhandler_fn</code>	<code>MPI_Comm_errhandler_function</code>
<code>MPI_File_errhandler_fn</code>	<code>MPI_File_errhandler_function</code>
<code>MPI_Win_errhandler_fn</code>	<code>MPI_Win_errhandler_function</code>

## 16.3 Deprecated since MPI-4.0

Canceling a send request by calling `MPI_CANCEL` has been deprecated and may be removed in a future version of the MPI specification.

The following function is deprecated and is superseded by the new `MPI_INFO_GET_STRING` call in MPI-4.0.

```

35 MPI_INFO_GET(info, key, valuelen, value, flag)
36
37     IN      info                info object (handle)
38
39     IN      key                 key (string)
40
41     IN      valuelen            length of value arg (integer)
42
43     OUT     value               value (string)
44
45     OUT     flag                true if key defined, false if not (boolean)

```

### C binding

```
int MPI_Info_get(MPI_Info info, const char *key, int valuelen, char *value,
                int *flag)
```

**Fortran 2008 binding**

```

MPI_Info_get(info, key, valuelen, value, flag, ierror)
  TYPE(MPI_Info), INTENT(IN) :: info
  CHARACTER(LEN=*), INTENT(IN) :: key
  INTEGER, INTENT(IN) :: valuelen
  CHARACTER(LEN=valuelen), INTENT(OUT) :: value
  LOGICAL, INTENT(OUT) :: flag
  INTEGER, OPTIONAL, INTENT(OUT) :: ierror

```

**Fortran binding**

```

MPI_INFO_GET(INFO, KEY, VALUELEN, VALUE, FLAG, IERROR)
  INTEGER INFO, VALUELEN, IERROR
  CHARACTER*(*) KEY, VALUE
  LOGICAL FLAG

```

The following function is deprecated and is superseded by the new MPI\_INFO\_GET\_STRING call in MPI-4.0.

**MPI\_INFO\_GET\_VALUELEN(info, key, valuelen, flag)**

IN	info	info object (handle)
IN	key	key (string)
OUT	valuelen	length of value arg (integer)
OUT	flag	true if key defined, false if not (boolean)

**C binding**

```

int MPI_Info_get_valuelen(MPI_Info info, const char *key, int *valuelen,
  int *flag)

```

**Fortran 2008 binding**

```

MPI_Info_get_valuelen(info, key, valuelen, flag, ierror)
  TYPE(MPI_Info), INTENT(IN) :: info
  CHARACTER(LEN=*), INTENT(IN) :: key
  INTEGER, INTENT(OUT) :: valuelen
  LOGICAL, INTENT(OUT) :: flag
  INTEGER, OPTIONAL, INTENT(OUT) :: ierror

```

**Fortran binding**

```

MPI_INFO_GET_VALUELEN(INFO, KEY, VALUELEN, FLAG, IERROR)
  INTEGER INFO, VALUELEN, IERROR
  CHARACTER*(*) KEY
  LOGICAL FLAG

```

The following return class has been deprecated and is superseded by a new name.

Deprecated Name	Replacement Name
<u>MPI_T_ERR_INVALID_ITEM</u>	<u>MPI_T_ERR_INVALID_INDEX</u>

The following Fortran subroutines are deprecated because the Fortran language storage\_size() and c\_sizeof() intrinsic functions provide similar functionality. Note that while

1 MPI\_SIZEOF and c\_sizeof() return the size in bytes, storage\_size() provides the size in bits.

2  
3  
4  
5 MPI\_SIZEOF(x, size)

6     IN        x                            a Fortran variable of numeric intrinsic type (choice)  
7     OUT       size                        size of machine representation of that type (integer)

9  
10 **Fortran 2008 binding**

11 MPI\_Sizeof(x, size, ierror)  
12     TYPE(\*), DIMENSION(..) :: x  
13     INTEGER, INTENT(OUT) :: size  
14     INTEGER, OPTIONAL, INTENT(OUT) :: ierror

15 **Fortran binding**

16 MPI\_SIZEOF(X, SIZE, IERROR)  
17     <type> X  
18     INTEGER SIZE, IERROR

DRAFT



1  
2  
3  
4  
5  
6  
7  
8  
9  
10  
11  
12  
13  
14  
15  
16  
17  
18  
19  
20  
21  
22  
23  
24  
25  
26  
27  
28  
29  
30  
31  
32  
33  
34  
35  
36  
37  
38  
39  
40  
41  
42  
43  
44  
45  
46  
47  
48

# Chapter 17

## Removed Interfaces

### 17.1 Removed MPI-1 Bindings

#### 17.1.1 Overview

The following MPI-1 bindings were deprecated as of MPI-2 and are removed in MPI-3. They may be provided by an implementation for backwards compatibility, but are not required. Removal of these bindings affects all language-specific definitions thereof. Only the language-neutral bindings are listed when possible.

#### 17.1.2 Removed MPI-1 Functions

Table 17.1 shows the removed MPI-1 functions and their replacements.

Table 17.1: Removed MPI-1 functions and their replacements

Removed	MPI-2 Replacement
MPI_ADDRESS	MPI_GET_ADDRESS
MPI_ERRHANDLER_CREATE	MPI_COMM_CREATE_ERRHANDLER
MPI_ERRHANDLER_GET	MPI_COMM_GET_ERRHANDLER
MPI_ERRHANDLER_SET	MPI_COMM_SET_ERRHANDLER
MPI_TYPE_EXTENT	MPI_TYPE_GET_EXTENT
MPI_TYPE_HINDEXED	MPI_TYPE_CREATE_HINDEXED
MPI_TYPE_HVECTOR	MPI_TYPE_CREATE_HVECTOR
MPI_TYPE_LB	MPI_TYPE_GET_EXTENT
MPI_TYPE_STRUCT	MPI_TYPE_CREATE_STRUCT
MPI_TYPE_UB	MPI_TYPE_GET_EXTENT

#### 17.1.3 Removed MPI-1 Datatypes

Table 17.2 shows the removed MPI-1 datatypes and their replacements.

#### 17.1.4 Removed MPI-1 Constants

Table 17.3 shows the removed MPI-1 constants. There are no MPI-2 replacements.

Table 17.2: Removed MPI-1 datatypes. The indicated routine may be used for changing the lower and upper bound respectively.

Removed	MPI-2 Replacement
MPI_LB	MPI_TYPE_CREATE_RESIZED
MPI_UB	MPI_TYPE_CREATE_RESIZED

Table 17.3: Removed MPI-1 constants

Removed MPI-1 Constants
C type: <code>const int</code> (or unnamed <code>enum</code> )
Fortran type: <code>INTEGER</code>
MPI_COMBINER_HINDEXED_INTEGER
MPI_COMBINER_HVECTOR_INTEGER
MPI_COMBINER_STRUCT_INTEGER

### 17.1.5 Removed MPI-1 Callback Prototypes

Table 17.4 shows the removed MPI-1 callback prototypes and their MPI-2 replacements.

Table 17.4: Removed MPI-1 callback prototypes and their replacements

Removed	MPI-2 Replacement
MPI_Handler_function	MPI_Comm_errhandler_function

## 17.2 C++ Bindings

The C++ bindings were deprecated as of MPI-2.2. The C++ bindings are removed in MPI-3.0. The namespace is still reserved, however, and bindings may only be provided by an implementation as described in the MPI-2.2 standard.

1  
2  
3  
4  
5  
6  
7  
8  
9  
10  
11  
12  
13  
14  
15  
16  
17  
18  
19  
20  
21  
22  
23  
24  
25  
26  
27  
28  
29  
30  
31  
32  
33  
34  
35  
36  
37  
38  
39  
40  
41  
42  
43  
44  
45  
46  
47  
48

## Chapter 18

# Backward Incompatibilities

### 18.1 Backward Incompatibilities Starting in MPI-4.0

MPI\_COMM\_DUP and MPI\_COMM\_IDUP no longer propagate info hints from the input communicator to the output communicator. This behavior can be achieved using MPI\_COMM\_DUP\_WITH\_INFO and MPI\_COMM\_IDUP\_WITH\_INFO.

The default communicator where errors are raised when not involving a communicator, window, or file was changed from MPI\_COMM\_WORLD to MPI\_COMM\_SELF.

The limit for length of MPI identifiers was removed. Prior to MPI-4.0, MPI identifiers were limited to 30 characters (31 with the profiling interface). This was done to avoid exceeding the limit on some compilation systems.

*Rationale.* For Fortran, this limit was already relaxed for the Fortran specific function names, see Section 19.1.5, and the Fortran language specification 2003 requires support for a minimum of 63 characters for internal and external identifiers. Starting with the ISO/IEC 9899:1999 C programming language standard, support for a minimum of 63 characters is required for internal identifiers, but only 31 characters are required to be significant for external identifiers. At the time of the release of MPI-4.0, most or nearly all compilers allow external identifiers longer than 31 characters. Therefore, the restriction is removed. (*End of rationale.*)

1  
2  
3  
4  
5  
6  
7  
8  
9  
10  
11  
12  
13  
14  
15  
16  
17  
18  
19  
20  
21  
22  
23  
24  
25  
26  
27  
28  
29  
30  
31  
32  
33  
34  
35  
36  
37  
38  
39  
40  
41  
42  
43  
44  
45  
46  
47  
48

DRAFT

1  
2  
3  
4  
5  
6  
7  
8  
9  
10  
11  
12  
13  
14  
15  
16  
17  
18  
19  
20  
21  
22  
23  
24  
25  
26  
27  
28  
29  
30  
31  
32  
33  
34  
35  
36  
37  
38  
39  
40  
41  
42  
43  
44  
45  
46  
47  
48

# Chapter 19

## Language Bindings

### 19.1 Support for Fortran

#### 19.1.1 Overview

The Fortran MPI language bindings have been designed to be compatible with the Fortran 90 standard with additional features from Fortran 2003 and Fortran 2008 [45] + TS 29113 [46].

*Rationale.* Fortran 90 contains numerous features designed to make it a more “modern” language than Fortran 77. It seems natural that MPI should be able to take advantage of these new features with a set of bindings tailored to Fortran 90. In Fortran 2008 + TS 29113, the major new language features used are the `ASYNCHRONOUS` attribute to protect nonblocking MPI operations, and assumed-type and assumed-rank dummy arguments for choice buffer arguments. Further requirements for compiler support are listed in Section 19.1.7. (*End of rationale.*)

MPI defines three methods of Fortran support:

1. **USE mpi\_f08:** This method is described in Section 19.1.2. It requires compile-time argument checking with unique MPI handle types and provides techniques to fully solve the optimization problems with nonblocking calls. This is the only Fortran support method that is consistent with the Fortran standard (Fortran 2008 + TS 29113 and later). This method is highly recommended for all MPI applications.
2. **USE mpi:** This method is described in Section 19.1.3 and requires compile-time argument checking. Handles are defined as `INTEGER`. This Fortran support method is inconsistent with the Fortran standard, and its use is therefore not recommended. It exists only for backwards compatibility.
3. **INCLUDE 'mpif.h':** This method is described in Section 19.1.4. The use of the include file `mpif.h` is strongly discouraged starting with MPI-3.0, because this method neither guarantees compile-time argument checking nor provides sufficient techniques to solve the optimization problems with nonblocking calls, and is therefore inconsistent with the Fortran standard. It exists only for backwards compatibility with legacy MPI applications.

Compliant MPI-3 implementations providing a Fortran interface must provide one or both of the following:

- The `USE mpi_f08` Fortran support method.
- The `USE mpi` and `INCLUDE 'mpif.h'` Fortran support methods.

Section 19.1.6 describes restrictions if the compiler does not support all the needed features.

Application subroutines and functions may use either one of the modules or the `mpif.h` include file. An implementation may require the use of one of the modules to prevent type mismatch errors.

*Advice to users.* Users are advised to utilize one of the MPI modules even if `mpif.h` enforces type checking on a particular system. Using a module provides several potential advantages over using an include file; the `mpi_f08` module offers the most robust and complete Fortran support. (*End of advice to users.*)

In a single application, it must be possible to link together routines which `USE mpi_f08`, `USE mpi`, and `INCLUDE 'mpif.h'`.

The LOGICAL compile-time constant `MPI_SUBARRAYS_SUPPORTED` is set to `.TRUE.` if all buffer choice arguments are defined in explicit interfaces with assumed-type and assumed-rank [46]; otherwise it is set to `.FALSE.`. The LOGICAL compile-time constant `MPI_ASYNC_PROTECTS_NONBLOCKING` is set to `.TRUE.` if the `ASYNCHRONOUS` attribute was added to the choice buffer arguments of all nonblocking interfaces **and** the underlying Fortran compiler supports the `ASYNCHRONOUS` attribute for MPI communication (as part of TS 29113), otherwise it is set to `.FALSE.`. These constants exist for each Fortran support method, but not in the C header file. The values may be different for each Fortran support method. All other constants and the integer values of handles must be the same for each Fortran support method.

Section 19.1.2 through 19.1.4 define the Fortran support methods. The Fortran interfaces of each MPI routine are shorthands. Section 19.1.5 defines the corresponding full interface specification together with the specific procedure names and implications for the profiling interface. Section 19.1.6 the implementation of the MPI routines for different versions of the Fortran standard. Section 19.1.7 summarizes major requirements for valid MPI-3.0 implementations with Fortran support. Section 19.1.8 and Section 19.1.9 describe additional functionality that is part of the Fortran support. `MPI_F_SYNC_REG` is needed for one of the methods to prevent register optimization problems. A set of functions provides additional support for Fortran intrinsic numeric types, including parameterized types: `MPI_TYPE_MATCH_SIZE`, `MPI_TYPE_CREATE_F90_INTEGER`, `MPI_TYPE_CREATE_F90_REAL` and `MPI_TYPE_CREATE_F90_COMPLEX`. In the context of MPI, parameterized types are Fortran intrinsic types which are specified using `KIND` type parameters. Sections 19.1.10 through 19.1.19 give an overview and details on known problems when using Fortran together with MPI; Section 19.1.20 compares the Fortran problems with those in C.

## 19.1.2 Fortran Support Through the `mpi_f08` Module

An MPI implementation providing a Fortran interface must provide a module named `mpi_f08` that can be used in a Fortran program. Section 19.1.6 describes restrictions if the compiler does not support all the needed features. Within all MPI function specifications, the first

of the set of two Fortran routine interface specifications is provided by this module. This module must:

- Define all named MPI constants.
- Declare MPI functions that return a value.
- Provide explicit interfaces according to the Fortran routine interface specifications. This module therefore guarantees compile-time argument checking for all arguments which are not `TYPE(*)`, with the following exception:

Only one Fortran interface is defined for functions that are deprecated as of MPI-3.0. This interface must be provided as an explicit interface according to the rules defined for the `mpi` module, see Section 19.1.3.

*Advice to users.* It is strongly recommended that developers substitute calls to deprecated routines when upgrading from `mpif.h` or the `mpi` module to the `mpi_f08` module. (*End of advice to users.*)

- Define the derived type `MPI_Status`, and define all MPI handles with uniquely named handle types (instead of `INTEGER` handles, as in the `mpi` module). This is reflected in the first Fortran binding in each MPI function definition throughout this document (except for the deprecated routines).
- Overload the operators `.EQ.` and `.NE.` to allow the comparison of these MPI handles with `.EQ.`, `.NE.`, `==` and `/=`.
- Use the `ASYNCHRONOUS` attribute to protect the buffers of nonblocking operations, and set the `LOGICAL` compile-time constant `MPI_ASYNC_PROTECTS_NONBLOCKING` to `.TRUE.` if the underlying Fortran compiler supports the `ASYNCHRONOUS` attribute for MPI communication (as part of TS 29113). See Section 19.1.6 for older compiler versions.
- Set the `LOGICAL` compile-time constant `MPI_SUBARRAYS_SUPPORTED` to `.TRUE.` and declare choice buffers using the Fortran 2008 TS 29113 features assumed-type and assumed-rank, i.e., `TYPE(*)`, `DIMENSION(..)` in all nonblocking, split collective and persistent communication routines, if the underlying Fortran compiler supports it. With this, non-contiguous sub-arrays can be used as buffers in nonblocking routines.

*Rationale.* In all blocking routines, i.e., if the choice-buffer is not declared as `ASYNCHRONOUS`, the TS 29113 feature is not needed for the support of non-contiguous buffers because the compiler can pass the buffer by in-and-out-copy through a contiguous scratch array. (*End of rationale.*)

- Set the `MPI_SUBARRAYS_SUPPORTED` compile-time constant to `.FALSE.` and declare choice buffers with a compiler-dependent mechanism that overrides type checking if the underlying Fortran compiler does not support the Fortran 2008 TS 29113 assumed-type and assumed-rank notation. In this case, the use of non-contiguous sub-arrays as buffers in nonblocking calls may be invalid. See Section 19.1.6 for details.
- Declare each argument with an `INTENT` of `IN`, `OUT`, or `INOUT` as defined in this standard.

1 *Rationale.* For these definitions in the `mpi_f08` bindings, in most cases, `INTENT(IN)`  
 2 is used if the C interface uses call-by-value. For all buffer arguments and for `OUT` and  
 3 `INOUT` dummy arguments that allow one of the non-ordinary Fortran constants (see  
 4 `MPI_BOTTOM`, etc. in Section 2.5.4) as input, an `INTENT` is not specified. (*End of*  
 5 *rationale.*)

6  
 7 *Advice to users.* If a dummy argument is declared with `INTENT(OUT)`, then the  
 8 Fortran standard stipulates that the actual argument becomes undefined upon invo-  
 9 cation of the MPI routine, i.e., it may be overwritten by some other values, e.g. zeros;  
 10 according to [45], 12.5.2.4 Ordinary dummy variables, Paragraph 17: “If a dummy  
 11 argument has `INTENT(OUT)`, the actual argument becomes undefined at the time  
 12 the association is established, except [...]”. For example, if the dummy argument is  
 13 an assumed-size array and the actual argument is a strided array, the call may be im-  
 14 plemented with copy-in and copy-out of the argument. In the case of `INTENT(OUT)` the  
 15 copy-in may be suppressed by the optimization and the routine starts execution using  
 16 an array of undefined values. If the routine stores fewer elements into the dummy  
 17 argument than is provided in the actual argument, then the remaining locations are  
 18 overwritten with these undefined values. See also both advices to implementors in  
 19 Section 19.1.3. (*End of advice to users.*)

- 20  
 21 • Declare all `ierror` output arguments as `OPTIONAL`, except for user-defined callback  
 22 functions (e.g., `COMM_COPY_ATTR_FUNCTION`) and predefined callbacks (e.g.,  
 23 `MPI_COMM_NULL_COPY_FN`).

24  
 25 *Rationale.* For user-defined callback functions (e.g., `COMM_COPY_ATTR_FUNCTION`) and  
 26 their predefined callbacks (e.g., `MPI_COMM_NULL_COPY_FN`), the `ierror` argument  
 27 is not optional. The MPI library must always call these routines with an actual `ierror`  
 28 argument. Therefore, these user-defined functions need not check whether the MPI  
 29 library calls these routines with or without an actual `ierror` output argument. (*End of*  
 30 *rationale.*)

31  
 32 The MPI Fortran bindings in the `mpi_f08` module are designed based on the Fortran  
 33 2008 standard [45] together with the Technical Specification “TS 29113 Further Interoper-  
 34 ability with C” [46] of the ISO/IEC JTC1/SC22/WG5 (Fortran) working group.

35  
 36 *Rationale.* The features in TS 29113 on further interoperability with C were decided  
 37 on by ISO/IEC JTC1/SC22/WG5 and designed by PL22.3 (formerly J3) to support a  
 38 higher level of integration between Fortran-specific features and C than was provided  
 39 in the Fortran 2008 standard; part of this design is based on requirements from the  
 40 MPI Forum to support MPI-3.0. According to [46], “an ISO/IEC TS is reviewed after  
 41 three years in order to decide whether it will be confirmed for a further three years,  
 42 revised to become an International Standard, or withdrawn. If the ISO/IEC TS is  
 43 confirmed, it is reviewed again after a further three years, at which time it must either  
 44 be transformed into an International Standard or be withdrawn.”

45 The TS 29113 contains the following language features that are needed for the MPI  
 46 bindings in the `mpi_f08` module: assumed-type and assumed-rank. It is important  
 47 that any possible actual argument can be used for such dummy arguments, e.g.,  
 48 scalars, arrays, assumed-shape arrays, assumed-size arrays, allocatable arrays, and



with any element type, e.g., `REAL`, `CHARACTER*5`, `CHARACTER*(*)`, sequence derived types, or `BIND(C)` derived types. Especially for backward compatibility reasons, it is important that any possible actual argument in an implicit interface implementation of a choice buffer dummy argument (e.g., with `mpif.h` without argument-checking) can be used in an implementation with assumed-type and assumed-rank argument in an explicit interface (e.g., with the `mpi_f08` module).

A further feature useful for MPI is the extension of the semantics of the `ASYNCHRONOUS` attribute: In F2003 and F2008, this attribute could be used only to protect buffers of Fortran asynchronous I/O. With TS 29113, this attribute now also covers asynchronous communication occurring within library routines written in C.

The MPI Forum hereby wishes to acknowledge this important effort by the Fortran PL22.3 and WG5 committee. (*End of rationale.*)

### 19.1.3 Fortran Support Through the `mpi` Module

An MPI implementation providing a Fortran interface must provide a module named `mpi` that can be used in a Fortran program. Within all MPI function specifications, the second of the set of two Fortran routine interface specifications is provided by this module. This module must:

- Define all named MPI constants
- Declare MPI functions that return a value.
- Provide explicit interfaces according to the Fortran routine interface specifications. This module therefore guarantees compile-time argument checking and allows positional and keyword-based argument lists. If an implementation is paired with a compiler that either does not support `TYPE(*)`, `DIMENSION(..)` from TS 29113, or is otherwise unable to ignore the types of choice buffers, then the implementation must provide explicit interfaces only for MPI routines with no choice buffer arguments. See Section 19.1.6 for more details.
- Define all MPI handles as type `INTEGER`.
- Define the derived type `MPI_Status` and all named handle types that are used in the `mpi_f08` module. For these named handle types, overload the operators `.EQ.` and `.NE.` to allow handle comparison via the `.EQ.`, `.NE.`, `==` and `/=` operators.

*Rationale.* They are needed only when the application converts old-style `INTEGER` handles into new-style handles with a named type. (*End of rationale.*)

- A high quality MPI implementation may enhance the interface by using the `ASYNCHRONOUS` attribute in the same way as in the `mpi_f08` module if it is supported by the underlying compiler.
- Set the `LOGICAL` compile-time constant `MPI_ASYNC_PROTECTS_NONBLOCKING` to `.TRUE.` if the `ASYNCHRONOUS` attribute is used in all nonblocking interfaces **and** the underlying Fortran compiler supports the `ASYNCHRONOUS` attribute for MPI communication (as part of TS 29113), otherwise to `.FALSE..`

*Advice to users.* For an MPI implementation that fully supports nonblocking calls with the `ASYNCHRONOUS` attribute for choice buffers, an existing MPI-2.2 application may fail to compile even if it compiled and executed with expected results with an MPI-2.2 implementation. One reason may be that the application uses “contiguous” but not “simply contiguous” `ASYNCHRONOUS` arrays as actual arguments for choice buffers of nonblocking routines, e.g., by using subscript triplets with stride one or specifying `(1:n)` for a whole dimension instead of using `(:)`. This should be fixed to fulfill the Fortran constraints for `ASYNCHRONOUS` dummy arguments. This is not considered a violation of backward compatibility because existing applications can not use the `ASYNCHRONOUS` attribute to protect nonblocking calls. Another reason may be that the application does not conform either to MPI-2.2, or to MPI-3.0, or to the Fortran standard, typically because the program forces the compiler to perform copy-in/out for a choice buffer argument in a nonblocking MPI call. This is also not a violation of backward compatibility because the application itself is non-conforming. See Section 19.1.12 for more details. (*End of advice to users.*)

- A high quality MPI implementation may enhance the interface by using `TYPE(*)`, `DIMENSION(..)` choice buffer dummy arguments instead of using non-standardized extensions such as `!$PRAGMA IGNORE_TKR` or a set of overloaded functions as described by M. Hennecke in [32], if the compiler supports this TS 29113 language feature. See Section 19.1.6 for further details.
- Set the `LOGICAL` compile-time constant `MPI_SUBARRAYS_SUPPORTED` to `.TRUE.` if all choice buffer arguments in all nonblocking, split collective and persistent communication routines are declared with `TYPE(*)`, `DIMENSION(..)`, otherwise set it to `.FALSE.`. When `MPI_SUBARRAYS_SUPPORTED` is defined as `.TRUE.`, non-contiguous sub-arrays can be used as buffers in nonblocking routines.
- Set the `MPI_SUBARRAYS_SUPPORTED` compile-time constant to `.FALSE.` and declare choice buffers with a compiler-dependent mechanism that overrides type checking if the underlying Fortran compiler does not support the TS 29113 assumed-type and assumed-rank features. In this case, the use of non-contiguous sub-arrays in non-blocking calls may be disallowed. See Section 19.1.6 for details.

An MPI implementation may provide other features in the `mpi` module that enhance the usability of MPI while maintaining adherence to the standard. For example, it may provide `INTENT` information in these interface blocks.

*Advice to implementors.* The appropriate `INTENT` may be different from what is given in the MPI language-neutral bindings. Implementations must choose `INTENT` so that the function adheres to the MPI standard, e.g., by defining the `INTENT` as provided in the `mpi_f08` bindings. (*End of advice to implementors.*)

*Rationale.* The intent given by the MPI generic interface is not precisely defined and does not in all cases correspond to the correct Fortran `INTENT`. For instance, receiving into a buffer specified by a datatype with absolute addresses may require associating `MPI_BOTTOM` with a dummy `OUT` argument. Moreover, “constants” such as `MPI_BOTTOM` and `MPI_STATUS_IGNORE` are not constants as defined by Fortran, but “special addresses” used in a nonstandard way. Finally, the MPI-1 generic intent

was changed in several places in MPI-2. For instance, `MPI_IN_PLACE` changes the intent of an `OUT` argument to be `INOUT`. (*End of rationale.*)

*Advice to implementors.* The Fortran 2008 standard illustrates in its Note 5.17 that “`INTENT(OUT)` means that the value of the argument after invoking the procedure is entirely the result of executing that procedure. If an argument should retain its value rather than being redefined, `INTENT(INOUT)` should be used rather than `INTENT(OUT)`, even if there is no explicit reference to the value of the dummy argument. Furthermore, `INTENT(INOUT)` is not equivalent to omitting the `INTENT` attribute, because `INTENT(INOUT)` always requires that the associated actual argument is definable.” Applications that include `mpif.h` may not expect that `INTENT(OUT)` is used. In particular, output array arguments are expected to keep their content as long as the MPI routine does not modify them. To keep this behavior, it is recommended that implementations not use `INTENT(OUT)` in the `mpi` module and the `mpif.h` include file, even though `INTENT(OUT)` is specified in an interface description of the `mpi_f08` module. (*End of advice to implementors.*)

#### 19.1.4 Fortran Support Through the `mpif.h` Include File

The use of the `mpif.h` include file is strongly discouraged and may be deprecated in a future version of MPI.

An MPI implementation providing a Fortran interface must provide an include file named `mpif.h` that can be used in a Fortran program. Within all MPI function specifications, the second of the set of two Fortran routine interface specifications is supported by this include file. This include file must:

- Define all named MPI constants.
- Declare MPI functions that return a value.
- Define all handles as `INTEGER`.
- Be valid and equivalent for both fixed and free source form.

For each MPI routine, an implementation can choose to use an implicit or explicit interface for the second Fortran binding (in deprecated routines, the first one may be omitted).

- Set the `LOGICAL` compile-time constants `MPI_SUBARRAYS_SUPPORTED` and `MPI_ASYNC_PROTECTS_NONBLOCKING` according to the same rules as for the `mpi` module. In the case of implicit interfaces for choice buffer or nonblocking routines, the constants must be set to `.FALSE..`

*Advice to users.* Instead of using `mpif.h`, the use of the `mpi_f08` or `mpi` module is strongly encouraged for the following reasons:

- Most `mpif.h` implementations do not include compile-time argument checking.
- Therefore, many bugs in MPI applications remain undetected at compile-time, such as:
  - Missing `ierror` as last argument in most Fortran bindings.

- Declaration of a `status` as an `INTEGER` variable instead of an `INTEGER` array with size `MPI_STATUS_SIZE`.
  - Incorrect argument positions; e.g., interchanging the `count` and `datatype` arguments.
  - Passing incorrect MPI handles; e.g., passing a `datatype` instead of a communicator.
- The migration from `mpif.h` to the `mpi` module should be relatively straightforward (i.e., substituting `include 'mpif.h'` after an `implicit` statement by `use mpi` before that `implicit` statement) as long as the application syntax is correct.
  - Migrating portable and correctly written applications to the `mpi` module is not expected to be difficult. No compile or runtime problems should occur because an `mpif.h` include file was always allowed to provide explicit Fortran interfaces.

*(End of advice to users.)*

*Rationale.* With MPI-3.0, the `mpif.h` include file was not deprecated in order to retain strong backward compatibility. Internally, `mpif.h` and the `mpi` module may be implemented so that essentially the same library implementation of the MPI routines can be used. *(End of rationale.)*

### 19.1.5 Interface Specifications, Procedure Names, and the Profiling Interface

The Fortran interface specification of each MPI routine specifies the routine name that must be called by the application program, and the names and types of the dummy arguments together with additional attributes. The Fortran standard allows a given Fortran interface to be implemented with several methods, e.g., within or outside of a module, with or without `BIND(C)`, or the buffers with or without TS 29113. Such implementation decisions imply different binary interfaces and different specific procedure names. The requirements for several implementation schemes together with the rules for the specific procedure names and its implications for the profiling interface are specified within this section, but not the implementation details.

*Rationale.* This section was introduced in MPI-3.0 on Sep. 21, 2012. The major goals for implementing the three Fortran support methods have been:

- Portable implementation of the wrappers from the MPI Fortran interfaces to the MPI routines in C.
- Binary backward compatible implementation path when switching `MPI_SUBARRAYS_SUPPORTED` from `.FALSE.` to `.TRUE.`
- The Fortran PMPI interface need not be backward compatible, but a method must be included that a tools layer can use to examine the MPI library about the specific procedure names and interfaces used.
- No performance drawbacks.
- Consistency between all three Fortran support methods.
- Consistent with Fortran 2008 + TS 29113.

No.	Specific procedure name	Calling convention
1A	MPI_Isend_f08	Fortran interface and arguments, as in Annex A.4, except that in routines with a choice buffer dummy argument, this dummy argument is implemented with non-standard extensions like !\$PRAGMA IGNORE_TKR, which provides a call-by-reference argument without type, kind, and dimension checking.
1B	MPI_Isend_f08ts	Fortran interface and arguments, as in Annex A.4, but only for routines with one or more choice buffer dummy arguments; these dummy arguments are implemented with TYPE(*), DIMENSION(..).
2A	MPI_ISEND	Fortran interface and arguments, as in Annex A.5, except that in routines with a choice buffer dummy argument, this dummy argument is implemented with non-standard extensions like !\$PRAGMA IGNORE_TKR, which provides a call-by-reference argument without type, kind, and dimension checking.
2B	MPI_ISEND_FTS	Fortran interface and arguments, as in Annex A.5, but only for routines with one or more choice buffer dummy arguments; these dummy arguments are implemented with TYPE(*), DIMENSION(..). In mpif.h only, the postfix “_FTS” for MPI_NEIGHBOR_ALLGATHERV_INIT, MPI_NEIGHBOR_ALLTOALLV_INIT, and MPI_NEIGHBOR_ALLTOALLW_INIT is shortened to “_F”.

Table 19.1: Specific Fortran procedure names and related calling conventions. MPI\_ISEND is used as an example. For routines without choice buffers, only 1A and 2A apply.

The design expected that all dummy arguments in the MPI Fortran interfaces are interoperable with C according to Fortran 2008 + TS 29113. This expectation was not fulfilled. The LOGICAL arguments are not interoperable with C, mainly because the internal representations for .FALSE. and .TRUE. are compiler dependent. The provided interface was mainly based on BIND(C) interfaces and therefore inconsistent with Fortran. To be consistent with Fortran, the BIND(C) had to be removed from the callback procedure interfaces and the predefined callbacks, e.g., MPI\_COMM\_DUP\_FN. Non-BIND(C) procedures are also not interoperable with C, and therefore the BIND(C) had to be removed from all routines with PROCEDURE arguments, e.g., from MPI\_OP\_CREATE.

Therefore, this section was rewritten as an erratum to MPI-3.0. (*End of rationale.*)

A Fortran call to an MPI routine shall result in a call to a procedure with one of the specific procedure names and calling conventions, as described in Table 19.1. Case is not significant in the names.

Note that for the deprecated routines in Section 16.1, which are reported only in Annex A.5, scheme 2A is utilized in the mpi module and mpif.h, and also in the mpi\_f08

1 module.

2 To set `MPI_SUBARRAYS_SUPPORTED` to `.TRUE.` within a Fortran support method,  
3 it is required that all nonblocking and split-collective routines with buffer arguments are  
4 implemented according to 1B and 2B, i.e., with `MPI_Xxxx_f08ts` in the `mpi_f08` module,  
5 and with `MPI_XXXX_FTS` in the `mpi` module and the `mpif.h` include file.

6 The `mpi` and `mpi_f08` modules and the `mpif.h` include file will each correspond to  
7 exactly one implementation scheme from Table 19.1. However, the MPI library may contain  
8 multiple implementation schemes from Table 19.1.

9 *Advice to implementors.* This may be desirable for backwards binary compatibility  
10 in the scope of a single MPI implementation, for example. (*End of advice to imple-*  
11 *mentors.*)

12  
13 *Rationale.* After a compiler provides the facilities from TS 29113, i.e., `TYPE(*)`,  
14 `DIMENSION(. .)`, it is possible to change the bindings within a Fortran support method  
15 to support subarrays without recompiling the complete application provided that the  
16 previous interfaces with their specific procedure names are still included in the li-  
17 brary. Of course, only recompiled routines can benefit from the added facilities.  
18 There is no binary compatibility conflict because each interface uses its own spe-  
19 cific procedure names and all interfaces use the same constants (except the value of  
20 `MPI_SUBARRAYS_SUPPORTED` and `MPI_ASYNC_PROTECTS_NONBLOCKING`) and type  
21 definitions. After a compiler also ensures that buffer arguments of nonblocking MPI  
22 operations can be protected through the `ASYNCHRONOUS` attribute, and the proce-  
23 dure declarations in the `mpi_f08` and `mpi` module and the `mpif.h` include file declare  
24 choice buffers with the `ASYNCHRONOUS` attribute, then the value of  
25 `MPI_ASYNC_PROTECTS_NONBLOCKING` can be switched to `.TRUE.` in the module def-  
26 inition and include file. (*End of rationale.*)

27  
28 *Advice to users.* Partial recompilation of user applications when upgrading MPI  
29 implementations is a highly complex and subtle topic. Users are strongly advised to  
30 consult their MPI implementation’s documentation to see exactly what is—and what  
31 is not—supported. (*End of advice to users.*)

32 Within the `mpi_f08` and `mpi` modules and `mpif.h`, for all MPI procedures, a second  
33 procedure with the same calling conventions shall be supplied, except that the name is  
34 modified by prefixing with the letter “P”, e.g., `PMPI_Isend`. The specific procedure names  
35 for these `PMPI_Xxxx` procedures must be different from the specific procedure names for  
36 the `MPI_Xxxx` procedures and are not specified by this standard.

37 A user-written or middleware profiling routine should provide the same specific Fortran  
38 procedure names and calling conventions, and therefore can interpose itself as the MPI  
39 library routine. The profiling routine can internally call the matching  
40 `PMPI` routine with any of its existing bindings, except for routines that have callback routine  
41 dummy arguments, choice buffer arguments, or that are attribute caching routines (  
42 `MPI_{COMM|WIN|TYPE}_{SET|GET}_ATTR`). In this case, the profiling software should  
43 invoke the corresponding `PMPI` routine using the same Fortran support method as used in  
44 the calling application program, because the C, `mpi_f08` and `mpi` callback prototypes are  
45 different or the meaning of the choice buffer or `attribute_val` arguments are different.  
46

47 *Advice to users.* Although for each support method and MPI routine (e.g.,  
48 `MPI_ISEND` in `mpi_f08`), multiple routines may need to be provided to intercept

the specific procedures in the MPI library (e.g., `MPI_Isend_f08` and `MPI_Isend_f08ts`), each profiling routine itself uses only one support method (e.g., `mpi_f08`) and calls the real MPI routine through the one PMPI routine defined in this support method (i.e., `PMPI_Isend` in this example). (*End of advice to users.*)

*Advice to implementors.* If all of the following conditions are fulfilled:

- the handles in the `mpi_f08` module occupy one Fortran numerical storage unit (same as an `INTEGER` handle),
- the internal argument passing mechanism used to pass an actual `ierror` argument to a non-optional `ierror` dummy argument is binary compatible to passing an actual `ierror` argument to an `ierror` dummy argument that is declared as `OPTIONAL`,
- the internal argument passing mechanism for `ASYNCHRONOUS` and non-`ASYNCHRONOUS` arguments is the same,
- the internal routine call mechanism is the same for the Fortran and the C compilers for which the MPI library is compiled,
- the compiler does not provide TS 29113,

then the implementor may use the same internal routine implementations for all Fortran support methods but with several different specific procedure names. If the accompanying Fortran compiler supports TS 29113, then the new routines are needed only for routines with choice buffer arguments. (*End of advice to implementors.*)

*Advice to implementors.* In the Fortran support method `mpif.h`, compile-time argument checking can be also implemented for all routines. For `mpif.h`, the argument names are not specified through the MPI standard, i.e., only positional argument lists are defined, and not key-word based lists. Due to the rule that `mpif.h` must be valid for fixed and free source form, the subroutine declaration is restricted to one line with 72 characters. To keep the argument lists short, each argument name can be shortened to a minimum of one character. With this, the three longest subroutine declaration statements are

```
SUBROUTINE PMPI_DIST_GRAPH_CREATE_ADJACENT(a,b,c,d,e,f,g,h,i,j,k)
SUBROUTINE PMPI_NEIGHBOR_ALLTOALLW_INIT(a,b,c,d,e,f,g,h,i,j,k,l)
SUBROUTINE PMPI_NEIGHBOR_ALLTOALLV_INIT(a,b,c,d,e,f,g,h,i,j,k,l)
```

with 71 and 70 characters each. With buffers implemented with TS 29113, the specific procedure names have an additional postfix. Some of the longest of such interface definitions are

```
INTERFACE PMPI_NEIGHBOR_ALLTOALLW_INIT
SUBROUTINE PMPI_NEIGHBOR_ALLTOALLW_INIT_F(a,b,c,d,e,f,g,h,i,j,j,k)
INTERFACE PMPI_NEIGHBOR_ALLGATHERV_INIT
SUBROUTINE PMPI_NEIGHBOR_ALLGATHERV_INIT_F(a,b,c,d,e,f,g,h,i,j,k)
INTERFACE PMPI_RGET_ACCUMULATE
SUBROUTINE PMPI_RGET_ACCUMULATE_FTS(a,b,c,d,e,f,g,h,i,j,k,l,m,n)
```

with 72, 71, and 70 characters. In principle, continuation lines would be possible in `mpif.h` (spaces in columns 73–131, & in column 132, and in column 6 of the continuation line) but this would not be valid if the source line length is extended with a compiler flag to 132 characters. Column 133 is also not available for the continuation character because lines longer than 132 characters are invalid with some compilers by default.

The longest specific procedure name is `PMPI_Reduce_scatter_block_init_c_f08ts` with 38 characters in the `mpi_f08` module.

For example, the interface specifications together with the specific procedure names can be implemented with

```

12 MODULE mpi_f08
13   TYPE, BIND(C) :: MPI_Comm
14   INTEGER :: MPI_VAL
15 END TYPE MPI_Comm
16 ...
17 INTERFACE MPI_Comm_rank ! (as defined in Chapter 6)
18   SUBROUTINE MPI_Comm_rank_f08(comm, rank, ierror)
19     IMPORT :: MPI_Comm
20     TYPE(MPI_Comm), INTENT(IN) :: comm
21     INTEGER, INTENT(OUT) :: rank
22     INTEGER, OPTIONAL, INTENT(OUT) :: ierror
23   END SUBROUTINE
24 END INTERFACE
25 END MODULE mpi_f08
26
27 MODULE mpi
28   INTERFACE MPI_Comm_rank ! (as defined in Chapter 6)
29     SUBROUTINE MPI_Comm_rank(comm, rank, ierror)
30       INTEGER, INTENT(IN) :: comm ! The INTENT may be added although
31       INTEGER, INTENT(OUT) :: rank ! it is not defined in the
32       INTEGER, INTENT(OUT) :: ierror ! official routine definition.
33     END SUBROUTINE
34   END INTERFACE
35 END MODULE mpi

```

And if interfaces are provided in `mpif.h`, they might look like this (outside of any module and in fixed source format):

```

36 !23456789012345678901234567890123456789012345678901234567890123456789012
37   INTERFACE MPI_Comm_rank ! (as defined in Chapter 6)
38     SUBROUTINE MPI_Comm_rank(comm, rank, ierror)
39       INTEGER, INTENT(IN) :: comm ! The argument names may be
40       INTEGER, INTENT(OUT) :: rank ! shortened so that the
41       INTEGER, INTENT(OUT) :: ierror ! subroutine line fits to the
42     END SUBROUTINE ! maximum of 72 characters.
43   END INTERFACE

```

*(End of advice to implementors.)*

*Advice to users.* The following is an example of how a user-written or middleware profiling routine can be implemented:



```

SUBROUTINE MPI_Isend_f08ts(buf, count, datatype, dest, tag, comm, request, ierror)
  USE :: mpi_f08, my_noname => MPI_Isend_f08ts
  TYPE(*), DIMENSION(..), ASYNCHRONOUS :: buf
  INTEGER,          INTENT(IN)          :: count, dest, tag
  TYPE(MPI_Datatype), INTENT(IN)        :: datatype
  TYPE(MPI_Comm),   INTENT(IN)          :: comm
  TYPE(MPI_Request), INTENT(OUT)        :: request
  INTEGER, OPTIONAL, INTENT(OUT)       :: ierror
  ! ... some code for the begin of profiling
  call PMPI_Isend (buf, count, datatype, dest, tag, comm, request, ierror)
  ! ... some code for the end of profiling
END SUBROUTINE MPI_Isend_f08ts

```

Note that this routine is used to intercept the existing specific procedure name `MPI_Isend_f08ts` in the MPI library. This routine must not be part of a module. This routine itself calls `PMPI_Isend`. The `USE` of the `mpi_f08` module is needed for definitions of handle types and the interface for `PMPI_Isend`. However, this module also contains an interface definition for the specific procedure name `MPI_Isend_f08ts` that conflicts with the definition of this profiling routine (i.e., the name is doubly defined). Therefore, the `USE` here specifically excludes the interface from the module by renaming the unused routine name in the `mpi_f08` module into “`my_noname`” in the scope of this routine. (*End of advice to users.*)

*Advice to users.* The PMPI interface allows intercepting MPI routines. For example, an additional `MPI_ISEND` profiling wrapper can be provided that is called by the application and internally calls `PMPI_ISEND`. There are two typical use cases: a profiling layer that is developed independently from the application and the MPI library, and profiling routines that are part of the application and have access to the application data. With MPI-3.0, new Fortran interfaces and implementation schemes were introduced that have several implications on how Fortran MPI routines are internally implemented and optimized. For profiling layers, these schemes imply that several internal interfaces with different specific procedure names may need to be intercepted, as shown in the example code above. Therefore, for wrapper routines that are part of a Fortran application, it may be more convenient to make the name shift within the application, i.e., to substitute the call to the MPI routine (e.g., `MPI_ISEND`) by a call to a user-written profiling wrapper with a new name (e.g., `X_MPI_ISEND`) and to call the Fortran `MPI_ISEND` from this wrapper, instead of using the PMPI interface. (*End of advice to users.*)

*Advice to implementors.* An implementation that provides a Fortran interface must provide a combination of MPI library and module or include file that uses the specific procedure names as described in Table 19.1 so that the MPI Fortran routines are interceptable as described above. (*End of advice to implementors.*)

### 19.1.6 MPI for Different Fortran Standard Versions

This section describes which Fortran interface functionality can be provided for different versions of the Fortran standard.

- *For Fortran 77* with some extensions:

- 1 – MPI identifiers may be up to 30 characters (31 with the profiling interface).
- 2 – MPI identifiers may contain underscores after the first character.
- 3
- 4 – An MPI subroutine with a choice argument may be called with different argument
- 5 types.
- 6 – Although not required by the MPI standard, the `INCLUDE` statement should be
- 7 available for including `mpif.h` into the user application source code.

8  
9 Only MPI-1.1, MPI-1.2, and MPI-1.3 can be implemented. The use of absolute ad-  
10 dresses from `MPI_ADDRESS` and `MPI_BOTTOM` may cause problems if an address  
11 does not fit into the memory space provided by an `INTEGER`. (In MPI-2.0 this problem  
12 is solved with `MPI_GET_ADDRESS`, but not for Fortran 77.)

- 13 • *For Fortran 90:*

14 The major additional features that are needed from Fortran 90 are:

- 15
- 16 – The `MODULE` and `INTERFACE` concept.
- 17 – The `KIND=` and `SELECTED_XXX_KIND` concept.
- 18 – Fortran derived `TYPES` and the `SEQUENCE` attribute.
- 19 – The `OPTIONAL` attribute for dummy arguments.
- 20 – The `OPTIONAL` attribute for dummy arguments.
- 21 – Cray pointers, which are a non-standard compiler extension, are needed for the
- 22 use of `MPI_ALLOC_MEM`.

23  
24 With these features, MPI-1.1 – MPI-2.2 can be implemented without restrictions.  
25 MPI-3.0 can be implemented with some restrictions. The Fortran support methods  
26 are abbreviated with `S1` = the `mpi_f08` module, `S2` = the `mpi` module, and `S3` = the  
27 `mpif.f` include file. If not stated otherwise, restrictions exist for each method which  
28 prevent implementing the complete semantics of MPI-3.0.

- 29
- 30 – `MPI_SUBARRAYS_SUPPORTED` equals `.FALSE.`, i.e., subscript triplets and non-
- 31 contiguous subarrays cannot be used as buffers in nonblocking routines, RMA,
- 32 or split-collective I/O.
- 33 – `S1`, `S2`, and `S3` can be implemented, but for `S1`, only a preliminary implementa-
- 34 tion is possible.
- 35 – In this preliminary interface of `S1`, the following changes are necessary:
- 36 \* `TYPE(*)`, `DIMENSION(..)` is substituted by non-standardized extensions
- 37 like `!$PRAGMA IGNORE_TKR`.
- 38 \* The `ASYNCHRONOUS` attribute is omitted.
- 39 \* `PROCEDURE(...)` callback declarations are substituted by `EXTERNAL`.
- 40
- 41 – The specific procedure names are specified in Section 19.1.5.
- 42
- 43 – Due to the rules specified in Section 19.1.5, choice buffer declarations should be
- 44 implemented only with non-standardized extensions like `!$PRAGMA IGNORE_TKR`
- 45 (as long as F2008+TS 29113 is not available).

46 In `S2` and `S3`: Without such extensions, routines with choice buffers should be  
47 provided with an implicit interface, instead of overloading with a different MPI  
48 function for each possible buffer type (as mentioned in Section 19.1.11). Such

overloading would also imply restrictions for passing Fortran derived types as choice buffer, see also Section 19.1.15.

Only in S1: The implicit interfaces for routines with choice buffer arguments imply that the `ierror` argument cannot be defined as `OPTIONAL`. For this reason, it is recommended not to provide the `mpi_f08` module if such an extension is not available.

- The `ASYNCHRONOUS` attribute can **not** be used in applications to protect buffers in nonblocking MPI calls (S1–S3).
  - The `TYPE(C_PTR)` binding of the `MPI_ALLOC_MEM` and `MPI_WIN_ALLOCATE` routines is not available.
  - In S1 and S2, the definition of the handle types (e.g., `TYPE(MPI_Comm)` and the status type `TYPE(MPI_Status)` must be modified: The `SEQUENCE` attribute must be used instead of `BIND(C)` (which is not available in Fortran 90/95). This restriction implies that the application must be fully recompiled if one switches to an MPI library for Fortran 2003 and later because the internal memory size of the handles may have changed. For this reason, an implementor may choose not to provide the `mpi_f08` module for Fortran 90 compilers. In this case, the `mpi_f08` handle types and all routines, constants and types related to `TYPE(MPI_Status)` (see Section 19.3.5) are also not available in the `mpi` module and `mpif.h`.
- *For Fortran 95:*  
The quality of the MPI interface and the restrictions are the same as with Fortran 90.
  - *For Fortran 2003:*  
The major features that are needed from Fortran 2003 are:
    - Interoperability with C, i.e.,
      - \* `BIND(C)` derived types.
      - \* The `ISO_C_BINDING` intrinsic type `C_PTR` and routine `C_F_POINTER`.
    - The ability to define an `ABSTRACT INTERFACE` and to use it for `PROCEDURE` dummy arguments.
    - The ability to overload the operators `.EQ.` and `.NE.` to allow the comparison of derived types (used in MPI-3.0 for MPI handles).
    - The `ASYNCHRONOUS` attribute is available to protect Fortran asynchronous I/O. This feature is not yet used by MPI, but it is the basis for the enhancement for MPI communication in the TS 29113.

With these features (but still without the features of TS 29113), MPI-1.1 – MPI-2.2 can be implemented without restrictions, but with one enhancement:

- The user application can use `TYPE(C_PTR)` together with `MPI_ALLOC_MEM` as long as `MPI_ALLOC_MEM` is defined with an implicit interface because a `C_PTR` and an `INTEGER(KIND=MPI_ADDRESS_KIND)` argument must both map to a `void *` argument.

MPI-3.0 can be implemented with the following restrictions:

- `MPI_SUBARRAYS_SUPPORTED` equals `.FALSE.`

- 1       – For S1, only a preliminary implementation is possible. The following changes are
- 2       necessary:
- 3             \* `TYPE(*)`, `DIMENSION(..)` is substituted by non-standardized extensions
- 4             like `!$PRAGMA IGNORE_TKR`.
- 5
- 6       – The specific procedure names are specified in Section 19.1.5.
- 7       – With S1, the `ASYNCHRONOUS` is required as specified in the second Fortran inter-
- 8       faces. With S2 and S3 the implementation can also add this attribute if explicit
- 9       interfaces are used.
- 10       – The `ASYNCHRONOUS` Fortran attribute can be used in applications to *try to* protect
- 11       buffers in nonblocking MPI calls, but the protection can work only if the compiler
- 12       is able to protect asynchronous Fortran I/O and makes no difference between such
- 13       asynchronous Fortran I/O and MPI communication.
- 14       – The `TYPE(C_PTR)` binding of the `MPI_ALLOC_MEM`, `MPI_WIN_ALLOCATE`,
- 15       `MPI_WIN_ALLOCATE_SHARED`, and `MPI_WIN_SHARED_QUERY` routines can
- 16       be used only for Fortran types that are C compatible.
- 17       – The same restriction as for Fortran 90 applies if non-standardized extensions like
- 18       `!$PRAGMA IGNORE_TKR` are not available.
- 19

- 20
- 21     • *For Fortran 2008 + TS 29113 and later and*
- 22     *For Fortran 2003 + TS 29113:*

23     The major feature that are needed from TS 29113 are:

- 24       – `TYPE(*)`, `DIMENSION(..)` is available.
- 25       – The `ASYNCHRONOUS` attribute is extended to protect also nonblocking MPI com-
- 26       munication.
- 27       – The array dummy argument of the `ISO_C_BINDING` intrinsic `C_F_POINTER` is not
- 28       restricted to Fortran types for which a corresponding type in C exists.
- 29

30     Using these features, MPI-3.0 can be implemented without any restrictions.

- 31
- 32       – With S1, `MPI_SUBARRAYS_SUPPORTED` equals `.TRUE..` The
- 33       `ASYNCHRONOUS` attribute can be used to protect buffers in nonblocking MPI calls.
- 34       The `TYPE(C_PTR)` binding of the `MPI_ALLOC_MEM`, `MPI_WIN_ALLOCATE`,
- 35       `MPI_WIN_ALLOCATE_SHARED`, and `MPI_WIN_SHARED_QUERY` routines can
- 36       be used for any Fortran type.
- 37       – With S2 and S3, the value of `MPI_SUBARRAYS_SUPPORTED` is implementation
- 38       dependent. A high quality implementation will also provide
- 39       `MPI_SUBARRAYS_SUPPORTED` set to `.TRUE.` and will use the `ASYNCHRONOUS` at-
- 40       tribute in the same way as in S1.
- 41       – If non-standardized extensions like `!$PRAGMA IGNORE_TKR` are not available then
- 42       S2 must be implemented with `TYPE(*)`, `DIMENSION(..)`.
- 43

44     *Advice to implementors.* If `MPI_SUBARRAYS_SUPPORTED==.FALSE.`, the choice

45     argument may be implemented with an explicit interface using compiler directives,

46     for example:

47

48

```

INTERFACE
SUBROUTINE MPI...(buf, ...)
  !DEC$ ATTRIBUTES NO_ARG_CHECK :: buf
  !$PRAGMA IGNORE_TKR buf
  !DIR$ IGNORE_TKR buf
  !IBM* IGNORE_TKR buf
  REAL, DIMENSION(*) :: buf
  ... ! declarations of the other arguments
END SUBROUTINE
END INTERFACE

```

*(End of advice to implementors.)*

### 19.1.7 Requirements on Fortran Compilers

MPI-3.0 (and later) compliant Fortran bindings are not only a property of the MPI library itself, but rather a property of an MPI library together with the Fortran compiler suite for which it is compiled.

*Advice to users.* Users must take appropriate steps to ensure that proper options are specified to compilers. MPI libraries must document these options. Some MPI libraries are shipped together with special compilation scripts (e.g., `mpif90`, `mpicc`) that set these options automatically. *(End of advice to users.)*

An MPI library together with the Fortran compiler suite is only compliant with MPI-3.0 (and later), as referred by `MPI_GET_VERSION`, if all the solutions described in Sections 19.1.11 through 19.1.19 work correctly. Based on this rule, major requirements for all three Fortran support methods (i.e., the `mpi_f08` and `mpi` modules, and `mpif.h`) are:

- The language features assumed-type and assumed-rank from Fortran 2008 TS 29113 [46] are available. This is required only for `mpi_f08`. As long as this requirement is not supported by the compiler, it is valid to build an MPI library that implements the `mpi_f08` module with `MPI_SUBARRAYS_SUPPORTED` set to `.FALSE.`
- “Simply contiguous” arrays and scalars must be passed to choice buffer dummy arguments of nonblocking routines with call by reference. This is needed only if one of the support methods does not use the `ASYNCHRONOUS` attribute. See Section 19.1.12 for more details.
- `SEQUENCE` and `BIND(C)` derived types are valid as actual arguments passed to choice buffer dummy arguments, and, in the case of `MPI_SUBARRAYS_SUPPORTED==.FALSE.`, they are passed with call by reference, and passed by descriptor in the case of `.TRUE.`
- All actual arguments that are allowed for a dummy argument in an implicitly defined and separately compiled Fortran routine with the given compiler (e.g., `CHARACTER(LEN=*)` strings and array of strings) must also be valid for choice buffer dummy arguments with all Fortran support methods.
- The array dummy argument of the `ISO_C_BINDING` intrinsic module procedure `C_F_POINTER` is not restricted to Fortran types for which a corresponding type in C exists.

- The Fortran compiler shall not provide `TYPE(*)` unless the `ASYNCHRONOUS` attribute protects MPI communication as described in TS 29113. Specifically, the TS 29113 must be implemented as a whole.

The following rules are required at least as long as the compiler does not provide the extension of the `ASYNCHRONOUS` attribute as part of TS 29113 and there still exists a Fortran support method with `MPI_ASYNC_PROTECTS_NONBLOCKING` set to `.FALSE.`. Observation of these rules by the MPI application developer is especially recommended for backward compatibility of existing applications that use the `mpi` module or the `mpif.h` include file. The rules are as follows:

- Separately compiled empty Fortran routines with implicit interfaces and separately compiled empty C routines with `BIND(C)` Fortran interfaces (e.g., `MPI_F_SYNC_REG` on page 822 and Section 19.1.8, and DD on page 823) solve the problems described in Section 19.1.17.
- The problems with temporary data movement (described in detail in Section 19.1.18) are solved as long as the application uses different sets of variables for the nonblocking communication (or nonblocking or split collective I/O) and the computation when overlapping communication and computation.
- Problems caused by automatic and permanent data movement (e.g., within a garbage collection, see Section 19.1.19) are resolved **without** any further requirements on the application program, neither on the usage of the buffers, nor on the declaration of application routines that are involved in invoking MPI procedures.

All of these rules are valid for the `mpi_f08` and `mpi` modules and independently of whether `mpif.h` uses explicit interfaces.

*Advice to implementors.* Some of these rules are already part of the Fortran 2003 standard, some of these requirements require the Fortran TS 29113 [46], and some of these requirements for MPI-3.0 are beyond the scope of TS 29113. (*End of advice to implementors.*)

### 19.1.8 Additional Support for Fortran Register-Memory-Synchronization

As described in Section 19.1.17, a dummy call may be necessary to tell the compiler that registers are to be flushed for a given buffer or that accesses to a buffer may not be moved across a given point in the execution sequence. Only a Fortran binding exists for this call.

`MPI_F_SYNC_REG(buf)`

INOUT buf initial address of buffer (choice)

#### Fortran 2008 binding

`MPI_F_sync_reg(buf)`

`TYPE(*), DIMENSION(..), ASYNCHRONOUS :: buf`

#### Fortran binding

`MPI_F_SYNC_REG(BUF)`

`<type> BUF(*)`

This routine has no executable statements. It must be compiled in the MPI library in such a manner that a Fortran compiler cannot detect in the module that the routine has an empty body. It is used only to force the compiler to flush a cached register value of a variable or buffer back to memory (when necessary), or to invalidate the register value.

*Rationale.* This function is not available in other languages because it would not be useful. This routine has no `ierror` return argument because there is no operation that can fail. (*End of rationale.*)

*Advice to implementors.* This routine can be bound to a C routine to minimize the risk that the Fortran compiler can learn that this routine is empty (and that the call to this routine can be removed as part of an optimization). However, it is explicitly allowed to implement this routine within the `mpi_f08` module according to the definition for the `mpi` module or `mpif.h` to circumvent the overhead of building the internal dope vector to handle the assumed-type, assumed-rank argument. (*End of advice to implementors.*)

*Rationale.* This routine is not defined with `TYPE(*)`, `DIMENSION(*)`, i.e., assumed size instead of assumed rank, because this would restrict the usability to “simply contiguous” arrays and would require overloading with another interface for scalar arguments. (*End of rationale.*)

*Advice to users.* If only a part of an array (e.g., defined by a subscript triplet) is used in a nonblocking routine, it is recommended to pass the whole array to `MPI_F_SYNC_REG` anyway to minimize the overhead of this no-operation call. Note that this routine need not be called if `MPI_ASYNC_PROTECTS_NONBLOCKING` is `.TRUE.` and the application fully uses the facilities of `ASYNCHRONOUS` arrays. (*End of advice to users.*)

### 19.1.9 Additional Support for Fortran Numeric Intrinsic Types

MPI provides a small number of named datatypes that correspond to named intrinsic types supported by C and Fortran. These include `MPI_INTEGER`, `MPI_REAL`, `MPI_INT`, `MPI_DOUBLE`, etc., as well as the optional types `MPI_REAL4`, `MPI_REAL8`, etc. There is a one-to-one correspondence between language declarations and MPI types.

Fortran (starting with Fortran 90) provides so-called `KIND`-parameterized types. These types are declared using an intrinsic type (one of `INTEGER`, `REAL`, `COMPLEX`, `LOGICAL`, and `CHARACTER`) with an optional integer `KIND` parameter that selects from among one or more variants. The specific meaning of different `KIND` values themselves are implementation dependent and not specified by the language. Fortran provides the `KIND` selection functions `selected_real_kind` for `REAL` and `COMPLEX` types, and `selected_int_kind` for `INTEGER` types that allow users to declare variables with a minimum precision or number of digits. These functions provide a portable way to declare `KIND`-parameterized `REAL`, `COMPLEX`, and `INTEGER` variables in Fortran. This scheme is backward compatible with Fortran 77. `REAL` and `INTEGER` Fortran variables have a default `KIND` if none is specified. Fortran `DOUBLE PRECISION` variables are of intrinsic type `REAL` with a non-default `KIND`. The following two declarations are equivalent:

```
double precision x
real(KIND(0.0d0)) x
```



1 MPI provides two orthogonal methods for handling communication buffers of numeric  
2 intrinsic types. The first method (see the following section) can be used when variables have  
3 been declared in a portable way—using default `KIND` or using `KIND` parameters obtained  
4 with the `selected_int_kind` or `selected_real_kind` functions. With this method, MPI  
5 automatically selects the correct data size (e.g., 4 or 8 bytes) and provides representation  
6 conversion in heterogeneous environments. The second method (see “Support for size-  
7 specific MPI Datatypes” on page 806) gives the user complete control over communication  
8 by exposing machine representations.

### 10 Parameterized Datatypes with Specified Precision and Exponent Range

11 MPI provides named datatypes corresponding to standard Fortran 77 numeric types:  
12 `MPI_INTEGER`, `MPI_COMPLEX`, `MPI_REAL`, `MPI_DOUBLE_PRECISION` and  
13 `MPI_DOUBLE_COMPLEX`. MPI automatically selects the correct data size and provides rep-  
14 resentation conversion in heterogeneous environments. The mechanism described in this  
15 section extends this model to support portable parameterized numeric types.

16 The model for supporting portable parameterized types is as follows. Real variables  
17 are declared (perhaps indirectly) using `selected_real_kind(p, r)` to determine the `KIND`  
18 parameter, where `p` is decimal digits of precision and `r` is an exponent range. Implicitly  
19 MPI maintains a two-dimensional array of predefined MPI datatypes  $D(p, r)$ .  $D(p, r)$  is  
20 defined for each value of  $(p, r)$  supported by the compiler, including pairs for which one  
21 value is unspecified. Attempting to access an element of the array with an index  $(p, r)$  not  
22 supported by the compiler is erroneous. MPI implicitly maintains a similar array of `COMPLEX`  
23 datatypes. For integers, there is a similar implicit array related to `selected_int_kind` and  
24 indexed by the requested number of digits `r`. Note that the predefined datatypes contained  
25 in these implicit arrays are not the same as the named MPI datatypes `MPI_REAL`, etc., but  
26 a new set.

27  
28 *Advice to implementors.* The above description is for explanatory purposes only. It  
29 is not expected that implementations will have such internal arrays. (*End of advice*  
30 *to implementors.*)

31  
32 *Advice to users.* `selected_real_kind()` maps a large number of  $(p, r)$  pairs to a  
33 much smaller number of `KIND` parameters supported by the compiler. `KIND` parameters  
34 are not specified by the language and are not portable. From the language point of  
35 view intrinsic types of the same base type and `KIND` parameter are of the same type. In  
36 order to allow interoperability in a heterogeneous environment, MPI is more stringent.  
37 The corresponding MPI datatypes match if and only if they have the same  $(p, r)$  value  
38 (`REAL` and `COMPLEX`) or `r` value (`INTEGER`). Thus MPI has many more datatypes than  
39 there are fundamental language types. (*End of advice to users.*)  
40  
41  
42  
43  
44  
45  
46  
47  
48



MPI\_TYPE\_CREATE\_F90\_REAL(p, r, newtype) 1

IN	p	precision, in decimal digits (integer)	2
IN	r	decimal exponent range (integer)	3
OUT	newtype	the requested MPI datatype (handle)	4

### C binding 6

```
int MPI_Type_create_f90_real(int p, int r, MPI_Datatype *newtype) 7
```

### Fortran 2008 binding 8

```
MPI_Type_create_f90_real(p, r, newtype, ierror) 9
  INTEGER, INTENT(IN) :: p, r 10
  TYPE(MPI_Datatype), INTENT(OUT) :: newtype 11
  INTEGER, OPTIONAL, INTENT(OUT) :: ierror 12
```

### Fortran binding 13

```
MPI_TYPE_CREATE_F90_REAL(P, R, NEWTYPE, IERROR) 14
  INTEGER P, R, NEWTYPE, IERROR 15
```

This function returns a predefined MPI datatype that matches a REAL variable of KIND selected\_real\_kind(p, r). In the model described above it returns a handle for the element D(p, r). Either p or r may be omitted from calls to selected\_real\_kind(p, r) (but not both). Analogously, either p or r may be set to MPI\_UNDEFINED. In communication, an MPI datatype A returned by MPI\_TYPE\_CREATE\_F90\_REAL matches a datatype B if and only if B was returned by MPI\_TYPE\_CREATE\_F90\_REAL called with the same values for p and r or B is a duplicate of such a datatype. Restrictions on using the returned datatype with the "external32" data representation are given on page 805. 16-25

It is erroneous to supply values for p and r not supported by the compiler. 26-27

MPI\_TYPE\_CREATE\_F90\_COMPLEX(p, r, newtype) 28

IN	p	precision, in decimal digits (integer)	29
IN	r	decimal exponent range (integer)	30
OUT	newtype	the requested MPI datatype (handle)	31

### C binding 32

```
int MPI_Type_create_f90_complex(int p, int r, MPI_Datatype *newtype) 33
```

### Fortran 2008 binding 34

```
MPI_Type_create_f90_complex(p, r, newtype, ierror) 35
  INTEGER, INTENT(IN) :: p, r 36
  TYPE(MPI_Datatype), INTENT(OUT) :: newtype 37
  INTEGER, OPTIONAL, INTENT(OUT) :: ierror 38
```

### Fortran binding 39

```
MPI_TYPE_CREATE_F90_COMPLEX(P, R, NEWTYPE, IERROR) 40
  INTEGER P, R, NEWTYPE, IERROR 41
```

This function returns a predefined MPI datatype that matches a `COMPLEX` variable of `KIND selected_real_kind(p, r)`. Either `p` or `r` may be omitted from calls to `selected_real_kind(p, r)` (but not both). Analogously, either `p` or `r` may be set to `MPI_UNDEFINED`. Matching rules for datatypes created by this function are analogous to the matching rules for datatypes created by `MPI_TYPE_CREATE_F90_REAL`. Restrictions on using the returned datatype with the "external32" data representation are given on page 805.

It is erroneous to supply values for `p` and `r` not supported by the compiler.

```
MPI_TYPE_CREATE_F90_INTEGER(r, newtype)
```

IN	r	decimal exponent range, i.e., number of decimal digits (integer)
OUT	newtype	the requested MPI datatype (handle)

### C binding

```
int MPI_Type_create_f90_integer(int r, MPI_Datatype *newtype)
```

### Fortran 2008 binding

```
MPI_Type_create_f90_integer(r, newtype, ierror)
  INTEGER, INTENT(IN) :: r
  TYPE(MPI_Datatype), INTENT(OUT) :: newtype
  INTEGER, OPTIONAL, INTENT(OUT) :: ierror
```

### Fortran binding

```
MPI_TYPE_CREATE_F90_INTEGER(R, NEWTYPE, IERROR)
  INTEGER R, NEWTYPE, IERROR
```

This function returns a predefined MPI datatype that matches an `INTEGER` variable of `KIND selected_int_kind(r)`. Matching rules for datatypes created by this function are analogous to the matching rules for datatypes created by `MPI_TYPE_CREATE_F90_REAL`. Restrictions on using the returned datatype with the "external32" data representation are given on page 805.

It is erroneous to supply a value for `r` that is not supported by the compiler.

Example:

```
integer      longtype, quadtype
integer, parameter :: long = selected_int_kind(15)
integer(long) ii(10)
real(selected_real_kind(30)) x(10)
call MPI_TYPE_CREATE_F90_INTEGER(15, longtype, ierror)
call MPI_TYPE_CREATE_F90_REAL(30, MPI_UNDEFINED, quadtype, ierror)
...

call MPI_SEND(ii, 10, longtype, ...)
call MPI_SEND(x, 10, quadtype, ...)
```

*Advice to users.* The datatypes returned by the above functions are predefined datatypes. They cannot be freed; they do not need to be committed; they can be used with predefined reduction operations. There are two situations in which they

behave differently syntactically, but not semantically, from the MPI named predefined datatypes.

1. `MPI_TYPE_GET_ENVELOPE` returns special combiners that allow a program to retrieve the values of `p` and `r`.
2. Because the datatypes are not named, they cannot be used as compile-time initializers or otherwise accessed before a call to one of the `MPI_TYPE_CREATE_F90_XXX` routines.

If a variable was declared specifying a non-default `KIND` value that was not obtained with `selected_real_kind()` or `selected_int_kind()`, the only way to obtain a matching MPI datatype is to use the size-based mechanism described in the next section. (*End of advice to users.*)

*Advice to implementors.* An application may often repeat a call to `MPI_TYPE_CREATE_F90_XXX` with the same combination of `(XXX,p,r)`. The application is not allowed to free the returned predefined, unnamed datatype handles. To prevent the creation of a potentially huge amount of handles, a high quality MPI implementation should return the same datatype handle for the same `(REAL/COMPLEX/INTEGER,p,r)` combination. Checking for the combination `(p,r)` in the preceding call to `MPI_TYPE_CREATE_F90_XXX` and using a hash table to find formerly generated handles should limit the overhead of finding a previously generated datatype with same combination of `(XXX,p,r)`. (*End of advice to implementors.*)

*Rationale.* The `MPI_TYPE_CREATE_F90_REAL/COMPLEX/INTEGER` interface needs as input the original range and precision values to be able to define useful and compiler-independent external (Section 14.5.2) or user-defined (Section 14.5.3) data representations, and in order to be able to perform automatic and efficient data conversions in a heterogeneous environment. (*End of rationale.*)

We now specify how the datatypes described in this section behave when used with the "external32" external data representation described in Section 14.5.2.

The "external32" representation specifies data formats for integer and floating point values. Integer values are represented in two's complement big-endian format. Floating point values are represented by one of three IEEE formats. These are the IEEE "Single," "Double," and "Double Extended" formats, requiring 4, 8, and 16 bytes of storage, respectively. For the IEEE "Double Extended" formats, MPI specifies a Format Width of 16 bytes, with 15 exponent bits, bias = +10383, 112 fraction bits, and an encoding analogous to the "Double" format.

The "external32" representations of the datatypes returned by `MPI_TYPE_CREATE_F90_REAL/COMPLEX/INTEGER` are given by the following rules.

For `MPI_TYPE_CREATE_F90_REAL`:

```

if      (p > 33) or (r > 4931) then  external32 representation
                                     is undefined
else if (p > 15) or (r > 307) then  external32_size = 16
else if (p > 6) or (r > 37) then   external32_size = 8
else                                  external32_size = 4

```

1 For MPI\_TYPE\_CREATE\_F90\_COMPLEX: twice the size as for  
 2 MPI\_TYPE\_CREATE\_F90\_REAL.  
 3 For MPI\_TYPE\_CREATE\_F90\_INTEGER:

```
4     if      (r > 38) then  external32 representation is undefined
5     else if (r > 18) then  external32_size = 16
6     else if (r >  9) then  external32_size =  8
7     else if (r >  4) then  external32_size =  4
8     else if (r >  2) then  external32_size =  2
9     else
10      external32_size =  1
```

11 If the "external32" representation of a datatype is undefined, the result of using the datatype  
 12 directly or indirectly (i.e., as part of another datatype or through a duplicated datatype)  
 13 in operations that require the "external32" representation is undefined. These operations in-  
 14 clude MPI\_PACK\_EXTERNAL, MPI\_UNPACK\_EXTERNAL, and many MPI\_FILE functions,  
 15 when the "external32" data representation is used. The ranges for which the "external32"  
 16 representation is undefined are reserved for future standardization.

### 18 Support for Size-specific MPI Datatypes

19 MPI provides named datatypes corresponding to optional Fortran 77 numeric types that  
 20 contain explicit byte lengths—MPI\_REAL4, MPI\_INTEGER8, etc. This section describes a  
 21 mechanism that generalizes this model to support all Fortran numeric intrinsic types.

22 We assume that for each **typeclass** (integer, real, complex) and each word size there is  
 23 a unique machine representation. For every pair (**typeclass**, **n**) supported by a compiler,  
 24 MPI must provide a named size-specific datatype. The name of this datatype is of the form  
 25 MPI\_<TYPE>n in C and Fortran where <TYPE> is one of REAL, INTEGER and COMPLEX, and  
 26 **n** is the length in bytes of the machine representation. This datatype locally matches all  
 27 variables of type (**typeclass**, **n**) in Fortran. The list of names for such types includes:

```
29 MPI_REAL4
30 MPI_REAL8
31 MPI_REAL16
32 MPI_COMPLEX8
33 MPI_COMPLEX16
34 MPI_COMPLEX32
35 MPI_INTEGER1
36 MPI_INTEGER2
37 MPI_INTEGER4
38 MPI_INTEGER8
39 MPI_INTEGER16
```

40 One datatype is required for each representation supported by the Fortran compiler.

41  
 42 *Rationale.* Particularly for the longer floating-point types, C and Fortran may use  
 43 different representations. For example, a Fortran compiler may define a 16-byte REAL  
 44 type with 33 decimal digits of precision while a C compiler may define a 16-byte long  
 45 double type that implements an 80-bit (10 byte) extended precision floating point  
 46 value. Both of these types are 16 bytes long, but they are not interoperable. Thus,  
 47 these types are defined by Fortran, even though C may define types of the same length.  
 48 (*End of rationale.*)

To be backward compatible with the interpretation of these types in MPI-1, we assume that the nonstandard declarations `REAL*n`, `INTEGER*n`, always create a variable whose representation is of size `n`. These datatypes may also be used for variables declared with `KIND=INT8/16/32/64` or `KIND=REAL32/64/128`, which are defined in the `ISO_FORTRAN_ENV` intrinsic module. Note that the MPI datatypes and the `REAL*n`, `INTEGER*n` declarations count bytes whereas the Fortran `KIND` values count bits. All these datatypes are predefined.

The following function allows a user to obtain a size-specific MPI datatype for any intrinsic Fortran type.

```
MPI_TYPE_MATCH_SIZE(typeclass, size, datatype)
```

IN	typeclass	generic type specifier (integer)
IN	size	size, in bytes, of representation (integer)
OUT	datatype	datatype with correct type, size (handle)

### C binding

```
int MPI_Type_match_size(int typeclass, int size, MPI_Datatype *datatype)
```

### Fortran 2008 binding

```
MPI_Type_match_size(typeclass, size, datatype, ierror)
  INTEGER, INTENT(IN) :: typeclass, size
  TYPE(MPI_Datatype), INTENT(OUT) :: datatype
  INTEGER, OPTIONAL, INTENT(OUT) :: ierror
```

### Fortran binding

```
MPI_TYPE_MATCH_SIZE(TYPECLASS, SIZE, DATATYPE, IERROR)
  INTEGER TYPECLASS, SIZE, DATATYPE, IERROR
```

`typeclass` is one of `MPI_TYPECLASS_REAL`, `MPI_TYPECLASS_INTEGER` and `MPI_TYPECLASS_COMPLEX`, corresponding to the desired **typeclass**. The function returns an MPI datatype matching a local variable of type (**typeclass**, **size**).

This function returns a reference (handle) to one of the predefined named datatypes, not a duplicate. This type cannot be freed. `MPI_TYPE_MATCH_SIZE` can be used to obtain a size-specific type that matches a Fortran numeric intrinsic type by first calling `storage_size()` in order to compute the variable size in bits, dividing it by eight, and then calling `MPI_TYPE_MATCH_SIZE` to find a suitable datatype. In C, one can use the C function `sizeof()` (which returns the size in bytes) instead of `storage_size()` (which returns the size in bits). In addition, for variables of default kind the variable's size can be computed by a call to `MPI_TYPE_GET_EXTENT`, if the `typeclass` is known. It is erroneous to specify a size not supported by the compiler.

*Rationale.* This is a convenience function. Without it, it can be tedious to find the correct named type. See note to implementors below. (*End of rationale.*)

*Advice to implementors.* This function could be implemented as a series of tests.

```
int MPI_Type_match_size(int typeclass, int size, MPI_Datatype *rtype)
{
  switch(typeclass) {
```

```

1      case MPI_TYPECLASS_REAL: switch(size) {
2          case 4: *rtype = MPI_REAL4; return MPI_SUCCESS;
3          case 8: *rtype = MPI_REAL8; return MPI_SUCCESS;
4          default: error(...);
5      }
6      case MPI_TYPECLASS_INTEGER: switch(size) {
7          case 4: *rtype = MPI_INTEGER4; return MPI_SUCCESS;
8          case 8: *rtype = MPI_INTEGER8; return MPI_SUCCESS;
9          default: error(...);
10     }
11     ... etc. ...
12 }
13
14     return MPI_SUCCESS;
15 }
16
17     (End of advice to implementors.)
18

```

### 19 Communication With Size-specific Types

20 The usual type matching rules apply to size-specific datatypes: a value sent with datatype  
 21 MPI\_<TYPE>n can be received with this same datatype on another process. Most modern  
 22 computers use two's complement for integers and IEEE format for floating point. Thus,  
 23 communication using these size-specific datatypes will not entail loss of precision or trun-  
 24 cation errors.

25  
 26 *Advice to users.* Care is required when communicating in a heterogeneous environ-  
 27 ment. Consider the following code:

```

28
29     real(selected_real_kind(5)) x(100)
30     size = storage_size(x) / 8
31     call MPI_TYPE_MATCH_SIZE(MPI_TYPECLASS_REAL, size, xtype, ierror)
32     if (myrank .eq. 0) then
33         ... initialize x ...
34         call MPI_SEND(x, xtype, 100, 1, ...)
35     else if (myrank .eq. 1) then
36         call MPI_RECV(x, xtype, 100, 0, ...)
37     endif
38

```

39 This may not work in a heterogeneous environment if the value of size is not the  
 40 same on process 1 and process 0. There should be no problem in a homogeneous  
 41 environment. To communicate in a heterogeneous environment, there are at least four  
 42 options. The first is to declare variables of default type and use the MPI datatypes  
 43 for these types, e.g., declare a variable of type REAL and use MPI\_REAL. The second  
 44 is to use `selected_real_kind` or `selected_int_kind` and with the functions of the  
 45 previous section. The third is to declare a variable that is known to be the same  
 46 size on all architectures (e.g., `selected_real_kind(12)` on almost all compilers will  
 47 result in an 8-byte representation). The fourth is to carefully check representation  
 48 size before communication. This may require explicit conversion to a variable of size

that can be communicated and handshaking between sender and receiver to agree on a size.

Note finally that using the "external32" representation for I/O requires explicit attention to the representation sizes. Consider the following code:

```

real(selected_real_kind(5)) x(100)
size = storage_size(x) / 8
call MPI_TYPE_MATCH_SIZE(MPI_TYPECLASS_REAL, size, xtype, ierror)

if (myrank .eq. 0) then
  call MPI_FILE_OPEN(MPI_COMM_SELF, 'foo',
                    MPI_MODE_CREATE+MPI_MODE_WRONLY,
                    MPI_INFO_NULL, fh, ierror)
  call MPI_FILE_SET_VIEW(fh, zero, xtype, xtype, 'external32',
                        MPI_INFO_NULL, ierror)
  call MPI_FILE_WRITE(fh, x, 100, xtype, status, ierror)
  call MPI_FILE_CLOSE(fh, ierror)
endif

call MPI_BARRIER(MPI_COMM_WORLD, ierror)

if (myrank .eq. 1) then
  call MPI_FILE_OPEN(MPI_COMM_SELF, 'foo', MPI_MODE_RDONLY,
                    MPI_INFO_NULL, fh, ierror)
  call MPI_FILE_SET_VIEW(fh, zero, xtype, xtype, 'external32',
                        MPI_INFO_NULL, ierror)
  call MPI_FILE_WRITE(fh, x, 100, xtype, status, ierror)
  call MPI_FILE_CLOSE(fh, ierror)
endif

```

If processes 0 and 1 are on different machines, this code may not work as expected if the size is different on the two machines. (*End of advice to users.*)

### 19.1.10 Problems With Fortran Bindings for MPI

This section discusses a number of problems that may arise when using MPI in a Fortran program. It is intended as advice to users, and clarifies how MPI interacts with Fortran. It is intended to clarify, not add to, this standard.

As noted in the original MPI specification, the interface violates the Fortran standard in several ways. While these may cause few problems for Fortran 77 programs, they become more significant for Fortran 90 programs, so that users must exercise care when using new Fortran 90 features. With Fortran 2008 and the new semantics defined in TS 29113, most violations are resolved, and this is hinted at in an addendum to each item. The violations were originally adopted and have been retained because they are important for the usability of MPI. The rest of this section describes the potential problems in detail.

The following MPI features are inconsistent with Fortran 90 and Fortran 77.

- 1 1. An MPI subroutine with a choice argument may be called with different argument  
2 types. When using the `mpi_f08` module together with a compiler that supports For-  
3 tran 2008 + TS 29113, this problem is resolved.
- 4  
5 2. An MPI subroutine with an assumed-size dummy argument may be passed an actual  
6 scalar argument. This is only solved for choice buffers through the use of  
7 `DIMENSION(...)`.
- 8  
9 3. Nonblocking and split-collective MPI routines assume that actual arguments are passed  
10 by address or descriptor and that arguments and the associated data are not copied  
11 on entrance to or exit from the subroutine. This problem is solved with the use of the  
12 `ASYNCHRONOUS` attribute.
- 13  
14 4. An MPI implementation may read or modify user data (e.g., communication buffers  
15 used by nonblocking communications) concurrently with a user program that is ex-  
16 ecuting outside of MPI calls. This problem is resolved by relying on the extended  
17 semantics of the `ASYNCHRONOUS` attribute as specified in TS 29113.
- 18  
19 5. Several named “constants,” such as `MPI_BOTTOM`, `MPI_IN_PLACE`,  
20 `MPI_STATUS_IGNORE`, `MPI_STATUSES_IGNORE`, `MPI_ERRCODES_IGNORE`,  
21 `MPI_UNWEIGHTED`, `MPI_WEIGHTS_EMPTY`, `MPI_ARGV_NULL`, and `MPI_ARGVS_NULL`  
22 are not ordinary Fortran constants and require a special implementation. See Sec-  
23 tion 2.5.4 for more information.
- 24  
25 6. The memory allocation routine `MPI_ALLOC_MEM` cannot be used from  
26 Fortran 77/90/95 without a language extension (for example, Cray pointers) that  
27 allows the allocated memory to be associated with a Fortran variable. Therefore,  
28 address sized integers were used in MPI-2.0 – MPI-2.2. In Fortran 2003,  
29 `TYPE(C_PTR)` entities were added, which allow a standard-conforming implementation  
30 of the semantics of `MPI_ALLOC_MEM`. In MPI-3.0 and later, `MPI_ALLOC_MEM` has  
31 an additional, overloaded interface to support this language feature. The use of Cray  
32 pointers is deprecated. The `mpi_f08` module only supports `TYPE(C_PTR)` pointers.

33 Additionally, MPI is inconsistent with Fortran 77 in a number of ways, as noted below.

- 34 • MPI identifiers exceed 6 characters.
- 35 • MPI identifiers may contain underscores after the first character.
- 36  
37 • MPI requires an include file, `mpif.h`. On systems that do not support include files,  
38 the implementation should specify the values of named constants.
- 39  
40 • Many routines in MPI have `KIND`-parameterized integers (e.g., `MPI_ADDRESS_KIND`  
41 and `MPI_OFFSET_KIND`) that hold address information. On systems that do not sup-  
42 port Fortran 90-style parameterized types, `INTEGER*8` or `INTEGER` should be used  
43 instead.

44 MPI-1 contained several routines that take address-sized information as input or return  
45 address-sized information as output. In C such arguments were of type  
46 `MPI_Aint` and in Fortran of type `INTEGER`. On machines where integers are smaller than  
47 addresses, these routines can lose information. In MPI-2 the use of these functions has  
48 been deprecated and they have been replaced by routines taking `INTEGER` arguments of



KIND=MPI\_ADDRESS\_KIND. A number of MPI-2 functions also take INTEGER arguments of non-default KIND. See Section 2.6 and Section 5.1.1 for more information.

Sections 19.1.11 through 19.1.19 describe several problems in detail which concern the interaction of MPI and Fortran as well as their solutions. Some of these solutions require special capabilities from the compilers. Major requirements are summarized in Section 19.1.7.

### 19.1.11 Problems Due to Strong Typing

All MPI functions with choice arguments associate actual arguments of different Fortran datatypes with the same dummy argument. This is not allowed by Fortran 77, and in Fortran 90, it is technically only allowed if the function is overloaded with a different function for each type (see also Section 19.1.6). In C, the use of `void*` formal arguments avoids these problems. Similar to C, with Fortran 2008 + TS 29113 (and later) together with the `mpi_f08` module, the problem is avoided by declaring choice arguments with `TYPE(*)`, `DIMENSION(..)`, i.e., as assumed-type and assumed-rank dummy arguments.

Using `INCLUDE 'mpif.h'`, the following code fragment is technically invalid and may generate a compile-time error.

```
integer i(5)
real    x(5)
...
call mpi_send(x, 5, MPI_REAL, ...)
call mpi_send(i, 5, MPI_INTEGER, ...)
```

In practice, it is rare for compilers to do more than issue a warning. When using either the `mpi_f08` or `mpi` module, the problem is usually resolved through the assumed-type and assumed-rank declarations of the dummy arguments, or with a compiler-dependent mechanism that overrides type checking for choice arguments.

It is also technically invalid in Fortran to pass a scalar actual argument to an array dummy argument that is not a choice buffer argument. Thus, when using the `mpi_f08` or `mpi` module, the following code fragment usually generates an error since the `dims` and `periods` arguments to `MPI_CART_CREATE` are declared as assumed size arrays `INTEGER :: DIMS(*)` and `LOGICAL :: PERIODS(*)`.

```
USE mpi_f08      ! or USE mpi
INTEGER size
CALL MPI_Cart_create(comm_old, 1, size, .TRUE., .TRUE., comm_cart, ierror)
```

Although this is a non-conforming MPI call, compiler warnings are not expected (but may occur) when using `INCLUDE 'mpif.h'` and this include file does not use Fortran explicit interfaces.

### 19.1.12 Problems Due to Data Copying and Sequence Association with Subscript Triplets

Arrays with subscript **triplets** describe Fortran subarrays with or without strides, e.g.,

```
REAL a(100,100,100)
CALL MPI_Send(a(11:17, 12:99:3, 1:100), 7*30*100, MPI_REAL, ...)
```

The handling of subscript triplets depends on the value of the constant `MPI_SUBARRAYS_SUPPORTED`:

- If `MPI_SUBARRAYS_SUPPORTED` equals `.TRUE.`:

Choice buffer arguments are declared as `TYPE(*)`, `DIMENSION(..)`. For example, consider the following code fragment:

```

REAL s(100), r(100)
CALL MPI_Isend(s(1:100:5), 3, MPI_REAL, ..., rq, ierror)
CALL MPI_Wait(rq, status, ierror)
CALL MPI_Irecv(r(1:100:5), 3, MPI_REAL, ..., rq, ierror)
CALL MPI_Wait(rq, status, ierror)

```

In this case, the individual elements `s(1)`, `s(6)`, and `s(11)` are sent between the start of `MPI_ISEND` and the end of `MPI_WAIT` even though the compiled code will not copy `s(1:100:5)` to a real contiguous temporary scratch buffer. Instead, the compiled code will pass a descriptor to `MPI_ISEND` that allows MPI to operate directly on `s(1)`, `s(6)`, `s(11)`, ..., `s(96)`. The called `MPI_ISEND` routine will take only the first three of these elements due to the type signature “3, `MPI_REAL`”.

All nonblocking MPI functions (e.g., `MPI_ISEND`, `MPI_PUT`, `MPI_FILE_WRITE_ALL_BEGIN`) behave as if *the user-specified elements of choice buffers are copied to a contiguous scratch buffer in the MPI runtime environment*. All datatype descriptions (in the example above, “3, `MPI_REAL`”) read and store data from and to this virtual contiguous scratch buffer. Displacements in MPI derived datatypes are relative to the beginning of this virtual contiguous scratch buffer. Upon completion of a nonblocking receive operation (e.g., when `MPI_WAIT` on a corresponding `MPI_Request` returns), it is as if the received data has been copied from the virtual contiguous scratch buffer back to the non-contiguous application buffer. In the example above, `r(1)`, `r(6)`, and `r(11)` are guaranteed to be defined with the received data when `MPI_WAIT` returns.

Note that the above definition does not supercede restrictions about buffers used with nonblocking operations (e.g., those specified in Section 3.7.2).

*Advice to implementors.* The Fortran descriptor for `TYPE(*)`, `DIMENSION(..)` arguments contains enough information that, if desired, the MPI library can make a real contiguous copy of non-contiguous user buffers when the nonblocking operation is started, and release this buffer not before the nonblocking communication has completed (e.g., the `MPI_WAIT` routine). Efficient implementations may avoid such additional memory-to-memory data copying. (*End of advice to implementors.*)

*Rationale.* If `MPI_SUBARRAYS_SUPPORTED` equals `.TRUE.`, non-contiguous buffers are handled inside the MPI library instead of by the compiler through argument association conventions. Therefore, the scope of MPI library scratch buffers can be from the beginning of a nonblocking operation until the completion of the operation although beginning and completion are implemented in different routines. (*End of rationale.*)

- If `MPI_SUBARRAYS_SUPPORTED` equals `.FALSE.`:

In this case, the use of Fortran arrays with subscript triplets as actual choice buffer arguments in any nonblocking MPI operation (which also includes persistent request, and split collectives) may cause undefined behavior. They may, however, be used in blocking MPI operations.

Implicit in MPI is the idea of a contiguous chunk of memory accessible through a linear address space. MPI copies data to and from this memory. An MPI program specifies the location of data by providing memory addresses and offsets. In the C language, sequence association rules plus pointers provide all the necessary low-level structure.

In Fortran, array data is not necessarily stored contiguously. For example, the array section `A(1:N:2)` involves only the elements of `A` with indices 1, 3, 5, . . . . The same is true for a pointer array whose target is such a section. Most compilers ensure that an array that is a dummy argument is held in contiguous memory if it is declared with an explicit shape (e.g., `B(N)`) or is of assumed size (e.g., `B(*)`). If necessary, they do this by making a copy of the array into contiguous memory.<sup>1</sup>

Because MPI dummy buffer arguments are assumed-size arrays if `MPI_SUBARRAYS_SUPPORTED` equals `.FALSE.`, this leads to a serious problem for a nonblocking call: the compiler copies the temporary array back on return but MPI continues to copy data to the memory that held it. For example, consider the following code fragment:

```
real a(100)
call MPI_Irecv(a(1:100:2), MPI_REAL, 50, ...)
```

Since the first dummy argument to `MPI_Irecv` is an assumed-size array (`<type> buf(*)`), the array section `a(1:100:2)` is copied to a temporary before being passed to `MPI_Irecv`, so that it is contiguous in memory. `MPI_Irecv` returns immediately, and data is copied from the temporary back into the array `a`. Sometime later, MPI may write to the address of the deallocated temporary. Copying is also a problem for `MPI_Isend` since the temporary array may be deallocated before the data has all been sent from it.

Most Fortran 90 compilers do not make a copy if the actual argument is the whole of an explicit-shape or assumed-size array or is a “simply contiguous” section such as `A(1:N)` of such an array. (“Simply contiguous” is defined in the next paragraph.) Also, many compilers treat allocatable arrays the same as they treat explicit-shape arrays in this regard (though we know of one that does not). However, the same is not true for assumed-shape and pointer arrays; since they may be discontinuous, copying is often done. It is this copying that causes problems for MPI as described in the previous paragraph.

According to the Fortran 2008 Standard, Section 6.5.4, a “simply contiguous” array section is

```
name ( [:,]... [<subscript>]:[<subscript>] [,<subscript>]... )
```

<sup>1</sup>Technically, the Fortran standard is worded to allow non-contiguous storage of any array data, unless the dummy argument has the `CONTIGUOUS` attribute.

1 That is, there are zero or more dimensions that are selected in full, then one dimension  
 2 selected without a stride, then zero or more dimensions that are selected with a simple  
 3 subscript. The compiler can detect from analyzing the source code that the array is  
 4 contiguous. Examples are

```
5
6     A(1:N), A(:,N), A(:,1:N,1), A(1:6,N), A(:, :, 1:N)
```

7  
 8 Because of Fortran’s column-major ordering, where the first index varies fastest, a  
 9 “simply contiguous” section of a contiguous array will also be contiguous.

10 The same problem can occur with a scalar argument. A compiler may make a copy of  
 11 scalar dummy arguments within a called procedure when passed as an actual argument  
 12 to a choice buffer routine. That this can cause a problem is illustrated by the example  
 13

```
14
15     real :: a
16     call user1(a,rq)
17     call MPI_WAIT(rq,status,ierr)
18     write (*,*) a
19
20     subroutine user1(buf,request)
21     call MPI_IRecv(buf,...,request,...)
22     end
23
```

24 If `a` is copied, `MPI_IRecv` will alter the copy when it completes the communication  
 25 and will not alter `a` itself.

26 Note that copying will almost certainly occur for an argument that is a non-trivial  
 27 expression (one with at least one operator or function call), a section that does not  
 28 select a contiguous part of its parent (e.g., `A(1:n:2)`), a pointer whose target is such  
 29 a section, or an assumed-shape array that is (directly or indirectly) associated with  
 30 such a section.  
 31

32 If a compiler option exists that inhibits copying of arguments, in either the calling or  
 33 called procedure, this must be employed.

34 If a compiler makes copies in the calling procedure of arguments that are explicit-  
 35 shape or assumed-size arrays, “simply contiguous” array sections of such arrays, or  
 36 scalars, and if no compiler option exists to inhibit such copying, then the compiler  
 37 cannot be used for applications that use `MPI_GET_ADDRESS`, or any nonblocking  
 38 MPI routine. If a compiler copies scalar arguments in the called procedure and there  
 39 is no compiler option to inhibit this, then this compiler cannot be used for applications  
 40 that use memory references across subroutine calls as in the example above.  
 41

### 42 19.1.13 Problems Due to Data Copying and Sequence Association with Vector Subscripts

43 Fortran arrays with **vector** subscripts describe subarrays containing a possibly irregular  
 44 set of elements  
 45

```
46
47     REAL a(100)
48     CALL MPI_Send(A((/7,9,23,81,82/)), 5, MPI_REAL, ...)
```

Fortran arrays with a vector subscript must not be used as actual choice buffer arguments in any nonblocking or split collective MPI operations. They may, however, be used in blocking MPI operations.

#### 19.1.14 Special Constants

MPI requires a number of special “constants” that cannot be implemented as normal Fortran constants, e.g., `MPI_BOTTOM`. The complete list can be found in Section 2.5.4. In C, these are implemented as constant pointers, usually as `NULL` and are used where the function prototype calls for a pointer to a variable, not the variable itself.

In Fortran, using special values for the constants (e.g., by defining them through `parameter` statements) is not possible because an implementation cannot distinguish these values from valid data. Typically these constants are implemented as predefined static variables (e.g., a variable in an MPI-declared `COMMON` block), relying on the fact that the target compiler passes data by address. Inside the subroutine, the address of the actual choice buffer argument can be compared with the address of such a predefined static variable.

These special constants also cause an exception with the usage of Fortran `INTENT`: with `USE mpi_f08`, the attributes `INTENT(IN)`, `INTENT(OUT)`, and `INTENT(INOUT)` are used in the Fortran interface. In most cases, `INTENT(IN)` is used if the C interface uses call-by-value. For all buffer arguments and for dummy arguments that may be modified and allow one of these special constants as input, an `INTENT` is not specified.

#### 19.1.15 Fortran Derived Types

MPI supports passing Fortran entities of `BIND(C)` and `SEQUENCE` derived types to choice dummy arguments, provided no type component has the `ALLOCATABLE` or `POINTER` attribute.

The following code fragment shows some possible ways to send scalars or arrays of interoperable derived type in Fortran. The example assumes that all data is passed by address.

```

type, BIND(C) :: mytype
  integer :: i
  real :: x
  double precision :: d
  logical :: l
end type mytype

type(mytype) :: foo, fooarr(5)
integer :: blocklen(4), type(4)
integer(KIND=MPI_ADDRESS_KIND) :: disp(4), base, lb, extent

call MPI_GET_ADDRESS(foo%i, disp(1), ierr)
call MPI_GET_ADDRESS(foo%x, disp(2), ierr)
call MPI_GET_ADDRESS(foo%d, disp(3), ierr)
call MPI_GET_ADDRESS(foo%l, disp(4), ierr)

base = disp(1)
disp(1) = disp(1) - base
disp(2) = disp(2) - base

```

```

1  disp(3) = disp(3) - base
2  disp(4) = disp(4) - base
3
4  blocklen(1) = 1
5  blocklen(2) = 1
6  blocklen(3) = 1
7  blocklen(4) = 1
8
9  type(1) = MPI_INTEGER
10 type(2) = MPI_REAL
11 type(3) = MPI_DOUBLE_PRECISION
12 type(4) = MPI_LOGICAL
13
14 call MPI_TYPE_CREATE_STRUCT(4, blocklen, disp, type, newtype, ierr)
15 call MPI_TYPE_COMMIT(newtype, ierr)
16
17 call MPI_SEND(foo%i, 1, newtype, dest, tag, comm, ierr)
18 ! or
19 call MPI_SEND(foo, 1, newtype, dest, tag, comm, ierr)
20 ! expects that base == address(foo%i) == address(foo)
21
22 call MPI_GET_ADDRESS(fooarr(1), disp(1), ierr)
23 call MPI_GET_ADDRESS(fooarr(2), disp(2), ierr)
24 extent = disp(2) - disp(1)
25 lb = 0
26 call MPI_TYPE_CREATE_RESIZED(newtype, lb, extent, newarrtype, ierr)
27 call MPI_TYPE_COMMIT(newarrtype, ierr)
28
29 call MPI_SEND(fooarr, 5, newarrtype, dest, tag, comm, ierr)
30

```

Using the derived type variable `foo` instead of its first basic type element `foo%i` may be impossible if the MPI library implements choice buffer arguments through overloading instead of using `TYPE(*)`, `DIMENSION(..)`, or through a non-standardized extension such as `!$PRAGMA IGNORE_TKR`; see Section 19.1.6.

To use a derived type in an array requires a correct extent of the datatype handle to take care of the alignment rules applied by the compiler. These alignment rules may imply that there are gaps between the components of a derived type, and also between the subsequent elements of an array of a derived type. The extent of an interoperable derived type (i.e., defined with `BIND(C)`) and a `SEQUENCE` derived type with the same content may be different because C and Fortran may apply different alignment rules. As recommended in the advice to users in Section 5.1.6, one should add an additional fifth structure element with one numerical storage unit at the end of this structure to force in most cases that the array of structures is contiguous. Even with such an additional element, one should keep this resizing due to the special alignment rules that can be used by the compiler for structures, as also mentioned in this advice.

Using the extended semantics defined in TS 29113, it is also possible to use entities or derived types without either the `BIND(C)` or the `SEQUENCE` attribute as choice buffer arguments; some additional constraints must be observed, e.g., no `ALLOCATABLE` or `POINTER`

type components may exist. In this case, the `base` address in the example must be changed to become the address of `foo` instead of `foo%i`, because the Fortran compiler may rearrange type components or add padding. Sending the structure `foo` should then also be performed by providing it (and not `foo%i`) as actual argument for `MPI_Send`.

### 19.1.16 Optimization Problems, an Overview

MPI provides operations that may be hidden from the user code and run concurrently with it, accessing the same memory as user code. Examples include the data transfer for an `MPI_IRECV`. The optimizer of a compiler will assume that it can recognize periods when a copy of a variable can be kept in a register without reloading from or storing to memory. When the user code is working with a register copy of some variable while the hidden operation reads or writes the memory copy, problems occur. These problems are independent of the Fortran support method; i.e., they occur with the `mpi_f08` module, the `mpi` module, and the `mpif.h` include file.

This section shows four problematic usage areas (the abbreviations in parentheses are used in the table below):

- Use of nonblocking routines or persistent requests (*Nonbl.*).
- Use of one-sided routines (*1-sided*).
- Use of MPI parallel file I/O split collective operations (*Split*).
- Use of `MPI_BOTTOM` together with absolute displacements in MPI datatypes, or relative displacements between two variables in such datatypes (*Bottom*).

The following compiler optimization strategies (valid for serial code) may cause problems in MPI applications:

- Code movement and register optimization problems; see Section 19.1.17.
- Temporary data movement and temporary memory modifications; see Section 19.1.18.
- Permanent data movement (e.g., through garbage collection); see Section 19.1.19.

Table 19.2 shows the only usage areas where these optimization problems may occur.

Optimization ...	... may cause a problem in following usage areas			
	Nonbl.	1-sided	Split	Bottom
Code movement and register optimization	yes	yes	no	yes
Temporary data movement	yes	yes	yes	no
Permanent data movement	yes	yes	yes	yes

Table 19.2: Occurrence of Fortran optimization problems in several usage areas

The solutions in the following sections are based on compromises:



- to minimize the burden for the application programmer, e.g., as shown in Sections “Solutions” through “The (Poorly Performing) Fortran VOLATILE Attribute” on pages 819–824,
- to minimize the drawbacks on compiler based optimization, and
- to minimize the requirements defined in Section 19.1.7.

### 19.1.17 Problems with Code Movement and Register Optimization

#### Nonblocking Operations

If a variable is local to a Fortran subroutine (i.e., not in a module or a `COMMON` block), the compiler will assume that it cannot be modified by a called subroutine unless it is an actual argument of the call. In the most common linkage convention, the subroutine is expected to save and restore certain registers. Thus, the optimizer will assume that a register which held a valid copy of such a variable before the call will still hold a valid copy on return.

**Example 19.1** Fortran 90 register optimization—extreme.

Source	compiled as	or compiled as
<code>REAL :: buf, b1</code>	<code>REAL :: buf, b1</code>	<code>REAL :: buf, b1</code>
<code>call MPI_Irecv(buf, ..req)</code>	<code>call MPI_Irecv(buf, ..req)</code>	<code>call MPI_Irecv(buf, ..req)</code>
	<code>register = buf</code>	<code>b1 = buf</code>
<code>call MPI_WAIT(req, ..)</code>	<code>call MPI_WAIT(req, ..)</code>	<code>call MPI_WAIT(req, ..)</code>
<code>b1 = buf</code>	<code>b1 = register</code>	

Example 19.1 shows extreme, but allowed, possibilities. `MPI_WAIT` on a concurrent thread modifies `buf` between the invocation of `MPI_Irecv` and the completion of `MPI_WAIT`. But the compiler cannot see any possibility that `buf` can be changed after `MPI_Irecv` has returned, and may schedule the load of `buf` earlier than typed in the source. The compiler has no reason to avoid using a register to hold `buf` across the call to `MPI_WAIT`. It also may reorder the instructions as illustrated in the rightmost column.

**Example 19.2** Similar example with `MPI_ISEND`

Source	compiled as	with a possible MPI-internal execution sequence
<code>REAL :: buf, copy</code>	<code>REAL :: buf, copy</code>	<code>REAL :: buf, copy</code>
<code>buf = val</code>	<code>buf = val</code>	<code>buf = val</code>
<code>call MPI_ISEND(buf, ..req)</code>	<code>call MPI_ISEND(buf, ..req)</code>	<code>addr = &amp;buf</code>
<code>copy = buf</code>	<code>copy = buf</code>	<code>copy = buf</code>
	<code>buf = val_overwrite</code>	<code>buf = val_overwrite</code>
<code>call MPI_WAIT(req, ..)</code>	<code>call MPI_WAIT(req, ..)</code>	<code>call send(*addr) ! within</code>
		<code>! MPI_WAIT</code>
<code>buf = val_overwrite</code>		

Due to valid compiler code movement optimizations in Example 19.2, the content of `buf` may already have been overwritten by the compiler when the content of `buf` is sent.



The code movement is permitted because the compiler cannot detect a possible access to `buf` in `MPI_WAIT` (or in a second thread between the start of `MPI_ISEND` and the end of `MPI_WAIT`).

Such register optimization is based on moving code; here, the access to `buf` was moved from after `MPI_WAIT` to before `MPI_WAIT`. Note that code movement may also occur across subroutine boundaries when subroutines or functions are inlined.

This register optimization/code movement problem for nonblocking operations does not occur with MPI parallel file I/O split collective operations, because in the `MPI_XXX_BEGIN` and `MPI_XXX_END` calls, the same buffer has to be provided as an actual argument. The register optimization / code movement problem for `MPI_BOTTOM` and derived MPI datatypes may occur in each blocking and nonblocking communication call, as well as in each parallel file I/O operation.

### Persistent Operations

With persistent requests, the buffer argument is hidden from the `MPI_START` and `MPI_STARTALL` calls, i.e., the Fortran compiler may move buffer accesses across the `MPI_START` or `MPI_STARTALL` call, similar to the `MPI_WAIT` call as described in the Nonblocking Operations subsection in Section 19.1.17.

### One-sided Communication

An example with instruction reordering due to register optimization can be found in Section 12.7.4.

### MPI\_BOTTOM and Combining Independent Variables in Datatypes

This section is only relevant if the MPI program uses a buffer argument to an `MPI_SEND`, `MPI_RECV`, etc., that hides the actual variables involved in the communication. `MPI_BOTTOM` with an MPI\_Datatype containing *absolute addresses* is one example. Creating a datatype which uses one variable as an anchor and brings along others by using `MPI_GET_ADDRESS` to determine their offsets from the anchor is another. The anchor variable would be the only one referenced in the call. Also attention must be paid if MPI operations are used that run in parallel with the user's application.

Example 19.3 shows what Fortran compilers are allowed to do.

In Example 19.3, the compiler does not invalidate the register because it cannot see that `MPI_RECV` changes the value of `buf`. The access to `buf` is hidden by the use of `MPI_GET_ADDRESS` and `MPI_BOTTOM`.

In Example 19.4, several successive assignments to the same variable `buf` can be combined in a way such that only the last assignment is executed. "Successive" means that no interfering load access to this variable occurs between the assignments. The compiler cannot detect that the call to `MPI_SEND` statement is interfering because the load access to `buf` is hidden by the usage of `MPI_BOTTOM`.

### Solutions

The following sections show in detail how the problems with code movement and register optimization can be portably solved. Application writers can partially or fully avoid these compiler optimization problems by using one or more of the special Fortran declarations

**Example 19.3** Fortran 90 register optimization.

<pre> 1 2 3 This source ... 4 5 call MPI_GET_ADDRESS(buf,bufaddr, 6     ierror) 7 call MPI_TYPE_CREATE_STRUCT(1,1, 8     bufaddr, 9     MPI_REAL,type,ierror) 10 call MPI_TYPE_COMMIT(type,ierror) 11 val_old = buf 12 13 call MPI_RECV(MPI_BOTTOM,1,type,...) 14 val_new = buf </pre>	<pre> can be compiled as: call MPI_GET_ADDRESS(buf,...) call MPI_TYPE_CREATE_STRUCT(...) call MPI_TYPE_COMMIT(...) register = buf val_old = register call MPI_RECV(MPI_BOTTOM,...) val_new = register </pre>
--	--

**Example 19.4** Similar example with MPI\_SEND

<pre> 18 This source ... 19 20 ! buf contains val_old 21 buf = val_new 22 call MPI_SEND(MPI_BOTTOM,1,type,...) 23 ! with buf as a displacement in type 24 25 26 27 28 29 buf = val_overwrite </pre>	<pre> can be compiled as: ! buf contains val_old call MPI_SEND(...) ! i.e. val_old is sent ! ! buf=val_new is moved to here ! and detected as dead code ! and therefore removed ! buf = val_overwrite </pre>
---	--

with the send and receive buffers used in nonblocking operations, or in operations in which MPI\_BOTTOM is used, or if datatype handles that combine several variables are used:

- Use of the Fortran `ASYNCHRONOUS` attribute.
- Use of the helper routine `MPI_F_SYNC_REG`, or an equivalent user-written dummy routine.
- Declare the buffer as a Fortran module variable or within a Fortran common block.
- Use of the Fortran `VOLATILE` attribute.

Each of these methods solves the problems of code movement and register optimization, but may incur various degrees of performance impact, and may not be usable in every application context. These methods may not be guaranteed by the Fortran standard, but they must be guaranteed by a MPI-3.0 (and later) compliant MPI library and associated compiler suite according to the requirements listed in Section 19.1.7. The performance impact of using `MPI_F_SYNC_REG` is expected to be low, that of using module variables or the `ASYNCHRONOUS` attribute is expected to be low to medium, and that of using the

VOLATILE attribute is expected to be high or very high. Note that there is one attribute that cannot be used for this purpose: the Fortran TARGET attribute does not solve code movement problems in MPI applications.

### The Fortran ASYNCHRONOUS Attribute

Declaring an actual buffer argument with the ASYNCHRONOUS Fortran attribute in a scoping unit (or BLOCK) informs the compiler that any statement in the scoping unit may be executed while the buffer is affected by a pending asynchronous Fortran input/output operation (since Fortran 2003) or by an asynchronous communication (TS 29113 extension). Without the extensions specified in TS 29113, a Fortran compiler may totally ignore this attribute if the Fortran compiler implements asynchronous Fortran input/output operations with blocking I/O. The ASYNCHRONOUS attribute protects the buffer accesses from optimizations through code movements across routine calls, and the buffer itself from temporary and permanent data movements. If the choice buffer dummy argument of a nonblocking MPI routine is declared with ASYNCHRONOUS (which is mandatory for the mpi\_f08 module, with allowable exceptions listed in Section 19.1.6), then the compiler has to guarantee call by reference and should report a compile-time error if call by reference is impossible, e.g., if vector subscripts are used. The MPI\_ASYNC\_PROTECTS\_NONBLOCKING is set to .TRUE. if both the protection of the actual buffer argument through ASYNCHRONOUS according to the TS 29113 extension and the declaration of the dummy argument with ASYNCHRONOUS in the Fortran support method is guaranteed for all nonblocking routines, otherwise it is set to .FALSE..

The ASYNCHRONOUS attribute has some restrictions. Section 5.4.2 of the TS 29113 specifies:

“Asynchronous communication for a Fortran variable occurs through the action of procedures defined by means other than Fortran. It is initiated by execution of an asynchronous communication initiation procedure and completed by execution of an asynchronous communication completion procedure. Between the execution of the initiation and completion procedures, any variable of which any part is associated with any part of the asynchronous communication variable is a pending communication affector. Whether a procedure is an asynchronous communication initiation or completion procedure is processor dependent.

Asynchronous communication is either input communication or output communication. For input communication, a pending communication affector shall not be referenced, become defined, become undefined, become associated with a dummy argument that has the VALUE attribute, or have its pointer association status changed. For output communication, a pending communication affector shall not be redefined, become undefined, or have its pointer association status changed.”

In Example 19.5 Case (a) on page 827, the read accesses to **b** within `function(b(i-1), b(i), b(i+1))` cannot be moved by compiler optimizations to before the wait call because **b** was declared as ASYNCHRONOUS. Note that only the elements 0, 1, 100, and 101 of **b** are involved in asynchronous communication but by definition, the total variable **b** is the pending communication affector and is usable for input and output asynchronous communication between the MPI\_IXXX routines and MPI\_Waitall. Case (a) works fine because the read accesses to **b** occur after the communication has completed.

In Case (b), the read accesses to `b(1:100)` in the loop `i=2,99` are read accesses to a pending communication affector while input communication (i.e., the two `MPI_Irecv` calls) is pending. This is a contradiction to the rule that *for input communication, a pending communication affector shall not be referenced*. The problem can be solved by using separate variables for the halos and the inner array, or by splitting a common array into disjoint subarrays which are passed through different dummy arguments into a subroutine, as shown in Example 19.9.

If one does not overlap communication and computation on the same variable, then all optimization problems can be solved through the `ASYNCHRONOUS` attribute.

The problems with `MPI_BOTTOM`, as shown in Example 19.3 and Example 19.4, can also be solved by declaring the buffer `buf` with the `ASYNCHRONOUS` attribute.

In some MPI routines, a buffer dummy argument is defined as `ASYNCHRONOUS` to guarantee passing by reference, provided that the actual argument is also defined as `ASYNCHRONOUS`.

### Calling `MPI_F_SYNC_REG`

The compiler may be prevented from moving a reference to a buffer across a call to an MPI subroutine by surrounding the call by calls to an external subroutine with the buffer as an actual argument. The MPI library provides the `MPI_F_SYNC_REG` routine for this purpose; see Section 19.1.8.

- The problems illustrated by the Examples 19.1 and 19.2 can be solved by calling `MPI_F_SYNC_REG(buf)` once immediately after `MPI_WAIT`.

#### Example 19.1

can be solved with

```
call MPI_IRecv(buf, ..req)

call MPI_WAIT(req, ..)
call MPI_F_SYNC_REG(buf)
b1 = buf
```

#### Example 19.2

can be solved with

```
buf = val
call MPI_ISEND(buf, ..req)
copy = buf
call MPI_WAIT(req, ..)
call MPI_F_SYNC_REG(buf)
buf = val_overwrite
```

The call to `MPI_F_SYNC_REG(buf)` prevents moving the last line before the `MPI_WAIT` call. Further calls to `MPI_F_SYNC_REG(buf)` are not needed because it is still correct if the additional read access `copy=buf` is moved below `MPI_WAIT` and before `buf=val_overwrite`.

- The problems illustrated by the Examples 19.3 and 19.4 can be solved with two additional `MPI_F_SYNC_REG(buf)` statements; one directly before `MPI_RECV/MPI_SEND`, and one directly after this communication operation.

#### Example 19.3

can be solved with

```
call MPI_F_SYNC_REG(buf)
call MPI_RECV(MPI_BOTTOM, ...)
call MPI_F_SYNC_REG(buf)
```

#### Example 19.4

can be solved with

```
call MPI_F_SYNC_REG(buf)
call MPI_SEND(MPI_BOTTOM, ...)
call MPI_F_SYNC_REG(buf)
```

The first call to `MPI_F_SYNC_REG(buf)` is needed to finish all load and store references to `buf` prior to `MPI_RECV/MPI_SEND`; the second call is needed to assure that any subsequent access to `buf` is not moved before `MPI_RECV/MPI_SEND`.

- In the example in Section 12.7.4, two asynchronous accesses must be protected: in Process 1, the access to `bbbb` must be protected similar to Example 19.1, i.e., a call to `MPI_F_SYNC_REG(bbbb)` is needed after the second `MPI_WIN_FENCE` to guarantee that further accesses to `bbbb` are not moved ahead of the call to `MPI_WIN_FENCE`. In Process 2, both calls to `MPI_WIN_FENCE` together act as a communication call with `MPI_BOTTOM` as the buffer. That is, before the first fence and after the second fence, a call to `MPI_F_SYNC_REG(buff)` is needed to guarantee that accesses to `buff` are not moved after or ahead of the calls to `MPI_WIN_FENCE`. Using `MPI_GET` instead of `MPI_PUT`, the same calls to `MPI_F_SYNC_REG` are necessary.

#### Source of Process 1

```
bbbb = 777

call MPI_WIN_FENCE
call MPI_PUT(bbbb
into buff of process 2)

call MPI_WIN_FENCE
call MPI_F_SYNC_REG(bbbb)
```

#### Source of Process 2

```
buff = 999
call MPI_F_SYNC_REG(buff)
call MPI_WIN_FENCE

call MPI_WIN_FENCE
call MPI_F_SYNC_REG(buff)
ccc = buff
```

- The temporary memory modification problem, i.e., Example 19.6, can **not** be solved with this method.

#### A User Defined Routine Instead of `MPI_F_SYNC_REG`

Instead of `MPI_F_SYNC_REG`, one can also use a user defined external subroutine, which is separately compiled:

```
subroutine DD(buf)
  integer buf
end
```

Note that if the `INTENT` is declared in an explicit interface for the external subroutine, it must be `OUT` or `INOUT`. The subroutine itself may have an empty body, but the compiler does not know this and has to assume that the buffer may be altered. For example, a call to `MPI_RECV` with `MPI_BOTTOM` as buffer might be replaced by

```
call DD(buf)
call MPI_RECV(MPI_BOTTOM,...)
call DD(buf)
```

Such a user-defined routine was introduced in MPI-2.0 and is still included here to document such usage in existing application programs although new applications should prefer `MPI_F_SYNC_REG` or one of the other possibilities. In an existing application, calls to

1 such a user-written routine should be substituted by a call to `MPI_F_SYNC_REG` because  
 2 the user-written routine may not be implemented in accordance with the rules specified in  
 3 Section 19.1.7.

#### 4 5 Module Variables and COMMON Blocks

6 An alternative to the previously mentioned methods is to put the buffer or variable into a  
 7 module or a common block and access it through a `USE` or `COMMON` statement in each scope  
 8 where it is referenced, defined or appears as an actual argument in a call to an MPI routine.  
 9 The compiler will then have to assume that the MPI procedure may alter the buffer or  
 10 variable, provided that the compiler cannot infer that the MPI procedure does not reference  
 11 the module or common block.

- 12
- 13 • This method solves problems of instruction reordering, code movement, and register  
 14 optimization related to nonblocking and one-sided communication, or related to the  
 15 usage of `MPI_BOTTOM` and derived datatype handles.
- 16
- 17 • Unfortunately, this method does **not** solve problems caused by asynchronous accesses  
 18 between the start and end of a nonblocking or one-sided communication. Specifically,  
 19 problems caused by temporary memory modifications are not solved.
- 20

#### 21 The (Poorly Performing) Fortran VOLATILE Attribute

22 The `VOLATILE` attribute gives the buffer or variable the properties needed to avoid register  
 23 optimization or code movement problems, but it may inhibit optimization of any code  
 24 containing references or definitions of the buffer or variable. On many modern systems, the  
 25 performance impact will be large because not only register, but also cache optimizations  
 26 will not be applied. Therefore, use of the `VOLATILE` attribute to enforce correct execution  
 27 of MPI programs is discouraged.

#### 28 29 30 The Fortran TARGET Attribute

31 The `TARGET` attribute does not solve the code movement problem because it is not specified  
 32 for the choice buffer dummy arguments of nonblocking routines. If the compiler detects that  
 33 the application program specifies the `TARGET` attribute for an actual buffer argument used  
 34 in the call to a nonblocking routine, the compiler may ignore this attribute if no pointer  
 35 reference to this buffer exists.

36  
37 *Rationale.* The Fortran standardization body decided to extend the `ASYNCHRONOUS`  
 38 attribute within the TS 29113 to protect buffers in nonblocking calls from all kinds of  
 39 optimization, instead of extending the `TARGET` attribute. (*End of rationale.*)

#### 40 41 19.1.18 Temporary Data Movement and Temporary Memory Modification

42 The compiler is allowed to temporarily modify data in memory. Normally, this problem  
 43 may occur only when overlapping communication and computation, as in Example 19.5,  
 44 Case (b) on page 827. Example 19.6 also shows a possibility that could be problematic.

45 In the compiler-generated, possible optimization in Example 19.7, `buf(100,100)` from  
 46 Example 19.6 is equivalenced with the 1-dimensional array `buf_1dim(10000)`. The nonblock-  
 47 ing receive may asynchronously receive the data in the boundary `buf(1,1:100)` while the fused  
 48



loop is temporarily using this part of the buffer. When the `tmp` data is written back to `buf`, the previous data of `buf(1,1:100)` is restored and the received data is lost. The principle behind this optimization is that the receive buffer data `buf(1,1:100)` was temporarily moved to `tmp`.

Example 19.8 shows a second possible optimization. The whole array is temporarily moved to `local_buf`.

When storing `local_buf` back to the original location `buf`, then this implies overwriting the section of `buf` that serves as a receive buffer in the nonblocking MPI call, i.e., this storing back of `local_buf` is therefore likely to interfere with asynchronously received data in `buf(1,1:100)`.

Note that this problem may also occur:

- With the local buffer at the origin process, between an RMA communication call and the ensuing synchronization call; see Chapter 12.
- With the window buffer at the target process between two ensuing RMA synchronization calls.
- With the local buffer in MPI parallel file I/O split collective operations between the `MPI_XXX_BEGIN` and `MPI_XXX_END` calls; see Section 14.4.5.

As already mentioned in subsection *The Fortran ASYNCHRONOUS attribute* on page 821 of Section 19.1.17, the `ASYNCHRONOUS` attribute can prevent compiler optimization with temporary data movement, but only if the receive buffer and the local references are separated into different variables, as shown in Example 19.9 and in Example 19.10.

Note also that the methods

- calling `MPI_F_SYNC_REG` (or such a user-defined routine),
- using module variables and `COMMON` blocks, and
- the `TARGET` attribute

cannot be used to prevent such temporary data movement. These methods influence compiler optimization when library routines are called. They cannot prevent the optimizations of the code fragments shown in Example 19.6 and 19.7.

Note also that compiler optimization with temporary data movement should **not** be prevented by declaring `buf` as `VOLATILE` because the `VOLATILE` implies that all accesses to any storage unit (word) of `buf` must be directly done in the main memory exactly in the sequence defined by the application program. The `VOLATILE` attribute prevents all register and cache optimizations. Therefore, `VOLATILE` may cause a huge performance degradation.

Instead of solving the problem, it is better to **prevent** the problem: when overlapping communication and computation, the nonblocking communication (or nonblocking or split collective I/O) and the computation should be executed **on different variables**, and the communication should be *protected* with the `ASYNCHRONOUS` attribute. In this case, the temporary memory modifications are done only on the variables used in the computation and cannot have any side effect on the data used in the nonblocking MPI operations.

*Rationale.* This is a strong restriction for application programs. To weaken this restriction, a new or modified asynchronous feature in the Fortran language would be necessary: an asynchronous attribute that can be used on parts of an array and

1 together with asynchronous operations outside the scope of Fortran. If such a feature  
2 becomes available in a future edition of the Fortran standard, then this restriction  
3 also may be weakened in a later version of the MPI standard. (*End of rationale.*)  
4

5 In Example 19.9 (which is a solution for the problem shown in Example 19.5 and  
6 in Example 19.10 (which is a solution for the problem shown in Example 19.8), the ar-  
7 ray is split into inner and halo part and both disjoint parts are passed to a subroutine  
8 `separated_sections`. This routine overlaps the receiving of the halo data and the calcu-  
9 lations on the inner part of the array. In a second step, the whole array is used to do the  
10 calculation on the elements where inner+halo is needed. Note that the halo and the inner  
11 area are strided arrays. Those can be used in nonblocking communication only with a TS  
12 29113 based MPI library.  
13

#### 14 19.1.19 Permanent Data Movement

15 A Fortran compiler may implement permanent data movement during the execution of a  
16 Fortran program. This would require that pointers to such data are appropriately updated.  
17 An implementation with automatic garbage collection is one use case. Such permanent data  
18 movement is in conflict with MPI in several areas:  
19

- 20 • MPI datatype handles with absolute addresses in combination with `MPI_BOTTOM`.
- 21
- 22 • All nonblocking MPI operations if the internally used pointers to the buffers are not  
23 updated by the Fortran runtime, or if within an MPI process, the data movement is  
24 executed in parallel with the MPI operation.  
25

26 This problem can be also solved by using the `ASYNCHRONOUS` attribute for such buffers.  
27 This MPI standard requires that the problems with permanent data movement do not  
28 occur by imposing suitable restrictions on the MPI library together with the compiler used;  
29 see Section 19.1.7.  
30

#### 31 19.1.20 Comparison with C

32 In C, subroutines which modify variables that are not in the argument list will not cause  
33 register optimization problems. This is because taking pointers to storage objects by using  
34 the `&` operator and later referencing the objects by indirection on the pointer is an integral  
35 part of the language. A C compiler understands the implications, so that the problem should  
36 not occur, in general. However, some compilers do offer optional aggressive optimization  
37 levels which may not be safe. Problems due to temporary memory modifications can also  
38 occur in C. As above, the best advice is to avoid the problem: use different variables for  
39 buffers in nonblocking MPI operations and computation that is executed while a nonblocking  
40 operation is pending.  
41  
42  
43  
44  
45  
46  
47  
48



**Example 19.5** Protecting nonblocking communication with the ASYNCHRONOUS attribute.

```

USE mpi_f08
REAL, ASYNCHRONOUS :: b(0:101) ! elements 0 and 101 are halo cells
REAL :: bnew(0:101)           ! elements 1 and 100 are newly computed
TYPE(MPI_Request) :: req(4)
INTEGER :: left, right, i
CALL MPI_Cart_shift(...,left,right,...)
CALL MPI_Irecv(b( 0), ..., left, ..., req(1), ...)
CALL MPI_Irecv(b(101), ..., right, ..., req(2), ...)
CALL MPI_Isend(b( 1), ..., left, ..., req(3), ...)
CALL MPI_Isend(b(100), ..., right, ..., req(4), ...)

#ifdef WITHOUT_OVERLAPPING_COMMUNICATION_AND_COMPUTATION
! Case (a)
CALL MPI_Waitall(4, req, ...)
DO i=1,100 ! compute all new local data
  bnew(i) = function(b(i-1), b(i), b(i+1))
END DO
#endif

#ifdef WITH_OVERLAPPING_COMMUNICATION_AND_COMPUTATION
! Case (b)
DO i=2,99 ! compute only elements for which halo data is not needed
  bnew(i) = function(b(i-1), b(i), b(i+1))
END DO
CALL MPI_Waitall(4, req, ...)
i=1 ! compute leftmost element
  bnew(i) = function(b(i-1), b(i), b(i+1))
i=100 ! compute rightmost element
  bnew(i) = function(b(i-1), b(i), b(i+1))
#endif

```

**Example 19.6** Overlapping Communication and Computation.

```

USE mpi_f08
REAL :: buf(100,100)
CALL MPI_Irecv(buf(1,1:100),..., req,...)
DO j=1,100
  DO i=2,100
    buf(i,j)=...
  END DO
END DO
CALL MPI_Wait(req,...)

```

**Example 19.7** The compiler may substitute the nested loops through loop fusion.

```
1
2
3 REAL :: buf(100,100), buf_1dim(10000)
4 EQUIVALENCE (buf(1,1), buf_1dim(1))
5 CALL MPI_Irecv(buf(1,1:100),..., req,...)
6 tmp(1:100) = buf(1,1:100)
7 DO j=1,10000
8   buf_1dim(h)=...
9 END DO
10 buf(1,1:100) = tmp(1:100)
11 CALL MPI_Wait(req,...)
12
13
14
15
16
17
18
19
20
21
22
23
24
25
26
27
```

**Example 19.8** Another optimization is based on the usage of a separate memory storage area, e.g., in a GPU.

```
28
29
30 REAL :: buf(100,100), local_buf(100,100)
31 CALL MPI_Irecv(buf(1,1:100),..., req,...)
32 local_buf = buf
33 DO j=1,100
34   DO i=2,100
35     local_buf(i,j)=...
36   END DO
37 END DO
38 buf = local_buf ! may overwrite asynchronously received
39                 ! data in buf(1,1:100)
40 CALL MPI_Wait(req,...)
41
42
43
44
45
46
47
48
```

**Example 19.9** Using separated variables for overlapping communication and computation to allow the protection of nonblocking communication with the `ASYNCHRONOUS` attribute.

```

USE mpi_f08
REAL :: b(0:101)      ! elements 0 and 101 are halo cells
REAL :: bnew(0:101)  ! elements 1 and 100 are newly computed
INTEGER :: i
CALL separated_sections(b(0), b(1:100), b(101), bnew(0:101))
i=1 ! compute leftmost element
  bnew(i) = function(b(i-1), b(i), b(i+1))
i=100 ! compute rightmost element
  bnew(i) = function(b(i-1), b(i), b(i+1))
END

SUBROUTINE separated_sections(b_lefthalo, b_inner, b_righthalo, bnew)
USE mpi_f08
REAL, ASYNCHRONOUS :: b_lefthalo(0:0), b_inner(1:100), b_righthalo(101:101)
REAL :: bnew(0:101) ! elements 1 and 100 are newly computed
TYPE(MPI_Request) :: req(4)
INTEGER :: left, right, i
CALL MPI_Cart_shift(...,left, right,...)
CALL MPI_Irecv(b_lefthalo ( 0), ..., left, ..., req(1), ...)
CALL MPI_Irecv(b_righthalo(101), ..., right, ..., req(2), ...)
! b_lefthalo and b_righthalo is written asynchronously.
! There is no other concurrent access to b_lefthalo and b_righthalo.
CALL MPI_Isend(b_inner( 1), ..., left, ..., req(3), ...)
CALL MPI_Isend(b_inner(100), ..., right, ..., req(4), ...)

DO i=2,99 ! compute only elements for which halo data is not needed
  bnew(i) = function(b_inner(i-1), b_inner(i), b_inner(i+1))
  ! b_inner is read and sent at the same time.
  ! This is allowed based on the rules for ASYNCHRONOUS.
END DO
CALL MPI_Waitall(4, req,...)
END SUBROUTINE

```

1 **Example 19.10** Protecting GPU optimizations with the `ASYNCHRONOUS` attribute.  
2

```
3 USE mpi_f08  
4 REAL :: buf(100,100)  
5 CALL separated_sections(buf(1:1,1:100), buf(2:100,1:100))  
6 END
```

```
7  
8 SUBROUTINE separated_sections(buf_halo, buf_inner)  
9 REAL, ASYNCHRONOUS :: buf_halo(1:1,1:100)  
10 REAL :: buf_inner(2:100,1:100)  
11 REAL :: local_buf(2:100,100)
```

```
12  
13 CALL MPI_Irecv(buf_halo(1,1:100),..., req,...)  
14 local_buf = buf_inner  
15 DO j=1,100  
16   DO i=2,100  
17     local_buf(i,j)=...  
18   END DO  
19 END DO  
20 buf_inner = local_buf ! buf_halo is not touched!!!
```

```
21  
22 CALL MPI_Wait(req,...)  
23  
24  
25  
26  
27  
28  
29  
30  
31  
32  
33  
34  
35  
36  
37  
38  
39  
40  
41  
42  
43  
44  
45  
46  
47  
48
```

## 19.2 Support for Large Count and Large Byte Displacement in MPI Language Bindings

The following types, which were used prior to MPI-4.0, have been deemed too small to hold values that applications wish to use:

- The C `int` type and the Fortran `INTEGER` type were used for *count* parameters.
- The C `int` type and the Fortran `INTEGER` type were used for some parameters that represent *byte displacement* in memory.
- The C `MPI_Aint` type and the Fortran `INTEGER(KIND=MPI_ADDRESS_KIND)` type were used for some parameters that represent *byte displacement* in files (e.g., in constructors of MPI datatypes that can be used with files).

In order to avoid breaking backwards compatibility, this version of MPI supports larger types via separate additional MPI procedures in C (suffixed with “\_c”) and via interface polymorphism in Fortran when using `USE mpi_f08`. No polymorphic support for larger types is provided in Fortran when using `mpif.h` and `use mpi`.

For the large count versions of three datatype constructors, `MPI_TYPE_CREATE_HINDEXED`, `MPI_TYPE_CREATE_HINDEXED_BLOCK`, and `MPI_TYPE_CREATE_STRUCT`, absolute addresses shall not be used to specify byte displacements since the parameter is of type `MPI_COUNT` instead of type `MPI_AINT` (see Section 2.5.8).

In addition, the functions `MPI_TYPE_GET_ENVELOPE` and `MPI_TYPE_GET_CONTENTS` also support large count types via *additional parameters* in separate additional MPI procedures in C (suffixed with “\_c”) and interface polymorphism in Fortran when using `USE mpi_f08` (see Section 5.1.13).

Further, the callbacks `MPI_USER_FUNCTION` and `MPI_DATAREP_CONVERSION_FUNCTION` also support large count types via separate additional callback prototypes in C (suffixed with “\_c”) and multiple abstract interfaces in Fortran when using `USE mpi_f08` (see Sections 6.9.5 and 14.5.3, respectively).

In C bindings, for each MPI procedure that had at least one *count* or *byte displacement* parameter that used the `int` and/or `MPI_Aint` types prior to MPI-4.0, an additional MPI procedure is provided, with the same name but suffixed by “\_c”. The MPI procedure without the “\_c” token has the same name and parameter types as versions prior to MPI-4.0. The “\_c” suffixed MPI procedure has `MPI_Count` for all *count* parameters, `MPI_Aint` for parameters that represent *byte displacement* in memory, `MPI_Offset` for parameters that represent *byte displacement* in files, and `MPI_Count` for parameters that may represent *byte displacement* in both memory and files.

In Fortran, when using `USE mpi_f08`, for each MPI procedure that had at least one *count* or *byte displacement* parameter that used the `INTEGER` or `INTEGER(KIND=MPI_ADDRESS_KIND)` types prior to MPI-4.0, a polymorphic interface containing two specific procedures is provided. One of the specific procedures has the same name and dummy parameter types as in versions prior to MPI-4.0. `INTEGER` and/or `INTEGER(KIND=MPI_ADDRESS_KIND)` for *count* and *byte displacement* parameters. The other specific procedure has the same name followed by “\_c”, and then suffixed by the token specified in Table 19.1 for `USE mpi_f08`. It also has `INTEGER(KIND=MPI_COUNT_KIND)` for all *count* parameters, `INTEGER(KIND=MPI_ADDRESS_KIND)` for parameters that represent *byte displacement* in memory, `INTEGER(KIND=MPI_OFFSET_KIND)` for parameters that

1 represent *byte displacement* in files, and `INTEGER(KIND=MPI_COUNT_KIND)` for param-  
 2 eters that may represent *byte displacement* in both memory and files (for more details  
 3 on specific Fortran procedure names and related calling conventions, refer to Table 19.1  
 4 in Section 19.1.5). There is one exception: if the type signatures of the two specific  
 5 procedures are identical (e.g., if `INTEGER(KIND=MPI_COUNT_KIND)` is the same type as  
 6 `INTEGER(KIND=MPI_ADDRESS_KIND)`), then the implementation shall not provide the “\_c”  
 7 specific procedure.

8 It is erroneous to directly invoke the “\_c” specific procedures in the Fortran `mpi_f08`  
 9 module with the exception of the following procedures: `MPI_Op_create_c` and  
 10 `MPI_Register_datarep_c`.

11 In older Fortran bindings (`mpif.h` and `use mpi`), no new interfaces and no new specific  
 12 procedures for larger types are provided beyond what existed in MPI-4.0; all MPI procedures  
 13 have the same types as in the versions prior to MPI-4.0.

## 15 19.3 Language Interoperability

### 17 19.3.1 Introduction

19 It is not uncommon for library developers to use one language to develop an application  
 20 library that may be called by an application program written in a different language. MPI  
 21 currently supports ISO (previously ANSI) C and Fortran bindings. It should be possible  
 22 for applications in any of the supported languages to call MPI-related functions in another  
 23 language.

24 Moreover, MPI allows the development of client-server code, with MPI communication  
 25 used between a parallel client and a parallel server. It should be possible to code the server  
 26 in one language and the clients in another language. To do so, communications should be  
 27 possible between applications written in different languages.

28 There are several issues that need to be addressed in order to achieve interoperability.

29 **Initialization** We need to specify how the MPI environment is initialized for all languages.

31 **Interlanguage passing of MPI opaque objects** We need to specify how MPI object  
 32 handles are passed between languages. We also need to specify what happens when  
 33 an MPI object is accessed in one language, to retrieve information (e.g., attributes)  
 34 set in another language.

36 **Interlanguage communication** We need to specify how messages sent in one language  
 37 can be received in another language.

38 It is highly desirable that the solution for interlanguage interoperability be extensible  
 39 to new languages, should MPI bindings be defined for such languages.

### 41 19.3.2 Assumptions

43 We assume that conventions exist for programs written in one language to call routines  
 44 written in another language. These conventions specify how to link routines in different  
 45 languages into one program, how to call functions in a different language, how to pass  
 46 arguments between languages, and the correspondence between basic datatypes in different  
 47 languages. In general, these conventions will be implementation dependent. Furthermore,  
 48 not every basic datatype may have a matching type in other languages. For example,

C character strings may not be compatible with Fortran CHARACTER variables. However, we assume that a Fortran INTEGER, as well as a (sequence associated) Fortran array of INTEGERS, can be passed to a C program. We also assume that Fortran and C have address-sized integers. This does not mean that the default-size integers are the same size as default-sized pointers, but only that there is some way to hold (and pass) a C address in a Fortran integer. It is also assumed that INTEGER(KIND=MPI\_OFFSET\_KIND) can be passed from Fortran to C as MPI\_Offset.

### 19.3.3 Initialization

A call to MPI\_INIT or MPI\_INIT\_THREAD, from any language, initializes MPI for execution in all languages.

*Advice to users.* Certain implementations use the (inout) argc, argv arguments of the C version of MPI\_INIT in order to propagate values for argc and argv to all executing processes. Use of the Fortran version of MPI\_INIT to initialize MPI may result in a loss of this ability. (*End of advice to users.*)

The function MPI\_INITIALIZED returns the same answer in all languages.

The function MPI\_FINALIZE finalizes the MPI environments for all languages.

The function MPI\_FINALIZED returns the same answer in all languages.

The function MPI\_ABORT kills processes, irrespective of the language used by the caller or by the processes killed.

The MPI environment is initialized in the same manner for all languages by MPI\_INIT. E.g., MPI\_COMM\_WORLD carries the same information regardless of language: same processes, same environmental attributes, same error handlers.

Information can be added to info objects in one language and retrieved in another.

*Advice to users.* The use of several languages in one MPI program may require the use of special options at compile and/or link time. (*End of advice to users.*)

*Advice to implementors.* Implementations may selectively link language specific MPI libraries only to codes that need them, so as not to increase the size of binaries for codes that use only one language. The MPI initialization code need perform initialization for a language only if that language library is loaded. (*End of advice to implementors.*)

### 19.3.4 Transfer of Handles

Handles are passed between Fortran and C by using an explicit C wrapper to convert Fortran handles to C handles. There is no direct access to C handles in Fortran.

The type definition MPI\_Fint is provided in C for an integer of the size that matches a Fortran INTEGER; usually, MPI\_Fint will be equivalent to int. With the Fortran mpi module or the mpif.h include file, a Fortran handle is a Fortran INTEGER value that can be used in the following conversion functions. With the Fortran mpi\_f08 module, a Fortran handle is a BIND(C) derived type that contains an INTEGER component named MPI\_VAL. This INTEGER value can be used in the following conversion functions.

The following functions are provided in C to convert from a Fortran communicator handle (which is an integer) to a C communicator handle, and vice versa. See also Section 2.6.4.

**C binding**

```
MPI_Comm MPI_Comm_f2c(MPI_Fint comm)
```

If `comm` is a valid Fortran handle to a communicator, then `MPI_Comm_f2c` returns a valid C handle to that same communicator; if `comm = MPI_COMM_NULL` (Fortran value), then `MPI_Comm_f2c` returns a null C handle; if `comm` is an invalid Fortran handle, then `MPI_Comm_f2c` returns an invalid C handle.

```
MPI_Fint MPI_Comm_c2f(MPI_Comm comm)
```

The function `MPI_Comm_c2f` translates a C communicator handle into a Fortran handle to the same communicator; it maps a null handle into a null handle and an invalid handle into an invalid handle.

Similar functions are provided for the other types of opaque objects.

```
MPI_Datatype MPI_Type_f2c(MPI_Fint datatype)
```

```
MPI_Fint MPI_Type_c2f(MPI_Datatype datatype)
```

```
MPI_Group MPI_Group_f2c(MPI_Fint group)
```

```
MPI_Fint MPI_Group_c2f(MPI_Group group)
```

```
MPI_Request MPI_Request_f2c(MPI_Fint request)
```

```
MPI_Fint MPI_Request_c2f(MPI_Request request)
```

```
MPI_File MPI_File_f2c(MPI_Fint file)
```

```
MPI_Fint MPI_File_c2f(MPI_File file)
```

```
MPI_Win MPI_Win_f2c(MPI_Fint win)
```

```
MPI_Fint MPI_Win_c2f(MPI_Win win)
```

```
MPI_Op MPI_Op_f2c(MPI_Fint op)
```

```
MPI_Fint MPI_Op_c2f(MPI_Op op)
```

```
MPI_Info MPI_Info_f2c(MPI_Fint info)
```

```
MPI_Fint MPI_Info_c2f(MPI_Info info)
```

```
MPI_Errhandler MPI_Errhandler_f2c(MPI_Fint errhandler)
```

```
MPI_Fint MPI_Errhandler_c2f(MPI_Errhandler errhandler)
```

```
MPI_Message MPI_Message_f2c(MPI_Fint message)
```

```
MPI_Fint MPI_Message_c2f(MPI_Message message)
```

```
MPI_Session MPI_Session_f2c(MPI_Fint session)
```

```
MPI_Fint MPI_Session_c2f(MPI_Session session)
```



**Example 19.11** The example below illustrates how the Fortran MPI function `MPI_TYPE_COMMIT` can be implemented by wrapping the C MPI function `MPI_Type_commit` with a C wrapper to do handle conversions. In this example a Fortran-C interface is assumed where a Fortran function is all upper case when referred to from C and arguments are passed by addresses.

```

! FORTRAN PROCEDURE
SUBROUTINE MPI_TYPE_COMMIT(DATATYPE, IERR)
INTEGER :: DATATYPE, IERR
CALL MPI_X_TYPE_COMMIT(DATATYPE, IERR)
RETURN
END

/* C wrapper */

void MPI_X_TYPE_COMMIT(MPI_Fint *f_handle, MPI_Fint *ierr)
{
    MPI_Datatype datatype;

    datatype = MPI_Type_f2c(*f_handle);
    *ierr = (MPI_Fint)MPI_Type_commit(&datatype);
    *f_handle = MPI_Type_c2f(datatype);
    return;
}

```

The same approach can be used for all other MPI functions. The call to `MPI_XXX_f2c` (resp. `MPI_XXX_c2f`) can be omitted when the handle is an OUT (resp. IN) argument, rather than INOUT.

*Rationale.* The design here provides a convenient solution for the prevalent case, where a C wrapper is used to allow Fortran code to call a C library, or C code to call a Fortran library. The use of C wrappers is much more likely than the use of Fortran wrappers, because it is much more likely that a variable of type `INTEGER` can be passed to C, than a C handle can be passed to Fortran.

Returning the converted value as a function value rather than through the argument list allows the generation of efficient inlined code when these functions are simple (e.g., the identity). The conversion function in the wrapper does not catch an invalid handle argument. Instead, an invalid handle is passed below to the library function, which, presumably, checks its input arguments. (*End of rationale.*)

### 19.3.5 Status

The following two procedures are provided in C to convert from a Fortran (with the `mpi` module or `mpif.h`) status (which is an array of integers) to a C status (which is a structure), and vice versa. The conversion occurs on all the information in status, including that which is hidden. That is, no status information is lost in the conversion.

```
int MPI_Status_f2c(const MPI_Fint *f_status, MPI_Status *c_status)
```

1 If `f_status` is a valid Fortran status, but not the Fortran value of `MPI_STATUS_IGNORE`  
 2 or `MPI_STATUSES_IGNORE`, then `MPI_Status_f2c` returns in `c_status` a valid C status with  
 3 the same content. If `f_status` is the Fortran value of `MPI_STATUS_IGNORE` or  
 4 `MPI_STATUSES_IGNORE`, or if `f_status` is not a valid Fortran status, then the call is erroneous.

5 In C, such an `f_status` array can be defined with `MPI_Fint f_status[`  
 6 `MPI_F_STATUS_SIZE]`. Within this array, one can use in C the indexes `MPI_F_SOURCE`,  
 7 `MPI_F_TAG`, and `MPI_F_ERROR`, to access the same elements as in Fortran with `MPI_SOURCE`,  
 8 `MPI_TAG` and `MPI_ERROR`. The C indexes are 1 less than the corresponding indexes in  
 9 Fortran due to the different default array start indexes in both languages.

10 The C status has the same source, tag and error code values as the Fortran status,  
 11 and returns the same answers when queried for count, elements, and cancellation. The  
 12 conversion function may be called with a Fortran status argument that has an undefined  
 13 error field, in which case the value of the error field in the C status argument is undefined.

14 Two global variables of type `MPI_Fint*`, `MPI_F_STATUS_IGNORE` and  
 15 `MPI_F_STATUSES_IGNORE` are declared in `mpi.h`. They can be used to test, in C, whether  
 16 `f_status` is the Fortran value of `MPI_STATUS_IGNORE` or `MPI_STATUSES_IGNORE` defined in  
 17 the `mpi` module or `mpif.h`. These are global variables, not C constant expressions and  
 18 cannot be used in places where C requires constant expressions. Their value is defined only  
 19 between the calls to `MPI_INIT` and `MPI_FINALIZE` and should not be changed by user code.

20 To do the conversion in the other direction, we have the following:

```
21 int MPI_Status_c2f(const MPI_Status *c_status, MPI_Fint *f_status)
```

22  
 23 This call converts a C status into a Fortran status, and has a behavior similar to  
 24 `MPI_Status_f2c`. That is, the value of `c_status` must not be either `MPI_STATUS_IGNORE` or  
 25 `MPI_STATUSES_IGNORE`.

26  
 27 *Advice to users.* There exists no separate conversion function for arrays of statuses,  
 28 since one can simply loop through the array, converting each status with the routines  
 29 in Figure 19.1. (*End of advice to users.*)

30  
 31 *Rationale.* The handling of `MPI_STATUS_IGNORE` is required in order to layer libraries  
 32 with only a C wrapper: if the Fortran call has passed `MPI_STATUS_IGNORE`, then the  
 33 C wrapper must handle this correctly. Note that this constant need not have the  
 34 same value in Fortran and C. If `MPI_Status_f2c` were to handle `MPI_STATUS_IGNORE`,  
 35 then the type of its result would have to be `MPI_Status**`, which was considered an  
 36 inferior solution. (*End of rationale.*)

37  
 38 Using the `mpi_f08` Fortran module, a status is declared as `TYPE(MPI_Status)`. The C  
 39 type `MPI_F08_status` can be used to pass a Fortran `TYPE(MPI_Status)` argument into a C  
 40 routine. Figure 19.1 illustrates all status conversion routines. Some are only available in  
 41 C, some in both C and the Fortran `mpi` and `mpi_f08` interfaces (but not in the `mpif.h`  
 42 interface).

```
43 int MPI_Status_f082c(const MPI_F08_status *f08_status,  
44 MPI_Status *c_status)
```

45  
 46 This C routine converts a Fortran `mpi_f08` `TYPE(MPI_Status)` into a C `MPI_Status`.

```
47 int MPI_Status_c2f08(const MPI_Status *c_status,  
48 MPI_F08_status *f08_status)
```

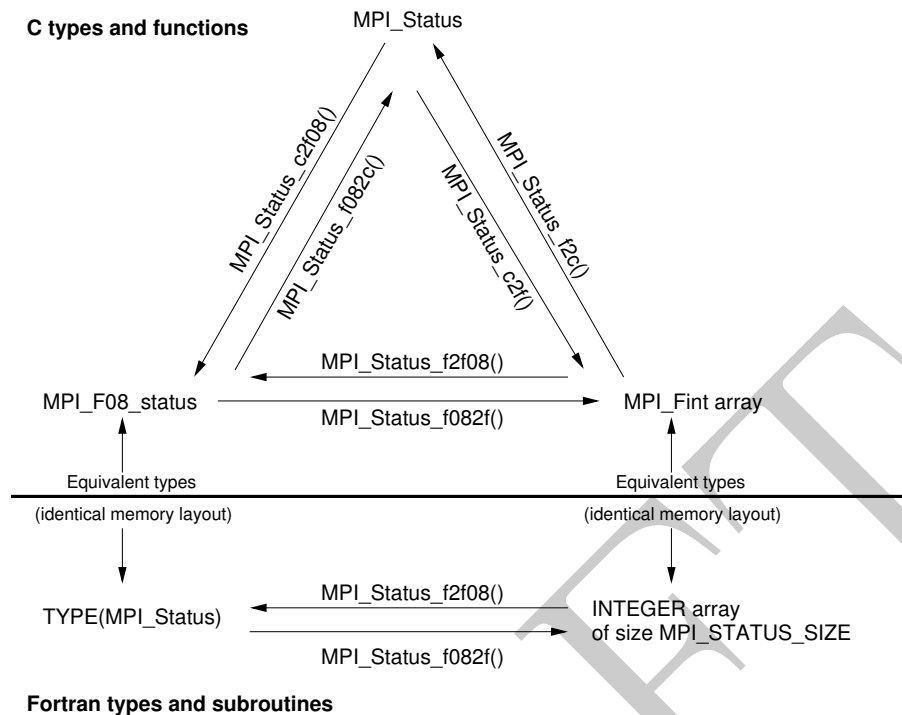

Figure 19.1: Status conversion routines

This C routine converts a C `MPI_Status` into a Fortran `mpi_f08 TYPE(MPI_Status)`. Two global variables of type `MPI_F08_status*`, `MPI_F08_STATUS_IGNORE` and `MPI_F08_STATUSES_IGNORE` are declared in `mpi.h`. They can be used to test, in C, whether `f_status` is the Fortran value of `MPI_STATUS_IGNORE` or `MPI_STATUSES_IGNORE` defined in the `mpi_f08` module. These are global variables, not C constant expressions and cannot be used in places where C requires constant expressions. Their value is defined only between the calls to `MPI_INIT` and `MPI_FINALIZE` and should not be changed by user code.

Conversion between the two Fortran versions of a status can be done with:

```
MPI_STATUS_F2F08(f_status, f08_status)
```

IN	<code>f_status</code>	status object declared as array
OUT	<code>f08_status</code>	status object declared as named type

### C binding

```
int MPI_Status_f2f08(const MPI_Fint *f_status, MPI_F08_status *f08_status)
```

### Fortran 2008 binding

```
MPI_Status_f2f08(f_status, f08_status, ierror)
  INTEGER, INTENT(IN) :: f_status(MPI_STATUS_SIZE)
  TYPE(MPI_Status), INTENT(OUT) :: f08_status
  INTEGER, OPTIONAL, INTENT(OUT) :: ierror
```

### Fortran binding (the following procedure is not available with `mpif.h`)

```
MPI_STATUS_F2F08(F_STATUS, F08_STATUS, IERROR)
```

```

1     INTEGER :: F_STATUS(MPI_STATUS_SIZE), IERROR
2     TYPE(MPI_Status) :: F08_STATUS

```

This routine converts a Fortran `INTEGER`, `DIMENSION(MPI_STATUS_SIZE)` status array into a Fortran `mpi_f08` `TYPE(MPI_Status)`.

```

7 MPI_STATUS_F082F(f08_status, f_status)

```

```

9     IN     f08_status      status object declared as named type
10    OUT    f_status       status object declared as array

```

### C binding

```

13 int MPI_Status_f082f(const MPI_F08_status *f08_status, MPI_Fint *f_status)

```

### Fortran 2008 binding

```

16 MPI_Status_f082f(f08_status, f_status, ierror)
17     TYPE(MPI_Status), INTENT(IN) :: f08_status
18     INTEGER, INTENT(OUT) :: f_status(MPI_STATUS_SIZE)
19     INTEGER, OPTIONAL, INTENT(OUT) :: ierror

```

### Fortran binding (the following procedure is not available with `mpif.h`)

```

21 MPI_STATUS_F082F(F08_STATUS, F_STATUS, IERROR)
22     TYPE(MPI_Status) :: F08_STATUS
23     INTEGER :: F_STATUS(MPI_STATUS_SIZE), IERROR

```

This routine converts a Fortran `mpi_f08` `TYPE(MPI_Status)` into a Fortran `INTEGER`, `DIMENSION(MPI_STATUS_SIZE)` status array.

## 19.3.6 MPI Opaque Objects

Unless said otherwise, opaque objects are “the same” in all languages: they carry the same information, and have the same meaning in both languages. The mechanism described in the previous section can be used to pass references to MPI objects from language to language. An object created in one language can be accessed, modified or freed in another language.

We examine below in more detail issues that arise for each type of MPI object.

### Datatypes

Datatypes encode the same information in all languages. E.g., a datatype accessor like `MPI_TYPE_GET_EXTENT` will return the same information in all languages. If a datatype defined in one language is used for a communication call in another language, then the message sent will be identical to the message that would be sent from the first language: the same communication buffer is accessed, and the same representation conversion is performed, if needed. All predefined datatypes can be used in datatype constructors in any language. If a datatype is committed, it can be used for communication in any language.

The function `MPI_GET_ADDRESS` returns the same value in all languages. Note that we do not require that the constant `MPI_BOTTOM` have the same value in all languages (see Section 19.3.9).

**Example 19.12**

```

! FORTRAN CODE
REAL :: R(5)
INTEGER :: TYPE, IERR, AOBLN(1), AOTYPE(1)
INTEGER (KIND=MPI_ADDRESS_KIND) :: AODISP(1)

! create an absolute datatype for array R
AOBLN(1) = 5
CALL MPI_GET_ADDRESS(R, AODISP(1), IERR)
AOTYPE(1) = MPI_REAL
CALL MPI_TYPE_CREATE_STRUCT(1, AOBLN, AODISP, AOTYPE, TYPE, IERR)
CALL C_ROUTINE(TYPE)

/* C code */

void C_ROUTINE(MPI_Fint *ftype)
{
    int count = 5;
    int lens[2] = {1,1};
    MPI_Aint displs[2];
    MPI_Datatype types[2], newtype;

    /* create an absolute datatype for buffer that consists
    /* of count, followed by R(5)

    MPI_Get_address(&count, &displs[0]);
    displs[1] = 0;
    types[0] = MPI_INT;
    types[1] = MPI_Type_f2c(*ftype);
    MPI_Type_create_struct(2, lens, displs, types, &newtype);
    MPI_Type_commit(&newtype);

    MPI_Send(MPI_BOTTOM, 1, newtype, 1, 0, MPI_COMM_WORLD);
    /* the message sent contains an int count of 5, followed
    /* by the 5 REAL entries of the Fortran array R.

}

```

*Advice to implementors.* The following implementation can be used: MPI addresses, as returned by `MPI_GET_ADDRESS`, will have the same value in all languages. One obvious choice is that MPI addresses be identical to regular addresses. The address is stored in the datatype, when datatypes with absolute addresses are constructed. When a send or receive operation is performed, then addresses stored in a datatype are interpreted as displacements that are all augmented by a base address. This base address is (the address of) `buf`, or zero, if `buf = MPI_BOTTOM`. Thus, if `MPI_BOTTOM` is zero then a send or receive call with `buf = MPI_BOTTOM` is implemented exactly as a call with a regular buffer argument: in both cases the base address is `buf`. On the other hand, if `MPI_BOTTOM` is not zero, then the implementation has to be slightly different. A test is performed to check whether `buf = MPI_BOTTOM`. If true, then the

1 base address is zero, otherwise it is buf. In particular, if MPI\_BOTTOM does not have  
2 the same value in Fortran and C, then an additional test for buf = MPI\_BOTTOM is  
3 needed in at least one of the languages.

4 It may be desirable to use a value other than zero for MPI\_BOTTOM even in C, so as  
5 to distinguish it from a NULL pointer. If MPI\_BOTTOM = c then one can still avoid  
6 the test buf = MPI\_BOTTOM, by using the displacement from MPI\_BOTTOM, i.e., the  
7 regular address - c, as the MPI address returned by MPI\_GET\_ADDRESS and stored  
8 in absolute datatypes. (*End of advice to implementors.*)  
9

## 10 Callback Functions

11  
12 MPI calls may associate callback functions with MPI objects: error handlers are associated  
13 with communicators, files, windows, and sessions; attribute copy and delete functions are  
14 associated with attribute keys; reduce operations are associated with operation objects, etc.  
15 In a multilanguage environment, a function passed in an MPI call in one language may be  
16 invoked by an MPI call in another language. MPI implementations must make sure that  
17 such invocation will use the calling convention of the language the function is bound to.  
18

19 *Advice to implementors.* Callback functions need to have a language tag. This  
20 tag is set when the callback function is passed in by the library function (which is  
21 presumably different for each language and language support method), and is used  
22 to generate the right calling sequence when the callback function is invoked. (*End of*  
23 *advice to implementors.*)  
24

25 *Advice to users.* If a subroutine written in one language or Fortran support method  
26 wants to pass a callback routine including the predefined Fortran functions (e.g.,  
27 MPI\_COMM\_NULL\_COPY\_FN) to another application routine written in another lan-  
28 guage or Fortran support method, then it must be guaranteed that both routines use  
29 the callback interface definition that is defined for the argument when passing the  
30 callback to an MPI routine (e.g., MPI\_COMM\_CREATE\_KEYVAL); see also the advice  
31 to users on page 365. (*End of advice to users.*)  
32

## 33 Error Handlers

34 *Advice to implementors.* Error handlers, have, in C, a variable length argument list.  
35 It might be useful to provide to the handler information on the language environment  
36 where the error occurred. (*End of advice to implementors.*)  
37

## 38 Reduce Operations

39  
40 All predefined named and unnamed datatypes as listed in Section 6.9.2 can be used in the  
41 listed predefined operations independent of the programming language from which the MPI  
42 routine is called.  
43

44 *Advice to users.* Reduce operations receive as one of their arguments the datatype  
45 of the operands. Thus, one can define “polymorphic” reduce operations that work for  
46 C and Fortran datatypes. (*End of advice to users.*)  
47  
48

### 19.3.7 Attributes

Attribute keys can be allocated in one language and freed in another. Similarly, attribute values can be set in one language and accessed in another. To achieve this, attribute keys will be allocated in an integer range that is valid all languages. The same holds true for system-defined attribute values (such as `MPI_TAG_UB`, `MPI_WTIME_IS_GLOBAL`, etc.).

Attribute keys declared in one language are associated with copy and delete functions in that language (the functions provided by the `MPI_XXX_CREATE_KEYVAL` call). When a communicator is duplicated, for each attribute, the corresponding copy function is called, using the right calling convention for the language of that function; and similarly, for the delete callback function.

*Advice to implementors.* This requires that attributes be tagged either as “C” or “Fortran” and that the language tag be checked in order to use the right calling convention for the callback function. (*End of advice to implementors.*)

The attribute manipulation functions described in Section 7.7 defines attributes arguments to be of type `void*` in C, and of type `INTEGER`, in Fortran. On some systems, `INTEGER`s will have 32 bits, while C pointers will have 64 bits. This is a problem if communicator attributes are used to move information from a Fortran caller to a C callee, or vice-versa.

MPI behaves as if it stores, internally, address sized attributes. If Fortran `INTEGER`s are smaller, then the (deprecated) Fortran function `MPI_ATTR_GET` will return the least significant part of the attribute word; the (deprecated) Fortran function `MPI_ATTR_PUT` will set the least significant part of the attribute word, which will be sign extended to the entire word. (These two functions may be invoked explicitly by user code, or implicitly, by attribute copying callback functions.)

As for addresses, new functions are provided that manipulate Fortran address sized attributes, and have the same functionality as the old functions in C. These functions are described in Section 7.7. Users are encouraged to use these new functions.

MPI supports two types of attributes: address-valued (pointer) attributes, and integer-valued attributes. C attribute functions put and get address-valued attributes. Fortran attribute functions put and get integer-valued attributes. When an integer-valued attribute is accessed from C, then `MPI_XXX_get_attr` will return the address of (a pointer to) the integer-valued attribute, which is a pointer to `MPI_Aint` if the attribute was stored with Fortran `MPI_XXX_SET_ATTR`, and a pointer to `int` if it was stored with the deprecated Fortran `MPI_ATTR_PUT`. When an address-valued attribute is accessed from Fortran, then `MPI_XXX_GET_ATTR` will convert the address into an integer and return the result of this conversion. This conversion is lossless if new style attribute functions are used, and an integer of kind `MPI_ADDRESS_KIND` is returned. The conversion may cause truncation if deprecated attribute functions are used. In C, the deprecated routines `MPI_Attr_put` and `MPI_Attr_get` behave identical to `MPI_Comm_set_attr` and `MPI_Comm_get_attr`.

#### Example 19.13

A. Setting an attribute value in C

```

1  int set_val = 3;
2  struct foo set_struct;
3
4  /* Set a value that is a pointer to an int */
5
6  MPI_Comm_set_attr(MPI_COMM_WORLD, keyval1, &set_val);
7  /* Set a value that is a pointer to a struct */
8  MPI_Comm_set_attr(MPI_COMM_WORLD, keyval2, &set_struct);
9  /* Set an integer value */
10 MPI_Comm_set_attr(MPI_COMM_WORLD, keyval3, (void *) 17);
11
12     B. Reading the attribute value in C
13
14     int flag, *get_val;
15     struct foo *get_struct;
16
17     /* Upon successful return, get_val == &set_val
18        (and therefore *get_val == 3) */
19     MPI_Comm_get_attr(MPI_COMM_WORLD, keyval1, &get_val, &flag);
20     /* Upon successful return, get_struct == &set_struct */
21     MPI_Comm_get_attr(MPI_COMM_WORLD, keyval2, &get_struct, &flag);
22     /* Upon successful return, get_val == (void*) 17 */
23     /*      i.e., (MPI_Aint) get_val == 17 */
24     MPI_Comm_get_attr(MPI_COMM_WORLD, keyval3, &get_val, &flag);
25
26     C. Reading the attribute value with (deprecated) Fortran MPI-1 calls
27
28     LOGICAL FLAG
29     INTEGER IERR, GET_VAL, GET_STRUCT
30
31     ! Upon successful return, GET_VAL == &set_val, possibly truncated
32     CALL MPI_ATTR_GET(MPI_COMM_WORLD, KEYVAL1, GET_VAL, FLAG, IERR)
33     ! Upon successful return, GET_STRUCT == &set_struct, possibly truncated
34     CALL MPI_ATTR_GET(MPI_COMM_WORLD, KEYVAL2, GET_STRUCT, FLAG, IERR)
35     ! Upon successful return, GET_VAL == 17
36     CALL MPI_ATTR_GET(MPI_COMM_WORLD, KEYVAL3, GET_VAL, FLAG, IERR)
37
38     D. Reading the attribute value with Fortran MPI-2 calls
39
40     LOGICAL FLAG
41     INTEGER IERR
42     INTEGER (KIND=MPI_ADDRESS_KIND) GET_VAL, GET_STRUCT
43
44     ! Upon successful return, GET_VAL == &set_val
45     CALL MPI_COMM_GET_ATTR(MPI_COMM_WORLD, KEYVAL1, GET_VAL, FLAG, IERR)
46     ! Upon successful return, GET_STRUCT == &set_struct
47     CALL MPI_COMM_GET_ATTR(MPI_COMM_WORLD, KEYVAL2, GET_STRUCT, FLAG, IERR)
48     ! Upon successful return, GET_VAL == 17
49     CALL MPI_COMM_GET_ATTR(MPI_COMM_WORLD, KEYVAL3, GET_VAL, FLAG, IERR)

```



**Example 19.14** A. Setting an attribute value with the (deprecated) Fortran MPI-1 call

```

INTEGER IERR, VAL
VAL = 7
CALL MPI_ATTR_PUT(MPI_COMM_WORLD, KEYVAL, VAL, IERR)

```

B. Reading the attribute value in C

```

int flag;
int *value;

/* Upon successful return, value points to internal MPI storage and
   *value == (int) 7 */
MPI_Comm_get_attr(MPI_COMM_WORLD, keyval, &value, &flag);

```

C. Reading the attribute value with (deprecated) Fortran MPI-1 calls

```

LOGICAL FLAG
INTEGER IERR, VALUE

! Upon successful return, VALUE == 7
CALL MPI_ATTR_GET(MPI_COMM_WORLD, KEYVAL, VALUE, FLAG, IERR)

```

D. Reading the attribute value with Fortran MPI-2 calls

```

LOGICAL FLAG
INTEGER IERR
INTEGER (KIND=MPI_ADDRESS_KIND) VALUE

! Upon successful return, VALUE == 7 (sign extended)
CALL MPI_COMM_GET_ATTR(MPI_COMM_WORLD, KEYVAL, VALUE, FLAG, IERR)

```

**Example 19.15** A. Setting an attribute value via a Fortran MPI-2 call

```

INTEGER IERR
INTEGER(KIND=MPI_ADDRESS_KIND) VALUE1
INTEGER(KIND=MPI_ADDRESS_KIND) VALUE2
VALUE1 = 42
VALUE2 = INT(2, KIND=MPI_ADDRESS_KIND) ** 40

CALL MPI_COMM_SET_ATTR(MPI_COMM_WORLD, KEYVAL1, VALUE1, IERR)
CALL MPI_COMM_SET_ATTR(MPI_COMM_WORLD, KEYVAL2, VALUE2, IERR)

```

B. Reading the attribute value in C

```

1  int flag;
2  MPI_Aint *value1, *value2;
3
4  /* Upon successful return, value1 points to internal MPI storage and
5     *value1 == 42 */
6  MPI_Comm_get_attr(MPI_COMM_WORLD, keyval1, &value1, &flag);
7  /* Upon successful return, value2 points to internal MPI storage and
8     *value2 == 2^40 */
9  MPI_Comm_get_attr(MPI_COMM_WORLD, keyval2, &value2, &flag);

```

10 C. Reading the attribute value with (deprecated) Fortran MPI-1 calls

```

12 LOGICAL FLAG
13 INTEGER IERR, VALUE1, VALUE2
14
15 ! Upon successful return, VALUE1 == 42
16 CALL MPI_ATTR_GET(MPI_COMM_WORLD, KEYVAL1, VALUE1, FLAG, IERR)
17 ! Upon successful return, VALUE2 == 2^40, or 0 if truncation
18 ! needed (i.e., the least significant part of the attribute word)
19 CALL MPI_ATTR_GET(MPI_COMM_WORLD, KEYVAL2, VALUE2, FLAG, IERR)
20

```

21 D. Reading the attribute value with Fortran MPI-2 calls

```

22 LOGICAL FLAG
23 INTEGER IERR
24 INTEGER (KIND=MPI_ADDRESS_KIND) VALUE1, VALUE2
25
26 ! Upon successful return, VALUE1 == 42
27 CALL MPI_COMM_GET_ATTR(MPI_COMM_WORLD, KEYVAL1, VALUE1, FLAG, IERR)
28 ! Upon successful return, VALUE2 == 2^40
29 CALL MPI_COMM_GET_ATTR(MPI_COMM_WORLD, KEYVAL2, VALUE2, FLAG, IERR)
30

```

31 The predefined MPI attributes can be integer valued or address-valued. Predefined  
32 integer valued attributes, such as `MPI_TAG_UB`, behave as if they were put by a call to  
33 the deprecated Fortran routine `MPI_ATTR_PUT`, i.e., in Fortran,  
34 `MPI_COMM_GET_ATTR(MPI_COMM_WORLD, MPI_TAG_UB, val, flag, ierr)` will return  
35 in `val` the upper bound for tag value; in C, `MPI_Comm_get_attr(MPI_COMM_WORLD,`  
36 `MPI_TAG_UB, &p, &flag)` will return in `p` a pointer to an int containing the upper bound  
37 for tag value.

38 Address-valued predefined attributes, such as `MPI_WIN_BASE` behave as if they were  
39 put by a C call, i.e., in Fortran, `MPI_WIN_GET_ATTR(win, MPI_WIN_BASE, val, flag,`  
40 `ierror)` will return in `val` the base address of the window, converted to an integer. In C,  
41 `MPI_Win_get_attr(win, MPI_WIN_BASE, &p, &flag)` will return in `p` a pointer to the window  
42 base, cast to `(void *)`.

43  
44 *Rationale.* The design is consistent with the behavior specified for predefined at-  
45 tributes, and ensures that no information is lost when attributes are passed from  
46 language to language. Because the language interoperability for predefined attributes  
47 was defined based on `MPI_ATTR_PUT`, this definition is kept for compatibility reasons  
48 although the routine itself is now deprecated. (*End of rationale.*)

*Advice to implementors.* Implementations should tag attributes either as (1) address attributes, (2) as `INTEGER(KIND=MPI_ADDRESS_KIND)` attributes or (3) as `INTEGER` attributes, according to whether they were set in (1) C (with `MPI_Attr_put` or `MPI_XXX_set_attr`), (2) in Fortran with `MPI_XXX_SET_ATTR` or (3) with the deprecated Fortran routine `MPI_ATTR_PUT`. Thus, the right choice can be made when the attribute is retrieved. (*End of advice to implementors.*)

### 19.3.8 Extra-State

Extra-state should not be modified by the copy or delete callback functions. (This is obvious from the C binding, but not obvious from the Fortran binding). However, these functions may update state that is indirectly accessed via extra-state. E.g., in C, extra-state can be a pointer to a data structure that is modified by the copy or callback functions; in Fortran, extra-state can be an index into an entry in a `COMMON` array that is modified by the copy or callback functions. In a multithreaded environment, users should be aware that distinct threads may invoke the same callback function concurrently: if this function modifies state associated with extra-state, then mutual exclusion code must be used to protect updates and accesses to the shared state.

### 19.3.9 Constants

MPI constants have the same value in all languages, unless specified otherwise. This does not apply to constant handles (`MPI_INT`, `MPI_COMM_WORLD`, `MPI_ERRORS_RETURN`, `MPI_SUM`, etc.) These handles need to be converted, as explained in Section 19.3.4. Constants that specify maximum lengths of strings (see Section A.1.1 for a listing) have a value one less in Fortran than C since in C the length includes the null terminating character. Thus, these constants represent the amount of space which must be allocated to hold the largest possible such string, rather than the maximum number of printable characters the string could contain.

*Advice to users.* This definition means that it is safe in C to allocate a buffer to receive a string using a declaration like

```
char name [MPI_MAX_OBJECT_NAME];
```

(*End of advice to users.*)

Also constant “addresses,” i.e., special values for reference arguments that are not handles, such as `MPI_BOTTOM` or `MPI_STATUS_IGNORE` may have different values in different languages.

*Rationale.* The current MPI standard specifies that `MPI_BOTTOM` can be used in initialization expressions in C, but not in Fortran. Since Fortran does not normally support call by value, then `MPI_BOTTOM` in Fortran must be the name of a predefined static variable, e.g., a variable in an MPI declared `COMMON` block. On the other hand, in C, it is natural to take `MPI_BOTTOM = 0` (Caveat: Defining `MPI_BOTTOM = 0` implies that `NULL` pointer cannot be distinguished from `MPI_BOTTOM`; it may be that `MPI_BOTTOM = 1` is better. See the advice to implementors in the *Datatypes* subsection in Section 19.3.6) Requiring that the Fortran and C values be the same will complicate the initialization process. (*End of rationale.*)

### 19.3.10 Interlanguage Communication

The type matching rules for communication in MPI are not changed: the datatype specification for each item sent should match, in type signature, the datatype specification used to receive this item (unless one of the types is MPI\_PACKED). Also, the type of a message item should match the type declaration for the corresponding communication buffer location, unless the type is MPI\_BYTE or MPI\_PACKED. Interlanguage communication is allowed if it complies with these rules.

**Example 19.16** In the example below, a Fortran array is sent from Fortran and received in C.

```

12 ! FORTRAN CODE
13 SUBROUTINE MYEXAMPLE()
14 USE mpi_f08
15 REAL :: R(5)
16 INTEGER :: IERR, MYRANK, AOBLEN(1)
17 TYPE(MPI_Datatype) :: TYPE, AOTYPE(1)
18 INTEGER (KIND=MPI_ADDRESS_KIND) :: AODISP(1)
19
20 ! create an absolute datatype for array R
21 AOBLEN(1) = 5
22 CALL MPI_GET_ADDRESS(R, AODISP(1), IERR)
23 AOTYPE(1) = MPI_REAL
24 CALL MPI_TYPE_CREATE_STRUCT(1, AOBLEN, AODISP, AOTYPE, TYPE, IERR)
25 CALL MPI_TYPE_COMMIT(TYPE, IERR)
26
27 CALL MPI_COMM_RANK(MPI_COMM_WORLD, MYRANK, IERR)
28 IF (MYRANK.EQ.0) THEN
29     CALL MPI_SEND(MPI_BOTTOM, 1, TYPE, 1, 0, MPI_COMM_WORLD, IERR)
30 ELSE
31     CALL C_ROUTINE(TYPE%MPI_VAL)
32 END IF
33 END SUBROUTINE
34
35 /* C code */
36
37 void C_ROUTINE(MPI_Fint *fhandle)
38 {
39     MPI_Datatype type;
40     MPI_Status status;
41
42     type = MPI_Type_f2c(*fhandle);
43
44     MPI_Recv(MPI_BOTTOM, 1, type, 0, 0, MPI_COMM_WORLD, &status);
45 }

```

MPI implementors may weaken these type matching rules, and allow messages to be sent with Fortran types and received with C types, and vice versa, when those types match. I.e.,

if the Fortran type `INTEGER` is identical to the C type `int`, then an MPI implementation may allow data to be sent with datatype `MPI_INTEGER` and be received with datatype `MPI_INT`. However, such code is not portable.

DRAFT

1  
2  
3  
4  
5  
6  
7  
8  
9  
10  
11  
12  
13  
14  
15  
16  
17  
18  
19  
20  
21  
22  
23  
24  
25  
26  
27  
28  
29  
30  
31  
32  
33  
34  
35  
36  
37  
38  
39  
40  
41  
42  
43  
44  
45  
46  
47  
48

1  
2  
3  
4  
5  
6  
7  
8  
9  
10  
11  
12  
13  
14  
15  
16  
17  
18  
19  
20  
21  
22  
23  
24  
25  
26  
27  
28  
29  
30  
31  
32  
33  
34  
35  
36  
37  
38  
39  
40  
41  
42  
43  
44  
45  
46  
47  
48

DRAFT

1  
2  
3  
4  
5  
6  
7  
8  
9  
10  
11  
12  
13  
14  
15  
16  
17  
18  
19  
20  
21  
22  
23  
24  
25  
26  
27  
28  
29  
30  
31  
32  
33  
34  
35  
36  
37  
38  
39  
40  
41  
42  
43  
44  
45  
46  
47  
48

## Annex A

# Language Bindings Summary

In this section we summarize the specific bindings for C and Fortran. First we present the constants, type definitions, info values and keys. Then we present the routine prototypes separately for each binding. Listings are alphabetical within chapter.

### A.1 Defined Values and Handles

#### A.1.1 Defined Constants

The C and Fortran names are listed below. Constants with the type `const int` may also be implemented as literal integer constants substituted by the preprocessor.

#### **Error classes**

---

C type: `const int` (or unnamed `enum`)

Fortran type: `INTEGER`

---

`MPI_SUCCESS`

`MPI_ERR_BUFFER`

`MPI_ERR_COUNT`

`MPI_ERR_TYPE`

`MPI_ERR_TAG`

`MPI_ERR_COMM`

`MPI_ERR_RANK`

`MPI_ERR_REQUEST`

`MPI_ERR_ROOT`

`MPI_ERR_GROUP`

`MPI_ERR_OP`

`MPI_ERR_TOPOLOGY`

`MPI_ERR_DIMS`

`MPI_ERR_ARG`

`MPI_ERR_UNKNOWN`

`MPI_ERR_TRUNCATE`

`MPI_ERR_OTHER`

`MPI_ERR_INTERN`

`MPI_ERR_PENDING`

---

(Continued on next page)

	<b>Error classes (continued)</b>
1	
2	C type: <code>const int</code> (or unnamed <code>enum</code> )
3	Fortran type: <code>INTEGER</code>
4	<hr/> MPI_ERR_IN_STATUS
5	MPI_ERR_ACCESS
6	MPI_ERR_AMODE
7	MPI_ERR_ASSERT
8	MPI_ERR_BAD_FILE
9	MPI_ERR_BASE
10	MPI_ERR_CONVERSION
11	MPI_ERR_DISP
12	MPI_ERR_DUP_DATAREP
13	MPI_ERR_FILE_EXISTS
14	MPI_ERR_FILE_IN_USE
15	MPI_ERR_FILE
16	MPI_ERR_INFO_KEY
17	MPI_ERR_INFO_NOKEY
18	MPI_ERR_INFO_VALUE
19	MPI_ERR_INFO
20	MPI_ERR_IO
21	MPI_ERR_KEYVAL
22	MPI_ERR_LOCKTYPE
23	MPI_ERR_NAME
24	MPI_ERR_NO_MEM
25	MPI_ERR_NOT_SAME
26	MPI_ERR_NO_SPACE
27	MPI_ERR_NO_SUCH_FILE
28	MPI_ERR_PORT
29	MPI_ERR_PROC_ABORTED
30	MPI_ERR_QUOTA
31	MPI_ERR_READ_ONLY
32	MPI_ERR_RMA_ATTACH
33	MPI_ERR_RMA_CONFLICT
34	MPI_ERR_RMA_RANGE
35	MPI_ERR_RMA_SHARED
36	MPI_ERR_RMA_SYNC
37	MPI_ERR_RMA_FLAVOR
38	MPI_ERR_SERVICE
39	MPI_ERR_SIZE
40	MPI_ERR_SPAWN
41	MPI_ERR_UNSUPPORTED_DATAREP
42	MPI_ERR_UNSUPPORTED_OPERATION
43	MPI_ERR_WIN
44	<hr/> (Continued on next page)
45	
46	
47	
48	



**Error classes (continued)**C type: `const int` (or unnamed `enum`)Fortran type: `INTEGER`

---

MPI\_T\_ERR\_CANNOT\_INIT

MPI\_T\_ERR\_NOT\_ACCESSIBLE

MPI\_T\_ERR\_NOT\_INITIALIZED

MPI\_T\_ERR\_NOT\_SUPPORTED

MPI\_T\_ERR\_MEMORY

MPI\_T\_ERR\_INVALID

MPI\_T\_ERR\_INVALID\_INDEX

MPI\_T\_ERR\_INVALID\_ITEM

MPI\_T\_ERR\_INVALID\_SESSION

MPI\_T\_ERR\_INVALID\_HANDLE

MPI\_T\_ERR\_INVALID\_NAME

MPI\_T\_ERR\_OUT\_OF\_HANDLES

MPI\_T\_ERR\_OUT\_OF\_SESSIONS

MPI\_T\_ERR\_CVAR\_SET\_NOT\_NOW

MPI\_T\_ERR\_CVAR\_SET\_NEVER

MPI\_T\_ERR\_PVAR\_NO\_WRITE

MPI\_T\_ERR\_PVAR\_NO\_STARTSTOP

MPI\_T\_ERR\_PVAR\_NO\_ATOMIC

---

MPI\_ERR\_LASTCODE

---

**Buffer Address Constants**C type: `void * const`Fortran type: (predefined memory location)<sup>1</sup>

---

MPI\_BOTTOM

---

MPI\_IN\_PLACE

---

<sup>1</sup> Note that in Fortran these constants are not usable for initialization expressions or assignment. See Section 2.5.4.**Assorted Constants**C type: `const int` (or unnamed `enum`)Fortran type: `INTEGER`

---

MPI\_PROC\_NULL

MPI\_ANY\_SOURCE

MPI\_ANY\_TAG

MPI\_UNDEFINED

MPI\_BSEND\_OVERHEAD

MPI\_KEYVAL\_INVALID

MPI\_LOCK\_EXCLUSIVE

MPI\_LOCK\_SHARED

---

MPI\_ROOT

---

**No Process Message Handle**C type: `MPI_Message`Fortran type: `INTEGER` or `TYPE(MPI_Message)`

---

MPI\_MESSAGE\_NO\_PROC

---

**Fortran Support Method Specific Constants**

Fortran type: LOGICAL

MPI\_SUBARRAYS\_SUPPORTED (Fortran only)

MPI\_ASYNC\_PROTECTS\_NONBLOCKING (Fortran only)

**Status array size and reserved index values (Fortran only)**

Fortran type: INTEGER

MPI\_STATUS\_SIZE

MPI\_SOURCE

MPI\_TAG

MPI\_ERROR

**Fortran status array size and reserved index values (C only)**

C type: int

MPI\_F\_STATUS\_SIZE

MPI\_F\_SOURCE

MPI\_F\_TAG

MPI\_F\_ERROR

**Variable Address Size (Fortran only)**

Fortran type: INTEGER

MPI\_ADDRESS\_KIND

MPI\_COUNT\_KIND

MPI\_INTEGER\_KIND

MPI\_OFFSET\_KIND

**Error-handling specifiers**

C type: MPI\_Errhandler

Fortran type: INTEGER or TYPE(MPI\_Errhandler)

MPI\_ERRORS\_ARE\_FATAL

MPI\_ERRORS\_RETURN

**Maximum Sizes for Strings**

C type: const int (or unnamed enum)

Fortran type: INTEGER

MPI\_MAX\_DATAREP\_STRING

MPI\_MAX\_ERROR\_STRING

MPI\_MAX\_INFO\_KEY

MPI\_MAX\_INFO\_VAL

MPI\_MAX\_LIBRARY\_VERSION\_STRING

MPI\_MAX\_OBJECT\_NAME

MPI\_MAX\_PORT\_NAME

MPI\_MAX\_PROCESSOR\_NAME

MPI\_MAX\_FROM\_GROUP\_TAG

MPI\_MAX\_PSET\_NAME\_LEN

Named Predefined Datatypes	C types	
C type: MPI_Datatype		1
Fortran type: INTEGER		2
or TYPE(MPI_Datatype)		3
MPI_CHAR	char	4
	(treated as printable character)	5
MPI_SHORT	signed short int	6
MPI_INT	signed int	7
MPI_LONG	signed long	8
MPI_LONG_LONG_INT	signed long long	9
MPI_LONG_LONG (as a synonym)	signed long long	10
MPI_SIGNED_CHAR	signed char	11
	(treated as integral value)	12
MPI_UNSIGNED_CHAR	unsigned char	13
	(treated as integral value)	14
MPI_UNSIGNED_SHORT	unsigned short	15
MPI_UNSIGNED	unsigned int	16
MPI_UNSIGNED_LONG	unsigned long	17
MPI_UNSIGNED_LONG_LONG	unsigned long long	18
MPI_FLOAT	float	19
MPI_DOUBLE	double	20
MPI_LONG_DOUBLE	long double	21
MPI_WCHAR	wchar_t	22
	(defined in <stddef.h>)	23
	(treated as printable character)	24
MPI_C_BOOL	_Bool	25
MPI_INT8_T	int8_t	26
MPI_INT16_T	int16_t	27
MPI_INT32_T	int32_t	28
MPI_INT64_T	int64_t	29
MPI_UINT8_T	uint8_t	30
MPI_UINT16_T	uint16_t	31
MPI_UINT32_T	uint32_t	32
MPI_UINT64_T	uint64_t	33
MPI_AINT	MPI_Aint	34
MPI_COUNT	MPI_Count	35
MPI_OFFSET	MPI_Offset	36
MPI_C_COMPLEX	float _Complex	37
MPI_C_FLOAT_COMPLEX	float _Complex	38
MPI_C_DOUBLE_COMPLEX	double _Complex	39
MPI_C_LONG_DOUBLE_COMPLEX	long double _Complex	40
MPI_BYTE	(any C type)	41
MPI_PACKED	(any C type)	42

Named Predefined Datatypes	Fortran types
C type: MPI_Datatype Fortran type: INTEGER or TYPE(MPI_Datatype)	
MPI_INTEGER	INTEGER
MPI_REAL	REAL
MPI_DOUBLE_PRECISION	DOUBLE PRECISION
MPI_COMPLEX	COMPLEX
MPI_LOGICAL	LOGICAL
MPI_CHARACTER	CHARACTER(1)
MPI_AINT	INTEGER (KIND=MPI_ADDRESS_KIND)
MPI_COUNT	INTEGER (KIND=MPI_COUNT_KIND)
MPI_OFFSET	INTEGER (KIND=MPI_OFFSET_KIND)
MPI_BYTE	(any Fortran type)
MPI_PACKED	(any Fortran type)

Named Predefined Datatypes <sup>1</sup>	C++ types
C type: MPI_Datatype Fortran type: INTEGER or TYPE(MPI_Datatype)	
MPI_CXX_BOOL	bool
MPI_CXX_FLOAT_COMPLEX	std::complex<float>
MPI_CXX_DOUBLE_COMPLEX	std::complex<double>
MPI_CXX_LONG_DOUBLE_COMPLEX	std::complex<long double>

<sup>1</sup> If an accompanying C++ compiler is missing, then the MPI datatypes in this table are not defined.

Optional datatypes (Fortran)	Fortran types
C type: MPI_Datatype Fortran type: INTEGER or TYPE(MPI_Datatype)	
MPI_DOUBLE_COMPLEX	DOUBLE COMPLEX
MPI_INTEGER1	INTEGER*1
MPI_INTEGER2	INTEGER*2
MPI_INTEGER4	INTEGER*4
MPI_INTEGER8	INTEGER*8
MPI_INTEGER16	INTEGER*16
MPI_REAL2	REAL*2
MPI_REAL4	REAL*4
MPI_REAL8	REAL*8
MPI_REAL16	REAL*16
MPI_COMPLEX4	COMPLEX*4
MPI_COMPLEX8	COMPLEX*8
MPI_COMPLEX16	COMPLEX*16
MPI_COMPLEX32	COMPLEX*32

<b>Datatypes for reduction functions (C)</b>	1
C type: MPI_Datatype	2
Fortran type: INTEGER or TYPE(MPI_Datatype)	3
MPI_FLOAT_INT	4
MPI_DOUBLE_INT	5
MPI_LONG_INT	6
MPI_2INT	7
MPI_SHORT_INT	8
MPI_LONG_DOUBLE_INT	9
<b>Datatypes for reduction functions (Fortran)</b>	10
C type: MPI_Datatype	11
Fortran type: INTEGER or TYPE(MPI_Datatype)	12
MPI_2REAL	13
MPI_2DOUBLE_PRECISION	14
MPI_2INTEGER	15
<b>Reserved communicators</b>	16
C type: MPI_Comm	17
Fortran type: INTEGER or TYPE(MPI_Comm)	18
MPI_COMM_WORLD	19
MPI_COMM_SELF	20
<b>Communicator split type constants</b>	21
C type: const int (or unnamed enum)	22
Fortran type: INTEGER	23
MPI_COMM_TYPE_SHARED	24
MPI_COMM_TYPE_HW_UNGUIDED	25
MPI_COMM_TYPE_HW_GUIDED	26
<b>Results of communicator and group comparisons</b>	27
C type: const int (or unnamed enum)	28
Fortran type: INTEGER	29
MPI_IDENT	30
MPI_CONGRUENT	31
MPI_SIMILAR	32
MPI_UNEQUAL	33
<b>Environmental inquiry info key</b>	34
C type: MPI_Info	35
Fortran type: INTEGER or TYPE(MPI_Info)	36
MPI_INFO_ENV	37
<b>Environmental inquiry keys</b>	38
C type: const int (or unnamed enum)	39
Fortran type: INTEGER	40
MPI_TAG_UB	41
MPI_IO	42
MPI_HOST	43
MPI_WTIME_IS_GLOBAL	44

---

**Collective Operations**

---

C type: MPI\_Op  
 Fortran type: INTEGER or TYPE(MPI\_Op)

---

MPI\_MAX  
 MPI\_MIN  
 MPI\_SUM  
 MPI\_PROD  
 MPI\_MAXLOC  
 MPI\_MINLOC  
 MPI\_BAND  
 MPI\_BOR  
 MPI\_BXOR  
 MPI\_LAND  
 MPI\_LOR  
 MPI\_LXOR  
 MPI\_REPLACE  
 MPI\_NO\_OP

---



---

**Null Handles**

---

C/Fortran name	C type / Fortran type
MPI_GROUP_NULL	MPI_Group / INTEGER or TYPE(MPI_Group)
MPI_COMM_NULL	MPI_Comm / INTEGER or TYPE(MPI_Comm)
MPI_DATATYPE_NULL	MPI_Datatype / INTEGER or TYPE(MPI_Datatype)
MPI_REQUEST_NULL	MPI_Request / INTEGER or TYPE(MPI_Request)
MPI_OP_NULL	MPI_Op / INTEGER or TYPE(MPI_Op)
MPI_ERRHANDLER_NULL	MPI_Errhandler / INTEGER or TYPE(MPI_Errhandler)
MPI_FILE_NULL	MPI_File / INTEGER or TYPE(MPI_File)
MPI_INFO_NULL	MPI_Info / INTEGER or TYPE(MPI_Info)
MPI_SESSION_NULL	MPI_Session / INTEGER
MPI_WIN_NULL	MPI_Win / INTEGER or TYPE(MPI_Win)
MPI_MESSAGE_NULL	MPI_Message / INTEGER or TYPE(MPI_Message)

---



---

**Empty group**

---

C type: MPI\_Group  
 Fortran type: INTEGER or TYPE(MPI\_Group)

---

MPI\_GROUP\_EMPTY

---

**Unofficial Draft for Comment Only**

**Topologies**

C type: <code>const int</code> (or unnamed <code>enum</code> )
Fortran type: <code>INTEGER</code>
<code>MPI_GRAPH</code>
<code>MPI_CART</code>
<code>MPI_DIST_GRAPH</code>

**Predefined functions**

C/Fortran name	
C type	
/ Fortran type with <code>mpi</code> module	/ Fortran type with <code>mpi_f08</code> module
<code>MPI_COMM_NULL_COPY_FN</code>	
<code>MPI_Comm_copy_attr_function</code>	
/ <code>COMM_COPY_ATTR_FUNCTION</code>	/ <code>PROCEDURE(MPI_Comm_copy_attr_function)</code> <sup>1)</sup>
<code>MPI_COMM_DUP_FN</code>	
<code>MPI_Comm_copy_attr_function</code>	
/ <code>COMM_COPY_ATTR_FUNCTION</code>	/ <code>PROCEDURE(MPI_Comm_copy_attr_function)</code> <sup>1)</sup>
<code>MPI_COMM_NULL_DELETE_FN</code>	
<code>MPI_Comm_delete_attr_function</code>	
/ <code>COMM_DELETE_ATTR_FUNCTION</code>	/ <code>PROCEDURE(MPI_Comm_delete_attr_function)</code> <sup>1)</sup>
<code>MPI_WIN_NULL_COPY_FN</code>	
<code>MPI_Win_copy_attr_function</code>	
/ <code>WIN_COPY_ATTR_FUNCTION</code>	/ <code>PROCEDURE(MPI_Win_copy_attr_function)</code> <sup>1)</sup>
<code>MPI_WIN_DUP_FN</code>	
<code>MPI_Win_copy_attr_function</code>	
/ <code>WIN_COPY_ATTR_FUNCTION</code>	/ <code>PROCEDURE(MPI_Win_copy_attr_function)</code> <sup>1)</sup>
<code>MPI_WIN_NULL_DELETE_FN</code>	
<code>MPI_Win_delete_attr_function</code>	
/ <code>WIN_DELETE_ATTR_FUNCTION</code>	/ <code>PROCEDURE(MPI_Win_delete_attr_function)</code> <sup>1)</sup>
<code>MPI_TYPE_NULL_COPY_FN</code>	
<code>MPI_Type_copy_attr_function</code>	
/ <code>TYPE_COPY_ATTR_FUNCTION</code>	/ <code>PROCEDURE(MPI_Type_copy_attr_function)</code> <sup>1)</sup>
<code>MPI_TYPE_DUP_FN</code>	
<code>MPI_Type_copy_attr_function</code>	
/ <code>TYPE_COPY_ATTR_FUNCTION</code>	/ <code>PROCEDURE(MPI_Type_copy_attr_function)</code> <sup>1)</sup>
<code>MPI_TYPE_NULL_DELETE_FN</code>	
<code>MPI_Type_delete_attr_function</code>	
/ <code>TYPE_DELETE_ATTR_FUNCTION</code>	/ <code>PROCEDURE(MPI_Type_delete_attr_function)</code> <sup>1)</sup>
<code>MPI_CONVERSION_FN_NULL</code>	
<code>MPI_Datarep_conversion_function</code>	
/ <code>DATAREP_CONVERSION_FUNCTION</code>	/ <code>PROCEDURE(MPI_Datarep_conversion_function)</code> <sup>1)</sup>

<sup>1)</sup> See the advice to implementors (on page 365) and advice to users (on page 365) on the predefined Fortran functions `MPI_COMM_NULL_COPY_FN`, ... in Section 7.7.2.

<b>Deprecated predefined functions</b>	
C/Fortran name	
C type / Fortran type with <code>mpi</code> module	
<b>MPI_NULL_COPY_FN</b>	
<code>MPI_Copy_function</code> / <code>COPY_FUNCTION</code>	
<b>MPI_DUP_FN</b>	
<code>MPI_Copy_function</code> / <code>COPY_FUNCTION</code>	
<b>MPI_NULL_DELETE_FN</b>	
<code>MPI_Delete_function</code> / <code>DELETE_FUNCTION</code>	

<b>Predefined Attribute Keys</b>	
C type: <code>const int</code> (or unnamed <code>enum</code> )	
Fortran type: <code>INTEGER</code>	
<b>MPI_APPNUM</b>	
<b>MPI_LASTUSED</b>	
<b>MPI_UNIVERSE_SIZE</b>	
<b>MPI_WIN_BASE</b>	
<b>MPI_WIN_DISP_UNIT</b>	
<b>MPI_WIN_SIZE</b>	
<b>MPI_WIN_CREATE_FLAVOR</b>	
<b>MPI_WIN_MODEL</b>	

<b>MPI Window Create Flavors</b>	
C type: <code>const int</code> (or unnamed <code>enum</code> )	
Fortran type: <code>INTEGER</code>	
<b>MPI_WIN_FLAVOR_CREATE</b>	
<b>MPI_WIN_FLAVOR_ALLOCATE</b>	
<b>MPI_WIN_FLAVOR_DYNAMIC</b>	
<b>MPI_WIN_FLAVOR_SHARED</b>	

<b>MPI Window Models</b>	
C type: <code>const int</code> (or unnamed <code>enum</code> )	
Fortran type: <code>INTEGER</code>	
<b>MPI_WIN_SEPARATE</b>	
<b>MPI_WIN_UNIFIED</b>	



<b>Mode Constants</b>	1
<hr/> C type: <code>const int</code> (or unnamed <code>enum</code> )	2
Fortran type: <code>INTEGER</code>	3
<hr/> MPI_MODE_APPEND	4
MPI_MODE_CREATE	5
MPI_MODE_DELETE_ON_CLOSE	6
MPI_MODE_EXCL	7
MPI_MODE_NOCHECK	8
MPI_MODE_NOPRECEDE	9
MPI_MODE_NOPUT	10
MPI_MODE_NOSTORE	11
MPI_MODE_NOSUCCEED	12
MPI_MODE_RDONLY	13
MPI_MODE_RDWR	14
MPI_MODE_SEQUENTIAL	15
MPI_MODE_UNIQUE_OPEN	16
MPI_MODE_WRONLY	17
<hr/>	18
<b>Datatype Decoding Constants</b>	19
<hr/> C type: <code>const int</code> (or unnamed <code>enum</code> )	20
Fortran type: <code>INTEGER</code>	21
<hr/> MPI_COMBINER_CONTIGUOUS	22
MPI_COMBINER_DARRAY	23
MPI_COMBINER_DUP	24
MPI_COMBINER_F90_COMPLEX	25
MPI_COMBINER_F90_INTEGER	26
MPI_COMBINER_F90_REAL	27
MPI_COMBINER_HINDEXED	28
MPI_COMBINER_HVECTOR	29
MPI_COMBINER_INDEXED_BLOCK	30
MPI_COMBINER_HINDEXED_BLOCK	31
MPI_COMBINER_INDEXED	32
MPI_COMBINER_NAMED	33
MPI_COMBINER_RESIZED	34
MPI_COMBINER_STRUCT	35
MPI_COMBINER_SUBARRAY	36
MPI_COMBINER_VECTOR	37
<hr/>	38
<b>Threads Constants</b>	39
<hr/> C type: <code>const int</code> (or unnamed <code>enum</code> )	40
Fortran type: <code>INTEGER</code>	41
<hr/> MPI_THREAD_FUNNELED	42
MPI_THREAD_MULTIPLE	43
MPI_THREAD_SERIALIZED	44
MPI_THREAD_SINGLE	45
<hr/>	46
	47
	48

**File Operation Constants, Part 1**

---

C type: `const MPI_Offset` (or unnamed `enum`)  
 Fortran type: `INTEGER (KIND=MPI_OFFSET_KIND)`

---

`MPI_DISPLACEMENT_CURRENT`

---

**File Operation Constants, Part 2**

---

C type: `const int` (or unnamed `enum`)  
 Fortran type: `INTEGER`

---

`MPI_DISTRIBUTE_BLOCK`  
`MPI_DISTRIBUTE_CYCLIC`  
`MPI_DISTRIBUTE_DFLT_DARG`  
`MPI_DISTRIBUTE_NONE`  
`MPI_ORDER_C`  
`MPI_ORDER_FORTRAN`  
`MPI_SEEK_CUR`  
`MPI_SEEK_END`  
`MPI_SEEK_SET`

---

**F90 Datatype Matching Constants**

---

C type: `const int` (or unnamed `enum`)  
 Fortran type: `INTEGER`

---

`MPI_TYPECLASS_COMPLEX`  
`MPI_TYPECLASS_INTEGER`  
`MPI_TYPECLASS_REAL`

---

**Constants Specifying Empty or Ignored Input**

---

C/Fortran name	C type / Fortran type <sup>1</sup>
<code>MPI_ARGVS_NULL</code>	<code>char***</code> / 2-dim. array of <code>CHARACTER*(*)</code>
<code>MPI_ARGV_NULL</code>	<code>char**</code> / array of <code>CHARACTER*(*)</code>
<code>MPI_ERRCODES_IGNORE</code>	<code>int*</code> / <code>INTEGER</code> array
<code>MPI_STATUSES_IGNORE</code>	<code>MPI_Status*</code> / <code>INTEGER</code> , <code>DIMENSION(MPI_STATUS_SIZE,*)</code> or <code>TYPE(MPI_Status)</code> , <code>DIMENSION(*)</code>
<code>MPI_STATUS_IGNORE</code>	<code>MPI_Status*</code> / <code>INTEGER</code> , <code>DIMENSION(MPI_STATUS_SIZE)</code> or <code>TYPE(MPI_Status)</code>
<code>MPI_UNWEIGHTED</code>	<code>int*</code> / <code>INTEGER</code> array
<code>MPI_WEIGHTS_EMPTY</code>	<code>int*</code> / <code>INTEGER</code> array

---

<sup>1</sup> Note that in Fortran these constants are not usable for initialization expressions or assignment. See Section [2.5.4](#).

**C Constants Specifying Ignored Input (no Fortran)**

C type: MPI_Fint*	equivalent to Fortran	1
MPI_F_STATUSES_IGNORE	MPI_STATUSES_IGNORE in <code>mpi / mpif.h</code>	2
MPI_F_STATUS_IGNORE	MPI_STATUS_IGNORE in <code>mpi / mpif.h</code>	3
C type: MPI_F08_status*	equivalent to Fortran	4
MPI_F08_STATUSES_IGNORE	MPI_STATUSES_IGNORE in <code>mpi_f08</code>	5
MPI_F08_STATUS_IGNORE	MPI_STATUS_IGNORE in <code>mpi_f08</code>	6

**C preprocessor Constants and Fortran Parameters**C type: C-preprocessor macro that expands to an `int` valueFortran type: `INTEGER`

MPI\_SUBVERSION

MPI\_VERSION

**Null handles used in the MPI tool information interface**

MPI\_T\_ENUM\_NULL

MPI\_T\_enum

MPI\_T\_CVAR\_HANDLE\_NULL

MPI\_T\_cvar\_handle

MPI\_T\_PVAR\_HANDLE\_NULL

MPI\_T\_pvar\_handle

MPI\_T\_PVAR\_SESSION\_NULL

MPI\_T\_pvar\_session

**Verbosity Levels in the MPI tool information interface**C type: `const int` (or unnamed `enum`)

MPI\_T\_VERBOSITY\_USER\_BASIC

MPI\_T\_VERBOSITY\_USER\_DETAIL

MPI\_T\_VERBOSITY\_USER\_ALL

MPI\_T\_VERBOSITY\_TUNER\_BASIC

MPI\_T\_VERBOSITY\_TUNER\_DETAIL

MPI\_T\_VERBOSITY\_TUNER\_ALL

MPI\_T\_VERBOSITY\_MPIDEV\_BASIC

MPI\_T\_VERBOSITY\_MPIDEV\_DETAIL

MPI\_T\_VERBOSITY\_MPIDEV\_ALL

**Constants to identify associations of variables  
in the MPI tool information interface**

---

C type: const int (or unnamed enum)

---

MPI\_T\_BIND\_NO\_OBJECT  
 MPI\_T\_BIND\_MPI\_COMM  
 MPI\_T\_BIND\_MPI\_DATATYPE  
 MPI\_T\_BIND\_MPI\_ERRHANDLER  
 MPI\_T\_BIND\_MPI\_FILE  
 MPI\_T\_BIND\_MPI\_GROUP  
 MPI\_T\_BIND\_MPI\_OP  
 MPI\_T\_BIND\_MPI\_REQUEST  
 MPI\_T\_BIND\_MPI\_WIN  
 MPI\_T\_BIND\_MPI\_MESSAGE  
 MPI\_T\_BIND\_MPI\_INFO

---

**Constants describing the scope of a control variable  
in the MPI tool information interface**

---

C type: const int (or unnamed enum)

---

MPI\_T\_SCOPE\_CONSTANT  
 MPI\_T\_SCOPE\_READONLY  
 MPI\_T\_SCOPE\_LOCAL  
 MPI\_T\_SCOPE\_GROUP  
 MPI\_T\_SCOPE\_GROUP\_EQ  
 MPI\_T\_SCOPE\_ALL  
 MPI\_T\_SCOPE\_ALL\_EQ

---

**Additional constants used  
by the MPI tool information interface**

---

C type: MPI\_T\_pvar\_handle

---

MPI\_T\_PVAR\_ALL\_HANDLES

---

**Performance variables classes used by the  
MPI tool information interface**

---

C type: const int (or unnamed enum)

---

MPI\_T\_PVAR\_CLASS\_STATE  
 MPI\_T\_PVAR\_CLASS\_LEVEL  
 MPI\_T\_PVAR\_CLASS\_SIZE  
 MPI\_T\_PVAR\_CLASS\_PERCENTAGE  
 MPI\_T\_PVAR\_CLASS\_HIGHWATERMARK  
 MPI\_T\_PVAR\_CLASS\_LOWWATERMARK  
 MPI\_T\_PVAR\_CLASS\_COUNTER  
 MPI\_T\_PVAR\_CLASS\_AGGREGATE  
 MPI\_T\_PVAR\_CLASS\_TIMER  
 MPI\_T\_PVAR\_CLASS\_GENERIC

---

**Source event ordering guarantees in the  
MPI tool information interface**

---

C type: MPI\_T\_source\_order

---

MPI\_T\_SOURCE\_ORDERED

---

MPI\_T\_SOURCE\_UNORDERED

---

**Callback safety requirement levels used in the  
MPI tool information interface**

---

C type: MPI\_T\_cb\_safety

---

MPI\_T\_CB\_REQUIRE\_NONE

MPI\_T\_CB\_REQUIRE\_MPI\_RESTRICTED

MPI\_T\_CB\_REQUIRE\_THREAD\_SAFE

---

MPI\_T\_CB\_REQUIRE\_ASYNC\_SIGNAL\_SAFE

---

## A.1.2 Types

The following are defined C type definitions, included in the file `mpi.h`.

```
/* C opaque types */
```

```
MPI_Aint
```

```
MPI_Count
```

```
MPI_Fint
```

```
MPI_Offset
```

```
MPI_Status
```

```
MPI_F08_status
```

```
/* C handles to assorted structures */
```

```
MPI_Comm
```

```
MPI_Datatype
```

```
MPI_Errhandler
```

```
MPI_File
```

```
MPI_Group
```

```
MPI_Info
```

```
MPI_Message
```

```
MPI_Op
```

```
MPI_Request
```

```
MPI_Session
```

```
MPI_Win
```

```
/* Types for the MPI_T interface */
```

```
MPI_T_enum
```

```
MPI_T_cvar_handle
```

```
MPI_T_pvar_handle
```

```
MPI_T_pvar_session
```

```
MPI_T_event_instance
```

```
MPI_T_event_registration
```

```
MPI_T_source_order
```

```
MPI_T_cb_safety
```

1  
2  
3 The following are defined Fortran type definitions, included in the `mpi_f08` and `mpi`  
4 modules.

```
5 ! Fortran opaque types in the mpi_f08 and mpi modules
6 TYPE(MPI_Status)
7
8 ! Fortran handles in the mpi_f08 and mpi modules
9 TYPE(MPI_Comm)
10 TYPE(MPI_Datatype)
11 TYPE(MPI_Errhandler)
12 TYPE(MPI_File)
13 TYPE(MPI_Group)
14 TYPE(MPI_Info)
15 TYPE(MPI_Message)
16 TYPE(MPI_Op)
17 TYPE(MPI_Request)
18 TYPE(MPI_Session)
19 TYPE(MPI_Win)
20
```

### 21 A.1.3 Prototype Definitions

#### 22 C Bindings

23  
24 The following are defined C typedefs for user-defined functions, also included in the file  
25 `mpi.h`.

```
26
27 /* prototypes for user-defined functions */
28
29 typedef void MPI_User_function(void *invec, void *inoutvec, int *len,
30                               MPI_Datatype *datatype);
31
32 typedef void MPI_User_function_c(void *invec, void *inoutvec,
33                                 MPI_Count *len, MPI_Datatype *datatype);
34
35 typedef int MPI_Comm_copy_attr_function(MPI_Comm oldcomm, int comm_keyval,
36                                       void *extra_state, void *attribute_val_in,
37                                       void *attribute_val_out, int *flag);
38
39 typedef int MPI_Comm_delete_attr_function(MPI_Comm comm, int comm_keyval,
40                                         void *attribute_val, void *extra_state);
41
42 typedef int MPI_Win_copy_attr_function(MPI_Win oldwin, int win_keyval,
43                                       void *extra_state, void *attribute_val_in,
44                                       void *attribute_val_out, int *flag);
45
46 typedef int MPI_Win_delete_attr_function(MPI_Win win, int win_keyval,
47                                         void *attribute_val, void *extra_state);
48
49 typedef int MPI_Type_copy_attr_function(MPI_Datatype oldtype,
50                                       int type_keyval, void *extra_state, void *attribute_val_in,
51                                       void *attribute_val_out, int *flag);
```

```
typedef int MPI_Type_delete_attr_function(MPI_Datatype datatype,      1
    int type_keyval, void *attribute_val, void *extra_state);      2
                                                                    3
typedef void MPI_Comm_errhandler_function(MPI_Comm *comm, int *error_code,  4
    ...);                                                            5
                                                                    6
typedef void MPI_Win_errhandler_function(MPI_Win *win, int *error_code,  7
    ...);                                                            8
                                                                    9
typedef void MPI_File_errhandler_function(MPI_File *file, int *error_code, 10
    ...);                                                            11
                                                                    12
typedef void MPI_Session_errhandler_function(MPI_Session *session,      13
    int *error_code, ...);                                           14
                                                                    15
typedef int MPI_Grequest_query_function(void *extra_state,              16
    MPI_Status *status);                                             17
                                                                    18
typedef int MPI_Grequest_free_function(void *extra_state);             19
                                                                    20
typedef int MPI_Grequest_cancel_function(void *extra_state, int complete); 21
                                                                    22
typedef int MPI_Datarep_extent_function(MPI_Datatype datatype,         23
    MPI_Aint *extent, void *extra_state);                             24
                                                                    25
typedef int MPI_Datarep_conversion_function(void *userbuf,             26
    MPI_Datatype datatype, int count, void *filebuf,                 27
    MPI_Offset position, void *extra_state);                          28
                                                                    29
typedef int MPI_Datarep_conversion_function_c(void *userbuf,           30
    MPI_Datatype datatype, MPI_Count count, void *filebuf,           31
    MPI_Offset position, void *extra_state);                          32
                                                                    33
typedef void MPI_T_event_cb_function(                                  34
    MPI_T_event_instance event_instance,                               35
    MPI_T_event_registration event_registration,                       36
    MPI_T_cb_safety cb_safety,                                        37
    void *user_data);                                                38
                                                                    39
                                                                    40
typedef void MPI_T_event_free_cb_function(                              41
    MPI_T_event_registration event_registration,                       42
    MPI_T_cb_safety cb_safety,                                        43
    void *user_data);                                                44
                                                                    45
                                                                    46
typedef void MPI_T_event_dropped_cb_function(int count,                47
    MPI_T_event_registration event_registration,                       48
    MPI_T_cb_safety cb_safety,                                        49
    void *user_data);                                                50
```

1 Fortran 2008 Bindings with the mpi\_f08 Module

2 The callback prototypes when using the Fortran mpi\_f08 module are shown below:

3 The user-function argument to MPI\_Op\_create should be declared according to:

4 ABSTRACT INTERFACE

5 SUBROUTINE MPI\_User\_function(invec, inoutvec, len, datatype)  
6 USE, INTRINSIC :: ISO\_C\_BINDING, ONLY : C\_PTR  
7 TYPE(C\_PTR), VALUE :: invec, inoutvec  
8 INTEGER :: len  
9 TYPE(MPI\_Datatype) :: datatype

10 ABSTRACT INTERFACE

11 SUBROUTINE MPI\_User\_function\_c(invec, inoutvec, len, datatype)  
12 USE, INTRINSIC :: ISO\_C\_BINDING, ONLY : C\_PTR  
13 TYPE(C\_PTR), VALUE :: invec, inoutvec  
14 INTEGER(KIND=MPI\_COUNT\_KIND) :: len  
15 TYPE(MPI\_Datatype) :: datatype

16 The copy and delete function arguments to MPI\_Comm\_create\_keyval should be de-  
17 clared according to:

18 ABSTRACT INTERFACE

19 SUBROUTINE MPI\_Comm\_copy\_attr\_function(oldcomm, comm\_keyval, extra\_state,  
20 attribute\_val\_in, attribute\_val\_out, flag, ierror)  
21 TYPE(MPI\_Comm) :: oldcomm  
22 INTEGER :: comm\_keyval, ierror  
23 INTEGER(KIND=MPI\_ADDRESS\_KIND) :: extra\_state, attribute\_val\_in,  
24 attribute\_val\_out  
25 LOGICAL :: flag

26 ABSTRACT INTERFACE

27 SUBROUTINE MPI\_Comm\_delete\_attr\_function(comm, comm\_keyval,  
28 attribute\_val, extra\_state, ierror)  
29 TYPE(MPI\_Comm) :: comm  
30 INTEGER :: comm\_keyval, ierror  
31 INTEGER(KIND=MPI\_ADDRESS\_KIND) :: attribute\_val, extra\_state

32 The copy and delete function arguments to MPI\_Win\_create\_keyval should be declared  
33 according to:

34 ABSTRACT INTERFACE

35 SUBROUTINE MPI\_Win\_copy\_attr\_function(oldwin, win\_keyval, extra\_state,  
36 attribute\_val\_in, attribute\_val\_out, flag, ierror)  
37 TYPE(MPI\_Win) :: oldwin  
38 INTEGER :: win\_keyval, ierror  
39 INTEGER(KIND=MPI\_ADDRESS\_KIND) :: extra\_state, attribute\_val\_in,  
40 attribute\_val\_out  
41 LOGICAL :: flag

42 ABSTRACT INTERFACE

43 SUBROUTINE MPI\_Win\_delete\_attr\_function(win, win\_keyval, attribute\_val,  
44 extra\_state, ierror)



```

TYPE(MPI_Win) :: win
INTEGER :: win_keyval, ierror
INTEGER(KIND=MPI_ADDRESS_KIND) :: attribute_val, extra_state

```

The copy and delete function arguments to MPI\_Type\_create\_keyval should be declared according to:

ABSTRACT INTERFACE

```

SUBROUTINE MPI_Type_copy_attr_function(oldtype, type_keyval, extra_state,
    attribute_val_in, attribute_val_out, flag, ierror)
TYPE(MPI_Datatype) :: oldtype
INTEGER :: type_keyval, ierror
INTEGER(KIND=MPI_ADDRESS_KIND) :: extra_state, attribute_val_in,
    attribute_val_out
LOGICAL :: flag

```

ABSTRACT INTERFACE

```

SUBROUTINE MPI_Type_delete_attr_function(datatype, type_keyval,
    attribute_val, extra_state, ierror)
TYPE(MPI_Datatype) :: datatype
INTEGER :: type_keyval, ierror
INTEGER(KIND=MPI_ADDRESS_KIND) :: attribute_val, extra_state

```

The handler-function argument to MPI\_Comm\_create\_errhandler should be declared like this:

ABSTRACT INTERFACE

```

SUBROUTINE MPI_Comm_errhandler_function(comm, error_code)
TYPE(MPI_Comm) :: comm
INTEGER :: error_code

```

The handler-function argument to MPI\_Win\_create\_errhandler should be declared like this:

ABSTRACT INTERFACE

```

SUBROUTINE MPI_Win_errhandler_function(win, error_code)
TYPE(MPI_Win) :: win
INTEGER :: error_code

```

The handler-function argument to MPI\_File\_create\_errhandler should be declared like this:

ABSTRACT INTERFACE

```

SUBROUTINE MPI_File_errhandler_function(file, error_code)
TYPE(MPI_File) :: file
INTEGER :: error_code

```

ABSTRACT INTERFACE

```

SUBROUTINE MPI_File_errhandler_function(file, error_code)
TYPE(MPI_File) :: file
INTEGER :: error_code

```

The handler-function argument to MPI\_Session\_create\_errhandler should be declared like this:

ABSTRACT INTERFACE

```

1  SUBROUTINE MPI_Session_errhandler_function(session, error_code)
2  TYPE(MPI_Session) :: session
3  INTEGER :: error_code
4
5  ABSTRACT INTERFACE
6  SUBROUTINE MPI_Session_errhandler_function(session, error_code)
7  TYPE(MPI_Session) :: session
8  INTEGER :: error_code
9
10 The query, free, and cancel function arguments to MPI_Grequest_start should be de-
11 clared according to:
12 ABSTRACT INTERFACE
13 SUBROUTINE MPI_Grequest_query_function(extra_state, status, ierror)
14 INTEGER(KIND=MPI_ADDRESS_KIND) :: extra_state
15 TYPE(MPI_Status) :: status
16 INTEGER :: ierror
17
18 ABSTRACT INTERFACE
19 SUBROUTINE MPI_Grequest_free_function(extra_state, ierror)
20 INTEGER(KIND=MPI_ADDRESS_KIND) :: extra_state
21 INTEGER :: ierror
22
23 ABSTRACT INTERFACE
24 SUBROUTINE MPI_Grequest_cancel_function(extra_state, complete, ierror)
25 INTEGER(KIND=MPI_ADDRESS_KIND) :: extra_state
26 LOGICAL :: complete
27 INTEGER :: ierror
28
29 The extent and conversion function arguments to MPI_Register_datarep should be de-
30 clared according to:
31 ABSTRACT INTERFACE
32 SUBROUTINE MPI_Datarep_extent_function(datatype, extent, extra_state,
33 ierror)
34 TYPE(MPI_Datatype) :: datatype
35 INTEGER(KIND=MPI_ADDRESS_KIND) :: extent, extra_state
36 INTEGER :: ierror
37
38 ABSTRACT INTERFACE
39 SUBROUTINE MPI_Datarep_conversion_function(userbuf, datatype, count,
40 filebuf, position, extra_state, ierror)
41 USE, INTRINSIC :: ISO_C_BINDING, ONLY : C_PTR
42 TYPE(C_PTR), VALUE :: userbuf, filebuf
43 TYPE(MPI_Datatype) :: datatype
44 INTEGER :: count, ierror
45 INTEGER(KIND=MPI_OFFSET_KIND) :: position
46 INTEGER(KIND=MPI_ADDRESS_KIND) :: extra_state
47
48 ABSTRACT INTERFACE
49 SUBROUTINE MPI_Datarep_conversion_function_c(userbuf, datatype, count,
50 filebuf, position, extra_state, ierror)
51 USE, INTRINSIC :: ISO_C_BINDING, ONLY : C_PTR

```

```

TYPE(C_PTR), VALUE :: userbuf, filebuf
TYPE(MPI_Datatype) :: datatype
INTEGER(KIND=MPI_COUNT_KIND) :: count
INTEGER(KIND=MPI_OFFSET_KIND) :: position
INTEGER(KIND=MPI_ADDRESS_KIND) :: extra_state
INTEGER :: ierror

```

#### Fortran Bindings with mpif.h or the mpi Module

With the Fortran `mpi` module or `mpif.h`, here are examples of how each of the user-defined subroutines should be declared.

The user-function argument to `MPI_OP_CREATE` should be declared like this:

```

SUBROUTINE USER_FUNCTION(INVEC, INOUTVEC, LEN, DATATYPE)
<type> INVEC(LEN), INOUTVEC(LEN)
INTEGER LEN, DATATYPE

```

The copy and delete function arguments to `MPI_COMM_CREATE_KEYVAL` should be declared like these:

```

SUBROUTINE COMM_COPY_ATTR_FUNCTION(OLDCOMM, COMM_KEYVAL, EXTRA_STATE,
    ATTRIBUTE_VAL_IN, ATTRIBUTE_VAL_OUT, FLAG, IERROR)
INTEGER OLDCOMM, COMM_KEYVAL, IERROR
INTEGER(KIND=MPI_ADDRESS_KIND) EXTRA_STATE, ATTRIBUTE_VAL_IN,
    ATTRIBUTE_VAL_OUT
LOGICAL FLAG

```

```

SUBROUTINE COMM_DELETE_ATTR_FUNCTION(COMM, COMM_KEYVAL, ATTRIBUTE_VAL,
    EXTRA_STATE, IERROR)
INTEGER COMM, COMM_KEYVAL, IERROR
INTEGER(KIND=MPI_ADDRESS_KIND) ATTRIBUTE_VAL, EXTRA_STATE

```

The copy and delete function arguments to `MPI_WIN_CREATE_KEYVAL` should be declared like these:

```

SUBROUTINE WIN_COPY_ATTR_FUNCTION(OLDWIN, WIN_KEYVAL, EXTRA_STATE,
    ATTRIBUTE_VAL_IN, ATTRIBUTE_VAL_OUT, FLAG, IERROR)
INTEGER OLDWIN, WIN_KEYVAL, IERROR
INTEGER(KIND=MPI_ADDRESS_KIND) EXTRA_STATE, ATTRIBUTE_VAL_IN,
    ATTRIBUTE_VAL_OUT
LOGICAL FLAG

```

```

SUBROUTINE WIN_DELETE_ATTR_FUNCTION(WIN, WIN_KEYVAL, ATTRIBUTE_VAL,
    EXTRA_STATE, IERROR)
INTEGER WIN, WIN_KEYVAL, IERROR
INTEGER(KIND=MPI_ADDRESS_KIND) ATTRIBUTE_VAL, EXTRA_STATE

```

The delete function argument to `MPI_SESSION_CREATE_KEYVAL` should be declared like this:

```

SUBROUTINE SESSION_DELETE_ATTR_FUNCTION(SESSION, SESSION_KEYVAL,
    ATTRIBUTE_VAL, EXTRA_STATE, IERROR)
INTEGER SESSION, SESSION_KEYVAL, IERROR

```

```
1     INTEGER(KIND=MPI_ADDRESS_KIND) ATTRIBUTE_VAL, EXTRA_STATE
```

2  
3 The copy and delete function arguments to MPI\_TYPE\_CREATE\_KEYVAL should be  
4 declared like these:

```
5     SUBROUTINE TYPE_COPY_ATTR_FUNCTION(OLDTYPE, TYPE_KEYVAL, EXTRA_STATE,
6         ATTRIBUTE_VAL_IN, ATTRIBUTE_VAL_OUT, FLAG, IERROR)
7         INTEGER OLDTYPE, TYPE_KEYVAL, IERROR
8         INTEGER(KIND=MPI_ADDRESS_KIND) EXTRA_STATE, ATTRIBUTE_VAL_IN,
9             ATTRIBUTE_VAL_OUT
10        LOGICAL FLAG
```

```
11    SUBROUTINE TYPE_DELETE_ATTR_FUNCTION(DATATYPE, TYPE_KEYVAL, ATTRIBUTE_VAL,
12        EXTRA_STATE, IERROR)
13        INTEGER DATATYPE, TYPE_KEYVAL, IERROR
14        INTEGER(KIND=MPI_ADDRESS_KIND) ATTRIBUTE_VAL, EXTRA_STATE
```

15  
16 The handler-function argument to MPI\_COMM\_CREATE\_ERRHANDLER should be de-  
17 clared like this:

```
18    SUBROUTINE COMM_ERRHANDLER_FUNCTION(COMM, ERROR_CODE)
19        INTEGER COMM, ERROR_CODE
```

20  
21 The handler-function argument to MPI\_WIN\_CREATE\_ERRHANDLER should be de-  
22 clared like this:

```
23    SUBROUTINE WIN_ERRHANDLER_FUNCTION(WIN, ERROR_CODE)
24        INTEGER WIN, ERROR_CODE
```

25  
26 The handler-function argument to MPI\_FILE\_CREATE\_ERRHANDLER should be de-  
27 clared like this:

```
28    SUBROUTINE FILE_ERRHANDLER_FUNCTION(FILE, ERROR_CODE)
29        INTEGER FILE, ERROR_CODE
```

30  
31 The handler-function argument to MPI\_SESSION\_CREATE\_ERRHANDLER should be  
32 declared like this:

```
33    SUBROUTINE SESSION_ERRHANDLER_FUNCTION(SESSION, ERROR_CODE)
34        INTEGER SESSION, ERROR_CODE
```

35  
36 The query, free, and cancel function arguments to MPI\_GREQUEST\_START should be  
37 declared like these:

```
38    SUBROUTINE GREQUEST_QUERY_FUNCTION(EXTRA_STATE, STATUS, IERROR)
39        INTEGER(KIND=MPI_ADDRESS_KIND) EXTRA_STATE
40        INTEGER STATUS(MPI_STATUS_SIZE), IERROR
```

```
41    SUBROUTINE GREQUEST_FREE_FUNCTION(EXTRA_STATE, IERROR)
42        INTEGER(KIND=MPI_ADDRESS_KIND) EXTRA_STATE
43        INTEGER IERROR
```

```
44    SUBROUTINE GREQUEST_CANCEL_FUNCTION(EXTRA_STATE, COMPLETE, IERROR)
45        INTEGER(KIND=MPI_ADDRESS_KIND) EXTRA_STATE
46        LOGICAL COMPLETE
47        INTEGER IERROR
```

The extent and conversion function arguments to MPI\_REGISTER\_DATAREP should be declared like these:

```

SUBROUTINE DATAREP_EXTENT_FUNCTION(DATATYPE, EXTENT, EXTRA_STATE, IERROR)
  INTEGER DATATYPE, IERROR
  INTEGER(KIND=MPI_ADDRESS_KIND) EXTENT, EXTRA_STATE

SUBROUTINE DATAREP_CONVERSION_FUNCTION(USERBUF, DATATYPE, COUNT, FILEBUF,
  POSITION, EXTRA_STATE, IERROR)
  <TYPE> USERBUF(*), FILEBUF(*)
  INTEGER DATATYPE, COUNT, IERROR
  INTEGER(KIND=MPI_OFFSET_KIND) POSITION
  INTEGER(KIND=MPI_ADDRESS_KIND) EXTRA_STATE

```

#### A.1.4 Deprecated Prototype Definitions

The following are defined C typedefs for deprecated user-defined functions, also included in the file `mpi.h`.

```

/* prototypes for user-defined functions */

typedef int MPI_Copy_function(MPI_Comm oldcomm, int keyval,
  void *extra_state, void *attribute_val_in,
  void *attribute_val_out, int *flag);

typedef int MPI_Delete_function(MPI_Comm comm, int keyval,
  void *attribute_val, void *extra_state);

```

The following are deprecated Fortran user-defined callback subroutine prototypes. The deprecated copy and delete function arguments to MPI\_KEYVAL\_CREATE should be declared like these:

```

SUBROUTINE COPY_FUNCTION(OLDCOMM, KEYVAL, EXTRA_STATE, ATTRIBUTE_VAL_IN,
  ATTRIBUTE_VAL_OUT, FLAG, IERR)
  INTEGER OLDCOMM, KEYVAL, EXTRA_STATE, ATTRIBUTE_VAL_IN,
  ATTRIBUTE_VAL_OUT, IERR
  LOGICAL FLAG

SUBROUTINE DELETE_FUNCTION(COMM, KEYVAL, ATTRIBUTE_VAL, EXTRA_STATE, IERR)
  INTEGER COMM, KEYVAL, ATTRIBUTE_VAL, EXTRA_STATE, IERR

```

#### A.1.5 Info Keys

The following info keys are reserved. They are strings.

```

"access_style"
"accumulate_ops"
"accumulate_ordering"
"alloc_shared_noncontig"
"appnum"
"arch"
"cb_block_size"

```

1 "cb\_buffer\_size"  
2 "cb\_nodes"  
3 "chunked\_item"  
4 "chunked\_size"  
5 "chunked"  
6 "collective\_buffering"  
7 "file"  
8 "file\_perm"  
9 "filename"  
10 "host"  
11 "io\_node\_list"  
12 "ip\_address"  
13 "ip\_port"  
14 "mpi\_assert\_allow\_overtaking"  
15 "mpi\_assert\_exact\_length"  
16 "mpi\_assert\_no\_any\_source"  
17 "mpi\_assert\_no\_any\_tag"  
18 "mpi\_assert\_strict\_start\_ordering"  
19 "mpi\_hw\_resource\_type"  
20 "mpi\_initial\_errhandler"  
21 "mpi\_optimization\_goal"  
22 "mpi\_reuse\_count"  
23 "mpi\_minimum\_memory\_alignment"  
24 "nb\_proc"  
25 "no\_locks"  
26 "num\_io\_nodes"  
27 "path"  
28 "same\_disp\_unit"  
29 "same\_size"  
30 "soft"  
31 "striping\_factor"  
32 "striping\_unit"  
33 "wdir"

#### 36 A.1.6 Info Values

37 The following info values are reserved. They are strings.

38 "false"  
39 "mpi\_errors\_abort"  
40 "mpi\_errors\_are\_fatal"  
41 "mpi\_errors\_return"  
42 "mpi\_shared\_memory"  
43 "random"  
44 "rar"  
45 "raw"  
46 "read\_mostly"  
47 "read\_once"  
48

"reverse_sequential"	1
"same_op"	2
"same_op_no_op"	3
"sequential"	4
"true"	5
"war"	6
"waw"	7
"write_mostly"	8
"write_once"	9

## A.2 Summary of the Semantics of all Operation-Related MPI Procedures

A summary of the semantics of all operation-related MPI procedures can be found in [51].

DRAFT

## A.3 C Bindings

### A.3.1 Point-to-Point Communication C Bindings

```
1 int MPI_Bsend(const void *buf, int count, MPI_Datatype datatype, int dest,
2               int tag, MPI_Comm comm)
3
4 int MPI_Bsend_c(const void *buf, MPI_Count count, MPI_Datatype datatype,
5                 int dest, int tag, MPI_Comm comm)
6
7 int MPI_Bsend_init(const void *buf, int count, MPI_Datatype datatype,
8                   int dest, int tag, MPI_Comm comm, MPI_Request *request)
9
10 int MPI_Bsend_init_c(const void *buf, MPI_Count count,
11                     MPI_Datatype datatype, int dest, int tag, MPI_Comm comm,
12                     MPI_Request *request)
13
14 int MPI_Buffer_attach(void *buffer, int size)
15
16 int MPI_Buffer_attach_c(void *buffer, MPI_Count size)
17
18 int MPI_Buffer_detach(void *buffer_addr, int *size)
19
20 int MPI_Buffer_detach_c(void *buffer_addr, MPI_Count *size)
21
22 int MPI_Cancel(MPI_Request *request)
23
24 int MPI_Get_count(const MPI_Status *status, MPI_Datatype datatype,
25                  int *count)
26
27 int MPI_Get_count_c(const MPI_Status *status, MPI_Datatype datatype,
28                    MPI_Count *count)
29
30 int MPI_Ibsend(const void *buf, int count, MPI_Datatype datatype, int dest,
31               int tag, MPI_Comm comm, MPI_Request *request)
32
33 int MPI_Ibsend_c(const void *buf, MPI_Count count, MPI_Datatype datatype,
34                  int dest, int tag, MPI_Comm comm, MPI_Request *request)
35
36 int MPI_Improbe(int source, int tag, MPI_Comm comm, int *flag,
37                MPI_Message *message, MPI_Status *status)
38
39 int MPI_Imrecv(void *buf, int count, MPI_Datatype datatype,
40                MPI_Message *message, MPI_Request *request)
41
42 int MPI_Imrecv_c(void *buf, MPI_Count count, MPI_Datatype datatype,
43                  MPI_Message *message, MPI_Request *request)
44
45 int MPI_Iprobe(int source, int tag, MPI_Comm comm, int *flag,
46                MPI_Status *status)
47
48 int MPI_Irecv(void *buf, int count, MPI_Datatype datatype, int source,
49               int tag, MPI_Comm comm, MPI_Request *request)
50
51 int MPI_Irecv_c(void *buf, MPI_Count count, MPI_Datatype datatype,
52                 int source, int tag, MPI_Comm comm, MPI_Request *request)
```



```
int MPI_Irsend(const void *buf, int count, MPI_Datatype datatype, int dest, 1
               int tag, MPI_Comm comm, MPI_Request *request) 2
3
int MPI_Irsend_c(const void *buf, MPI_Count count, MPI_Datatype datatype, 4
                 int dest, int tag, MPI_Comm comm, MPI_Request *request) 5
6
int MPI_Isend(const void *buf, int count, MPI_Datatype datatype, int dest, 7
              int tag, MPI_Comm comm, MPI_Request *request) 8
9
int MPI_Isend_c(const void *buf, MPI_Count count, MPI_Datatype datatype, 9
                int dest, int tag, MPI_Comm comm, MPI_Request *request) 10
11
int MPI_Isendrecv(const void *sendbuf, int sendcount, 11
                  MPI_Datatype sendtype, int dest, int sendtag, void *recvbuf, 12
                  int recvcount, MPI_Datatype recvtype, int source, int recvtag, 13
                  MPI_Comm comm, MPI_Request *request) 14
15
int MPI_Isendrecv_c(const void *sendbuf, MPI_Count sendcount, 16
                    MPI_Datatype sendtype, int dest, int sendtag, void *recvbuf, 17
                    MPI_Count recvcount, MPI_Datatype recvtype, int source, 18
                    int recvtag, MPI_Comm comm, MPI_Request *request) 19
20
int MPI_Isendrecv_replace(void *buf, int count, MPI_Datatype datatype, 20
                           int dest, int sendtag, int source, int recvtag, MPI_Comm comm, 21
                           MPI_Request *request) 22
23
int MPI_Isendrecv_replace_c(void *buf, MPI_Count count, 24
                             MPI_Datatype datatype, int dest, int sendtag, int source, 25
                             int recvtag, MPI_Comm comm, MPI_Request *request) 26
27
int MPI_Issend(const void *buf, int count, MPI_Datatype datatype, int dest, 27
               int tag, MPI_Comm comm, MPI_Request *request) 28
29
int MPI_Issend_c(const void *buf, MPI_Count count, MPI_Datatype datatype, 30
                 int dest, int tag, MPI_Comm comm, MPI_Request *request) 31
32
int MPI_Mprobe(int source, int tag, MPI_Comm comm, MPI_Message *message, 32
               MPI_Status *status) 33
34
int MPI_Mrecv(void *buf, int count, MPI_Datatype datatype, 35
              MPI_Message *message, MPI_Status *status) 36
37
int MPI_Mrecv_c(void *buf, MPI_Count count, MPI_Datatype datatype, 37
                MPI_Message *message, MPI_Status *status) 38
39
int MPI_Probe(int source, int tag, MPI_Comm comm, MPI_Status *status) 40
41
int MPI_Recv(void *buf, int count, MPI_Datatype datatype, int source, 41
             int tag, MPI_Comm comm, MPI_Status *status) 42
43
int MPI_Recv_c(void *buf, MPI_Count count, MPI_Datatype datatype, 44
               int source, int tag, MPI_Comm comm, MPI_Status *status) 45
46
int MPI_Recv_init(void *buf, int count, MPI_Datatype datatype, int source, 46
                  int tag, MPI_Comm comm, MPI_Request *request) 47
48
```

```
1 int MPI_Recv_init_c(void *buf, MPI_Count count, MPI_Datatype datatype,
2     int source, int tag, MPI_Comm comm, MPI_Request *request)
3
4 int MPI_Request_free(MPI_Request *request)
5
6 int MPI_Request_get_status(MPI_Request request, int *flag,
7     MPI_Status *status)
8
9 int MPI_Rsend(const void *buf, int count, MPI_Datatype datatype, int dest,
10     int tag, MPI_Comm comm)
11
12 int MPI_Rsend_c(const void *buf, MPI_Count count, MPI_Datatype datatype,
13     int dest, int tag, MPI_Comm comm)
14
15 int MPI_Rsend_init(const void *buf, int count, MPI_Datatype datatype,
16     int dest, int tag, MPI_Comm comm, MPI_Request *request)
17
18 int MPI_Rsend_init_c(const void *buf, MPI_Count count,
19     MPI_Datatype datatype, int dest, int tag, MPI_Comm comm,
20     MPI_Request *request)
21
22 int MPI_Send(const void *buf, int count, MPI_Datatype datatype, int dest,
23     int tag, MPI_Comm comm)
24
25 int MPI_Send_c(const void *buf, MPI_Count count, MPI_Datatype datatype,
26     int dest, int tag, MPI_Comm comm)
27
28 int MPI_Send_init(const void *buf, int count, MPI_Datatype datatype,
29     int dest, int tag, MPI_Comm comm, MPI_Request *request)
30
31 int MPI_Send_init_c(const void *buf, MPI_Count count,
32     MPI_Datatype datatype, int dest, int tag, MPI_Comm comm,
33     MPI_Request *request)
34
35 int MPI_Sendrecv(const void *sendbuf, int sendcount, MPI_Datatype sendtype,
36     int dest, int sendtag, void *recvbuf, int recvcount,
37     MPI_Datatype recvtype, int source, int recvtag, MPI_Comm comm,
38     MPI_Status *status)
39
40 int MPI_Sendrecv_c(const void *sendbuf, MPI_Count sendcount,
41     MPI_Datatype sendtype, int dest, int sendtag, void *recvbuf,
42     MPI_Count recvcount, MPI_Datatype recvtype, int source,
43     int recvtag, MPI_Comm comm, MPI_Status *status)
44
45 int MPI_Sendrecv_replace(void *buf, int count, MPI_Datatype datatype,
46     int dest, int sendtag, int source, int recvtag, MPI_Comm comm,
47     MPI_Status *status)
48
49 int MPI_Sendrecv_replace_c(void *buf, MPI_Count count,
50     MPI_Datatype datatype, int dest, int sendtag, int source,
51     int recvtag, MPI_Comm comm, MPI_Status *status)
52
53 int MPI_Ssend(const void *buf, int count, MPI_Datatype datatype, int dest,
54     int tag, MPI_Comm comm)
```

```
int MPI_Ssend_c(const void *buf, MPI_Count count, MPI_Datatype datatype, 1
                int dest, int tag, MPI_Comm comm) 2
int MPI_Ssend_init(const void *buf, int count, MPI_Datatype datatype, 3
                  int dest, int tag, MPI_Comm comm, MPI_Request *request) 4
int MPI_Ssend_init_c(const void *buf, MPI_Count count, 5
                    MPI_Datatype datatype, int dest, int tag, MPI_Comm comm, 6
                    MPI_Request *request) 7
int MPI_Start(MPI_Request *request) 8
int MPI_Startall(int count, MPI_Request array_of_requests[]) 9
int MPI_Test(MPI_Request *request, int *flag, MPI_Status *status) 10
int MPI_Test_cancelled(const MPI_Status *status, int *flag) 11
int MPI_Testall(int count, MPI_Request array_of_requests[], int *flag, 12
                MPI_Status array_of_statuses[]) 13
int MPI_Testany(int count, MPI_Request array_of_requests[], int *index, 14
                int *flag, MPI_Status *status) 15
int MPI_Testsome(int incount, MPI_Request array_of_requests[], 16
                 int *outcount, int array_of_indices[], 17
                 MPI_Status array_of_statuses[]) 18
int MPI_Wait(MPI_Request *request, MPI_Status *status) 19
int MPI_Waitall(int count, MPI_Request array_of_requests[], 20
                MPI_Status array_of_statuses[]) 21
int MPI_Waitany(int count, MPI_Request array_of_requests[], int *index, 22
                MPI_Status *status) 23
int MPI_Waitsome(int incount, MPI_Request array_of_requests[], 24
                 int *outcount, int array_of_indices[], 25
                 MPI_Status array_of_statuses[]) 26
```

### A.3.2 Partitioned Communication C Bindings

```
int MPI_Parrived(MPI_Request *request, int partition, int *flag) 27
int MPI_Pready(int partition, MPI_Request *request) 28
int MPI_Pready_list(int length, const int array_of_partitions[], 29
                    MPI_Request *request) 30
int MPI_Pready_range(int partition_low, int partition_high, 31
                    MPI_Request *request) 32
int MPI_Precv_init(void *buf, int partitions, MPI_Count count, 33
                  MPI_Datatype datatype, int dest, int tag, MPI_Comm comm, 34
                  MPI_Info info, MPI_Request *request) 35
```

```

1 int MPI_Psend_init(const void *buf, int partitions, MPI_Count count,
2                   MPI_Datatype datatype, int dest, int tag, MPI_Comm comm,
3                   MPI_Info info, MPI_Request *request)
4
5

```

### 6 A.3.3 Datatypes C Bindings

```

7 int MPI_Get_address(const void *location, MPI_Aint *address)
8
9 int MPI_Get_elements(const MPI_Status *status, MPI_Datatype datatype,
10                    int *count)
11
12 int MPI_Get_elements_c(const MPI_Status *status, MPI_Datatype datatype,
13                      MPI_Count *count)
14
15 int MPI_Get_elements_x(const MPI_Status *status, MPI_Datatype datatype,
16                      MPI_Count *count)
17
18 int MPI_Pack(const void *inbuf, int incount, MPI_Datatype datatype,
19             void *outbuf, int outsize, int *position, MPI_Comm comm)
20
21 int MPI_Pack_c(const void *inbuf, MPI_Count incount, MPI_Datatype datatype,
22              void *outbuf, MPI_Count outsize, MPI_Count *position,
23              MPI_Comm comm)
24
25 int MPI_Pack_external(const char datarep[], const void *inbuf, int incount,
26                    MPI_Datatype datatype, void *outbuf, MPI_Aint outsize,
27                    MPI_Aint *position)
28
29 int MPI_Pack_external_c(const char datarep[], const void *inbuf,
30                      MPI_Count incount, MPI_Datatype datatype, void *outbuf,
31                      MPI_Count outsize, MPI_Count *position)
32
33 int MPI_Pack_external_size(const char datarep[], int incount,
34                          MPI_Datatype datatype, MPI_Aint *size)
35
36 int MPI_Pack_external_size_c(const char datarep[], MPI_Count incount,
37                             MPI_Datatype datatype, MPI_Count *size)
38
39 int MPI_Pack_size(int incount, MPI_Datatype datatype, MPI_Comm comm,
40                 int *size)
41
42 int MPI_Pack_size_c(MPI_Count incount, MPI_Datatype datatype,
43                   MPI_Comm comm, MPI_Count *size)
44
45 int MPI_Type_commit(MPI_Datatype *datatype)
46
47 int MPI_Type_contiguous(int count, MPI_Datatype oldtype,
48                       MPI_Datatype *newtype)
49
50 int MPI_Type_contiguous_c(MPI_Count count, MPI_Datatype oldtype,
51                          MPI_Datatype *newtype)
52
53 int MPI_Type_create_darray(int size, int rank, int ndims,
54                          const int array_of_gsizes[], const int array_of_distrib[],
55                          MPI_Datatype *newtype)
56
57

```

```
    const int array_of_dargs[], const int array_of_psizes[],  
    int order, MPI_Datatype oldtype, MPI_Datatype *newtype)  
  
int MPI_Type_create_darray_c(int size, int rank, int ndims,  
    const MPI_Count array_of_gsizes[],  
    const int array_of_distrib[], const int array_of_dargs[],  
    const int array_of_psizes[], int order, MPI_Datatype oldtype,  
    MPI_Datatype *newtype)  
  
int MPI_Type_create_hindexed(int count, const int array_of_blocklengths[],  
    const MPI_Aint array_of_displacements[], MPI_Datatype oldtype,  
    MPI_Datatype *newtype)  
  
int MPI_Type_create_hindexed_block(int count, int blocklength,  
    const MPI_Aint array_of_displacements[], MPI_Datatype oldtype,  
    MPI_Datatype *newtype)  
  
int MPI_Type_create_hindexed_block_c(MPI_Count count,  
    MPI_Count blocklength,  
    const MPI_Count array_of_displacements[],  
    MPI_Datatype oldtype, MPI_Datatype *newtype)  
  
int MPI_Type_create_hindexed_c(MPI_Count count,  
    const MPI_Count array_of_blocklengths[],  
    const MPI_Count array_of_displacements[],  
    MPI_Datatype oldtype, MPI_Datatype *newtype)  
  
int MPI_Type_create_hvector(int count, int blocklength, MPI_Aint stride,  
    MPI_Datatype oldtype, MPI_Datatype *newtype)  
  
int MPI_Type_create_hvector_c(MPI_Count count, MPI_Count blocklength,  
    MPI_Count stride, MPI_Datatype oldtype, MPI_Datatype *newtype)  
  
int MPI_Type_create_indexed_block(int count, int blocklength,  
    const int array_of_displacements[], MPI_Datatype oldtype,  
    MPI_Datatype *newtype)  
  
int MPI_Type_create_indexed_block_c(MPI_Count count, MPI_Count blocklength,  
    const MPI_Count array_of_displacements[],  
    MPI_Datatype oldtype, MPI_Datatype *newtype)  
  
int MPI_Type_create_resized(MPI_Datatype oldtype, MPI_Aint lb,  
    MPI_Aint extent, MPI_Datatype *newtype)  
  
int MPI_Type_create_resized_c(MPI_Datatype oldtype, MPI_Count lb,  
    MPI_Count extent, MPI_Datatype *newtype)  
  
int MPI_Type_create_struct(int count, const int array_of_blocklengths[],  
    const MPI_Aint array_of_displacements[],  
    const MPI_Datatype array_of_types[], MPI_Datatype *newtype)  
  
int MPI_Type_create_struct_c(MPI_Count count,  
    const MPI_Count array_of_blocklengths[],  
    const MPI_Count array_of_displacements[],
```

```

1         const MPI_Datatype array_of_types[], MPI_Datatype *newtype)
2
3     int MPI_Type_create_subarray(int ndims, const int array_of_sizes[],
4         const int array_of_subsizes[], const int array_of_starts[],
5         int order, MPI_Datatype oldtype, MPI_Datatype *newtype)
6
7     int MPI_Type_create_subarray_c(int ndims, const MPI_Count array_of_sizes[],
8         const MPI_Count array_of_subsizes[],
9         const MPI_Count array_of_starts[], int order,
10        MPI_Datatype oldtype, MPI_Datatype *newtype)
11
12    int MPI_Type_dup(MPI_Datatype oldtype, MPI_Datatype *newtype)
13
14    int MPI_Type_free(MPI_Datatype *datatype)
15
16    int MPI_Type_get_contents(MPI_Datatype datatype, int max_integers,
17        int max_addresses, int max_datatypes, int array_of_integers[],
18        MPI_Aint array_of_addresses[],
19        MPI_Datatype array_of_datatypes[])
20
21    int MPI_Type_get_contents_c(MPI_Datatype datatype, MPI_Count max_integers,
22        MPI_Count max_addresses, MPI_Count max_large_counts,
23        MPI_Count max_datatypes, int array_of_integers[],
24        MPI_Aint array_of_addresses[],
25        MPI_Count array_of_large_counts[],
26        MPI_Datatype array_of_datatypes[])
27
28    int MPI_Type_get_envelope(MPI_Datatype datatype, int *num_integers,
29        int *num_addresses, int *num_datatypes, int *combiner)
30
31    int MPI_Type_get_envelope_c(MPI_Datatype datatype, MPI_Count *num_integers,
32        MPI_Count *num_addresses, MPI_Count *num_large_counts,
33        MPI_Count *num_datatypes, int *combiner)
34
35    int MPI_Type_get_extent(MPI_Datatype datatype, MPI_Aint *lb,
36        MPI_Aint *extent)
37
38    int MPI_Type_get_extent_c(MPI_Datatype datatype, MPI_Count *lb,
39        MPI_Count *extent)
40
41    int MPI_Type_get_extent_x(MPI_Datatype datatype, MPI_Count *lb,
42        MPI_Count *extent)
43
44    int MPI_Type_get_true_extent(MPI_Datatype datatype, MPI_Aint *true_lb,
45        MPI_Aint *true_extent)
46
47    int MPI_Type_get_true_extent_c(MPI_Datatype datatype, MPI_Count *true_lb,
48        MPI_Count *true_extent)
49
50    int MPI_Type_get_true_extent_x(MPI_Datatype datatype, MPI_Count *true_lb,
51        MPI_Count *true_extent)
52
53    int MPI_Type_indexed(int count, const int array_of_blocklengths[],
54        const int array_of_displacements[], MPI_Datatype oldtype,
55        MPI_Datatype *newtype)

```

```
int MPI_Type_indexed_c(MPI_Count count,
                      const MPI_Count array_of_blocklengths[],
                      const MPI_Count array_of_displacements[],
                      MPI_Datatype oldtype, MPI_Datatype *newtype)
int MPI_Type_size(MPI_Datatype datatype, int *size)
int MPI_Type_size_c(MPI_Datatype datatype, MPI_Count *size)
int MPI_Type_size_x(MPI_Datatype datatype, MPI_Count *size)
int MPI_Type_vector(int count, int blocklength, int stride,
                   MPI_Datatype oldtype, MPI_Datatype *newtype)
int MPI_Type_vector_c(MPI_Count count, MPI_Count blocklength,
                     MPI_Count stride, MPI_Datatype oldtype, MPI_Datatype *newtype)
int MPI_Unpack(const void *inbuf, int insize, int *position, void *outbuf,
              int outcount, MPI_Datatype datatype, MPI_Comm comm)
int MPI_Unpack_c(const void *inbuf, MPI_Count insize, MPI_Count *position,
                void *outbuf, MPI_Count outcount, MPI_Datatype datatype,
                MPI_Comm comm)
int MPI_Unpack_external(const char datarep[], const void *inbuf,
                       MPI_Aint insize, MPI_Aint *position, void *outbuf,
                       int outcount, MPI_Datatype datatype)
int MPI_Unpack_external_c(const char datarep[], const void *inbuf,
                          MPI_Count insize, MPI_Count *position, void *outbuf,
                          MPI_Count outcount, MPI_Datatype datatype)

A.3.4 Collective Communication C Bindings

int MPI_Allgather(const void *sendbuf, int sendcount,
                 MPI_Datatype sendtype, void *recvbuf, int recvcount,
                 MPI_Datatype recvtype, MPI_Comm comm)
int MPI_Allgather_c(const void *sendbuf, MPI_Count sendcount,
                   MPI_Datatype sendtype, void *recvbuf, MPI_Count recvcount,
                   MPI_Datatype recvtype, MPI_Comm comm)
int MPI_Allgather_init(const void *sendbuf, int sendcount,
                      MPI_Datatype sendtype, void *recvbuf, int recvcount,
                      MPI_Datatype recvtype, MPI_Comm comm, MPI_Info info,
                      MPI_Request *request)
int MPI_Allgather_init_c(const void *sendbuf, MPI_Count sendcount,
                        MPI_Datatype sendtype, void *recvbuf, MPI_Count recvcount,
                        MPI_Datatype recvtype, MPI_Comm comm, MPI_Info info,
                        MPI_Request *request)
int MPI_Allgatherv(const void *sendbuf, int sendcount,
```

```

1         MPI_Datatype sendtype, void *recvbuf, const int recvcnts[],
2         const int displs[], MPI_Datatype recvtype, MPI_Comm comm)
3
4     int MPI_Allgatherv_c(const void *sendbuf, MPI_Count sendcount,
5         MPI_Datatype sendtype, void *recvbuf,
6         const MPI_Count recvcnts[], const MPI_Aint displs[],
7         MPI_Datatype recvtype, MPI_Comm comm)
8
9     int MPI_Allgatherv_init(const void *sendbuf, int sendcount,
10        MPI_Datatype sendtype, void *recvbuf, const int recvcnts[],
11        const int displs[], MPI_Datatype recvtype, MPI_Comm comm,
12        MPI_Info info, MPI_Request *request)
13
14    int MPI_Allgatherv_init_c(const void *sendbuf, MPI_Count sendcount,
15        MPI_Datatype sendtype, void *recvbuf,
16        const MPI_Count recvcnts[], const MPI_Aint displs[],
17        MPI_Datatype recvtype, MPI_Comm comm, MPI_Info info,
18        MPI_Request *request)
19
20    int MPI_Allreduce(const void *sendbuf, void *recvbuf, int count,
21        MPI_Datatype datatype, MPI_Op op, MPI_Comm comm)
22
23    int MPI_Allreduce_c(const void *sendbuf, void *recvbuf, MPI_Count count,
24        MPI_Datatype datatype, MPI_Op op, MPI_Comm comm)
25
26    int MPI_Allreduce_init(const void *sendbuf, void *recvbuf, int count,
27        MPI_Datatype datatype, MPI_Op op, MPI_Comm comm,
28        MPI_Info info, MPI_Request *request)
29
30    int MPI_Allreduce_init_c(const void *sendbuf, void *recvbuf,
31        MPI_Count count, MPI_Datatype datatype, MPI_Op op,
32        MPI_Comm comm, MPI_Info info, MPI_Request *request)
33
34    int MPI_Alltoall(const void *sendbuf, int sendcount, MPI_Datatype sendtype,
35        void *recvbuf, int recvcnt, MPI_Datatype recvtype,
36        MPI_Comm comm)
37
38    int MPI_Alltoall_c(const void *sendbuf, MPI_Count sendcount,
39        MPI_Datatype sendtype, void *recvbuf, MPI_Count recvcnt,
40        MPI_Datatype recvtype, MPI_Comm comm)
41
42    int MPI_Alltoall_init(const void *sendbuf, int sendcount,
43        MPI_Datatype sendtype, void *recvbuf, int recvcnt,
44        MPI_Datatype recvtype, MPI_Comm comm, MPI_Info info,
45        MPI_Request *request)
46
47    int MPI_Alltoall_init_c(const void *sendbuf, MPI_Count sendcount,
48        MPI_Datatype sendtype, void *recvbuf, MPI_Count recvcnt,
49        MPI_Datatype recvtype, MPI_Comm comm, MPI_Info info,
50        MPI_Request *request)
51
52    int MPI_Alltoallv(const void *sendbuf, const int sendcounts[],
53        const int sdispls[], MPI_Datatype sendtype, void *recvbuf,
54        const int recvcnts[], const MPI_Aint rdispls[], MPI_Datatype recvtype,
55        MPI_Comm comm, MPI_Info info, MPI_Request *request)

```



```
    const int recvcnts[], const int rdispls[],  
    MPI_Datatype recvtype, MPI_Comm comm) 1  
2  
3  
int MPI_Alltoallv_c(const void *sendbuf, const MPI_Count sendcounts[],  
    const MPI_Aint sdispls[], MPI_Datatype sendtype,  
    void *recvbuf, const MPI_Count recvcnts[],  
    const MPI_Aint rdispls[], MPI_Datatype recvtype,  
    MPI_Comm comm) 4  
5  
6  
7  
8  
int MPI_Alltoallv_init(const void *sendbuf, const int sendcounts[],  
    const int sdispls[], MPI_Datatype sendtype, void *recvbuf,  
    const int recvcnts[], const int rdispls[],  
    MPI_Datatype recvtype, MPI_Comm comm, MPI_Info info,  
    MPI_Request *request) 9  
10  
11  
12  
13  
14  
int MPI_Alltoallv_init_c(const void *sendbuf, const MPI_Count sendcounts[],  
    const MPI_Aint sdispls[], MPI_Datatype sendtype,  
    void *recvbuf, const MPI_Count recvcnts[],  
    const MPI_Aint rdispls[], MPI_Datatype recvtype,  
    MPI_Comm comm, MPI_Info info, MPI_Request *request) 15  
16  
17  
18  
19  
int MPI_Alltoallw(const void *sendbuf, const int sendcounts[],  
    const int sdispls[], const MPI_Datatype sendtypes[],  
    void *recvbuf, const int recvcnts[], const int rdispls[],  
    const MPI_Datatype recvtypes[], MPI_Comm comm) 20  
21  
22  
23  
24  
int MPI_Alltoallw_c(const void *sendbuf, const MPI_Count sendcounts[],  
    const MPI_Aint sdispls[], const MPI_Datatype sendtypes[],  
    void *recvbuf, const MPI_Count recvcnts[],  
    const MPI_Aint rdispls[], const MPI_Datatype recvtypes[],  
    MPI_Comm comm) 25  
26  
27  
28  
29  
int MPI_Alltoallw_init(const void *sendbuf, const int sendcounts[],  
    const int sdispls[], const MPI_Datatype sendtypes[],  
    void *recvbuf, const int recvcnts[], const int rdispls[],  
    const MPI_Datatype recvtypes[], MPI_Comm comm, MPI_Info info,  
    MPI_Request *request) 30  
31  
32  
33  
34  
35  
int MPI_Alltoallw_init_c(const void *sendbuf, const MPI_Count sendcounts[],  
    const MPI_Aint sdispls[], const MPI_Datatype sendtypes[],  
    void *recvbuf, const MPI_Count recvcnts[],  
    const MPI_Aint rdispls[], const MPI_Datatype recvtypes[],  
    MPI_Comm comm, MPI_Info info, MPI_Request *request) 36  
37  
38  
39  
40  
41  
int MPI_Barrier(MPI_Comm comm) 42  
43  
int MPI_Barrier_init(MPI_Comm comm, MPI_Info info, MPI_Request *request) 44  
45  
int MPI_Bcast(void *buffer, int count, MPI_Datatype datatype, int root,  
    MPI_Comm comm) 46  
47  
int MPI_Bcast_c(void *buffer, MPI_Count count, MPI_Datatype datatype,  
    int root, MPI_Comm comm) 48
```

```

1  int MPI_Bcast_init(void *buffer, int count, MPI_Datatype datatype,
2      int root, MPI_Comm comm, MPI_Info info, MPI_Request *request)
3
4  int MPI_Bcast_init_c(void *buffer, MPI_Count count, MPI_Datatype datatype,
5      int root, MPI_Comm comm, MPI_Info info, MPI_Request *request)
6
7  int MPI_Exscan(const void *sendbuf, void *recvbuf, int count,
8      MPI_Datatype datatype, MPI_Op op, MPI_Comm comm)
9
10 int MPI_Exscan_c(const void *sendbuf, void *recvbuf, MPI_Count count,
11     MPI_Datatype datatype, MPI_Op op, MPI_Comm comm)
12
13 int MPI_Exscan_init(const void *sendbuf, void *recvbuf, int count,
14     MPI_Datatype datatype, MPI_Op op, MPI_Comm comm,
15     MPI_Info info, MPI_Request *request)
16
17 int MPI_Exscan_init_c(const void *sendbuf, void *recvbuf, MPI_Count count,
18     MPI_Datatype datatype, MPI_Op op, MPI_Comm comm,
19     MPI_Info info, MPI_Request *request)
20
21 int MPI_Gather(const void *sendbuf, int sendcount, MPI_Datatype sendtype,
22     void *recvbuf, int recvcount, MPI_Datatype recvttype, int root,
23     MPI_Comm comm)
24
25 int MPI_Gather_c(const void *sendbuf, MPI_Count sendcount,
26     MPI_Datatype sendtype, void *recvbuf, MPI_Count recvcount,
27     MPI_Datatype recvttype, int root, MPI_Comm comm)
28
29 int MPI_Gather_init(const void *sendbuf, int sendcount,
30     MPI_Datatype sendtype, void *recvbuf, int recvcount,
31     MPI_Datatype recvttype, int root, MPI_Comm comm, MPI_Info info,
32     MPI_Request *request)
33
34 int MPI_Gather_init_c(const void *sendbuf, MPI_Count sendcount,
35     MPI_Datatype sendtype, void *recvbuf, MPI_Count recvcount,
36     MPI_Datatype recvttype, int root, MPI_Comm comm, MPI_Info info,
37     MPI_Request *request)
38
39 int MPI_Gatherv(const void *sendbuf, int sendcount, MPI_Datatype sendtype,
40     void *recvbuf, const int recvcounts[], const int displs[],
41     MPI_Datatype recvttype, int root, MPI_Comm comm)
42
43 int MPI_Gatherv_c(const void *sendbuf, MPI_Count sendcount,
44     MPI_Datatype sendtype, void *recvbuf,
45     const MPI_Count recvcounts[], const MPI_Aint displs[],
46     MPI_Datatype recvttype, int root, MPI_Comm comm)
47
48 int MPI_Gatherv_init(const void *sendbuf, int sendcount,
49     MPI_Datatype sendtype, void *recvbuf, const int recvcounts[],
50     const int displs[], MPI_Datatype recvttype, int root,
51     MPI_Comm comm, MPI_Info info, MPI_Request *request)
52
53 int MPI_Gatherv_init_c(const void *sendbuf, MPI_Count sendcount,
54     MPI_Datatype sendtype, void *recvbuf,
55     const MPI_Count recvcounts[], const MPI_Aint displs[],
56     MPI_Datatype recvttype, int root, MPI_Comm comm, MPI_Info info,
57     MPI_Request *request)

```

```

    const MPI_Count recvcnts[], const MPI_Aint displs[],
    MPI_Datatype recvtype, int root, MPI_Comm comm, MPI_Info info,
    MPI_Request *request)
1
2
3
4
int MPI_Iallgather(const void *sendbuf, int sendcount,
5
    MPI_Datatype sendtype, void *recvbuf, int recvcount,
6
    MPI_Datatype recvtype, MPI_Comm comm, MPI_Request *request)
7
8
int MPI_Iallgather_c(const void *sendbuf, MPI_Count sendcount,
9
    MPI_Datatype sendtype, void *recvbuf, MPI_Count recvcount,
10
    MPI_Datatype recvtype, MPI_Comm comm, MPI_Request *request)
11
12
int MPI_Iallgatherv(const void *sendbuf, int sendcount,
13
    MPI_Datatype sendtype, void *recvbuf, const int recvcnts[],
14
    const int displs[], MPI_Datatype recvtype, MPI_Comm comm,
15
    MPI_Request *request)
16
17
int MPI_Iallgatherv_c(const void *sendbuf, MPI_Count sendcount,
18
    MPI_Datatype sendtype, void *recvbuf,
19
    const MPI_Count recvcnts[], const MPI_Aint displs[],
20
    MPI_Datatype recvtype, MPI_Comm comm, MPI_Request *request)
21
22
int MPI_Iallreduce(const void *sendbuf, void *recvbuf, int count,
23
    MPI_Datatype datatype, MPI_Op op, MPI_Comm comm,
24
    MPI_Request *request)
25
26
int MPI_Iallreduce_c(const void *sendbuf, void *recvbuf, MPI_Count count,
27
    MPI_Datatype datatype, MPI_Op op, MPI_Comm comm,
28
    MPI_Request *request)
29
30
int MPI_Ialltoall(const void *sendbuf, int sendcount,
31
    MPI_Datatype sendtype, void *recvbuf, int recvcount,
32
    MPI_Datatype recvtype, MPI_Comm comm, MPI_Request *request)
33
34
int MPI_Ialltoall_c(const void *sendbuf, MPI_Count sendcount,
35
    MPI_Datatype sendtype, void *recvbuf, MPI_Count recvcount,
36
    MPI_Datatype recvtype, MPI_Comm comm, MPI_Request *request)
37
38
int MPI_Ialltoallv(const void *sendbuf, const int sendcounts[],
39
    const int sdispls[], MPI_Datatype sendtype, void *recvbuf,
40
    const int recvcnts[], const int rdispls[],
41
    MPI_Datatype recvtype, MPI_Comm comm, MPI_Request *request)
42
43
int MPI_Ialltoallv_c(const void *sendbuf, const MPI_Count sendcounts[],
44
    const MPI_Aint sdispls[], MPI_Datatype sendtype,
45
    void *recvbuf, const MPI_Count recvcnts[],
46
    const MPI_Aint rdispls[], MPI_Datatype recvtype,
47
    MPI_Comm comm, MPI_Request *request)
48
int MPI_Ialltoallw(const void *sendbuf, const int sendcounts[],
    const int sdispls[], const MPI_Datatype sendtypes[],
    void *recvbuf, const int recvcnts[], const int rdispls[],
    const MPI_Datatype recvtypes[], MPI_Comm comm,

```

```

1         MPI_Request *request)
2
3     int MPI_Ialltoallw_c(const void *sendbuf, const MPI_Count sendcounts[],
4         const MPI_Aint sdispls[], const MPI_Datatype sendtypes[],
5         void *recvbuf, const MPI_Count recvcounts[],
6         const MPI_Aint rdispls[], const MPI_Datatype recvtypes[],
7         MPI_Comm comm, MPI_Request *request)
8
9     int MPI_Ibarrier(MPI_Comm comm, MPI_Request *request)
10
11    int MPI_Ibcast(void *buffer, int count, MPI_Datatype datatype, int root,
12        MPI_Comm comm, MPI_Request *request)
13
14    int MPI_Ibcast_c(void *buffer, MPI_Count count, MPI_Datatype datatype,
15        int root, MPI_Comm comm, MPI_Request *request)
16
17    int MPI_Iexscan(const void *sendbuf, void *recvbuf, int count,
18        MPI_Datatype datatype, MPI_Op op, MPI_Comm comm,
19        MPI_Request *request)
20
21    int MPI_Iexscan_c(const void *sendbuf, void *recvbuf, MPI_Count count,
22        MPI_Datatype datatype, MPI_Op op, MPI_Comm comm,
23        MPI_Request *request)
24
25    int MPI_Igather(const void *sendbuf, int sendcount, MPI_Datatype sendtype,
26        void *recvbuf, int recvcount, MPI_Datatype recvtype, int root,
27        MPI_Comm comm, MPI_Request *request)
28
29    int MPI_Igather_c(const void *sendbuf, MPI_Count sendcount,
30        MPI_Datatype sendtype, void *recvbuf, MPI_Count recvcount,
31        MPI_Datatype recvtype, int root, MPI_Comm comm,
32        MPI_Request *request)
33
34    int MPI_Igather_v(const void *sendbuf, int sendcount, MPI_Datatype sendtype,
35        void *recvbuf, const int recvcounts[], const int displs[],
36        MPI_Datatype recvtype, int root, MPI_Comm comm,
37        MPI_Request *request)
38
39    int MPI_Igather_v_c(const void *sendbuf, MPI_Count sendcount,
40        MPI_Datatype sendtype, void *recvbuf,
41        const MPI_Count recvcounts[], const MPI_Aint displs[],
42        MPI_Datatype recvtype, int root, MPI_Comm comm,
43        MPI_Request *request)
44
45    int MPI_Ireduce(const void *sendbuf, void *recvbuf, int count,
46        MPI_Datatype datatype, MPI_Op op, int root, MPI_Comm comm,
47        MPI_Request *request)
48
49    int MPI_Ireduce_c(const void *sendbuf, void *recvbuf, MPI_Count count,
50        MPI_Datatype datatype, MPI_Op op, int root, MPI_Comm comm,
51        MPI_Request *request)
52
53    int MPI_Ireduce_scatter(const void *sendbuf, void *recvbuf,
54        const int recvcounts[], MPI_Datatype datatype, MPI_Op op,

```

```
    MPI_Comm comm, MPI_Request *request) 1
int MPI_Ireduce_scatter_block(const void *sendbuf, void *recvbuf, 2
    int recvcnt, MPI_Datatype datatype, MPI_Op op, 3
    MPI_Comm comm, MPI_Request *request) 4
int MPI_Ireduce_scatter_block_c(const void *sendbuf, void *recvbuf, 5
    MPI_Count recvcnt, MPI_Datatype datatype, MPI_Op op, 6
    MPI_Comm comm, MPI_Request *request) 7
int MPI_Ireduce_scatter_c(const void *sendbuf, void *recvbuf, 8
    const MPI_Count recvcnts[], MPI_Datatype datatype, 9
    MPI_Op op, MPI_Comm comm, MPI_Request *request) 10
int MPI_Iscan(const void *sendbuf, void *recvbuf, int count, 11
    MPI_Datatype datatype, MPI_Op op, MPI_Comm comm, 12
    MPI_Request *request) 13
int MPI_Iscan_c(const void *sendbuf, void *recvbuf, MPI_Count count, 14
    MPI_Datatype datatype, MPI_Op op, MPI_Comm comm, 15
    MPI_Request *request) 16
int MPI_Iscatter(const void *sendbuf, int sendcount, MPI_Datatype sendtype, 17
    void *recvbuf, int recvcnt, MPI_Datatype recvtype, int root, 18
    MPI_Comm comm, MPI_Request *request) 19
int MPI_Iscatter_c(const void *sendbuf, MPI_Count sendcount, 20
    MPI_Datatype sendtype, void *recvbuf, MPI_Count recvcnt, 21
    MPI_Datatype recvtype, int root, MPI_Comm comm, 22
    MPI_Request *request) 23
int MPI_Iscatterv(const void *sendbuf, const int sendcounts[], 24
    const int displs[], MPI_Datatype sendtype, void *recvbuf, 25
    int recvcnt, MPI_Datatype recvtype, int root, MPI_Comm comm, 26
    MPI_Request *request) 27
int MPI_Iscatterv_c(const void *sendbuf, const MPI_Count sendcounts[], 28
    const MPI_Aint displs[], MPI_Datatype sendtype, void *recvbuf, 29
    MPI_Count recvcnt, MPI_Datatype recvtype, int root, 30
    MPI_Comm comm, MPI_Request *request) 31
int MPI_Op_commutative(MPI_Op op, int *commute) 32
int MPI_Op_create(MPI_User_function *user_fn, int commute, MPI_Op *op) 33
int MPI_Op_create_c(MPI_User_function_c *user_fn, int commute, MPI_Op *op) 34
int MPI_Op_free(MPI_Op *op) 35
int MPI_Reduce(const void *sendbuf, void *recvbuf, int count, 36
    MPI_Datatype datatype, MPI_Op op, int root, MPI_Comm comm) 37
int MPI_Reduce_c(const void *sendbuf, void *recvbuf, MPI_Count count, 38
    MPI_Datatype datatype, MPI_Op op, int root, MPI_Comm comm) 39
int MPI_Reduce_scatter(const void *sendbuf, void *recvbuf, MPI_Count count, 40
    MPI_Datatype datatype, MPI_Op op, int root, MPI_Comm comm) 41
int MPI_Reduce_scatter_block(const void *sendbuf, void *recvbuf, MPI_Count count, 42
    MPI_Datatype datatype, MPI_Op op, int root, MPI_Comm comm) 43
int MPI_Reduce_scatter_block_c(const void *sendbuf, void *recvbuf, MPI_Count count, 44
    MPI_Datatype datatype, MPI_Op op, int root, MPI_Comm comm) 45
int MPI_Reduce_scatter_c(const void *sendbuf, void *recvbuf, MPI_Count count, 46
    MPI_Datatype datatype, MPI_Op op, int root, MPI_Comm comm) 47
int MPI_Reduce_scatter_block_c(const void *sendbuf, void *recvbuf, MPI_Count count, 48
    MPI_Datatype datatype, MPI_Op op, int root, MPI_Comm comm) 49
```

```
1 int MPI_Reduce_init(const void *sendbuf, void *recvbuf, int count,
2     MPI_Datatype datatype, MPI_Op op, int root, MPI_Comm comm,
3     MPI_Info info, MPI_Request *request)
4
5 int MPI_Reduce_init_c(const void *sendbuf, void *recvbuf, MPI_Count count,
6     MPI_Datatype datatype, MPI_Op op, int root, MPI_Comm comm,
7     MPI_Info info, MPI_Request *request)
8
9 int MPI_Reduce_local(const void *inbuf, void *inoutbuf, int count,
10    MPI_Datatype datatype, MPI_Op op)
11
12 int MPI_Reduce_local_c(const void *inbuf, void *inoutbuf, MPI_Count count,
13    MPI_Datatype datatype, MPI_Op op)
14
15 int MPI_Reduce_scatter(const void *sendbuf, void *recvbuf,
16    const int recvcounts[], MPI_Datatype datatype, MPI_Op op,
17    MPI_Comm comm)
18
19 int MPI_Reduce_scatter_block(const void *sendbuf, void *recvbuf,
20    int recvcount, MPI_Datatype datatype, MPI_Op op,
21    MPI_Comm comm)
22
23 int MPI_Reduce_scatter_block_c(const void *sendbuf, void *recvbuf,
24    MPI_Count recvcount, MPI_Datatype datatype, MPI_Op op,
25    MPI_Comm comm)
26
27 int MPI_Reduce_scatter_block_init(const void *sendbuf, void *recvbuf,
28    int recvcount, MPI_Datatype datatype, MPI_Op op,
29    MPI_Comm comm, MPI_Info info, MPI_Request *request)
30
31 int MPI_Reduce_scatter_block_init_c(const void *sendbuf, void *recvbuf,
32    MPI_Count recvcount, MPI_Datatype datatype, MPI_Op op,
33    MPI_Comm comm, MPI_Info info, MPI_Request *request)
34
35 int MPI_Reduce_scatter_c(const void *sendbuf, void *recvbuf,
36    const MPI_Count recvcounts[], MPI_Datatype datatype,
37    MPI_Op op, MPI_Comm comm)
38
39 int MPI_Reduce_scatter_init(const void *sendbuf, void *recvbuf,
40    const int recvcounts[], MPI_Datatype datatype, MPI_Op op,
41    MPI_Comm comm, MPI_Info info, MPI_Request *request)
42
43 int MPI_Reduce_scatter_init_c(const void *sendbuf, void *recvbuf,
44    const MPI_Count recvcounts[], MPI_Datatype datatype,
45    MPI_Op op, MPI_Comm comm, MPI_Info info, MPI_Request *request)
46
47 int MPI_Scan(const void *sendbuf, void *recvbuf, int count,
48    MPI_Datatype datatype, MPI_Op op, MPI_Comm comm)
```

```

        MPI_Info info, MPI_Request *request)
1
2
int MPI_Scan_init_c(const void *sendbuf, void *recvbuf, MPI_Count count,
3
4
5
6
7
8
9
10
11
12
13
14
15
16
17
18
19
20
21
22
23
24
25
26
27
28
29
30
31
32
33
34
35
36
37
38
39
40
41
42
43
44
45
46
47
48
        MPI_Datatype datatype, MPI_Op op, MPI_Comm comm,
        MPI_Info info, MPI_Request *request)
int MPI_Scatter(const void *sendbuf, int sendcount, MPI_Datatype sendtype,
        void *recvbuf, int recvcount, MPI_Datatype recvtype, int root,
        MPI_Comm comm)
int MPI_Scatter_c(const void *sendbuf, MPI_Count sendcount,
        MPI_Datatype sendtype, void *recvbuf, MPI_Count recvcount,
        MPI_Datatype recvtype, int root, MPI_Comm comm)
int MPI_Scatter_init(const void *sendbuf, int sendcount,
        MPI_Datatype sendtype, void *recvbuf, int recvcount,
        MPI_Datatype recvtype, int root, MPI_Comm comm, MPI_Info info,
        MPI_Request *request)
int MPI_Scatter_init_c(const void *sendbuf, MPI_Count sendcount,
        MPI_Datatype sendtype, void *recvbuf, MPI_Count recvcount,
        MPI_Datatype recvtype, int root, MPI_Comm comm, MPI_Info info,
        MPI_Request *request)
int MPI_Scatterv(const void *sendbuf, const int sendcounts[],
        const int displs[], MPI_Datatype sendtype, void *recvbuf,
        int recvcount, MPI_Datatype recvtype, int root, MPI_Comm comm)
int MPI_Scatterv_c(const void *sendbuf, const MPI_Count sendcounts[],
        const MPI_Aint displs[], MPI_Datatype sendtype, void *recvbuf,
        MPI_Count recvcount, MPI_Datatype recvtype, int root,
        MPI_Comm comm)
int MPI_Scatterv_init(const void *sendbuf, const int sendcounts[],
        const int displs[], MPI_Datatype sendtype, void *recvbuf,
        int recvcount, MPI_Datatype recvtype, int root, MPI_Comm comm,
        MPI_Info info, MPI_Request *request)
int MPI_Scatterv_init_c(const void *sendbuf, const MPI_Count sendcounts[],
        const MPI_Aint displs[], MPI_Datatype sendtype, void *recvbuf,
        MPI_Count recvcount, MPI_Datatype recvtype, int root,
        MPI_Comm comm, MPI_Info info, MPI_Request *request)

```

### A.3.5 Groups, Contexts, Communicators, and Caching C Bindings

```

int MPI_COMM_DUP_FN(MPI_Comm oldcomm, int comm_keyval, void *extra_state,
        void *attribute_val_in, void *attribute_val_out, int *flag)
int MPI_COMM_NULL_COPY_FN(MPI_Comm oldcomm, int comm_keyval,
        void *extra_state, void *attribute_val_in,
        void *attribute_val_out, int *flag)

```

```
1 int MPI_COMM_NULL_DELETE_FN(MPI_Comm comm, int comm_keyval,
2     void *attribute_val, void *extra_state)
3
4 int MPI_Comm_compare(MPI_Comm comm1, MPI_Comm comm2, int *result)
5
6 int MPI_Comm_create(MPI_Comm comm, MPI_Group group, MPI_Comm *newcomm)
7
8 int MPI_Comm_create_from_group(MPI_Group group, const char *stringtag,
9     MPI_Info info, MPI_Errhandler errhandler, MPI_Comm *newcomm)
10
11 int MPI_Comm_create_group(MPI_Comm comm, MPI_Group group, int tag,
12     MPI_Comm *newcomm)
13
14 int MPI_Comm_create_keyval(MPI_Comm_copy_attr_function *comm_copy_attr_fn,
15     MPI_Comm_delete_attr_function *comm_delete_attr_fn,
16     int *comm_keyval, void *extra_state)
17
18 int MPI_Comm_delete_attr(MPI_Comm comm, int comm_keyval)
19
20 int MPI_Comm_dup(MPI_Comm comm, MPI_Comm *newcomm)
21
22 int MPI_Comm_dup_with_info(MPI_Comm comm, MPI_Info info, MPI_Comm *newcomm)
23
24 int MPI_Comm_free(MPI_Comm *comm)
25
26 int MPI_Comm_free_keyval(int *comm_keyval)
27
28 int MPI_Comm_get_attr(MPI_Comm comm, int comm_keyval, void *attribute_val,
29     int *flag)
30
31 int MPI_Comm_get_info(MPI_Comm comm, MPI_Info *info_used)
32
33 int MPI_Comm_get_name(MPI_Comm comm, char *comm_name, int *resultlen)
34
35 int MPI_Comm_group(MPI_Comm comm, MPI_Group *group)
36
37 int MPI_Comm_idup(MPI_Comm comm, MPI_Comm *newcomm, MPI_Request *request)
38
39 int MPI_Comm_idup_with_info(MPI_Comm comm, MPI_Info info,
40     MPI_Comm *newcomm, MPI_Request *request)
41
42 int MPI_Comm_rank(MPI_Comm comm, int *rank)
43
44 int MPI_Comm_remote_group(MPI_Comm comm, MPI_Group *group)
45
46 int MPI_Comm_remote_size(MPI_Comm comm, int *size)
47
48 int MPI_Comm_set_attr(MPI_Comm comm, int comm_keyval, void *attribute_val)
49
50 int MPI_Comm_set_info(MPI_Comm comm, MPI_Info info)
51
52 int MPI_Comm_set_name(MPI_Comm comm, const char *comm_name)
53
54 int MPI_Comm_size(MPI_Comm comm, int *size)
55
56 int MPI_Comm_split(MPI_Comm comm, int color, int key, MPI_Comm *newcomm)
57
58 int MPI_Comm_split_type(MPI_Comm comm, int split_type, int key,
59     MPI_Info info, MPI_Comm *newcomm)
60
```



```
int MPI_Comm_test_inter(MPI_Comm comm, int *flag) 1
int MPI_Group_compare(MPI_Group group1, MPI_Group group2, int *result) 2
int MPI_Group_difference(MPI_Group group1, MPI_Group group2, 3
    MPI_Group *newgroup) 4
int MPI_Group_excl(MPI_Group group, int n, const int ranks[], 5
    MPI_Group *newgroup) 6
int MPI_Group_free(MPI_Group *group) 7
int MPI_Group_from_session_pset(MPI_Session session, const char *pset_name, 8
    MPI_Group *newgroup) 9
int MPI_Group_incl(MPI_Group group, int n, const int ranks[], 10
    MPI_Group *newgroup) 11
int MPI_Group_intersection(MPI_Group group1, MPI_Group group2, 12
    MPI_Group *newgroup) 13
int MPI_Group_range_excl(MPI_Group group, int n, int ranges[][3], 14
    MPI_Group *newgroup) 15
int MPI_Group_range_incl(MPI_Group group, int n, int ranges[][3], 16
    MPI_Group *newgroup) 17
int MPI_Group_rank(MPI_Group group, int *rank) 18
int MPI_Group_size(MPI_Group group, int *size) 19
int MPI_Group_translate_ranks(MPI_Group group1, int n, const int ranks1[], 20
    MPI_Group group2, int ranks2[]) 21
int MPI_Group_union(MPI_Group group1, MPI_Group group2, 22
    MPI_Group *newgroup) 23
int MPI_Intercomm_create(MPI_Comm local_comm, int local_leader, 24
    MPI_Comm peer_comm, int remote_leader, int tag, 25
    MPI_Comm *newintercomm) 26
int MPI_Intercomm_create_from_groups(MPI_Group local_group, 27
    int local_leader, MPI_Group remote_group, int remote_leader, 28
    const char *stringtag, MPI_Info info, 29
    MPI_Errhandler errhandler, MPI_Comm *newintercomm) 30
int MPI_Intercomm_merge(MPI_Comm intercomm, int high, 31
    MPI_Comm *newintracomm) 32
int MPI_TYPE_DUP_FN(MPI_Datatype oldtype, int type_keyval, 33
    void *extra_state, void *attribute_val_in, 34
    void *attribute_val_out, int *flag) 35
int MPI_TYPE_NULL_COPY_FN(MPI_Datatype oldtype, int type_keyval, 36
    void *extra_state, void *attribute_val_in, 37
    void *attribute_val_out, int *flag) 38
int MPI_Type_dup(MPI_Datatype oldtype, int type_keyval, 39
    void *extra_state, void *attribute_val_in, 40
    void *attribute_val_out, int *flag) 41
int MPI_Type_copy(MPI_Datatype oldtype, int type_keyval, 42
    void *extra_state, void *attribute_val_in, 43
    void *attribute_val_out, int *flag) 44
int MPI_Type_create_subarray(MPI_Datatype oldtype, int type_keyval, 45
    void *extra_state, void *attribute_val_in, 46
    void *attribute_val_out, int *flag) 47
int MPI_Type_create_subvector(MPI_Datatype oldtype, int type_keyval, 48
    void *extra_state, void *attribute_val_in, 49
    void *attribute_val_out, int *flag) 50
```

```

1  int MPI_TYPE_NULL_DELETE_FN(MPI_Datatype datatype, int type_keyval,
2      void *attribute_val, void *extra_state)
3
4  int MPI_Type_create_keyval(MPI_Type_copy_attr_function *type_copy_attr_fn,
5      MPI_Type_delete_attr_function *type_delete_attr_fn,
6      int *type_keyval, void *extra_state)
7
8  int MPI_Type_delete_attr(MPI_Datatype datatype, int type_keyval)
9
10 int MPI_Type_free_keyval(int *type_keyval)
11
12 int MPI_Type_get_attr(MPI_Datatype datatype, int type_keyval,
13     void *attribute_val, int *flag)
14
15 int MPI_Type_get_name(MPI_Datatype datatype, char *type_name,
16     int *resultlen)
17
18 int MPI_Type_set_attr(MPI_Datatype datatype, int type_keyval,
19     void *attribute_val)
20
21 int MPI_Type_set_name(MPI_Datatype datatype, const char *type_name)
22
23 int MPI_WIN_DUP_FN(MPI_Win oldwin, int win_keyval, void *extra_state,
24     void *attribute_val_in, void *attribute_val_out, int *flag)
25
26 int MPI_WIN_NULL_COPY_FN(MPI_Win oldwin, int win_keyval, void *extra_state,
27     void *attribute_val_in, void *attribute_val_out, int *flag)
28
29 int MPI_WIN_NULL_DELETE_FN(MPI_Win win, int win_keyval,
30     void *attribute_val, void *extra_state)
31
32 int MPI_Win_create_keyval(MPI_Win_copy_attr_function *win_copy_attr_fn,
33     MPI_Win_delete_attr_function *win_delete_attr_fn,
34     int *win_keyval, void *extra_state)
35
36 int MPI_Win_delete_attr(MPI_Win win, int win_keyval)
37
38 int MPI_Win_free_keyval(int *win_keyval)
39
40 int MPI_Win_get_attr(MPI_Win win, int win_keyval, void *attribute_val,
41     int *flag)
42
43 int MPI_Win_get_name(MPI_Win win, char *win_name, int *resultlen)
44
45 int MPI_Win_set_attr(MPI_Win win, int win_keyval, void *attribute_val)
46
47 int MPI_Win_set_name(MPI_Win win, const char *win_name)
48

```

### A.3.6 Process Topologies C Bindings

```

43 int MPI_Cart_coords(MPI_Comm comm, int rank, int maxdims, int coords[])
44
45 int MPI_Cart_create(MPI_Comm comm_old, int ndims, const int dims[],
46     const int periods[], int reorder, MPI_Comm *comm_cart)
47
48

```

```
int MPI_Cart_get(MPI_Comm comm, int maxdims, int dims[], int periods[],  
                int coords[]) 1  
int MPI_Cart_map(MPI_Comm comm, int ndims, const int dims[],  
                const int periods[], int *newrank) 2  
int MPI_Cart_rank(MPI_Comm comm, const int coords[], int *rank) 3  
int MPI_Cart_shift(MPI_Comm comm, int direction, int disp,  
                  int *rank_source, int *rank_dest) 4  
int MPI_Cart_sub(MPI_Comm comm, const int remain_dims[], MPI_Comm *newcomm) 5  
int MPI_Cartdim_get(MPI_Comm comm, int *ndims) 6  
int MPI_Dims_create(int nnodes, int ndims, int dims[]) 7  
int MPI_Dist_graph_create(MPI_Comm comm_old, int n, const int sources[],  
                          const int degrees[], const int destinations[],  
                          const int weights[], MPI_Info info, int reorder,  
                          MPI_Comm *comm_dist_graph) 8  
int MPI_Dist_graph_create_adjacent(MPI_Comm comm_old, int indegree,  
                                   const int sources[], const int sourceweights[], int outdegree,  
                                   const int destinations[], const int destweights[],  
                                   MPI_Info info, int reorder, MPI_Comm *comm_dist_graph) 9  
int MPI_Dist_graph_neighbors(MPI_Comm comm, int maxindegree, int sources[],  
                             int sourceweights[], int maxoutdegree, int destinations[],  
                             int destweights[]) 10  
int MPI_Dist_graph_neighbors_count(MPI_Comm comm, int *indegree,  
                                   int *outdegree, int *weighted) 11  
int MPI_Graph_create(MPI_Comm comm_old, int nnodes, const int index[],  
                    const int edges[], int reorder, MPI_Comm *comm_graph) 12  
int MPI_Graph_get(MPI_Comm comm, int maxindex, int maxedges, int index[],  
                  int edges[]) 13  
int MPI_Graph_map(MPI_Comm comm, int nnodes, const int index[],  
                  const int edges[], int *newrank) 14  
int MPI_Graph_neighbors(MPI_Comm comm, int rank, int maxneighbors,  
                        int neighbors[]) 15  
int MPI_Graph_neighbors_count(MPI_Comm comm, int rank, int *nneighbors) 16  
int MPI_Graphdims_get(MPI_Comm comm, int *nnodes, int *nedges) 17  
int MPI_Ineighbor_allgather(const void *sendbuf, int sendcount,  
                            MPI_Datatype sendtype, void *recvbuf, int recvcount,  
                            MPI_Datatype recvtype, MPI_Comm comm, MPI_Request *request) 18  
int MPI_Ineighbor_allgather_c(const void *sendbuf, MPI_Count sendcount,  
                              MPI_Datatype sendtype, void *recvbuf, MPI_Count recvcount,
```

```

1         MPI_Datatype recvtype, MPI_Comm comm, MPI_Request *request)
2
3     int MPI_Ineighbor_allgatherv(const void *sendbuf, int sendcount,
4         MPI_Datatype sendtype, void *recvbuf, const int recvcnts[],
5         const int displs[], MPI_Datatype recvtype, MPI_Comm comm,
6         MPI_Request *request)
7
8     int MPI_Ineighbor_allgatherv_c(const void *sendbuf, MPI_Count sendcount,
9         MPI_Datatype sendtype, void *recvbuf,
10        const MPI_Count recvcnts[], const MPI_Aint displs[],
11        MPI_Datatype recvtype, MPI_Comm comm, MPI_Request *request)
12
13    int MPI_Ineighbor_alltoall(const void *sendbuf, int sendcount,
14        MPI_Datatype sendtype, void *recvbuf, int recvcnt,
15        MPI_Datatype recvtype, MPI_Comm comm, MPI_Request *request)
16
17    int MPI_Ineighbor_alltoall_c(const void *sendbuf, MPI_Count sendcount,
18        MPI_Datatype sendtype, void *recvbuf, MPI_Count recvcnt,
19        MPI_Datatype recvtype, MPI_Comm comm, MPI_Request *request)
20
21    int MPI_Ineighbor_alltoallv(const void *sendbuf, const int sendcounts[],
22        const int sdispls[], MPI_Datatype sendtype, void *recvbuf,
23        const int recvcnts[], const int rdispls[],
24        MPI_Datatype recvtype, MPI_Comm comm, MPI_Request *request)
25
26    int MPI_Ineighbor_alltoallv_c(const void *sendbuf,
27        const MPI_Count sendcounts[], const MPI_Aint sdispls[],
28        MPI_Datatype sendtype, void *recvbuf,
29        const MPI_Count recvcnts[], const MPI_Aint rdispls[],
30        MPI_Datatype recvtype, MPI_Comm comm, MPI_Request *request)
31
32    int MPI_Ineighbor_alltoallw(const void *sendbuf, const int sendcounts[],
33        const MPI_Aint sdispls[], const MPI_Datatype sendtypes[],
34        void *recvbuf, const int recvcnts[],
35        const MPI_Aint rdispls[], const MPI_Datatype recvtypes[],
36        MPI_Comm comm, MPI_Request *request)
37
38    int MPI_Ineighbor_alltoallw_c(const void *sendbuf,
39        const MPI_Count sendcounts[], const MPI_Aint sdispls[],
40        const MPI_Datatype sendtypes[], void *recvbuf,
41        const MPI_Count recvcnts[], const MPI_Aint rdispls[],
42        const MPI_Datatype recvtypes[], MPI_Comm comm,
43        MPI_Request *request)
44
45    int MPI_Neighbor_allgather(const void *sendbuf, int sendcount,
46        MPI_Datatype sendtype, void *recvbuf, int recvcnt,
47        MPI_Datatype recvtype, MPI_Comm comm)
48
49    int MPI_Neighbor_allgather_c(const void *sendbuf, MPI_Count sendcount,
50        MPI_Datatype sendtype, void *recvbuf, MPI_Count recvcnt,
51        MPI_Datatype recvtype, MPI_Comm comm)
52
53    int MPI_Neighbor_allgather_init(const void *sendbuf, int sendcount,

```

```
    MPI_Datatype sendtype, void *recvbuf, int recvcnt,      1
    MPI_Datatype recvtype, MPI_Comm comm, MPI_Info info,    2
    MPI_Request *request)                                   3
                                                         4
int MPI_Neighbor_allgather_init_c(const void *sendbuf, MPI_Count sendcount,
    MPI_Datatype sendtype, void *recvbuf, MPI_Count recvcnt, 5
    MPI_Datatype recvtype, MPI_Comm comm, MPI_Info info,    6
    MPI_Request *request)                                   7
                                                         8
int MPI_Neighbor_allgather_v(const void *sendbuf, int sendcount,
    MPI_Datatype sendtype, void *recvbuf, const int recvcnts[], 9
    const int displs[], MPI_Datatype recvtype, MPI_Comm comm) 10
                                                         11
int MPI_Neighbor_allgather_v_c(const void *sendbuf, MPI_Count sendcount,
    MPI_Datatype sendtype, void *recvbuf,                   12
    const MPI_Count recvcnts[], const MPI_Aint displs[],    13
    MPI_Datatype recvtype, MPI_Comm comm)                  14
                                                         15
int MPI_Neighbor_allgather_v_init(const void *sendbuf, int sendcount,
    MPI_Datatype sendtype, void *recvbuf, const int recvcnts[], 16
    const int displs[], MPI_Datatype recvtype, MPI_Comm comm, 17
    MPI_Info info, MPI_Request *request)                    18
                                                         19
int MPI_Neighbor_allgather_v_init_c(const void *sendbuf,
    MPI_Count sendcount, MPI_Datatype sendtype, void *recvbuf, 20
    const MPI_Count recvcnts[], const MPI_Aint displs[],    21
    MPI_Datatype recvtype, MPI_Comm comm, MPI_Info info,   22
    MPI_Request *request)                                   23
                                                         24
int MPI_Neighbor_alltoall(const void *sendbuf, int sendcount,
    MPI_Datatype sendtype, void *recvbuf, int recvcnt,      25
    MPI_Datatype recvtype, MPI_Comm comm)                  26
                                                         27
int MPI_Neighbor_alltoall_c(const void *sendbuf, MPI_Count sendcount,
    MPI_Datatype sendtype, void *recvbuf, MPI_Count recvcnt, 28
    MPI_Datatype recvtype, MPI_Comm comm)                  29
                                                         30
int MPI_Neighbor_alltoall_init(const void *sendbuf, int sendcount,
    MPI_Datatype sendtype, void *recvbuf, int recvcnt,      31
    MPI_Datatype recvtype, MPI_Comm comm, MPI_Info info,   32
    MPI_Request *request)                                   33
                                                         34
int MPI_Neighbor_alltoall_init_c(const void *sendbuf, MPI_Count sendcount,
    MPI_Datatype sendtype, void *recvbuf, MPI_Count recvcnt, 35
    MPI_Datatype recvtype, MPI_Comm comm, MPI_Info info,   36
    MPI_Request *request)                                   37
                                                         38
int MPI_Neighbor_alltoall_v(const void *sendbuf, const int sendcounts[],
    const int sdispls[], MPI_Datatype sendtype, void *recvbuf, 39
    const int recvcnts[], const int rdispls[],              40
    MPI_Datatype recvtype, MPI_Comm comm)                  41
                                                         42
int MPI_Neighbor_alltoall_v_c(const void *sendbuf,          43
```

```
1      const MPI_Count sendcounts[], const MPI_Aint sdispls[],
2      MPI_Datatype sendtype, void *recvbuf,
3      const MPI_Count recvcounts[], const MPI_Aint rdispls[],
4      MPI_Datatype recvtype, MPI_Comm comm)
5
6  int MPI_Neighbor_alltoallv_init(const void *sendbuf,
7      const int sendcounts[], const int sdispls[],
8      MPI_Datatype sendtype, void *recvbuf, const int recvcounts[],
9      const int rdispls[], MPI_Datatype recvtype, MPI_Comm comm,
10     MPI_Info info, MPI_Request *request)
11
12 int MPI_Neighbor_alltoallv_init_c(const void *sendbuf,
13     const MPI_Count sendcounts[], const MPI_Aint sdispls[],
14     MPI_Datatype sendtype, void *recvbuf,
15     const MPI_Count recvcounts[], const MPI_Aint rdispls[],
16     MPI_Datatype recvtype, MPI_Comm comm, MPI_Info info,
17     MPI_Request *request)
18
19 int MPI_Neighbor_alltoallw(const void *sendbuf, const int sendcounts[],
20     const MPI_Aint sdispls[], const MPI_Datatype sendtypes[],
21     void *recvbuf, const int recvcounts[],
22     const MPI_Aint rdispls[], const MPI_Datatype recvtypes[],
23     MPI_Comm comm)
24
25 int MPI_Neighbor_alltoallw_c(const void *sendbuf,
26     const MPI_Count sendcounts[], const MPI_Aint sdispls[],
27     const MPI_Datatype sendtypes[], void *recvbuf,
28     const MPI_Count recvcounts[], const MPI_Aint rdispls[],
29     const MPI_Datatype recvtypes[], MPI_Comm comm)
30
31 int MPI_Neighbor_alltoallw_init(const void *sendbuf,
32     const int sendcounts[], const MPI_Aint sdispls[],
33     const MPI_Datatype sendtypes[], void *recvbuf,
34     const int recvcounts[], const MPI_Aint rdispls[],
35     const MPI_Datatype recvtypes[], MPI_Comm comm, MPI_Info info,
36     MPI_Request *request)
37
38 int MPI_Neighbor_alltoallw_init_c(const void *sendbuf,
39     const MPI_Count sendcounts[], const MPI_Aint sdispls[],
40     const MPI_Datatype sendtypes[], void *recvbuf,
41     const MPI_Count recvcounts[], const MPI_Aint rdispls[],
42     const MPI_Datatype recvtypes[], MPI_Comm comm, MPI_Info info,
43     MPI_Request *request)
44
45 int MPI_Topo_test(MPI_Comm comm, int *status)
```

### A.3.7 MPI Environmental Management C Bindings

```
46 int MPI_Add_error_class(int *errorclass)
47
48 int MPI_Add_error_code(int errorclass, int *errorcode)
```

```
int MPI_Add_error_string(int errorcode, const char *string) 1
int MPI_Alloc_mem(MPI_Aint size, MPI_Info info, void *baseptr) 2
int MPI_Comm_call_errhandler(MPI_Comm comm, int errorcode) 3
int MPI_Comm_create_errhandler( 4
    MPI_Comm_errhandler_function *comm_errhandler_fn, 5
    MPI_Errhandler *errhandler) 6
int MPI_Comm_get_errhandler(MPI_Comm comm, MPI_Errhandler *errhandler) 7
int MPI_Comm_set_errhandler(MPI_Comm comm, MPI_Errhandler errhandler) 8
int MPI_Errhandler_free(MPI_Errhandler *errhandler) 9
int MPI_Error_class(int errorcode, int *errorclass) 10
int MPI_Error_string(int errorcode, char *string, int *resultlen) 11
int MPI_File_call_errhandler(MPI_File fh, int errorcode) 12
int MPI_File_create_errhandler( 13
    MPI_File_errhandler_function *file_errhandler_fn, 14
    MPI_Errhandler *errhandler) 15
int MPI_File_get_errhandler(MPI_File file, MPI_Errhandler *errhandler) 16
int MPI_File_set_errhandler(MPI_File file, MPI_Errhandler errhandler) 17
int MPI_Free_mem(void *base) 18
int MPI_Get_library_version(char *version, int *resultlen) 19
int MPI_Get_processor_name(char *name, int *resultlen) 20
int MPI_Get_version(int *version, int *subversion) 21
int MPI_Session_call_errhandler(MPI_Session session, int errorcode) 22
int MPI_Session_create_errhandler( 23
    MPI_Session_errhandler_function *session_errhandler_fn, 24
    MPI_Errhandler *errhandler) 25
int MPI_Session_get_errhandler(MPI_Session session, 26
    MPI_Errhandler *errhandler) 27
int MPI_Session_set_errhandler(MPI_Session session, 28
    MPI_Errhandler errhandler) 29
int MPI_Win_call_errhandler(MPI_Win win, int errorcode) 30
int MPI_Win_create_errhandler( 31
    MPI_Win_errhandler_function *win_errhandler_fn, 32
    MPI_Errhandler *errhandler) 33
int MPI_Win_get_errhandler(MPI_Win win, MPI_Errhandler *errhandler) 34
int MPI_Win_set_errhandler(MPI_Win win, MPI_Errhandler errhandler) 35
int MPI_Win_get_errhandler(MPI_Win win, MPI_Errhandler *errhandler) 36
int MPI_Win_set_errhandler(MPI_Win win, MPI_Errhandler errhandler) 37
int MPI_Win_get_errhandler(MPI_Win win, MPI_Errhandler *errhandler) 38
int MPI_Win_set_errhandler(MPI_Win win, MPI_Errhandler errhandler) 39
int MPI_Win_get_errhandler(MPI_Win win, MPI_Errhandler *errhandler) 40
int MPI_Win_set_errhandler(MPI_Win win, MPI_Errhandler errhandler) 41
int MPI_Win_get_errhandler(MPI_Win win, MPI_Errhandler *errhandler) 42
int MPI_Win_set_errhandler(MPI_Win win, MPI_Errhandler errhandler) 43
int MPI_Win_get_errhandler(MPI_Win win, MPI_Errhandler *errhandler) 44
int MPI_Win_set_errhandler(MPI_Win win, MPI_Errhandler errhandler) 45
int MPI_Win_get_errhandler(MPI_Win win, MPI_Errhandler *errhandler) 46
int MPI_Win_set_errhandler(MPI_Win win, MPI_Errhandler errhandler) 47
int MPI_Win_get_errhandler(MPI_Win win, MPI_Errhandler *errhandler) 48
int MPI_Win_set_errhandler(MPI_Win win, MPI_Errhandler errhandler) 49
```

### A.3.8 The Info Object C Bindings

```
1 int MPI_Info_create(MPI_Info *info)
2
3 int MPI_Info_create_env(int argc, char argv[], MPI_Info *info)
4
5 int MPI_Info_delete(MPI_Info info, const char *key)
6
7 int MPI_Info_dup(MPI_Info info, MPI_Info *newinfo)
8
9 int MPI_Info_free(MPI_Info *info)
10
11 int MPI_Info_get(MPI_Info info, const char *key, int valuelen, char *value,
12                 int *flag)
13
14 int MPI_Info_get_nkeys(MPI_Info info, int *nkeys)
15
16 int MPI_Info_get_nthkey(MPI_Info info, int n, char *key)
17
18 int MPI_Info_get_string(MPI_Info info, const char *key, int *buflen,
19                         char *value, int *flag)
20
21 int MPI_Info_get_valuelen(MPI_Info info, const char *key, int *valuelen,
22                           int *flag)
23
24 int MPI_Info_set(MPI_Info info, const char *key, const char *value)
```

### A.3.9 Process Creation and Management C Bindings

```
25 int MPI_Abort(MPI_Comm comm, int errorcode)
26
27 int MPI_Close_port(const char *port_name)
28
29 int MPI_Comm_accept(const char *port_name, MPI_Info info, int root,
30                   MPI_Comm comm, MPI_Comm *newcomm)
31
32 int MPI_Comm_connect(const char *port_name, MPI_Info info, int root,
33                    MPI_Comm comm, MPI_Comm *newcomm)
34
35 int MPI_Comm_disconnect(MPI_Comm *comm)
36
37 int MPI_Comm_get_parent(MPI_Comm *parent)
38
39 int MPI_Comm_join(int fd, MPI_Comm *intercomm)
40
41 int MPI_Comm_spawn(const char *command, char *argv[], int maxprocs,
42                  MPI_Info info, int root, MPI_Comm comm, MPI_Comm *intercomm,
43                  int array_of_errcodes[])
44
45 int MPI_Comm_spawn_multiple(int count, char *array_of_commands[],
46                             char **array_of_argv[], const int array_of_maxprocs[],
47                             const MPI_Info array_of_info[], int root, MPI_Comm comm,
48                             MPI_Comm *intercomm, int array_of_errcodes[])
49
50 int MPI_Finalize(void)
51
52 int MPI_Finalized(int *flag)
```



```
int MPI_Init(int *argc, char ***argv) 1
int MPI_Init_thread(int *argc, char ***argv, int required, int *provided) 2
int MPI_Initialized(int *flag) 3
int MPI_Is_thread_main(int *flag) 4
int MPI_Lookup_name(const char *service_name, MPI_Info info, 5
                   char *port_name) 6
int MPI_Open_port(MPI_Info info, char *port_name) 7
int MPI_Publish_name(const char *service_name, MPI_Info info, 8
                    const char *port_name) 9
int MPI_Query_thread(int *provided) 10
int MPI_Session_finalize(MPI_Session *session) 11
int MPI_Session_get_info(MPI_Session session, MPI_Info *info_used) 12
int MPI_Session_get_nth_pset(MPI_Session session, MPI_Info info, int n, 13
                             int *pset_len, char *pset_name) 14
int MPI_Session_get_num_psets(MPI_Session session, MPI_Info info, 15
                              int *npset_names) 16
int MPI_Session_get_pset_info(MPI_Session session, const char *pset_name, 17
                              MPI_Info *info) 18
int MPI_Session_init(MPI_Info info, MPI_Errhandler errhandler, 19
                    MPI_Session *session) 20
int MPI_Unpublish_name(const char *service_name, MPI_Info info, 21
                      const char *port_name) 22
```

#### A.3.10 One-Sided Communications C Bindings

```
int MPI_Accumulate(const void *origin_addr, int origin_count, 23
                  MPI_Datatype origin_datatype, int target_rank, 24
                  MPI_Aint target_disp, int target_count, 25
                  MPI_Datatype target_datatype, MPI_Op op, MPI_Win win) 26
int MPI_Accumulate_c(const void *origin_addr, MPI_Count origin_count, 27
                    MPI_Datatype origin_datatype, int target_rank, 28
                    MPI_Aint target_disp, MPI_Count target_count, 29
                    MPI_Datatype target_datatype, MPI_Op op, MPI_Win win) 30
int MPI_Compare_and_swap(const void *origin_addr, const void *compare_addr, 31
                        void *result_addr, MPI_Datatype datatype, int target_rank, 32
                        MPI_Aint target_disp, MPI_Win win) 33
int MPI_Fetch_and_op(const void *origin_addr, void *result_addr, 34
                    MPI_Datatype datatype, int target_rank, MPI_Aint target_disp, 35
                    MPI_Op op, MPI_Win win) 36
```

```
1         MPI_Op op, MPI_Win win)
2
3     int MPI_Get(void *origin_addr, int origin_count,
4                 MPI_Datatype origin_datatype, int target_rank,
5                 MPI_Aint target_disp, int target_count,
6                 MPI_Datatype target_datatype, MPI_Win win)
7
8     int MPI_Get_accumulate(const void *origin_addr, int origin_count,
9                            MPI_Datatype origin_datatype, void *result_addr,
10                           int result_count, MPI_Datatype result_datatype,
11                           int target_rank, MPI_Aint target_disp, int target_count,
12                           MPI_Datatype target_datatype, MPI_Op op, MPI_Win win)
13
14     int MPI_Get_accumulate_c(const void *origin_addr, MPI_Count origin_count,
15                             MPI_Datatype origin_datatype, void *result_addr,
16                             MPI_Count result_count, MPI_Datatype result_datatype,
17                             int target_rank, MPI_Aint target_disp, MPI_Count target_count,
18                             MPI_Datatype target_datatype, MPI_Op op, MPI_Win win)
19
20     int MPI_Get_c(void *origin_addr, MPI_Count origin_count,
21                  MPI_Datatype origin_datatype, int target_rank,
22                  MPI_Aint target_disp, MPI_Count target_count,
23                  MPI_Datatype target_datatype, MPI_Win win)
24
25     int MPI_Put(const void *origin_addr, int origin_count,
26                MPI_Datatype origin_datatype, int target_rank,
27                MPI_Aint target_disp, int target_count,
28                MPI_Datatype target_datatype, MPI_Win win)
29
30     int MPI_Put_c(const void *origin_addr, MPI_Count origin_count,
31                  MPI_Datatype origin_datatype, int target_rank,
32                  MPI_Aint target_disp, MPI_Count target_count,
33                  MPI_Datatype target_datatype, MPI_Win win)
34
35     int MPI_Raccumulate(const void *origin_addr, int origin_count,
36                        MPI_Datatype origin_datatype, int target_rank,
37                        MPI_Aint target_disp, int target_count,
38                        MPI_Datatype target_datatype, MPI_Op op, MPI_Win win,
39                        MPI_Request *request)
40
41     int MPI_Raccumulate_c(const void *origin_addr, MPI_Count origin_count,
42                           MPI_Datatype origin_datatype, int target_rank,
43                           MPI_Aint target_disp, MPI_Count target_count,
44                           MPI_Datatype target_datatype, MPI_Op op, MPI_Win win,
45                           MPI_Request *request)
46
47     int MPI_Rget(void *origin_addr, int origin_count,
48                 MPI_Datatype origin_datatype, int target_rank,
49                 MPI_Aint target_disp, int target_count,
50                 MPI_Datatype target_datatype, MPI_Win win,
51                 MPI_Request *request)
```

```
int MPI_Rget_accumulate(const void *origin_addr, int origin_count,      1
                        MPI_Datatype origin_datatype, void *result_addr,  2
                        int result_count, MPI_Datatype result_datatype,  3
                        int target_rank, MPI_Aint target_disp, int target_count,  4
                        MPI_Datatype target_datatype, MPI_Op op, MPI_Win win,  5
                        MPI_Request *request)                               6
                                                                    7
int MPI_Rget_accumulate_c(const void *origin_addr, MPI_Count origin_count,  8
                          MPI_Datatype origin_datatype, void *result_addr,  9
                          MPI_Count result_count, MPI_Datatype result_datatype, 10
                          int target_rank, MPI_Aint target_disp, MPI_Count target_count, 11
                          MPI_Datatype target_datatype, MPI_Op op, MPI_Win win, 12
                          MPI_Request *request)                           13
                                                                    14
int MPI_Rget_c(void *origin_addr, MPI_Count origin_count,              15
               MPI_Datatype origin_datatype, int target_rank,         16
               MPI_Aint target_disp, MPI_Count target_count,          17
               MPI_Datatype target_datatype, MPI_Win win,             18
               MPI_Request *request)                                    19
                                                                    20
int MPI_Rput(const void *origin_addr, int origin_count,                21
             MPI_Datatype origin_datatype, int target_rank,           22
             MPI_Aint target_disp, int target_count,                  23
             MPI_Datatype target_datatype, MPI_Win win,               24
             MPI_Request *request)                                      25
                                                                    26
int MPI_Rput_c(const void *origin_addr, MPI_Count origin_count,        27
               MPI_Datatype origin_datatype, int target_rank,         28
               MPI_Aint target_disp, MPI_Count target_count,          29
               MPI_Datatype target_datatype, MPI_Win win,             30
               MPI_Request *request)                                    31
                                                                    32
int MPI_Win_allocate(MPI_Aint size, int disp_unit, MPI_Info info,      33
                    MPI_Comm comm, void *baseptr, MPI_Win *win)        34
                                                                    35
int MPI_Win_allocate_c(MPI_Aint size, MPI_Aint disp_unit, MPI_Info info, 36
                       MPI_Comm comm, void *baseptr, MPI_Win *win)     37
                                                                    38
int MPI_Win_allocate_shared(MPI_Aint size, int disp_unit, MPI_Info info, 39
                             MPI_Comm comm, void *baseptr, MPI_Win *win) 40
                                                                    41
int MPI_Win_allocate_shared_c(MPI_Aint size, MPI_Aint disp_unit,        42
                              MPI_Info info, MPI_Comm comm, void *baseptr, MPI_Win *win) 43
                                                                    44
int MPI_Win_attach(MPI_Win win, void *base, MPI_Aint size)            45
                                                                    46
int MPI_Win_complete(MPI_Win win)                                     47
                                                                    48
int MPI_Win_create(void *base, MPI_Aint size, int disp_unit, MPI_Info info,
                  MPI_Comm comm, MPI_Win *win)
int MPI_Win_create_c(void *base, MPI_Aint size, MPI_Aint disp_unit,
                    MPI_Info info, MPI_Comm comm, MPI_Win *win)
```

```

1  int MPI_Win_create_dynamic(MPI_Info info, MPI_Comm comm, MPI_Win *win)
2
3  int MPI_Win_detach(MPI_Win win, const void *base)
4
5  int MPI_Win_fence(int assert, MPI_Win win)
6
7  int MPI_Win_flush(int rank, MPI_Win win)
8
9  int MPI_Win_flush_all(MPI_Win win)
10
11 int MPI_Win_flush_local(int rank, MPI_Win win)
12
13 int MPI_Win_flush_local_all(MPI_Win win)
14
15 int MPI_Win_free(MPI_Win *win)
16
17 int MPI_Win_get_group(MPI_Win win, MPI_Group *group)
18
19 int MPI_Win_get_info(MPI_Win win, MPI_Info *info_used)
20
21 int MPI_Win_lock(int lock_type, int rank, int assert, MPI_Win win)
22
23 int MPI_Win_lock_all(int assert, MPI_Win win)
24
25 int MPI_Win_post(MPI_Group group, int assert, MPI_Win win)
26
27 int MPI_Win_set_info(MPI_Win win, MPI_Info info)
28
29 int MPI_Win_shared_query(MPI_Win win, int rank, MPI_Aint *size,
30                          int *disp_unit, void *baseptr)
31
32 int MPI_Win_shared_query_c(MPI_Win win, int rank, MPI_Aint *size,
33                             MPI_Aint *disp_unit, void *baseptr)
34
35 int MPI_Win_start(MPI_Group group, int assert, MPI_Win win)
36
37 int MPI_Win_sync(MPI_Win win)
38
39 int MPI_Win_test(MPI_Win win, int *flag)
40
41 int MPI_Win_unlock(int rank, MPI_Win win)
42
43 int MPI_Win_unlock_all(MPI_Win win)
44
45 int MPI_Win_wait(MPI_Win win)
46
47
48

```

### A.3.11 External Interfaces C Bindings

```

39  int MPI_Grequest_complete(MPI_Request request)
40
41  int MPI_Grequest_start(MPI_Grequest_query_function *query_fn,
42                        MPI_Grequest_free_function *free_fn,
43                        MPI_Grequest_cancel_function *cancel_fn, void *extra_state,
44                        MPI_Request *request)
45
46  int MPI_Status_set_cancelled(MPI_Status *status, int flag)
47
48  int MPI_Status_set_elements(MPI_Status *status, MPI_Datatype datatype,
                              int count)

```

```
int MPI_Status_set_elements_x(MPI_Status *status, MPI_Datatype datatype,
                             MPI_Count count)
```

### A.3.12 I/O C Bindings

```
int MPI_CONVERSION_FN_NULL(void *userbuf, MPI_Datatype datatype, int count,
                           void *filebuf, MPI_Offset position, void *extra_state)
```

```
int MPI_CONVERSION_FN_NULL_c(void *userbuf, MPI_Datatype datatype,
                              MPI_Count count, void *filebuf, MPI_Offset position,
                              void *extra_state)
```

```
int MPI_File_close(MPI_File *fh)
```

```
int MPI_File_delete(const char *filename, MPI_Info info)
```

```
int MPI_File_get_amode(MPI_File fh, int *amode)
```

```
int MPI_File_get_atomicity(MPI_File fh, int *flag)
```

```
int MPI_File_get_byte_offset(MPI_File fh, MPI_Offset offset,
                             MPI_Offset *disp)
```

```
int MPI_File_get_group(MPI_File fh, MPI_Group *group)
```

```
int MPI_File_get_info(MPI_File fh, MPI_Info *info_used)
```

```
int MPI_File_get_position(MPI_File fh, MPI_Offset *offset)
```

```
int MPI_File_get_position_shared(MPI_File fh, MPI_Offset *offset)
```

```
int MPI_File_get_size(MPI_File fh, MPI_Offset *size)
```

```
int MPI_File_get_type_extent(MPI_File fh, MPI_Datatype datatype,
                             MPI_Aint *extent)
```

```
int MPI_File_get_type_extent_c(MPI_File fh, MPI_Datatype datatype,
                               MPI_Count *extent)
```

```
int MPI_File_get_view(MPI_File fh, MPI_Offset *disp, MPI_Datatype *etype,
                     MPI_Datatype *filetype, char *datarep)
```

```
int MPI_File_iread(MPI_File fh, void *buf, int count,
                  MPI_Datatype datatype, MPI_Request *request)
```

```
int MPI_File_iread_all(MPI_File fh, void *buf, int count,
                      MPI_Datatype datatype, MPI_Request *request)
```

```
int MPI_File_iread_all_c(MPI_File fh, void *buf, MPI_Count count,
                        MPI_Datatype datatype, MPI_Request *request)
```

```
int MPI_File_iread_at(MPI_File fh, MPI_Offset offset, void *buf, int count,
                    MPI_Datatype datatype, MPI_Request *request)
```

```
int MPI_File_iread_at_all(MPI_File fh, MPI_Offset offset, void *buf,
                          int count, MPI_Datatype datatype, MPI_Request *request)
```

```
1 int MPI_File_iread_at_all_c(MPI_File fh, MPI_Offset offset, void *buf,
2     MPI_Count count, MPI_Datatype datatype, MPI_Request *request)
3
4 int MPI_File_iread_at_c(MPI_File fh, MPI_Offset offset, void *buf,
5     MPI_Count count, MPI_Datatype datatype, MPI_Request *request)
6
7 int MPI_File_iread_c(MPI_File fh, void *buf, MPI_Count count,
8     MPI_Datatype datatype, MPI_Request *request)
9
10 int MPI_File_iread_shared(MPI_File fh, void *buf, int count,
11     MPI_Datatype datatype, MPI_Request *request)
12
13 int MPI_File_iread_shared_c(MPI_File fh, void *buf, MPI_Count count,
14     MPI_Datatype datatype, MPI_Request *request)
15
16 int MPI_File_iwrite(MPI_File fh, const void *buf, int count,
17     MPI_Datatype datatype, MPI_Request *request)
18
19 int MPI_File_iwrite_all(MPI_File fh, const void *buf, int count,
20     MPI_Datatype datatype, MPI_Request *request)
21
22 int MPI_File_iwrite_all_c(MPI_File fh, const void *buf, MPI_Count count,
23     MPI_Datatype datatype, MPI_Request *request)
24
25 int MPI_File_iwrite_at(MPI_File fh, MPI_Offset offset, const void *buf,
26     int count, MPI_Datatype datatype, MPI_Request *request)
27
28 int MPI_File_iwrite_at_all(MPI_File fh, MPI_Offset offset, const void *buf,
29     int count, MPI_Datatype datatype, MPI_Request *request)
30
31 int MPI_File_iwrite_at_all_c(MPI_File fh, MPI_Offset offset,
32     const void *buf, MPI_Count count, MPI_Datatype datatype,
33     MPI_Request *request)
34
35 int MPI_File_iwrite_at_c(MPI_File fh, MPI_Offset offset, const void *buf,
36     MPI_Count count, MPI_Datatype datatype, MPI_Request *request)
37
38 int MPI_File_iwrite_c(MPI_File fh, const void *buf, MPI_Count count,
39     MPI_Datatype datatype, MPI_Request *request)
40
41 int MPI_File_iwrite_shared(MPI_File fh, const void *buf, int count,
42     MPI_Datatype datatype, MPI_Request *request)
43
44 int MPI_File_iwrite_shared_c(MPI_File fh, const void *buf, MPI_Count count,
45     MPI_Datatype datatype, MPI_Request *request)
46
47 int MPI_File_open(MPI_Comm comm, const char *filename, int amode,
48     MPI_Info info, MPI_File *fh)
49
50 int MPI_File_preallocate(MPI_File fh, MPI_Offset size)
51
52 int MPI_File_read(MPI_File fh, void *buf, int count, MPI_Datatype datatype,
53     MPI_Status *status)
54
55 int MPI_File_read_all(MPI_File fh, void *buf, int count,
56     MPI_Datatype datatype, MPI_Status *status)
```

```
int MPI_File_read_all_begin(MPI_File fh, void *buf, int count,      1
                           MPI_Datatype datatype)                  2
int MPI_File_read_all_begin_c(MPI_File fh, void *buf, MPI_Count count, 3
                              MPI_Datatype datatype)              4
int MPI_File_read_all_c(MPI_File fh, void *buf, MPI_Count count,    6
                        MPI_Datatype datatype, MPI_Status *status) 7
int MPI_File_read_all_end(MPI_File fh, void *buf, MPI_Status *status) 8
int MPI_File_read_at(MPI_File fh, MPI_Offset offset, void *buf, int count, 10
                     MPI_Datatype datatype, MPI_Status *status)    11
int MPI_File_read_at_all(MPI_File fh, MPI_Offset offset, void *buf, 13
                          int count, MPI_Datatype datatype, MPI_Status *status) 14
int MPI_File_read_at_all_begin(MPI_File fh, MPI_Offset offset, void *buf, 15
                               int count, MPI_Datatype datatype)    16
int MPI_File_read_at_all_begin_c(MPI_File fh, MPI_Offset offset, void *buf, 18
                                  MPI_Count count, MPI_Datatype datatype) 19
int MPI_File_read_at_all_c(MPI_File fh, MPI_Offset offset, void *buf, 21
                            MPI_Count count, MPI_Datatype datatype, MPI_Status *status) 22
int MPI_File_read_at_all_end(MPI_File fh, void *buf, MPI_Status *status) 23
int MPI_File_read_at_c(MPI_File fh, MPI_Offset offset, void *buf, 25
                       MPI_Count count, MPI_Datatype datatype, MPI_Status *status) 26
int MPI_File_read_c(MPI_File fh, void *buf, MPI_Count count, 27
                    MPI_Datatype datatype, MPI_Status *status)    28
int MPI_File_read_ordered(MPI_File fh, void *buf, int count, 29
                           MPI_Datatype datatype, MPI_Status *status) 30
int MPI_File_read_ordered_begin(MPI_File fh, void *buf, int count, 32
                                 MPI_Datatype datatype)            33
int MPI_File_read_ordered_begin_c(MPI_File fh, void *buf, MPI_Count count, 35
                                   MPI_Datatype datatype)          36
int MPI_File_read_ordered_c(MPI_File fh, void *buf, MPI_Count count, 37
                             MPI_Datatype datatype, MPI_Status *status) 38
int MPI_File_read_ordered_end(MPI_File fh, void *buf, MPI_Status *status) 39
int MPI_File_read_shared(MPI_File fh, void *buf, int count, 41
                          MPI_Datatype datatype, MPI_Status *status) 42
int MPI_File_read_shared_c(MPI_File fh, void *buf, MPI_Count count, 44
                            MPI_Datatype datatype, MPI_Status *status) 45
int MPI_File_seek(MPI_File fh, MPI_Offset offset, int whence) 46
int MPI_File_seek_shared(MPI_File fh, MPI_Offset offset, int whence) 47
                                                                    48
```

```
1 int MPI_File_set_atomicsity(MPI_File fh, int flag)
2
3 int MPI_File_set_info(MPI_File fh, MPI_Info info)
4
5 int MPI_File_set_size(MPI_File fh, MPI_Offset size)
6
7 int MPI_File_set_view(MPI_File fh, MPI_Offset disp, MPI_Datatype etype,
8     MPI_Datatype filetype, const char *datarep, MPI_Info info)
9
10 int MPI_File_sync(MPI_File fh)
11
12 int MPI_File_write(MPI_File fh, const void *buf, int count,
13     MPI_Datatype datatype, MPI_Status *status)
14
15 int MPI_File_write_all(MPI_File fh, const void *buf, int count,
16     MPI_Datatype datatype, MPI_Status *status)
17
18 int MPI_File_write_all_begin(MPI_File fh, const void *buf, int count,
19     MPI_Datatype datatype)
20
21 int MPI_File_write_all_begin_c(MPI_File fh, const void *buf,
22     MPI_Count count, MPI_Datatype datatype)
23
24 int MPI_File_write_all_c(MPI_File fh, const void *buf, MPI_Count count,
25     MPI_Datatype datatype, MPI_Status *status)
26
27 int MPI_File_write_all_end(MPI_File fh, const void *buf,
28     MPI_Status *status)
29
30 int MPI_File_write_at(MPI_File fh, MPI_Offset offset, const void *buf,
31     int count, MPI_Datatype datatype, MPI_Status *status)
32
33 int MPI_File_write_at_all(MPI_File fh, MPI_Offset offset, const void *buf,
34     int count, MPI_Datatype datatype, MPI_Status *status)
35
36 int MPI_File_write_at_all_begin(MPI_File fh, MPI_Offset offset,
37     const void *buf, int count, MPI_Datatype datatype)
38
39 int MPI_File_write_at_all_begin_c(MPI_File fh, MPI_Offset offset,
40     const void *buf, MPI_Count count, MPI_Datatype datatype)
41
42 int MPI_File_write_at_all_c(MPI_File fh, MPI_Offset offset,
43     const void *buf, MPI_Count count, MPI_Datatype datatype,
44     MPI_Status *status)
45
46 int MPI_File_write_at_all_end(MPI_File fh, const void *buf,
47     MPI_Status *status)
48
49 int MPI_File_write_at_c(MPI_File fh, MPI_Offset offset, const void *buf,
50     MPI_Count count, MPI_Datatype datatype, MPI_Status *status)
51
52 int MPI_File_write_c(MPI_File fh, const void *buf, MPI_Count count,
53     MPI_Datatype datatype, MPI_Status *status)
54
55 int MPI_File_write_ordered(MPI_File fh, const void *buf, int count,
56     MPI_Datatype datatype, MPI_Status *status)
```



```

int MPI_File_write_ordered_begin(MPI_File fh, const void *buf, int count,
    MPI_Datatype datatype)
int MPI_File_write_ordered_begin_c(MPI_File fh, const void *buf,
    MPI_Count count, MPI_Datatype datatype)
int MPI_File_write_ordered_c(MPI_File fh, const void *buf, MPI_Count count,
    MPI_Datatype datatype, MPI_Status *status)
int MPI_File_write_ordered_end(MPI_File fh, const void *buf,
    MPI_Status *status)
int MPI_File_write_shared(MPI_File fh, const void *buf, int count,
    MPI_Datatype datatype, MPI_Status *status)
int MPI_File_write_shared_c(MPI_File fh, const void *buf, MPI_Count count,
    MPI_Datatype datatype, MPI_Status *status)
int MPI_Register_datarep(const char *datarep,
    MPI_Datarep_conversion_function *read_conversion_fn,
    MPI_Datarep_conversion_function *write_conversion_fn,
    MPI_Datarep_extent_function *dtype_file_extent_fn,
    void *extra_state)
int MPI_Register_datarep_c(const char *datarep,
    MPI_Datarep_conversion_function_c *read_conversion_fn,
    MPI_Datarep_conversion_function_c *write_conversion_fn,
    MPI_Datarep_extent_function *dtype_file_extent_fn,
    void *extra_state)

```

### A.3.13 Language Bindings C Bindings

```

int MPI_Status_f082f(const MPI_F08_status *f08_status, MPI_Fint *f_status)
int MPI_Status_f2f08(const MPI_Fint *f_status, MPI_F08_status *f08_status)
int MPI_Type_create_f90_complex(int p, int r, MPI_Datatype *newtype)
int MPI_Type_create_f90_integer(int r, MPI_Datatype *newtype)
int MPI_Type_create_f90_real(int p, int r, MPI_Datatype *newtype)
int MPI_Type_match_size(int typeclass, int size, MPI_Datatype *datatype)

```

### A.3.14 Tools / Profiling Interface C Bindings

```

int MPI_Pcontrol(const int level, ...)

```

### A.3.15 Tools / MPI Tool Information Interface C Bindings

```

int MPI_T_category_changed(int *stamp)
int MPI_T_category_get_categories(int cat_index, int len, int indices[])

```

```
1 int MPI_T_category_get_cvars(int cat_index, int len, int indices[])
2
3 int MPI_T_category_get_events(int cat_index, int len, int indices[])
4
5 int MPI_T_category_get_index(const char *name, int *cat_index)
6
7 int MPI_T_category_get_info(int cat_index, char *name, int *name_len,
8                             char *desc, int *desc_len, int *num_cvars, int *num_pvars,
9                             int *num_categories)
10
11 int MPI_T_category_get_num(int *num_cat)
12
13 int MPI_T_category_get_num_events(int cat_index, int *num_events)
14
15 int MPI_T_category_get_pvars(int cat_index, int len, int indices[])
16
17 int MPI_T_cvar_get_index(const char *name, int *cvar_index)
18
19 int MPI_T_cvar_get_info(int cvar_index, char *name, int *name_len,
20                         int *verbosity, MPI_Datatype *datatype, MPI_T_enum *enumtype,
21                         char *desc, int *desc_len, int *bind, int *scope)
22
23 int MPI_T_cvar_get_num(int *num_cvar)
24
25 int MPI_T_cvar_handle_alloc(int cvar_index, void *obj_handle,
26                             MPI_T_cvar_handle *handle, int *count)
27
28 int MPI_T_cvar_handle_free(MPI_T_cvar_handle *handle)
29
30 int MPI_T_cvar_read(MPI_T_cvar_handle handle, void *buf)
31
32 int MPI_T_cvar_write(MPI_T_cvar_handle handle, const void *buf)
33
34 int MPI_T_enum_get_info(MPI_T_enum enumtype, int *num, char *name,
35                         int *name_len)
36
37 int MPI_T_enum_get_item(MPI_T_enum enumtype, int index, int *value,
38                         char *name, int *name_len)
39
40 int MPI_T_event_callback_get_info(
41     MPI_T_event_registration event_registration,
42     MPI_T_cb_safety cb_safety, MPI_Info *info_used)
43
44 int MPI_T_event_callback_set_info(
45     MPI_T_event_registration event_registration,
46     MPI_T_cb_safety cb_safety, MPI_Info info)
47
48 int MPI_T_event_copy(MPI_T_event_instance event_instance, void *buffer)
49
50 int MPI_T_event_get_index(const char *name, int *event_index)
51
52 int MPI_T_event_get_info(int event_index, char *name, int *name_len,
53                         int *verbosity, MPI_Datatype array_of_datatypes[],
54                         MPI_Aint array_of_displacements[], int *num_elements,
55                         MPI_T_enum *enumtype, MPI_Info *info, char *desc,
56                         int *desc_len, int *bind)
```

```
int MPI_T_event_get_num(int *num_events) 1
int MPI_T_event_get_source(MPI_T_event_instance event_instance, 2
    int *source_index) 3
int MPI_T_event_get_timestamp(MPI_T_event_instance event_instance, 4
    MPI_Count *event_timestamp) 5
int MPI_T_event_handle_alloc(int event_index, void *obj_handle, 6
    MPI_Info info, MPI_T_event_registration *event_registration) 7
int MPI_T_event_handle_free(MPI_T_event_registration event_registration, 8
    void *user_data, 9
    MPI_T_event_free_cb_function free_cb_function) 10
int MPI_T_event_handle_get_info(MPI_T_event_registration event_registration, 11
    MPI_Info *info_used) 12
int MPI_T_event_handle_set_info(MPI_T_event_registration event_registration, MPI_Info info) 13
int MPI_T_event_read(MPI_T_event_instance event_instance, 14
    int element_index, void *buffer) 15
int MPI_T_event_register_callback(MPI_T_event_registration event_registration, 16
    MPI_T_cb_safety cb_safety, MPI_Info info, void *user_data, 17
    MPI_T_event_cb_function event_cb_function) 18
int MPI_T_event_set_dropped_handler(MPI_T_event_registration event_registration, 19
    MPI_T_event_dropped_cb_function dropped_cb_function) 20
int MPI_T_finalize(void) 21
int MPI_T_init_thread(int required, int *provided) 22
int MPI_T_pvar_get_index(const char *name, int var_class, int *pvar_index) 23
int MPI_T_pvar_get_info(int pvar_index, char *name, int *name_len, 24
    int *verbosity, int *var_class, MPI_Datatype *datatype, 25
    MPI_T_enum *enumtype, char *desc, int *desc_len, int *bind, 26
    int *readonly, int *continuous, int *atomic) 27
int MPI_T_pvar_get_num(int *num_pvar) 28
int MPI_T_pvar_handle_alloc(MPI_T_pvar_session pe_session, int pvar_index, 29
    void *obj_handle, MPI_T_pvar_handle *handle, int *count) 30
int MPI_T_pvar_handle_free(MPI_T_pvar_session pe_session, 31
    MPI_T_pvar_handle *handle) 32
int MPI_T_pvar_read(MPI_T_pvar_session pe_session, 33
    MPI_T_pvar_handle handle, void *buf) 34

```

```

1  int MPI_T_pvar_readreset(MPI_T_pvar_session pe_session,
2      MPI_T_pvar_handle handle, void *buf)
3
4  int MPI_T_pvar_reset(MPI_T_pvar_session pe_session,
5      MPI_T_pvar_handle handle)
6
7  int MPI_T_pvar_session_create(MPI_T_pvar_session *pe_session)
8
9  int MPI_T_pvar_session_free(MPI_T_pvar_session *pe_session)
10
11 int MPI_T_pvar_start(MPI_T_pvar_session pe_session,
12     MPI_T_pvar_handle handle)
13
14 int MPI_T_pvar_stop(MPI_T_pvar_session pe_session,
15     MPI_T_pvar_handle handle)
16
17 int MPI_T_pvar_write(MPI_T_pvar_session pe_session,
18     MPI_T_pvar_handle handle, const void *buf)
19
20 int MPI_T_source_get_info(int source_index, char *name, int *name_len,
21     char *desc, int *desc_len, MPI_T_source_order *ordering,
22     MPI_Count *ticks_per_second, MPI_Count *max_ticks,
23     MPI_Info *info)
24
25 int MPI_T_source_get_num(int *num_sources)
26
27 int MPI_T_source_get_timestamp(int source_index, MPI_Count *timestamp)
28
29
30
31
32
33
34
35
36
37
38
39
40
41
42
43
44
45
46
47
48

```

A.3.16 Deprecated C Bindings

```

27 int MPI_Attr_delete(MPI_Comm comm, int keyval)
28
29 int MPI_Attr_get(MPI_Comm comm, int keyval, void *attribute_val, int *flag)
30
31 int MPI_Attr_put(MPI_Comm comm, int keyval, void *attribute_val)
32
33 int MPI_DUP_FN(MPI_Comm oldcomm, int keyval, void *extra_state,
34     void *attribute_val_in, void *attribute_val_out, int *flag)
35
36 int MPI_Info_get(MPI_Info info, const char *key, int valuelen, char *value,
37     int *flag)
38
39 int MPI_Info_get_valuelen(MPI_Info info, const char *key, int *valuelen,
40     int *flag)
41
42 int MPI_Keyval_create(MPI_Copy_function *copy_fn,
43     MPI_Delete_function *delete_fn, int *keyval,
44     void *extra_state)
45
46 int MPI_Keyval_free(int *keyval)
47
48 int MPI_NULL_COPY_FN(MPI_Comm oldcomm, int keyval, void *extra_state,
49     void *attribute_val_in, void *attribute_val_out, int *flag)
50
51 int MPI_NULL_DELETE_FN(MPI_Comm comm, int keyval, void *attribute_val,
52     void *extra_state)

```

## A.4 Fortran 2008 Bindings with the mpi\_f08 Module

### A.4.1 Point-to-Point Communication Fortran 2008 Bindings

```
MPI_Bsend(buf, count, datatype, dest, tag, comm, ierror)
  TYPE(*), DIMENSION(..), INTENT(IN) :: buf
  INTEGER(KIND=MPI_COUNT_KIND), INTENT(IN) :: count
  TYPE(MPI_Datatype), INTENT(IN) :: datatype
  INTEGER, INTENT(IN) :: dest, tag
  TYPE(MPI_Comm), INTENT(IN) :: comm
  INTEGER, OPTIONAL, INTENT(OUT) :: ierror
```

```
MPI_Bsend(buf, count, datatype, dest, tag, comm, ierror)
  TYPE(*), DIMENSION(..), INTENT(IN) :: buf
  INTEGER, INTENT(IN) :: count, dest, tag
  TYPE(MPI_Datatype), INTENT(IN) :: datatype
  TYPE(MPI_Comm), INTENT(IN) :: comm
  INTEGER, OPTIONAL, INTENT(OUT) :: ierror
```

```
MPI_Bsend_init(buf, count, datatype, dest, tag, comm, request, ierror)
  TYPE(*), DIMENSION(..), INTENT(IN), ASYNCHRONOUS :: buf
  INTEGER(KIND=MPI_COUNT_KIND), INTENT(IN) :: count
  TYPE(MPI_Datatype), INTENT(IN) :: datatype
  INTEGER, INTENT(IN) :: dest, tag
  TYPE(MPI_Comm), INTENT(IN) :: comm
  TYPE(MPI_Request), INTENT(OUT) :: request
  INTEGER, OPTIONAL, INTENT(OUT) :: ierror
```

```
MPI_Bsend_init(buf, count, datatype, dest, tag, comm, request, ierror)
  TYPE(*), DIMENSION(..), INTENT(IN), ASYNCHRONOUS :: buf
  INTEGER, INTENT(IN) :: count, dest, tag
  TYPE(MPI_Datatype), INTENT(IN) :: datatype
  TYPE(MPI_Comm), INTENT(IN) :: comm
  TYPE(MPI_Request), INTENT(OUT) :: request
  INTEGER, OPTIONAL, INTENT(OUT) :: ierror
```

```
MPI_Buffer_attach(buffer, size, ierror)
  TYPE(*), DIMENSION(..), ASYNCHRONOUS :: buffer
  INTEGER(KIND=MPI_COUNT_KIND), INTENT(IN) :: size
  INTEGER, OPTIONAL, INTENT(OUT) :: ierror
```

```
MPI_Buffer_attach(buffer, size, ierror)
  TYPE(*), DIMENSION(..), ASYNCHRONOUS :: buffer
  INTEGER, INTENT(IN) :: size
  INTEGER, OPTIONAL, INTENT(OUT) :: ierror
```

```
MPI_Buffer_detach(buffer_addr, size, ierror)
  USE, INTRINSIC :: ISO_C_BINDING, ONLY : C_PTR
  TYPE(C_PTR), INTENT(OUT) :: buffer_addr
  INTEGER(KIND=MPI_COUNT_KIND), INTENT(OUT) :: size
  INTEGER, OPTIONAL, INTENT(OUT) :: ierror
```

```

1 MPI_Buffer_detach(buffer_addr, size, ierror)
2   USE, INTRINSIC :: ISO_C_BINDING, ONLY : C_PTR
3   TYPE(C_PTR), INTENT(OUT) :: buffer_addr
4   INTEGER, INTENT(OUT) :: size
5   INTEGER, OPTIONAL, INTENT(OUT) :: ierror
6
7 MPI_Cancel(request, ierror)
8   TYPE(MPI_Request), INTENT(IN) :: request
9   INTEGER, OPTIONAL, INTENT(OUT) :: ierror
10
11 MPI_Get_count(status, datatype, count, ierror)
12   TYPE(MPI_Status), INTENT(IN) :: status
13   TYPE(MPI_Datatype), INTENT(IN) :: datatype
14   INTEGER(KIND=MPI_COUNT_KIND), INTENT(OUT) :: count
15   INTEGER, OPTIONAL, INTENT(OUT) :: ierror
16
17 MPI_Get_count(status, datatype, count, ierror)
18   TYPE(MPI_Status), INTENT(IN) :: status
19   TYPE(MPI_Datatype), INTENT(IN) :: datatype
20   INTEGER, INTENT(OUT) :: count
21   INTEGER, OPTIONAL, INTENT(OUT) :: ierror
22
23 MPI_Ibsend(buf, count, datatype, dest, tag, comm, request, ierror)
24   TYPE(*), DIMENSION(..), INTENT(IN), ASYNCHRONOUS :: buf
25   INTEGER(KIND=MPI_COUNT_KIND), INTENT(IN) :: count
26   TYPE(MPI_Datatype), INTENT(IN) :: datatype
27   INTEGER, INTENT(IN) :: dest, tag
28   TYPE(MPI_Comm), INTENT(IN) :: comm
29   TYPE(MPI_Request), INTENT(OUT) :: request
30   INTEGER, OPTIONAL, INTENT(OUT) :: ierror
31
32 MPI_Ibsend(buf, count, datatype, dest, tag, comm, request, ierror)
33   TYPE(*), DIMENSION(..), INTENT(IN), ASYNCHRONOUS :: buf
34   INTEGER, INTENT(IN) :: count, dest, tag
35   TYPE(MPI_Datatype), INTENT(IN) :: datatype
36   TYPE(MPI_Comm), INTENT(IN) :: comm
37   TYPE(MPI_Request), INTENT(OUT) :: request
38   INTEGER, OPTIONAL, INTENT(OUT) :: ierror
39
40 MPI_Iprobe(source, tag, comm, flag, message, status, ierror)
41   INTEGER, INTENT(IN) :: source, tag
42   TYPE(MPI_Comm), INTENT(IN) :: comm
43   LOGICAL, INTENT(OUT) :: flag
44   TYPE(MPI_Message), INTENT(OUT) :: message
45   TYPE(MPI_Status) :: status
46   INTEGER, OPTIONAL, INTENT(OUT) :: ierror
47
48 MPI_Imrecv(buf, count, datatype, message, request, ierror)
49   TYPE(*), DIMENSION(..), ASYNCHRONOUS :: buf
50   INTEGER(KIND=MPI_COUNT_KIND), INTENT(IN) :: count
51   TYPE(MPI_Datatype), INTENT(IN) :: datatype

```

```

TYPE(MPI_Message), INTENT(INOUT) :: message           1
TYPE(MPI_Request), INTENT(OUT) :: request             2
INTEGER, OPTIONAL, INTENT(OUT) :: ierror             3
                                                    4
MPI_Imrecv(buf, count, datatype, message, request, ierror) 5
TYPE(*), DIMENSION(..), ASYNCHRONOUS :: buf         6
INTEGER, INTENT(IN) :: count                          7
TYPE(MPI_Datatype), INTENT(IN) :: datatype           8
TYPE(MPI_Message), INTENT(INOUT) :: message          9
TYPE(MPI_Request), INTENT(OUT) :: request            10
INTEGER, OPTIONAL, INTENT(OUT) :: ierror             11
                                                    12
MPI_Iprobe(source, tag, comm, flag, status, ierror)     13
INTEGER, INTENT(IN) :: source, tag                   14
TYPE(MPI_Comm), INTENT(IN) :: comm                    15
LOGICAL, INTENT(OUT) :: flag                          16
TYPE(MPI_Status) :: status                             17
INTEGER, OPTIONAL, INTENT(OUT) :: ierror             18
                                                    19
MPI_Irecv(buf, count, datatype, source, tag, comm, request, ierror) 20
TYPE(*), DIMENSION(..), ASYNCHRONOUS :: buf         21
INTEGER(KIND=MPI_COUNT_KIND), INTENT(IN) :: count    22
TYPE(MPI_Datatype), INTENT(IN) :: datatype           23
INTEGER, INTENT(IN) :: source, tag                    24
TYPE(MPI_Comm), INTENT(IN) :: comm                    25
TYPE(MPI_Request), INTENT(OUT) :: request            26
INTEGER, OPTIONAL, INTENT(OUT) :: ierror             27
                                                    28
MPI_Irecv(buf, count, datatype, source, tag, comm, request, ierror) 29
TYPE(*), DIMENSION(..), ASYNCHRONOUS :: buf         30
INTEGER, INTENT(IN) :: count, source, tag             31
TYPE(MPI_Datatype), INTENT(IN) :: datatype           32
TYPE(MPI_Comm), INTENT(IN) :: comm                    33
TYPE(MPI_Request), INTENT(OUT) :: request            34
INTEGER, OPTIONAL, INTENT(OUT) :: ierror             35
                                                    36
MPI_Irsend(buf, count, datatype, dest, tag, comm, request, ierror) 37
TYPE(*), DIMENSION(..), INTENT(IN), ASYNCHRONOUS :: buf 38
INTEGER(KIND=MPI_COUNT_KIND), INTENT(IN) :: count    39
TYPE(MPI_Datatype), INTENT(IN) :: datatype           40
INTEGER, INTENT(IN) :: dest, tag                      41
TYPE(MPI_Comm), INTENT(IN) :: comm                    42
TYPE(MPI_Request), INTENT(OUT) :: request            43
INTEGER, OPTIONAL, INTENT(OUT) :: ierror             44
                                                    45
MPI_Irsend(buf, count, datatype, dest, tag, comm, request, ierror) 46
TYPE(*), DIMENSION(..), INTENT(IN), ASYNCHRONOUS :: buf 47
INTEGER, INTENT(IN) :: count, dest, tag              48
TYPE(MPI_Datatype), INTENT(IN) :: datatype           49
TYPE(MPI_Comm), INTENT(IN) :: comm                    50

```

```

1     TYPE(MPI_Request), INTENT(OUT) :: request
2     INTEGER, OPTIONAL, INTENT(OUT) :: ierror
3
4     MPI_Isend(buf, count, datatype, dest, tag, comm, request, ierror)
5         TYPE(*), DIMENSION(..), INTENT(IN), ASYNCHRONOUS :: buf
6         INTEGER(KIND=MPI_COUNT_KIND), INTENT(IN) :: count
7         TYPE(MPI_Datatype), INTENT(IN) :: datatype
8         INTEGER, INTENT(IN) :: dest, tag
9         TYPE(MPI_Comm), INTENT(IN) :: comm
10        TYPE(MPI_Request), INTENT(OUT) :: request
11        INTEGER, OPTIONAL, INTENT(OUT) :: ierror
12
13    MPI_Isend(buf, count, datatype, dest, tag, comm, request, ierror)
14        TYPE(*), DIMENSION(..), INTENT(IN), ASYNCHRONOUS :: buf
15        INTEGER, INTENT(IN) :: count, dest, tag
16        TYPE(MPI_Datatype), INTENT(IN) :: datatype
17        TYPE(MPI_Comm), INTENT(IN) :: comm
18        TYPE(MPI_Request), INTENT(OUT) :: request
19        INTEGER, OPTIONAL, INTENT(OUT) :: ierror
20
21    MPI_Isendrecv(sendbuf, sendcount, sendtype, dest, sendtag, recvbuf,
22        recvcount, recvtype, source, recvtag, comm, request, ierror)
23        TYPE(*), DIMENSION(..), INTENT(IN), ASYNCHRONOUS :: sendbuf
24        INTEGER(KIND=MPI_COUNT_KIND), INTENT(IN) :: sendcount, recvcount
25        TYPE(MPI_Datatype), INTENT(IN) :: sendtype, recvtype
26        INTEGER, INTENT(IN) :: dest, sendtag, source, recvtag
27        TYPE(*), DIMENSION(..), ASYNCHRONOUS :: recvbuf
28        TYPE(MPI_Comm), INTENT(IN) :: comm
29        TYPE(MPI_Request), INTENT(OUT) :: request
30        INTEGER, OPTIONAL, INTENT(OUT) :: ierror
31
32    MPI_Isendrecv(sendbuf, sendcount, sendtype, dest, sendtag, recvbuf,
33        recvcount, recvtype, source, recvtag, comm, request, ierror)
34        TYPE(*), DIMENSION(..), INTENT(IN), ASYNCHRONOUS :: sendbuf
35        INTEGER, INTENT(IN) :: sendcount, dest, sendtag, recvcount, source,
36        recvtag
37        TYPE(MPI_Datatype), INTENT(IN) :: sendtype, recvtype
38        TYPE(*), DIMENSION(..), ASYNCHRONOUS :: recvbuf
39        TYPE(MPI_Comm), INTENT(IN) :: comm
40        TYPE(MPI_Request), INTENT(OUT) :: request
41        INTEGER, OPTIONAL, INTENT(OUT) :: ierror
42
43    MPI_Isendrecv_replace(buf, count, datatype, dest, sendtag, source, recvtag,
44        comm, request, ierror)
45        TYPE(*), DIMENSION(..), ASYNCHRONOUS :: buf
46        INTEGER(KIND=MPI_COUNT_KIND), INTENT(IN) :: count
47        TYPE(MPI_Datatype), INTENT(IN) :: datatype
48        INTEGER, INTENT(IN) :: dest, sendtag, source, recvtag
49        TYPE(MPI_Comm), INTENT(IN) :: comm
50        TYPE(MPI_Request), INTENT(OUT) :: request

```



```

INTEGER, OPTIONAL, INTENT(OUT) :: ierror 1
MPI_Isendrecv_replace(buf, count, datatype, dest, sendtag, source, recvtag, 2
comm, request, ierror) 3
TYPE(*), DIMENSION(..), ASYNCHRONOUS :: buf 4
INTEGER, INTENT(IN) :: count, dest, sendtag, source, recvtag 5
TYPE(MPI_Datatype), INTENT(IN) :: datatype 6
TYPE(MPI_Comm), INTENT(IN) :: comm 7
TYPE(MPI_Request), INTENT(OUT) :: request 8
INTEGER, OPTIONAL, INTENT(OUT) :: ierror 9
MPI_Issend(buf, count, datatype, dest, tag, comm, request, ierror) 10
TYPE(*), DIMENSION(..), INTENT(IN), ASYNCHRONOUS :: buf 11
INTEGER(KIND=MPI_COUNT_KIND), INTENT(IN) :: count 12
TYPE(MPI_Datatype), INTENT(IN) :: datatype 13
INTEGER, INTENT(IN) :: dest, tag 14
TYPE(MPI_Comm), INTENT(IN) :: comm 15
TYPE(MPI_Request), INTENT(OUT) :: request 16
INTEGER, OPTIONAL, INTENT(OUT) :: ierror 17
MPI_Issend(buf, count, datatype, dest, tag, comm, request, ierror) 18
TYPE(*), DIMENSION(..), INTENT(IN), ASYNCHRONOUS :: buf 19
INTEGER, INTENT(IN) :: count, dest, tag 20
TYPE(MPI_Datatype), INTENT(IN) :: datatype 21
TYPE(MPI_Comm), INTENT(IN) :: comm 22
TYPE(MPI_Request), INTENT(OUT) :: request 23
INTEGER, OPTIONAL, INTENT(OUT) :: ierror 24
MPI_Mprobe(source, tag, comm, message, status, ierror) 25
INTEGER, INTENT(IN) :: source, tag 26
TYPE(MPI_Comm), INTENT(IN) :: comm 27
TYPE(MPI_Message), INTENT(OUT) :: message 28
TYPE(MPI_Status) :: status 29
INTEGER, OPTIONAL, INTENT(OUT) :: ierror 30
MPI_Mrecv(buf, count, datatype, message, status, ierror) 31
TYPE(*), DIMENSION(..) :: buf 32
INTEGER(KIND=MPI_COUNT_KIND), INTENT(IN) :: count 33
TYPE(MPI_Datatype), INTENT(IN) :: datatype 34
TYPE(MPI_Message), INTENT(INOUT) :: message 35
TYPE(MPI_Status) :: status 36
INTEGER, OPTIONAL, INTENT(OUT) :: ierror 37
MPI_Mrecv(buf, count, datatype, message, status, ierror) 38
TYPE(*), DIMENSION(..) :: buf 39
INTEGER, INTENT(IN) :: count 40
TYPE(MPI_Datatype), INTENT(IN) :: datatype 41
TYPE(MPI_Message), INTENT(INOUT) :: message 42
TYPE(MPI_Status) :: status 43
INTEGER, OPTIONAL, INTENT(OUT) :: ierror 44

```

```

1 MPI_Probe(source, tag, comm, status, ierror)
2     INTEGER, INTENT(IN) :: source, tag
3     TYPE(MPI_Comm), INTENT(IN) :: comm
4     TYPE(MPI_Status) :: status
5     INTEGER, OPTIONAL, INTENT(OUT) :: ierror
6
7 MPI_Recv(buf, count, datatype, source, tag, comm, status, ierror)
8     TYPE(*), DIMENSION(..) :: buf
9     INTEGER(KIND=MPI_COUNT_KIND), INTENT(IN) :: count
10    TYPE(MPI_Datatype), INTENT(IN) :: datatype
11    INTEGER, INTENT(IN) :: source, tag
12    TYPE(MPI_Comm), INTENT(IN) :: comm
13    TYPE(MPI_Status) :: status
14    INTEGER, OPTIONAL, INTENT(OUT) :: ierror
15
16 MPI_Recv(buf, count, datatype, source, tag, comm, status, ierror)
17    TYPE(*), DIMENSION(..) :: buf
18    INTEGER, INTENT(IN) :: count, source, tag
19    TYPE(MPI_Datatype), INTENT(IN) :: datatype
20    TYPE(MPI_Comm), INTENT(IN) :: comm
21    TYPE(MPI_Status) :: status
22    INTEGER, OPTIONAL, INTENT(OUT) :: ierror
23
24 MPI_Recv_init(buf, count, datatype, source, tag, comm, request, ierror)
25    TYPE(*), DIMENSION(..), ASYNCHRONOUS :: buf
26    INTEGER(KIND=MPI_COUNT_KIND), INTENT(IN) :: count
27    TYPE(MPI_Datatype), INTENT(IN) :: datatype
28    INTEGER, INTENT(IN) :: source, tag
29    TYPE(MPI_Comm), INTENT(IN) :: comm
30    TYPE(MPI_Request), INTENT(OUT) :: request
31    INTEGER, OPTIONAL, INTENT(OUT) :: ierror
32
33 MPI_Recv_init(buf, count, datatype, source, tag, comm, request, ierror)
34    TYPE(*), DIMENSION(..), ASYNCHRONOUS :: buf
35    INTEGER, INTENT(IN) :: count, source, tag
36    TYPE(MPI_Datatype), INTENT(IN) :: datatype
37    TYPE(MPI_Comm), INTENT(IN) :: comm
38    TYPE(MPI_Request), INTENT(OUT) :: request
39    INTEGER, OPTIONAL, INTENT(OUT) :: ierror
40
41 MPI_Request_free(request, ierror)
42    TYPE(MPI_Request), INTENT(INOUT) :: request
43    INTEGER, OPTIONAL, INTENT(OUT) :: ierror
44
45 MPI_Request_get_status(request, flag, status, ierror)
46    TYPE(MPI_Request), INTENT(IN) :: request
47    LOGICAL, INTENT(OUT) :: flag
48    TYPE(MPI_Status) :: status
49    INTEGER, OPTIONAL, INTENT(OUT) :: ierror
50
51 MPI_Rsend(buf, count, datatype, dest, tag, comm, ierror)

```

```

TYPE(*), DIMENSION(..), INTENT(IN) :: buf           1
INTEGER(KIND=MPI_COUNT_KIND), INTENT(IN) :: count   2
TYPE(MPI_Datatype), INTENT(IN) :: datatype          3
INTEGER, INTENT(IN) :: dest, tag                   4
TYPE(MPI_Comm), INTENT(IN) :: comm                  5
INTEGER, OPTIONAL, INTENT(OUT) :: ierror           6
                                                    7
MPI_Rsend(buf, count, datatype, dest, tag, comm, ierror) 8
TYPE(*), DIMENSION(..), INTENT(IN) :: buf           9
INTEGER, INTENT(IN) :: count, dest, tag            10
TYPE(MPI_Datatype), INTENT(IN) :: datatype         11
TYPE(MPI_Comm), INTENT(IN) :: comm                  12
INTEGER, OPTIONAL, INTENT(OUT) :: ierror           13
                                                    14
MPI_Rsend_init(buf, count, datatype, dest, tag, comm, request, ierror) 15
TYPE(*), DIMENSION(..), INTENT(IN), ASYNCHRONOUS :: buf 16
INTEGER(KIND=MPI_COUNT_KIND), INTENT(IN) :: count   17
TYPE(MPI_Datatype), INTENT(IN) :: datatype         18
INTEGER, INTENT(IN) :: dest, tag                   19
TYPE(MPI_Comm), INTENT(IN) :: comm                  20
TYPE(MPI_Request), INTENT(OUT) :: request          21
INTEGER, OPTIONAL, INTENT(OUT) :: ierror           22
                                                    23
MPI_Rsend_init(buf, count, datatype, dest, tag, comm, request, ierror) 24
TYPE(*), DIMENSION(..), INTENT(IN), ASYNCHRONOUS :: buf 25
INTEGER, INTENT(IN) :: count, dest, tag            26
TYPE(MPI_Datatype), INTENT(IN) :: datatype         27
TYPE(MPI_Comm), INTENT(IN) :: comm                  28
TYPE(MPI_Request), INTENT(OUT) :: request          29
INTEGER, OPTIONAL, INTENT(OUT) :: ierror           30
                                                    31
MPI_Send(buf, count, datatype, dest, tag, comm, ierror) 32
TYPE(*), DIMENSION(..), INTENT(IN) :: buf           33
INTEGER(KIND=MPI_COUNT_KIND), INTENT(IN) :: count   34
TYPE(MPI_Datatype), INTENT(IN) :: datatype         35
INTEGER, INTENT(IN) :: dest, tag                   36
TYPE(MPI_Comm), INTENT(IN) :: comm                  37
INTEGER, OPTIONAL, INTENT(OUT) :: ierror           38
                                                    39
MPI_Send(buf, count, datatype, dest, tag, comm, ierror) 40
TYPE(*), DIMENSION(..), INTENT(IN) :: buf           41
INTEGER, INTENT(IN) :: count, dest, tag            42
TYPE(MPI_Datatype), INTENT(IN) :: datatype         43
TYPE(MPI_Comm), INTENT(IN) :: comm                  44
INTEGER, OPTIONAL, INTENT(OUT) :: ierror           45
                                                    46
MPI_Send_init(buf, count, datatype, dest, tag, comm, request, ierror) 47
TYPE(*), DIMENSION(..), INTENT(IN), ASYNCHRONOUS :: buf 48
INTEGER(KIND=MPI_COUNT_KIND), INTENT(IN) :: count
TYPE(MPI_Datatype), INTENT(IN) :: datatype

```

```

1     INTEGER, INTENT(IN) :: dest, tag
2     TYPE(MPI_Comm), INTENT(IN) :: comm
3     TYPE(MPI_Request), INTENT(OUT) :: request
4     INTEGER, OPTIONAL, INTENT(OUT) :: ierror
5
6 MPI_Send_init(buf, count, datatype, dest, tag, comm, request, ierror)
7     TYPE(*), DIMENSION(..), INTENT(IN), ASYNCHRONOUS :: buf
8     INTEGER, INTENT(IN) :: count, dest, tag
9     TYPE(MPI_Datatype), INTENT(IN) :: datatype
10    TYPE(MPI_Comm), INTENT(IN) :: comm
11    TYPE(MPI_Request), INTENT(OUT) :: request
12    INTEGER, OPTIONAL, INTENT(OUT) :: ierror
13
14 MPI_Sendrecv(sendbuf, sendcount, sendtype, dest, sendtag, recvbuf,
15             recvcount, recvtype, source, recvtag, comm, status, ierror)
16    TYPE(*), DIMENSION(..), INTENT(IN) :: sendbuf
17    INTEGER(KIND=MPI_COUNT_KIND), INTENT(IN) :: sendcount, recvcount
18    TYPE(MPI_Datatype), INTENT(IN) :: sendtype, recvtype
19    INTEGER, INTENT(IN) :: dest, sendtag, source, recvtag
20    TYPE(*), DIMENSION(..) :: recvbuf
21    TYPE(MPI_Comm), INTENT(IN) :: comm
22    TYPE(MPI_Status) :: status
23    INTEGER, OPTIONAL, INTENT(OUT) :: ierror
24
25 MPI_Sendrecv(sendbuf, sendcount, sendtype, dest, sendtag, recvbuf,
26             recvcount, recvtype, source, recvtag, comm, status, ierror)
27    TYPE(*), DIMENSION(..), INTENT(IN) :: sendbuf
28    INTEGER, INTENT(IN) :: sendcount, dest, sendtag, recvcount, source,
29             recvtag
30    TYPE(MPI_Datatype), INTENT(IN) :: sendtype, recvtype
31    TYPE(*), DIMENSION(..) :: recvbuf
32    TYPE(MPI_Comm), INTENT(IN) :: comm
33    TYPE(MPI_Status) :: status
34    INTEGER, OPTIONAL, INTENT(OUT) :: ierror
35
36 MPI_Sendrecv_replace(buf, count, datatype, dest, sendtag, source, recvtag,
37                     comm, status, ierror)
38    TYPE(*), DIMENSION(..) :: buf
39    INTEGER(KIND=MPI_COUNT_KIND), INTENT(IN) :: count
40    TYPE(MPI_Datatype), INTENT(IN) :: datatype
41    INTEGER, INTENT(IN) :: dest, sendtag, source, recvtag
42    TYPE(MPI_Comm), INTENT(IN) :: comm
43    TYPE(MPI_Status) :: status
44    INTEGER, OPTIONAL, INTENT(OUT) :: ierror
45
46 MPI_Sendrecv_replace(buf, count, datatype, dest, sendtag, source, recvtag,
47                     comm, status, ierror)
48    TYPE(*), DIMENSION(..) :: buf
49    INTEGER, INTENT(IN) :: count, dest, sendtag, source, recvtag
50    TYPE(MPI_Datatype), INTENT(IN) :: datatype

```

```

TYPE(MPI_Comm), INTENT(IN) :: comm
TYPE(MPI_Status) :: status
INTEGER, OPTIONAL, INTENT(OUT) :: ierror

MPI_Ssend(buf, count, datatype, dest, tag, comm, ierror)
TYPE(*), DIMENSION(..), INTENT(IN) :: buf
INTEGER(KIND=MPI_COUNT_KIND), INTENT(IN) :: count
TYPE(MPI_Datatype), INTENT(IN) :: datatype
INTEGER, INTENT(IN) :: dest, tag
TYPE(MPI_Comm), INTENT(IN) :: comm
INTEGER, OPTIONAL, INTENT(OUT) :: ierror

MPI_Ssend(buf, count, datatype, dest, tag, comm, ierror)
TYPE(*), DIMENSION(..), INTENT(IN) :: buf
INTEGER, INTENT(IN) :: count, dest, tag
TYPE(MPI_Datatype), INTENT(IN) :: datatype
TYPE(MPI_Comm), INTENT(IN) :: comm
INTEGER, OPTIONAL, INTENT(OUT) :: ierror

MPI_Ssend_init(buf, count, datatype, dest, tag, comm, request, ierror)
TYPE(*), DIMENSION(..), INTENT(IN), ASYNCHRONOUS :: buf
INTEGER(KIND=MPI_COUNT_KIND), INTENT(IN) :: count
TYPE(MPI_Datatype), INTENT(IN) :: datatype
INTEGER, INTENT(IN) :: dest, tag
TYPE(MPI_Comm), INTENT(IN) :: comm
TYPE(MPI_Request), INTENT(OUT) :: request
INTEGER, OPTIONAL, INTENT(OUT) :: ierror

MPI_Ssend_init(buf, count, datatype, dest, tag, comm, request, ierror)
TYPE(*), DIMENSION(..), INTENT(IN), ASYNCHRONOUS :: buf
INTEGER, INTENT(IN) :: count, dest, tag
TYPE(MPI_Datatype), INTENT(IN) :: datatype
TYPE(MPI_Comm), INTENT(IN) :: comm
TYPE(MPI_Request), INTENT(OUT) :: request
INTEGER, OPTIONAL, INTENT(OUT) :: ierror

MPI_Start(request, ierror)
TYPE(MPI_Request), INTENT(INOUT) :: request
INTEGER, OPTIONAL, INTENT(OUT) :: ierror

MPI_Startall(count, array_of_requests, ierror)
INTEGER, INTENT(IN) :: count
TYPE(MPI_Request), INTENT(INOUT) :: array_of_requests(count)
INTEGER, OPTIONAL, INTENT(OUT) :: ierror

MPI_Test(request, flag, status, ierror)
TYPE(MPI_Request), INTENT(INOUT) :: request
LOGICAL, INTENT(OUT) :: flag
TYPE(MPI_Status) :: status
INTEGER, OPTIONAL, INTENT(OUT) :: ierror

```

```
1 MPI_Test_cancelled(status, flag, ierror)
2     TYPE(MPI_Status), INTENT(IN) :: status
3     LOGICAL, INTENT(OUT) :: flag
4     INTEGER, OPTIONAL, INTENT(OUT) :: ierror
5
6 MPI_Testall(count, array_of_requests, flag, array_of_statuses, ierror)
7     INTEGER, INTENT(IN) :: count
8     TYPE(MPI_Request), INTENT(INOUT) :: array_of_requests(count)
9     LOGICAL, INTENT(OUT) :: flag
10    TYPE(MPI_Status) :: array_of_statuses(*)
11    INTEGER, OPTIONAL, INTENT(OUT) :: ierror
12
13 MPI_Testany(count, array_of_requests, index, flag, status, ierror)
14    INTEGER, INTENT(IN) :: count
15    TYPE(MPI_Request), INTENT(INOUT) :: array_of_requests(count)
16    INTEGER, INTENT(OUT) :: index
17    LOGICAL, INTENT(OUT) :: flag
18    TYPE(MPI_Status) :: status
19    INTEGER, OPTIONAL, INTENT(OUT) :: ierror
20
21 MPI_Testsome(incount, array_of_requests, outcount, array_of_indices,
22             array_of_statuses, ierror)
23    INTEGER, INTENT(IN) :: incount
24    TYPE(MPI_Request), INTENT(INOUT) :: array_of_requests(incount)
25    INTEGER, INTENT(OUT) :: outcount, array_of_indices(*)
26    TYPE(MPI_Status) :: array_of_statuses(*)
27    INTEGER, OPTIONAL, INTENT(OUT) :: ierror
28
29 MPI_Wait(request, status, ierror)
30    TYPE(MPI_Request), INTENT(INOUT) :: request
31    TYPE(MPI_Status) :: status
32    INTEGER, OPTIONAL, INTENT(OUT) :: ierror
33
34 MPI_Waitall(count, array_of_requests, array_of_statuses, ierror)
35    INTEGER, INTENT(IN) :: count
36    TYPE(MPI_Request), INTENT(INOUT) :: array_of_requests(count)
37    TYPE(MPI_Status) :: array_of_statuses(*)
38    INTEGER, OPTIONAL, INTENT(OUT) :: ierror
39
40 MPI_Waitany(count, array_of_requests, index, status, ierror)
41    INTEGER, INTENT(IN) :: count
42    TYPE(MPI_Request), INTENT(INOUT) :: array_of_requests(count)
43    INTEGER, INTENT(OUT) :: index
44    TYPE(MPI_Status) :: status
45    INTEGER, OPTIONAL, INTENT(OUT) :: ierror
46
47 MPI_Waitsome(incount, array_of_requests, outcount, array_of_indices,
48             array_of_statuses, ierror)
49    INTEGER, INTENT(IN) :: incount
50    TYPE(MPI_Request), INTENT(INOUT) :: array_of_requests(incount)
51    INTEGER, INTENT(OUT) :: outcount, array_of_indices(*)
```

```

TYPE(MPI_Status) :: array_of_statuses(*)
INTEGER, OPTIONAL, INTENT(OUT) :: ierror

```

#### A.4.2 Partitioned Communication Fortran 2008 Bindings

```

MPI_Parrived(request, partition, flag, ierror)
  TYPE(MPI_Request), INTENT(INOUT) :: request
  INTEGER, INTENT(IN) :: partition
  LOGICAL, INTENT(OUT) :: flag
  INTEGER, OPTIONAL, INTENT(OUT) :: ierror

MPI_Pready(partition, request, ierror)
  INTEGER, INTENT(IN) :: partition
  TYPE(MPI_Request), INTENT(INOUT) :: request
  INTEGER, OPTIONAL, INTENT(OUT) :: ierror

MPI_Pready_list(length, array_of_partitions, request, ierror)
  INTEGER, INTENT(IN) :: length, array_of_partitions(length)
  TYPE(MPI_Request), INTENT(INOUT) :: request
  INTEGER, OPTIONAL, INTENT(OUT) :: ierror

MPI_Pready_range(partition_low, partition_high, request, ierror)
  INTEGER, INTENT(IN) :: partition_low, partition_high
  TYPE(MPI_Request), INTENT(INOUT) :: request
  INTEGER, OPTIONAL, INTENT(OUT) :: ierror

MPI_Precv_init(buf, partitions, count, datatype, dest, tag, comm, info,
               request, ierror)
  TYPE(*), DIMENSION(..), INTENT(IN) :: buf
  INTEGER, INTENT(IN) :: partitions, dest, tag
  INTEGER(KIND=MPI_COUNT_KIND), INTENT(IN) :: count
  TYPE(MPI_Datatype), INTENT(IN) :: datatype
  TYPE(MPI_Comm), INTENT(IN) :: comm
  TYPE(MPI_Info), INTENT(IN) :: info
  TYPE(MPI_Request), INTENT(OUT) :: request
  INTEGER, OPTIONAL, INTENT(OUT) :: ierror

MPI_Psend_init(buf, partitions, count, datatype, dest, tag, comm, info,
               request, ierror)
  TYPE(*), DIMENSION(..), INTENT(IN) :: buf
  INTEGER, INTENT(IN) :: partitions, dest, tag
  INTEGER(KIND=MPI_COUNT_KIND), INTENT(IN) :: count
  TYPE(MPI_Datatype), INTENT(IN) :: datatype
  TYPE(MPI_Comm), INTENT(IN) :: comm
  TYPE(MPI_Info), INTENT(IN) :: info
  TYPE(MPI_Request), INTENT(OUT) :: request
  INTEGER, OPTIONAL, INTENT(OUT) :: ierror

```

### A.4.3 Datatypes Fortran 2008 Bindings

```

1  INTEGER(KIND=MPI_ADDRESS_KIND) MPI_Aint_add(base, disp)
2      INTEGER(KIND=MPI_ADDRESS_KIND), INTENT(IN) :: base, disp
3
4  INTEGER(KIND=MPI_ADDRESS_KIND) MPI_Aint_diff(addr1, addr2)
5      INTEGER(KIND=MPI_ADDRESS_KIND), INTENT(IN) :: addr1, addr2
6
7  MPI_Get_address(location, address, ierror)
8      TYPE(*), DIMENSION(..), ASYNCHRONOUS :: location
9      INTEGER(KIND=MPI_ADDRESS_KIND), INTENT(OUT) :: address
10     INTEGER, OPTIONAL, INTENT(OUT) :: ierror
11
12 MPI_Get_elements(status, datatype, count, ierror)
13     TYPE(MPI_Status), INTENT(IN) :: status
14     TYPE(MPI_Datatype), INTENT(IN) :: datatype
15     INTEGER(KIND=MPI_COUNT_KIND), INTENT(OUT) :: count
16     INTEGER, OPTIONAL, INTENT(OUT) :: ierror
17
18 MPI_Get_elements(status, datatype, count, ierror)
19     TYPE(MPI_Status), INTENT(IN) :: status
20     TYPE(MPI_Datatype), INTENT(IN) :: datatype
21     INTEGER, INTENT(OUT) :: count
22     INTEGER, OPTIONAL, INTENT(OUT) :: ierror
23
24 MPI_Get_elements_x(status, datatype, count, ierror)
25     TYPE(MPI_Status), INTENT(IN) :: status
26     TYPE(MPI_Datatype), INTENT(IN) :: datatype
27     INTEGER(KIND=MPI_COUNT_KIND), INTENT(OUT) :: count
28     INTEGER, OPTIONAL, INTENT(OUT) :: ierror
29
30 MPI_Pack(inbuf, incount, datatype, outbuf, outsize, position, comm, ierror)
31     TYPE(*), DIMENSION(..), INTENT(IN) :: inbuf
32     INTEGER(KIND=MPI_COUNT_KIND), INTENT(IN) :: incount, outsize
33     TYPE(MPI_Datatype), INTENT(IN) :: datatype
34     TYPE(*), DIMENSION(..) :: outbuf
35     INTEGER(KIND=MPI_COUNT_KIND), INTENT(INOUT) :: position
36     TYPE(MPI_Comm), INTENT(IN) :: comm
37     INTEGER, OPTIONAL, INTENT(OUT) :: ierror
38
39 MPI_Pack(inbuf, incount, datatype, outbuf, outsize, position, comm, ierror)
40     TYPE(*), DIMENSION(..), INTENT(IN) :: inbuf
41     INTEGER, INTENT(IN) :: incount, outsize
42     TYPE(MPI_Datatype), INTENT(IN) :: datatype
43     TYPE(*), DIMENSION(..) :: outbuf
44     INTEGER, INTENT(INOUT) :: position
45     TYPE(MPI_Comm), INTENT(IN) :: comm
46     INTEGER, OPTIONAL, INTENT(OUT) :: ierror
47
48 MPI_Pack_external(datarep, inbuf, incount, datatype, outbuf, outsize,
49     position, ierror)
50     CHARACTER(LEN=*) , INTENT(IN) :: datarep

```



```

TYPE(*), DIMENSION(..), INTENT(IN) :: inbuf           1
INTEGER(KIND=MPI_COUNT_KIND), INTENT(IN) :: incount, outsize  2
TYPE(MPI_Datatype), INTENT(IN) :: datatype           3
TYPE(*), DIMENSION(..) :: outbuf                   4
INTEGER(KIND=MPI_COUNT_KIND), INTENT(INOUT) :: position  5
INTEGER, OPTIONAL, INTENT(OUT) :: ierror            6
                                                    7
MPI_Pack_external(datarep, inbuf, incount, datatype, outbuf, outsize,
                  position, ierror)                  8
                                                    9
CHARACTER(LEN=*), INTENT(IN) :: datarep             10
TYPE(*), DIMENSION(..), INTENT(IN) :: inbuf        11
INTEGER, INTENT(IN) :: incount                      12
TYPE(MPI_Datatype), INTENT(IN) :: datatype         13
TYPE(*), DIMENSION(..) :: outbuf                   14
INTEGER(KIND=MPI_ADDRESS_KIND), INTENT(IN) :: outsize  15
INTEGER(KIND=MPI_ADDRESS_KIND), INTENT(INOUT) :: position  16
INTEGER, OPTIONAL, INTENT(OUT) :: ierror            17
                                                    18
MPI_Pack_external_size(datarep, incount, datatype, size, ierror)  19
CHARACTER(LEN=*), INTENT(IN) :: datarep            20
INTEGER(KIND=MPI_COUNT_KIND), INTENT(IN) :: incount  21
TYPE(MPI_Datatype), INTENT(IN) :: datatype         22
INTEGER(KIND=MPI_COUNT_KIND), INTENT(OUT) :: size   23
INTEGER, OPTIONAL, INTENT(OUT) :: ierror            24
                                                    25
MPI_Pack_external_size(datarep, incount, datatype, size, ierror)  26
CHARACTER(LEN=*), INTENT(IN) :: datarep            27
INTEGER, INTENT(IN) :: incount                      28
TYPE(MPI_Datatype), INTENT(IN) :: datatype         29
INTEGER(KIND=MPI_ADDRESS_KIND), INTENT(OUT) :: size  30
INTEGER, OPTIONAL, INTENT(OUT) :: ierror            31
                                                    32
MPI_Pack_size(incount, datatype, comm, size, ierror)  33
INTEGER(KIND=MPI_COUNT_KIND), INTENT(IN) :: incount  34
TYPE(MPI_Datatype), INTENT(IN) :: datatype         35
TYPE(MPI_Comm), INTENT(IN) :: comm                  36
INTEGER(KIND=MPI_COUNT_KIND), INTENT(OUT) :: size   37
INTEGER, OPTIONAL, INTENT(OUT) :: ierror            38
                                                    39
MPI_Pack_size(incount, datatype, comm, size, ierror)  40
INTEGER, INTENT(IN) :: incount                      41
TYPE(MPI_Datatype), INTENT(IN) :: datatype         42
TYPE(MPI_Comm), INTENT(IN) :: comm                  43
INTEGER, INTENT(OUT) :: size                         44
INTEGER, OPTIONAL, INTENT(OUT) :: ierror            45
                                                    46
MPI_Type_commit(datatype, ierror)                   47
TYPE(MPI_Datatype), INTENT(INOUT) :: datatype      48
INTEGER, OPTIONAL, INTENT(OUT) :: ierror

```

```

1     INTEGER(KIND=MPI_COUNT_KIND), INTENT(IN) :: count
2     TYPE(MPI_Datatype), INTENT(IN) :: oldtype
3     TYPE(MPI_Datatype), INTENT(OUT) :: newtype
4     INTEGER, OPTIONAL, INTENT(OUT) :: ierror
5
6 MPI_Type_contiguous(count, oldtype, newtype, ierror)
7     INTEGER, INTENT(IN) :: count
8     TYPE(MPI_Datatype), INTENT(IN) :: oldtype
9     TYPE(MPI_Datatype), INTENT(OUT) :: newtype
10    INTEGER, OPTIONAL, INTENT(OUT) :: ierror
11
12 MPI_Type_create_darray(size, rank, ndims, array_of_gsizes,
13                       array_of_distribs, array_of_dargs, array_of_psizes, order,
14                       oldtype, newtype, ierror)
15    INTEGER, INTENT(IN) :: size, rank, ndims, array_of_distribs(ndims),
16                       array_of_dargs(ndims), array_of_psizes(ndims), order
17    INTEGER(KIND=MPI_COUNT_KIND), INTENT(IN) :: array_of_gsizes(ndims)
18    TYPE(MPI_Datatype), INTENT(IN) :: oldtype
19    TYPE(MPI_Datatype), INTENT(OUT) :: newtype
20    INTEGER, OPTIONAL, INTENT(OUT) :: ierror
21
22 MPI_Type_create_darray(size, rank, ndims, array_of_gsizes,
23                       array_of_distribs, array_of_dargs, array_of_psizes, order,
24                       oldtype, newtype, ierror)
25    INTEGER, INTENT(IN) :: size, rank, ndims, array_of_gsizes(ndims),
26                       array_of_distribs(ndims), array_of_dargs(ndims),
27                       array_of_psizes(ndims), order
28    TYPE(MPI_Datatype), INTENT(IN) :: oldtype
29    TYPE(MPI_Datatype), INTENT(OUT) :: newtype
30    INTEGER, OPTIONAL, INTENT(OUT) :: ierror
31
32 MPI_Type_create_hindexed(count, array_of_blocklengths,
33                          array_of_displacements, oldtype, newtype, ierror)
34    INTEGER(KIND=MPI_COUNT_KIND), INTENT(IN) :: count,
35                          array_of_blocklengths(count), array_of_displacements(count)
36    TYPE(MPI_Datatype), INTENT(IN) :: oldtype
37    TYPE(MPI_Datatype), INTENT(OUT) :: newtype
38    INTEGER, OPTIONAL, INTENT(OUT) :: ierror
39
40 MPI_Type_create_hindexed(count, array_of_blocklengths,
41                          array_of_displacements, oldtype, newtype, ierror)
42    INTEGER, INTENT(IN) :: count, array_of_blocklengths(count)
43    INTEGER(KIND=MPI_ADDRESS_KIND), INTENT(IN) ::
44                          array_of_displacements(count)
45    TYPE(MPI_Datatype), INTENT(IN) :: oldtype
46    TYPE(MPI_Datatype), INTENT(OUT) :: newtype
47    INTEGER, OPTIONAL, INTENT(OUT) :: ierror
48
49 MPI_Type_create_hindexed_block(count, blocklength, array_of_displacements,
50                               oldtype, newtype, ierror)

```

```

INTEGER(KIND=MPI_COUNT_KIND), INTENT(IN) :: count, blocklength,
    array_of_displacements(count)
TYPE(MPI_Datatype), INTENT(IN) :: oldtype
TYPE(MPI_Datatype), INTENT(OUT) :: newtype
INTEGER, OPTIONAL, INTENT(OUT) :: ierror

MPI_Type_create_hindexed_block(count, blocklength, array_of_displacements,
    oldtype, newtype, ierror)
INTEGER, INTENT(IN) :: count, blocklength
INTEGER(KIND=MPI_ADDRESS_KIND), INTENT(IN) ::
    array_of_displacements(count)
TYPE(MPI_Datatype), INTENT(IN) :: oldtype
TYPE(MPI_Datatype), INTENT(OUT) :: newtype
INTEGER, OPTIONAL, INTENT(OUT) :: ierror

MPI_Type_create_hvector(count, blocklength, stride, oldtype, newtype,
    ierror)
INTEGER(KIND=MPI_COUNT_KIND), INTENT(IN) :: count, blocklength, stride
TYPE(MPI_Datatype), INTENT(IN) :: oldtype
TYPE(MPI_Datatype), INTENT(OUT) :: newtype
INTEGER, OPTIONAL, INTENT(OUT) :: ierror

MPI_Type_create_hvector(count, blocklength, stride, oldtype, newtype,
    ierror)
INTEGER, INTENT(IN) :: count, blocklength
INTEGER(KIND=MPI_ADDRESS_KIND), INTENT(IN) :: stride
TYPE(MPI_Datatype), INTENT(IN) :: oldtype
TYPE(MPI_Datatype), INTENT(OUT) :: newtype
INTEGER, OPTIONAL, INTENT(OUT) :: ierror

MPI_Type_create_indexed_block(count, blocklength, array_of_displacements,
    oldtype, newtype, ierror)
INTEGER(KIND=MPI_COUNT_KIND), INTENT(IN) :: count, blocklength,
    array_of_displacements(count)
TYPE(MPI_Datatype), INTENT(IN) :: oldtype
TYPE(MPI_Datatype), INTENT(OUT) :: newtype
INTEGER, OPTIONAL, INTENT(OUT) :: ierror

MPI_Type_create_indexed_block(count, blocklength, array_of_displacements,
    oldtype, newtype, ierror)
INTEGER, INTENT(IN) :: count, blocklength,
    array_of_displacements(count)
TYPE(MPI_Datatype), INTENT(IN) :: oldtype
TYPE(MPI_Datatype), INTENT(OUT) :: newtype
INTEGER, OPTIONAL, INTENT(OUT) :: ierror

MPI_Type_create_resized(oldtype, lb, extent, newtype, ierror)
TYPE(MPI_Datatype), INTENT(IN) :: oldtype
INTEGER(KIND=MPI_ADDRESS_KIND), INTENT(IN) :: lb, extent
TYPE(MPI_Datatype), INTENT(OUT) :: newtype

```

```

1     INTEGER, OPTIONAL, INTENT(OUT) :: ierror
2
3     MPI_Type_create_resized(oldtype, lb, extent, newtype, ierror)
4     TYPE(MPI_Datatype), INTENT(IN) :: oldtype
5     INTEGER(KIND=MPI_COUNT_KIND), INTENT(IN) :: lb, extent
6     TYPE(MPI_Datatype), INTENT(OUT) :: newtype
7     INTEGER, OPTIONAL, INTENT(OUT) :: ierror
8
9     MPI_Type_create_struct(count, array_of_blocklengths,
10        array_of_displacements, array_of_types, newtype, ierror)
11    INTEGER(KIND=MPI_COUNT_KIND), INTENT(IN) :: count,
12        array_of_blocklengths(count), array_of_displacements(count)
13    TYPE(MPI_Datatype), INTENT(IN) :: array_of_types(count)
14    TYPE(MPI_Datatype), INTENT(OUT) :: newtype
15    INTEGER, OPTIONAL, INTENT(OUT) :: ierror
16
17    MPI_Type_create_struct(count, array_of_blocklengths,
18        array_of_displacements, array_of_types, newtype, ierror)
19    INTEGER, INTENT(IN) :: count, array_of_blocklengths(count)
20    INTEGER(KIND=MPI_ADDRESS_KIND), INTENT(IN) ::
21        array_of_displacements(count)
22    TYPE(MPI_Datatype), INTENT(IN) :: array_of_types(count)
23    TYPE(MPI_Datatype), INTENT(OUT) :: newtype
24    INTEGER, OPTIONAL, INTENT(OUT) :: ierror
25
26    MPI_Type_create_subarray(ndims, array_of_sizes, array_of_subsizes,
27        array_of_starts, order, oldtype, newtype, ierror)
28    INTEGER, INTENT(IN) :: ndims, array_of_sizes(ndims),
29        array_of_subsizes(ndims), array_of_starts(ndims), order
30    TYPE(MPI_Datatype), INTENT(IN) :: oldtype
31    TYPE(MPI_Datatype), INTENT(OUT) :: newtype
32    INTEGER, OPTIONAL, INTENT(OUT) :: ierror
33
34    MPI_Type_create_subarray(ndims, array_of_sizes, array_of_subsizes,
35        array_of_starts, order, oldtype, newtype, ierror)
36    INTEGER, INTENT(IN) :: ndims, order
37    INTEGER(KIND=MPI_COUNT_KIND), INTENT(IN) :: array_of_sizes(ndims),
38        array_of_subsizes(ndims), array_of_starts(ndims)
39    TYPE(MPI_Datatype), INTENT(IN) :: oldtype
40    TYPE(MPI_Datatype), INTENT(OUT) :: newtype
41    INTEGER, OPTIONAL, INTENT(OUT) :: ierror
42
43    MPI_Type_dup(oldtype, newtype, ierror)
44    TYPE(MPI_Datatype), INTENT(IN) :: oldtype
45    TYPE(MPI_Datatype), INTENT(OUT) :: newtype
46    INTEGER, OPTIONAL, INTENT(OUT) :: ierror
47
48    MPI_Type_free(datatype, ierror)
49    TYPE(MPI_Datatype), INTENT(INOUT) :: datatype
50    INTEGER, OPTIONAL, INTENT(OUT) :: ierror

```

```

MPI_Type_get_contents(datatype, max_integers, max_addresses, max_datatypes,
    array_of_integers, array_of_addresses, array_of_datatypes,
    ierror)
TYPE(MPI_Datatype), INTENT(IN) :: datatype
INTEGER, INTENT(IN) :: max_integers, max_addresses, max_datatypes
INTEGER, INTENT(OUT) :: array_of_integers(max_integers)
INTEGER(KIND=MPI_ADDRESS_KIND), INTENT(OUT) ::
    array_of_addresses(max_addresses)
TYPE(MPI_Datatype), INTENT(OUT) :: array_of_datatypes(max_datatypes)
INTEGER, OPTIONAL, INTENT(OUT) :: ierror

MPI_Type_get_contents(datatype, max_integers, max_addresses,
    max_large_counts, max_datatypes, array_of_integers,
    array_of_addresses, array_of_large_counts, array_of_datatypes,
    ierror)
TYPE(MPI_Datatype), INTENT(IN) :: datatype
INTEGER(KIND=MPI_COUNT_KIND), INTENT(IN) :: max_integers,
    max_addresses, max_large_counts, max_datatypes
INTEGER, INTENT(OUT) :: array_of_integers(max_integers)
INTEGER(KIND=MPI_ADDRESS_KIND), INTENT(OUT) ::
    array_of_addresses(max_addresses)
INTEGER(KIND=MPI_COUNT_KIND), INTENT(OUT) ::
    array_of_large_counts(max_large_counts)
TYPE(MPI_Datatype), INTENT(OUT) :: array_of_datatypes(max_datatypes)
INTEGER, OPTIONAL, INTENT(OUT) :: ierror

MPI_Type_get_envelope(datatype, num_integers, num_addresses, num_datatypes,
    combiner, ierror)
TYPE(MPI_Datatype), INTENT(IN) :: datatype
INTEGER, INTENT(OUT) :: num_integers, num_addresses, num_datatypes,
    combiner
INTEGER, OPTIONAL, INTENT(OUT) :: ierror

MPI_Type_get_envelope(datatype, num_integers, num_addresses,
    num_large_counts, num_datatypes, combiner, ierror)
TYPE(MPI_Datatype), INTENT(IN) :: datatype
INTEGER(KIND=MPI_COUNT_KIND), INTENT(OUT) :: num_integers,
    num_addresses, num_large_counts, num_datatypes
INTEGER, INTENT(OUT) :: combiner
INTEGER, OPTIONAL, INTENT(OUT) :: ierror

MPI_Type_get_extent(datatype, lb, extent, ierror)
TYPE(MPI_Datatype), INTENT(IN) :: datatype
INTEGER(KIND=MPI_ADDRESS_KIND), INTENT(OUT) :: lb, extent
INTEGER, OPTIONAL, INTENT(OUT) :: ierror

MPI_Type_get_extent(datatype, lb, extent, ierror)
TYPE(MPI_Datatype), INTENT(IN) :: datatype
INTEGER(KIND=MPI_COUNT_KIND), INTENT(OUT) :: lb, extent
INTEGER, OPTIONAL, INTENT(OUT) :: ierror

```

```

1 MPI_Type_get_extent_x(datatype, lb, extent, ierror)
2     TYPE(MPI_Datatype), INTENT(IN) :: datatype
3     INTEGER(KIND=MPI_COUNT_KIND), INTENT(OUT) :: lb, extent
4     INTEGER, OPTIONAL, INTENT(OUT) :: ierror
5
6 MPI_Type_get_true_extent(datatype, true_lb, true_extent, ierror)
7     TYPE(MPI_Datatype), INTENT(IN) :: datatype
8     INTEGER(KIND=MPI_ADDRESS_KIND), INTENT(OUT) :: true_lb, true_extent
9     INTEGER, OPTIONAL, INTENT(OUT) :: ierror
10
11 MPI_Type_get_true_extent(datatype, true_lb, true_extent, ierror)
12     TYPE(MPI_Datatype), INTENT(IN) :: datatype
13     INTEGER(KIND=MPI_COUNT_KIND), INTENT(OUT) :: true_lb, true_extent
14     INTEGER, OPTIONAL, INTENT(OUT) :: ierror
15
16 MPI_Type_get_true_extent_x(datatype, true_lb, true_extent, ierror)
17     TYPE(MPI_Datatype), INTENT(IN) :: datatype
18     INTEGER(KIND=MPI_COUNT_KIND), INTENT(OUT) :: true_lb, true_extent
19     INTEGER, OPTIONAL, INTENT(OUT) :: ierror
20
21 MPI_Type_indexed(count, array_of_blocklengths, array_of_displacements,
22                 oldtype, newtype, ierror)
23     INTEGER(KIND=MPI_COUNT_KIND), INTENT(IN) :: count,
24     array_of_blocklengths(count), array_of_displacements(count)
25     TYPE(MPI_Datatype), INTENT(IN) :: oldtype
26     TYPE(MPI_Datatype), INTENT(OUT) :: newtype
27     INTEGER, OPTIONAL, INTENT(OUT) :: ierror
28
29 MPI_Type_indexed(count, array_of_blocklengths, array_of_displacements,
30                 oldtype, newtype, ierror)
31     INTEGER, INTENT(IN) :: count, array_of_blocklengths(count),
32     array_of_displacements(count)
33     TYPE(MPI_Datatype), INTENT(IN) :: oldtype
34     TYPE(MPI_Datatype), INTENT(OUT) :: newtype
35     INTEGER, OPTIONAL, INTENT(OUT) :: ierror
36
37 MPI_Type_size(datatype, size, ierror)
38     TYPE(MPI_Datatype), INTENT(IN) :: datatype
39     INTEGER(KIND=MPI_COUNT_KIND), INTENT(OUT) :: size
40     INTEGER, OPTIONAL, INTENT(OUT) :: ierror
41
42 MPI_Type_size(datatype, size, ierror)
43     TYPE(MPI_Datatype), INTENT(IN) :: datatype
44     INTEGER, INTENT(OUT) :: size
45     INTEGER, OPTIONAL, INTENT(OUT) :: ierror
46
47 MPI_Type_size_x(datatype, size, ierror)
48     TYPE(MPI_Datatype), INTENT(IN) :: datatype
49     INTEGER(KIND=MPI_COUNT_KIND), INTENT(OUT) :: size
50     INTEGER, OPTIONAL, INTENT(OUT) :: ierror
51
52 MPI_Type_vector(count, blocklength, stride, oldtype, newtype, ierror)

```

```

INTEGER(KIND=MPI_COUNT_KIND), INTENT(IN) :: count, blocklength, stride      1
TYPE(MPI_Datatype), INTENT(IN) :: oldtype                                  2
TYPE(MPI_Datatype), INTENT(OUT) :: newtype                                3
INTEGER, OPTIONAL, INTENT(OUT) :: ierror                                  4
                                                                 5
MPI_Type_vector(count, blocklength, stride, oldtype, newtype, ierror)      6
  INTEGER, INTENT(IN) :: count, blocklength, stride                        7
  TYPE(MPI_Datatype), INTENT(IN) :: oldtype                                8
  TYPE(MPI_Datatype), INTENT(OUT) :: newtype                               9
  INTEGER, OPTIONAL, INTENT(OUT) :: ierror                                10
MPI_Unpack(inbuf, insize, position, outbuf, outcount, datatype, comm,      11
           ierror)                                                         12
  TYPE(*), DIMENSION(..), INTENT(IN) :: inbuf                             13
  INTEGER(KIND=MPI_COUNT_KIND), INTENT(IN) :: insize, outcount            14
  INTEGER(KIND=MPI_COUNT_KIND), INTENT(INOUT) :: position                 15
  TYPE(*), DIMENSION(..) :: outbuf                                       16
  TYPE(MPI_Datatype), INTENT(IN) :: datatype                              17
  TYPE(MPI_Comm), INTENT(IN) :: comm                                       18
  INTEGER, OPTIONAL, INTENT(OUT) :: ierror                                  19
                                                                 20
MPI_Unpack(inbuf, insize, position, outbuf, outcount, datatype, comm,      21
           ierror)                                                         22
  TYPE(*), DIMENSION(..), INTENT(IN) :: inbuf                             23
  INTEGER, INTENT(IN) :: insize, outcount                                  24
  INTEGER, INTENT(INOUT) :: position                                       25
  TYPE(*), DIMENSION(..) :: outbuf                                       26
  TYPE(MPI_Datatype), INTENT(IN) :: datatype                              27
  TYPE(MPI_Comm), INTENT(IN) :: comm                                       28
  INTEGER, OPTIONAL, INTENT(OUT) :: ierror                                  29
                                                                 30
MPI_Unpack_external(datarep, inbuf, insize, position, outbuf, outcount,    31
                   datatype, ierror)                                       32
  CHARACTER(LEN=*), INTENT(IN) :: datarep                                  33
  TYPE(*), DIMENSION(..), INTENT(IN) :: inbuf                             34
  INTEGER(KIND=MPI_ADDRESS_KIND), INTENT(IN) :: insize                     35
  INTEGER(KIND=MPI_ADDRESS_KIND), INTENT(INOUT) :: position                36
  TYPE(*), DIMENSION(..) :: outbuf                                       37
  INTEGER, INTENT(IN) :: outcount                                           38
  TYPE(MPI_Datatype), INTENT(IN) :: datatype                              39
  INTEGER, OPTIONAL, INTENT(OUT) :: ierror                                  40
                                                                 41
MPI_Unpack_external(datarep, inbuf, insize, position, outbuf, outcount,    42
                   datatype, ierror)                                       43
  CHARACTER(LEN=*), INTENT(IN) :: datarep                                  44
  TYPE(*), DIMENSION(..), INTENT(IN) :: inbuf                             45
  INTEGER(KIND=MPI_COUNT_KIND), INTENT(IN) :: insize, outcount            46
  INTEGER(KIND=MPI_COUNT_KIND), INTENT(INOUT) :: position                 47
  TYPE(*), DIMENSION(..) :: outbuf                                       48
  TYPE(MPI_Datatype), INTENT(IN) :: datatype

```

```

1     INTEGER, OPTIONAL, INTENT(OUT) :: ierror
2
3

```

#### 4 A.4.4 Collective Communication Fortran 2008 Bindings

```

5 MPI_Allgather(sendbuf, sendcount, sendtype, recvbuf, recvcount, recvtype,
6             comm, ierror)
7     TYPE(*), DIMENSION(..), INTENT(IN) :: sendbuf
8     INTEGER(KIND=MPI_COUNT_KIND), INTENT(IN) :: sendcount, recvcount
9     TYPE(MPI_Datatype), INTENT(IN) :: sendtype, recvtype
10    TYPE(*), DIMENSION(..) :: recvbuf
11    TYPE(MPI_Comm), INTENT(IN) :: comm
12    INTEGER, OPTIONAL, INTENT(OUT) :: ierror
13
14 MPI_Allgather(sendbuf, sendcount, sendtype, recvbuf, recvcount, recvtype,
15             comm, ierror)
16    TYPE(*), DIMENSION(..), INTENT(IN) :: sendbuf
17    INTEGER, INTENT(IN) :: sendcount, recvcount
18    TYPE(MPI_Datatype), INTENT(IN) :: sendtype, recvtype
19    TYPE(*), DIMENSION(..) :: recvbuf
20    TYPE(MPI_Comm), INTENT(IN) :: comm
21    INTEGER, OPTIONAL, INTENT(OUT) :: ierror
22
23 MPI_Allgather_init(sendbuf, sendcount, sendtype, recvbuf, recvcount,
24                  recvtype, comm, info, request, ierror)
25    TYPE(*), DIMENSION(..), INTENT(IN), ASYNCHRONOUS :: sendbuf
26    INTEGER(KIND=MPI_COUNT_KIND), INTENT(IN) :: sendcount, recvcount
27    TYPE(MPI_Datatype), INTENT(IN) :: sendtype, recvtype
28    TYPE(*), DIMENSION(..), ASYNCHRONOUS :: recvbuf
29    TYPE(MPI_Comm), INTENT(IN) :: comm
30    TYPE(MPI_Info), INTENT(IN) :: info
31    TYPE(MPI_Request), INTENT(OUT) :: request
32    INTEGER, OPTIONAL, INTENT(OUT) :: ierror
33
34 MPI_Allgather_init(sendbuf, sendcount, sendtype, recvbuf, recvcount,
35                  recvtype, comm, info, request, ierror)
36    TYPE(*), DIMENSION(..), INTENT(IN), ASYNCHRONOUS :: sendbuf
37    INTEGER, INTENT(IN) :: sendcount, recvcount
38    TYPE(MPI_Datatype), INTENT(IN) :: sendtype, recvtype
39    TYPE(*), DIMENSION(..), ASYNCHRONOUS :: recvbuf
40    TYPE(MPI_Comm), INTENT(IN) :: comm
41    TYPE(MPI_Info), INTENT(IN) :: info
42    TYPE(MPI_Request), INTENT(OUT) :: request
43    INTEGER, OPTIONAL, INTENT(OUT) :: ierror
44
45 MPI_Allgatherv(sendbuf, sendcount, sendtype, recvbuf, recvcounts, displs,
46              recvtype, comm, ierror)
47    TYPE(*), DIMENSION(..), INTENT(IN) :: sendbuf
48    INTEGER(KIND=MPI_COUNT_KIND), INTENT(IN) :: sendcount, recvcounts(*)
49    TYPE(MPI_Datatype), INTENT(IN) :: sendtype, recvtype

```



```

TYPE(*), DIMENSION(..) :: recvbuf                                1
INTEGER(KIND=MPI_ADDRESS_KIND), INTENT(IN) :: displs(*)        2
TYPE(MPI_Comm), INTENT(IN) :: comm                              3
INTEGER, OPTIONAL, INTENT(OUT) :: ierror                        4
                                                                    5
MPI_Allgatherv(sendbuf, sendcount, sendtype, recvbuf, recvcnts, displs,
               recvtype, comm, ierror)                          6
TYPE(*), DIMENSION(..), INTENT(IN) :: sendbuf                  7
INTEGER, INTENT(IN) :: sendcount, recvcnts(*), displs(*)       8
TYPE(MPI_Datatype), INTENT(IN) :: sendtype, recvtype          9
TYPE(*), DIMENSION(..) :: recvbuf                             10
TYPE(MPI_Comm), INTENT(IN) :: comm                             11
INTEGER, OPTIONAL, INTENT(OUT) :: ierror                       12
                                                                    13
MPI_Allgatherv_init(sendbuf, sendcount, sendtype, recvbuf, recvcnts,
                   displs, recvtype, comm, info, request, ierror) 14
TYPE(*), DIMENSION(..), INTENT(IN), ASYNCHRONOUS :: sendbuf    15
INTEGER(KIND=MPI_COUNT_KIND), INTENT(IN) :: sendcount          16
TYPE(MPI_Datatype), INTENT(IN) :: sendtype, recvtype          17
TYPE(*), DIMENSION(..), ASYNCHRONOUS :: recvbuf               18
INTEGER(KIND=MPI_COUNT_KIND), INTENT(IN), ASYNCHRONOUS :: recvcnts(*) 19
INTEGER(KIND=MPI_ADDRESS_KIND), INTENT(IN), ASYNCHRONOUS :: displs(*) 20
TYPE(MPI_Comm), INTENT(IN) :: comm                             21
TYPE(MPI_Info), INTENT(IN) :: info                             22
TYPE(MPI_Request), INTENT(OUT) :: request                       23
INTEGER, OPTIONAL, INTENT(OUT) :: ierror                       24
                                                                    25
MPI_Allgatherv_init(sendbuf, sendcount, sendtype, recvbuf, recvcnts,
                   displs, recvtype, comm, info, request, ierror) 26
TYPE(*), DIMENSION(..), INTENT(IN), ASYNCHRONOUS :: sendbuf    27
INTEGER, INTENT(IN) :: sendcount                                28
TYPE(MPI_Datatype), INTENT(IN) :: sendtype, recvtype          29
TYPE(*), DIMENSION(..), ASYNCHRONOUS :: recvbuf               30
INTEGER, INTENT(IN), ASYNCHRONOUS :: recvcnts(*), displs(*)    31
TYPE(MPI_Comm), INTENT(IN) :: comm                             32
TYPE(MPI_Info), INTENT(IN) :: info                             33
TYPE(MPI_Request), INTENT(OUT) :: request                       34
INTEGER, OPTIONAL, INTENT(OUT) :: ierror                       35
                                                                    36
MPI_Allreduce(sendbuf, recvbuf, count, datatype, op, comm, ierror) 37
TYPE(*), DIMENSION(..), INTENT(IN) :: sendbuf                  38
TYPE(*), DIMENSION(..) :: recvbuf                              39
INTEGER(KIND=MPI_COUNT_KIND), INTENT(IN) :: count              40
TYPE(MPI_Datatype), INTENT(IN) :: datatype                     41
TYPE(MPI_Op), INTENT(IN) :: op                                  42
TYPE(MPI_Comm), INTENT(IN) :: comm                             43
INTEGER, OPTIONAL, INTENT(OUT) :: ierror                       44
                                                                    45
MPI_Allreduce(sendbuf, recvbuf, count, datatype, op, comm, ierror) 46
TYPE(*), DIMENSION(..), INTENT(IN) :: sendbuf                  47
                                                                    48

```

```

1     TYPE(*), DIMENSION(..) :: recvbuf
2     INTEGER, INTENT(IN) :: count
3     TYPE(MPI_Datatype), INTENT(IN) :: datatype
4     TYPE(MPI_Op), INTENT(IN) :: op
5     TYPE(MPI_Comm), INTENT(IN) :: comm
6     INTEGER, OPTIONAL, INTENT(OUT) :: ierror
7
8     MPI_Allreduce_init(sendbuf, recvbuf, count, datatype, op, comm, info,
9         request, ierror)
10    TYPE(*), DIMENSION(..), INTENT(IN), ASYNCHRONOUS :: sendbuf
11    TYPE(*), DIMENSION(..), ASYNCHRONOUS :: recvbuf
12    INTEGER(KIND=MPI_COUNT_KIND), INTENT(IN) :: count
13    TYPE(MPI_Datatype), INTENT(IN) :: datatype
14    TYPE(MPI_Op), INTENT(IN) :: op
15    TYPE(MPI_Comm), INTENT(IN) :: comm
16    TYPE(MPI_Info), INTENT(IN) :: info
17    TYPE(MPI_Request), INTENT(OUT) :: request
18    INTEGER, OPTIONAL, INTENT(OUT) :: ierror
19
20    MPI_Allreduce_init(sendbuf, recvbuf, count, datatype, op, comm, info,
21        request, ierror)
22    TYPE(*), DIMENSION(..), INTENT(IN), ASYNCHRONOUS :: sendbuf
23    TYPE(*), DIMENSION(..), ASYNCHRONOUS :: recvbuf
24    INTEGER, INTENT(IN) :: count
25    TYPE(MPI_Datatype), INTENT(IN) :: datatype
26    TYPE(MPI_Op), INTENT(IN) :: op
27    TYPE(MPI_Comm), INTENT(IN) :: comm
28    TYPE(MPI_Info), INTENT(IN) :: info
29    TYPE(MPI_Request), INTENT(OUT) :: request
30    INTEGER, OPTIONAL, INTENT(OUT) :: ierror
31
32    MPI_Alltoall(sendbuf, sendcount, sendtype, recvbuf, recvcnt, recvtype,
33        comm, ierror)
34    TYPE(*), DIMENSION(..), INTENT(IN) :: sendbuf
35    INTEGER(KIND=MPI_COUNT_KIND), INTENT(IN) :: sendcount, recvcnt
36    TYPE(MPI_Datatype), INTENT(IN) :: sendtype, recvtype
37    TYPE(*), DIMENSION(..) :: recvbuf
38    TYPE(MPI_Comm), INTENT(IN) :: comm
39    INTEGER, OPTIONAL, INTENT(OUT) :: ierror
40
41    MPI_Alltoall(sendbuf, sendcount, sendtype, recvbuf, recvcnt, recvtype,
42        comm, ierror)
43    TYPE(*), DIMENSION(..), INTENT(IN) :: sendbuf
44    INTEGER, INTENT(IN) :: sendcount, recvcnt
45    TYPE(MPI_Datatype), INTENT(IN) :: sendtype, recvtype
46    TYPE(*), DIMENSION(..) :: recvbuf
47    TYPE(MPI_Comm), INTENT(IN) :: comm
48    INTEGER, OPTIONAL, INTENT(OUT) :: ierror

```

```

MPI_Alltoall_init(sendbuf, sendcount, sendtype, recvbuf, recvcount,
                  recvtype, comm, info, request, ierror)
TYPE(*), DIMENSION(..), INTENT(IN), ASYNCHRONOUS :: sendbuf
INTEGER(KIND=MPI_COUNT_KIND), INTENT(IN) :: sendcount, recvcount
TYPE(MPI_Datatype), INTENT(IN) :: sendtype, recvtype
TYPE(*), DIMENSION(..), ASYNCHRONOUS :: recvbuf
TYPE(MPI_Comm), INTENT(IN) :: comm
TYPE(MPI_Info), INTENT(IN) :: info
TYPE(MPI_Request), INTENT(OUT) :: request
INTEGER, OPTIONAL, INTENT(OUT) :: ierror

MPI_Alltoall_init(sendbuf, sendcount, sendtype, recvbuf, recvcount,
                  recvtype, comm, info, request, ierror)
TYPE(*), DIMENSION(..), INTENT(IN), ASYNCHRONOUS :: sendbuf
INTEGER, INTENT(IN) :: sendcount, recvcount
TYPE(MPI_Datatype), INTENT(IN) :: sendtype, recvtype
TYPE(*), DIMENSION(..), ASYNCHRONOUS :: recvbuf
TYPE(MPI_Comm), INTENT(IN) :: comm
TYPE(MPI_Info), INTENT(IN) :: info
TYPE(MPI_Request), INTENT(OUT) :: request
INTEGER, OPTIONAL, INTENT(OUT) :: ierror

MPI_Alltoallv(sendbuf, sendcounts, sdispls, sendtype, recvbuf, recvcounts,
              rdispls, recvtype, comm, ierror)
TYPE(*), DIMENSION(..), INTENT(IN) :: sendbuf
INTEGER(KIND=MPI_COUNT_KIND), INTENT(IN) :: sendcounts(*),
              recvcounts(*)
INTEGER(KIND=MPI_ADDRESS_KIND), INTENT(IN) :: sdispls(*), rdispls(*)
TYPE(MPI_Datatype), INTENT(IN) :: sendtype, recvtype
TYPE(*), DIMENSION(..) :: recvbuf
TYPE(MPI_Comm), INTENT(IN) :: comm
INTEGER, OPTIONAL, INTENT(OUT) :: ierror

MPI_Alltoallv(sendbuf, sendcounts, sdispls, sendtype, recvbuf, recvcounts,
              rdispls, recvtype, comm, ierror)
TYPE(*), DIMENSION(..), INTENT(IN) :: sendbuf
INTEGER, INTENT(IN) :: sendcounts(*), sdispls(*), recvcounts(*),
              rdispls(*)
TYPE(MPI_Datatype), INTENT(IN) :: sendtype, recvtype
TYPE(*), DIMENSION(..) :: recvbuf
TYPE(MPI_Comm), INTENT(IN) :: comm
INTEGER, OPTIONAL, INTENT(OUT) :: ierror

MPI_Alltoallv_init(sendbuf, sendcounts, sdispls, sendtype, recvbuf,
                  recvcounts, rdispls, recvtype, comm, info, request, ierror)
TYPE(*), DIMENSION(..), INTENT(IN), ASYNCHRONOUS :: sendbuf
INTEGER(KIND=MPI_COUNT_KIND), INTENT(IN), ASYNCHRONOUS ::
              sendcounts(*), recvcounts(*)

```

```

1     INTEGER(KIND=MPI_ADDRESS_KIND), INTENT(IN), ASYNCHRONOUS :: sdispls(*),
2         rdispls(*)
3     TYPE(MPI_Datatype), INTENT(IN) :: sendtype, recvtype
4     TYPE(*), DIMENSION(..), ASYNCHRONOUS :: recvbuf
5     TYPE(MPI_Comm), INTENT(IN) :: comm
6     TYPE(MPI_Info), INTENT(IN) :: info
7     TYPE(MPI_Request), INTENT(OUT) :: request
8     INTEGER, OPTIONAL, INTENT(OUT) :: ierror
9
10    MPI_Alltoallv_init(sendbuf, sendcounts, sdispls, sendtype, recvbuf,
11        recvcounts, rdispls, recvtype, comm, info, request, ierror)
12    TYPE(*), DIMENSION(..), INTENT(IN), ASYNCHRONOUS :: sendbuf
13    INTEGER, INTENT(IN), ASYNCHRONOUS :: sendcounts(*), sdispls(*),
14        recvcounts(*), rdispls(*)
15    TYPE(MPI_Datatype), INTENT(IN) :: sendtype, recvtype
16    TYPE(*), DIMENSION(..), ASYNCHRONOUS :: recvbuf
17    TYPE(MPI_Comm), INTENT(IN) :: comm
18    TYPE(MPI_Info), INTENT(IN) :: info
19    TYPE(MPI_Request), INTENT(OUT) :: request
20    INTEGER, OPTIONAL, INTENT(OUT) :: ierror
21
22    MPI_Alltoallw(sendbuf, sendcounts, sdispls, sendtypes, recvbuf, recvcounts,
23        rdispls, recvtypes, comm, ierror)
24    TYPE(*), DIMENSION(..), INTENT(IN) :: sendbuf
25    INTEGER(KIND=MPI_COUNT_KIND), INTENT(IN) :: sendcounts(*),
26        recvcounts(*)
27    INTEGER(KIND=MPI_ADDRESS_KIND), INTENT(IN) :: sdispls(*), rdispls(*)
28    TYPE(MPI_Datatype), INTENT(IN) :: sendtypes(*), recvtypes(*)
29    TYPE(*), DIMENSION(..) :: recvbuf
30    TYPE(MPI_Comm), INTENT(IN) :: comm
31    INTEGER, OPTIONAL, INTENT(OUT) :: ierror
32
33    MPI_Alltoallw(sendbuf, sendcounts, sdispls, sendtypes, recvbuf, recvcounts,
34        rdispls, recvtypes, comm, ierror)
35    TYPE(*), DIMENSION(..), INTENT(IN) :: sendbuf
36    INTEGER, INTENT(IN) :: sendcounts(*), sdispls(*), recvcounts(*),
37        rdispls(*)
38    TYPE(MPI_Datatype), INTENT(IN) :: sendtypes(*), recvtypes(*)
39    TYPE(*), DIMENSION(..) :: recvbuf
40    TYPE(MPI_Comm), INTENT(IN) :: comm
41    INTEGER, OPTIONAL, INTENT(OUT) :: ierror
42
43    MPI_Alltoallw_init(sendbuf, sendcounts, sdispls, sendtypes, recvbuf,
44        recvcounts, rdispls, recvtypes, comm, info, request, ierror)
45    TYPE(*), DIMENSION(..), INTENT(IN), ASYNCHRONOUS :: sendbuf
46    INTEGER(KIND=MPI_COUNT_KIND), INTENT(IN), ASYNCHRONOUS ::
47        sendcounts(*), recvcounts(*)
48    INTEGER(KIND=MPI_ADDRESS_KIND), INTENT(IN), ASYNCHRONOUS :: sdispls(*),
49        rdispls(*)

```

```

TYPE(MPI_Datatype), INTENT(IN), ASYNCHRONOUS :: sendtypes(*),
    recvtypes(*)
TYPE(*), DIMENSION(..), ASYNCHRONOUS :: recvbuf
TYPE(MPI_Comm), INTENT(IN) :: comm
TYPE(MPI_Info), INTENT(IN) :: info
TYPE(MPI_Request), INTENT(OUT) :: request
INTEGER, OPTIONAL, INTENT(OUT) :: ierror

MPI_Alltoallw_init(sendbuf, sendcounts, sdispls, sendtypes, recvbuf,
    recvcnts, rdispls, recvtypes, comm, info, request, ierror)
TYPE(*), DIMENSION(..), INTENT(IN), ASYNCHRONOUS :: sendbuf
INTEGER, INTENT(IN), ASYNCHRONOUS :: sendcounts(*), sdispls(*),
    recvcnts(*), rdispls(*)
TYPE(MPI_Datatype), INTENT(IN), ASYNCHRONOUS :: sendtypes(*),
    recvtypes(*)
TYPE(*), DIMENSION(..), ASYNCHRONOUS :: recvbuf
TYPE(MPI_Comm), INTENT(IN) :: comm
TYPE(MPI_Info), INTENT(IN) :: info
TYPE(MPI_Request), INTENT(OUT) :: request
INTEGER, OPTIONAL, INTENT(OUT) :: ierror

MPI_Barrier(comm, ierror)
TYPE(MPI_Comm), INTENT(IN) :: comm
INTEGER, OPTIONAL, INTENT(OUT) :: ierror

MPI_Barrier_init(comm, info, request, ierror)
TYPE(MPI_Comm), INTENT(IN) :: comm
TYPE(MPI_Info), INTENT(IN) :: info
TYPE(MPI_Request), INTENT(OUT) :: request
INTEGER, OPTIONAL, INTENT(OUT) :: ierror

MPI_Bcast(buffer, count, datatype, root, comm, ierror)
TYPE(*), DIMENSION(..) :: buffer
INTEGER(KIND=MPI_COUNT_KIND), INTENT(IN) :: count
TYPE(MPI_Datatype), INTENT(IN) :: datatype
INTEGER, INTENT(IN) :: root
TYPE(MPI_Comm), INTENT(IN) :: comm
INTEGER, OPTIONAL, INTENT(OUT) :: ierror

MPI_Bcast(buffer, count, datatype, root, comm, ierror)
TYPE(*), DIMENSION(..) :: buffer
INTEGER, INTENT(IN) :: count, root
TYPE(MPI_Datatype), INTENT(IN) :: datatype
TYPE(MPI_Comm), INTENT(IN) :: comm
INTEGER, OPTIONAL, INTENT(OUT) :: ierror

MPI_Bcast_init(buffer, count, datatype, root, comm, info, request, ierror)
TYPE(*), DIMENSION(..), ASYNCHRONOUS :: buffer
INTEGER(KIND=MPI_COUNT_KIND), INTENT(IN) :: count
TYPE(MPI_Datatype), INTENT(IN) :: datatype

```

```

1     INTEGER, INTENT(IN) :: root
2     TYPE(MPI_Comm), INTENT(IN) :: comm
3     TYPE(MPI_Info), INTENT(IN) :: info
4     TYPE(MPI_Request), INTENT(OUT) :: request
5     INTEGER, OPTIONAL, INTENT(OUT) :: ierror
6
7 MPI_Bcast_init(buffer, count, datatype, root, comm, info, request, ierror)
8     TYPE(*), DIMENSION(..), ASYNCHRONOUS :: buffer
9     INTEGER, INTENT(IN) :: count, root
10    TYPE(MPI_Datatype), INTENT(IN) :: datatype
11    TYPE(MPI_Comm), INTENT(IN) :: comm
12    TYPE(MPI_Info), INTENT(IN) :: info
13    TYPE(MPI_Request), INTENT(OUT) :: request
14    INTEGER, OPTIONAL, INTENT(OUT) :: ierror
15
16 MPI_Exscan(sendbuf, recvbuf, count, datatype, op, comm, ierror)
17    TYPE(*), DIMENSION(..), INTENT(IN) :: sendbuf
18    TYPE(*), DIMENSION(..) :: recvbuf
19    INTEGER(KIND=MPI_COUNT_KIND), INTENT(IN) :: count
20    TYPE(MPI_Datatype), INTENT(IN) :: datatype
21    TYPE(MPI_Op), INTENT(IN) :: op
22    TYPE(MPI_Comm), INTENT(IN) :: comm
23    INTEGER, OPTIONAL, INTENT(OUT) :: ierror
24
25 MPI_Exscan(sendbuf, recvbuf, count, datatype, op, comm, ierror)
26    TYPE(*), DIMENSION(..), INTENT(IN) :: sendbuf
27    TYPE(*), DIMENSION(..) :: recvbuf
28    INTEGER, INTENT(IN) :: count
29    TYPE(MPI_Datatype), INTENT(IN) :: datatype
30    TYPE(MPI_Op), INTENT(IN) :: op
31    TYPE(MPI_Comm), INTENT(IN) :: comm
32    INTEGER, OPTIONAL, INTENT(OUT) :: ierror
33
34 MPI_Exscan_init(sendbuf, recvbuf, count, datatype, op, comm, info, request,
35                ierror)
36    TYPE(*), DIMENSION(..), INTENT(IN), ASYNCHRONOUS :: sendbuf
37    TYPE(*), DIMENSION(..), ASYNCHRONOUS :: recvbuf
38    INTEGER(KIND=MPI_COUNT_KIND), INTENT(IN) :: count
39    TYPE(MPI_Datatype), INTENT(IN) :: datatype
40    TYPE(MPI_Op), INTENT(IN) :: op
41    TYPE(MPI_Comm), INTENT(IN) :: comm
42    TYPE(MPI_Info), INTENT(IN) :: info
43    TYPE(MPI_Request), INTENT(OUT) :: request
44    INTEGER, OPTIONAL, INTENT(OUT) :: ierror
45
46 MPI_Exscan_init(sendbuf, recvbuf, count, datatype, op, comm, info, request,
47                ierror)
48    TYPE(*), DIMENSION(..), INTENT(IN), ASYNCHRONOUS :: sendbuf
49    TYPE(*), DIMENSION(..), ASYNCHRONOUS :: recvbuf
50    INTEGER, INTENT(IN) :: count

```

```

TYPE(MPI_Datatype), INTENT(IN) :: datatype
TYPE(MPI_Op), INTENT(IN) :: op
TYPE(MPI_Comm), INTENT(IN) :: comm
TYPE(MPI_Info), INTENT(IN) :: info
TYPE(MPI_Request), INTENT(OUT) :: request
INTEGER, OPTIONAL, INTENT(OUT) :: ierror

MPI_Gather(sendbuf, sendcount, sendtype, recvbuf, recvcount, recvttype,
           root, comm, ierror)
TYPE(*), DIMENSION(..), INTENT(IN) :: sendbuf
INTEGER(KIND=MPI_COUNT_KIND), INTENT(IN) :: sendcount, recvcount
TYPE(MPI_Datatype), INTENT(IN) :: sendtype, recvttype
TYPE(*), DIMENSION(..) :: recvbuf
INTEGER, INTENT(IN) :: root
TYPE(MPI_Comm), INTENT(IN) :: comm
INTEGER, OPTIONAL, INTENT(OUT) :: ierror

MPI_Gather(sendbuf, sendcount, sendtype, recvbuf, recvcount, recvttype,
           root, comm, ierror)
TYPE(*), DIMENSION(..), INTENT(IN) :: sendbuf
INTEGER, INTENT(IN) :: sendcount, recvcount, root
TYPE(MPI_Datatype), INTENT(IN) :: sendtype, recvttype
TYPE(*), DIMENSION(..) :: recvbuf
TYPE(MPI_Comm), INTENT(IN) :: comm
INTEGER, OPTIONAL, INTENT(OUT) :: ierror

MPI_Gather_init(sendbuf, sendcount, sendtype, recvbuf, recvcount, recvttype,
                root, comm, info, request, ierror)
TYPE(*), DIMENSION(..), INTENT(IN), ASYNCHRONOUS :: sendbuf
INTEGER(KIND=MPI_COUNT_KIND), INTENT(IN) :: sendcount, recvcount
TYPE(MPI_Datatype), INTENT(IN) :: sendtype, recvttype
TYPE(*), DIMENSION(..), ASYNCHRONOUS :: recvbuf
INTEGER, INTENT(IN) :: root
TYPE(MPI_Comm), INTENT(IN) :: comm
TYPE(MPI_Info), INTENT(IN) :: info
TYPE(MPI_Request), INTENT(OUT) :: request
INTEGER, OPTIONAL, INTENT(OUT) :: ierror

MPI_Gather_init(sendbuf, sendcount, sendtype, recvbuf, recvcount, recvttype,
                root, comm, info, request, ierror)
TYPE(*), DIMENSION(..), INTENT(IN), ASYNCHRONOUS :: sendbuf
INTEGER, INTENT(IN) :: sendcount, recvcount, root
TYPE(MPI_Datatype), INTENT(IN) :: sendtype, recvttype
TYPE(*), DIMENSION(..), ASYNCHRONOUS :: recvbuf
TYPE(MPI_Comm), INTENT(IN) :: comm
TYPE(MPI_Info), INTENT(IN) :: info
TYPE(MPI_Request), INTENT(OUT) :: request
INTEGER, OPTIONAL, INTENT(OUT) :: ierror

```

```

1 MPI_Gatherv(sendbuf, sendcount, sendtype, recvbuf, recvcnts, displs,
2             recvtype, root, comm, ierror)
3     TYPE(*), DIMENSION(..), INTENT(IN) :: sendbuf
4     INTEGER(KIND=MPI_COUNT_KIND), INTENT(IN) :: sendcount, recvcnts(*)
5     TYPE(MPI_Datatype), INTENT(IN) :: sendtype, recvtype
6     TYPE(*), DIMENSION(..) :: recvbuf
7     INTEGER(KIND=MPI_ADDRESS_KIND), INTENT(IN) :: displs(*)
8     INTEGER, INTENT(IN) :: root
9     TYPE(MPI_Comm), INTENT(IN) :: comm
10    INTEGER, OPTIONAL, INTENT(OUT) :: ierror
11
12 MPI_Gatherv(sendbuf, sendcount, sendtype, recvbuf, recvcnts, displs,
13             recvtype, root, comm, ierror)
14    TYPE(*), DIMENSION(..), INTENT(IN) :: sendbuf
15    INTEGER, INTENT(IN) :: sendcount, recvcnts(*), displs(*), root
16    TYPE(MPI_Datatype), INTENT(IN) :: sendtype, recvtype
17    TYPE(*), DIMENSION(..) :: recvbuf
18    TYPE(MPI_Comm), INTENT(IN) :: comm
19    INTEGER, OPTIONAL, INTENT(OUT) :: ierror
20
21 MPI_Gatherv_init(sendbuf, sendcount, sendtype, recvbuf, recvcnts, displs,
22                 recvtype, root, comm, info, request, ierror)
23    TYPE(*), DIMENSION(..), INTENT(IN), ASYNCHRONOUS :: sendbuf
24    INTEGER(KIND=MPI_COUNT_KIND), INTENT(IN) :: sendcount
25    TYPE(MPI_Datatype), INTENT(IN) :: sendtype, recvtype
26    TYPE(*), DIMENSION(..), ASYNCHRONOUS :: recvbuf
27    INTEGER(KIND=MPI_COUNT_KIND), INTENT(IN), ASYNCHRONOUS :: recvcnts(*)
28    INTEGER(KIND=MPI_ADDRESS_KIND), INTENT(IN), ASYNCHRONOUS :: displs(*)
29    INTEGER, INTENT(IN) :: root
30    TYPE(MPI_Comm), INTENT(IN) :: comm
31    TYPE(MPI_Info), INTENT(IN) :: info
32    TYPE(MPI_Request), INTENT(OUT) :: request
33    INTEGER, OPTIONAL, INTENT(OUT) :: ierror
34
35 MPI_Gatherv_init(sendbuf, sendcount, sendtype, recvbuf, recvcnts, displs,
36                 recvtype, root, comm, info, request, ierror)
37    TYPE(*), DIMENSION(..), INTENT(IN), ASYNCHRONOUS :: sendbuf
38    INTEGER, INTENT(IN) :: sendcount, root
39    TYPE(MPI_Datatype), INTENT(IN) :: sendtype, recvtype
40    TYPE(*), DIMENSION(..), ASYNCHRONOUS :: recvbuf
41    INTEGER, INTENT(IN), ASYNCHRONOUS :: recvcnts(*), displs(*)
42    TYPE(MPI_Comm), INTENT(IN) :: comm
43    TYPE(MPI_Info), INTENT(IN) :: info
44    TYPE(MPI_Request), INTENT(OUT) :: request
45    INTEGER, OPTIONAL, INTENT(OUT) :: ierror
46
47 MPI_Iallgather(sendbuf, sendcount, sendtype, recvbuf, recvcount, recvtype,
48               comm, request, ierror)
49    TYPE(*), DIMENSION(..), INTENT(IN), ASYNCHRONOUS :: sendbuf

```



```

INTEGER(KIND=MPI_COUNT_KIND), INTENT(IN) :: sendcount, recvcount      1
TYPE(MPI_Datatype), INTENT(IN) :: sendtype, recvtype                  2
TYPE(*), DIMENSION(..), ASYNCHRONOUS :: recvbuf                      3
TYPE(MPI_Comm), INTENT(IN) :: comm                                    4
TYPE(MPI_Request), INTENT(OUT) :: request                            5
INTEGER, OPTIONAL, INTENT(OUT) :: ierror                             6
                                                                    7
MPI_Iallgather(sendbuf, sendcount, sendtype, recvbuf, recvcount, recvtype,
               comm, request, ierror)                                 8
TYPE(*), DIMENSION(..), INTENT(IN), ASYNCHRONOUS :: sendbuf        9
INTEGER, INTENT(IN) :: sendcount, recvcount                          10
TYPE(MPI_Datatype), INTENT(IN) :: sendtype, recvtype                11
TYPE(*), DIMENSION(..), ASYNCHRONOUS :: recvbuf                    12
TYPE(MPI_Comm), INTENT(IN) :: comm                                  13
TYPE(MPI_Request), INTENT(OUT) :: request                           14
INTEGER, OPTIONAL, INTENT(OUT) :: ierror                             15
                                                                    16
MPI_Iallgatherv(sendbuf, sendcount, sendtype, recvbuf, recvcounts, displs,
                recvtype, comm, request, ierror)                    17
TYPE(*), DIMENSION(..), INTENT(IN), ASYNCHRONOUS :: sendbuf        18
INTEGER(KIND=MPI_COUNT_KIND), INTENT(IN) :: sendcount               19
TYPE(MPI_Datatype), INTENT(IN) :: sendtype, recvtype               20
TYPE(*), DIMENSION(..), ASYNCHRONOUS :: recvbuf                    21
INTEGER(KIND=MPI_COUNT_KIND), INTENT(IN), ASYNCHRONOUS :: recvcounts(*) 22
INTEGER(KIND=MPI_ADDRESS_KIND), INTENT(IN), ASYNCHRONOUS :: displs(*) 23
TYPE(MPI_Comm), INTENT(IN) :: comm                                  24
TYPE(MPI_Request), INTENT(OUT) :: request                           25
INTEGER, OPTIONAL, INTENT(OUT) :: ierror                             26
                                                                    27
MPI_Iallgatherv(sendbuf, sendcount, sendtype, recvbuf, recvcounts, displs,
                recvtype, comm, request, ierror)                    28
TYPE(*), DIMENSION(..), INTENT(IN), ASYNCHRONOUS :: sendbuf        29
INTEGER, INTENT(IN) :: sendcount                                    30
TYPE(MPI_Datatype), INTENT(IN) :: sendtype, recvtype               31
TYPE(*), DIMENSION(..), ASYNCHRONOUS :: recvbuf                    32
INTEGER, INTENT(IN), ASYNCHRONOUS :: recvcounts(*), displs(*)     33
TYPE(MPI_Comm), INTENT(IN) :: comm                                  34
TYPE(MPI_Request), INTENT(OUT) :: request                           35
INTEGER, OPTIONAL, INTENT(OUT) :: ierror                             36
                                                                    37
MPI_Iallreduce(sendbuf, recvbuf, count, datatype, op, comm, request,
               ierror)                                              38
TYPE(*), DIMENSION(..), INTENT(IN), ASYNCHRONOUS :: sendbuf        39
TYPE(*), DIMENSION(..), ASYNCHRONOUS :: recvbuf                    40
INTEGER(KIND=MPI_COUNT_KIND), INTENT(IN) :: count                  41
TYPE(MPI_Datatype), INTENT(IN) :: datatype                          42
TYPE(MPI_Op), INTENT(IN) :: op                                      43
TYPE(MPI_Comm), INTENT(IN) :: comm                                  44
TYPE(MPI_Request), INTENT(OUT) :: request                           45
INTEGER, OPTIONAL, INTENT(OUT) :: ierror                             46
                                                                    47

```

```

1     INTEGER, OPTIONAL, INTENT(OUT) :: ierror
2
3     MPI_Iallreduce(sendbuf, recvbuf, count, datatype, op, comm, request,
4         ierror)
5     TYPE(*), DIMENSION(..), INTENT(IN), ASYNCHRONOUS :: sendbuf
6     TYPE(*), DIMENSION(..), ASYNCHRONOUS :: recvbuf
7     INTEGER, INTENT(IN) :: count
8     TYPE(MPI_Datatype), INTENT(IN) :: datatype
9     TYPE(MPI_Op), INTENT(IN) :: op
10    TYPE(MPI_Comm), INTENT(IN) :: comm
11    TYPE(MPI_Request), INTENT(OUT) :: request
12    INTEGER, OPTIONAL, INTENT(OUT) :: ierror
13
14    MPI_Ialltoall(sendbuf, sendcount, sendtype, recvbuf, recvcount, recvtype,
15        comm, request, ierror)
16    TYPE(*), DIMENSION(..), INTENT(IN), ASYNCHRONOUS :: sendbuf
17    INTEGER(KIND=MPI_COUNT_KIND), INTENT(IN) :: sendcount, recvcount
18    TYPE(MPI_Datatype), INTENT(IN) :: sendtype, recvtype
19    TYPE(*), DIMENSION(..), ASYNCHRONOUS :: recvbuf
20    TYPE(MPI_Comm), INTENT(IN) :: comm
21    TYPE(MPI_Request), INTENT(OUT) :: request
22    INTEGER, OPTIONAL, INTENT(OUT) :: ierror
23
24    MPI_Ialltoall(sendbuf, sendcount, sendtype, recvbuf, recvcount, recvtype,
25        comm, request, ierror)
26    TYPE(*), DIMENSION(..), INTENT(IN), ASYNCHRONOUS :: sendbuf
27    INTEGER, INTENT(IN) :: sendcount, recvcount
28    TYPE(MPI_Datatype), INTENT(IN) :: sendtype, recvtype
29    TYPE(*), DIMENSION(..), ASYNCHRONOUS :: recvbuf
30    TYPE(MPI_Comm), INTENT(IN) :: comm
31    TYPE(MPI_Request), INTENT(OUT) :: request
32    INTEGER, OPTIONAL, INTENT(OUT) :: ierror
33
34    MPI_Ialltoallv(sendbuf, sendcounts, sdispls, sendtype, recvbuf, recvcounts,
35        rdispls, recvtype, comm, request, ierror)
36    TYPE(*), DIMENSION(..), INTENT(IN), ASYNCHRONOUS :: sendbuf
37    INTEGER(KIND=MPI_COUNT_KIND), INTENT(IN), ASYNCHRONOUS ::
38        sendcounts(*), recvcounts(*)
39    INTEGER(KIND=MPI_ADDRESS_KIND), INTENT(IN), ASYNCHRONOUS :: sdispls(*),
40        rdispls(*)
41    TYPE(MPI_Datatype), INTENT(IN) :: sendtype, recvtype
42    TYPE(*), DIMENSION(..), ASYNCHRONOUS :: recvbuf
43    TYPE(MPI_Comm), INTENT(IN) :: comm
44    TYPE(MPI_Request), INTENT(OUT) :: request
45    INTEGER, OPTIONAL, INTENT(OUT) :: ierror
46
47    MPI_Ialltoallv(sendbuf, sendcounts, sdispls, sendtype, recvbuf, recvcounts,
48        rdispls, recvtype, comm, request, ierror)
49    TYPE(*), DIMENSION(..), INTENT(IN), ASYNCHRONOUS :: sendbuf

```

```

INTEGER, INTENT(IN), ASYNCHRONOUS :: sendcounts(*), sdispls(*),      1
    recvcounts(*), rdispls(*)                                       2
TYPE(MPI_Datatype), INTENT(IN) :: sendtype, recvtype                3
TYPE(*), DIMENSION(..), ASYNCHRONOUS :: recvbuf                    4
TYPE(MPI_Comm), INTENT(IN) :: comm                                  5
TYPE(MPI_Request), INTENT(OUT) :: request                           6
INTEGER, OPTIONAL, INTENT(OUT) :: ierror                            7
                                                                    8
MPI_Ialltoallw(sendbuf, sendcounts, sdispls, sendtypes, recvbuf,    9
    recvcounts, rdispls, recvtypes, comm, request, ierror)         10
TYPE(*), DIMENSION(..), INTENT(IN), ASYNCHRONOUS :: sendbuf       11
INTEGER(KIND=MPI_COUNT_KIND), INTENT(IN), ASYNCHRONOUS ::          12
    sendcounts(*), recvcounts(*)                                    13
INTEGER(KIND=MPI_ADDRESS_KIND), INTENT(IN), ASYNCHRONOUS :: sdispls(*), 14
    rdispls(*)                                                      15
TYPE(MPI_Datatype), INTENT(IN), ASYNCHRONOUS :: sendtypes(*),     16
    recvtypes(*)                                                    17
TYPE(*), DIMENSION(..), ASYNCHRONOUS :: recvbuf                    18
TYPE(MPI_Comm), INTENT(IN) :: comm                                  19
TYPE(MPI_Request), INTENT(OUT) :: request                           20
INTEGER, OPTIONAL, INTENT(OUT) :: ierror                            21
                                                                    22
MPI_Ialltoallw(sendbuf, sendcounts, sdispls, sendtypes, recvbuf,    23
    recvcounts, rdispls, recvtypes, comm, request, ierror)         24
TYPE(*), DIMENSION(..), INTENT(IN), ASYNCHRONOUS :: sendbuf       25
INTEGER, INTENT(IN), ASYNCHRONOUS :: sendcounts(*), sdispls(*),    26
    recvcounts(*), rdispls(*)                                       27
TYPE(MPI_Datatype), INTENT(IN), ASYNCHRONOUS :: sendtypes(*),     28
    recvtypes(*)                                                    29
TYPE(*), DIMENSION(..), ASYNCHRONOUS :: recvbuf                    30
TYPE(MPI_Comm), INTENT(IN) :: comm                                  31
TYPE(MPI_Request), INTENT(OUT) :: request                           32
INTEGER, OPTIONAL, INTENT(OUT) :: ierror                            33
                                                                    34
MPI_Ibarrier(comm, request, ierror)                                  35
TYPE(MPI_Comm), INTENT(IN) :: comm                                  36
TYPE(MPI_Request), INTENT(OUT) :: request                           37
INTEGER, OPTIONAL, INTENT(OUT) :: ierror                            38
                                                                    39
MPI_Ibcast(buffer, count, datatype, root, comm, request, ierror)    40
TYPE(*), DIMENSION(..), ASYNCHRONOUS :: buffer                      41
INTEGER(KIND=MPI_COUNT_KIND), INTENT(IN) :: count                    42
TYPE(MPI_Datatype), INTENT(IN) :: datatype                          43
INTEGER, INTENT(IN) :: root                                          44
TYPE(MPI_Comm), INTENT(IN) :: comm                                  45
TYPE(MPI_Request), INTENT(OUT) :: request                           46
INTEGER, OPTIONAL, INTENT(OUT) :: ierror                            47
                                                                    48
MPI_Ibcast(buffer, count, datatype, root, comm, request, ierror)    49
TYPE(*), DIMENSION(..), ASYNCHRONOUS :: buffer                      50

```

```

1     INTEGER, INTENT(IN) :: count, root
2     TYPE(MPI_Datatype), INTENT(IN) :: datatype
3     TYPE(MPI_Comm), INTENT(IN) :: comm
4     TYPE(MPI_Request), INTENT(OUT) :: request
5     INTEGER, OPTIONAL, INTENT(OUT) :: ierror
6
7 MPI_Iexscan(sendbuf, recvbuf, count, datatype, op, comm, request, ierror)
8     TYPE(*), DIMENSION(..), INTENT(IN), ASYNCHRONOUS :: sendbuf
9     TYPE(*), DIMENSION(..), ASYNCHRONOUS :: recvbuf
10    INTEGER(KIND=MPI_COUNT_KIND), INTENT(IN) :: count
11    TYPE(MPI_Datatype), INTENT(IN) :: datatype
12    TYPE(MPI_Op), INTENT(IN) :: op
13    TYPE(MPI_Comm), INTENT(IN) :: comm
14    TYPE(MPI_Request), INTENT(OUT) :: request
15    INTEGER, OPTIONAL, INTENT(OUT) :: ierror
16
17 MPI_Iexscan(sendbuf, recvbuf, count, datatype, op, comm, request, ierror)
18    TYPE(*), DIMENSION(..), INTENT(IN), ASYNCHRONOUS :: sendbuf
19    TYPE(*), DIMENSION(..), ASYNCHRONOUS :: recvbuf
20    INTEGER, INTENT(IN) :: count
21    TYPE(MPI_Datatype), INTENT(IN) :: datatype
22    TYPE(MPI_Op), INTENT(IN) :: op
23    TYPE(MPI_Comm), INTENT(IN) :: comm
24    TYPE(MPI_Request), INTENT(OUT) :: request
25    INTEGER, OPTIONAL, INTENT(OUT) :: ierror
26
27 MPI_Igather(sendbuf, sendcount, sendtype, recvbuf, recvcount, recvtype,
28             root, comm, request, ierror)
29    TYPE(*), DIMENSION(..), INTENT(IN), ASYNCHRONOUS :: sendbuf
30    INTEGER(KIND=MPI_COUNT_KIND), INTENT(IN) :: sendcount, recvcount
31    TYPE(MPI_Datatype), INTENT(IN) :: sendtype, recvtype
32    TYPE(*), DIMENSION(..), ASYNCHRONOUS :: recvbuf
33    INTEGER, INTENT(IN) :: root
34    TYPE(MPI_Comm), INTENT(IN) :: comm
35    TYPE(MPI_Request), INTENT(OUT) :: request
36    INTEGER, OPTIONAL, INTENT(OUT) :: ierror
37
38 MPI_Igather(sendbuf, sendcount, sendtype, recvbuf, recvcount, recvtype,
39             root, comm, request, ierror)
40    TYPE(*), DIMENSION(..), INTENT(IN), ASYNCHRONOUS :: sendbuf
41    INTEGER, INTENT(IN) :: sendcount, recvcount, root
42    TYPE(MPI_Datatype), INTENT(IN) :: sendtype, recvtype
43    TYPE(*), DIMENSION(..), ASYNCHRONOUS :: recvbuf
44    TYPE(MPI_Comm), INTENT(IN) :: comm
45    TYPE(MPI_Request), INTENT(OUT) :: request
46    INTEGER, OPTIONAL, INTENT(OUT) :: ierror
47
48 MPI_Igatherv(sendbuf, sendcount, sendtype, recvbuf, recvcounts, displs,
49              recvtype, root, comm, request, ierror)
50    TYPE(*), DIMENSION(..), INTENT(IN), ASYNCHRONOUS :: sendbuf

```

```

INTEGER(KIND=MPI_COUNT_KIND), INTENT(IN) :: sendcount      1
TYPE(MPI_Datatype), INTENT(IN) :: sendtype, recvtype      2
TYPE(*), DIMENSION(..), ASYNCHRONOUS :: recvbuf         3
INTEGER(KIND=MPI_COUNT_KIND), INTENT(IN), ASYNCHRONOUS :: recvcounts(*) 4
INTEGER(KIND=MPI_ADDRESS_KIND), INTENT(IN), ASYNCHRONOUS :: displs(*) 5
INTEGER, INTENT(IN) :: root                               6
TYPE(MPI_Comm), INTENT(IN) :: comm                       7
TYPE(MPI_Request), INTENT(OUT) :: request               8
INTEGER, OPTIONAL, INTENT(OUT) :: ierror                9
10
MPI_Igatherv(sendbuf, sendcount, sendtype, recvbuf, recvcounts, displs, 11
             recvtype, root, comm, request, ierror)      12
TYPE(*), DIMENSION(..), INTENT(IN), ASYNCHRONOUS :: sendbuf 13
INTEGER, INTENT(IN) :: sendcount, root                  14
TYPE(MPI_Datatype), INTENT(IN) :: sendtype, recvtype    15
TYPE(*), DIMENSION(..), ASYNCHRONOUS :: recvbuf        16
INTEGER, INTENT(IN), ASYNCHRONOUS :: recvcounts(*), displs(*) 17
TYPE(MPI_Comm), INTENT(IN) :: comm                     18
TYPE(MPI_Request), INTENT(OUT) :: request               19
INTEGER, OPTIONAL, INTENT(OUT) :: ierror                20
21
MPI_Ireduce(sendbuf, recvbuf, count, datatype, op, root, comm, request, 22
            ierror)
TYPE(*), DIMENSION(..), INTENT(IN), ASYNCHRONOUS :: sendbuf 23
TYPE(*), DIMENSION(..), ASYNCHRONOUS :: recvbuf         24
INTEGER(KIND=MPI_COUNT_KIND), INTENT(IN) :: count       25
TYPE(MPI_Datatype), INTENT(IN) :: datatype              26
TYPE(MPI_Op), INTENT(IN) :: op                          27
INTEGER, INTENT(IN) :: root                              28
TYPE(MPI_Comm), INTENT(IN) :: comm                     29
TYPE(MPI_Request), INTENT(OUT) :: request               30
INTEGER, OPTIONAL, INTENT(OUT) :: ierror                31
32
MPI_Ireduce(sendbuf, recvbuf, count, datatype, op, root, comm, request, 33
            ierror)
TYPE(*), DIMENSION(..), INTENT(IN), ASYNCHRONOUS :: sendbuf 34
TYPE(*), DIMENSION(..), ASYNCHRONOUS :: recvbuf         35
INTEGER, INTENT(IN) :: count, root                      36
TYPE(MPI_Datatype), INTENT(IN) :: datatype              37
TYPE(MPI_Op), INTENT(IN) :: op                          38
TYPE(MPI_Comm), INTENT(IN) :: comm                     39
TYPE(MPI_Request), INTENT(OUT) :: request               40
INTEGER, OPTIONAL, INTENT(OUT) :: ierror                41
42
MPI_Ireduce_scatter(sendbuf, recvbuf, recvcounts, datatype, op, comm, 43
                    request, ierror)
TYPE(*), DIMENSION(..), INTENT(IN), ASYNCHRONOUS :: sendbuf 44
TYPE(*), DIMENSION(..), ASYNCHRONOUS :: recvbuf         45
INTEGER(KIND=MPI_COUNT_KIND), INTENT(IN), ASYNCHRONOUS :: recvcounts(*) 46
47
48

```

```

1     TYPE(MPI_Datatype), INTENT(IN) :: datatype
2     TYPE(MPI_Op), INTENT(IN) :: op
3     TYPE(MPI_Comm), INTENT(IN) :: comm
4     TYPE(MPI_Request), INTENT(OUT) :: request
5     INTEGER, OPTIONAL, INTENT(OUT) :: ierror
6
7 MPI_Ireduce_scatter(sendbuf, recvbuf, recvcounts, datatype, op, comm,
8     request, ierror)
9     TYPE(*), DIMENSION(..), INTENT(IN), ASYNCHRONOUS :: sendbuf
10    TYPE(*), DIMENSION(..), ASYNCHRONOUS :: recvbuf
11    INTEGER, INTENT(IN), ASYNCHRONOUS :: recvcounts(*)
12    TYPE(MPI_Datatype), INTENT(IN) :: datatype
13    TYPE(MPI_Op), INTENT(IN) :: op
14    TYPE(MPI_Comm), INTENT(IN) :: comm
15    TYPE(MPI_Request), INTENT(OUT) :: request
16    INTEGER, OPTIONAL, INTENT(OUT) :: ierror
17
18 MPI_Ireduce_scatter_block(sendbuf, recvbuf, recvcount, datatype, op, comm,
19    request, ierror)
20    TYPE(*), DIMENSION(..), INTENT(IN), ASYNCHRONOUS :: sendbuf
21    TYPE(*), DIMENSION(..), ASYNCHRONOUS :: recvbuf
22    INTEGER(KIND=MPI_COUNT_KIND), INTENT(IN) :: recvcount
23    TYPE(MPI_Datatype), INTENT(IN) :: datatype
24    TYPE(MPI_Op), INTENT(IN) :: op
25    TYPE(MPI_Comm), INTENT(IN) :: comm
26    TYPE(MPI_Request), INTENT(OUT) :: request
27    INTEGER, OPTIONAL, INTENT(OUT) :: ierror
28
29 MPI_Ireduce_scatter_block(sendbuf, recvbuf, recvcount, datatype, op, comm,
30    request, ierror)
31    TYPE(*), DIMENSION(..), INTENT(IN), ASYNCHRONOUS :: sendbuf
32    TYPE(*), DIMENSION(..), ASYNCHRONOUS :: recvbuf
33    INTEGER, INTENT(IN) :: recvcount
34    TYPE(MPI_Datatype), INTENT(IN) :: datatype
35    TYPE(MPI_Op), INTENT(IN) :: op
36    TYPE(MPI_Comm), INTENT(IN) :: comm
37    TYPE(MPI_Request), INTENT(OUT) :: request
38    INTEGER, OPTIONAL, INTENT(OUT) :: ierror
39
40 MPI_Iscan(sendbuf, recvbuf, count, datatype, op, comm, request, ierror)
41    TYPE(*), DIMENSION(..), INTENT(IN), ASYNCHRONOUS :: sendbuf
42    TYPE(*), DIMENSION(..), ASYNCHRONOUS :: recvbuf
43    INTEGER(KIND=MPI_COUNT_KIND), INTENT(IN) :: count
44    TYPE(MPI_Datatype), INTENT(IN) :: datatype
45    TYPE(MPI_Op), INTENT(IN) :: op
46    TYPE(MPI_Comm), INTENT(IN) :: comm
47    TYPE(MPI_Request), INTENT(OUT) :: request
48    INTEGER, OPTIONAL, INTENT(OUT) :: ierror
49
50 MPI_Iscan(sendbuf, recvbuf, count, datatype, op, comm, request, ierror)

```

```

TYPE(*), DIMENSION(..), INTENT(IN), ASYNCHRONOUS :: sendbuf      1
TYPE(*), DIMENSION(..), ASYNCHRONOUS :: recvbuf                2
INTEGER, INTENT(IN) :: count                                    3
TYPE(MPI_Datatype), INTENT(IN) :: datatype                      4
TYPE(MPI_Op), INTENT(IN) :: op                                  5
TYPE(MPI_Comm), INTENT(IN) :: comm                             6
TYPE(MPI_Request), INTENT(OUT) :: request                       7
INTEGER, OPTIONAL, INTENT(OUT) :: ierror                       8
                                                                9
MPI_Iscatter(sendbuf, sendcount, sendtype, recvbuf, recvcount,   10
             root, comm, request, ierror)                       11
TYPE(*), DIMENSION(..), INTENT(IN), ASYNCHRONOUS :: sendbuf   12
INTEGER(KIND=MPI_COUNT_KIND), INTENT(IN) :: sendcount, recvcount 13
TYPE(MPI_Datatype), INTENT(IN) :: sendtype, recvtype           14
TYPE(*), DIMENSION(..), ASYNCHRONOUS :: recvbuf               15
INTEGER, INTENT(IN) :: root                                     16
TYPE(MPI_Comm), INTENT(IN) :: comm                             17
TYPE(MPI_Request), INTENT(OUT) :: request                       18
INTEGER, OPTIONAL, INTENT(OUT) :: ierror                       19
                                                                20
MPI_Iscatter(sendbuf, sendcount, sendtype, recvbuf, recvcount,   21
             root, comm, request, ierror)                       22
TYPE(*), DIMENSION(..), INTENT(IN), ASYNCHRONOUS :: sendbuf   23
INTEGER, INTENT(IN) :: sendcount, recvcount, root              24
TYPE(MPI_Datatype), INTENT(IN) :: sendtype, recvtype           25
TYPE(*), DIMENSION(..), ASYNCHRONOUS :: recvbuf               26
TYPE(MPI_Comm), INTENT(IN) :: comm                             27
TYPE(MPI_Request), INTENT(OUT) :: request                       28
INTEGER, OPTIONAL, INTENT(OUT) :: ierror                       29
                                                                30
MPI_Iscatterv(sendbuf, sendcounts, displs, sendtype, recvbuf,   31
             recvtype, root, comm, request, ierror)            32
TYPE(*), DIMENSION(..), INTENT(IN), ASYNCHRONOUS :: sendbuf   33
INTEGER(KIND=MPI_COUNT_KIND), INTENT(IN), ASYNCHRONOUS :: sendcounts(*) 34
INTEGER(KIND=MPI_ADDRESS_KIND), INTENT(IN), ASYNCHRONOUS :: displs(*) 35
TYPE(MPI_Datatype), INTENT(IN) :: sendtype, recvtype           36
TYPE(*), DIMENSION(..), ASYNCHRONOUS :: recvbuf               37
INTEGER(KIND=MPI_COUNT_KIND), INTENT(IN) :: recvcount          38
INTEGER, INTENT(IN) :: root                                     39
TYPE(MPI_Comm), INTENT(IN) :: comm                             40
TYPE(MPI_Request), INTENT(OUT) :: request                       41
INTEGER, OPTIONAL, INTENT(OUT) :: ierror                       42
                                                                43
MPI_Iscatterv(sendbuf, sendcounts, displs, sendtype, recvbuf,   44
             recvtype, root, comm, request, ierror)            45
TYPE(*), DIMENSION(..), INTENT(IN), ASYNCHRONOUS :: sendbuf   46
INTEGER, INTENT(IN), ASYNCHRONOUS :: sendcounts(*), displs(*) 47
TYPE(MPI_Datatype), INTENT(IN) :: sendtype, recvtype           48
TYPE(*), DIMENSION(..), ASYNCHRONOUS :: recvbuf

```

```

1     INTEGER, INTENT(IN) :: recvcount, root
2     TYPE(MPI_Comm), INTENT(IN) :: comm
3     TYPE(MPI_Request), INTENT(OUT) :: request
4     INTEGER, OPTIONAL, INTENT(OUT) :: ierror
5
6 MPI_Op_commutative(op, commute, ierror)
7     TYPE(MPI_Op), INTENT(IN) :: op
8     LOGICAL, INTENT(OUT) :: commute
9     INTEGER, OPTIONAL, INTENT(OUT) :: ierror
10
11 MPI_Op_create(user_fn, commute, op, ierror)
12     PROCEDURE(MPI_User_function), INTENT(IN) :: user_fn
13     LOGICAL, INTENT(IN) :: commute
14     TYPE(MPI_Op), INTENT(OUT) :: op
15     INTEGER, OPTIONAL, INTENT(OUT) :: ierror
16
17 MPI_Op_create_c(user_fn, commute, op, ierror)
18     PROCEDURE(MPI_User_function_c), INTENT(IN) :: user_fn
19     LOGICAL, INTENT(IN) :: commute
20     TYPE(MPI_Op), INTENT(OUT) :: op
21     INTEGER, OPTIONAL, INTENT(OUT) :: ierror
22
23 MPI_Op_free(op, ierror)
24     TYPE(MPI_Op), INTENT(INOUT) :: op
25     INTEGER, OPTIONAL, INTENT(OUT) :: ierror
26
27 MPI_Reduce(sendbuf, recvbuf, count, datatype, op, root, comm, ierror)
28     TYPE(*), DIMENSION(..), INTENT(IN) :: sendbuf
29     TYPE(*), DIMENSION(..) :: recvbuf
30     INTEGER(KIND=MPI_COUNT_KIND), INTENT(IN) :: count
31     TYPE(MPI_Datatype), INTENT(IN) :: datatype
32     TYPE(MPI_Op), INTENT(IN) :: op
33     INTEGER, INTENT(IN) :: root
34     TYPE(MPI_Comm), INTENT(IN) :: comm
35     INTEGER, OPTIONAL, INTENT(OUT) :: ierror
36
37 MPI_Reduce(sendbuf, recvbuf, count, datatype, op, root, comm, ierror)
38     TYPE(*), DIMENSION(..), INTENT(IN) :: sendbuf
39     TYPE(*), DIMENSION(..) :: recvbuf
40     INTEGER, INTENT(IN) :: count, root
41     TYPE(MPI_Datatype), INTENT(IN) :: datatype
42     TYPE(MPI_Op), INTENT(IN) :: op
43     TYPE(MPI_Comm), INTENT(IN) :: comm
44     INTEGER, OPTIONAL, INTENT(OUT) :: ierror
45
46 MPI_Reduce_init(sendbuf, recvbuf, count, datatype, op, root, comm, info,
47     request, ierror)
48     TYPE(*), DIMENSION(..), INTENT(IN), ASYNCHRONOUS :: sendbuf
49     TYPE(*), DIMENSION(..), ASYNCHRONOUS :: recvbuf
50     INTEGER(KIND=MPI_COUNT_KIND), INTENT(IN) :: count
51     TYPE(MPI_Datatype), INTENT(IN) :: datatype

```



```

TYPE(MPI_Op), INTENT(IN) :: op
INTEGER, INTENT(IN) :: root
TYPE(MPI_Comm), INTENT(IN) :: comm
TYPE(MPI_Info), INTENT(IN) :: info
TYPE(MPI_Request), INTENT(OUT) :: request
INTEGER, OPTIONAL, INTENT(OUT) :: ierror

MPI_Reduce_init(sendbuf, recvbuf, count, datatype, op, root, comm, info,
               request, ierror)
TYPE(*), DIMENSION(..), INTENT(IN), ASYNCHRONOUS :: sendbuf
TYPE(*), DIMENSION(..), ASYNCHRONOUS :: recvbuf
INTEGER, INTENT(IN) :: count, root
TYPE(MPI_Datatype), INTENT(IN) :: datatype
TYPE(MPI_Op), INTENT(IN) :: op
TYPE(MPI_Comm), INTENT(IN) :: comm
TYPE(MPI_Info), INTENT(IN) :: info
TYPE(MPI_Request), INTENT(OUT) :: request
INTEGER, OPTIONAL, INTENT(OUT) :: ierror

MPI_Reduce_local(inbuf, inoutbuf, count, datatype, op, ierror)
TYPE(*), DIMENSION(..), INTENT(IN) :: inbuf
TYPE(*), DIMENSION(..) :: inoutbuf
INTEGER(KIND=MPI_COUNT_KIND), INTENT(IN) :: count
TYPE(MPI_Datatype), INTENT(IN) :: datatype
TYPE(MPI_Op), INTENT(IN) :: op
INTEGER, OPTIONAL, INTENT(OUT) :: ierror

MPI_Reduce_local(inbuf, inoutbuf, count, datatype, op, ierror)
TYPE(*), DIMENSION(..), INTENT(IN) :: inbuf
TYPE(*), DIMENSION(..) :: inoutbuf
INTEGER, INTENT(IN) :: count
TYPE(MPI_Datatype), INTENT(IN) :: datatype
TYPE(MPI_Op), INTENT(IN) :: op
INTEGER, OPTIONAL, INTENT(OUT) :: ierror

MPI_Reduce_scatter(sendbuf, recvbuf, recvcnt, datatype, op, comm,
                  ierror)
TYPE(*), DIMENSION(..), INTENT(IN) :: sendbuf
TYPE(*), DIMENSION(..) :: recvbuf
INTEGER(KIND=MPI_COUNT_KIND), INTENT(IN) :: recvcnt(*)
TYPE(MPI_Datatype), INTENT(IN) :: datatype
TYPE(MPI_Op), INTENT(IN) :: op
TYPE(MPI_Comm), INTENT(IN) :: comm
INTEGER, OPTIONAL, INTENT(OUT) :: ierror

MPI_Reduce_scatter(sendbuf, recvbuf, recvcnt, datatype, op, comm,
                  ierror)
TYPE(*), DIMENSION(..), INTENT(IN) :: sendbuf
TYPE(*), DIMENSION(..) :: recvbuf
INTEGER, INTENT(IN) :: recvcnt(*)

```

```

1     TYPE(MPI_Datatype), INTENT(IN) :: datatype
2     TYPE(MPI_Op), INTENT(IN) :: op
3     TYPE(MPI_Comm), INTENT(IN) :: comm
4     INTEGER, OPTIONAL, INTENT(OUT) :: ierror
5
6 MPI_Reduce_scatter_block(sendbuf, recvbuf, recvcount, datatype, op, comm,
7     ierror)
8     TYPE(*), DIMENSION(..), INTENT(IN) :: sendbuf
9     TYPE(*), DIMENSION(..) :: recvbuf
10    INTEGER(KIND=MPI_COUNT_KIND), INTENT(IN) :: recvcount
11    TYPE(MPI_Datatype), INTENT(IN) :: datatype
12    TYPE(MPI_Op), INTENT(IN) :: op
13    TYPE(MPI_Comm), INTENT(IN) :: comm
14    INTEGER, OPTIONAL, INTENT(OUT) :: ierror
15
16 MPI_Reduce_scatter_block(sendbuf, recvbuf, recvcount, datatype, op, comm,
17     ierror)
18    TYPE(*), DIMENSION(..), INTENT(IN) :: sendbuf
19    TYPE(*), DIMENSION(..) :: recvbuf
20    INTEGER, INTENT(IN) :: recvcount
21    TYPE(MPI_Datatype), INTENT(IN) :: datatype
22    TYPE(MPI_Op), INTENT(IN) :: op
23    TYPE(MPI_Comm), INTENT(IN) :: comm
24    INTEGER, OPTIONAL, INTENT(OUT) :: ierror
25
26 MPI_Reduce_scatter_block_init(sendbuf, recvbuf, recvcount, datatype, op,
27     comm, info, request, ierror)
28    TYPE(*), DIMENSION(..), INTENT(IN), ASYNCHRONOUS :: sendbuf
29    TYPE(*), DIMENSION(..), ASYNCHRONOUS :: recvbuf
30    INTEGER(KIND=MPI_COUNT_KIND), INTENT(IN) :: recvcount
31    TYPE(MPI_Datatype), INTENT(IN) :: datatype
32    TYPE(MPI_Op), INTENT(IN) :: op
33    TYPE(MPI_Comm), INTENT(IN) :: comm
34    TYPE(MPI_Info), INTENT(IN) :: info
35    TYPE(MPI_Request), INTENT(OUT) :: request
36    INTEGER, OPTIONAL, INTENT(OUT) :: ierror
37
38 MPI_Reduce_scatter_block_init(sendbuf, recvbuf, recvcount, datatype, op,
39     comm, info, request, ierror)
40    TYPE(*), DIMENSION(..), INTENT(IN), ASYNCHRONOUS :: sendbuf
41    TYPE(*), DIMENSION(..), ASYNCHRONOUS :: recvbuf
42    INTEGER, INTENT(IN) :: recvcount
43    TYPE(MPI_Datatype), INTENT(IN) :: datatype
44    TYPE(MPI_Op), INTENT(IN) :: op
45    TYPE(MPI_Comm), INTENT(IN) :: comm
46    TYPE(MPI_Info), INTENT(IN) :: info
47    TYPE(MPI_Request), INTENT(OUT) :: request
48    INTEGER, OPTIONAL, INTENT(OUT) :: ierror

```

```

MPI_Reduce_scatter_init(sendbuf, recvbuf, recvcnt, datatype, op, comm,
    info, request, ierror)
    TYPE(*), DIMENSION(..), INTENT(IN), ASYNCHRONOUS :: sendbuf
    TYPE(*), DIMENSION(..), ASYNCHRONOUS :: recvbuf
    INTEGER(KIND=MPI_COUNT_KIND), INTENT(IN), ASYNCHRONOUS :: recvcnt(*)
    TYPE(MPI_Datatype), INTENT(IN) :: datatype
    TYPE(MPI_Op), INTENT(IN) :: op
    TYPE(MPI_Comm), INTENT(IN) :: comm
    TYPE(MPI_Info), INTENT(IN) :: info
    TYPE(MPI_Request), INTENT(OUT) :: request
    INTEGER, OPTIONAL, INTENT(OUT) :: ierror

MPI_Reduce_scatter_init(sendbuf, recvbuf, recvcnt, datatype, op, comm,
    info, request, ierror)
    TYPE(*), DIMENSION(..), INTENT(IN), ASYNCHRONOUS :: sendbuf
    TYPE(*), DIMENSION(..), ASYNCHRONOUS :: recvbuf
    INTEGER, INTENT(IN), ASYNCHRONOUS :: recvcnt(*)
    TYPE(MPI_Datatype), INTENT(IN) :: datatype
    TYPE(MPI_Op), INTENT(IN) :: op
    TYPE(MPI_Comm), INTENT(IN) :: comm
    TYPE(MPI_Info), INTENT(IN) :: info
    TYPE(MPI_Request), INTENT(OUT) :: request
    INTEGER, OPTIONAL, INTENT(OUT) :: ierror

MPI_Scan(sendbuf, recvbuf, count, datatype, op, comm, ierror)
    TYPE(*), DIMENSION(..), INTENT(IN) :: sendbuf
    TYPE(*), DIMENSION(..) :: recvbuf
    INTEGER(KIND=MPI_COUNT_KIND), INTENT(IN) :: count
    TYPE(MPI_Datatype), INTENT(IN) :: datatype
    TYPE(MPI_Op), INTENT(IN) :: op
    TYPE(MPI_Comm), INTENT(IN) :: comm
    INTEGER, OPTIONAL, INTENT(OUT) :: ierror

MPI_Scan(sendbuf, recvbuf, count, datatype, op, comm, ierror)
    TYPE(*), DIMENSION(..), INTENT(IN) :: sendbuf
    TYPE(*), DIMENSION(..) :: recvbuf
    INTEGER, INTENT(IN) :: count
    TYPE(MPI_Datatype), INTENT(IN) :: datatype
    TYPE(MPI_Op), INTENT(IN) :: op
    TYPE(MPI_Comm), INTENT(IN) :: comm
    INTEGER, OPTIONAL, INTENT(OUT) :: ierror

MPI_Scan_init(sendbuf, recvbuf, count, datatype, op, comm, info, request,
    ierror)
    TYPE(*), DIMENSION(..), INTENT(IN), ASYNCHRONOUS :: sendbuf
    TYPE(*), DIMENSION(..), ASYNCHRONOUS :: recvbuf
    INTEGER(KIND=MPI_COUNT_KIND), INTENT(IN) :: count
    TYPE(MPI_Datatype), INTENT(IN) :: datatype
    TYPE(MPI_Op), INTENT(IN) :: op

```

```

1     TYPE(MPI_Comm), INTENT(IN) :: comm
2     TYPE(MPI_Info), INTENT(IN) :: info
3     TYPE(MPI_Request), INTENT(OUT) :: request
4     INTEGER, OPTIONAL, INTENT(OUT) :: ierror
5
6 MPI_Scan_init(sendbuf, recvbuf, count, datatype, op, comm, info, request,
7             ierror)
8     TYPE(*), DIMENSION(..), INTENT(IN), ASYNCHRONOUS :: sendbuf
9     TYPE(*), DIMENSION(..), ASYNCHRONOUS :: recvbuf
10    INTEGER, INTENT(IN) :: count
11    TYPE(MPI_Datatype), INTENT(IN) :: datatype
12    TYPE(MPI_Op), INTENT(IN) :: op
13    TYPE(MPI_Comm), INTENT(IN) :: comm
14    TYPE(MPI_Info), INTENT(IN) :: info
15    TYPE(MPI_Request), INTENT(OUT) :: request
16    INTEGER, OPTIONAL, INTENT(OUT) :: ierror
17
18 MPI_Scatter(sendbuf, sendcount, sendtype, recvbuf, recvcount, recvtype,
19           root, comm, ierror)
20    TYPE(*), DIMENSION(..), INTENT(IN) :: sendbuf
21    INTEGER(KIND=MPI_COUNT_KIND), INTENT(IN) :: sendcount, recvcount
22    TYPE(MPI_Datatype), INTENT(IN) :: sendtype, recvtype
23    TYPE(*), DIMENSION(..) :: recvbuf
24    INTEGER, INTENT(IN) :: root
25    TYPE(MPI_Comm), INTENT(IN) :: comm
26    INTEGER, OPTIONAL, INTENT(OUT) :: ierror
27
28 MPI_Scatter(sendbuf, sendcount, sendtype, recvbuf, recvcount, recvtype,
29           root, comm, ierror)
30    TYPE(*), DIMENSION(..), INTENT(IN) :: sendbuf
31    INTEGER, INTENT(IN) :: sendcount, recvcount, root
32    TYPE(MPI_Datatype), INTENT(IN) :: sendtype, recvtype
33    TYPE(*), DIMENSION(..) :: recvbuf
34    TYPE(MPI_Comm), INTENT(IN) :: comm
35    INTEGER, OPTIONAL, INTENT(OUT) :: ierror
36
37 MPI_Scatter_init(sendbuf, sendcount, sendtype, recvbuf, recvcount,
38                recvtype, root, comm, info, request, ierror)
39    TYPE(*), DIMENSION(..), INTENT(IN), ASYNCHRONOUS :: sendbuf
40    INTEGER(KIND=MPI_COUNT_KIND), INTENT(IN) :: sendcount, recvcount
41    TYPE(MPI_Datatype), INTENT(IN) :: sendtype, recvtype
42    TYPE(*), DIMENSION(..), ASYNCHRONOUS :: recvbuf
43    INTEGER, INTENT(IN) :: root
44    TYPE(MPI_Comm), INTENT(IN) :: comm
45    TYPE(MPI_Info), INTENT(IN) :: info
46    TYPE(MPI_Request), INTENT(OUT) :: request
47    INTEGER, OPTIONAL, INTENT(OUT) :: ierror
48
49 MPI_Scatter_init(sendbuf, sendcount, sendtype, recvbuf, recvcount,
50                recvtype, root, comm, info, request, ierror)

```

```

TYPE(*), DIMENSION(..), INTENT(IN), ASYNCHRONOUS :: sendbuf      1
INTEGER, INTENT(IN) :: sendcount, recvcount, root                2
TYPE(MPI_Datatype), INTENT(IN) :: sendtype, recvtype             3
TYPE(*), DIMENSION(..), ASYNCHRONOUS :: recvbuf                 4
TYPE(MPI_Comm), INTENT(IN) :: comm                               5
TYPE(MPI_Info), INTENT(IN) :: info                               6
TYPE(MPI_Request), INTENT(OUT) :: request                        7
INTEGER, OPTIONAL, INTENT(OUT) :: ierror                         8
                                                                    9
MPI_Scatterv(sendbuf, sendcounts, displs, sendtype, recvbuf, recvcount, 10
             recvtype, root, comm, ierror)                       11
TYPE(*), DIMENSION(..), INTENT(IN) :: sendbuf                   12
INTEGER(KIND=MPI_COUNT_KIND), INTENT(IN) :: sendcounts(*), recvcount 13
INTEGER(KIND=MPI_ADDRESS_KIND), INTENT(IN) :: displs(*)         14
TYPE(MPI_Datatype), INTENT(IN) :: sendtype, recvtype           15
TYPE(*), DIMENSION(..) :: recvbuf                               16
INTEGER, INTENT(IN) :: root                                     17
TYPE(MPI_Comm), INTENT(IN) :: comm                              18
INTEGER, OPTIONAL, INTENT(OUT) :: ierror                        19
                                                                    20
MPI_Scatterv(sendbuf, sendcounts, displs, sendtype, recvbuf, recvcount, 21
             recvtype, root, comm, ierror)                       22
TYPE(*), DIMENSION(..), INTENT(IN) :: sendbuf                   23
INTEGER, INTENT(IN) :: sendcounts(*), displs(*), recvcount, root 24
TYPE(MPI_Datatype), INTENT(IN) :: sendtype, recvtype           25
TYPE(*), DIMENSION(..) :: recvbuf                               26
TYPE(MPI_Comm), INTENT(IN) :: comm                              27
INTEGER, OPTIONAL, INTENT(OUT) :: ierror                        28
                                                                    29
MPI_Scatterv_init(sendbuf, sendcounts, displs, sendtype, recvbuf, 30
                  recvcount, recvtype, root, comm, info, request, ierror) 31
TYPE(*), DIMENSION(..), INTENT(IN), ASYNCHRONOUS :: sendbuf    32
INTEGER(KIND=MPI_COUNT_KIND), INTENT(IN), ASYNCHRONOUS :: sendcounts(*) 33
INTEGER(KIND=MPI_ADDRESS_KIND), INTENT(IN), ASYNCHRONOUS :: displs(*) 34
TYPE(MPI_Datatype), INTENT(IN) :: sendtype, recvtype           35
TYPE(*), DIMENSION(..), ASYNCHRONOUS :: recvbuf                 36
INTEGER(KIND=MPI_COUNT_KIND), INTENT(IN) :: recvcount           37
INTEGER, INTENT(IN) :: root                                     38
TYPE(MPI_Comm), INTENT(IN) :: comm                              39
TYPE(MPI_Info), INTENT(IN) :: info                              40
TYPE(MPI_Request), INTENT(OUT) :: request                       41
INTEGER, OPTIONAL, INTENT(OUT) :: ierror                         42
                                                                    43
MPI_Scatterv_init(sendbuf, sendcounts, displs, sendtype, recvbuf, 44
                  recvcount, recvtype, root, comm, info, request, ierror) 45
TYPE(*), DIMENSION(..), INTENT(IN), ASYNCHRONOUS :: sendbuf    46
INTEGER, INTENT(IN), ASYNCHRONOUS :: sendcounts(*), displs(*) 47
TYPE(MPI_Datatype), INTENT(IN) :: sendtype, recvtype           48
TYPE(*), DIMENSION(..), ASYNCHRONOUS :: recvbuf

```

```

1     INTEGER, INTENT(IN) :: recvcount, root
2     TYPE(MPI_Comm), INTENT(IN) :: comm
3     TYPE(MPI_Info), INTENT(IN) :: info
4     TYPE(MPI_Request), INTENT(OUT) :: request
5     INTEGER, OPTIONAL, INTENT(OUT) :: ierror
6
7

```

#### A.4.5 Groups, Contexts, Communicators, and Caching Fortran 2008 Bindings

```

9     MPI_COMM_DUP_FN(oldcomm, comm_keyval, extra_state, attribute_val_in,
10                    attribute_val_out, flag, ierror)
11     TYPE(MPI_Comm) :: oldcomm
12     INTEGER :: comm_keyval, ierror
13     INTEGER(KIND=MPI_ADDRESS_KIND) :: extra_state, attribute_val_in,
14                    attribute_val_out
15     LOGICAL :: flag
16
17     MPI_COMM_NULL_COPY_FN(oldcomm, comm_keyval, extra_state, attribute_val_in,
18                           attribute_val_out, flag, ierror)
19     TYPE(MPI_Comm) :: oldcomm
20     INTEGER :: comm_keyval, ierror
21     INTEGER(KIND=MPI_ADDRESS_KIND) :: extra_state, attribute_val_in,
22                    attribute_val_out
23     LOGICAL :: flag
24
25     MPI_COMM_NULL_DELETE_FN(comm, comm_keyval, attribute_val, extra_state,
26                             ierror)
27     TYPE(MPI_Comm) :: comm
28     INTEGER :: comm_keyval, ierror
29     INTEGER(KIND=MPI_ADDRESS_KIND) :: attribute_val, extra_state
30
31     MPI_Comm_compare(comm1, comm2, result, ierror)
32     TYPE(MPI_Comm), INTENT(IN) :: comm1, comm2
33     INTEGER, INTENT(OUT) :: result
34     INTEGER, OPTIONAL, INTENT(OUT) :: ierror
35
36     MPI_Comm_create(comm, group, newcomm, ierror)
37     TYPE(MPI_Comm), INTENT(IN) :: comm
38     TYPE(MPI_Group), INTENT(IN) :: group
39     TYPE(MPI_Comm), INTENT(OUT) :: newcomm
40     INTEGER, OPTIONAL, INTENT(OUT) :: ierror
41
42     MPI_Comm_create_from_group(group, stringtag, info, errhandler, newcomm,
43                               ierror)
44     TYPE(MPI_Group), INTENT(IN) :: group
45     CHARACTER(LEN=*), INTENT(IN) :: stringtag
46     TYPE(MPI_Info), INTENT(IN) :: info
47     TYPE(MPI_Errhandler), INTENT(IN) :: errhandler
48     TYPE(MPI_Comm), INTENT(OUT) :: newcomm
49     INTEGER, OPTIONAL, INTENT(OUT) :: ierror

```

```

MPI_Comm_create_group(comm, group, tag, newcomm, ierror)           1
  TYPE(MPI_Comm), INTENT(IN) :: comm                               2
  TYPE(MPI_Group), INTENT(IN) :: group                             3
  INTEGER, INTENT(IN) :: tag                                       4
  TYPE(MPI_Comm), INTENT(OUT) :: newcomm                           5
  INTEGER, OPTIONAL, INTENT(OUT) :: ierror                         6
                                                                    7
MPI_Comm_create_keyval(comm_copy_attr_fn, comm_delete_attr_fn, comm_keyval,
  extra_state, ierror)                                           8
  PROCEDURE(MPI_Comm_copy_attr_function), INTENT(IN) :: comm_copy_attr_fn 9
  PROCEDURE(MPI_Comm_delete_attr_function), INTENT(IN) ::
    comm_delete_attr_fn                                           10
  INTEGER, INTENT(OUT) :: comm_keyval                               11
  INTEGER(KIND=MPI_ADDRESS_KIND), INTENT(IN) :: extra_state       12
  INTEGER, OPTIONAL, INTENT(OUT) :: ierror                         13
                                                                    14
MPI_Comm_delete_attr(comm, comm_keyval, ierror)                   15
  TYPE(MPI_Comm), INTENT(IN) :: comm                               16
  INTEGER, INTENT(IN) :: comm_keyval                               17
  INTEGER, OPTIONAL, INTENT(OUT) :: ierror                         18
                                                                    19
MPI_Comm_dup(comm, newcomm, ierror)                                20
  TYPE(MPI_Comm), INTENT(IN) :: comm                               21
  TYPE(MPI_Comm), INTENT(OUT) :: newcomm                           22
  INTEGER, OPTIONAL, INTENT(OUT) :: ierror                         23
                                                                    24
MPI_Comm_dup_with_info(comm, info, newcomm, ierror)               25
  TYPE(MPI_Comm), INTENT(IN) :: comm                               26
  TYPE(MPI_Info), INTENT(IN) :: info                               27
  TYPE(MPI_Comm), INTENT(OUT) :: newcomm                           28
  INTEGER, OPTIONAL, INTENT(OUT) :: ierror                         29
                                                                    30
MPI_Comm_free(comm, ierror)                                        31
  TYPE(MPI_Comm), INTENT(INOUT) :: comm                            32
  INTEGER, OPTIONAL, INTENT(OUT) :: ierror                         33
                                                                    34
MPI_Comm_free_keyval(comm_keyval, ierror)                          35
  INTEGER, INTENT(INOUT) :: comm_keyval                            36
  INTEGER, OPTIONAL, INTENT(OUT) :: ierror                         37
                                                                    38
MPI_Comm_get_attr(comm, comm_keyval, attribute_val, flag, ierror)
  TYPE(MPI_Comm), INTENT(IN) :: comm                               39
  INTEGER, INTENT(IN) :: comm_keyval                               40
  INTEGER(KIND=MPI_ADDRESS_KIND), INTENT(OUT) :: attribute_val    41
  LOGICAL, INTENT(OUT) :: flag                                     42
  INTEGER, OPTIONAL, INTENT(OUT) :: ierror                         43
                                                                    44
MPI_Comm_get_info(comm, info_used, ierror)                         45
  TYPE(MPI_Comm), INTENT(IN) :: comm                               46
  TYPE(MPI_Info), INTENT(OUT) :: info_used                         47
  INTEGER, OPTIONAL, INTENT(OUT) :: ierror                         48

```

```
1 MPI_Comm_get_name(comm, comm_name, resultlen, ierror)
2   TYPE(MPI_Comm), INTENT(IN) :: comm
3   CHARACTER(LEN=MPI_MAX_OBJECT_NAME), INTENT(OUT) :: comm_name
4   INTEGER, INTENT(OUT) :: resultlen
5   INTEGER, OPTIONAL, INTENT(OUT) :: ierror
6
7 MPI_Comm_group(comm, group, ierror)
8   TYPE(MPI_Comm), INTENT(IN) :: comm
9   TYPE(MPI_Group), INTENT(OUT) :: group
10  INTEGER, OPTIONAL, INTENT(OUT) :: ierror
11
12 MPI_Comm_idup(comm, newcomm, request, ierror)
13   TYPE(MPI_Comm), INTENT(IN) :: comm
14   TYPE(MPI_Comm), INTENT(OUT), ASYNCHRONOUS :: newcomm
15   TYPE(MPI_Request), INTENT(OUT) :: request
16   INTEGER, OPTIONAL, INTENT(OUT) :: ierror
17
18 MPI_Comm_idup_with_info(comm, info, newcomm, request, ierror)
19   TYPE(MPI_Comm), INTENT(IN) :: comm
20   TYPE(MPI_Info), INTENT(IN) :: info
21   TYPE(MPI_Comm), INTENT(OUT), ASYNCHRONOUS :: newcomm
22   TYPE(MPI_Request), INTENT(OUT) :: request
23   INTEGER, OPTIONAL, INTENT(OUT) :: ierror
24
25 MPI_Comm_rank(comm, rank, ierror)
26   TYPE(MPI_Comm), INTENT(IN) :: comm
27   INTEGER, INTENT(OUT) :: rank
28   INTEGER, OPTIONAL, INTENT(OUT) :: ierror
29
30 MPI_Comm_remote_group(comm, group, ierror)
31   TYPE(MPI_Comm), INTENT(IN) :: comm
32   TYPE(MPI_Group), INTENT(OUT) :: group
33   INTEGER, OPTIONAL, INTENT(OUT) :: ierror
34
35 MPI_Comm_remote_size(comm, size, ierror)
36   TYPE(MPI_Comm), INTENT(IN) :: comm
37   INTEGER, INTENT(OUT) :: size
38   INTEGER, OPTIONAL, INTENT(OUT) :: ierror
39
40 MPI_Comm_set_attr(comm, comm_keyval, attribute_val, ierror)
41   TYPE(MPI_Comm), INTENT(IN) :: comm
42   INTEGER, INTENT(IN) :: comm_keyval
43   INTEGER(KIND=MPI_ADDRESS_KIND), INTENT(IN) :: attribute_val
44   INTEGER, OPTIONAL, INTENT(OUT) :: ierror
45
46 MPI_Comm_set_info(comm, info, ierror)
47   TYPE(MPI_Comm), INTENT(IN) :: comm
48   TYPE(MPI_Info), INTENT(IN) :: info
49   INTEGER, OPTIONAL, INTENT(OUT) :: ierror
50
51 MPI_Comm_set_name(comm, comm_name, ierror)
52   TYPE(MPI_Comm), INTENT(IN) :: comm
```



```
CHARACTER(LEN=*), INTENT(IN) :: comm_name      1
INTEGER, OPTIONAL, INTENT(OUT) :: ierror      2
      3
MPI_Comm_size(comm, size, ierror)             4
  TYPE(MPI_Comm), INTENT(IN) :: comm          5
  INTEGER, INTENT(OUT) :: size                6
  INTEGER, OPTIONAL, INTENT(OUT) :: ierror    7
      8
MPI_Comm_split(comm, color, key, newcomm, ierror) 9
  TYPE(MPI_Comm), INTENT(IN) :: comm         10
  INTEGER, INTENT(IN) :: color, key          11
  TYPE(MPI_Comm), INTENT(OUT) :: newcomm     12
  INTEGER, OPTIONAL, INTENT(OUT) :: ierror   13
      14
MPI_Comm_split_type(comm, split_type, key, info, newcomm, ierror) 15
  TYPE(MPI_Comm), INTENT(IN) :: comm         16
  INTEGER, INTENT(IN) :: split_type, key     17
  TYPE(MPI_Info), INTENT(IN) :: info         18
  TYPE(MPI_Comm), INTENT(OUT) :: newcomm     19
  INTEGER, OPTIONAL, INTENT(OUT) :: ierror   20
      21
MPI_Comm_test_inter(comm, flag, ierror)       22
  TYPE(MPI_Comm), INTENT(IN) :: comm         23
  LOGICAL, INTENT(OUT) :: flag              24
  INTEGER, OPTIONAL, INTENT(OUT) :: ierror   25
      26
MPI_Group_compare(group1, group2, result, ierror) 27
  TYPE(MPI_Group), INTENT(IN) :: group1, group2 28
  INTEGER, INTENT(OUT) :: result            29
  INTEGER, OPTIONAL, INTENT(OUT) :: ierror   30
      31
MPI_Group_difference(group1, group2, newgroup, ierror) 32
  TYPE(MPI_Group), INTENT(IN) :: group1, group2 33
  TYPE(MPI_Group), INTENT(OUT) :: newgroup    34
  INTEGER, OPTIONAL, INTENT(OUT) :: ierror   35
      36
MPI_Group_excl(group, n, ranks, newgroup, ierror) 37
  TYPE(MPI_Group), INTENT(IN) :: group        38
  INTEGER, INTENT(IN) :: n, ranks(n)        39
  TYPE(MPI_Group), INTENT(OUT) :: newgroup    40
  INTEGER, OPTIONAL, INTENT(OUT) :: ierror   41
      42
MPI_Group_free(group, ierror)                 43
  TYPE(MPI_Group), INTENT(INOUT) :: group    44
  INTEGER, OPTIONAL, INTENT(OUT) :: ierror   45
      46
MPI_Group_from_session_pset(session, pset_name, newgroup, ierror) 47
  TYPE(MPI_Session), INTENT(IN) :: session   48
  CHARACTER(LEN=*), INTENT(IN) :: pset_name
  TYPE(MPI_Group), INTENT(OUT) :: newgroup
  INTEGER, OPTIONAL, INTENT(OUT) :: ierror
```

```
1 MPI_Group_incl(group, n, ranks, newgroup, ierror)
2   TYPE(MPI_Group), INTENT(IN) :: group
3   INTEGER, INTENT(IN) :: n, ranks(n)
4   TYPE(MPI_Group), INTENT(OUT) :: newgroup
5   INTEGER, OPTIONAL, INTENT(OUT) :: ierror
6
7 MPI_Group_intersection(group1, group2, newgroup, ierror)
8   TYPE(MPI_Group), INTENT(IN) :: group1, group2
9   TYPE(MPI_Group), INTENT(OUT) :: newgroup
10  INTEGER, OPTIONAL, INTENT(OUT) :: ierror
11
12 MPI_Group_range_excl(group, n, ranges, newgroup, ierror)
13   TYPE(MPI_Group), INTENT(IN) :: group
14   INTEGER, INTENT(IN) :: n, ranges(3, n)
15   TYPE(MPI_Group), INTENT(OUT) :: newgroup
16   INTEGER, OPTIONAL, INTENT(OUT) :: ierror
17
18 MPI_Group_range_incl(group, n, ranges, newgroup, ierror)
19   TYPE(MPI_Group), INTENT(IN) :: group
20   INTEGER, INTENT(IN) :: n, ranges(3, n)
21   TYPE(MPI_Group), INTENT(OUT) :: newgroup
22   INTEGER, OPTIONAL, INTENT(OUT) :: ierror
23
24 MPI_Group_rank(group, rank, ierror)
25   TYPE(MPI_Group), INTENT(IN) :: group
26   INTEGER, INTENT(OUT) :: rank
27   INTEGER, OPTIONAL, INTENT(OUT) :: ierror
28
29 MPI_Group_size(group, size, ierror)
30   TYPE(MPI_Group), INTENT(IN) :: group
31   INTEGER, INTENT(OUT) :: size
32   INTEGER, OPTIONAL, INTENT(OUT) :: ierror
33
34 MPI_Group_translate_ranks(group1, n, ranks1, group2, ranks2, ierror)
35   TYPE(MPI_Group), INTENT(IN) :: group1, group2
36   INTEGER, INTENT(IN) :: n, ranks1(n)
37   INTEGER, INTENT(OUT) :: ranks2(n)
38   INTEGER, OPTIONAL, INTENT(OUT) :: ierror
39
40 MPI_Group_union(group1, group2, newgroup, ierror)
41   TYPE(MPI_Group), INTENT(IN) :: group1, group2
42   TYPE(MPI_Group), INTENT(OUT) :: newgroup
43   INTEGER, OPTIONAL, INTENT(OUT) :: ierror
44
45 MPI_Intercomm_create(local_comm, local_leader, peer_comm, remote_leader,
46   tag, newintercomm, ierror)
47   TYPE(MPI_Comm), INTENT(IN) :: local_comm, peer_comm
48   INTEGER, INTENT(IN) :: local_leader, remote_leader, tag
49   TYPE(MPI_Comm), INTENT(OUT) :: newintercomm
50   INTEGER, OPTIONAL, INTENT(OUT) :: ierror
```

```

MPI_Intercomm_create_from_groups(local_group, local_leader, remote_group,
                                remote_leader, stringtag, info, errhandler, newintercomm,
                                ierror)
    TYPE(MPI_Group), INTENT(IN) :: local_group, remote_group
    INTEGER, INTENT(IN) :: local_leader, remote_leader
    CHARACTER(LEN=*), INTENT(IN) :: stringtag
    TYPE(MPI_Info), INTENT(IN) :: info
    TYPE(MPI_Errhandler), INTENT(IN) :: errhandler
    TYPE(MPI_Comm), INTENT(OUT) :: newintercomm
    INTEGER, OPTIONAL, INTENT(OUT) :: ierror

MPI_Intercomm_merge(intercomm, high, newintracomm, ierror)
    TYPE(MPI_Comm), INTENT(IN) :: intercomm
    LOGICAL, INTENT(IN) :: high
    TYPE(MPI_Comm), INTENT(OUT) :: newintracomm
    INTEGER, OPTIONAL, INTENT(OUT) :: ierror

MPI_TYPE_DUP_FN(oldtype, type_keyval, extra_state, attribute_val_in,
                attribute_val_out, flag, ierror)
    TYPE(MPI_Datatype) :: oldtype
    INTEGER :: type_keyval, ierror
    INTEGER(KIND=MPI_ADDRESS_KIND) :: extra_state, attribute_val_in,
        attribute_val_out
    LOGICAL :: flag

MPI_TYPE_NULL_COPY_FN(oldtype, type_keyval, extra_state, attribute_val_in,
                    attribute_val_out, flag, ierror)
    TYPE(MPI_Datatype) :: oldtype
    INTEGER :: type_keyval, ierror
    INTEGER(KIND=MPI_ADDRESS_KIND) :: extra_state, attribute_val_in,
        attribute_val_out
    LOGICAL :: flag

MPI_TYPE_NULL_DELETE_FN(datatype, type_keyval, attribute_val, extra_state,
                        ierror)
    TYPE(MPI_Datatype) :: datatype
    INTEGER :: type_keyval
    INTEGER(KIND=MPI_ADDRESS_KIND) :: attribute_val, extra_state
    INTEGER, INTENT(OUT) :: ierror

MPI_Type_create_keyval(type_copy_attr_fn, type_delete_attr_fn, type_keyval,
                    extra_state, ierror)
    PROCEDURE(MPI_Type_copy_attr_function), INTENT(IN) :: type_copy_attr_fn
    PROCEDURE(MPI_Type_delete_attr_function), INTENT(IN) ::
        type_delete_attr_fn
    INTEGER, INTENT(OUT) :: type_keyval
    INTEGER(KIND=MPI_ADDRESS_KIND), INTENT(IN) :: extra_state
    INTEGER, OPTIONAL, INTENT(OUT) :: ierror

MPI_Type_delete_attr(datatype, type_keyval, ierror)

```

```

1     TYPE(MPI_Datatype), INTENT(IN) :: datatype
2     INTEGER, INTENT(IN) :: type_keyval
3     INTEGER, OPTIONAL, INTENT(OUT) :: ierror
4
5     MPI_Type_free_keyval(type_keyval, ierror)
6     INTEGER, INTENT(INOUT) :: type_keyval
7     INTEGER, OPTIONAL, INTENT(OUT) :: ierror
8
9     MPI_Type_get_attr(datatype, type_keyval, attribute_val, flag, ierror)
10    TYPE(MPI_Datatype), INTENT(IN) :: datatype
11    INTEGER, INTENT(IN) :: type_keyval
12    INTEGER(KIND=MPI_ADDRESS_KIND), INTENT(OUT) :: attribute_val
13    LOGICAL, INTENT(OUT) :: flag
14    INTEGER, OPTIONAL, INTENT(OUT) :: ierror
15
16    MPI_Type_get_name(datatype, type_name, resultlen, ierror)
17    TYPE(MPI_Datatype), INTENT(IN) :: datatype
18    CHARACTER(LEN=MPI_MAX_OBJECT_NAME), INTENT(OUT) :: type_name
19    INTEGER, INTENT(OUT) :: resultlen
20    INTEGER, OPTIONAL, INTENT(OUT) :: ierror
21
22    MPI_Type_set_attr(datatype, type_keyval, attribute_val, ierror)
23    TYPE(MPI_Datatype), INTENT(IN) :: datatype
24    INTEGER, INTENT(IN) :: type_keyval
25    INTEGER(KIND=MPI_ADDRESS_KIND), INTENT(IN) :: attribute_val
26    INTEGER, OPTIONAL, INTENT(OUT) :: ierror
27
28    MPI_Type_set_name(datatype, type_name, ierror)
29    TYPE(MPI_Datatype), INTENT(IN) :: datatype
30    CHARACTER(LEN=*), INTENT(IN) :: type_name
31    INTEGER, OPTIONAL, INTENT(OUT) :: ierror
32
33    MPI_WIN_DUP_FN(oldwin, win_keyval, extra_state, attribute_val_in,
34    attribute_val_out, flag, ierror)
35    TYPE(MPI_Win) :: oldwin
36    INTEGER :: win_keyval, ierror
37    INTEGER(KIND=MPI_ADDRESS_KIND) :: extra_state, attribute_val_in,
38    attribute_val_out
39    LOGICAL :: flag
40
41    MPI_WIN_NULL_COPY_FN(oldwin, win_keyval, extra_state, attribute_val_in,
42    attribute_val_out, flag, ierror)
43    TYPE(MPI_Win) :: oldwin
44    INTEGER :: win_keyval, ierror
45    INTEGER(KIND=MPI_ADDRESS_KIND) :: extra_state, attribute_val_in,
46    attribute_val_out
47    LOGICAL :: flag
48
49    MPI_WIN_NULL_DELETE_FN(win, win_keyval, attribute_val, extra_state, ierror)
50    TYPE(MPI_Win) :: win
51    INTEGER :: win_keyval, ierror

```

```

    INTEGER(KIND=MPI_ADDRESS_KIND) :: attribute_val, extra_state
1
MPI_Win_create_keyval(win_copy_attr_fn, win_delete_attr_fn, win_keyval,
2
    extra_state, ierror)
3
    PROCEDURE(MPI_Win_copy_attr_function), INTENT(IN) :: win_copy_attr_fn
4
    PROCEDURE(MPI_Win_delete_attr_function), INTENT(IN) ::
5
        win_delete_attr_fn
6
    INTEGER, INTENT(OUT) :: win_keyval
7
    INTEGER(KIND=MPI_ADDRESS_KIND), INTENT(IN) :: extra_state
8
    INTEGER, OPTIONAL, INTENT(OUT) :: ierror
9
MPI_Win_delete_attr(win, win_keyval, ierror)
10
    TYPE(MPI_Win), INTENT(IN) :: win
11
    INTEGER, INTENT(IN) :: win_keyval
12
    INTEGER, OPTIONAL, INTENT(OUT) :: ierror
13
MPI_Win_free_keyval(win_keyval, ierror)
14
    INTEGER, INTENT(INOUT) :: win_keyval
15
    INTEGER, OPTIONAL, INTENT(OUT) :: ierror
16
MPI_Win_get_attr(win, win_keyval, attribute_val, flag, ierror)
17
    TYPE(MPI_Win), INTENT(IN) :: win
18
    INTEGER, INTENT(IN) :: win_keyval
19
    INTEGER(KIND=MPI_ADDRESS_KIND), INTENT(OUT) :: attribute_val
20
    LOGICAL, INTENT(OUT) :: flag
21
    INTEGER, OPTIONAL, INTENT(OUT) :: ierror
22
MPI_Win_get_name(win, win_name, resultlen, ierror)
23
    TYPE(MPI_Win), INTENT(IN) :: win
24
    CHARACTER(LEN=MPI_MAX_OBJECT_NAME), INTENT(OUT) :: win_name
25
    INTEGER, INTENT(OUT) :: resultlen
26
    INTEGER, OPTIONAL, INTENT(OUT) :: ierror
27
MPI_Win_set_attr(win, win_keyval, attribute_val, ierror)
28
    TYPE(MPI_Win), INTENT(IN) :: win
29
    INTEGER, INTENT(IN) :: win_keyval
30
    INTEGER(KIND=MPI_ADDRESS_KIND), INTENT(IN) :: attribute_val
31
    INTEGER, OPTIONAL, INTENT(OUT) :: ierror
32
MPI_Win_set_name(win, win_name, ierror)
33
    TYPE(MPI_Win), INTENT(IN) :: win
34
    CHARACTER(LEN=*), INTENT(IN) :: win_name
35
    INTEGER, OPTIONAL, INTENT(OUT) :: ierror
36
37
38
39
40
41
42
A.4.6 Process Topologies Fortran 2008 Bindings
43
MPI_Cart_coords(comm, rank, maxdims, coords, ierror)
44
    TYPE(MPI_Comm), INTENT(IN) :: comm
45
    INTEGER, INTENT(IN) :: rank, maxdims
46
    INTEGER, INTENT(OUT) :: coords(maxdims)
47
    INTEGER, OPTIONAL, INTENT(OUT) :: ierror
48

```

```
1 MPI_Cart_create(comm_old, ndims, dims, periods, reorder, comm_cart, ierror)
2     TYPE(MPI_Comm), INTENT(IN) :: comm_old
3     INTEGER, INTENT(IN) :: ndims, dims(ndims)
4     LOGICAL, INTENT(IN) :: periods(ndims), reorder
5     TYPE(MPI_Comm), INTENT(OUT) :: comm_cart
6     INTEGER, OPTIONAL, INTENT(OUT) :: ierror
7
8 MPI_Cart_get(comm, maxdims, dims, periods, coords, ierror)
9     TYPE(MPI_Comm), INTENT(IN) :: comm
10    INTEGER, INTENT(IN) :: maxdims
11    INTEGER, INTENT(OUT) :: dims(maxdims), coords(maxdims)
12    LOGICAL, INTENT(OUT) :: periods(maxdims)
13    INTEGER, OPTIONAL, INTENT(OUT) :: ierror
14
15 MPI_Cart_map(comm, ndims, dims, periods, newrank, ierror)
16    TYPE(MPI_Comm), INTENT(IN) :: comm
17    INTEGER, INTENT(IN) :: ndims, dims(ndims)
18    LOGICAL, INTENT(IN) :: periods(ndims)
19    INTEGER, INTENT(OUT) :: newrank
20    INTEGER, OPTIONAL, INTENT(OUT) :: ierror
21
22 MPI_Cart_rank(comm, coords, rank, ierror)
23    TYPE(MPI_Comm), INTENT(IN) :: comm
24    INTEGER, INTENT(IN) :: coords(*)
25    INTEGER, INTENT(OUT) :: rank
26    INTEGER, OPTIONAL, INTENT(OUT) :: ierror
27
28 MPI_Cart_shift(comm, direction, disp, rank_source, rank_dest, ierror)
29    TYPE(MPI_Comm), INTENT(IN) :: comm
30    INTEGER, INTENT(IN) :: direction, disp
31    INTEGER, INTENT(OUT) :: rank_source, rank_dest
32    INTEGER, OPTIONAL, INTENT(OUT) :: ierror
33
34 MPI_Cart_sub(comm, remain_dims, newcomm, ierror)
35    TYPE(MPI_Comm), INTENT(IN) :: comm
36    LOGICAL, INTENT(IN) :: remain_dims(*)
37    TYPE(MPI_Comm), INTENT(OUT) :: newcomm
38    INTEGER, OPTIONAL, INTENT(OUT) :: ierror
39
40 MPI_Cartdim_get(comm, ndims, ierror)
41    TYPE(MPI_Comm), INTENT(IN) :: comm
42    INTEGER, INTENT(OUT) :: ndims
43    INTEGER, OPTIONAL, INTENT(OUT) :: ierror
44
45 MPI_Dims_create(nnodes, ndims, dims, ierror)
46    INTEGER, INTENT(IN) :: nnodes, ndims
47    INTEGER, INTENT(INOUT) :: dims(ndims)
48    INTEGER, OPTIONAL, INTENT(OUT) :: ierror
49
50 MPI_Dist_graph_create(comm_old, n, sources, degrees, destinations, weights,
51    info, reorder, comm_dist_graph, ierror)
```

```

TYPE(MPI_Comm), INTENT(IN) :: comm_old
INTEGER, INTENT(IN) :: n, sources(n), degrees(n), destinations(*),
    weights(*)
TYPE(MPI_Info), INTENT(IN) :: info
LOGICAL, INTENT(IN) :: reorder
TYPE(MPI_Comm), INTENT(OUT) :: comm_dist_graph
INTEGER, OPTIONAL, INTENT(OUT) :: ierror

MPI_Dist_graph_create_adjacent(comm_old, indegree, sources, sourceweights,
    outdegree, destinations, destweights, info, reorder,
    comm_dist_graph, ierror)
TYPE(MPI_Comm), INTENT(IN) :: comm_old
INTEGER, INTENT(IN) :: indegree, sources(indegree), sourceweights(*),
    outdegree, destinations(outdegree), destweights(*)
TYPE(MPI_Info), INTENT(IN) :: info
LOGICAL, INTENT(IN) :: reorder
TYPE(MPI_Comm), INTENT(OUT) :: comm_dist_graph
INTEGER, OPTIONAL, INTENT(OUT) :: ierror

MPI_Dist_graph_neighbors(comm, maxindegree, sources, sourceweights,
    maxoutdegree, destinations, destweights, ierror)
TYPE(MPI_Comm), INTENT(IN) :: comm
INTEGER, INTENT(IN) :: maxindegree, maxoutdegree
INTEGER, INTENT(OUT) :: sources(maxindegree),
    destinations(maxoutdegree)
INTEGER :: sourceweights(*), destweights(*)
INTEGER, OPTIONAL, INTENT(OUT) :: ierror

MPI_Dist_graph_neighbors_count(comm, indegree, outdegree, weighted, ierror)
TYPE(MPI_Comm), INTENT(IN) :: comm
INTEGER, INTENT(OUT) :: indegree, outdegree
LOGICAL, INTENT(OUT) :: weighted
INTEGER, OPTIONAL, INTENT(OUT) :: ierror

MPI_Graph_create(comm_old, nnodes, index, edges, reorder, comm_graph,
    ierror)
TYPE(MPI_Comm), INTENT(IN) :: comm_old
INTEGER, INTENT(IN) :: nnodes, index(nnodes), edges(*)
LOGICAL, INTENT(IN) :: reorder
TYPE(MPI_Comm), INTENT(OUT) :: comm_graph
INTEGER, OPTIONAL, INTENT(OUT) :: ierror

MPI_Graph_get(comm, maxindex, maxedges, index, edges, ierror)
TYPE(MPI_Comm), INTENT(IN) :: comm
INTEGER, INTENT(IN) :: maxindex, maxedges
INTEGER, INTENT(OUT) :: index(maxindex), edges(maxedges)
INTEGER, OPTIONAL, INTENT(OUT) :: ierror

MPI_Graph_map(comm, nnodes, index, edges, newrank, ierror)
TYPE(MPI_Comm), INTENT(IN) :: comm

```

```

1     INTEGER, INTENT(IN) :: nnodes, index(nnodes), edges(*)
2     INTEGER, INTENT(OUT) :: newrank
3     INTEGER, OPTIONAL, INTENT(OUT) :: ierror
4
5     MPI_Graph_neighbors(comm, rank, maxneighbors, neighbors, ierror)
6     TYPE(MPI_Comm), INTENT(IN) :: comm
7     INTEGER, INTENT(IN) :: rank, maxneighbors
8     INTEGER, INTENT(OUT) :: neighbors(maxneighbors)
9     INTEGER, OPTIONAL, INTENT(OUT) :: ierror
10
11    MPI_Graph_neighbors_count(comm, rank, nneighbors, ierror)
12    TYPE(MPI_Comm), INTENT(IN) :: comm
13    INTEGER, INTENT(IN) :: rank
14    INTEGER, INTENT(OUT) :: nneighbors
15    INTEGER, OPTIONAL, INTENT(OUT) :: ierror
16
17    MPI_Graphdims_get(comm, nnodes, nedges, ierror)
18    TYPE(MPI_Comm), INTENT(IN) :: comm
19    INTEGER, INTENT(OUT) :: nnodes, nedges
20    INTEGER, OPTIONAL, INTENT(OUT) :: ierror
21
22    MPI_Ineighbor_allgather(sendbuf, sendcount, sendtype, recvbuf, recvcount,
23    recvtype, comm, request, ierror)
24    TYPE(*), DIMENSION(..), INTENT(IN), ASYNCHRONOUS :: sendbuf
25    INTEGER(KIND=MPI_COUNT_KIND), INTENT(IN) :: sendcount, recvcount
26    TYPE(MPI_Datatype), INTENT(IN) :: sendtype, recvtype
27    TYPE(*), DIMENSION(..), ASYNCHRONOUS :: recvbuf
28    TYPE(MPI_Comm), INTENT(IN) :: comm
29    TYPE(MPI_Request), INTENT(OUT) :: request
30    INTEGER, OPTIONAL, INTENT(OUT) :: ierror
31
32    MPI_Ineighbor_allgather(sendbuf, sendcount, sendtype, recvbuf, recvcount,
33    recvtype, comm, request, ierror)
34    TYPE(*), DIMENSION(..), INTENT(IN), ASYNCHRONOUS :: sendbuf
35    INTEGER, INTENT(IN) :: sendcount, recvcount
36    TYPE(MPI_Datatype), INTENT(IN) :: sendtype, recvtype
37    TYPE(*), DIMENSION(..), ASYNCHRONOUS :: recvbuf
38    TYPE(MPI_Comm), INTENT(IN) :: comm
39    TYPE(MPI_Request), INTENT(OUT) :: request
40    INTEGER, OPTIONAL, INTENT(OUT) :: ierror
41
42    MPI_Ineighbor_allgatherv(sendbuf, sendcount, sendtype, recvbuf, recvcoun
43    ts, displs, recvtype, comm, request, ierror)
44    TYPE(*), DIMENSION(..), INTENT(IN), ASYNCHRONOUS :: sendbuf
45    INTEGER(KIND=MPI_COUNT_KIND), INTENT(IN) :: sendcount
46    TYPE(MPI_Datatype), INTENT(IN) :: sendtype, recvtype
47    TYPE(*), DIMENSION(..), ASYNCHRONOUS :: recvbuf
48    INTEGER(KIND=MPI_COUNT_KIND), INTENT(IN), ASYNCHRONOUS :: recvcoun
49    ts(*)
50    INTEGER(KIND=MPI_ADDRESS_KIND), INTENT(IN), ASYNCHRONOUS :: displs(*)
51    TYPE(MPI_Comm), INTENT(IN) :: comm

```



```

TYPE(MPI_Request), INTENT(OUT) :: request
INTEGER, OPTIONAL, INTENT(OUT) :: ierror
MPI_Ineighbor_allgatherv(sendbuf, sendcount, sendtype, recvbuf, recvcoun
    displs, recvtype, comm, request, ierror)
TYPE(*), DIMENSION(..), INTENT(IN), ASYNCHRONOUS :: sendbuf
INTEGER, INTENT(IN) :: sendcount
TYPE(MPI_Datatype), INTENT(IN) :: sendtype, recvtype
TYPE(*), DIMENSION(..), ASYNCHRONOUS :: recvbuf
INTEGER, INTENT(IN), ASYNCHRONOUS :: recvcoun(*), displs(*)
TYPE(MPI_Comm), INTENT(IN) :: comm
TYPE(MPI_Request), INTENT(OUT) :: request
INTEGER, OPTIONAL, INTENT(OUT) :: ierror
MPI_Ineighbor_alltoall(sendbuf, sendcount, sendtype, recvbuf, recvcoun
    recvtype, comm, request, ierror)
TYPE(*), DIMENSION(..), INTENT(IN), ASYNCHRONOUS :: sendbuf
INTEGER(KIND=MPI_COUNT_KIND), INTENT(IN) :: sendcount, recvcoun
TYPE(MPI_Datatype), INTENT(IN) :: sendtype, recvtype
TYPE(*), DIMENSION(..), ASYNCHRONOUS :: recvbuf
TYPE(MPI_Comm), INTENT(IN) :: comm
TYPE(MPI_Request), INTENT(OUT) :: request
INTEGER, OPTIONAL, INTENT(OUT) :: ierror
MPI_Ineighbor_alltoall(sendbuf, sendcount, sendtype, recvbuf, recvcoun
    recvtype, comm, request, ierror)
TYPE(*), DIMENSION(..), INTENT(IN), ASYNCHRONOUS :: sendbuf
INTEGER, INTENT(IN) :: sendcount, recvcoun
TYPE(MPI_Datatype), INTENT(IN) :: sendtype, recvtype
TYPE(*), DIMENSION(..), ASYNCHRONOUS :: recvbuf
TYPE(MPI_Comm), INTENT(IN) :: comm
TYPE(MPI_Request), INTENT(OUT) :: request
INTEGER, OPTIONAL, INTENT(OUT) :: ierror
MPI_Ineighbor_alltoallv(sendbuf, sendcounts, sdispls, sendtype, recvbuf,
    recvcoun, rdispls, recvtype, comm, request, ierror)
TYPE(*), DIMENSION(..), INTENT(IN), ASYNCHRONOUS :: sendbuf
INTEGER(KIND=MPI_COUNT_KIND), INTENT(IN), ASYNCHRONOUS ::
    sendcounts(*), recvcoun(*)
INTEGER(KIND=MPI_ADDRESS_KIND), INTENT(IN), ASYNCHRONOUS :: sdispls(*),
    rdispls(*)
TYPE(MPI_Datatype), INTENT(IN) :: sendtype, recvtype
TYPE(*), DIMENSION(..), ASYNCHRONOUS :: recvbuf
TYPE(MPI_Comm), INTENT(IN) :: comm
TYPE(MPI_Request), INTENT(OUT) :: request
INTEGER, OPTIONAL, INTENT(OUT) :: ierror
MPI_Ineighbor_alltoallv(sendbuf, sendcounts, sdispls, sendtype, recvbuf,
    recvcoun, rdispls, recvtype, comm, request, ierror)
TYPE(*), DIMENSION(..), INTENT(IN), ASYNCHRONOUS :: sendbuf

```

```

1     INTEGER, INTENT(IN), ASYNCHRONOUS :: sendcounts(*), sdispls(*),
2         recvcounts(*), rdispls(*)
3     TYPE(MPI_Datatype), INTENT(IN) :: sendtype, recvtype
4     TYPE(*), DIMENSION(..), ASYNCHRONOUS :: recvbuf
5     TYPE(MPI_Comm), INTENT(IN) :: comm
6     TYPE(MPI_Request), INTENT(OUT) :: request
7     INTEGER, OPTIONAL, INTENT(OUT) :: ierror
8
9     MPI_Ineighbor_alltoallw(sendbuf, sendcounts, sdispls, sendtypes, recvbuf,
10         recvcounts, rdispls, recvtypes, comm, request, ierror)
11     TYPE(*), DIMENSION(..), INTENT(IN), ASYNCHRONOUS :: sendbuf
12     INTEGER(KIND=MPI_COUNT_KIND), INTENT(IN), ASYNCHRONOUS ::
13         sendcounts(*), recvcounts(*)
14     INTEGER(KIND=MPI_ADDRESS_KIND), INTENT(IN), ASYNCHRONOUS :: sdispls(*),
15         rdispls(*)
16     TYPE(MPI_Datatype), INTENT(IN), ASYNCHRONOUS :: sendtypes(*),
17         recvtypes(*)
18     TYPE(*), DIMENSION(..), ASYNCHRONOUS :: recvbuf
19     TYPE(MPI_Comm), INTENT(IN) :: comm
20     TYPE(MPI_Request), INTENT(OUT) :: request
21     INTEGER, OPTIONAL, INTENT(OUT) :: ierror
22
23     MPI_Ineighbor_alltoallw(sendbuf, sendcounts, sdispls, sendtypes, recvbuf,
24         recvcounts, rdispls, recvtypes, comm, request, ierror)
25     TYPE(*), DIMENSION(..), INTENT(IN), ASYNCHRONOUS :: sendbuf
26     INTEGER, INTENT(IN), ASYNCHRONOUS :: sendcounts(*), recvcounts(*)
27     INTEGER(KIND=MPI_ADDRESS_KIND), INTENT(IN), ASYNCHRONOUS :: sdispls(*),
28         rdispls(*)
29     TYPE(MPI_Datatype), INTENT(IN), ASYNCHRONOUS :: sendtypes(*),
30         recvtypes(*)
31     TYPE(*), DIMENSION(..), ASYNCHRONOUS :: recvbuf
32     TYPE(MPI_Comm), INTENT(IN) :: comm
33     TYPE(MPI_Request), INTENT(OUT) :: request
34     INTEGER, OPTIONAL, INTENT(OUT) :: ierror
35
36     MPI_Neighbor_allgather(sendbuf, sendcount, sendtype, recvbuf, recvcount,
37         recvtype, comm, ierror)
38     TYPE(*), DIMENSION(..), INTENT(IN) :: sendbuf
39     INTEGER(KIND=MPI_COUNT_KIND), INTENT(IN) :: sendcount, recvcount
40     TYPE(MPI_Datatype), INTENT(IN) :: sendtype, recvtype
41     TYPE(*), DIMENSION(..) :: recvbuf
42     TYPE(MPI_Comm), INTENT(IN) :: comm
43     INTEGER, OPTIONAL, INTENT(OUT) :: ierror
44
45     MPI_Neighbor_allgather(sendbuf, sendcount, sendtype, recvbuf, recvcount,
46         recvtype, comm, ierror)
47     TYPE(*), DIMENSION(..), INTENT(IN) :: sendbuf
48     INTEGER, INTENT(IN) :: sendcount, recvcount
49     TYPE(MPI_Datatype), INTENT(IN) :: sendtype, recvtype

```

```

TYPE(*), DIMENSION(..) :: recvbuf 1
TYPE(MPI_Comm), INTENT(IN) :: comm 2
INTEGER, OPTIONAL, INTENT(OUT) :: ierror 3
4
MPI_Neighbor_allgather_init(sendbuf, sendcount, sendtype, recvbuf, 5
    recvcount, recvtype, comm, info, request, ierror) 6
TYPE(*), DIMENSION(..), INTENT(IN), ASYNCHRONOUS :: sendbuf 7
INTEGER(KIND=MPI_COUNT_KIND), INTENT(IN) :: sendcount, recvcount 8
TYPE(MPI_Datatype), INTENT(IN) :: sendtype, recvtype 9
TYPE(*), DIMENSION(..), ASYNCHRONOUS :: recvbuf 10
TYPE(MPI_Comm), INTENT(IN) :: comm 11
TYPE(MPI_Info), INTENT(IN) :: info 12
TYPE(MPI_Request), INTENT(OUT) :: request 13
INTEGER, OPTIONAL, INTENT(OUT) :: ierror 14
15
MPI_Neighbor_allgather_init(sendbuf, sendcount, sendtype, recvbuf, 16
    recvcount, recvtype, comm, info, request, ierror) 17
TYPE(*), DIMENSION(..), INTENT(IN), ASYNCHRONOUS :: sendbuf 18
INTEGER, INTENT(IN) :: sendcount, recvcount 19
TYPE(MPI_Datatype), INTENT(IN) :: sendtype, recvtype 20
TYPE(*), DIMENSION(..), ASYNCHRONOUS :: recvbuf 21
TYPE(MPI_Comm), INTENT(IN) :: comm 22
TYPE(MPI_Info), INTENT(IN) :: info 23
TYPE(MPI_Request), INTENT(OUT) :: request 24
INTEGER, OPTIONAL, INTENT(OUT) :: ierror 25
26
MPI_Neighbor_allgatherv(sendbuf, sendcount, sendtype, recvbuf, recvcounts, 27
    displs, recvtype, comm, ierror) 28
TYPE(*), DIMENSION(..), INTENT(IN) :: sendbuf 29
INTEGER(KIND=MPI_COUNT_KIND), INTENT(IN) :: sendcount, recvcounts(*) 30
TYPE(MPI_Datatype), INTENT(IN) :: sendtype, recvtype 31
TYPE(*), DIMENSION(..) :: recvbuf 32
INTEGER(KIND=MPI_ADDRESS_KIND), INTENT(IN) :: displs(*) 33
TYPE(MPI_Comm), INTENT(IN) :: comm 34
INTEGER, OPTIONAL, INTENT(OUT) :: ierror 35
36
MPI_Neighbor_allgatherv(sendbuf, sendcount, sendtype, recvbuf, recvcounts, 37
    displs, recvtype, comm, ierror) 38
TYPE(*), DIMENSION(..), INTENT(IN) :: sendbuf 39
INTEGER, INTENT(IN) :: sendcount, recvcounts(*), displs(*) 40
TYPE(MPI_Datatype), INTENT(IN) :: sendtype, recvtype 41
TYPE(*), DIMENSION(..) :: recvbuf 42
TYPE(MPI_Comm), INTENT(IN) :: comm 43
INTEGER, OPTIONAL, INTENT(OUT) :: ierror 44
45
MPI_Neighbor_allgatherv_init(sendbuf, sendcount, sendtype, recvbuf, 46
    recvcounts, displs, recvtype, comm, info, request, ierror) 47
TYPE(*), DIMENSION(..), INTENT(IN), ASYNCHRONOUS :: sendbuf 48
INTEGER(KIND=MPI_COUNT_KIND), INTENT(IN) :: sendcount
TYPE(MPI_Datatype), INTENT(IN) :: sendtype, recvtype

```

```

1     TYPE(*), DIMENSION(..), ASYNCHRONOUS :: recvbuf
2     INTEGER(KIND=MPI_COUNT_KIND), INTENT(IN), ASYNCHRONOUS :: recvcounts(*)
3     INTEGER(KIND=MPI_ADDRESS_KIND), INTENT(IN) :: displs(*)
4     TYPE(MPI_Comm), INTENT(IN) :: comm
5     TYPE(MPI_Info), INTENT(IN) :: info
6     TYPE(MPI_Request), INTENT(OUT) :: request
7     INTEGER, OPTIONAL, INTENT(OUT) :: ierror
8
9     MPI_Neighbor_allgatherv_init(sendbuf, sendcount, sendtype, recvbuf,
10        recvcounts, displs, recvtype, comm, info, request, ierror)
11     TYPE(*), DIMENSION(..), INTENT(IN), ASYNCHRONOUS :: sendbuf
12     INTEGER, INTENT(IN) :: sendcount, displs(*)
13     TYPE(MPI_Datatype), INTENT(IN) :: sendtype, recvtype
14     TYPE(*), DIMENSION(..), ASYNCHRONOUS :: recvbuf
15     INTEGER, INTENT(IN), ASYNCHRONOUS :: recvcounts(*)
16     TYPE(MPI_Comm), INTENT(IN) :: comm
17     TYPE(MPI_Info), INTENT(IN) :: info
18     TYPE(MPI_Request), INTENT(OUT) :: request
19     INTEGER, OPTIONAL, INTENT(OUT) :: ierror
20
21     MPI_Neighbor_alltoall(sendbuf, sendcount, sendtype, recvbuf, recvcount,
22        recvtype, comm, ierror)
23     TYPE(*), DIMENSION(..), INTENT(IN) :: sendbuf
24     INTEGER(KIND=MPI_COUNT_KIND), INTENT(IN) :: sendcount, recvcount
25     TYPE(MPI_Datatype), INTENT(IN) :: sendtype, recvtype
26     TYPE(*), DIMENSION(..) :: recvbuf
27     TYPE(MPI_Comm), INTENT(IN) :: comm
28     INTEGER, OPTIONAL, INTENT(OUT) :: ierror
29
30     MPI_Neighbor_alltoall(sendbuf, sendcount, sendtype, recvbuf, recvcount,
31        recvtype, comm, ierror)
32     TYPE(*), DIMENSION(..), INTENT(IN) :: sendbuf
33     INTEGER, INTENT(IN) :: sendcount, recvcount
34     TYPE(MPI_Datatype), INTENT(IN) :: sendtype, recvtype
35     TYPE(*), DIMENSION(..) :: recvbuf
36     TYPE(MPI_Comm), INTENT(IN) :: comm
37     INTEGER, OPTIONAL, INTENT(OUT) :: ierror
38
39     MPI_Neighbor_alltoall_init(sendbuf, sendcount, sendtype, recvbuf,
40        recvcount, recvtype, comm, info, request, ierror)
41     TYPE(*), DIMENSION(..), INTENT(IN), ASYNCHRONOUS :: sendbuf
42     INTEGER(KIND=MPI_COUNT_KIND), INTENT(IN) :: sendcount, recvcount
43     TYPE(MPI_Datatype), INTENT(IN) :: sendtype, recvtype
44     TYPE(*), DIMENSION(..), ASYNCHRONOUS :: recvbuf
45     TYPE(MPI_Comm), INTENT(IN) :: comm
46     TYPE(MPI_Info), INTENT(IN) :: info
47     TYPE(MPI_Request), INTENT(OUT) :: request
48     INTEGER, OPTIONAL, INTENT(OUT) :: ierror

```

```

MPI_Neighbor_alltoall_init(sendbuf, sendcount, sendtype, recvbuf,
    recvcount, recvtype, comm, info, request, ierror)
    TYPE(*), DIMENSION(..), INTENT(IN), ASYNCHRONOUS :: sendbuf
    INTEGER, INTENT(IN) :: sendcount, recvcount
    TYPE(MPI_Datatype), INTENT(IN) :: sendtype, recvtype
    TYPE(*), DIMENSION(..), ASYNCHRONOUS :: recvbuf
    TYPE(MPI_Comm), INTENT(IN) :: comm
    TYPE(MPI_Info), INTENT(IN) :: info
    TYPE(MPI_Request), INTENT(OUT) :: request
    INTEGER, OPTIONAL, INTENT(OUT) :: ierror

MPI_Neighbor_alltoallv(sendbuf, sendcounts, sdispls, sendtype, recvbuf,
    recvcounts, rdispls, recvtype, comm, ierror)
    TYPE(*), DIMENSION(..), INTENT(IN) :: sendbuf
    INTEGER(KIND=MPI_COUNT_KIND), INTENT(IN) :: sendcounts(*),
        recvcounts(*)
    INTEGER(KIND=MPI_ADDRESS_KIND), INTENT(IN) :: sdispls(*), rdispls(*)
    TYPE(MPI_Datatype), INTENT(IN) :: sendtype, recvtype
    TYPE(*), DIMENSION(..) :: recvbuf
    TYPE(MPI_Comm), INTENT(IN) :: comm
    INTEGER, OPTIONAL, INTENT(OUT) :: ierror

MPI_Neighbor_alltoallv(sendbuf, sendcounts, sdispls, sendtype, recvbuf,
    recvcounts, rdispls, recvtype, comm, ierror)
    TYPE(*), DIMENSION(..), INTENT(IN) :: sendbuf
    INTEGER, INTENT(IN) :: sendcounts(*), sdispls(*), recvcounts(*),
        rdispls(*)
    TYPE(MPI_Datatype), INTENT(IN) :: sendtype, recvtype
    TYPE(*), DIMENSION(..) :: recvbuf
    TYPE(MPI_Comm), INTENT(IN) :: comm
    INTEGER, OPTIONAL, INTENT(OUT) :: ierror

MPI_Neighbor_alltoallv_init(sendbuf, sendcounts, sdispls, sendtype,
    recvbuf, recvcounts, rdispls, recvtype, comm, info, request,
    ierror)
    TYPE(*), DIMENSION(..), INTENT(IN), ASYNCHRONOUS :: sendbuf
    INTEGER(KIND=MPI_COUNT_KIND), INTENT(IN), ASYNCHRONOUS ::
        sendcounts(*), recvcounts(*)
    INTEGER(KIND=MPI_ADDRESS_KIND), INTENT(IN), ASYNCHRONOUS :: sdispls(*),
        rdispls(*)
    TYPE(MPI_Datatype), INTENT(IN) :: sendtype, recvtype
    TYPE(*), DIMENSION(..), ASYNCHRONOUS :: recvbuf
    TYPE(MPI_Comm), INTENT(IN) :: comm
    TYPE(MPI_Info), INTENT(IN) :: info
    TYPE(MPI_Request), INTENT(OUT) :: request
    INTEGER, OPTIONAL, INTENT(OUT) :: ierror

MPI_Neighbor_alltoallv_init(sendbuf, sendcounts, sdispls, sendtype,
    recvbuf, recvcounts, rdispls, recvtype, comm, info, request,

```

```

1         ierror)
2     TYPE(*), DIMENSION(..), INTENT(IN), ASYNCHRONOUS :: sendbuf
3     INTEGER, INTENT(IN), ASYNCHRONOUS :: sendcounts(*), sdispls(*),
4         recvcounts(*), rdispls(*)
5     TYPE(MPI_Datatype), INTENT(IN) :: sendtype, recvtype
6     TYPE(*), DIMENSION(..), ASYNCHRONOUS :: recvbuf
7     TYPE(MPI_Comm), INTENT(IN) :: comm
8     TYPE(MPI_Info), INTENT(IN) :: info
9     TYPE(MPI_Request), INTENT(OUT) :: request
10    INTEGER, OPTIONAL, INTENT(OUT) :: ierror
11
12    MPI_Neighbor_alltoallw(sendbuf, sendcounts, sdispls, sendtypes, recvbuf,
13        recvcounts, rdispls, recvtypes, comm, ierror)
14    TYPE(*), DIMENSION(..), INTENT(IN) :: sendbuf
15    INTEGER(KIND=MPI_COUNT_KIND), INTENT(IN) :: sendcounts(*),
16        recvcounts(*)
17    INTEGER(KIND=MPI_ADDRESS_KIND), INTENT(IN) :: sdispls(*), rdispls(*)
18    TYPE(MPI_Datatype), INTENT(IN) :: sendtypes(*), recvtypes(*)
19    TYPE(*), DIMENSION(..) :: recvbuf
20    TYPE(MPI_Comm), INTENT(IN) :: comm
21    INTEGER, OPTIONAL, INTENT(OUT) :: ierror
22
23    MPI_Neighbor_alltoallw(sendbuf, sendcounts, sdispls, sendtypes, recvbuf,
24        recvcounts, rdispls, recvtypes, comm, ierror)
25    TYPE(*), DIMENSION(..), INTENT(IN) :: sendbuf
26    INTEGER, INTENT(IN) :: sendcounts(*), recvcounts(*)
27    INTEGER(KIND=MPI_ADDRESS_KIND), INTENT(IN) :: sdispls(*), rdispls(*)
28    TYPE(MPI_Datatype), INTENT(IN) :: sendtypes(*), recvtypes(*)
29    TYPE(*), DIMENSION(..) :: recvbuf
30    TYPE(MPI_Comm), INTENT(IN) :: comm
31    INTEGER, OPTIONAL, INTENT(OUT) :: ierror
32
33    MPI_Neighbor_alltoallw_init(sendbuf, sendcounts, sdispls, sendtypes,
34        recvbuf, recvcounts, rdispls, recvtypes, comm, info, request,
35        ierror)
36    TYPE(*), DIMENSION(..), INTENT(IN), ASYNCHRONOUS :: sendbuf
37    INTEGER(KIND=MPI_COUNT_KIND), INTENT(IN), ASYNCHRONOUS ::
38        sendcounts(*), recvcounts(*)
39    INTEGER(KIND=MPI_ADDRESS_KIND), INTENT(IN), ASYNCHRONOUS :: sdispls(*),
40        rdispls(*)
41    TYPE(MPI_Datatype), INTENT(IN), ASYNCHRONOUS :: sendtypes(*),
42        recvtypes(*)
43    TYPE(*), DIMENSION(..), ASYNCHRONOUS :: recvbuf
44    TYPE(MPI_Comm), INTENT(IN) :: comm
45    TYPE(MPI_Info), INTENT(IN) :: info
46    TYPE(MPI_Request), INTENT(OUT) :: request
47    INTEGER, OPTIONAL, INTENT(OUT) :: ierror
48

```

```

MPI_Neighbor_alltoallw_init(sendbuf, sendcounts, sdispls, sendtypes,
    recvbuf, recvcounts, rdispls, recvtypes, comm, info, request,
    ierror)
    TYPE(*), DIMENSION(..), INTENT(IN), ASYNCHRONOUS :: sendbuf
    INTEGER, INTENT(IN), ASYNCHRONOUS :: sendcounts(*), recvcounts(*)
    INTEGER(KIND=MPI_ADDRESS_KIND), INTENT(IN), ASYNCHRONOUS :: sdispls(*),
        rdispls(*)
    TYPE(MPI_Datatype), INTENT(IN), ASYNCHRONOUS :: sendtypes(*),
        recvtypes(*)
    TYPE(*), DIMENSION(..), ASYNCHRONOUS :: recvbuf
    TYPE(MPI_Comm), INTENT(IN) :: comm
    TYPE(MPI_Info), INTENT(IN) :: info
    TYPE(MPI_Request), INTENT(OUT) :: request
    INTEGER, OPTIONAL, INTENT(OUT) :: ierror

MPI_Topo_test(comm, status, ierror)
    TYPE(MPI_Comm), INTENT(IN) :: comm
    INTEGER, INTENT(OUT) :: status
    INTEGER, OPTIONAL, INTENT(OUT) :: ierror

A.4.7 MPI Environmental Management Fortran 2008 Bindings

DOUBLE PRECISION MPI_Wtick()

DOUBLE PRECISION MPI_Wtime()

MPI_Add_error_class(errorclass, ierror)
    INTEGER, INTENT(OUT) :: errorclass
    INTEGER, OPTIONAL, INTENT(OUT) :: ierror

MPI_Add_error_code(errorclass, errorcode, ierror)
    INTEGER, INTENT(IN) :: errorclass
    INTEGER, INTENT(OUT) :: errorcode
    INTEGER, OPTIONAL, INTENT(OUT) :: ierror

MPI_Add_error_string(errorcode, string, ierror)
    INTEGER, INTENT(IN) :: errorcode
    CHARACTER(LEN=*), INTENT(IN) :: string
    INTEGER, OPTIONAL, INTENT(OUT) :: ierror

MPI_Alloc_mem(size, info, baseptr, ierror)
    USE, INTRINSIC :: ISO_C_BINDING, ONLY : C_PTR
    INTEGER(KIND=MPI_ADDRESS_KIND), INTENT(IN) :: size
    TYPE(MPI_Info), INTENT(IN) :: info
    TYPE(C_PTR), INTENT(OUT) :: baseptr
    INTEGER, OPTIONAL, INTENT(OUT) :: ierror

MPI_Comm_call_errhandler(comm, errorcode, ierror)
    TYPE(MPI_Comm), INTENT(IN) :: comm
    INTEGER, INTENT(IN) :: errorcode
    INTEGER, OPTIONAL, INTENT(OUT) :: ierror

```

```
1 MPI_Comm_create_errhandler(comm_errhandler_fn, errhandler, ierror)
2   PROCEDURE(MPI_Comm_errhandler_function), INTENT(IN) ::
3     comm_errhandler_fn
4   TYPE(MPI_Errhandler), INTENT(OUT) :: errhandler
5   INTEGER, OPTIONAL, INTENT(OUT) :: ierror
6
7 MPI_Comm_get_errhandler(comm, errhandler, ierror)
8   TYPE(MPI_Comm), INTENT(IN) :: comm
9   TYPE(MPI_Errhandler), INTENT(OUT) :: errhandler
10  INTEGER, OPTIONAL, INTENT(OUT) :: ierror
11
12 MPI_Comm_set_errhandler(comm, errhandler, ierror)
13   TYPE(MPI_Comm), INTENT(IN) :: comm
14   TYPE(MPI_Errhandler), INTENT(IN) :: errhandler
15   INTEGER, OPTIONAL, INTENT(OUT) :: ierror
16
17 MPI_Errhandler_free(errhandler, ierror)
18   TYPE(MPI_Errhandler), INTENT(INOUT) :: errhandler
19   INTEGER, OPTIONAL, INTENT(OUT) :: ierror
20
21 MPI_Error_class(errorcode, errorclass, ierror)
22   INTEGER, INTENT(IN) :: errorcode
23   INTEGER, INTENT(OUT) :: errorclass
24   INTEGER, OPTIONAL, INTENT(OUT) :: ierror
25
26 MPI_Error_string(errorcode, string, resultlen, ierror)
27   INTEGER, INTENT(IN) :: errorcode
28   CHARACTER(LEN=MPI_MAX_ERROR_STRING), INTENT(OUT) :: string
29   INTEGER, INTENT(OUT) :: resultlen
30   INTEGER, OPTIONAL, INTENT(OUT) :: ierror
31
32 MPI_File_call_errhandler(fh, errorcode, ierror)
33   TYPE(MPI_File), INTENT(IN) :: fh
34   INTEGER, INTENT(IN) :: errorcode
35   INTEGER, OPTIONAL, INTENT(OUT) :: ierror
36
37 MPI_File_create_errhandler(file_errhandler_fn, errhandler, ierror)
38   PROCEDURE(MPI_File_errhandler_function), INTENT(IN) ::
39     file_errhandler_fn
40   TYPE(MPI_Errhandler), INTENT(OUT) :: errhandler
41   INTEGER, OPTIONAL, INTENT(OUT) :: ierror
42
43 MPI_File_get_errhandler(file, errhandler, ierror)
44   TYPE(MPI_File), INTENT(IN) :: file
45   TYPE(MPI_Errhandler), INTENT(OUT) :: errhandler
46   INTEGER, OPTIONAL, INTENT(OUT) :: ierror
47
48 MPI_File_set_errhandler(file, errhandler, ierror)
49   TYPE(MPI_File), INTENT(IN) :: file
50   TYPE(MPI_Errhandler), INTENT(IN) :: errhandler
51   INTEGER, OPTIONAL, INTENT(OUT) :: ierror
```



```

MPI_Free_mem(base, ierror)
    TYPE(*), DIMENSION(..), INTENT(IN), ASYNCHRONOUS :: base
    INTEGER, OPTIONAL, INTENT(OUT) :: ierror

MPI_Get_library_version(version, resultlen, ierror)
    CHARACTER(LEN=MPI_MAX_LIBRARY_VERSION_STRING), INTENT(OUT) :: version
    INTEGER, INTENT(OUT) :: resultlen
    INTEGER, OPTIONAL, INTENT(OUT) :: ierror

MPI_Get_processor_name(name, resultlen, ierror)
    CHARACTER(LEN=MPI_MAX_PROCESSOR_NAME), INTENT(OUT) :: name
    INTEGER, INTENT(OUT) :: resultlen
    INTEGER, OPTIONAL, INTENT(OUT) :: ierror

MPI_Get_version(version, subversion, ierror)
    INTEGER, INTENT(OUT) :: version, subversion
    INTEGER, OPTIONAL, INTENT(OUT) :: ierror

MPI_Session_call_errhandler(session, errorcode, ierror)
    TYPE(MPI_Session), INTENT(IN) :: session
    INTEGER, INTENT(IN) :: errorcode
    INTEGER, OPTIONAL, INTENT(OUT) :: ierror

MPI_Session_create_errhandler(session_errhandler_fn, errhandler, ierror)
    PROCEDURE(MPI_Session_errhandler_function), INTENT(IN) ::
        session_errhandler_fn
    TYPE(MPI_Errhandler), INTENT(OUT) :: errhandler
    INTEGER, OPTIONAL, INTENT(OUT) :: ierror

MPI_Session_get_errhandler(session, errhandler, ierror)
    TYPE(MPI_Session), INTENT(IN) :: session
    TYPE(MPI_Errhandler), INTENT(OUT) :: errhandler
    INTEGER, OPTIONAL, INTENT(OUT) :: ierror

MPI_Session_set_errhandler(session, errhandler, ierror)
    TYPE(MPI_Session), INTENT(IN) :: session
    TYPE(MPI_Errhandler), INTENT(IN) :: errhandler
    INTEGER, OPTIONAL, INTENT(OUT) :: ierror

MPI_Win_call_errhandler(win, errorcode, ierror)
    TYPE(MPI_Win), INTENT(IN) :: win
    INTEGER, INTENT(IN) :: errorcode
    INTEGER, OPTIONAL, INTENT(OUT) :: ierror

MPI_Win_create_errhandler(win_errhandler_fn, errhandler, ierror)
    PROCEDURE(MPI_Win_errhandler_function), INTENT(IN) :: win_errhandler_fn
    TYPE(MPI_Errhandler), INTENT(OUT) :: errhandler
    INTEGER, OPTIONAL, INTENT(OUT) :: ierror

MPI_Win_get_errhandler(win, errhandler, ierror)
    TYPE(MPI_Win), INTENT(IN) :: win
    TYPE(MPI_Errhandler), INTENT(OUT) :: errhandler

```

```
1     INTEGER, OPTIONAL, INTENT(OUT) :: ierror
2
3     MPI_Win_set_errhandler(win, errhandler, ierror)
4     TYPE(MPI_Win), INTENT(IN) :: win
5     TYPE(MPI_Errhandler), INTENT(IN) :: errhandler
6     INTEGER, OPTIONAL, INTENT(OUT) :: ierror
7
8     A.4.8 The Info Object Fortran 2008 Bindings
9
10    MPI_Info_create(info, ierror)
11    TYPE(MPI_Info), INTENT(OUT) :: info
12    INTEGER, OPTIONAL, INTENT(OUT) :: ierror
13
14    MPI_Info_create_env(info, ierror)
15    TYPE(MPI_Info), INTENT(OUT) :: info
16    INTEGER, OPTIONAL, INTENT(OUT) :: ierror
17
18    MPI_Info_delete(info, key, ierror)
19    TYPE(MPI_Info), INTENT(IN) :: info
20    CHARACTER(LEN=*), INTENT(IN) :: key
21    INTEGER, OPTIONAL, INTENT(OUT) :: ierror
22
23    MPI_Info_dup(info, newinfo, ierror)
24    TYPE(MPI_Info), INTENT(IN) :: info
25    TYPE(MPI_Info), INTENT(OUT) :: newinfo
26    INTEGER, OPTIONAL, INTENT(OUT) :: ierror
27
28    MPI_Info_free(info, ierror)
29    TYPE(MPI_Info), INTENT(INOUT) :: info
30    INTEGER, OPTIONAL, INTENT(OUT) :: ierror
31
32    MPI_Info_get(info, key, valuelen, value, flag, ierror)
33    TYPE(MPI_Info), INTENT(IN) :: info
34    CHARACTER(LEN=*), INTENT(IN) :: key
35    INTEGER, INTENT(IN) :: valuelen
36    CHARACTER(LEN=valuelen), INTENT(OUT) :: value
37    LOGICAL, INTENT(OUT) :: flag
38    INTEGER, OPTIONAL, INTENT(OUT) :: ierror
39
40    MPI_Info_get_nkeys(info, nkeys, ierror)
41    TYPE(MPI_Info), INTENT(IN) :: info
42    INTEGER, INTENT(OUT) :: nkeys
43    INTEGER, OPTIONAL, INTENT(OUT) :: ierror
44
45    MPI_Info_get_nthkey(info, n, key, ierror)
46    TYPE(MPI_Info), INTENT(IN) :: info
47    INTEGER, INTENT(IN) :: n
48    CHARACTER(LEN=*), INTENT(OUT) :: key
49    INTEGER, OPTIONAL, INTENT(OUT) :: ierror
50
51    MPI_Info_get_string(info, key, buflen, value, flag, ierror)
52    TYPE(MPI_Info), INTENT(IN) :: info
```

```

CHARACTER(LEN=*), INTENT(IN) :: key           1
INTEGER, INTENT(INOUT) :: buflen             2
CHARACTER(LEN=*), INTENT(OUT) :: value       3
LOGICAL, INTENT(OUT) :: flag                 4
INTEGER, OPTIONAL, INTENT(OUT) :: ierror     5
                                                6
MPI_Info_get_valuelen(info, key, valuelen, flag, ierror) 7
TYPE(MPI_Info), INTENT(IN) :: info           8
CHARACTER(LEN=*), INTENT(IN) :: key         9
INTEGER, INTENT(OUT) :: valuelen           10
LOGICAL, INTENT(OUT) :: flag               11
INTEGER, OPTIONAL, INTENT(OUT) :: ierror    12
                                                13
MPI_Info_set(info, key, value, ierror)      14
TYPE(MPI_Info), INTENT(IN) :: info         15
CHARACTER(LEN=*), INTENT(IN) :: key, value 16
INTEGER, OPTIONAL, INTENT(OUT) :: ierror    17
                                                18
A.4.9 Process Creation and Management Fortran 2008 Bindings 19
                                                20
MPI_Abort(comm, errorcode, ierror)         21
TYPE(MPI_Comm), INTENT(IN) :: comm         22
INTEGER, INTENT(IN) :: errorcode          23
INTEGER, OPTIONAL, INTENT(OUT) :: ierror    24
                                                25
MPI_Close_port(port_name, ierror)         26
CHARACTER(LEN=*), INTENT(IN) :: port_name 27
INTEGER, OPTIONAL, INTENT(OUT) :: ierror    28
                                                29
MPI_Comm_accept(port_name, info, root, comm, newcomm, ierror) 30
CHARACTER(LEN=*), INTENT(IN) :: port_name 31
TYPE(MPI_Info), INTENT(IN) :: info         32
INTEGER, INTENT(IN) :: root                33
TYPE(MPI_Comm), INTENT(IN) :: comm         34
TYPE(MPI_Comm), INTENT(OUT) :: newcomm     35
INTEGER, OPTIONAL, INTENT(OUT) :: ierror    36
                                                37
MPI_Comm_connect(port_name, info, root, comm, newcomm, ierror) 38
CHARACTER(LEN=*), INTENT(IN) :: port_name 39
TYPE(MPI_Info), INTENT(IN) :: info         40
INTEGER, INTENT(IN) :: root                41
TYPE(MPI_Comm), INTENT(IN) :: comm         42
TYPE(MPI_Comm), INTENT(OUT) :: newcomm     43
INTEGER, OPTIONAL, INTENT(OUT) :: ierror    44
                                                45
MPI_Comm_disconnect(comm, ierror)         46
TYPE(MPI_Comm), INTENT(INOUT) :: comm      47
INTEGER, OPTIONAL, INTENT(OUT) :: ierror    48
                                                49
MPI_Comm_get_parent(parent, ierror)       50
TYPE(MPI_Comm), INTENT(OUT) :: parent      51

```

```

1     INTEGER, OPTIONAL, INTENT(OUT) :: ierror
2
3     MPI_Comm_join(fd, intercomm, ierror)
4         INTEGER, INTENT(IN) :: fd
5         TYPE(MPI_Comm), INTENT(OUT) :: intercomm
6         INTEGER, OPTIONAL, INTENT(OUT) :: ierror
7
8     MPI_Comm_spawn(command, argv, maxprocs, info, root, comm, intercomm,
9         array_of_errcodes, ierror)
10        CHARACTER(LEN=*), INTENT(IN) :: command, argv(*)
11        INTEGER, INTENT(IN) :: maxprocs, root
12        TYPE(MPI_Info), INTENT(IN) :: info
13        TYPE(MPI_Comm), INTENT(IN) :: comm
14        TYPE(MPI_Comm), INTENT(OUT) :: intercomm
15        INTEGER :: array_of_errcodes(*)
16        INTEGER, OPTIONAL, INTENT(OUT) :: ierror
17
18    MPI_Comm_spawn_multiple(count, array_of_commands, array_of_argv,
19        array_of_maxprocs, array_of_info, root, comm, intercomm,
20        array_of_errcodes, ierror)
21        INTEGER, INTENT(IN) :: count, array_of_maxprocs(*), root
22        CHARACTER(LEN=*), INTENT(IN) :: array_of_commands(*),
23            array_of_argv(count, *)
24        TYPE(MPI_Info), INTENT(IN) :: array_of_info(*)
25        TYPE(MPI_Comm), INTENT(IN) :: comm
26        TYPE(MPI_Comm), INTENT(OUT) :: intercomm
27        INTEGER :: array_of_errcodes(*)
28        INTEGER, OPTIONAL, INTENT(OUT) :: ierror
29
30    MPI_Finalize(ierror)
31        INTEGER, OPTIONAL, INTENT(OUT) :: ierror
32
33    MPI_Finalized(flag, ierror)
34        LOGICAL, INTENT(OUT) :: flag
35        INTEGER, OPTIONAL, INTENT(OUT) :: ierror
36
37    MPI_Init(ierror)
38        INTEGER, OPTIONAL, INTENT(OUT) :: ierror
39
40    MPI_Init_thread(required, provided, ierror)
41        INTEGER, INTENT(IN) :: required
42        INTEGER, INTENT(OUT) :: provided
43        INTEGER, OPTIONAL, INTENT(OUT) :: ierror
44
45    MPI_Initialized(flag, ierror)
46        LOGICAL, INTENT(OUT) :: flag
47        INTEGER, OPTIONAL, INTENT(OUT) :: ierror
48
49    MPI_Is_thread_main(flag, ierror)
50        LOGICAL, INTENT(OUT) :: flag
51        INTEGER, OPTIONAL, INTENT(OUT) :: ierror

```

```
MPI_Lookup_name(service_name, info, port_name, ierror) 1
  CHARACTER(LEN=*), INTENT(IN) :: service_name 2
  TYPE(MPI_Info), INTENT(IN) :: info 3
  CHARACTER(LEN=MPI_MAX_PORT_NAME), INTENT(OUT) :: port_name 4
  INTEGER, OPTIONAL, INTENT(OUT) :: ierror 5
  6
MPI_Open_port(info, port_name, ierror) 7
  TYPE(MPI_Info), INTENT(IN) :: info 8
  CHARACTER(LEN=MPI_MAX_PORT_NAME), INTENT(OUT) :: port_name 9
  INTEGER, OPTIONAL, INTENT(OUT) :: ierror 10
  11
MPI_Publish_name(service_name, info, port_name, ierror) 11
  CHARACTER(LEN=*), INTENT(IN) :: service_name, port_name 12
  TYPE(MPI_Info), INTENT(IN) :: info 13
  INTEGER, OPTIONAL, INTENT(OUT) :: ierror 14
  15
MPI_Query_thread(provided, ierror) 16
  INTEGER, INTENT(OUT) :: provided 17
  INTEGER, OPTIONAL, INTENT(OUT) :: ierror 18
  19
MPI_Session_finalize(session, ierror) 19
  TYPE(MPI_Session), INTENT(INOUT) :: session 20
  INTEGER, OPTIONAL, INTENT(OUT) :: ierror 21
  22
MPI_Session_get_info(session, info_used, ierror) 23
  TYPE(MPI_Session), INTENT(IN) :: session 24
  TYPE(MPI_Info), INTENT(OUT) :: info_used 25
  INTEGER, OPTIONAL, INTENT(OUT) :: ierror 26
  27
MPI_Session_get_nth_pset(session, info, n, pset_len, pset_name, ierror) 27
  TYPE(MPI_Session), INTENT(IN) :: session 28
  TYPE(MPI_Info), INTENT(IN) :: info 29
  INTEGER, INTENT(IN) :: n 30
  INTEGER, INTENT(INOUT) :: pset_len 31
  CHARACTER(LEN=*), INTENT(OUT) :: pset_name 32
  INTEGER, OPTIONAL, INTENT(OUT) :: ierror 33
  34
MPI_Session_get_num_psets(session, info, npset_names, ierror) 35
  TYPE(MPI_Session), INTENT(IN) :: session 36
  TYPE(MPI_Info), INTENT(IN) :: info 37
  INTEGER, INTENT(OUT) :: npset_names 38
  INTEGER, OPTIONAL, INTENT(OUT) :: ierror 39
  40
MPI_Session_get_pset_info(session, pset_name, info, ierror) 40
  TYPE(MPI_Session), INTENT(IN) :: session 41
  CHARACTER(LEN=*), INTENT(IN) :: pset_name 42
  TYPE(MPI_Info), INTENT(OUT) :: info 43
  INTEGER, OPTIONAL, INTENT(OUT) :: ierror 44
  45
MPI_Session_init(info, errhandler, session, ierror) 46
  TYPE(MPI_Info), INTENT(IN) :: info 47
  TYPE(MPI_Errhandler), INTENT(IN) :: errhandler 48
```

```

1     TYPE(MPI_Session), INTENT(OUT) :: session
2     INTEGER, OPTIONAL, INTENT(OUT) :: ierror
3
4     MPI_Unpublish_name(service_name, info, port_name, ierror)
5     CHARACTER(LEN=*), INTENT(IN) :: service_name, port_name
6     TYPE(MPI_Info), INTENT(IN) :: info
7     INTEGER, OPTIONAL, INTENT(OUT) :: ierror
8

```

#### A.4.10 One-Sided Communications Fortran 2008 Bindings

```

9
10
11    MPI_Accumulate(origin_addr, origin_count, origin_datatype, target_rank,
12                  target_disp, target_count, target_datatype, op, win, ierror)
13    TYPE(*), DIMENSION(..), INTENT(IN), ASYNCHRONOUS :: origin_addr
14    INTEGER(KIND=MPI_COUNT_KIND), INTENT(IN) :: origin_count, target_count
15    TYPE(MPI_Datatype), INTENT(IN) :: origin_datatype, target_datatype
16    INTEGER, INTENT(IN) :: target_rank
17    INTEGER(KIND=MPI_ADDRESS_KIND), INTENT(IN) :: target_disp
18    TYPE(MPI_Op), INTENT(IN) :: op
19    TYPE(MPI_Win), INTENT(IN) :: win
20    INTEGER, OPTIONAL, INTENT(OUT) :: ierror
21

```

```

22    MPI_Accumulate(origin_addr, origin_count, origin_datatype, target_rank,
23                  target_disp, target_count, target_datatype, op, win, ierror)
24    TYPE(*), DIMENSION(..), INTENT(IN), ASYNCHRONOUS :: origin_addr
25    INTEGER, INTENT(IN) :: origin_count, target_rank, target_count
26    TYPE(MPI_Datatype), INTENT(IN) :: origin_datatype, target_datatype
27    INTEGER(KIND=MPI_ADDRESS_KIND), INTENT(IN) :: target_disp
28    TYPE(MPI_Op), INTENT(IN) :: op
29    TYPE(MPI_Win), INTENT(IN) :: win
30    INTEGER, OPTIONAL, INTENT(OUT) :: ierror
31

```

```

32    MPI_Compare_and_swap(origin_addr, compare_addr, result_addr, datatype,
33                          target_rank, target_disp, win, ierror)
34    TYPE(*), DIMENSION(..), INTENT(IN), ASYNCHRONOUS :: origin_addr,
35    compare_addr
36    TYPE(*), DIMENSION(..), ASYNCHRONOUS :: result_addr
37    TYPE(MPI_Datatype), INTENT(IN) :: datatype
38    INTEGER, INTENT(IN) :: target_rank
39    INTEGER(KIND=MPI_ADDRESS_KIND), INTENT(IN) :: target_disp
40    TYPE(MPI_Win), INTENT(IN) :: win
41    INTEGER, OPTIONAL, INTENT(OUT) :: ierror
42

```

```

43    MPI_Fetch_and_op(origin_addr, result_addr, datatype, target_rank,
44                     target_disp, op, win, ierror)
45    TYPE(*), DIMENSION(..), INTENT(IN), ASYNCHRONOUS :: origin_addr
46    TYPE(*), DIMENSION(..), ASYNCHRONOUS :: result_addr
47    TYPE(MPI_Datatype), INTENT(IN) :: datatype
48    INTEGER, INTENT(IN) :: target_rank
49    INTEGER(KIND=MPI_ADDRESS_KIND), INTENT(IN) :: target_disp

```

```

TYPE(MPI_Op), INTENT(IN) :: op
TYPE(MPI_Win), INTENT(IN) :: win
INTEGER, OPTIONAL, INTENT(OUT) :: ierror
MPI_Get(origin_addr, origin_count, origin_datatype, target_rank,
        target_disp, target_count, target_datatype, win, ierror)
TYPE(*), DIMENSION(..), ASYNCHRONOUS :: origin_addr
INTEGER(KIND=MPI_COUNT_KIND), INTENT(IN) :: origin_count, target_count
TYPE(MPI_Datatype), INTENT(IN) :: origin_datatype, target_datatype
INTEGER, INTENT(IN) :: target_rank
INTEGER(KIND=MPI_ADDRESS_KIND), INTENT(IN) :: target_disp
TYPE(MPI_Win), INTENT(IN) :: win
INTEGER, OPTIONAL, INTENT(OUT) :: ierror
MPI_Get(origin_addr, origin_count, origin_datatype, target_rank,
        target_disp, target_count, target_datatype, win, ierror)
TYPE(*), DIMENSION(..), ASYNCHRONOUS :: origin_addr
INTEGER, INTENT(IN) :: origin_count, target_rank, target_count
TYPE(MPI_Datatype), INTENT(IN) :: origin_datatype, target_datatype
INTEGER(KIND=MPI_ADDRESS_KIND), INTENT(IN) :: target_disp
TYPE(MPI_Win), INTENT(IN) :: win
INTEGER, OPTIONAL, INTENT(OUT) :: ierror
MPI_Get_accumulate(origin_addr, origin_count, origin_datatype, result_addr,
        result_count, result_datatype, target_rank, target_disp,
        target_count, target_datatype, op, win, ierror)
TYPE(*), DIMENSION(..), INTENT(IN), ASYNCHRONOUS :: origin_addr
INTEGER(KIND=MPI_COUNT_KIND), INTENT(IN) :: origin_count, result_count,
        target_count
TYPE(MPI_Datatype), INTENT(IN) :: origin_datatype, result_datatype,
        target_datatype
TYPE(*), DIMENSION(..), ASYNCHRONOUS :: result_addr
INTEGER, INTENT(IN) :: target_rank
INTEGER(KIND=MPI_ADDRESS_KIND), INTENT(IN) :: target_disp
TYPE(MPI_Op), INTENT(IN) :: op
TYPE(MPI_Win), INTENT(IN) :: win
INTEGER, OPTIONAL, INTENT(OUT) :: ierror
MPI_Get_accumulate(origin_addr, origin_count, origin_datatype, result_addr,
        result_count, result_datatype, target_rank, target_disp,
        target_count, target_datatype, op, win, ierror)
TYPE(*), DIMENSION(..), INTENT(IN), ASYNCHRONOUS :: origin_addr
INTEGER, INTENT(IN) :: origin_count, result_count, target_rank,
        target_count
TYPE(MPI_Datatype), INTENT(IN) :: origin_datatype, result_datatype,
        target_datatype
TYPE(*), DIMENSION(..), ASYNCHRONOUS :: result_addr
INTEGER(KIND=MPI_ADDRESS_KIND), INTENT(IN) :: target_disp
TYPE(MPI_Op), INTENT(IN) :: op

```

```

1     TYPE(MPI_Win), INTENT(IN) :: win
2     INTEGER, OPTIONAL, INTENT(OUT) :: ierror
3
4     MPI_Put(origin_addr, origin_count, origin_datatype, target_rank,
5            target_disp, target_count, target_datatype, win, ierror)
6     TYPE(*), DIMENSION(..), INTENT(IN), ASYNCHRONOUS :: origin_addr
7     INTEGER(KIND=MPI_COUNT_KIND), INTENT(IN) :: origin_count, target_count
8     TYPE(MPI_Datatype), INTENT(IN) :: origin_datatype, target_datatype
9     INTEGER, INTENT(IN) :: target_rank
10    INTEGER(KIND=MPI_ADDRESS_KIND), INTENT(IN) :: target_disp
11    TYPE(MPI_Win), INTENT(IN) :: win
12    INTEGER, OPTIONAL, INTENT(OUT) :: ierror
13
14    MPI_Put(origin_addr, origin_count, origin_datatype, target_rank,
15           target_disp, target_count, target_datatype, win, ierror)
16    TYPE(*), DIMENSION(..), INTENT(IN), ASYNCHRONOUS :: origin_addr
17    INTEGER, INTENT(IN) :: origin_count, target_rank, target_count
18    TYPE(MPI_Datatype), INTENT(IN) :: origin_datatype, target_datatype
19    INTEGER(KIND=MPI_ADDRESS_KIND), INTENT(IN) :: target_disp
20    TYPE(MPI_Win), INTENT(IN) :: win
21    INTEGER, OPTIONAL, INTENT(OUT) :: ierror
22
23    MPI_Raccumulate(origin_addr, origin_count, origin_datatype, target_rank,
24                   target_disp, target_count, target_datatype, op, win, request,
25                   ierror)
26    TYPE(*), DIMENSION(..), INTENT(IN), ASYNCHRONOUS :: origin_addr
27    INTEGER(KIND=MPI_COUNT_KIND), INTENT(IN) :: origin_count, target_count
28    TYPE(MPI_Datatype), INTENT(IN) :: origin_datatype, target_datatype
29    INTEGER, INTENT(IN) :: target_rank
30    INTEGER(KIND=MPI_ADDRESS_KIND), INTENT(IN) :: target_disp
31    TYPE(MPI_Op), INTENT(IN) :: op
32    TYPE(MPI_Win), INTENT(IN) :: win
33    TYPE(MPI_Request), INTENT(OUT) :: request
34    INTEGER, OPTIONAL, INTENT(OUT) :: ierror
35
36    MPI_Raccumulate(origin_addr, origin_count, origin_datatype, target_rank,
37                   target_disp, target_count, target_datatype, op, win, request,
38                   ierror)
39    TYPE(*), DIMENSION(..), INTENT(IN), ASYNCHRONOUS :: origin_addr
40    INTEGER, INTENT(IN) :: origin_count, target_rank, target_count
41    TYPE(MPI_Datatype), INTENT(IN) :: origin_datatype, target_datatype
42    INTEGER(KIND=MPI_ADDRESS_KIND), INTENT(IN) :: target_disp
43    TYPE(MPI_Op), INTENT(IN) :: op
44    TYPE(MPI_Win), INTENT(IN) :: win
45    TYPE(MPI_Request), INTENT(OUT) :: request
46    INTEGER, OPTIONAL, INTENT(OUT) :: ierror
47
48    MPI_Rget(origin_addr, origin_count, origin_datatype, target_rank,
49            target_disp, target_count, target_datatype, win, request,
50            ierror)

```



```

TYPE(*), DIMENSION(..), ASYNCHRONOUS :: origin_addr           1
INTEGER(KIND=MPI_COUNT_KIND), INTENT(IN) :: origin_count, target_count 2
TYPE(MPI_Datatype), INTENT(IN) :: origin_datatype, target_datatype     3
INTEGER, INTENT(IN) :: target_rank                                     4
INTEGER(KIND=MPI_ADDRESS_KIND), INTENT(IN) :: target_disp           5
TYPE(MPI_Win), INTENT(IN) :: win                                     6
TYPE(MPI_Request), INTENT(OUT) :: request                           7
INTEGER, OPTIONAL, INTENT(OUT) :: ierror                             8
                                                                    9
MPI_Rget(origin_addr, origin_count, origin_datatype, target_rank,    10
          target_disp, target_count, target_datatype, win, request,  11
          ierror)                                                    12
TYPE(*), DIMENSION(..), ASYNCHRONOUS :: origin_addr           13
INTEGER, INTENT(IN) :: origin_count, target_rank, target_count      14
TYPE(MPI_Datatype), INTENT(IN) :: origin_datatype, target_datatype  15
INTEGER(KIND=MPI_ADDRESS_KIND), INTENT(IN) :: target_disp           16
TYPE(MPI_Win), INTENT(IN) :: win                                     17
TYPE(MPI_Request), INTENT(OUT) :: request                           18
INTEGER, OPTIONAL, INTENT(OUT) :: ierror                             19
                                                                    20
MPI_Rget_accumulate(origin_addr, origin_count, origin_datatype,    21
                    result_addr, result_count, result_datatype, target_rank,  22
                    target_disp, target_count, target_datatype, op, win, request,  23
                    ierror)                                           24
TYPE(*), DIMENSION(..), INTENT(IN), ASYNCHRONOUS :: origin_addr  25
INTEGER(KIND=MPI_COUNT_KIND), INTENT(IN) :: origin_count, result_count,  26
                    target_count                                       27
TYPE(MPI_Datatype), INTENT(IN) :: origin_datatype, result_datatype,  28
                    target_datatype                                     29
TYPE(*), DIMENSION(..), ASYNCHRONOUS :: result_addr           30
INTEGER, INTENT(IN) :: target_rank                                   31
INTEGER(KIND=MPI_ADDRESS_KIND), INTENT(IN) :: target_disp           32
TYPE(MPI_Op), INTENT(IN) :: op                                       33
TYPE(MPI_Win), INTENT(IN) :: win                                     34
TYPE(MPI_Request), INTENT(OUT) :: request                           35
INTEGER, OPTIONAL, INTENT(OUT) :: ierror                             36
                                                                    37
MPI_Rget_accumulate(origin_addr, origin_count, origin_datatype,    38
                    result_addr, result_count, result_datatype, target_rank,  39
                    target_disp, target_count, target_datatype, op, win, request,  40
                    ierror)                                           41
TYPE(*), DIMENSION(..), INTENT(IN), ASYNCHRONOUS :: origin_addr  42
INTEGER, INTENT(IN) :: origin_count, result_count, target_rank,    43
                    target_count                                       44
TYPE(MPI_Datatype), INTENT(IN) :: origin_datatype, result_datatype,  45
                    target_datatype                                     46
TYPE(*), DIMENSION(..), ASYNCHRONOUS :: result_addr           47
INTEGER(KIND=MPI_ADDRESS_KIND), INTENT(IN) :: target_disp           48
TYPE(MPI_Op), INTENT(IN) :: op                                       49

```

```

1     TYPE(MPI_Win), INTENT(IN) :: win
2     TYPE(MPI_Request), INTENT(OUT) :: request
3     INTEGER, OPTIONAL, INTENT(OUT) :: ierror
4
5     MPI_Rput(origin_addr, origin_count, origin_datatype, target_rank,
6             target_disp, target_count, target_datatype, win, request,
7             ierror)
8     TYPE(*), DIMENSION(..), INTENT(IN), ASYNCHRONOUS :: origin_addr
9     INTEGER(KIND=MPI_COUNT_KIND), INTENT(IN) :: origin_count, target_count
10    TYPE(MPI_Datatype), INTENT(IN) :: origin_datatype, target_datatype
11    INTEGER, INTENT(IN) :: target_rank
12    INTEGER(KIND=MPI_ADDRESS_KIND), INTENT(IN) :: target_disp
13    TYPE(MPI_Win), INTENT(IN) :: win
14    TYPE(MPI_Request), INTENT(OUT) :: request
15    INTEGER, OPTIONAL, INTENT(OUT) :: ierror
16
17    MPI_Rput(origin_addr, origin_count, origin_datatype, target_rank,
18            target_disp, target_count, target_datatype, win, request,
19            ierror)
20    TYPE(*), DIMENSION(..), INTENT(IN), ASYNCHRONOUS :: origin_addr
21    INTEGER, INTENT(IN) :: origin_count, target_rank, target_count
22    TYPE(MPI_Datatype), INTENT(IN) :: origin_datatype, target_datatype
23    INTEGER(KIND=MPI_ADDRESS_KIND), INTENT(IN) :: target_disp
24    TYPE(MPI_Win), INTENT(IN) :: win
25    TYPE(MPI_Request), INTENT(OUT) :: request
26    INTEGER, OPTIONAL, INTENT(OUT) :: ierror
27
28    MPI_Win_allocate(size, disp_unit, info, comm, baseptr, win, ierror)
29    USE, INTRINSIC :: ISO_C_BINDING, ONLY : C_PTR
30    INTEGER(KIND=MPI_ADDRESS_KIND), INTENT(IN) :: size
31    INTEGER, INTENT(IN) :: disp_unit
32    TYPE(MPI_Info), INTENT(IN) :: info
33    TYPE(MPI_Comm), INTENT(IN) :: comm
34    TYPE(C_PTR), INTENT(OUT) :: baseptr
35    TYPE(MPI_Win), INTENT(OUT) :: win
36    INTEGER, OPTIONAL, INTENT(OUT) :: ierror
37
38    MPI_Win_allocate(size, disp_unit, info, comm, baseptr, win, ierror)
39    USE, INTRINSIC :: ISO_C_BINDING, ONLY : C_PTR
40    INTEGER(KIND=MPI_ADDRESS_KIND), INTENT(IN) :: size, disp_unit
41    TYPE(MPI_Info), INTENT(IN) :: info
42    TYPE(MPI_Comm), INTENT(IN) :: comm
43    TYPE(C_PTR), INTENT(OUT) :: baseptr
44    TYPE(MPI_Win), INTENT(OUT) :: win
45    INTEGER, OPTIONAL, INTENT(OUT) :: ierror
46
47    MPI_Win_allocate_shared(size, disp_unit, info, comm, baseptr, win, ierror)
48    USE, INTRINSIC :: ISO_C_BINDING, ONLY : C_PTR
49    INTEGER(KIND=MPI_ADDRESS_KIND), INTENT(IN) :: size
50    INTEGER, INTENT(IN) :: disp_unit

```

```

TYPE(MPI_Info), INTENT(IN) :: info
TYPE(MPI_Comm), INTENT(IN) :: comm
TYPE(C_PTR), INTENT(OUT) :: baseptr
TYPE(MPI_Win), INTENT(OUT) :: win
INTEGER, OPTIONAL, INTENT(OUT) :: ierror

MPI_Win_allocate_shared(size, disp_unit, info, comm, baseptr, win, ierror)
USE, INTRINSIC :: ISO_C_BINDING, ONLY : C_PTR
INTEGER(KIND=MPI_ADDRESS_KIND), INTENT(IN) :: size, disp_unit
TYPE(MPI_Info), INTENT(IN) :: info
TYPE(MPI_Comm), INTENT(IN) :: comm
TYPE(C_PTR), INTENT(OUT) :: baseptr
TYPE(MPI_Win), INTENT(OUT) :: win
INTEGER, OPTIONAL, INTENT(OUT) :: ierror

MPI_Win_attach(win, base, size, ierror)
TYPE(MPI_Win), INTENT(IN) :: win
TYPE(*), DIMENSION(..), ASYNCHRONOUS :: base
INTEGER(KIND=MPI_ADDRESS_KIND), INTENT(IN) :: size
INTEGER, OPTIONAL, INTENT(OUT) :: ierror

MPI_Win_complete(win, ierror)
TYPE(MPI_Win), INTENT(IN) :: win
INTEGER, OPTIONAL, INTENT(OUT) :: ierror

MPI_Win_create(base, size, disp_unit, info, comm, win, ierror)
TYPE(*), DIMENSION(..), ASYNCHRONOUS :: base
INTEGER(KIND=MPI_ADDRESS_KIND), INTENT(IN) :: size
INTEGER, INTENT(IN) :: disp_unit
TYPE(MPI_Info), INTENT(IN) :: info
TYPE(MPI_Comm), INTENT(IN) :: comm
TYPE(MPI_Win), INTENT(OUT) :: win
INTEGER, OPTIONAL, INTENT(OUT) :: ierror

MPI_Win_create(base, size, disp_unit, info, comm, win, ierror)
TYPE(*), DIMENSION(..), ASYNCHRONOUS :: base
INTEGER(KIND=MPI_ADDRESS_KIND), INTENT(IN) :: size, disp_unit
TYPE(MPI_Info), INTENT(IN) :: info
TYPE(MPI_Comm), INTENT(IN) :: comm
TYPE(MPI_Win), INTENT(OUT) :: win
INTEGER, OPTIONAL, INTENT(OUT) :: ierror

MPI_Win_create_dynamic(info, comm, win, ierror)
TYPE(MPI_Info), INTENT(IN) :: info
TYPE(MPI_Comm), INTENT(IN) :: comm
TYPE(MPI_Win), INTENT(OUT) :: win
INTEGER, OPTIONAL, INTENT(OUT) :: ierror

MPI_Win_detach(win, base, ierror)
TYPE(MPI_Win), INTENT(IN) :: win
TYPE(*), DIMENSION(..), ASYNCHRONOUS :: base

```

```
1     INTEGER, OPTIONAL, INTENT(OUT) :: ierror
2
3     MPI_Win_fence(assert, win, ierror)
4         INTEGER, INTENT(IN) :: assert
5         TYPE(MPI_Win), INTENT(IN) :: win
6         INTEGER, OPTIONAL, INTENT(OUT) :: ierror
7
8     MPI_Win_flush(rank, win, ierror)
9         INTEGER, INTENT(IN) :: rank
10        TYPE(MPI_Win), INTENT(IN) :: win
11        INTEGER, OPTIONAL, INTENT(OUT) :: ierror
12
13    MPI_Win_flush_all(win, ierror)
14        TYPE(MPI_Win), INTENT(IN) :: win
15        INTEGER, OPTIONAL, INTENT(OUT) :: ierror
16
17    MPI_Win_flush_local(rank, win, ierror)
18        INTEGER, INTENT(IN) :: rank
19        TYPE(MPI_Win), INTENT(IN) :: win
20        INTEGER, OPTIONAL, INTENT(OUT) :: ierror
21
22    MPI_Win_flush_local_all(win, ierror)
23        TYPE(MPI_Win), INTENT(IN) :: win
24        INTEGER, OPTIONAL, INTENT(OUT) :: ierror
25
26    MPI_Win_free(win, ierror)
27        TYPE(MPI_Win), INTENT(INOUT) :: win
28        INTEGER, OPTIONAL, INTENT(OUT) :: ierror
29
30    MPI_Win_get_group(win, group, ierror)
31        TYPE(MPI_Win), INTENT(IN) :: win
32        TYPE(MPI_Group), INTENT(OUT) :: group
33        INTEGER, OPTIONAL, INTENT(OUT) :: ierror
34
35    MPI_Win_get_info(win, info_used, ierror)
36        TYPE(MPI_Win), INTENT(IN) :: win
37        TYPE(MPI_Info), INTENT(OUT) :: info_used
38        INTEGER, OPTIONAL, INTENT(OUT) :: ierror
39
40    MPI_Win_lock(lock_type, rank, assert, win, ierror)
41        INTEGER, INTENT(IN) :: lock_type, rank, assert
42        TYPE(MPI_Win), INTENT(IN) :: win
43        INTEGER, OPTIONAL, INTENT(OUT) :: ierror
44
45    MPI_Win_lock_all(assert, win, ierror)
46        INTEGER, INTENT(IN) :: assert
47        TYPE(MPI_Win), INTENT(IN) :: win
48        INTEGER, OPTIONAL, INTENT(OUT) :: ierror
49
50    MPI_Win_post(group, assert, win, ierror)
51        TYPE(MPI_Group), INTENT(IN) :: group
52        INTEGER, INTENT(IN) :: assert
53        TYPE(MPI_Win), INTENT(IN) :: win
```

```
INTEGER, OPTIONAL, INTENT(OUT) :: ierror 1
MPI_Win_set_info(win, info, ierror) 2
TYPE(MPI_Win), INTENT(IN) :: win 3
TYPE(MPI_Info), INTENT(IN) :: info 4
INTEGER, OPTIONAL, INTENT(OUT) :: ierror 5
MPI_Win_shared_query(win, rank, size, disp_unit, baseptr, ierror) 6
USE, INTRINSIC :: ISO_C_BINDING, ONLY : C_PTR 7
TYPE(MPI_Win), INTENT(IN) :: win 8
INTEGER, INTENT(IN) :: rank 9
INTEGER(KIND=MPI_ADDRESS_KIND), INTENT(OUT) :: size 10
INTEGER, INTENT(OUT) :: disp_unit 11
TYPE(C_PTR), INTENT(OUT) :: baseptr 12
INTEGER, OPTIONAL, INTENT(OUT) :: ierror 13
MPI_Win_shared_query(win, rank, size, disp_unit, baseptr, ierror) 14
USE, INTRINSIC :: ISO_C_BINDING, ONLY : C_PTR 15
TYPE(MPI_Win), INTENT(IN) :: win 16
INTEGER, INTENT(IN) :: rank 17
INTEGER(KIND=MPI_ADDRESS_KIND), INTENT(OUT) :: size, disp_unit 18
TYPE(C_PTR), INTENT(OUT) :: baseptr 19
INTEGER, OPTIONAL, INTENT(OUT) :: ierror 20
MPI_Win_start(group, assert, win, ierror) 21
TYPE(MPI_Group), INTENT(IN) :: group 22
INTEGER, INTENT(IN) :: assert 23
TYPE(MPI_Win), INTENT(IN) :: win 24
INTEGER, OPTIONAL, INTENT(OUT) :: ierror 25
MPI_Win_sync(win, ierror) 26
TYPE(MPI_Win), INTENT(IN) :: win 27
INTEGER, OPTIONAL, INTENT(OUT) :: ierror 28
MPI_Win_test(win, flag, ierror) 29
TYPE(MPI_Win), INTENT(IN) :: win 30
LOGICAL, INTENT(OUT) :: flag 31
INTEGER, OPTIONAL, INTENT(OUT) :: ierror 32
MPI_Win_unlock(rank, win, ierror) 33
INTEGER, INTENT(IN) :: rank 34
TYPE(MPI_Win), INTENT(IN) :: win 35
INTEGER, OPTIONAL, INTENT(OUT) :: ierror 36
MPI_Win_unlock_all(win, ierror) 37
TYPE(MPI_Win), INTENT(IN) :: win 38
INTEGER, OPTIONAL, INTENT(OUT) :: ierror 39
MPI_Win_wait(win, ierror) 40
TYPE(MPI_Win), INTENT(IN) :: win 41
INTEGER, OPTIONAL, INTENT(OUT) :: ierror 42
43
44
45
46
47
48
```

#### A.4.11 External Interfaces Fortran 2008 Bindings

```

1 MPI_Grequest_complete(request, ierror)
2
3     TYPE(MPI_Request), INTENT(IN) :: request
4     INTEGER, OPTIONAL, INTENT(OUT) :: ierror
5
6 MPI_Grequest_start(query_fn, free_fn, cancel_fn, extra_state, request,
7     ierror)
8     PROCEDURE(MPI_Grequest_query_function), INTENT(IN) :: query_fn
9     PROCEDURE(MPI_Grequest_free_function), INTENT(IN) :: free_fn
10    PROCEDURE(MPI_Grequest_cancel_function), INTENT(IN) :: cancel_fn
11    INTEGER(KIND=MPI_ADDRESS_KIND), INTENT(IN) :: extra_state
12    TYPE(MPI_Request), INTENT(OUT) :: request
13    INTEGER, OPTIONAL, INTENT(OUT) :: ierror
14
15 MPI_Status_set_cancelled(status, flag, ierror)
16     TYPE(MPI_Status), INTENT(INOUT) :: status
17     LOGICAL, INTENT(IN) :: flag
18     INTEGER, OPTIONAL, INTENT(OUT) :: ierror
19
20 MPI_Status_set_elements(status, datatype, count, ierror)
21     TYPE(MPI_Status), INTENT(INOUT) :: status
22     TYPE(MPI_Datatype), INTENT(IN) :: datatype
23     INTEGER, INTENT(IN) :: count
24     INTEGER, OPTIONAL, INTENT(OUT) :: ierror
25
26 MPI_Status_set_elements_x(status, datatype, count, ierror)
27     TYPE(MPI_Status), INTENT(INOUT) :: status
28     TYPE(MPI_Datatype), INTENT(IN) :: datatype
29     INTEGER(KIND=MPI_COUNT_KIND), INTENT(IN) :: count
30     INTEGER, OPTIONAL, INTENT(OUT) :: ierror

```

#### A.4.12 I/O Fortran 2008 Bindings

```

31
32 MPI_CONVERSION_FN_NULL(userbuf, datatype, count, filebuf, position,
33     extra_state, ierror)
34     USE, INTRINSIC :: ISO_C_BINDING, ONLY : C_PTR
35     TYPE(C_PTR), VALUE :: userbuf, filebuf
36     TYPE(MPI_Datatype) :: datatype
37     INTEGER(KIND=MPI_COUNT_KIND) :: count
38     INTEGER(KIND=MPI_OFFSET_KIND) :: position
39     INTEGER(KIND=MPI_ADDRESS_KIND) :: extra_state
40     INTEGER :: ierror
41
42 MPI_CONVERSION_FN_NULL(userbuf, datatype, count, filebuf, position,
43     extra_state, ierror)
44     USE, INTRINSIC :: ISO_C_BINDING, ONLY : C_PTR
45     TYPE(C_PTR), VALUE :: userbuf, filebuf
46     TYPE(MPI_Datatype) :: datatype
47     INTEGER :: count, ierror
48

```

```

    INTEGER(KIND=MPI_OFFSET_KIND) :: position
    INTEGER(KIND=MPI_ADDRESS_KIND) :: extra_state
MPI_File_close(fh, ierror)
    TYPE(MPI_File), INTENT(INOUT) :: fh
    INTEGER, OPTIONAL, INTENT(OUT) :: ierror
MPI_File_delete(filename, info, ierror)
    CHARACTER(LEN=*), INTENT(IN) :: filename
    TYPE(MPI_Info), INTENT(IN) :: info
    INTEGER, OPTIONAL, INTENT(OUT) :: ierror
MPI_File_get_amode(fh, amode, ierror)
    TYPE(MPI_File), INTENT(IN) :: fh
    INTEGER, INTENT(OUT) :: amode
    INTEGER, OPTIONAL, INTENT(OUT) :: ierror
MPI_File_get_atomicity(fh, flag, ierror)
    TYPE(MPI_File), INTENT(IN) :: fh
    LOGICAL, INTENT(OUT) :: flag
    INTEGER, OPTIONAL, INTENT(OUT) :: ierror
MPI_File_get_byte_offset(fh, offset, disp, ierror)
    TYPE(MPI_File), INTENT(IN) :: fh
    INTEGER(KIND=MPI_OFFSET_KIND), INTENT(IN) :: offset
    INTEGER(KIND=MPI_OFFSET_KIND), INTENT(OUT) :: disp
    INTEGER, OPTIONAL, INTENT(OUT) :: ierror
MPI_File_get_group(fh, group, ierror)
    TYPE(MPI_File), INTENT(IN) :: fh
    TYPE(MPI_Group), INTENT(OUT) :: group
    INTEGER, OPTIONAL, INTENT(OUT) :: ierror
MPI_File_get_info(fh, info_used, ierror)
    TYPE(MPI_File), INTENT(IN) :: fh
    TYPE(MPI_Info), INTENT(OUT) :: info_used
    INTEGER, OPTIONAL, INTENT(OUT) :: ierror
MPI_File_get_position(fh, offset, ierror)
    TYPE(MPI_File), INTENT(IN) :: fh
    INTEGER(KIND=MPI_OFFSET_KIND), INTENT(OUT) :: offset
    INTEGER, OPTIONAL, INTENT(OUT) :: ierror
MPI_File_get_position_shared(fh, offset, ierror)
    TYPE(MPI_File), INTENT(IN) :: fh
    INTEGER(KIND=MPI_OFFSET_KIND), INTENT(OUT) :: offset
    INTEGER, OPTIONAL, INTENT(OUT) :: ierror
MPI_File_get_size(fh, size, ierror)
    TYPE(MPI_File), INTENT(IN) :: fh
    INTEGER(KIND=MPI_OFFSET_KIND), INTENT(OUT) :: size
    INTEGER, OPTIONAL, INTENT(OUT) :: ierror

```

```

1 MPI_File_get_type_extent(fh, datatype, extent, ierror)
2     TYPE(MPI_File), INTENT(IN) :: fh
3     TYPE(MPI_Datatype), INTENT(IN) :: datatype
4     INTEGER(KIND=MPI_ADDRESS_KIND), INTENT(OUT) :: extent
5     INTEGER, OPTIONAL, INTENT(OUT) :: ierror
6
7 MPI_File_get_type_extent(fh, datatype, extent, ierror)
8     TYPE(MPI_File), INTENT(IN) :: fh
9     TYPE(MPI_Datatype), INTENT(IN) :: datatype
10    INTEGER(KIND=MPI_COUNT_KIND), INTENT(OUT) :: extent
11    INTEGER, OPTIONAL, INTENT(OUT) :: ierror
12
13 MPI_File_get_view(fh, disp, etype, filetype, datarep, ierror)
14    TYPE(MPI_File), INTENT(IN) :: fh
15    INTEGER(KIND=MPI_OFFSET_KIND), INTENT(OUT) :: disp
16    TYPE(MPI_Datatype), INTENT(OUT) :: etype, filetype
17    CHARACTER(LEN=*), INTENT(OUT) :: datarep
18    INTEGER, OPTIONAL, INTENT(OUT) :: ierror
19
20 MPI_File_iread(fh, buf, count, datatype, request, ierror)
21    TYPE(MPI_File), INTENT(IN) :: fh
22    TYPE(*), DIMENSION(..), ASYNCHRONOUS :: buf
23    INTEGER(KIND=MPI_COUNT_KIND), INTENT(IN) :: count
24    TYPE(MPI_Datatype), INTENT(IN) :: datatype
25    TYPE(MPI_Request), INTENT(OUT) :: request
26    INTEGER, OPTIONAL, INTENT(OUT) :: ierror
27
28 MPI_File_iread(fh, buf, count, datatype, request, ierror)
29    TYPE(MPI_File), INTENT(IN) :: fh
30    TYPE(*), DIMENSION(..), ASYNCHRONOUS :: buf
31    INTEGER, INTENT(IN) :: count
32    TYPE(MPI_Datatype), INTENT(IN) :: datatype
33    TYPE(MPI_Request), INTENT(OUT) :: request
34    INTEGER, OPTIONAL, INTENT(OUT) :: ierror
35
36 MPI_File_iread_all(fh, buf, count, datatype, request, ierror)
37    TYPE(MPI_File), INTENT(IN) :: fh
38    TYPE(*), DIMENSION(..), ASYNCHRONOUS :: buf
39    INTEGER(KIND=MPI_COUNT_KIND), INTENT(IN) :: count
40    TYPE(MPI_Datatype), INTENT(IN) :: datatype
41    TYPE(MPI_Request), INTENT(OUT) :: request
42    INTEGER, OPTIONAL, INTENT(OUT) :: ierror
43
44 MPI_File_iread_all(fh, buf, count, datatype, request, ierror)
45    TYPE(MPI_File), INTENT(IN) :: fh
46    TYPE(*), DIMENSION(..), ASYNCHRONOUS :: buf
47    INTEGER, INTENT(IN) :: count
48    TYPE(MPI_Datatype), INTENT(IN) :: datatype
49    TYPE(MPI_Request), INTENT(OUT) :: request
50    INTEGER, OPTIONAL, INTENT(OUT) :: ierror

```



```

MPI_File_iread_at(fh, offset, buf, count, datatype, request, ierror)      1
  TYPE(MPI_File), INTENT(IN) :: fh                                       2
  INTEGER(KIND=MPI_OFFSET_KIND), INTENT(IN) :: offset                    3
  TYPE(*), DIMENSION(..), ASYNCHRONOUS :: buf                            4
  INTEGER(KIND=MPI_COUNT_KIND), INTENT(IN) :: count                       5
  TYPE(MPI_Datatype), INTENT(IN) :: datatype                             6
  TYPE(MPI_Request), INTENT(OUT) :: request                              7
  INTEGER, OPTIONAL, INTENT(OUT) :: ierror                               8
                                                                           9
MPI_File_iread_at(fh, offset, buf, count, datatype, request, ierror)    10
  TYPE(MPI_File), INTENT(IN) :: fh                                       11
  INTEGER(KIND=MPI_OFFSET_KIND), INTENT(IN) :: offset                    12
  TYPE(*), DIMENSION(..), ASYNCHRONOUS :: buf                            13
  INTEGER, INTENT(IN) :: count                                           14
  TYPE(MPI_Datatype), INTENT(IN) :: datatype                             15
  TYPE(MPI_Request), INTENT(OUT) :: request                              16
  INTEGER, OPTIONAL, INTENT(OUT) :: ierror                               17
                                                                           18
MPI_File_iread_at_all(fh, offset, buf, count, datatype, request, ierror) 19
  TYPE(MPI_File), INTENT(IN) :: fh                                       20
  INTEGER(KIND=MPI_OFFSET_KIND), INTENT(IN) :: offset                    21
  TYPE(*), DIMENSION(..), ASYNCHRONOUS :: buf                            22
  INTEGER(KIND=MPI_COUNT_KIND), INTENT(IN) :: count                       23
  TYPE(MPI_Datatype), INTENT(IN) :: datatype                             24
  TYPE(MPI_Request), INTENT(OUT) :: request                              25
  INTEGER, OPTIONAL, INTENT(OUT) :: ierror                               26
                                                                           27
MPI_File_iread_at_all(fh, offset, buf, count, datatype, request, ierror) 28
  TYPE(MPI_File), INTENT(IN) :: fh                                       29
  INTEGER(KIND=MPI_OFFSET_KIND), INTENT(IN) :: offset                    30
  TYPE(*), DIMENSION(..), ASYNCHRONOUS :: buf                            31
  INTEGER, INTENT(IN) :: count                                           32
  TYPE(MPI_Datatype), INTENT(IN) :: datatype                             33
  TYPE(MPI_Request), INTENT(OUT) :: request                              34
  INTEGER, OPTIONAL, INTENT(OUT) :: ierror                               35
                                                                           36
MPI_File_iread_shared(fh, buf, count, datatype, request, ierror)        37
  TYPE(MPI_File), INTENT(IN) :: fh                                       38
  TYPE(*), DIMENSION(..), ASYNCHRONOUS :: buf                            39
  INTEGER(KIND=MPI_COUNT_KIND), INTENT(IN) :: count                       40
  TYPE(MPI_Datatype), INTENT(IN) :: datatype                             41
  TYPE(MPI_Request), INTENT(OUT) :: request                              42
  INTEGER, OPTIONAL, INTENT(OUT) :: ierror                               43
                                                                           44
MPI_File_iread_shared(fh, buf, count, datatype, request, ierror)        45
  TYPE(MPI_File), INTENT(IN) :: fh                                       46
  TYPE(*), DIMENSION(..), ASYNCHRONOUS :: buf                            47
  INTEGER, INTENT(IN) :: count                                           48
  TYPE(MPI_Datatype), INTENT(IN) :: datatype                             49
  TYPE(MPI_Request), INTENT(OUT) :: request                              50

```

```

1     INTEGER, OPTIONAL, INTENT(OUT) :: ierror
2
3     MPI_File_iwrite(fh, buf, count, datatype, request, ierror)
4         TYPE(MPI_File), INTENT(IN) :: fh
5         TYPE(*), DIMENSION(..), INTENT(IN), ASYNCHRONOUS :: buf
6         INTEGER(KIND=MPI_COUNT_KIND), INTENT(IN) :: count
7         TYPE(MPI_Datatype), INTENT(IN) :: datatype
8         TYPE(MPI_Request), INTENT(OUT) :: request
9         INTEGER, OPTIONAL, INTENT(OUT) :: ierror
10
11    MPI_File_iwrite(fh, buf, count, datatype, request, ierror)
12        TYPE(MPI_File), INTENT(IN) :: fh
13        TYPE(*), DIMENSION(..), INTENT(IN), ASYNCHRONOUS :: buf
14        INTEGER, INTENT(IN) :: count
15        TYPE(MPI_Datatype), INTENT(IN) :: datatype
16        TYPE(MPI_Request), INTENT(OUT) :: request
17        INTEGER, OPTIONAL, INTENT(OUT) :: ierror
18
19    MPI_File_iwrite_all(fh, buf, count, datatype, request, ierror)
20        TYPE(MPI_File), INTENT(IN) :: fh
21        TYPE(*), DIMENSION(..), INTENT(IN), ASYNCHRONOUS :: buf
22        INTEGER(KIND=MPI_COUNT_KIND), INTENT(IN) :: count
23        TYPE(MPI_Datatype), INTENT(IN) :: datatype
24        TYPE(MPI_Request), INTENT(OUT) :: request
25        INTEGER, OPTIONAL, INTENT(OUT) :: ierror
26
27    MPI_File_iwrite_all(fh, buf, count, datatype, request, ierror)
28        TYPE(MPI_File), INTENT(IN) :: fh
29        TYPE(*), DIMENSION(..), INTENT(IN), ASYNCHRONOUS :: buf
30        INTEGER, INTENT(IN) :: count
31        TYPE(MPI_Datatype), INTENT(IN) :: datatype
32        TYPE(MPI_Request), INTENT(OUT) :: request
33        INTEGER, OPTIONAL, INTENT(OUT) :: ierror
34
35    MPI_File_iwrite_at(fh, offset, buf, count, datatype, request, ierror)
36        TYPE(MPI_File), INTENT(IN) :: fh
37        INTEGER(KIND=MPI_OFFSET_KIND), INTENT(IN) :: offset
38        TYPE(*), DIMENSION(..), INTENT(IN), ASYNCHRONOUS :: buf
39        INTEGER(KIND=MPI_COUNT_KIND), INTENT(IN) :: count
40        TYPE(MPI_Datatype), INTENT(IN) :: datatype
41        TYPE(MPI_Request), INTENT(OUT) :: request
42        INTEGER, OPTIONAL, INTENT(OUT) :: ierror
43
44    MPI_File_iwrite_at(fh, offset, buf, count, datatype, request, ierror)
45        TYPE(MPI_File), INTENT(IN) :: fh
46        INTEGER(KIND=MPI_OFFSET_KIND), INTENT(IN) :: offset
47        TYPE(*), DIMENSION(..), INTENT(IN), ASYNCHRONOUS :: buf
48        INTEGER, INTENT(IN) :: count
49        TYPE(MPI_Datatype), INTENT(IN) :: datatype
50        TYPE(MPI_Request), INTENT(OUT) :: request

```

```

    INTEGER, OPTIONAL, INTENT(OUT) :: ierror
1
MPI_File_iwrite_at_all(fh, offset, buf, count, datatype, request, ierror)
2
    TYPE(MPI_File), INTENT(IN) :: fh
3
    INTEGER(KIND=MPI_OFFSET_KIND), INTENT(IN) :: offset
4
    TYPE(*), DIMENSION(..), INTENT(IN), ASYNCHRONOUS :: buf
5
    INTEGER(KIND=MPI_COUNT_KIND), INTENT(IN) :: count
6
    TYPE(MPI_Datatype), INTENT(IN) :: datatype
7
    TYPE(MPI_Request), INTENT(OUT) :: request
8
    INTEGER, OPTIONAL, INTENT(OUT) :: ierror
9
10
MPI_File_iwrite_at_all(fh, offset, buf, count, datatype, request, ierror)
11
    TYPE(MPI_File), INTENT(IN) :: fh
12
    INTEGER(KIND=MPI_OFFSET_KIND), INTENT(IN) :: offset
13
    TYPE(*), DIMENSION(..), INTENT(IN), ASYNCHRONOUS :: buf
14
    INTEGER, INTENT(IN) :: count
15
    TYPE(MPI_Datatype), INTENT(IN) :: datatype
16
    TYPE(MPI_Request), INTENT(OUT) :: request
17
    INTEGER, OPTIONAL, INTENT(OUT) :: ierror
18
19
MPI_File_iwrite_shared(fh, buf, count, datatype, request, ierror)
20
    TYPE(MPI_File), INTENT(IN) :: fh
21
    TYPE(*), DIMENSION(..), INTENT(IN), ASYNCHRONOUS :: buf
22
    INTEGER(KIND=MPI_COUNT_KIND), INTENT(IN) :: count
23
    TYPE(MPI_Datatype), INTENT(IN) :: datatype
24
    TYPE(MPI_Request), INTENT(OUT) :: request
25
    INTEGER, OPTIONAL, INTENT(OUT) :: ierror
26
27
MPI_File_iwrite_shared(fh, buf, count, datatype, request, ierror)
28
    TYPE(MPI_File), INTENT(IN) :: fh
29
    TYPE(*), DIMENSION(..), INTENT(IN), ASYNCHRONOUS :: buf
30
    INTEGER, INTENT(IN) :: count
31
    TYPE(MPI_Datatype), INTENT(IN) :: datatype
32
    TYPE(MPI_Request), INTENT(OUT) :: request
33
    INTEGER, OPTIONAL, INTENT(OUT) :: ierror
34
35
MPI_File_open(comm, filename, amode, info, fh, ierror)
36
    TYPE(MPI_Comm), INTENT(IN) :: comm
37
    CHARACTER(LEN=*), INTENT(IN) :: filename
38
    INTEGER, INTENT(IN) :: amode
39
    TYPE(MPI_Info), INTENT(IN) :: info
40
    TYPE(MPI_File), INTENT(OUT) :: fh
41
    INTEGER, OPTIONAL, INTENT(OUT) :: ierror
42
43
MPI_File_preallocate(fh, size, ierror)
44
    TYPE(MPI_File), INTENT(IN) :: fh
45
    INTEGER(KIND=MPI_OFFSET_KIND), INTENT(IN) :: size
46
    INTEGER, OPTIONAL, INTENT(OUT) :: ierror
47
48
MPI_File_read(fh, buf, count, datatype, status, ierror)
49
    TYPE(MPI_File), INTENT(IN) :: fh
50

```

```

1     TYPE(*), DIMENSION(..) :: buf
2     INTEGER(KIND=MPI_COUNT_KIND), INTENT(IN) :: count
3     TYPE(MPI_Datatype), INTENT(IN) :: datatype
4     TYPE(MPI_Status) :: status
5     INTEGER, OPTIONAL, INTENT(OUT) :: ierror
6
7 MPI_File_read(fh, buf, count, datatype, status, ierror)
8     TYPE(MPI_File), INTENT(IN) :: fh
9     TYPE(*), DIMENSION(..) :: buf
10    INTEGER, INTENT(IN) :: count
11    TYPE(MPI_Datatype), INTENT(IN) :: datatype
12    TYPE(MPI_Status) :: status
13    INTEGER, OPTIONAL, INTENT(OUT) :: ierror
14
15 MPI_File_read_all(fh, buf, count, datatype, status, ierror)
16    TYPE(MPI_File), INTENT(IN) :: fh
17    TYPE(*), DIMENSION(..) :: buf
18    INTEGER(KIND=MPI_COUNT_KIND), INTENT(IN) :: count
19    TYPE(MPI_Datatype), INTENT(IN) :: datatype
20    TYPE(MPI_Status) :: status
21    INTEGER, OPTIONAL, INTENT(OUT) :: ierror
22
23 MPI_File_read_all(fh, buf, count, datatype, status, ierror)
24    TYPE(MPI_File), INTENT(IN) :: fh
25    TYPE(*), DIMENSION(..) :: buf
26    INTEGER, INTENT(IN) :: count
27    TYPE(MPI_Datatype), INTENT(IN) :: datatype
28    TYPE(MPI_Status) :: status
29    INTEGER, OPTIONAL, INTENT(OUT) :: ierror
30
31 MPI_File_read_all_begin(fh, buf, count, datatype, ierror)
32    TYPE(MPI_File), INTENT(IN) :: fh
33    TYPE(*), DIMENSION(..), ASYNCHRONOUS :: buf
34    INTEGER(KIND=MPI_COUNT_KIND), INTENT(IN) :: count
35    TYPE(MPI_Datatype), INTENT(IN) :: datatype
36    INTEGER, OPTIONAL, INTENT(OUT) :: ierror
37
38 MPI_File_read_all_begin(fh, buf, count, datatype, ierror)
39    TYPE(MPI_File), INTENT(IN) :: fh
40    TYPE(*), DIMENSION(..), ASYNCHRONOUS :: buf
41    INTEGER, INTENT(IN) :: count
42    TYPE(MPI_Datatype), INTENT(IN) :: datatype
43    INTEGER, OPTIONAL, INTENT(OUT) :: ierror
44
45 MPI_File_read_all_end(fh, buf, status, ierror)
46    TYPE(MPI_File), INTENT(IN) :: fh
47    TYPE(*), DIMENSION(..), ASYNCHRONOUS :: buf
48    TYPE(MPI_Status) :: status
49    INTEGER, OPTIONAL, INTENT(OUT) :: ierror
50
51 MPI_File_read_at(fh, offset, buf, count, datatype, status, ierror)

```

```

TYPE(MPI_File), INTENT(IN) :: fh
INTEGER(KIND=MPI_OFFSET_KIND), INTENT(IN) :: offset
TYPE(*), DIMENSION(..) :: buf
INTEGER(KIND=MPI_COUNT_KIND), INTENT(IN) :: count
TYPE(MPI_Datatype), INTENT(IN) :: datatype
TYPE(MPI_Status) :: status
INTEGER, OPTIONAL, INTENT(OUT) :: ierror

MPI_File_read_at(fh, offset, buf, count, datatype, status, ierror)
TYPE(MPI_File), INTENT(IN) :: fh
INTEGER(KIND=MPI_OFFSET_KIND), INTENT(IN) :: offset
TYPE(*), DIMENSION(..) :: buf
INTEGER, INTENT(IN) :: count
TYPE(MPI_Datatype), INTENT(IN) :: datatype
TYPE(MPI_Status) :: status
INTEGER, OPTIONAL, INTENT(OUT) :: ierror

MPI_File_read_at_all(fh, offset, buf, count, datatype, status, ierror)
TYPE(MPI_File), INTENT(IN) :: fh
INTEGER(KIND=MPI_OFFSET_KIND), INTENT(IN) :: offset
TYPE(*), DIMENSION(..) :: buf
INTEGER(KIND=MPI_COUNT_KIND), INTENT(IN) :: count
TYPE(MPI_Datatype), INTENT(IN) :: datatype
TYPE(MPI_Status) :: status
INTEGER, OPTIONAL, INTENT(OUT) :: ierror

MPI_File_read_at_all(fh, offset, buf, count, datatype, status, ierror)
TYPE(MPI_File), INTENT(IN) :: fh
INTEGER(KIND=MPI_OFFSET_KIND), INTENT(IN) :: offset
TYPE(*), DIMENSION(..) :: buf
INTEGER, INTENT(IN) :: count
TYPE(MPI_Datatype), INTENT(IN) :: datatype
TYPE(MPI_Status) :: status
INTEGER, OPTIONAL, INTENT(OUT) :: ierror

MPI_File_read_at_all_begin(fh, offset, buf, count, datatype, ierror)
TYPE(MPI_File), INTENT(IN) :: fh
INTEGER(KIND=MPI_OFFSET_KIND), INTENT(IN) :: offset
TYPE(*), DIMENSION(..), ASYNCHRONOUS :: buf
INTEGER(KIND=MPI_COUNT_KIND), INTENT(IN) :: count
TYPE(MPI_Datatype), INTENT(IN) :: datatype
INTEGER, OPTIONAL, INTENT(OUT) :: ierror

MPI_File_read_at_all_begin(fh, offset, buf, count, datatype, ierror)
TYPE(MPI_File), INTENT(IN) :: fh
INTEGER(KIND=MPI_OFFSET_KIND), INTENT(IN) :: offset
TYPE(*), DIMENSION(..), ASYNCHRONOUS :: buf
INTEGER, INTENT(IN) :: count
TYPE(MPI_Datatype), INTENT(IN) :: datatype
INTEGER, OPTIONAL, INTENT(OUT) :: ierror

```

```
1 MPI_File_read_at_all_end(fh, buf, status, ierror)
2   TYPE(MPI_File), INTENT(IN) :: fh
3   TYPE(*), DIMENSION(..), ASYNCHRONOUS :: buf
4   TYPE(MPI_Status) :: status
5   INTEGER, OPTIONAL, INTENT(OUT) :: ierror
6
7 MPI_File_read_ordered(fh, buf, count, datatype, status, ierror)
8   TYPE(MPI_File), INTENT(IN) :: fh
9   TYPE(*), DIMENSION(..) :: buf
10  INTEGER(KIND=MPI_COUNT_KIND), INTENT(IN) :: count
11  TYPE(MPI_Datatype), INTENT(IN) :: datatype
12  TYPE(MPI_Status) :: status
13  INTEGER, OPTIONAL, INTENT(OUT) :: ierror
14
15 MPI_File_read_ordered(fh, buf, count, datatype, status, ierror)
16  TYPE(MPI_File), INTENT(IN) :: fh
17  TYPE(*), DIMENSION(..) :: buf
18  INTEGER, INTENT(IN) :: count
19  TYPE(MPI_Datatype), INTENT(IN) :: datatype
20  TYPE(MPI_Status) :: status
21  INTEGER, OPTIONAL, INTENT(OUT) :: ierror
22
23 MPI_File_read_ordered_begin(fh, buf, count, datatype, ierror)
24  TYPE(MPI_File), INTENT(IN) :: fh
25  TYPE(*), DIMENSION(..), ASYNCHRONOUS :: buf
26  INTEGER(KIND=MPI_COUNT_KIND), INTENT(IN) :: count
27  TYPE(MPI_Datatype), INTENT(IN) :: datatype
28  INTEGER, OPTIONAL, INTENT(OUT) :: ierror
29
30 MPI_File_read_ordered_begin(fh, buf, count, datatype, ierror)
31  TYPE(MPI_File), INTENT(IN) :: fh
32  TYPE(*), DIMENSION(..), ASYNCHRONOUS :: buf
33  INTEGER, INTENT(IN) :: count
34  TYPE(MPI_Datatype), INTENT(IN) :: datatype
35  INTEGER, OPTIONAL, INTENT(OUT) :: ierror
36
37 MPI_File_read_ordered_end(fh, buf, status, ierror)
38  TYPE(MPI_File), INTENT(IN) :: fh
39  TYPE(*), DIMENSION(..), ASYNCHRONOUS :: buf
40  TYPE(MPI_Status) :: status
41  INTEGER, OPTIONAL, INTENT(OUT) :: ierror
42
43 MPI_File_read_shared(fh, buf, count, datatype, status, ierror)
44  TYPE(MPI_File), INTENT(IN) :: fh
45  TYPE(*), DIMENSION(..) :: buf
46  INTEGER(KIND=MPI_COUNT_KIND), INTENT(IN) :: count
47  TYPE(MPI_Datatype), INTENT(IN) :: datatype
48  TYPE(MPI_Status) :: status
49  INTEGER, OPTIONAL, INTENT(OUT) :: ierror
50
51 MPI_File_read_shared(fh, buf, count, datatype, status, ierror)
```

```

TYPE(MPI_File), INTENT(IN) :: fh
TYPE(*), DIMENSION(..) :: buf
INTEGER, INTENT(IN) :: count
TYPE(MPI_Datatype), INTENT(IN) :: datatype
TYPE(MPI_Status) :: status
INTEGER, OPTIONAL, INTENT(OUT) :: ierror

MPI_File_seek(fh, offset, whence, ierror)
TYPE(MPI_File), INTENT(IN) :: fh
INTEGER(KIND=MPI_OFFSET_KIND), INTENT(IN) :: offset
INTEGER, INTENT(IN) :: whence
INTEGER, OPTIONAL, INTENT(OUT) :: ierror

MPI_File_seek_shared(fh, offset, whence, ierror)
TYPE(MPI_File), INTENT(IN) :: fh
INTEGER(KIND=MPI_OFFSET_KIND), INTENT(IN) :: offset
INTEGER, INTENT(IN) :: whence
INTEGER, OPTIONAL, INTENT(OUT) :: ierror

MPI_File_set_atomicity(fh, flag, ierror)
TYPE(MPI_File), INTENT(IN) :: fh
LOGICAL, INTENT(IN) :: flag
INTEGER, OPTIONAL, INTENT(OUT) :: ierror

MPI_File_set_info(fh, info, ierror)
TYPE(MPI_File), INTENT(IN) :: fh
TYPE(MPI_Info), INTENT(IN) :: info
INTEGER, OPTIONAL, INTENT(OUT) :: ierror

MPI_File_set_size(fh, size, ierror)
TYPE(MPI_File), INTENT(IN) :: fh
INTEGER(KIND=MPI_OFFSET_KIND), INTENT(IN) :: size
INTEGER, OPTIONAL, INTENT(OUT) :: ierror

MPI_File_set_view(fh, disp, etype, filetype, datarep, info, ierror)
TYPE(MPI_File), INTENT(IN) :: fh
INTEGER(KIND=MPI_OFFSET_KIND), INTENT(IN) :: disp
TYPE(MPI_Datatype), INTENT(IN) :: etype, filetype
CHARACTER(LEN=*), INTENT(IN) :: datarep
TYPE(MPI_Info), INTENT(IN) :: info
INTEGER, OPTIONAL, INTENT(OUT) :: ierror

MPI_File_sync(fh, ierror)
TYPE(MPI_File), INTENT(IN) :: fh
INTEGER, OPTIONAL, INTENT(OUT) :: ierror

MPI_File_write(fh, buf, count, datatype, status, ierror)
TYPE(MPI_File), INTENT(IN) :: fh
TYPE(*), DIMENSION(..), INTENT(IN) :: buf
INTEGER(KIND=MPI_COUNT_KIND), INTENT(IN) :: count
TYPE(MPI_Datatype), INTENT(IN) :: datatype

```

```

1     TYPE(MPI_Status) :: status
2     INTEGER, OPTIONAL, INTENT(OUT) :: ierror
3
4     MPI_File_write(fh, buf, count, datatype, status, ierror)
5         TYPE(MPI_File), INTENT(IN) :: fh
6         TYPE(*), DIMENSION(..), INTENT(IN) :: buf
7         INTEGER, INTENT(IN) :: count
8         TYPE(MPI_Datatype), INTENT(IN) :: datatype
9         TYPE(MPI_Status) :: status
10        INTEGER, OPTIONAL, INTENT(OUT) :: ierror
11
12     MPI_File_write_all(fh, buf, count, datatype, status, ierror)
13         TYPE(MPI_File), INTENT(IN) :: fh
14         TYPE(*), DIMENSION(..), INTENT(IN) :: buf
15         INTEGER(KIND=MPI_COUNT_KIND), INTENT(IN) :: count
16         TYPE(MPI_Datatype), INTENT(IN) :: datatype
17         TYPE(MPI_Status) :: status
18         INTEGER, OPTIONAL, INTENT(OUT) :: ierror
19
20     MPI_File_write_all(fh, buf, count, datatype, status, ierror)
21         TYPE(MPI_File), INTENT(IN) :: fh
22         TYPE(*), DIMENSION(..), INTENT(IN) :: buf
23         INTEGER, INTENT(IN) :: count
24         TYPE(MPI_Datatype), INTENT(IN) :: datatype
25         TYPE(MPI_Status) :: status
26         INTEGER, OPTIONAL, INTENT(OUT) :: ierror
27
28     MPI_File_write_all_begin(fh, buf, count, datatype, ierror)
29         TYPE(MPI_File), INTENT(IN) :: fh
30         TYPE(*), DIMENSION(..), INTENT(IN), ASYNCHRONOUS :: buf
31         INTEGER(KIND=MPI_COUNT_KIND), INTENT(IN) :: count
32         TYPE(MPI_Datatype), INTENT(IN) :: datatype
33         INTEGER, OPTIONAL, INTENT(OUT) :: ierror
34
35     MPI_File_write_all_begin(fh, buf, count, datatype, ierror)
36         TYPE(MPI_File), INTENT(IN) :: fh
37         TYPE(*), DIMENSION(..), INTENT(IN), ASYNCHRONOUS :: buf
38         INTEGER, INTENT(IN) :: count
39         TYPE(MPI_Datatype), INTENT(IN) :: datatype
40         INTEGER, OPTIONAL, INTENT(OUT) :: ierror
41
42     MPI_File_write_all_end(fh, buf, status, ierror)
43         TYPE(MPI_File), INTENT(IN) :: fh
44         TYPE(*), DIMENSION(..), INTENT(IN), ASYNCHRONOUS :: buf
45         TYPE(MPI_Status) :: status
46         INTEGER, OPTIONAL, INTENT(OUT) :: ierror
47
48     MPI_File_write_at(fh, offset, buf, count, datatype, status, ierror)
49         TYPE(MPI_File), INTENT(IN) :: fh
50         INTEGER(KIND=MPI_OFFSET_KIND), INTENT(IN) :: offset
51         TYPE(*), DIMENSION(..), INTENT(IN) :: buf

```



```

INTEGER(KIND=MPI_COUNT_KIND), INTENT(IN) :: count           1
TYPE(MPI_Datatype), INTENT(IN) :: datatype                 2
TYPE(MPI_Status) :: status                                 3
INTEGER, OPTIONAL, INTENT(OUT) :: ierror                  4
                                                            5
MPI_File_write_at(fh, offset, buf, count, datatype, status, ierror) 6
TYPE(MPI_File), INTENT(IN) :: fh                          7
INTEGER(KIND=MPI_OFFSET_KIND), INTENT(IN) :: offset       8
TYPE(*), DIMENSION(..), INTENT(IN) :: buf                9
INTEGER, INTENT(IN) :: count                             10
TYPE(MPI_Datatype), INTENT(IN) :: datatype               11
TYPE(MPI_Status) :: status                                12
INTEGER, OPTIONAL, INTENT(OUT) :: ierror                 13
                                                            14
MPI_File_write_at_all(fh, offset, buf, count, datatype, status, ierror) 15
TYPE(MPI_File), INTENT(IN) :: fh                          16
INTEGER(KIND=MPI_OFFSET_KIND), INTENT(IN) :: offset       17
TYPE(*), DIMENSION(..), INTENT(IN) :: buf                18
INTEGER(KIND=MPI_COUNT_KIND), INTENT(IN) :: count         19
TYPE(MPI_Datatype), INTENT(IN) :: datatype               20
TYPE(MPI_Status) :: status                                21
INTEGER, OPTIONAL, INTENT(OUT) :: ierror                 22
                                                            23
MPI_File_write_at_all(fh, offset, buf, count, datatype, status, ierror) 24
TYPE(MPI_File), INTENT(IN) :: fh                          25
INTEGER(KIND=MPI_OFFSET_KIND), INTENT(IN) :: offset       26
TYPE(*), DIMENSION(..), INTENT(IN) :: buf                27
INTEGER, INTENT(IN) :: count                             28
TYPE(MPI_Datatype), INTENT(IN) :: datatype               29
TYPE(MPI_Status) :: status                                30
INTEGER, OPTIONAL, INTENT(OUT) :: ierror                 31
                                                            32
MPI_File_write_at_all_begin(fh, offset, buf, count, datatype, ierror) 33
TYPE(MPI_File), INTENT(IN) :: fh                          34
INTEGER(KIND=MPI_OFFSET_KIND), INTENT(IN) :: offset       35
TYPE(*), DIMENSION(..), INTENT(IN), ASYNCHRONOUS :: buf  36
INTEGER(KIND=MPI_COUNT_KIND), INTENT(IN) :: count         37
TYPE(MPI_Datatype), INTENT(IN) :: datatype               38
INTEGER, OPTIONAL, INTENT(OUT) :: ierror                 39
                                                            40
MPI_File_write_at_all_begin(fh, offset, buf, count, datatype, ierror) 41
TYPE(MPI_File), INTENT(IN) :: fh                          42
INTEGER(KIND=MPI_OFFSET_KIND), INTENT(IN) :: offset       43
TYPE(*), DIMENSION(..), INTENT(IN), ASYNCHRONOUS :: buf  44
INTEGER, INTENT(IN) :: count                             45
TYPE(MPI_Datatype), INTENT(IN) :: datatype               46
INTEGER, OPTIONAL, INTENT(OUT) :: ierror                 47
                                                            48
MPI_File_write_at_all_end(fh, buf, status, ierror)
TYPE(MPI_File), INTENT(IN) :: fh

```

```

1     TYPE(*), DIMENSION(..), INTENT(IN), ASYNCHRONOUS :: buf
2     TYPE(MPI_Status) :: status
3     INTEGER, OPTIONAL, INTENT(OUT) :: ierror
4
5     MPI_File_write_ordered(fh, buf, count, datatype, status, ierror)
6         TYPE(MPI_File), INTENT(IN) :: fh
7         TYPE(*), DIMENSION(..), INTENT(IN) :: buf
8         INTEGER(KIND=MPI_COUNT_KIND), INTENT(IN) :: count
9         TYPE(MPI_Datatype), INTENT(IN) :: datatype
10        TYPE(MPI_Status) :: status
11        INTEGER, OPTIONAL, INTENT(OUT) :: ierror
12
13    MPI_File_write_ordered(fh, buf, count, datatype, status, ierror)
14        TYPE(MPI_File), INTENT(IN) :: fh
15        TYPE(*), DIMENSION(..), INTENT(IN) :: buf
16        INTEGER, INTENT(IN) :: count
17        TYPE(MPI_Datatype), INTENT(IN) :: datatype
18        TYPE(MPI_Status) :: status
19        INTEGER, OPTIONAL, INTENT(OUT) :: ierror
20
21    MPI_File_write_ordered_begin(fh, buf, count, datatype, ierror)
22        TYPE(MPI_File), INTENT(IN) :: fh
23        TYPE(*), DIMENSION(..), INTENT(IN), ASYNCHRONOUS :: buf
24        INTEGER(KIND=MPI_COUNT_KIND), INTENT(IN) :: count
25        TYPE(MPI_Datatype), INTENT(IN) :: datatype
26        INTEGER, OPTIONAL, INTENT(OUT) :: ierror
27
28    MPI_File_write_ordered_begin(fh, buf, count, datatype, ierror)
29        TYPE(MPI_File), INTENT(IN) :: fh
30        TYPE(*), DIMENSION(..), INTENT(IN), ASYNCHRONOUS :: buf
31        INTEGER, INTENT(IN) :: count
32        TYPE(MPI_Datatype), INTENT(IN) :: datatype
33        INTEGER, OPTIONAL, INTENT(OUT) :: ierror
34
35    MPI_File_write_ordered_end(fh, buf, status, ierror)
36        TYPE(MPI_File), INTENT(IN) :: fh
37        TYPE(*), DIMENSION(..), INTENT(IN), ASYNCHRONOUS :: buf
38        TYPE(MPI_Status) :: status
39        INTEGER, OPTIONAL, INTENT(OUT) :: ierror
40
41    MPI_File_write_shared(fh, buf, count, datatype, status, ierror)
42        TYPE(MPI_File), INTENT(IN) :: fh
43        TYPE(*), DIMENSION(..), INTENT(IN) :: buf
44        INTEGER(KIND=MPI_COUNT_KIND), INTENT(IN) :: count
45        TYPE(MPI_Datatype), INTENT(IN) :: datatype
46        TYPE(MPI_Status) :: status
47        INTEGER, OPTIONAL, INTENT(OUT) :: ierror
48
49    MPI_File_write_shared(fh, buf, count, datatype, status, ierror)
50        TYPE(MPI_File), INTENT(IN) :: fh
51        TYPE(*), DIMENSION(..), INTENT(IN) :: buf

```

```

INTEGER, INTENT(IN) :: count
TYPE(MPI_Datatype), INTENT(IN) :: datatype
TYPE(MPI_Status) :: status
INTEGER, OPTIONAL, INTENT(OUT) :: ierror

MPI_Register_datarep(datarep, read_conversion_fn, write_conversion_fn,
dtype_file_extent_fn, extra_state, ierror)
CHARACTER(LEN=*), INTENT(IN) :: datarep
PROCEDURE(MPI_Datarep_conversion_function), INTENT(IN) ::
read_conversion_fn, write_conversion_fn
PROCEDURE(MPI_Datarep_extent_function) :: dtype_file_extent_fn
INTEGER(KIND=MPI_ADDRESS_KIND), INTENT(IN) :: extra_state
INTEGER, OPTIONAL, INTENT(OUT) :: ierror

MPI_Register_datarep_c(datarep, read_conversion_fn, write_conversion_fn,
dtype_file_extent_fn, extra_state, ierror)
CHARACTER(LEN=*), INTENT(IN) :: datarep
PROCEDURE(MPI_Datarep_conversion_function_c), INTENT(IN) ::
read_conversion_fn, write_conversion_fn
PROCEDURE(MPI_Datarep_extent_function) :: dtype_file_extent_fn
INTEGER(KIND=MPI_ADDRESS_KIND), INTENT(IN) :: extra_state
INTEGER, OPTIONAL, INTENT(OUT) :: ierror

A.4.13 Language Bindings Fortran 2008 Bindings

MPI_F_sync_reg(buf)
TYPE(*), DIMENSION(..), ASYNCHRONOUS :: buf

MPI_Status_f082f(f08_status, f_status, ierror)
TYPE(MPI_Status), INTENT(IN) :: f08_status
INTEGER, INTENT(OUT) :: f_status(MPI_STATUS_SIZE)
INTEGER, OPTIONAL, INTENT(OUT) :: ierror

MPI_Status_f2f08(f_status, f08_status, ierror)
INTEGER, INTENT(IN) :: f_status(MPI_STATUS_SIZE)
TYPE(MPI_Status), INTENT(OUT) :: f08_status
INTEGER, OPTIONAL, INTENT(OUT) :: ierror

MPI_Type_create_f90_complex(p, r, newtype, ierror)
INTEGER, INTENT(IN) :: p, r
TYPE(MPI_Datatype), INTENT(OUT) :: newtype
INTEGER, OPTIONAL, INTENT(OUT) :: ierror

MPI_Type_create_f90_integer(r, newtype, ierror)
INTEGER, INTENT(IN) :: r
TYPE(MPI_Datatype), INTENT(OUT) :: newtype
INTEGER, OPTIONAL, INTENT(OUT) :: ierror

MPI_Type_create_f90_real(p, r, newtype, ierror)
INTEGER, INTENT(IN) :: p, r
TYPE(MPI_Datatype), INTENT(OUT) :: newtype

```

```
1     INTEGER, OPTIONAL, INTENT(OUT) :: ierror
2
3     MPI_Type_match_size(typeclass, size, datatype, ierror)
4         INTEGER, INTENT(IN) :: typeclass, size
5         TYPE(MPI_Datatype), INTENT(OUT) :: datatype
6         INTEGER, OPTIONAL, INTENT(OUT) :: ierror
```

7

#### 8 A.4.14 Tools / Profiling Interface Fortran 2008 Bindings

9

```
10    MPI_Pcontrol(level)
11        INTEGER, INTENT(IN) :: level
```

12

#### 13 A.4.15 Deprecated Fortran 2008 Bindings

14

```
15    MPI_Info_get(info, key, valuelen, value, flag, ierror)
16        TYPE(MPI_Info), INTENT(IN) :: info
17        CHARACTER(LEN=*), INTENT(IN) :: key
18        INTEGER, INTENT(IN) :: valuelen
19        CHARACTER(LEN=valuelen), INTENT(OUT) :: value
20        LOGICAL, INTENT(OUT) :: flag
21        INTEGER, OPTIONAL, INTENT(OUT) :: ierror
22
23    MPI_Info_get_valuelen(info, key, valuelen, flag, ierror)
24        TYPE(MPI_Info), INTENT(IN) :: info
25        CHARACTER(LEN=*), INTENT(IN) :: key
26        INTEGER, INTENT(OUT) :: valuelen
27        LOGICAL, INTENT(OUT) :: flag
28        INTEGER, OPTIONAL, INTENT(OUT) :: ierror
29
30    MPI_Sizeof(x, size, ierror)
31        TYPE(*), DIMENSION(..) :: x
32        INTEGER, INTENT(OUT) :: size
33        INTEGER, OPTIONAL, INTENT(OUT) :: ierror
```

33

34

35

36

37

38

39

40

41

42

43

44

45

46

47

48

## A.5 Fortran Bindings with mpif.h or the mpi Module

### A.5.1 Point-to-Point Communication Fortran Bindings

```

MPI_BSEND(BUF, COUNT, DATATYPE, DEST, TAG, COMM, IERROR)
  <type> BUF(*)
  INTEGER COUNT, DATATYPE, DEST, TAG, COMM, IERROR

MPI_BSEND_INIT(BUF, COUNT, DATATYPE, DEST, TAG, COMM, REQUEST, IERROR)
  <type> BUF(*)
  INTEGER COUNT, DATATYPE, DEST, TAG, COMM, REQUEST, IERROR

MPI_BUFFER_ATTACH(BUFFER, SIZE, IERROR)
  <type> BUFFER(*)
  INTEGER SIZE, IERROR

MPI_BUFFER_DETACH(BUFFER_ADDR, SIZE, IERROR)
  <type> BUFFER_ADDR(*)
  INTEGER SIZE, IERROR

MPI_CANCEL(REQUEST, IERROR)
  INTEGER REQUEST, IERROR

MPI_GET_COUNT(STATUS, DATATYPE, COUNT, IERROR)
  INTEGER STATUS(MPI_STATUS_SIZE), DATATYPE, COUNT, IERROR

MPI_IBSEND(BUF, COUNT, DATATYPE, DEST, TAG, COMM, REQUEST, IERROR)
  <type> BUF(*)
  INTEGER COUNT, DATATYPE, DEST, TAG, COMM, REQUEST, IERROR

MPI_IMPROBE(SOURCE, TAG, COMM, FLAG, MESSAGE, STATUS, IERROR)
  INTEGER SOURCE, TAG, COMM, MESSAGE, STATUS(MPI_STATUS_SIZE), IERROR
  LOGICAL FLAG

MPI_IMRECV(BUF, COUNT, DATATYPE, MESSAGE, REQUEST, IERROR)
  <type> BUF(*)
  INTEGER COUNT, DATATYPE, MESSAGE, REQUEST, IERROR

MPI_IPROBE(SOURCE, TAG, COMM, FLAG, STATUS, IERROR)
  INTEGER SOURCE, TAG, COMM, STATUS(MPI_STATUS_SIZE), IERROR
  LOGICAL FLAG

MPI_IRecv(BUF, COUNT, DATATYPE, SOURCE, TAG, COMM, REQUEST, IERROR)
  <type> BUF(*)
  INTEGER COUNT, DATATYPE, SOURCE, TAG, COMM, REQUEST, IERROR

MPI_IRSEND(BUF, COUNT, DATATYPE, DEST, TAG, COMM, REQUEST, IERROR)
  <type> BUF(*)
  INTEGER COUNT, DATATYPE, DEST, TAG, COMM, REQUEST, IERROR

MPI_ISEND(BUF, COUNT, DATATYPE, DEST, TAG, COMM, REQUEST, IERROR)
  <type> BUF(*)
  INTEGER COUNT, DATATYPE, DEST, TAG, COMM, REQUEST, IERROR

```

```
1 MPI_ISENDRECV(SENDBUF, SENDCOUNT, SENDTYPE, DEST, SENDTAG, RECVBUFF,
2             RECVCOUNT, RECVMYPE, SOURCE, RECVTAG, COMM, REQUEST, IERROR)
3     <type> SENDBUF(*), RECVBUFF(*)
4     INTEGER SENDCOUNT, SENDTYPE, DEST, SENDTAG, RECVCOUNT, RECVMYPE,
5             SOURCE, RECVTAG, COMM, REQUEST, IERROR
6
7 MPI_ISENDRECV_REPLACE(BUF, COUNT, DATATYPE, DEST, SENDTAG, SOURCE, RECVTAG,
8                       COMM, REQUEST, IERROR)
9     <type> BUF(*)
10    INTEGER COUNT, DATATYPE, DEST, SENDTAG, SOURCE, RECVTAG, COMM, REQUEST,
11    IERROR
12
13 MPI_ISSEND(BUF, COUNT, DATATYPE, DEST, TAG, COMM, REQUEST, IERROR)
14    <type> BUF(*)
15    INTEGER COUNT, DATATYPE, DEST, TAG, COMM, REQUEST, IERROR
16
17 MPI_MPROBE(SOURCE, TAG, COMM, MESSAGE, STATUS, IERROR)
18    INTEGER SOURCE, TAG, COMM, MESSAGE, STATUS(MPI_STATUS_SIZE), IERROR
19
20 MPI_MRECV(BUF, COUNT, DATATYPE, MESSAGE, STATUS, IERROR)
21    <type> BUF(*)
22    INTEGER COUNT, DATATYPE, MESSAGE, STATUS(MPI_STATUS_SIZE), IERROR
23
24 MPI_PROBE(SOURCE, TAG, COMM, STATUS, IERROR)
25    INTEGER SOURCE, TAG, COMM, STATUS(MPI_STATUS_SIZE), IERROR
26
27 MPI_RECV(BUF, COUNT, DATATYPE, SOURCE, TAG, COMM, STATUS, IERROR)
28    <type> BUF(*)
29    INTEGER COUNT, DATATYPE, SOURCE, TAG, COMM, STATUS(MPI_STATUS_SIZE),
30    IERROR
31
32 MPI_RECV_INIT(BUF, COUNT, DATATYPE, SOURCE, TAG, COMM, REQUEST, IERROR)
33    <type> BUF(*)
34    INTEGER COUNT, DATATYPE, SOURCE, TAG, COMM, REQUEST, IERROR
35
36 MPI_REQUEST_FREE(REQUEST, IERROR)
37    INTEGER REQUEST, IERROR
38
39 MPI_REQUEST_GET_STATUS(REQUEST, FLAG, STATUS, IERROR)
40    INTEGER REQUEST, STATUS(MPI_STATUS_SIZE), IERROR
41    LOGICAL FLAG
42
43 MPI_RSEND(BUF, COUNT, DATATYPE, DEST, TAG, COMM, IERROR)
44    <type> BUF(*)
45    INTEGER COUNT, DATATYPE, DEST, TAG, COMM, IERROR
46
47 MPI_RSEND_INIT(BUF, COUNT, DATATYPE, DEST, TAG, COMM, REQUEST, IERROR)
48    <type> BUF(*)
49    INTEGER COUNT, DATATYPE, DEST, TAG, COMM, REQUEST, IERROR
50
51 MPI_SEND(BUF, COUNT, DATATYPE, DEST, TAG, COMM, IERROR)
52    <type> BUF(*)
53    INTEGER COUNT, DATATYPE, DEST, TAG, COMM, IERROR
```

```
MPI_SENDRECV(SENDBUF, SENDCOUNT, SENDTYPE, DEST, SENDTAG, RECVBUFF, 1
              RECVCOUNT, RECVTYPE, SOURCE, RECVTAG, COMM, STATUS, IERROR) 2
    <type> SENDBUF(*), RECVBUFF(*) 3
    INTEGER SENDCOUNT, SENDTYPE, DEST, SENDTAG, RECVCOUNT, RECVTYPE, 4
              SOURCE, RECVTAG, COMM, STATUS(MPI_STATUS_SIZE), IERROR 5
MPI_SENDRECV_REPLACE(BUF, COUNT, DATATYPE, DEST, SENDTAG, SOURCE, RECVTAG, 6
                    COMM, STATUS, IERROR) 7
    <type> BUF(*) 8
    INTEGER COUNT, DATATYPE, DEST, SENDTAG, SOURCE, RECVTAG, COMM, 9
              STATUS(MPI_STATUS_SIZE), IERROR 10
MPI_SEND_INIT(BUF, COUNT, DATATYPE, DEST, TAG, COMM, REQUEST, IERROR) 12
    <type> BUF(*) 13
    INTEGER COUNT, DATATYPE, DEST, TAG, COMM, REQUEST, IERROR 14
MPI_SSEND(BUF, COUNT, DATATYPE, DEST, TAG, COMM, IERROR) 15
    <type> BUF(*) 16
    INTEGER COUNT, DATATYPE, DEST, TAG, COMM, IERROR 17
MPI_SSEND_INIT(BUF, COUNT, DATATYPE, DEST, TAG, COMM, REQUEST, IERROR) 18
    <type> BUF(*) 19
    INTEGER COUNT, DATATYPE, DEST, TAG, COMM, REQUEST, IERROR 20
MPI_START(REQUEST, IERROR) 21
    INTEGER REQUEST, IERROR 22
MPI_STARTALL(COUNT, ARRAY_OF_REQUESTS, IERROR) 23
    INTEGER COUNT, ARRAY_OF_REQUESTS(*), IERROR 24
MPI_TEST(REQUEST, FLAG, STATUS, IERROR) 25
    INTEGER REQUEST, STATUS(MPI_STATUS_SIZE), IERROR 26
    LOGICAL FLAG 27
MPI_TESTALL(COUNT, ARRAY_OF_REQUESTS, FLAG, ARRAY_OF_STATUSES, IERROR) 28
    INTEGER COUNT, ARRAY_OF_REQUESTS(*), ARRAY_OF_STATUSES(MPI_STATUS_SIZE, 29
                    *), IERROR 30
    LOGICAL FLAG 31
MPI_TESTANY(COUNT, ARRAY_OF_REQUESTS, INDEX, FLAG, STATUS, IERROR) 32
    INTEGER COUNT, ARRAY_OF_REQUESTS(*), INDEX, STATUS(MPI_STATUS_SIZE), 33
                    IERROR 34
    LOGICAL FLAG 35
MPI_TESTSOME(INCOUNT, ARRAY_OF_REQUESTS, OUTCOUNT, ARRAY_OF_INDICES, 36
             ARRAY_OF_STATUSES, IERROR) 37
    INTEGER INCOUNT, ARRAY_OF_REQUESTS(*), OUTCOUNT, ARRAY_OF_INDICES(*), 38
             ARRAY_OF_STATUSES(MPI_STATUS_SIZE, *), IERROR 39
MPI_TEST_CANCELLED(STATUS, FLAG, IERROR) 40
    INTEGER STATUS(MPI_STATUS_SIZE), IERROR 41
    LOGICAL FLAG 42

```

```

1 MPI_WAIT(REQUEST, STATUS, IERROR)
2     INTEGER REQUEST, STATUS(MPI_STATUS_SIZE), IERROR
3
4 MPI_WAITALL(COUNT, ARRAY_OF_REQUESTS, ARRAY_OF_STATUSES, IERROR)
5     INTEGER COUNT, ARRAY_OF_REQUESTS(*), ARRAY_OF_STATUSES(MPI_STATUS_SIZE,
6         *), IERROR
7
8 MPI_WAITANY(COUNT, ARRAY_OF_REQUESTS, INDEX, STATUS, IERROR)
9     INTEGER COUNT, ARRAY_OF_REQUESTS(*), INDEX, STATUS(MPI_STATUS_SIZE),
10        IERROR
11
12 MPI_WAITSSOME(INCOUNT, ARRAY_OF_REQUESTS, OUTCOUNT, ARRAY_OF_INDICES,
13     ARRAY_OF_STATUSES, IERROR)
14     INTEGER INCOUNT, ARRAY_OF_REQUESTS(*), OUTCOUNT, ARRAY_OF_INDICES(*),
15     ARRAY_OF_STATUSES(MPI_STATUS_SIZE, *), IERROR

```

### A.5.2 Partitioned Communication Fortran Bindings

```

16
17
18 MPI_PARRIVED(REQUEST, PARTITION, FLAG, IERROR)
19     INTEGER REQUEST, PARTITION, IERROR
20     LOGICAL FLAG
21
22 MPI_PREADY(PARTITION, REQUEST, IERROR)
23     INTEGER PARTITION, REQUEST, IERROR
24
25 MPI_PREADY_LIST(LENGTH, ARRAY_OF_PARTITIONS, REQUEST, IERROR)
26     INTEGER LENGTH, ARRAY_OF_PARTITIONS(*), REQUEST, IERROR
27
28 MPI_PREADY_RANGE(PARTITION_LOW, PARTITION_HIGH, REQUEST, IERROR)
29     INTEGER PARTITION_LOW, PARTITION_HIGH, REQUEST, IERROR
30
31 MPI_PRECV_INIT(BUF, PARTITIONS, COUNT, DATATYPE, DEST, TAG, COMM, INFO,
32     REQUEST, IERROR)
33     <type> BUF(*)
34     INTEGER PARTITIONS, DATATYPE, DEST, TAG, COMM, INFO, REQUEST, IERROR
35     INTEGER(KIND=MPI_COUNT_KIND) COUNT
36
37 MPI_PSEND_INIT(BUF, PARTITIONS, COUNT, DATATYPE, DEST, TAG, COMM, INFO,
38     REQUEST, IERROR)
39     <type> BUF(*)
40     INTEGER PARTITIONS, DATATYPE, DEST, TAG, COMM, INFO, REQUEST, IERROR
41     INTEGER(KIND=MPI_COUNT_KIND) COUNT

```

### A.5.3 Datatypes Fortran Bindings

```

42
43 INTEGER(KIND=MPI_ADDRESS_KIND) MPI_AINT_ADD(BASE, DISP)
44     INTEGER(KIND=MPI_ADDRESS_KIND) BASE, DISP
45
46 INTEGER(KIND=MPI_ADDRESS_KIND) MPI_AINT_DIFF(ADDR1, ADDR2)
47     INTEGER(KIND=MPI_ADDRESS_KIND) ADDR1, ADDR2
48
49 MPI_GET_ADDRESS(LOCATION, ADDRESS, IERROR)

```



```

<type> LOCATION(*)                                1
INTEGER(KIND=MPI_ADDRESS_KIND) ADDRESS           2
INTEGER IERROR                                    3
MPI_GET_ELEMENTS(STATUS, DATATYPE, COUNT, IERROR) 4
INTEGER STATUS(MPI_STATUS_SIZE), DATATYPE, COUNT, IERROR 5
MPI_GET_ELEMENTS_X(STATUS, DATATYPE, COUNT, IERROR) 7
INTEGER STATUS(MPI_STATUS_SIZE), DATATYPE, IERROR 8
INTEGER(KIND=MPI_COUNT_KIND) COUNT              9
MPI_PACK(INBUF, INCOUNT, DATATYPE, OUTBUF, OUTSIZE, POSITION, COMM, IERROR) 10
<type> INBUF(*), OUTBUF(*)                      12
INTEGER INCOUNT, DATATYPE, OUTSIZE, POSITION, COMM, IERROR 13
MPI_PACK_EXTERNAL(DATAREP, INBUF, INCOUNT, DATATYPE, OUTBUF, OUTSIZE, 14
POSITION, IERROR)                               15
CHARACTER*(*) DATAREP                          16
<type> INBUF(*), OUTBUF(*)                      17
INTEGER INCOUNT, DATATYPE, IERROR              18
INTEGER(KIND=MPI_ADDRESS_KIND) OUTSIZE, POSITION 19
MPI_PACK_EXTERNAL_SIZE(DATAREP, INCOUNT, DATATYPE, SIZE, IERROR) 20
CHARACTER*(*) DATAREP                          21
INTEGER INCOUNT, DATATYPE, IERROR              22
INTEGER(KIND=MPI_ADDRESS_KIND) SIZE            23
MPI_PACK_SIZE(INCOUNT, DATATYPE, COMM, SIZE, IERROR) 25
INTEGER INCOUNT, DATATYPE, COMM, SIZE, IERROR 26
MPI_TYPE_COMMIT(DATATYPE, IERROR)               27
INTEGER DATATYPE, IERROR                       28
MPI_TYPE_CONTIGUOUS(COUNT, OLDTYPE, NEWTYPE, IERROR) 29
INTEGER COUNT, OLDTYPE, NEWTYPE, IERROR        30
MPI_TYPE_CREATE_DARRAY(SIZE, RANK, NDIMS, ARRAY_OF_GSIZES, 31
ARRAY_OF_DISTRIBS, ARRAY_OF_DARGS, ARRAY_OF_PSIZEs, ORDER, 32
OLDTYPE, NEWTYPE, IERROR)                      33
INTEGER SIZE, RANK, NDIMS, ARRAY_OF_GSIZES(*), ARRAY_OF_DISTRIBS(*), 34
ARRAY_OF_DARGS(*), ARRAY_OF_PSIZEs(*), ORDER, OLDTYPE, 35
NEWTYPE, IERROR                                36
MPI_TYPE_CREATE_HINDEXED(COUNT, ARRAY_OF_BLOCKLENGTHS, 37
ARRAY_OF_DISPLACEMENTS, OLDTYPE, NEWTYPE, IERROR) 38
INTEGER COUNT, ARRAY_OF_BLOCKLENGTHS(*), OLDTYPE, NEWTYPE, IERROR 39
INTEGER(KIND=MPI_ADDRESS_KIND) ARRAY_OF_DISPLACEMENTS(*) 40
MPI_TYPE_CREATE_HINDEXED_BLOCK(COUNT, BLOCKLENGTH, ARRAY_OF_DISPLACEMENTS, 41
OLDTYPE, NEWTYPE, IERROR)                      42
INTEGER COUNT, BLOCKLENGTH, OLDTYPE, NEWTYPE, IERROR 43
INTEGER(KIND=MPI_ADDRESS_KIND) ARRAY_OF_DISPLACEMENTS(*) 44

```

```
1 MPI_TYPE_CREATE_HVECTOR(COUNT, BLOCKLENGTH, STRIDE, OLDTYPE, NEWTYPE,
2     IERROR)
3     INTEGER COUNT, BLOCKLENGTH, OLDTYPE, NEWTYPE, IERROR
4     INTEGER(KIND=MPI_ADDRESS_KIND) STRIDE
5
6 MPI_TYPE_CREATE_INDEXED_BLOCK(COUNT, BLOCKLENGTH, ARRAY_OF_DISPLACEMENTS,
7     OLDTYPE, NEWTYPE, IERROR)
8     INTEGER COUNT, BLOCKLENGTH, ARRAY_OF_DISPLACEMENTS(*), OLDTYPE,
9     NEWTYPE, IERROR
10
11 MPI_TYPE_CREATE_RESIZED(OLDTYPE, LB, EXTENT, NEWTYPE, IERROR)
12     INTEGER OLDTYPE, NEWTYPE, IERROR
13     INTEGER(KIND=MPI_ADDRESS_KIND) LB, EXTENT
14
15 MPI_TYPE_CREATE_STRUCT(COUNT, ARRAY_OF_BLOCKLENGTHS,
16     ARRAY_OF_DISPLACEMENTS, ARRAY_OF_TYPES, NEWTYPE, IERROR)
17     INTEGER COUNT, ARRAY_OF_BLOCKLENGTHS(*), ARRAY_OF_TYPES(*), NEWTYPE,
18     IERROR
19     INTEGER(KIND=MPI_ADDRESS_KIND) ARRAY_OF_DISPLACEMENTS(*)
20
21 MPI_TYPE_CREATE_SUBARRAY(NDIMS, ARRAY_OF_SIZES, ARRAY_OF_SUBSIZES,
22     ARRAY_OF_STARTS, ORDER, OLDTYPE, NEWTYPE, IERROR)
23     INTEGER NDIMS, ARRAY_OF_SIZES(*), ARRAY_OF_SUBSIZES(*),
24     ARRAY_OF_STARTS(*), ORDER, OLDTYPE, NEWTYPE, IERROR
25
26 MPI_TYPE_DUP(OLDTYPE, NEWTYPE, IERROR)
27     INTEGER OLDTYPE, NEWTYPE, IERROR
28
29 MPI_TYPE_FREE(DATATYPE, IERROR)
30     INTEGER DATATYPE, IERROR
31
32 MPI_TYPE_GET_CONTENTS(DATATYPE, MAX_INTEGERS, MAX_ADDRESSES, MAX_DATATYPES,
33     ARRAY_OF_INTEGERS, ARRAY_OF_ADDRESSES, ARRAY_OF_DATATYPES,
34     IERROR)
35     INTEGER DATATYPE, MAX_INTEGERS, MAX_ADDRESSES, MAX_DATATYPES,
36     ARRAY_OF_INTEGERS(*), ARRAY_OF_DATATYPES(*), IERROR
37     INTEGER(KIND=MPI_ADDRESS_KIND) ARRAY_OF_ADDRESSES(*)
38
39 MPI_TYPE_GET_ENVELOPE(DATATYPE, NUM_INTEGERS, NUM_ADDRESSES, NUM_DATATYPES,
40     COMBINER, IERROR)
41     INTEGER DATATYPE, NUM_INTEGERS, NUM_ADDRESSES, NUM_DATATYPES, COMBINER,
42     IERROR
43
44 MPI_TYPE_GET_EXTENT(DATATYPE, LB, EXTENT, IERROR)
45     INTEGER DATATYPE, IERROR
46     INTEGER(KIND=MPI_ADDRESS_KIND) LB, EXTENT
47
48 MPI_TYPE_GET_EXTENT_X(DATATYPE, LB, EXTENT, IERROR)
49     INTEGER DATATYPE, IERROR
50     INTEGER(KIND=MPI_COUNT_KIND) LB, EXTENT
51
52 MPI_TYPE_GET_TRUE_EXTENT(DATATYPE, TRUE_LB, TRUE_EXTENT, IERROR)
53     INTEGER DATATYPE, IERROR
```

```

INTEGER(KIND=MPI_ADDRESS_KIND) TRUE_LB, TRUE_EXTENT
1
MPI_TYPE_GET_TRUE_EXTENT_X(DATATYPE, TRUE_LB, TRUE_EXTENT, IERROR)
2
INTEGER DATATYPE, IERROR
3
INTEGER(KIND=MPI_COUNT_KIND) TRUE_LB, TRUE_EXTENT
4
MPI_TYPE_INDEXED(COUNT, ARRAY_OF_BLOCKLENGTHS, ARRAY_OF_DISPLACEMENTS,
5
OLDTYPE, NEWTYPE, IERROR)
6
INTEGER COUNT, ARRAY_OF_BLOCKLENGTHS(*), ARRAY_OF_DISPLACEMENTS(*),
7
OLDTYPE, NEWTYPE, IERROR
8
MPI_TYPE_SIZE(DATATYPE, SIZE, IERROR)
9
INTEGER DATATYPE, SIZE, IERROR
10
MPI_TYPE_SIZE_X(DATATYPE, SIZE, IERROR)
11
INTEGER DATATYPE, IERROR
12
INTEGER(KIND=MPI_COUNT_KIND) SIZE
13
MPI_TYPE_VECTOR(COUNT, BLOCKLENGTH, STRIDE, OLDTYPE, NEWTYPE, IERROR)
14
INTEGER COUNT, BLOCKLENGTH, STRIDE, OLDTYPE, NEWTYPE, IERROR
15
MPI_UNPACK(INBUF, INSIZE, POSITION, OUTBUF, OUTCOUNT, DATATYPE, COMM,
16
IERROR)
17
<type> INBUF(*), OUTBUF(*)
18
INTEGER INSIZE, POSITION, OUTCOUNT, DATATYPE, COMM, IERROR
19
MPI_UNPACK_EXTERNAL(DATAREP, INBUF, INSIZE, POSITION, OUTBUF, OUTCOUNT,
20
DATATYPE, IERROR)
21
CHARACTER*(*) DATAREP
22
<type> INBUF(*), OUTBUF(*)
23
INTEGER(KIND=MPI_ADDRESS_KIND) INSIZE, POSITION
24
INTEGER OUTCOUNT, DATATYPE, IERROR
25

```

#### A.5.4 Collective Communication Fortran Bindings

```

MPI_ALLGATHER(SENDBUF, SENDCOUNT, SENDTYPE, RECVBUF, RECVCOUNT, RECVMYPE,
32
COMM, IERROR)
33
<type> SENDBUF(*), RECVBUF(*)
34
INTEGER SENDCOUNT, SENDTYPE, RECVCOUNT, RECVMYPE, COMM, IERROR
35
MPI_ALLGATHERV(SENDBUF, SENDCOUNT, SENDTYPE, RECVBUF, RECVCOUNTS, DISPLS,
36
RECVMYPE, COMM, IERROR)
37
<type> SENDBUF(*), RECVBUF(*)
38
INTEGER SENDCOUNT, SENDTYPE, RECVCOUNTS(*), DISPLS(*), RECVMYPE, COMM,
39
IERROR
40
MPI_ALLGATHERV_INIT(SENDBUF, SENDCOUNT, SENDTYPE, RECVBUF, RECVCOUNTS,
41
DISPLS, RECVMYPE, COMM, INFO, REQUEST, IERROR)
42
<type> SENDBUF(*), RECVBUF(*)
43
INTEGER SENDCOUNT, SENDTYPE, RECVCOUNTS(*), DISPLS(*), RECVMYPE, COMM,
44
INFO, REQUEST, IERROR
45

```

```
1 MPI_ALLGATHER_INIT(SENDBUF, SENDCOUNT, SENDTYPE, RECVBUF, RECVCOUNT,
2                   RECVTYPE, COMM, INFO, REQUEST, IERROR)
3   <type> SENDBUF(*), RECVBUF(*)
4   INTEGER SENDCOUNT, SENDTYPE, RECVCOUNT, RECVTYPE, COMM, INFO, REQUEST,
5   IERROR
6
7 MPI_ALLREDUCE(SENDBUF, RECVBUF, COUNT, DATATYPE, OP, COMM, IERROR)
8   <type> SENDBUF(*), RECVBUF(*)
9   INTEGER COUNT, DATATYPE, OP, COMM, IERROR
10
11 MPI_ALLREDUCE_INIT(SENDBUF, RECVBUF, COUNT, DATATYPE, OP, COMM, INFO,
12                   REQUEST, IERROR)
13   <type> SENDBUF(*), RECVBUF(*)
14   INTEGER COUNT, DATATYPE, OP, COMM, INFO, REQUEST, IERROR
15
16 MPI_ALLTOALL(SENDBUF, SENDCOUNT, SENDTYPE, RECVBUF, RECVCOUNT, RECVTYPE,
17              COMM, IERROR)
18   <type> SENDBUF(*), RECVBUF(*)
19   INTEGER SENDCOUNT, SENDTYPE, RECVCOUNT, RECVTYPE, COMM, IERROR
20
21 MPI_ALLTOALLV(SENDBUF, SENDCOUNTS, SDISPLS, SENDTYPE, RECVBUF, RECVCOUNTS,
22              RDISPLS, RECVTYPE, COMM, IERROR)
23   <type> SENDBUF(*), RECVBUF(*)
24   INTEGER SENDCOUNTS(*), SDISPLS(*), SENDTYPE, RECVCOUNTS(*), RDISPLS(*),
25   RECVTYPE, COMM, IERROR
26
27 MPI_ALLTOALLV_INIT(SENDBUF, SENDCOUNTS, SDISPLS, SENDTYPE, RECVBUF,
28                   RECVCOUNTS, RDISPLS, RECVTYPE, COMM, INFO, REQUEST, IERROR)
29   <type> SENDBUF(*), RECVBUF(*)
30   INTEGER SENDCOUNTS(*), SDISPLS(*), SENDTYPE, RECVCOUNTS(*), RDISPLS(*),
31   RECVTYPE, COMM, INFO, REQUEST, IERROR
32
33 MPI_ALLTOALLW(SENDBUF, SENDCOUNTS, SDISPLS, SENDTYPES, RECVBUF, RECVCOUNTS,
34              RDISPLS, RECVTYPES, COMM, IERROR)
35   <type> SENDBUF(*), RECVBUF(*)
36   INTEGER SENDCOUNTS(*), SDISPLS(*), SENDTYPES(*), RECVCOUNTS(*),
37   RDISPLS(*), RECVTYPES(*), COMM, IERROR
38
39 MPI_ALLTOALLW_INIT(SENDBUF, SENDCOUNTS, SDISPLS, SENDTYPES, RECVBUF,
40                   RECVCOUNTS, RDISPLS, RECVTYPES, COMM, INFO, REQUEST, IERROR)
41   <type> SENDBUF(*), RECVBUF(*)
42   INTEGER SENDCOUNTS(*), SDISPLS(*), SENDTYPES(*), RECVCOUNTS(*),
43   RDISPLS(*), RECVTYPES(*), COMM, INFO, REQUEST, IERROR
44
45 MPI_ALLTOALL_INIT(SENDBUF, SENDCOUNT, SENDTYPE, RECVBUF, RECVCOUNT,
46                  RECVTYPE, COMM, INFO, REQUEST, IERROR)
47   <type> SENDBUF(*), RECVBUF(*)
48   INTEGER SENDCOUNT, SENDTYPE, RECVCOUNT, RECVTYPE, COMM, INFO, REQUEST,
49   IERROR
50
51 MPI_BARRIER(COMM, IERROR)
52   INTEGER COMM, IERROR
```

```

MPI_BARRIER_INIT(COMM, INFO, REQUEST, IERROR) 1
    INTEGER COMM, INFO, REQUEST, IERROR 2
3
MPI_BCAST(BUFFER, COUNT, DATATYPE, ROOT, COMM, IERROR) 4
    <type> BUFFER(*) 5
    INTEGER COUNT, DATATYPE, ROOT, COMM, IERROR 6
7
MPI_BCAST_INIT(BUFFER, COUNT, DATATYPE, ROOT, COMM, INFO, REQUEST, IERROR) 7
    <type> BUFFER(*) 8
    INTEGER COUNT, DATATYPE, ROOT, COMM, INFO, REQUEST, IERROR 9
10
MPI_EXSCAN(SENDBUF, RECVBUF, COUNT, DATATYPE, OP, COMM, IERROR) 11
    <type> SENDBUF(*), RECVBUF(*) 12
    INTEGER COUNT, DATATYPE, OP, COMM, IERROR 13
14
MPI_EXSCAN_INIT(SENDBUF, RECVBUF, COUNT, DATATYPE, OP, COMM, INFO, REQUEST, 14
    IERROR) 15
    <type> SENDBUF(*), RECVBUF(*) 16
    INTEGER COUNT, DATATYPE, OP, COMM, INFO, REQUEST, IERROR 17
18
MPI_GATHER(SENDBUF, SENDCOUNT, SENDTYPE, RECVBUF, RECVCOUNT, RECVTYPE, 19
    ROOT, COMM, IERROR) 20
    <type> SENDBUF(*), RECVBUF(*) 21
    INTEGER SENDCOUNT, SENDTYPE, RECVCOUNT, RECVTYPE, ROOT, COMM, IERROR 22
23
MPI_GATHERV(SENDBUF, SENDCOUNT, SENDTYPE, RECVBUF, RECVCOUNTS, DISPLS, 23
    RECVTYPE, ROOT, COMM, IERROR) 24
    <type> SENDBUF(*), RECVBUF(*) 25
    INTEGER SENDCOUNT, SENDTYPE, RECVCOUNTS(*), DISPLS(*), RECVTYPE, ROOT, 26
    COMM, IERROR 27
28
MPI_GATHERV_INIT(SENDBUF, SENDCOUNT, SENDTYPE, RECVBUF, RECVCOUNTS, DISPLS, 29
    RECVTYPE, ROOT, COMM, INFO, REQUEST, IERROR) 30
    <type> SENDBUF(*), RECVBUF(*) 31
    INTEGER SENDCOUNT, SENDTYPE, RECVCOUNTS(*), DISPLS(*), RECVTYPE, ROOT, 32
    COMM, INFO, REQUEST, IERROR 33
34
MPI_GATHER_INIT(SENDBUF, SENDCOUNT, SENDTYPE, RECVBUF, RECVCOUNT, RECVTYPE, 34
    ROOT, COMM, INFO, REQUEST, IERROR) 35
    <type> SENDBUF(*), RECVBUF(*) 36
    INTEGER SENDCOUNT, SENDTYPE, RECVCOUNT, RECVTYPE, ROOT, COMM, INFO, 37
    REQUEST, IERROR 38
39
MPI_IALLGATHER(SENDBUF, SENDCOUNT, SENDTYPE, RECVBUF, RECVCOUNT, RECVTYPE, 40
    COMM, REQUEST, IERROR) 41
    <type> SENDBUF(*), RECVBUF(*) 42
    INTEGER SENDCOUNT, SENDTYPE, RECVCOUNT, RECVTYPE, COMM, REQUEST, IERROR 43
44
MPI_IALLGATHERV(SENDBUF, SENDCOUNT, SENDTYPE, RECVBUF, RECVCOUNTS, DISPLS, 44
    RECVTYPE, COMM, REQUEST, IERROR) 45
    <type> SENDBUF(*), RECVBUF(*) 46
47
48

```

```

1     INTEGER SENDCOUNT, SENDTYPE, RECVCOUNTS(*), DISPLS(*), RECVTYPE, COMM,
2         REQUEST, IERROR
3
4     MPI_IALLREDUCE(SENDBUF, RECVBUF, COUNT, DATATYPE, OP, COMM, REQUEST,
5         IERROR)
6     <type> SENDBUF(*), RECVBUF(*)
7     INTEGER COUNT, DATATYPE, OP, COMM, REQUEST, IERROR
8
9     MPI_IALLTOALL(SENDBUF, SENDCOUNT, SENDTYPE, RECVBUF, RECVCOUNT, RECVTYPE,
10        COMM, REQUEST, IERROR)
11    <type> SENDBUF(*), RECVBUF(*)
12    INTEGER SENDCOUNT, SENDTYPE, RECVCOUNT, RECVTYPE, COMM, REQUEST, IERROR
13
14    MPI_IALLTOALLV(SENDBUF, SENDCOUNTS, SDISPLS, SENDTYPE, RECVBUF, RECVCOUNTS,
15        RDISPLS, RECVTYPE, COMM, REQUEST, IERROR)
16    <type> SENDBUF(*), RECVBUF(*)
17    INTEGER SENDCOUNTS(*), SDISPLS(*), SENDTYPE, RECVCOUNTS(*), RDISPLS(*),
18        RECVTYPE, COMM, REQUEST, IERROR
19
20    MPI_IALLTOALLW(SENDBUF, SENDCOUNTS, SDISPLS, SENDTYPES, RECVBUF,
21        RECVCOUNTS, RDISPLS, RECVTYPES, COMM, REQUEST, IERROR)
22    <type> SENDBUF(*), RECVBUF(*)
23    INTEGER SENDCOUNTS(*), SDISPLS(*), SENDTYPES(*), RECVCOUNTS(*),
24        RDISPLS(*), RECVTYPES(*), COMM, REQUEST, IERROR
25
26    MPI_IBARRIER(COMM, REQUEST, IERROR)
27    INTEGER COMM, REQUEST, IERROR
28
29    MPI_IBCAST(BUFFER, COUNT, DATATYPE, ROOT, COMM, REQUEST, IERROR)
30    <type> BUFFER(*)
31    INTEGER COUNT, DATATYPE, ROOT, COMM, REQUEST, IERROR
32
33    MPI_IEXSCAN(SENDBUF, RECVBUF, COUNT, DATATYPE, OP, COMM, REQUEST, IERROR)
34    <type> SENDBUF(*), RECVBUF(*)
35    INTEGER COUNT, DATATYPE, OP, COMM, REQUEST, IERROR
36
37    MPI_IGATHER(SENDBUF, SENDCOUNT, SENDTYPE, RECVBUF, RECVCOUNT, RECVTYPE,
38        ROOT, COMM, REQUEST, IERROR)
39    <type> SENDBUF(*), RECVBUF(*)
40    INTEGER SENDCOUNT, SENDTYPE, RECVCOUNT, RECVTYPE, ROOT, COMM, REQUEST,
41        IERROR
42
43    MPI_IGATHERV(SENDBUF, SENDCOUNT, SENDTYPE, RECVBUF, RECVCOUNTS, DISPLS,
44        RECVTYPE, ROOT, COMM, REQUEST, IERROR)
45    <type> SENDBUF(*), RECVBUF(*)
46    INTEGER SENDCOUNT, SENDTYPE, RECVCOUNTS(*), DISPLS(*), RECVTYPE, ROOT,
47        COMM, REQUEST, IERROR
48
49    MPI_IREDUCE(SENDBUF, RECVBUF, COUNT, DATATYPE, OP, ROOT, COMM, REQUEST,
50        IERROR)
51    <type> SENDBUF(*), RECVBUF(*)
52    INTEGER COUNT, DATATYPE, OP, ROOT, COMM, REQUEST, IERROR

```

```

MPI_IREDUCE_SCATTER(SENDBUF, RECVBUF, RECVCOUNTS, DATATYPE, OP, COMM,
                    REQUEST, IERROR)
    <type> SENDBUF(*), RECVBUF(*)
    INTEGER RECVCOUNTS(*), DATATYPE, OP, COMM, REQUEST, IERROR
MPI_IREDUCE_SCATTER_BLOCK(SENDBUF, RECVBUF, RECVCOUNT, DATATYPE, OP, COMM,
                          REQUEST, IERROR)
    <type> SENDBUF(*), RECVBUF(*)
    INTEGER RECVCOUNT, DATATYPE, OP, COMM, REQUEST, IERROR
MPI_ISCAN(SENDBUF, RECVBUF, COUNT, DATATYPE, OP, COMM, REQUEST, IERROR)
    <type> SENDBUF(*), RECVBUF(*)
    INTEGER COUNT, DATATYPE, OP, COMM, REQUEST, IERROR
MPI_ISCATTER(SENDBUF, SENDCOUNT, SENDTYPE, RECVBUF, RECVCOUNT, RECVTYPE,
             ROOT, COMM, REQUEST, IERROR)
    <type> SENDBUF(*), RECVBUF(*)
    INTEGER SENDCOUNT, SENDTYPE, RECVCOUNT, RECVTYPE, ROOT, COMM, REQUEST,
    IERROR
MPI_ISCATTERV(SENDBUF, SENDCOUNTS, DISPLS, SENDTYPE, RECVBUF, RECVCOUNT,
              RECVTYPE, ROOT, COMM, REQUEST, IERROR)
    <type> SENDBUF(*), RECVBUF(*)
    INTEGER SENDCOUNTS(*), DISPLS(*), SENDTYPE, RECVCOUNT, RECVTYPE, ROOT,
    COMM, REQUEST, IERROR
MPI_OP_COMMUTATIVE(OP, COMMUTE, IERROR)
    INTEGER OP, IERROR
    LOGICAL COMMUTE
MPI_OP_CREATE(USER_FN, COMMUTE, OP, IERROR)
    EXTERNAL USER_FN
    LOGICAL COMMUTE
    INTEGER OP, IERROR
MPI_OP_FREE(OP, IERROR)
    INTEGER OP, IERROR
MPI_REDUCE(SENDBUF, RECVBUF, COUNT, DATATYPE, OP, ROOT, COMM, IERROR)
    <type> SENDBUF(*), RECVBUF(*)
    INTEGER COUNT, DATATYPE, OP, ROOT, COMM, IERROR
MPI_REDUCE_INIT(SENDBUF, RECVBUF, COUNT, DATATYPE, OP, ROOT, COMM, INFO,
                REQUEST, IERROR)
    <type> SENDBUF(*), RECVBUF(*)
    INTEGER COUNT, DATATYPE, OP, ROOT, COMM, INFO, REQUEST, IERROR
MPI_REDUCE_LOCAL(INBUF, INOUTBUF, COUNT, DATATYPE, OP, IERROR)
    <type> INBUF(*), INOUTBUF(*)
    INTEGER COUNT, DATATYPE, OP, IERROR
MPI_REDUCE_SCATTER(SENDBUF, RECVBUF, RECVCOUNTS, DATATYPE, OP, COMM,
                   IERROR)

```

```

1     <type> SENDBUF(*), RECVBUF(*)
2     INTEGER RECVCOUNTS(*), DATATYPE, OP, COMM, IERROR
3
4     MPI_REDUCE_SCATTER_BLOCK(SENDBUF, RECVBUF, RECVCOUNT, DATATYPE, OP, COMM,
5         IERROR)
6     <type> SENDBUF(*), RECVBUF(*)
7     INTEGER RECVCOUNT, DATATYPE, OP, COMM, IERROR
8
9     MPI_REDUCE_SCATTER_BLOCK_INIT(SENDBUF, RECVBUF, RECVCOUNT, DATATYPE, OP,
10        COMM, INFO, REQUEST, IERROR)
11    <type> SENDBUF(*), RECVBUF(*)
12    INTEGER RECVCOUNT, DATATYPE, OP, COMM, INFO, REQUEST, IERROR
13
14    MPI_REDUCE_SCATTER_INIT(SENDBUF, RECVBUF, RECVCOUNTS, DATATYPE, OP, COMM,
15        INFO, REQUEST, IERROR)
16    <type> SENDBUF(*), RECVBUF(*)
17    INTEGER RECVCOUNTS(*), DATATYPE, OP, COMM, INFO, REQUEST, IERROR
18
19    MPI_SCAN(SENDBUF, RECVBUF, COUNT, DATATYPE, OP, COMM, IERROR)
20    <type> SENDBUF(*), RECVBUF(*)
21    INTEGER COUNT, DATATYPE, OP, COMM, IERROR
22
23    MPI_SCAN_INIT(SENDBUF, RECVBUF, COUNT, DATATYPE, OP, COMM, INFO, REQUEST,
24        IERROR)
25    <type> SENDBUF(*), RECVBUF(*)
26    INTEGER COUNT, DATATYPE, OP, COMM, INFO, REQUEST, IERROR
27
28    MPI_SCATTER(SENDBUF, SENDCOUNT, SENDTYPE, RECVBUF, RECVCOUNT, RECVTYPE,
29        ROOT, COMM, IERROR)
30    <type> SENDBUF(*), RECVBUF(*)
31    INTEGER SENDCOUNT, SENDTYPE, RECVCOUNT, RECVTYPE, ROOT, COMM, IERROR
32
33    MPI_SCATTERV(SENDBUF, SENDCOUNTS, DISPLS, SENDTYPE, RECVBUF, RECVCOUNT,
34        RECVTYPE, ROOT, COMM, IERROR)
35    <type> SENDBUF(*), RECVBUF(*)
36    INTEGER SENDCOUNTS(*), DISPLS(*), SENDTYPE, RECVCOUNT, RECVTYPE, ROOT,
37        COMM, IERROR
38
39    MPI_SCATTERV_INIT(SENDBUF, SENDCOUNTS, DISPLS, SENDTYPE, RECVBUF,
40        RECVCOUNT, RECVTYPE, ROOT, COMM, INFO, REQUEST, IERROR)
41    <type> SENDBUF(*), RECVBUF(*)
42    INTEGER SENDCOUNTS(*), DISPLS(*), SENDTYPE, RECVCOUNT, RECVTYPE, ROOT,
43        COMM, INFO, REQUEST, IERROR
44
45    MPI_SCATTER_INIT(SENDBUF, SENDCOUNT, SENDTYPE, RECVBUF, RECVCOUNT,
46        RECVTYPE, ROOT, COMM, INFO, REQUEST, IERROR)
47    <type> SENDBUF(*), RECVBUF(*)
48    INTEGER SENDCOUNT, SENDTYPE, RECVCOUNT, RECVTYPE, ROOT, COMM, INFO,
49        REQUEST, IERROR

```



## A.5.5 Groups, Contexts, Communicators, and Caching Fortran Bindings

MPI_COMM_COMPARE(COMM1, COMM2, RESULT, IERROR)	1
INTEGER COMM1, COMM2, RESULT, IERROR	2
MPI_COMM_CREATE(COMM, GROUP, NEWCOMM, IERROR)	3
INTEGER COMM, GROUP, NEWCOMM, IERROR	4
MPI_COMM_CREATE_FROM_GROUP(GROUP, STRINGTAG, INFO, ERRHANDLER, NEWCOMM,	5
IERROR)	6
INTEGER GROUP, INFO, ERRHANDLER, NEWCOMM, IERROR	7
CHARACTER*(*) STRINGTAG	8
MPI_COMM_CREATE_GROUP(COMM, GROUP, TAG, NEWCOMM, IERROR)	9
INTEGER COMM, GROUP, TAG, NEWCOMM, IERROR	10
MPI_COMM_CREATE_KEYVAL(COMM_COPY_ATTR_FN, COMM_DELETE_ATTR_FN, COMM_KEYVAL,	11
EXTRA_STATE, IERROR)	12
EXTERNAL COMM_COPY_ATTR_FN, COMM_DELETE_ATTR_FN	13
INTEGER COMM_KEYVAL, IERROR	14
INTEGER(KIND=MPI_ADDRESS_KIND) EXTRA_STATE	15
MPI_COMM_DELETE_ATTR(COMM, COMM_KEYVAL, IERROR)	16
INTEGER COMM, COMM_KEYVAL, IERROR	17
MPI_COMM_DUP(COMM, NEWCOMM, IERROR)	18
INTEGER COMM, NEWCOMM, IERROR	19
MPI_COMM_DUP_FN(OLDCOMM, COMM_KEYVAL, EXTRA_STATE, ATTRIBUTE_VAL_IN,	20
ATTRIBUTE_VAL_OUT, FLAG, IERROR)	21
INTEGER OLDCOMM, COMM_KEYVAL, IERROR	22
INTEGER(KIND=MPI_ADDRESS_KIND) EXTRA_STATE, ATTRIBUTE_VAL_IN,	23
ATTRIBUTE_VAL_OUT	24
LOGICAL FLAG	25
MPI_COMM_DUP_WITH_INFO(COMM, INFO, NEWCOMM, IERROR)	26
INTEGER COMM, INFO, NEWCOMM, IERROR	27
MPI_COMM_FREE(COMM, IERROR)	28
INTEGER COMM, IERROR	29
MPI_COMM_FREE_KEYVAL(COMM_KEYVAL, IERROR)	30
INTEGER COMM_KEYVAL, IERROR	31
MPI_COMM_GET_ATTR(COMM, COMM_KEYVAL, ATTRIBUTE_VAL, FLAG, IERROR)	32
INTEGER COMM, COMM_KEYVAL, IERROR	33
INTEGER(KIND=MPI_ADDRESS_KIND) ATTRIBUTE_VAL	34
LOGICAL FLAG	35
MPI_COMM_GET_INFO(COMM, INFO_USED, IERROR)	36
INTEGER COMM, INFO_USED, IERROR	37
MPI_COMM_GET_NAME(COMM, COMM_NAME, RESULTLEN, IERROR)	38
INTEGER COMM, RESULTLEN, IERROR	39

```
1     CHARACTER*(*) COMM_NAME
2
3     MPI_COMM_GROUP(COMM, GROUP, IERROR)
4         INTEGER COMM, GROUP, IERROR
5
6     MPI_COMM_IDUP(COMM, NEWCOMM, REQUEST, IERROR)
7         INTEGER COMM, NEWCOMM, REQUEST, IERROR
8
9     MPI_COMM_IDUP_WITH_INFO(COMM, INFO, NEWCOMM, REQUEST, IERROR)
10        INTEGER COMM, INFO, NEWCOMM, REQUEST, IERROR
11
12    MPI_COMM_NULL_COPY_FN(OLDCOMM, COMM_KEYVAL, EXTRA_STATE, ATTRIBUTE_VAL_IN,
13        ATTRIBUTE_VAL_OUT, FLAG, IERROR)
14        INTEGER OLDCOMM, COMM_KEYVAL, IERROR
15        INTEGER(KIND=MPI_ADDRESS_KIND) EXTRA_STATE, ATTRIBUTE_VAL_IN,
16        ATTRIBUTE_VAL_OUT
17        LOGICAL FLAG
18
19    MPI_COMM_NULL_DELETE_FN(COMM, COMM_KEYVAL, ATTRIBUTE_VAL, EXTRA_STATE,
20        IERROR)
21        INTEGER COMM, COMM_KEYVAL, IERROR
22        INTEGER(KIND=MPI_ADDRESS_KIND) ATTRIBUTE_VAL, EXTRA_STATE
23
24    MPI_COMM_RANK(COMM, RANK, IERROR)
25        INTEGER COMM, RANK, IERROR
26
27    MPI_COMM_REMOTE_GROUP(COMM, GROUP, IERROR)
28        INTEGER COMM, GROUP, IERROR
29
30    MPI_COMM_REMOTE_SIZE(COMM, SIZE, IERROR)
31        INTEGER COMM, SIZE, IERROR
32
33    MPI_COMM_SET_ATTR(COMM, COMM_KEYVAL, ATTRIBUTE_VAL, IERROR)
34        INTEGER COMM, COMM_KEYVAL, IERROR
35        INTEGER(KIND=MPI_ADDRESS_KIND) ATTRIBUTE_VAL
36
37    MPI_COMM_SET_INFO(COMM, INFO, IERROR)
38        INTEGER COMM, INFO, IERROR
39
40    MPI_COMM_SET_NAME(COMM, COMM_NAME, IERROR)
41        INTEGER COMM, IERROR
42        CHARACTER*(*) COMM_NAME
43
44    MPI_COMM_SIZE(COMM, SIZE, IERROR)
45        INTEGER COMM, SIZE, IERROR
46
47    MPI_COMM_SPLIT(COMM, COLOR, KEY, NEWCOMM, IERROR)
48        INTEGER COMM, COLOR, KEY, NEWCOMM, IERROR
49
50    MPI_COMM_SPLIT_TYPE(COMM, SPLIT_TYPE, KEY, INFO, NEWCOMM, IERROR)
51        INTEGER COMM, SPLIT_TYPE, KEY, INFO, NEWCOMM, IERROR
52
53    MPI_COMM_TEST_INTER(COMM, FLAG, IERROR)
54        INTEGER COMM, IERROR
55        LOGICAL FLAG
```

```
MPI_GROUP_COMPARE(GROUP1, GROUP2, RESULT, IERROR) 1
    INTEGER GROUP1, GROUP2, RESULT, IERROR 2
3
MPI_GROUP_DIFFERENCE(GROUP1, GROUP2, NEWGROUP, IERROR) 4
    INTEGER GROUP1, GROUP2, NEWGROUP, IERROR 5
6
MPI_GROUP_EXCL(GROUP, N, RANKS, NEWGROUP, IERROR) 6
    INTEGER GROUP, N, RANKS(*), NEWGROUP, IERROR 7
8
MPI_GROUP_FREE(GROUP, IERROR) 8
    INTEGER GROUP, IERROR 9
10
MPI_GROUP_FROM_SESSION_PSET(SESSION, PSET_NAME, NEWGROUP, IERROR) 11
    INTEGER SESSION, NEWGROUP, IERROR 12
    CHARACTER*(*) PSET_NAME 13
14
MPI_GROUP_INCL(GROUP, N, RANKS, NEWGROUP, IERROR) 15
    INTEGER GROUP, N, RANKS(*), NEWGROUP, IERROR 16
17
MPI_GROUP_INTERSECTION(GROUP1, GROUP2, NEWGROUP, IERROR) 17
    INTEGER GROUP1, GROUP2, NEWGROUP, IERROR 18
19
MPI_GROUP_RANGE_EXCL(GROUP, N, RANGES, NEWGROUP, IERROR) 20
    INTEGER GROUP, N, RANGES(3, *), NEWGROUP, IERROR 21
22
MPI_GROUP_RANGE_INCL(GROUP, N, RANGES, NEWGROUP, IERROR) 22
    INTEGER GROUP, N, RANGES(3, *), NEWGROUP, IERROR 23
24
MPI_GROUP_RANK(GROUP, RANK, IERROR) 24
    INTEGER GROUP, RANK, IERROR 25
26
MPI_GROUP_SIZE(GROUP, SIZE, IERROR) 26
    INTEGER GROUP, SIZE, IERROR 27
28
MPI_GROUP_TRANSLATE_RANKS(GROUP1, N, RANKS1, GROUP2, RANKS2, IERROR) 28
    INTEGER GROUP1, N, RANKS1(*), GROUP2, RANKS2(*), IERROR 29
30
MPI_GROUP_UNION(GROUP1, GROUP2, NEWGROUP, IERROR) 30
    INTEGER GROUP1, GROUP2, NEWGROUP, IERROR 31
32
MPI_INTERCOMM_CREATE(LOCAL_COMM, LOCAL_LEADER, PEER_COMM, REMOTE_LEADER, 32
    TAG, NEWINTERCOMM, IERROR) 33
34
    INTEGER LOCAL_COMM, LOCAL_LEADER, PEER_COMM, REMOTE_LEADER, TAG, 34
    NEWINTERCOMM, IERROR 35
36
MPI_INTERCOMM_CREATE_FROM_GROUPS(LOCAL_GROUP, LOCAL_LEADER, REMOTE_GROUP, 36
    REMOTE_LEADER, STRINGTAG, INFO, ERRHANDLER, NEWINTERCOMM, 37
    IERROR) 38
39
    INTEGER LOCAL_GROUP, LOCAL_LEADER, REMOTE_GROUP, REMOTE_LEADER, INFO, 38
    ERRHANDLER, NEWINTERCOMM, IERROR 39
40
    CHARACTER*(*) STRINGTAG 40
41
42
MPI_INTERCOMM_MERGE(INTERCOMM, HIGH, NEWINTRACOMM, IERROR) 41
    INTEGER INTERCOMM, NEWINTRACOMM, IERROR 42
43
    LOGICAL HIGH 43
44
45
46
47
48
```

```
1 MPI_TYPE_CREATE_KEYVAL(TYPE_COPY_ATTR_FN, TYPE_DELETE_ATTR_FN, TYPE_KEYVAL,
2     EXTRA_STATE, IERROR)
3     EXTERNAL TYPE_COPY_ATTR_FN, TYPE_DELETE_ATTR_FN
4     INTEGER TYPE_KEYVAL, IERROR
5     INTEGER(KIND=MPI_ADDRESS_KIND) EXTRA_STATE
6
7 MPI_TYPE_DELETE_ATTR(DATATYPE, TYPE_KEYVAL, IERROR)
8     INTEGER DATATYPE, TYPE_KEYVAL, IERROR
9
10 MPI_TYPE_DUP_FN(OLDTYPE, TYPE_KEYVAL, EXTRA_STATE, ATTRIBUTE_VAL_IN,
11     ATTRIBUTE_VAL_OUT, FLAG, IERROR)
12     INTEGER OLDTYPE, TYPE_KEYVAL, IERROR
13     INTEGER(KIND=MPI_ADDRESS_KIND) EXTRA_STATE, ATTRIBUTE_VAL_IN,
14     ATTRIBUTE_VAL_OUT
15     LOGICAL FLAG
16
17 MPI_TYPE_FREE_KEYVAL(TYPE_KEYVAL, IERROR)
18     INTEGER TYPE_KEYVAL, IERROR
19
20 MPI_TYPE_GET_ATTR(DATATYPE, TYPE_KEYVAL, ATTRIBUTE_VAL, FLAG, IERROR)
21     INTEGER DATATYPE, TYPE_KEYVAL, IERROR
22     INTEGER(KIND=MPI_ADDRESS_KIND) ATTRIBUTE_VAL
23     LOGICAL FLAG
24
25 MPI_TYPE_GET_NAME(DATATYPE, TYPE_NAME, RESULTLEN, IERROR)
26     INTEGER DATATYPE, RESULTLEN, IERROR
27     CHARACTER*(*) TYPE_NAME
28
29 MPI_TYPE_NULL_COPY_FN(OLDTYPE, TYPE_KEYVAL, EXTRA_STATE, ATTRIBUTE_VAL_IN,
30     ATTRIBUTE_VAL_OUT, FLAG, IERROR)
31     INTEGER OLDTYPE, TYPE_KEYVAL, IERROR
32     INTEGER(KIND=MPI_ADDRESS_KIND) EXTRA_STATE, ATTRIBUTE_VAL_IN,
33     ATTRIBUTE_VAL_OUT
34     LOGICAL FLAG
35
36 MPI_TYPE_NULL_DELETE_FN(DATATYPE, TYPE_KEYVAL, ATTRIBUTE_VAL, EXTRA_STATE,
37     IERROR)
38     INTEGER DATATYPE, TYPE_KEYVAL, IERROR
39     INTEGER(KIND=MPI_ADDRESS_KIND) ATTRIBUTE_VAL, EXTRA_STATE
40
41 MPI_TYPE_SET_ATTR(DATATYPE, TYPE_KEYVAL, ATTRIBUTE_VAL, IERROR)
42     INTEGER DATATYPE, TYPE_KEYVAL, IERROR
43     INTEGER(KIND=MPI_ADDRESS_KIND) ATTRIBUTE_VAL
44
45 MPI_TYPE_SET_NAME(DATATYPE, TYPE_NAME, IERROR)
46     INTEGER DATATYPE, IERROR
47     CHARACTER*(*) TYPE_NAME
48
49 MPI_WIN_CREATE_KEYVAL(WIN_COPY_ATTR_FN, WIN_DELETE_ATTR_FN, WIN_KEYVAL,
50     EXTRA_STATE, IERROR)
51     EXTERNAL WIN_COPY_ATTR_FN, WIN_DELETE_ATTR_FN
52     INTEGER WIN_KEYVAL, IERROR
```

```

INTEGER(KIND=MPI_ADDRESS_KIND) EXTRA_STATE 1
MPI_WIN_DELETE_ATTR(WIN, WIN_KEYVAL, IERROR) 2
INTEGER WIN, WIN_KEYVAL, IERROR 3
MPI_WIN_DUP_FN(OLDWIN, WIN_KEYVAL, EXTRA_STATE, ATTRIBUTE_VAL_IN, 4
ATTRIBUTE_VAL_OUT, FLAG, IERROR) 5
INTEGER OLDWIN, WIN_KEYVAL, IERROR 6
INTEGER(KIND=MPI_ADDRESS_KIND) EXTRA_STATE, ATTRIBUTE_VAL_IN, 7
ATTRIBUTE_VAL_OUT 8
LOGICAL FLAG 9
MPI_WIN_FREE_KEYVAL(WIN_KEYVAL, IERROR) 10
INTEGER WIN_KEYVAL, IERROR 11
MPI_WIN_GET_ATTR(WIN, WIN_KEYVAL, ATTRIBUTE_VAL, FLAG, IERROR) 12
INTEGER WIN, WIN_KEYVAL, IERROR 13
INTEGER(KIND=MPI_ADDRESS_KIND) ATTRIBUTE_VAL 14
LOGICAL FLAG 15
MPI_WIN_GET_NAME(WIN, WIN_NAME, RESULTLEN, IERROR) 16
INTEGER WIN, RESULTLEN, IERROR 17
CHARACTER*(*) WIN_NAME 18
MPI_WIN_NULL_COPY_FN(OLDWIN, WIN_KEYVAL, EXTRA_STATE, ATTRIBUTE_VAL_IN, 19
ATTRIBUTE_VAL_OUT, FLAG, IERROR) 20
INTEGER OLDWIN, WIN_KEYVAL, IERROR 21
INTEGER(KIND=MPI_ADDRESS_KIND) EXTRA_STATE, ATTRIBUTE_VAL_IN, 22
ATTRIBUTE_VAL_OUT 23
LOGICAL FLAG 24
MPI_WIN_NULL_DELETE_FN(WIN, WIN_KEYVAL, ATTRIBUTE_VAL, EXTRA_STATE, IERROR) 25
INTEGER WIN, WIN_KEYVAL, IERROR 26
INTEGER(KIND=MPI_ADDRESS_KIND) ATTRIBUTE_VAL, EXTRA_STATE 27
MPI_WIN_SET_ATTR(WIN, WIN_KEYVAL, ATTRIBUTE_VAL, IERROR) 28
INTEGER WIN, WIN_KEYVAL, IERROR 29
INTEGER(KIND=MPI_ADDRESS_KIND) ATTRIBUTE_VAL 30
MPI_WIN_SET_NAME(WIN, WIN_NAME, IERROR) 31
INTEGER WIN, IERROR 32
CHARACTER*(*) WIN_NAME 33

```

#### A.5.6 Process Topologies Fortran Bindings

```

MPI_CARTDIM_GET(COMM, NDIMS, IERROR) 34
INTEGER COMM, NDIMS, IERROR 35
MPI_CART_COORDS(COMM, RANK, MAXDIMS, COORDS, IERROR) 36
INTEGER COMM, RANK, MAXDIMS, COORDS(*), IERROR 37
MPI_CART_CREATE(COMM_OLD, NDIMS, DIMS, PERIODS, REORDER, COMM_CART, IERROR) 38

```

```

1     INTEGER COMM_OLD, NDIMS, DIMS(*), COMM_CART, IERROR
2     LOGICAL PERIODS(*), REORDER
3
4     MPI_CART_GET(COMM, MAXDIMS, DIMS, PERIODS, COORDS, IERROR)
5     INTEGER COMM, MAXDIMS, DIMS(*), COORDS(*), IERROR
6     LOGICAL PERIODS(*)
7
8     MPI_CART_MAP(COMM, NDIMS, DIMS, PERIODS, NEWRANK, IERROR)
9     INTEGER COMM, NDIMS, DIMS(*), NEWRANK, IERROR
10    LOGICAL PERIODS(*)
11
12    MPI_CART_RANK(COMM, COORDS, RANK, IERROR)
13    INTEGER COMM, COORDS(*), RANK, IERROR
14
15    MPI_CART_SHIFT(COMM, DIRECTION, DISP, RANK_SOURCE, RANK_DEST, IERROR)
16    INTEGER COMM, DIRECTION, DISP, RANK_SOURCE, RANK_DEST, IERROR
17
18    MPI_CART_SUB(COMM, REMAIN_DIMS, NEWCOMM, IERROR)
19    INTEGER COMM, NEWCOMM, IERROR
20    LOGICAL REMAIN_DIMS(*)
21
22    MPI_DIMS_CREATE(NNODES, NDIMS, DIMS, IERROR)
23    INTEGER NNODES, NDIMS, DIMS(*), IERROR
24
25    MPI_DIST_GRAPH_CREATE(COMM_OLD, N, SOURCES, DEGREES, DESTINATIONS, WEIGHTS,
26                          INFO, REORDER, COMM_DIST_GRAPH, IERROR)
27    INTEGER COMM_OLD, N, SOURCES(*), DEGREES(*), DESTINATIONS(*),
28          WEIGHTS(*), INFO, COMM_DIST_GRAPH, IERROR
29    LOGICAL REORDER
30
31    MPI_DIST_GRAPH_CREATE_ADJACENT(COMM_OLD, INDEGREE, SOURCES, SOURCEWEIGHTS,
32                                   OUTDEGREE, DESTINATIONS, DESTWEIGHTS, INFO, REORDER,
33                                   COMM_DIST_GRAPH, IERROR)
34    INTEGER COMM_OLD, INDEGREE, SOURCES(*), SOURCEWEIGHTS(*), OUTDEGREE,
35          DESTINATIONS(*), DESTWEIGHTS(*), INFO, COMM_DIST_GRAPH,
36          IERROR
37    LOGICAL REORDER
38
39    MPI_DIST_GRAPH_NEIGHBORS(COMM, MAXINDEGREE, SOURCES, SOURCEWEIGHTS,
40                             MAXOUTDEGREE, DESTINATIONS, DESTWEIGHTS, IERROR)
41    INTEGER COMM, MAXINDEGREE, SOURCES(*), SOURCEWEIGHTS(*), MAXOUTDEGREE,
42          DESTINATIONS(*), DESTWEIGHTS(*), IERROR
43
44    MPI_DIST_GRAPH_NEIGHBORS_COUNT(COMM, INDEGREE, OUTDEGREE, WEIGHTED, IERROR)
45    INTEGER COMM, INDEGREE, OUTDEGREE, IERROR
46    LOGICAL WEIGHTED
47
48    MPI_GRAPHDIMS_GET(COMM, NNODES, NEDGES, IERROR)
49    INTEGER COMM, NNODES, NEDGES, IERROR
50
51    MPI_GRAPH_CREATE(COMM_OLD, NNODES, INDEX, EDGES, REORDER, COMM_GRAPH,
52                    IERROR)
53    INTEGER COMM_OLD, NNODES, INDEX(*), EDGES(*), COMM_GRAPH, IERROR

```

```

LOGICAL REORDER 1
MPI_GRAPH_GET(COMM, MAXINDEX, MAXEDGES, INDEX, EDGES, IERROR) 2
  INTEGER COMM, MAXINDEX, MAXEDGES, INDEX(*), EDGES(*), IERROR 3
MPI_GRAPH_MAP(COMM, NNODES, INDEX, EDGES, NEWRANK, IERROR) 4
  INTEGER COMM, NNODES, INDEX(*), EDGES(*), NEWRANK, IERROR 5
MPI_GRAPH_NEIGHBORS(COMM, RANK, MAXNEIGHBORS, NEIGHBORS, IERROR) 6
  INTEGER COMM, RANK, MAXNEIGHBORS, NEIGHBORS(*), IERROR 7
MPI_GRAPH_NEIGHBORS_COUNT(COMM, RANK, NNEIGHBORS, IERROR) 8
  INTEGER COMM, RANK, NNEIGHBORS, IERROR 9
MPI_INEIGHBOR_ALLGATHER(SENDBUF, SENDCOUNT, SENDTYPE, RECVBUFF, RECVCOUNT, 10
  RECVMODE, COMM, REQUEST, IERROR) 11
  <type> SENDBUF(*), RECVBUFF(*) 12
  INTEGER SENDCOUNT, SENDTYPE, RECVCOUNT, RECVMODE, COMM, REQUEST, IERROR 13
MPI_INEIGHBOR_ALLGATHERV(SENDBUF, SENDCOUNT, SENDTYPE, RECVBUFF, RECVCOUNTS, 14
  DISPLS, RECVMODE, COMM, REQUEST, IERROR) 15
  <type> SENDBUF(*), RECVBUFF(*) 16
  INTEGER SENDCOUNT, SENDTYPE, RECVCOUNTS(*), DISPLS(*), RECVMODE, COMM, 17
  REQUEST, IERROR 18
MPI_INEIGHBOR_ALLTOALL(SENDBUF, SENDCOUNT, SENDTYPE, RECVBUFF, RECVCOUNT, 19
  RECVMODE, COMM, REQUEST, IERROR) 20
  <type> SENDBUF(*), RECVBUFF(*) 21
  INTEGER SENDCOUNT, SENDTYPE, RECVCOUNT, RECVMODE, COMM, REQUEST, IERROR 22
MPI_INEIGHBOR_ALLTOALLV(SENDBUF, SENDCOUNTS, SDISPLS, SENDTYPE, RECVBUFF, 23
  RECVCOUNTS, RDISPLS, RECVMODE, COMM, REQUEST, IERROR) 24
  <type> SENDBUF(*), RECVBUFF(*) 25
  INTEGER SENDCOUNTS(*), SDISPLS(*), SENDTYPE, RECVCOUNTS(*), RDISPLS(*), 26
  RECVMODE, COMM, REQUEST, IERROR 27
MPI_INEIGHBOR_ALLTOALLW(SENDBUF, SENDCOUNTS, SDISPLS, SENDTYPES, RECVBUFF, 28
  RECVCOUNTS, RDISPLS, RECVMODES, COMM, REQUEST, IERROR) 29
  <type> SENDBUF(*), RECVBUFF(*) 30
  INTEGER SENDCOUNTS(*), SENDTYPES(*), RECVCOUNTS(*), RECVMODES(*), COMM, 31
  REQUEST, IERROR 32
  INTEGER(KIND=MPI_ADDRESS_KIND) SDISPLS(*), RDISPLS(*) 33
MPI_NEIGHBOR_ALLGATHER(SENDBUF, SENDCOUNT, SENDTYPE, RECVBUFF, RECVCOUNT, 34
  RECVMODE, COMM, IERROR) 35
  <type> SENDBUF(*), RECVBUFF(*) 36
  INTEGER SENDCOUNT, SENDTYPE, RECVCOUNT, RECVMODE, COMM, IERROR 37
MPI_NEIGHBOR_ALLGATHERV(SENDBUF, SENDCOUNT, SENDTYPE, RECVBUFF, RECVCOUNTS, 38
  DISPLS, RECVMODE, COMM, IERROR) 39
  <type> SENDBUF(*), RECVBUFF(*) 40
  INTEGER SENDCOUNT, SENDTYPE, RECVCOUNTS(*), DISPLS(*), RECVMODE, COMM, 41
  IERROR 42

```

```

1 MPI_NEIGHBOR_ALLGATHERV_INIT(SENDBUF, SENDCOUNT, SENDTYPE, RECVBUF,
2     RECVCOUNTS, DISPLS, RECVTYPE, COMM, INFO, REQUEST, IERROR)
3     <type> SENDBUF(*), RECVBUF(*)
4     INTEGER SENDCOUNT, SENDTYPE, RECVCOUNTS(*), DISPLS(*), RECVTYPE, COMM,
5     INFO, REQUEST, IERROR
6
7 MPI_NEIGHBOR_ALLGATHER_INIT(SENDBUF, SENDCOUNT, SENDTYPE, RECVBUF,
8     RECVCOUNT, RECVTYPE, COMM, INFO, REQUEST, IERROR)
9     <type> SENDBUF(*), RECVBUF(*)
10    INTEGER SENDCOUNT, SENDTYPE, RECVCOUNT, RECVTYPE, COMM, INFO, REQUEST,
11    IERROR
12
13 MPI_NEIGHBOR_ALLTOALL(SENDBUF, SENDCOUNT, SENDTYPE, RECVBUF, RECVCOUNT,
14     RECVTYPE, COMM, IERROR)
15     <type> SENDBUF(*), RECVBUF(*)
16     INTEGER SENDCOUNT, SENDTYPE, RECVCOUNT, RECVTYPE, COMM, IERROR
17
18 MPI_NEIGHBOR_ALLTOALLV(SENDBUF, SENDCOUNTS, SDISPLS, SENDTYPE, RECVBUF,
19     RECVCOUNTS, RDISPLS, RECVTYPE, COMM, IERROR)
20     <type> SENDBUF(*), RECVBUF(*)
21     INTEGER SENDCOUNTS(*), SDISPLS(*), SENDTYPE, RECVCOUNTS(*), RDISPLS(*),
22     RECVTYPE, COMM, IERROR
23
24 MPI_NEIGHBOR_ALLTOALLV_INIT(SENDBUF, SENDCOUNTS, SDISPLS, SENDTYPE,
25     RECVBUF, RECVCOUNTS, RDISPLS, RECVTYPE, COMM, INFO, REQUEST,
26     IERROR)
27     <type> SENDBUF(*), RECVBUF(*)
28     INTEGER SENDCOUNTS(*), SDISPLS(*), SENDTYPE, RECVCOUNTS(*), RDISPLS(*),
29     RECVTYPE, COMM, INFO, REQUEST, IERROR
30
31 MPI_NEIGHBOR_ALLTOALLW(SENDBUF, SENDCOUNTS, SDISPLS, SENDTYPES, RECVBUF,
32     RECVCOUNTS, RDISPLS, RECVTYPES, COMM, IERROR)
33     <type> SENDBUF(*), RECVBUF(*)
34     INTEGER SENDCOUNTS(*), SENDTYPES(*), RECVCOUNTS(*), RECVTYPES(*), COMM,
35     IERROR
36     INTEGER(KIND=MPI_ADDRESS_KIND) SDISPLS(*), RDISPLS(*)
37
38 MPI_NEIGHBOR_ALLTOALLW_INIT(SENDBUF, SENDCOUNTS, SDISPLS, SENDTYPES,
39     RECVBUF, RECVCOUNTS, RDISPLS, RECVTYPES, COMM, INFO, REQUEST,
40     IERROR)
41     <type> SENDBUF(*), RECVBUF(*)
42     INTEGER SENDCOUNTS(*), SENDTYPES(*), RECVCOUNTS(*), RECVTYPES(*), COMM,
43     INFO, REQUEST, IERROR
44     INTEGER(KIND=MPI_ADDRESS_KIND) SDISPLS(*), RDISPLS(*)
45
46 MPI_NEIGHBOR_ALLTOALL_INIT(SENDBUF, SENDCOUNT, SENDTYPE, RECVBUF,
47     RECVCOUNT, RECVTYPE, COMM, INFO, REQUEST, IERROR)
48     <type> SENDBUF(*), RECVBUF(*)
49     INTEGER SENDCOUNT, SENDTYPE, RECVCOUNT, RECVTYPE, COMM, INFO, REQUEST,
50     IERROR

```



```

MPI_TOPO_TEST(COMM, STATUS, IERROR) 1
    INTEGER COMM, STATUS, IERROR 2
3
4
A.5.7 MPI Environmental Management Fortran Bindings 5
6
DOUBLE PRECISION MPI_WTICK() 6
7
DOUBLE PRECISION MPI_WTIME() 8
9
MPI_ADD_ERROR_CLASS(ERRORCLASS, IERROR) 9
    INTEGER ERRORCLASS, IERROR 10
11
MPI_ADD_ERROR_CODE(ERRORCLASS, ERRORCODE, IERROR) 12
    INTEGER ERRORCLASS, ERRORCODE, IERROR 13
14
MPI_ADD_ERROR_STRING(ERRORCODE, STRING, IERROR) 14
    INTEGER ERRORCODE, IERROR 15
    CHARACTER*(*) STRING 16
17
MPI_ALLOC_MEM(SIZE, INFO, BASEPTR, IERROR) 18
    INTEGER(KIND=MPI_ADDRESS_KIND) SIZE, BASEPTR 19
    INTEGER INFO, IERROR 20
21
If the Fortran compiler provides TYPE(C_PTR), then overloaded by: 21
22
INTERFACE MPI_ALLOC_MEM 22
    SUBROUTINE MPI_ALLOC_MEM(SIZE, INFO, BASEPTR, IERROR) 23
        IMPORT :: MPI_ADDRESS_KIND 24
        INTEGER :: INFO, IERROR 25
        INTEGER(KIND=MPI_ADDRESS_KIND) :: SIZE, BASEPTR 26
    END SUBROUTINE 27
    SUBROUTINE MPI_ALLOC_MEM_CPTR(SIZE, INFO, BASEPTR, IERROR) 28
        USE, INTRINSIC :: ISO_C_BINDING, ONLY : C_PTR 29
        IMPORT :: MPI_ADDRESS_KIND 30
        INTEGER :: INFO, IERROR 31
        INTEGER(KIND=MPI_ADDRESS_KIND) :: SIZE 32
        TYPE(C_PTR) :: BASEPTR 33
    END SUBROUTINE 34
END INTERFACE 35
36
MPI_COMM_CALL_ERRHANDLER(COMM, ERRORCODE, IERROR) 37
    INTEGER COMM, ERRORCODE, IERROR 38
39
MPI_COMM_CREATE_ERRHANDLER(COMM_ERRHANDLER_FN, ERRHANDLER, IERROR) 39
    EXTERNAL COMM_ERRHANDLER_FN 40
    INTEGER ERRHANDLER, IERROR 41
42
MPI_COMM_GET_ERRHANDLER(COMM, ERRHANDLER, IERROR) 43
    INTEGER COMM, ERRHANDLER, IERROR 44
45
MPI_COMM_SET_ERRHANDLER(COMM, ERRHANDLER, IERROR) 45
    INTEGER COMM, ERRHANDLER, IERROR 46
47
MPI_ERRHANDLER_FREE(ERRHANDLER, IERROR) 48

```

```
1     INTEGER ERRHANDLER, IERROR
2
3     MPI_ERROR_CLASS(ERRORCODE, ERRORCLASS, IERROR)
4         INTEGER ERRORCODE, ERRORCLASS, IERROR
5
6     MPI_ERROR_STRING(ERRORCODE, STRING, RESULTLEN, IERROR)
7         INTEGER ERRORCODE, RESULTLEN, IERROR
8         CHARACTER*(*) STRING
9
10    MPI_FILE_CALL_ERRHANDLER(FH, ERRORCODE, IERROR)
11        INTEGER FH, ERRORCODE, IERROR
12
13    MPI_FILE_CREATE_ERRHANDLER(FILE_ERRHANDLER_FN, ERRHANDLER, IERROR)
14        EXTERNAL FILE_ERRHANDLER_FN
15        INTEGER ERRHANDLER, IERROR
16
17    MPI_FILE_GET_ERRHANDLER(FILE, ERRHANDLER, IERROR)
18        INTEGER FILE, ERRHANDLER, IERROR
19
20    MPI_FILE_SET_ERRHANDLER(FILE, ERRHANDLER, IERROR)
21        INTEGER FILE, ERRHANDLER, IERROR
22
23    MPI_FREE_MEM(BASE, IERROR)
24        <type> BASE(*)
25        INTEGER IERROR
26
27    MPI_GET_LIBRARY_VERSION(VERSION, RESULTLEN, IERROR)
28        CHARACTER*(*) VERSION
29        INTEGER RESULTLEN, IERROR
30
31    MPI_GET_PROCESSOR_NAME(NAME, RESULTLEN, IERROR)
32        CHARACTER*(*) NAME
33        INTEGER RESULTLEN, IERROR
34
35    MPI_GET_VERSION(VERSION, SUBVERSION, IERROR)
36        INTEGER VERSION, SUBVERSION, IERROR
37
38    MPI_SESSION_CALL_ERRHANDLER(SESSION, ERRORCODE, IERROR)
39        INTEGER SESSION, ERRORCODE, IERROR
40
41    MPI_SESSION_CREATE_ERRHANDLER(SESSION_ERRHANDLER_FN, ERRHANDLER, IERROR)
42        EXTERNAL SESSION_ERRHANDLER_FN
43        INTEGER ERRHANDLER, IERROR
44
45    MPI_SESSION_GET_ERRHANDLER(SESSION, ERRHANDLER, IERROR)
46        INTEGER SESSION, ERRHANDLER, IERROR
47
48    MPI_SESSION_SET_ERRHANDLER(SESSION, ERRHANDLER, IERROR)
49        INTEGER SESSION, ERRHANDLER, IERROR
50
51    MPI_WIN_CALL_ERRHANDLER(WIN, ERRORCODE, IERROR)
52        INTEGER WIN, ERRORCODE, IERROR
53
54    MPI_WIN_CREATE_ERRHANDLER(WIN_ERRHANDLER_FN, ERRHANDLER, IERROR)
55        EXTERNAL WIN_ERRHANDLER_FN
```

INTEGER ERRHANDLER, IERROR	1
MPI_WIN_GET_ERRHANDLER(WIN, ERRHANDLER, IERROR)	2
INTEGER WIN, ERRHANDLER, IERROR	3
	4
MPI_WIN_SET_ERRHANDLER(WIN, ERRHANDLER, IERROR)	5
INTEGER WIN, ERRHANDLER, IERROR	6
	7
	8
A.5.8 The Info Object Fortran Bindings	9
MPI_INFO_CREATE(INFO, IERROR)	10
INTEGER INFO, IERROR	11
	12
MPI_INFO_CREATE_ENV(INFO, IERROR)	13
INTEGER INFO, IERROR	14
	15
MPI_INFO_DELETE(INFO, KEY, IERROR)	16
INTEGER INFO, IERROR	17
CHARACTER*(*) KEY	18
	19
MPI_INFO_DUP(INFO, NEWINFO, IERROR)	20
INTEGER INFO, NEWINFO, IERROR	21
	22
MPI_INFO_FREE(INFO, IERROR)	23
INTEGER INFO, IERROR	24
	25
MPI_INFO_GET(INFO, KEY, VALUELEN, VALUE, FLAG, IERROR)	26
INTEGER INFO, VALUELEN, IERROR	27
CHARACTER*(*) KEY, VALUE	28
LOGICAL FLAG	29
	30
MPI_INFO_GET_NKEYS(INFO, NKEYS, IERROR)	31
INTEGER INFO, NKEYS, IERROR	32
	33
MPI_INFO_GET_NTHKEY(INFO, N, KEY, IERROR)	34
INTEGER INFO, N, IERROR	35
CHARACTER*(*) KEY	36
	37
MPI_INFO_GET_STRING(INFO, KEY, BUFLen, VALUE, FLAG, IERROR)	38
INTEGER INFO, BUFLen, IERROR	39
CHARACTER*(*) KEY, VALUE	40
LOGICAL FLAG	41
	42
MPI_INFO_GET_VALUELEN(INFO, KEY, VALUELEN, FLAG, IERROR)	43
INTEGER INFO, VALUELEN, IERROR	44
CHARACTER*(*) KEY	45
LOGICAL FLAG	46
	47
MPI_INFO_SET(INFO, KEY, VALUE, IERROR)	48
INTEGER INFO, IERROR	
CHARACTER*(*) KEY, VALUE	

## A.5.9 Process Creation and Management Fortran Bindings

```
1 MPI_ABORT(COMM, ERRORCODE, IERROR)
2   INTEGER COMM, ERRORCODE, IERROR
3
4 MPI_CLOSE_PORT(PORT_NAME, IERROR)
5   CHARACTER*(*) PORT_NAME
6   INTEGER IERROR
7
8 MPI_COMM_ACCEPT(PORT_NAME, INFO, ROOT, COMM, NEWCOMM, IERROR)
9   CHARACTER*(*) PORT_NAME
10  INTEGER INFO, ROOT, COMM, NEWCOMM, IERROR
11
12 MPI_COMM_CONNECT(PORT_NAME, INFO, ROOT, COMM, NEWCOMM, IERROR)
13  CHARACTER*(*) PORT_NAME
14  INTEGER INFO, ROOT, COMM, NEWCOMM, IERROR
15
16 MPI_COMM_DISCONNECT(COMM, IERROR)
17  INTEGER COMM, IERROR
18
19 MPI_COMM_GET_PARENT(PARENT, IERROR)
20  INTEGER PARENT, IERROR
21
22 MPI_COMM_JOIN(FD, INTERCOMM, IERROR)
23  INTEGER FD, INTERCOMM, IERROR
24
25 MPI_COMM_SPAWN(COMMAND, ARGV, MAXPROCS, INFO, ROOT, COMM, INTERCOMM,
26  ARRAY_OF_ERRCODES, IERROR)
27  CHARACTER*(*) COMMAND, ARGV(*)
28  INTEGER MAXPROCS, INFO, ROOT, COMM, INTERCOMM, ARRAY_OF_ERRCODES(*),
29  IERROR
30
31 MPI_COMM_SPAWN_MULTIPLE(COUNT, ARRAY_OF_COMMANDS, ARRAY_OF_ARGV,
32  ARRAY_OF_MAXPROCS, ARRAY_OF_INFO, ROOT, COMM, INTERCOMM,
33  ARRAY_OF_ERRCODES, IERROR)
34  INTEGER COUNT, ARRAY_OF_MAXPROCS(*), ARRAY_OF_INFO(*), ROOT, COMM,
35  INTERCOMM, ARRAY_OF_ERRCODES(*), IERROR
36  CHARACTER*(*) ARRAY_OF_COMMANDS(*), ARRAY_OF_ARGV(COUNT, *)
37
38 MPI_FINALIZE(IERROR)
39  INTEGER IERROR
40
41 MPI_FINALIZED(FLAG, IERROR)
42  LOGICAL FLAG
43  INTEGER IERROR
44
45 MPI_INIT(IERROR)
46  INTEGER IERROR
47
48 MPI_INITIALIZED(FLAG, IERROR)
49  LOGICAL FLAG
50  INTEGER IERROR
51
52 MPI_INIT_THREAD(REQUIRED, PROVIDED, IERROR)
```

INTEGER REQUIRED, PROVIDED, IERROR	1
MPI_IS_THREAD_MAIN(FLAG, IERROR)	2
LOGICAL FLAG	3
INTEGER IERROR	4
MPI_LOOKUP_NAME(SERVICE_NAME, INFO, PORT_NAME, IERROR)	5
CHARACTER*(*) SERVICE_NAME, PORT_NAME	6
INTEGER INFO, IERROR	7
MPI_OPEN_PORT(INFO, PORT_NAME, IERROR)	8
INTEGER INFO, IERROR	9
CHARACTER*(*) PORT_NAME	10
MPI_PUBLISH_NAME(SERVICE_NAME, INFO, PORT_NAME, IERROR)	11
CHARACTER*(*) SERVICE_NAME, PORT_NAME	12
INTEGER INFO, IERROR	13
MPI_QUERY_THREAD(PROVIDED, IERROR)	14
INTEGER PROVIDED, IERROR	15
MPI_SESSION_FINALIZE(SESSION, IERROR)	16
INTEGER SESSION, IERROR	17
MPI_SESSION_GET_INFO(SESSION, INFO_USED, IERROR)	18
INTEGER SESSION, INFO_USED, IERROR	19
MPI_SESSION_GET_NTH_PSET(SESSION, INFO, N, PSET_LEN, PSET_NAME, IERROR)	20
INTEGER SESSION, INFO, N, PSET_LEN, IERROR	21
CHARACTER*(*) PSET_NAME	22
MPI_SESSION_GET_NUM_PSETS(SESSION, INFO, NPSET_NAMES, IERROR)	23
INTEGER SESSION, INFO, NPSET_NAMES, IERROR	24
MPI_SESSION_GET_PSET_INFO(SESSION, PSET_NAME, INFO, IERROR)	25
INTEGER SESSION, INFO, IERROR	26
CHARACTER*(*) PSET_NAME	27
MPI_SESSION_INIT(INFO, ERRHANDLER, SESSION, IERROR)	28
INTEGER INFO, ERRHANDLER, SESSION, IERROR	29
MPI_UNPUBLISH_NAME(SERVICE_NAME, INFO, PORT_NAME, IERROR)	30
CHARACTER*(*) SERVICE_NAME, PORT_NAME	31
INTEGER INFO, IERROR	32

#### A.5.10 One-Sided Communications Fortran Bindings

MPI_ACCUMULATE(ORIGIN_ADDR, ORIGIN_COUNT, ORIGIN_DATATYPE, TARGET_RANK,	33
TARGET_DISP, TARGET_COUNT, TARGET_DATATYPE, OP, WIN, IERROR)	34
<type> ORIGIN_ADDR(*)	35
INTEGER ORIGIN_COUNT, ORIGIN_DATATYPE, TARGET_RANK, TARGET_COUNT,	36
TARGET_DATATYPE, OP, WIN, IERROR	37
INTEGER(KIND=MPI_ADDRESS_KIND) TARGET_DISP	38
	39
	40
	41
	42
	43
	44
	45
	46
	47
	48

```

1 MPI_COMPARE_AND_SWAP(ORIGIN_ADDR, COMPARE_ADDR, RESULT_ADDR, DATATYPE,
2     TARGET_RANK, TARGET_DISP, WIN, IERROR)
3     <type> ORIGIN_ADDR(*), COMPARE_ADDR(*), RESULT_ADDR(*)
4     INTEGER DATATYPE, TARGET_RANK, WIN, IERROR
5     INTEGER(KIND=MPI_ADDRESS_KIND) TARGET_DISP
6
7 MPI_FETCH_AND_OP(ORIGIN_ADDR, RESULT_ADDR, DATATYPE, TARGET_RANK,
8     TARGET_DISP, OP, WIN, IERROR)
9     <type> ORIGIN_ADDR(*), RESULT_ADDR(*)
10    INTEGER DATATYPE, TARGET_RANK, OP, WIN, IERROR
11    INTEGER(KIND=MPI_ADDRESS_KIND) TARGET_DISP
12
13 MPI_GET(ORIGIN_ADDR, ORIGIN_COUNT, ORIGIN_DATATYPE, TARGET_RANK,
14     TARGET_DISP, TARGET_COUNT, TARGET_DATATYPE, WIN, IERROR)
15     <type> ORIGIN_ADDR(*)
16     INTEGER ORIGIN_COUNT, ORIGIN_DATATYPE, TARGET_RANK, TARGET_COUNT,
17     TARGET_DATATYPE, WIN, IERROR
18     INTEGER(KIND=MPI_ADDRESS_KIND) TARGET_DISP
19
20 MPI_GET_ACCUMULATE(ORIGIN_ADDR, ORIGIN_COUNT, ORIGIN_DATATYPE, RESULT_ADDR,
21     RESULT_COUNT, RESULT_DATATYPE, TARGET_RANK, TARGET_DISP,
22     TARGET_COUNT, TARGET_DATATYPE, OP, WIN, IERROR)
23     <type> ORIGIN_ADDR(*), RESULT_ADDR(*)
24     INTEGER ORIGIN_COUNT, ORIGIN_DATATYPE, RESULT_COUNT, RESULT_DATATYPE,
25     TARGET_RANK, TARGET_COUNT, TARGET_DATATYPE, OP, WIN, IERROR
26     INTEGER(KIND=MPI_ADDRESS_KIND) TARGET_DISP
27
28 MPI_PUT(ORIGIN_ADDR, ORIGIN_COUNT, ORIGIN_DATATYPE, TARGET_RANK,
29     TARGET_DISP, TARGET_COUNT, TARGET_DATATYPE, WIN, IERROR)
30     <type> ORIGIN_ADDR(*)
31     INTEGER ORIGIN_COUNT, ORIGIN_DATATYPE, TARGET_RANK, TARGET_COUNT,
32     TARGET_DATATYPE, WIN, IERROR
33     INTEGER(KIND=MPI_ADDRESS_KIND) TARGET_DISP
34
35 MPI_RACCUMULATE(ORIGIN_ADDR, ORIGIN_COUNT, ORIGIN_DATATYPE, TARGET_RANK,
36     TARGET_DISP, TARGET_COUNT, TARGET_DATATYPE, OP, WIN, REQUEST,
37     IERROR)
38     <type> ORIGIN_ADDR(*)
39     INTEGER ORIGIN_COUNT, ORIGIN_DATATYPE, TARGET_RANK, TARGET_COUNT,
40     TARGET_DATATYPE, OP, WIN, REQUEST, IERROR
41     INTEGER(KIND=MPI_ADDRESS_KIND) TARGET_DISP
42
43 MPI_RGET(ORIGIN_ADDR, ORIGIN_COUNT, ORIGIN_DATATYPE, TARGET_RANK,
44     TARGET_DISP, TARGET_COUNT, TARGET_DATATYPE, WIN, REQUEST,
45     IERROR)
46     <type> ORIGIN_ADDR(*)
47     INTEGER ORIGIN_COUNT, ORIGIN_DATATYPE, TARGET_RANK, TARGET_COUNT,
48     TARGET_DATATYPE, WIN, REQUEST, IERROR
49     INTEGER(KIND=MPI_ADDRESS_KIND) TARGET_DISP
50
51 MPI_RGET_ACCUMULATE(ORIGIN_ADDR, ORIGIN_COUNT, ORIGIN_DATATYPE,

```

```

        RESULT_ADDR, RESULT_COUNT, RESULT_DATATYPE, TARGET_RANK,      1
        TARGET_DISP, TARGET_COUNT, TARGET_DATATYPE, OP, WIN, REQUEST,  2
        IERROR)                                                       3
<type> ORIGIN_ADDR(*), RESULT_ADDR(*)                                4
INTEGER ORIGIN_COUNT, ORIGIN_DATATYPE, RESULT_COUNT, RESULT_DATATYPE,  5
        TARGET_RANK, TARGET_COUNT, TARGET_DATATYPE, OP, WIN, REQUEST,  6
        IERROR                                                         7
INTEGER(KIND=MPI_ADDRESS_KIND) TARGET_DISP                            8
MPI_RPUT(ORIGIN_ADDR, ORIGIN_COUNT, ORIGIN_DATATYPE, TARGET_RANK,     9
        TARGET_DISP, TARGET_COUNT, TARGET_DATATYPE, WIN, REQUEST,    10
        IERROR)                                                       11
<type> ORIGIN_ADDR(*)                                               12
INTEGER ORIGIN_COUNT, ORIGIN_DATATYPE, TARGET_RANK, TARGET_COUNT,    13
        TARGET_DATATYPE, WIN, REQUEST, IERROR                         14
INTEGER(KIND=MPI_ADDRESS_KIND) TARGET_DISP                            15
MPI_WIN_ALLOCATE(SIZE, DISP_UNIT, INFO, COMM, BASEPTR, WIN, IERROR)   16
        INTEGER(KIND=MPI_ADDRESS_KIND) SIZE, BASEPTR                 17
        INTEGER DISP_UNIT, INFO, COMM, WIN, IERROR                   18
If the Fortran compiler provides TYPE(C_PTR), then overloaded by:    19
INTERFACE MPI_WIN_ALLOCATE                                           20
    SUBROUTINE MPI_WIN_ALLOCATE(SIZE, DISP_UNIT, INFO, COMM, BASEPTR, &  21
        WIN, IERROR)                                                 22
        IMPORT :: MPI_ADDRESS_KIND                                    23
        INTEGER :: DISP_UNIT, INFO, COMM, WIN, IERROR               24
        INTEGER(KIND=MPI_ADDRESS_KIND) :: SIZE, BASEPTR             25
    END SUBROUTINE                                                    26
    SUBROUTINE MPI_WIN_ALLOCATE_CPTR(SIZE, DISP_UNIT, INFO, COMM, BASEPTR, &  27
        WIN, IERROR)                                                 28
        USE, INTRINSIC :: ISO_C_BINDING, ONLY : C_PTR               29
        IMPORT :: MPI_ADDRESS_KIND                                    30
        INTEGER :: DISP_UNIT, INFO, COMM, WIN, IERROR               31
        INTEGER(KIND=MPI_ADDRESS_KIND) :: SIZE                       32
        TYPE(C_PTR) :: BASEPTR                                       33
    END SUBROUTINE                                                    34
END INTERFACE                                                         35
MPI_WIN_ALLOCATE_SHARED(SIZE, DISP_UNIT, INFO, COMM, BASEPTR, WIN, IERROR)  36
        INTEGER(KIND=MPI_ADDRESS_KIND) SIZE, BASEPTR                 37
        INTEGER DISP_UNIT, INFO, COMM, WIN, IERROR                   38
If the Fortran compiler provides TYPE(C_PTR), then overloaded by:    39
INTERFACE MPI_WIN_ALLOCATE_SHARED                                     40
    SUBROUTINE MPI_WIN_ALLOCATE_SHARED(SIZE, DISP_UNIT, INFO, COMM, &  41
        BASEPTR, WIN, IERROR)                                         42
        IMPORT :: MPI_ADDRESS_KIND                                    43
        INTEGER :: DISP_UNIT, INFO, COMM, WIN, IERROR               44
        INTEGER(KIND=MPI_ADDRESS_KIND) :: SIZE, BASEPTR             45
    END SUBROUTINE                                                    46
END INTERFACE                                                         47

```

```
1      END SUBROUTINE
2      SUBROUTINE MPI_WIN_ALLOCATE_SHARED_CPTR(SIZE, DISP_UNIT, INFO, COMM, &
3          BASEPTR, WIN, IERROR)
4          USE, INTRINSIC :: ISO_C_BINDING, ONLY : C_PTR
5          IMPORT :: MPI_ADDRESS_KIND
6          INTEGER :: DISP_UNIT, INFO, COMM, WIN, IERROR
7          INTEGER(KIND=MPI_ADDRESS_KIND) :: SIZE
8          TYPE(C_PTR) :: BASEPTR
9      END SUBROUTINE
10     END INTERFACE
11
12     MPI_WIN_ATTACH(WIN, BASE, SIZE, IERROR)
13         INTEGER WIN, IERROR
14         <type> BASE(*)
15         INTEGER(KIND=MPI_ADDRESS_KIND) SIZE
16
17     MPI_WIN_COMPLETE(WIN, IERROR)
18         INTEGER WIN, IERROR
19
20     MPI_WIN_CREATE(BASE, SIZE, DISP_UNIT, INFO, COMM, WIN, IERROR)
21         <type> BASE(*)
22         INTEGER(KIND=MPI_ADDRESS_KIND) SIZE
23         INTEGER DISP_UNIT, INFO, COMM, WIN, IERROR
24
25     MPI_WIN_CREATE_DYNAMIC(INFO, COMM, WIN, IERROR)
26         INTEGER INFO, COMM, WIN, IERROR
27
28     MPI_WIN_DETACH(WIN, BASE, IERROR)
29         INTEGER WIN, IERROR
30         <type> BASE(*)
31
32     MPI_WIN_FENCE(ASSERT, WIN, IERROR)
33         INTEGER ASSERT, WIN, IERROR
34
35     MPI_WIN_FLUSH(RANK, WIN, IERROR)
36         INTEGER RANK, WIN, IERROR
37
38     MPI_WIN_FLUSH_ALL(WIN, IERROR)
39         INTEGER WIN, IERROR
40
41     MPI_WIN_FLUSH_LOCAL(RANK, WIN, IERROR)
42         INTEGER RANK, WIN, IERROR
43
44     MPI_WIN_FLUSH_LOCAL_ALL(WIN, IERROR)
45         INTEGER WIN, IERROR
46
47     MPI_WIN_FREE(WIN, IERROR)
48         INTEGER WIN, IERROR
49
50     MPI_WIN_GET_GROUP(WIN, GROUP, IERROR)
51         INTEGER WIN, GROUP, IERROR
52
53     MPI_WIN_GET_INFO(WIN, INFO_USED, IERROR)
54         INTEGER WIN, INFO_USED, IERROR
```



```

MPI_WIN_LOCK(LOCK_TYPE, RANK, ASSERT, WIN, IERROR)           1
    INTEGER LOCK_TYPE, RANK, ASSERT, WIN, IERROR             2
                                                                3
MPI_WIN_LOCK_ALL(ASSERT, WIN, IERROR)                        4
    INTEGER ASSERT, WIN, IERROR                              5
                                                                6
MPI_WIN_POST(GROUP, ASSERT, WIN, IERROR)                    7
    INTEGER GROUP, ASSERT, WIN, IERROR                       8
                                                                9
MPI_WIN_SET_INFO(WIN, INFO, IERROR)                          10
    INTEGER WIN, INFO, IERROR                                11
                                                                12
MPI_WIN_SHARED_QUERY(WIN, RANK, SIZE, DISP_UNIT, BASEPTR, IERROR) 13
    INTEGER WIN, RANK, DISP_UNIT, IERROR                    14
    INTEGER(KIND=MPI_ADDRESS_KIND) SIZE, BASEPTR            15
If the Fortran compiler provides TYPE(C_PTR), then overloaded by:
INTERFACE MPI_WIN_SHARED_QUERY                               16
    SUBROUTINE MPI_WIN_SHARED_QUERY(WIN, RANK, SIZE, DISP_UNIT, & 17
        BASEPTR, IERROR)                                    18
        IMPORT :: MPI_ADDRESS_KIND                          19
        INTEGER :: WIN, RANK, DISP_UNIT, IERROR            20
        INTEGER(KIND=MPI_ADDRESS_KIND) :: SIZE, BASEPTR    21
    END SUBROUTINE                                          22
    SUBROUTINE MPI_WIN_SHARED_QUERY_CPTR(WIN, RANK, SIZE, DISP_UNIT, & 23
        BASEPTR, IERROR)                                    24
        USE, INTRINSIC :: ISO_C_BINDING, ONLY : C_PTR      25
        IMPORT :: MPI_ADDRESS_KIND                          26
        INTEGER :: WIN, RANK, DISP_UNIT, IERROR            27
        INTEGER(KIND=MPI_ADDRESS_KIND) :: SIZE              28
        TYPE(C_PTR) :: BASEPTR                             29
    END SUBROUTINE                                          30
END INTERFACE                                              31
                                                                32
MPI_WIN_START(GROUP, ASSERT, WIN, IERROR)                   33
    INTEGER GROUP, ASSERT, WIN, IERROR                       34
                                                                35
MPI_WIN_SYNC(WIN, IERROR)                                    36
    INTEGER WIN, IERROR                                      37
                                                                38
MPI_WIN_TEST(WIN, FLAG, IERROR)                              39
    INTEGER WIN, IERROR                                      40
    LOGICAL FLAG                                            41
                                                                42
MPI_WIN_UNLOCK(RANK, WIN, IERROR)                           43
    INTEGER RANK, WIN, IERROR                                44
                                                                45
MPI_WIN_UNLOCK_ALL(WIN, IERROR)                             46
    INTEGER WIN, IERROR                                      47
                                                                48
MPI_WIN_WAIT(WIN, IERROR)                                    48
    INTEGER WIN, IERROR

```

1 A.5.11 External Interfaces Fortran Bindings

2 MPI\_GREQUEST\_COMPLETE(REQUEST, IERROR)  
 3 INTEGER REQUEST, IERROR  
 4  
 5 MPI\_GREQUEST\_START(QUERY\_FN, FREE\_FN, CANCEL\_FN, EXTRA\_STATE, REQUEST,  
 6 IERROR)  
 7 EXTERNAL QUERY\_FN, FREE\_FN, CANCEL\_FN  
 8 INTEGER(KIND=MPI\_ADDRESS\_KIND) EXTRA\_STATE  
 9 INTEGER REQUEST, IERROR  
 10  
 11 MPI\_STATUS\_SET\_CANCELLED(STATUS, FLAG, IERROR)  
 12 INTEGER STATUS(MPI\_STATUS\_SIZE), IERROR  
 13 LOGICAL FLAG  
 14  
 15 MPI\_STATUS\_SET\_ELEMENTS(STATUS, DATATYPE, COUNT, IERROR)  
 16 INTEGER STATUS(MPI\_STATUS\_SIZE), DATATYPE, COUNT, IERROR  
 17  
 18 MPI\_STATUS\_SET\_ELEMENTS\_X(STATUS, DATATYPE, COUNT, IERROR)  
 19 INTEGER STATUS(MPI\_STATUS\_SIZE), DATATYPE, IERROR  
 20 INTEGER(KIND=MPI\_COUNT\_KIND) COUNT

21 A.5.12 I/O Fortran Bindings

22  
 23 MPI\_CONVERSION\_FN\_NULL(USERBUF, DATATYPE, COUNT, FILEBUF, POSITION,  
 24 EXTRA\_STATE, IERROR)  
 25 <TYPE> USERBUF(\*), FILEBUF(\*)  
 26 INTEGER DATATYPE, COUNT, IERROR  
 27 INTEGER(KIND=MPI\_OFFSET\_KIND) POSITION  
 28 INTEGER(KIND=MPI\_ADDRESS\_KIND) EXTRA\_STATE  
 29  
 30 MPI\_FILE\_CLOSE(FH, IERROR)  
 31 INTEGER FH, IERROR  
 32  
 33 MPI\_FILE\_DELETE(FILENAME, INFO, IERROR)  
 34 CHARACTER\*(\*) FILENAME  
 35 INTEGER INFO, IERROR  
 36  
 37 MPI\_FILE\_GET\_AMODE(FH, AMODE, IERROR)  
 38 INTEGER FH, AMODE, IERROR  
 39  
 40 MPI\_FILE\_GET\_ATOMICITY(FH, FLAG, IERROR)  
 41 INTEGER FH, IERROR  
 42 LOGICAL FLAG  
 43  
 44 MPI\_FILE\_GET\_BYTE\_OFFSET(FH, OFFSET, DISP, IERROR)  
 45 INTEGER FH, IERROR  
 46 INTEGER(KIND=MPI\_OFFSET\_KIND) OFFSET, DISP  
 47  
 48 MPI\_FILE\_GET\_GROUP(FH, GROUP, IERROR)  
 49 INTEGER FH, GROUP, IERROR  
 50  
 51 MPI\_FILE\_GET\_INFO(FH, INFO\_USED, IERROR)

```

    INTEGER FH, INFO_USED, IERROR                                1
MPI_FILE_GET_POSITION(FH, OFFSET, IERROR)                      2
    INTEGER FH, IERROR                                          3
    INTEGER(KIND=MPI_OFFSET_KIND) OFFSET                        4
                                                                5
MPI_FILE_GET_POSITION_SHARED(FH, OFFSET, IERROR)               6
    INTEGER FH, IERROR                                          7
    INTEGER(KIND=MPI_OFFSET_KIND) OFFSET                        8
                                                                9
MPI_FILE_GET_SIZE(FH, SIZE, IERROR)                            10
    INTEGER FH, IERROR                                          11
    INTEGER(KIND=MPI_OFFSET_KIND) SIZE                          12
                                                                13
MPI_FILE_GET_TYPE_EXTENT(FH, DATATYPE, EXTENT, IERROR)         14
    INTEGER FH, DATATYPE, IERROR                                15
    INTEGER(KIND=MPI_ADDRESS_KIND) EXTENT                       16
                                                                17
MPI_FILE_GET_VIEW(FH, DISP, ETYPE, FILETYPE, DATAREP, IERROR) 18
    INTEGER FH, ETYPE, FILETYPE, IERROR                        19
    INTEGER(KIND=MPI_OFFSET_KIND) DISP                          20
    CHARACTER*(*) DATAREP                                      21
                                                                22
MPI_FILE_IREAD(FH, BUF, COUNT, DATATYPE, REQUEST, IERROR)     23
    INTEGER FH, COUNT, DATATYPE, REQUEST, IERROR              24
    <type> BUF(*)                                              25
                                                                26
MPI_FILE_IREAD_ALL(FH, BUF, COUNT, DATATYPE, REQUEST, IERROR) 27
    INTEGER FH, COUNT, DATATYPE, REQUEST, IERROR              28
    <type> BUF(*)                                              29
                                                                30
MPI_FILE_IREAD_AT(FH, OFFSET, BUF, COUNT, DATATYPE, REQUEST, IERROR) 31
    INTEGER FH, COUNT, DATATYPE, REQUEST, IERROR              32
    INTEGER(KIND=MPI_OFFSET_KIND) OFFSET                       33
    <type> BUF(*)                                              34
                                                                35
MPI_FILE_IREAD_AT_ALL(FH, OFFSET, BUF, COUNT, DATATYPE, REQUEST, IERROR) 36
    INTEGER FH, COUNT, DATATYPE, REQUEST, IERROR              37
    INTEGER(KIND=MPI_OFFSET_KIND) OFFSET                       38
    <type> BUF(*)                                              39
                                                                40
MPI_FILE_IREAD_SHARED(FH, BUF, COUNT, DATATYPE, REQUEST, IERROR) 41
    INTEGER FH, COUNT, DATATYPE, REQUEST, IERROR              42
    <type> BUF(*)                                              43
                                                                44
MPI_FILE_IWRITE(FH, BUF, COUNT, DATATYPE, REQUEST, IERROR)    45
    INTEGER FH, COUNT, DATATYPE, REQUEST, IERROR              46
    <type> BUF(*)                                              47
                                                                48
MPI_FILE_IWRITE_ALL(FH, BUF, COUNT, DATATYPE, REQUEST, IERROR) 49
    INTEGER FH, COUNT, DATATYPE, REQUEST, IERROR              50
    <type> BUF(*)                                              51
                                                                52
MPI_FILE_IWRITE_AT(FH, OFFSET, BUF, COUNT, DATATYPE, REQUEST, IERROR) 53
    INTEGER FH, COUNT, DATATYPE, REQUEST, IERROR              54
    INTEGER(KIND=MPI_OFFSET_KIND) OFFSET                       55
    <type> BUF(*)                                              56

```

```

1     INTEGER FH, COUNT, DATATYPE, REQUEST, IERROR
2     INTEGER(KIND=MPI_OFFSET_KIND) OFFSET
3     <type> BUF(*)
4
5     MPI_FILE_IWRITE_AT_ALL(FH, OFFSET, BUF, COUNT, DATATYPE, REQUEST, IERROR)
6     INTEGER FH, COUNT, DATATYPE, REQUEST, IERROR
7     INTEGER(KIND=MPI_OFFSET_KIND) OFFSET
8     <type> BUF(*)
9
10    MPI_FILE_IWRITE_SHARED(FH, BUF, COUNT, DATATYPE, REQUEST, IERROR)
11    INTEGER FH, COUNT, DATATYPE, REQUEST, IERROR
12    <type> BUF(*)
13
14    MPI_FILE_OPEN(COMM, FILENAME, AMODE, INFO, FH, IERROR)
15    INTEGER COMM, AMODE, INFO, FH, IERROR
16    CHARACTER*(*) FILENAME
17
18    MPI_FILE_PREALLOCATE(FH, SIZE, IERROR)
19    INTEGER FH, IERROR
20    INTEGER(KIND=MPI_OFFSET_KIND) SIZE
21
22    MPI_FILE_READ(FH, BUF, COUNT, DATATYPE, STATUS, IERROR)
23    INTEGER FH, COUNT, DATATYPE, STATUS(MPI_STATUS_SIZE), IERROR
24    <type> BUF(*)
25
26    MPI_FILE_READ_ALL(FH, BUF, COUNT, DATATYPE, STATUS, IERROR)
27    INTEGER FH, COUNT, DATATYPE, STATUS(MPI_STATUS_SIZE), IERROR
28    <type> BUF(*)
29
30    MPI_FILE_READ_ALL_BEGIN(FH, BUF, COUNT, DATATYPE, IERROR)
31    INTEGER FH, COUNT, DATATYPE, IERROR
32    <type> BUF(*)
33
34    MPI_FILE_READ_ALL_END(FH, BUF, STATUS, IERROR)
35    INTEGER FH, STATUS(MPI_STATUS_SIZE), IERROR
36    <type> BUF(*)
37
38    MPI_FILE_READ_AT(FH, OFFSET, BUF, COUNT, DATATYPE, STATUS, IERROR)
39    INTEGER FH, COUNT, DATATYPE, STATUS(MPI_STATUS_SIZE), IERROR
40    INTEGER(KIND=MPI_OFFSET_KIND) OFFSET
41    <type> BUF(*)
42
43    MPI_FILE_READ_AT_ALL(FH, OFFSET, BUF, COUNT, DATATYPE, STATUS, IERROR)
44    INTEGER FH, COUNT, DATATYPE, STATUS(MPI_STATUS_SIZE), IERROR
45    INTEGER(KIND=MPI_OFFSET_KIND) OFFSET
46    <type> BUF(*)
47
48    MPI_FILE_READ_AT_ALL_BEGIN(FH, OFFSET, BUF, COUNT, DATATYPE, IERROR)
49    INTEGER FH, COUNT, DATATYPE, IERROR
50    INTEGER(KIND=MPI_OFFSET_KIND) OFFSET
51    <type> BUF(*)
52
53    MPI_FILE_READ_AT_ALL_END(FH, BUF, STATUS, IERROR)

```

```

    INTEGER FH, STATUS(MPI_STATUS_SIZE), IERROR
    <type> BUF(*)
MPI_FILE_READ_ORDERED(FH, BUF, COUNT, DATATYPE, STATUS, IERROR)
    INTEGER FH, COUNT, DATATYPE, STATUS(MPI_STATUS_SIZE), IERROR
    <type> BUF(*)
MPI_FILE_READ_ORDERED_BEGIN(FH, BUF, COUNT, DATATYPE, IERROR)
    INTEGER FH, COUNT, DATATYPE, IERROR
    <type> BUF(*)
MPI_FILE_READ_ORDERED_END(FH, BUF, STATUS, IERROR)
    INTEGER FH, STATUS(MPI_STATUS_SIZE), IERROR
    <type> BUF(*)
MPI_FILE_READ_SHARED(FH, BUF, COUNT, DATATYPE, STATUS, IERROR)
    INTEGER FH, COUNT, DATATYPE, STATUS(MPI_STATUS_SIZE), IERROR
    <type> BUF(*)
MPI_FILE_SEEK(FH, OFFSET, WHENCE, IERROR)
    INTEGER FH, WHENCE, IERROR
    INTEGER(KIND=MPI_OFFSET_KIND) OFFSET
MPI_FILE_SEEK_SHARED(FH, OFFSET, WHENCE, IERROR)
    INTEGER FH, WHENCE, IERROR
    INTEGER(KIND=MPI_OFFSET_KIND) OFFSET
MPI_FILE_SET_ATOMICITY(FH, FLAG, IERROR)
    INTEGER FH, IERROR
    LOGICAL FLAG
MPI_FILE_SET_INFO(FH, INFO, IERROR)
    INTEGER FH, INFO, IERROR
MPI_FILE_SET_SIZE(FH, SIZE, IERROR)
    INTEGER FH, IERROR
    INTEGER(KIND=MPI_OFFSET_KIND) SIZE
MPI_FILE_SET_VIEW(FH, DISP, ETYPE, FILETYPE, DATAREP, INFO, IERROR)
    INTEGER FH, ETYPE, FILETYPE, INFO, IERROR
    INTEGER(KIND=MPI_OFFSET_KIND) DISP
    CHARACTER*(*) DATAREP
MPI_FILE_SYNC(FH, IERROR)
    INTEGER FH, IERROR
MPI_FILE_WRITE(FH, BUF, COUNT, DATATYPE, STATUS, IERROR)
    INTEGER FH, COUNT, DATATYPE, STATUS(MPI_STATUS_SIZE), IERROR
    <type> BUF(*)
MPI_FILE_WRITE_ALL(FH, BUF, COUNT, DATATYPE, STATUS, IERROR)
    INTEGER FH, COUNT, DATATYPE, STATUS(MPI_STATUS_SIZE), IERROR
    <type> BUF(*)

```

```
1 MPI_FILE_WRITE_ALL_BEGIN(FH, BUF, COUNT, DATATYPE, IERROR)
2   INTEGER FH, COUNT, DATATYPE, IERROR
3   <type> BUF(*)
4
5 MPI_FILE_WRITE_ALL_END(FH, BUF, STATUS, IERROR)
6   INTEGER FH, STATUS(MPI_STATUS_SIZE), IERROR
7   <type> BUF(*)
8
9 MPI_FILE_WRITE_AT(FH, OFFSET, BUF, COUNT, DATATYPE, STATUS, IERROR)
10  INTEGER FH, COUNT, DATATYPE, STATUS(MPI_STATUS_SIZE), IERROR
11  INTEGER(KIND=MPI_OFFSET_KIND) OFFSET
12  <type> BUF(*)
13
14 MPI_FILE_WRITE_AT_ALL(FH, OFFSET, BUF, COUNT, DATATYPE, STATUS, IERROR)
15  INTEGER FH, COUNT, DATATYPE, STATUS(MPI_STATUS_SIZE), IERROR
16  INTEGER(KIND=MPI_OFFSET_KIND) OFFSET
17  <type> BUF(*)
18
19 MPI_FILE_WRITE_AT_ALL_BEGIN(FH, OFFSET, BUF, COUNT, DATATYPE, IERROR)
20  INTEGER FH, COUNT, DATATYPE, IERROR
21  INTEGER(KIND=MPI_OFFSET_KIND) OFFSET
22  <type> BUF(*)
23
24 MPI_FILE_WRITE_AT_ALL_END(FH, BUF, STATUS, IERROR)
25  INTEGER FH, STATUS(MPI_STATUS_SIZE), IERROR
26  <type> BUF(*)
27
28 MPI_FILE_WRITE_ORDERED(FH, BUF, COUNT, DATATYPE, STATUS, IERROR)
29  INTEGER FH, COUNT, DATATYPE, STATUS(MPI_STATUS_SIZE), IERROR
30  <type> BUF(*)
31
32 MPI_FILE_WRITE_ORDERED_BEGIN(FH, BUF, COUNT, DATATYPE, IERROR)
33  INTEGER FH, COUNT, DATATYPE, IERROR
34  <type> BUF(*)
35
36 MPI_FILE_WRITE_ORDERED_END(FH, BUF, STATUS, IERROR)
37  INTEGER FH, STATUS(MPI_STATUS_SIZE), IERROR
38  <type> BUF(*)
39
40 MPI_FILE_WRITE_SHARED(FH, BUF, COUNT, DATATYPE, STATUS, IERROR)
41  INTEGER FH, COUNT, DATATYPE, STATUS(MPI_STATUS_SIZE), IERROR
42  <type> BUF(*)
43
44 MPI_REGISTER_DATAREP(DATAREP, READ_CONVERSION_FN, WRITE_CONVERSION_FN,
45  DTYPE_FILE_EXTENT_FN, EXTRA_STATE, IERROR)
46  CHARACTER*(*) DATAREP
47  EXTERNAL READ_CONVERSION_FN, WRITE_CONVERSION_FN, DTYPE_FILE_EXTENT_FN
48  INTEGER(KIND=MPI_ADDRESS_KIND) EXTRA_STATE
49  INTEGER IERROR
```

## A.5.13 Language Bindings Fortran Bindings

```
MPI_F_SYNC_REG(BUF)
    <type> BUF(*)

MPI_TYPE_CREATE_F90_COMPLEX(P, R, NEWTYPE, IERROR)
    INTEGER P, R, NEWTYPE, IERROR

MPI_TYPE_CREATE_F90_INTEGER(R, NEWTYPE, IERROR)
    INTEGER R, NEWTYPE, IERROR

MPI_TYPE_CREATE_F90_REAL(P, R, NEWTYPE, IERROR)
    INTEGER P, R, NEWTYPE, IERROR

MPI_TYPE_MATCH_SIZE(TYPECLASS, SIZE, DATATYPE, IERROR)
    INTEGER TYPECLASS, SIZE, DATATYPE, IERROR
```

## A.5.14 Tools / Profiling Interface Fortran Bindings

```
MPI_PCONTROL(LEVEL)
    INTEGER LEVEL
```

## A.5.15 Deprecated Fortran Bindings

```
MPI_ATTR_DELETE(COMM, KEYVAL, IERROR)
    INTEGER COMM, KEYVAL, IERROR

MPI_ATTR_GET(COMM, KEYVAL, ATTRIBUTE_VAL, FLAG, IERROR)
    INTEGER COMM, KEYVAL, ATTRIBUTE_VAL, IERROR
    LOGICAL FLAG

MPI_ATTR_PUT(COMM, KEYVAL, ATTRIBUTE_VAL, IERROR)
    INTEGER COMM, KEYVAL, ATTRIBUTE_VAL, IERROR

MPI_DUP_FN(OLDCOMM, KEYVAL, EXTRA_STATE, ATTRIBUTE_VAL_IN,
           ATTRIBUTE_VAL_OUT, FLAG, IERR)
    INTEGER OLDCOMM, KEYVAL, EXTRA_STATE, ATTRIBUTE_VAL_IN,
           ATTRIBUTE_VAL_OUT, IERR
    LOGICAL FLAG

MPI_INFO_GET(INFO, KEY, VALUELEN, VALUE, FLAG, IERROR)
    INTEGER INFO, VALUELEN, IERROR
    CHARACTER*(*) KEY, VALUE
    LOGICAL FLAG

MPI_INFO_GET_VALUELEN(INFO, KEY, VALUELEN, FLAG, IERROR)
    INTEGER INFO, VALUELEN, IERROR
    CHARACTER*(*) KEY
    LOGICAL FLAG

MPI_KEYVAL_CREATE(COPY_FN, DELETE_FN, KEYVAL, EXTRA_STATE, IERROR)
    EXTERNAL COPY_FN, DELETE_FN
```

```
1     INTEGER KEYVAL, EXTRA_STATE, IERROR
2
3     MPI_KEYVAL_FREE(KEYVAL, IERROR)
4     INTEGER KEYVAL, IERROR
5
6     MPI_NULL_COPY_FN(OLDCOMM, KEYVAL, EXTRA_STATE, ATTRIBUTE_VAL_IN,
7     ATTRIBUTE_VAL_OUT, FLAG, IERR)
8     INTEGER OLDCOMM, KEYVAL, EXTRA_STATE, ATTRIBUTE_VAL_IN,
9     ATTRIBUTE_VAL_OUT, IERR
10    LOGICAL FLAG
11
12    MPI_NULL_DELETE_FN(COMM, KEYVAL, ATTRIBUTE_VAL, EXTRA_STATE, IERROR)
13    INTEGER COMM, KEYVAL, ATTRIBUTE_VAL, EXTRA_STATE, IERROR
14
15    MPI_SIZEOF(X, SIZE, IERROR)
16    <type> X
17    INTEGER SIZE, IERROR
18
19
20
21
22
23
24
25
26
27
28
29
30
31
32
33
34
35
36
37
38
39
40
41
42
43
44
45
46
47
48
```



1  
2  
3  
4  
5  
6  
7  
8  
9  
10  
11  
12  
13  
14  
15  
16  
17  
18  
19  
20  
21  
22  
23  
24  
25  
26  
27  
28  
29  
30  
31  
32  
33  
34  
35  
36  
37  
38  
39  
40  
41  
42  
43  
44  
45  
46  
47  
48

# Annex B

## Change-Log

Annex B.1 summarizes changes from the previous version of the MPI standard to the version presented by this document. Only significant changes (i.e., clarifications and new features) that might either require implementation effort in the MPI libraries or change the understanding of MPI from a user's perspective are presented. Editorial modifications, formatting, typo corrections and minor clarifications are not shown. If not otherwise noted, the section and page references refer to the locations of the change or new functionality in this version of the standard. Changes in Annexes ??–B.5 were already introduced in the corresponding sections in previous versions of this standard.

### B.1 Changes from Version 3.1 to Version 4.0

#### B.1.1 Fixes to Errata in Previous Versions of MPI

1. Sections 8.6.1, 8.6.2 and 8.9 on pages 413, 417 and 440, and MPI-3.1 Sections 7.6.1, 7.6.2 and 7.8 on pages 315, 318 and 329.  
MPI\_NEIGHBOR\_ALLTOALL\_{|V|W} and MPI\_NEIGHBOR\_ALLGATHER\_{|V} for Cartesian virtual grids were clarified. An advice to implementors was added to illustrate a correct implementation for the case of periods[d]==1 or .TRUE. and dims[d]==1 or 2 in a direction d.
2. Section 19.3.5 on page 836, and MPI-3.1 Section 17.2.5 on page 657 line 11.  
Clarified that the MPI\_STATUS\_F2F08 and MPI\_STATUS\_F082F routines and the declaration for TYPE(MPI\_Status) are not supposed to appear with mpif.h.
3. Sections 2.5.4, 19.3.5, and A.1.1 on pages 18, 836, and 852, and MPI-3.1 Sections 2.5.4, 17.2.5, and A.1.1 on pages 15, 656, and 669.  
Define the C constants MPI\_F\_STATUS\_SIZE, MPI\_F\_SOURCE, MPI\_F\_TAG, and MPI\_F\_ERROR.
4. Section 19.3.5 on page 837, and MPI-3.1 Section 17.2.5 on page 658.  
Added missing const to IN parameters for MPI\_STATUS\_F2F08 and MPI\_STATUS\_F082F.

## B.1.2 Changes in MPI-4.0

1. Sections [2.2](#), [18.1](#), and [19.1.5](#) on pages [9](#), [781](#), and [790](#).  
The limit for the maximum length of MPI identifiers was removed. This change is not backward compatible.
2. Section [2.4](#), [3.4](#), [3.7.2](#), [3.7.3](#), [3.8.1](#), [3.8.2](#), [6.13](#), [14.4.5](#), and Annex [A.2](#) on pages [11](#), [47](#), [61](#), [68](#), [82](#), [85](#), [274](#), [680](#), and [873](#).  
The semantic terms were updated.
3. Throughout the entire document.  
New large count functions and callbacks were introduced to accommodate large buffers and/or datatypes.  
Clarifications were added to the behavior of INOUT/OUT parameters that cannot represent the value to be returned for the MPI\_BUFFER\_DETACH and MPI\_FILE\_GET\_TYPE\_EXTENT functions.  
A new error class MPI\_ERR\_VALUE\_TOO\_LARGE was introduced.
4. Sections [2.8](#), [9.3](#), [9.5](#), and [11.2.1](#) on pages [25](#), [454](#), [469](#), and [484](#).  
MPI calls that are not related to any objects are considered to be attached to the communicator MPI\_COMM\_SELF instead of MPI\_COMM\_WORLD. The definition of MPI\_ERRORS\_ARE\_FATAL was clarified to cover all connected processes, and a new error handler, MPI\_ERRORS\_ABORT, was created to limit the scope of aborting.
5. Section [3.7](#) on page [59](#).  
The introduction of MPI nonblocking communication was changed to describe correctness and performance reasons for the use of nonblocking communication.
6. Sections [3.7](#) and [3.9](#) on pages [61](#) and [92](#).  
Addition of MPI\_ISENDRECV and MPI\_ISENDRECV\_REPLACE.
7. Sections [3.7.3](#), [3.9](#), [6.13](#), [8.8](#), and [8.9](#) on pages [68](#), [92](#), [274](#), [432](#), and [440](#).  
Persistent collective communication and persistent neighborhood communication were added to the standard.
8. Sections [3.8.4](#) and [16.3](#) on pages [90](#) and [776](#).  
Cancelling a send request by calling MPI\_CANCEL has been deprecated and may be removed in a future version of the MPI specification.
9. Chapter [4](#) on page [101](#).  
A new chapter on partitioned communication was added.
10. Section [7.4.2](#) on page [323](#).  
MPI\_COMM\_TYPE\_HW\_UNGUIDED was added as a new possible value for the split\_type parameter of the MPI\_COMM\_SPLIT\_TYPE function.
11. Section [7.4.2](#) on page [323](#).  
MPI\_COMM\_TYPE\_HW\_GUIDED was added as a new possible value for the split\_type parameter of the MPI\_COMM\_SPLIT\_TYPE function, as well as a new info key "mpi\_hw\_resource\_type". A specific value associated with this new info key is also defined: "mpi\_shared\_memory".

12. Section [7.4.2](#) on page [323](#).  
The functions `MPI_COMM_DUP` and `MPI_COMM_IDUP` were updated to no longer propagate info hints.  
This change may affect backward compatibility.
13. Section [7.4.2](#) on page [323](#).  
The `MPI_COMM_IDUP_WITH_INFO` function was added.
14. Sections [7.4.4](#), [12.2.7](#), and [14.2.8](#) on pages [341](#), [561](#), and [645](#).  
The definition of info hints was updated to allow applications to provide assertions regarding their usage of MPI objects and operations.
15. Section [7.4.4](#) on page [341](#).  
The new info hints `"mpi_assert_no_any_tag"`, `"mpi_assert_no_any_source"`, `"mpi_assert_exact_length"`, and `"mpi_assert_allow_overtaking"` were added for use with communicators.
16. Sections [7.4.4](#), [12.2.7](#), and [14.2.8](#) on pages [341](#), [561](#), and [645](#).  
The semantics of the `MPI_COMM_SET_INFO`, `MPI_COMM_GET_INFO`, `MPI_WIN_SET_INFO`, `MPI_WIN_GET_INFO`, `MPI_FILE_SET_INFO`, and `MPI_FILE_GET_INFO` were clarified.
17. Section [8.5](#) on page [388](#).  
`MPI_DIMS_CREATE` is now guaranteed to return `MPI_SUCCESS` if the number of dimensions passed to the routine is set to 0 and the number of nodes is set to 1.
18. Sections [9.2](#), [12.2.2](#), and [12.2.3](#) on pages [451](#), [550](#), and [552](#).  
Introduced alignment requirements for memory allocated through `MPI_ALLOC_MEM`, `MPI_WIN_ALLOCATE`, and `MPI_WIN_ALLOCATE_SHARED` and added a new info key `"mpi_minimum_memory_alignment"` to specify a desired alternative minimum alignment.
19. Sections [9.3](#) and [9.4](#) on pages [454](#) and [466](#).  
Clarified definition of errors to say that MPI should continue whenever possible and allow the user to recover from errors.
20. Section [9.4](#) on page [466](#).  
Added text to clarify what is implied about the status of MPI and user visible buffers when MPI functions return `MPI_SUCCESS` or other error codes.
21. Section [9.4](#) on page [467](#).  
The error class `MPI_ERR_PROC_ABORTED` has been added.
22. Section [10](#) on page [475](#).  
Added a new function `MPI_INFO_GET_STRING` that takes a buffer length argument for returning info value strings. This function returns the required buffer length for the requested string and guarantees null termination for C strings where buffer size is greater than 0.
23. Section [10](#) on page [475](#) and Section [16.3](#) on page [776](#).  
`MPI_INFO_GET` and `MPI_INFO_GET_VALUELEN` were deprecated.

- 1 24. Chapter 11, Sections 2.8, 3.2.3, 7.2.4, 7.3.2, 7.4.2, 7.6.2, 9.1.1, 9.1.2, 9.3, 9.3.4, 9.5,  
2 11.6, 14.2.1, 14.2.7, 14.7, 15.3.4, 19.3.4, 19.3.6, and Annex A on pages 483, 25, 33,  
3 311, 314, 323, 354, 447, 449, 454, 463, 469, 512, 637, 643, 711, 726, 833, 838, and 849  
4 The Sessions Model was added to the standard.  
5
- 6 25. Section 11.2.1 on page 484.  
7 A new function MPI\_INFO\_CREATE\_ENV was added.  
8
- 9 26. Sections 11.2.1 and 11.10.4 on pages 484 and 541.  
10 Clarified the semantic of failure and error reporting before (and during) MPI\_INIT  
11 and after MPI\_FINALIZE.  
12
- 13 27. Section 11.8.4 on page 525.  
14 Added the "mpi\_initial\_errhandler" reserved info key with the reserved values  
15 "mpi\_errors\_abort", "mpi\_errors\_are\_fatal", and "mpi\_errors\_return" to the launch keys in  
16 MPI\_COMM\_SPAWN, MPI\_COMM\_SPAWN\_MULTIPLE, and mpiexec  
17
- 18 28. Section 12.5.3 on page 596.  
19 RMA passive target synchronization using locks can now be used portably in memory  
20 allocated via MPI\_WIN\_ALLOCATE\_SHARED.  
21
- 22 29. Section 13.3 on page 632  
23 The mpi\_f08 binding incorrectly had the dummy parameter flag in the MPI F08  
24 binding for MPI\_STATUS\_SET\_CANCELLED marked as INTENT(OUT). It has been  
25 fixed to be INTENT(IN).  
26
- 27 30. Section 15.3.8 on page 749.  
28 A callback-driven event interface was added to the MPI tool information interface.  
29
- 30 31. Section 15.3.10, Table 15.7, and Section 16.3 on pages 769, 771, and 776.  
31 MPI\_T\_ERR\_INVALID\_ITEM is deprecated. MPI routines should return  
32 MPI\_T\_ERR\_INVALID\_INDEX instead of MPI\_T\_ERR\_INVALID\_ITEM.  
33
- 34 32. Section 16.3 on page 777.  
35 MPI\_SIZEOF was deprecated.  
36
- 37 33. Section 19.1.5 on page 790.  
38 An exception was added for the specific Fortran names in the case of TS 29113 interface  
39 specifications in mpif.h for MPI\_NEIGHBOR\_ALLTOALLW\_INIT,  
40 MPI\_NEIGHBOR\_ALLTOALLV\_INIT, and MPI\_NEIGHBOR\_ALLGATHERV\_INIT.

## 41 B.2 Changes from Version 3.0 to Version 3.1

### 42 B.2.1 Fixes to Errata in Previous Versions of MPI

- 43 1. Chapters 3–19, Annex A.4 on page 911, and Example 6.21 on page 236, and MPI-3.0  
44 Chapters 3–17, Annex A.3 on page 707, and Example 5.21 on page 187.  
45 Within the mpi\_f08 Fortran support method, BIND(C) was removed from all  
46 SUBROUTINE, FUNCTION, and ABSTRACT INTERFACE definitions.  
47  
48

2. Section 3.2.5 on page 36, and MPI-3.0 Section 3.2.5 on page 30. The three public fields MPI\_SOURCE, MPI\_TAG, and MPI\_ERROR of the Fortran derived type TYPE(MPI\_Status) must be of type INTEGER.
3. Section 3.8.2 on page 85, and MPI-3.0 Section 3.8.2 on page 67. The flag arguments of the Fortran interfaces of MPI\_IMPROBE were originally incorrectly defined as INTEGER (instead as LOGICAL).
4. Section 7.4.2 on page 323, and MPI-3.0 Section 6.4.2 on page 237. In the mpi\_f08 binding of MPI\_COMM\_IDUP, the output argument newcomm is declared as ASYNCHRONOUS.
5. Section 7.4.4 on page 341, and MPI-3.0 Section 6.4.4 on page 248. In the mpi\_f08 binding of MPI\_COMM\_SET\_INFO, the intent of comm is IN, and the optional output argument ierror was missing.
6. Section 8.6 on page 412, and MPI-3.0 Sections 7.6, on pages 314. In the case of virtual general graph topologies (created with MPI\_CART\_CREATE), the use of neighborhood collective communication is restricted to adjacency matrices with the number of edges between any two processes is defined to be the same for both processes (i.e., with a symmetric adjacency matrix).
7. Section 9.1.1 on page 447, and MPI-3.0 Section 8.1.1 on page 335. In the mpi\_f08 binding of MPI\_GET\_LIBRARY\_VERSION, a typo in the resultlen argument was corrected.
8. Sections 9.2 (MPI\_ALLOC\_MEM and MPI\_ALLOC\_MEM\_CPTR), 12.2.2 (MPI\_WIN\_ALLOCATE and MPI\_WIN\_ALLOCATE\_CPTR), 12.2.3 (MPI\_WIN\_ALLOCATE\_SHARED and MPI\_WIN\_ALLOCATE\_SHARED\_CPTR), 12.2.3 (MPI\_WIN\_SHARED\_QUERY and MPI\_WIN\_SHARED\_QUERY\_CPTR), 15.2.1 and 15.2.6 (Profiling interface), and corresponding sections in MPI-3.0. The linker name concept was substituted by defining specific procedure names.
9. Section 12.2.1 on page 547, and MPI-3.0 Section 11.2.2 on page 407. The "same\_size" info key can be used with all window flavors, and requires that all processes in the process group of the communicator have provided this info key with the same value.
10. Section 12.3.4 on page 570, and MPI-3.0 Section 11.3.4 on page 424. Origin buffer arguments to MPI\_GET\_ACCUMULATE are ignored when the MPI\_NO\_OP operation is used.
11. Section 12.3.4 on page 570, and MPI-3.0 Section 11.3.4 on page 424. Clarify the roles of origin, result, and target communication parameters in MPI\_GET\_ACCUMULATE.
12. Section 15.3 on page 723, and MPI-3.0 Section 14.3 on page 561. New paragraph and advice to users clarifying intent of variable names in the tools information interface.
13. Section 15.3.3 on page 725, and MPI-3.0 Section 14.3.3 on page 563. New paragraph clarifying variable name equivalence in the tools information interface.

- 1 14. Sections [15.3.6](#), [15.3.7](#), and [15.3.9](#) on pages [730](#), [736](#), and [764](#), and  
2 MPI-3.0 Sections 14.3.6, 14.3.7, and 14.3.8 on pages 567, 573, and 584.  
3 In functions `MPI_T_CVAR_GET_INFO`, `MPI_T_PVAR_GET_INFO`, and  
4 `MPI_T_CATEGORY_GET_INFO`, clarification of parameters that must be identical for  
5 equivalent control variable / performance variable / category names across connected  
6 processes.
- 7  
8 15. Section [15.3.7](#) on page [736](#), and MPI-3.0 Section 14.3.7 on page 573.  
9 Clarify return code of `MPI_T_PVAR_{START,STOP,RESET}` routines.
- 10  
11 16. Section [15.3.7](#) on page [736](#), and MPI-3.0 Section 14.3.7 on page 579, line 7.  
12 Clarify the return code when bad handle is passed to an `MPI_T_PVAR_*` routine.
- 13  
14 17. Section [19.1.4](#) on page [789](#), and MPI-3.0 Section 17.1.4 on page 603.  
15 The advice to implementors at the end of the section was rewritten and moved into  
16 the following section.
- 17  
18 18. Section [19.1.5](#) on page [790](#), and MPI-3.0 Section 17.1.5 on page 605.  
19 The section was fully rewritten. The linker name concept was substituted by defining  
20 specific procedure names.
- 21  
22 19. Section [19.1.6](#) on page [795](#), and MPI-3.0 Section 17.1.6 on page 611.  
23 The requirements on `BIND(C)` procedure interfaces were removed.
- 24  
25 20. Annexes [A.3](#), [A.4](#), and [A.5](#) on pages [874](#), [911](#), and [999](#), and  
26 MPI-3.0 Annexes A.2, A.3, and A.4 on pages 685, 707, and 756.  
27 The predefined callback `MPI_CONVERSION_FN_NULL` was added to all three an-  
28 nexes.
- 29  
30 21. Annex [A.4.5](#) on page [952](#), and MPI-3.0 Annex A.3.4 on page 724.  
31 In the `mpi_f08` binding of  
32 `MPI_{COMM|TYPE|WIN}_{DUP|NULL_COPY|NULL_DELETE}_FN`, all `INTENT(...)`  
33 information was removed.

## 33 B.2.2 Changes in MPI-3.1

- 34 1. Sections [2.6.4](#) and [5.1.5](#) on pages [24](#) and [139](#).  
35 The use of the intrinsic operators “+” and “-” for absolute addresses is substituted  
36 by `MPI_AINT_ADD` and `MPI_AINT_DIFF`. In C, they can be implemented as macros.  
37
- 38 2. Sections [9.1.1](#), [11.2.1](#), and [11.6](#) on pages [447](#), [484](#), and [512](#).  
39 The routines `MPI_INITIALIZED`, `MPI_FINALIZED`, `MPI_QUERY_THREAD`,  
40 `MPI_IS_THREAD_MAIN`, `MPI_GET_VERSION`, and `MPI_GET_LIBRARY_VERSION`  
41 are callable from threads without restriction (in the sense of `MPI_THREAD_MULTIPLE`),  
42 irrespective of the actual level of thread support provided, in the case where the im-  
43 plementation supports threads.  
44
- 45 3. Section [12.2.1](#) on page [547](#).  
46 The “`same_disp_unit`” info key was added for use in RMA window creation routines.  
47  
48

4. Sections [14.4.2](#) and [14.4.3](#) on pages [654](#) and [661](#).  
Added `MPI_FILE_IREAD_AT_ALL`, `MPI_FILE_IWRITE_AT_ALL`,  
`MPI_FILE_IREAD_ALL`, and `MPI_FILE_IWRITE_ALL`
5. Sections [15.3.6](#), [15.3.7](#), and [15.3.9](#) on pages [730](#), [736](#), and [764](#).  
Clarified that `NULL` parameters can be provided in  
`MPI_T_{CVAR|PVAR|CATEGORY}_GET_INFO` routines.
6. Sections [15.3.6](#), [15.3.7](#), [15.3.9](#), and [15.3.10](#) on pages [730](#), [736](#), [764](#), and [769](#).  
New routines `MPI_T_CVAR_GET_INDEX`, `MPI_T_PVAR_GET_INDEX`,  
`MPI_T_CATEGORY_GET_INDEX`, were added to support retrieving indices of vari-  
ables and categories. The error codes `MPI_T_ERR_INVALID` and  
`MPI_T_ERR_INVALID_NAME` were added to indicate invalid uses of the interface.

## B.3 Changes from Version 2.2 to Version 3.0

### B.3.1 Fixes to Errata in Previous Versions of MPI

1. Sections [2.6.2](#) and [2.6.3](#) on pages [22](#) and [23](#), and MPI-2.2 Section 2.6.2 on page 17,  
lines 41–42, Section 2.6.3 on page 18, lines 15–16, and Section 2.6.4 on page 18,  
lines 40–41.  
This is an MPI-2 erratum: The scope for the reserved prefix `MPI_` and the C++  
namespace `MPI` is now any name as originally intended in MPI-1.
2. Sections [3.2.2](#), [6.9.2](#), [14.5.2](#) Table [14.2](#), and Annex [A.1.1](#) on pages [31](#), [224](#), [694](#), and  
[849](#), and MPI-2.2 Sections 3.2.2, 5.9.2, 13.5.2 Table 13.2, 16.1.16 Table 16.1, and  
Annex A.1.1 on pages 27, 164, 433, 472 and 513  
This is an MPI-2.2 erratum: New named predefined datatypes  
`MPI_CXX_BOOL`, `MPI_CXX_FLOAT_COMPLEX`, `MPI_CXX_DOUBLE_COMPLEX`, and  
`MPI_CXX_LONG_DOUBLE_COMPLEX` were added in C and Fortran corresponding to  
the C++ types `bool`, `std::complex<float>`, `std::complex<double>`, and  
`std::complex<long double>`. These datatypes also correspond to the deprecated  
C++ predefined datatypes `MPI::BOOL`, `MPI::COMPLEX`, `MPI::DOUBLE_COMPLEX`, and  
`MPI::LONG_DOUBLE_COMPLEX`, which were removed in MPI-3.0. The non-standard  
C++ types `Complex<...>` were substituted by the standard types  
`std::complex<...>`.
3. Sections [6.9.2](#) on pages [224](#) and MPI-2.2 Section 5.9.2, page 165, line 47.  
This is an MPI-2.2 erratum: `MPI_C_COMPLEX` was added to the “Complex” reduction  
group.
4. Section [8.5.5](#) on page [399](#), and MPI-2.2, Section 7.5.5 on page 257, C++ interface on  
page 264, line 3.  
This is an MPI-2.2 erratum: The argument `rank` was removed and `in/outdegree` are  
now defined as `int& indegree` and `int& outdegree` in the C++ interface of  
`MPI_DIST_GRAPH_NEIGHBORS_COUNT`.
5. Section [14.5.2](#), Table [14.2](#) on page [694](#), and MPI-2.2, Section 13.5.3, Table 13.2 on  
page 433.



1 This was an MPI-2.2 erratum: The MPI\_C\_BOOL "external32" representation is cor-  
2 rected to a 1-byte size.

- 3  
4 6. MPI-2.2 Section 16.1.16 on page 471, line 45.

5 This is an MPI-2.2 erratum: The constant MPI::\_LONG\_LONG should be  
6 MPI::LONG\_LONG.

- 7  
8 7. Annex A.1.1 on page 849, Table "Optional datatypes (Fortran)," and  
9 MPI-2.2, Annex A.1.1, Table on page 517, lines 34, and 37–41.

10 This is an MPI-2.2 erratum: The C++ datatype handles MPI::INTEGER16,  
11 MPI::REAL16, MPI::F\_COMPLEX4, MPI::F\_COMPLEX8, MPI::F\_COMPLEX16,  
12 MPI::F\_COMPLEX32 were added to the table.

### 13 B.3.2 Changes in MPI-3.0

- 14  
15 1. Section 2.6.1 on page 22, Section 17.2 on page 780 and all other chapters.

16 The C++ bindings were removed from the standard. See errata in Section B.3.1 on  
17 page 1041 for the latest changes to the MPI C++ binding defined in MPI-2.2.

18 This change may affect backward compatibility.

- 19  
20 2. Section 2.6.1 on page 22, Section 16.1 on page 773 and Section 17.1 on page 779.

21 The deprecated functions MPI\_TYPE\_HVECTOR, MPI\_TYPE\_HINDEXED,  
22 MPI\_TYPE\_STRUCT, MPI\_ADDRESS, MPI\_TYPE\_EXTENT, MPI\_TYPE\_LB,  
23 MPI\_TYPE\_UB, MPI\_ERRHANDLER\_CREATE (and its callback function prototype  
24 MPI\_Handler\_function), MPI\_ERRHANDLER\_SET, MPI\_ERRHANDLER\_GET, the dep-  
25 recated special datatype handles MPI\_LB, MPI\_UB, and the constants  
26 MPI\_COMBINER\_HINDEXED\_INTEGER, MPI\_COMBINER\_HVECTOR\_INTEGER,  
27 MPI\_COMBINER\_STRUCT\_INTEGER were removed from the standard.

28 This change may affect backward compatibility.

- 29  
30 3. Section 2.3 on page 10.

31 Clarified parameter usage for IN parameters. C bindings are now const-correct where  
32 backward compatibility is preserved.

- 33  
34 4. Section 2.5.4 on page 18 and Section 8.5.4 on page 392.

35 The recommended C implementation value for MPI\_UNWEIGHTED changed from NULL  
36 to non-NULL. An additional weight array constant (MPI\_WEIGHTS\_EMPTY) was in-  
37 troduced.

- 38  
39 5. Section 2.5.4 on page 18 and Section 9.1.1 on page 447.

40 Added the new routine MPI\_GET\_LIBRARY\_VERSION to query library specific ver-  
41 sions, and the new constant MPI\_MAX\_LIBRARY\_VERSION\_STRING.

- 42  
43 6. Sections 2.5.8, 3.2.2, 3.3, 6.9.2, on pages 20, 31, 33, 224, Sections 5.1, 5.1.7, 5.1.8,  
44 5.1.11, 13.3 on pages 117, 145, 147, 151, 632, and Annex A.1.1 on page 849.

45 New inquiry functions, MPI\_TYPE\_SIZE\_X, MPI\_TYPE\_GET\_EXTENT\_X,  
46 MPI\_TYPE\_GET\_TRUE\_EXTENT\_X, and MPI\_GET\_ELEMENTS\_X, return their re-  
47 sults as an MPI\_Count value, which is a new type large enough to represent ele-  
48 ment counts in memory, file views, etc. A new function,

MPI\_STATUS\_SET\_ELEMENTS\_X, modifies the opaque part of an MPI\_Status object  
so that a call to MPI\_GET\_ELEMENTS\_X returns the provided MPI\_Count value (in



Fortran, `INTEGER(KIND=MPI_COUNT_KIND)`). The corresponding predefined datatype is `MPI_COUNT`.

7. Chapter 3 on page 29 through Chapter 19 on page 783.  
In the C language bindings, the array-arguments' interfaces were modified to consistently use `[]` instead of `*`.  
Exceptions are `MPI_INIT`, which continues to use `char ***argv` (correct because of subtle rules regarding the use of the `&` operator with `char *argv[]`), and `MPI_INIT_THREAD`, which is changed to be consistent with `MPI_INIT`.
8. Sections 3.2.5, 5.1.5, 5.1.11, 5.2 on pages 36, 139, 151, 172.  
The functions `MPI_GET_COUNT` and `MPI_GET_ELEMENTS` were defined to set the `count` argument to `MPI_UNDEFINED` when that argument would overflow. The functions `MPI_PACK_SIZE` and `MPI_TYPE_SIZE` were defined to set the `size` argument to `MPI_UNDEFINED` when that argument would overflow. In all other MPI-2.2 routines, the type and semantics of the count arguments remain unchanged, i.e., `int` or `INTEGER`.
9. Section 3.2.6 on page 39, and Section 3.8 on page 82.  
`MPI_STATUS_IGNORE` can be also used in `MPI_IPROBE`, `MPI_PROBE`, `MPI_IMPROBE`, and `MPI_MPROBE`.
10. Section 3.8 on page 82 and Section 3.10 on page 98.  
The use of `MPI_PROC_NULL` in probe operations was clarified. A special predefined message `MPI_MESSAGE_NO_PROC` was defined for the use of matching probe (i.e., the new `MPI_MPROBE` and `MPI_IMPROBE`) with `MPI_PROC_NULL`.
11. Sections 3.8.2, 3.8.3, 19.3.4, A.1.1 on pages 85, 87, 833, 849.  
Like `MPI_PROBE` and `MPI_IPROBE`, the new `MPI_MPROBE` and `MPI_IMPROBE` operations allow incoming messages to be queried without actually receiving them, except that `MPI_MPROBE` and `MPI_IMPROBE` provide a mechanism to receive the specific message with the new routines `MPI_MRECV` and `MPI_IMRECV` regardless of other intervening probe or receive operations. The opaque object `MPI_Message`, the null handle `MPI_MESSAGE_NULL`, and the conversion functions `MPI_Message_c2f` and `MPI_Message_f2c` were defined.
12. Section 5.1.2 on page 119 and Section 5.1.13 on page 155.  
The routine `MPI_TYPE_CREATE_HINDEXED_BLOCK` and constant `MPI_COMBINER_HINDEXED_BLOCK` were added.
13. Chapter 6 on page 185 and Section 6.12 on page 248.  
Added nonblocking interfaces to all collective operations.
14. Sections 7.4.2, 7.4.4, 12.2.7, on pages 323, 341, 561.  
The new routines `MPI_COMM_DUP_WITH_INFO`, `MPI_COMM_SET_INFO`, `MPI_COMM_GET_INFO`, `MPI_WIN_SET_INFO`, and `MPI_WIN_GET_INFO` were added. The routine `MPI_COMM_DUP` must also duplicate info hints.
15. Section 7.4.2 on page 323.  
Added `MPI_COMM_IDUP`.

- 1 16. Section 7.4.2 on page 323.  
2 Added the new communicator construction routine `MPI_COMM_CREATE_GROUP`,  
3 which is invoked only by the processes in the group of the new communicator being  
4 constructed.
- 5  
6 17. Section 7.4.2 on page 323.  
7 Added the `MPI_COMM_SPLIT_TYPE` routine and the communicator split type con-  
8 stant `MPI_COMM_TYPE_SHARED`.
- 9  
10 18. Section 7.6.2 on page 354.  
11 In MPI-2.2, communication involved in an `MPI_INTERCOMM_CREATE` operation  
12 could interfere with point-to-point communication on the parent communicator with  
13 the same tag or `MPI_ANY_TAG`. This interference has been removed in MPI-3.0.
- 14  
15 19. Section 7.8 on page 377.  
16 Section 6.8 on page 238. The constant `MPI_MAX_OBJECT_NAME` also applies for type  
17 and window names.
- 18  
19 20. Section 8.5.8 on page 410.  
20 `MPI_CART_MAP` can also be used for a zero-dimensional topologies.
- 21  
22 21. Section 8.6 on page 412 and Section 8.7 on page 425.  
23 The following neighborhood collective communication routines were added to sup-  
24 port sparse communication on virtual topology grids: `MPI_NEIGHBOR_ALLGATHER`,  
25 `MPI_NEIGHBOR_ALLGATHERV`, `MPI_NEIGHBOR_ALLTOALL`,  
26 `MPI_NEIGHBOR_ALLTOALLV`, `MPI_NEIGHBOR_ALLTOALLW` and the nonblocking  
27 variants `MPI_INEIGHBOR_ALLGATHER`, `MPI_INEIGHBOR_ALLGATHERV`,  
28 `MPI_INEIGHBOR_ALLTOALL`, `MPI_INEIGHBOR_ALLTOALLV`, and  
29 `MPI_INEIGHBOR_ALLTOALLW`. The displacement arguments in  
30 `MPI_NEIGHBOR_ALLTOALLW` and `MPI_INEIGHBOR_ALLTOALLW` were defined as  
31 address size integers. In `MPI_DIST_GRAPH_NEIGHBORS`, an ordering rule was added  
32 for communicators created with `MPI_DIST_GRAPH_CREATE_ADJACENT`.
- 33  
34 22. Section 11.2.1 on page 484 and Section 11.2.1 on page 487.  
35 The use of `MPI_INIT`, `MPI_INIT_THREAD` and `MPI_FINALIZE` was clarified. After  
36 MPI is initialized, the application can access information about the execution envi-  
37 ronment by querying the new predefined info object `MPI_INFO_ENV`.
- 38  
39 23. Section 11.2.1 on page 484.  
40 Allow calls to `MPI_T` routines before `MPI_INIT` and after `MPI_FINALIZE`.
- 41  
42 24. Chapter 12 on page 545.  
43 Substantial revision of the entire One-sided chapter, with new routines for window  
44 creation, additional synchronization methods in passive target communication, new  
45 one-sided communication routines, a new memory model, and other changes.
- 46  
47 25. Section 15.3 on page 723.  
48 A new MPI Tool Information Interface was added.  
The following changes are related to the Fortran language support.
26. Section 2.3 on page 10, and Sections 19.1.1, 19.1.2, 19.1.7 on pages 783, 784, and 799.  
The new `mpi_08` Fortran module was introduced.

27. Section 2.5.1 on page 16, and Sections 19.1.2, 19.1.3, 19.1.7 on pages 784, 787, and 799. Handles to opaque objects were defined as named types within the `mpi_08` Fortran module. The operators `.EQ.`, `.NE.`, `==`, and `/=` were overloaded to allow the comparison of these handles. The handle types and the overloaded operators are also available through the `mpi` Fortran module.
28. Sections 2.5.4, 2.5.5 on pages 18, 19, Sections 19.1.1, 19.1.10, 19.1.11, 19.1.12, 19.1.13 on pages 783, 809, 811, 811, 814, and Sections 19.1.2, 19.1.3, 19.1.7 on pages 784, 787, 799. Within the `mpi_08` Fortran module, choice buffers were defined as assumed-type and assumed-rank according to Fortran 2008 TS 29113 [46], and the compile-time constant `MPI_SUBARRAYS_SUPPORTED` was set to `.TRUE..` With this, Fortran subscript triplets can be used in nonblocking MPI operations; vector subscripts are not supported in nonblocking operations. If the compiler does not support this Fortran TS 29113 feature, the constant is set to `.FALSE..`
29. Section 2.6.2 on page 22, Section 19.1.2 on page 784, and Section 19.1.7 on page 799. The `ierror` dummy arguments are `OPTIONAL` within the `mpi_08` Fortran module.
30. Section 3.2.5 on page 36, Sections 19.1.2, 19.1.3, 19.1.7, on pages 784, 787, 799, and Section 19.3.5 on page 835. Within the `mpi_08` Fortran module, the status was defined as `TYPE(MPI_Status)`. Additionally, within both the `mpi` and the `mpi_f08` modules, the constants `MPI_STATUS_SIZE`, `MPI_SOURCE`, `MPI_TAG`, `MPI_ERROR`, and `TYPE(MPI_Status)` are defined. New conversion routines were added: `MPI_STATUS_F2F08`, `MPI_STATUS_F082F`, `MPI_Status_c2f08`, and `MPI_Status_f082c`. In `mpi.h`, the new type `MPI_F08_status`, and the external variables `MPI_F08_STATUS_IGNORE` and `MPI_F08_STATUSES_IGNORE` were added.
31. Section 3.6 on page 56. In Fortran with the `mpi` module or `mpif.h`, the type of the `buffer_addr` argument of `MPI_BUFFER_DETACH` is incorrectly defined and the argument is therefore unused.
32. Section 5.1 on page 117, Section 5.1.6 on page 142, and Section 19.1.15 on page 815. The Fortran alignments of basic datatypes within Fortran derived types are implementation dependent; therefore it is recommended to use the `BIND(C)` attribute for derived types in MPI communication buffers. If an array of structures (in C/C++) or derived types (in Fortran) is to be used in MPI communication buffers, it is recommended that the user creates a portable datatype handle and additionally applies `MPI_TYPE_CREATE_RESIZED` to this datatype handle.
33. Sections 5.1.10, 6.9.5, 6.9.7, 7.7.4, 7.8, 9.3.1, 9.3.2, 9.3.3, 16.1, 19.1.9 on pages 150, 231, 238, 372, 377, 457, 459, 461, 773, and 801. In some routines, the dummy argument names were changed because they were identical to the Fortran keywords `TYPE` and `FUNCTION`. The new dummy argument names must be used because the `mpi` and `mpi_08` modules guarantee keyword-based actual argument lists. The argument name type was changed in `MPI_TYPE_DUP`, the Fortran `USER_FUNCTION` of `MPI_OP_CREATE`, `MPI_TYPE_SET_ATTR`, `MPI_TYPE_GET_ATTR`, `MPI_TYPE_DELETE_ATTR`, `MPI_TYPE_SET_NAME`,

1 MPI\_TYPE\_GET\_NAME, MPI\_TYPE\_MATCH\_SIZE, the callback prototype defini-  
2 tion MPI\_Type\_delete\_attr\_function, and the predefined callback function  
3 MPI\_TYPE\_NULL\_DELETE\_FN; function was changed in MPI\_OP\_CREATE,  
4 MPI\_COMM\_CREATE\_ERRHANDLER, MPI\_WIN\_CREATE\_ERRHANDLER,  
5 MPI\_FILE\_CREATE\_ERRHANDLER, and MPI\_ERRHANDLER\_CREATE. For consi-  
6 stency reasons, INOUBUF was changed to INOUTBUF in MPI\_REDUCE\_LOCAL, and  
7 intracomm to newintracomm in MPI\_INTERCOMM\_MERGE.

8  
9 34. Section 7.7.2 on page 362.

10 It was clarified that in Fortran, the flag values returned by a comm\_copy\_attr\_fn  
11 callback, including MPI\_COMM\_NULL\_COPY\_FN and MPI\_COMM\_DUP\_FN, are  
12 .FALSE. and .TRUE.; see MPI\_COMM\_CREATE\_KEYVAL.

13  
14 35. Section 9.2 on page 451.

15 With the mpi and mpi\_f08 Fortran modules, MPI\_ALLOC\_MEM now also supports  
16 TYPE(C\_PTR) C-pointers instead of only returning an address-sized integer that may  
17 be usable together with a non-standard Cray-pointer.

18  
19 36. Section 19.1.15 on page 815, and Section 19.1.7 on page 799.

20 Fortran SEQUENCE and BIND(C) derived application types can now be used as buffers  
21 in MPI operations.

22  
23 37. Section 19.1.16 on page 817 to Section 19.1.19 on page 826, Section 19.1.7 on page 799,  
24 and Section 19.1.8 on page 800.

25 The sections about Fortran optimization problems and their solutions were partially  
26 rewritten and new methods are added, e.g., the use of the ASYNCHRONOUS attribute.  
27 The constant MPI\_ASYNC\_PROTECTS\_NONBLOCKING tells whether the semantics of  
28 the ASYNCHRONOUS attribute is extended to protect nonblocking operations. The For-  
29 tran routine MPI\_F\_SYNC\_REG is added. MPI-3.0 compliance for an MPI library  
30 together with a Fortran compiler is defined in Section 19.1.7.

31  
32 38. Section 19.1.2 on page 784.

33 Within the mpi\_08 Fortran module, dummy arguments are now declared with  
34 INTENT=IN, OUT, or INOUT as defined in the mpi\_08 interfaces.

35  
36 39. Section 19.1.3 on page 787, and Section 19.1.7 on page 799.

37 The existing mpi Fortran module must implement compile-time argument checking.

38  
39 40. Section 19.1.4 on page 789.

40 The use of the mpif.h Fortran include file is now strongly discouraged.

41  
42 41. Section A.1.1, Table “Predefined functions” on page 857, Section A.1.3 on page 864,  
43 and Section A.4.5 on page 952.

44 Within the new mpi\_f08 module, all callback prototype definitions are now defined  
45 with explicit interfaces PROCEDURE(MPI\_...) that have the BIND(C) attribute; user-  
46 written callbacks must be modified if the mpi\_f08 module is used.

47  
48 42. Section A.1.3 on page 864.

In some routines, the Fortran callback prototype names were changed from ...\_FN to  
...\_FUNCTION to be consistent with the other language bindings.

## B.4 Changes from Version 2.1 to Version 2.2

1. Section 2.5.4 on page 18.  
It is now guaranteed that predefined named constant handles (as other constants) can be used in initialization expressions or assignments, i.e., also before the call to MPI\_INIT.
2. Section 2.6 on page 21, and Section 17.2 on page 780.  
The C++ language bindings have been deprecated and may be removed in a future version of the MPI specification.
3. Section 3.2.2 on page 31.  
MPI\_CHAR for printable characters is now defined for C type char (instead of signed char). This change should not have any impact on applications nor on MPI libraries (except some comment lines), because printable characters could and can be stored in any of the C types char, signed char, and unsigned char, and MPI\_CHAR is not allowed for predefined reduction operations.
4. Section 3.2.2 on page 31.  
MPI\_(U)INT{8,16,32,64}\_T, MPI\_AINT, MPI\_OFFSET, MPI\_C\_BOOL, MPI\_C\_COMPLEX, MPI\_C\_FLOAT\_COMPLEX, MPI\_C\_DOUBLE\_COMPLEX, and MPI\_C\_LONG\_DOUBLE\_COMPLEX are now valid predefined MPI datatypes.
5. Section 3.4 on page 47, Section 3.7.2 on page 61, Section 3.9 on page 92, and Section 6.1 on page 185.  
The read access restriction on the send buffer for blocking, non blocking and collective API has been lifted. It is permitted to access for read the send buffer while the operation is in progress.
6. Section 3.7 on page 59.  
The Advice to users for IBSEND and IRSEND was slightly changed.
7. Section 3.7.3 on page 68.  
The advice to free an active request was removed in the Advice to users for MPI\_REQUEST\_FREE.
8. Section 3.7.6 on page 81.  
MPI\_REQUEST\_GET\_STATUS changed to permit inactive or null requests as input.
9. Section 6.8 on page 215.  
“In place” option is added to MPI\_ALLTOALL, MPI\_ALLTOALLV, and MPI\_ALLTOALLW for intra-communicators.
10. Section 6.9.2 on page 224.  
Predefined parameterized datatypes (e.g., returned by MPI\_TYPE\_CREATE\_F90\_REAL) and optional named predefined datatypes (e.g. MPI\_REAL8) have been added to the list of valid datatypes in reduction operations.
11. Section 6.9.2 on page 224.  
MPI\_(U)INT{8,16,32,64}\_T are all considered C integer types for the purposes of the predefined reduction operators. MPI\_AINT and MPI\_OFFSET are considered Fortran

1 integer types. MPI\_C\_BOOL is considered a Logical type.

2 MPI\_C\_COMPLEX, MPI\_C\_FLOAT\_COMPLEX, MPI\_C\_DOUBLE\_COMPLEX, and  
3 MPI\_C\_LONG\_DOUBLE\_COMPLEX are considered Complex types.

- 4  
5 12. Section 6.9.7 on page 238.

6 The local routines MPI\_REDUCE\_LOCAL and MPI\_OP\_COMMUTATIVE have been  
7 added.

- 8  
9 13. Section 6.10.1 on page 240.

10 The collective function MPI\_REDUCE\_SCATTER\_BLOCK is added to the MPI stan-  
11 dard.

- 12  
13 14. Section 6.11.2 on page 245.

14 Added in place argument to MPI\_EXSCAN.

- 15  
16 15. Section 7.4.2 on page 323, and Section 7.6 on page 351.

17 Implementations that did not implement MPI\_COMM\_CREATE on inter-communi-  
18 cators will need to add that functionality. As the standard described the behav-  
19 ior of this operation on inter-communicators, it is believed that most implementa-  
20 tions already provide this functionality. Note also that the C++ binding for both  
21 MPI\_COMM\_CREATE and MPI\_COMM\_SPLIT explicitly allow Intercomms.

- 22  
23 16. Section 7.4.2 on page 323.

24 MPI\_COMM\_CREATE is extended to allow several disjoint subgroups as input if comm  
25 is an intra-communicator. If comm is an inter-communicator it was clarified that all  
26 processes in the same local group of comm must specify the same value for group.

- 27  
28 17. Section 8.5.4 on page 392.

29 New functions for a scalable distributed graph topology interface has been added.  
30 In this section, the functions MPI\_DIST\_GRAPH\_CREATE\_ADJACENT and  
31 MPI\_DIST\_GRAPH\_CREATE, the constants MPI\_UNWEIGHTED, and the derived C++  
32 class Distgraphcomm were added.

- 33  
34 18. Section 8.5.5 on page 399.

35 For the scalable distributed graph topology interface, the functions  
36 MPI\_DIST\_GRAPH\_NEIGHBORS\_COUNT and MPI\_DIST\_GRAPH\_NEIGHBORS and  
37 the constant MPI\_DIST\_GRAPH were added.

- 38  
39 19. Section 8.5.5 on page 399.

40 Remove ambiguity regarding duplicated neighbors with MPI\_GRAPH\_NEIGHBORS  
41 and MPI\_GRAPH\_NEIGHBORS\_COUNT.

- 42  
43 20. Section 9.1.1 on page 447.

44 The subversion number changed from 1 to 2.

- 45  
46 21. Section 9.3 on page 454, Section 16.2 on page 776, and Annex A.1.3 on page 864.

47 Changed function pointer typedef names MPI\_{Comm,File,Win}\_errhandler\_fn to  
48 MPI\_{Comm,File,Win}\_errhandler\_function. Deprecated old “\_fn” names.

- 49  
50 22. Section 11.2.4 on page 494.

51 Attribute deletion callbacks on MPI\_COMM\_SELF are now called in LIFO order. Imple-  
52 mentors must now also register all implementation-internal attribute deletion callbacks  
53 on MPI\_COMM\_SELF before returning from MPI\_INIT/MPI\_INIT\_THREAD.



23. Section [12.3.4](#) on page [570](#).  
The restriction added in MPI 2.1 that the operation MPI\_REPLACE in MPI\_ACCUMULATE can be used only with predefined datatypes has been removed. MPI\_REPLACE can now be used even with derived datatypes, as it was in MPI 2.0. Also, a clarification has been made that MPI\_REPLACE can be used only in MPI\_ACCUMULATE, not in collective operations that do reductions, such as MPI\_REDUCE and others.
24. Section [13.2](#) on page [625](#).  
Add “\*” to the query\_fn, free\_fn, and cancel\_fn arguments to the C++ binding for MPI::Grequest::Start() for consistency with the rest of MPI functions that take function pointer arguments.
25. Section [14.5.2](#) on page [693](#), and Table [14.2](#) on page [694](#).  
MPI\_(U)INT{8,16,32,64}\_T, MPI\_AINT, MPI\_OFFSET, MPI\_C\_COMPLEX, MPI\_C\_FLOAT\_COMPLEX, MPI\_C\_DOUBLE\_COMPLEX, MPI\_C\_LONG\_DOUBLE\_COMPLEX, and MPI\_C\_BOOL are added as predefined datatypes in the "external32" representation.
26. Section [19.3.7](#) on page [841](#).  
The description was modified that it only describes how an MPI implementation behaves, but not how MPI stores attributes internally. The erroneous MPI-2.1 Example 16.17 was replaced with three new examples [19.13](#), [19.14](#), and [19.15](#) on pages [841–843](#) explicitly detailing cross-language attribute behavior. Implementations that matched the behavior of the old example will need to be updated.
27. Annex [A.1.1](#) on page [849](#).  
Removed type MPI::Fint (compare MPI\_Fint in Section [A.1.2](#) on page [863](#)).
28. Annex [A.1.1](#) on page [849](#). Table *Named Predefined Datatypes*.  
Added MPI\_(U)INT{8,16,32,64}\_T, MPI\_AINT, MPI\_OFFSET, MPI\_C\_BOOL, MPI\_C\_FLOAT\_COMPLEX, MPI\_C\_COMPLEX, MPI\_C\_DOUBLE\_COMPLEX, and MPI\_C\_LONG\_DOUBLE\_COMPLEX are added as predefined datatypes.

## B.5 Changes from Version 2.0 to Version 2.1

1. Section [3.2.2](#) on page [31](#), and Annex [A.1](#) on page [849](#).  
In addition, the MPI\_LONG\_LONG should be added as an optional type; it is a synonym for MPI\_LONG\_LONG\_INT.
2. Section [3.2.2](#) on page [31](#), and Annex [A.1](#) on page [849](#).  
MPI\_LONG\_LONG\_INT, MPI\_LONG\_LONG (as synonym), MPI\_UNSIGNED\_LONG\_LONG, MPI\_SIGNED\_CHAR, and MPI\_WCHAR are moved from optional to official and they are therefore defined for all three language bindings.
3. Section [3.2.5](#) on page [36](#).  
MPI\_GET\_COUNT with zero-length datatypes: The value returned as the count argument of MPI\_GET\_COUNT for a datatype of length zero where zero bytes have been transferred is zero. If the number of bytes transferred is greater than zero, MPI\_UNDEFINED is returned.

- 1 4. Section 5.1 on page 117.  
2 General rule about derived datatypes: Most datatype constructors have replication  
3 count or block length arguments. Allowed values are non-negative integers. If the  
4 value is zero, no elements are generated in the type map and there is no effect on  
5 datatype bounds or extent.  
6
- 7 5. Section 5.3 on page 180.  
8 MPI\_BYTE should be used to send and receive data that is packed using  
9 MPI\_PACK\_EXTERNAL.  
10
- 11 6. Section 6.9.6 on page 236.  
12 If comm is an inter-communicator in MPI\_ALLREDUCE, then both groups should  
13 provide count and datatype arguments that specify the same type signature (i.e., it is  
14 not necessary that both groups provide the same count value).  
15
- 16 7. Section 7.3.1 on page 312.  
17 MPI\_GROUP\_TRANSLATE\_RANKS and MPI\_PROC\_NULL: MPI\_PROC\_NULL is a valid  
18 rank for input to MPI\_GROUP\_TRANSLATE\_RANKS, which returns MPI\_PROC\_NULL  
19 as the translated rank.  
20
- 21 8. Section 7.7 on page 361.  
22 About the attribute caching functions:  
23 *Advice to implementors.* High-quality implementations should raise an er-  
24 ror when a keyval that was created by a call to MPI\_XXX\_CREATE\_KEYVAL  
25 is used with an object of the wrong type with a call to  
26 MPI\_YYY\_GET\_ATTR, MPI\_YYY\_SET\_ATTR, MPI\_YYY\_DELETE\_ATTR, or  
27 MPI\_YYY\_FREE\_KEYVAL. To do so, it is necessary to maintain, with each key-  
28 val, information on the type of the associated user function. (*End of advice to*  
29 *implementors.*)  
30
- 31 9. Section 7.8 on page 377.  
32 In MPI\_COMM\_GET\_NAME: In C, a null character is additionally stored at  
33 name[resultlen]. resultlen cannot be larger than MPI\_MAX\_OBJECT\_NAME-1. In For-  
34 tran, name is padded on the right with blank characters. resultlen cannot be larger  
35 than MPI\_MAX\_OBJECT\_NAME.  
36
- 37 10. Section 8.4 on page 387.  
38 About MPI\_GRAPH\_CREATE and MPI\_CART\_CREATE: All input arguments must  
39 have identical values on all processes of the group of comm\_old.  
40
- 41 11. Section 8.5.1 on page 388.  
42 In MPI\_CART\_CREATE: If ndims is zero then a zero-dimensional Cartesian topology  
43 is created. The call is erroneous if it specifies a grid that is larger than the group size  
44 or if ndims is negative.  
45
- 46 12. Section 8.5.3 on page 390.  
47 In MPI\_GRAPH\_CREATE: If the graph is empty, i.e., nnodes == 0, then  
48 MPI\_COMM\_NULL is returned in all processes.



13. Section 8.5.3 on page 390. 1  
 In MPI\_GRAPH\_CREATE: A single process is allowed to be defined multiple times 2  
 in the list of neighbors of a process (i.e., there may be multiple edges between two 3  
 processes). A process is also allowed to be a neighbor to itself (i.e., a self loop in the 4  
 graph). The adjacency matrix is allowed to be non-symmetric. 5  
6  
*Advice to users.* Performance implications of using multiple edges or a non- 7  
 symmetric adjacency matrix are not defined. The definition of a node-neighbor 8  
 edge does not imply a direction of the communication. (*End of advice to users.*) 9
14. Section 8.5.5 on page 399. 10  
 In MPI\_CARTDIM\_GET and MPI\_CART\_GET: If comm is associated with a zero- 11  
 dimensional Cartesian topology, MPI\_CARTDIM\_GET returns ndims=0 and 12  
 MPI\_CART\_GET will keep all output arguments unchanged. 13  
14
15. Section 8.5.5 on page 399. 15  
 In MPI\_CART\_RANK: If comm is associated with a zero-dimensional Cartesian topol- 16  
 ogy, coord is not significant and 0 is returned in rank. 17  
18
16. Section 8.5.5 on page 399. 19  
 In MPI\_CART\_COORDS: If comm is associated with a zero-dimensional Cartesian 20  
 topology, coords will be unchanged. 21  
22
17. Section 8.5.6 on page 407. 23  
 In MPI\_CART\_SHIFT: It is erroneous to call MPI\_CART\_SHIFT with a direction that 24  
 is either negative or greater than or equal to the number of dimensions in the Cartesian 25  
 communicator. This implies that it is erroneous to call MPI\_CART\_SHIFT with a 26  
 comm that is associated with a zero-dimensional Cartesian topology. 27
18. Section 8.5.7 on page 409. 28  
 In MPI\_CART\_SUB: If all entries in remain\_dims are false or comm is already associ- 29  
 ated with a zero-dimensional Cartesian topology then newcomm is associated with a 30  
 zero-dimensional Cartesian topology. 31  
32
- 18.1. Section 9.1.1 on page 447. 33  
 The subversion number changed from 0 to 1. 34  
35
19. Section 9.1.2 on page 449. 36  
 In MPI\_GET\_PROCESSOR\_NAME: In C, a null character is additionally stored at 37  
 name[resultlen]. resultlen cannot be larger then MPI\_MAX\_PROCESSOR\_NAME-1. In 38  
 Fortran, name is padded on the right with blank characters. resultlen cannot be larger 39  
 then MPI\_MAX\_PROCESSOR\_NAME. 40
20. Section 9.3 on page 454. 41  
 MPI\_{COMM,WIN,FILE}\_GET\_ERRHANDLER behave as if a new error handler object 42  
 is created. That is, once the error handler is no longer needed, 43  
 MPI\_ERRHANDLER\_FREE should be called with the error handler returned from 44  
 MPI\_ERRHANDLER\_GET or MPI\_{COMM,WIN,FILE}\_GET\_ERRHANDLER to mark 45  
 the error handler for deallocation. This provides behavior similar to that of 46  
 MPI\_COMM\_GROUP and MPI\_GROUP\_FREE. 47  
48

- 1 21. Section 11.2.1 on page 484, see explanations to MPI\_FINALIZE.  
2 MPI\_FINALIZE is collective over all connected processes. If no processes were spawned,  
3 accepted or connected then this means over MPI\_COMM\_WORLD; otherwise it is col-  
4 lective over the union of all processes that have been and continue to be connected,  
5 as explained in Section 11.10.4 on page 541.  
6
- 7 22. Section 11.2.1 on page 484.  
8 About MPI\_ABORT:  
9  
10 *Advice to users.* Whether the errorcode is returned from the executable or from  
11 the MPI process startup mechanism (e.g., mpiexec), is an aspect of quality of the  
12 MPI library but not mandatory. (*End of advice to users.*)  
13  
14 *Advice to implementors.* Where possible, a high-quality implementation will try  
15 to return the errorcode from the MPI process startup mechanism (e.g. mpiexec  
16 or singleton init). (*End of advice to implementors.*)
- 17 23. Section 10 on page 475.  
18 An implementation must support info objects as caches for arbitrary (key, value)  
19 pairs, regardless of whether it recognizes the key. Each function that takes hints in  
20 the form of an MPI\_Info must be prepared to ignore any key it does not recognize. This  
21 description of info objects does not attempt to define how a particular function should  
22 react if it recognizes a key but not the associated value. MPI\_INFO\_GET\_NKEYS,  
23 MPI\_INFO\_GET\_NTHKEY, MPI\_INFO\_GET\_VALUELEN, and MPI\_INFO\_GET must  
24 retain all (key,value) pairs so that layered functionality can also use the Info object.  
25
- 26 24. Section 12.3 on page 563.  
27 MPI\_PROC\_NULL is a valid target rank in the MPI RMA calls MPI\_ACCUMULATE,  
28 MPI\_GET, and MPI\_PUT. The effect is the same as for MPI\_PROC\_NULL in MPI point-  
29 to-point communication. See also item 25 in this list.  
30
- 31 25. Section 12.3 on page 563.  
32 After any RMA operation with rank MPI\_PROC\_NULL, it is still necessary to finish the  
33 RMA epoch with the synchronization method that started the epoch. See also item 24  
34 in this list.
- 35 26. Section 12.3.4 on page 570.  
36 MPI\_REPLACE in MPI\_ACCUMULATE, like the other predefined operations, is defined  
37 only for the predefined MPI datatypes.  
38
- 39 27. Section 14.2.8 on page 645.  
40 About MPI\_FILE\_SET\_VIEW and MPI\_FILE\_SET\_INFO: When an info object that  
41 specifies a subset of valid hints is passed to MPI\_FILE\_SET\_VIEW or  
42 MPI\_FILE\_SET\_INFO, there will be no effect on previously set or defaulted hints that  
43 the info does not specify.  
44
- 45 28. Section 14.2.8 on page 645.  
46 About MPI\_FILE\_GET\_INFO: If no hint exists for the file associated with fh, a handle  
47 to a newly created info object is returned that contains no key/value pair.  
48

29. Section 14.3 on page 648. 1  
If a file does not have the mode `MPI_MODE_SEQUENTIAL`, then 2  
`MPI_DISPLACEMENT_CURRENT` is invalid as `disp` in `MPI_FILE_SET_VIEW`. 3
30. Section 14.5.2 on page 693. 4  
The bias of 16 byte doubles was defined with 10383. The correct value is 16383. 5  
6
31. MPI-2.2, Section 16.1.4 (Section was removed in MPI-3.0). 7  
In the example in this section, the buffer should be declared as `const void* buf`. 8  
9
32. Section 19.1.9 on page 801. 10  
About `MPI_TYPE_CREATE_F90_XXX`: 11  
12  
*Advice to implementors.* An application may often repeat a call to 13  
`MPI_TYPE_CREATE_F90_XXX` with the same combination of `(XXX,p,r)`. The 14  
application is not allowed to free the returned predefined, unnamed datatype 15  
handles. To prevent the creation of a potentially huge amount of handles, the 16  
MPI implementation should return the same datatype handle for the same ( 17  
`REAL/COMPLEX/INTEGER,p,r`) combination. Checking for the combination ( 18  
`p,r`) in the preceding call to `MPI_TYPE_CREATE_F90_XXX` and using a hash- 19  
table to find formerly generated handles should limit the overhead of finding 20  
a previously generated datatype with same combination of `(XXX,p,r)`. (*End of 21  
advice to implementors.*) 22
33. Section A.1.1 on page 849. 23  
`MPI_BOTTOM` is defined as `void * const MPI::BOTTOM`. 24  
25  
26  
27  
28  
29  
30  
31  
32  
33  
34  
35  
36  
37  
38  
39  
40  
41  
42  
43  
44  
45  
46  
47  
48

- 1
- 2
- 3
- 4
- 5
- 6
- 7
- 8
- 9
- 10
- 11
- 12
- 13
- 14
- 15
- 16
- 17
- 18
- 19
- 20
- 21
- 22
- 23
- 24
- 25
- 26
- 27
- 28
- 29
- 30
- 31
- 32
- 33
- 34
- 35
- 36
- 37
- 38
- 39
- 40
- 41
- 42
- 43
- 44
- 45
- 46
- 47
- 48

DRAFT

1  
2  
3  
4  
5  
6  
7  
8  
9  
10  
11  
12  
13  
14  
15  
16  
17  
18  
19  
20  
21  
22  
23  
24  
25  
26  
27  
28  
29  
30  
31  
32  
33  
34  
35  
36  
37  
38  
39  
40  
41  
42  
43  
44  
45  
46  
47  
48

# Bibliography

- [1] Reverse domain name notation convention. <https://docs.oracle.com/javase/tutorial/java/package/namingpkgs.html>. 340
- [2] V. Bala and S. Kipnis. Process groups: a mechanism for the coordination of and communication among processes in the Venus collective communication library. Technical report, IBM T. J. Watson Research Center, October 1992. Preprint. 2
- [3] V. Bala, S. Kipnis, L. Rudolph, and Marc Snir. Designing efficient, scalable, and portable collective communication libraries. Technical report, IBM T. J. Watson Research Center, October 1992. Preprint. 2
- [4] Purushotham V. Bangalore, Nathan E. Doss, and Anthony Skjellum. MPI++: Issues and Features. In *OOO-SKI '94*, page in press, 1994. 307
- [5] A. Beguelin, J. Dongarra, A. Geist, R. Manchek, and V. Sunderam. Visualization and debugging in a heterogeneous environment. *IEEE Computer*, 26(6):88–95, June 1993. 2
- [6] Luc Bomans and Rolf Hempel. The Argonne/GMD macros in FORTRAN for portable parallel programming and their implementation on the Intel iPSC/2. *Parallel Computing*, 15:119–132, 1990. 2
- [7] Dan Bonachea and Jason Duell. Problems with using MPI 1.1 and 2.0 as compilation targets for parallel language implementations. *IJHPCN*, 1(1/2/3):91–99, 2004. 605
- [8] Rajesh Bordawekar, Juan Miguel del Rosario, and Alok Choudhary. Design and evaluation of primitives for parallel I/O. In *Proceedings of Supercomputing '93*, pages 452–461, 1993. 635
- [9] R. Butler and E. Lusk. User’s guide to the p4 programming system. Technical Report TM-ANL-92/17, Argonne National Laboratory, 1992. 2
- [10] Ralph Butler and Ewing Lusk. Monitors, messages, and clusters: The p4 parallel programming system. *Parallel Computing*, 20(4):547–564, April 1994. Also Argonne National Laboratory Mathematics and Computer Science Division preprint P362-0493. 2
- [11] Robin Calkin, Rolf Hempel, Hans-Christian Hoppe, and Peter Wypior. Portable programming with the PARMACS message-passing library. *Parallel Computing*, 20(4):615–632, April 1994. 2

- [12] S. Chittor and R. J. Enbody. Performance evaluation of mesh-connected wormhole-routed networks for interprocessor communication in multicomputers. In *Proceedings of the 1990 Supercomputing Conference*, pages 647–656, 1990. 385
- [13] S. Chittor and R. J. Enbody. Predicting the effect of mapping on the communication performance of large multicomputers. In *Proceedings of the 1991 International Conference on Parallel Processing, vol. II (Software)*, pages II–1–II–4, 1991. 385
- [14] Parasoftware Corporation. Express version 1.0: A communication environment for parallel computers, 1988. 2
- [15] Yiannis Cotronis, Anthony Danalis, Dimitrios S. Nikolopoulos, and Jack Dongarra, editors. *Recent Advances in the Message Passing Interface - 18th European MPI Users' Group Meeting, EuroMPI 2011, Santorini, Greece, September 18-21, 2011. Proceedings*, volume 6960 of *Lecture Notes in Computer Science*. Springer, 2011. 1056, 1058
- [16] Juan Miguel del Rosario, Rajesh Bordawekar, and Alok Choudhary. Improved parallel I/O via a two-phase run-time access strategy. In *IPPS '93 Workshop on Input/Output in Parallel Computer Systems*, pages 56–70, 1993. Also published in *Computer Architecture News* 21(5), December 1993, pages 31–38. 635
- [17] James Dinan, Sriram Krishnamoorthy, Pavan Balaji, Jeff R. Hammond, Manojkumar Krishnan, Vinod Tipparaju, and Abhinav Vishnu. Noncollective communicator creation in MPI. In Cotronis et al. [15], pages 282–291. 330
- [18] J. Dongarra, A. Geist, R. Manchek, and V. Sunderam. Integrated PVM framework supports heterogeneous network computing. *Computers in Physics*, 7(2):166–75, April 1993. 2
- [19] J. J. Dongarra, R. Hempel, A. J. G. Hey, and D. W. Walker. A proposal for a user-level, message passing interface in a distributed memory environment. Technical Report TM-12231, Oak Ridge National Laboratory, February 1993. 2
- [20] Edinburgh Parallel Computing Centre, University of Edinburgh. *CHIMP Concepts*, June 1991. 2
- [21] Edinburgh Parallel Computing Centre, University of Edinburgh. *CHIMP Version 1.0 Interface*, May 1992. 2
- [22] D. Feitelson. Communicators: Object-based multiparty interactions for parallel programming. Technical Report 91-12, Dept. Computer Science, The Hebrew University of Jerusalem, November 1991. 308
- [23] Message Passing Interface Forum. MPI: A Message-Passing Interface standard. *The International Journal of Supercomputer Applications and High Performance Computing*, 8, 1994. 2
- [24] Message Passing Interface Forum. MPI: A Message-Passing Interface standard (version 1.1). Technical report, 1995. <http://www.mpi-forum.org>. 3
- [25] Al Geist, Adam Beguelin, Jack Dongarra, Weicheng Jiang, Bob Manchek, and Vaidy Sunderam. *PVM: Parallel Virtual Machine—A User's Guide and Tutorial for Network Parallel Computing*. MIT Press, 1994. 483

- [26] G. A. Geist, M. T. Heath, B. W. Peyton, and P. H. Worley. PICL: A portable instrumented communications library, C reference manual. Technical Report TM-11130, Oak Ridge National Laboratory, Oak Ridge, TN, July 1990. [2](#)
- [27] Brice Goglin, Emmanuel Jeannot, Farouk Mansouri, and Guillaume Mercier. Hardware topology management in MPI applications through hierarchical communicators. *Parallel Computing*, 76:70–90, 2018. [339](#)
- [28] Ryan E. Grant, Matthew G. F. Dosanjh, Michael J. Levenhagen, Ron Brightwell, and Anthony Skjellum. Finepoints: Partitioned multithreaded MPI communication. In *ISC High Performance Conference (ISC)*, 2019. [101](#)
- [29] Ryan E. Grant, Anthony Skjellum, and Purushotham V. Bangalore. Lightweight threading with MPI using persistent communications semantics. In *Workshop on Exascale MPI (ExaMPI)*. Held in conjunction with the 2015 International Conference for High Performance Computing, Networking, Storage and Analysis (SC15), 2015. [101](#)
- [30] D. Gregor, T. Hoefler, B. Barrett, and A. Lumsdaine. Fixing probe for multi-threaded MPI applications. Technical Report 674, Indiana University, Jan. 2009. [85](#)
- [31] William D. Gropp and Barry Smith. Chameleon parallel programming tools users manual. Technical Report ANL-93/23, Argonne National Laboratory, March 1993. [2](#)
- [32] Michael Hennecke. A Fortran 90 interface to MPI version 1.1. Technical Report Internal Report 63/96, Rechenzentrum, Universität Karlsruhe, D-76128 Karlsruhe, Germany, June 1996. [788](#)
- [33] T. Hoefler, G. Bronevetsky, B. Barrett, B. R. de Supinski, and A. Lumsdaine. Efficient MPI support for advanced hybrid programming models. In *Recent Advances in the Message Passing Interface (EuroMPI'10)*, volume LNCS 6305, pages 50–61. Springer, Sep. 2010. [85](#)
- [34] T. Hoefler, P. Gottschling, A. Lumsdaine, and W. Rehm. Optimizing a conjugate gradient solver with non-blocking collective operations. *Elsevier Journal of Parallel Computing (PARCO)*, 33(9):624–633, Sep. 2007. [248](#)
- [35] T. Hoefler, F. Lorenzen, and A. Lumsdaine. Sparse non-blocking collectives in quantum mechanical calculations. In *Recent Advances in Parallel Virtual Machine and Message Passing Interface, 15th European PVM/MPI Users' Group Meeting*, volume LNCS 5205, pages 55–63. Springer, Sep. 2008. [412](#)
- [36] T. Hoefler and A. Lumsdaine. Message progression in parallel computing — to thread or not to thread? In *Proceedings of the 2008 IEEE International Conference on Cluster Computing*. IEEE Computer Society, Oct. 2008. [248](#)
- [37] T. Hoefler, A. Lumsdaine, and W. Rehm. Implementation and performance analysis of non-blocking collective operations for MPI. In *Proceedings of the 2007 International Conference on High Performance Computing, Networking, Storage and Analysis, SC07*. IEEE Computer Society/ACM, Nov. 2007. [249](#)



- [38] T. Hoefler, M. Schellmann, S. Gortlach, and A. Lumsdaine. Communication optimization for medical image reconstruction algorithms. In *Recent Advances in Parallel Virtual Machine and Message Passing Interface, 15th European PVM/MPI Users' Group Meeting*, volume LNCS 5205, pages 75–83. Springer, Sep. 2008. 248
- [39] T. Hoefler and J. L. Träff. Sparse collective operations for MPI. In *Proceedings of the 23rd IEEE International Parallel & Distributed Processing Symposium, HIPS'09 Workshop*, May 2009. 412
- [40] Torsten Hoefler and Marc Snir. Writing parallel libraries with MPI — common practice, issues, and extensions. In Cotronis et al. [15], pages 345–355. 326
- [41] Daniel J. Holmes, Bradley Morgan, Anthony Skjellum, Purushotham V. Bangalore, and Srinivas Sridharan. Planning for performance: Enhancing achievable performance for MPI through persistent collective operations. *Parallel Computing*, 81:32 – 57, 2019. 274
- [42] Institute of Electrical and Electronics Engineers, New York. *IEEE Standard for Binary Floating-Point Arithmetic, IEEE Standard 754-2008*, 2008. 693
- [43] International Organization for Standardization, Geneva. *ISO 8859-1:1987: Information processing — 8-bit single-byte coded graphic character sets — Part 1: Latin alphabet No. 1*, February 1987. 693
- [44] International Organization for Standardization, Geneva. *ISO/IEC 9945-1:1996: Information technology — Portable Operating System Interface (POSIX) — Part 1: System Application Program Interface (API) [C Language]*, December 1996. 512, 639
- [45] International Organization for Standardization, Geneva. *ISO/IEC 1539-1:2010: Information technology — Programming languages — Fortran — Part 1: Base language*, November 2010. 783, 786
- [46] International Organization for Standardization, Geneva. *ISO/IEC TS 29113:2012: Information technology — Further interoperability of Fortran with C*, December 2012. 783, 784, 786, 799, 800, 1045
- [47] Charles H. Koelbel, David B. Loveman, Robert S. Schreiber, Guy L. Steele Jr., and Mary E. Zosel. *The High Performance Fortran Handbook*. MIT Press, 1993. 133
- [48] David Kotz. Disk-directed I/O for MIMD multiprocessors. In *Proceedings of the 1994 Symposium on Operating Systems Design and Implementation*, pages 61–74, November 1994. Updated as Dartmouth TR PCS-TR94-226 on November 8, 1994. 635
- [49] O. Krämer and H. Mühlenbein. Mapping strategies in message-based multiprocessor systems. *Parallel Computing*, 9:213–225, 1989. 385
- [50] S. J. Lefflet, R. S. Fabry, W. N. Joy, P. Lapsley, S. Miller, and C. Torek. An advanced 4.4BSD interprocess communication tutorial, Unix programmer's supplementary documents (PSD) 21. Technical report, Computer Systems Research Group, Department of Electrical Engineering and Computer Science, University of California, Berkeley, 1993. Available online: <https://docs.freebsd.org/44doc/psd/21.ipc/paper.pdf>. 543



- [51] Message Passing Interface Forum. Summary of the semantics of all operation-related MPI procedures, 2020. Available online: <https://www.mpi-forum.org/docs>. 873
- [52] Bradley Morgan, Daniel J. Holmes, Anthony Skjellum, Purushotham Bangalore, and Srinivas Sridharan. Planning for performance: Persistent collective operations for MPI. In *Proceedings of the 24th European MPI Users' Group Meeting*, EuroMPI '17, pages 4:1–4:11, New York, NY, USA, 2017. ACM. 274
- [53] nCUBE Corporation. *nCUBE 2 Programmers Guide, r2.0*, December 1990. 2
- [54] Bill Nitzberg. Performance of the iPSC/860 Concurrent File System. Technical Report RND-92-020, NAS Systems Division, NASA Ames, December 1992. 635
- [55] William J. Nitzberg. *Collective Parallel I/O*. PhD thesis, Department of Computer and Information Science, University of Oregon, December 1995. 635
- [56] *4.4BSD Programmer's Supplementary Documents (PSD)*. O'Reilly and Associates, 1994. 543
- [57] Paul Pierce. The NX/2 operating system. In *Proceedings of the Third Conference on Hypercube Concurrent Computers and Applications*, pages 384–390. ACM Press, 1988. 2
- [58] Martin Schulz and Bronis R. de Supinski. P<sup>N</sup>MPI tools: A whole lot greater than the sum of their parts. In *ACM/IEEE Supercomputing Conference (SC)*, pages 1–10. ACM, 2007. 722
- [59] K. E. Seamons, Y. Chen, P. Jones, J. Jozwiak, and M. Winslett. Server-directed collective I/O in Panda. In *Proceedings of Supercomputing '95*, December 1995. 635
- [60] A. Skjellum and A. Leung. Zipcode: a portable multicomputer communication library atop the reactive kernel. In D. W. Walker and Q. F. Stout, editors, *Proceedings of the Fifth Distributed Memory Concurrent Computing Conference*, pages 767–776. IEEE Press, 1990. 2, 308
- [61] A. Skjellum, S. Smith, C. Still, A. Leung, and M. Morari. The Zipcode message passing system. Technical report, Lawrence Livermore National Laboratory, September 1992. 2
- [62] Anthony Skjellum, Nathan E. Doss, and Purushotham V. Bangalore. Writing Libraries in MPI. In Anthony Skjellum and Donna S. Reese, editors, *Proceedings of the Scalable Parallel Libraries Conference*, pages 166–173. IEEE Computer Society Press, October 1993. 307
- [63] Anthony Skjellum, Nathan E. Doss, and Kishore Viswanathan. Inter-communicator extensions to MPI in the MPIX (MPI eXtension) Library. Technical Report MSU-940722, Mississippi State University — Dept. of Computer Science, August 1994. Archived at <http://citeseerx.ist.psu.edu/viewdoc/summary?doi=10.1.1.49.6283>. 189
- [64] Anthony Skjellum, Steven G. Smith, Nathan E. Doss, Alvin P. Leung, and Manfred Morari. The Design and Evolution of Zipcode. *Parallel Computing*, 20(4):565–596, April 1994. 308, 350

- 1 [65] The Internet Society. XDR: External Data Representation Standard, May 2006. <http://www.rfc-editor.org/pdf/rfc4506.txt.pdf>. 693  
2  
3
- 4 [66] Rajeev Thakur and Alok Choudhary. An extended two-phase method for accessing  
5 sections of out-of-core arrays. *Scientific Programming*, 5(4):301–317, Winter 1996. 635  
6
- 7 [67] Jesper Larsson Träff. SMP-aware message passing programming. In *Eighth Inter-*  
8 *national Workshop on High-level Parallel Programming Models and Supportive Envi-*  
9 *ronments (HIPS), 17th International Parallel and Distributed Processing Symposium*  
10 *(IPDPS)*, pages 56–65, 2003. 339  
11
- 12 [68] *The Unicode Standard, Version 2.0*. Addison-Wesley, 1996. ISBN 0-201-48345-9. 693  
13
- 14 [69] D. Walker. Standards for message passing in a distributed memory environment. Tech-  
15 nical Report TM-12147, Oak Ridge National Laboratory, August 1992. 2  
16  
17  
18  
19  
20  
21  
22  
23  
24  
25  
26  
27  
28  
29  
30  
31  
32  
33  
34  
35  
36  
37  
38  
39  
40  
41  
42  
43  
44  
45  
46  
47  
48

# General Index

This index lists mainly terms of the MPI specification. The underlined page numbers refer to the definitions or parts of the definition of the terms. Bold face numbers mark section titles.

absolute addresses, [20](#), [139](#), [819](#)

access epoch, [587](#)

action

in function names, [10](#)

active, [69](#), [383](#)

active target communication, [587](#)

addresses, [154](#)

absolute, [20](#), [21](#), [139](#), [819](#)

correct use, [154](#)

relative displacement, [20](#), [139](#)

alignment, [452](#), [551](#), [554](#), [1037](#)

all-reduce, [236](#)

nonblocking, [268](#)

persistent, [293](#)

all-to-all, [215](#)

nonblocking, [261](#)

persistent, [287](#)

array arguments, [18](#)

assertions, [601](#)

ASYNCHRONOUS

Fortran attribute, [821](#)

attribute, [309](#), [361](#), [841](#)

caching, [308](#)

backward incompatibilities, [781](#)

barrier synchronization, [191](#)

nonblocking, [250](#)

persistent, [275](#)

blocking, [47](#), [51](#), [651](#)

I/O, [652](#)

Blocking operation, [12](#)

Blocking procedure, [14](#)

bounds of datatypes, [145](#)

broadcast, [192](#)

nonblocking, [251](#)

persistent, [276](#)

buffer allocation, [56](#)

buffered, [48](#), [60](#), [61](#)

nonblocking, [60](#)

buffered send, [52](#)

C

language binding, [23](#)

caching, [307](#), [308](#), [361](#)

callback functions

language interoperability, [840](#)

prototype definitions, [864](#)

deprecated, [871](#)

cancel, [23](#), [70](#), [82](#), [90](#), [492](#), [776](#), [1036](#)

canonical pack and unpack, [180](#)

Cartesian

topology, [387](#), [388](#)

Chameleon, [2](#)

change-log, [1035](#)

Chimp, [2](#)

choice, [19](#)

class

in function names, [10](#)

clock synchronization, [450](#)

collective, [651](#)

split, [701](#)

collective communication, [185](#)

correctness, [299](#)

file data access operations, [676](#)

neighborhood, [412](#)

nonblocking, [248](#)

Collective operation, [12](#)

Collective procedure, [14](#)

commit, [148](#)

COMMON blocks, [824](#)

communication, [545](#)

collective, [185](#)

modes, [47](#)

one-sided, [545](#)

overlap with computation, [59](#)

partitioned point-to-point, [101](#)

point-to-point, [29](#)

RMA, [545](#)

communicator, [34](#), [307](#), [308](#)

hidden, [188](#), [302](#), [595](#)

complete operation, [11](#)

Completing procedure, [14](#)

completion, [68](#)

- 1 multiple, [73](#)
- 2 completion stage, [11](#)
- 3 connected, [541](#)
- 4 constants, [18](#), [845](#), [849](#)
- 5 context, [307](#), [308](#), [310](#)
- 6 control variables
- 7 tools interface, [730](#)
- 8 conversion, [46](#)
- 9 counts, [20](#)
- 10 create
- 11 in function names, [10](#)
- 12 data, [31](#)
- 13 data conversion, [46](#)
- 14 datatype
- 15 derived, [15](#)
- 16 equivalent, [15](#)
- 17 named, [15](#)
- 18 portable, [15](#)
- 19 predefined, [15](#)
- 20 unnamed, [15](#)
- 21 datatypes, [117](#), [838](#)
- 22 deadlock avoidance
- 23 via nonblocking communication, [59](#)
- 24 default file error, [712](#)
- 25 delete
- 26 in function names, [10](#)
- 27 deprecated interfaces, [22](#), [773](#)
- 28 derived datatype, [15](#), [117](#), [815](#)
- 29 disconnected, [542](#)
- 30 displacement, [635](#), [649](#)
- 31 distributed graph
- 32 topology, [387](#), [392](#)
- 33 Dynamic Process Model, [483](#)
- 34 dynamically attached memory, [556](#)
- 35 elementary datatype, [635](#), [650](#)
- 36 empty, [69](#)
- 37 end of file, [637](#)
- 38 envelope, [30](#), [33](#)
- 39 environmental inquiries, [449](#)
- 40 equivalent datatypes, [15](#)
- 41 error handling, [25](#), [454](#)
- 42 default file error handler, [638](#), [641](#), [712](#)
- 43 error codes and classes, [466](#), [469](#)
- 44 error handlers, [457](#), [469](#), [840](#)
- 45 finalize, [25](#), [493](#), [542](#)
- 46 I/O, [711](#), [712](#)
- 47 initial error handler, [25](#), [455](#), [485](#), [493](#), [526](#)
- 48 one-sided communication, [603](#)
- process failure, [25](#), [542](#)
- program error, [25](#)
- resource error, [25](#)
- startup, [25](#), [485](#), [526](#)
- transmission failure, [25](#)
- establishing communication, [528](#)
- etype, [635](#), [650](#)
- events
- tools interface, [749](#)
- exclusive scan
- nonblocking, [273](#)
- persistent, [298](#)
- explicit offsets, [652](#), [654](#)
- exposure epoch, [587](#)
- extent of datatypes, [118](#), [143](#), [145](#)
- true extent, [147](#)
- external32
- file data representation, [691](#)
- extra-state, [845](#)
- fairness, [53](#), [79](#)
- file, [635](#)
- data access, [651](#)
- collective operations, [676](#)
- explicit offsets, [654](#)
- individual file pointers, [661](#)
- seek, [679](#)
- shared file pointers, [672](#)
- split collective, [680](#)
- end of file, [637](#)
- filetype, [636](#)
- handle, [637](#)
- interoperability, [689](#)
- manipulation, [637](#)
- offset, [20](#), [636](#)
- pointer, [637](#)
- size, [637](#)
- view, [635](#), [636](#), [648](#)
- file size, [707](#)
- finalize, [490](#)
- finished, [493](#)
- Fortran
- language binding, [22](#), [783](#)
- Fortran support, [783](#)
- Freeing procedure, [14](#)
- freeing stage, [12](#)
- gather, [194](#)
- nonblocking, [252](#)
- persistent, [277](#)
- gather-to-all, [211](#)
- nonblocking, [258](#)
- persistent, [284](#)
- general datatype, [117](#)
- generalized requests, [625](#), [625](#)
- get
- in function names, [10](#)
- graph

- topology, [387](#), [390](#)
- group, [307](#), [308](#), [310](#), [352](#)
- group objects, [310](#)
- handles, [16](#), [833](#)
- hardware resource type, [335](#), [336](#)
- host rank, [449](#)
- immediate, [14](#), [61](#)
- inactive, [68](#)
- inclusive scan, [243](#)
  - nonblocking, [272](#)
  - persistent, [297](#)
- incomplete, [14](#), [61](#)
- Incomplete procedure, [14](#)
- independent, [542](#)
- individual file pointers, [652](#), [661](#)
- info object, [475](#)
  - file info, [645](#)
  - keys, [871](#)
  - values, [872](#)
- initial error handler, [25](#)
- Initialization procedure, [13](#)
- initialization stage, [11](#)
- initiation, [11](#), [61](#)
- Initiation procedure, [13](#)
- inter-communication, [309](#), [351](#)
- inter-communicator, [309](#), [351](#)
  - collective operations, [189](#), [190](#)
- interlanguage communication, [846](#)
- internal
  - file data representation, [690](#)
- interoperability, [689](#)
- intra-communication, [309](#), [351](#)
- intra-communicator, [308](#), [351](#)
  - collective operations, [188](#)
- intra-communicator objects, [311](#)
- I/O, [635](#)
- IO rank, [450](#)
- is
  - in function names, [10](#)
- language binding, [21](#), [783](#)
  - interoperability, [832](#)
  - summary, [849](#)
- large
  - count, [21](#), [831](#)
  - displacement, [831](#)
- large count, [21](#)
- lb\_marker, [133](#), [137](#), [142](#), [143](#), [148](#)
  - erased, [146](#)
- local, [48](#)
- local group, [324](#)
- Local procedure, [13](#)
- loosely synchronous model, [382](#)
- lower bound, [143](#)
- lower-bound markers, [142](#)
- macros, [24](#)
- main thread, [514](#)
- matched receives, [87](#)
- matching
  - type, [43](#), [151](#), [706](#)
- matching probe, [85](#)
- memory
  - alignment, [452](#), [551](#), [554](#), [1037](#)
  - allocation, [451](#), [550](#), [552](#)
  - system, [16](#)
- memory model, [546](#), [586](#)
  - separate, [546](#), [554](#)
  - unified, [546](#), [554](#)
- message, [29](#)
  - data, [31](#)
  - envelope, [33](#)
- modes, [47](#)
- module variables, [824](#)
- mpi module
  - Fortran support, [787](#)
- MPI operation, [11](#)
- MPI process initialization, [483](#)
  - Dynamic Process Model, [483](#)
  - Sessions Model, [311](#), [314](#), [449](#), [483](#), [514](#), [638](#)
  - World Model, [311](#), [314](#), [449](#), [483](#), [514](#), [638](#), [712](#)
- mpi\_f08 module
  - Fortran support, [784](#)
- MPI\_SIZEOF and storage\_size(), [23](#), [778](#), [807–809](#)
- mpiexec, [486](#), [510](#)
- mpif.h include file
  - Fortran support, [789](#)
- mpirun, [510](#)
- multiple completions, [73](#)
- named datatype, [15](#)
- names, [529](#)
  - name publishing, [534](#)
- naming objects, [377](#)
- native
  - file data representation, [690](#)
- neighborhood collective communication, [412](#)
  - nonblocking, [425](#)
  - periodic and dims==1 or 2, [1035](#)
- non-local, [47](#), [48](#)
- Non-local procedure, [13](#)
- nonblocking, [59](#), [563](#), [651](#)
  - communication, [59](#)
  - completion, [68](#)

- 1 Fortran problems, [818](#)
- 2 I/O, [652](#)
- 3 initiation, [61](#)
- 4 persistent
  - 5 partitioned completion, [108](#)
  - 6 request objects, [61](#)
- 7 Nonblocking operation, [12](#)
- 8 Nonblocking procedure, [14](#)
- 9 Noncollective operation, [13](#)
- 10 null handle, [68](#)
- 11 null processes, [98](#)
- 12 offset, [20](#), [636](#)
- 13 one-sided communication, [545](#)
  - 14 Fortran problems, [819](#)
- 15 opaque objects, [16](#), [838](#)
- 16 operation
  - 17 blocking, [12](#)
  - 18 collective, [12](#)
  - 19 complete, [11](#)
  - 20 nonblocking, [12](#)
  - 21 noncollective, [13](#)
  - 22 operation-related, [13](#)
  - 23 partitioned receive, [12](#)
  - 24 partitioned send, [12](#)
  - 25 persistent, [12](#)
- 26 origin, [546](#)
- 27 pack, [172](#)
  - 28 canonical, [180](#)
- 29 packing unit, [175](#)
- 30 parallel procedure, [382](#)
- 31 partitioned completion, [108](#)
- 32 partitioned point-to-point communication, [101](#)
- 33 passive target communication, [587](#)
- 34 performance variables
  - 35 tools interface, [736](#)
- 36 persistent communication requests, [92](#)
  - 37 collective persistent, [274](#), [432](#)
  - 38 Fortran problems, [819](#)
- 39 Persistent operation, [12](#)
- 40 PICL, [2](#)
- 41 PMPI\_, [717](#)
- 42 point-to-point communication, [29](#)
- 43 portable datatype, [15](#)
- 44 ports, [529](#)
- 45 POSIX
  - 46 environment, [474](#)
  - 47 FORTRAN, [17](#)
  - 48 I/O, [638](#), [639](#), [652](#), [690](#), [702](#)
  - model, [635](#)
- predefined datatype, [15](#)
- predefined reduction operations, [224](#)
- private window copy, [585](#)
- probe, [82](#)
  - matching, [85](#)
- procedure
  - blocking, [14](#)
  - collective, [14](#)
  - completing, [14](#)
  - freeing, [14](#)
  - incomplete, [14](#)
  - initialization, [13](#)
  - initiation, [13](#)
  - local, [13](#)
  - non-local, [13](#)
  - nonblocking, [14](#)
  - operation-related, [13](#)
  - starting, [13](#)
- process creation, [483](#)
- process failures, [25](#)
- process group, [34](#)
- processes, [24](#)
- processor name, [450](#)
- profiling interface, [717](#)
- program error, [25](#)
- progress, [249](#)
- prototype definitions, [864](#)
  - deprecated, [871](#)
- public window copy, [585](#)
- PVM, [2](#)
- rank, [310](#)
- ready, [48](#), [60](#), [61](#)
  - nonblocking, [60](#)
- ready send, [52](#)
- receive, [29](#), [30](#), [34](#)
  - buffer, [30](#)
  - complete, [59](#)
  - context, [352](#)
  - start call, [59](#)
- reduce, [222](#)
  - nonblocking, [267](#)
  - persistent, [292](#)
- reduce-scatter, [240](#)
  - nonblocking, [269](#), [271](#)
  - persistent, [294](#), [296](#)
- reduction operations, [221](#), [840](#)
- predefined, [224](#)
- process-local, [238](#)
- scan, [243](#)
- user-defined, [231](#)
- related, [175](#)
- relative displacement, [20](#), [139](#)
- remote group, [324](#)
- Remote Memory Access
  - see RMA, [545](#)
- removed interfaces, [22](#), [779](#)

- request complete
  - I/O, [652](#)
- request objects, [61](#)
- resource error, [25](#)
- RMA, [545](#)
  - communication calls, [563](#)
    - request-based, [578](#)
  - memory model, [585](#)
  - synchronization calls, [587](#)
- scan, [243](#)
  - inclusive, [243](#)
- scatter, [204](#)
  - nonblocking, [255](#)
  - persistent, [281](#)
- seek, [679](#)
- semantics, [1036](#)
  - collective communications, [186](#)
  - file
    - collective, [705](#)
    - collective access, [676](#)
    - conflicting access, [702](#)
    - consistency, [701](#)
    - explicit offsets, [654](#)
    - nonblocking collective, [705](#)
    - shared file pointer, [672](#)
    - split collective, [701](#)
  - inter-communicator, [324](#)
  - MPI\_COMM\_IDUP, [326](#)
  - nonblocking communications, [72](#)
  - nonblocking partitioned communications, [109](#)
  - partitioned point-to-point communication, [102](#)
  - point-to-point communication, [52](#)
  - process failure, [542](#)
- semantics and correctness
  - one-sided communication, [604](#)
- send, [29](#), [30](#)
  - buffer, [29](#)
  - complete, [59](#)
  - context, [352](#)
  - start, [59](#)
- send-receive, [40](#)
  - nonblocking, [67](#), [68](#)
- separate memory model, [546](#), [554](#), [586](#)
- sequential storage, [155](#)
- serialization, [59](#)
- Sessions Model, [311](#), [314](#), [449](#), [483](#), [514](#), [638](#)
- set
  - in function names, [10](#)
- shared file pointers, [652](#), [672](#)
- shared memory allocation, [552](#)
- signals, [27](#)
- singleton init, [540](#)
- size changing
  - I/O, [707](#)
- source, [352](#)
- split collective, [651](#), [680](#)
- stage
  - completion, [11](#)
  - freeing, [12](#)
  - initialization, [11](#)
  - starting, [11](#)
- standard, [47](#), [60](#)
  - nonblocking, [60](#)
- standard send, [52](#)
- started, [493](#)
- Starting procedure, [13](#)
- starting processes, [516](#), [517](#)
- starting stage, [11](#)
- startup, [484](#)
  - portable, [510](#)
- state, [18](#)
- status, [36](#), [835](#)
  - associating information, [632](#)
  - ignore, [39](#)
  - test, [81](#)
- strong synchronization, [588](#)
- synchronization, [545](#), [563](#)
- synchronization calls
  - RMA, [587](#)
- synchronous, [48](#), [60](#), [61](#), [68](#)
  - nonblocking, [60](#)
- synchronous send, [52](#)
- system memory, [16](#)
- tag values, [449](#)
- target, [546](#)
- thread compliant, [488](#), [512](#)
- threads, [512](#)
  - thread-safe, [2](#), [448](#), [465](#), [469](#), [752](#)
- timers and synchronization, [473](#)
- tool information interface, [723](#)
- tool support, [717](#)
- topologies, [385](#)
- topology
  - Cartesian, [387](#), [388](#)
  - distributed graph, [387](#), [392](#)
  - graph, [387](#), [390](#)
  - virtual, [386](#)
- transmission failures, [25](#)
- true extent of datatypes, [147](#)
- TS 29113, [20](#), [22](#), [783–788](#), [790–793](#), [796–800](#), [809–811](#), [816](#), [821](#), [824](#), [826](#), [1045](#)
- type map, [118](#)
- type matching, [43](#), [151](#)
- type signature, [118](#)

1 types, [863](#)  
2  
3 ub\_marker, [133](#), [137](#), [138](#), [142](#), [143](#), [148](#)  
4     erased, [146](#)  
5 unified memory model, [546](#), [554](#), [586](#)  
6 universe size, [539](#)  
7 unnamed datatype, [15](#)  
8 unpack, [172](#)  
9     canonical, [180](#)  
10 upper bound, [143](#)  
11 upper-bound markers, [142](#)  
12 user functions at process termination, [494](#)  
13 user-defined data representations, [696](#)  
14 user-defined reduction operations, [231](#)  
15  
16 verbosity levels  
17     tools interface, [724](#)  
18 version inquiries, [447](#)  
19 view, [635](#), [636](#), [648](#)  
20 virtual topology, [308](#), [309](#), [386](#)  
21  
22 weak synchronization, [589](#)  
23 window  
24     allocation, [550](#)  
25     creation, [547](#)  
26     dynamically attached memory, [556](#)  
27     shared memory allocation, [552](#)  
28 World Model, [311](#), [314](#), [449](#), [483](#), [514](#), [638](#),  
29     [712](#)  
30  
31 XDR, [47](#)  
32  
33  
34  
35  
36  
37  
38  
39  
40  
41  
42  
43  
44  
45  
46  
47  
48



# Examples Index

This index lists code examples throughout the text. Some examples are referred to by content; others are listed by the major MPI function that they are demonstrating. MPI functions listed in all capital letter are Fortran examples; MPI functions listed in mixed case are C examples.

- ASYNCHRONOUS, [620](#), [827](#), [829](#)
- Attributes between languages, [841](#)
- Blocking/Nonblocking collectives do not match, [304](#)
- C/Fortran handle conversion, [835](#)
- Cartesian virtual topologies, [440](#)
- Client-server code, [80](#)
  - with probe, [84](#)
  - with probe (wrong), [84](#)
- Datatype
  - 3D array, [164](#)
  - absolute addresses, [169](#)
  - array of structures, [166](#)
  - elaborate example, [177](#), [178](#)
  - matching type, [151](#)
  - matrix transpose, [165](#)
  - union, [170](#)
- Datatypes
  - matching, [44](#)
  - not matching, [44](#)
  - untyped, [44](#)
- Deadlock
  - if not buffered, [55](#)
  - with MPI\_Bcast, [299](#), [300](#)
  - wrong message exchange, [54](#)
- False matching of collective operations, [303](#)
- Fortran 90
  - copying and sequence problem, [811](#), [813](#), [814](#)
  - derived types, [815](#)
  - heterogeneous communication (unsafe), [808](#), [809](#)
  - invalid KIND, [804](#)
  - MPI\_TYPE\_MATCH\_SIZE
    - implementation, [807](#)
  - overlapping communication and computation, [827](#), [828](#), [830](#)
  - register optimization, [818](#), [820](#)
- Independence of nonblocking operations, [306](#)
- Inter-communicator, [328](#), [334](#)
- Interlanguage communication, [846](#)
- Intertwined matching pairs, [53](#)
- Message exchange (ping-pong), [54](#)
- Mixing blocking and nonblocking collective operations, [302](#)
- Mixing collective and point-to-point requests, [304](#)
- MPI\_ACCUMULATE, [572](#)
- MPI\_Accumulate, [618](#), [619](#), [622](#)
- MPI\_Aint, [166](#)
- MPI\_Aint\_add, [622](#)
- MPI\_Allgather, [214](#)
- MPI\_ALLOC\_MEM, [453](#), [454](#)
- MPI\_Alloc\_mem, [454](#), [622](#)
- MPI\_ALLREDUCE, [237](#)
- MPI\_Alltoall, [304](#)
- MPI\_ASYNC\_PROTECTS\_NONBLOCKING, [620](#)
- MPI\_BARRIER, [506](#)
- MPI\_Barrier, [492](#), [608–611](#), [617–619](#)
- MPI\_Bcast, [193](#), [299–303](#)
- MPI\_BSEND, [53](#)
- MPI\_Buffer\_attach, [57](#), [492](#)
- MPI\_Buffer\_detach, [57](#)
- MPI\_BYTE, [44](#)
- MPI\_Cancel, [492](#)
- MPI\_CART\_COORDS, [408](#)
- MPI\_CART\_GET, [440](#)
- MPI\_CART\_RANK, [408](#)
- MPI\_CART\_SHIFT, [408](#), [419](#), [440](#)
- MPI\_CART\_SUB, [410](#)
- MPI\_CARTDIM\_GET, [419](#)
- MPI\_CHARACTER, [45](#)
- MPI\_Comm\_accept, [537](#), [538](#)
- MPI\_Comm\_connect, [537](#), [538](#)
- MPI\_Comm\_create, [328](#), [345](#), [346](#), [348](#)

- 1 MPI\_COMM\_CREATE\_FROM\_GROUP, 502,  
2 506
- 3 MPI\_Comm\_create\_keyval, 375
- 4 MPI\_Comm\_dup, 348
- 5 MPI\_Comm\_get\_attr, 375
- 6 MPI\_Comm\_get\_parent, 526
- 7 MPI\_Comm\_group, 328, 348, 375
- 8 MPI\_Comm\_rank, 29
- 9 MPI\_Comm\_remote\_size, 334
- 10 MPI\_Comm\_set\_attr, 375
- 11 MPI\_COMM\_SPAWN, 520
- 12 MPI\_Comm\_spawn, 520, 526
- 13 MPI\_COMM\_SPAWN\_MULTIPLE, 525
- 14 MPI\_Comm\_spawn\_multiple, 525
- 15 MPI\_Comm\_split, 334, 358, 359
- 16 MPI\_Comm\_split\_type, 337, 339
- 17 MPI\_Compare\_and\_swap, 619, 622
- 18 MPI\_DIMS\_CREATE, 390, 440
- 19 MPI\_DIST\_GRAPH\_CREATE, 397
- 20 MPI\_Dist\_graph\_create, 398
- 21 MPI\_DIST\_GRAPH\_CREATE\_ADJACENT,  
22 397
- 23 MPI\_F\_sync\_reg, 620
- 24 MPI\_FILE\_CLOSE, 663, 667
- 25 MPI\_FILE\_GET\_AMODE, 644
- 26 MPI\_FILE\_IREAD, 667
- 27 MPI\_FILE\_OPEN, 663, 667
- 28 MPI\_FILE\_READ, 663
- 29 MPI\_FILE\_SET\_ATOMICITY, 707
- 30 MPI\_FILE\_SET\_VIEW, 663, 667
- 31 MPI\_FILE\_SYNC, 708
- 32 MPI\_Finalize, 491–493
- 33 MPI\_FREE\_MEM, 453, 454
- 34 MPI\_Free\_mem, 622
- 35 MPI\_Gather, 178, 198, 199, 203
- 36 MPI\_Gatherv, 178, 199–203
- 37 MPI\_GET, 568, 570
- 38 MPI\_Get, 608–611, 616, 617
- 39 MPI\_Get\_accumulate, 618, 619, 622
- 40 MPI\_GET\_ADDRESS, 140, 815, 816, 838
- 41 MPI\_Get\_address, 166, 169, 170, 177
- 42 MPI\_GET\_COUNT, 153
- 43 MPI\_GET\_ELEMENTS, 153
- 44 MPI\_GRAPH\_CREATE, 391, 404
- 45 MPI\_GRAPH\_NEIGHBORS, 404
- 46 MPI\_GRAPH\_NEIGHBORS\_COUNT, 404
- 47 MPI\_Grequest\_complete, 630
- 48 MPI\_Grequest\_start, 630
- MPI\_Group\_excl, 345
- MPI\_Group\_free, 328, 345, 346
- MPI\_GROUP\_FROM\_SESSION\_PSET, 502,  
505, 506
- MPI\_Group\_incl, 328, 346, 348
- MPI\_Iallreduce, 305
- MPI\_Ialltoall, 304
- MPI\_Ibarrier, 302–304
- MPI\_Ibcast, 252, 305, 306
- MPI\_INFO\_CREATE, 502
- MPI\_INFO\_ENV, 486
- MPI\_INFO\_SET, 502
- MPI\_Init, 29
- MPI\_Intercomm\_create, 358, 359
- MPI\_Iprobe, 492
- MPI\_Irecv, 71–73, 80
- MPI\_Irecv, 304
- MPI\_ISEND, 71, 72, 80
- MPI\_NEIGHBOR\_ALLGATHER, 415
- MPI\_NEIGHBOR\_ALLTOALL, 419
- MPI\_Op\_create, 235, 236, 246
- MPI\_Open\_port, 537, 538
- MPI\_Pack, 177, 178
- MPI\_Pack\_size, 178
- MPI\_Parrived, 113
- MPI\_Pready, 102, 110, 111, 113
- MPI\_Precv\_init, 102, 110, 111, 113
- MPI\_PROBE, 84
- MPI\_Psend\_init, 102, 110, 111, 113
- MPI\_Publish\_name, 537
- MPI\_Put, 593, 599, 609–611, 616, 617
- MPI\_RECV, 44, 45, 53–55, 73, 84, 151
- MPI\_Recv, 29, 303
- MPI\_REDUCE, 226, 229
- MPI\_Reduce, 229, 230, 235, 236
- MPI\_REQUEST\_FREE, 72
- MPI\_Request\_free, 492
- MPI\_Rget, 621
- MPI\_Rput, 621
- MPI\_Scan, 246
- MPI\_Scatter, 208
- MPI\_Scatterv, 208, 209
- MPI\_SEND, 44, 45, 54, 55, 73, 84, 151
- MPI\_Send, 29, 166, 169, 170, 177, 303, 304
- MPI\_SENDRECV, 164, 165, 419
- MPI\_SENDRECV\_REPLACE, 408
- MPI\_SESSION\_FINALIZE, 502, 505, 506
- MPI\_SESSION\_GET\_NTH\_PSET, 505, 506
- MPI\_SESSION\_GET\_NUM\_PSETS, 505, 506
- MPI\_SESSION\_INIT, 502, 505, 506
- MPI\_SSEND, 53, 73
- MPI\_Test\_cancelled, 492
- MPI\_TYPE\_COMMIT, 149, 164, 165, 568,  
815, 816
- MPI\_Type\_commit, 166, 169, 170, 177,  
198–203, 209, 246
- MPI\_TYPE\_CONTIGUOUS, 120, 143, 151,  
153
- MPI\_Type\_contiguous, 198
- MPI\_TYPE\_CREATE\_DARRAY, 138

- MPI\_TYPE\_CREATE\_HVECTOR, [164](#), [165](#)
- MPI\_Type\_create\_hvector, [166](#), [169](#)
- MPI\_TYPE\_CREATE\_INDEXED\_BLOCK, [568](#)
- MPI\_TYPE\_CREATE\_RESIZED, [815](#), [816](#)
- MPI\_TYPE\_CREATE\_STRUCT, [130](#), [143](#), [165](#), [815](#), [816](#)
- MPI\_Type\_create\_struct, [166](#), [169](#), [170](#), [177](#), [201](#), [203](#), [246](#)
- MPI\_TYPE\_CREATE\_SUBARRAY, [716](#)
- MPI\_TYPE\_EXTENT, [568](#)
- MPI\_TYPE\_FREE, [568](#)
- MPI\_Type\_get\_contents, [171](#)
- MPI\_Type\_get\_envelope, [171](#)
- MPI\_TYPE\_GET\_EXTENT, [164](#), [165](#), [570](#), [572](#)
- MPI\_Type\_get\_extent, [166](#)
- MPI\_TYPE\_INDEXED, [125](#), [164](#)
- MPI\_Type\_indexed, [166](#), [169](#)
- MPI\_TYPE\_VECTOR, [121](#), [164](#), [165](#)
- MPI\_Type\_vector, [199](#), [200](#), [202](#), [209](#)
- MPI\_Unpack, [177](#), [178](#)
- MPI\_Unpublish\_name, [537](#)
- MPI\_User\_function, [236](#)
- MPI\_WAIT, [71–73](#), [80](#), [667](#)
- MPI\_Wait, [302–304](#)
- MPI\_Waitall, [304](#), [305](#), [621](#)
- MPI\_WAITANY, [80](#)
- MPI\_Waitany, [621](#)
- MPI\_WAITSOME, [80](#)
- MPI\_Win\_attach, [622](#)
- MPI\_Win\_complete, [593](#), [611](#), [617](#)
- MPI\_WIN\_CREATE, [568](#), [570](#), [572](#)
- MPI\_Win\_create\_dynamic, [622](#)
- MPI\_Win\_detach, [622](#)
- MPI\_WIN\_FENCE, [568](#), [570](#), [572](#)
- MPI\_Win\_fence, [616](#)
- MPI\_Win\_flush, [610](#), [618](#), [619](#), [622](#)
- MPI\_Win\_flush\_all, [619](#)
- MPI\_Win\_flush\_local, [609](#)
- MPI\_WIN\_FREE, [570](#), [572](#)
- MPI\_Win\_lock, [599](#), [608–611](#)
- MPI\_Win\_lock\_all, [620–622](#)
- MPI\_Win\_post, [611](#), [617](#)
- MPI\_Win\_start, [593](#), [611](#), [617](#)
- MPI\_Win\_sync, [609](#), [610](#), [618](#), [619](#)
  - shared memory windows, [620](#)
- MPI\_Win\_unlock, [599](#), [608–611](#)
- MPI\_Win\_unlock\_all, [621](#), [622](#)
- MPI\_Win\_wait, [611](#), [617](#)
- mpiexec, [486](#), [511](#), [512](#)
- Neighborhood collective communication, [440](#)
- Non-deterministic program with MPI\_Bcast, [301](#)
- Non-overtaking messages, [53](#)
- Nonblocking operations, [71](#), [72](#)
  - message ordering, [72](#)
  - progress, [73](#)
- Overlapping Communicators, [305](#)
- Partitioned Communication
  - Equal send/rcv partitioning, [110](#)
  - Partial completion notification, [113](#)
  - Send with tasks, [111](#)
  - Simple example, [102](#)
- Pipelining nonblocking collective operations, [305](#)
- Point-to-point
  - Hello world, [29](#)
- Profiling interface
  - implementation using the C macro preprocessor, [721](#)
  - implementation using weak symbols, [720](#)
  - measurement wrapper, [720](#)
- Progression of nonblocking collective operations, [303](#)
- Shared memory windows
  - MPI\_Win\_sync, [620](#)
- Threads and MPI, [513](#)
- Tool information interface
  - basic usage of performance variables, [747](#)
  - listing names of all control variables, [733](#)
  - reading the value of a control variable, [736](#)
- Topologies, [440](#)
- Typemap, [119–121](#), [125](#), [130](#), [138](#)
- Virtual topologies, [440](#)

# MPI Constant and Predefined Handle Index

This index lists predefined MPI constants and handles, including info keys and values. Underlined page numbers give the location of the primary definition or use of the indexed term.

"access_style", <a href="#">647</a>	MPI::DOUBLE_COMPLEX, <a href="#">1041</a>
"accumulate_ops", <a href="#">548</a>	MPI::F_COMPLEX16, <a href="#">1042</a>
"accumulate_ordering", <a href="#">548</a> , <a href="#">612</a> , <a href="#">613</a>	MPI::F_COMPLEX32, <a href="#">1042</a>
"alloc_shared_noncontig", <a href="#">553</a> , <a href="#">554</a>	MPI::F_COMPLEX4, <a href="#">1042</a>
"appnum", <a href="#">541</a>	MPI::F_COMPLEX8, <a href="#">1042</a>
"arch", <a href="#">486</a> , <a href="#">525</a>	MPI::INTEGER16, <a href="#">1042</a>
"argv", <a href="#">486</a>	MPI::LONG_DOUBLE_COMPLEX, <a href="#">1041</a>
	MPI::LONG_LONG, <a href="#">1042</a>
"cb_block_size", <a href="#">647</a>	MPI::REAL16, <a href="#">1042</a>
"cb_buffer_size", <a href="#">647</a>	MPI_2DOUBLE_PRECISION, <a href="#">228</a> , <a href="#">855</a>
"cb_nodes", <a href="#">647</a>	MPI_2INT, <a href="#">228</a> , <a href="#">855</a>
"chunked", <a href="#">647</a>	MPI_2INTEGER, <a href="#">228</a> , <a href="#">855</a>
"chunked_item", <a href="#">647</a>	MPI_2REAL, <a href="#">228</a> , <a href="#">855</a>
"chunked_size", <a href="#">647</a>	MPI_ADDRESS_KIND, <a href="#">19</a> , <a href="#">20</a> , <a href="#">33</a> , <a href="#">361</a> , <a href="#">810</a> , <a href="#">841</a> , <a href="#">852</a>
"collective_buffering", <a href="#">647</a>	MPI_AINT, <a href="#">33</a> , <a href="#">119</a> , <a href="#">225</a> , <a href="#">557</a> , <a href="#">694</a> , <a href="#">831</a> , <a href="#">853</a> , <a href="#">854</a> , <a href="#">1047</a> , <a href="#">1049</a>
"command", <a href="#">486</a>	MPI_ANY_SOURCE, <a href="#">35</a> , <a href="#">36</a> , <a href="#">40</a> , <a href="#">42</a> , <a href="#">52</a> , <a href="#">65–67</a> , <a href="#">69</a> , <a href="#">82–87</a> , <a href="#">96</a> , <a href="#">342</a> , <a href="#">383</a> , <a href="#">450</a> , <a href="#">851</a>
"external32", <a href="#">180</a> , <a href="#">690</a> , <a href="#">691</a> , <a href="#">693–696</a> , <a href="#">701</a> , <a href="#">803–806</a> , <a href="#">809</a> , <a href="#">1042</a> , <a href="#">1049</a>	MPI_ANY_TAG, <a href="#">18</a> , <a href="#">35</a> , <a href="#">36</a> , <a href="#">38</a> , <a href="#">40</a> , <a href="#">42</a> , <a href="#">65–67</a> , <a href="#">69</a> , <a href="#">82</a> , <a href="#">83</a> , <a href="#">85–87</a> , <a href="#">89</a> , <a href="#">90</a> , <a href="#">96</a> , <a href="#">99</a> , <a href="#">342</a> , <a href="#">851</a> , <a href="#">1044</a>
"false", <a href="#">342</a> , <a href="#">647</a>	MPI_APPNUM, <a href="#">541</a> , <a href="#">858</a>
"file", <a href="#">486</a> , <a href="#">526</a>	MPI_ARGV_NULL, <a href="#">19</a> , <a href="#">519</a> , <a href="#">520</a> , <a href="#">524</a> , <a href="#">810</a> , <a href="#">860</a>
"file_perm", <a href="#">647</a>	MPI_ARGVS_NULL, <a href="#">19</a> , <a href="#">524</a> , <a href="#">810</a> , <a href="#">860</a>
"filename", <a href="#">647</a>	"mpi_assert_allow_overtaking", <a href="#">342</a> , <a href="#">1037</a>
"host", <a href="#">486</a> , <a href="#">525</a>	"mpi_assert_exact_length", <a href="#">342</a> , <a href="#">1037</a>
"hwloc://L3Cache", <a href="#">498</a>	"mpi_assert_no_any_source", <a href="#">342</a> , <a href="#">1037</a>
	"mpi_assert_no_any_tag", <a href="#">342</a> , <a href="#">1037</a>
"internal", <a href="#">690</a> , <a href="#">691</a> , <a href="#">701</a>	MPI_ASYNC_PROTECTS_NONBLOCKING, <a href="#">19</a> , <a href="#">620</a> , <a href="#">784</a> , <a href="#">785</a> , <a href="#">787</a> , <a href="#">789</a> , <a href="#">792</a> , <a href="#">800</a> , <a href="#">801</a> , <a href="#">821</a> , <a href="#">852</a> , <a href="#">1046</a>
"io_node_list", <a href="#">648</a>	MPI_BAND, <a href="#">224</a> , <a href="#">226</a> , <a href="#">856</a>
"ip_address", <a href="#">537</a>	MPI_BOR, <a href="#">224</a> , <a href="#">226</a> , <a href="#">856</a>
"ip_port", <a href="#">536</a>	MPI_BOTTOM, <a href="#">10</a> , <a href="#">19</a> , <a href="#">20</a> , <a href="#">39</a> , <a href="#">109</a> , <a href="#">139</a> , <a href="#">154</a> , <a href="#">155</a> , <a href="#">188</a> , <a href="#">394</a> , <a href="#">396</a> , <a href="#">522</a> , <a href="#">557</a> , <a href="#">561</a> , <a href="#">786</a> , <a href="#">788</a> , <a href="#">796</a> , <a href="#">810</a> , <a href="#">815</a> , <a href="#">817</a> , <a href="#">819</a> , <a href="#">820</a> , <a href="#">822–824</a> , <a href="#">826</a> , <a href="#">838–840</a> , <a href="#">845</a> , <a href="#">851</a> , <a href="#">1053</a>
"maxprocs", <a href="#">486</a> , <a href="#">487</a>	MPI_BSEND_OVERHEAD, <a href="#">59</a> , <a href="#">851</a>
"mpi://", <a href="#">499</a>	
"mpi://SELF", <a href="#">498</a> , <a href="#">499</a> , <a href="#">638</a>	
"mpi://WORLD", <a href="#">498</a> , <a href="#">499</a> , <a href="#">505</a>	
MPI::_LONG_LONG, <a href="#">1042</a>	
MPI::BOOL, <a href="#">1041</a>	
MPI::COMPLEX, <a href="#">1041</a>	

MPI_BXOR, <a href="#">224</a> , <a href="#">226</a> , <a href="#">856</a>	MPI_COMM_TYPE_HW_GUIDED, <a href="#">335</a> , <a href="#">336</a> , <a href="#">855</a> , <a href="#">1036</a>	1
MPI_BYTE, <a href="#">31</a> , <a href="#">32</a> , <a href="#">43–46</a> , <a href="#">180</a> , <a href="#">225</a> , <a href="#">636</a> , <a href="#">690</a> , <a href="#">691</a> , <a href="#">694</a> , <a href="#">706</a> , <a href="#">846</a> , <a href="#">853</a> , <a href="#">854</a> , <a href="#">1050</a>	MPI_COMM_TYPE_HW_UNGUIDED, <a href="#">336</a> , <a href="#">337</a> , <a href="#">338</a> , <a href="#">855</a> , <a href="#">1036</a>	2
MPI_C_BOOL, <a href="#">32</a> , <a href="#">225</a> , <a href="#">694</a> , <a href="#">853</a> , <a href="#">1042</a> , <a href="#">1047–1049</a>	MPI_COMM_TYPE_SHARED, <a href="#">335</a> , <a href="#">336</a> , <a href="#">855</a> , <a href="#">1044</a>	3
MPI_C_COMPLEX, <a href="#">32</a> , <a href="#">225</a> , <a href="#">694</a> , <a href="#">853</a> , <a href="#">1041</a> , <a href="#">1047–1049</a>	MPI_COMM_WORLD, <a href="#">18</a> , <a href="#">26</a> , <a href="#">34</a> , <a href="#">309</a> , <a href="#">311–314</a> , <a href="#">322</a> , <a href="#">323</a> , <a href="#">337–339</a> , <a href="#">343</a> , <a href="#">346</a> , <a href="#">355</a> , <a href="#">379</a> , <a href="#">389</a> , <a href="#">449</a> , <a href="#">450</a> , <a href="#">458</a> , <a href="#">470</a> , <a href="#">483–486</a> , <a href="#">488–491</a> , <a href="#">493</a> , <a href="#">495</a> , <a href="#">509</a> , <a href="#">510</a> , <a href="#">516–519</a> , <a href="#">522</a> , <a href="#">524</a> , <a href="#">539–543</a> , <a href="#">689</a> , <a href="#">711</a> , <a href="#">712</a> , <a href="#">734</a> , <a href="#">743</a> , <a href="#">781</a> , <a href="#">833</a> , <a href="#">845</a> , <a href="#">855</a> , <a href="#">1036</a> , <a href="#">1052</a>	4
MPI_C_DOUBLE_COMPLEX, <a href="#">32</a> , <a href="#">225</a> , <a href="#">694</a> , <a href="#">853</a> , <a href="#">1047–1049</a>	MPI_COMPLEX, <a href="#">31</a> , <a href="#">225</a> , <a href="#">693</a> , <a href="#">694</a> , <a href="#">802</a> , <a href="#">854</a>	5
MPI_C_FLOAT_COMPLEX, <a href="#">32</a> , <a href="#">225</a> , <a href="#">694</a> , <a href="#">853</a> , <a href="#">1047–1049</a>	MPI_COMPLEX16, <a href="#">33</a> , <a href="#">225</a> , <a href="#">695</a> , <a href="#">854</a>	6
MPI_C_LONG_DOUBLE_COMPLEX, <a href="#">32</a> , <a href="#">225</a> , <a href="#">694</a> , <a href="#">853</a> , <a href="#">1047–1049</a>	MPI_COMPLEX32, <a href="#">33</a> , <a href="#">225</a> , <a href="#">695</a> , <a href="#">854</a>	7
MPI_CART, <a href="#">399</a> , <a href="#">857</a>	MPI_COMPLEX4, <a href="#">33</a> , <a href="#">225</a> , <a href="#">695</a> , <a href="#">854</a>	8
MPI_CHAR, <a href="#">32</a> , <a href="#">46</a> , <a href="#">130</a> , <a href="#">227</a> , <a href="#">694</a> , <a href="#">728</a> , <a href="#">853</a> , <a href="#">1047</a>	MPI_COMPLEX8, <a href="#">33</a> , <a href="#">225</a> , <a href="#">695</a> , <a href="#">854</a>	9
MPI_CHARACTER, <a href="#">31</a> , <a href="#">45</a> , <a href="#">46</a> , <a href="#">227</a> , <a href="#">694</a> , <a href="#">854</a>	MPI_CONGRUENT, <a href="#">323</a> , <a href="#">353</a> , <a href="#">855</a>	10
MPI_COMBINER_CONTIGUOUS, <a href="#">157</a> , <a href="#">161</a> , <a href="#">859</a>	MPI_CONVERSION_FN_NULL, <a href="#">700</a> , <a href="#">857</a>	11
MPI_COMBINER_DARRAY, <a href="#">157</a> , <a href="#">163</a> , <a href="#">859</a>	MPI_COUNT, <a href="#">33</a> , <a href="#">119</a> , <a href="#">225</a> , <a href="#">233</a> , <a href="#">694</a> , <a href="#">728</a> , <a href="#">831</a> , <a href="#">853</a> , <a href="#">854</a> , <a href="#">1043</a>	12
MPI_COMBINER_DUP, <a href="#">157</a> , <a href="#">161</a> , <a href="#">859</a>	MPI_COUNT_KIND, <a href="#">19</a> , <a href="#">21</a> , <a href="#">33</a> , <a href="#">852</a>	13
MPI_COMBINER_F90_COMPLEX, <a href="#">157</a> , <a href="#">163</a> , <a href="#">859</a>	MPI_CXX_BOOL, <a href="#">33</a> , <a href="#">225</a> , <a href="#">694</a> , <a href="#">695</a> , <a href="#">854</a> , <a href="#">1041</a>	14
MPI_COMBINER_F90_INTEGER, <a href="#">157</a> , <a href="#">163</a> , <a href="#">859</a>	MPI_CXX_DOUBLE_COMPLEX, <a href="#">33</a> , <a href="#">225</a> , <a href="#">694</a> , <a href="#">695</a> , <a href="#">854</a> , <a href="#">1041</a>	15
MPI_COMBINER_F90_REAL, <a href="#">157</a> , <a href="#">163</a> , <a href="#">859</a>	MPI_CXX_FLOAT_COMPLEX, <a href="#">33</a> , <a href="#">225</a> , <a href="#">694</a> , <a href="#">695</a> , <a href="#">854</a> , <a href="#">1041</a>	16
MPI_COMBINER_HINDEXED, <a href="#">23</a> , <a href="#">157</a> , <a href="#">162</a> , <a href="#">859</a>	MPI_CXX_LONG_DOUBLE_COMPLEX, <a href="#">33</a> , <a href="#">225</a> , <a href="#">694</a> , <a href="#">695</a> , <a href="#">854</a> , <a href="#">1041</a>	17
MPI_COMBINER_HINDEXED_BLOCK, <a href="#">157</a> , <a href="#">162</a> , <a href="#">859</a> , <a href="#">1043</a>	MPI_DATATYPE_NULL, <a href="#">150</a> , <a href="#">856</a>	18
MPI_COMBINER_HINDEXED_INTEGER, <a href="#">23</a> , <a href="#">780</a> , <a href="#">1042</a>	MPI_DISPLACEMENT_CURRENT, <a href="#">649</a> , <a href="#">860</a> , <a href="#">1053</a>	19
MPI_COMBINER_HVECTOR, <a href="#">23</a> , <a href="#">157</a> , <a href="#">162</a> , <a href="#">859</a>	MPI_DIST_GRAPH, <a href="#">399</a> , <a href="#">857</a> , <a href="#">1048</a>	20
MPI_COMBINER_HVECTOR_INTEGER, <a href="#">23</a> , <a href="#">780</a> , <a href="#">1042</a>	MPI_DISTRIBUTE_BLOCK, <a href="#">135</a> , <a href="#">136</a> , <a href="#">860</a>	21
MPI_COMBINER_INDEXED, <a href="#">157</a> , <a href="#">162</a> , <a href="#">859</a>	MPI_DISTRIBUTE_CYCLIC, <a href="#">135</a> , <a href="#">136</a> , <a href="#">860</a>	22
MPI_COMBINER_INDEXED_BLOCK, <a href="#">157</a> , <a href="#">162</a> , <a href="#">859</a>	MPI_DISTRIBUTE_DFLT_DARG, <a href="#">135</a> , <a href="#">136</a> , <a href="#">860</a>	23
MPI_COMBINER_NAMED, <a href="#">157</a> , <a href="#">161</a> , <a href="#">859</a>	MPI_DISTRIBUTE_NONE, <a href="#">135</a> , <a href="#">136</a> , <a href="#">860</a>	24
MPI_COMBINER_RESIZED, <a href="#">157</a> , <a href="#">163</a> , <a href="#">859</a>	MPI_DOUBLE, <a href="#">32</a> , <a href="#">225</a> , <a href="#">694</a> , <a href="#">728</a> , <a href="#">737–739</a> , <a href="#">801</a> , <a href="#">853</a>	25
MPI_COMBINER_STRUCT, <a href="#">23</a> , <a href="#">157</a> , <a href="#">162</a> , <a href="#">859</a>	MPI_DOUBLE_COMPLEX, <a href="#">32</a> , <a href="#">225</a> , <a href="#">693</a> , <a href="#">694</a> , <a href="#">802</a> , <a href="#">854</a>	26
MPI_COMBINER_STRUCT_INTEGER, <a href="#">23</a> , <a href="#">780</a> , <a href="#">1042</a>	MPI_DOUBLE_INT, <a href="#">228</a> , <a href="#">229</a> , <a href="#">855</a>	27
MPI_COMBINER_SUBARRAY, <a href="#">157</a> , <a href="#">163</a> , <a href="#">859</a>	MPI_DOUBLE_PRECISION, <a href="#">31</a> , <a href="#">225</a> , <a href="#">694</a> , <a href="#">802</a> , <a href="#">854</a>	28
MPI_COMBINER_VECTOR, <a href="#">157</a> , <a href="#">161</a> , <a href="#">859</a>	MPI_DUP_FN, <a href="#">23</a> , <a href="#">364</a> , <a href="#">774</a> , <a href="#">858</a>	29
MPI_COMM_DUP_FN, <a href="#">23</a> , <a href="#">364</a> , <a href="#">857</a> , <a href="#">1046</a>	MPI_ERR_ACCESS, <a href="#">467</a> , <a href="#">641</a> , <a href="#">713</a> , <a href="#">850</a>	30
MPI_COMM_NULL, <a href="#">311</a> , <a href="#">327</a> , <a href="#">328</a> , <a href="#">330–332</a> , <a href="#">335–337</a> , <a href="#">340</a> , <a href="#">341</a> , <a href="#">357</a> , <a href="#">379</a> , <a href="#">389</a> , <a href="#">391</a> , <a href="#">522</a> , <a href="#">543</a> , <a href="#">544</a> , <a href="#">834</a> , <a href="#">856</a> , <a href="#">1050</a>	MPI_ERR_AMODE, <a href="#">467</a> , <a href="#">639</a> , <a href="#">713</a> , <a href="#">850</a>	31
MPI_COMM_NULL_COPY_FN, <a href="#">23</a> , <a href="#">364</a> , <a href="#">786</a> , <a href="#">840</a> , <a href="#">857</a> , <a href="#">1046</a>	MPI_ERR_ARG, <a href="#">467</a> , <a href="#">849</a>	32
MPI_COMM_NULL_DELETE_FN, <a href="#">23</a> , <a href="#">365</a> , <a href="#">857</a>	MPI_ERR_ASSERT, <a href="#">467</a> , <a href="#">604</a> , <a href="#">850</a>	33
MPI_COMM_PARENT, <a href="#">379</a>	MPI_ERR_BAD_FILE, <a href="#">467</a> , <a href="#">713</a> , <a href="#">850</a>	34
MPI_COMM_SELF, <a href="#">25</a> , <a href="#">311</a> , <a href="#">330</a> , <a href="#">343</a> , <a href="#">361</a> , <a href="#">379</a> , <a href="#">455</a> , <a href="#">485</a> , <a href="#">490</a> , <a href="#">493</a> , <a href="#">495</a> , <a href="#">543</a> , <a href="#">638</a> , <a href="#">781</a> , <a href="#">855</a> , <a href="#">1036</a> , <a href="#">1048</a>	MPI_ERR_BASE, <a href="#">453</a> , <a href="#">467</a> , <a href="#">604</a> , <a href="#">850</a>	35
	MPI_ERR_BUFFER, <a href="#">467</a> , <a href="#">849</a>	36
	MPI_ERR_COMM, <a href="#">467</a> , <a href="#">849</a>	37

1	MPI_ERR_CONVERSION, <a href="#">467</a> , <a href="#">700</a> , <a href="#">713</a> , <a href="#">850</a>	MPI_ERR_UNSUPPORTED_OPERATION, <a href="#">468</a> ,
2	MPI_ERR_COUNT, <a href="#">467</a> , <a href="#">849</a>	<a href="#">713</a> , <a href="#">850</a>
3	MPI_ERR_DIMS, <a href="#">467</a> , <a href="#">849</a>	MPI_ERR_VALUE_TOO_LARGE, <a href="#">468</a> , <a href="#">698</a> ,
4	MPI_ERR_DISP, <a href="#">467</a> , <a href="#">604</a> , <a href="#">850</a>	<a href="#">1036</a>
5	MPI_ERR_DUP_DATAREP, <a href="#">467</a> , <a href="#">697</a> , <a href="#">713</a> , <a href="#">850</a>	MPI_ERR_WIN, <a href="#">468</a> , <a href="#">604</a> , <a href="#">850</a>
6	MPI_ERR_FILE, <a href="#">467</a> , <a href="#">713</a> , <a href="#">850</a>	MPI_ERRCODES_IGNORE, <a href="#">19</a> , <a href="#">521</a> , <a href="#">522</a> , <a href="#">810</a> ,
7	MPI_ERR_FILE_EXISTS, <a href="#">467</a> , <a href="#">713</a> , <a href="#">850</a>	<a href="#">860</a>
8	MPI_ERR_FILE_IN_USE, <a href="#">467</a> , <a href="#">641</a> , <a href="#">713</a> , <a href="#">850</a>	MPI_ERRHANDLER_NULL, <a href="#">465</a> , <a href="#">856</a>
9	MPI_ERR_GROUP, <a href="#">467</a> , <a href="#">849</a>	MPI_ERROR, <a href="#">37</a> , <a href="#">69</a> , <a href="#">248</a> , <a href="#">578</a> , <a href="#">836</a> , <a href="#">852</a> , <a href="#">1039</a> ,
10	MPI_ERR_IN_STATUS, <a href="#">37</a> , <a href="#">39</a> , <a href="#">69</a> , <a href="#">76</a> , <a href="#">78</a> , <a href="#">457</a> ,	<a href="#">1045</a>
11	<a href="#">466</a> , <a href="#">467</a> , <a href="#">629</a> , <a href="#">654</a> , <a href="#">850</a>	MPI_ERRORS_ABORT, <a href="#">455</a> , <a href="#">485</a> , <a href="#">526</a> , <a href="#">1036</a>
12	MPI_ERR_INFO, <a href="#">467</a> , <a href="#">850</a>	"mpi_errors_abort", <a href="#">526</a> , <a href="#">1038</a>
13	MPI_ERR_INFO_KEY, <a href="#">467</a> , <a href="#">477</a> , <a href="#">850</a>	MPI_ERRORS_ARE_FATAL, <a href="#">455</a> , <a href="#">456</a> , <a href="#">472</a> , <a href="#">526</a> ,
14	MPI_ERR_INFO_NOKEY, <a href="#">467</a> , <a href="#">477</a> , <a href="#">850</a>	<a href="#">603</a> , <a href="#">711</a> , <a href="#">852</a> , <a href="#">1036</a>
15	MPI_ERR_INFO_VALUE, <a href="#">467</a> , <a href="#">477</a> , <a href="#">850</a>	"mpi_errors_are_fatal", <a href="#">526</a> , <a href="#">1038</a>
16	MPI_ERR_INTERN, <a href="#">456</a> , <a href="#">467</a> , <a href="#">849</a>	MPI_ERRORS_RETURN, <a href="#">455</a> , <a href="#">456</a> , <a href="#">473</a> , <a href="#">509</a> ,
17	MPI_ERR_IO, <a href="#">467</a> , <a href="#">713</a> , <a href="#">850</a>	<a href="#">526</a> , <a href="#">712</a> , <a href="#">845</a> , <a href="#">852</a>
18	MPI_ERR_KEYVAL, <a href="#">375</a> , <a href="#">467</a> , <a href="#">850</a>	"mpi_errors_return", <a href="#">526</a> , <a href="#">1038</a>
19	MPI_ERR_LASTCODE, <a href="#">466</a> , <a href="#">468</a> , <a href="#">470</a> , <a href="#">471</a> , <a href="#">769</a> ,	MPI_F08_STATUS_IGNORE, <a href="#">837</a> , <a href="#">861</a> , <a href="#">1045</a>
20	<a href="#">851</a>	MPI_F08_STATUSES_IGNORE, <a href="#">837</a> , <a href="#">861</a> , <a href="#">1045</a>
21	MPI_ERR_LOCKTYPE, <a href="#">467</a> , <a href="#">604</a> , <a href="#">850</a>	MPI_F_ERROR, <a href="#">836</a> , <a href="#">852</a> , <a href="#">1035</a>
22	MPI_ERR_NAME, <a href="#">467</a> , <a href="#">536</a> , <a href="#">850</a>	MPI_F_SOURCE, <a href="#">836</a> , <a href="#">852</a> , <a href="#">1035</a>
23	MPI_ERR_NO_MEM, <a href="#">452</a> , <a href="#">467</a> , <a href="#">850</a>	MPI_F_STATUS_IGNORE, <a href="#">836</a> , <a href="#">861</a>
24	MPI_ERR_NO_SPACE, <a href="#">467</a> , <a href="#">713</a> , <a href="#">850</a>	MPI_F_STATUS_SIZE, <a href="#">19</a> , <a href="#">836</a> , <a href="#">852</a> , <a href="#">1035</a>
25	MPI_ERR_NO_SUCH_FILE, <a href="#">467</a> , <a href="#">641</a> , <a href="#">713</a> , <a href="#">850</a>	MPI_F_STATUSES_IGNORE, <a href="#">836</a> , <a href="#">861</a>
26	MPI_ERR_NO_SAME, <a href="#">467</a> , <a href="#">713</a> , <a href="#">850</a>	MPI_F_TAG, <a href="#">836</a> , <a href="#">852</a> , <a href="#">1035</a>
27	MPI_ERR_OP, <a href="#">468</a> , <a href="#">603</a> , <a href="#">849</a>	MPI_FILE_NULL, <a href="#">640</a> , <a href="#">712</a> , <a href="#">856</a>
28	MPI_ERR_OTHER, <a href="#">466</a> , <a href="#">468</a> , <a href="#">849</a>	MPI_FLOAT, <a href="#">32</a> , <a href="#">130</a> , <a href="#">223</a> , <a href="#">225</a> , <a href="#">692</a> , <a href="#">694</a> , <a href="#">853</a>
29	MPI_ERR_PENDING, <a href="#">76</a> , <a href="#">468</a> , <a href="#">849</a>	MPI_FLOAT_INT, <a href="#">15</a> , <a href="#">228</a> , <a href="#">229</a> , <a href="#">855</a>
30	MPI_ERR_PORT, <a href="#">468</a> , <a href="#">533</a> , <a href="#">850</a>	MPI_GRAPH, <a href="#">399</a> , <a href="#">857</a>
31	MPI_ERR_PROC_ABORTED, <a href="#">468</a> , <a href="#">510</a> , <a href="#">850</a> ,	MPI_GROUP_EMPTY, <a href="#">310</a> , <a href="#">316</a> , <a href="#">317</a> , <a href="#">327</a> , <a href="#">328</a> ,
32	<a href="#">1037</a>	<a href="#">330</a> , <a href="#">340</a> , <a href="#">357</a> , <a href="#">856</a>
33	MPI_ERR_QUOTA, <a href="#">468</a> , <a href="#">713</a> , <a href="#">850</a>	MPI_GROUP_NULL, <a href="#">310</a> , <a href="#">320</a> , <a href="#">321</a> , <a href="#">856</a>
34	MPI_ERR_RANK, <a href="#">468</a> , <a href="#">603</a> , <a href="#">849</a>	MPI_HOST, <a href="#">449</a> , <a href="#">855</a>
35	MPI_ERR_READ_ONLY, <a href="#">468</a> , <a href="#">713</a> , <a href="#">850</a>	"mpi_hw_resource_type", <a href="#">336</a> , <a href="#">337</a> , <a href="#">1036</a>
36	MPI_ERR_REQUEST, <a href="#">468</a> , <a href="#">849</a>	MPI_IDENT, <a href="#">314</a> , <a href="#">323</a> , <a href="#">855</a>
37	MPI_ERR_RMA_ATTACH, <a href="#">468</a> , <a href="#">604</a> , <a href="#">850</a>	MPI_IN_PLACE, <a href="#">19</a> , <a href="#">188</a> , <a href="#">218</a> , <a href="#">789</a> , <a href="#">810</a> , <a href="#">851</a>
38	MPI_ERR_RMA_CONFLICT, <a href="#">468</a> , <a href="#">604</a> , <a href="#">850</a>	MPI_INFO_ENV, <a href="#">482</a> , <a href="#">486</a> , <a href="#">487</a> , <a href="#">495</a> , <a href="#">855</a> , <a href="#">1044</a>
39	MPI_ERR_RMA_FLAVOR, <a href="#">468</a> , <a href="#">555</a> , <a href="#">604</a> , <a href="#">850</a>	MPI_INFO_NULL, <a href="#">397</a> , <a href="#">452</a> , <a href="#">481</a> , <a href="#">521</a> , <a href="#">531</a> , <a href="#">639</a> ,
40	MPI_ERR_RMA_RANGE, <a href="#">468</a> , <a href="#">604</a> , <a href="#">850</a>	<a href="#">641</a> , <a href="#">650</a> , <a href="#">856</a>
41	MPI_ERR_RMA_SHARED, <a href="#">468</a> , <a href="#">604</a> , <a href="#">850</a>	"mpi_initial_errhandler", <a href="#">485</a> , <a href="#">486</a> , <a href="#">526</a> , <a href="#">1038</a>
42	MPI_ERR_RMA_SYNC, <a href="#">468</a> , <a href="#">604</a> , <a href="#">850</a>	MPI_INT, <a href="#">15</a> , <a href="#">32</a> , <a href="#">118</a> , <a href="#">224</a> , <a href="#">692</a> – <a href="#">694</a> , <a href="#">727</a> , <a href="#">728</a> ,
43	MPI_ERR_ROOT, <a href="#">468</a> , <a href="#">849</a>	<a href="#">731</a> , <a href="#">737</a> , <a href="#">741</a> , <a href="#">801</a> , <a href="#">845</a> , <a href="#">847</a> , <a href="#">853</a>
44	MPI_ERR_SERVICE, <a href="#">468</a> , <a href="#">536</a> , <a href="#">850</a>	MPI_INT16_T, <a href="#">32</a> , <a href="#">225</a> , <a href="#">694</a> , <a href="#">853</a> , <a href="#">1047</a> , <a href="#">1049</a>
45	MPI_ERR_SESSION, <a href="#">468</a>	MPI_INT32_T, <a href="#">32</a> , <a href="#">225</a> , <a href="#">694</a> , <a href="#">728</a> , <a href="#">853</a> , <a href="#">1047</a> ,
46	MPI_ERR_SIZE, <a href="#">468</a> , <a href="#">604</a> , <a href="#">850</a>	<a href="#">1049</a>
47	MPI_ERR_SPAWN, <a href="#">468</a> , <a href="#">520</a> , <a href="#">521</a> , <a href="#">850</a>	MPI_INT64_T, <a href="#">32</a> , <a href="#">225</a> , <a href="#">694</a> , <a href="#">728</a> , <a href="#">853</a> , <a href="#">1047</a> ,
48	MPI_ERR_TAG, <a href="#">468</a> , <a href="#">849</a>	<a href="#">1049</a>
	MPI_ERR_TOPOLOGY, <a href="#">468</a> , <a href="#">849</a>	MPI_INT8_T, <a href="#">32</a> , <a href="#">225</a> , <a href="#">694</a> , <a href="#">853</a> , <a href="#">1047</a> , <a href="#">1049</a>
	MPI_ERR_TRUNCATE, <a href="#">468</a> , <a href="#">849</a>	MPI_INTEGER, <a href="#">31</a> , <a href="#">43</a> , <a href="#">225</a> , <a href="#">694</a> , <a href="#">801</a> , <a href="#">802</a> , <a href="#">847</a> ,
	MPI_ERR_TYPE, <a href="#">157</a> , <a href="#">159</a> , <a href="#">468</a> , <a href="#">712</a> , <a href="#">849</a>	<a href="#">854</a>
	MPI_ERR_UNKNOWN, <a href="#">466</a> , <a href="#">468</a> , <a href="#">849</a>	MPI_INTEGER1, <a href="#">33</a> , <a href="#">225</a> , <a href="#">695</a> , <a href="#">854</a>
	MPI_ERR_UNSUPPORTED_DATAREP, <a href="#">468</a> ,	MPI_INTEGER16, <a href="#">225</a> , <a href="#">695</a> , <a href="#">854</a>
	<a href="#">713</a> , <a href="#">850</a>	MPI_INTEGER2, <a href="#">33</a> , <a href="#">225</a> , <a href="#">693</a> , <a href="#">695</a> , <a href="#">854</a>



MPI_INTEGER4, <a href="#">33</a> , <a href="#">225</a> , <a href="#">695</a> , <a href="#">854</a>	MPI_MODE_NOSTORE, <a href="#">602</a> , <a href="#">603</a> , <a href="#">859</a>	1
MPI_INTEGER8, <a href="#">33</a> , <a href="#">225</a> , <a href="#">695</a> , <a href="#">806</a> , <a href="#">854</a>	MPI_MODE_NOSUCCEED, <a href="#">602</a> , <a href="#">603</a> , <a href="#">859</a>	2
MPI_INTEGER_KIND, <a href="#">19</a> , <a href="#">852</a>	MPI_MODE_RDONLY, <a href="#">638</a> , <a href="#">639</a> , <a href="#">644</a> , <a href="#">859</a>	3
MPI_IO, <a href="#">449</a> , <a href="#">450</a> , <a href="#">855</a>	MPI_MODE_RDWR, <a href="#">638</a> , <a href="#">639</a> , <a href="#">859</a>	4
MPI_KEYVAL_INVALID, <a href="#">365</a> , <a href="#">366</a> , <a href="#">367</a> , <a href="#">851</a>	MPI_MODE_SEQUENTIAL, <a href="#">638</a> , <a href="#">639</a> , <a href="#">642</a> , <a href="#">649</a> , <a href="#">654</a> , <a href="#">662</a> , <a href="#">679</a> , <a href="#">704</a> , <a href="#">859</a> , <a href="#">1053</a>	5
MPI_LAND, <a href="#">224</a> , <a href="#">225</a> , <a href="#">856</a>	MPI_MODE_UNIQUE_OPEN, <a href="#">638</a> , <a href="#">639</a> , <a href="#">859</a>	6
MPI_LASTUSED_CODE, <a href="#">470</a> , <a href="#">858</a>	MPI_MODE_WRONLY, <a href="#">638</a> , <a href="#">639</a> , <a href="#">859</a>	7
MPI_LB, <a href="#">23</a> , <a href="#">780</a> , <a href="#">1042</a>	MPI_NO_OP, <a href="#">548</a> , <a href="#">575</a> – <a href="#">577</a> , <a href="#">856</a> , <a href="#">1039</a>	8
MPI_LOCK_EXCLUSIVE, <a href="#">596</a> , <a href="#">851</a>	MPI_NULL_COPY_FN, <a href="#">23</a> , <a href="#">364</a> , <a href="#">774</a> , <a href="#">858</a>	9
MPI_LOCK_SHARED, <a href="#">596</a> , <a href="#">597</a> , <a href="#">851</a>	MPI_NULL_DELETE_FN, <a href="#">23</a> , <a href="#">365</a> , <a href="#">774</a> , <a href="#">858</a>	10
MPI_LOGICAL, <a href="#">31</a> , <a href="#">225</a> , <a href="#">694</a> , <a href="#">854</a>	MPI_OFFSET, <a href="#">33</a> , <a href="#">225</a> , <a href="#">694</a> , <a href="#">853</a> , <a href="#">854</a> , <a href="#">1047</a> , <a href="#">1049</a>	11
MPI_LONG, <a href="#">32</a> , <a href="#">224</a> , <a href="#">694</a> , <a href="#">853</a>	MPI_OFFSET_KIND, <a href="#">19</a> , <a href="#">20</a> , <a href="#">33</a> , <a href="#">706</a> , <a href="#">810</a> , <a href="#">852</a>	12
MPI_LONG_DOUBLE, <a href="#">32</a> , <a href="#">225</a> , <a href="#">694</a> , <a href="#">853</a>	MPI_OP_NULL, <a href="#">235</a> , <a href="#">856</a>	13
MPI_LONG_DOUBLE_INT, <a href="#">228</a> , <a href="#">855</a>	MPI_ORDER_C, <a href="#">18</a> , <a href="#">132</a> , <a href="#">133</a> , <a href="#">136</a> , <a href="#">860</a>	14
MPI_LONG_INT, <a href="#">228</a> , <a href="#">229</a> , <a href="#">855</a>	MPI_ORDER_FORTRAN, <a href="#">18</a> , <a href="#">132</a> , <a href="#">133</a> , <a href="#">136</a> , <a href="#">860</a>	15
MPI_LONG_LONG, <a href="#">32</a> , <a href="#">225</a> , <a href="#">853</a> , <a href="#">1049</a>	MPI_PACKED, <a href="#">15</a> , <a href="#">31</a> , <a href="#">32</a> , <a href="#">43</a> , <a href="#">44</a> , <a href="#">173</a> , <a href="#">175</a> , <a href="#">180</a> , <a href="#">693</a> , <a href="#">694</a> , <a href="#">846</a> , <a href="#">853</a> , <a href="#">854</a>	16
MPI_LONG_LONG_INT, <a href="#">32</a> , <a href="#">225</a> , <a href="#">694</a> , <a href="#">853</a> , <a href="#">1049</a>	MPI_PROC_NULL, <a href="#">30</a> , <a href="#">34</a> , <a href="#">36</a> , <a href="#">83</a> , <a href="#">86</a> , <a href="#">89</a> , <a href="#">90</a> , <a href="#">98</a> , <a href="#">99</a> , <a href="#">190</a> , <a href="#">193</a> , <a href="#">195</a> , <a href="#">197</a> , <a href="#">206</a> , <a href="#">208</a> , <a href="#">224</a> , <a href="#">313</a> , <a href="#">408</a> , <a href="#">412</a> , <a href="#">449</a> , <a href="#">450</a> , <a href="#">554</a> , <a href="#">555</a> , <a href="#">564</a> , <a href="#">851</a> , <a href="#">1043</a> , <a href="#">1050</a> , <a href="#">1052</a>	17
MPI_LOR, <a href="#">224</a> , <a href="#">225</a> , <a href="#">856</a>	MPI_PROD, <a href="#">224</a> , <a href="#">225</a> , <a href="#">856</a>	18
MPI_LXOR, <a href="#">224</a> , <a href="#">225</a> , <a href="#">856</a>	MPI_REAL, <a href="#">31</a> , <a href="#">43</a> , <a href="#">225</a> , <a href="#">693</a> , <a href="#">694</a> , <a href="#">801</a> , <a href="#">802</a> , <a href="#">808</a> , <a href="#">854</a>	19
MPI_MAX, <a href="#">223</a> – <a href="#">225</a> , <a href="#">246</a> , <a href="#">856</a>	MPI_REAL16, <a href="#">33</a> , <a href="#">225</a> , <a href="#">695</a> , <a href="#">854</a>	20
MPI_MAX_DATAREP_STRING, <a href="#">19</a> , <a href="#">651</a> , <a href="#">697</a> , <a href="#">852</a>	MPI_REAL2, <a href="#">33</a> , <a href="#">225</a> , <a href="#">695</a> , <a href="#">854</a>	21
MPI_MAX_ERROR_STRING, <a href="#">19</a> , <a href="#">465</a> , <a href="#">471</a> , <a href="#">852</a>	MPI_REAL4, <a href="#">33</a> , <a href="#">225</a> , <a href="#">695</a> , <a href="#">801</a> , <a href="#">806</a> , <a href="#">854</a>	22
MPI_MAX_FROM_GROUP_STRINGTAG, <a href="#">357</a>	MPI_REAL8, <a href="#">33</a> , <a href="#">225</a> , <a href="#">695</a> , <a href="#">801</a> , <a href="#">854</a> , <a href="#">1047</a>	23
MPI_MAX_FROM_GROUP_TAG, <a href="#">340</a> , <a href="#">852</a>	MPI_REPLACE, <a href="#">572</a> , <a href="#">573</a> , <a href="#">575</a> , <a href="#">577</a> , <a href="#">620</a> , <a href="#">856</a> , <a href="#">1049</a> , <a href="#">1052</a>	24
MPI_MAX_INFO_KEY, <a href="#">19</a> , <a href="#">467</a> , <a href="#">475</a> , <a href="#">478</a> , <a href="#">479</a> , <a href="#">852</a>	MPI_REQUEST_NULL, <a href="#">68</a> – <a href="#">71</a> , <a href="#">74</a> – <a href="#">78</a> , <a href="#">628</a> , <a href="#">856</a>	25
MPI_MAX_INFO_VAL, <a href="#">19</a> , <a href="#">467</a> , <a href="#">475</a> , <a href="#">852</a>	MPI_ROOT, <a href="#">190</a> , <a href="#">851</a>	26
MPI_MAX_LIBRARY_VERSION_STRING, <a href="#">19</a> , <a href="#">448</a> , <a href="#">852</a> , <a href="#">1042</a>	MPI_SEEK_CUR, <a href="#">671</a> , <a href="#">679</a> , <a href="#">860</a>	27
MPI_MAX_OBJECT_NAME, <a href="#">19</a> , <a href="#">378</a> – <a href="#">381</a> , <a href="#">852</a> , <a href="#">1044</a> , <a href="#">1050</a>	MPI_SEEK_END, <a href="#">671</a> , <a href="#">679</a> , <a href="#">860</a>	28
MPI_MAX_PORT_NAME, <a href="#">19</a> , <a href="#">530</a> , <a href="#">852</a>	MPI_SEEK_SET, <a href="#">671</a> , <a href="#">672</a> , <a href="#">679</a> , <a href="#">860</a>	29
MPI_MAX_PROCESSOR_NAME, <a href="#">19</a> , <a href="#">451</a> , <a href="#">852</a> , <a href="#">1051</a>	MPI_SESSION_NULL, <a href="#">498</a> , <a href="#">856</a>	30
MPI_MAX_PSET_NAME_LEN, <a href="#">501</a> , <a href="#">852</a>	"mpi_shared_memory", <a href="#">336</a> , <a href="#">1036</a>	31
MPI_MAXLOC, <a href="#">224</a> , <a href="#">227</a> , <a href="#">228</a> , <a href="#">231</a> , <a href="#">856</a>	MPI_SHORT, <a href="#">32</a> , <a href="#">224</a> , <a href="#">694</a> , <a href="#">853</a>	32
MPI_MESSAGE_NO_PROC, <a href="#">86</a> , <a href="#">89</a> , <a href="#">90</a> , <a href="#">99</a> , <a href="#">851</a> , <a href="#">1043</a>	MPI_SHORT_INT, <a href="#">228</a> , <a href="#">855</a>	33
MPI_MESSAGE_NULL, <a href="#">86</a> , <a href="#">88</a> – <a href="#">90</a> , <a href="#">856</a> , <a href="#">1043</a>	MPI_SIGNED_CHAR, <a href="#">32</a> , <a href="#">225</a> , <a href="#">227</a> , <a href="#">694</a> , <a href="#">853</a> , <a href="#">1049</a>	34
MPI_MESSAGE_PROC_NULL, <a href="#">87</a>	MPI_SIMILAR, <a href="#">314</a> , <a href="#">323</a> , <a href="#">353</a> , <a href="#">855</a>	35
MPI_MIN, <a href="#">224</a> , <a href="#">225</a> , <a href="#">856</a>	"mpi_size", <a href="#">499</a> , <a href="#">502</a> , <a href="#">506</a>	36
"mpi_minimum_memory_alignment", <a href="#">452</a> , <a href="#">551</a> , <a href="#">554</a> , <a href="#">1037</a>	MPI_SOURCE, <a href="#">37</a> , <a href="#">248</a> , <a href="#">836</a> , <a href="#">852</a> , <a href="#">1039</a> , <a href="#">1045</a>	37
MPI_MINLOC, <a href="#">224</a> , <a href="#">227</a> , <a href="#">228</a> , <a href="#">231</a> , <a href="#">856</a>	MPI_STATUS_IGNORE, <a href="#">10</a> , <a href="#">19</a> , <a href="#">39</a> , <a href="#">40</a> , <a href="#">627</a> , <a href="#">654</a> , <a href="#">788</a> , <a href="#">810</a> , <a href="#">836</a> , <a href="#">837</a> , <a href="#">845</a> , <a href="#">860</a> , <a href="#">861</a> , <a href="#">1043</a>	38
MPI_MODE_APPEND, <a href="#">638</a> , <a href="#">639</a> , <a href="#">859</a>	MPI_STATUS_SIZE, <a href="#">19</a> , <a href="#">37</a> , <a href="#">790</a> , <a href="#">852</a> , <a href="#">1045</a>	39
MPI_MODE_CREATE, <a href="#">638</a> , <a href="#">639</a> , <a href="#">648</a> , <a href="#">859</a>	MPI_STATUSES_IGNORE, <a href="#">18</a> , <a href="#">19</a> , <a href="#">39</a> , <a href="#">40</a> , <a href="#">627</a> , <a href="#">629</a> , <a href="#">810</a> , <a href="#">836</a> , <a href="#">837</a> , <a href="#">860</a> , <a href="#">861</a>	40
MPI_MODE_DELETE_ON_CLOSE, <a href="#">638</a> – <a href="#">640</a> , <a href="#">859</a>	MPI_SUBARRAYS_SUPPORTED, <a href="#">19</a> , <a href="#">784</a> , <a href="#">785</a> ,	41
MPI_MODE_EXCL, <a href="#">638</a> , <a href="#">639</a> , <a href="#">859</a>		42
MPI_MODE_NOCHECK, <a href="#">597</a> , <a href="#">602</a> , <a href="#">603</a> , <a href="#">859</a>		43
MPI_MODE_NOPRECEDE, <a href="#">592</a> , <a href="#">602</a> , <a href="#">603</a> , <a href="#">859</a>		44
MPI_MODE_NOPUT, <a href="#">602</a> , <a href="#">603</a> , <a href="#">859</a>		45
		46
		47
		48

1	788–790, 792, 796–799, 812, 813, 852,	MPI_T_ERR_PVAR_NO_ATOMIC, <a href="#">746</a> , <a href="#">771</a> ,
2	<a href="#">1045</a>	<a href="#">851</a>
3	MPI_SUBVERSION, <a href="#">19</a> , <a href="#">448</a> , <a href="#">861</a>	MPI_T_ERR_PVAR_NO_STARTSTOP, <a href="#">744</a> ,
4	MPI_SUCCESS, <a href="#">22</a> , <a href="#">24</a> , <a href="#">69</a> , <a href="#">76</a> , <a href="#">78</a> , <a href="#">364–366</a> ,	<a href="#">745</a> , <a href="#">771</a> , <a href="#">851</a>
5	<a href="#">368–370</a> , <a href="#">372</a> , <a href="#">373</a> , <a href="#">390</a> , <a href="#">466</a> , <a href="#">467</a> ,	MPI_T_ERR_PVAR_NO_WRITE, <a href="#">746</a> , <a href="#">771</a> , <a href="#">851</a>
6	<a href="#">471–473</a> , <a href="#">485</a> , <a href="#">521</a> , <a href="#">700</a> , <a href="#">723</a> , <a href="#">733</a> , <a href="#">741</a> ,	MPI_T_PVAR_ALL_HANDLES, <a href="#">744</a> , <a href="#">745–747</a> ,
7	<a href="#">744–746</a> , <a href="#">751</a> , <a href="#">755</a> , <a href="#">756</a> , <a href="#">760</a> , <a href="#">767</a> , <a href="#">769</a> ,	<a href="#">862</a>
8	<a href="#">771</a> , <a href="#">774</a> , <a href="#">849</a> , <a href="#">1037</a>	MPI_T_PVAR_CLASS_AGGREGATE, <a href="#">738</a> , <a href="#">739</a> ,
9	MPI_SUM, <a href="#">224</a> , <a href="#">225</a> , <a href="#">572</a> , <a href="#">845</a> , <a href="#">856</a>	<a href="#">862</a>
10	MPI_T_BIND_MPI_COMM, <a href="#">725</a> , <a href="#">862</a>	MPI_T_PVAR_CLASS_COUNTER, <a href="#">738</a> , <a href="#">862</a>
11	MPI_T_BIND_MPI_DATATYPE, <a href="#">725</a> , <a href="#">862</a>	MPI_T_PVAR_CLASS_GENERIC, <a href="#">739</a> , <a href="#">862</a>
12	MPI_T_BIND_MPI_ERRHANDLER, <a href="#">725</a> , <a href="#">862</a>	MPI_T_PVAR_CLASS_HIGHWATERMARK,
13	MPI_T_BIND_MPI_FILE, <a href="#">725</a> , <a href="#">862</a>	<a href="#">738</a> , <a href="#">862</a>
14	MPI_T_BIND_MPI_GROUP, <a href="#">725</a> , <a href="#">862</a>	MPI_T_PVAR_CLASS_LEVEL, <a href="#">737</a> , <a href="#">862</a>
15	MPI_T_BIND_MPI_INFO, <a href="#">725</a> , <a href="#">862</a>	MPI_T_PVAR_CLASS_LOWWATERMARK,
16	MPI_T_BIND_MPI_MESSAGE, <a href="#">725</a> , <a href="#">862</a>	<a href="#">738</a> , <a href="#">862</a>
17	MPI_T_BIND_MPI_OP, <a href="#">725</a> , <a href="#">862</a>	MPI_T_PVAR_CLASS_PERCENTAGE, <a href="#">738</a> , <a href="#">862</a>
18	MPI_T_BIND_MPI_REQUEST, <a href="#">725</a> , <a href="#">862</a>	MPI_T_PVAR_CLASS_SIZE, <a href="#">737</a> , <a href="#">862</a>
19	MPI_T_BIND_MPI_SESSION, <a href="#">725</a>	MPI_T_PVAR_CLASS_STATE, <a href="#">737</a> , <a href="#">862</a>
20	MPI_T_BIND_MPI_WIN, <a href="#">725</a> , <a href="#">862</a>	MPI_T_PVAR_CLASS_TIMER, <a href="#">738</a> , <a href="#">862</a>
21	MPI_T_BIND_NO_OBJECT, <a href="#">725</a> , <a href="#">732</a> , <a href="#">734</a> ,	MPI_T_PVAR_HANDLE_NULL, <a href="#">744</a> , <a href="#">861</a>
22	<a href="#">741</a> , <a href="#">743</a> , <a href="#">755</a> , <a href="#">757</a> , <a href="#">862</a>	MPI_T_PVAR_SESSION_NULL, <a href="#">742</a> , <a href="#">861</a>
23	MPI_T_CB_REQUIRE_ASYNC_SIGNAL_SAFE,	MPI_T_SCOPE_ALL, <a href="#">732</a> , <a href="#">862</a>
24	<a href="#">752</a> , <a href="#">863</a>	MPI_T_SCOPE_ALL_EQ, <a href="#">732</a> , <a href="#">736</a> , <a href="#">862</a>
25	MPI_T_CB_REQUIRE_MPI_RESTRICTED,	MPI_T_SCOPE_CONSTANT, <a href="#">732</a> , <a href="#">862</a>
26	<a href="#">752</a> , <a href="#">863</a>	MPI_T_SCOPE_GROUP, <a href="#">732</a> , <a href="#">862</a>
27	MPI_T_CB_REQUIRE_NONE, <a href="#">752</a> , <a href="#">863</a>	MPI_T_SCOPE_GROUP_EQ, <a href="#">732</a> , <a href="#">736</a> , <a href="#">862</a>
28	MPI_T_CB_REQUIRE_THREAD_SAFE, <a href="#">752</a> ,	MPI_T_SCOPE_LOCAL, <a href="#">732</a> , <a href="#">862</a>
29	<a href="#">863</a>	MPI_T_SCOPE_READONLY, <a href="#">732</a> , <a href="#">862</a>
30	MPI_T_CVAR_HANDLE_NULL, <a href="#">735</a> , <a href="#">861</a>	MPI_T_SOURCE_ORDERED, <a href="#">751</a> , <a href="#">863</a>
31	MPI_T_ENUM_NULL, <a href="#">731</a> , <a href="#">741</a> , <a href="#">755</a> , <a href="#">861</a>	MPI_T_SOURCE_UNORDERED, <a href="#">751</a> , <a href="#">863</a>
32	MPI_T_ERR_CANNOT_INIT, <a href="#">771</a> , <a href="#">851</a>	MPI_T_VERBOSITY_MPIDEV_ALL, <a href="#">724</a> , <a href="#">861</a>
33	MPI_T_ERR_CVAR_SET_NEVER, <a href="#">736</a> , <a href="#">771</a> ,	MPI_T_VERBOSITY_MPIDEV_BASIC, <a href="#">724</a> ,
34	<a href="#">851</a>	<a href="#">861</a>
35	MPI_T_ERR_CVAR_SET_NOT_NOW, <a href="#">736</a> ,	MPI_T_VERBOSITY_MPIDEV_DETAIL, <a href="#">724</a> ,
36	<a href="#">771</a> , <a href="#">851</a>	<a href="#">861</a>
37	MPI_T_ERR_INVALID, <a href="#">771</a> , <a href="#">851</a> , <a href="#">1041</a>	MPI_T_VERBOSITY_TUNER_ALL, <a href="#">724</a> , <a href="#">861</a>
38	MPI_T_ERR_INVALID_HANDLE, <a href="#">743</a> , <a href="#">760</a> ,	MPI_T_VERBOSITY_TUNER_BASIC, <a href="#">724</a> , <a href="#">861</a>
39	<a href="#">771</a> , <a href="#">851</a>	MPI_T_VERBOSITY_TUNER_DETAIL, <a href="#">724</a> ,
40	MPI_T_ERR_INVALID_INDEX, <a href="#">23</a> , <a href="#">751</a> , <a href="#">755</a> ,	<a href="#">861</a>
41	<a href="#">771</a> , <a href="#">777</a> , <a href="#">851</a> , <a href="#">1038</a>	MPI_T_VERBOSITY_USER_ALL, <a href="#">724</a> , <a href="#">861</a>
42	MPI_T_ERR_INVALID_ITEM, <a href="#">23</a> , <a href="#">777</a> , <a href="#">851</a> ,	MPI_T_VERBOSITY_USER_BASIC, <a href="#">724</a> , <a href="#">861</a>
43	<a href="#">1038</a>	MPI_T_VERBOSITY_USER_DETAIL, <a href="#">724</a> , <a href="#">861</a>
44	MPI_T_ERR_INVALID_NAME, <a href="#">733</a> , <a href="#">741</a> , <a href="#">756</a> ,	MPI_TAG, <a href="#">37</a> , <a href="#">248</a> , <a href="#">836</a> , <a href="#">852</a> , <a href="#">1039</a> , <a href="#">1045</a>
45	<a href="#">767</a> , <a href="#">771</a> , <a href="#">851</a> , <a href="#">1041</a>	MPI_TAG_UB, <a href="#">34</a> , <a href="#">449</a> , <a href="#">841</a> , <a href="#">844</a> , <a href="#">855</a>
46	MPI_T_ERR_INVALID_SESSION, <a href="#">771</a> , <a href="#">851</a>	MPI_THREAD_FUNNELED, <a href="#">487</a> , <a href="#">488</a> , <a href="#">859</a>
47	MPI_T_ERR_MEMORY, <a href="#">771</a> , <a href="#">851</a>	"MPI_THREAD_FUNNELED", <a href="#">497</a>
48	MPI_T_ERR_NOT_ACCESSIBLE, <a href="#">753</a> , <a href="#">771</a> , <a href="#">851</a>	MPI_THREAD_MULTIPLE, <a href="#">487</a> , <a href="#">488</a> , <a href="#">490</a> , <a href="#">859</a> ,
	MPI_T_ERR_NOT_INITIALIZED, <a href="#">771</a> , <a href="#">851</a>	<a href="#">1040</a>
	MPI_T_ERR_NOT_SUPPORTED, <a href="#">751</a> , <a href="#">771</a> ,	"MPI_THREAD_MULTIPLE", <a href="#">497</a>
	<a href="#">851</a>	MPI_THREAD_SERIALIZED, <a href="#">487</a> , <a href="#">488</a> , <a href="#">859</a>
	MPI_T_ERR_OUT_OF_HANDLES, <a href="#">771</a> , <a href="#">851</a>	"MPI_THREAD_SERIALIZED", <a href="#">497</a>
	MPI_T_ERR_OUT_OF_SESSIONS, <a href="#">771</a> , <a href="#">851</a>	MPI_THREAD_SINGLE, <a href="#">487–489</a> , <a href="#">497</a> , <a href="#">498</a> , <a href="#">859</a>
		"MPI_THREAD_SINGLE", <a href="#">497</a>



MPI_TYPE_DUP_FN, <a href="#">372</a> , <a href="#">857</a>	"native", <a href="#">690–692</a> , <a href="#">701</a>	1
MPI_TYPE_NULL_COPY_FN, <a href="#">372</a> , <a href="#">857</a>	"nb_proc", <a href="#">648</a>	2
MPI_TYPE_NULL_DELETE_FN, <a href="#">372</a> , <a href="#">857</a> , <a href="#">1046</a>	"no_locks", <a href="#">548</a> , <a href="#">560</a>	3
MPI_TYPECLASS_COMPLEX, <a href="#">807</a> , <a href="#">860</a>	"none", <a href="#">613</a>	4
MPI_TYPECLASS_INTEGER, <a href="#">807</a> , <a href="#">860</a>	"num_io_nodes", <a href="#">648</a>	5
MPI_TYPECLASS_REAL, <a href="#">807</a> , <a href="#">860</a>	"path", <a href="#">526</a>	6
MPI_UB, <a href="#">4</a> , <a href="#">23</a> , <a href="#">780</a> , <a href="#">1042</a>	"random", <a href="#">647</a>	7
MPI_UINT16_T, <a href="#">32</a> , <a href="#">225</a> , <a href="#">694</a> , <a href="#">853</a> , <a href="#">1047</a> , <a href="#">1049</a>	"rar", <a href="#">613</a>	8
MPI_UINT32_T, <a href="#">32</a> , <a href="#">225</a> , <a href="#">694</a> , <a href="#">728</a> , <a href="#">853</a> , <a href="#">1047</a> , <a href="#">1049</a>	"raw", <a href="#">613</a>	9
MPI_UINT64_T, <a href="#">32</a> , <a href="#">225</a> , <a href="#">694</a> , <a href="#">728</a> , <a href="#">853</a> , <a href="#">1047</a> , <a href="#">1049</a>	"read_mostly", <a href="#">647</a>	10
MPI_UINT8_T, <a href="#">32</a> , <a href="#">225</a> , <a href="#">694</a> , <a href="#">853</a> , <a href="#">1047</a> , <a href="#">1049</a>	"read_once", <a href="#">647</a>	11
MPI_UNDEFINED, <a href="#">21</a> , <a href="#">38</a> , <a href="#">39</a> , <a href="#">57</a> , <a href="#">74</a> , <a href="#">75</a> , <a href="#">78</a> , <a href="#">79</a> , <a href="#">142</a> , <a href="#">146</a> , <a href="#">148</a> , <a href="#">153</a> , <a href="#">176</a> , <a href="#">312</a> , <a href="#">313</a> , <a href="#">331</a> , <a href="#">332</a> , <a href="#">335</a> , <a href="#">399</a> , <a href="#">410</a> , <a href="#">411</a> , <a href="#">693</a> , <a href="#">698</a> , <a href="#">803</a> , <a href="#">804</a> , <a href="#">851</a> , <a href="#">1043</a> , <a href="#">1049</a>	"reverse_sequential", <a href="#">647</a>	12
MPI_UNEQUAL, <a href="#">314</a> , <a href="#">323</a> , <a href="#">353</a> , <a href="#">855</a>	"same_disp_unit", <a href="#">548</a> , <a href="#">1040</a>	13
MPI_UNIVERSE_SIZE, <a href="#">517</a> , <a href="#">539</a> , <a href="#">540</a> , <a href="#">858</a>	"same_op", <a href="#">548</a>	14
MPI_UNSIGNED, <a href="#">32</a> , <a href="#">224</a> , <a href="#">694</a> , <a href="#">728</a> , <a href="#">737–739</a> , <a href="#">853</a>	"same_op_no_op", <a href="#">548</a>	15
MPI_UNSIGNED_CHAR, <a href="#">32</a> , <a href="#">225</a> , <a href="#">227</a> , <a href="#">694</a> , <a href="#">853</a>	"same_size", <a href="#">548</a> , <a href="#">1039</a>	16
MPI_UNSIGNED_LONG, <a href="#">32</a> , <a href="#">225</a> , <a href="#">694</a> , <a href="#">728</a> , <a href="#">737–739</a> , <a href="#">853</a>	"sequential", <a href="#">647</a>	17
MPI_UNSIGNED_LONG_LONG, <a href="#">32</a> , <a href="#">225</a> , <a href="#">694</a> , <a href="#">728</a> , <a href="#">737–739</a> , <a href="#">853</a> , <a href="#">1049</a>	"soft", <a href="#">486</a> , <a href="#">521</a> , <a href="#">526</a>	18
MPI_UNSIGNED_SHORT, <a href="#">32</a> , <a href="#">224</a> , <a href="#">694</a> , <a href="#">853</a>	"striping_factor", <a href="#">648</a>	19
MPI_UNWEIGHTED, <a href="#">19</a> , <a href="#">394</a> , <a href="#">396–398</a> , <a href="#">405</a> , <a href="#">407</a> , <a href="#">810</a> , <a href="#">860</a> , <a href="#">1042</a> , <a href="#">1048</a>	"striping_unit", <a href="#">648</a>	20
MPI_VAL, <a href="#">16</a> , <a href="#">833</a>	"thread_level", <a href="#">486</a> , <a href="#">497</a>	21
MPI_VERSION, <a href="#">19</a> , <a href="#">448</a> , <a href="#">861</a>	"true", <a href="#">342</a> , <a href="#">560</a> , <a href="#">647</a>	22
MPI_WCHAR, <a href="#">32</a> , <a href="#">227</a> , <a href="#">381</a> , <a href="#">693</a> , <a href="#">694</a> , <a href="#">853</a> , <a href="#">1049</a>	"war", <a href="#">613</a>	23
MPI_WEIGHTS_EMPTY, <a href="#">19</a> , <a href="#">394</a> , <a href="#">396</a> , <a href="#">810</a> , <a href="#">860</a> , <a href="#">1042</a>	"waw", <a href="#">613</a>	24
MPI_WIN_BASE, <a href="#">560</a> , <a href="#">844</a> , <a href="#">858</a>	"wdir", <a href="#">486</a> , <a href="#">525</a>	25
MPI_WIN_CREATE_FLAVOR, <a href="#">560</a> , <a href="#">858</a>	"write_mostly", <a href="#">647</a>	26
MPI_WIN_DISP_UNIT, <a href="#">560</a> , <a href="#">858</a>	"write_once", <a href="#">647</a>	27
MPI_WIN_DUP_FN, <a href="#">369</a> , <a href="#">857</a>		28
MPI_WIN_FLAVOR_ALLOCATE, <a href="#">561</a> , <a href="#">858</a>		29
MPI_WIN_FLAVOR_CREATE, <a href="#">561</a> , <a href="#">858</a>		30
MPI_WIN_FLAVOR_DYNAMIC, <a href="#">561</a> , <a href="#">858</a>		31
MPI_WIN_FLAVOR_SHARED, <a href="#">555</a> , <a href="#">561</a> , <a href="#">858</a>		32
MPI_WIN_MODEL, <a href="#">560</a> , <a href="#">587</a> , <a href="#">858</a>		33
MPI_WIN_NULL, <a href="#">559</a> , <a href="#">856</a>		34
MPI_WIN_NULL_COPY_FN, <a href="#">369</a> , <a href="#">857</a>		35
MPI_WIN_NULL_DELETE_FN, <a href="#">369</a> , <a href="#">857</a>		36
MPI_WIN_SEPARATE, <a href="#">561</a> , <a href="#">586</a> , <a href="#">587</a> , <a href="#">606</a> , <a href="#">858</a>		37
MPI_WIN_SIZE, <a href="#">560</a> , <a href="#">858</a>		38
MPI_WIN_UNIFIED, <a href="#">561</a> , <a href="#">587</a> , <a href="#">606</a> , <a href="#">615</a> , <a href="#">858</a>		39
MPI_WTIME_IS_GLOBAL, <a href="#">449</a> , <a href="#">450</a> , <a href="#">474</a> , <a href="#">841</a> , <a href="#">855</a>		40
"mpix://UNIVERSE", <a href="#">498</a>		41
		42
		43
		44
		45
		46
		47
		48

# MPI Declarations Index

This index refers to declarations needed in C and Fortran, such as address kind integers, handles, etc. The underlined page numbers is the “main” reference (sometimes there are more than one when key concepts are discussed in multiple areas). Fortran defined types are shown as `TYPE(name)`.

MPI\_Aint, [20](#), [20](#), [21](#), [33](#), [119](#), [122](#), [125](#), [129](#),  
[139–141](#), [145–147](#), [157](#), [180–182](#), [547](#),  
[550](#), [552](#), [556](#), [557](#), [560](#), [564](#), [567](#), [571](#),  
[573](#), [576–578](#), [580](#), [581](#), [583](#), [692](#), [697](#),  
[751](#), [810](#), [841](#), [853](#), [863](#)

MPI\_Comm, [16](#), [30](#), [314](#), [321–326](#), [329](#), [331](#),  
[334](#), [341–343](#), [353–357](#), [363](#), [366](#), [367](#),  
[500](#), [855](#), [856](#), [863](#), [864](#)

TYPE(MPI\_Comm), [797](#), [855](#), [856](#), [864](#)

MPI\_Count, [21](#), [33](#), [749](#), [751](#), [853](#), [863](#), [1042](#)

MPI\_Datatype, [119](#), [372](#), [373](#), [819](#), [853–856](#),  
[863](#), [864](#)

TYPE(MPI\_Datatype), [853–856](#), [864](#)

MPI\_Errhandler, [457](#), [458–465](#), [834](#), [852](#), [856](#),  
[863](#), [864](#)

TYPE(MPI\_Errhandler), [852](#), [856](#), [864](#)

MPI\_F08\_status, [836](#), [861](#), [863](#), [1045](#)

MPI\_File, [461](#), [462](#), [637](#), [640–643](#), [645](#), [646](#),  
[648](#), [650](#), [654–660](#), [662–666](#), [668–675](#),  
[677–679](#), [681–688](#), [692](#), [702–704](#), [834](#),  
[856](#), [863](#), [864](#)

TYPE(MPI\_File), [856](#), [864](#)

MPI\_Fint, [833](#), [861](#), [863](#), [1049](#)

MPI\_Group, [312](#), [313–320](#), [354](#), [500](#), [561](#), [592](#),  
[593](#), [643](#), [834](#), [856](#), [863](#), [864](#)

TYPE(MPI\_Group), [856](#), [864](#)

MPI\_Info, [451](#), [475](#), [476–481](#), [499](#), [502](#), [517](#),  
[521](#), [522](#), [530](#), [534–536](#), [543](#), [562](#), [637](#),  
[640](#), [645](#), [646](#), [648](#), [776](#), [834](#), [855](#), [856](#),  
[863](#), [864](#), [1052](#)

TYPE(MPI\_Info), [855](#), [856](#), [864](#)

MPI\_Message, [85](#), [834](#), [851](#), [856](#), [863](#), [864](#), [1043](#)

TYPE(MPI\_Message), [851](#), [856](#), [864](#)

MPI\_Offset, [20](#), [20](#), [21](#), [33](#), [641–643](#), [648](#), [650](#),  
[654–660](#), [670–672](#), [679](#), [681](#), [683](#), [698](#),  
[706](#), [751](#), [833](#), [853](#), [863](#)

MPI\_Op, [222](#), [231](#), [234](#), [236](#), [238–241](#), [243](#), [245](#),  
[246](#), [267–269](#), [271–273](#), [292–294](#),  
[296–298](#), [571](#), [573](#), [576](#), [581](#), [583](#), [834](#),  
[856](#), [863](#), [864](#)

TYPE(MPI\_Op), [856](#), [864](#)

MPI\_Request, [61–65](#), [67](#), [69](#), [70](#), [71](#), [74–77](#), [79](#),  
[81](#), [90–97](#), [104–108](#), [466](#), [626](#), [629](#),  
[657–660](#), [666](#), [668–670](#), [674](#), [675](#), [812](#),  
[834](#), [856](#), [863](#), [864](#)

TYPE(MPI\_Request), [856](#), [864](#)

MPI\_Session, [463](#), [464](#), [834](#), [856](#), [863](#), [864](#)

TYPE(MPI\_Session), [864](#)

MPI\_Status, [34](#), [37](#), [39–41](#), [69](#), [70](#), [74–77](#), [79](#),  
[81–83](#), [85](#), [87](#), [91](#), [152](#), [153](#), [627](#), [632](#),  
[633](#), [654–657](#), [662–665](#), [673](#), [674](#), [677](#),  
[678](#), [682](#), [684–688](#), [787](#), [835–838](#), [860](#),  
[863](#), [864](#), [1039](#), [1042](#), [1045](#)

TYPE(MPI\_Status), [37](#), [797](#), [836–838](#), [860](#), [864](#),  
[1035](#), [1039](#), [1045](#)

MPI\_T\_cb\_safety, [863](#)

MPI\_T\_cvar\_handle, [734](#), [735](#), [861](#)

MPI\_T\_enum, [728](#), [729](#), [730](#), [739](#), [754](#), [861](#)

MPI\_T\_event\_instance, [759](#)

MPI\_T\_event\_registration, [756](#)

MPI\_T\_pvar\_handle, [742](#), [743–746](#), [861](#), [862](#)

MPI\_T\_pvar\_session, [742](#), [743–746](#), [861](#)

MPI\_T\_source\_order, [863](#)

MPI\_Win, [369–371](#), [459](#), [460](#), [547](#), [550](#), [552](#),  
[556](#), [559](#), [561](#), [562](#), [564](#), [567](#), [571](#), [573](#),  
[576–578](#), [580](#), [581](#), [583](#), [590](#), [592–594](#),  
[596–601](#), [834](#), [856](#), [863](#), [864](#)

TYPE(MPI\_Win), [856](#), [864](#)

# MPI Callback Function Prototype Index

This index lists the C typedef names for callback routines, such as those used with attribute caching or user-defined reduction operations. Fortran example prototypes are given near the text of the C name.

MPI\_Comm\_copy\_attr\_function, [22](#), [23](#), [363](#),  
[364](#), [786](#), [857](#), [864](#)  
MPI\_Comm\_delete\_attr\_function, [23](#), [363](#), [365](#),  
[857](#), [864](#)  
MPI\_Comm\_errhandler\_fn, [776](#), [1048](#)  
MPI\_Comm\_errhandler\_function, [23](#), [457](#), [776](#),  
[780](#), [865](#), [1048](#)  
MPI\_Copy\_function, [23](#), [773](#), [858](#), [871](#)  
MPI\_Datarep\_conversion\_function, [698](#), [857](#), [865](#)  
MPI\_Datarep\_conversion\_function\_c, [698](#), [865](#)  
MPI\_Datarep\_extent\_function, [697](#), [865](#)  
MPI\_Delete\_function, [23](#), [774](#), [858](#), [871](#)  
MPI\_File\_errhandler\_fn, [776](#), [1048](#)  
MPI\_File\_errhandler\_function, [461](#), [776](#), [865](#),  
[1048](#)  
MPI\_Grequest\_cancel\_function, [628](#), [865](#)  
MPI\_Grequest\_free\_function, [627](#), [865](#)  
MPI\_Grequest\_query\_function, [627](#), [865](#)  
MPI\_Handler\_function, [23](#), [780](#), [1042](#)  
MPI\_Session\_errhandler\_function, [463](#), [865](#)  
MPI\_T\_event\_cb\_function, [758](#), [865](#)  
MPI\_T\_event\_dropped\_function, [761](#), [865](#)  
MPI\_T\_event\_free\_cb\_function, [760](#), [865](#)  
MPI\_Type\_copy\_attr\_function, [372](#), [857](#), [864](#)  
MPI\_Type\_delete\_attr\_function, [372](#), [373](#), [857](#),  
[865](#), [1046](#)  
MPI\_User\_function, [232](#), [236](#), [864](#)  
MPI\_User\_function\_c, [232](#), [864](#)  
MPI\_Win\_copy\_attr\_function, [368](#), [369](#), [857](#),  
[864](#)  
MPI\_Win\_delete\_attr\_function, [368](#), [369](#), [857](#),  
[864](#)  
MPI\_Win\_errhandler\_fn, [776](#), [1048](#)  
MPI\_Win\_errhandler\_function, [459](#), [776](#), [865](#),  
[1048](#)

# MPI Function Index

The underlined page numbers refer to the function definitions.

COMM\_COPY\_ATTR\_FUNCTION, [23](#)  
COMM\_DELETE\_ATTR\_FUNCTION, [23](#)  
COPY\_FUNCTION, [23](#)  
DELETE\_FUNCTION, [23](#)  
MPI\_ABORT, [233](#), [455](#), [485](#), [491](#), [508](#), [509](#),  
[542](#), [727](#), [833](#), [1052](#)  
MPI\_ACCUMULATE, [545](#), [563](#), [571](#), [572](#), [576](#),  
[583](#), [587](#), [612](#), [618](#), [620](#), [1049](#), [1052](#)  
MPI\_Accumulate\_c, [571](#)  
MPI\_ADD\_ERROR\_CLASS, [469](#), [470](#)  
MPI\_ADD\_ERROR\_CODE, [470](#)  
MPI\_ADD\_ERROR\_STRING, [471](#)  
MPI\_ADDRESS, [23](#), [779](#), [796](#), [1042](#)  
MPI\_AINT\_ADD, [24](#), [139](#), [140](#), [557](#), [1040](#)  
MPI\_AINT\_DIFF, [24](#), [139](#), [140](#), [141](#), [557](#), [1040](#)  
MPI\_ALLGATHER, [185](#), [189](#), [190](#), [211](#), [212](#),  
[214](#), [216](#), [259](#)  
MPI\_Allgather\_c, [211](#)  
MPI\_ALLGATHER\_INIT, [284](#)  
MPI\_Allgather\_init\_c, [284](#)  
MPI\_ALLGATHERV, [185](#), [189](#), [190](#), [213](#), [214](#),  
[261](#)  
MPI\_Allgatherv\_c, [213](#)  
MPI\_ALLGATHERV\_INIT, [285](#)  
MPI\_Allgatherv\_init\_c, [285](#)  
MPI\_ALLOC\_MEM, [451](#), [452–454](#), [467](#), [549](#),  
[551](#), [553–555](#), [558](#), [566](#), [599](#), [796–798](#),  
[810](#), [1037](#), [1039](#), [1046](#)  
MPI\_ALLOC\_MEM\_CPTR, [452](#), [1039](#)  
MPI\_ALLREDUCE, [185](#), [188–190](#), [224](#), [232](#),  
[236](#), [237](#), [269](#), [1050](#)  
MPI\_Allreduce\_c, [237](#)  
MPI\_ALLREDUCE\_INIT, [293](#)  
MPI\_Allreduce\_init\_c, [293](#)  
MPI\_ALLTOALL, [185](#), [189](#), [190](#), [215](#), [216](#),  
[218](#), [219](#), [262](#), [1047](#)  
MPI\_Alltoall\_c, [215](#)  
MPI\_ALLTOALL\_INIT, [287](#)  
MPI\_Alltoall\_init\_c, [287](#)  
MPI\_ALLTOALLV, [185](#), [189](#), [190](#), [217](#), [218](#),  
[219](#), [221](#), [264](#), [1047](#)  
MPI\_Alltoallv\_c, [217](#)  
MPI\_ALLTOALLV\_INIT, [288](#)  
MPI\_Alltoallv\_init\_c, [288](#)  
MPI\_ALLTOALLW, [185](#), [189](#), [190](#), [219](#), [220](#),  
[221](#), [266](#), [1047](#)  
MPI\_Alltoallw\_c, [220](#)  
MPI\_ALLTOALLW\_INIT, [290](#)  
MPI\_Alltoallw\_init\_c, [290](#)  
MPI\_ATTR\_DELETE, [23](#), [375](#), [774](#), [776](#)  
MPI\_ATTR\_GET, [23](#), [375](#), [775](#), [841](#)  
MPI\_ATTR\_PUT, [23](#), [375](#), [775](#), [841](#), [844](#), [845](#)  
MPI\_BARRIER, [185](#), [189](#), [191](#), [250](#), [508](#),  
[609–611](#), [708](#)  
MPI\_BARRIER\_INIT, [275](#)  
MPI\_BCAST, [14](#), [185](#), [189](#), [192](#), [193](#), [223](#), [251](#),  
[302](#), [303](#)  
MPI\_Bcast\_c, [192](#)  
MPI\_BCAST\_INIT, [14](#), [276](#)  
MPI\_Bcast\_init\_c, [276](#)  
MPI\_BSEND, [14](#), [48](#), [49](#), [59](#)  
MPI\_Bsend\_c, [49](#)  
MPI\_BSEND\_INIT, [93](#), [97](#)  
MPI\_Bsend\_init\_c, [93](#)  
MPI\_BUFFER\_ATTACH, [56](#), [69](#)  
MPI\_Buffer\_attach\_c, [56](#)  
MPI\_BUFFER\_DETACH, [57](#), [1036](#), [1045](#)  
MPI\_Buffer\_detach\_c, [57](#)  
MPI\_CANCEL, [23](#), [52](#), [70](#), [82](#), [90](#), [91](#), [92](#), [249](#),  
[275](#), [492](#), [578](#), [625](#), [628](#), [629](#), [776](#), [1036](#)  
MPI\_CART\_COORDS, [387](#), [402](#), [403](#), [1051](#)  
MPI\_CART\_CREATE, [352](#), [387](#), [388](#),  
[389–391](#), [411](#), [412](#), [811](#), [1039](#), [1050](#)  
MPI\_CART\_GET, [387](#), [401](#), [1051](#)  
MPI\_CART\_MAP, [387](#), [410](#), [411](#), [1044](#)  
MPI\_CART\_RANK, [387](#), [402](#), [1051](#)  
MPI\_CART\_SHIFT, [387](#), [407](#), [408](#), [412](#), [1051](#)  
MPI\_CART\_SUB, [387](#), [409](#), [411](#), [1051](#)  
MPI\_CARTDIM\_GET, [387](#), [400](#), [401](#), [1051](#)  
MPI\_CLOSE\_PORT, [531](#), [535](#)  
MPI\_COMM\_ACCEPT, [529](#), [530](#), [532](#), [533](#),  
[540](#), [541](#)  
MPI\_COMM\_C2F, [834](#)

MPI_COMM_CALL_ERRHANDLER, <a href="#">471</a> , <a href="#">473</a>	MPI_COMM_RANK, <a href="#">14</a> , <a href="#">322</a> , <a href="#">353</a> , <a href="#">794</a>	1
MPI_COMM_COMPARE, <a href="#">323</a> , <a href="#">353</a>	MPI_COMM_RANK_F08, <a href="#">794</a>	2
MPI_COMM_CONNECT, <a href="#">468</a> , <a href="#">533</a> , <a href="#">540</a> , <a href="#">541</a>	MPI_COMM_REMOTE_GROUP, <a href="#">354</a>	3
MPI_COMM_CREATE, <a href="#">321</a> , <a href="#">323</a> , <a href="#">327</a> , <a href="#">328–332</a> , <a href="#">387</a> , <a href="#">1048</a>	MPI_COMM_REMOTE_SIZE, <a href="#">354</a>	4
MPI_COMM_CREATE_ERRHANDLER, <a href="#">23</a> , <a href="#">456</a> , <a href="#">457</a> , <a href="#">458</a> , <a href="#">779</a> , <a href="#">867</a> , <a href="#">870</a> , <a href="#">1046</a>	MPI_COMM_SET_ATTR, <a href="#">23</a> , <a href="#">361</a> , <a href="#">365</a> , <a href="#">366</a> , <a href="#">375</a> , <a href="#">774</a> , <a href="#">792</a> , <a href="#">841</a> , <a href="#">845</a>	5
MPI_COMM_CREATE_FROM_GROUP, <a href="#">323</a> , <a href="#">339</a> , <a href="#">340</a> , <a href="#">357</a> , <a href="#">449</a>	MPI_COMM_SET_ERRHANDLER, <a href="#">23</a> , <a href="#">456</a> , <a href="#">458</a> , <a href="#">779</a>	6
MPI_COMM_CREATE_GROUP, <a href="#">323</a> , <a href="#">330</a> , <a href="#">331</a> , <a href="#">332</a> , <a href="#">340</a> , <a href="#">1044</a>	MPI_COMM_SET_INFO, <a href="#">275</a> , <a href="#">341</a> , <a href="#">342</a> , <a href="#">343</a> , <a href="#">1037</a> , <a href="#">1039</a> , <a href="#">1043</a>	8
MPI_COMM_CREATE_KEYVAL, <a href="#">23</a> , <a href="#">361</a> , <a href="#">362</a> , <a href="#">364</a> , <a href="#">365</a> , <a href="#">375</a> , <a href="#">773</a> , <a href="#">840</a> , <a href="#">841</a> , <a href="#">866</a> , <a href="#">869</a> , <a href="#">1046</a> , <a href="#">1050</a>	MPI_COMM_SET_NAME, <a href="#">378</a>	10
MPI_COMM_DELETE_ATTR, <a href="#">23</a> , <a href="#">361</a> , <a href="#">365</a> , <a href="#">366</a> , <a href="#">368</a> , <a href="#">375</a> , <a href="#">775</a>	MPI_COMM_SIZE, <a href="#">321</a> , <a href="#">322</a> , <a href="#">353</a> , <a href="#">618</a>	11
MPI_COMM_DISCONNECT, <a href="#">375</a> , <a href="#">498</a> , <a href="#">508</a> , <a href="#">522</a> , <a href="#">542</a> , <a href="#">543</a>	MPI_COMM_SPAWN, <a href="#">485</a> , <a href="#">486</a> , <a href="#">511</a> , <a href="#">516</a> , <a href="#">517</a> , <a href="#">518</a> , <a href="#">519–522</a> , <a href="#">524–526</a> , <a href="#">540</a> , <a href="#">541</a> , <a href="#">1038</a>	12
MPI_COMM_DUP, <a href="#">314</a> , <a href="#">321</a> , <a href="#">323</a> , <a href="#">324</a> , <a href="#">325</a> , <a href="#">326</a> , <a href="#">328</a> , <a href="#">355</a> , <a href="#">358</a> , <a href="#">361</a> , <a href="#">364</a> , <a href="#">368</a> , <a href="#">375</a> , <a href="#">383</a> , <a href="#">773</a> , <a href="#">781</a> , <a href="#">1037</a> , <a href="#">1043</a>	MPI_COMM_SPAWN_MULTIPLE, <a href="#">485</a> , <a href="#">486</a> , <a href="#">511</a> , <a href="#">516</a> , <a href="#">517</a> , <a href="#">522</a> , <a href="#">523</a> , <a href="#">524</a> , <a href="#">541</a> , <a href="#">1038</a>	14
MPI_COMM_DUP_FN, <a href="#">23</a> , <a href="#">364</a> , <a href="#">365</a> , <a href="#">791</a> , <a href="#">857</a> , <a href="#">1040</a> , <a href="#">1046</a>	MPI_COMM_SPLIT, <a href="#">323</a> , <a href="#">327</a> , <a href="#">328</a> , <a href="#">331</a> , <a href="#">332</a> , <a href="#">333</a> , <a href="#">383</a> , <a href="#">387</a> , <a href="#">389</a> , <a href="#">391</a> , <a href="#">409</a> , <a href="#">411</a> , <a href="#">412</a> , <a href="#">1048</a>	15
MPI_COMM_DUP_WITH_INFO, <a href="#">323</a> , <a href="#">325</a> , <a href="#">326</a> , <a href="#">341</a> , <a href="#">781</a> , <a href="#">1043</a>	MPI_COMM_SPLIT_TYPE, <a href="#">323</a> , <a href="#">335</a> , <a href="#">338</a> , <a href="#">341</a> , <a href="#">1036</a> , <a href="#">1044</a>	18
MPI_COMM_F2C, <a href="#">834</a>	MPI_COMM_TEST_INTER, <a href="#">352</a> , <a href="#">353</a>	20
MPI_COMM_FREE, <a href="#">321</a> , <a href="#">324</a> , <a href="#">341</a> , <a href="#">355</a> , <a href="#">358</a> , <a href="#">365</a> , <a href="#">366</a> , <a href="#">368</a> , <a href="#">375</a> , <a href="#">491</a> , <a href="#">495</a> , <a href="#">498</a> , <a href="#">508</a> , <a href="#">522</a> , <a href="#">542</a> , <a href="#">543</a> , <a href="#">774</a>	MPI_COMPARE_AND_SWAP, <a href="#">545</a> , <a href="#">563</a> , <a href="#">577</a> , <a href="#">618</a>	21
MPI_COMM_FREE_KEYVAL, <a href="#">23</a> , <a href="#">361</a> , <a href="#">365</a> , <a href="#">375</a> , <a href="#">774</a>	MPI_CONVERSION_FN_NULL, <a href="#">700</a> , <a href="#">857</a> , <a href="#">1040</a>	22
MPI_COMM_GET_ATTR, <a href="#">23</a> , <a href="#">361</a> , <a href="#">366</a> , <a href="#">367</a> , <a href="#">375</a> , <a href="#">449</a> , <a href="#">775</a> , <a href="#">792</a> , <a href="#">841</a> , <a href="#">844</a>	MPI_DATAREP_CONVERSION_FUNCTION, <a href="#">698</a> , <a href="#">831</a>	24
MPI_COMM_GET_ERRHANDLER, <a href="#">23</a> , <a href="#">456</a> , <a href="#">458</a> , <a href="#">779</a> , <a href="#">1051</a>	MPI_Datarep_conversion_function_c, <a href="#">698</a> , <a href="#">865</a>	26
MPI_COMM_GET_INFO, <a href="#">341</a> , <a href="#">343</a> , <a href="#">1037</a> , <a href="#">1043</a>	MPI_DIMS_CREATE, <a href="#">387</a> , <a href="#">389</a> , <a href="#">390</a> , <a href="#">1037</a>	27
MPI_COMM_GET_NAME, <a href="#">378</a> , <a href="#">379</a> , <a href="#">380</a> , <a href="#">1050</a>	MPI_DIST_GRAPH_CREATE, <a href="#">341</a> , <a href="#">387</a> , <a href="#">392</a> , <a href="#">395</a> , <a href="#">396–398</a> , <a href="#">407</a> , <a href="#">412</a> , <a href="#">1048</a>	28
MPI_COMM_GET_PARENT, <a href="#">379</a> , <a href="#">485</a> , <a href="#">486</a> , <a href="#">491</a> , <a href="#">496</a> , <a href="#">519</a> , <a href="#">522</a>	MPI_DIST_GRAPH_CREATE_ADJACENT, <a href="#">341</a> , <a href="#">387</a> , <a href="#">392</a> , <a href="#">393</a> , <a href="#">394</a> , <a href="#">398</a> , <a href="#">407</a> , <a href="#">412</a> , <a href="#">1044</a> , <a href="#">1048</a>	29
MPI_COMM_GROUP, <a href="#">17</a> , <a href="#">312</a> , <a href="#">314</a> , <a href="#">315</a> , <a href="#">321</a> , <a href="#">322</a> , <a href="#">353</a> , <a href="#">456</a> , <a href="#">1051</a>	MPI_DIST_GRAPH_NEIGHBORS, <a href="#">387</a> , <a href="#">405</a> , <a href="#">406</a> , <a href="#">407</a> , <a href="#">412</a> , <a href="#">1044</a> , <a href="#">1048</a>	32
MPI_COMM_IDUP, <a href="#">321</a> , <a href="#">323</a> , <a href="#">325</a> , <a href="#">326</a> , <a href="#">351</a> , <a href="#">361</a> , <a href="#">364</a> , <a href="#">368</a> , <a href="#">375</a> , <a href="#">781</a> , <a href="#">1037</a> , <a href="#">1039</a> , <a href="#">1043</a>	MPI_DIST_GRAPH_NEIGHBORS_COUNT, <a href="#">387</a> , <a href="#">405</a> , <a href="#">407</a> , <a href="#">1041</a> , <a href="#">1048</a>	34
MPI_COMM_IDUP_WITH_INFO, <a href="#">323</a> , <a href="#">326</a> , <a href="#">341</a> , <a href="#">781</a> , <a href="#">1037</a>	MPI_DUP_FN, <a href="#">23</a> , <a href="#">364</a> , <a href="#">774</a> , <a href="#">858</a>	35
MPI_COMM_JOIN, <a href="#">496</a> , <a href="#">543</a> , <a href="#">544</a>	MPI_ERRHANDLER_C2F, <a href="#">509</a> , <a href="#">834</a>	36
MPI_COMM_NULL_COPY_FN, <a href="#">23</a> , <a href="#">364</a> , <a href="#">365</a> , <a href="#">786</a> , <a href="#">840</a> , <a href="#">857</a> , <a href="#">1040</a> , <a href="#">1046</a>	MPI_ERRHANDLER_CREATE, <a href="#">23</a> , <a href="#">779</a> , <a href="#">1042</a> , <a href="#">1046</a>	37
MPI_COMM_NULL_DELETE_FN, <a href="#">23</a> , <a href="#">365</a> , <a href="#">857</a> , <a href="#">1040</a>	MPI_ERRHANDLER_F2C, <a href="#">509</a> , <a href="#">834</a>	38
	MPI_ERRHANDLER_FREE, <a href="#">456</a> , <a href="#">465</a> , <a href="#">491</a> , <a href="#">498</a> , <a href="#">509</a> , <a href="#">1051</a>	39
	MPI_ERRHANDLER_GET, <a href="#">23</a> , <a href="#">779</a> , <a href="#">1042</a> , <a href="#">1051</a>	40
	MPI_ERRHANDLER_SET, <a href="#">23</a> , <a href="#">779</a> , <a href="#">1042</a>	41
	MPI_ERROR_CLASS, <a href="#">466</a> , <a href="#">469</a> , <a href="#">509</a>	42
	MPI_ERROR_STRING, <a href="#">465</a> , <a href="#">466</a> , <a href="#">469</a> , <a href="#">471</a> , <a href="#">509</a>	43
	MPI_EVENT_CALLBACK_GET_INFO, <a href="#">759</a>	44
	MPI_EVENT_HANDLE_GET_INFO, <a href="#">757</a>	45
		46
		47
		48

- 1 MPI\_EXSCAN, [186](#), [189](#), [224](#), [232](#), [245](#), [274](#),  
2 [1048](#)
- 3 MPI\_Exscan\_c, [245](#)
- 4 MPI\_EXSCAN\_INIT, [298](#)
- 5 MPI\_Exscan\_init\_c, [298](#)
- 6 MPI\_F\_SYNC\_REG, [140](#), [620](#), [784](#), [800](#), [801](#),  
7 [820](#), [822–825](#), [1046](#)
- 8 MPI\_FETCH\_AND\_OP, [545](#), [563](#), [572](#), [576](#)
- 9 MPI\_FILE\_C2F, [834](#)
- 10 MPI\_FILE\_CALL\_ERRHANDLER, [472](#), [473](#)
- 11 MPI\_FILE\_CLOSE, [543](#), [637](#), [638](#), [640](#)
- 12 MPI\_FILE\_CREATE\_ERRHANDLER, [456](#),  
13 [461](#), [462](#), [867](#), [870](#), [1046](#)
- 14 MPI\_FILE\_DELETE, [639](#), [640](#), [641](#), [645](#), [647](#),  
15 [712](#)
- 16 MPI\_FILE\_F2C, [834](#)
- 17 MPI\_FILE\_GET\_AMODE, [644](#)
- 18 MPI\_FILE\_GET\_ATOMICITY, [703](#), [704](#)
- 19 MPI\_FILE\_GET\_BYTE\_OFFSET, [662](#), [672](#),  
20 [680](#)
- 21 MPI\_FILE\_GET\_ERRHANDLER, [456](#), [462](#),  
22 [712](#), [1051](#)
- 23 MPI\_FILE\_GET\_GROUP, [643](#)
- 24 MPI\_FILE\_GET\_INFO, [645](#), [646](#), [647](#), [1037](#),  
25 [1052](#)
- 26 MPI\_FILE\_GET\_POSITION, [671](#), [672](#)
- 27 MPI\_FILE\_GET\_POSITION\_SHARED, [679](#),  
28 [680](#), [704](#)
- 29 MPI\_FILE\_GET\_SIZE, [643](#), [707](#)
- 30 MPI\_FILE\_GET\_TYPE\_EXTENT, [691](#), [692](#),  
31 [700](#), [1036](#)
- 32 MPI\_File\_get\_type\_extent\_c, [692](#)
- 33 MPI\_FILE\_GET\_VIEW, [650](#), [651](#)
- 34 MPI\_FILE\_IREAD, [651](#), [667](#), [680](#), [701](#), [702](#)
- 35 MPI\_FILE\_IREAD\_ALL, [651](#), [668](#), [669](#), [1041](#)
- 36 MPI\_File\_iread\_all\_c, [668](#)
- 37 MPI\_FILE\_IREAD\_AT, [651](#), [658](#)
- 38 MPI\_FILE\_IREAD\_AT\_ALL, [651](#), [659](#), [1041](#)
- 39 MPI\_File\_iread\_at\_all\_c, [659](#)
- 40 MPI\_File\_iread\_at\_c, [658](#)
- 41 MPI\_File\_iread\_c, [667](#)
- 42 MPI\_FILE\_IREAD\_SHARED, [651](#), [675](#)
- 43 MPI\_File\_iread\_shared\_c, [675](#)
- 44 MPI\_FILE\_IWRITE, [651](#), [669](#), [670](#)
- 45 MPI\_FILE\_IWRITE\_ALL, [651](#), [670](#), [1041](#)
- 46 MPI\_File\_iwrite\_all\_c, [670](#)
- 47 MPI\_FILE\_IWRITE\_AT, [651](#), [660](#)
- 48 MPI\_FILE\_IWRITE\_AT\_ALL, [651](#), [661](#), [1041](#)
- MPI\_File\_iwrite\_at\_all\_c, [661](#)
- MPI\_File\_iwrite\_at\_c, [660](#)
- MPI\_File\_iwrite\_c, [669](#)
- MPI\_FILE\_IWRITE\_SHARED, [651](#), [676](#)
- MPI\_File\_iwrite\_shared\_c, [676](#)
- MPI\_FILE\_OPEN, [467](#), [515](#), [637](#), [638](#), [639](#),  
[645](#), [647](#), [649](#), [672](#), [706](#), [707](#), [712](#), [713](#)
- MPI\_FILE\_PREALLOCATE, [641](#), [642](#), [702](#),  
[707](#)
- MPI\_FILE\_READ, [651](#), [652](#), [662](#), [663](#), [664](#),  
[667](#), [706](#), [707](#)
- MPI\_FILE\_READ\_ALL, [651](#), [664](#), [669](#), [681](#)
- MPI\_FILE\_READ\_ALL\_BEGIN, [651](#), [680](#),  
[681](#), [684](#), [701](#), [825](#)
- MPI\_File\_read\_all\_begin\_c, [684](#)
- MPI\_File\_read\_all\_c, [664](#)
- MPI\_FILE\_READ\_ALL\_END, [651](#), [680](#), [681](#),  
[685](#), [701](#), [825](#)
- MPI\_FILE\_READ\_ALL\_FN, [14](#)
- MPI\_FILE\_READ\_AT, [651](#), [654](#), [655](#), [656](#), [658](#)
- MPI\_FILE\_READ\_AT\_ALL, [651](#), [655](#), [656](#),  
[659](#)
- MPI\_FILE\_READ\_AT\_ALL\_BEGIN, [651](#),  
[682](#), [825](#)
- MPI\_File\_read\_at\_all\_begin\_c, [682](#)
- MPI\_File\_read\_at\_all\_c, [655](#)
- MPI\_FILE\_READ\_AT\_ALL\_END, [651](#), [682](#),  
[825](#)
- MPI\_FILE\_READ\_AT\_ALL\_FN, [14](#)
- MPI\_File\_read\_at\_c, [654](#)
- MPI\_File\_read\_c, [662](#)
- MPI\_FILE\_READ\_ORDERED, [651](#), [677](#), [678](#)
- MPI\_FILE\_READ\_ORDERED\_BEGIN, [651](#),  
[687](#), [825](#)
- MPI\_File\_read\_ordered\_begin\_c, [687](#)
- MPI\_File\_read\_ordered\_c, [677](#)
- MPI\_FILE\_READ\_ORDERED\_END, [651](#),  
[687](#), [825](#)
- MPI\_FILE\_READ\_ORDERED\_FN, [14](#)
- MPI\_FILE\_READ\_SHARED, [651](#), [673](#), [674](#),  
[675](#), [678](#)
- MPI\_File\_read\_shared\_c, [673](#)
- MPI\_FILE\_SEEK, [671](#), [672](#)
- MPI\_FILE\_SEEK\_SHARED, [679](#), [680](#), [704](#)
- MPI\_FILE\_SET\_ATOMICITY, [639](#), [702](#), [703](#)
- MPI\_FILE\_SET\_ERRHANDLER, [456](#), [462](#),  
[712](#)
- MPI\_FILE\_SET\_INFO, [645](#), [646](#), [647](#), [1037](#),  
[1052](#)
- MPI\_FILE\_SET\_SIZE, [641](#), [642](#), [702](#), [705](#), [707](#)
- MPI\_FILE\_SET\_VIEW, [134](#), [468](#), [638](#),  
[645–647](#), [648](#), [649](#), [650](#), [672](#), [680](#), [690](#),  
[697](#), [706](#), [713](#), [1052](#), [1053](#)
- MPI\_FILE\_SYNC, [640](#), [652](#), [701](#), [702](#), [704](#), [709](#)
- MPI\_FILE\_WRITE, [651](#), [652](#), [665](#), [666](#), [670](#),  
[706](#)
- MPI\_FILE\_WRITE\_ALL, [651](#), [666](#), [670](#)
- MPI\_FILE\_WRITE\_ALL\_BEGIN, [651](#), [685](#),  
[812](#), [825](#)



MPI_File_write_all_begin_c, <a href="#">685</a>	MPI_GET_COUNT, <a href="#">37</a> , <a href="#">38</a> , <a href="#">39</a> , <a href="#">69</a> , <a href="#">153</a> , <a href="#">154</a> , <a href="#">578</a> , <a href="#">633</a> , <a href="#">654</a> , <a href="#">1043</a> , <a href="#">1049</a>	1
MPI_File_write_all_c, <a href="#">666</a>	MPI_Get_count_c, <a href="#">38</a>	2
MPI_FILE_WRITE_ALL_END, <a href="#">651</a> , <a href="#">686</a> , <a href="#">825</a>	MPI_GET_ELEMENTS, <a href="#">69</a> , <a href="#">152</a> , <a href="#">153</a> , <a href="#">154</a> , <a href="#">633</a> , <a href="#">634</a> , <a href="#">654</a> , <a href="#">1043</a>	3
MPI_FILE_WRITE_ALL_FN, <a href="#">14</a>	MPI_Get_elements_c, <a href="#">152</a>	4
MPI_FILE_WRITE_AT, <a href="#">651</a> , <a href="#">652</a> , <a href="#">656</a> , <a href="#">657</a> , <a href="#">660</a>	MPI_GET_ELEMENTS_X, <a href="#">69</a> , <a href="#">152</a> , <a href="#">153</a> , <a href="#">154</a> , <a href="#">633</a> , <a href="#">654</a> , <a href="#">1042</a>	5
MPI_FILE_WRITE_AT_ALL, <a href="#">651</a> , <a href="#">657</a> , <a href="#">661</a>	MPI_GET_LIBRARY_VERSION, <a href="#">448</a> , <a href="#">509</a> , <a href="#">1039</a> , <a href="#">1040</a> , <a href="#">1042</a>	6
MPI_FILE_WRITE_AT_ALL_BEGIN, <a href="#">651</a> , <a href="#">683</a> , <a href="#">825</a>	MPI_GET_PROCESSOR_NAME, <a href="#">450</a> , <a href="#">451</a> , <a href="#">1051</a>	7
MPI_File_write_at_all_begin_c, <a href="#">683</a>	MPI_GET_VERSION, <a href="#">447</a> , <a href="#">448</a> , <a href="#">509</a> , <a href="#">799</a> , <a href="#">1040</a>	8
MPI_File_write_at_all_c, <a href="#">657</a>	MPI_GRAPH_CREATE, <a href="#">387</a> , <a href="#">390</a> , <a href="#">392</a> , <a href="#">397</a> , <a href="#">400</a> , <a href="#">404</a> , <a href="#">411</a> , <a href="#">412</a> , <a href="#">1050</a> , <a href="#">1051</a>	9
MPI_FILE_WRITE_AT_ALL_END, <a href="#">651</a> , <a href="#">684</a> , <a href="#">825</a>	MPI_GRAPH_GET, <a href="#">387</a> , <a href="#">400</a>	10
MPI_FILE_WRITE_AT_ALL_FN, <a href="#">14</a>	MPI_GRAPH_MAP, <a href="#">387</a> , <a href="#">411</a> , <a href="#">412</a>	11
MPI_File_write_at_c, <a href="#">656</a>	MPI_GRAPH_NEIGHBORS, <a href="#">387</a> , <a href="#">403</a> , <a href="#">404</a> , <a href="#">412</a> , <a href="#">1048</a>	12
MPI_File_write_c, <a href="#">665</a>	MPI_GRAPH_NEIGHBORS_COUNT, <a href="#">387</a> , <a href="#">403</a> , <a href="#">404</a> , <a href="#">1048</a>	13
MPI_FILE_WRITE_ORDERED, <a href="#">651</a> , <a href="#">677</a> , <a href="#">678</a>	MPI_GRAPHDIMS_GET, <a href="#">387</a> , <a href="#">399</a> , <a href="#">400</a>	14
MPI_FILE_WRITE_ORDERED_BEGIN, <a href="#">651</a> , <a href="#">688</a> , <a href="#">825</a>	MPI_GREQUEST_COMPLETE, <a href="#">626</a> – <a href="#">628</a> , <a href="#">629</a>	15
MPI_File_write_ordered_begin_c, <a href="#">688</a>	MPI_GREQUEST_START, <a href="#">626</a> , <a href="#">868</a> , <a href="#">870</a> , <a href="#">1049</a>	16
MPI_File_write_ordered_c, <a href="#">678</a>	MPI_GROUP_C2F, <a href="#">834</a>	17
MPI_FILE_WRITE_ORDERED_END, <a href="#">651</a> , <a href="#">689</a> , <a href="#">825</a>	MPI_GROUP_COMPARE, <a href="#">314</a> , <a href="#">317</a>	18
MPI_FILE_WRITE_ORDERED_FN, <a href="#">14</a>	MPI_GROUP_DIFFERENCE, <a href="#">316</a>	19
MPI_FILE_WRITE_SHARED, <a href="#">651</a> , <a href="#">652</a> , <a href="#">674</a> , <a href="#">676</a> – <a href="#">678</a>	MPI_GROUP_EXCL, <a href="#">317</a> , <a href="#">318</a> , <a href="#">319</a>	20
MPI_File_write_shared_c, <a href="#">674</a>	MPI_GROUP_F2C, <a href="#">834</a>	21
MPI_FINALIZE, <a href="#">18</a> , <a href="#">25</a> , <a href="#">26</a> , <a href="#">449</a> , <a href="#">455</a> , <a href="#">483</a> , <a href="#">490</a> , <a href="#">491</a> – <a href="#">495</a> , <a href="#">514</a> , <a href="#">542</a> , <a href="#">543</a> , <a href="#">638</a> , <a href="#">723</a> , <a href="#">734</a> , <a href="#">747</a> , <a href="#">749</a> , <a href="#">833</a> , <a href="#">836</a> , <a href="#">837</a> , <a href="#">1038</a> , <a href="#">1044</a> , <a href="#">1052</a>	MPI_GROUP_FREE, <a href="#">320</a> , <a href="#">321</a> , <a href="#">322</a> , <a href="#">456</a> , <a href="#">491</a> , <a href="#">498</a> , <a href="#">1051</a>	22
MPI_FINALIZED, <a href="#">493</a> , <a href="#">494</a> , <a href="#">495</a> , <a href="#">509</a> , <a href="#">833</a> , <a href="#">1040</a>	MPI_GROUP_FROM_SESSION_PSET, <a href="#">320</a>	23
MPI_FREE_MEM, <a href="#">453</a> , <a href="#">467</a> , <a href="#">551</a> , <a href="#">553</a>	MPI_GROUP_INCL, <a href="#">317</a> , <a href="#">319</a>	24
MPI_GATHER, <a href="#">185</a> , <a href="#">188</a> , <a href="#">189</a> , <a href="#">194</a> , <a href="#">197</a> , <a href="#">198</a> , <a href="#">205</a> , <a href="#">212</a> , <a href="#">223</a> , <a href="#">253</a>	MPI_GROUP_INTERSECTION, <a href="#">315</a>	25
MPI_Gather_c, <a href="#">194</a>	MPI_GROUP_RANGE_EXCL, <a href="#">319</a>	26
MPI_GATHER_INIT, <a href="#">277</a>	MPI_GROUP_RANGE_INCL, <a href="#">318</a> , <a href="#">319</a>	27
MPI_Gather_init_c, <a href="#">277</a>	MPI_GROUP_RANK, <a href="#">312</a> , <a href="#">322</a>	28
MPI_GATHERV, <a href="#">185</a> , <a href="#">189</a> , <a href="#">196</a> , <a href="#">197</a> – <a href="#">199</a> , <a href="#">207</a> , <a href="#">214</a> , <a href="#">255</a>	MPI_GROUP_SIZE, <a href="#">312</a> , <a href="#">322</a>	29
MPI_Gatherv_c, <a href="#">196</a>	MPI_GROUP_TRANSLATE_RANKS, <a href="#">313</a> , <a href="#">1050</a>	30
MPI_GATHERV_INIT, <a href="#">279</a>	MPI_GROUP_UNION, <a href="#">315</a>	31
MPI_Gatherv_init_c, <a href="#">279</a>	MPI_IALLGATHER, <a href="#">185</a> , <a href="#">189</a> , <a href="#">190</a> , <a href="#">258</a>	32
MPI_GET, <a href="#">545</a> , <a href="#">563</a> , <a href="#">567</a> , <a href="#">568</a> , <a href="#">576</a> , <a href="#">581</a> , <a href="#">587</a> , <a href="#">609</a> , <a href="#">611</a> , <a href="#">612</a> , <a href="#">620</a> , <a href="#">823</a> , <a href="#">1052</a>	MPI_Iallgather_c, <a href="#">258</a>	33
MPI_GET_ACCUMULATE, <a href="#">545</a> , <a href="#">563</a> , <a href="#">572</a> , <a href="#">574</a> , <a href="#">575</a> , <a href="#">576</a> , <a href="#">585</a> , <a href="#">612</a> , <a href="#">618</a> , <a href="#">1039</a>	MPI_IALLGATHERV, <a href="#">185</a> , <a href="#">189</a> , <a href="#">190</a> , <a href="#">260</a>	34
MPI_Get_accumulate_c, <a href="#">574</a>	MPI_Iallgather_v_c, <a href="#">260</a>	35
MPI_GET_ADDRESS, <a href="#">23</a> , <a href="#">119</a> , <a href="#">139</a> , <a href="#">140</a> , <a href="#">141</a> , <a href="#">155</a> , <a href="#">557</a> , <a href="#">779</a> , <a href="#">796</a> , <a href="#">814</a> , <a href="#">819</a> , <a href="#">838</a> – <a href="#">840</a>	MPI_IALLREDUCE, <a href="#">185</a> , <a href="#">189</a> , <a href="#">190</a> , <a href="#">268</a>	36
MPI_Get_c, <a href="#">567</a>	MPI_Iallreduce_c, <a href="#">268</a>	37
	MPI_IALLTOALL, <a href="#">185</a> , <a href="#">189</a> , <a href="#">190</a> , <a href="#">261</a>	38
	MPI_Ialltoall_c, <a href="#">261</a>	39
	MPI_IALLTOALLV, <a href="#">185</a> , <a href="#">189</a> , <a href="#">190</a> , <a href="#">263</a>	40
	MPI_Ialltoall_v_c, <a href="#">263</a>	41
	MPI_IALLTOALLW, <a href="#">185</a> , <a href="#">189</a> , <a href="#">190</a> , <a href="#">265</a>	42
		43
		44
		45
		46
		47
		48

- 1 MPI\_Ialltoallw\_c, [265](#)
- 2 MPI\_IBARRIER, [185](#), [189](#), [248](#), [250](#), [303](#)
- 3 MPI\_IBCAST, [14](#), [185](#), [189](#), [251](#), [306](#)
- 4 MPI\_Ibcast\_c, [251](#)
- 5 MPI\_IBSEND, [62](#), [69](#), [97](#)
- 6 MPI\_Ibsend\_c, [62](#)
- 7 MPI\_IEXSCAN, [186](#), [189](#), [273](#)
- 8 MPI\_Iexscan\_c, [273](#)
- 9 MPI\_IGATHER, [185](#), [189](#), [252](#)
- 10 MPI\_IGATHERV, [185](#), [189](#), [254](#)
- 11 MPI\_Igather\_c, [252](#)
- 12 MPI\_IGATHERV, [185](#), [189](#), [254](#)
- 13 MPI\_Igatherv\_c, [254](#)
- 14 MPI\_IMPROBE, [14](#), [82](#), [85](#), [86](#), [87](#), [90](#), [515](#),  
[1039](#), [1043](#)
- 15 MPI\_IMRECV, [85–87](#), [89](#), [90](#), [1043](#)
- 16 MPI\_Imrecv\_c, [89](#)
- 17 MPI\_INEIGHBOR\_ALLGATHER, [388](#), [425](#),  
[1044](#)
- 18 MPI\_Ineighbor\_allgather\_c, [425](#)
- 19 MPI\_INEIGHBOR\_ALLGATHERV, [388](#), [426](#),  
[1044](#)
- 20 MPI\_Ineighbor\_allgatherv\_c, [427](#)
- 21 MPI\_INEIGHBOR\_ALLTOALL, [388](#), [428](#),  
[1044](#)
- 22 MPI\_Ineighbor\_alltoall\_c, [428](#)
- 23 MPI\_INEIGHBOR\_ALLTOALLV, [388](#), [429](#),  
[1044](#)
- 24 MPI\_Ineighbor\_alltoallv\_c, [429](#)
- 25 MPI\_INEIGHBOR\_ALLTOALLW, [388](#), [431](#),  
[1044](#)
- 26 MPI\_Ineighbor\_alltoallw\_c, [431](#)
- 27 MPI\_INFO\_C2F, [509](#), [834](#)
- 28 MPI\_INFO\_CREATE, [476](#), [509](#)
- 29 MPI\_INFO\_CREATE\_ENV, [481](#), [509](#), [1038](#)
- 30 MPI\_INFO\_DELETE, [467](#), [477](#), [480](#), [509](#)
- 31 MPI\_INFO\_DUP, [481](#), [509](#)
- 32 MPI\_INFO\_F2C, [509](#), [834](#)
- 33 MPI\_INFO\_FREE, [343](#), [481](#), [482](#), [491](#), [498](#),  
[502](#), [509](#), [563](#), [646](#), [751](#), [755](#), [757](#), [760](#)
- 34 MPI\_INFO\_GET, [23](#), [475](#), [477](#), [509](#), [776](#), [1037](#),  
[1052](#)
- 35 MPI\_INFO\_GET\_NKEYS, [475](#), [480](#), [509](#), [1052](#)
- 36 MPI\_INFO\_GET\_NTHKEY, [475](#), [480](#), [509](#),  
[1052](#)
- 37 MPI\_INFO\_GET\_STRING, [23](#), [475](#), [479](#), [776](#),  
[777](#), [1037](#)
- 38 MPI\_INFO\_GET\_VALUELEN, [23](#), [475](#), [478](#),  
[509](#), [777](#), [1037](#), [1052](#)
- 39 MPI\_INFO\_SET, [476](#), [477–480](#), [509](#)
- 40 MPI\_INIT, [18](#), [25](#), [26](#), [311](#), [449](#), [455](#), [482](#), [483](#),  
[484](#), [485](#), [487–490](#), [493–495](#), [508](#), [514](#),  
[519](#), [520](#), [522](#), [539](#), [540](#), [723](#), [726](#), [734](#),  
[747](#), [833](#), [836](#), [837](#), [1038](#), [1043](#), [1044](#),  
[1047](#), [1048](#)
- 41 MPI\_INIT\_THREAD, [25](#), [311](#), [455](#), [482–485](#),  
[487](#), [488–490](#), [493–495](#), [497](#), [514](#), [540](#),  
[723](#), [726](#), [734](#), [833](#), [1043](#), [1044](#), [1048](#)
- 42 MPI\_INITIALIZED, [493](#), [494](#), [509](#), [833](#), [1040](#)
- 43 MPI\_INTERCOMM\_CREATE, [324](#), [330](#), [331](#),  
[354](#), [355](#), [357](#), [358](#), [1044](#)
- 44 MPI\_INTERCOMM\_CREATE\_FROM\_GROUPS,  
[323](#), [324](#), [354](#), [356](#), [449](#)
- 45 MPI\_INTERCOMM\_MERGE, [323](#), [330](#), [351](#),  
[354](#), [355](#), [357](#), [358](#), [1046](#)
- 46 MPI\_IPROBE, [14](#), [38](#), [82](#), [83](#), [85–87](#), [90](#), [514](#),  
[1043](#)
- 47 MPI\_Irecv, [14](#), [65](#), [89](#), [813](#), [814](#), [817](#), [818](#)
- 48 MPI\_Irecv\_c, [65](#)
- 49 MPI\_IREDUCE, [185](#), [189](#), [190](#), [267](#), [268](#)
- 50 MPI\_Ireduce\_c, [267](#)
- 51 MPI\_IREDUCE\_SCATTER, [185](#), [189](#), [190](#),  
[271](#)
- 52 MPI\_IREDUCE\_SCATTER\_BLOCK, [185](#),  
[189](#), [190](#), [269](#)
- 53 MPI\_Ireduce\_scatter\_block\_c, [270](#)
- 54 MPI\_Ireduce\_scatter\_c, [271](#)
- 55 MPI\_IRSEND, [64](#)
- 56 MPI\_Irsend\_c, [64](#)
- 57 MPI\_IS\_THREAD\_MAIN, [487](#), [490](#), [1040](#)
- 58 MPI\_ISCAN, [186](#), [189](#), [272](#)
- 59 MPI\_Iscan\_c, [272](#)
- 60 MPI\_ISCATTER, [185](#), [189](#), [255](#)
- 61 MPI\_Iscatter\_c, [256](#)
- 62 MPI\_ISCATTERV, [185](#), [189](#), [257](#)
- 63 MPI\_Iscatterv\_c, [257](#)
- 64 MPI\_ISEND, [14](#), [61](#), [97](#), [791](#), [792](#), [795](#), [812](#),  
[813](#), [818](#), [819](#)
- 65 MPI\_Isend\_c, [61](#)
- 66 MPI\_ISENDRECV, [66](#), [1036](#)
- 67 MPI\_Isendrecv\_c, [66](#)
- 68 MPI\_ISENDRECV\_REPLACE, [67](#), [1036](#)
- 69 MPI\_Isendrecv\_replace\_c, [67](#)
- 70 MPI\_ISSEND, [63](#)
- 71 MPI\_Issend\_c, [63](#)
- 72 MPI\_KEYVAL\_CREATE, [23](#), [773](#), [775](#), [871](#)
- 73 MPI\_KEYVAL\_FREE, [23](#), [375](#), [774](#)
- 74 MPI\_LOOKUP\_NAME, [467](#), [529](#), [535](#), [536](#)
- 75 MPI\_MESSAGE\_C2F, [834](#), [1043](#)
- 76 MPI\_MESSAGE\_F2C, [834](#), [1043](#)
- 77 MPI\_MPROBE, [14](#), [82](#), [85](#), [86](#), [87](#), [90](#), [515](#),  
[1043](#)
- 78 MPI\_MRECV, [14](#), [85–87](#), [88](#), [89](#), [1043](#)
- 79 MPI\_Mrecv\_c, [88](#)
- 80 MPI\_NEIGHBOR\_ALLGATHER, [388](#), [413](#),  
[415](#), [417](#), [426](#), [1035](#), [1044](#)
- 81 MPI\_Neighbor\_allgather\_c, [413](#)
- 82 MPI\_NEIGHBOR\_ALLGATHER\_INIT, [433](#)
- 83 MPI\_Neighbor\_allgather\_init\_c, [433](#)



MPI_NEIGHBOR_ALLGATHERV, <a href="#">388</a> , <a href="#">416</a> , <a href="#">427</a> , <a href="#">1035</a> , <a href="#">1044</a>	<a href="#">1052</a>	1
MPI_Neighbor_allgatherv_c, <a href="#">416</a>	MPI_Put_c, <a href="#">565</a>	2
MPI_NEIGHBOR_ALLGATHERV_INIT, <a href="#">434</a> , <a href="#">791</a> , <a href="#">1038</a>	MPI_QUERY_THREAD, <a href="#">489</a> , <a href="#">490</a> , <a href="#">514</a> , <a href="#">1040</a>	3
MPI_Neighbor_allgatherv_init_c, <a href="#">434</a>	MPI_RACCUMULATE, <a href="#">545</a> , <a href="#">563</a> , <a href="#">572</a> , <a href="#">576</a> , <a href="#">582</a> , <a href="#">583</a>	4
MPI_NEIGHBOR_ALLTOALL, <a href="#">388</a> , <a href="#">418</a> , <a href="#">419</a> , <a href="#">420</a> , <a href="#">429</a> , <a href="#">1035</a> , <a href="#">1044</a>	MPI_Raccumulate_c, <a href="#">582</a>	5
MPI_Neighbor_alltoall_c, <a href="#">418</a>	MPI_RECV, <a href="#">14</a> , <a href="#">30</a> , <a href="#">35</a> , <a href="#">37–39</a> , <a href="#">82</a> , <a href="#">85</a> , <a href="#">86</a> , <a href="#">89</a> , <a href="#">118</a> , <a href="#">151</a> , <a href="#">152</a> , <a href="#">175</a> , <a href="#">186</a> , <a href="#">195</a> , <a href="#">304</a> , <a href="#">634</a> , <a href="#">708</a> , <a href="#">747</a> , <a href="#">819</a> , <a href="#">822</a> , <a href="#">823</a>	6
MPI_NEIGHBOR_ALLTOALL_INIT, <a href="#">436</a>	MPI_Recv_c, <a href="#">35</a>	7
MPI_Neighbor_alltoall_init_c, <a href="#">436</a>	MPI_RECV_INIT, <a href="#">14</a> , <a href="#">96</a> , <a href="#">97</a> , <a href="#">106</a>	8
MPI_NEIGHBOR_ALLTOALLV, <a href="#">388</a> , <a href="#">421</a> , <a href="#">430</a> , <a href="#">1035</a> , <a href="#">1044</a>	MPI_Recv_init_c, <a href="#">96</a>	9
MPI_Neighbor_alltoallv_c, <a href="#">421</a>	MPI_REDUCE, <a href="#">185</a> , <a href="#">189</a> , <a href="#">190</a> , <a href="#">222</a> , <a href="#">223</a> , <a href="#">224</a> , <a href="#">232–234</a> , <a href="#">237</a> , <a href="#">241</a> , <a href="#">243</a> , <a href="#">244</a> , <a href="#">246</a> , <a href="#">268</a> , <a href="#">572</a> , <a href="#">575–577</a> , <a href="#">1049</a>	10
MPI_NEIGHBOR_ALLTOALLV_INIT, <a href="#">437</a> , <a href="#">791</a> , <a href="#">1038</a>	MPI_Reduce_c, <a href="#">222</a>	11
MPI_Neighbor_alltoallv_init_c, <a href="#">437</a>	MPI_REDUCE_INIT, <a href="#">292</a>	12
MPI_NEIGHBOR_ALLTOALLW, <a href="#">388</a> , <a href="#">423</a> , <a href="#">432</a> , <a href="#">1035</a> , <a href="#">1044</a>	MPI_Reduce_init_c, <a href="#">292</a>	13
MPI_Neighbor_alltoallw_c, <a href="#">423</a>	MPI_REDUCE_LOCAL, <a href="#">223</a> , <a href="#">224</a> , <a href="#">232</a> , <a href="#">238</a> , <a href="#">1046</a> , <a href="#">1048</a>	14
MPI_NEIGHBOR_ALLTOALLW_INIT, <a href="#">439</a> , <a href="#">791</a> , <a href="#">1038</a>	MPI_Reduce_local_c, <a href="#">238</a>	15
MPI_Neighbor_alltoallw_init_c, <a href="#">439</a>	MPI_REDUCE_SCATTER, <a href="#">185</a> , <a href="#">189</a> , <a href="#">190</a> , <a href="#">224</a> , <a href="#">232</a> , <a href="#">241</a> , <a href="#">242</a> , <a href="#">243</a> , <a href="#">272</a>	16
MPI_NULL_COPY_FN, <a href="#">22</a> , <a href="#">23</a> , <a href="#">364</a> , <a href="#">774</a> , <a href="#">858</a>	MPI_REDUCE_SCATTER_BLOCK, <a href="#">185</a> , <a href="#">189</a> , <a href="#">190</a> , <a href="#">224</a> , <a href="#">232</a> , <a href="#">240</a> , <a href="#">241</a> , <a href="#">270</a> , <a href="#">1048</a>	17
MPI_NULL_DELETE_FN, <a href="#">23</a> , <a href="#">365</a> , <a href="#">774</a> , <a href="#">858</a>	MPI_Reduce_scatter_block_c, <a href="#">240</a>	18
MPI_OP_C2F, <a href="#">834</a>	MPI_REDUCE_SCATTER_BLOCK_INIT, <a href="#">294</a>	19
MPI_OP_COMMUTATIVE, <a href="#">239</a> , <a href="#">1048</a>	MPI_Reduce_scatter_block_init_c, <a href="#">294</a>	20
MPI_OP_CREATE, <a href="#">231</a> , <a href="#">232</a> , <a href="#">234</a> , <a href="#">791</a> , <a href="#">866</a> , <a href="#">869</a> , <a href="#">1045</a> , <a href="#">1046</a>	MPI_Reduce_scatter_c, <a href="#">242</a>	21
MPI_Op_create_c, <a href="#">231</a> , <a href="#">832</a>	MPI_REDUCE_SCATTER_INIT, <a href="#">296</a>	22
MPI_OP_F2C, <a href="#">834</a>	MPI_Reduce_scatter_init_c, <a href="#">296</a>	23
MPI_OP_FREE, <a href="#">234</a> , <a href="#">491</a> , <a href="#">498</a>	MPI_REGISTER_DATAREP, <a href="#">467</a> , <a href="#">696</a> , <a href="#">697–700</a> , <a href="#">713</a> , <a href="#">868</a> , <a href="#">871</a>	24
MPI_OPEN_PORT, <a href="#">529</a> , <a href="#">530</a> , <a href="#">532–537</a>	MPI_Register_datarep_c, <a href="#">696</a> , <a href="#">832</a>	25
MPI_PACK, <a href="#">59</a> , <a href="#">173</a> , <a href="#">175–177</a> , <a href="#">180</a> , <a href="#">693</a> , <a href="#">699</a>	MPI_REQUEST_C2F, <a href="#">834</a>	26
MPI_Pack_c, <a href="#">173</a>	MPI_REQUEST_F2C, <a href="#">834</a>	27
MPI_PACK_EXTERNAL, <a href="#">8</a> , <a href="#">180</a> , <a href="#">806</a> , <a href="#">1050</a>	MPI_REQUEST_FREE, <a href="#">71</a> , <a href="#">72</a> , <a href="#">90</a> , <a href="#">98</a> , <a href="#">249</a> , <a href="#">274</a> , <a href="#">275</a> , <a href="#">491</a> , <a href="#">498</a> , <a href="#">578</a> , <a href="#">628</a> , <a href="#">629</a> , <a href="#">1047</a>	28
MPI_Pack_external_c, <a href="#">180</a>	MPI_REQUEST_GET_STATUS, <a href="#">39</a> , <a href="#">81</a> , <a href="#">627</a> , <a href="#">1047</a>	29
MPI_PACK_EXTERNAL_SIZE, <a href="#">182</a>	MPI_RGET, <a href="#">545</a> , <a href="#">563</a> , <a href="#">580</a> , <a href="#">581</a>	30
MPI_Pack_external_size_c, <a href="#">182</a>	MPI_RGET_ACCUMULATE, <a href="#">545</a> , <a href="#">563</a> , <a href="#">572</a> , <a href="#">575</a> , <a href="#">584</a> , <a href="#">585</a>	31
MPI_PACK_SIZE, <a href="#">59</a> , <a href="#">176</a> , <a href="#">1043</a>	MPI_Rget_accumulate_c, <a href="#">584</a>	32
MPI_Pack_size_c, <a href="#">176</a>	MPI_Rget_c, <a href="#">580</a>	33
MPI_PARRIVED, <a href="#">102</a> , <a href="#">108</a> , <a href="#">109</a>	MPI_RPUT, <a href="#">545</a> , <a href="#">563</a> , <a href="#">579</a> , <a href="#">580</a>	34
MPI_PCONTROL, <a href="#">718</a> , <a href="#">719</a> , <a href="#">720</a>	MPI_Rput_c, <a href="#">579</a>	35
MPI_PREADY, <a href="#">102</a> , <a href="#">104</a> , <a href="#">106</a> , <a href="#">107–109</a>	MPI_RSEND, <a href="#">14</a> , <a href="#">51</a>	36
MPI_PREADY_LIST, <a href="#">108</a>	MPI_Rsend_c, <a href="#">51</a>	37
MPI_PREADY_RANGE, <a href="#">107</a> , <a href="#">108</a>	MPI_RSEND_INIT, <a href="#">95</a>	38
MPI_PRECV_INIT, <a href="#">102</a> , <a href="#">105</a> , <a href="#">106</a> , <a href="#">110</a>	MPI_Rsend_init_c, <a href="#">95</a>	39
MPI_PROBE, <a href="#">14</a> , <a href="#">36</a> , <a href="#">38</a> , <a href="#">39</a> , <a href="#">82</a> , <a href="#">83</a> , <a href="#">84</a> , <a href="#">85</a> , <a href="#">87</a> , <a href="#">89</a> , <a href="#">90</a> , <a href="#">514</a> , <a href="#">1043</a>	MPI_SCAN, <a href="#">186</a> , <a href="#">189</a> , <a href="#">224</a> , <a href="#">232</a> , <a href="#">243</a> , <a href="#">244</a> , <a href="#">246</a> , <a href="#">273</a>	40
MPI_PSEND_INIT, <a href="#">102</a> , <a href="#">104</a> , <a href="#">105–107</a> , <a href="#">110</a>		41
MPI_PUBLISH_NAME, <a href="#">529</a> , <a href="#">530</a> , <a href="#">534</a> , <a href="#">535</a> , <a href="#">536</a>		42
MPI_PUT, <a href="#">545</a> , <a href="#">563</a> , <a href="#">564</a> , <a href="#">568</a> , <a href="#">572</a> , <a href="#">580</a> , <a href="#">587</a> , <a href="#">593</a> , <a href="#">603</a> , <a href="#">605</a> , <a href="#">610</a> , <a href="#">611</a> , <a href="#">620</a> , <a href="#">812</a> , <a href="#">823</a> , <a href="#">1052</a>		43
		44
		45
		46
		47
		48

- 1 MPI\_Scan\_c, [244](#)  
2 MPI\_SCAN\_INIT, [297](#)  
3 MPI\_Scan\_init\_c, [297](#)  
4 MPI\_SCATTER, [185](#), [189](#), [204](#), [205](#), [207](#), [208](#),  
5 [241](#), [256](#)  
6 MPI\_Scatter\_c, [204](#)  
7 MPI\_SCATTER\_INIT, [281](#)  
8 MPI\_Scatter\_init\_c, [281](#)  
9 MPI\_SCATTERV, [185](#), [189](#), [206](#), [207](#), [208](#),  
10 [243](#), [258](#)  
11 MPI\_Scatterv\_c, [206](#)  
12 MPI\_SCATTERV\_INIT, [282](#)  
13 MPI\_Scatterv\_init\_c, [283](#)  
14 MPI\_SEND, [14](#), [29](#), [30](#), [31](#), [39](#), [44](#), [118](#), [151](#),  
15 [173](#), [304](#), [638](#), [708](#), [720](#), [819](#), [820](#), [822](#),  
16 [823](#)  
17 MPI\_Send\_c, [30](#)  
18 MPI\_SEND\_INIT, [14](#), [92](#), [97](#), [105](#)  
19 MPI\_Send\_init\_c, [92](#)  
20 MPI\_SENDR.recv, [40](#), [407](#)  
21 MPI\_Sendrecv\_c, [41](#)  
22 MPI\_SENDR.recv\_REPLACE, [42](#)  
23 MPI\_Sendrecv\_replace\_c, [42](#)  
24 MPI\_SESSION\_C2F, [834](#)  
25 MPI\_SESSION\_CALL\_ERRHANDLER, [473](#),  
26 [509](#)  
27 MPI\_SESSION\_CREATE\_ERRHANDLER,  
28 [456](#), [463](#), [464](#), [497](#), [509](#), [867](#), [870](#)  
29 MPI\_SESSION\_CREATE\_KEYVAL, [869](#)  
30 MPI\_SESSION\_F2C, [834](#)  
31 MPI\_SESSION\_FINALIZE, [498](#), [508](#)  
32 MPI\_SESSION\_GET\_ERRHANDLER, [456](#),  
33 [464](#)  
34 MPI\_SESSION\_GET\_INFO, [497](#), [501](#), [502](#)  
35 MPI\_SESSION\_GET\_NTH\_PSET, [320](#), [500](#),  
36 [501](#)  
37 MPI\_SESSION\_GET\_NUM\_PSETS, [499](#), [500](#)  
38 MPI\_SESSION\_GET\_PSET\_INFO, [502](#)  
39 MPI\_SESSION\_INIT, [456](#), [491](#), [497](#), [508](#), [514](#),  
40 [540](#), [727](#)  
41 MPI\_SESSION\_SET\_ERRHANDLER, [456](#),  
42 [464](#)  
43 MPI\_SIZEOF, [23](#), [778](#), [1038](#)  
44 MPI\_SSEND, [50](#)  
45 MPI\_Ssend\_c, [50](#)  
46 MPI\_SSEND\_INIT, [94](#)  
47 MPI\_Ssend\_init\_c, [94](#)  
48 MPI\_START, [97](#), [98](#), [101](#), [104](#), [107](#), [108](#), [274](#),  
[275](#), [819](#)  
MPI\_STARTALL, [97](#), [98](#), [101](#), [104](#), [107](#), [108](#),  
[274](#), [275](#), [819](#)  
MPI\_STATUS\_C2F, [836](#)  
MPI\_STATUS\_C2F08, [836](#), [1045](#)  
MPI\_STATUS\_F082C, [836](#), [1045](#)  
MPI\_STATUS\_F082F, [838](#), [1035](#), [1045](#)  
MPI\_STATUS\_F2C, [835](#)  
MPI\_STATUS\_F2F08, [837](#), [1035](#), [1045](#)  
MPI\_STATUS\_SET\_CANCELLED, [633](#), [1038](#)  
MPI\_STATUS\_SET\_ELEMENTS, [632](#), [633](#)  
MPI\_STATUS\_SET\_ELEMENTS\_X, [633](#),  
[1042](#)  
MPI\_T\_CATEGORY\_CHANGED, [769](#)  
MPI\_T\_CATEGORY\_GET\_CATEGORIES,  
[768](#), [769](#), [771](#)  
MPI\_T\_CATEGORY\_GET\_CVARS, [767](#), [769](#),  
[771](#)  
MPI\_T\_CATEGORY\_GET\_EVENTS, [768](#),  
[769](#)  
MPI\_T\_CATEGORY\_GET\_INDEX, [767](#), [771](#),  
[1041](#)  
MPI\_T\_CATEGORY\_GET\_INFO, [766](#), [769](#),  
[771](#), [1040](#), [1041](#)  
MPI\_T\_CATEGORY\_GET\_NUM, [765](#)  
MPI\_T\_CATEGORY\_GET\_NUM\_EVENTS,  
[766](#), [767](#)  
MPI\_T\_CATEGORY\_GET\_PVARS, [768](#), [769](#),  
[771](#)  
MPI\_T\_CVAR\_GET\_INDEX, [732](#), [733](#), [771](#),  
[1041](#)  
MPI\_T\_CVAR\_GET\_INFO, [728](#), [730](#), [731](#),  
[732](#), [734](#)–[736](#), [769](#), [771](#), [1040](#), [1041](#)  
MPI\_T\_CVAR\_GET\_NUM, [730](#), [735](#)  
MPI\_T\_CVAR\_HANDLE\_ALLOC, [728](#), [734](#),  
[735](#), [736](#), [771](#)  
MPI\_T\_CVAR\_HANDLE\_FREE, [735](#), [771](#)  
MPI\_T\_CVAR\_READ, [735](#), [771](#)  
MPI\_T\_CVAR\_WRITE, [735](#), [771](#)  
MPI\_T\_ENUM\_GET\_INFO, [728](#), [729](#), [771](#)  
MPI\_T\_ENUM\_GET\_ITEM, [729](#), [771](#)  
MPI\_T\_EVENT\_CALLBACK\_GET\_INFO,  
[759](#)  
MPI\_T\_EVENT\_CALLBACK\_SET\_INFO,  
[759](#)  
MPI\_T\_EVENT\_COPY, [753](#), [755](#), [763](#)  
MPI\_T\_EVENT\_GET\_INDEX, [756](#), [771](#)  
MPI\_T\_EVENT\_GET\_INFO, [728](#), [754](#), [756](#),  
[763](#), [769](#), [771](#)  
MPI\_T\_EVENT\_GET\_NUM, [754](#)  
MPI\_T\_EVENT\_GET\_SOURCE, [753](#), [764](#)  
MPI\_T\_EVENT\_GET\_TIMESTAMP, [751](#),  
[753](#), [763](#)  
MPI\_T\_EVENT\_HANDLE\_ALLOC, [756](#), [759](#),  
[771](#)  
MPI\_T\_EVENT\_HANDLE\_FREE, [760](#), [771](#)  
MPI\_T\_EVENT\_HANDLE\_GET\_INFO, [757](#)  
MPI\_T\_EVENT\_HANDLE\_SET\_INFO, [757](#)  
MPI\_T\_EVENT\_READ, [753](#), [755](#), [762](#)

MPI_T_EVENT_REGISTER_CALLBACK,	MPI_TYPE_CREATE_HINDEXED, 15, 23,	1
<a href="#">758</a>	<a href="#">119, 125, 126, 129, 131, 157, 779, 831</a>	2
MPI_T_EVENT_SET_DROPPED_HANDLER,	MPI_TYPE_CREATE_HINDEXED_BLOCK,	3
<a href="#">761, 762</a>	<a href="#">15, 119, 128, 157, 831, 1043</a>	4
MPI_T_FINALIZE, <a href="#">727</a>	MPI_Type_create_hindexed_block_c, <a href="#">128</a>	5
MPI_T_INIT_THREAD, <a href="#">726, 727</a>	MPI_Type_create_hindexed_c, <a href="#">126</a>	6
MPI_T_PVAR_GET_INDEX, <a href="#">741, 771, 1041</a>	MPI_TYPE_CREATE_HVECTOR, 15, 23,	7
MPI_T_PVAR_GET_INFO, <a href="#">728, 739, 740,</a>	<a href="#">119, 122, 157, 779</a>	8
<a href="#">743, 745, 747, 769, 771, 1040, 1041</a>	MPI_Type_create_hvector_c, <a href="#">122</a>	9
MPI_T_PVAR_GET_NUM, <a href="#">739, 743</a>	MPI_TYPE_CREATE_INDEXED_BLOCK,	10
MPI_T_PVAR_HANDLE_ALLOC, <a href="#">728, 743,</a>	<a href="#">15, 127, 128, 157</a>	11
<a href="#">745, 771</a>	MPI_Type_create_indexed_block_c, <a href="#">127</a>	12
MPI_T_PVAR_HANDLE_FREE, <a href="#">743, 744,</a>	MPI_TYPE_CREATE_KEYVAL, <a href="#">361, 372,</a>	13
<a href="#">771, 1040</a>	<a href="#">375, 841, 867, 870, 1050</a>	14
MPI_T_PVAR_READ, <a href="#">745, 746, 753, 771,</a>	MPI_TYPE_CREATE_RESIZED, 23, 119,	15
<a href="#">1040</a>	<a href="#">143, 146, 147, 157, 692, 780, 1045</a>	16
MPI_T_PVAR_READRESET, <a href="#">741, 746, 753,</a>	MPI_Type_create_resized_c, <a href="#">146</a>	17
<a href="#">771, 1040</a>	MPI_TYPE_CREATE_STRUCT, 15, 23, 119,	18
MPI_T_PVAR_RESET, <a href="#">746, 753, 771, 1040</a>	<a href="#">129, 130, 131, 143, 157, 220, 779, 831</a>	19
MPI_T_PVAR_SESSION_CREATE, <a href="#">742, 771</a>	MPI_Type_create_struct_c, <a href="#">129</a>	20
MPI_T_PVAR_SESSION_FREE, <a href="#">742, 771</a>	MPI_TYPE_CREATE_SUBARRAY, 15, 18,	21
MPI_T_PVAR_START, <a href="#">744, 753, 771, 1040</a>	<a href="#">131, 133, 136, 157</a>	22
MPI_T_PVAR_STOP, <a href="#">744, 753, 771, 1040</a>	MPI_Type_create_subarray_c, <a href="#">131</a>	23
MPI_T_PVAR_WRITE, <a href="#">745, 746, 753, 771,</a>	MPI_TYPE_DELETE_ATTR, <a href="#">361, 375, 1045</a>	24
<a href="#">1040</a>	MPI_TYPE_DUP, 15, 150, 157, 1045	25
MPI_T_SOURCE_GET_INFO, <a href="#">750, 751, 764,</a>	MPI_TYPE_DUP_FN, <a href="#">372, 857, 1040</a>	26
<a href="#">771</a>	MPI_TYPE_EXTENT, 23, 779, 1042	27
MPI_T_SOURCE_GET_NUM, <a href="#">750, 771</a>	MPI_TYPE_F2C, <a href="#">834</a>	28
MPI_T_SOURCE_GET_TIMESTAMP, <a href="#">751,</a>	MPI_TYPE_FREE, <a href="#">149, 159, 373, 491, 498</a>	29
<a href="#">753, 771</a>	MPI_TYPE_FREE_KEYVAL, <a href="#">361, 373, 375</a>	30
MPI_TEST, 39, 68, 69, <a href="#">70, 72, 73, 75, 81, 90,</a>	<a href="#">841, 1045</a>	31
<a href="#">98, 101, 102, 108, 109, 275, 491, 629,</a>	MPI_TYPE_GET_ATTR, <a href="#">361, 374, 375, 792,</a>	32
<a href="#">652, 653</a>	<a href="#">841, 1045</a>	33
MPI_TEST_CANCELLED, 69, 70, <a href="#">91, 627,</a>	MPI_TYPE_GET_CONTENTS, 156, 157,	34
<a href="#">634, 654</a>	<a href="#">158, 159–161, 831</a>	35
MPI_TESTALL, 73, <a href="#">77, 514, 627–629, 632</a>	MPI_Type_get_contents_c, <a href="#">158</a>	36
MPI_TESTANY, 73, <a href="#">75, 79, 514, 627, 628, 632</a>	MPI_TYPE_GET_ENVELOPE, <a href="#">156, 157,</a>	37
MPI_TESTSOME, 74, <a href="#">79, 80, 514, 627–629,</a>	<a href="#">159, 160, 805, 831</a>	38
<a href="#">632</a>	MPI_Type_get_envelope_c, <a href="#">156</a>	39
MPI_TOPO_TEST, <a href="#">387, 399</a>	MPI_TYPE_GET_EXTENT, 23, <a href="#">145, 148,</a>	40
MPI_TYPE_C2F, <a href="#">834</a>	<a href="#">779, 807, 838</a>	41
MPI_TYPE_COMMIT, <a href="#">149, 835</a>	MPI_Type_get_extent_c, <a href="#">145</a>	42
MPI_TYPE_CONTIGUOUS, 15, <a href="#">119, 122,</a>	MPI_TYPE_GET_EXTENT_X, <a href="#">145, 1042</a>	43
<a href="#">143, 157, 636, 692</a>	MPI_TYPE_GET_NAME, <a href="#">381, 1046</a>	44
MPI_Type_contiguous_c, <a href="#">119</a>	MPI_TYPE_GET_TRUE_EXTENT, <a href="#">147</a>	45
MPI_TYPE_CREATE_DARRAY, 15, 39, <a href="#">134,</a>	MPI_Type_get_true_extent_c, <a href="#">147</a>	46
<a href="#">135, 157</a>	MPI_TYPE_GET_TRUE_EXTENT_X, 147,	47
MPI_Type_create_darray_c, <a href="#">134</a>	<a href="#">148, 1042</a>	48
MPI_TYPE_CREATE_F90_COMPLEX, 15,	MPI_TYPE_HINDEXED, 23, 779, 1042	
<a href="#">157, 160, 225, 696, 784, 803, 805, 806</a>	MPI_TYPE_HVECTOR, 23, 779, 1042	
MPI_TYPE_CREATE_F90_INTEGER, 15,	MPI_TYPE_INDEXED, 15, <a href="#">124, 125, 127, 157</a>	
<a href="#">157, 160, 225, 696, 784, 804, 805, 806</a>	MPI_Type_indexed_c, <a href="#">124</a>	
MPI_TYPE_CREATE_F90_REAL, 15, 157,	MPI_TYPE_LB, 23, 779, 1042	
<a href="#">160, 225, 696, 784, 803, 804–806, 1047</a>	MPI_TYPE_MATCH_SIZE, <a href="#">784, 807, 1046</a>	

- 1 MPI\_TYPE\_NULL\_COPY\_FN, [372](#), [857](#),  
2 [1040](#)
- 3 MPI\_TYPE\_NULL\_DELETE\_FN, [372](#), [857](#),  
4 [1040](#), [1046](#)
- 5 MPI\_TYPE\_SET\_ATTR, [361](#), [374](#), [375](#), [792](#),  
6 [841](#), [845](#), [1045](#)
- 7 MPI\_TYPE\_SET\_NAME, [380](#), [1045](#)
- 8 MPI\_TYPE\_SIZE, [141](#), [142](#), [720](#), [1043](#)
- 9 MPI\_Type\_size\_c, [141](#)
- 10 MPI\_TYPE\_SIZE\_X, [142](#), [1042](#)
- 11 MPI\_TYPE\_STRUCT, [23](#), [779](#), [1042](#)
- 12 MPI\_TYPE\_UB, [23](#), [779](#), [1042](#)
- 13 MPI\_TYPE\_VECTOR, [15](#), [120](#), [121](#), [122](#), [125](#),  
14 [157](#)
- 15 MPI\_Type\_vector\_c, [121](#)
- 16 MPI\_UNPACK, [174](#), [175](#), [180](#), [699](#)
- 17 MPI\_Unpack\_c, [174](#)
- 18 MPI\_UNPACK\_EXTERNAL, [8](#), [181](#), [806](#)
- 19 MPI\_Unpack\_external\_c, [181](#)
- 20 MPI\_UNPUBLISH\_NAME, [468](#), [535](#), [536](#)
- 21 MPI\_USER\_FUNCTION, [232](#), [831](#)
- 22 MPI\_User\_function\_c, [232](#), [864](#)
- 23 MPI\_WAIT, [37](#), [39](#), [68](#), [69](#), [70](#)–[74](#), [76](#), [90](#), [98](#),  
24 [101](#), [102](#), [108](#), [109](#), [248](#), [275](#), [304](#), [491](#),  
25 [514](#), [625](#), [629](#), [652](#), [653](#), [680](#), [701](#)–[703](#),  
26 [812](#), [818](#), [819](#), [822](#)
- 27 MPI\_WAITALL, [73](#), [76](#), [77](#), [248](#), [305](#), [514](#), [578](#),  
28 [627](#)–[629](#), [632](#)
- 29 MPI\_WAITANY, [52](#), [73](#), [74](#), [80](#), [514](#), [627](#), [628](#),  
30 [632](#)
- 31 MPI\_WAITSOME, [74](#), [78](#), [79](#), [80](#), [514](#),  
32 [627](#)–[629](#), [632](#)
- 33 MPI\_WIN\_ALLOCATE, [546](#), [550](#), [551](#), [553](#),  
34 [559](#), [561](#), [566](#), [599](#), [797](#), [798](#), [1037](#),  
35 [1039](#)
- 36 MPI\_Win\_allocate\_c, [550](#)
- 37 MPI\_WIN\_ALLOCATE\_CPTR, [551](#), [1039](#)
- 38 MPI\_WIN\_ALLOCATE\_SHARED, [335](#), [546](#),  
39 [552](#), [553](#), [555](#), [559](#), [561](#), [599](#), [798](#),  
40 [1037](#)–[1039](#)
- 41 MPI\_Win\_allocate\_shared\_c, [552](#)
- 42 MPI\_WIN\_ALLOCATE\_SHARED\_CPTR,  
43 [553](#), [1039](#)
- 44 MPI\_WIN\_ATTACH, [556](#), [557](#), [558](#), [559](#), [599](#)
- 45 MPI\_WIN\_C2F, [834](#)
- 46 MPI\_WIN\_CALL\_ERRHANDLER, [472](#), [473](#)
- 47 MPI\_WIN\_COMPLETE, [559](#), [588](#), [592](#),  
48 [593](#)–[596](#), [604](#), [611](#)
- MPI\_WIN\_CREATE, [515](#), [546](#), [547](#), [549](#), [551](#),  
[553](#), [557](#)–[559](#), [561](#), [603](#)
- MPI\_Win\_create\_c, [547](#)
- MPI\_WIN\_CREATE\_DYNAMIC, [468](#), [546](#),  
[556](#), [557](#), [558](#), [560](#), [561](#), [604](#)
- MPI\_WIN\_CREATE\_ERRHANDLER, [456](#),  
[459](#), [460](#), [867](#), [870](#), [1046](#)
- MPI\_WIN\_CREATE\_KEYVAL, [361](#), [368](#), [375](#),  
[841](#), [866](#), [869](#), [1050](#)
- MPI\_WIN\_DELETE\_ATTR, [361](#), [371](#), [375](#)
- MPI\_WIN\_DETACH, [556](#), [558](#), [560](#)
- MPI\_WIN\_DUP\_FN, [369](#), [857](#), [1040](#)
- MPI\_WIN\_F2C, [834](#)
- MPI\_WIN\_FENCE, [559](#), [568](#), [588](#), [590](#), [591](#),  
[592](#), [601](#), [602](#), [604](#), [605](#), [608](#), [613](#), [823](#)
- MPI\_WIN\_FLUSH, [554](#), [578](#), [580](#), [599](#), [600](#),  
[604](#), [618](#), [620](#)
- MPI\_WIN\_FLUSH\_ALL, [578](#), [580](#), [600](#), [604](#)
- MPI\_WIN\_FLUSH\_LOCAL, [578](#), [600](#), [604](#)
- MPI\_WIN\_FLUSH\_LOCAL\_ALL, [578](#), [601](#),  
[604](#)
- MPI\_WIN\_FREE, [370](#), [491](#), [498](#), [543](#), [559](#), [560](#)
- MPI\_WIN\_FREE\_KEYVAL, [361](#), [370](#), [375](#)
- MPI\_WIN\_GET\_ATTR, [361](#), [371](#), [375](#), [560](#),  
[792](#), [841](#), [844](#)
- MPI\_WIN\_GET\_ERRHANDLER, [456](#), [460](#),  
[1051](#)
- MPI\_WIN\_GET\_GROUP, [561](#)
- MPI\_WIN\_GET\_INFO, [561](#), [562](#), [563](#), [1037](#),  
[1043](#)
- MPI\_WIN\_GET\_NAME, [382](#)
- MPI\_WIN\_LOCK, [548](#), [559](#), [588](#), [596](#),  
[597](#)–[599](#), [601](#), [603](#), [605](#), [608](#)–[610](#)
- MPI\_WIN\_LOCK\_ALL, [548](#), [588](#), [597](#), [598](#),  
[601](#), [603](#), [605](#), [610](#), [618](#), [619](#)
- MPI\_WIN\_NULL\_COPY\_FN, [369](#), [857](#), [1040](#)
- MPI\_WIN\_NULL\_DELETE\_FN, [369](#), [857](#),  
[1040](#)
- MPI\_WIN\_POST, [559](#), [588](#), [592](#), [593](#), [594](#)–[596](#),  
[598](#), [601](#), [602](#), [605](#), [611](#), [613](#)
- MPI\_WIN\_SET\_ATTR, [361](#), [370](#), [375](#), [560](#),  
[792](#), [841](#), [845](#)
- MPI\_WIN\_SET\_ERRHANDLER, [456](#), [460](#)
- MPI\_WIN\_SET\_INFO, [562](#), [1037](#), [1043](#)
- MPI\_WIN\_SET\_NAME, [381](#)
- MPI\_WIN\_SHARED\_QUERY, [553](#), [554](#), [798](#),  
[1039](#)
- MPI\_Win\_shared\_query\_c, [554](#)
- MPI\_WIN\_SHARED\_QUERY\_CPTR, [556](#),  
[1039](#)
- MPI\_WIN\_START, [559](#), [588](#), [592](#), [593](#)–[596](#),  
[601](#), [602](#), [611](#), [618](#)
- MPI\_WIN\_SYNC, [601](#), [605](#)–[608](#), [611](#), [618](#)–[620](#)
- MPI\_WIN\_TEST, [594](#), [595](#)
- MPI\_WIN\_UNLOCK, [559](#), [580](#), [588](#), [597](#), [599](#),  
[604](#), [605](#), [608](#), [609](#)
- MPI\_WIN\_UNLOCK\_ALL, [580](#), [588](#), [597](#),  
[598](#), [604](#), [605](#), [608](#), [619](#)
- MPI\_WIN\_WAIT, [559](#), [588](#), [594](#), [595](#), [596](#),  
[598](#), [604](#), [605](#), [608](#), [611](#), [612](#)

MPI\_WTICK, [24](#), [474](#), [752](#)  
MPI\_WTIME, [14](#), [24](#), [450](#), [474](#), [720](#), [739](#), [752](#)  
mpiexec, [485](#), [486](#), [488](#), [510](#), [1038](#)  
mpirun, [510](#)  
  
PMPI\_, [717](#), [792](#)  
PMPI\_AINT\_ADD, [24](#)  
PMPI\_AINT\_DIFF, [24](#)  
PMPI\_ISEND, [792](#), [795](#)  
PMPI\_T\_EVENT\_COPY, [753](#)  
PMPI\_T\_EVENT\_GET\_SOURCE, [753](#)  
PMPI\_T\_EVENT\_GET\_TIMESTAMP, [753](#)  
PMPI\_T\_EVENT\_READ, [753](#)  
PMPI\_T\_PVAR\_READ, [753](#)  
PMPI\_T\_PVAR\_READRESET, [753](#)  
PMPI\_T\_PVAR\_RESET, [753](#)  
PMPI\_T\_PVAR\_START, [753](#)  
PMPI\_T\_PVAR\_STOP, [753](#)  
PMPI\_T\_PVAR\_WRITE, [753](#)  
PMPI\_T\_SOURCE\_GET\_TIMESTAMP, [753](#)  
PMPI\_WTICK, [24](#)  
PMPI\_WTIME, [24](#)

1  
2  
3  
4  
5  
6  
7  
8  
9  
10  
11  
12  
13  
14  
15  
16  
17  
18  
19  
20  
21  
22  
23  
24  
25  
26  
27  
28  
29  
30  
31  
32  
33  
34  
35  
36  
37  
38  
39  
40  
41  
42  
43  
44  
45  
46  
47  
48

