

ConditionalAndExpression

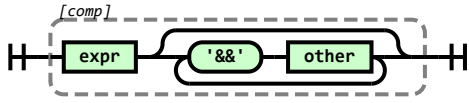

RelationalExpression

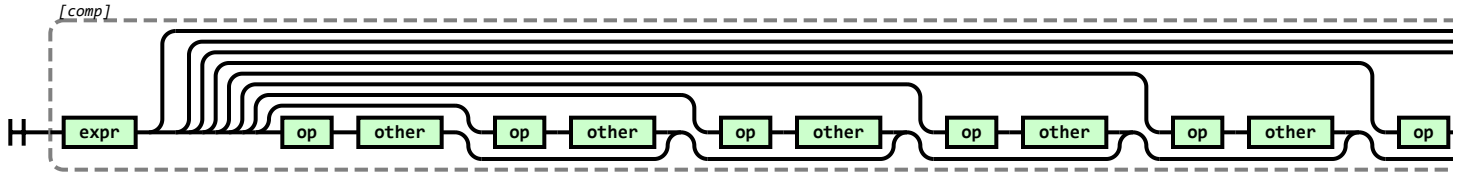

AdditiveExpression

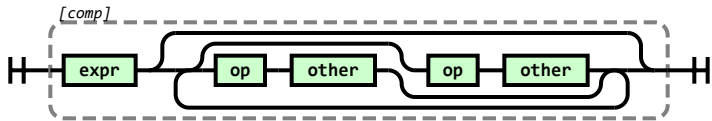

MultiplicativeExpression

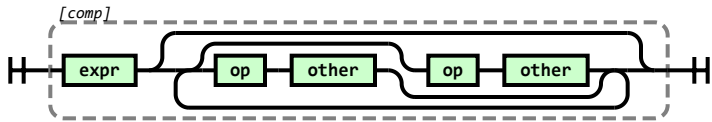

UnaryExpression

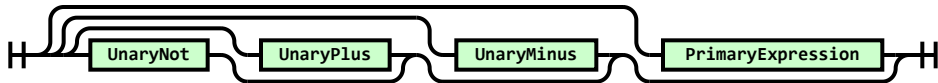

UnaryNot

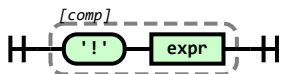

PrimaryExpression

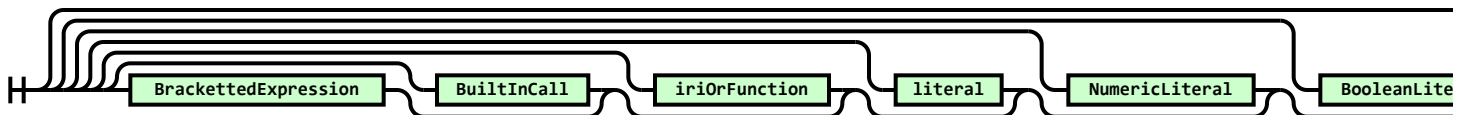

BrackettedExpression

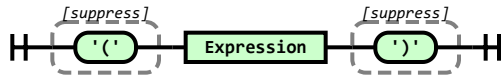

BuiltInCall

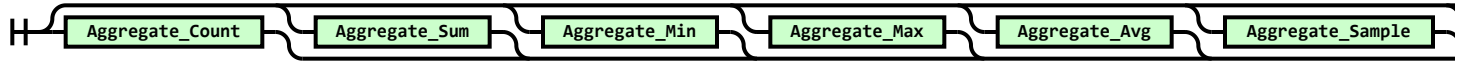

Aggregate_Count

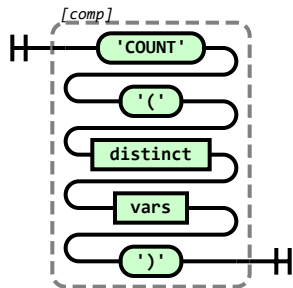

distinct

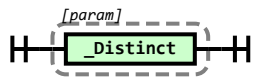

vars

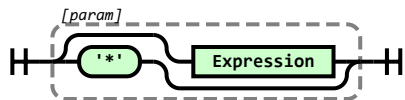

Aggregate_Sum

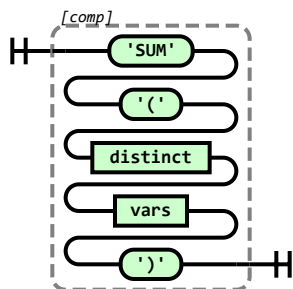

Aggregate_Min

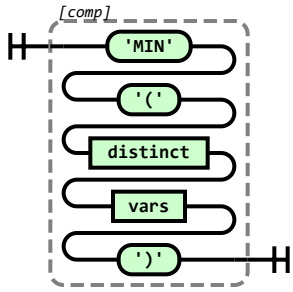

Aggregate_Max

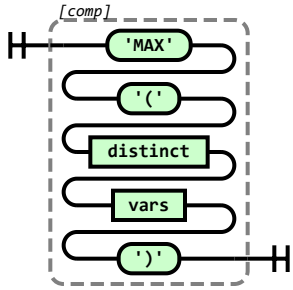

Aggregate_Avg

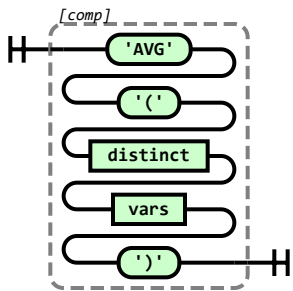

Aggregate_Sample

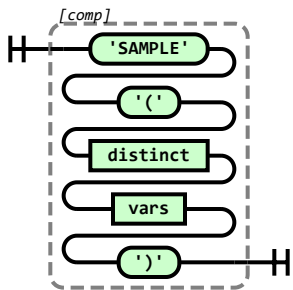

Aggregate_GroupConcat

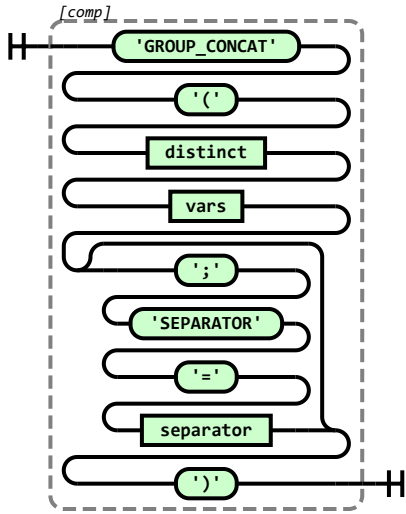

separator

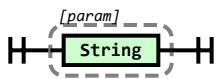

Builtin_STR

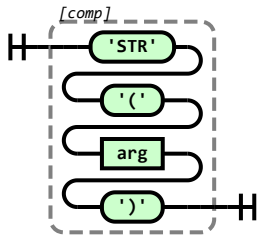

arg

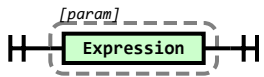

Builtin_LANG

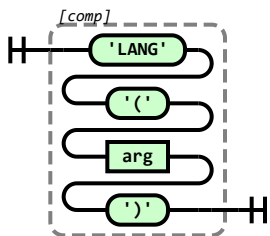

Builtin_LANGMATCHES

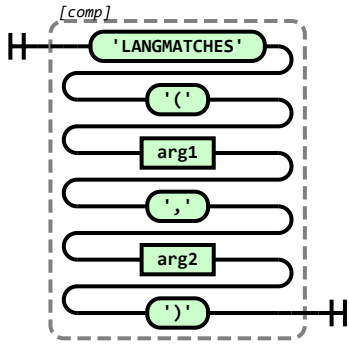

arg1

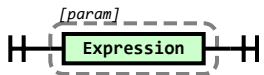

arg2

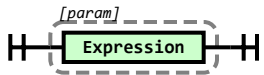

Builtin_DATATYPE

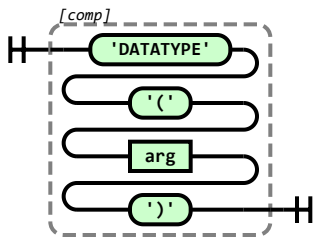

Builtin_BOUND

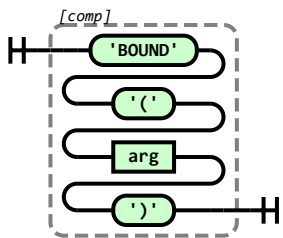

Builtin_IRI

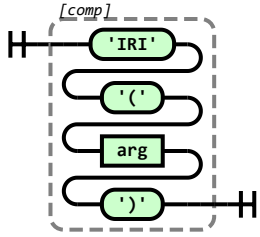

Builtin_URI

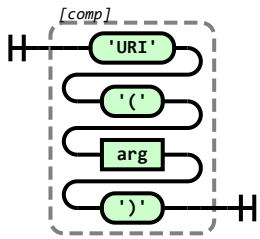

Builtin_BNODE

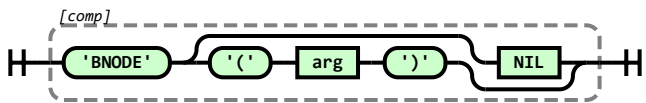

Builtin_RAND

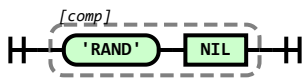

Builtin_ABS

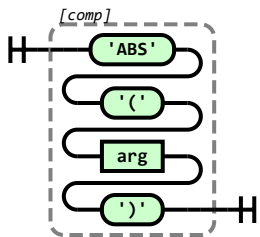

Builtin_CEIL

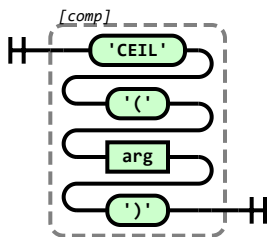

Builtin_FLOOR

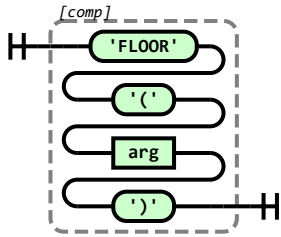

Builtin_ROUND

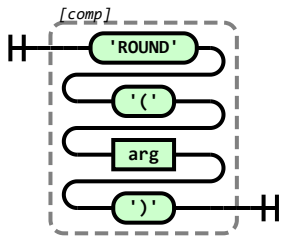

Builtin_CONCAT

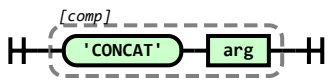

ExpressionList

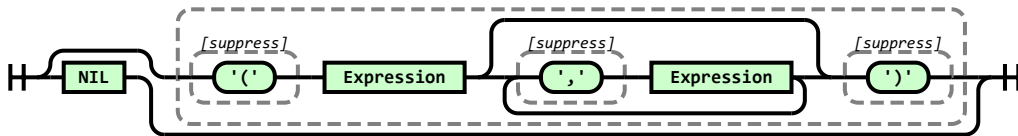

Builtin_SUBSTR

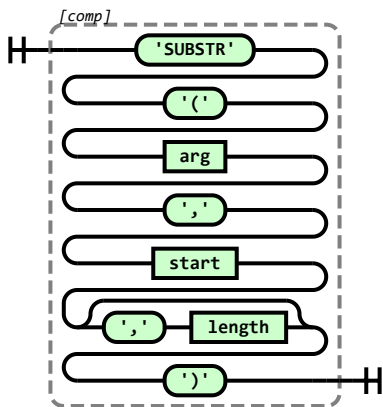

start

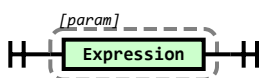

length

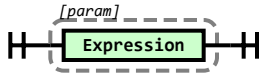

Builtin_STRLEN

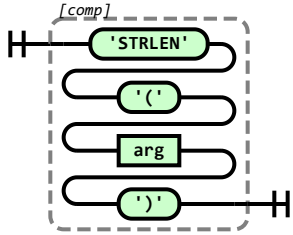

Builtin_REPLACE

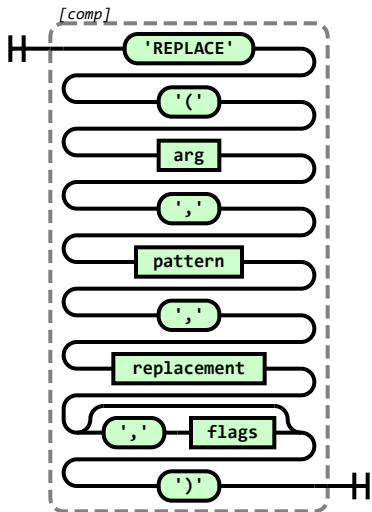

pattern

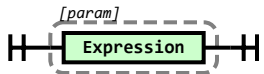

replacement

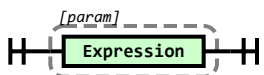

flags

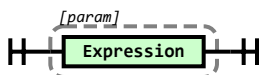

Builtin_UCASE

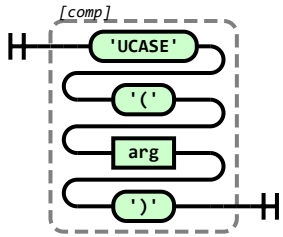

Builtin_LCASE

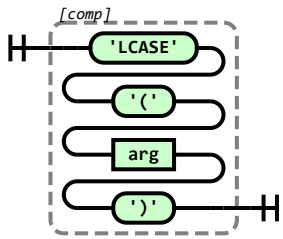

Builtin_ENCODE_FOR_URI

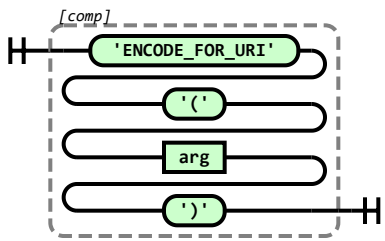

Builtin_CONTAINS

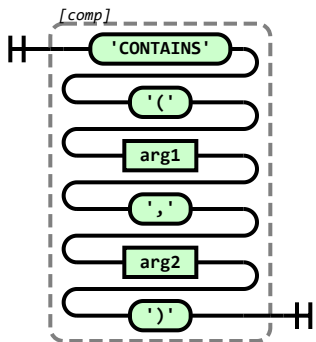

Builtin_STRSTARTS

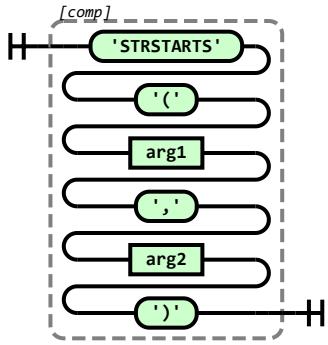

Builtin_STRSTARTS

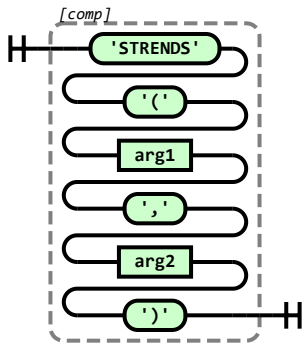

Builtin_STRBEFORE

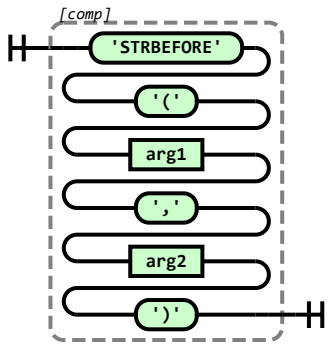

Builtin_STRAFTR

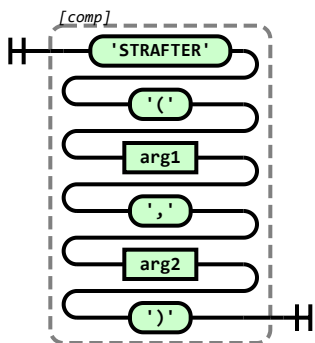

Builtin_YEAR

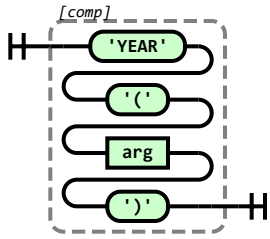

Builtin_MONTH

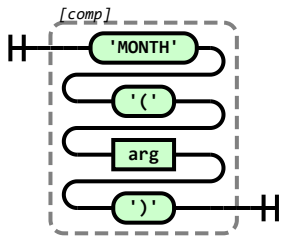

Builtin_DAY

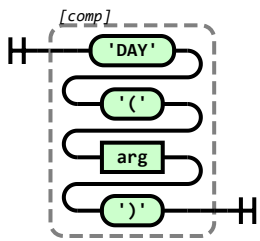

Builtin_HOURS

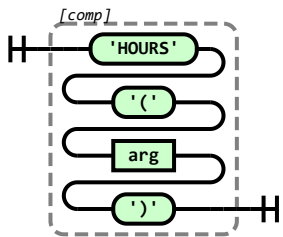

Builtin_MINUTES

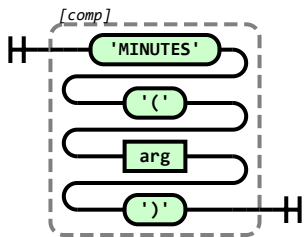

Builtin_SECONDS

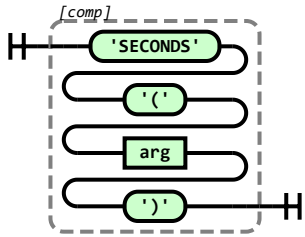

Builtin_TIMEZONE

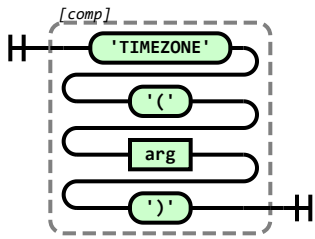

Builtin_TZ

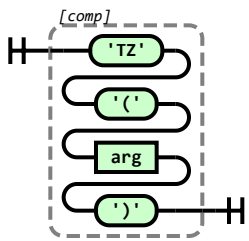

Builtin_NOW

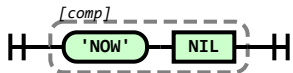

Builtin_UUID

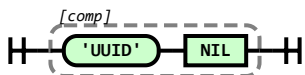

Builtin_STRUUID

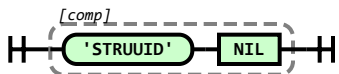

Builtin_MD5

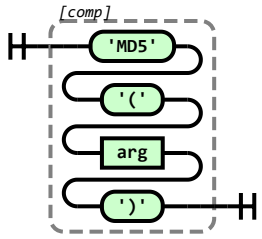

Builtin_SHA1

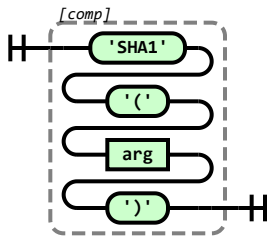

Builtin_SHA256

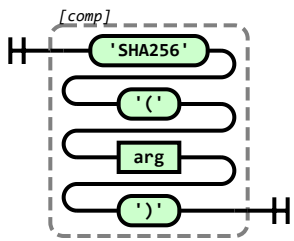

Builtin_SHA384

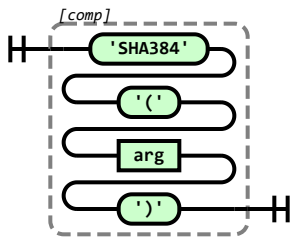

Builtin_SHA512

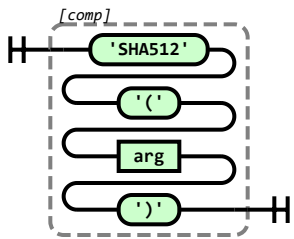

Builtin_COALESCE

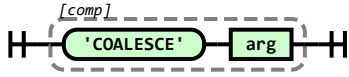

Builtin_IF

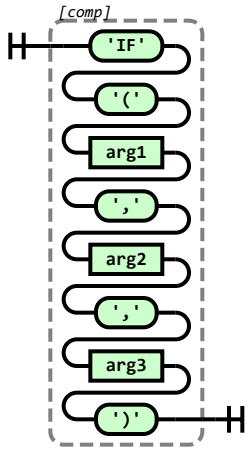

arg3

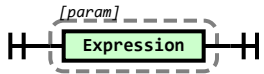

Builtin_STRLANG

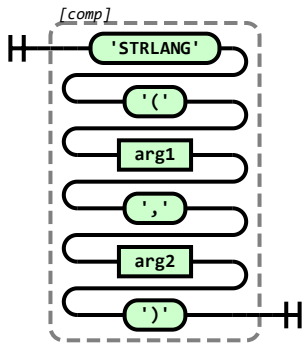

Builtin_STRDT

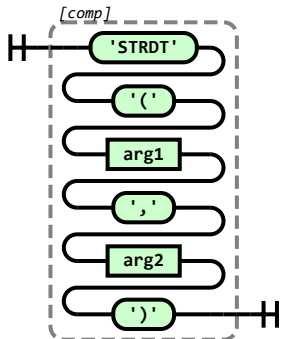

Builtin_sameTerm

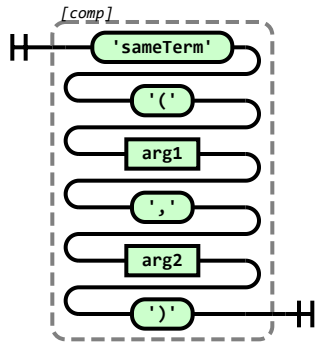

Builtin_isIRI

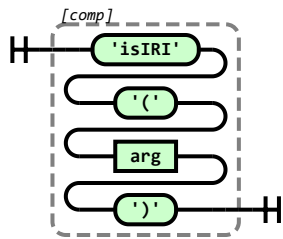

Builtin_isURI

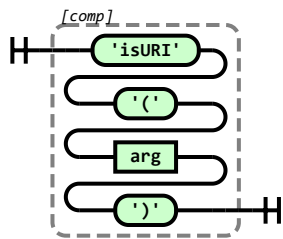

Builtin_isBLANK

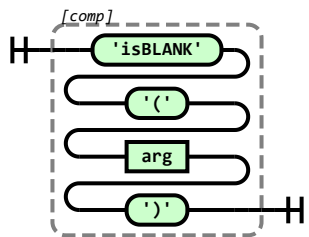

Builtin_isLITERAL

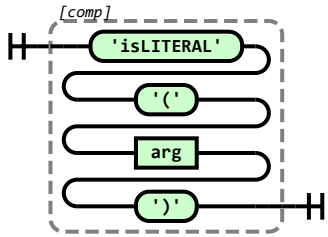

Builtin_isNUMERIC

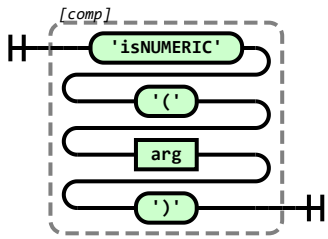

Builtin_REGEX

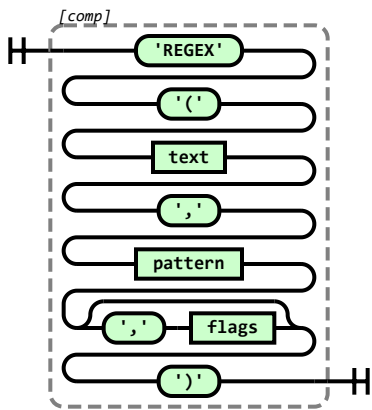

text

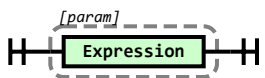

Builtin_EXISTS

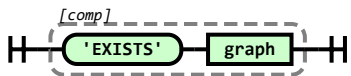

GroupGraphPattern

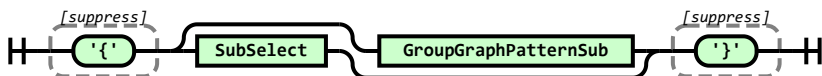

SubSelect

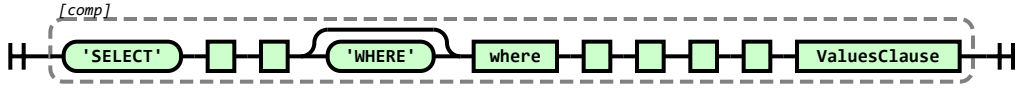

where

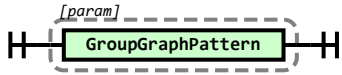

groupby

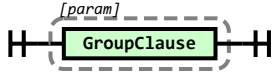

GroupClause

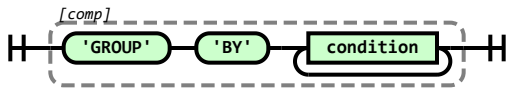

condition

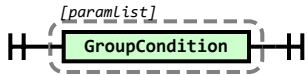

GroupCondition

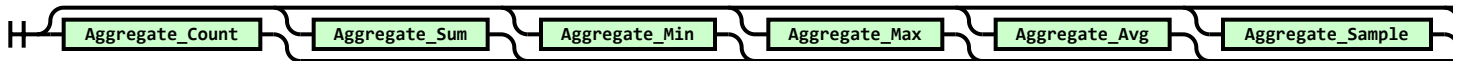

Builtin_NOTEXISTS

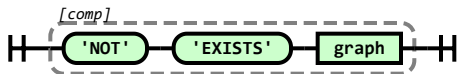

graph

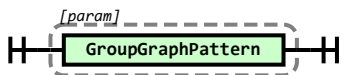

Function

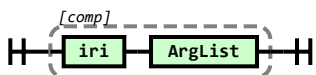

pname

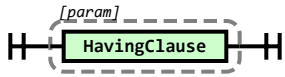

HavingClause

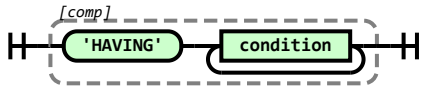

Constraint

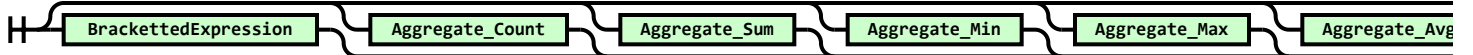

orderby

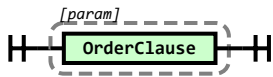

OrderClause

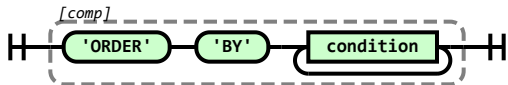

OrderCondition

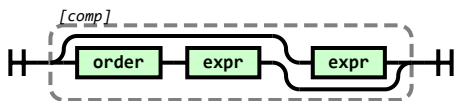

order

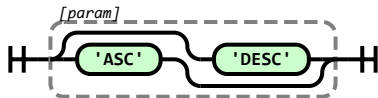

limitoffset

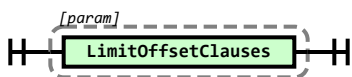

LimitOffsetClauses

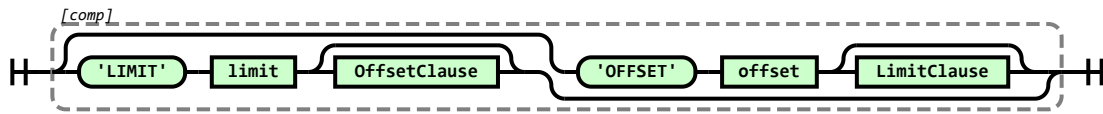

OffsetClause

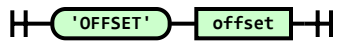

offset

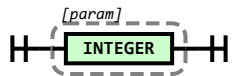

LimitClause

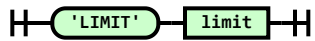

limit

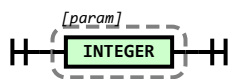

valuesClause

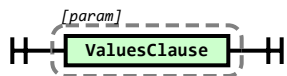

ValuesClause

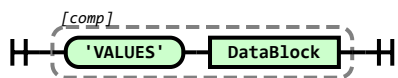

DataBlock



InlineDataOneVar

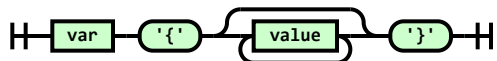

value

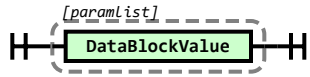

DataBlockValue

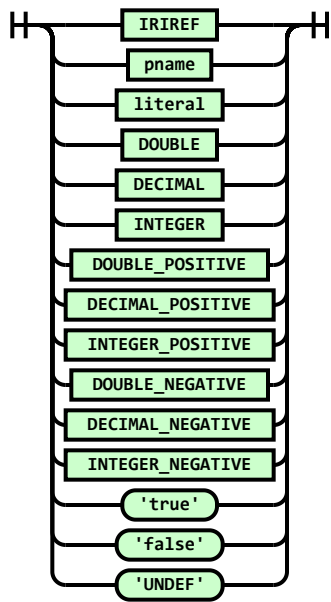

literal

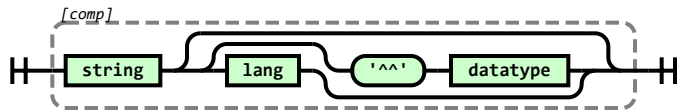

string

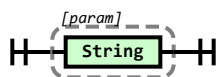

String

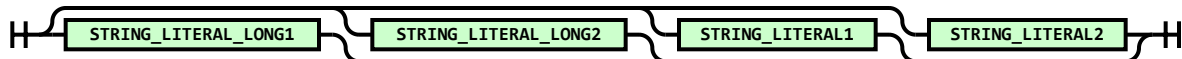

STRING_LITERAL_LONG1

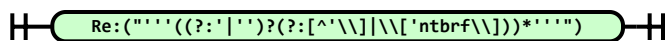

STRING_LITERAL_LONG2

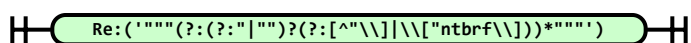

STRING_LITERAL1

Path

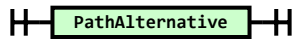

PathAlternative

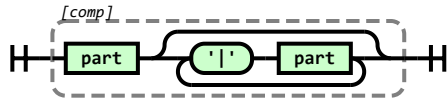

PathSequence

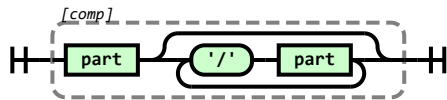

PathElt

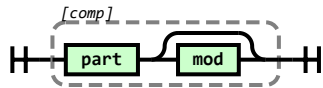

PathPrimary

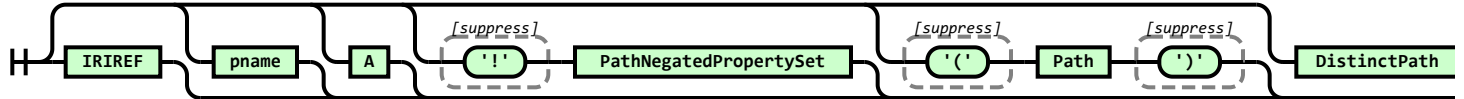

PathNegatedPropertySet

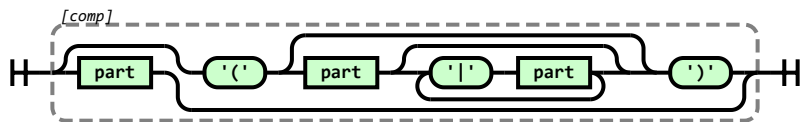

part

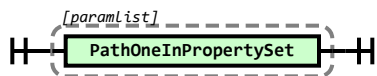

PathOneInPropertySet



InversePath

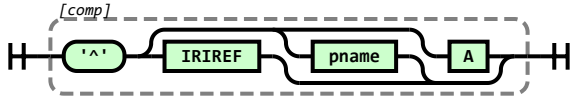

DistinctPath

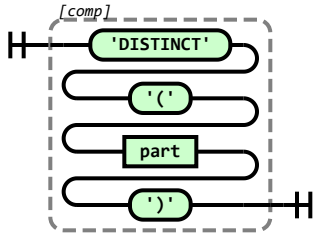

mod

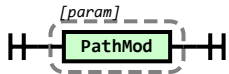

PathMod

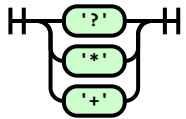

PathEltOrInverse

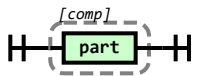

GraphNodePath



TriplesNodePath

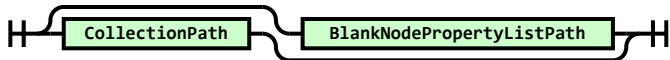

CollectionPath

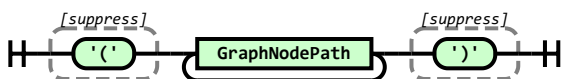

BlankNodePropertyListPath

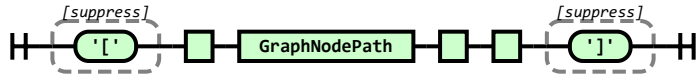

PropertyListPath

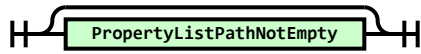

PropertyListPathNotEmpty

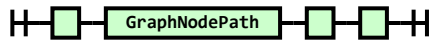

GraphPatternNotTriples

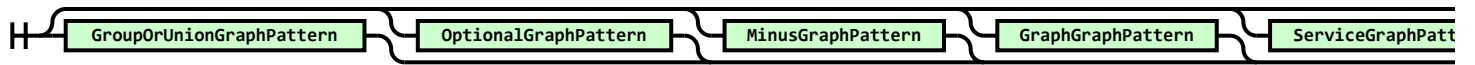

GroupOrUnionGraphPattern

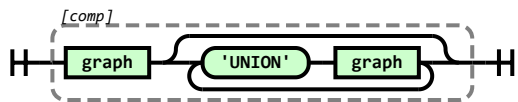

OptionalGraphPattern

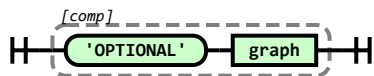

MinusGraphPattern

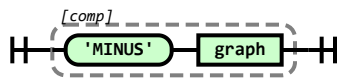

GraphGraphPattern

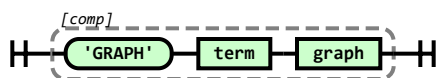

term

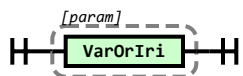

VarOrIri



ServiceGraphPattern

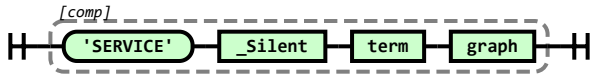

_Silent

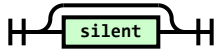

silent

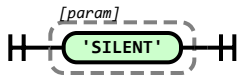

Filter

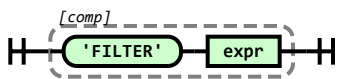

Bind

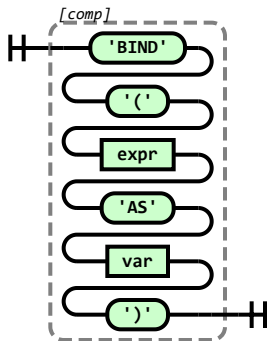

InlineData

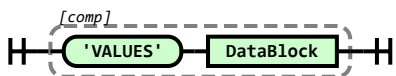

iriOrFunction

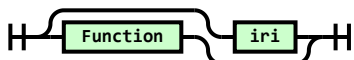

NumericLiteral

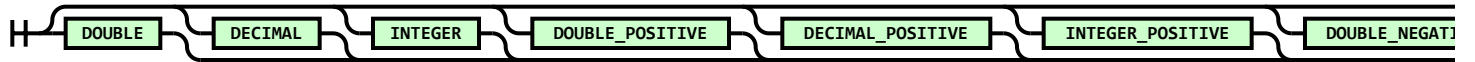

BooleanLiteral



UnaryPlus

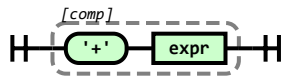

UnaryMinus

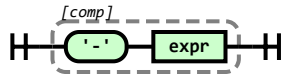

op

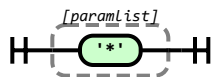

other

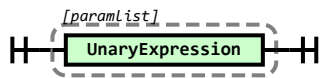

evvar

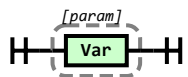

datasetClause

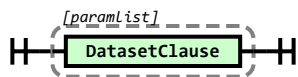

DatasetClause

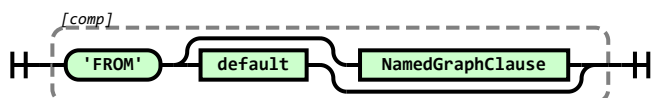

default

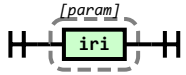

NamedGraphClause

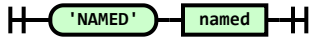

named



ConstructQuery

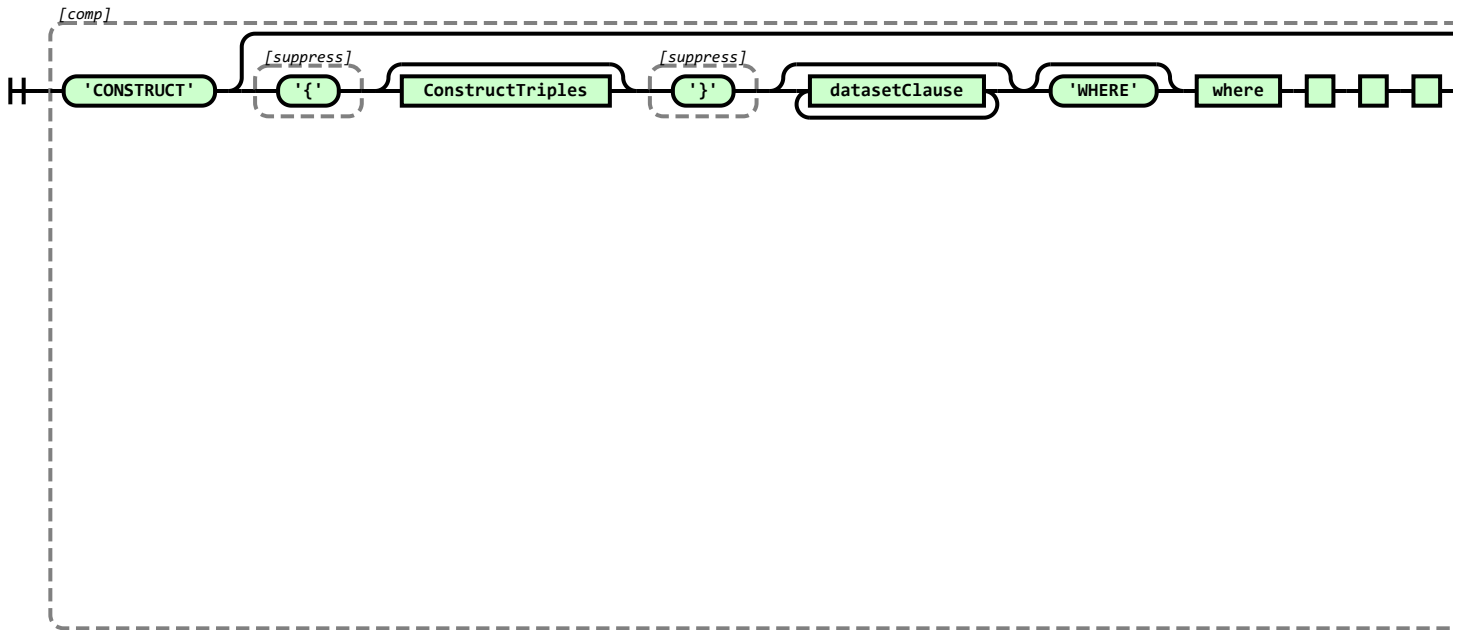

ConstructTriples

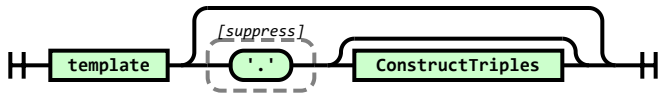

template

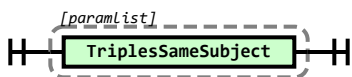

TriplesSameSubject

