

T

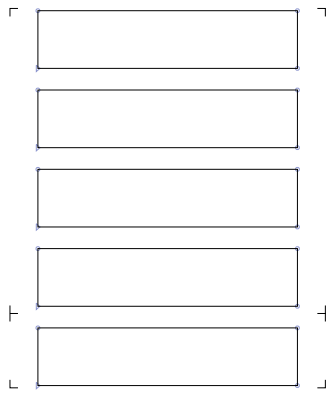

┌ ┐

┌ ┐

+

┌ ┐

┌ ┐

└ ┘

└ ┘

└ ┘

.null

.notdef

space

0020

nbspace

00A0

┌ ┐

┌ ┐

┌ ┐

┌ ┐

┌ ┐

┌ ┐

┌ ┐

┌ ┐

uni202F

202F

uni205F

205F

A

0041

Adieresis

00C4



Atilde

00C3

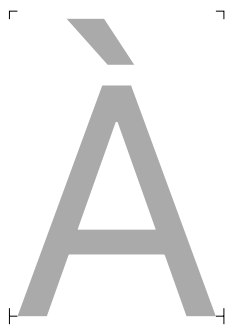

Agrave

00C0



Aacute

00C1

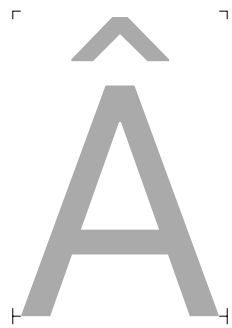

Acircumflex

00C2

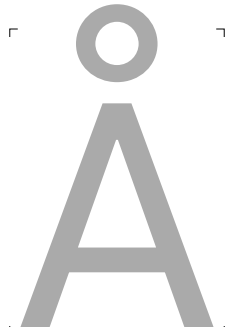

Aring

00C5

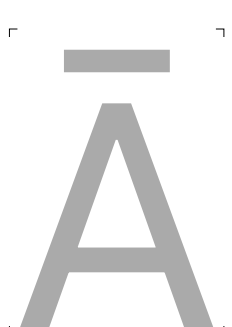

Amacron

0100

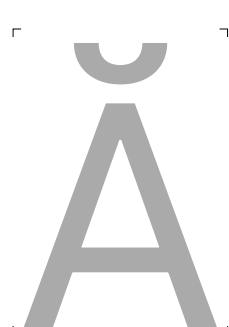

Abreve

0102



Aogonek

0104

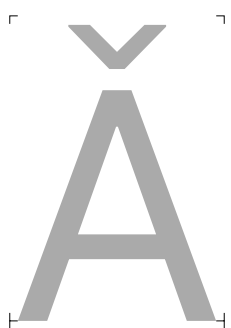

Acaron

01CD

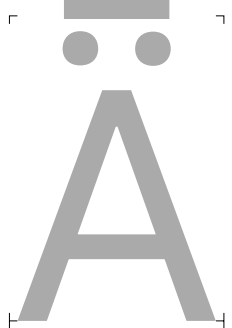

Adieresismacron

01DE

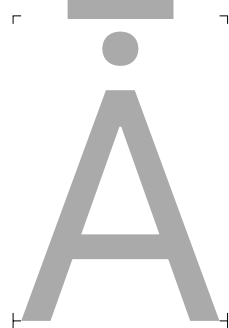

Adotmacron

01E0

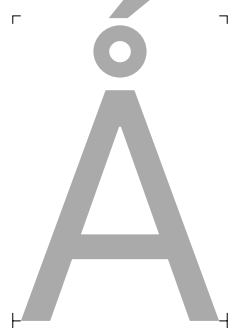

Aringacute

01FA



Adblgrave

0200

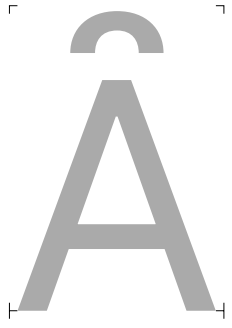

Ainvertedbreve

0202



uni0226

0226



Aringbelow

1E00

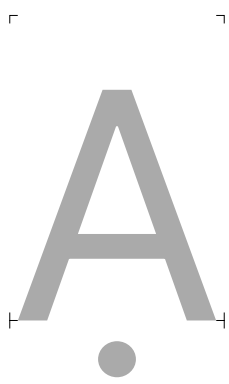

Adotbelow 1EA0

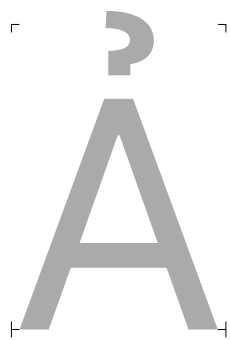

Ahookabove 1EA2

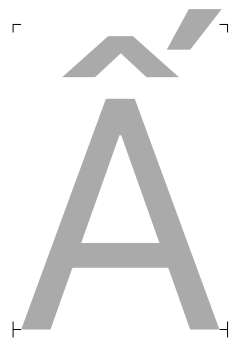

Acircumflexacute 1EA4

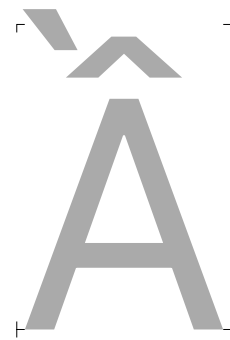

Acircumflexgrave 1EA6

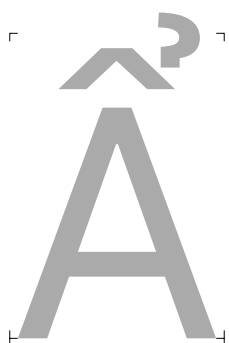

Acircumflexhookabove 1EA8

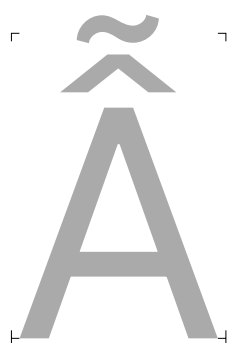

Acircumflextilde 1EAA

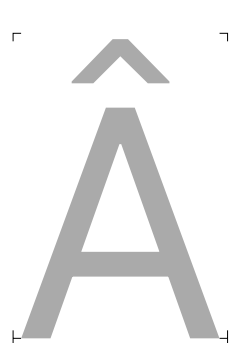

Acircumflexdotbelow 1EAC

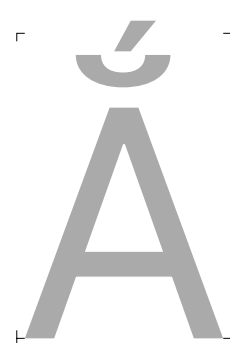

Abreveacute 1EAE

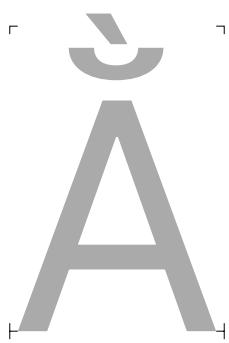

Abrevegrave 1EB0

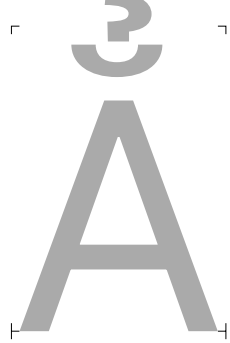

Abrevehookabove 1EB2

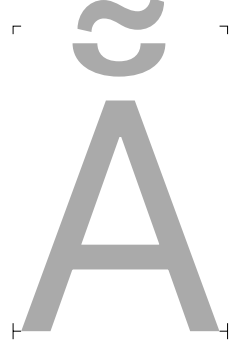

Abrevetilde 1EB4



Abrevedotbelow 1EB6



Alpha 0391



Alphatonos 0386



uni1F08 1F08



uni1F09 1F09



uni1F0A 1F0A



uni1F0B 1F0B



uni1F0C 1F0C



uni1F0D 1F0D



uni1F0E 1F0E



uni1F0F 1F0F

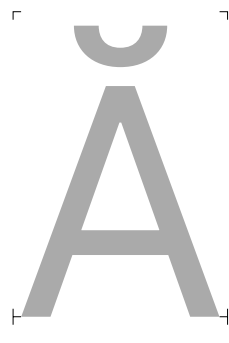

uni1FB8 1FB8



uni1FB9 1FB9

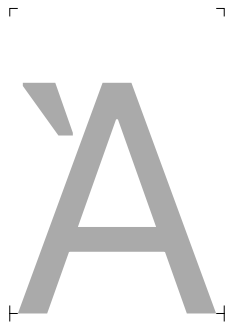

uni1FBA

1FBA

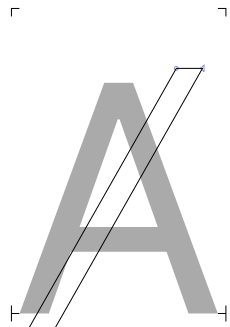

023A



uni1FBB

1FBB

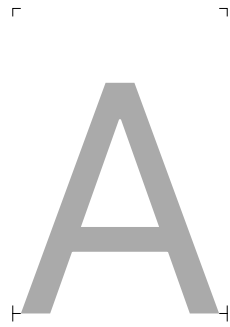

afii10017

0410

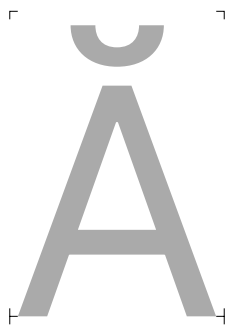

Abrevecyrillic

04D0

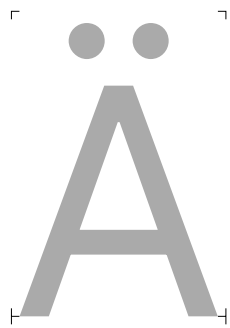

Adieresiscyrillic

04D2



uni1F88

1F88



uni1F89

1F89



uni1F8A

1F8A



uni1F8B

1F8B



uni1F8C

1F8C



uni1F8D

1F8D



uni1F8E

1F8E

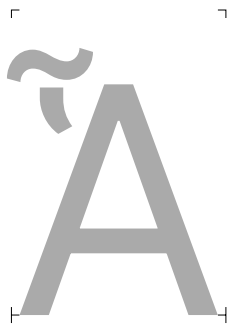

uni1F8F

1F8F



uni1FBC

1FBC

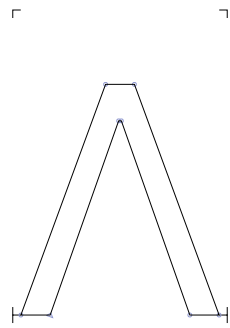

Lambda

039B

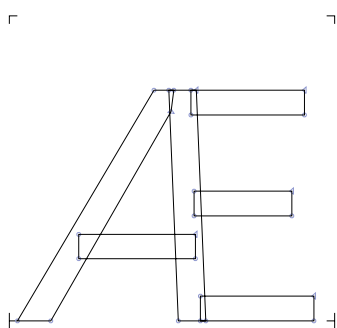

AE

00C6

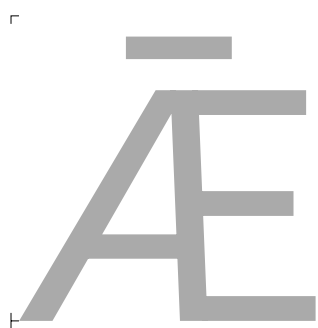

AEmacron

01E2



AEacute

01FC



Aicyrillic

04D4

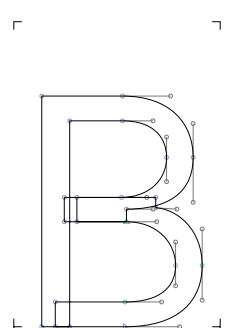

B

0042



Bdotaccent

1E02



Bdotbelow

1E04



Blinebelow

1E06

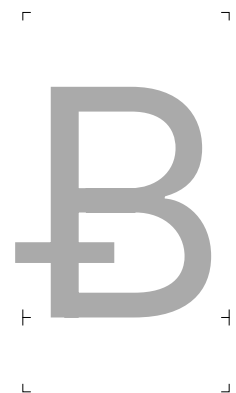

uni0243

0243

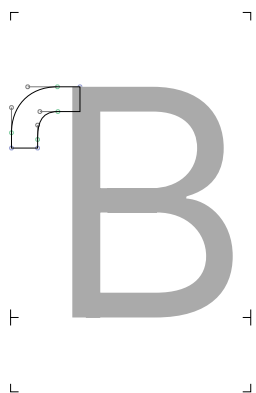

Bhook

0181



afii10019

0412



Beta

0392

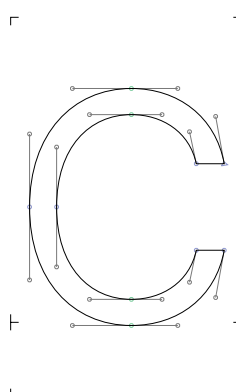

C

0043

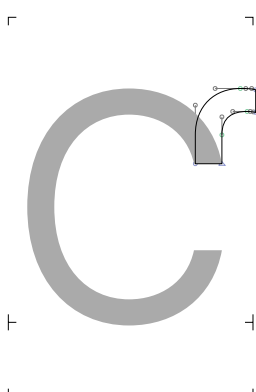

Chook

0187

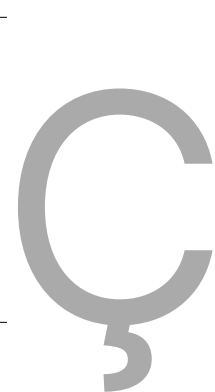

Ccedilla

00C7

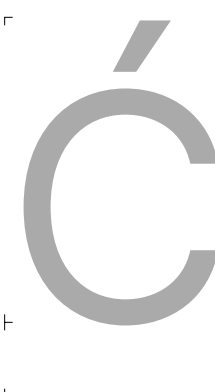

Cacute

0106

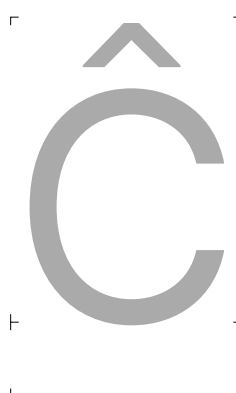

Ccircumflex

0108

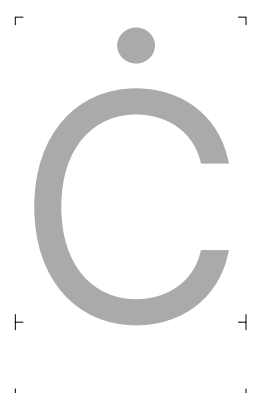

Cdotaccent

010A

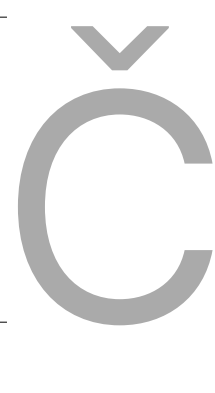

Ccaron

010C

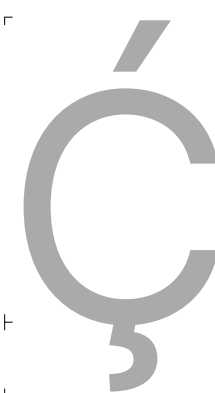

Ccedillaacute

1E08

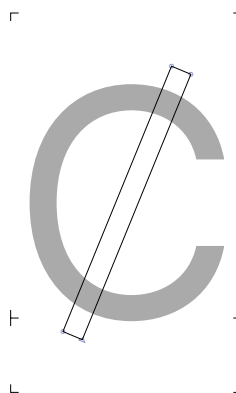

uni023B

023B

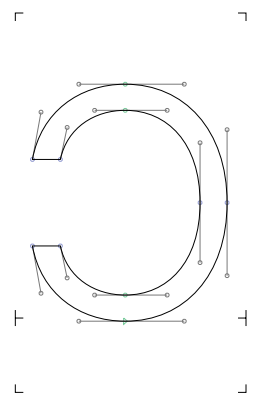

Open

0186

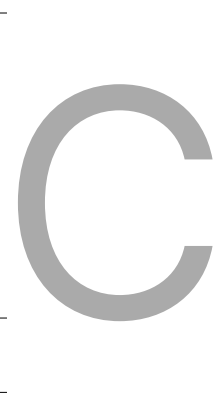

uni03F9

03F9

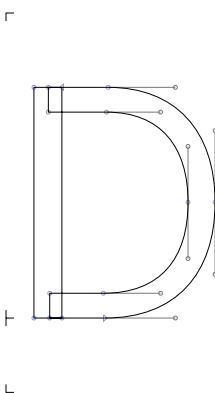

D

0044

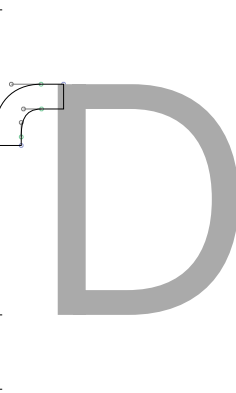

Dhook

018A

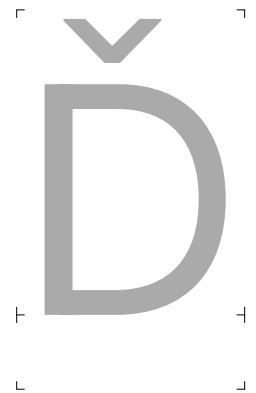

Dcaron

010E



Ddotaccent

1E0A



Ddotbelow

1E0C



Dlinebelow

1E0E

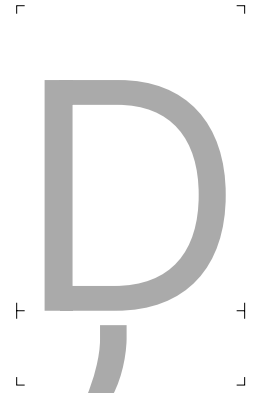

Dcedilla

1E10



Dcircumflexbelow

1E12



Dbar1

0189



Dz 01F2



Dzcaron\_ 01C5

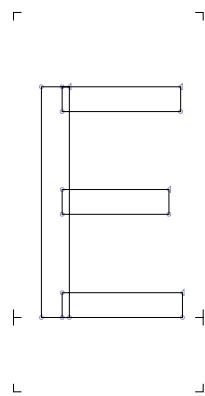

E 0045



Egrave 00C8



Eacute 00C9



Ecircumflex 00CA



Edieresis 00CB



Emacron 0112



Ebreve 0114



Edotaccent 0116



Eogonek 0118



Ecaron 011A



Edblgrave 0204



Einvertedbreve 0206



uni0228 0228

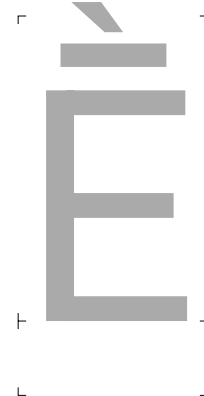

Emacrongrave 1E14

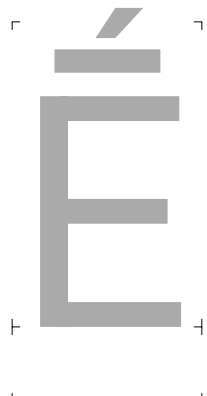

Emacronacute 1E16

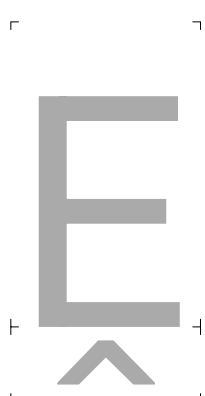

Ecircumflexbelow 1E18



Etildebelow 1E1A



Ecedillabreve 1E1C



Edotbelow 1E88

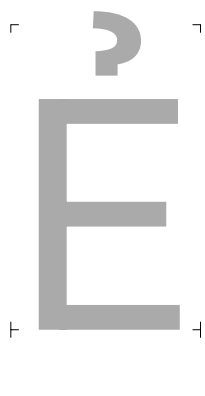

Ehookabove 1E8A



Etilde 1EBC



Ecircumflexacute 1EBE



Ecircumflexgrave 1EC0



Ecircumflexhookabove 1EC2



Ecircumflexilde 1EC4



Ecircumflexdotbelow 1EC6

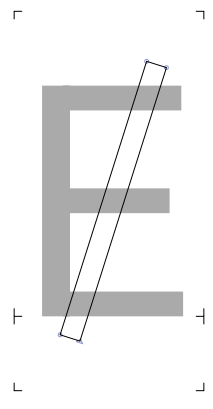

uni0246 0246

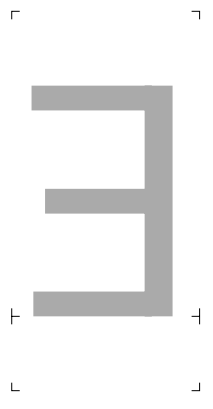

Eturn 018E



Epsilon 0395



Epsilontonos 0388



uni1F18 1F18



uni1F19 1F19



uni1F1A 1F1A



uni1F1B 1F1B



uni1F1C 1F1C



uni1F1D 1F1D



uni1FC8 1FC8



uni1FC9 1FC9



afi10022 0415



uni0400 0400



afi10023 0401



lebrevecyrillic 04D6

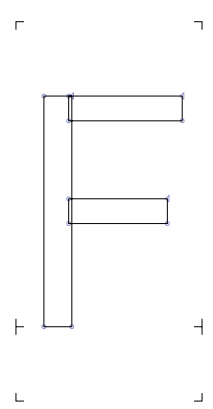

F 0046



Fhook 0191



Fdotaccent 1E1E



Fturn 2132

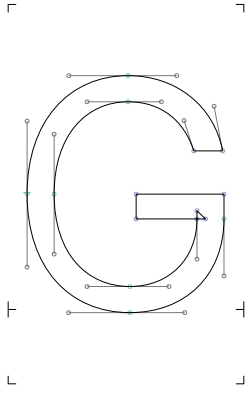

G

0047

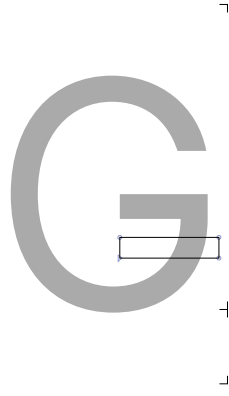

Gbar

01E4

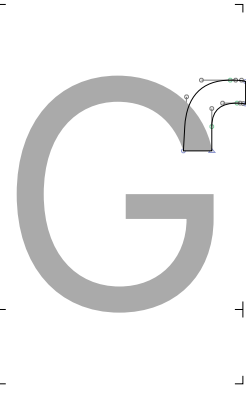

Ghook

0193



Gcircumflex

011C

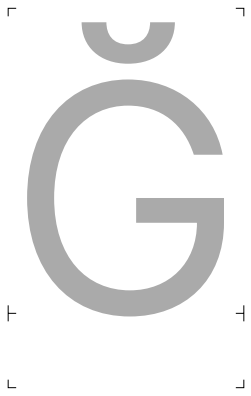

Gbreve

011E



Gdotaccent

0120

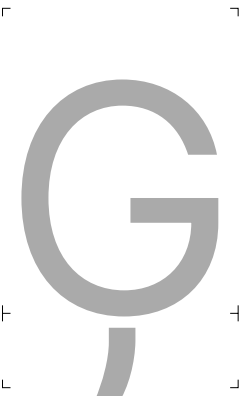

Gcommaaccent

0122



Gcaron

01E6

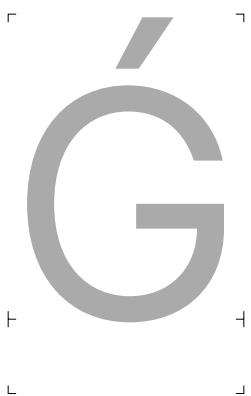

Gacute

01F4



Gmacron

1E20

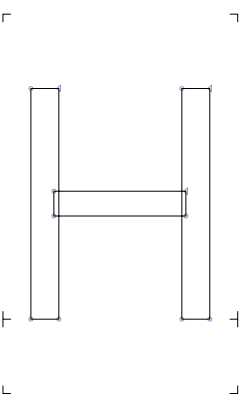

H

0048



Hcedilla

1E28

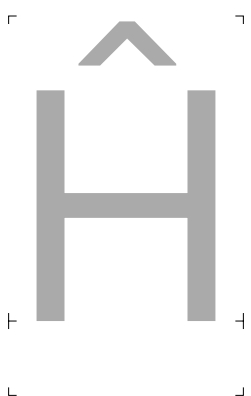

Hcircumflex

0124

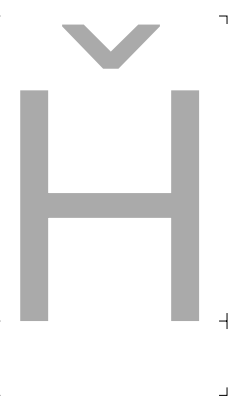

uni021E

021E

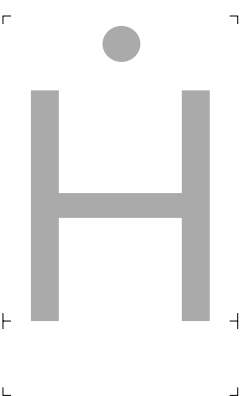

Hdotaccent

1E22



Hdotbelow

1E24

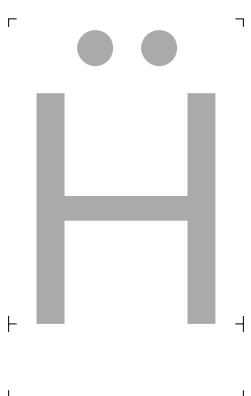

Hdieresis

1E26

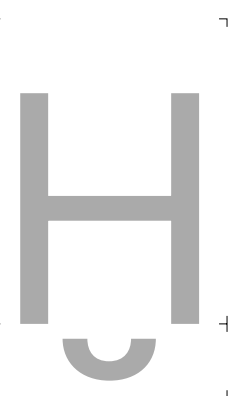

Hbrevebelow

1E2A

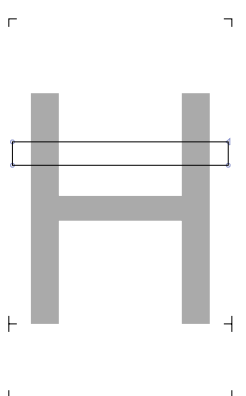

Hbar

0126

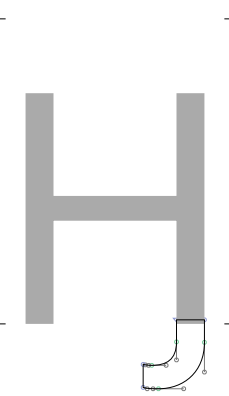

Enhookcyrillic

04C7

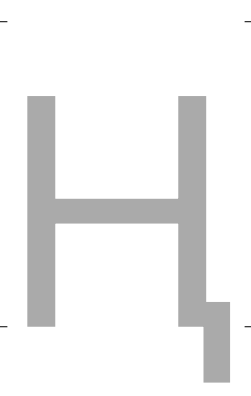

Endescendercyrillic

04A2

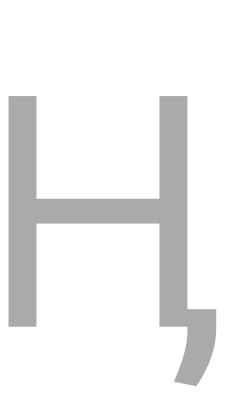

uni04C9

04C9

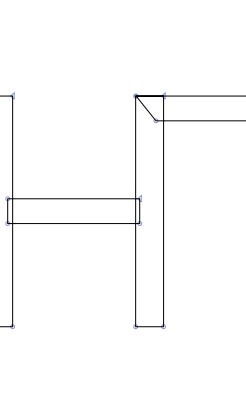

Enghecyrillic

04A4

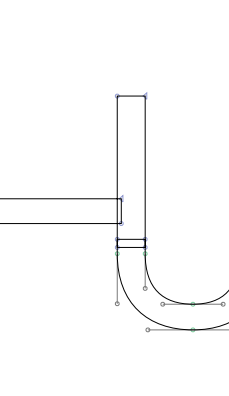

uni01F6

01F6

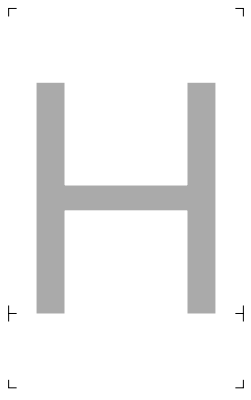

Eta 0397

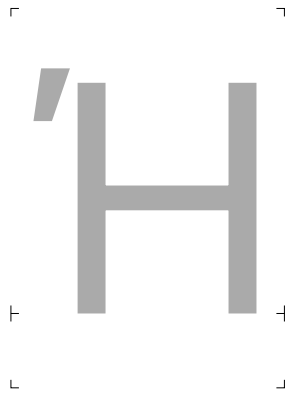

Etatonos 0389



uni1F28 1F28

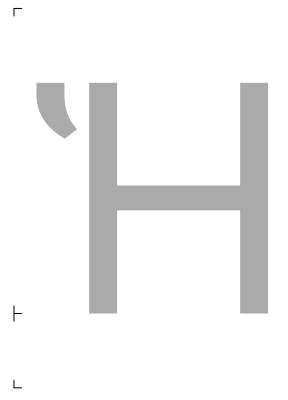

uni1F29 1F29



uni1F2A 1F2A

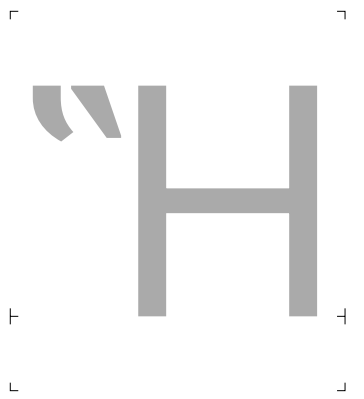

uni1F2B 1F2B



uni1F2C 1F2C



uni1F2D 1F2D



uni1F2E 1F2E

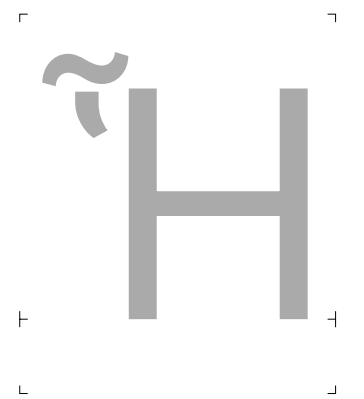

uni1F2F 1F2F

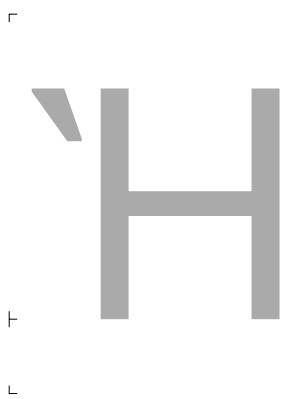

uni1FCA 1FCA



uni1FCB 1FCB

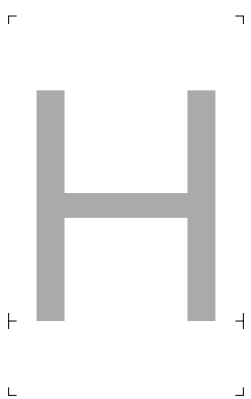

afii10031 041D



uni1F98 1F98



uni1F99 1F99



uni1F9A 1F9A

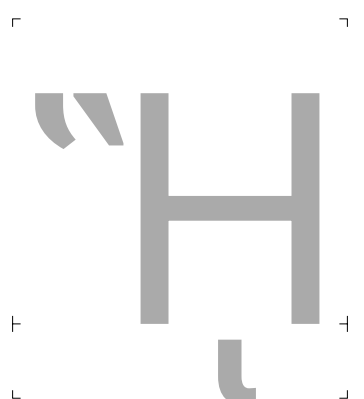

uni1F9B 1F9B

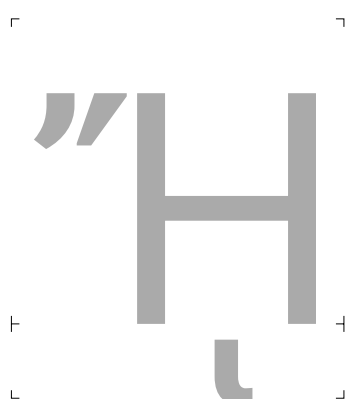

uni1F9C 1F9C

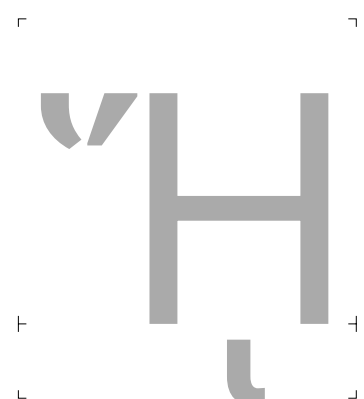

uni1F9D 1F9D

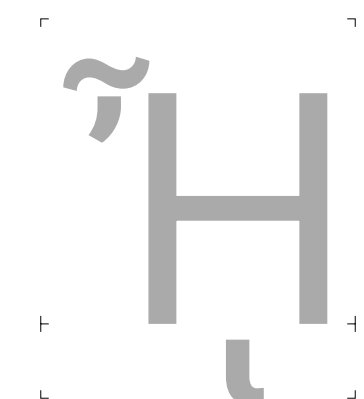

uni1F9E 1F9E

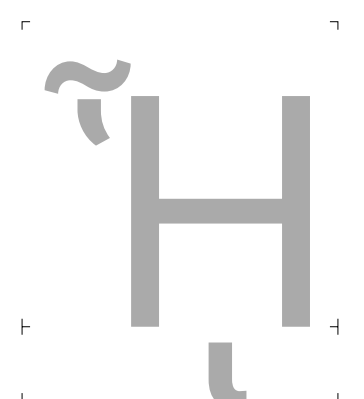

uni1F9F 1F9F

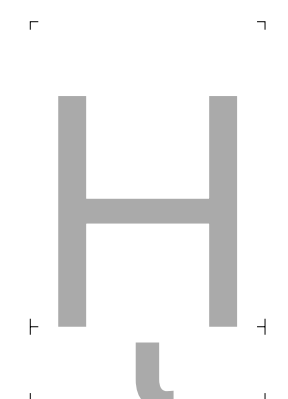

uni1FCC 1FCC

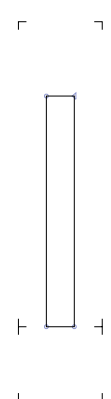

I 0049



Idieresis 00CF



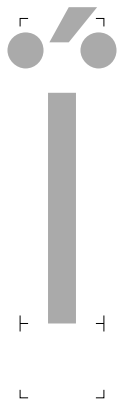

**Idieresisacute**

1E2E



**Istroke**

0197



**Itildebelow**

1E2C



**Igrave**

00CC



**Iacute**

00CD



**Icircumflex**

00CE



**Itilde**

0128



**Imacron**

012A



**Ibreve**

012C



**Ilogonek**

012E



**Idotaccent**

0130



**Icaron**

01CF

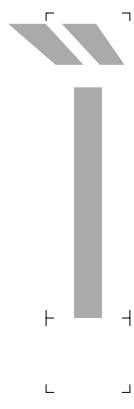

**Idblgrave**

0208



**Iinvertedbreve**

020A



**Ihookabove**

1EC8



**Idotbelow**

1ECA



**Iota**

0399



**Iotatonos**

038A



**Iotadieresis**

03AA



**uni1F38**

1F38



**uni1F39**

1F39



**uni1F3A**

1F3A



**uni1F3B**

1F3B



**uni1F3C**

1F3C

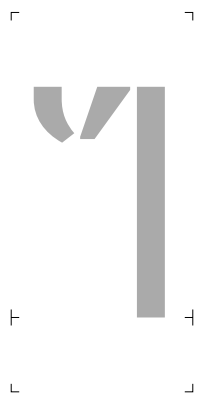

uni1F3D 1F3D

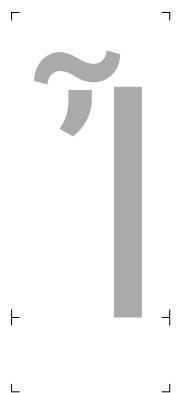

uni1F3E 1F3E



uni1F3F 1F3F

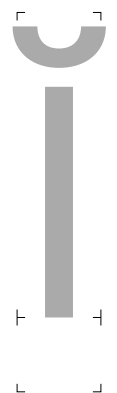

uni1FD8 1FD8

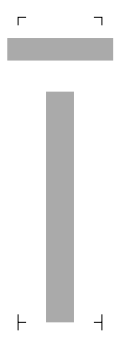

uni1FD9 1FD9



uni1FDA 1FDA



uni1FDB 1FDB



afii10055 0406

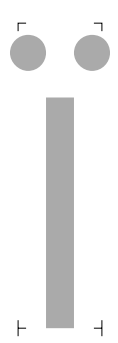

afii10056 0407

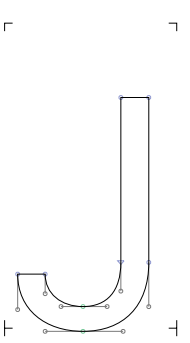

J 004A



Jcircumflex 0134

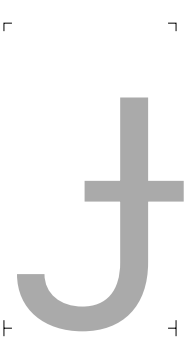

uni0248 0248

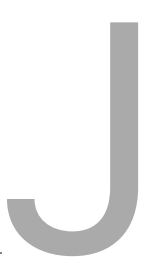

uni037F 037F

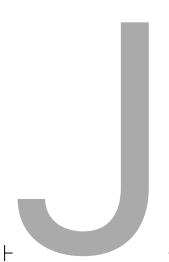

afii10057 0408

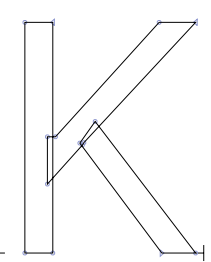

K 004B

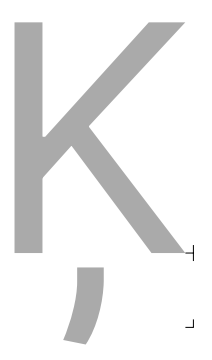

Kcommaaccent 0136

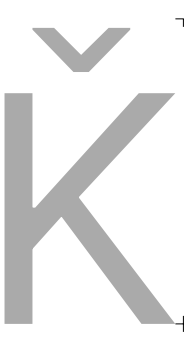

Kcaron 01E8

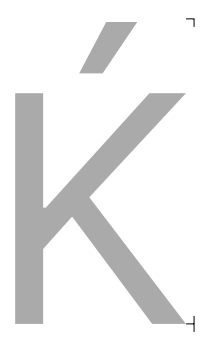

Kacute 1E30

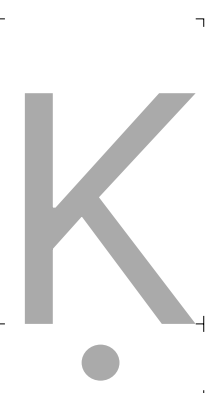

Kdotbelow 1E32

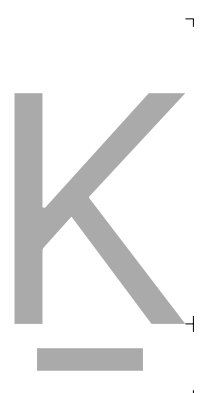

Klinebelow 1E34

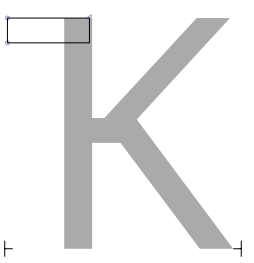

Kabashkircyrillic 04A0

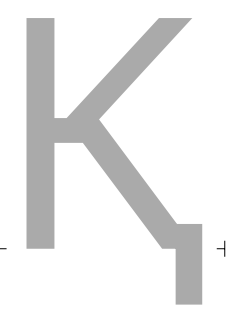

Kadescendercyrillic 049A

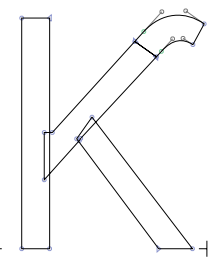

Khook 0198

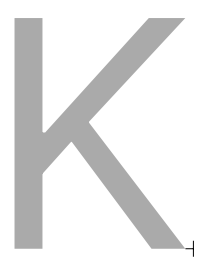

Kappa 039A

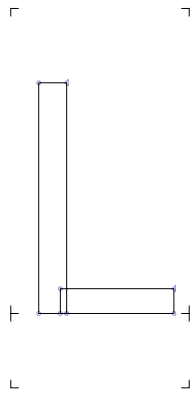

**L** 004C

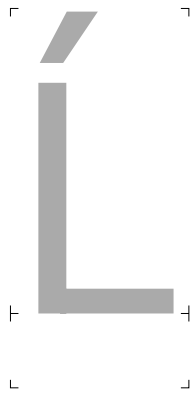

**Lacute** 0139

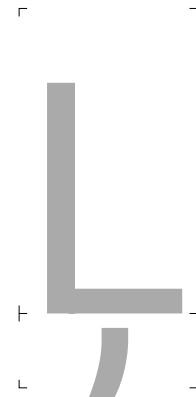

**Lcommaaccent** 013B



**Lcaron** 013D

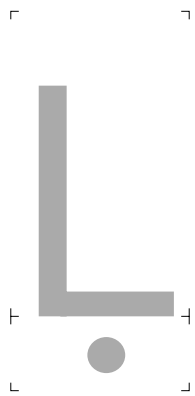

**Ldotbelow** 1E36



**Ldotbelowmacron** 1E38

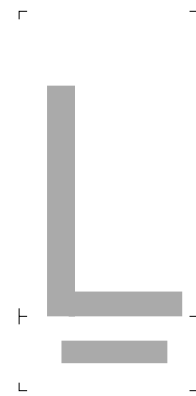

**Llinebelow** 1E3A



**Lcircumflexbelow** 1E3C

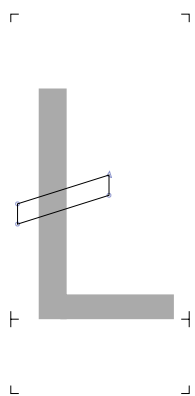

**Lslash** 0141

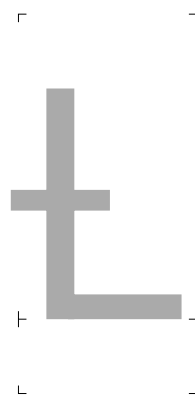

**Lbar** 023D



**Lj** 01C8

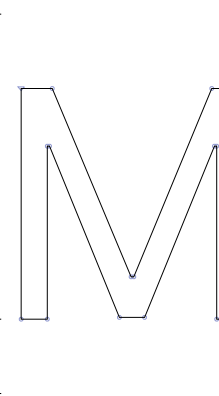

**M** 004D



**Macute** 1E3E



**Mdotaccent** 1E40



**Mdotbelow** 1E42



**uni04CD** 04CD



**Mu** 039C



**uni03FA** 03FA



**afi10030** 041C

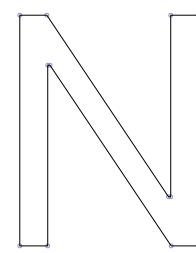

**N** 004E



**Ntilde** 00D1



**Nacute** 0143



**Ncommaaccent** 0145



**Ncaron** 0147

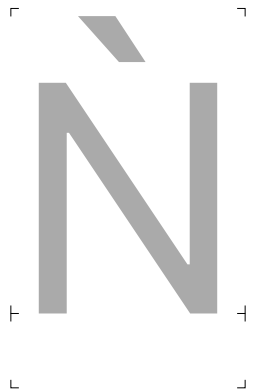

uni01F8

01F8

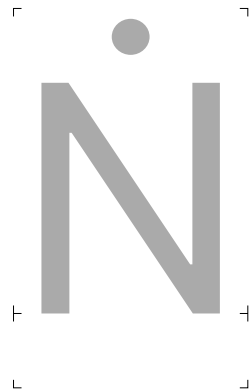

Ndotaccent

1E44

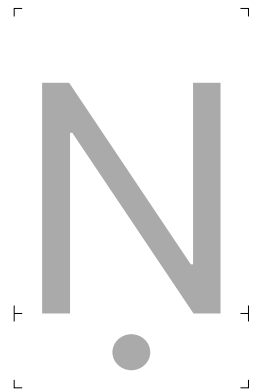

Ndotbelow

1E46

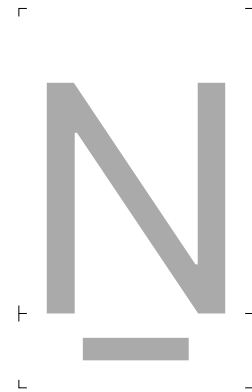

Nlinebelow

1E48

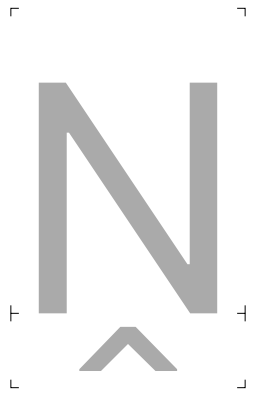

Ncircumflexbelow

1E4A

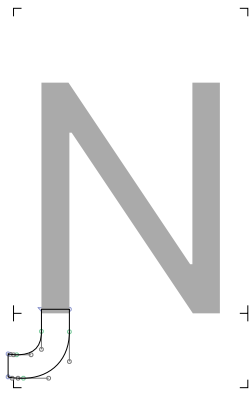

Nhook

019D

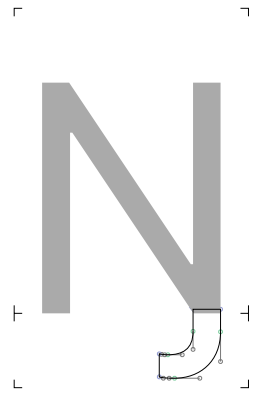

Eng

014A

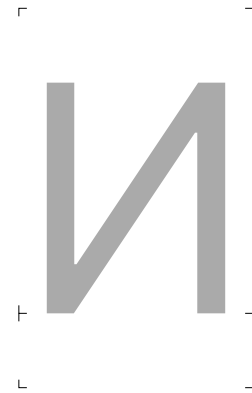

afi10026

0418

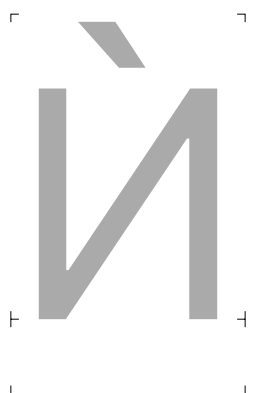

uni040D

040D

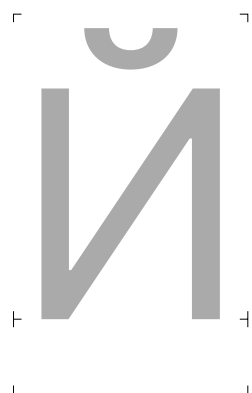

afi10027

0419

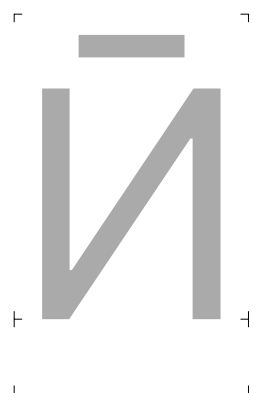

Imacroncyrillic

04E2

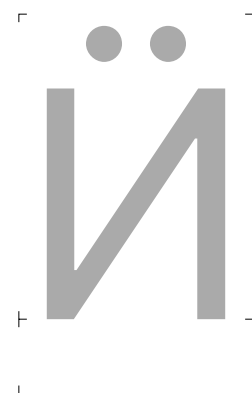

Idieresiscyrillic

04E4

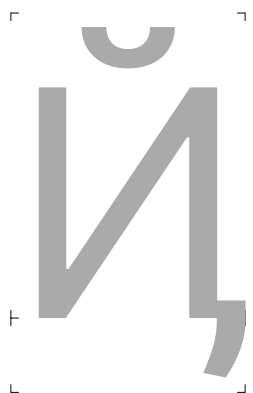

uni048A

048A

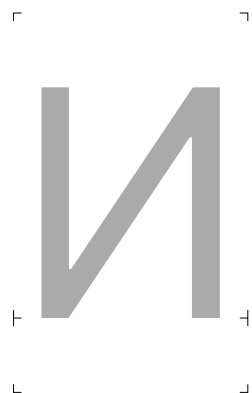

uni0376

0376

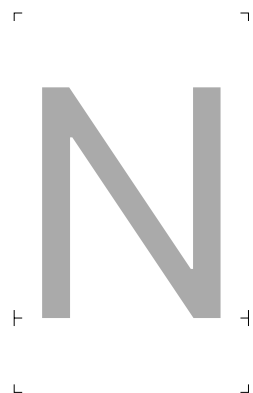

Nu

039D



Nj

01CB

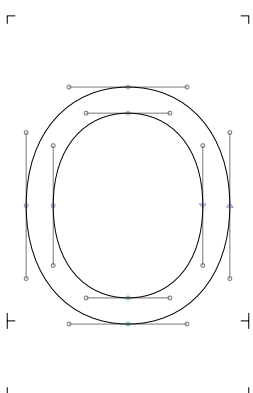

O

004F

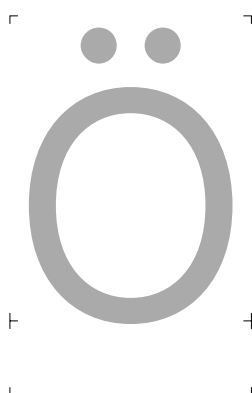

Odieresis

00D6

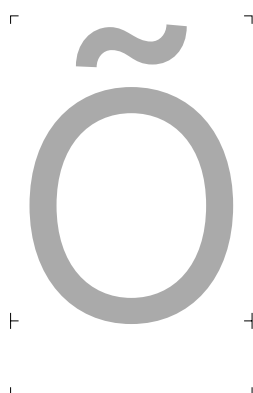

Otilde

00D5

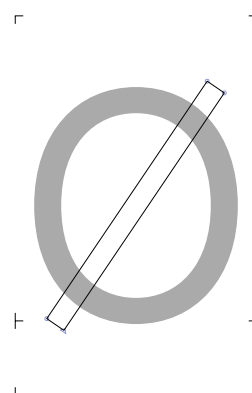

Oslash

00D8

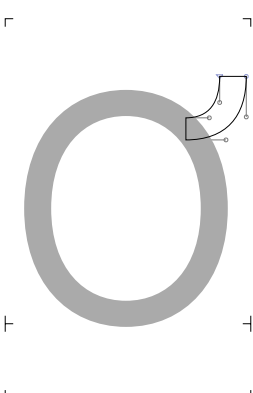

Ohorn

01A0

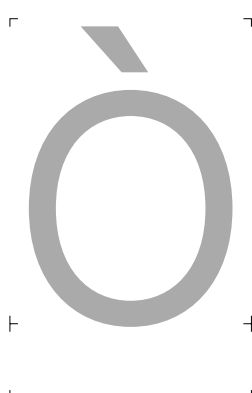

Ograve

00D2

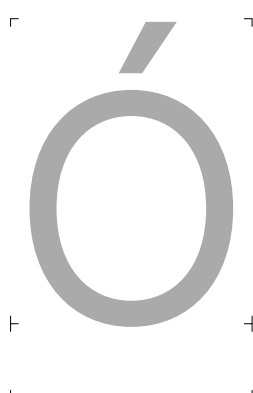

Oacute

00D3

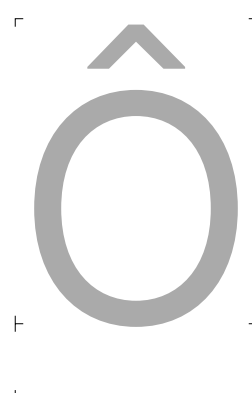

Ocircumflex

00D4

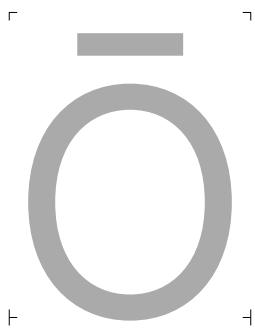

Omacron 014C

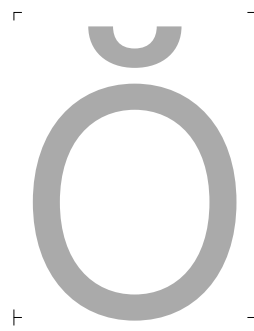

Obreve 014E

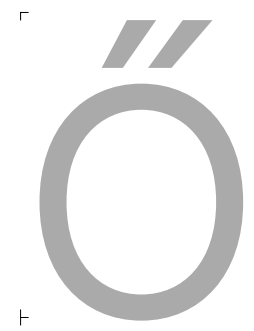

Ohungarumlaut 0150

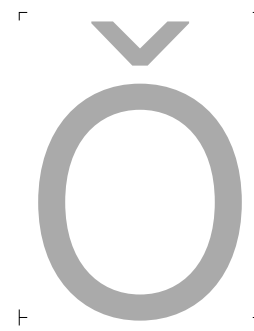

Ocaron 01D1

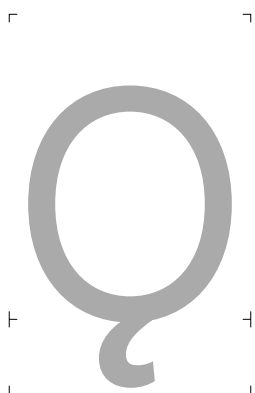

Oogonek 01EA

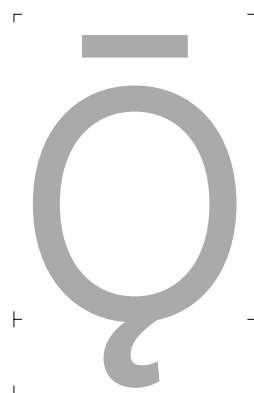

Oogonekmacron 01EC

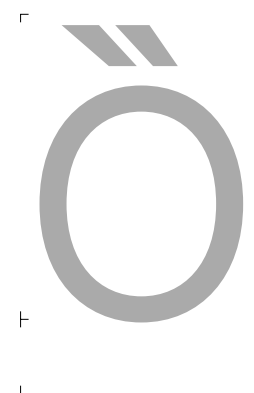

Oddblgrave 020C

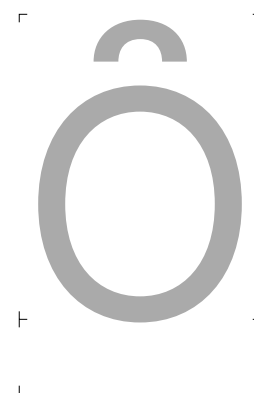

Oinvertedbreve 020E

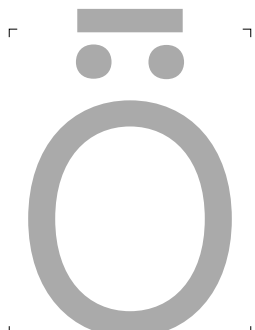

uni022A 022A

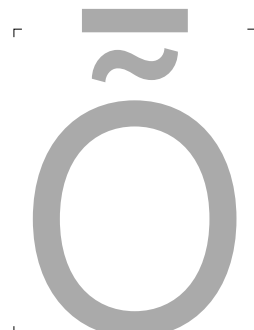

uni022C 022C

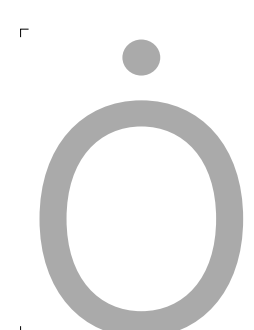

uni022E 022E

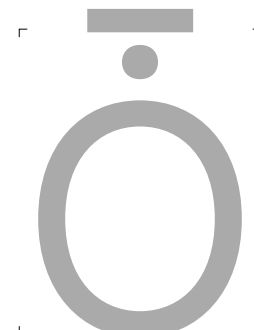

uni0230 0230



Otildeacute 1E4C

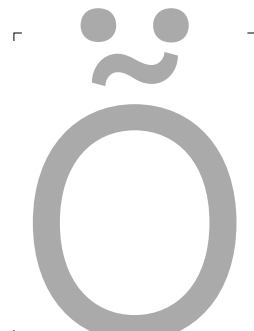

Otildedieresis 1E4E

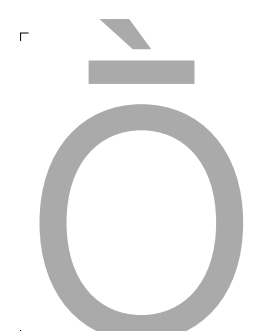

Omacrongrave 1E50

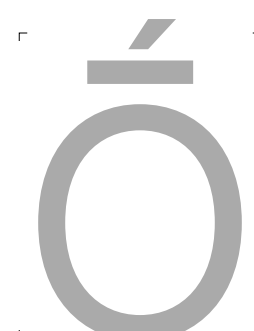

Omacronacute 1E52

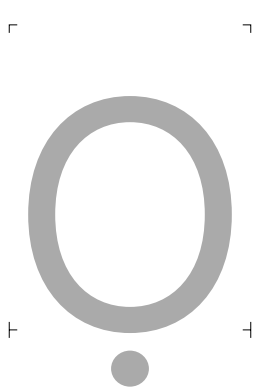

Odotbelow 1ECC

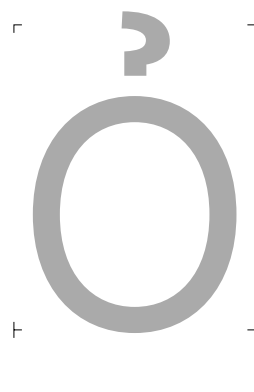

Ohookabove 1ECE

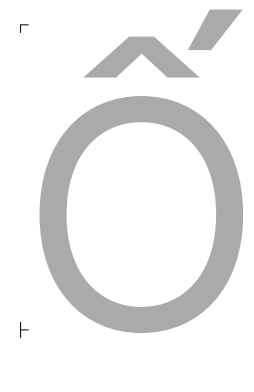

Ocircumflexacute 1ED0

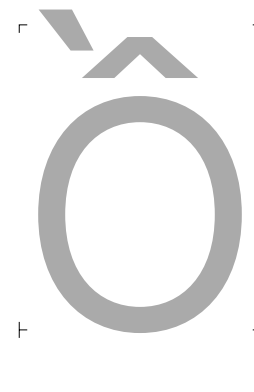

Ocircumflexgrave 1ED2

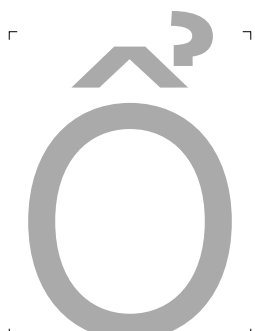

Ocircumflexhookabove 1ED4

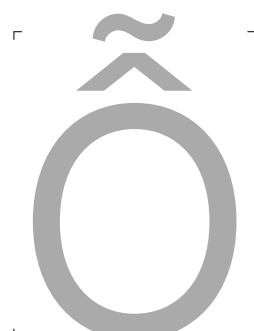

Ocircumflextilde 1ED6

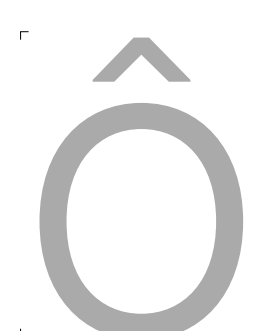

Ocircumflexdotbelow 1ED8



Ohornacute 1EDA

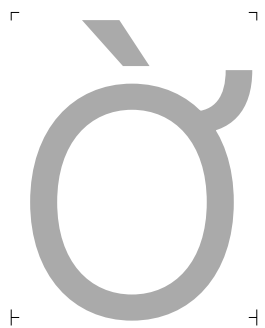

Ohorngrave 1EDC

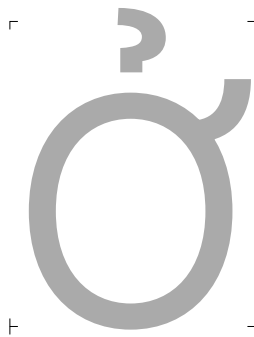

Ohornhookabove 1EDE

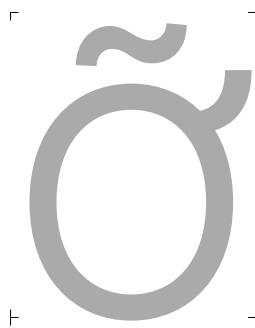

Ohorntilde 1EE0

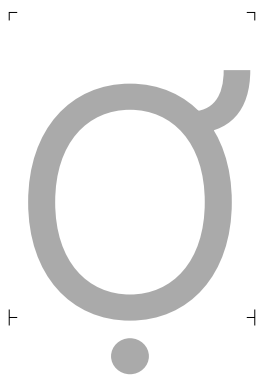

Ohorndotbelow 1EE2

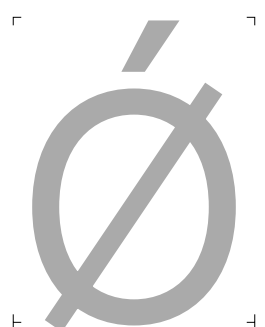

Oslashacute 01FE

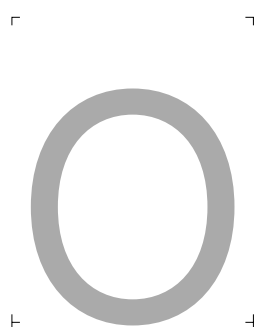

Omicron 039F



Omicrontonos 038C



uni1F48 1F48

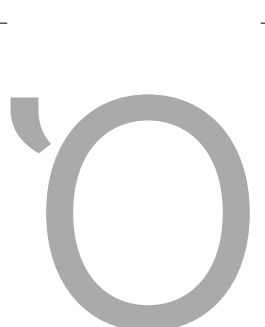

uni1F49 1F49

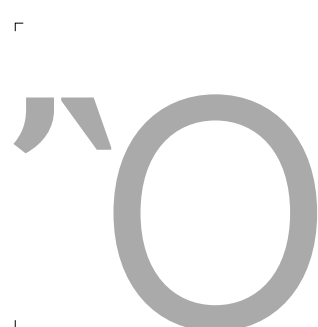

uni1F4A 1F4A



uni1F4B 1F4B



uni1F4C 1F4C

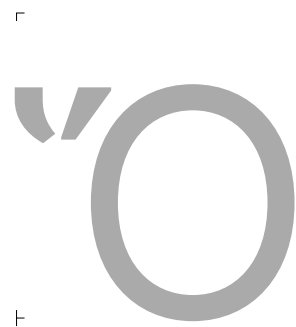

uni1F4D 1F4D



uni1FF8 1FF8

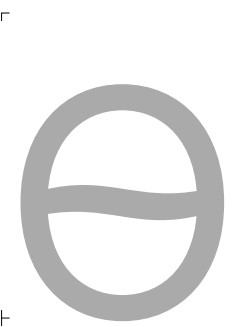

uni03F4 03F4



uni1FF9 1FF9

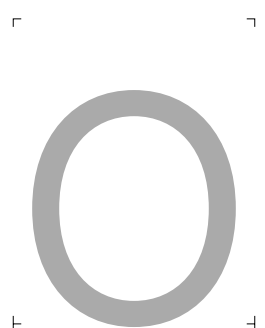

afi10032 041E

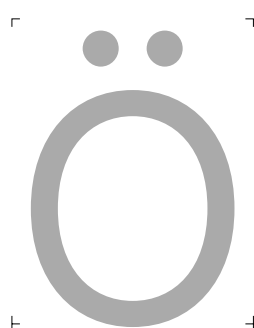

Odiereiscyrillic 04E6

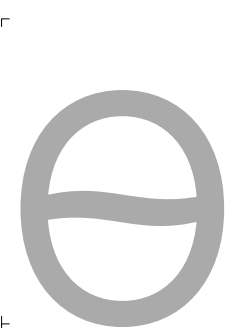

Obar 019F

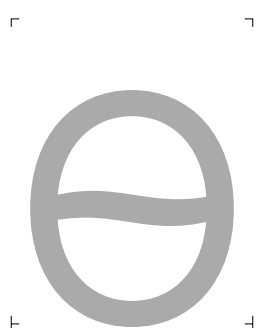

Obarredcyrillic 04E8

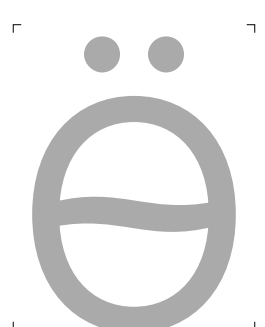

Obarreddiereiscyrillic 04EA

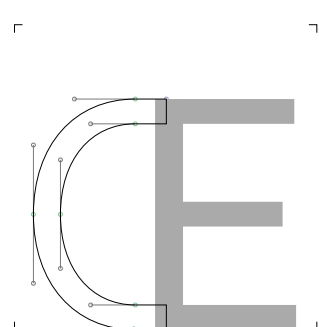

OE 0152

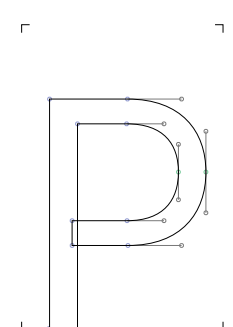

P 0050

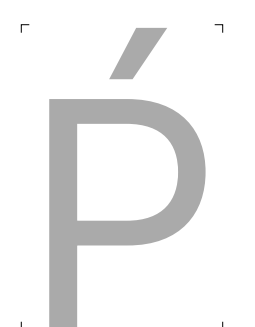

Pacute 1E54



Pdotaccent 1E56

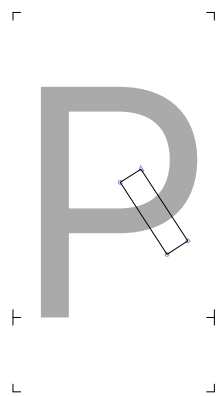

uni048E 048E

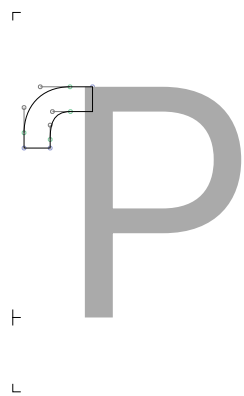

Phook 01A4



Rho 03A1



uni1FEC 1FEC

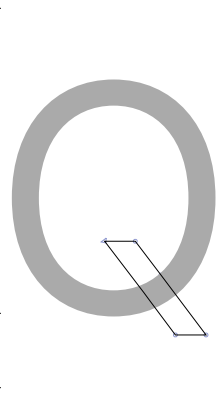

Q 0051

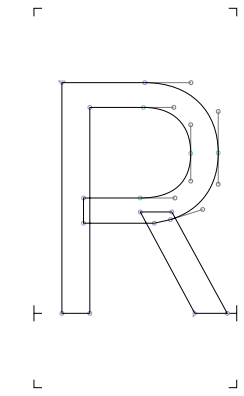

R 0052



Racute 0154



Rcommaaccent 0156



Rcaron 0158



Rdblgrave 0210



Rinvertedbreve 0212



Rdotaccent 1E58



Rdotbelow 1E5A

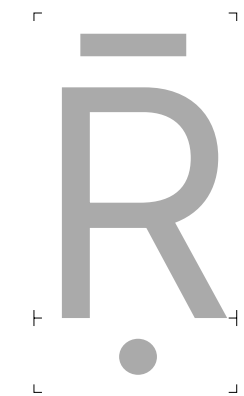

Rdotbelowmacron 1E5C



Rlinebelow 1E5E

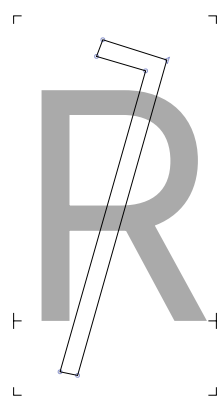

response 211F

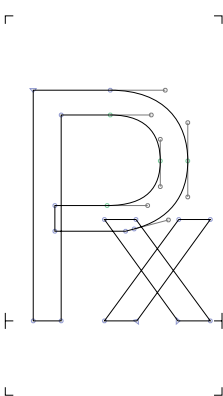

Rx 211E

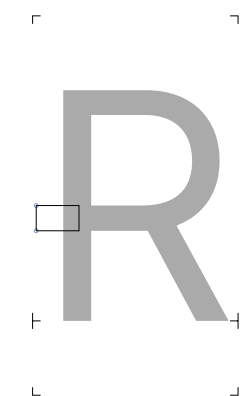

uni024C 024C

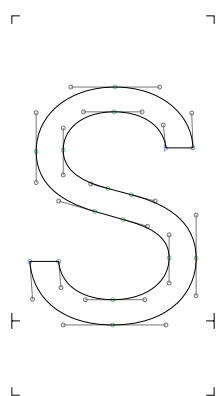

S 0053



Sacute 015A



Scircumflex 015C



Scedilla 015E



Scaron 0160



Scommaaccent 0218



Sdotaccent 1E60



Sdotbelow 1E62



Sacutedotaccent 1E64



Scarondotaccent 1E66



Sdotbelowdotaccent 1E68



afii10054 0405



Tonetwo 01A7

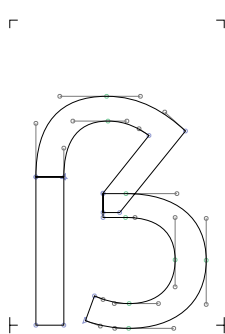

Germandbls 1E9E

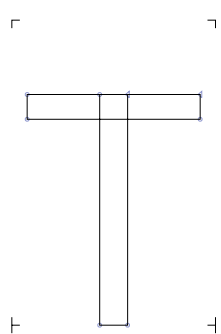

T 0054

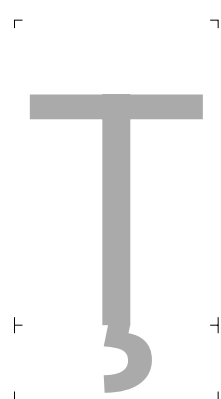

Tcommaaccent 0162

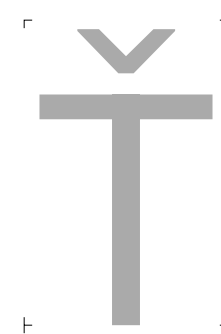

Tcaron 0164

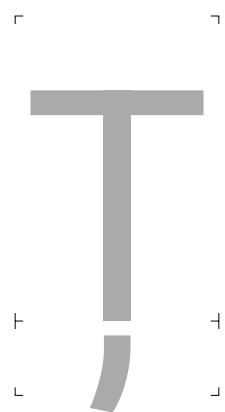

uni021A 021A

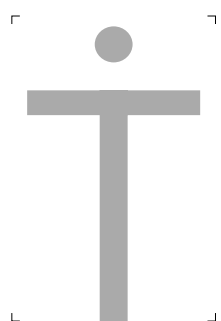

Tdotaccent 1E6A

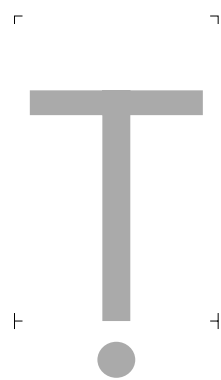

Tdotbelow 1E6C



Tlinebelow 1E6E

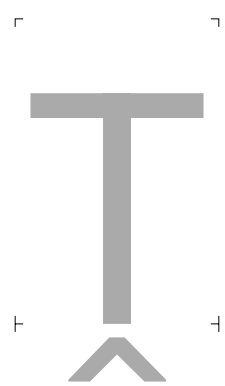

Tcircumflexbelow 1E70

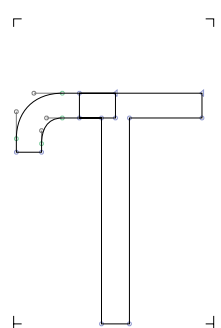

Thook 01AC

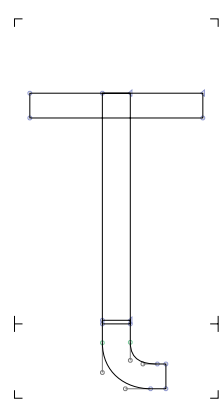

Trhook 01AE

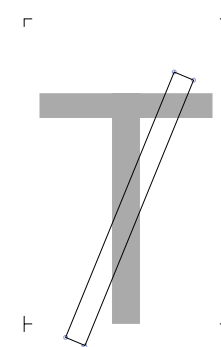

uni023E 023E

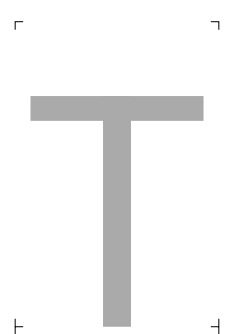

Tau 03A4

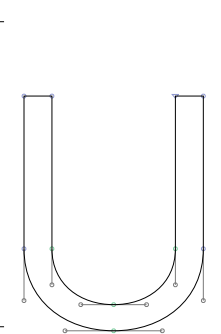

U 0055

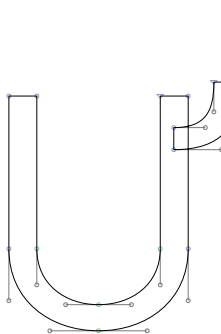

Uhorn 01AF

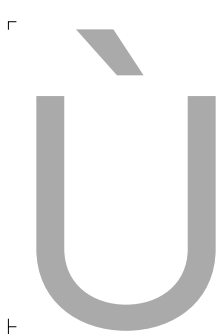

Ugrave 00D9



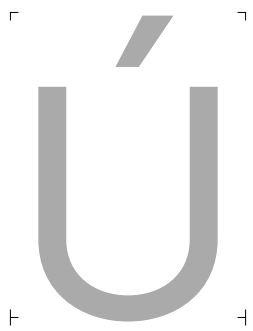

Uacute 00DA

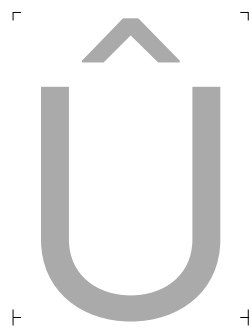

Ucircumflex 00DB

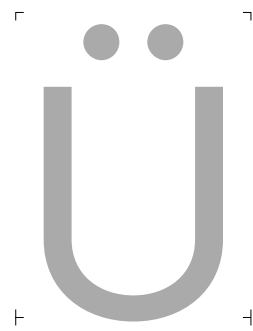

Udieresis 00DC



Utilde 0168

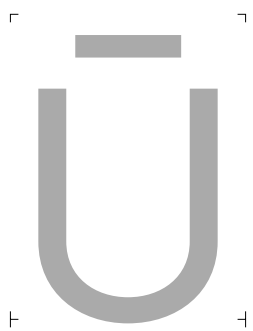

Umacron 016A

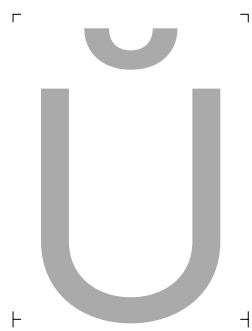

Ubreve 016C

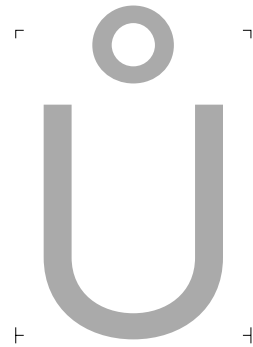

Uring 016E



Uhungarumlaut 0170

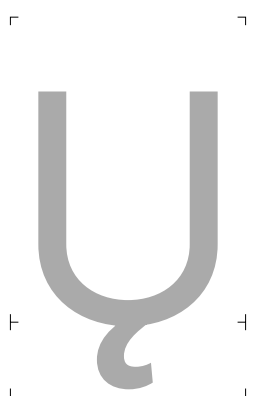

Uogonek 0172



Ucaron 01D3

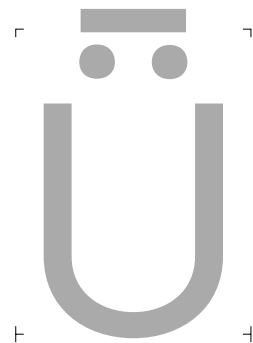

Udieresismacron 01D5

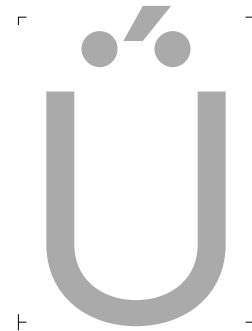

Udieresisacute 01D7

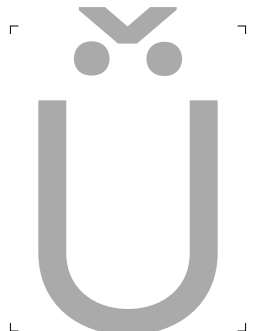

Udieresiscaron 01D9

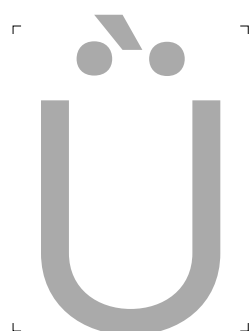

Udieresisgrave 01DB



Udblgrave 0214



Uinvertedbreve 0216



Udieresisbelow 1E72



Utildebelow 1E74



Ucircumflexbelow 1E76



Utildeacute 1E78

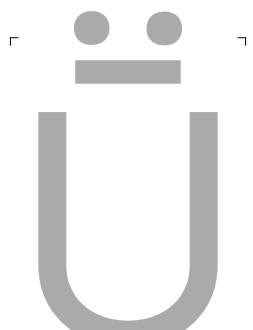

Umacrondieresis 1E7A

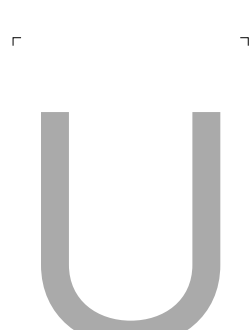

Udotbelow 1E74

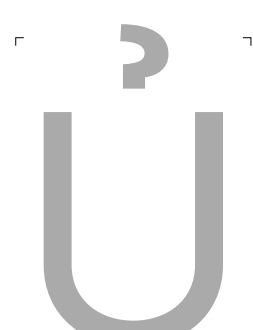

Uhookabove 1E76



Uhornacute 1E78

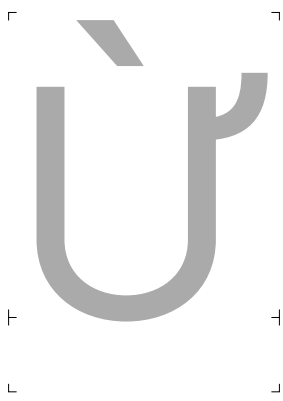

Uhorngrave

1EEA



Uhornhookabove

1EEC



Uhorntilde

1EEE

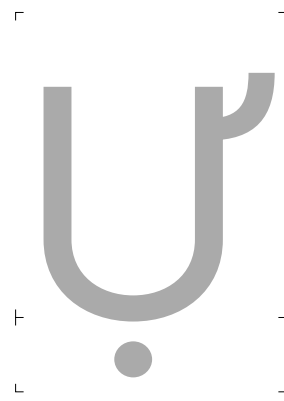

Uhorndotbelow

1EF0

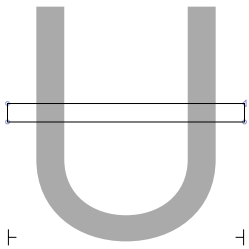

uni0244

0244

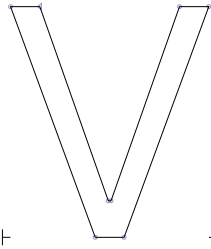

V

0056



Vtilde

1E7C



Vdotbelow

1E7E

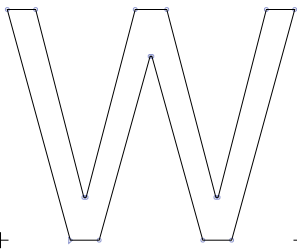

W

0057



Wcircumflex

0174



Wgrave

1E80



Wacute

1E82



Wdieresis

1E84



Wdotaccent

1E86



Wdotbelow

1E88

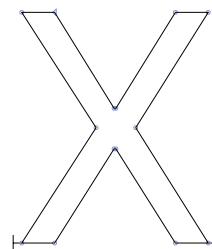

X

0058



Xdotaccent

1E8A



Xdieresis

1E8C

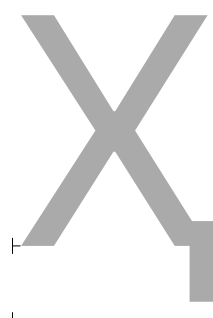

Hadescendercyrillic

04B2

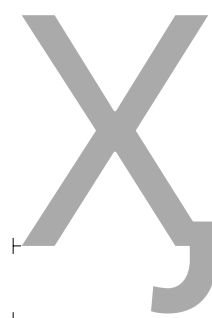

uni04FC

04FC



Chi

03A7

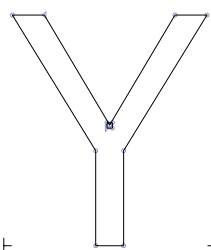

Y

0059

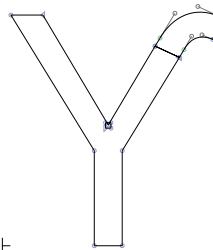

Yhook

01B3



Yacute

00DD

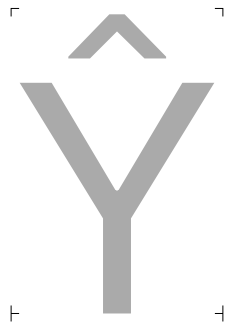

Ycircumflex

0176



Ydieresis

0178



uni0232

0232



Ydotaccent

1E8E

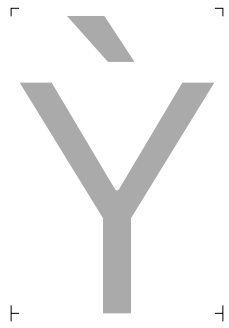

Ygrave

1EF2



Ydotbelow

1EF4



Yhookabove

1EF6



Ytilde

1EF8

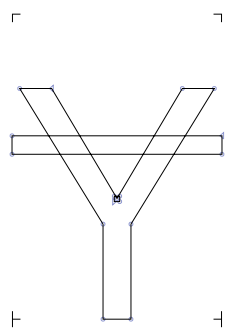

uni024E

024E



Upsilon

03A5



Upsilontonos

038E



Upsilondieresis

03AB

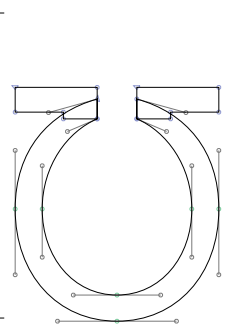

Upsilon2

01B1

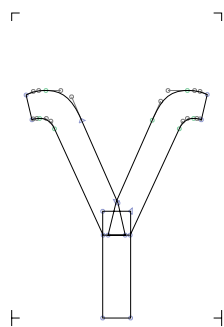

Upsilonhooksymbol

03D2



Upsilonacutehooksymbolgreek

03D3



Upsilondieresishooksymbolgreek

03D4



uni1F59

1F59

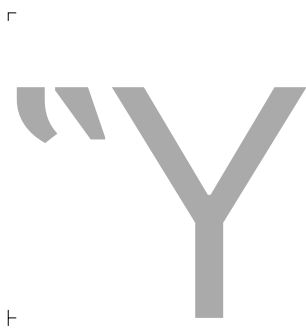

uni1F5B

1F5B

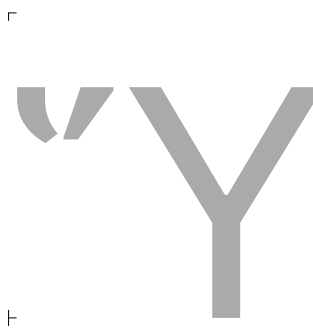

uni1F5D

1F5D

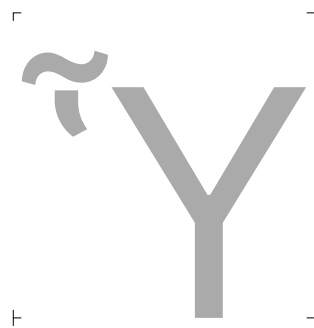

uni1F5F

1F5F

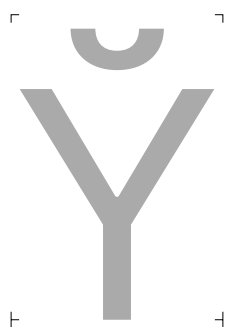

uni1FE8

1FE8

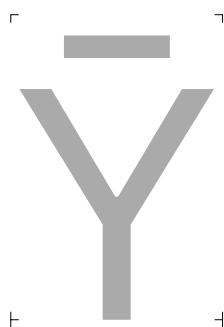

uni1FE9

1FE9



uni1FEA

1FEA

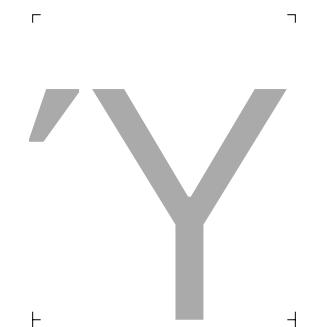

uni1FEB

1FEB

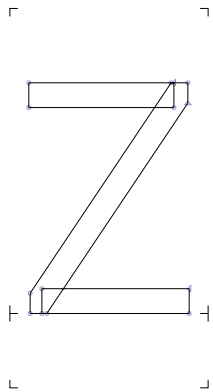

Z

005A



Zacute

0179



Zdotaccent

017B



Zcaron

017D



Zcircumflex

1E90



Zdotbelow

1E92



Zlinebelow

1E94

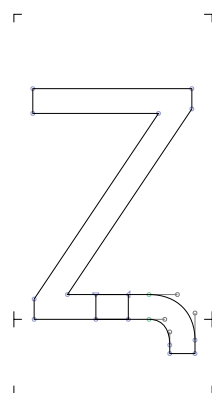

uni0224

0224



Zbar

01B5



Zeta

0396

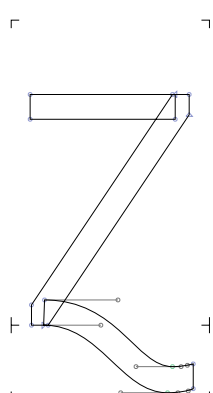

uni2C7F

2C7F

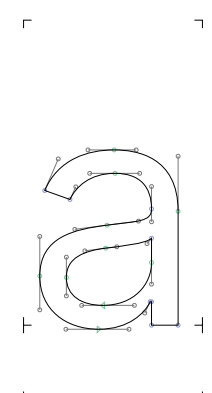

a

0061



adieresis

00E4



atilde

00E3



arighthalfring

1E9A



agrave

00E0



acute

00E1



acircumflex

00E2



aring

00E5



amacron

0101



abreve

0103



aogonek

0105



acaron

01CE



adieresismacron

01DF

adotmacron 01E1

aringacute 01FB

adblgrave 0201

ainvertedbreve 0203

uni0227 0227

aringbelow 1E01

adotbelow 1EA1

ahookabove 1EA3

acircumflexacute 1EA5

acircumflexgrave 1EA7

acircumflexhookabove 1EA9

acircumflextilde 1EAB

acircumflexdotbelow 1EAD

abreveacute 1EAF

abrevegrave 1EB1

abrevehookabove 1EB3

abrevetilde 1EB5

abrevedotbelow 1EB7

aturn 0250

afi10065 0430

abrev Cyrillic 04D1

adieresis Cyrillic 04D3

æ dieresis 00E6

æ macron 01E3

aeacute 01FD      aiecyrillic 04D5      **b** 0062      bbar 0180

btopbar 0183      bhook 0253      bdotaccent 1E03      bdotbelow 1E05

blinebelow 1E07      **c** 0063      uni023C 023C      chook 0188

ccurl 0255      ccedilla 00E7      cacute 0107      ccircumflex 0109

cdotaccent 010B      ccaron 010D      ccedillaacute 1E09      sigmalunatesymbolgreek 03F2

escyrillic 0441      **d** 0064      dcroat 0111      drthook 0256

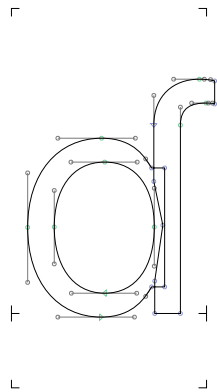

dhook

0257

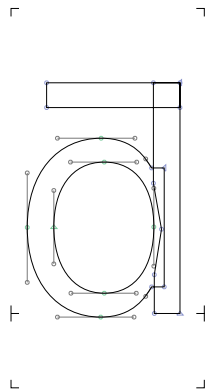

dtopbar

018C

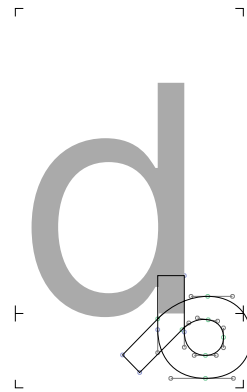

uni0221

0221

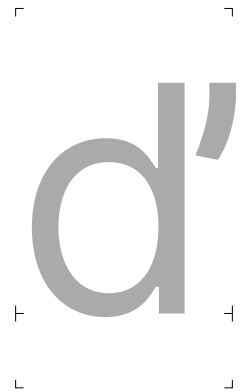

dcaron

010F



ddotaccent

1E0B

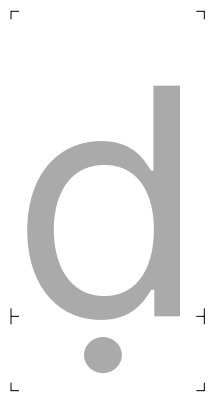

ddotbelow

1E0D

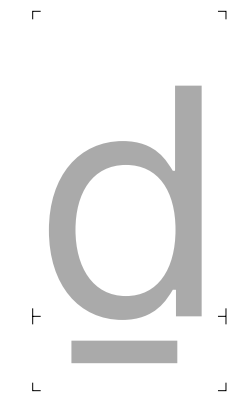

dlinebelow

1E0F

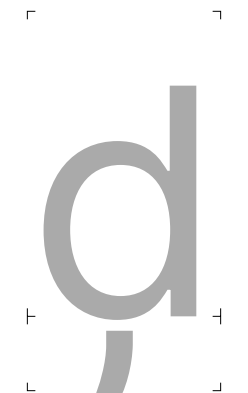

dcedilla

1E11



dcircumflexbelow

1E13



dz

02A3



dzcaron

01C6



dzcurl

02A5

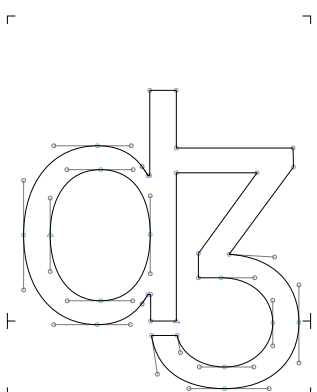

dyogh

02A4



dong

20AB

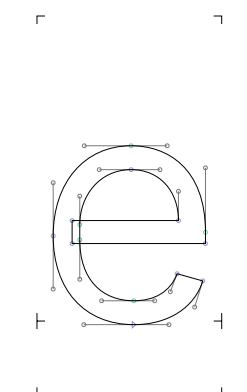

e

0065



edieresis

00EB

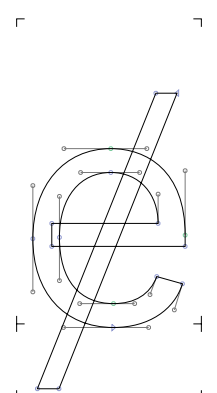

uni0247

0247

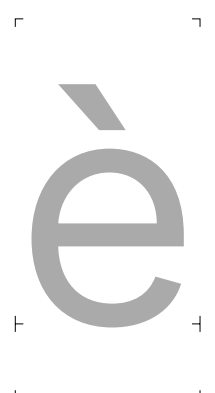

egrave

00E8

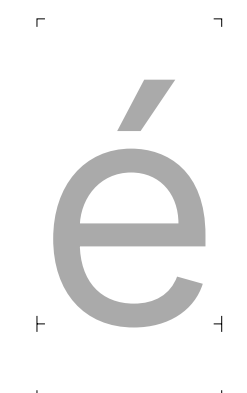

eacute

00E9



ecircumflex

00EA



emacron

0113

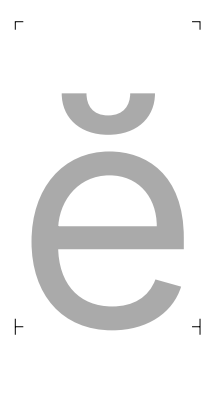

ebreve

0115



edotaccent

0117



eogonek

0119

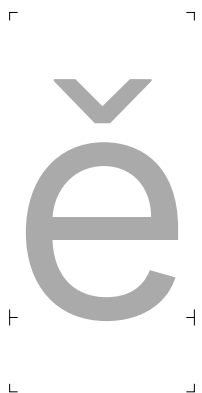

ecaron

011B

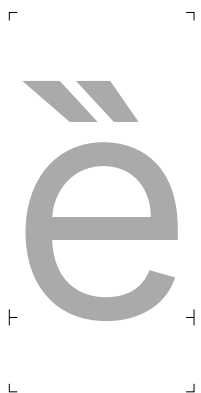

edblgrave

0205



einvertedbreve

0207



uni0229

0229

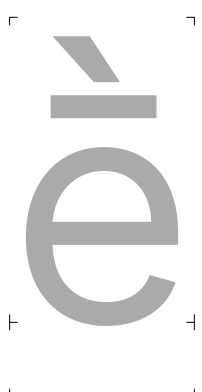

emacrongrave

1E15

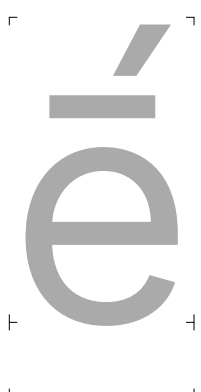

emacronacute

1E17



ecircumflexbelow

1E19



etildebelow

1E1B

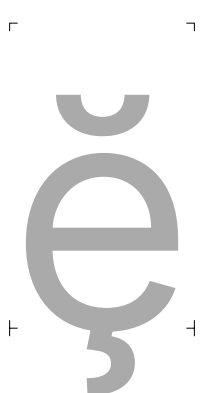

ecedillabreve

1E1D



edotbelow

1E19

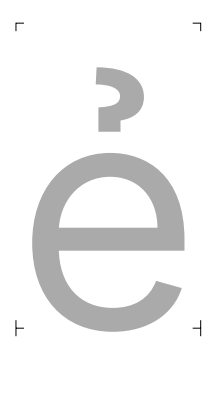

ehookabove

1EBB



etilde

1EBD

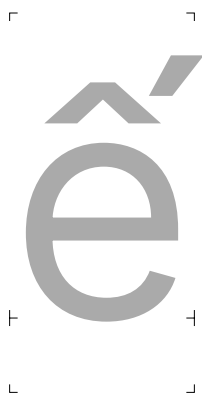

ecircumflexacute

1EBF

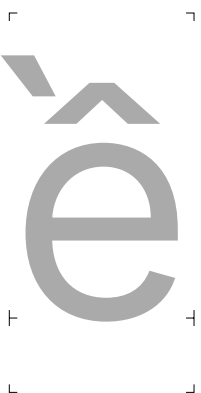

ecircumflexgrave

1EC1



ecircumflexhookabove

1EC3



ecircumflextilde

1EC5

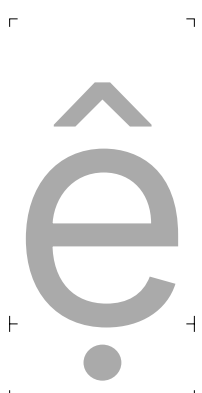

ecircumflexdotbelow

1EC7



iecyrillic

0435



uni0450

0450



iocyrillic

0451

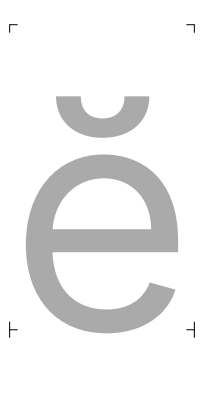

iebrevecyrillic

04D7



eturn

01DD

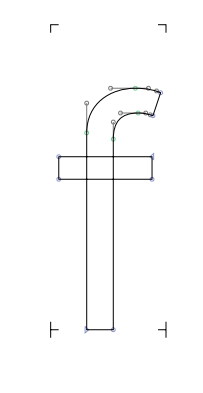

f

0066

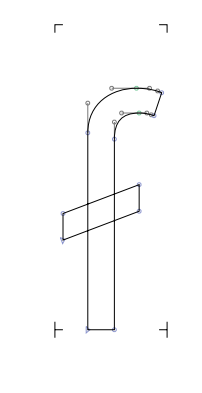

slongstroke

1E9C



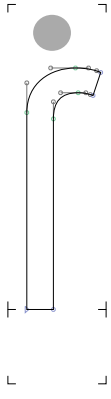

slongdotaccent

1E9B



fdotaccent

1E1F



feng

02A9

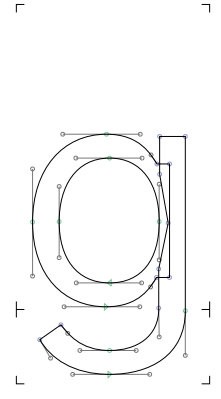

g

0067

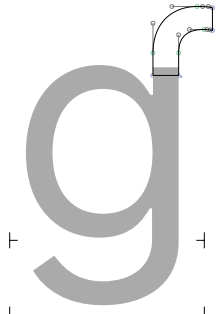

ghook

0260



gbar

01E5



gcircumflex

011D



gbreve

011F



gdotaccent

0121

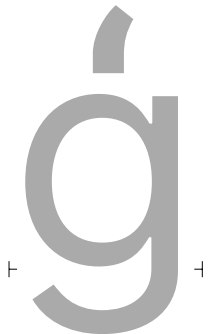

gcommaaccent

0123



gcaron

01E7

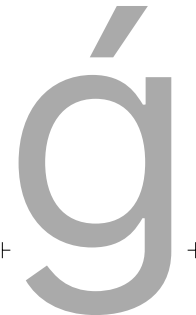

gacute

01F5



gmacron

1E21

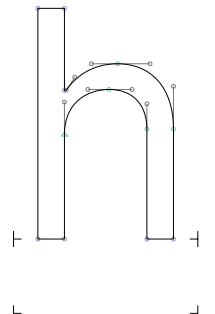

h

0068



hcedilla

1E29



tshecyrillic

045B

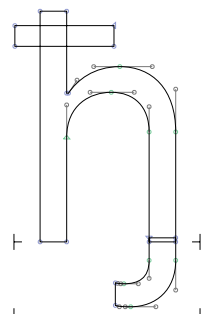

djecyrillic

0452

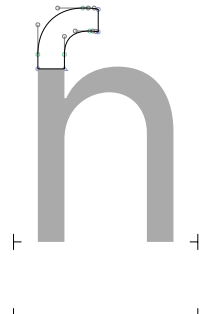

hhook

0266

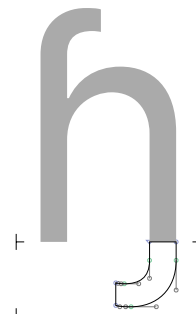

henghook

0267

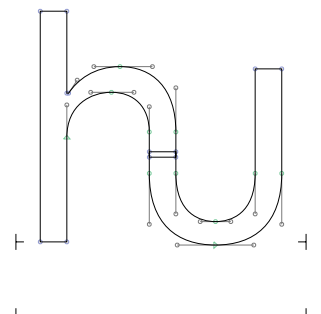

hv

0195

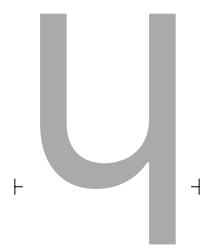

hturn

0265

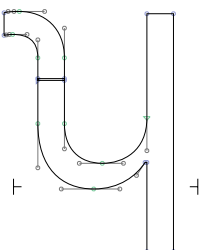

hturnlthook

02AE

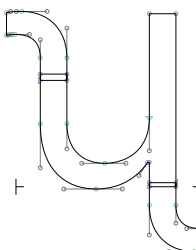

hturnhook2

02AF

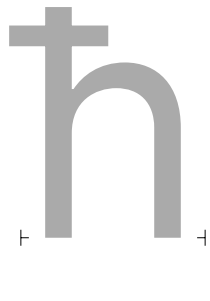

hbar

0127



hcircumflex

0125



uni021F

021F



hdotaccent

1E23



hdotbelow

1E25



hdieresis

1E27



hbrevebelow

1E2B



hlinebelow

1E96



shhacrylic

04BB



i

0069



idotless

0131



idieresis

00EF

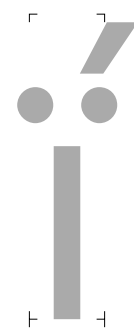

idieresisacute

1E2F

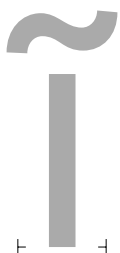

itilde

0129

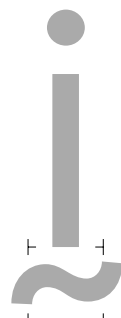

itildebelow

1E2D

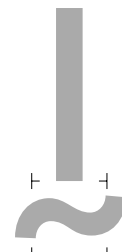

uni1E2D.ccmp



ibar

0268



igrave

00EC



iacute

00ED



icircumflex

00EE



imacron

012B



ibreve

012D



uni012F.ccmp



iogonek

012F



icaron

01D0



idblgrave

0209



iinvertedbreve

020B



ihookabove

1EC9



idotbelow

1ECB



uni1ECB.ccmp

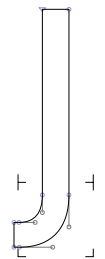

jdotless

0237



jdotlessbar

025F



uni0249

0249

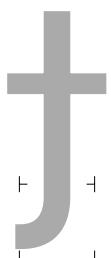

uni0249.ccmp



icyrillic

0456



ycyrillic

0457



ij

0133



j

006A

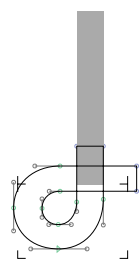

jcrosstail.ccmp



jcrosstail

029D



jcircumflex

0135



jcaron

01F0



yotgreek

03F3



jecyrillic

0458

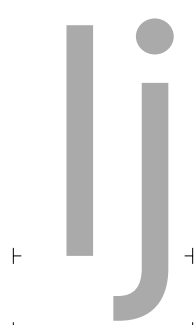

lj

01C9

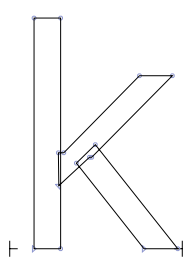

k

006B

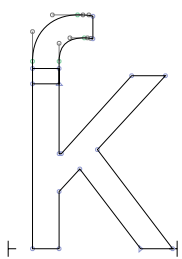

khook

0199

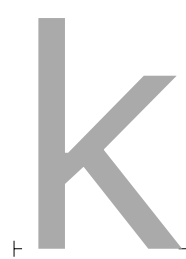

kcommaaccent

0137

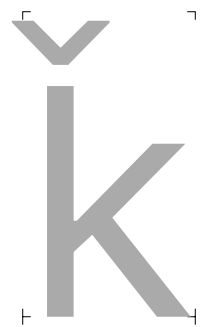

kcaron

01E9

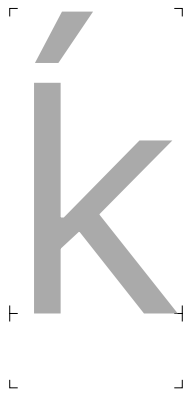

kacute

1E31

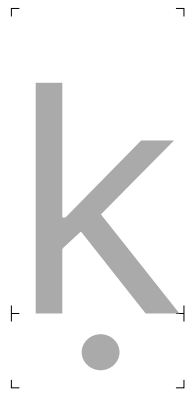

kdotbelow

1E33

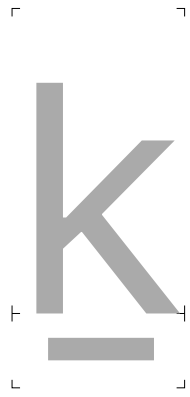

klinebelow

1E35

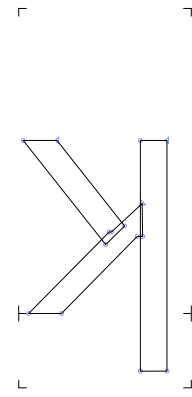

kturn

029E

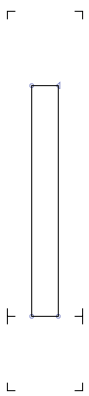

l

006C

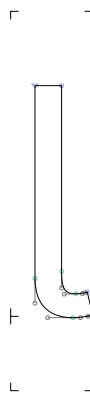

l.ss02

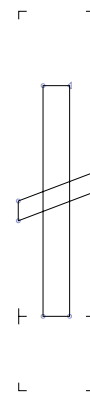

lslash

0142

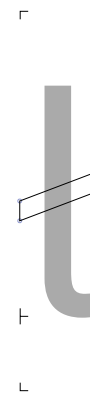

lslash.ss02



lbar

019A



lbar.ss02



lmidtilde

026B



lmidtilde.ss02

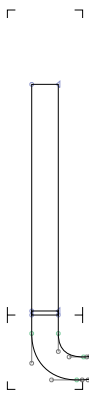

lrhook

026D

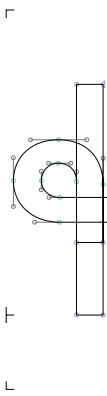

lbelt

026C

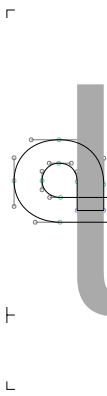

lbelt.ss02

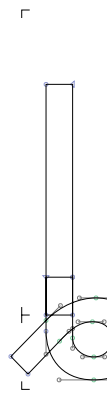

lcurl

0234



ldot

0140



ldot.ss02



lacute

013A



lacute.ss02



lcommaaccent

013C



lcommaaccent.ss02



lcaron

013E



lcaron.ss02



Idotbelow

1E37



Idotbelow.ss02



Idotbelowmacron

1E39



Idotbelowmacron.ss02



llinebelow

1E3B



llinebelow.ss02



Icircumflexbelow

1E3D



Icircumflexbelow.ss02

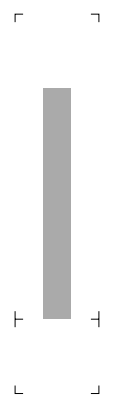

uni04CF

04CF

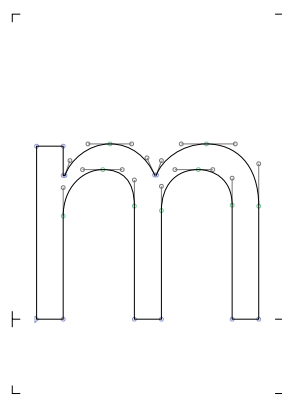

m

006D

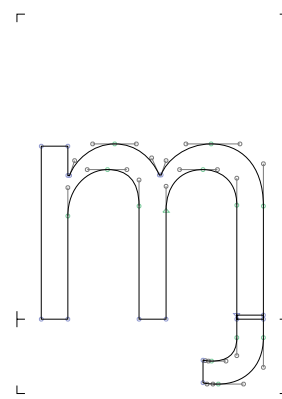

mhook

0271



mturn

026F

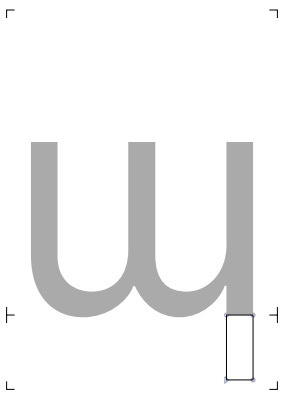

mturndescend

0270

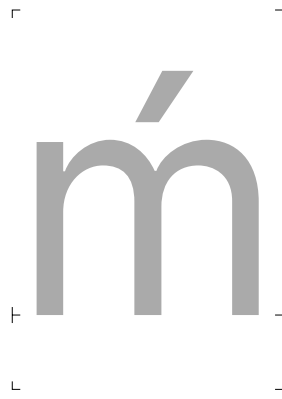

macute

1E3F



mdotaccent

1E41

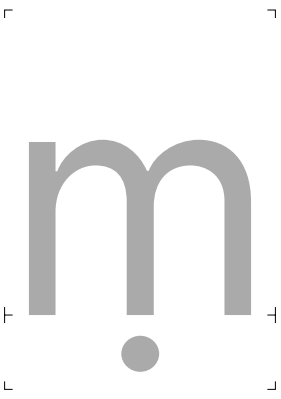

mdotbelow

1E43

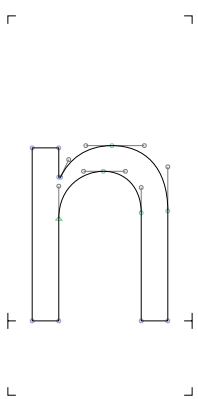

n

006E



ntilde

00F1

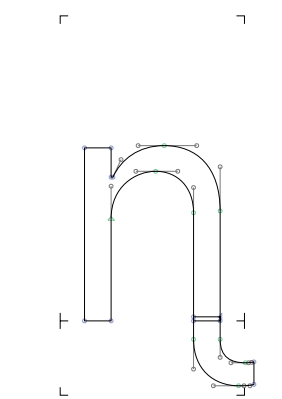

nrthook

0273

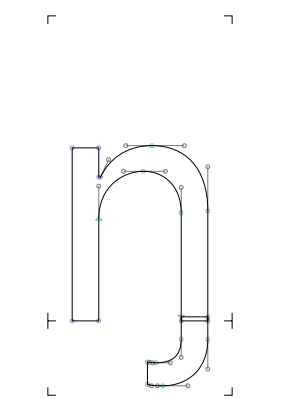

eng

014B

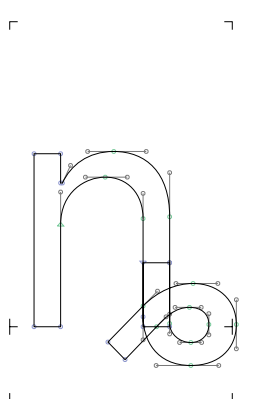

ncurl

0235

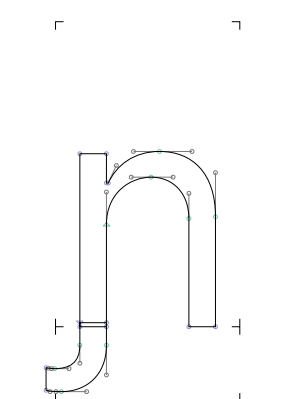

nlfthook

0272

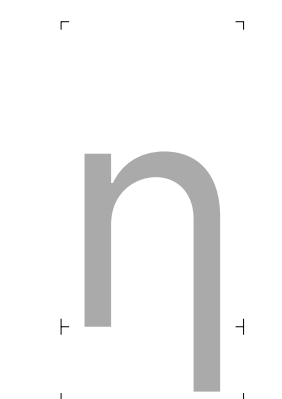

nletrightlong

019E

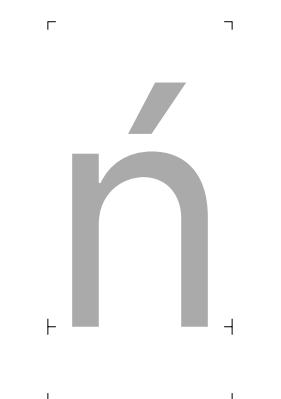

nacute

0144



ncommaaccent 0146



ncaron 0148

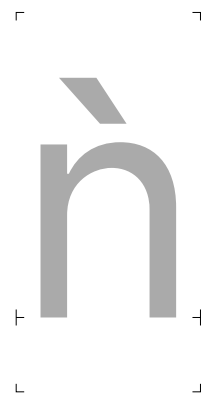

uni01F9 01F9



ndotaccent 1E45



ndotbelow 1E47



nlinebelow 1E49



ncircumflexbelow 1E4B



nj 01CC

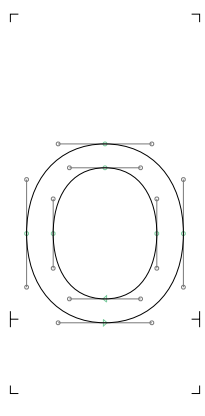

o 006F

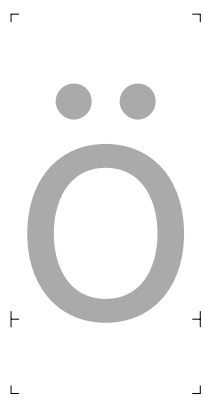

odieresis 00F6



otilde 00F5

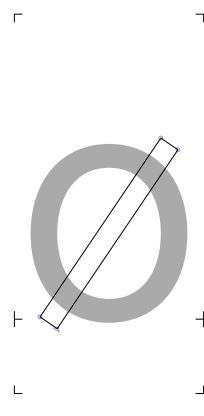

oslash 00F8

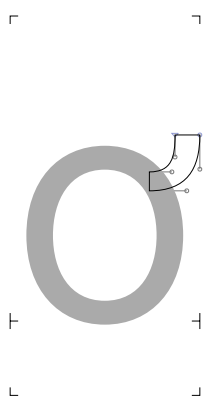

ohorn 01A1

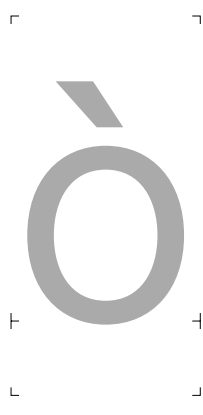

ograve 00F2



oacute 00F3

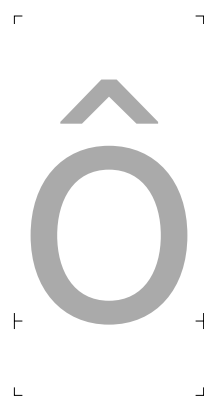

ocircumflex 00F4

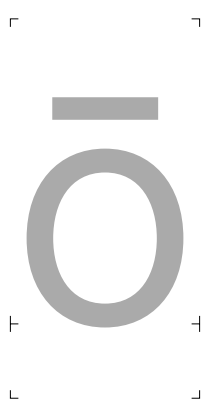

omacron 014D

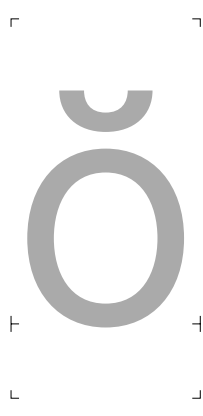

obreve 014F



ohungarumlaut 0151

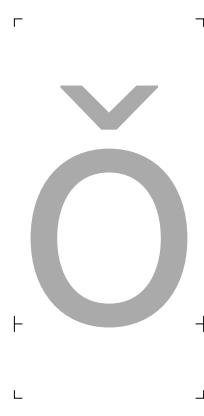

ocaron 01D2

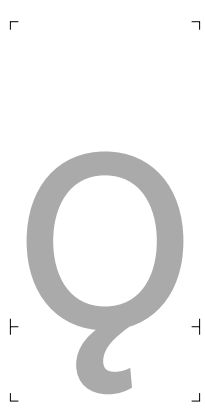

oogonek 01EB

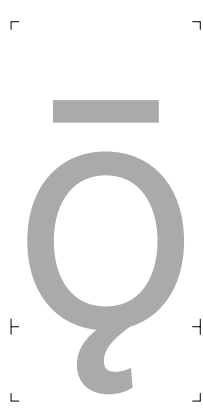

oogonekmacron 01ED

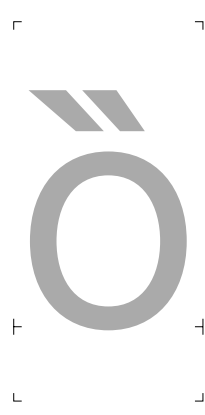

odblgrave 020D

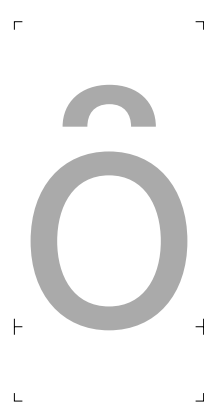

oinvertedbreve 020F

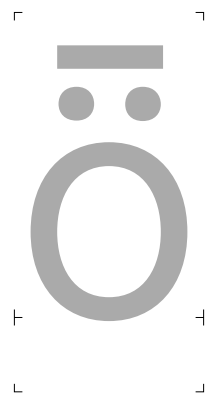

uni022B

022B

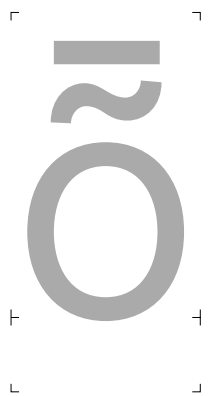

uni022D

022D

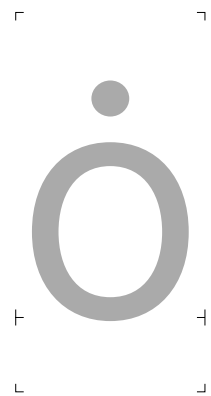

uni022F

022F

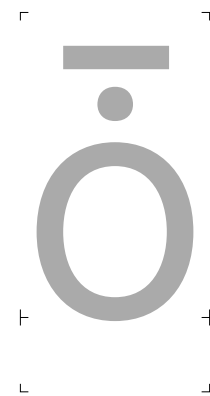

uni0231

0231

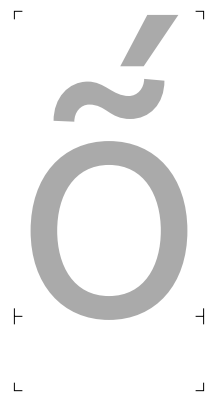

otildeacute

1E4D

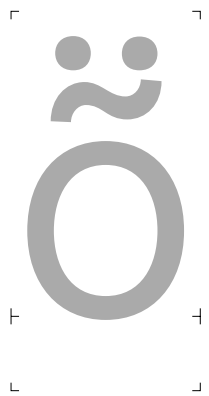

otildedieresis

1E4F

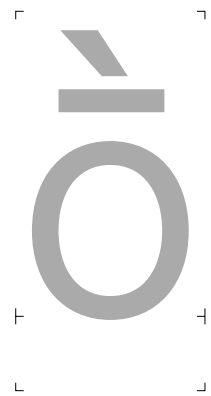

omacrongrave

1E51

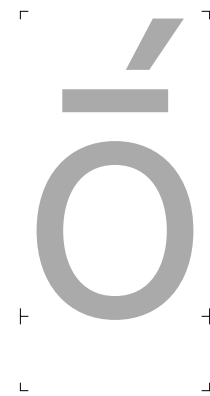

omacronacute

1E53

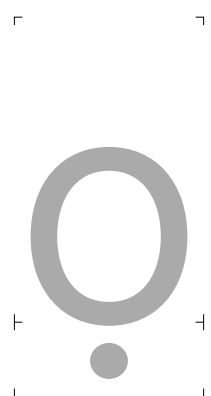

odotbelow

1ECD

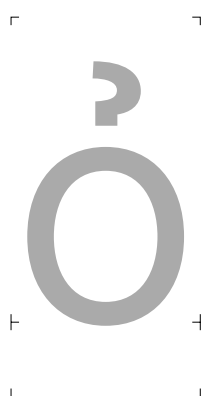

ohookabove

1ECF

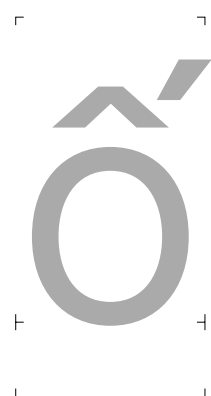

ocircumflexacute

1ED1

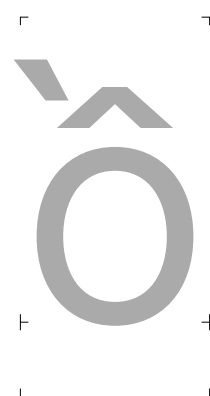

ocircumflexgrave

1ED3

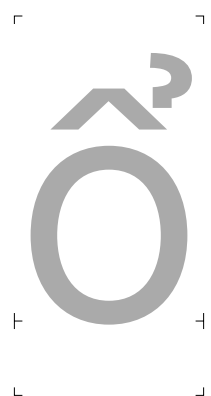

ocircumflexhookabove

1ED5

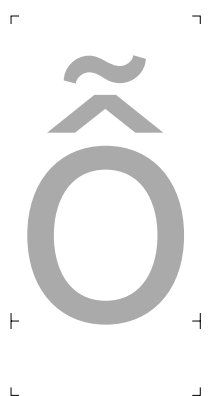

ocircumflextilde

1ED7

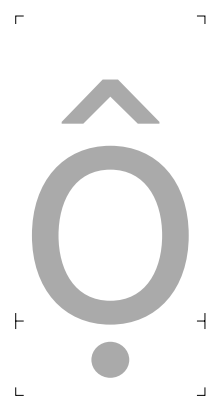

ocircumflexdotbelow

1ED9



ohornacute

1EDB

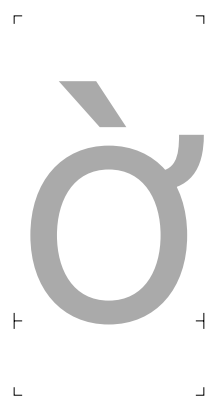

ohorngrave

1EDD

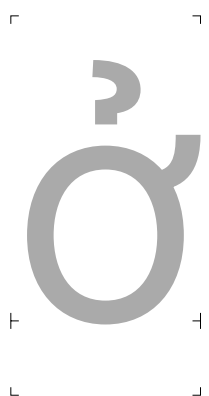

ohornhookabove

1EDF



ohorntilde

1EE1



ohorndotbelow

1EE3

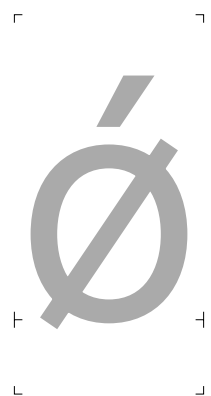

oslashacute

01FF

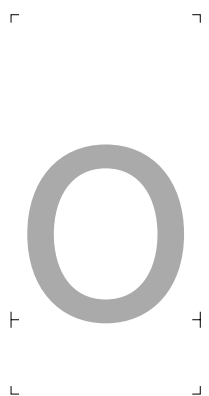

omicron

03BF

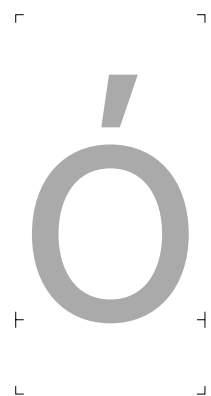

omicrontonos

03CC

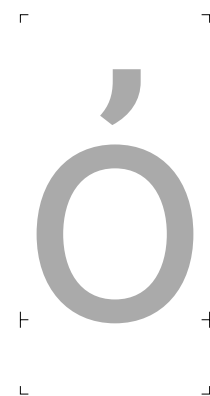

uni1F40

1F40

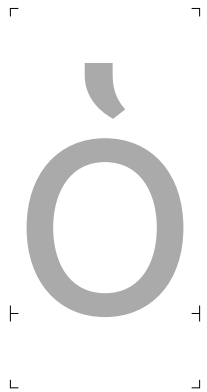

uni1F41

1F41

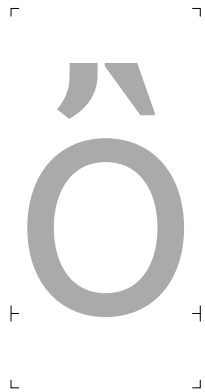

uni1F42

1F42



uni1F43

1F43



uni1F44

1F44

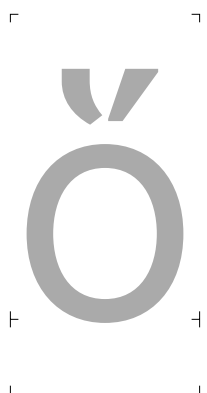

uni1F45

1F45

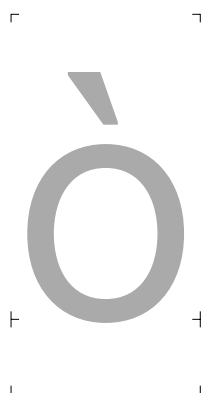

uni1F78

1F78

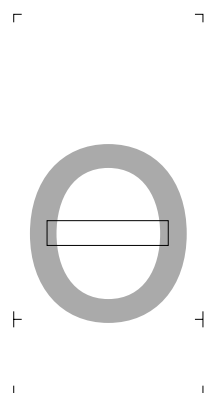

fitacyrillic

0473



obar

0275

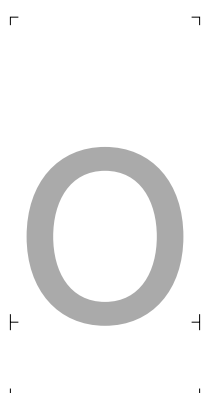

ocyrillic

043E

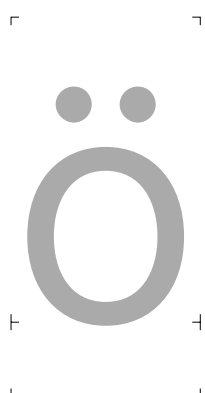

odieresiscyrillic

04E7



oe

0153

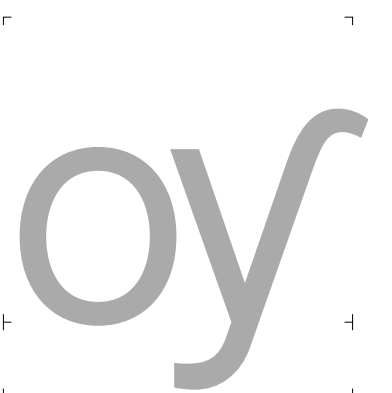

ukcyrillic

0479

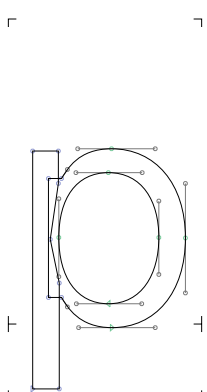

p

0070

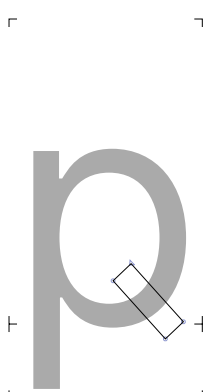

uni048F

048F

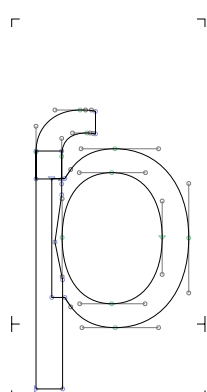

phook

01A5



pacute

1E55



pdotaccent

1E57



ercyrillic

0440



q

0071

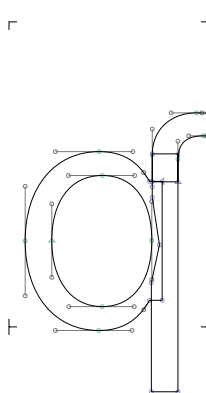

qhook

02A0

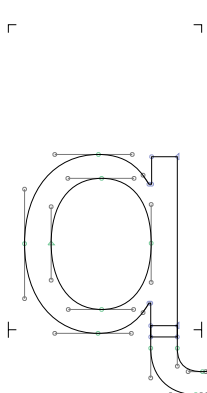

qrhook

024B

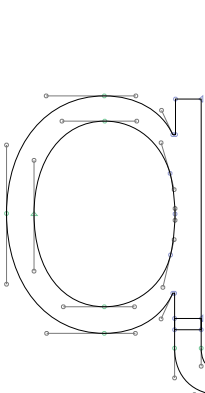

Q\_rhook

024A

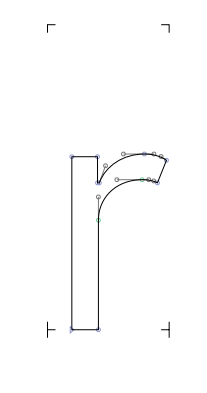

r

0072



rrhook

027D





uni024D

024D

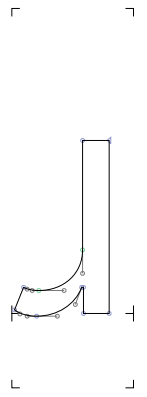

rturn

0279



rturnrthook

027B

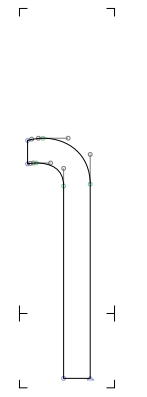

rfishhookrev

027F



rfishhook

027E



rdescend

027C



racute

0155



rcommaaccent

0157



rcaron

0159



rdblgrave

0211



rinvertedbreve

0213



rdotaccent

1E59



rdotbelow

1E5B



rdotbelowmacron

1E5D



rlinebelow

1E5F

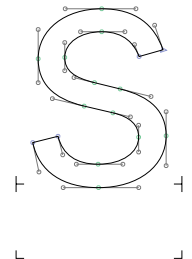

s

0073

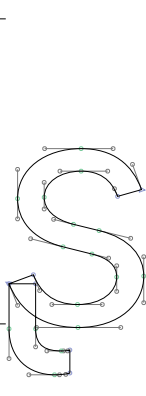

srthook

0282



uni023F

023F



sacute

015B



scircumflex

015D



scedilla

015F



scaron

0161



scommaaccent

0219



sdotaccent

1E61



sdotbelow 1E63



sacutedotaccent 1E65



scarondotaccent 1E67



sdotbelowdotaccent 1E69



dzecyrillic 0455



tonetwo 01A8

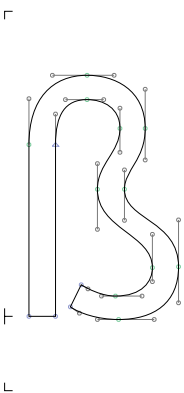

germandbls 00DF

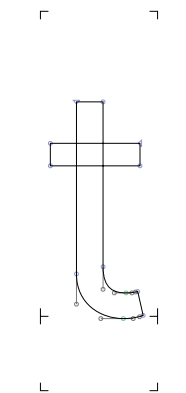

t 0074

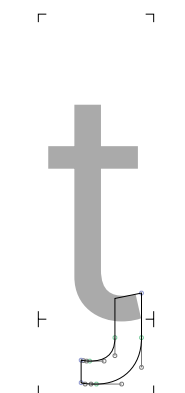

tpalatalhook 01AB

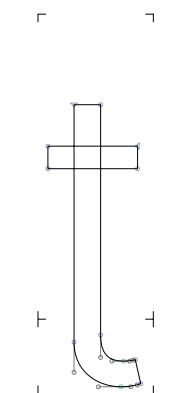

trthook 0288

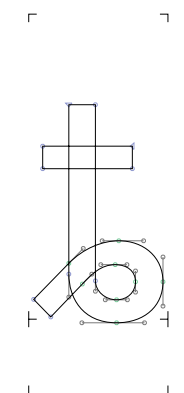

tcurl 0236

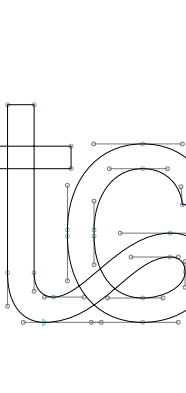

tcurl 02A8

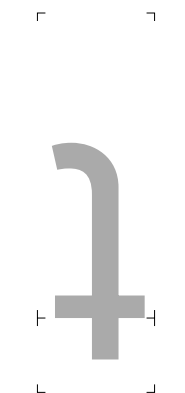

tturn 0287

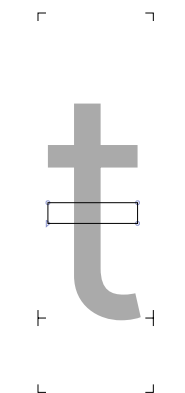

tbar 0167



tcommaaccent 0163

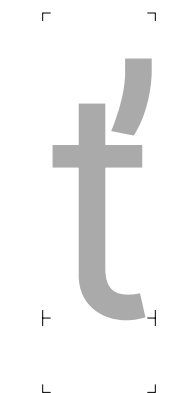

tcaron 0165

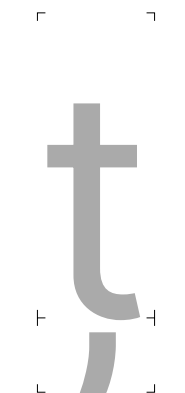

uni021B 021B

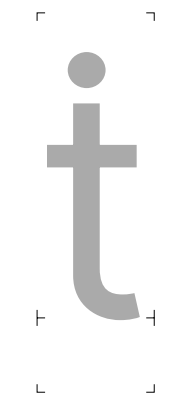

tdotaccent 1E6B

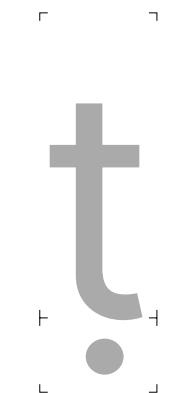

tdotbelow 1E6D

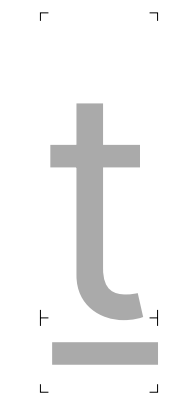

tlinebelow 1E6F

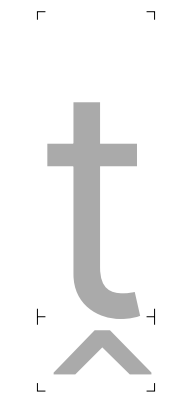

tcircumflexbelow 1E71

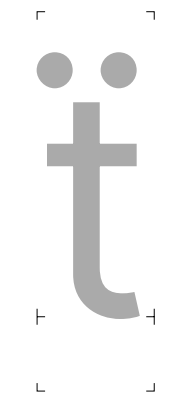

tdieresis 1E97

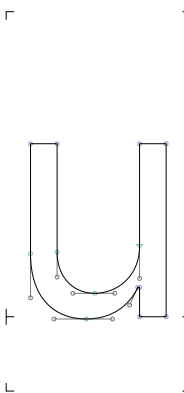

u 0075



udieresis 00FC



utilde 0169

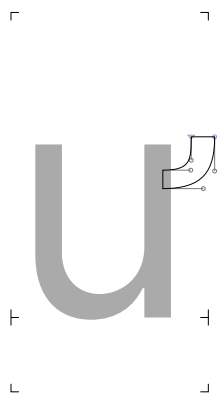

uhorn 0180

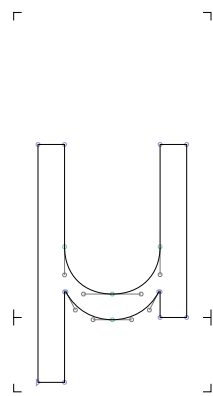

micro 0085

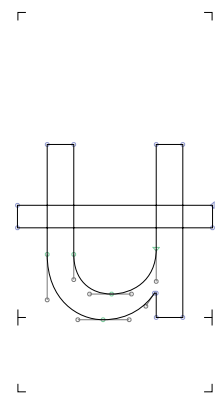

ubar 0289

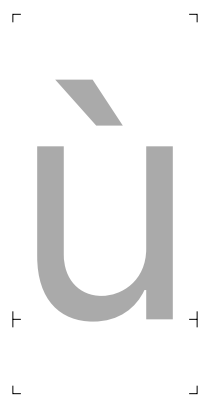

ugrave 00F9



uacute 00FA

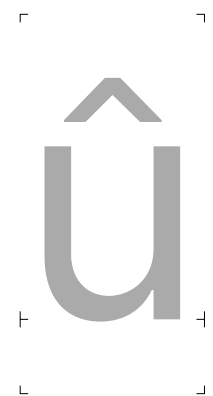

ucircumflex 00FB



umacron 016B

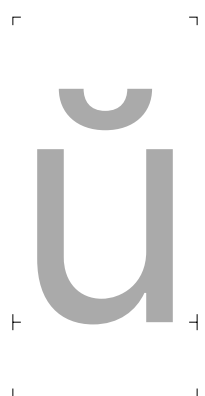

ubreve 016D



uring 016F



uhungarumlaut 0171



uogonek 0173

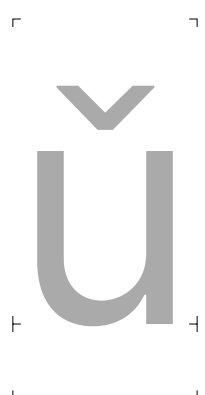

ucaron 01D4



udieresismacron 01D6



udieresisacute 01D8

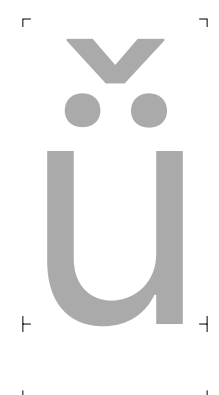

udieresiscaron 01DA



udieresisgrave 01DC



udblgrave 0215

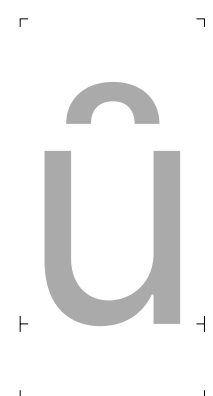

uinvertedbreve 0217

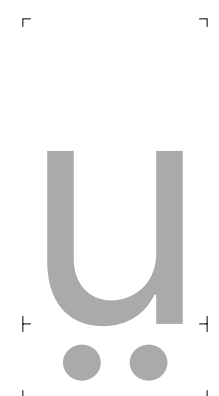

udieresisbelow 1E73



utildebelow 1E75



ucircumflexbelow 1E77



utildeacute 1E79



umacrondiereis 1E7B



udotbelow 1EE5



uhookabove 1EE7



uhornacute 1EE9



uhorngrave 1EEB



uhornhookabove 1EED



uhorntilde 1EEF

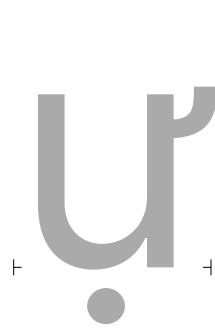

uhorndotbelow 1EF1

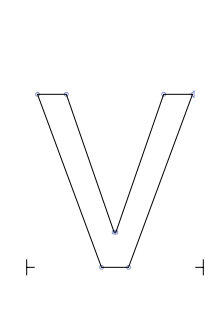

v 0076



vturn 028C



vtilde 1E7D



vdotbelow 1E7F

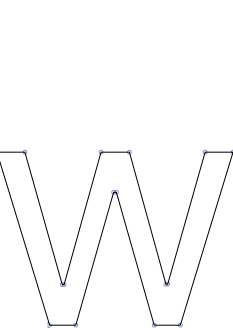

w 0077



wdieresis 1E85



wturn 028D

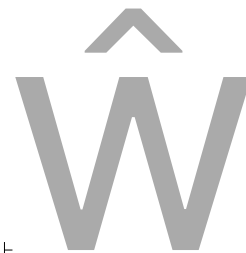

wcircumflex 0175



wgrave 1E81



wacute 1E83



wdotaccent 1E87



wdotbelow 1E89



wring 1E98

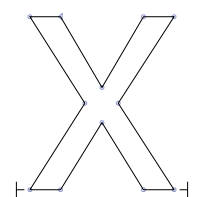

x 0078

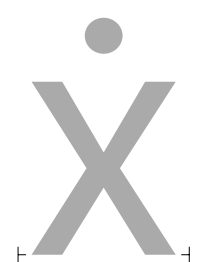

xdotaccent 1E8B

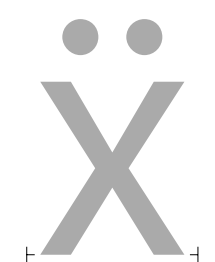

xdieresis 1E8D

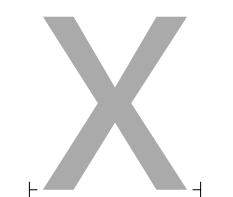

khacyrillic 0445

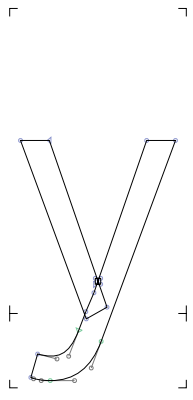

y

0079



y-dieresis

00FF

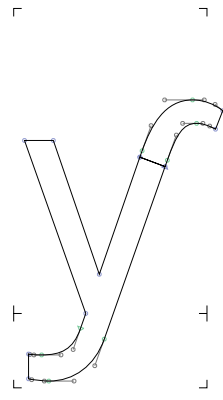

y-hook

01B4

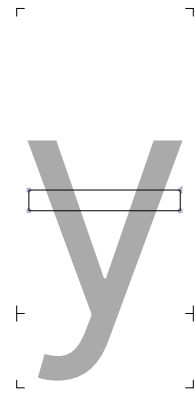

uni024F

024F



yacute

00FD

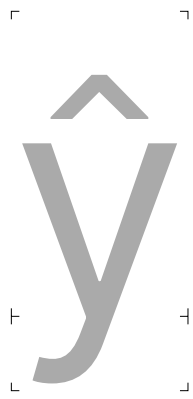

y-circumflex

0177

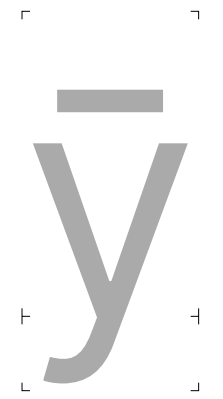

uni0233

0233



y-dotaccent

1E8F



y-ring

1E99



ygrave

1EF3



y-dotbelow

1EF5



y-hookabove

1EF7



y-tilde

1EF9



u-cyrillic

0443



u-shortcyrillic

045E

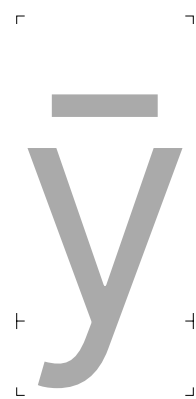

u-macroncyrillic

04EF



u-dieresis-cyrillic

04F1



u-hungarumlaut-cyrillic

04F3

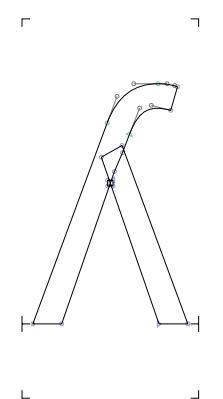

Z-turn

028E

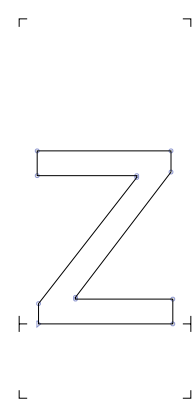

z

007A



Z-bar

01B6

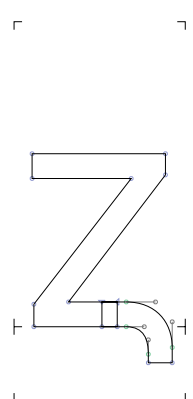

Z-hook

0225

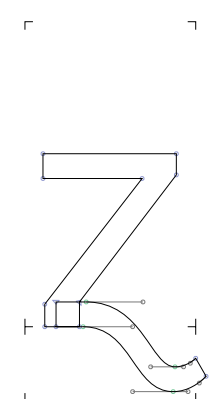

uni0240

0240



Zr-hook

0290



zacute 017A



zdotaccent 017C



zcaron 017E



zcircumflex 1E91



zdotbelow 1E93



zlinebelow 1E95

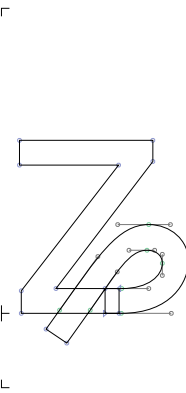

zcurl 0291

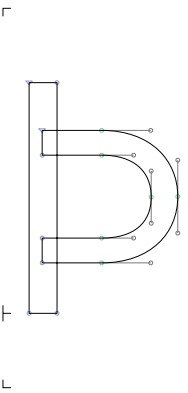

Thorn 00DE

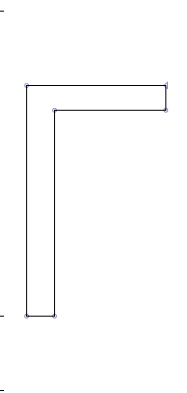

Gamma 0393

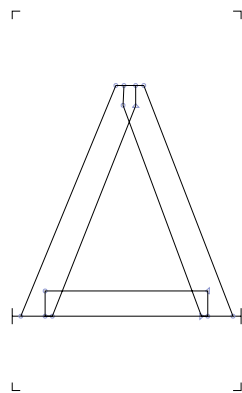

Delta 0394

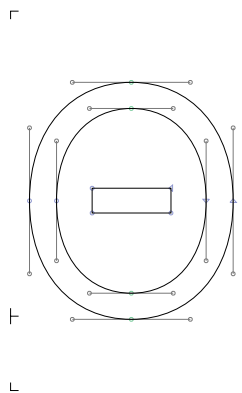

Theta 0398

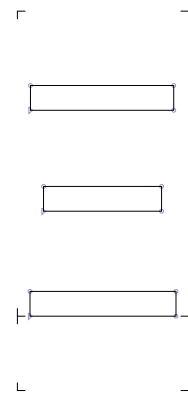

Xi 039E

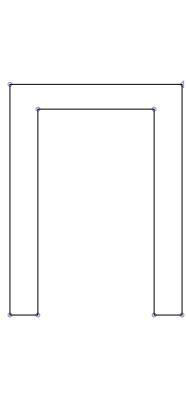

Pi 03A0

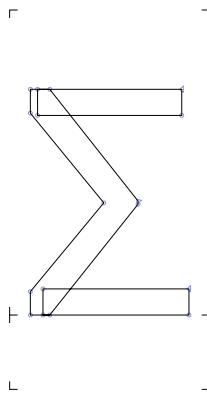

Sigma 03A3

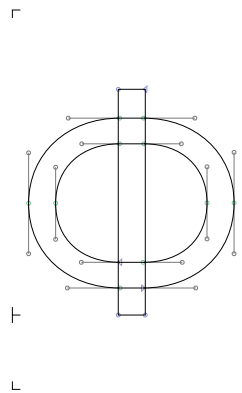

Phi 03A6

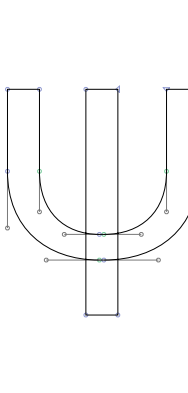

Psi 03A8

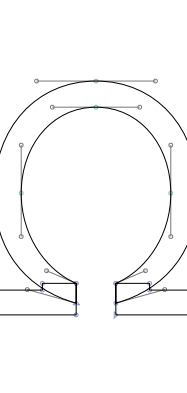

Omega 03A9

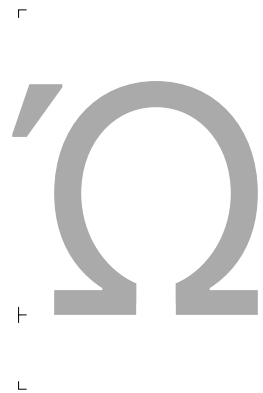

uni1FFB 1FFB

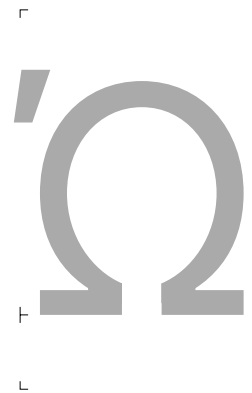

Omegatonos 038F

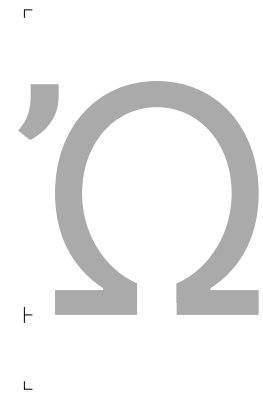

uni1F68 1F68

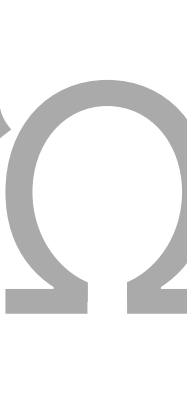

uni1F69 1F69

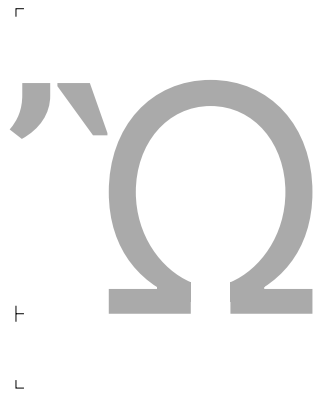

uni1F6A 1F6A

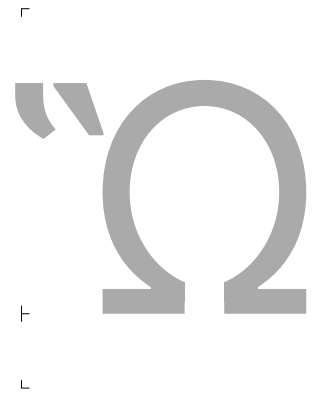

uni1F6B 1F6B

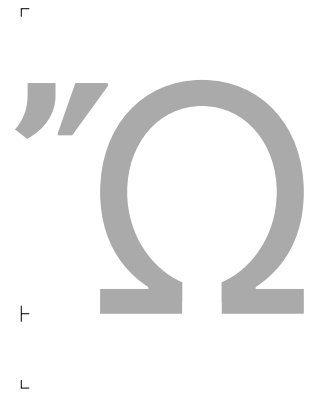

uni1F6C 1F6C

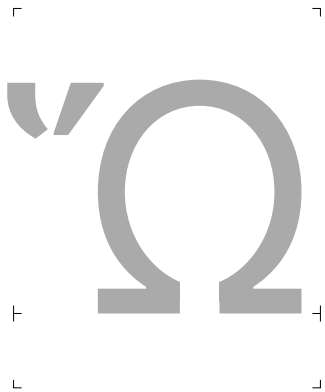

uni1F6D

1F6D

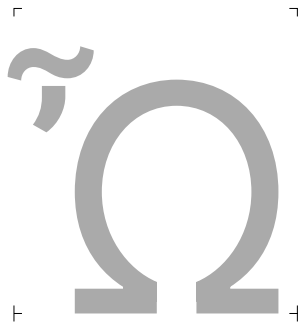

uni1F6E

1F6E



uni1F6F

1F6F

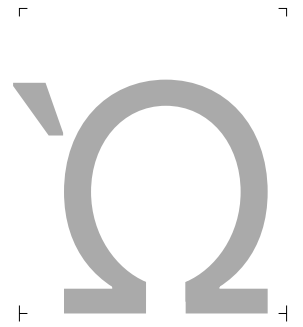

uni1FFA

1FFA

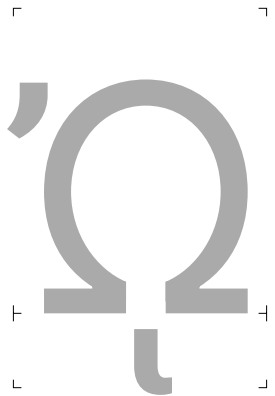

uni1FA8

1FA8

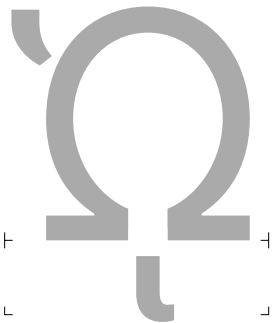

uni1FA9

1FA9

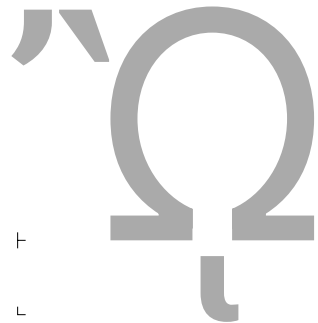

uni1FAA

1FAA

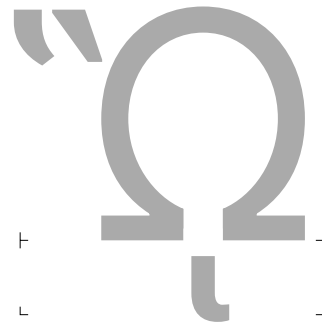

uni1FAB

1FAB

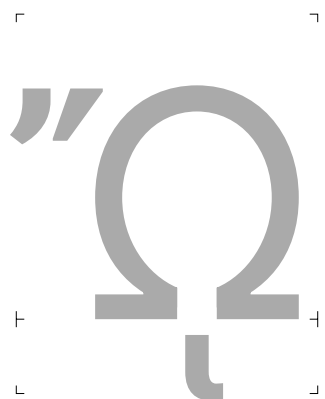

uni1FAC

1FAC

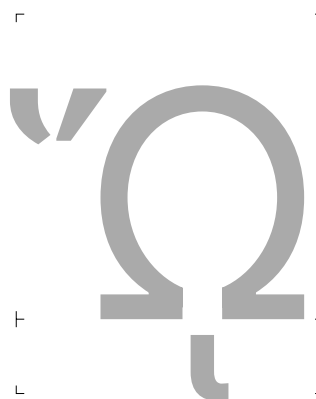

uni1FAD

1FAD

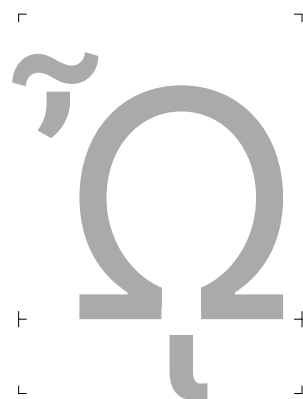

uni1FAE

1FAE

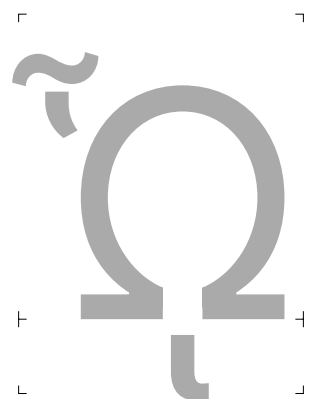

uni1FAF

1FAF

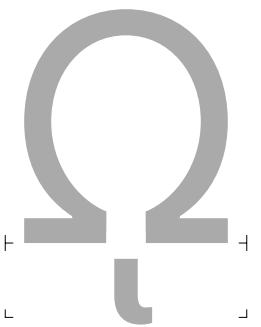

uni1FFC

1FFC

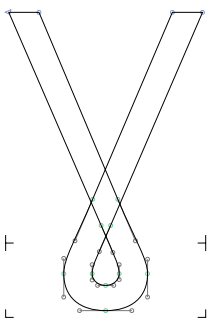

Gamma1

0194



afii10018

0411

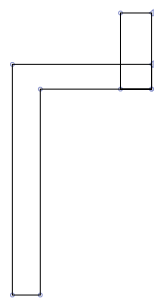

afii10050

0490

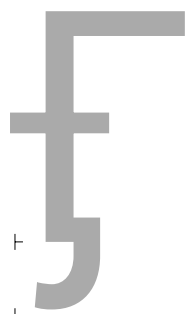

uni04FA

04FA

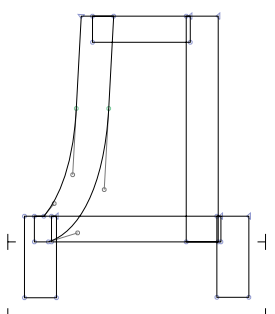

afii10021

0414

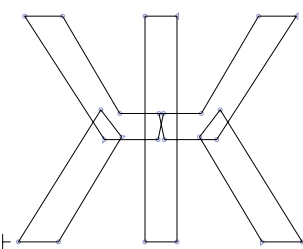

afii10024

0416



Zhedescendercyrillic

0496

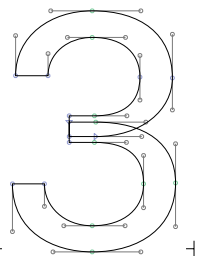

afii10025

0417

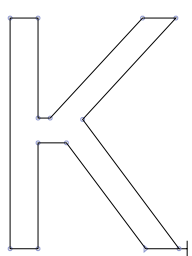

Kacyr

041A

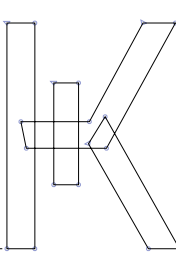

Kavertikalstrokeycyrillic

049C

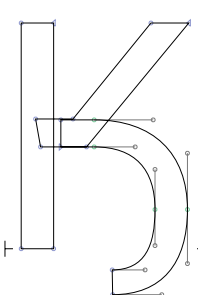

Kahookcyrillic

04C3

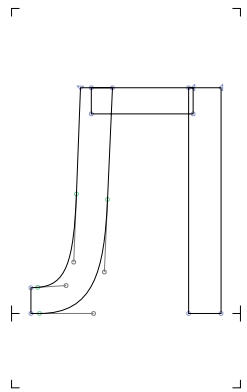

afii10029

041B

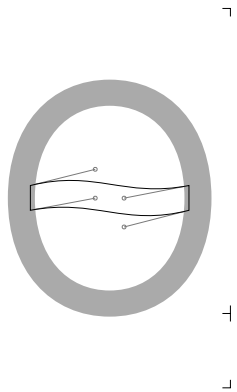

afii10147

0472

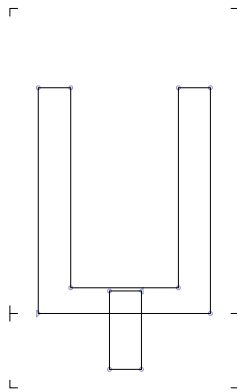

afii10145

040F

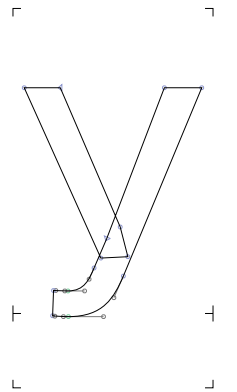

afii10037

0423

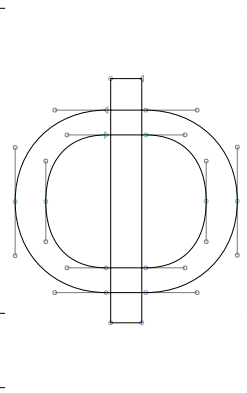

afii10038

0424

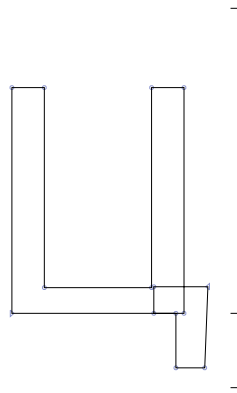

afii10040

0426

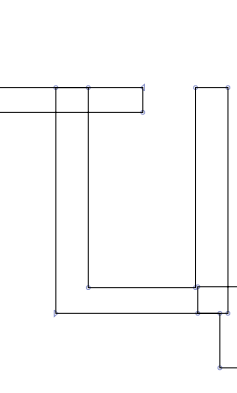

Tetsecyrillic

04B4

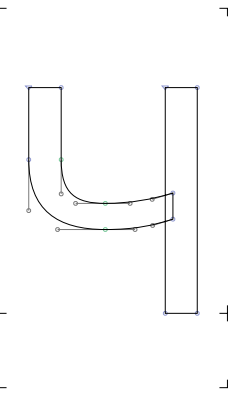

afii10041

0427

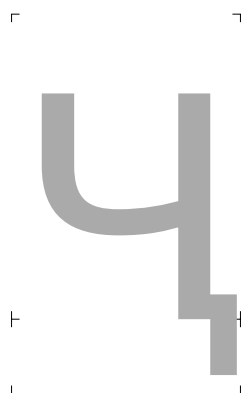

Chedescendercyrillic

04B6

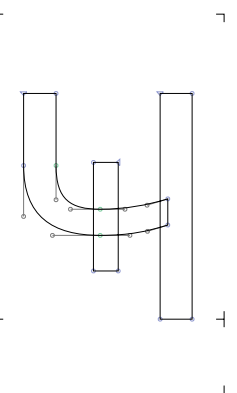

Cheverticalstrokecyrillic

04B8

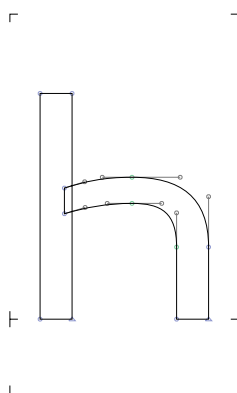

Shhacyrillic

04BA

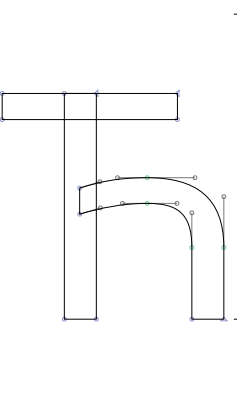

afii10060

040B

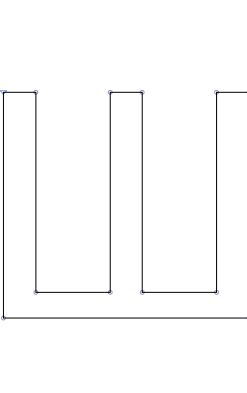

afii10042

0428

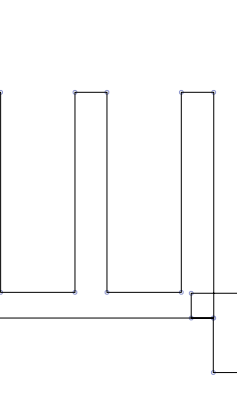

afii10043

0429

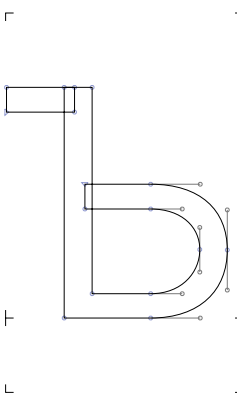

afii10044

042A



afii10045

042B

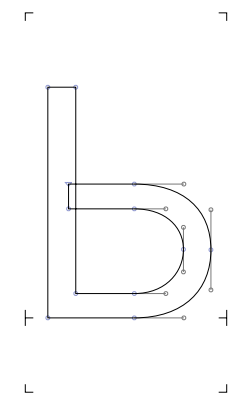

afii10046

042C

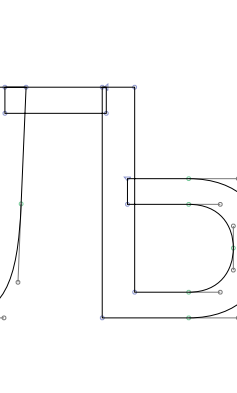

afii10058

0409

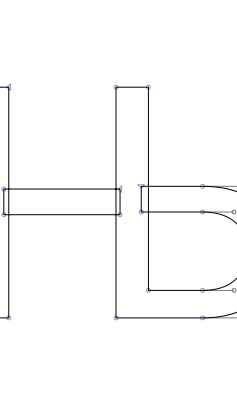

afii10059

040A

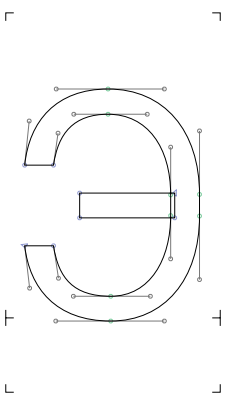

afii10047

042D



afii10048

042E

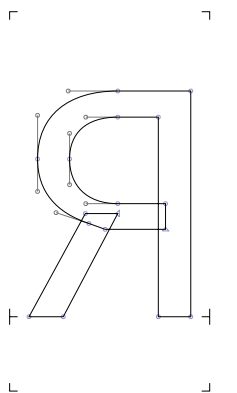

afii10049

042F

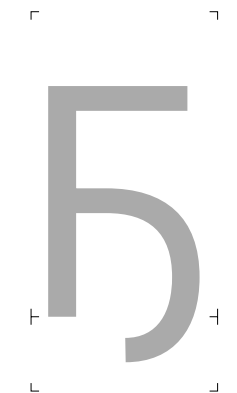

Ghemiddlehookcyrillic

0494



Pemiddlehookcyrillic

04A6



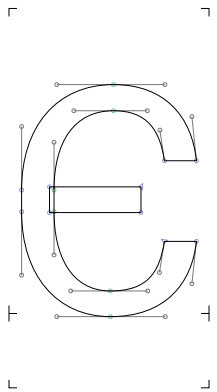

afii10053

0404

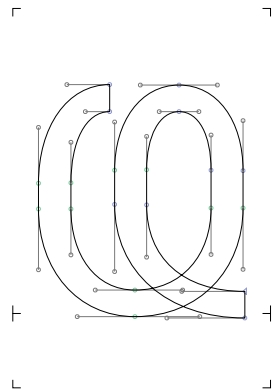

Haabkhasiancyrillic

04A8

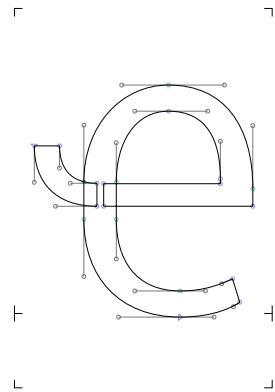

Cheabkhasiancyrillic

04BC

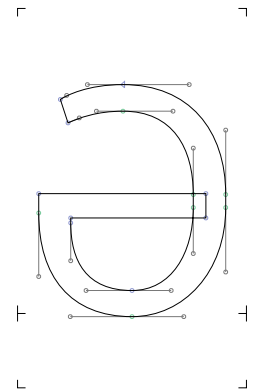

Schwacyrillic

04D8

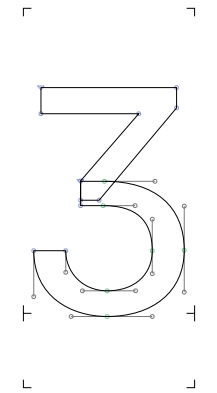

Dzeabkhasiancyrillic

04E0

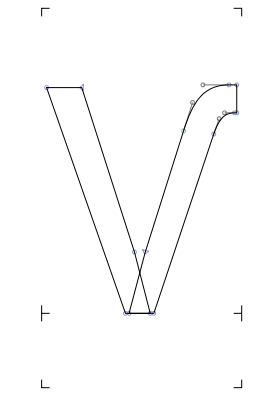

afii10148

0474

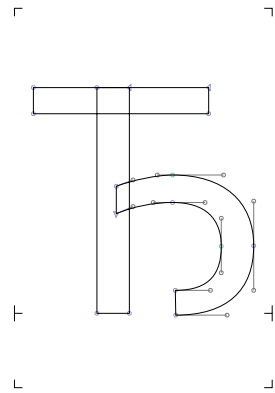

afii10051

0402

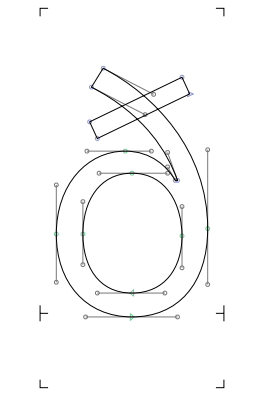

eth

00F0

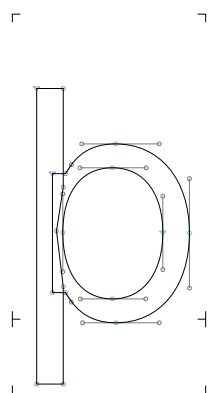

thorn

00FE

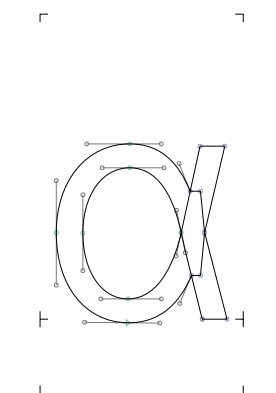

alpha

03B1

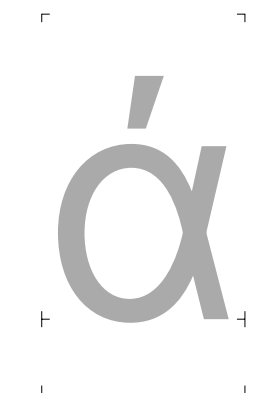

alphatonos

03AC

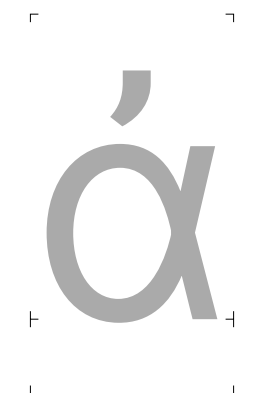

uni1F00

1F00



uni1F01

1F01

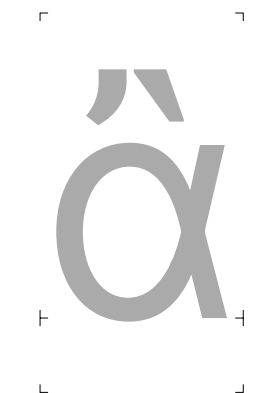

uni1F02

1F02

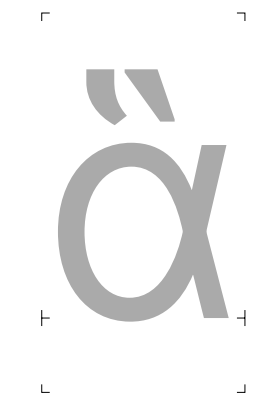

uni1F03

1F03

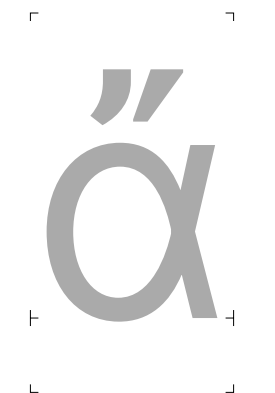

uni1F04

1F04



uni1F05

1F05

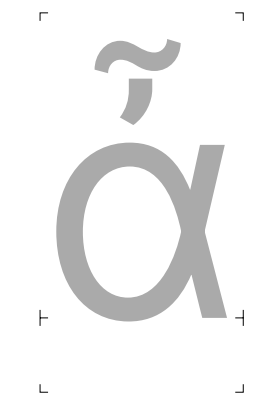

uni1F06

1F06

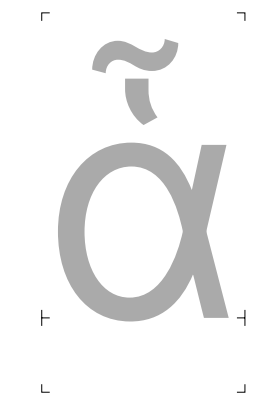

uni1F07

1F07

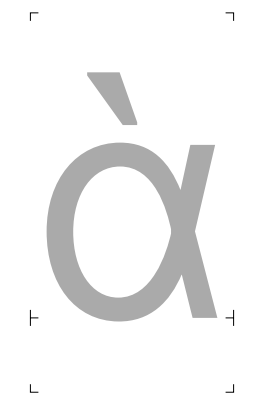

uni1F70

1F70

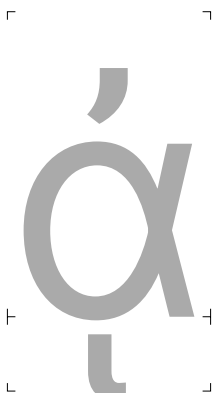

uni1F80

1F80

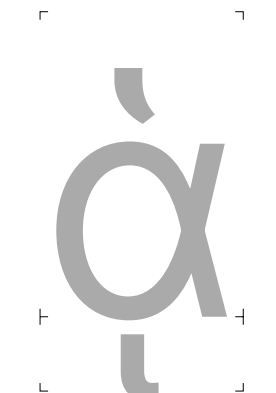

uni1F81

1F81



uni1F82

1F82

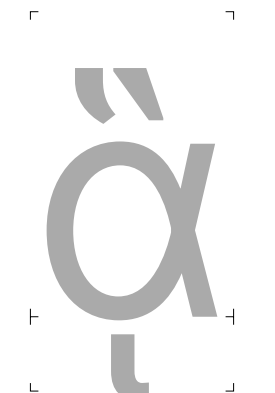

uni1F83

1F83



uni1F84

1F84



uni1F85

1F85

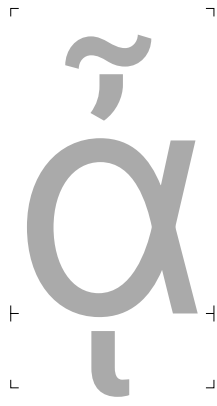

uni1F86

1F86

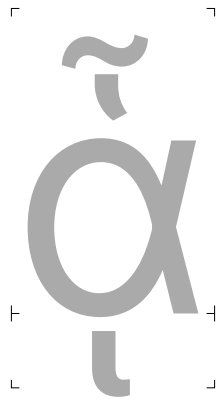

uni1F87

1F87

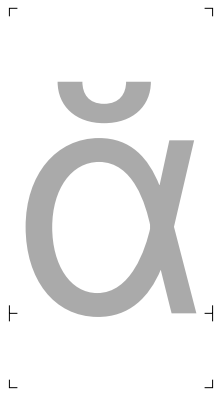

uni1F80

1F80



uni1F81

1F81



uni1F82

1F82



uni1F83

1F83

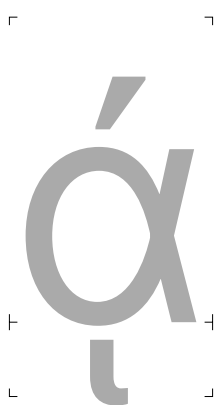

uni1FB4

1FB4



uni1FB6

1FB6



uni1FB7

1FB7

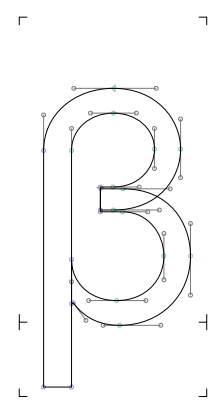

beta

03B2

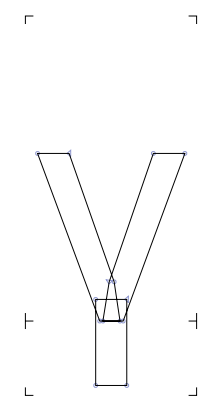

gamma

03B3

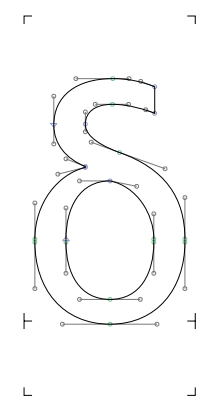

delta

03B4

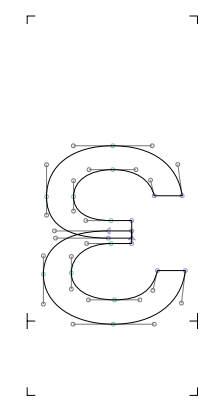

epsilon

03B5



epsilon-tonos

03AD

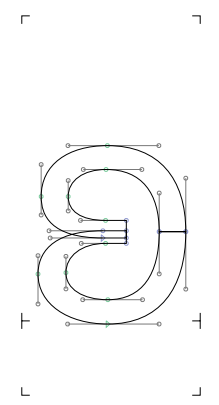

epsilon-closed

029A



epsilon-1

025B



epsilon-1rev

025C



epsilon-1rev-closed

025E

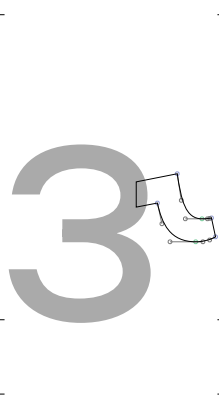

epsilon-1rev-hook

025D



uni1F10

1F10



uni1F11

1F11



uni1F12

1F12



uni1F13

1F13



uni1F14

1F14



uni1F15

1F15



uni1F72

1F72

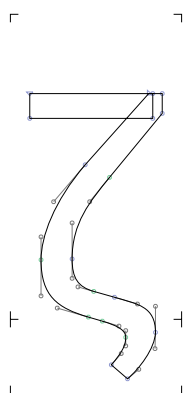

zeta

03B6

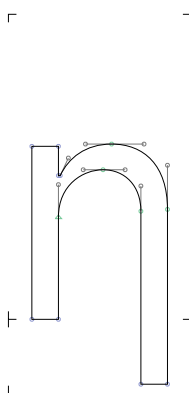

eta

03B7



etatonos

03AE

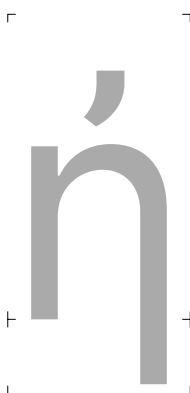

uni1F20

1F20



uni1F21

1F21



uni1F22

1F22



uni1F23

1F23



uni1F24

1F24



uni1F25

1F25



uni1F26

1F26



uni1F27

1F27



uni1F74

1F74



uni1F90

1F90



uni1F91

1F91



uni1F92

1F92



uni1F93

1F93



uni1F94

1F94



uni1F95

1F95



uni1F96

1F96

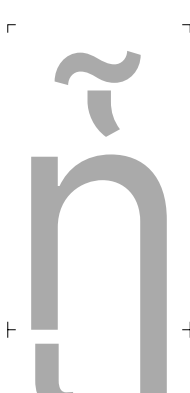

uni1F97

1F97



uni1FC2

1FC2



uni1FC3

1FC3



uni1FC4

1FC4



uni1FC6

1FC6



uni1FC7

1FC7

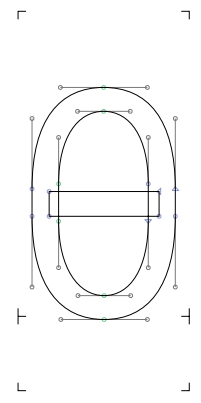

theta

03B8

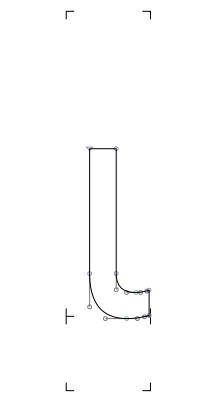

iota

03B9

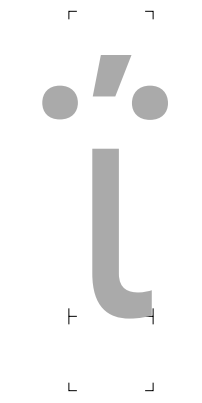

iotadiesistonos

0390

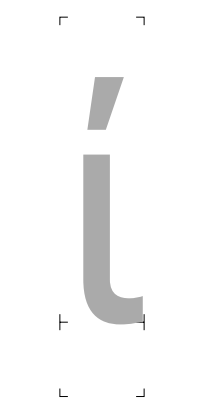

iotatonos

03AF

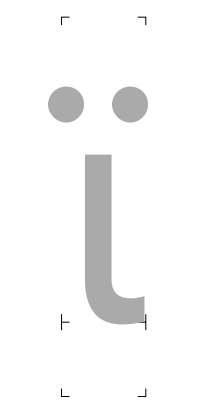

iotadiesis

03CA

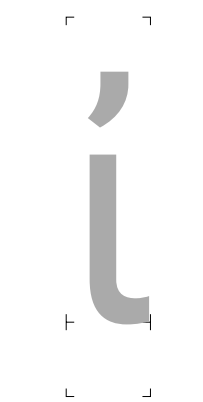

uni1F30

1F30

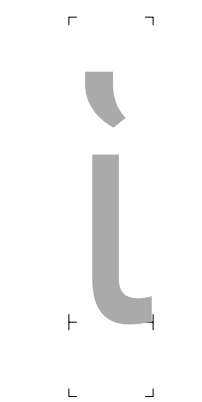

uni1F31

1F31

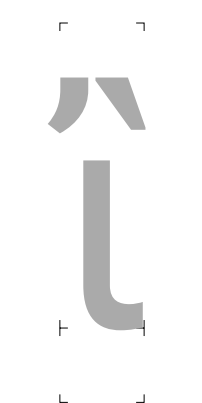

uni1F32

1F32

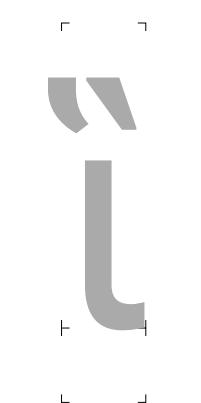

uni1F33

1F33



uni1F34

1F34



uni1F35

1F35

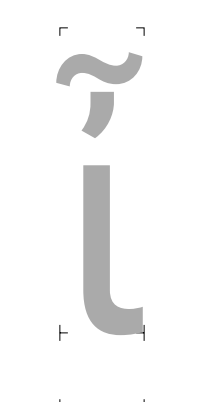

uni1F36

1F36



uni1F37

1F37

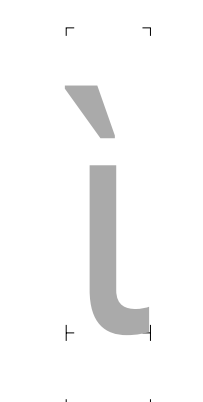

uni1F76

1F76

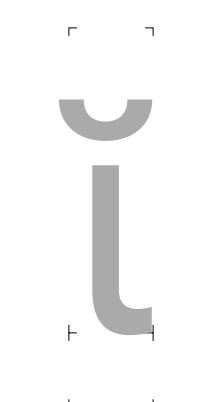

uni1FD0

1FD0

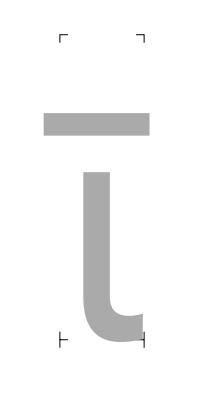

uni1FD1

1FD1

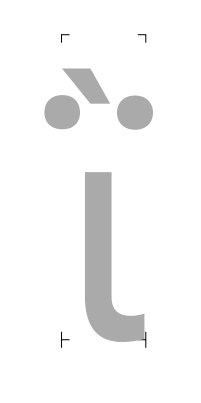

uni1FD2

1FD2



uni1FD6

1FD6

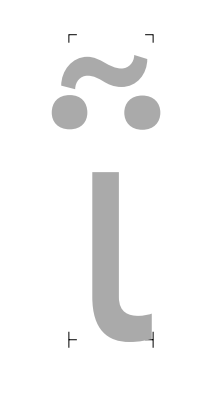

uni1FD7

1FD7

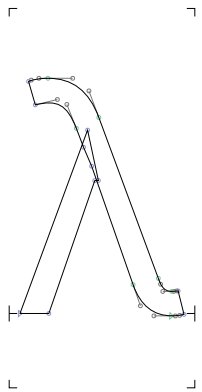

lambda

03BB

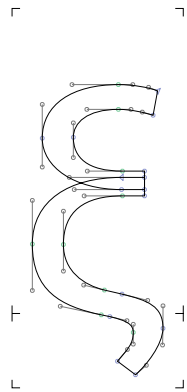

xi

03BE

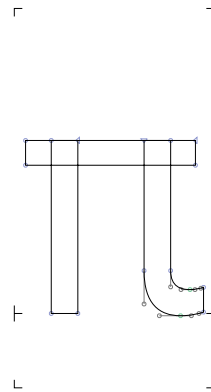

pi

03C0

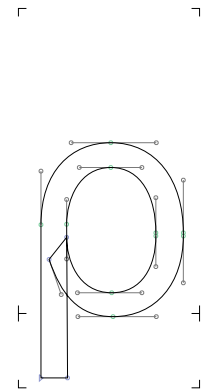

rho

03C1

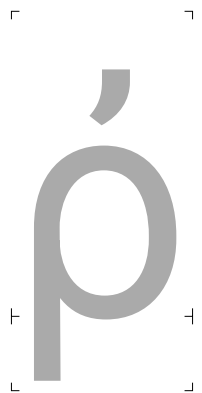

uni1FE4

1FE4

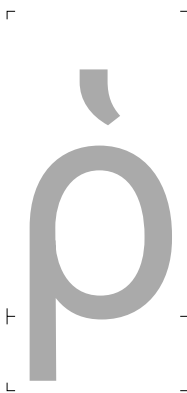

uni1FE5

1FE5



uni03FC

03FC

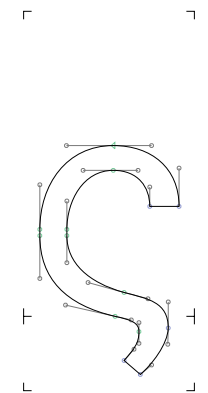

sigma1

03C2

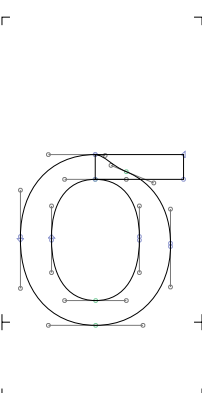

sigma

03C3

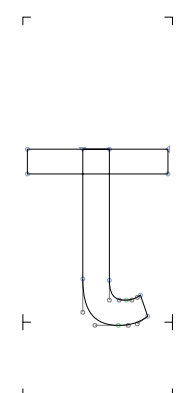

tau

03C4

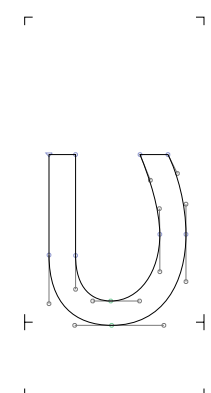

upsilon

03C5

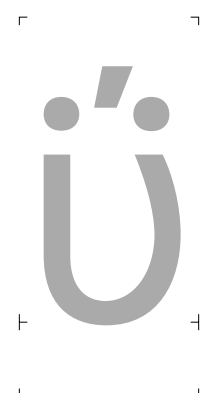

upsilondieresis

03B0

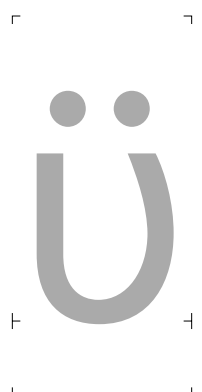

upsilondieresis

03CB

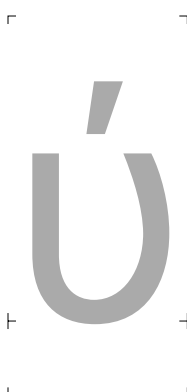

upsilontonos

03CD

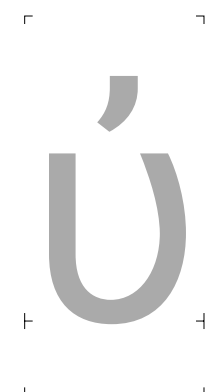

uni1F50

1F50

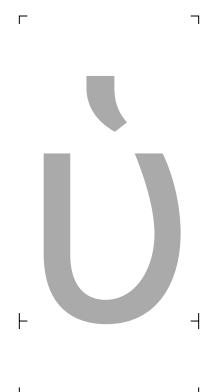

uni1F51

1F51

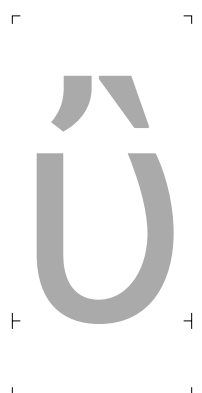

uni1F52

1F52



uni1F53

1F53



uni1F54

1F54

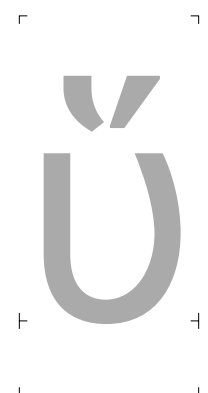

uni1F55

1F55

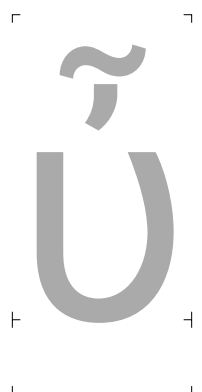

uni1F56

1F56

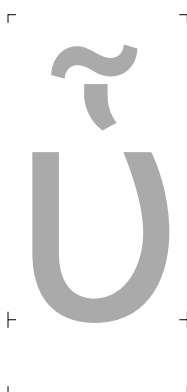

uni1F57

1F57

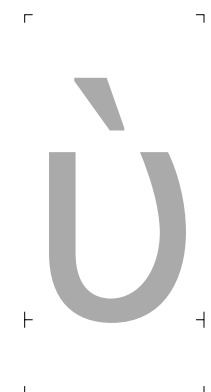

uni1F7A

1F7A

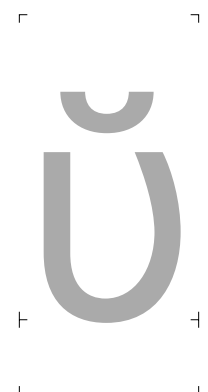

uni1FE0

1FE0

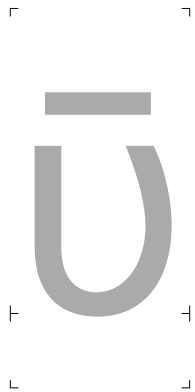

uni1FE1

1FE1

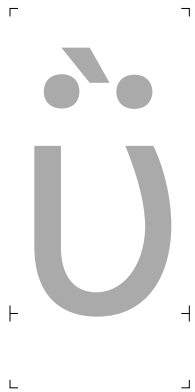

uni1FE2

1FE2

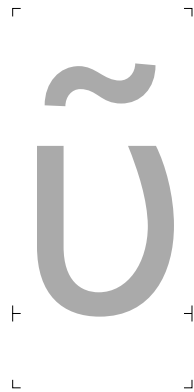

uni1FE6

1FE6

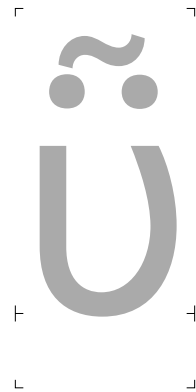

uni1FE7

1FE7

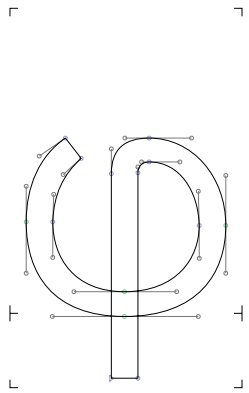

phi

03C6

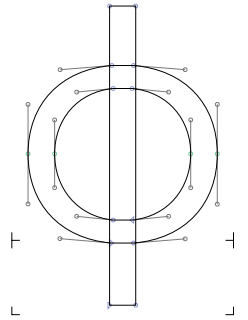

phigreek

03D5

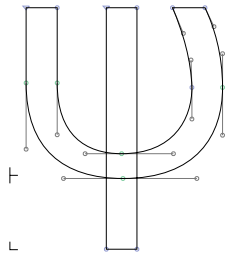

psi

03C8

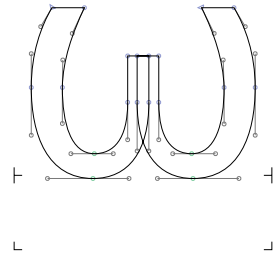

omega

03C9



omegatonos

03CE



uni1F60

1F60



uni1F61

1F61

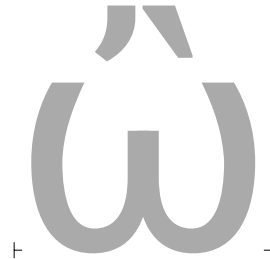

uni1F62

1F62



uni1F63

1F63



uni1F64

1F64



uni1F65

1F65

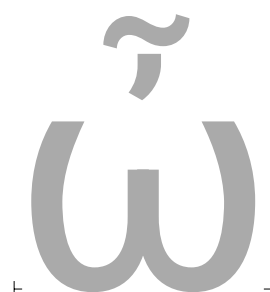

uni1F66

1F66

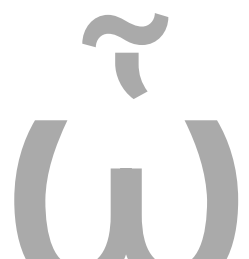

uni1F67

1F67

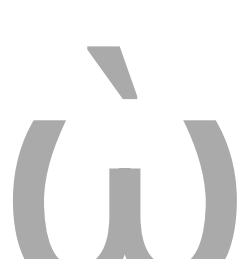

uni1F7C

1F7C

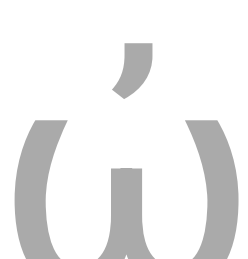

uni1FA0

1FA0

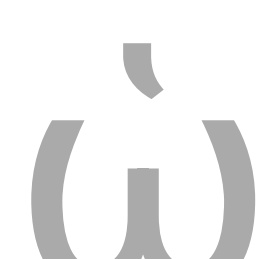

uni1FA1

1FA1



uni1FA2

1FA2



uni1FA3

1FA3



uni1FA4

1FA4

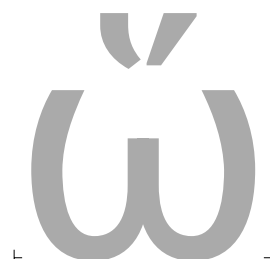

uni1FA5

1FA5

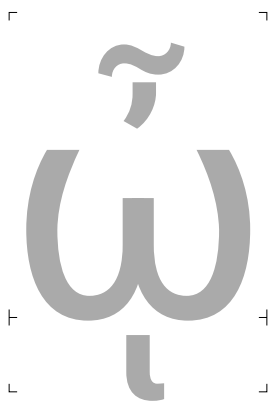

uni1FA6

1FA6

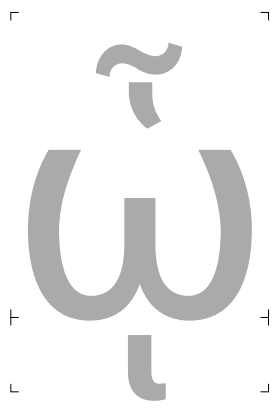

uni1FA7

1FA7

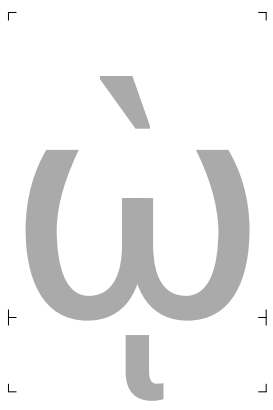

uni1FF2

1FF2

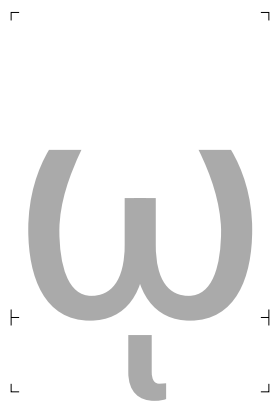

uni1FF3

1FF3

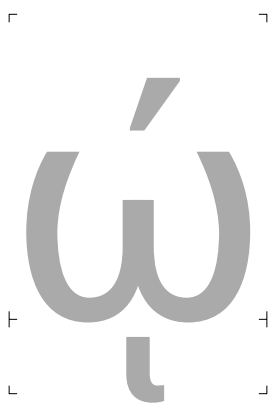

uni1FF4

1FF4

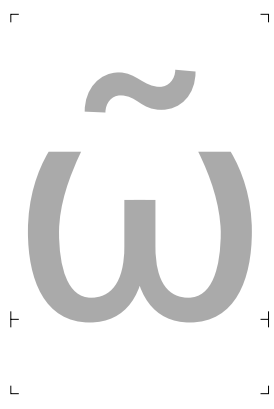

uni1FF6

1FF6

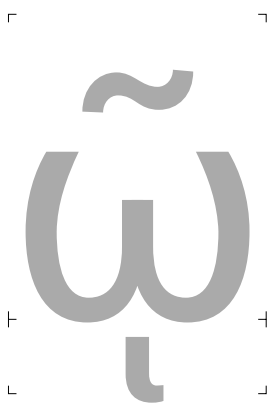

uni1FF7

1FF7

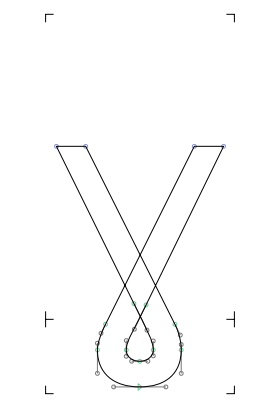

gamma1

0263

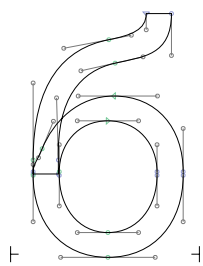

becyrillic

0431

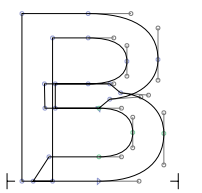

vecyrillic

0432

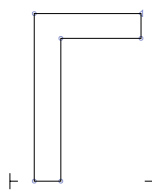

gecyrillic

0433

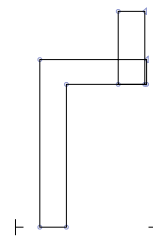

gheupturncyrillic

0491

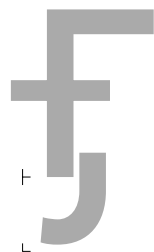

uni04FB

04FB

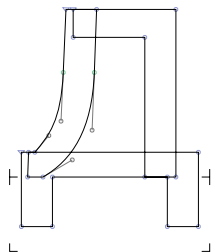

decyrillic

0434

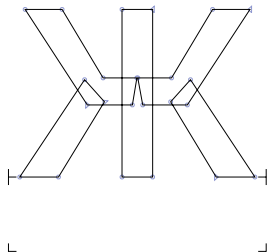

zhecyrillic

0436

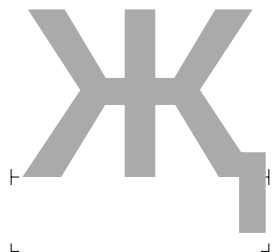

zhedescendecyrillic

0497

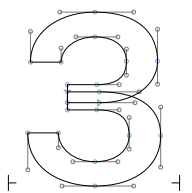

zecyrillic

0437

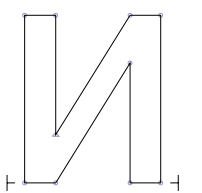

iicyrillic

0438

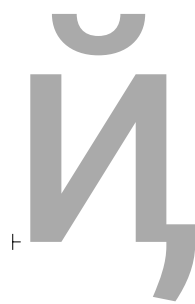

uni048B

048B

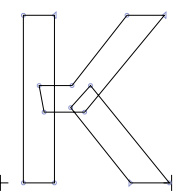

kacyrillic

043A

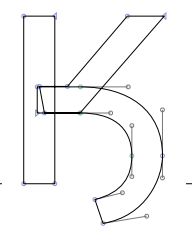

kahookcyrillic

04C4

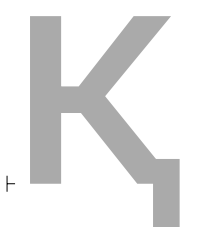

kadescendecyrillic

049B

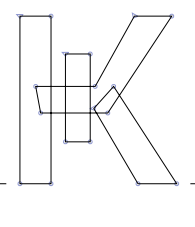

kaverticastrokescyrillic

049D

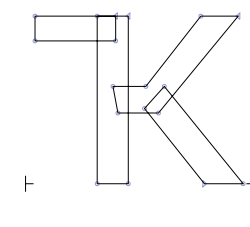

kabashkircyrillic

04A1

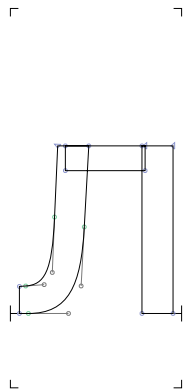

elcyrillic

043B

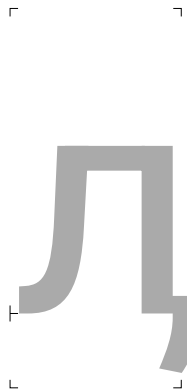

uni04C6

04C6

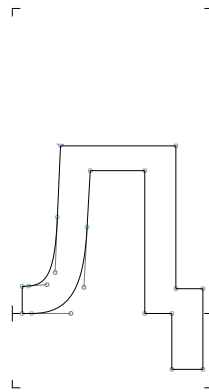

uni052F

052F

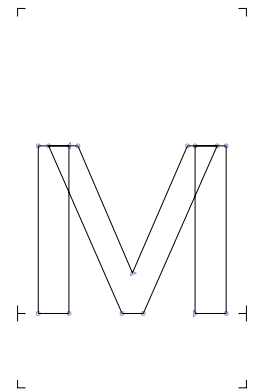

emcyrillic

043C

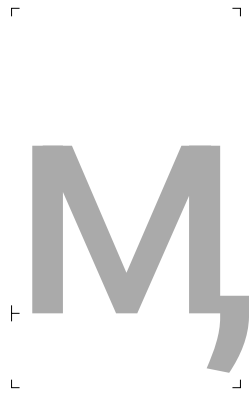

uni04CE

04CE

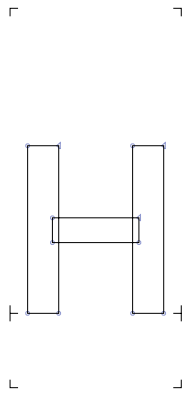

encyrillic

043D



endescendercyrillic

04A3

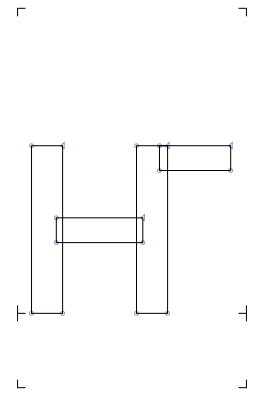

enghecyrillic

04A5

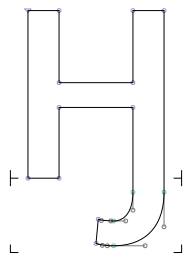

enhookcyrillic

04C8



uni04CA

04CA

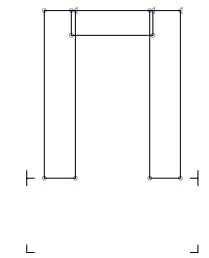

pecyrillic

043F

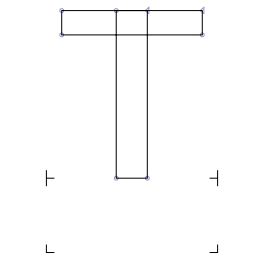

tecyrillic

0442

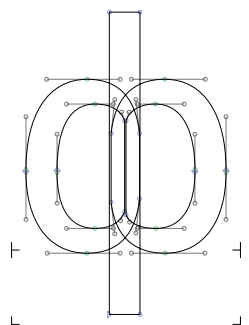

efcyrillic

0444

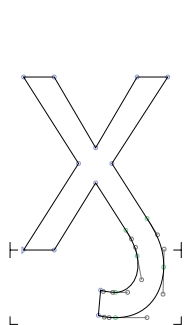

uni04FD

04FD

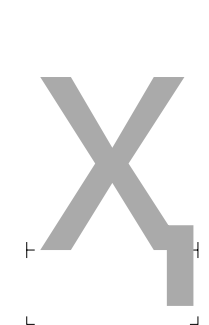

hadescendercyrillic

04B3

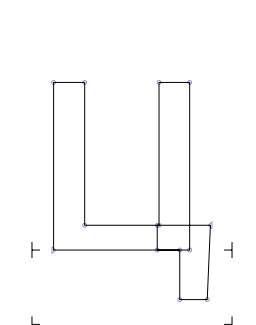

tsecyrillic

0446

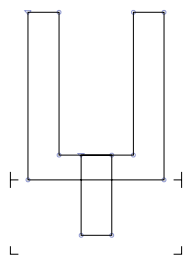

dzhecyrillic

045F

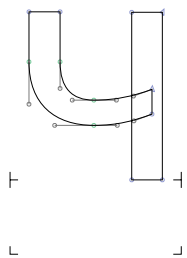

checyrillic

0447

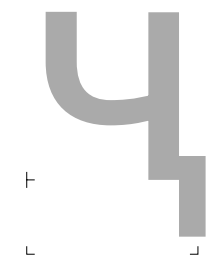

chedescendercyrillic

04B7

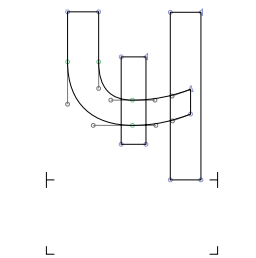

cheverticalstrokecyrillic

04B9

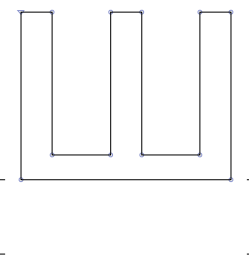

shacyrillic

0448

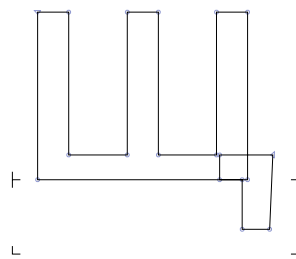

shchacyrillic

0449

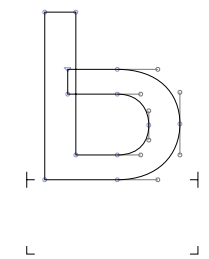

softsigncyrillic

044C

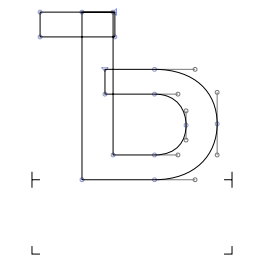

hardsigncyrillic

044A





yericyrillic 044B

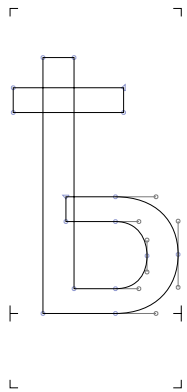

uni048D 048D

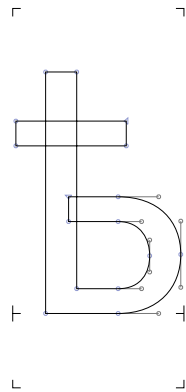

yatcyrillic 0463

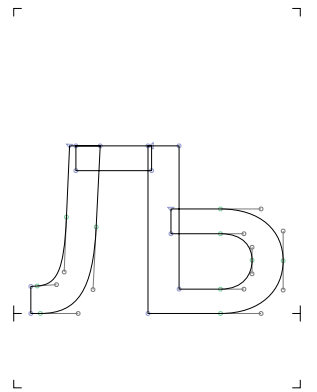

ljecyrillic 0459

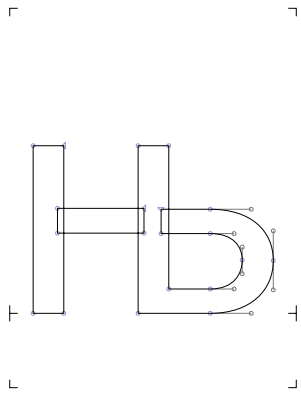

njecyrillic 045A

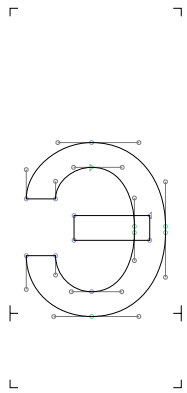

ereversedcyrillic 044D

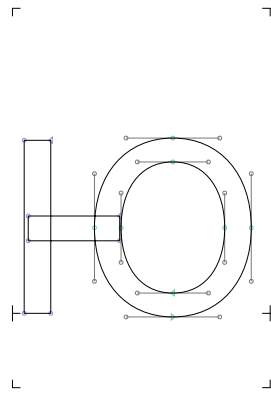

iucyrillic 044E

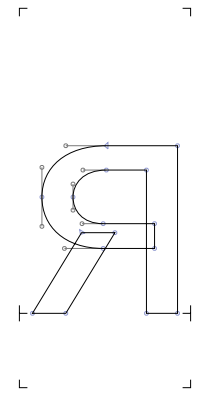

iacyrillic 044F

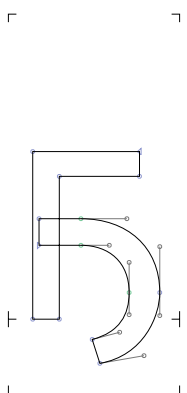

ghemiddlehookcyrillic 0495

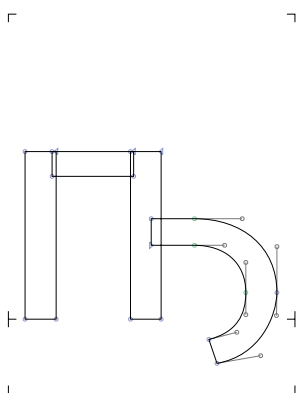

pemiddlehookcyrillic 04A7

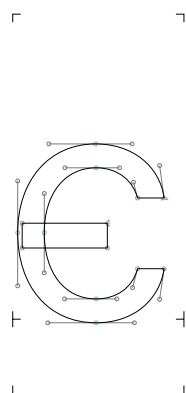

ecyrillic 0454

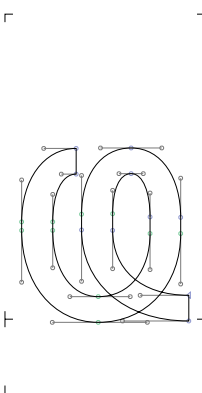

haabkhasiancyrillic 04A9

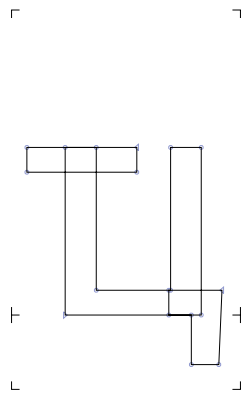

tetsecyrillic 04B5

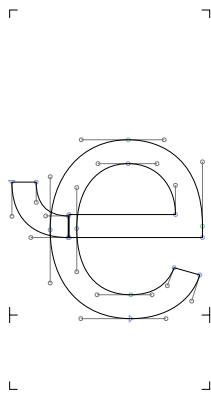

cheabkhasiancyrillic 04BD

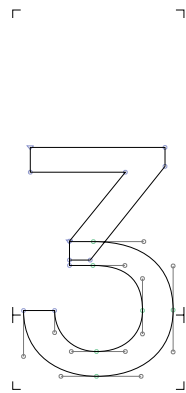

dzeabkhasiancyrillic 04E1

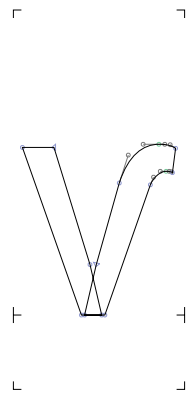

izhitsacyrillic 0475

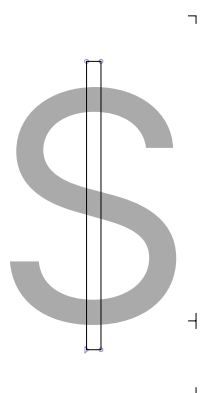

dollar 0024

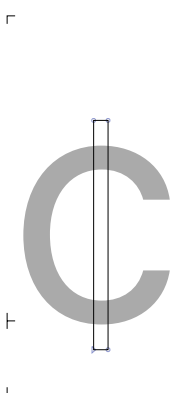

cent 00A2

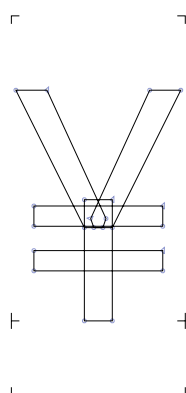

yen 00A5

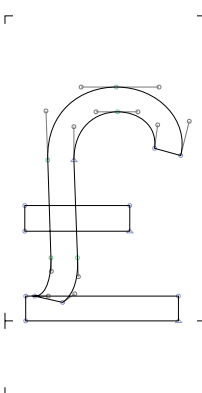

sterling 00A3

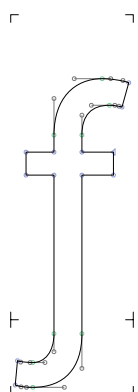

florin 0192

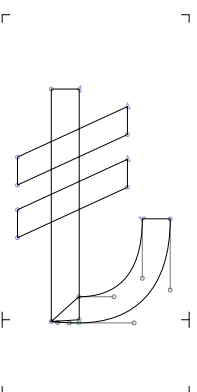

uni20BA 20BA

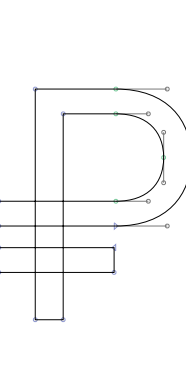

uni20BD 20BD

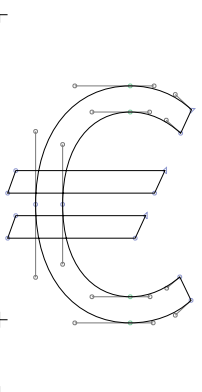

euro 20AC

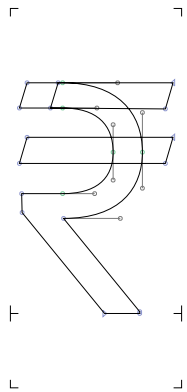

uni20B9 20B9

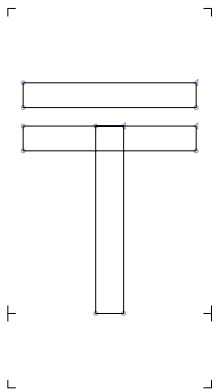

tenge 20B8

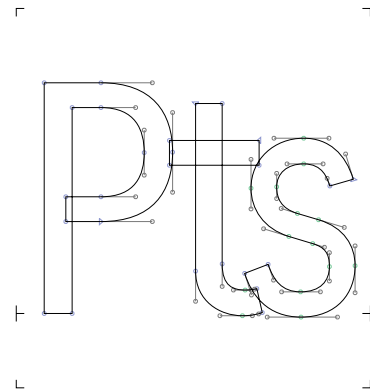

peseta 20A7

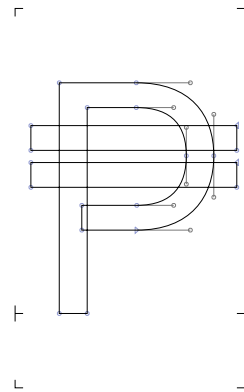

peso 20B1

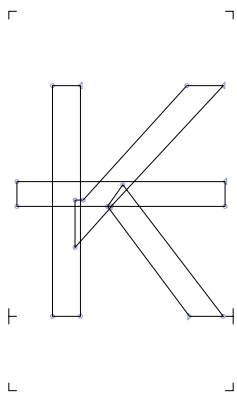

kip 20AD

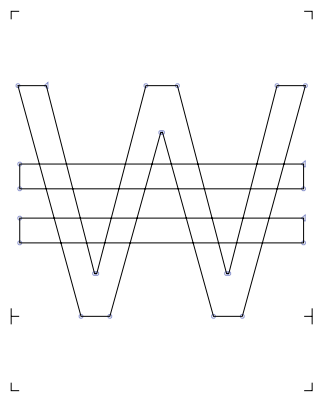

won 20A9

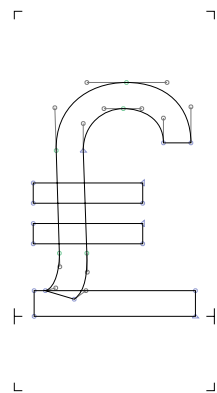

lira 20A4

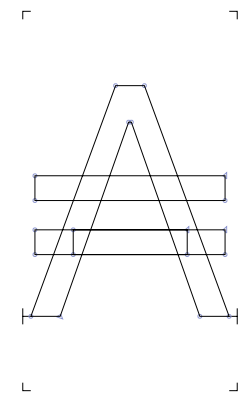

austral 20B3

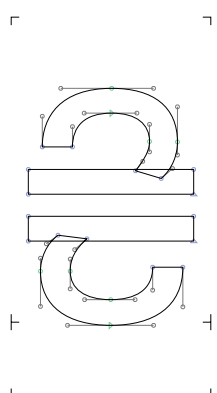

hryvnia 20B4

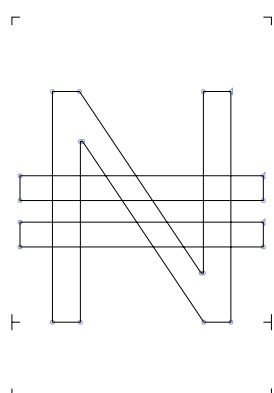

naira 20A6

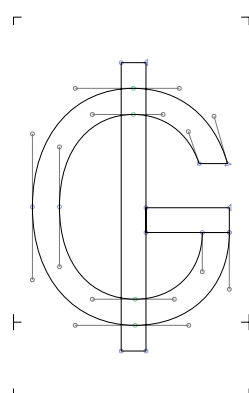

guarani 20B2

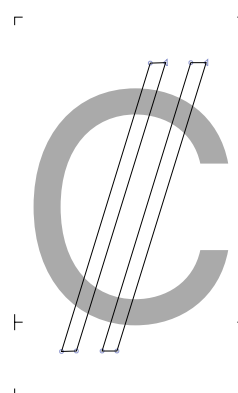

coloncurrency 20A1

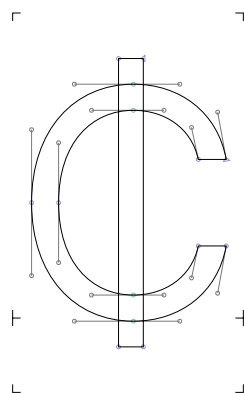

cedi 20B5

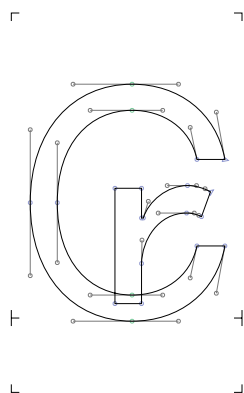

cruzeiro 20A2

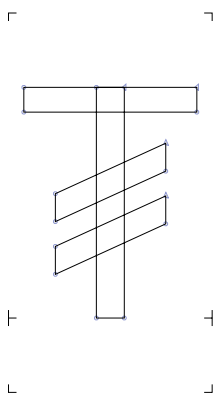

tugrik 20AE

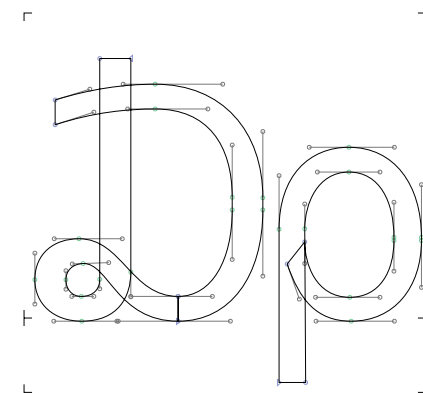

uni20AF 20AF

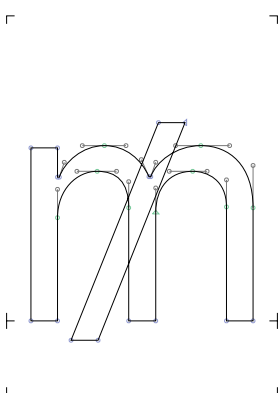

mill 20A5

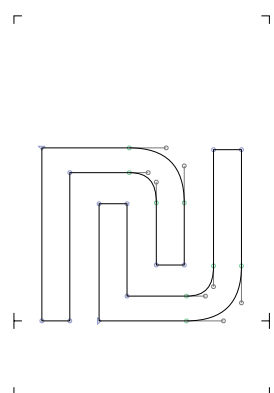

afi57636 20AA

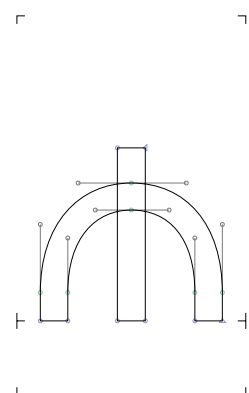

manat 20BC



rupee 20A8

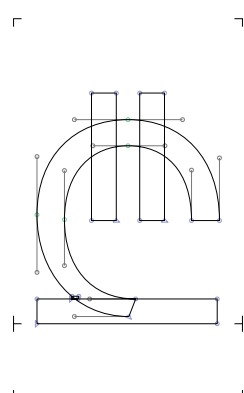

lari 20BE



franc 20A3

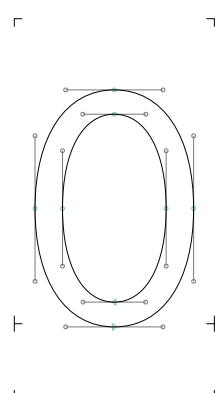

zero 0030

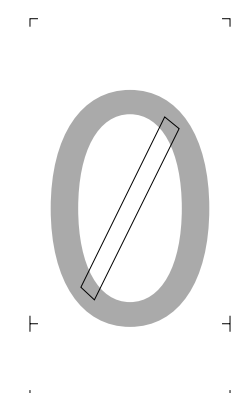

zero.slash

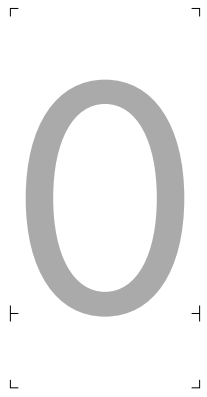

zero.tf

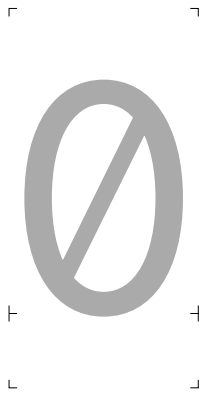

zero.tf.slash

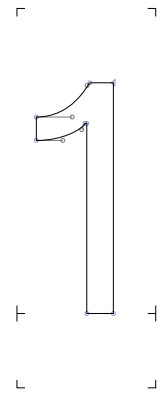

one

0031

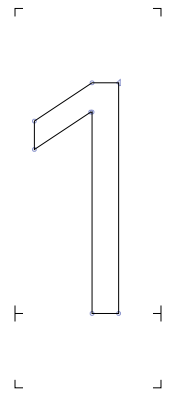

one.ss01

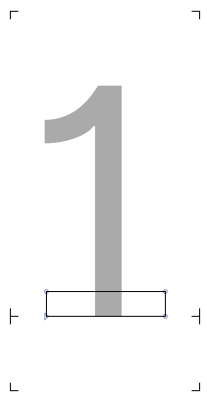

one.tf

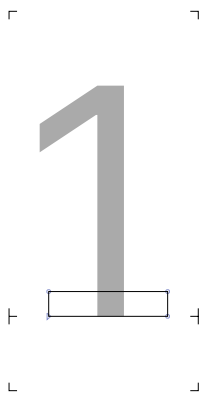

one.tf.ss01

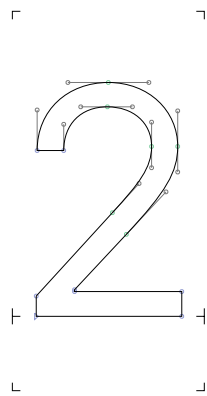

two

0032



two.tf



twostroke

01BB

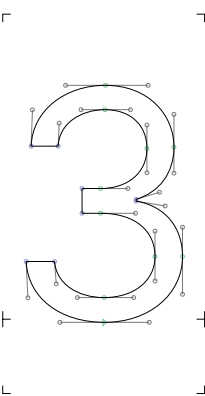

three

0033



three.tf

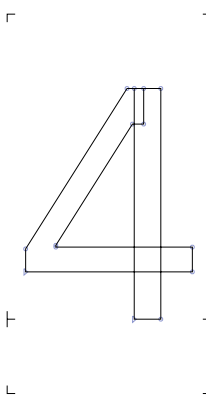

four

0034

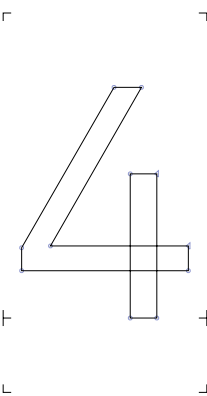

four.ss01



four.tf



four.tf.ss01

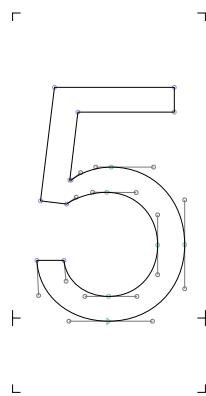

five

0035



five.tf

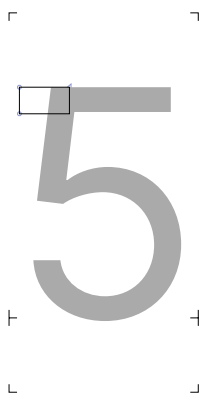

Tonefive

01BC

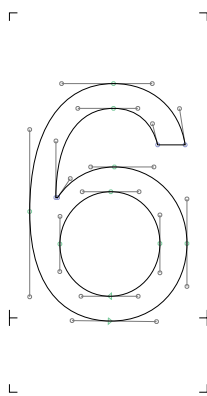

six

0036

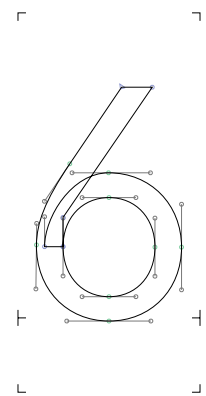

six.ss01



six.tf



six.tf.ss01

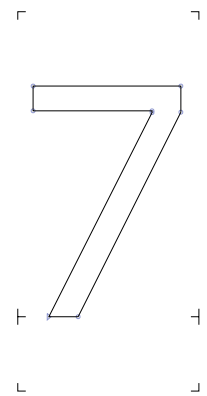

seven

0037



seven.tf

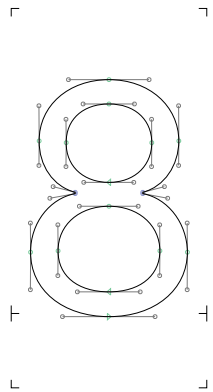

eight 0038

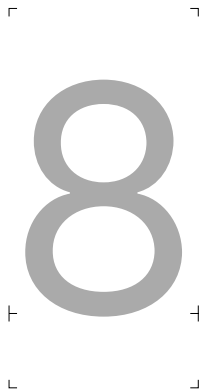

eight.tf

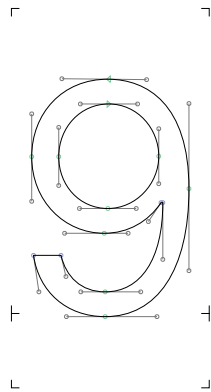

nine 0039

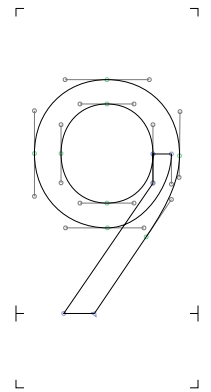

nine.ss01



nine.tf



nine.tf.ss01

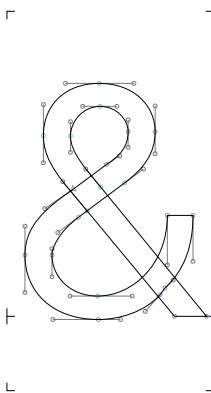

ampersand 0026

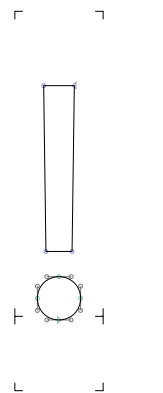

exclam 0021



exclamdbl 203C

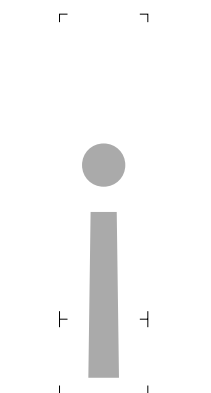

exclamdown 00A1



uni2049 2049

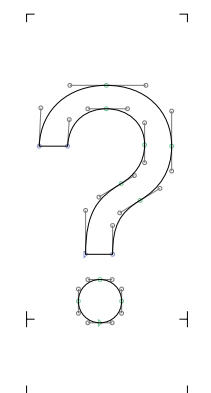

question 003F



uni2047 2047



uni2048 2048

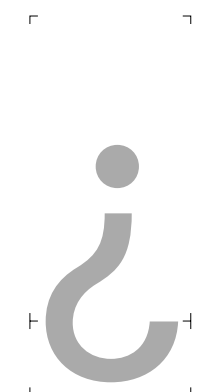

questiondown 00BF

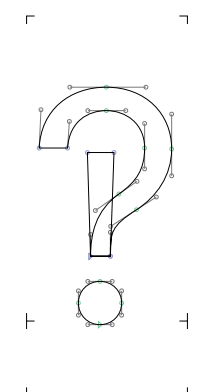

interrobang 203D



invertedinterrobang 2E18

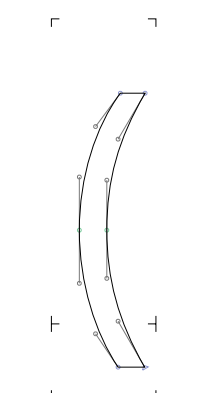

parenleft 0028

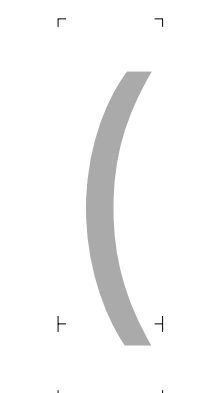

parenleft.case

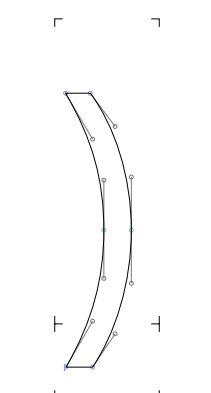

parenright 0029

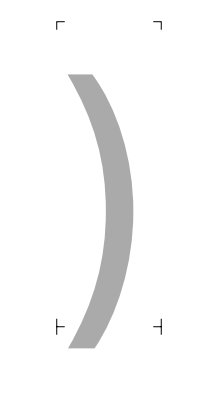

parenright.case

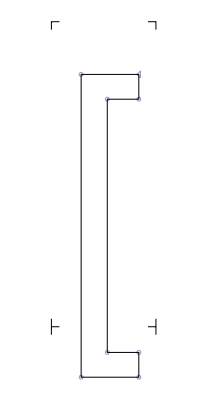

bracketleft 005B

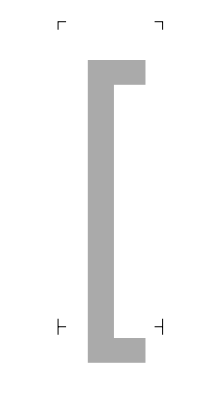

bracketleft.case

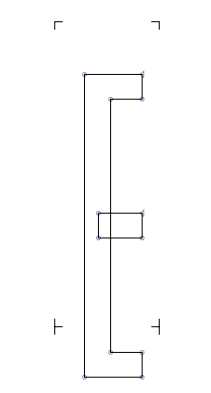

bracketleft\_quill 2045

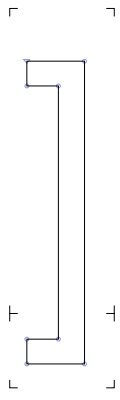

bracketright

005D



bracketright.case

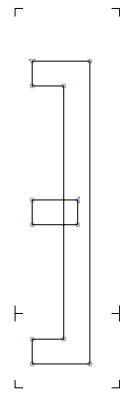

bracketright\_quill

2046

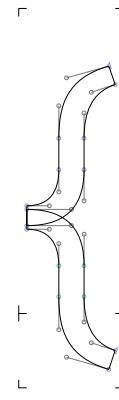

braceleft

007B



braceleft.case

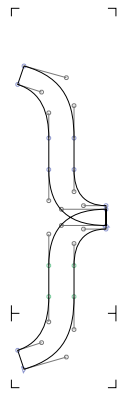

braceright

007D



braceright.case

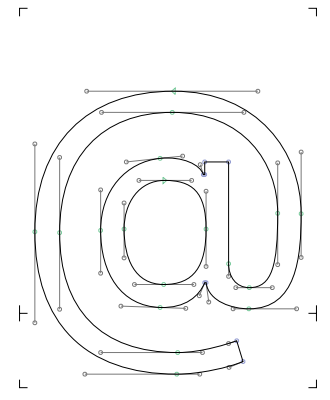

at

0040



at.case

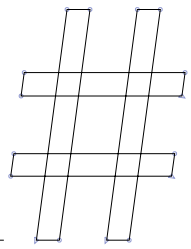

numbersign

0023

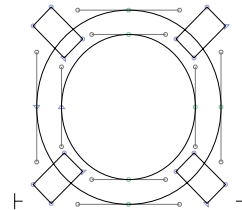

currency

00A4

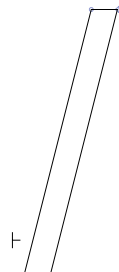

slash

002F

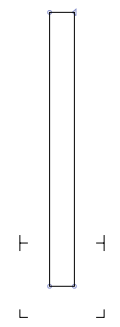

bar

007C

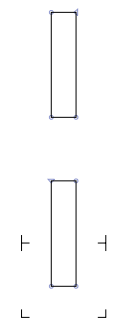

brokenbar

00A6

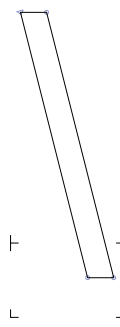

backslash

005C



hyphenbullet

2043

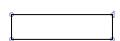

hyphen

002D



softyphen

00AD



hyphen.case

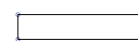

enddash

2013



enddash.case

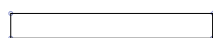

figuredash

2012



figuredash.case



emdash

2014

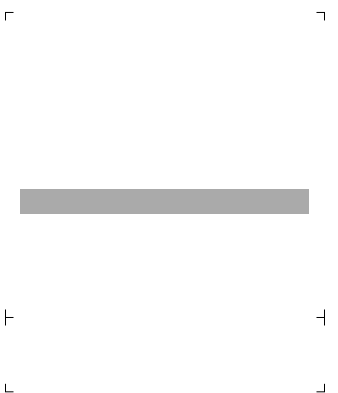

emdash.case



horizontalbar

2015

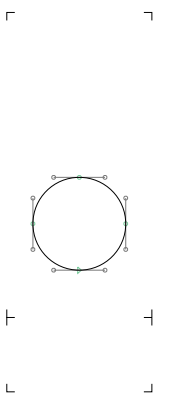

bullet

2022

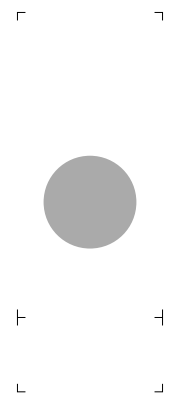

bullet.case

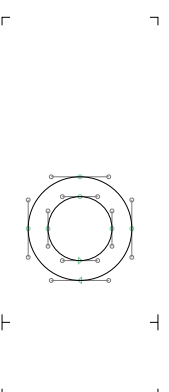

openbullet

25E6

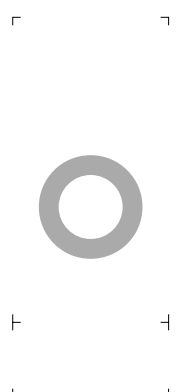

openbullet.case



quoteleft

2018



quoteright

2019



apostrophemod

02BC

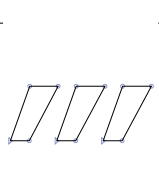

primetripl1

2034

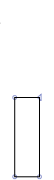

quotesingle

0027



minute

2032

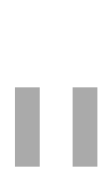

quotedbl

0022

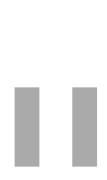

second

2033



quotedblleft

201C



quotedblright

201D



quotedblbase

201E

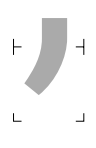

quotesingbase

201A

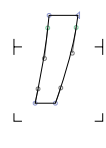

comma

002C

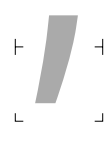

comma.tf

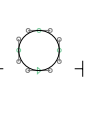

period

002E

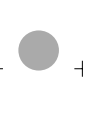

period.tf



ellipsis

2026

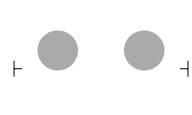

twodotleader

2025

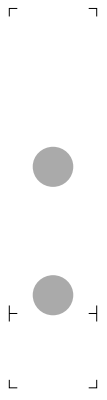

colon 003A



colon.case



colon.tf



semicolon 003B

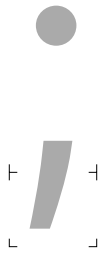

semicolon.tf

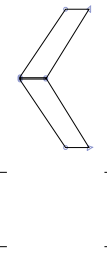

guilsingleft 2039

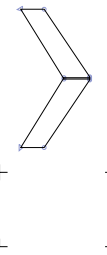

guilsingright 203A



guillemetleft 00AB



guillemetright 00BB

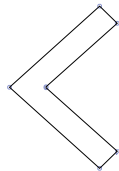

less 003C

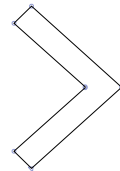

greater 003E

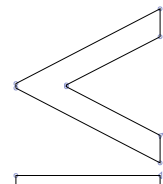

lessequal 2264

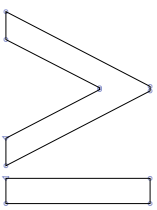

greaterequal 2265

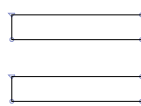

equal 003D



equal.case

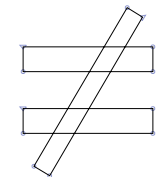

notequal 2260



notequal.case

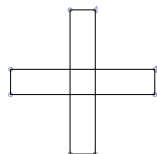

plus 002B



plus.case

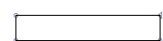

minus 2212



minus.case

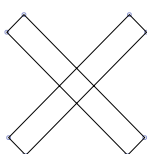

multiply 00D7



multiply.case

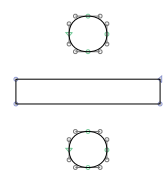

divide 00F7

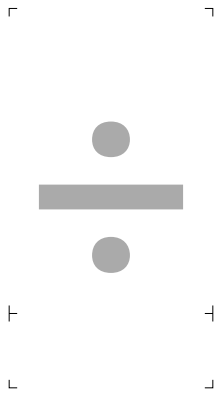

divide.case

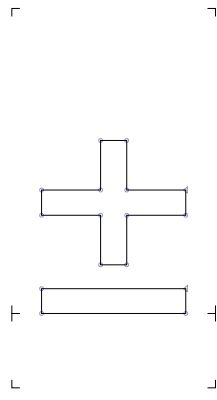

plusminus 00B1

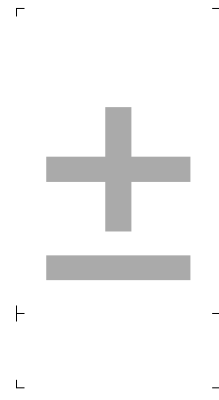

plusminus.case

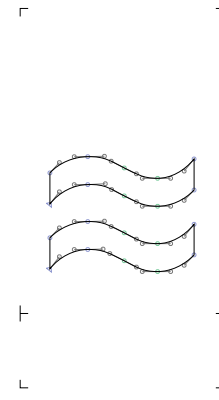

approxequal 2248

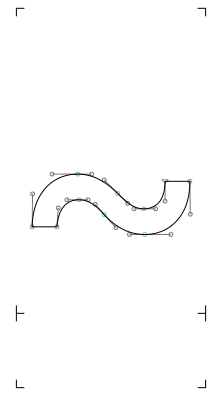

asciitilde 007E

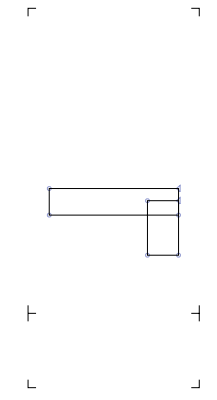

logicalnot 00AC

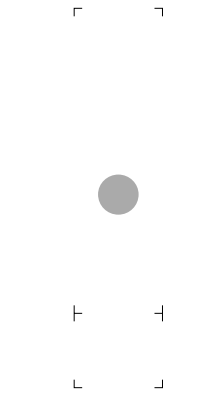

periodcentered 00B7

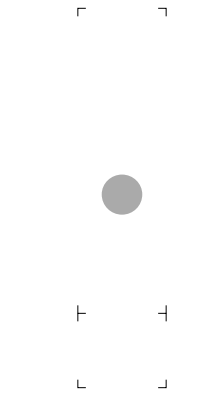

anoteleia 0387



questiongreek 037E



underscore 005F

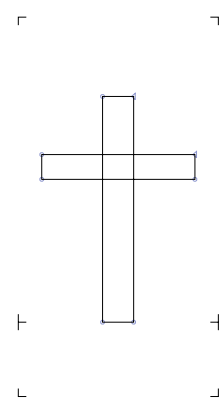

dagger 2020

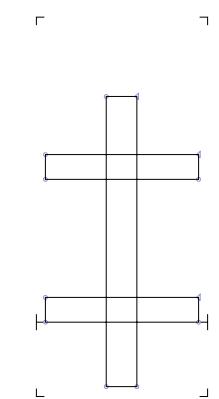

daggerdbl 2021

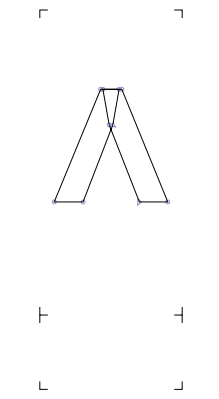

asciicircum 005E

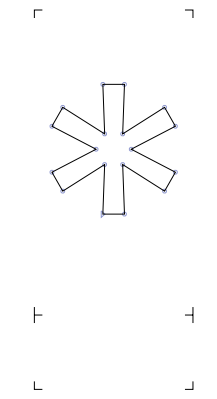

asterisk 002A

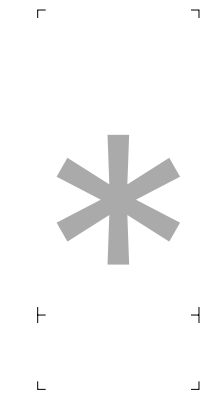

asterisk.case

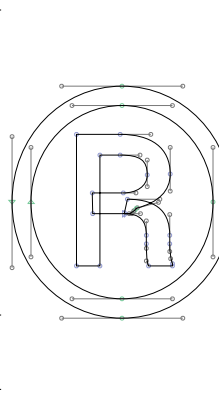

registered 00AE

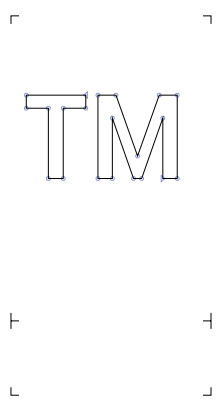

trademark 2122

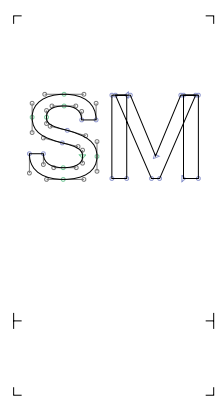

servicemark 2120

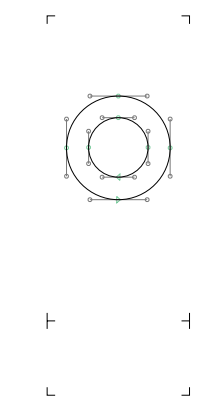

degree 00B0

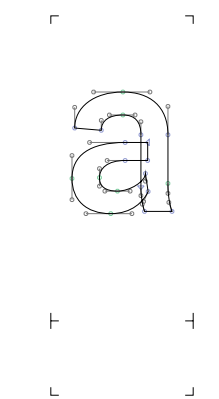

ordfeminine 00AA

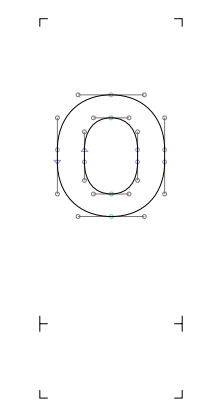

ordmasculine 00BA

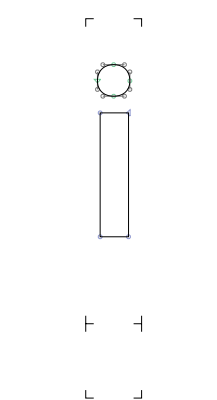

i.numr

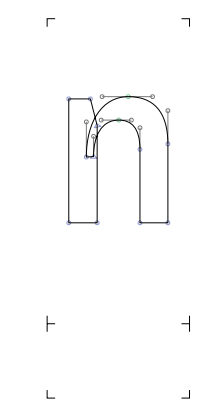

n.numr

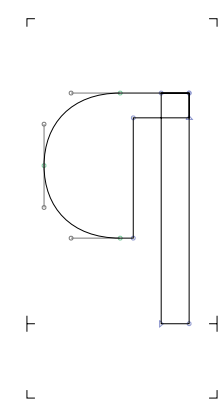

paragraph 00B6



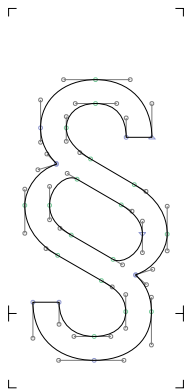

section 00A7

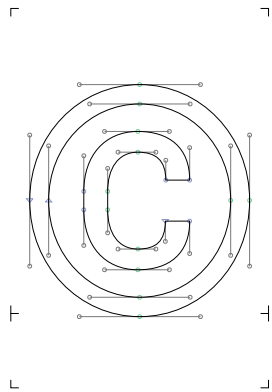

copyright 00A9

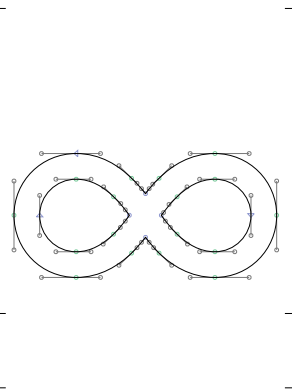

infinity 221E

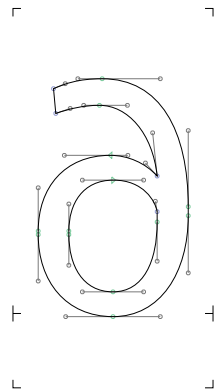

partialdiff 2202

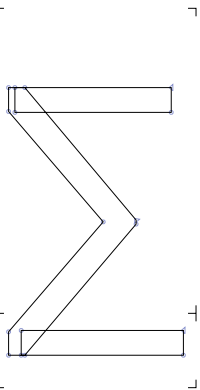

summation 2211

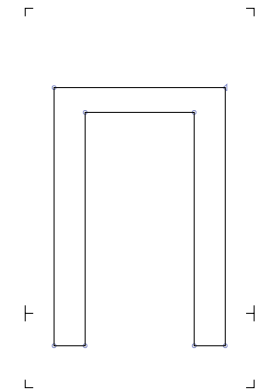

product 220F

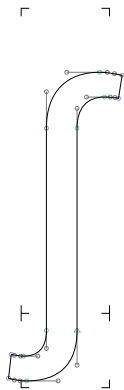

integral 222B

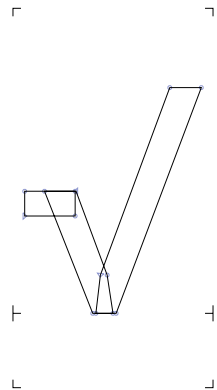

radical 221A

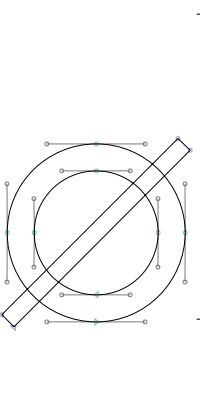

emptyset 2205

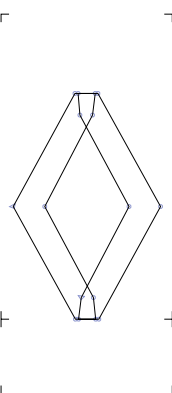

lozenge 25CA

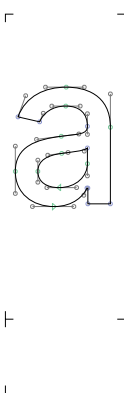

a.sups 1D43

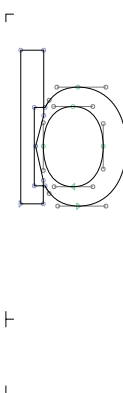

b.sups 1D47

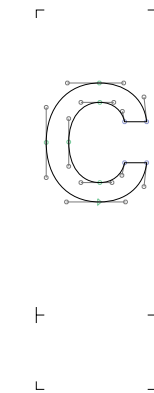

c.sups 1D9C

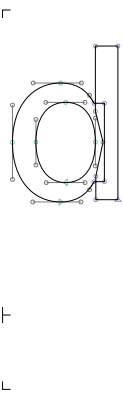

d.sups 1D48

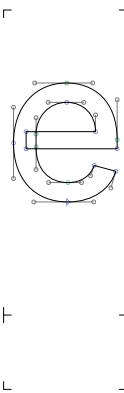

e.sups 1D49

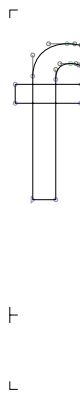

f.sups 1DA0

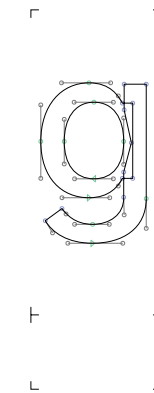

g.sups 1D4D

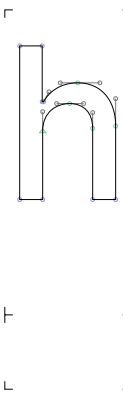

h.sups 02B0

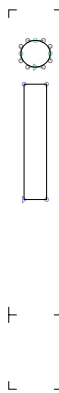

i.sups 2071

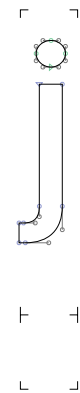

j.sups 02B2

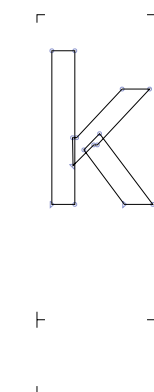

k.sups 1D4F



l.sups 02E1

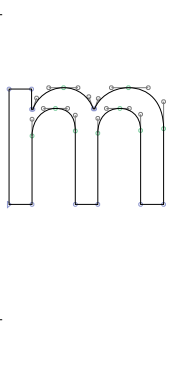

m.sups 1D50

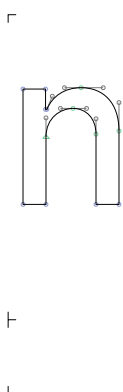

n.sups 207F

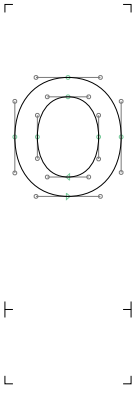

o.sups

1D52

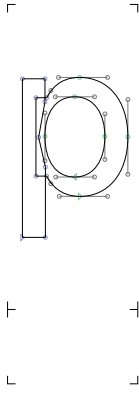

p.sups

1D56

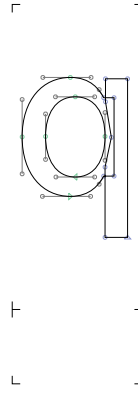

q.sups

146B

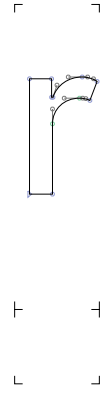

r.sups

02B3

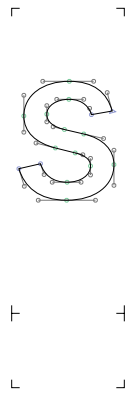

s.sups

02E2

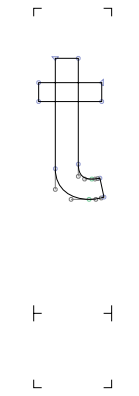

t.sups

1D57

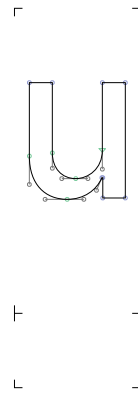

u.sups

1D58



v.sups

1D5B

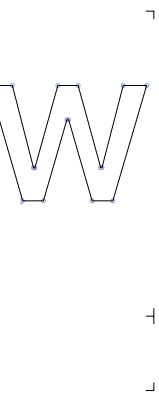

w.sups

02B7

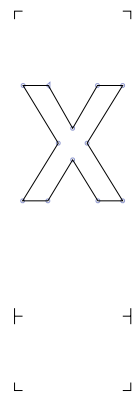

x.sups

02E3

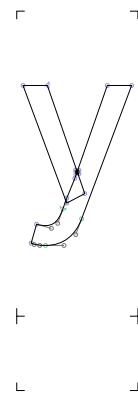

y.sups

02B8

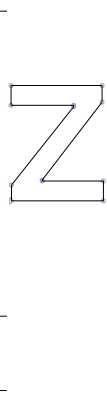

z.sups

1DBB

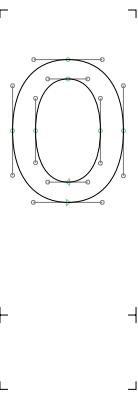

zero.sups

2070

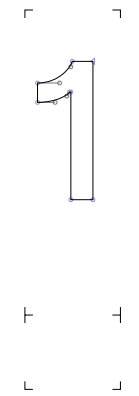

one.sups

00B9

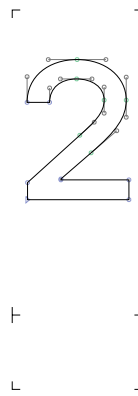

two.sups

00B2

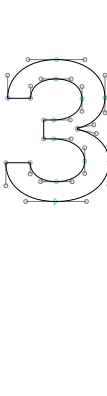

three.sups

00B3

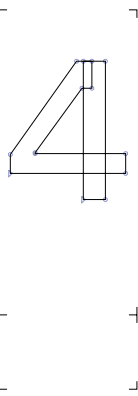

four.sups

2074

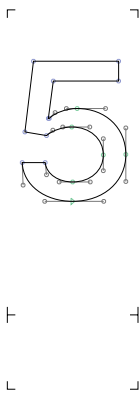

five.sups

2075

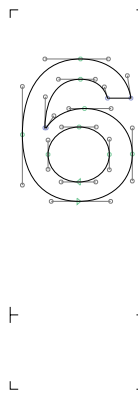

six.sups

2076

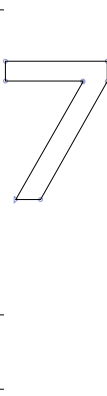

seven.sups

2077

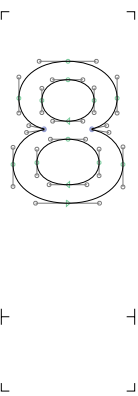

eight.sups

2078

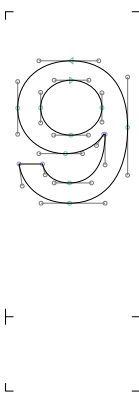

nine.sups

2079

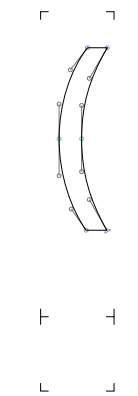

parenleft.sups

207D

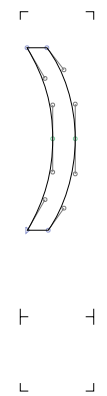

parenright.sups

207E

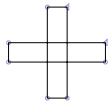

plus.sups

207A

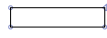

minus.sups

207B

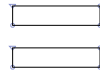

equal.sups

207C

a

a.sups

2090

b

b.sups

c

c.sups

d

d.sups

e

e.sups

2091

f

f.sups

g

g.sups

h

h.sups

2095

i

i.sups

1D62

j

j.sups

2C7C

k

k.sups

2096

l

l.sups

2097

m

m.sups

2098

n

n.sups

2099

o

o.sups

209B

p

p.sups

209A

q

q.sups

r

r.sups

1D63

s

s.sups

209B

t

t.sups

209C

u

u.sups

1D64

v

v.subs 1D65

w

w.subs

x

x.subs 2093

y

y.subs

z

z.subs

0

zero.subs 2080

1

one.subs 2081

2

two.subs 2082

3

three.subs 2083

4

four.subs 2084

5

five.subs 2085

6

six.subs 2086

7

seven.subs 2087

8

eight.subs 2088

9

nine.subs 2089

(

parenleft.subs 208D

)

parenright.subs 208E

+

plus.subs 208A

-

minus.subs 208B

=

equal.subs 208C

0

zero.dnomf

1

one.dnomf

2

two.dnomf

3

three.dnomf

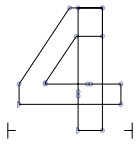

four.dnomf

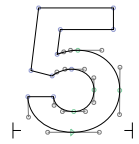

five.dnomf

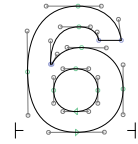

six.dnomf

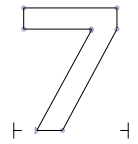

seven.dnomf

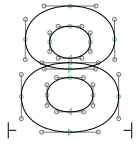

eight.dnomf



nine.dnomf

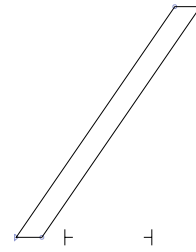

fraction 2044

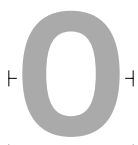

zero.dnom



one.dnom



two.dnom



three.dnom



four.dnom



five.dnom



six.dnom



seven.dnom

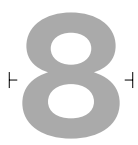

eight.dnom



nine.dnom

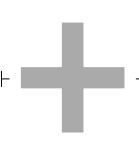

plus.dnom



minus.dnom

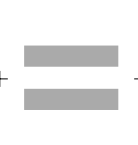

equal.dnom

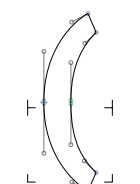

parenleft.dnom

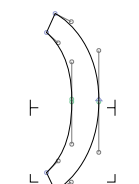

parenright.dnom

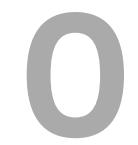

zero.numr



one.numr

2

3

4

5

└──┘

└──┘

└──┘

└──┘

┌──┐

┌──┐

┌──┐

┌──┐

two.numr

three.numr

four.numr

five.numr

6

7

8

9

└──┘

└──┘

└──┘

└──┘

┌──┐

┌──┐

┌──┐

┌──┐

six.numr

seven.numr

eight.numr

nine.numr

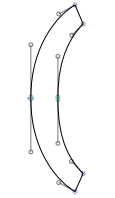
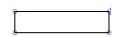
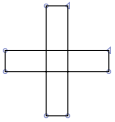

└──┘

└──┘

└──┘

└──┘

┌──┐

┌──┐

┌──┐

┌──┐

plus.numr

minus.numr

equal.numr

parenleft.numr

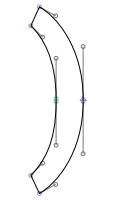

0

1

2

└──┘

└──┘

└──┘

└──┘

┌──┐

┌──┐

┌──┐

┌──┐

parenright.numr

zero.frac

one.frac

two.frac

3

4

5

6

└──┘

└──┘

└──┘

└──┘

┌──┐

┌──┐

┌──┐

┌──┐

three.frac

four.frac

five.frac

six.frac

7

8

9

1/2

└──┘

└──┘

└──┘

└──┘

┌──┐

┌──┐

┌──┐

┌──┐

seven.frac

eight.frac

nine.frac

onehalf

00BD

1/4

onequarter

00BC

3/4

threequarters

00BE

5/6

fivesixths

215A

1/

onefraction

215F

7/8

seveneighths

215E

1/8

oneeighth

215B

5/8

fiveeighths

215D

3/8

threeeighths

215C

0/0

percent

0025

0/00

perthousand

2030

0/000

pertenthousand

2031

A/S

uni214D

214D

C/U

cadauna

2106

C/O

careof

2105

a/C

accountof

2100

a/S

addresssubject

2101

No

numero

2116

◌́

acute

00B4

◌̃

hungarumlaut

02DD

◌̀

grave

0060

◌̂

tonos

0384

◌̈

dieresis

00A8

◌̇

casedieresis.cn

◌̆

circumflex

02C6

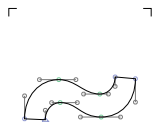

tilde 02DC



casetilde.cn

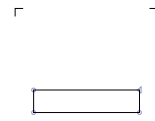

macron 00AF

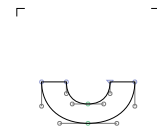

breve 02D8



cyrillicbreve



dotaccent 02D9

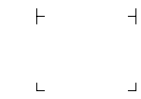
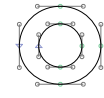

ring 02DA

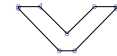

caron 02C7

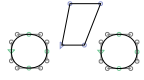

dieresistonos 0385



cedilla 00B8

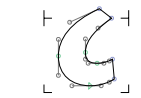
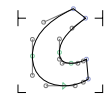

ogonek 02DB

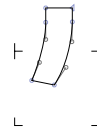
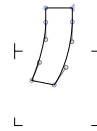

commaaccent F6C3



acutecomb 0301



acutedblnosp 030B



gravecomb 0300

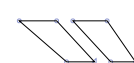

dblgravecmb 030F



macroncomb 0304



dieresisnosp 0308



brevenosp 0306



breveinvnosp 0311



hook 0309



circumflexnosp 0302

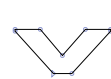

caroncmb 030C



tildecomb 0303





dotnosp 0307



ringnosp 030A

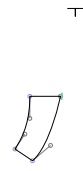

hornnosp 031B



ogoneknosp 0328

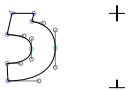

cedillanosp 0327



circumflexsubnosp 032D

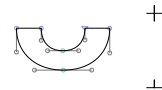

brevesubnosp 032E



dotbelow 0323

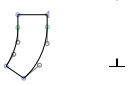

commabelowcmb 0326



dotdblsubnosp 0324



ringsubnosp 0325



underscorenosp 0332



tildesubnosp 0330



enquad 2000



emquad 2001



enspace 2002



emspace 2003



thirdemspace 2004



quarteremspace 2005



sixthemspace 2006



figurespace 2007



punctuationspace 2008



thinspace 2009



hairspace 200A

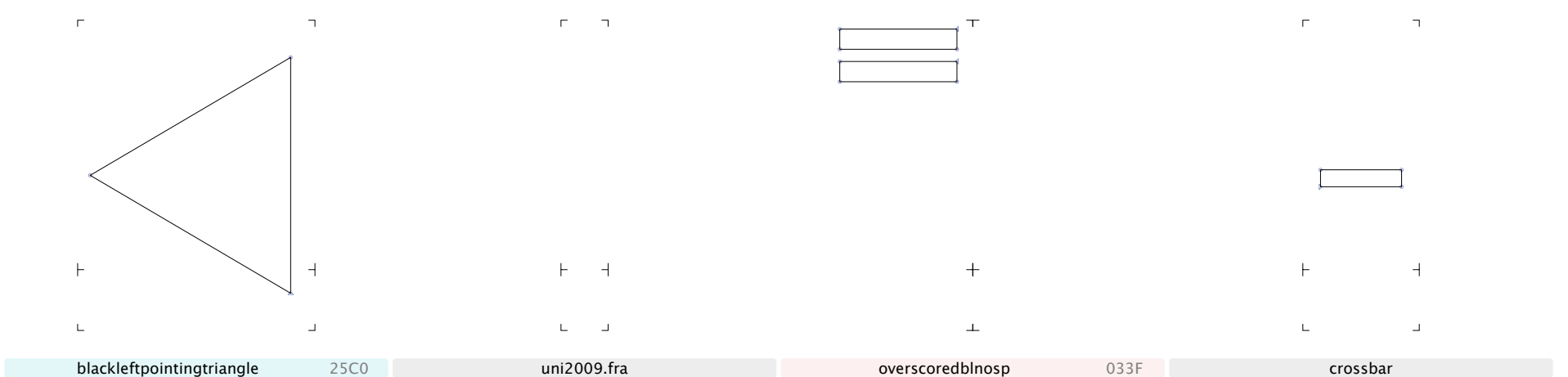
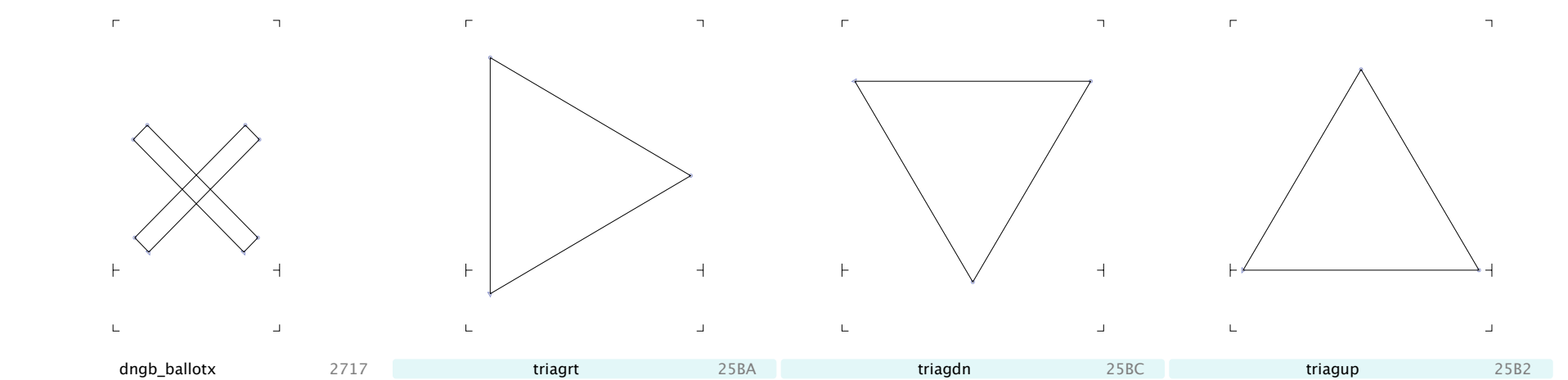
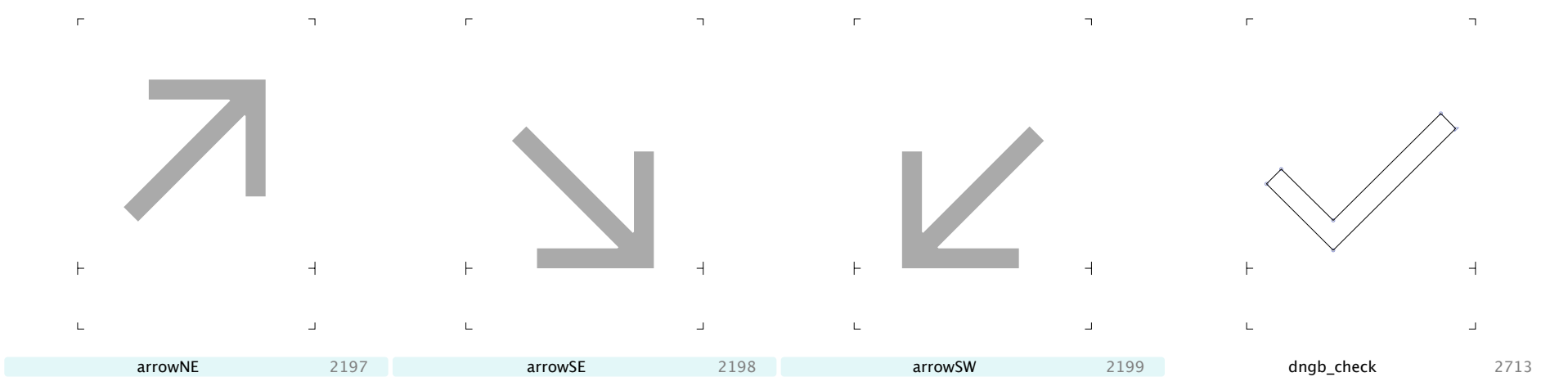
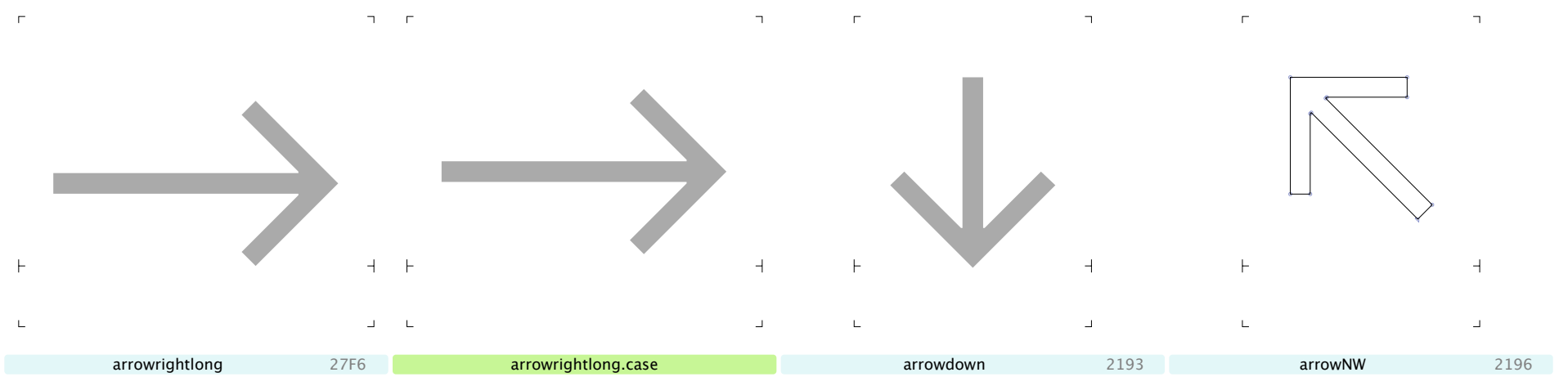
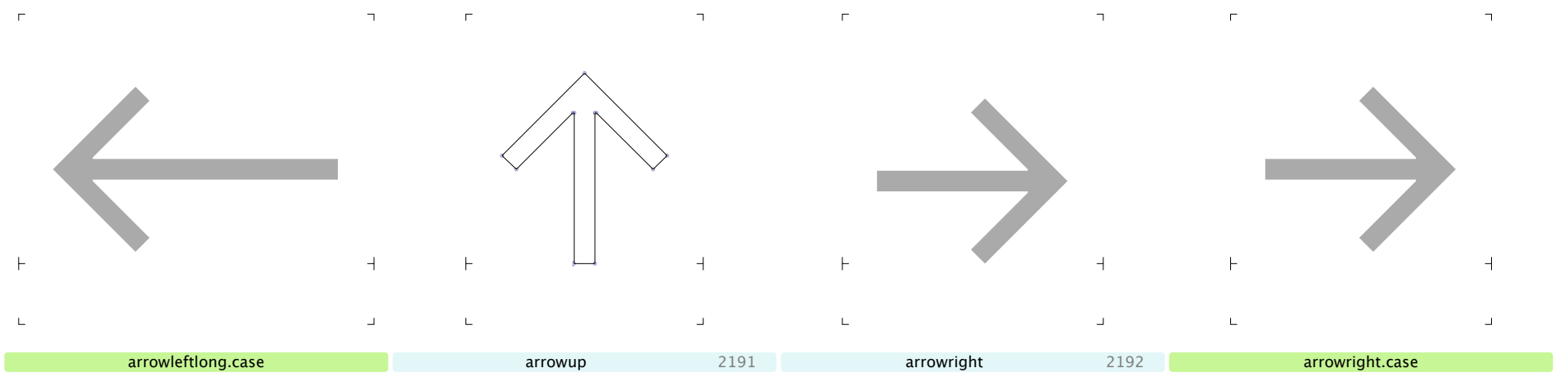
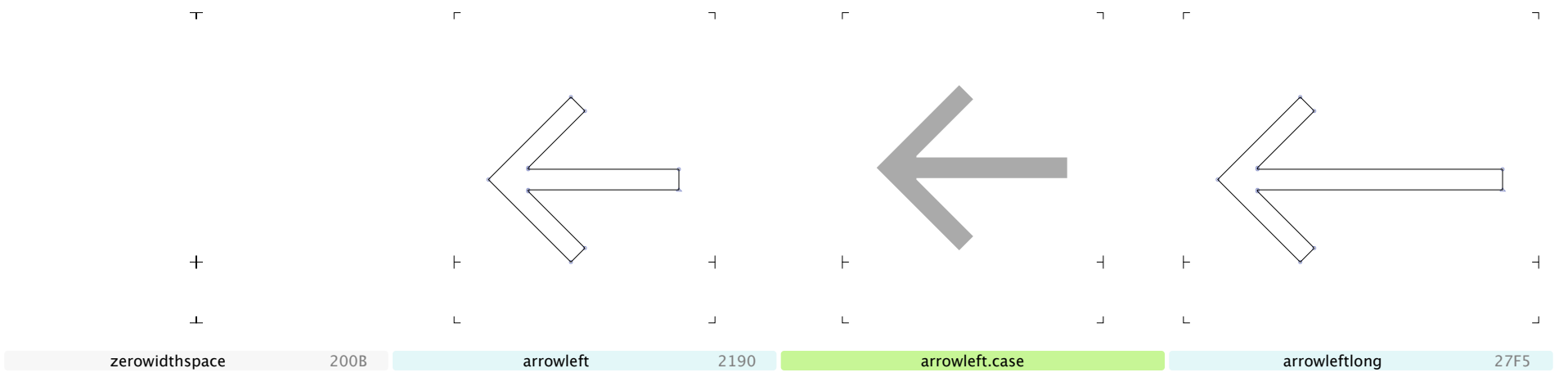

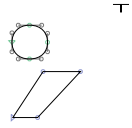

T

+

⊥

acutedotcomb.lc

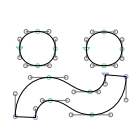

T

+

⊥

tildedieresiscomb.lc

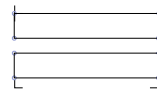

underscoredbl

2017

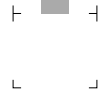
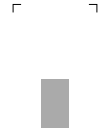

romanone

2160

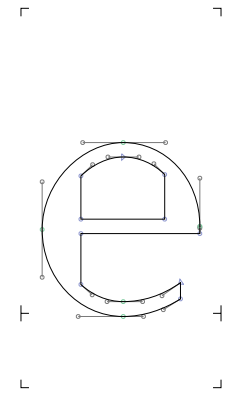

estimated

212E



degreecentigrade

2103



dieresisacutecomb.lc



carondotcomb.lc



uni1FFD

1FFD



uni1FFE

1FFE

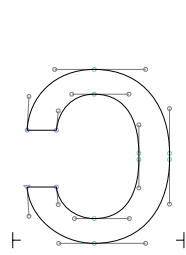

oopen

0254

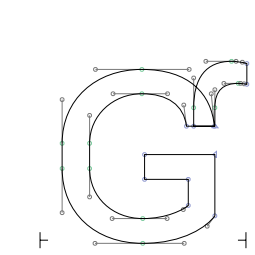

Gsmallcaphook

029B

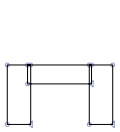

uni0346

0346

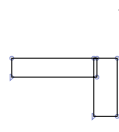

anglesupnosp

031A

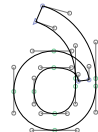

uni1DD8

1DD8



uni1DD9

1DD9

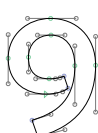

uni1DD2

1DD2

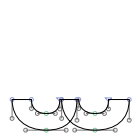

uni1DD3

1DD3



uni1DD0

1DD0



uni1DD1

1DD1

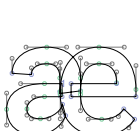

uni1DD4

1DD4

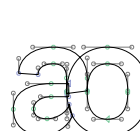

uni1DD5

1DD5



breveinvsubnosp

032F

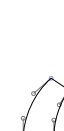

commaturnsupnosp

0312

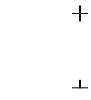
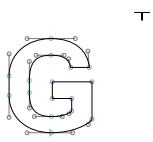

uni1DDB 1DDB

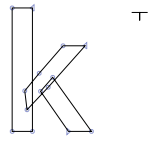

uni1DDC 1DDC



ringrighthalfsubnosp 0339

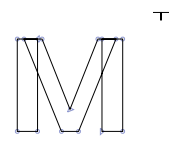

uni1DDF 1DDF

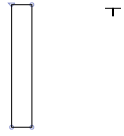

uni1DDD 1DDD

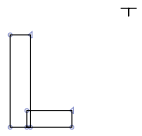

uni1DDE 1DDE



romanten 2169



degreefarenheit 2109

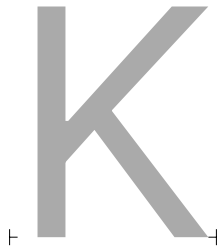

degreekelvin 212A

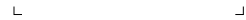
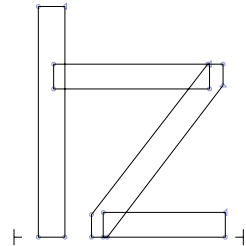

uni02AB 02AB

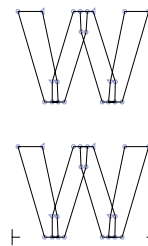

uni02AC 02AC

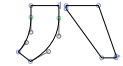

uni1FCD 1FCD

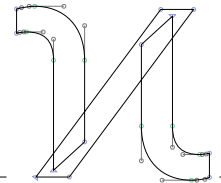

kappa1 03F0

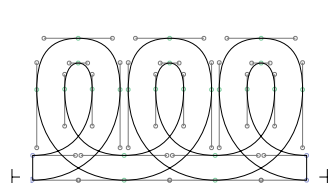

uni214F 214F

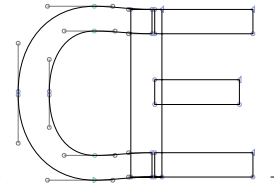

OEsmallcap 0276



tackupsubnosp 031D

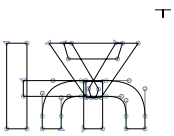

uni2DFF 2DFF

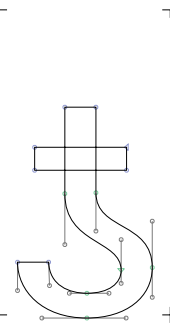

glottalstopbarinv 01BE

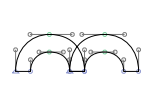

seagullsubnosp 033C

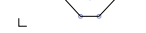
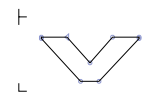

uni02EC 02EC

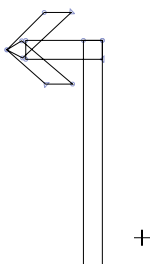

afii300 200F

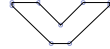

caronnosp



romanfour 2163

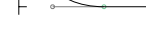
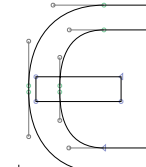

uni03F5 03F5

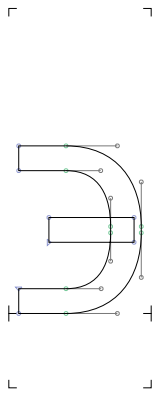

uni03F6 03F6

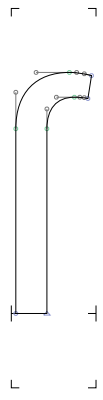

longs 017F

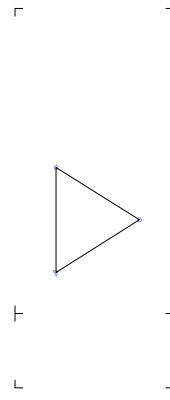

trianglebullet 2023

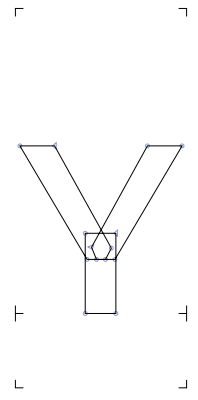

Ysmallcap 028F

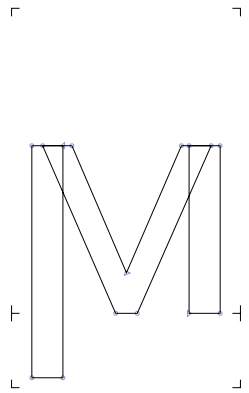

uni03FB 03FB

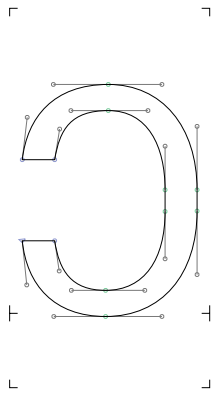

uni03FD 03FD

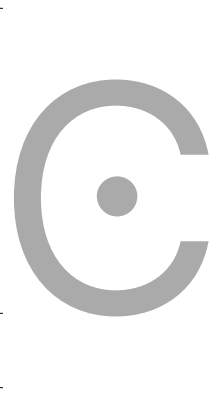

uni03FE 03FE

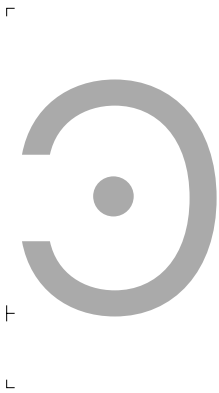

uni03FF 03FF

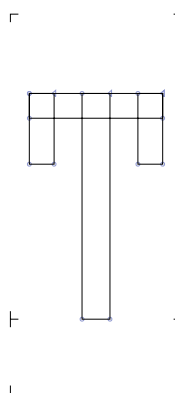

uni0373 0373

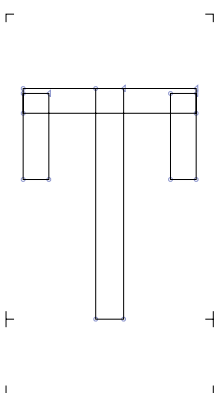

uni0372 0372

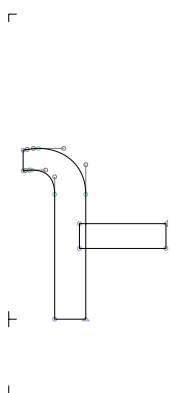

uni0371 0371

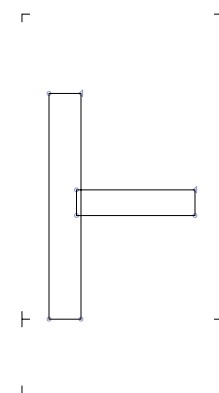

uni0370 0370

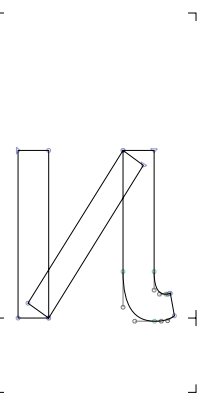

uni0377 0377

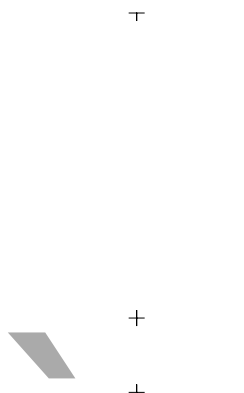

gravesubnosp 0316

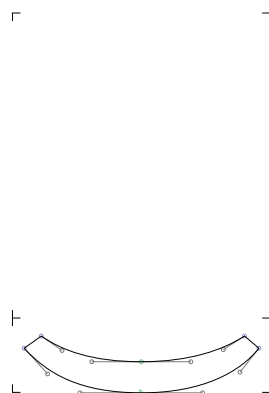

undertie 203F

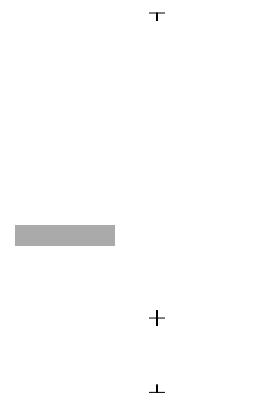

barmidshortnosp 0335

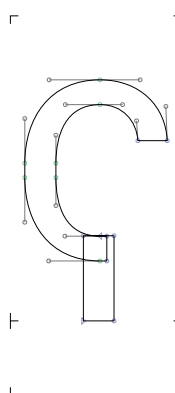

glottalstopvinv 0295

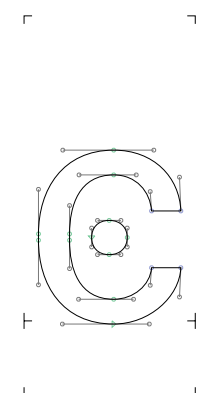

uni037C 037C

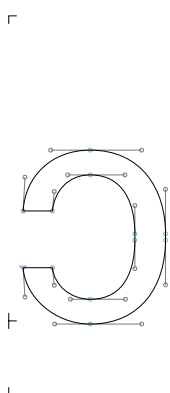

uni037B 037B

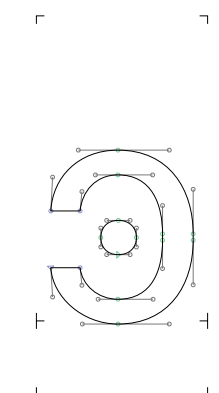

uni037D 037D



primemod 0289

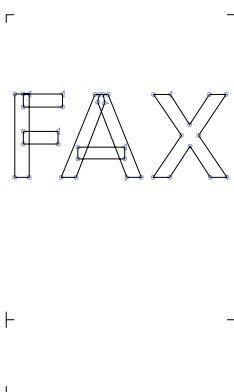

uni213B 213B

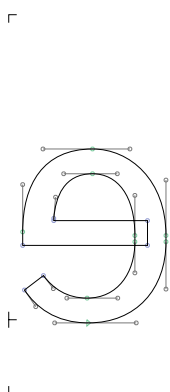

erev 0258

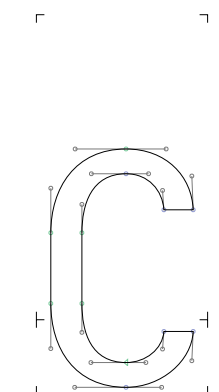

cstretch 0297



Btopbar

0182

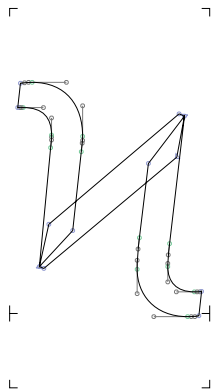

Koppa

03DE

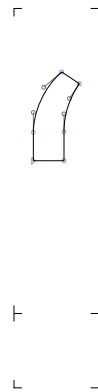

commaturnedmod

02BB



commareversedmod

02BD



ringhalfleft

02BF

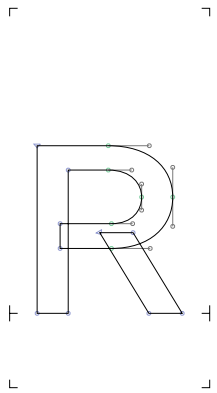

Rsmallcap

0280

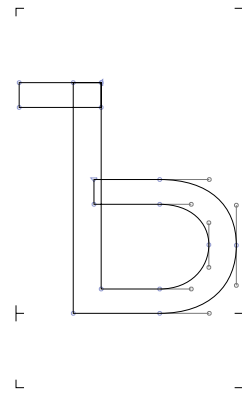

Tonesix

0184

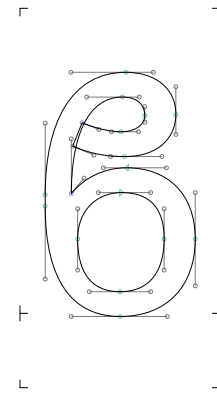

beta1

03D0



uni204F

204F

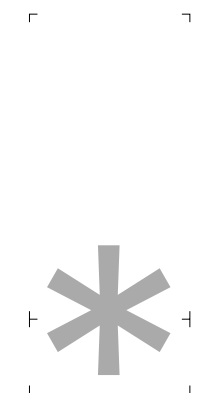

uni204E

204E

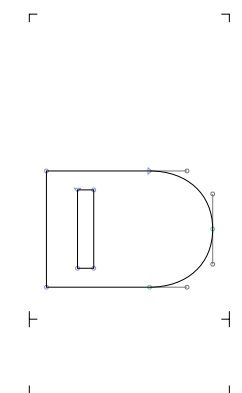

uni204D

204D

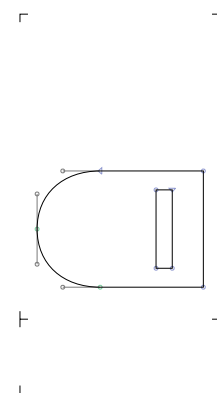

uni204C

204C

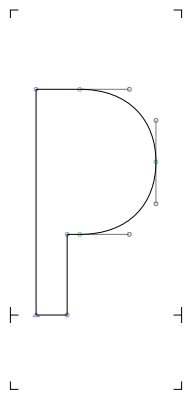

uni204B

204B

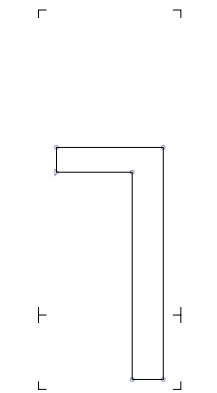

uni204A

204A



CR

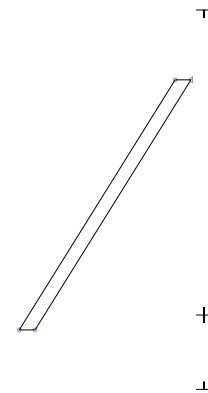

slashlongnosp

0338



exclam1

01C3

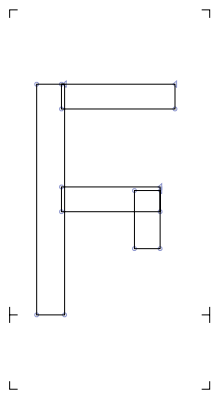

Digamma

03DC

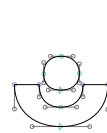

candrabindunosp

0310

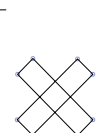

qofdagesh

02DF

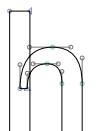

uni036A

036A

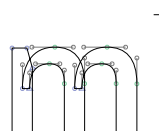

uni036B

036B

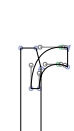

uni036C

036C

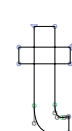

uni036D

036D

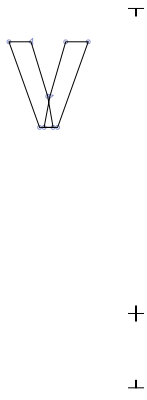

uni036E 036E

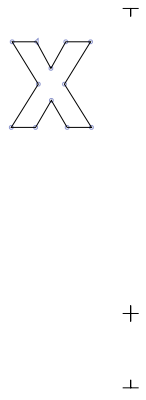

uni036F 036F

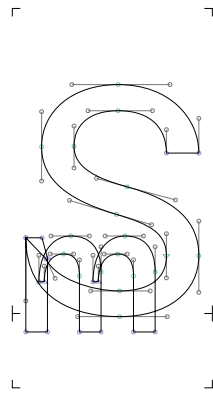

uni20B7 20B7

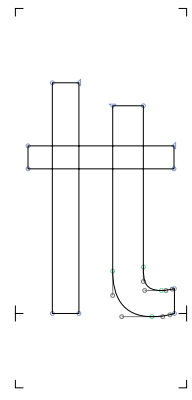

uni20B6 20B6

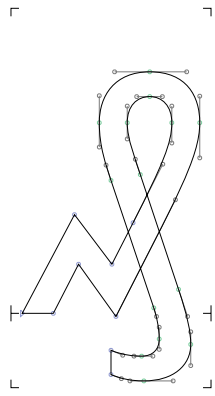

uni20B0 20B0

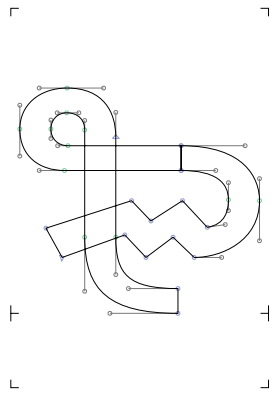

uni20BB 20BB

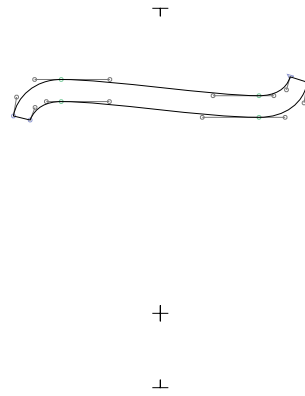

tildedoublecmb 0360

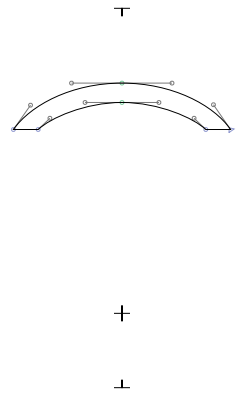

breveinverteddoublecmb 0361

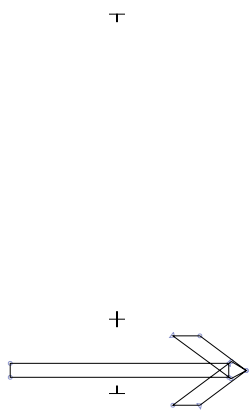

uni0362 0362

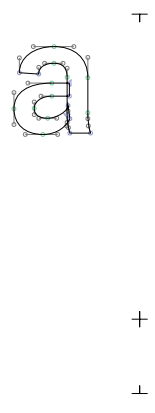

uni0363 0363

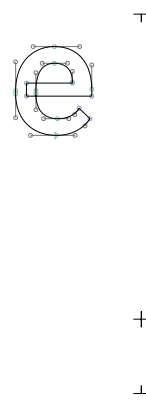

uni0364 0364



uni0365 0365

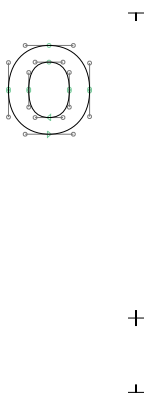

uni0366 0366

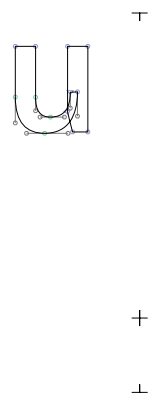

uni0367 0367

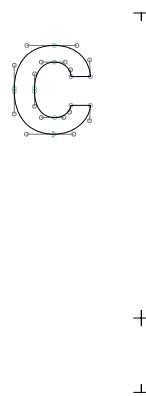

uni0368 0368

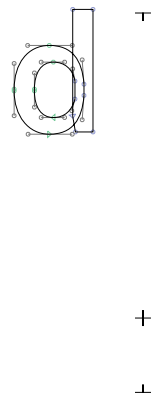

uni0369 0369



tildemidnosp 0334

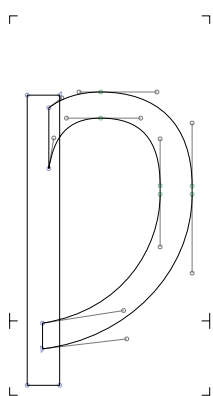

uni01F7 01F7

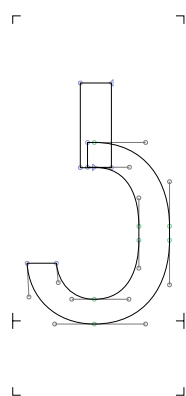

glottalstopinv 0296



acutelowmod 02CF



gravelowmod 02CE

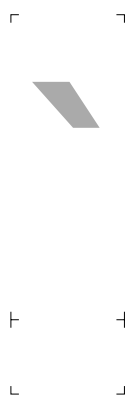

fourthtonechinese 02CB



verticallinelowmod 02CC



secondtonechinese 02CA

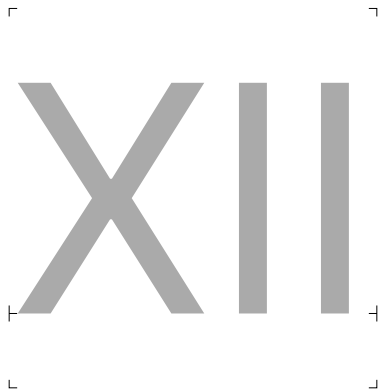

romantwelve 216B

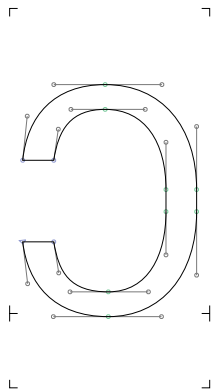

uni2183

2183

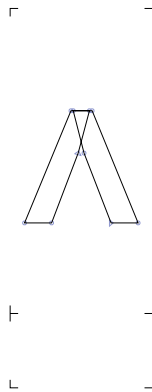

arrowheadupmod 02C4

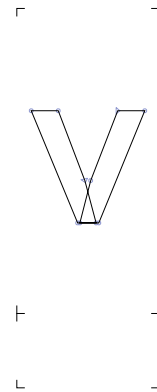

arrowheaddownmod 02C5

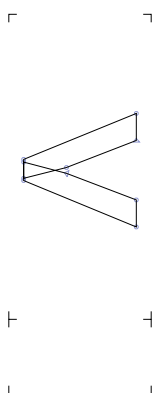

arrowheadleftmod 02C2

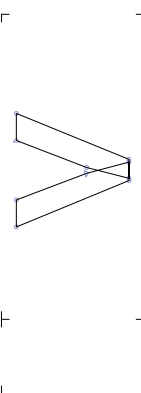

arrowheadrightmod 02C3

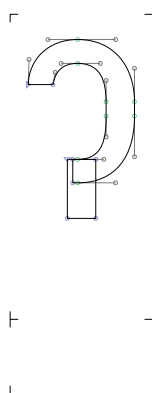

glottalstopmod 02C0



firststonechinese 02C9

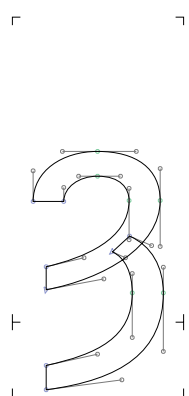

uni021D

021D



uni0268.ccmp

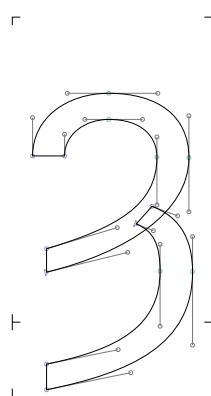

uni021C

021C



numeralgreeksub 0375



caronsubnosp



uni205E 205E



uni205A 205A

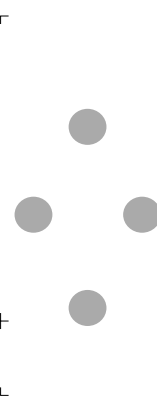

uni205B 205B

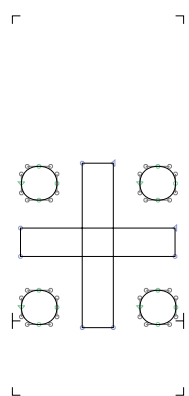

uni205C 205C

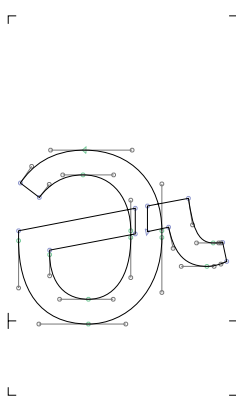

schwahook 025A

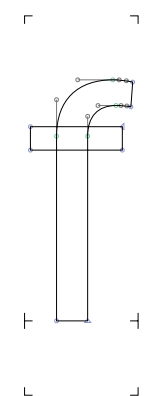

uni1E9D 1E9D



uni1E9F 1E9F

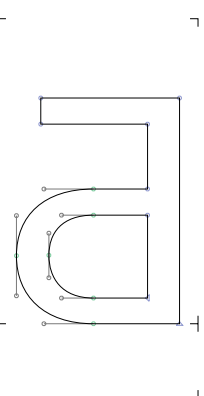

Dtopbar 018B

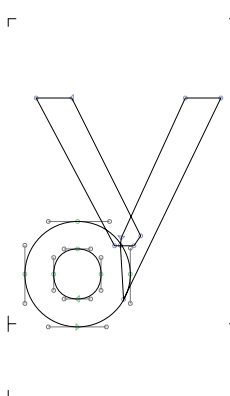

uni1EFE 1EFE

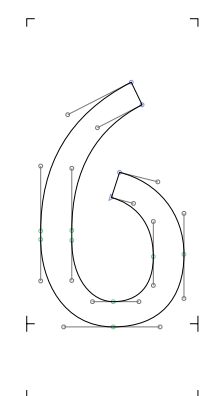

uni1EFD 1EFD

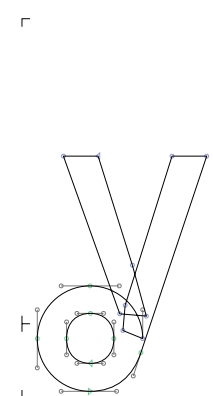

uni1EFF 1EFF



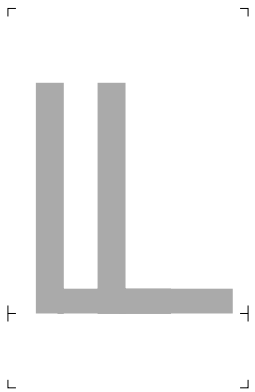

uni1EFA

1EFA

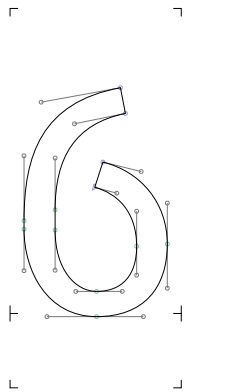

uni1EFC

1EFC

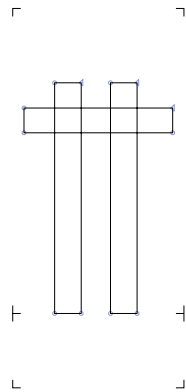

uni1EFB

1EFB

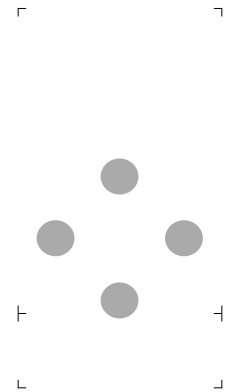

uni2058

2058

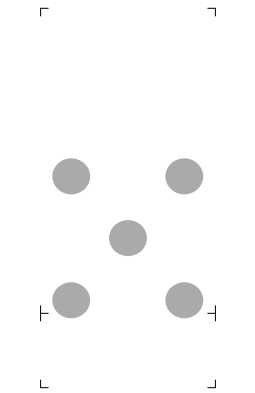

uni2059

2059

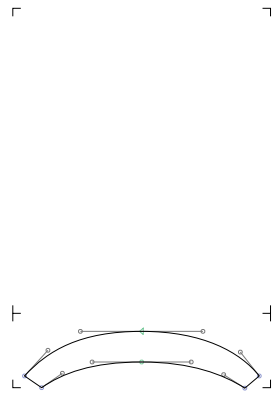

uni2054

2054

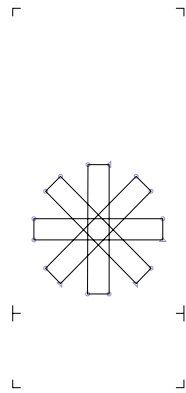

uni2055

2055

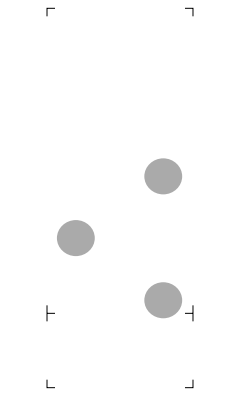

uni2056

2056

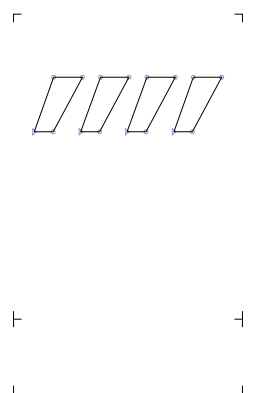

uni2057

2057

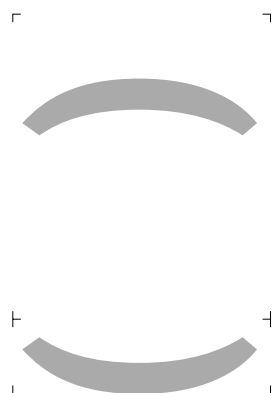

uni2050

2050

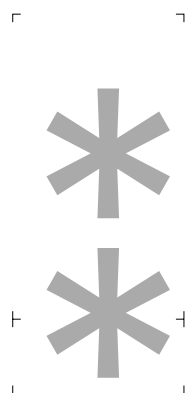

uni2051

2051

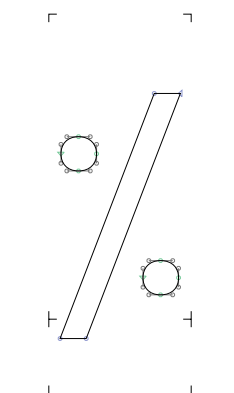

uni2052

2052

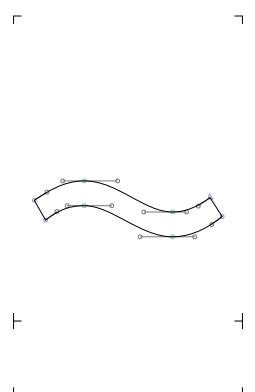

uni2053

2053

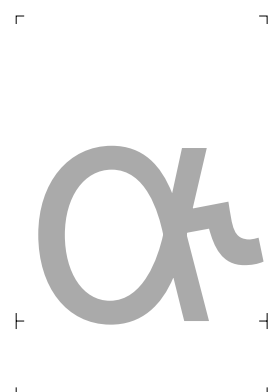

ascript\_ uni02DE

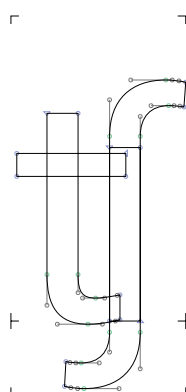

tesh

02A7

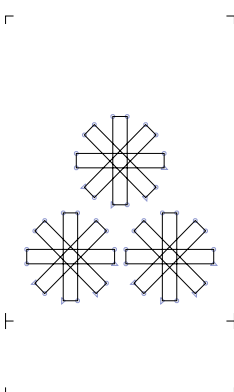

asterism

2042

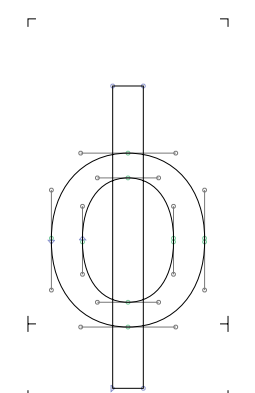

philatin

0278



sixroman

2175



cyrillichookleft

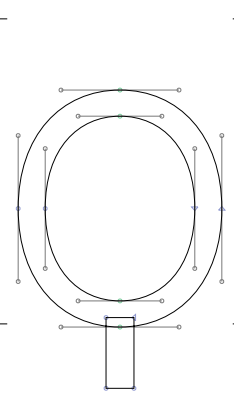

uni03D8

03D8

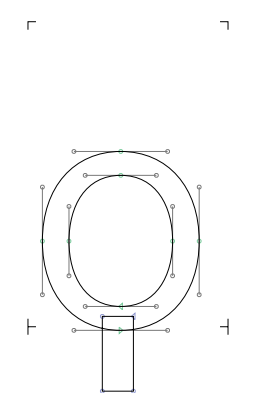

uni03D9

03D9

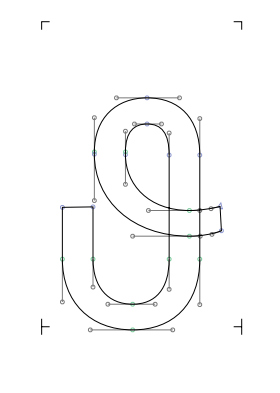

thetasymbolgreek

03D1

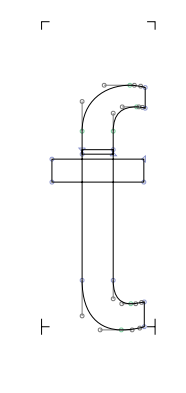

thook

01AD

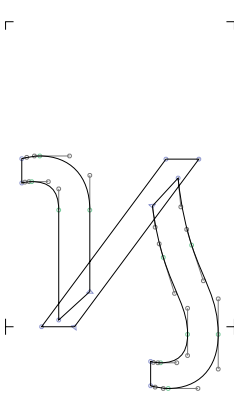

uni03D7

03D7

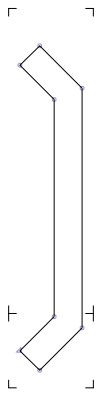

uni27EF 27EF

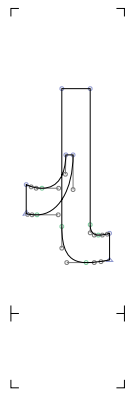

finaliatsadi 02B5

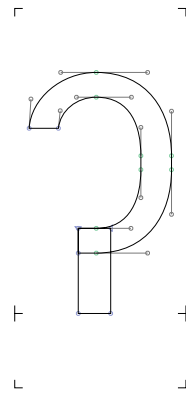

glottalstop 0294



uni0359 0359



uni0358 0358



uni0355 0355



uni0354 0354



uni0357 0357



uni0356 0356



uni0351 0351



uni0350 0350



uni0353 0353



uni0352 0352

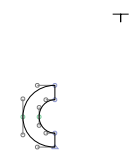

glottalstopreversedmod 02C1

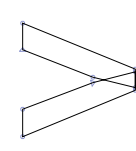

uni035E 035E



uni0220 0220



uni0356 0356



uni0351 0351



uni0350 0350

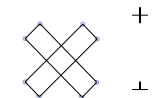

uni0353 0353

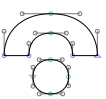

uni0352 0352

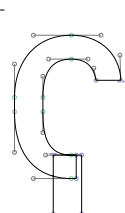

glottalstopreversedmod 02C1



uni035E 035E

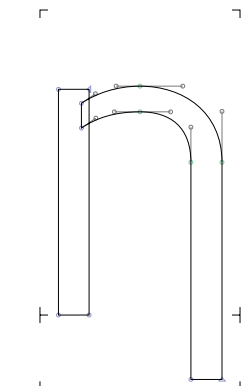

uni0220 0220

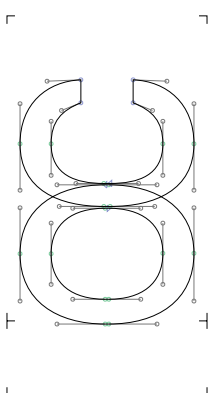

uni0223 0223



uni035F 035F



uni035C 035C

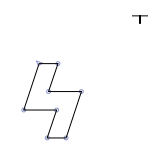

uni035B 035B

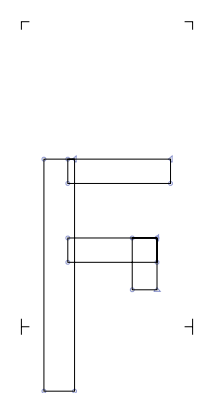

digamma 03DD

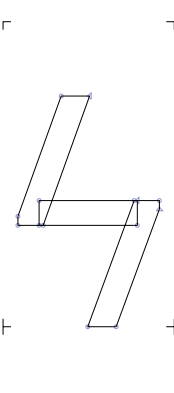

koppa 03DF



ringhalfrightcentered 02D2



colontriangularhalfmod 02D1



colontriangularmod

02D0



minusmod

02D7



plusmod

02D6



downtackmod

02D5

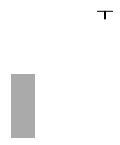

linevertnosp

030D

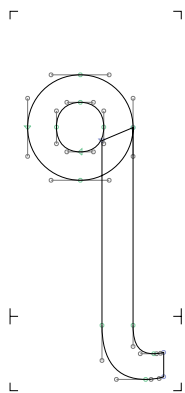

eshloopprev

01AA



verticalbardbl

2016



romaneleven

216A

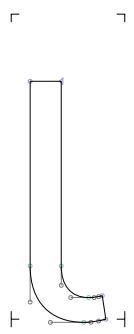

lota1

0196

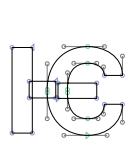

uniA69F

A69F

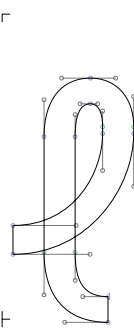

lsquare

2113

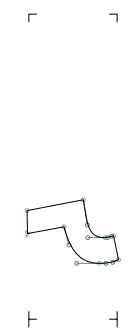

rhotichookmod

02DE

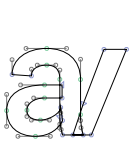

uni1DD6

1DD6

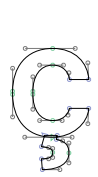

uni1DD7

1DD7



linevertsubnosp

0329

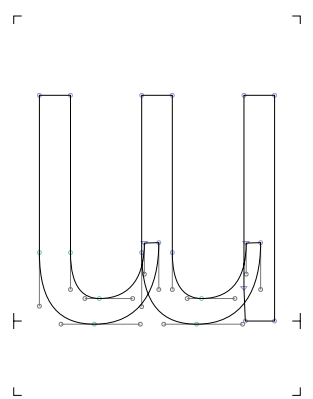

mcapturen

019C



uni205D

205D

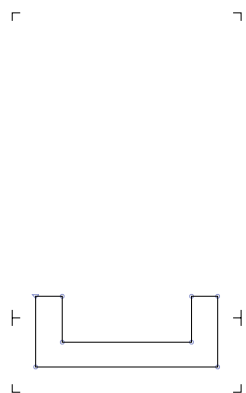

spaceopenbox

2423

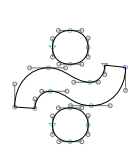

uni034B

034B

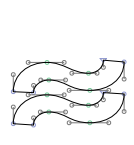

uni034C

034C

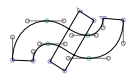

uni034A

034A

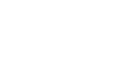

uni034F

034F

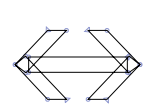

uni034D

034D

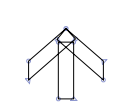

uni034E

034E



uni0348 0348



uni0349 0349

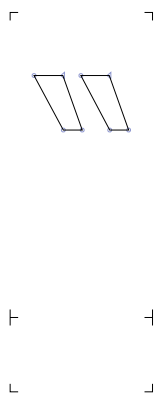

reverseddblprime 2036



perispomenigreekcmb 0342



koroniscmb 0343



uni0347 0347

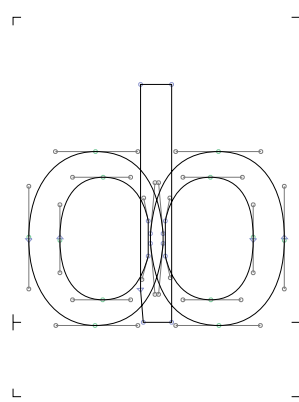

uni0238 0238

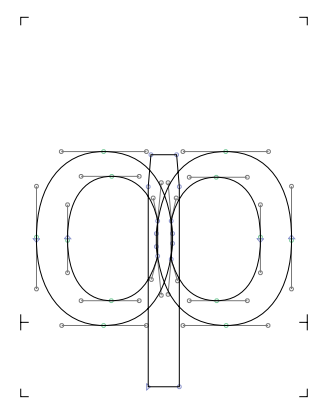

uni0239 0239



tackdownsubnosp 031E

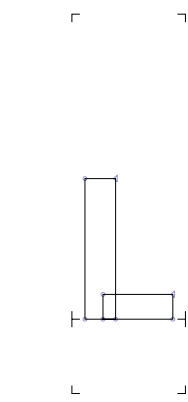

uni02EA 02EA

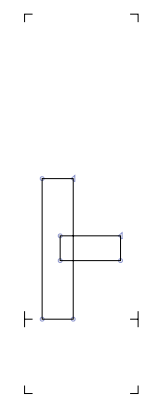

uni02EB 02EB



uni2071.ccmp

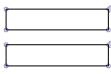

uni02ED 02ED

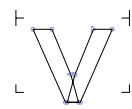

uni02EF 02EF

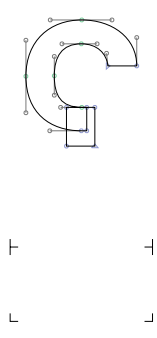

glottalstopreversed.numr 02E4



afi61664 200C

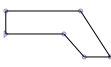

uni1DC6 1DC6

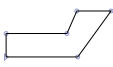

uni1DC4 1DC4

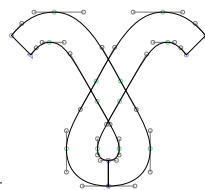

babygamma 0264

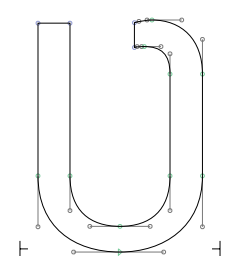

Vcursive 01B2

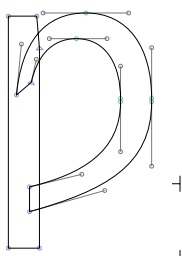

wynn 01BF

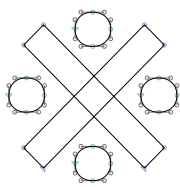

referencemark 203B



overscorenosp 0305

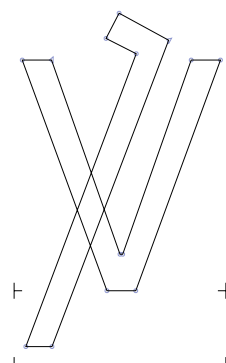

versicle 2123



hyphen\_ 2010



diaeresistonosp 0344

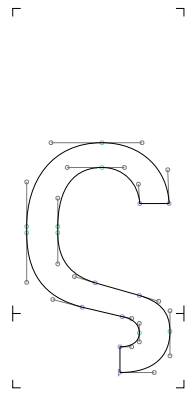

stigma 03DB

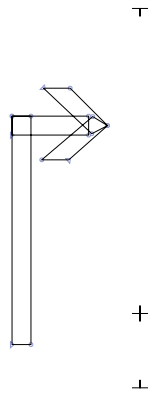

afi57596 200E

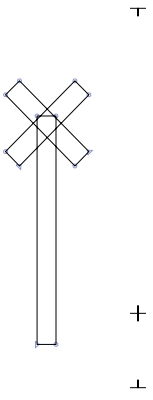

afi57598 200D

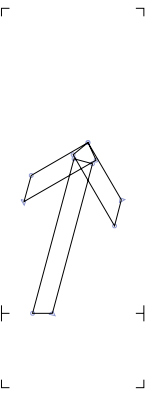

uni2B4E 2B4E

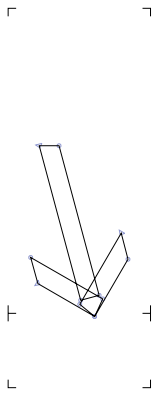

uni2B4F 2B4F

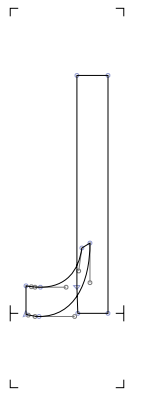

rturnascend 027A

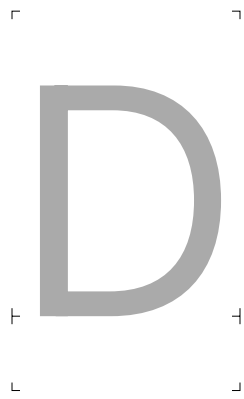

romanfivehundred 216E



caret 2038

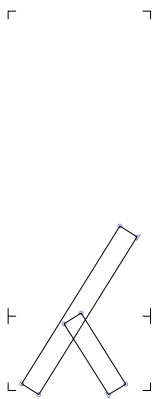

caretinsertionpoint 2041



bridgesubno 032A

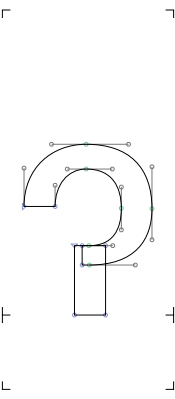

uni0242 0242

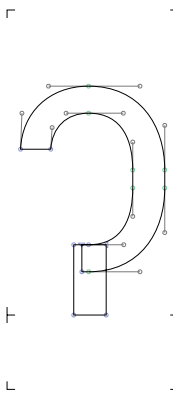

uni0241 0241

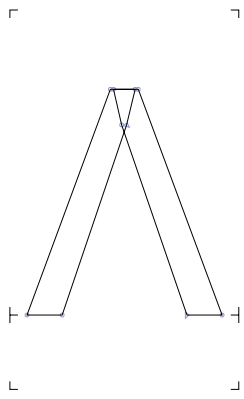

uni0245 0245



uni02F9 02F9



uni02F8 02F8



uni02F5 02F5



uni02F4 02F4



uni02F7 02F7



uni02F6 02F6



uni02F1 02F1



uni02F0 02F0



uni02F3 02F3

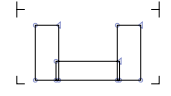
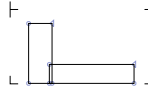
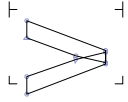
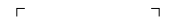
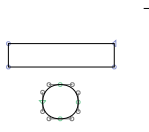

uni02F2

02F2

dotmacroncomb.lc

uni02FE

02FE

uni02FD

02FD

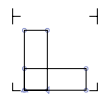
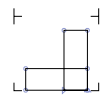
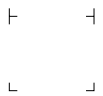
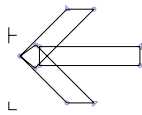

uni02FF

02FF

uni02FA

02FA

uni02FC

02FC

uni02FB

02FB

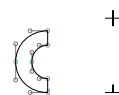
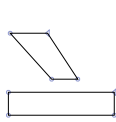
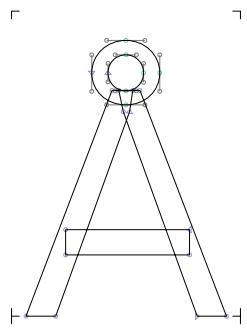

angstrom

212B

macrongravcomb.lc

macronsubnosp

0331

ringleftsubnosp

031C

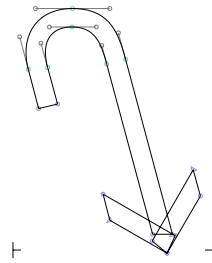
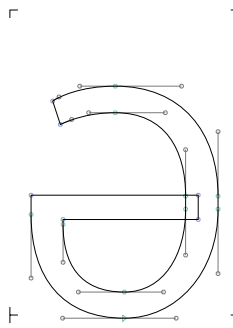
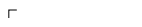

Lsmallcap

029F

squaresubnosp

033B

Schwa

018F

uni2B5B

2B5B

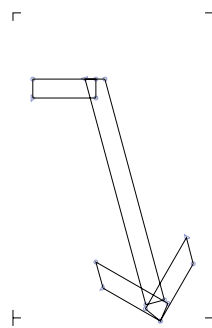
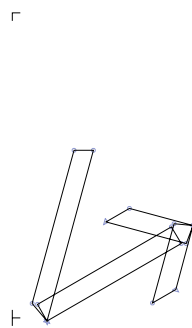
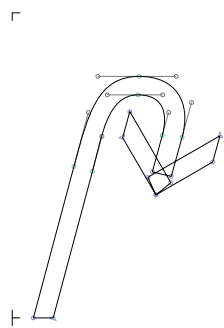
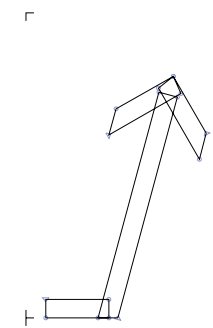

uni2B5C

2B5C

uni2B5A

2B5A

uni2B5F

2B5F

uni2B5D

2B5D

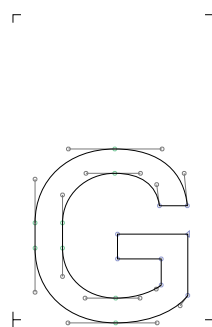
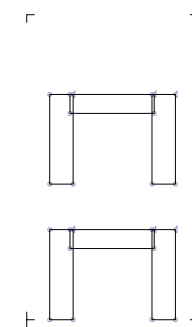
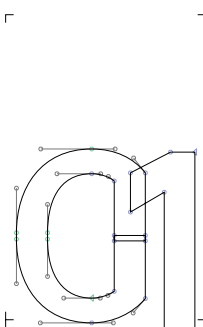
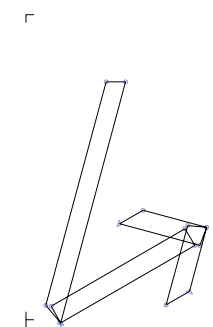

uni2B5E

2B5E

oi

01A3

finalmem

02AD

Gsmallcap

0262

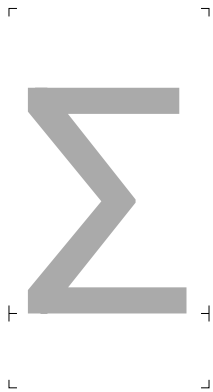

Esh

01A9

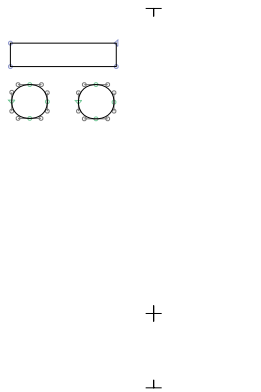

dieresis macron comb.lc

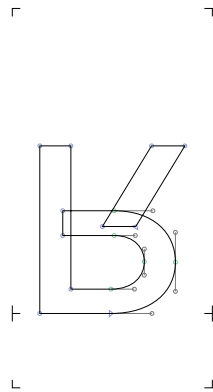

Rsmallcapinv

0281

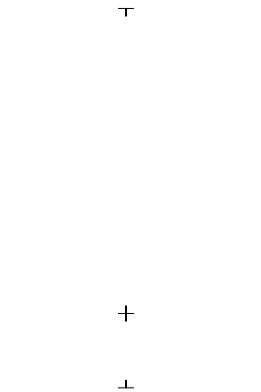

zerowidthjoiner

FEFF

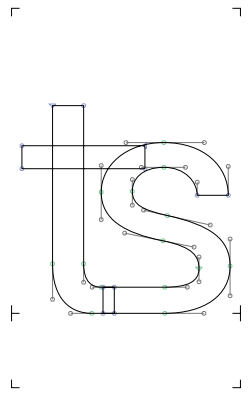

ts

02A6

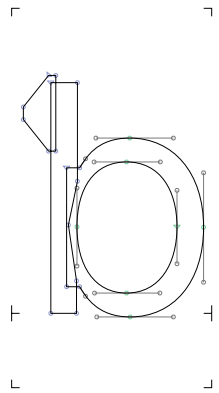

tonesix

0185

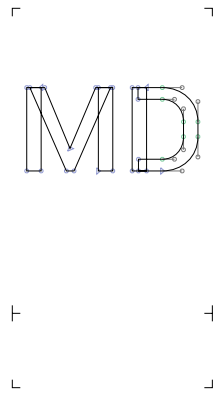

uni1F16B

1F16B

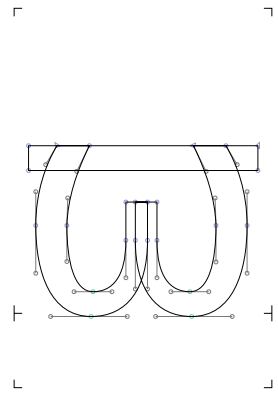

pisymbolgreek

03D6

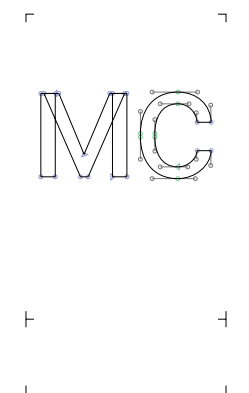

uni1F16A

1F16A

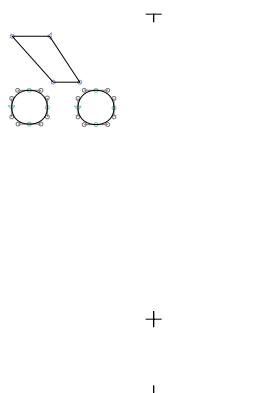

dieresis grave comb.lc

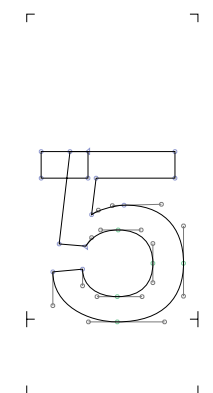

tonefive

01BD

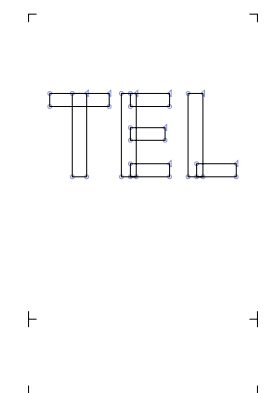

tel

2121

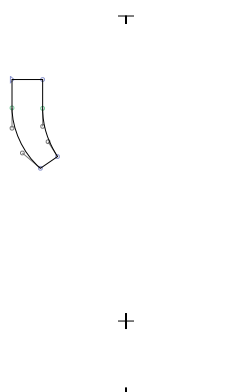

commasuprevnosp

0314



hyphennobreak

2011

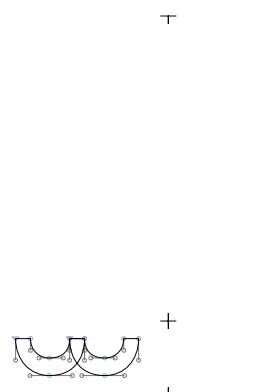

archdblsubnosp

032B

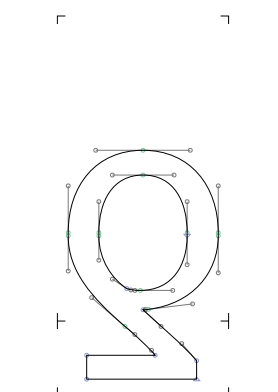

deltaturn

018D

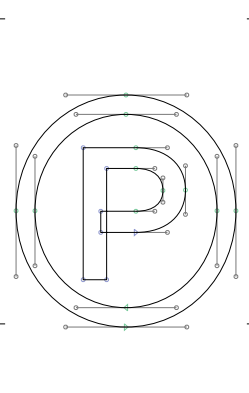

published

2117

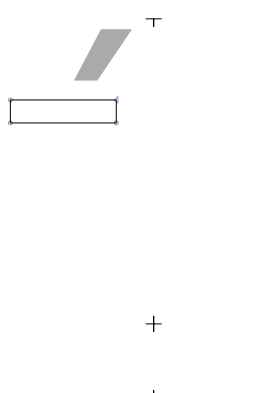

macronacute comb.lc

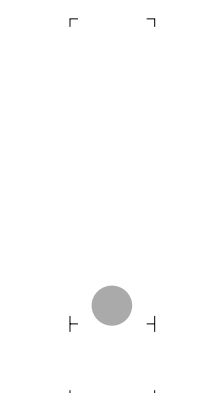

onedotleader

2024

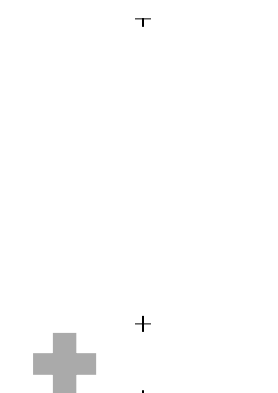

plus.dnomnosp

031F

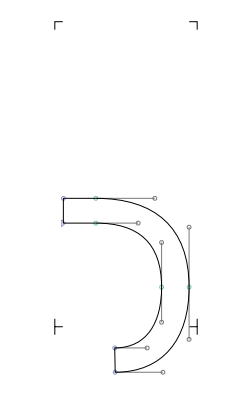

largerighthook

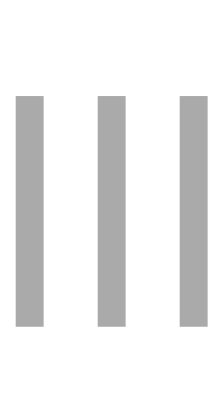

romanthree

2162



uni1DCF

1DCF

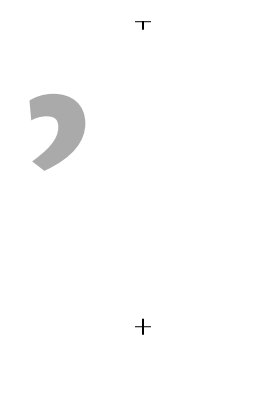

uni1DCE

1DCE

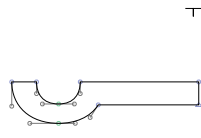
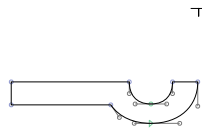
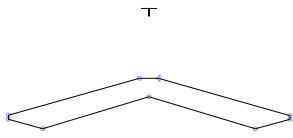

uni1DCD

1DCD

uni1DCC

1DCC

uni1DCB

1DCB

uni1DCA

1DCA

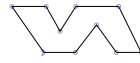
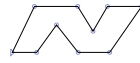
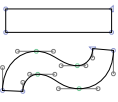

tildemacroncomb.lc

iota1

0269

uni1DC9

1DC9

uni1DC8

1DC8

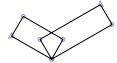
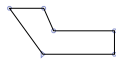
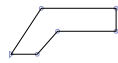

uni1DC7

1DC7

uni1DC5

1DC5

uni1DC3

1DC3

uni1DC2

1DC2

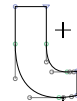
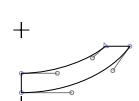
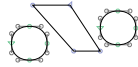
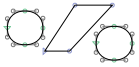

uni1DC1

1DC1

uni1DC0

1DC0

uniFE28

FE28

hooksubretronosp

0322

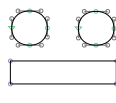

primerev1

2035

macrondiereiscomb.lc

romannine

2168

uni1FBD

1FBD

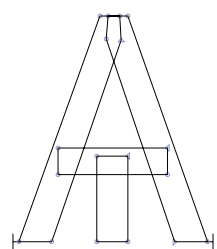
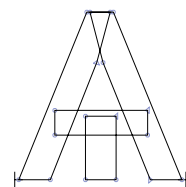
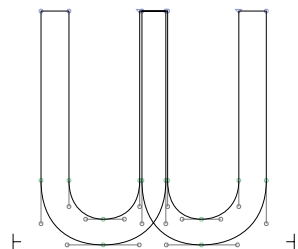
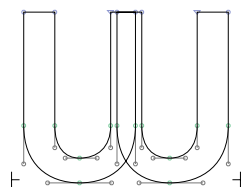

omegacyrillic

0461

Omegacyrillic

0460

yuslitlecyrillic

0467

Yuslitlecyrillic

0466



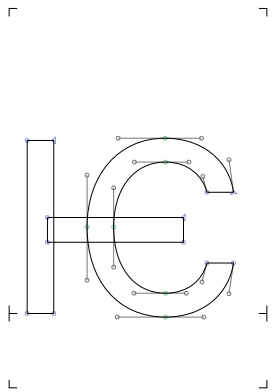

eiotifiedcyrillic 0465

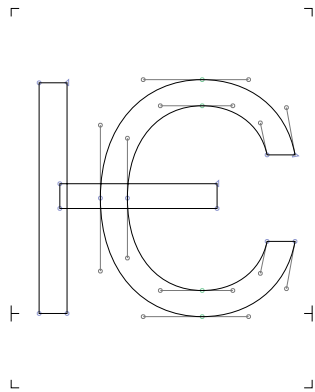

Eiotifiedcyrillic 0464

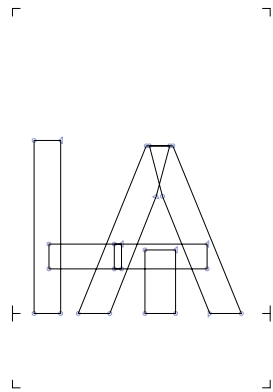

yuslitleiotifiedcyrillic 0469

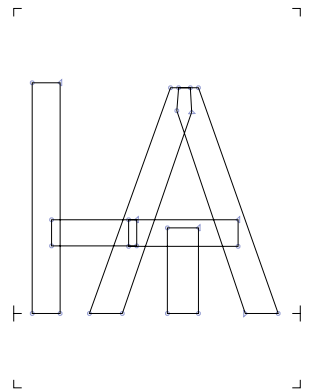

Yuslitleiotifiedcyrillic 0468

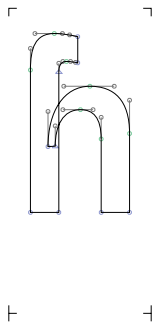

hhooksuper 02B1

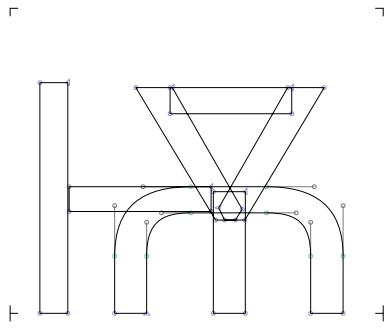

Yusbigiotifiedcyrillic 046C

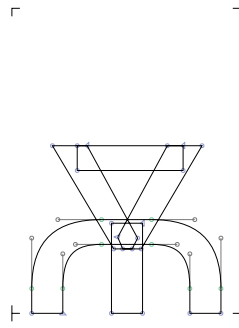

yusbigcyrillic 046B

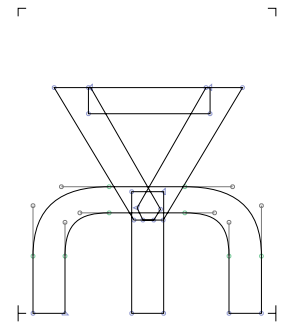

Yusbigcyrillic 046A

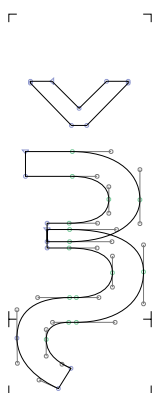

ksicyrillic 046F

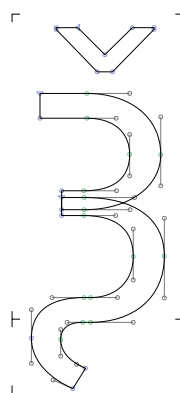

Ksicyrillic 046E

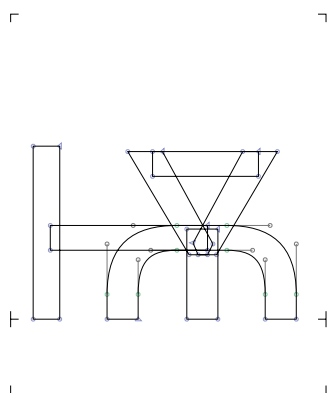

yusbigiotifiedcyrillic 046D



tildeacutecomb.lc



romanthousand 216F



macronsub 02CD

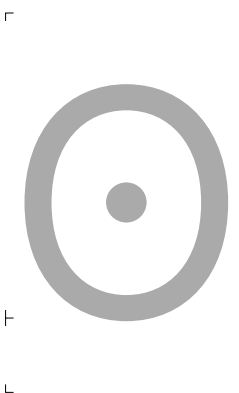

bullseye 0298

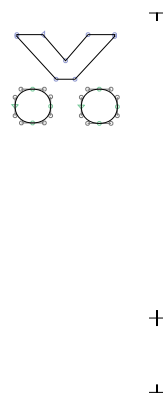

dieresiscaroncomb.lc

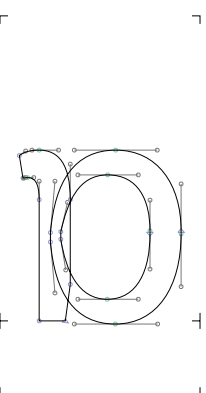

ascriptturn 0252

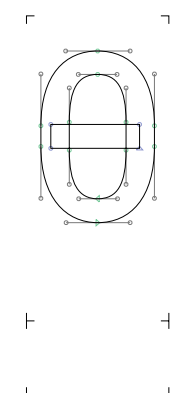

uni1DBF 1DBF

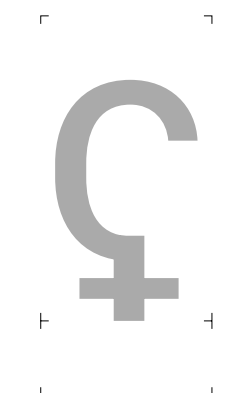

glottalstopbarrev 02A2



cyrillichook

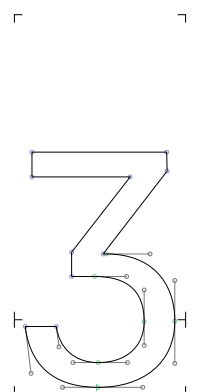

ezh 0292

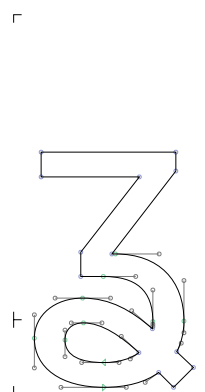

ezhcurl 0293

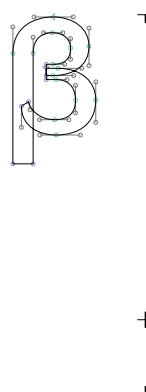

uni1DE9 1DE9



numeralgreek 0374

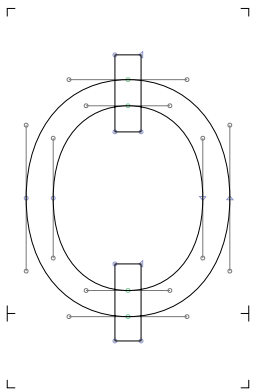

Omegaroundcyrillic 047A

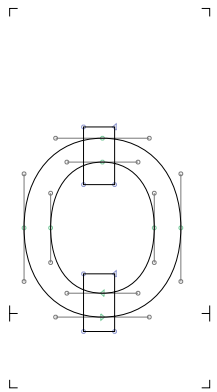

omegaroundcyrillic 047B

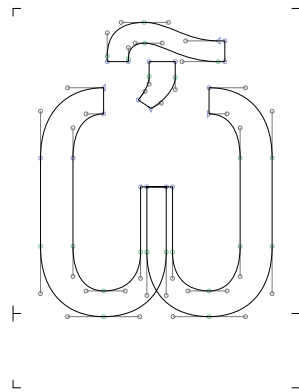

Omegatitlocyrillic 047C

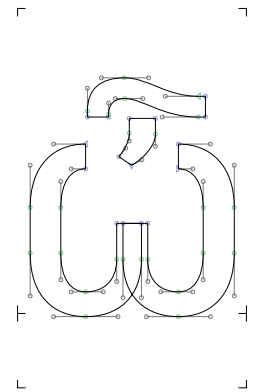

omegatitlocyrillic 047D

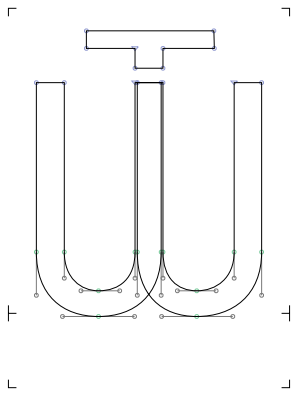

Otcyrillic 047E

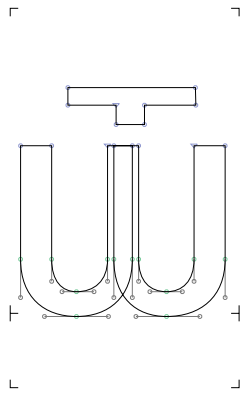

otcyrillic 047F



gcursive 0261

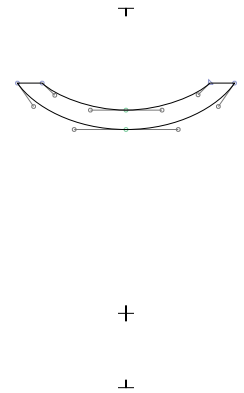

uni035D 035D



uni035A 035A



quotedblreversed 201F

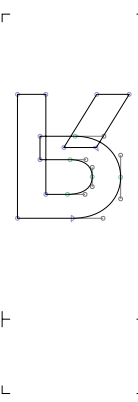

Rturnsuper 02B6



uni1FCE 1FCE



uni1FCF 1FCF

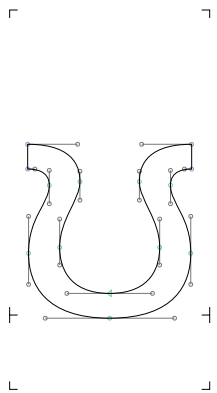

upsilonlatin 028A



uni1FC1 1FC1



uni1FC0 1FC0



ringhalfleftcentered 02D3

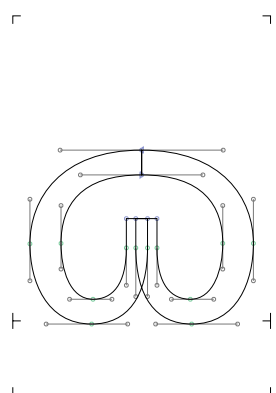

omegaclosed 0277

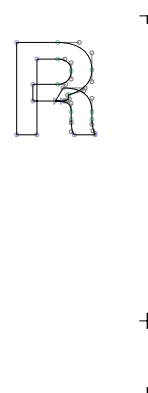

uni1DE2 1DE2

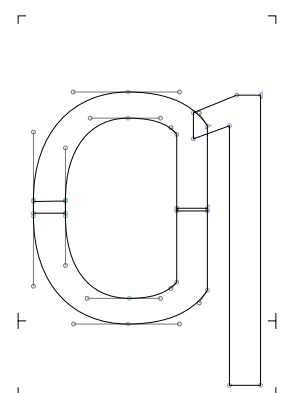

OI 01A2



xsupnosp 033D

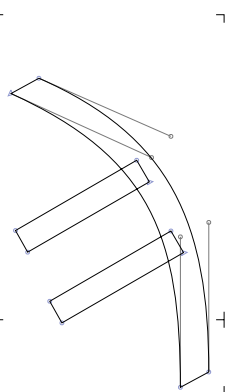

sampi 03E1

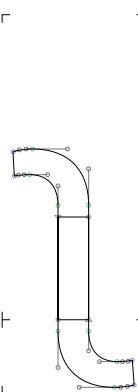

eshshortrev 0285

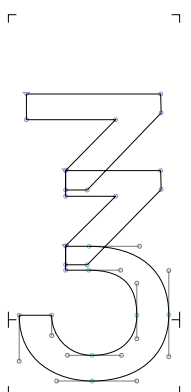

ounce 2125

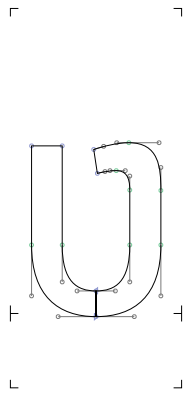

vscript

028B



acuterightnosp

0341



barmidlongnosp

0336



tildevertsupnosp

033E



linevertdblnosp

030E

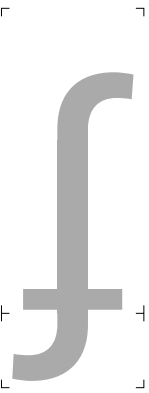

jhookdblbar

0284



overline

203E



ascript

0251

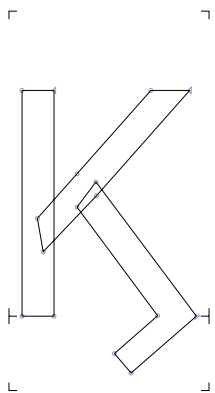

uni03CF

03CF



uni20DC

20DC



uni20DB

20DB



romansix

2165



uni1FBF

1FBF

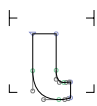

uni1FBE

1FBE



ypogegrammeni

037A



romaneight

2167

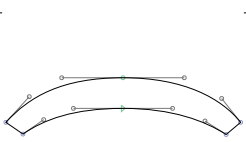

charactertie

2040

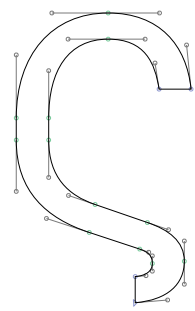

Stigma

03DA

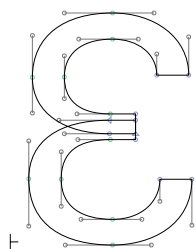

Epsilon1

0190



iotasubnosp

0345



pipedblbar

01C2

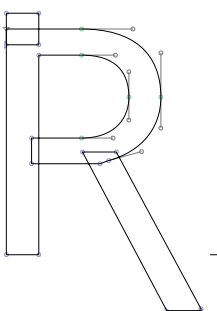

YR

01A6

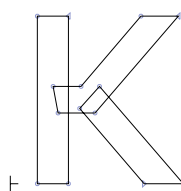

kgreenlandic

0138

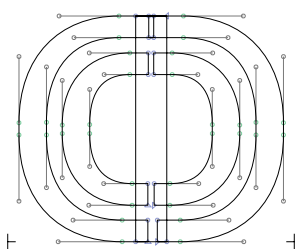

uni2182

2182

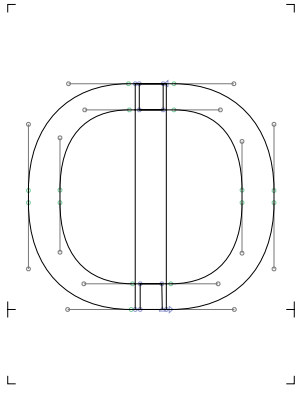

uni2180

2180

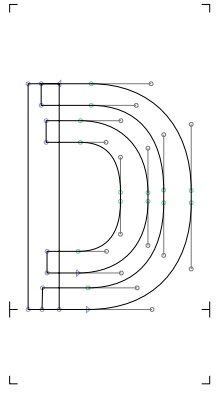

uni2181

2181

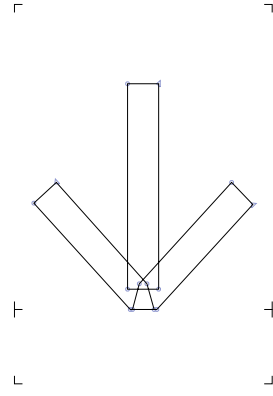

uni2186

2186

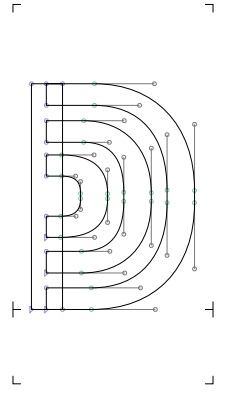

uni2187

2187

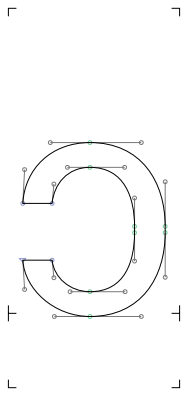

uni2184

2184

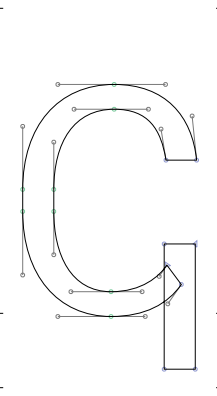

uni2185

2185

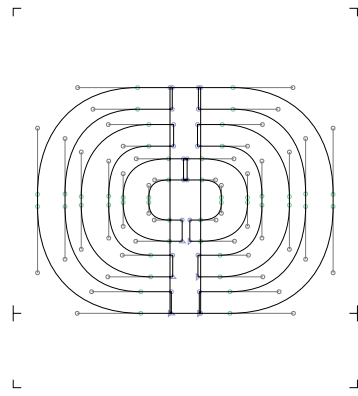

uni2188

2188

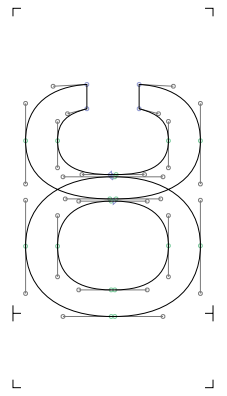

uni0222

0222



romanseven

2166

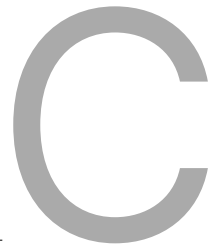

romanhundred

216D

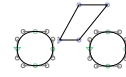

uni1FEE

1FEE

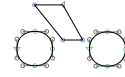

uni1FED

1FED



graveleftnosp

0340

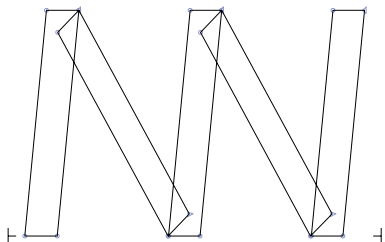

uniA7FF

A7FF



tackleftsubnosp

0318

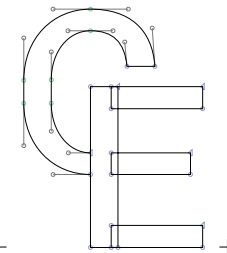

eurocurrency

20A0



uni20E8

20E8

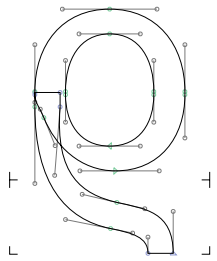

rho1

03F1

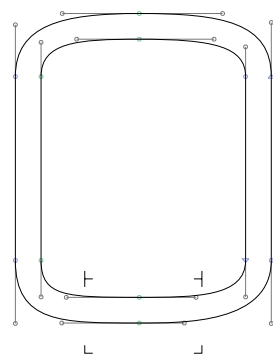

uni20E3

20E3

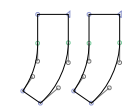

dblapostrophe

02EE

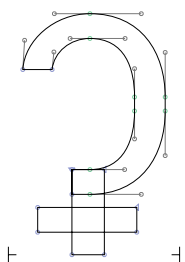

glottalstopbar

02A1



minus.dnomnosp

0320

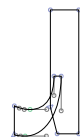

rturnsuper

02B4



linevert

02C8

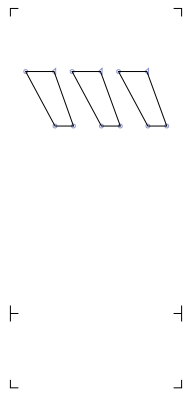

primetriplev1 2037

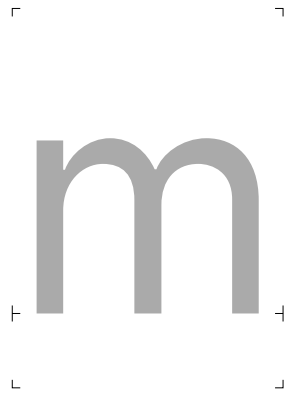

uni217F 217F



uni217E 217E

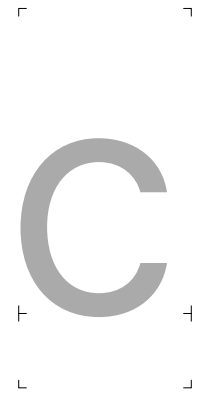

uni217D 217D

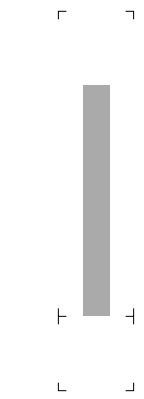

uni217C 217C



twelveroman 217B



elevenroman 217A

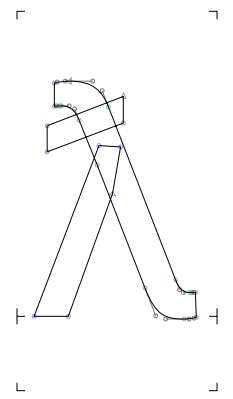

lambdabar 019B

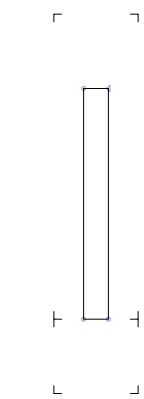

pipe 01C0



tenroman 2179



nineroman 2178



eightroman 2177



sevenroman 2176



fiveroman 2174



fourroman 2173

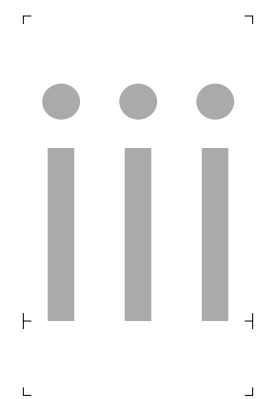

threeroman 2172



tworoman 2171



oneroman 2170

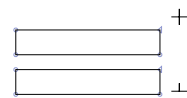

underscoredblensp 0333

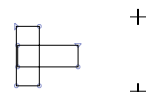

tackrightsubnosp 0319

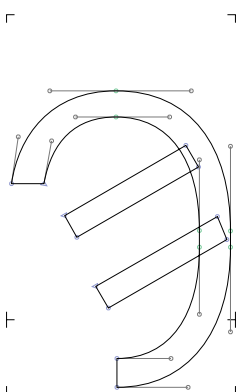

Sampi 03E0



schwa 0259

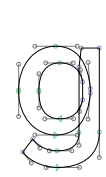

uni1DDA 1DDA

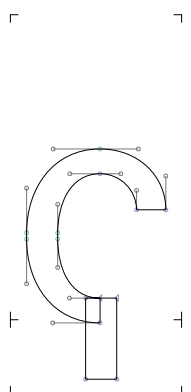

koppacyrillic 0481

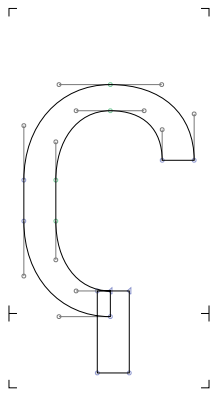

Koppacyrillic

0480

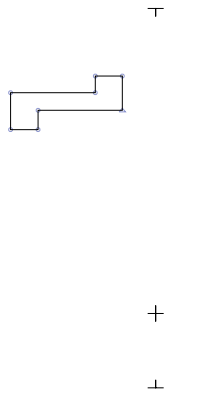

titlocyrlliccmb

0483

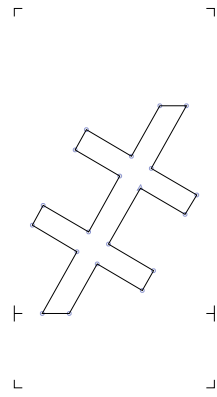

thousandcyrllic

0482

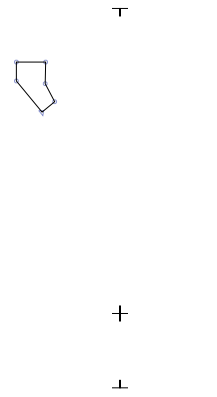

dasiapneumatocyrlliccmb

0485

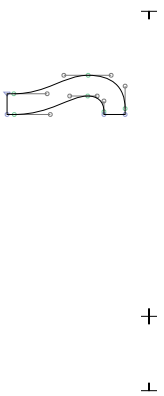

palatalizationcyrlliccmb

0484

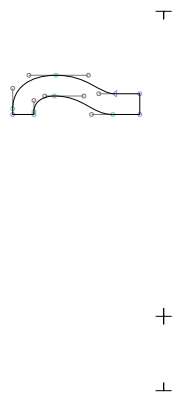

uni0487

0487

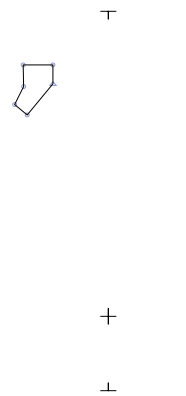

psilipneumatocyrlliccmb

0486

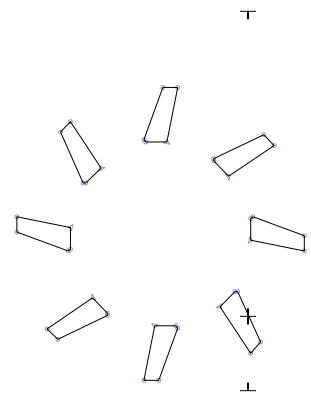

uni0489

0489

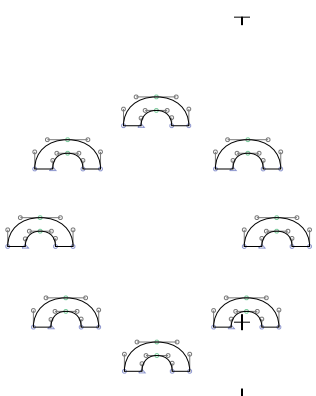

uni0488

0488

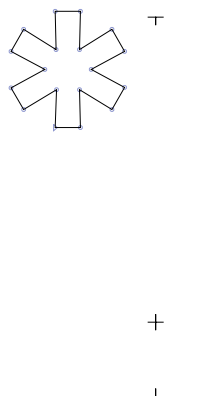

uni20F0

20F0

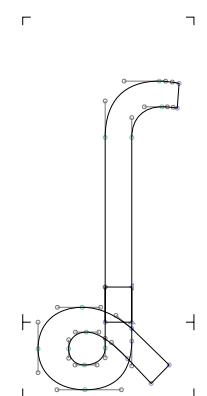

eshcurl

0286



quotereversed

201B



romanfive

2164

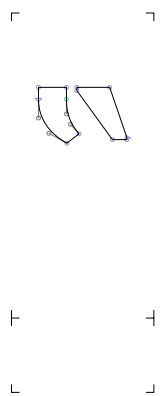

uni1FDD

1FDD

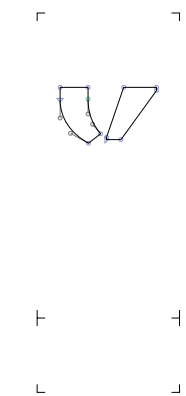

uni1FDE

1FDE



uni1FDF

1FDF

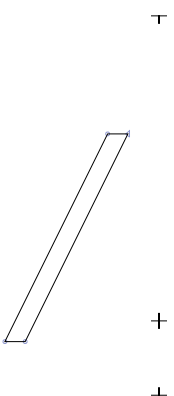

slashshortnosp

0337

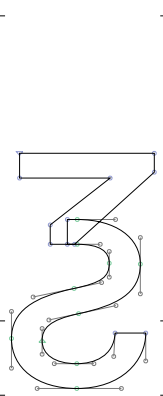

ezhtail

01BA

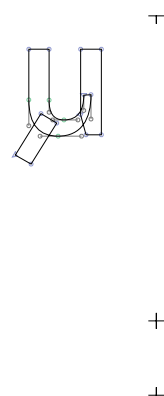

uni1DF0

1DF0

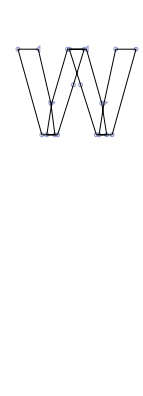

uni1DF1

1DF1



uni1DF2

1DF2

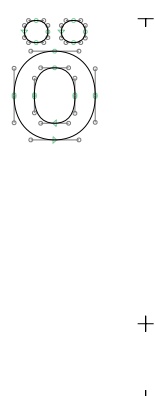

uni1DF3

1DF3

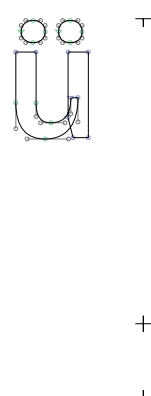

uni1DF4

1DF4

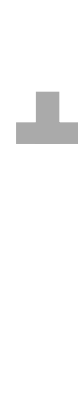

uni1DF5

1DF5



caronbelowcmb

032C



acutesubnosp

0317



romantwo

2161

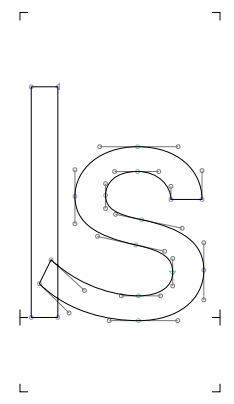

finalkaf

02AA

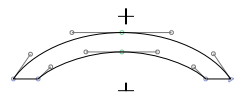

uni1DFC

1DFC

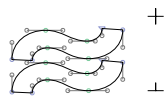

uni1DFD

1DFD



uni1DFE

1DFE

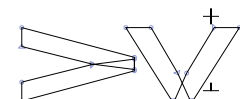

uni1DFF

1DFF



uni1FEF

1FEF



dblprimemod

02BA

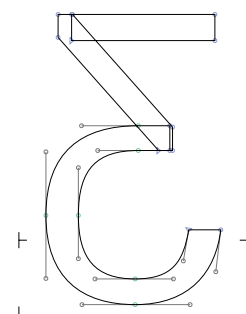

Ezhreversed

01B8

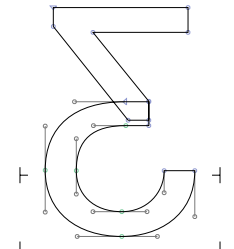

ezhreversed

01B9

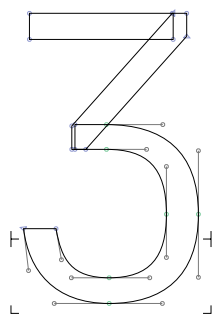

Ezh

01B7



romanfifty

216C



ringhalfright

02BE

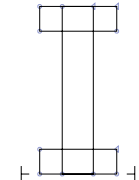

lsmallcap

026A



uptackmod

02D4



hyphendot

2027

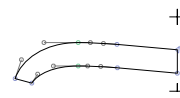

uniFE29

FE29

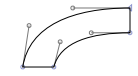

uniFE20

FE20

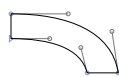

uniFE21

FE21



uniFE22

FE22



uniFE23

FE23

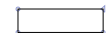

uniFE24

FE24

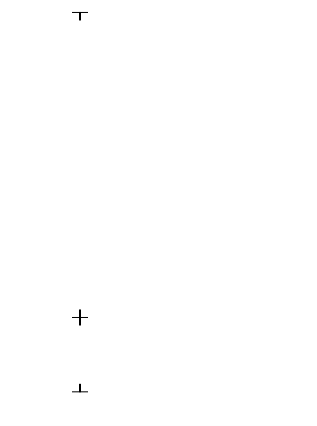
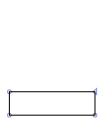

uniFE25 FE25

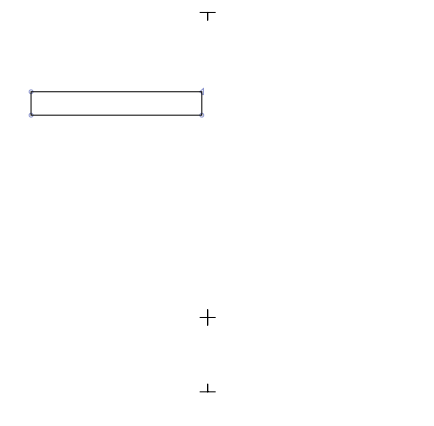

uniFE26 FE26

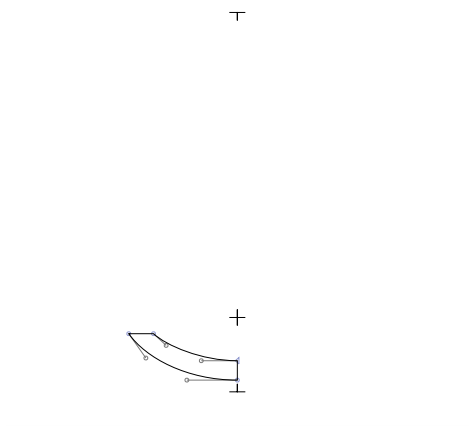

uniFE27 FE27

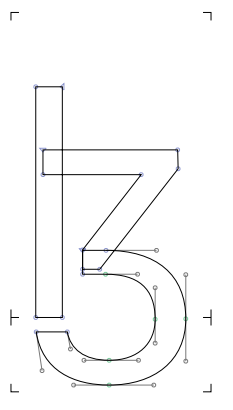

lyogh 026E

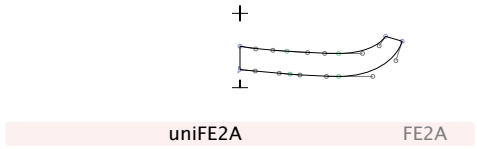

uniFE2A FE2A

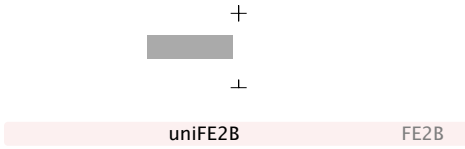
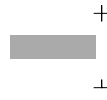

uniFE2B FE2B

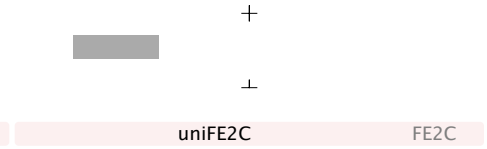

uniFE2C FE2C

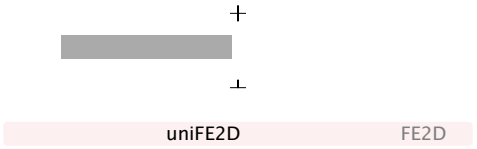

uniFE2D FE2D

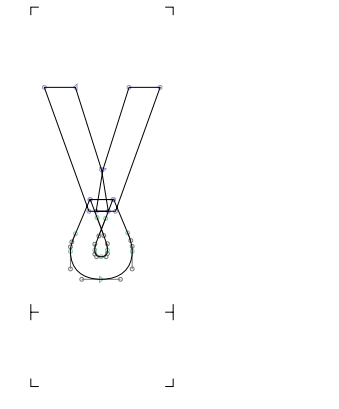

gammaster 02E0

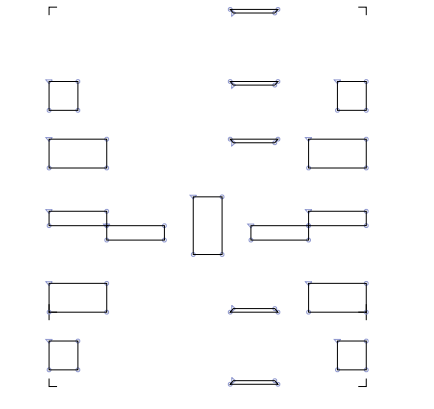
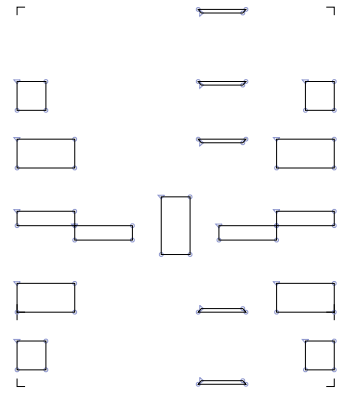

uniE001 E001

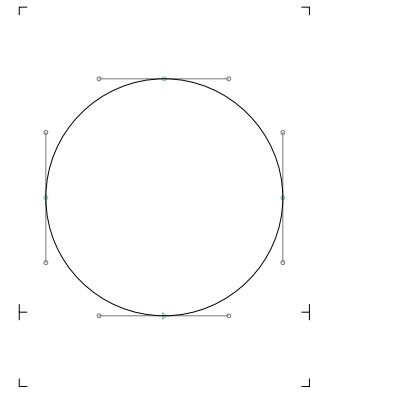
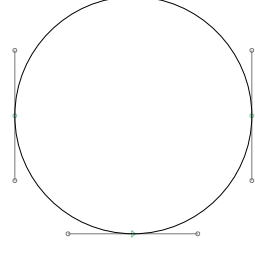

circleblack 25CF

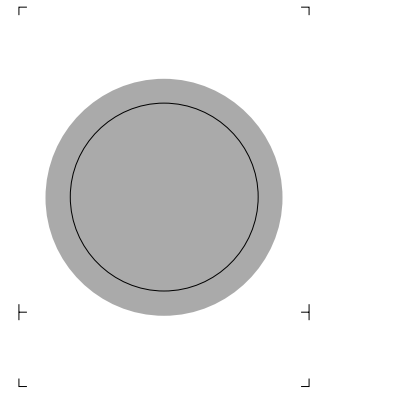
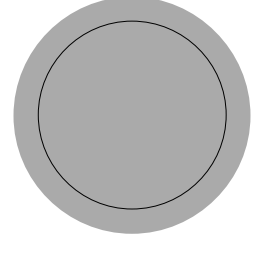

circlewhite 25CB

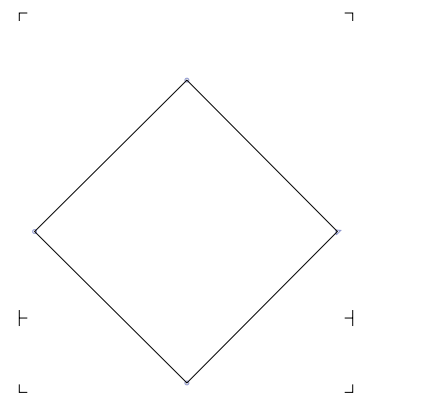
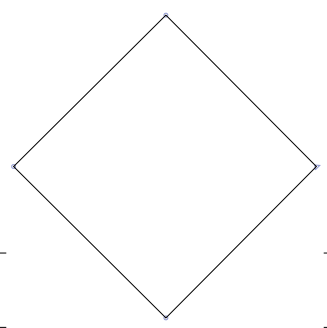

diamondblack 25C6

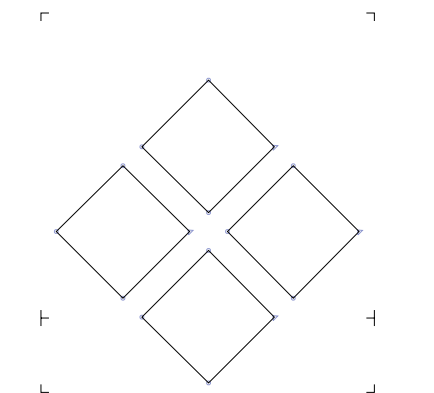
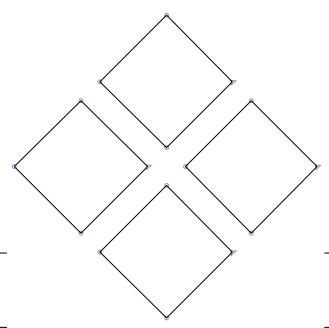

diamondblack\_x 2756

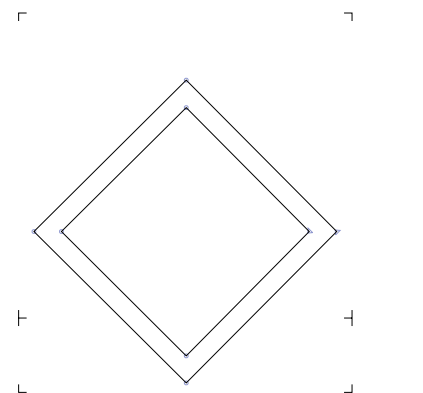
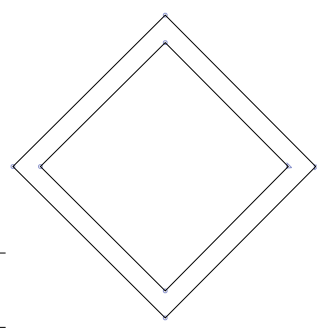

diamondwhite 25C7

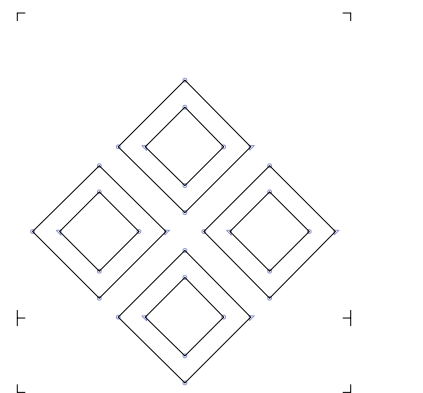
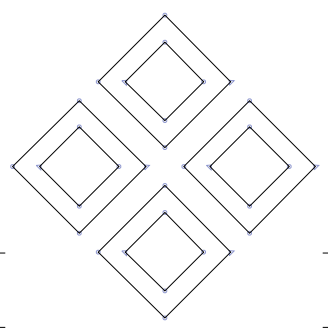

diamondwhite\_x E000

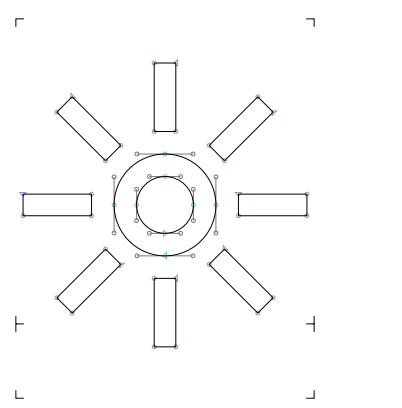
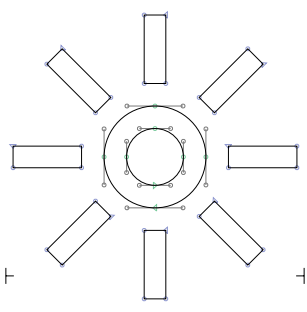

sunWithRays 263C

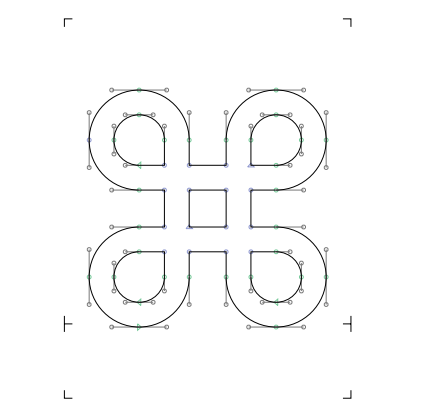
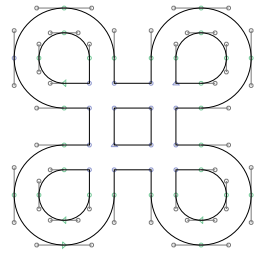

placeofinterestsign 2318

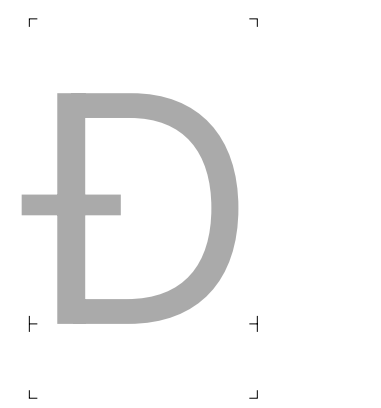
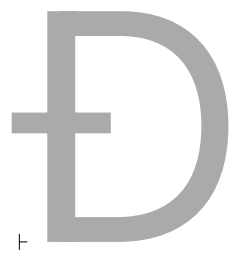

Eth 00D0

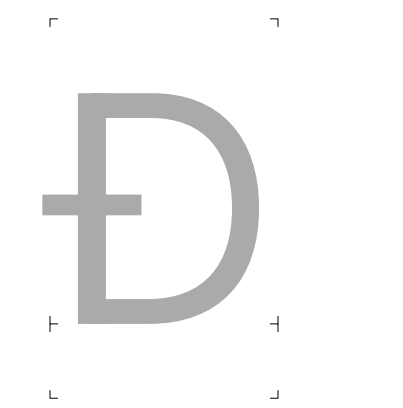
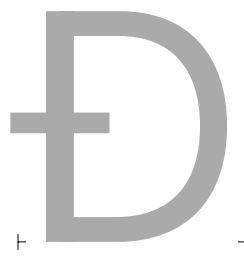

Dcroat 0110

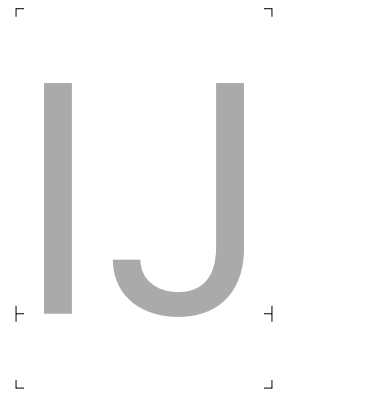
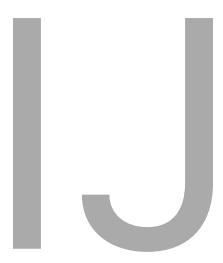

IJ 0132

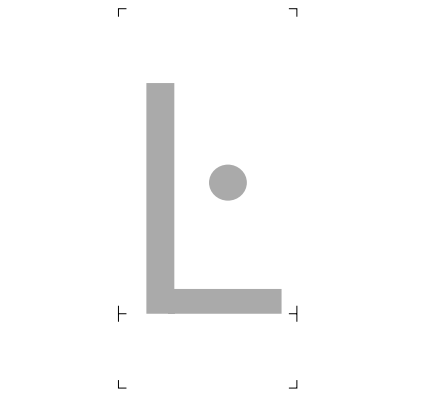
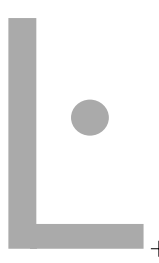

Ldot 013F

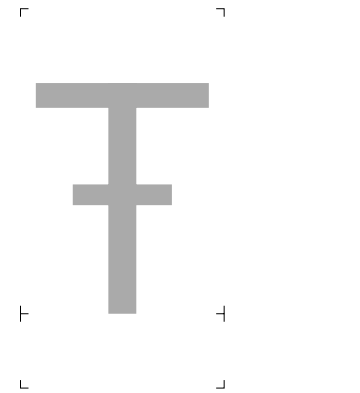
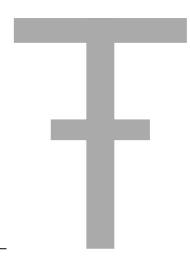

Tbar 0166

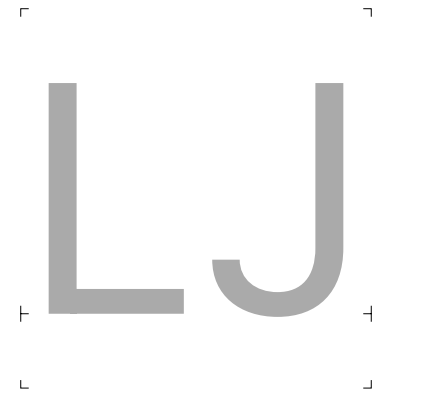

LJ 01C7



NJ 01CA DZ 01F1

Aogonek.NAV

Eogonek.NAV

Oogonek.NAV

uni03F7 03F7

afii10020 0413

afii10052 0403

afii10033 041F

afii10034 0420

afii10035 0421

afii10036 0422

afii10039 0425

afii10146 0462

Psicyrillic 0470

Ukcyrillic 0478

uni048C 048C

Ghestrokecyrillic 0492

Zedescendercyrillic 0498

Edescendercyrillic 04AA

Tedescendercyrillic 04AC

Ustraightcyrillic 04AE

Ustraightstrokecyrillic 04B0

Chedescenderabkhasiancyrillic 04BE



palochkacyrillic 04C0

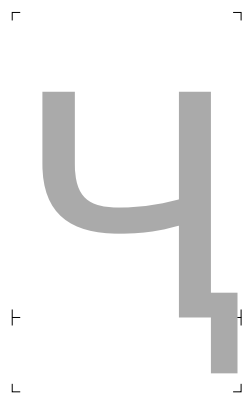

Chekhakassiancyrillic 04CB

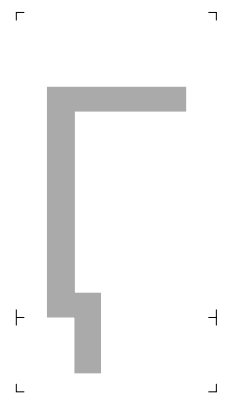

uni04F6 04F6

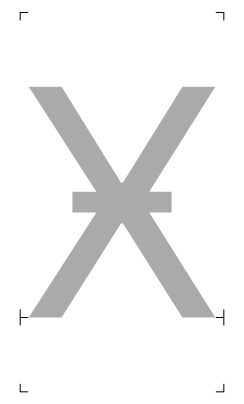

uni04FE 04FE

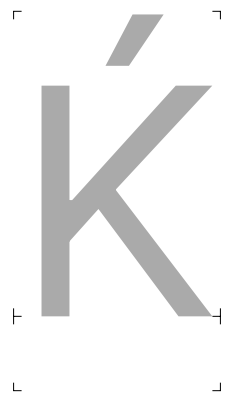

afi10061 040C

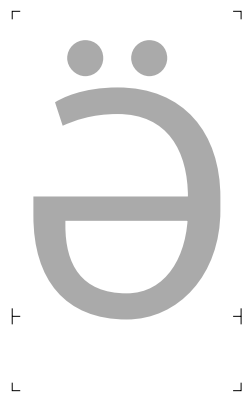

Schwadiesescyrillic 04DA

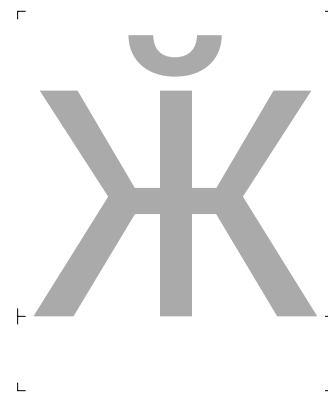

Zhebrevecyrillic 04C1

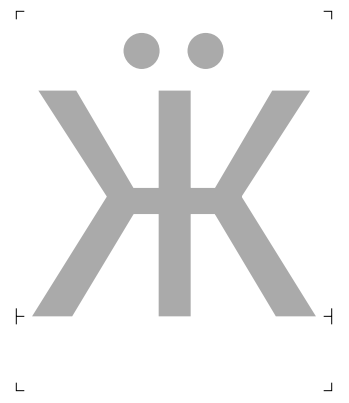

Zhedieresicyrillic 04DC



Zedieresicyrillic 04DE

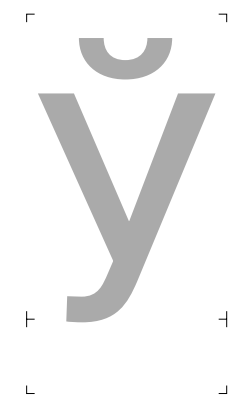

afi10062 040E

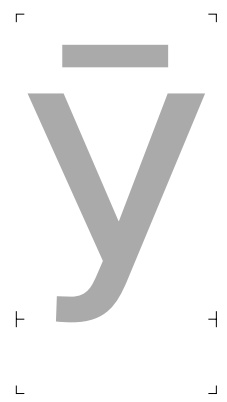

Umacroncyrillic 04EE

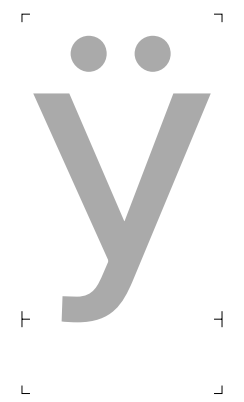

Udieresicyrillic 04F0



Uhungarumlautcyrillic 04F2

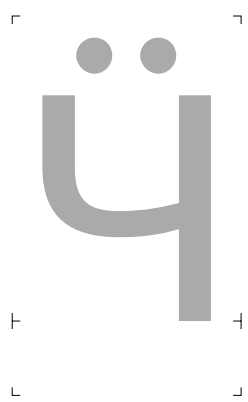

Chedieresicyrillic 04F4

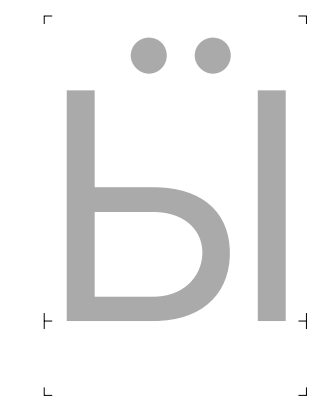

Yerudieresicyrillic 04F8

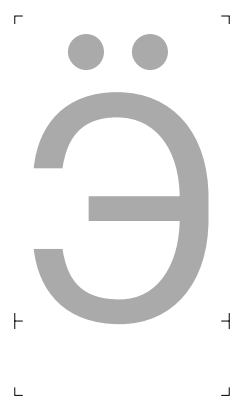

uni04EC 04EC



Izhitsadblgravecyrillic 0476

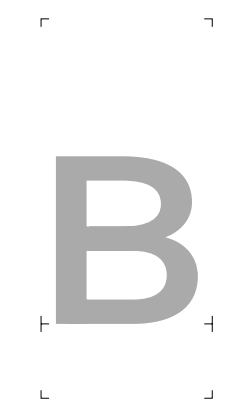

uni0299 0299



uni029C 029C



aogonek.NAV



eogonek.NAV

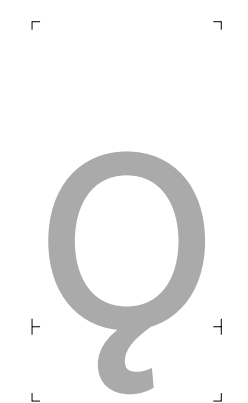

oogonek.NAV

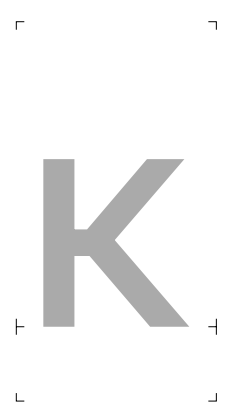

kappa

03BA



mugreek

03BC

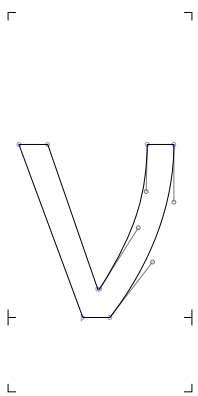

nu 03BD



uni03F8 03F8



uni1F71 1F71



uni1F73 1F73



uni1F75 1F75

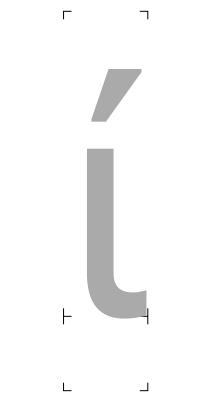

uni1F77 1F77



uni1F79 1F79

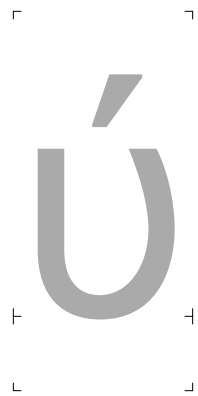

uni1F7B 1F7B



uni1F7D 1F7D

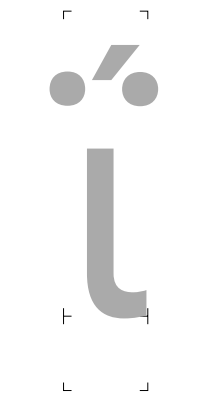

uni1FD3 1FD3



uni1FE3 1FE3



psicyrillic 0471



ghestrokecyrillic 0493



zedescendercyrillic 0499



esdescendercyrillic 04AB



tedescendercyrillic 04AD



ustraightcyrillic 04AF



ustraightstrokecyrillic 04B1



chedescenderabkhasiancyrillic 04BF



chekhakassiancyrillic 04CC



schwacyrillic 04D9



schwadiesiscyrlilic 04DB



obarredcyrillic 04E9



obarreddieresiscyrillic 04EB



uni04F7 04F7



uni04FF 04FF



chedieresiscyrillic 04F5



uni04ED 04ED



gjecyrillic 0453



iishortcyrillic 0439



uni045D 045D



imacroncyrillic 04E3



idieresiscyrillic 04E5



izhitsadblgravecyrillic 0477

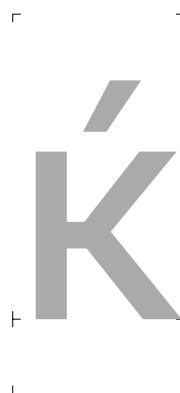

kjecyrillic 045C



yerudieresiscyrillic 04F9



zedieresiscyrillic 04DF



zhebrevecyrillic 04C2



zhedieresiscyrillic 04DD



Ezhcaron 01EE

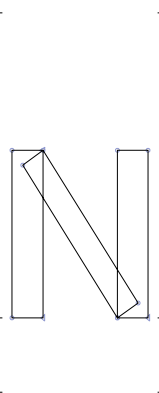

Nsmallcap 0274

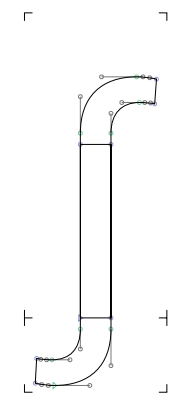

esh 0283

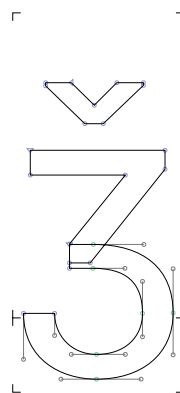

ezhcaron 01EF

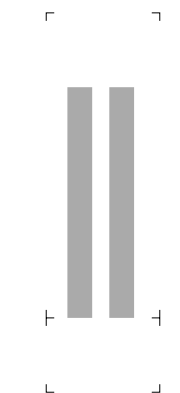

pipedbl 01C1

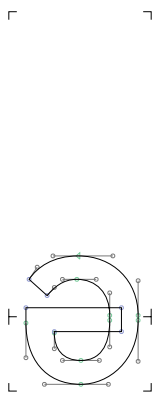

uni2094 2094

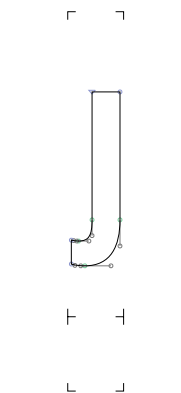

uni02B2.ccmp



Eltail-cy 04C5

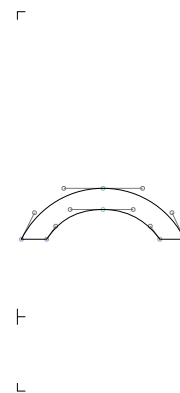

uniA92E A92E

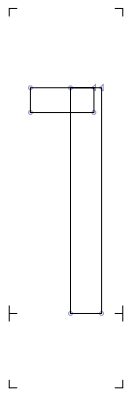

tonebarextrahighmod.cn 02E5

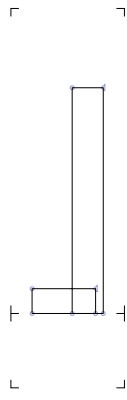

tonebarextralowmod.cn 02E9

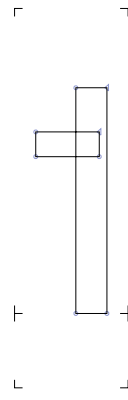

tonebarhighmod.cn 02E6

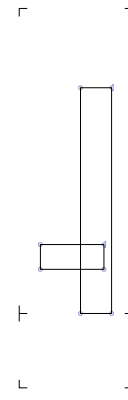

tonebarlowmod.cn 02E8

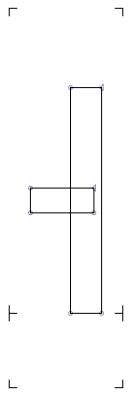

tonebarmidmod.cn 02E7



commaabovecmb 0313



commaaboverightcmb 0315



hooksubpalatosp 0321



bridgeinsubnosp 033A

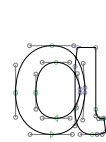

uni1DE7 1DE7

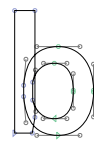

uni1DE8 1DE8

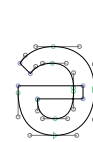

uni1DEA 1DEA

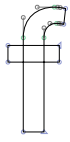

uni1DEB 1DEB

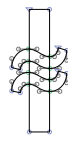

uni1DEC 1DEC

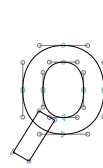

uni1DED 1DED



uni1DEE 1DEE

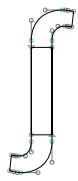

uni1DEF 1DEF

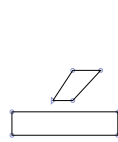

macronacutecomb.cn

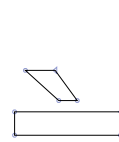

macrongravecomb.cn



uni1FFE.tonos



uni1FCD.tonos



uni1FDD.tonos



uni1FCE.tonos



uni1FDE.tonos



uni1FCF.tonos



uni1FDF.tonos



uni1FEF.tonos



uni1FFD.tonos



uni1DE0 1DE0

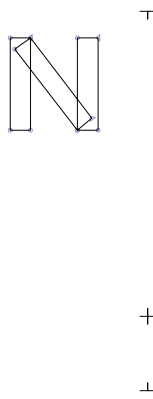

uni1DE1 1DE1

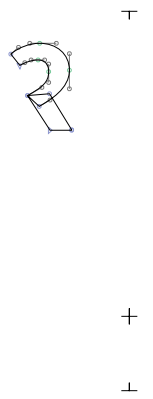

uni1DE3 1DE3

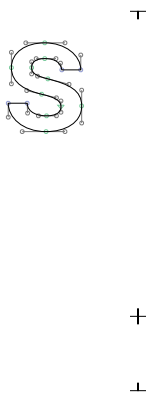

uni1DE4 1DE4



uni1DE5 1DE5

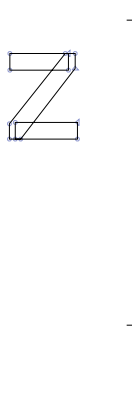

uni1DE6 1DE6



cyrillicic.cn



controlHT



controlSOT



commaaccentright.cn

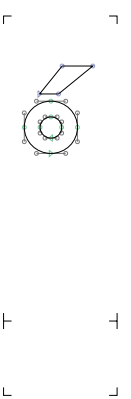

ringacute.cn



circumflexgravecomb.cn



dieresiscaroncomb.cn



dieresismacroncomb.cn



carondotcomb.cn



breveacutecomb.cn

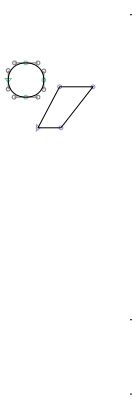

acutedotcomb.cn



brevegravecomb.cn



circumflexacutecomb.cn



tildedieresiscomb.cn

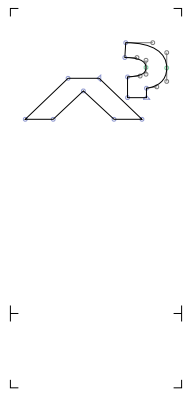

circumflexhookcomb.cn

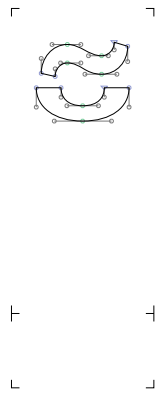

brevetildecomb.cn

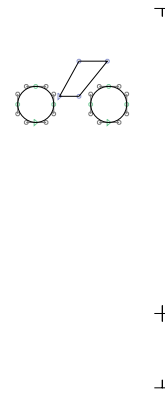

dieresisacutecomb.cn



dotmacroncomb.cn

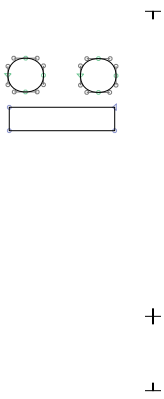

macrondieresiscomb.cn



dieresisgravecomb.cn



tildemacroncomb.cn

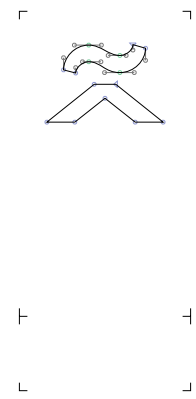

circumflextildecomb.cn

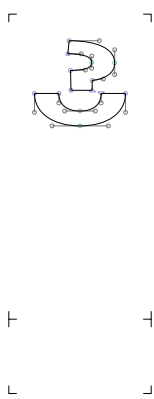

brevehookcomb.cn



commaaccentrotate.cn

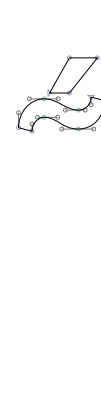

tildeacutecomb.cn



tonostop



cyrillictail.cn



koronisaccentleft.cn