

DATA SHEET

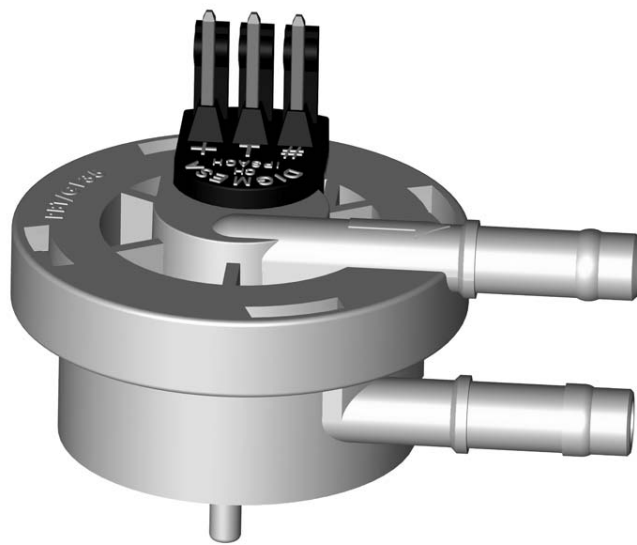

DIGMESA

FHKSC Arnite using fastening pin
with double isolation
Part number: 932-950X/BXXX

Digmesa AG, Keltenstrasse 31, CH-2563 Ipsach / Switzerland
Phone +41 (32) 332 77 77, Fax +41 (32) 332 77 88

www.digmesa.com

Version 01 FHKSC 932-950X/BXXX GB 20V Page 1-21

General Description

The FHKSC Flowmeter is a general-purpose device that has been specially designed for coffee machines that use vibratory pumps. The device is installed between the water container and the vibratory pump (on the suction side) and in this way prevents the measuring errors that arise during pulsating water flow caused by vibratory pumps.

Specific applications: Thanks to its closure system, the water outlet side can be assembled in four different positions. Central sprayed fastening pin \varnothing 2.8mm x 7.5mm. Recommended washer disk: Quicklock® Benzing \varnothing 3mm or Starlock P-6490 \varnothing 3mm. **Doubled isolation (water/electronics) according to the standard IEC/EN 60335-1: 2001/2002 + A1: 04+A2: 06+A11: 04+A12: 06.**

Approvals / Standards

EN55014-1:00+A1:01+A2:02, EN61000-6-3:01+A11:04, IEC61000-6-3:06(ed.2.0), EN61000-3-2:06, IEC61000-3-2:05(ed.3.0), EN61000-3-3:95+A1:01+A2:05, IEC61000-3-3:94+A1:01+A2:05(Cons.ed 1.2), EN55014-2:97+A1:01, EN61000-6-1:01, IEC61000-6-1:05(ed.2)



Material:

Housing:	PBT 35%GF (Arnite)
Bearing pin:	Injection-moulded like the housing
Nozzle:	Injection-moulded like the housing
O-ring:	MVQ (Silikon)
Turbine:	PP (red dyed)
Magnets:	Keramik Sr Fe O (in contact with the medium)

Technical data:

Flow rate:	0.033 - 2 l/min depending on the nozzle diameter
Measuring accuracy:	+/- 2.0%
Repetition:	< +/- 0.25%
Temperature range:	-10°C to +65°C 14°F to 149°F
Pressure range:	-1 bar to 0.3 bar at 20°C -14.5 psi to 4.35 psi /68°F
Mounting position:	Horizontal*
Nozzle size:	\varnothing 1.0, 1.2, 1.8, 2.0 mm

Electrical connection ratings:

Power supply:	+3.8 to +20 VDC
Consumption:	< 8 mA
Signal connection:	Open collector NPN
Signal voltage:	0 VDC GND (saturation < 0.7 V)
Signal load:	max. 20 mA
Leakage current:	max. 10 μ A
Connections:	PANCON MAS-CON 156 MLSS
Signal:	Square-wave output
Duty Cycle:	~ 50%

Dimensions in mm:

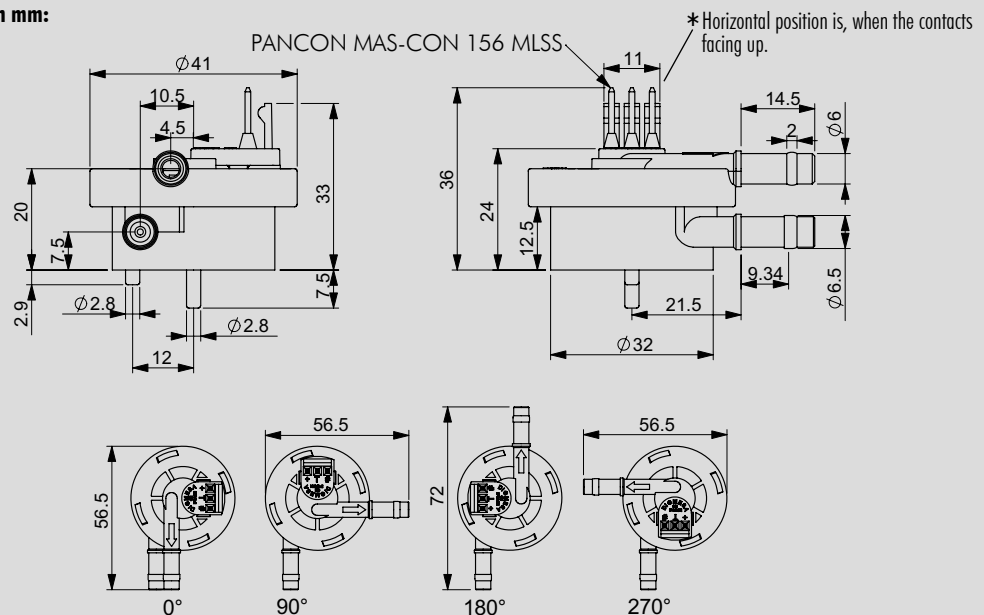

RESISTANCE

Special regulations which must be complied with by the flowmeter manufacturer apply to each country, e.g. CE, NSF, FDA and SK. The various media flowing through the flowmeter differ from application to application. You are advised to enquire with the medium manufacturer as to whether the entire installation and the flowmeter are resistant to the medium itself (see Material)!

ELECTRONIC

DIGMESA electronic circuitry is always designed for operation with DIGMESA flowmeters. Please note the following if connecting to other electronic circuitry:

- The flowmeter does not supply an output voltage but switches the signal terminal to 0 V ground (actuated) or leaves it open (non-actuated)
- There must be a pull-up resistor between power supply + and signal depending on electronic circuitry!

Interface Connection: Examples Open Collector

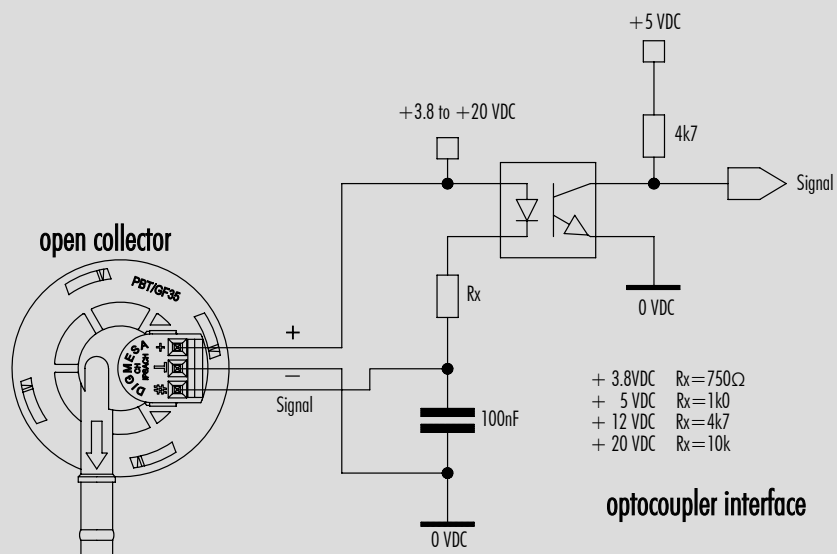
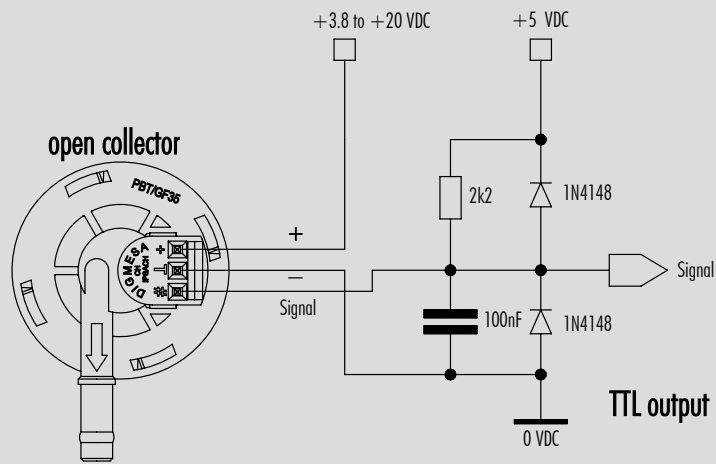
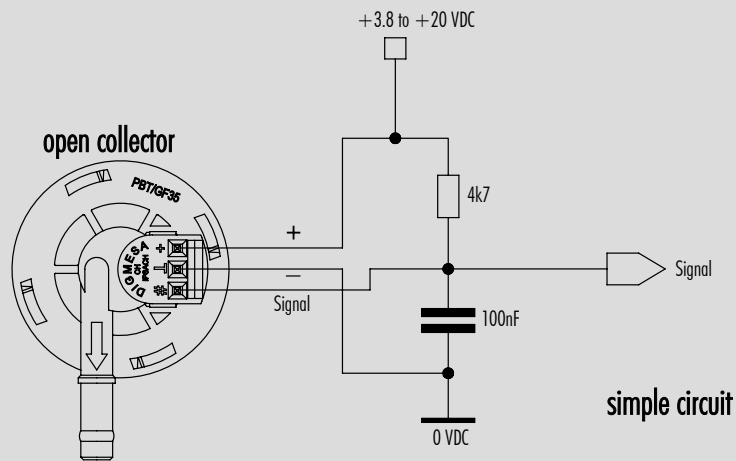

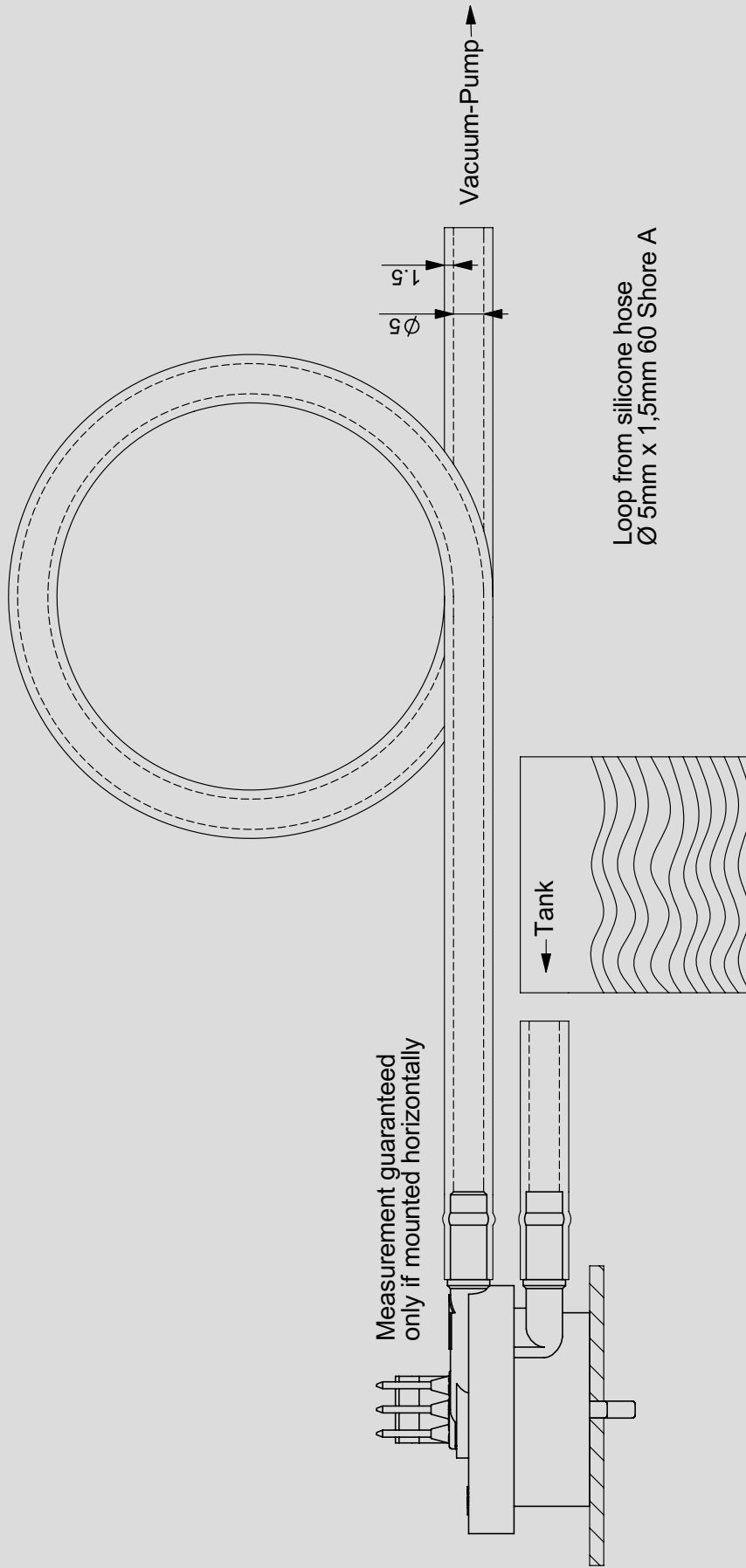

Measurement Curve FHKSC 1.00 mm 0° (#932-9505/B)

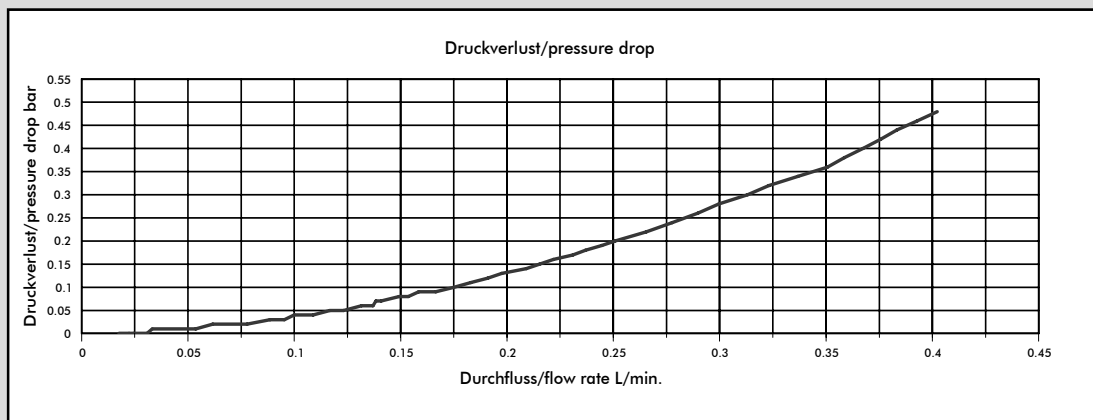
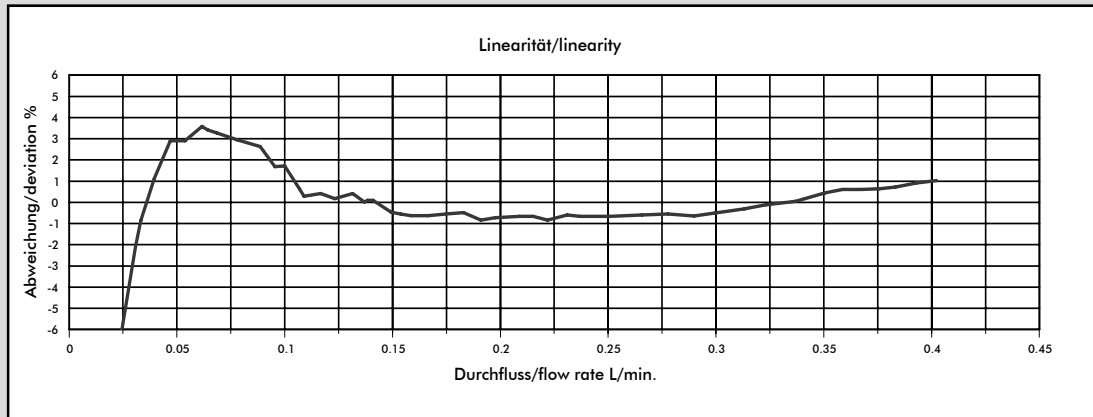

Medium: Water / max. Pressure: 1 bar

Nozzle size	Pulses/litre	g/pulse	min. flow rate in litres/min at Linear start	max. flow rate in litres/min	Pressure loss
Ø 1.00 mm	2382	0.4197	0.0333	0.4023	0.48
Ø 1.20 mm	1925	0.5194	0.0750	0.5692	0.42
Ø 1.80 mm	1315	0.7601	0.0753	0.8994	0.25
Ø 2.00 mm	1250	0.8001	0.1121	0.9068	0.21

MEASUREMENT TIPS

- Ensure that there is no fast-pulsatory movement of the media
- Ensure that there are no reverse pressure surges
- Ensure that there is no air in the system
- Note the mounting position of the flowmeter
- Min/max flow should be in the linear range of the selected flowmeter
- Clean the system at appropriate intervals
- Avoid electrical current peaks
- Incorrect cabling of power supply +, signal and ground will destroy the flowmeter
- Do not mechanically load electrical contacts
- Avoid moisture on the electrical contacts
- Avoid stray pick-up via the cable (Do not lay cables in parallel with high current loads)

The values specified must be considered as approximate values.

The number of pulses per litre may differ depending on medium and installation.

We recommend to calibrate the number of pulses per litre in line with the complete installation.

Measurement Curve FHKSC 1.00 mm 90° (#932-9505/B90)

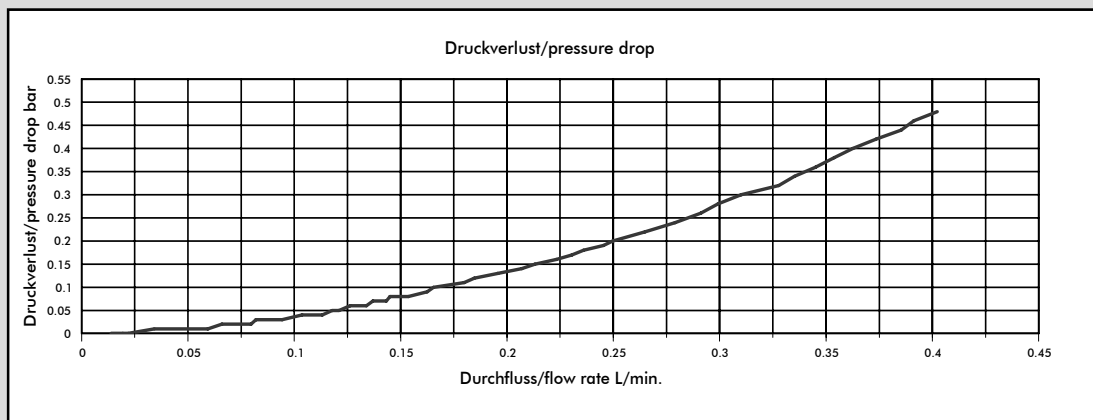
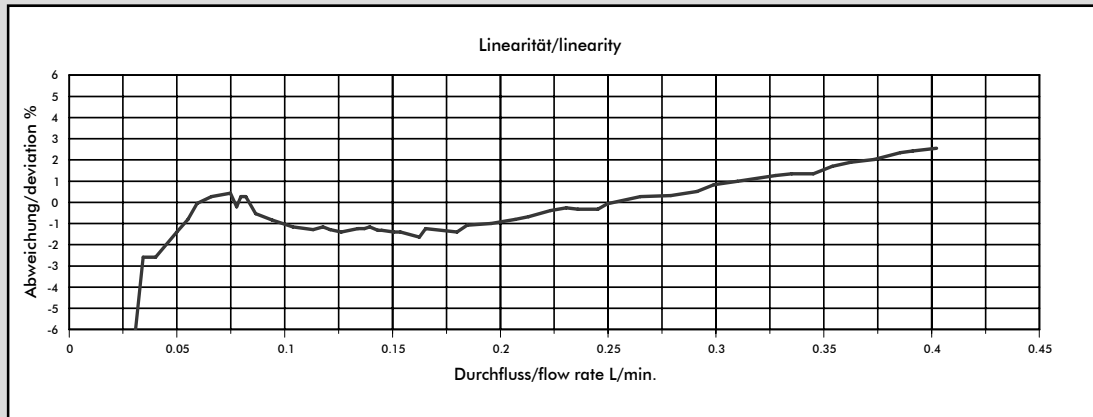

Medium: Water / max. Pressure: 1 bar

Nozzle size	Pulses/litre	g/pulse	min. flow rate in litres/min at Linear start	max. flow rate in litres/min	Pressure loss
Ø 1.00 mm	2386	0.4191	0.0500	0.4023	0.48
Ø 1.20 mm	1934	0.5171	0.0813	0.5667	0.43
Ø 1.80 mm	1300	0.7691	0.0910	0.9012	0.25
Ø 2.00 mm	1215	0.8231	0.1396	0.9156	0.21

MEASUREMENT TIPS

- Ensure that there is no fast-pulsatory movement of the media
- Ensure that there are no reverse pressure surges
- Ensure that there is no air in the system
- Note the mounting position of the flowmeter
- Min/max flow should be in the linear range of the selected flowmeter
- Clean the system at appropriate intervals
- Avoid electrical current peaks
- Incorrect cabling of power supply +, signal and ground will destroy the flowmeter
- Do not mechanically load electrical contacts
- Avoid moisture on the electrical contacts
- Avoid stray pick-up via the cable (Do not lay cables in parallel with high current loads)

The values specified must be considered as approximate values.

The number of pulses per litre may differ depending on medium and installation.

We recommend to calibrate the number of pulses per litre in line with the complete installation.

Measurement Curve FHKSC 1.00 mm 180° (#932-9505/B180)

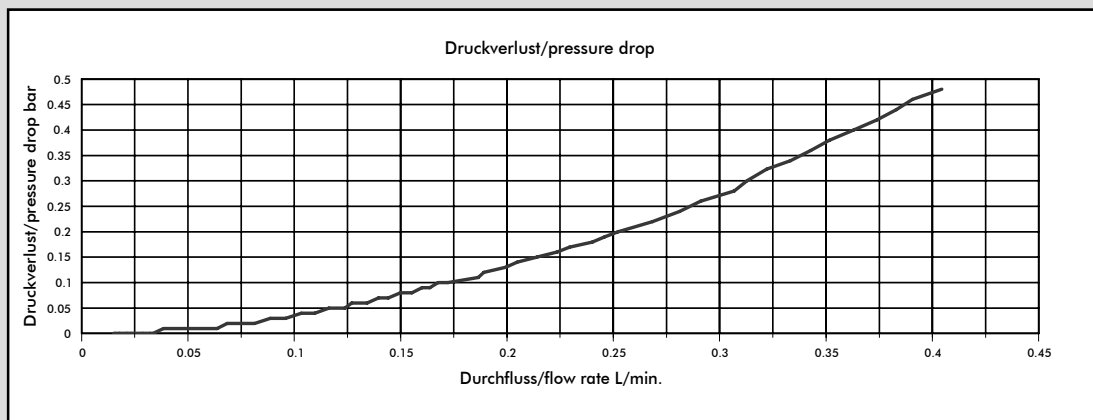
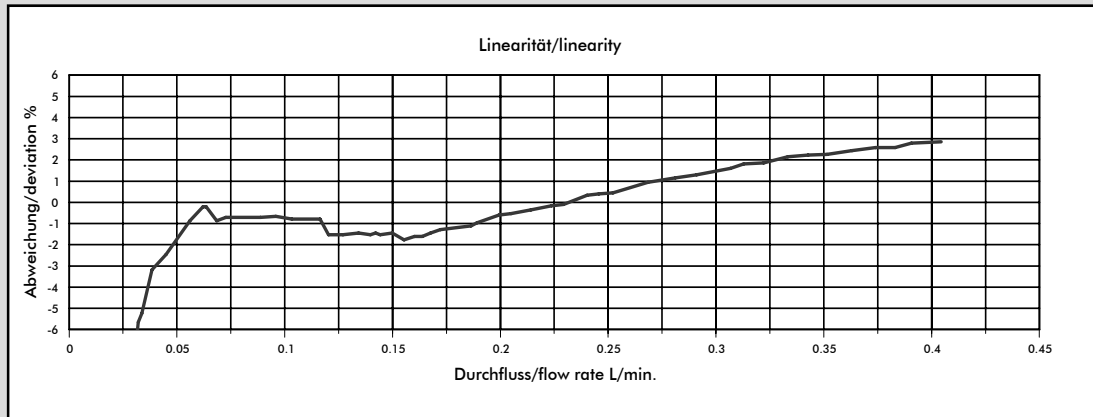

Medium: Water / max. Pressure: 1 bar

Nozzle size	Pulses/litre	g/pulse	min. flow rate in litres/min at Linear start	max. flow rate in litres/min	Pressure loss
Ø 1.00 mm	2476	0.4038	0.0560	0.4044	0.48
Ø 1.20 mm	2016	0.4960	0.1022	0.5705	0.43
Ø 1.80 mm	1360	0.7349	0.1185	0.8966	0.26
Ø 2.00 mm	1280	0.7815	0.1785	0.9175	0.22

MEASUREMENT TIPS

- Ensure that there is no fast-pulsatory movement of the media
- Ensure that there are no reverse pressure surges
- Ensure that there is no air in the system
- Note the mounting position of the flowmeter
- Min/max flow should be in the linear range of the selected flowmeter
- Clean the system at appropriate intervals
- Avoid electrical current peaks
- Incorrect cabling of power supply +, signal and ground will destroy the flowmeter
- Do not mechanically load electrical contacts
- Avoid moisture on the electrical contacts
- Avoid stray pick-up via the cable (Do not lay cables in parallel with high current loads)

The values specified must be considered as approximate values.

The number of pulses per litre may differ depending on medium and installation.

We recommend to calibrate the number of pulses per litre in line with the complete installation.

Measurement Curve FHKSC 1.00 mm 270° (#932-9505/B270)

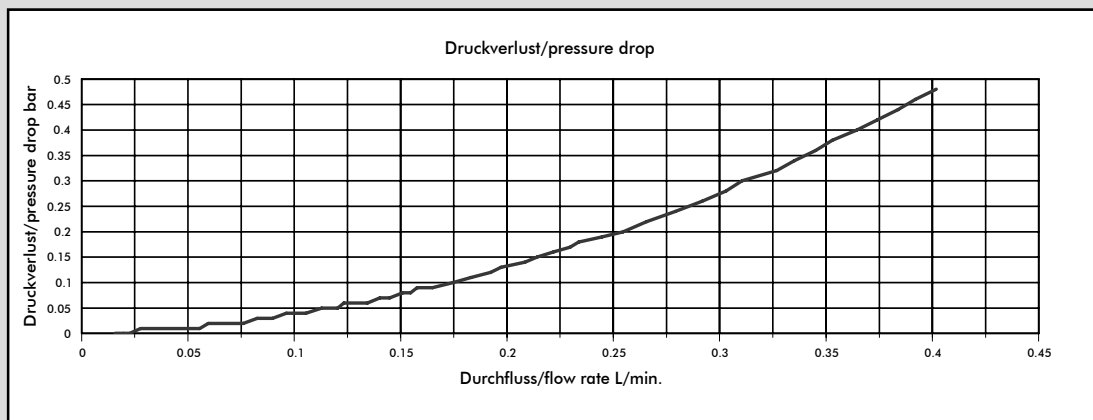
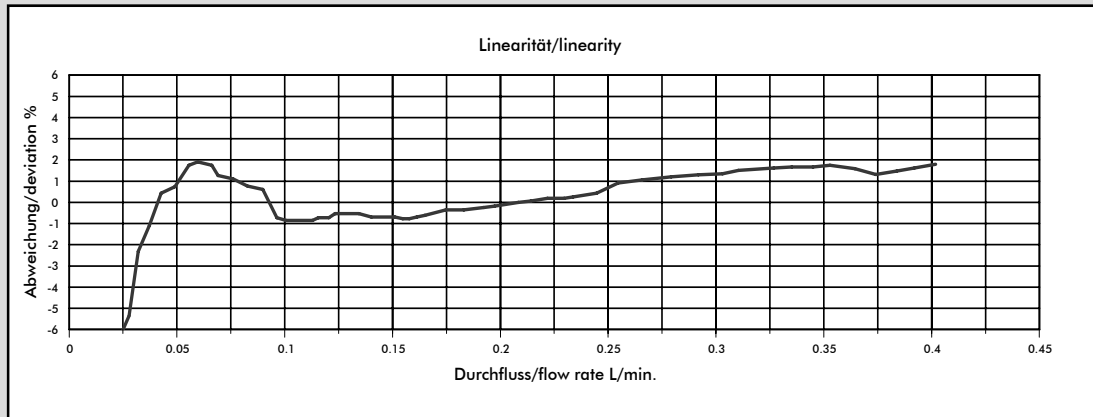

Medium: Water / max. Pressure: 1 bar

Nozzle size	Pulses/litre	g/pulse	min. flow rate in litres/min at Linear start	max. flow rate in litres/min	Pressure loss
Ø 1.00 mm	2436	0.4105	0.0427	0.4019	0.48
Ø 1.20 mm	2012	0.4969	0.0801	0.5677	0.42
Ø 1.80 mm	1352	0.7397	0.0824	0.8982	0.26
Ø 2.00 mm	1274	0.7849	0.1573	0.9056	0.22

MEASUREMENT TIPS

- Ensure that there is no fast-pulsatory movement of the media
- Ensure that there are no reverse pressure surges
- Ensure that there is no air in the system
- Note the mounting position of the flowmeter
- Min/max flow should be in the linear range of the selected flowmeter
- Clean the system at appropriate intervals
- Avoid electrical current peaks
- Incorrect cabling of power supply +, signal and ground will destroy the flowmeter
- Do not mechanically load electrical contacts
- Avoid moisture on the electrical contacts
- Avoid stray pick-up via the cable (Do not lay cables in parallel with high current loads)

The values specified must be considered as approximate values.

The number of pulses per litre may differ depending on medium and installation.

We recommend to calibrate the number of pulses per litre in line with the complete installation.

Measurement Curve FHKSC 1.20 mm 0° (#932-9501/B)

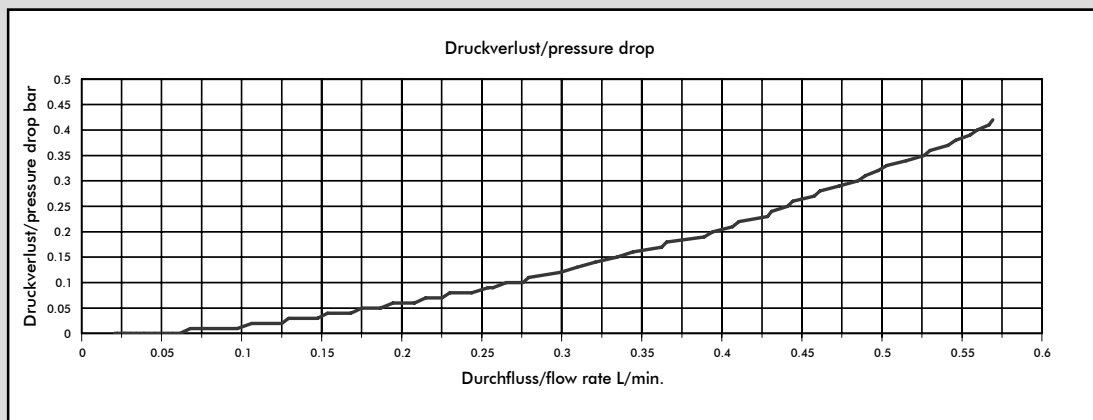
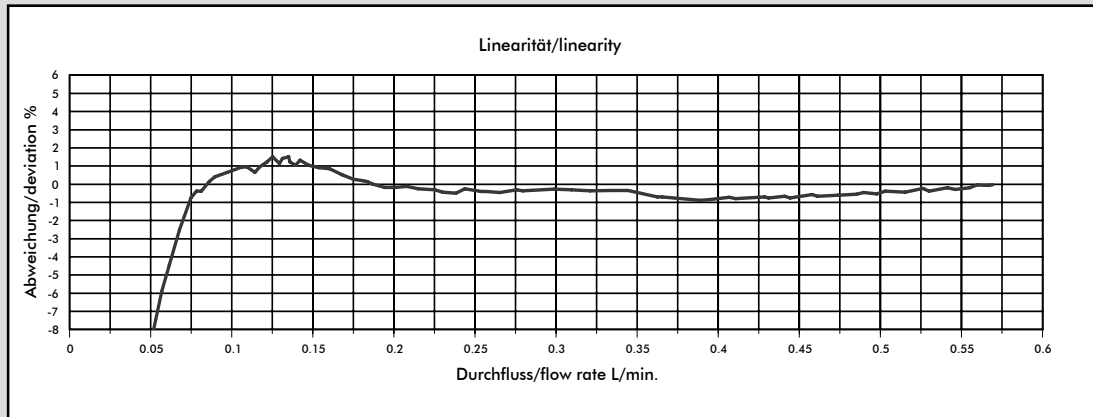

Medium: Water / max. Pressure: 1 bar

Nozzle size	Pulses/litre	g/pulse	min. flow rate in litres/min at Linear start	max. flow rate in litres/min	Pressure loss
Ø 1.00 mm	2382	0.4197	0.0333	0.4023	0.48
Ø 1.20 mm	1925	0.5194	0.0750	0.5692	0.42
Ø 1.80 mm	1315	0.7601	0.0753	0.8994	0.25
Ø 2.00 mm	1250	0.8001	0.1121	0.9068	0.21

MEASUREMENT TIPS

- Ensure that there is no fast-pulsatory movement of the media
- Ensure that there are no reverse pressure surges
- Ensure that there is no air in the system
- Note the mounting position of the flowmeter
- Min/max flow should be in the linear range of the selected flowmeter
- Clean the system at appropriate intervals
- Avoid electrical current peaks
- Incorrect cabling of power supply +, signal and ground will destroy the flowmeter
- Do not mechanically load electrical contacts
- Avoid moisture on the electrical contacts
- Avoid stray pick-up via the cable (Do not lay cables in parallel with high current loads)

The values specified must be considered as approximate values.

The number of pulses per litre may differ depending on medium and installation.

We recommend to calibrate the number of pulses per litre in line with the complete installation.

Measurement Curve FHKSC 1.20 mm 90° (#932-9501/B90)

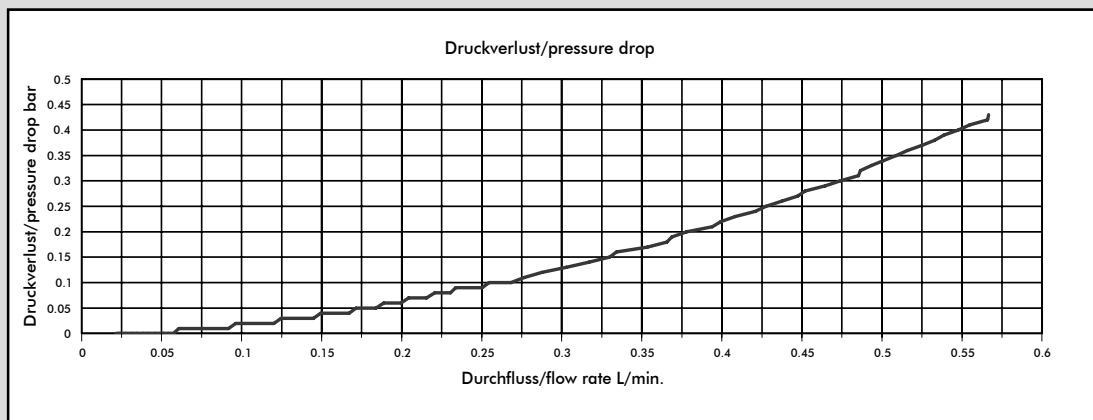
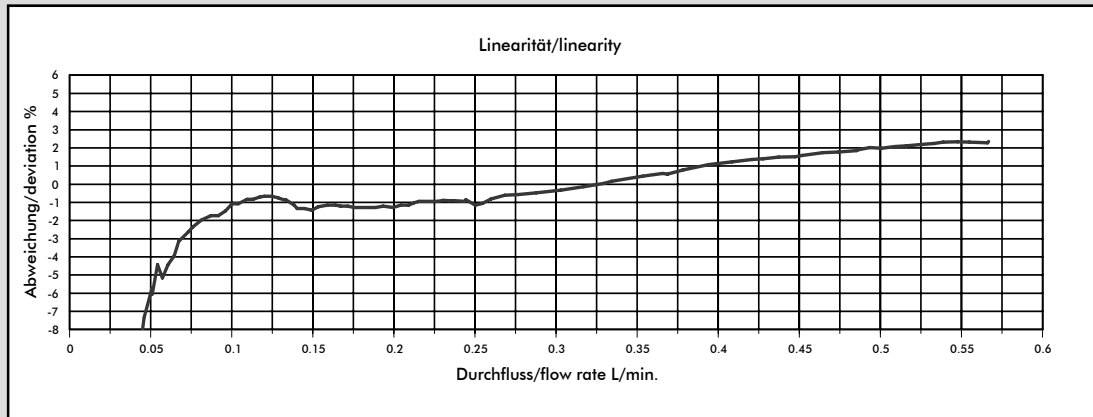

Medium: Water / max. Pressure: 1 bar

Nozzle size	Pulses/litre	g/pulse	min. flow rate in litres/min at Linear start	max. flow rate in litres/min	Pressure loss
Ø 1.00 mm	2386	0.4191	0.0500	0.4023	0.48
Ø 1.20 mm	1934	0.5171	0.0813	0.5667	0.43
Ø 1.80 mm	1300	0.7691	0.0910	0.9012	0.25
Ø 2.00 mm	1215	0.8231	0.1396	0.9156	0.21

MEASUREMENT TIPS

- Ensure that there is no fast-pulsatory movement of the media
- Ensure that there are no reverse pressure surges
- Ensure that there is no air in the system
- Note the mounting position of the flowmeter
- Min/max flow should be in the linear range of the selected flowmeter
- Clean the system at appropriate intervals
- Avoid electrical current peaks
- Incorrect cabling of power supply +, signal and ground will destroy the flowmeter
- Do not mechanically load electrical contacts
- Avoid moisture on the electrical contacts
- Avoid stray pick-up via the cable (Do not lay cables in parallel with high current loads)

The values specified must be considered as approximate values.

The number of pulses per litre may differ depending on medium and installation.

We recommend to calibrate the number of pulses per litre in line with the complete installation.

Measurement Curve FHKSC 1.20 mm 180° (#932-9501/B180)

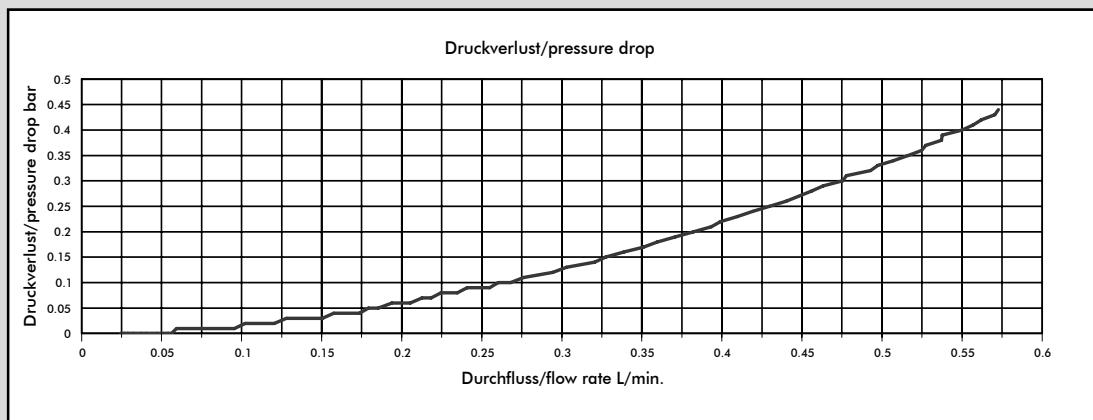
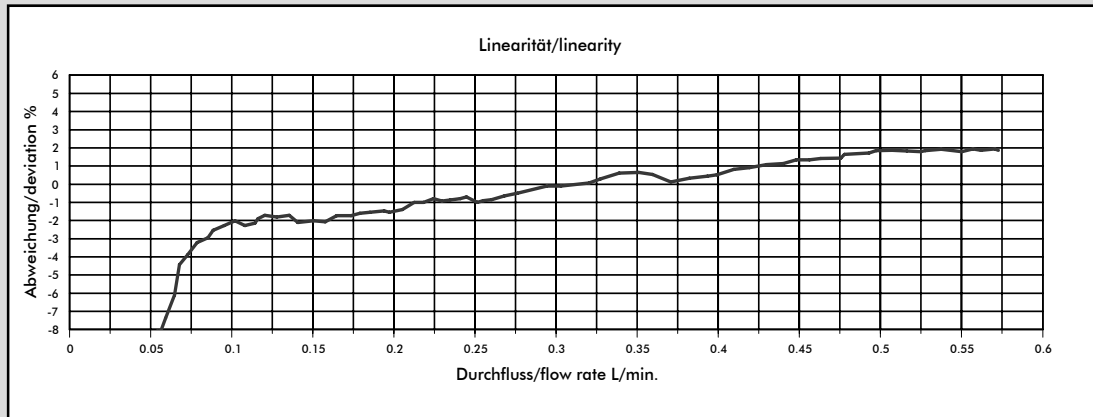

Medium: Water / max. Pressure: 1 bar

Nozzle size	Pulses/litre	g/pulse	min. flow rate in litres/min at Linear start	max. flow rate in litres/min	Pressure loss
Ø 1.00 mm	2476	0.4038	0.0560	0.4044	0.48
Ø 1.20 mm	2016	0.4960	0.1022	0.5705	0.43
Ø 1.80 mm	1360	0.7349	0.1185	0.8966	0.26
Ø 2.00 mm	1280	0.7815	0.1785	0.9175	0.22

MEASUREMENT TIPS

- Ensure that there is no fast-pulsatory movement of the media
- Ensure that there are no reverse pressure surges
- Ensure that there is no air in the system
- Note the mounting position of the flowmeter
- Min/max flow should be in the linear range of the selected flowmeter
- Clean the system at appropriate intervals
- Avoid electrical current peaks
- Incorrect cabling of power supply +, signal and ground will destroy the flowmeter
- Do not mechanically load electrical contacts
- Avoid moisture on the electrical contacts
- Avoid stray pick-up via the cable (Do not lay cables in parallel with high current loads)

The values specified must be considered as approximate values.

The number of pulses per litre may differ depending on medium and installation.

We recommend to calibrate the number of pulses per litre in line with the complete installation.

Measurement Curve FHKSC 1.20 mm 270° (#932-9501/B270)

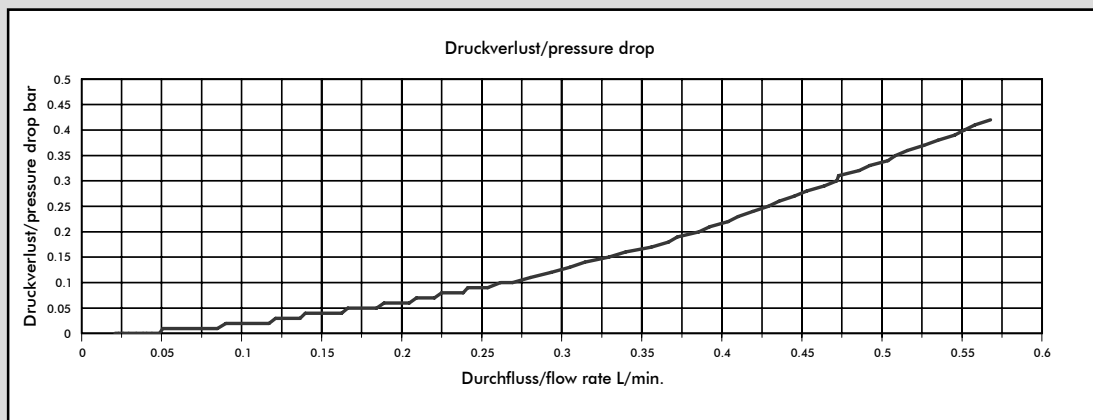
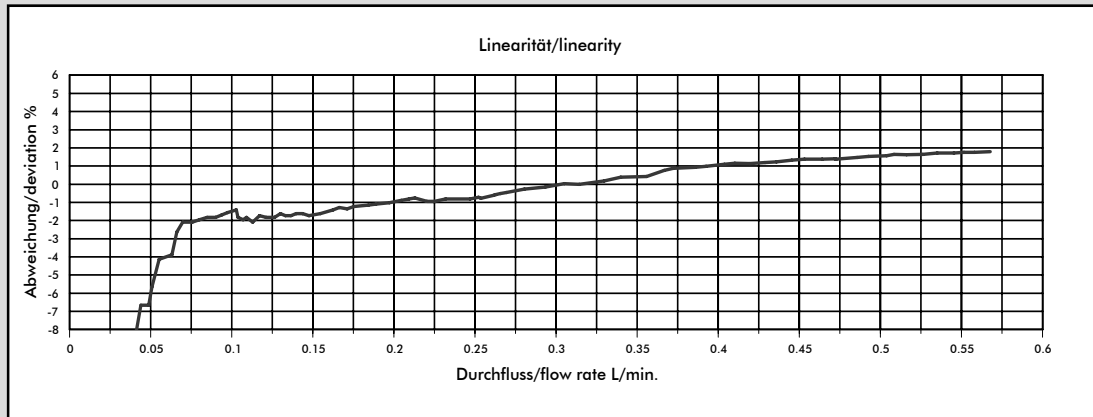

Medium: Water / max. Pressure: 1 bar

Nozzle size	Pulses/litre	g/pulse	min. flow rate in litres/min at Linear start	max. flow rate in litres/min	Pressure loss
Ø 1.00 mm	2436	0.4105	0.0427	0.4019	0.48
Ø 1.20 mm	2012	0.4969	0.0801	0.5677	0.42
Ø 1.80 mm	1352	0.7397	0.0824	0.8982	0.26
Ø 2.00 mm	1274	0.7849	0.1573	0.9056	0.22

MEASUREMENT TIPS

- Ensure that there is no fast-pulsatory movement of the media
- Ensure that there are no reverse pressure surges
- Ensure that there is no air in the system
- Note the mounting position of the flowmeter
- Min/max flow should be in the linear range of the selected flowmeter
- Clean the system at appropriate intervals
- Avoid electrical current peaks
- Incorrect cabling of power supply +, signal and ground will destroy the flowmeter
- Do not mechanically load electrical contacts
- Avoid moisture on the electrical contacts
- Avoid stray pick-up via the cable (Do not lay cables in parallel with high current loads)

The values specified must be considered as approximate values.

The number of pulses per litre may differ depending on medium and installation.

We recommend to calibrate the number of pulses per litre in line with the complete installation.

Measurement Curve FHKSC 1.80 mm 0° (#932-9502/B)

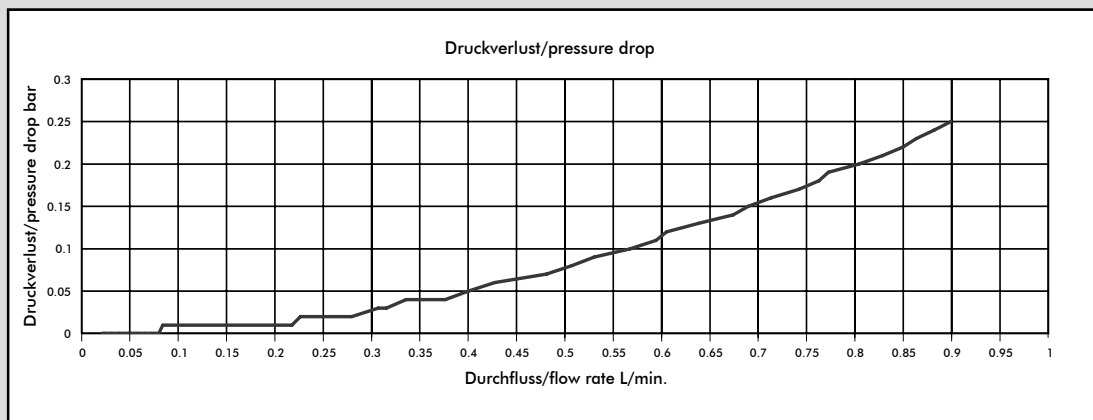
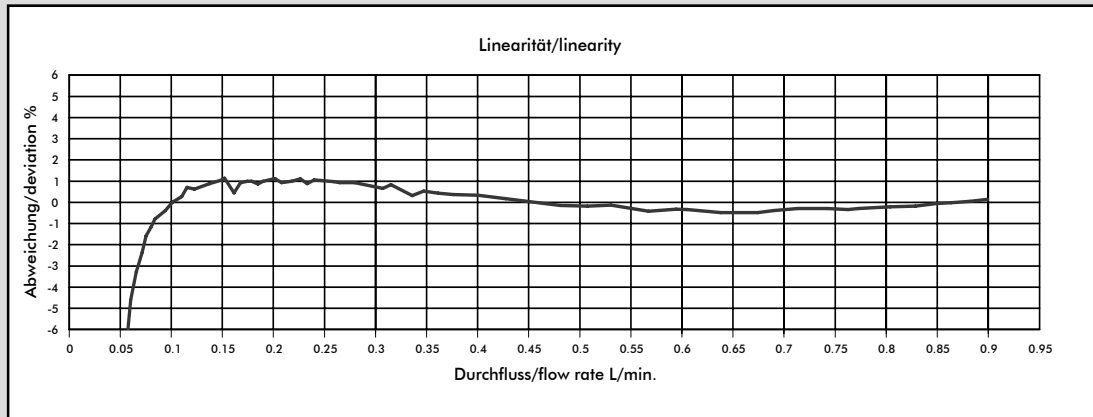

Medium: Water / max. Pressure: 1 bar

Nozzle size	Pulses/litre	g/pulse	min. flow rate in litres/min at Linear start	max. flow rate in litres/min	Pressure loss
Ø 1.00 mm	2382	0.4197	0.0333	0.4023	0.48
Ø 1.20 mm	1925	0.5194	0.0750	0.5692	0.42
Ø 1.80 mm	1315	0.7601	0.0753	0.8994	0.25
Ø 2.00 mm	1250	0.8001	0.1121	0.9068	0.21

MEASUREMENT TIPS

- Ensure that there is no fast-pulsatory movement of the media
- Ensure that there are no reverse pressure surges
- Ensure that there is no air in the system
- Note the mounting position of the flowmeter
- Min/max flow should be in the linear range of the selected flowmeter
- Clean the system at appropriate intervals
- Avoid electrical current peaks
- Incorrect cabling of power supply +, signal and ground will destroy the flowmeter
- Do not mechanically load electrical contacts
- Avoid moisture on the electrical contacts
- Avoid stray pick-up via the cable (Do not lay cables in parallel with high current loads)

The values specified must be considered as approximate values.

The number of pulses per litre may differ depending on medium and installation.

We recommend to calibrate the number of pulses per litre in line with the complete installation.

Measurement Curve FHKSC 1.80 mm 90° (#932-9502/B90)

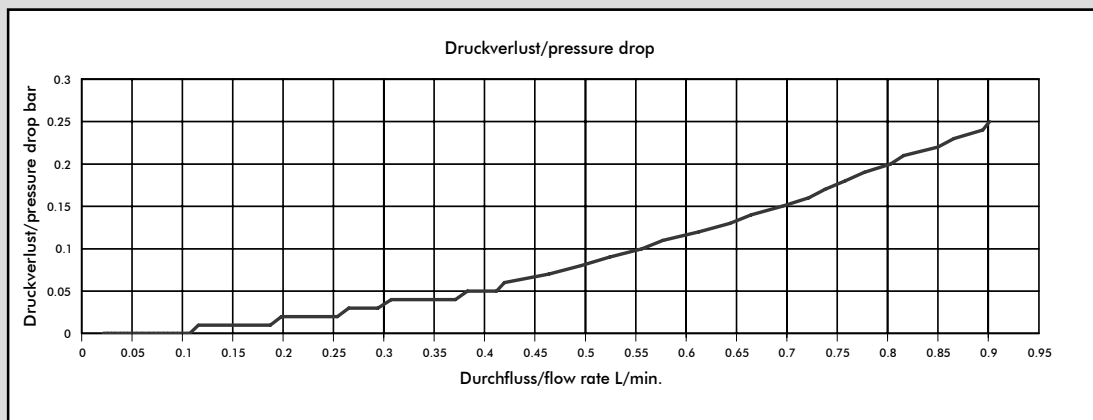
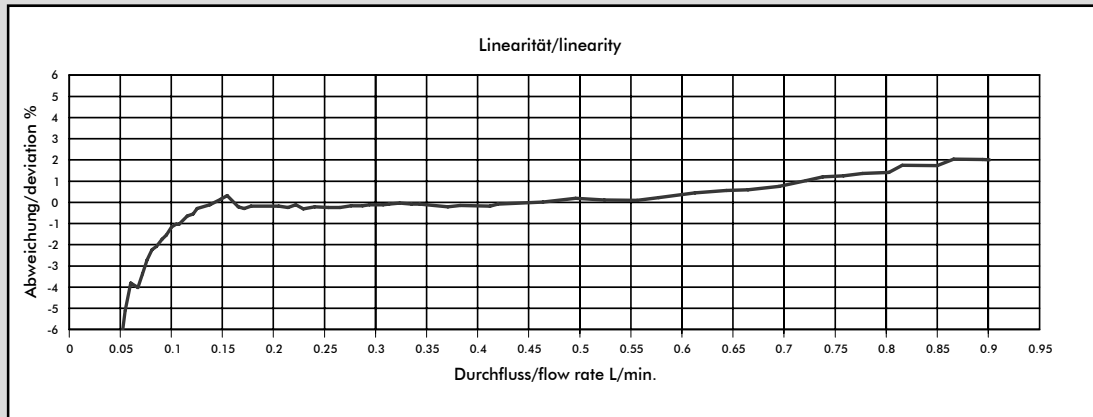

Medium: Water / max. Pressure: 1 bar

Nozzle size	Pulses/litre	g/pulse	min. flow rate in litres/min at Linear start	max. flow rate in litres/min	Pressure loss
Ø 1.00 mm	2386	0.4191	0.0500	0.4023	0.48
Ø 1.20 mm	1934	0.5171	0.0813	0.5667	0.43
Ø 1.80 mm	1300	0.7691	0.0910	0.9012	0.25
Ø 2.00 mm	1215	0.8231	0.1396	0.9156	0.21

MEASUREMENT TIPS

- Ensure that there is no fast-pulsatory movement of the media
- Ensure that there are no reverse pressure surges
- Ensure that there is no air in the system
- Note the mounting position of the flowmeter
- Min/max flow should be in the linear range of the selected flowmeter
- Clean the system at appropriate intervals
- Avoid electrical current peaks
- Incorrect cabling of power supply +, signal and ground will destroy the flowmeter
- Do not mechanically load electrical contacts
- Avoid moisture on the electrical contacts
- Avoid stray pick-up via the cable (Do not lay cables in parallel with high current loads)

The values specified must be considered as approximate values.

The number of pulses per litre may differ depending on medium and installation.

We recommend to calibrate the number of pulses per litre in line with the complete installation.

Measurement Curve FHKSC 1.80 mm 180° (#932-9502/B180)

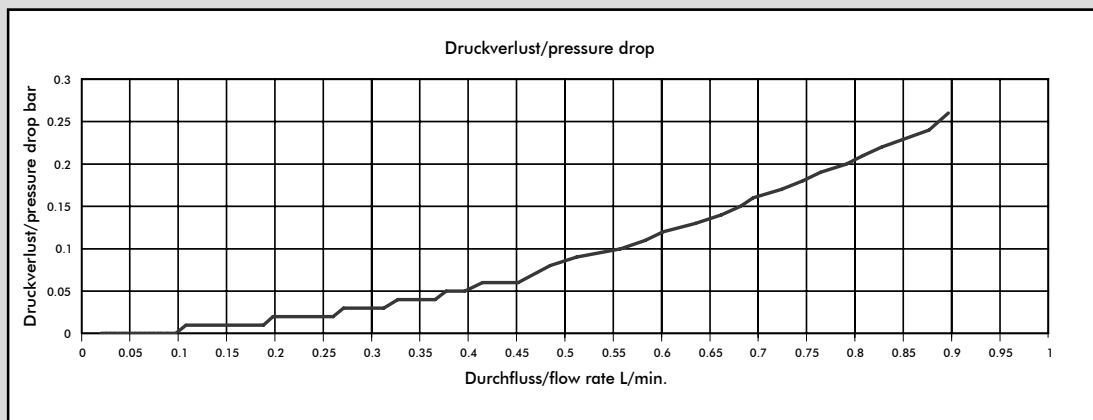
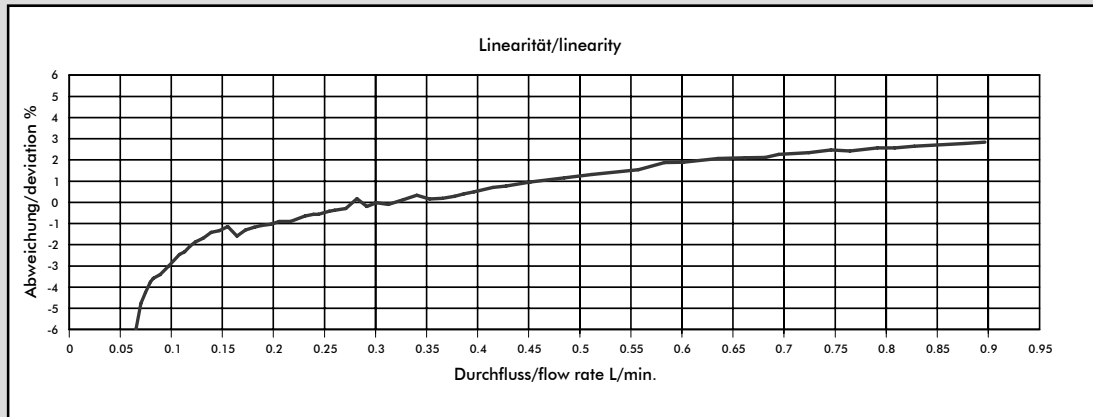

Medium: Water / max. Pressure: 1 bar

Nozzle size	Pulses/litre	g/pulse	min. flow rate in litres/min at Linear start	max. flow rate in litres/min	Pressure loss
Ø 1.00 mm	2476	0.4038	0.0560	0.4044	0.48
Ø 1.20 mm	2016	0.4960	0.1022	0.5705	0.43
Ø 1.80 mm	1360	0.7349	0.1185	0.8966	0.26
Ø 2.00 mm	1280	0.7815	0.1785	0.9175	0.22

MEASUREMENT TIPS

- Ensure that there is no fast-pulsatory movement of the media
- Ensure that there are no reverse pressure surges
- Ensure that there is no air in the system
- Note the mounting position of the flowmeter
- Min/max flow should be in the linear range of the selected flowmeter
- Clean the system at appropriate intervals
- Avoid electrical current peaks
- Incorrect cabling of power supply +, signal and ground will destroy the flowmeter
- Do not mechanically load electrical contacts
- Avoid moisture on the electrical contacts
- Avoid stray pick-up via the cable (Do not lay cables in parallel with high current loads)

The values specified must be considered as approximate values.

The number of pulses per litre may differ depending on medium and installation.

We recommend to calibrate the number of pulses per litre in line with the complete installation.

Measurement Curve FHKSC 1.80 mm 270° (#932-9502/B270)

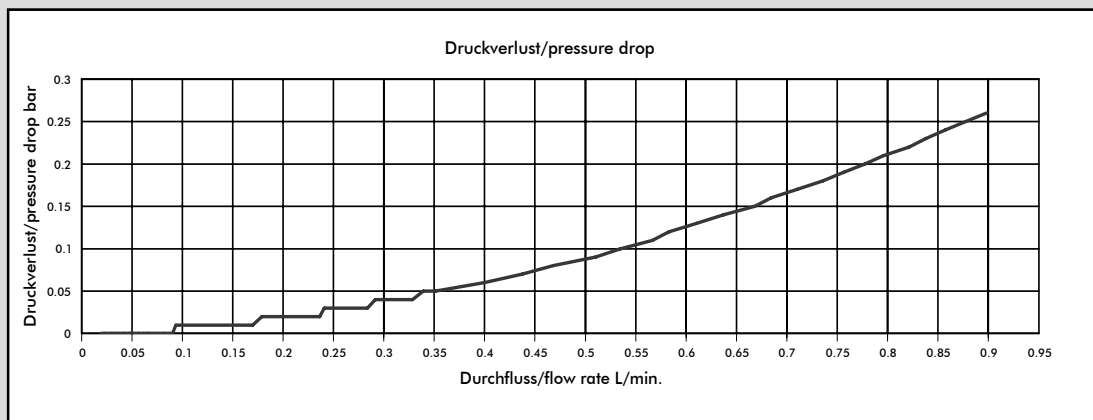
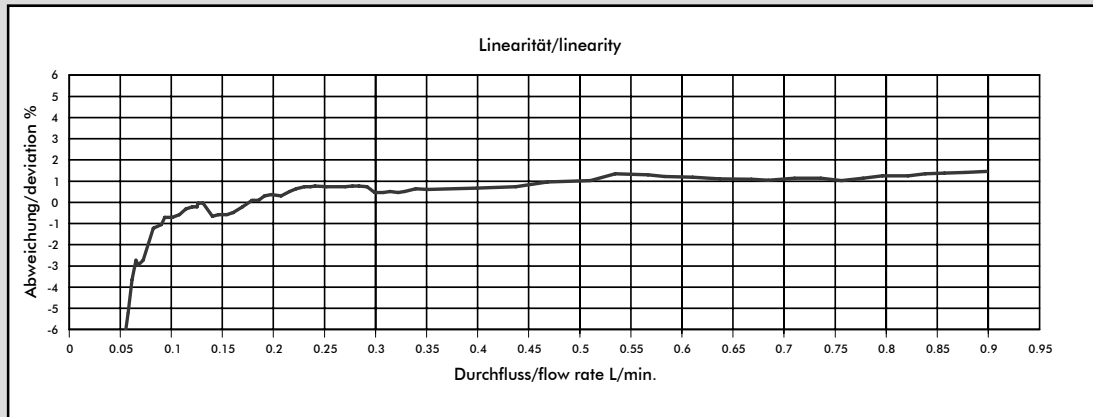

Medium: Water / max. Pressure: 1 bar

Nozzle size	Pulses/litre	g/pulse	min. flow rate in litres/min at Linear start	max. flow rate in litres/min	Pressure loss
Ø 1.00 mm	2436	0.4105	0.0427	0.4019	0.48
Ø 1.20 mm	2012	0.4969	0.0801	0.5677	0.42
Ø 1.80 mm	1352	0.7397	0.0824	0.8982	0.26
Ø 2.00 mm	1274	0.7849	0.1573	0.9056	0.22

MEASUREMENT TIPS

- Ensure that there is no fast-pulsatory movement of the media
- Ensure that there are no reverse pressure surges
- Ensure that there is no air in the system
- Note the mounting position of the flowmeter
- Min/max flow should be in the linear range of the selected flowmeter
- Clean the system at appropriate intervals
- Avoid electrical current peaks
- Incorrect cabling of power supply +, signal and ground will destroy the flowmeter
- Do not mechanically load electrical contacts
- Avoid moisture on the electrical contacts
- Avoid stray pick-up via the cable (Do not lay cables in parallel with high current loads)

The values specified must be considered as approximate values.

The number of pulses per litre may differ depending on medium and installation.

We recommend to calibrate the number of pulses per litre in line with the complete installation.

Measurement Curve FHKSC 2.00 mm 0° (#932-9506/B)

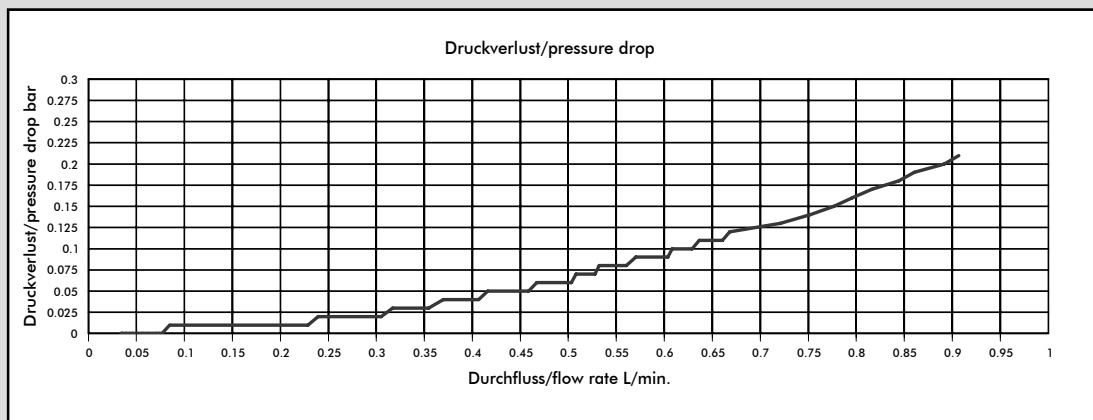
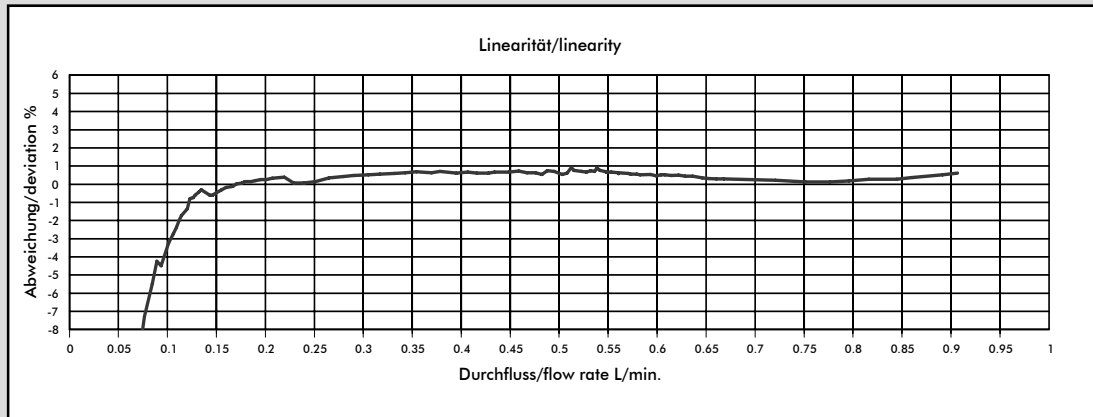

Medium: Water / max. Pressure: 1 bar

Nozzle size	Pulses/litre	g/pulse	min. flow rate in litres/min at Linear start	max. flow rate in litres/min	Pressure loss
Ø 1.00 mm	2382	0.4197	0.0333	0.4023	0.48
Ø 1.20 mm	1925	0.5194	0.0750	0.5692	0.42
Ø 1.80 mm	1315	0.7601	0.0753	0.8994	0.25
Ø 2.00 mm	1250	0.8001	0.1121	0.9068	0.21

MEASUREMENT TIPS

- Ensure that there is no fast-pulsatory movement of the media
- Ensure that there are no reverse pressure surges
- Ensure that there is no air in the system
- Note the mounting position of the flowmeter
- Min/max flow should be in the linear range of the selected flowmeter
- Clean the system at appropriate intervals
- Avoid electrical current peaks
- Incorrect cabling of power supply +, signal and ground will destroy the flowmeter
- Do not mechanically load electrical contacts
- Avoid moisture on the electrical contacts
- Avoid stray pick-up via the cable (Do not lay cables in parallel with high current loads)

The values specified must be considered as approximate values.

The number of pulses per litre may differ depending on medium and installation.

We recommend to calibrate the number of pulses per litre in line with the complete installation.

Measurement Curve FHKSC 2.00 mm 90° (#932-9506/B90)

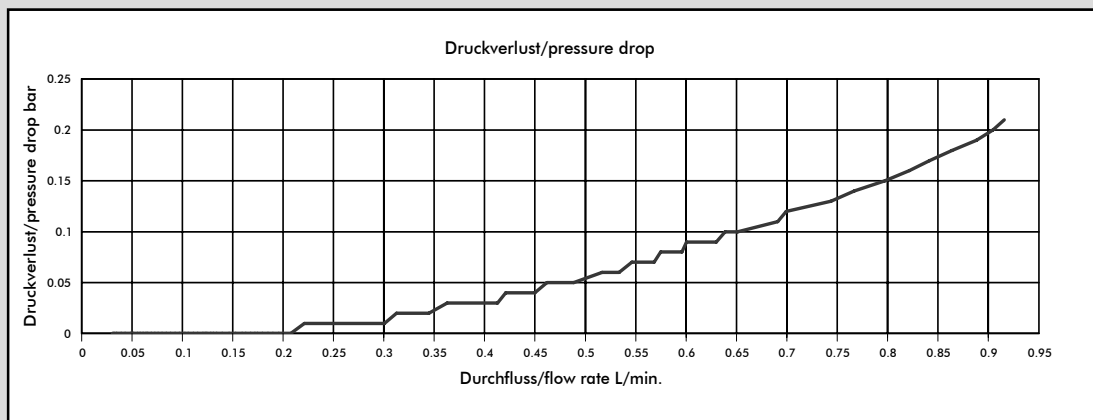
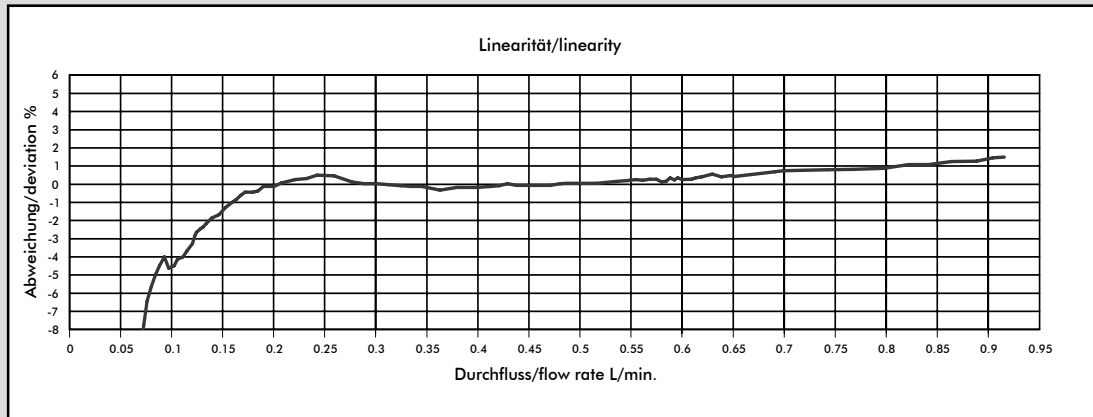

Medium: Water / max. Pressure: 1 bar

Nozzle size	Pulses/litre	g/pulse	min. flow rate in litres/min at Linear start	max. flow rate in litres/min	Pressure loss
Ø 1.00 mm	2386	0.4191	0.0500	0.4023	0.48
Ø 1.20 mm	1934	0.5171	0.0813	0.5667	0.43
Ø 1.80 mm	1300	0.7691	0.0910	0.9012	0.25
Ø 2.00 mm	1215	0.8231	0.1396	0.9156	0.21

MEASUREMENT TIPS

- Ensure that there is no fast-pulsatory movement of the media
- Ensure that there are no reverse pressure surges
- Ensure that there is no air in the system
- Note the mounting position of the flowmeter
- Min/max flow should be in the linear range of the selected flowmeter
- Clean the system at appropriate intervals
- Avoid electrical current peaks
- Incorrect cabling of power supply +, signal and ground will destroy the flowmeter
- Do not mechanically load electrical contacts
- Avoid moisture on the electrical contacts
- Avoid stray pick-up via the cable (Do not lay cables in parallel with high current loads)

The values specified must be considered as approximate values.

The number of pulses per litre may differ depending on medium and installation.

We recommend to calibrate the number of pulses per litre in line with the complete installation.

Measurement Curve FHKSC 2.00 mm 180° (#932-9506/B180)

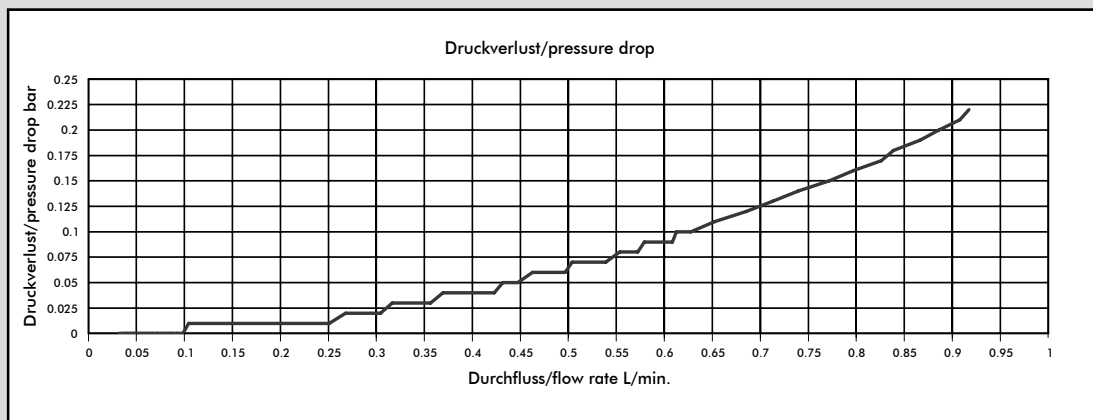
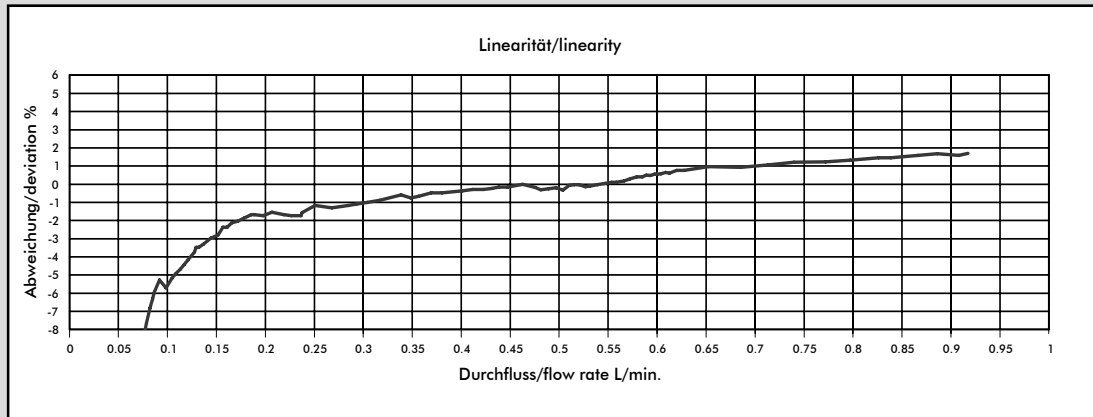

Medium: Water / max. Pressure: 1 bar

Nozzle size	Pulses/litre	g/pulse	min. flow rate in litres/min at Linear start	max. flow rate in litres/min	Pressure loss
Ø 1.00 mm	2476	0.4038	0.0560	0.4044	0.48
Ø 1.20 mm	2016	0.4960	0.1022	0.5705	0.43
Ø 1.80 mm	1360	0.7349	0.1185	0.8966	0.26
Ø 2.00 mm	1280	0.7815	0.1785	0.9175	0.22

MEASUREMENT TIPS

- Ensure that there is no fast-pulsatory movement of the media
- Ensure that there are no reverse pressure surges
- Ensure that there is no air in the system
- Note the mounting position of the flowmeter
- Min/max flow should be in the linear range of the selected flowmeter
- Clean the system at appropriate intervals
- Avoid electrical current peaks
- Incorrect cabling of power supply +, signal and ground will destroy the flowmeter
- Do not mechanically load electrical contacts
- Avoid moisture on the electrical contacts
- Avoid stray pick-up via the cable (Do not lay cables in parallel with high current loads)

The values specified must be considered as approximate values.

The number of pulses per litre may differ depending on medium and installation.

We recommend to calibrate the number of pulses per litre in line with the complete installation.

Measurement Curve FHKSC 2.00 mm 270° (#932-9506/B270)

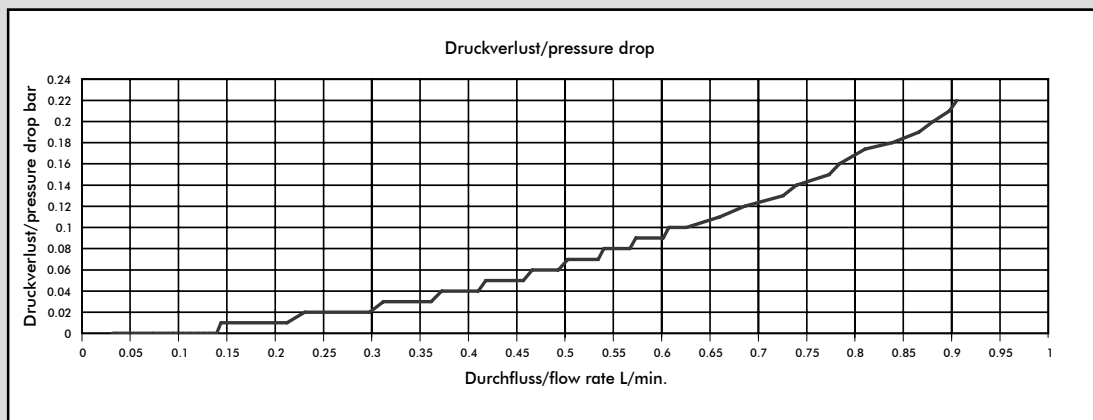
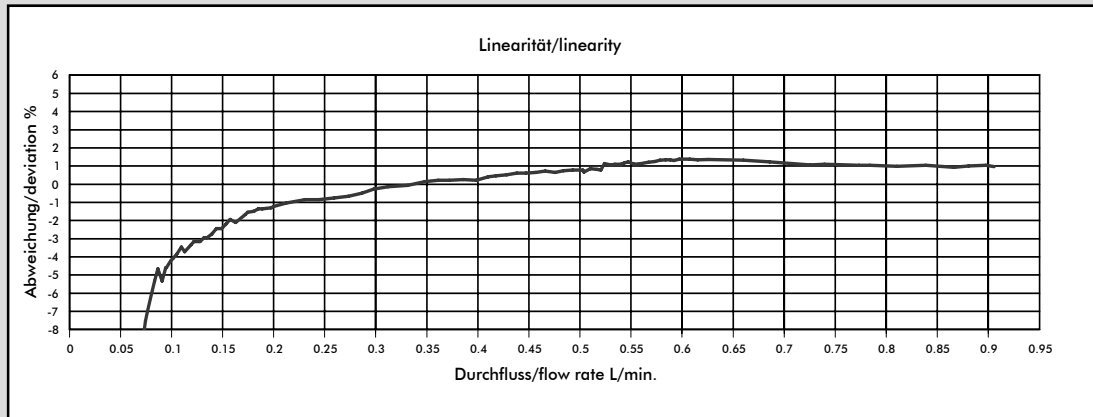

Medium: Water / max. Pressure: 1 bar

Nozzle size	Pulses/litre	g/pulse	min. flow rate in litres/min at Linear start	max. flow rate in litres/min	Pressure loss
Ø 1.00 mm	2436	0.4105	0.0427	0.4019	0.48
Ø 1.20 mm	2012	0.4969	0.0801	0.5677	0.42
Ø 1.80 mm	1352	0.7397	0.0824	0.8982	0.26
Ø 2.00 mm	1274	0.7849	0.1573	0.9056	0.22

MEASUREMENT TIPS

- Ensure that there is no fast-pulsatory movement of the media
- Ensure that there are no reverse pressure surges
- Ensure that there is no air in the system
- Note the mounting position of the flowmeter
- Min/max flow should be in the linear range of the selected flowmeter
- Clean the system at appropriate intervals
- Avoid electrical current peaks
- Incorrect cabling of power supply +, signal and ground will destroy the flowmeter
- Do not mechanically load electrical contacts
- Avoid moisture on the electrical contacts
- Avoid stray pick-up via the cable (Do not lay cables in parallel with high current loads)

The values specified must be considered as approximate values.

The number of pulses per litre may differ depending on medium and installation.

We recommend to calibrate the number of pulses per litre in line with the complete installation.

