

Automate™ Pulse 2 LINQ

OVERVIEW

The Automate Pulse LINQ tool has been designed to help integrators & installers validate and troubleshoot their Automate Pulse 2 installations before integrating into 3rd party systems. Pulse LINQ supports communication via Ethernet Cable (CAT 5) and 2.4GHz Wireless Communication to aid in integrations.

THE APP ALLOWS FOR:

- Connection to your Pulse 2 Hub via Wi-Fi Network or Ethernet connection. Supports operational control of devices (motors) that are connected to hubs in a project and provides a utility to test and verify the ASCII protocol for controlling and configuring motors, as well as providing logs of motor responses to better understand the protocol.
 - Note, cabled LAN connections require the Hubs to be first paired to the user account via the Automate Pulse 2 App on a WiFi connection before the LAN connection is activated on the Hub.
- The application is intended to provide a trouble shooting resource to allow RA support staff to verify the hubs and motors in a project are paired and functioning properly prior to connecting the system to any 3rd parties, in order to confirm any connectivity or operational issues subsequently encountered are network, or driver relayed to assist in diagnosing and troubleshooting issues.

PULSE 2 CONNECTION

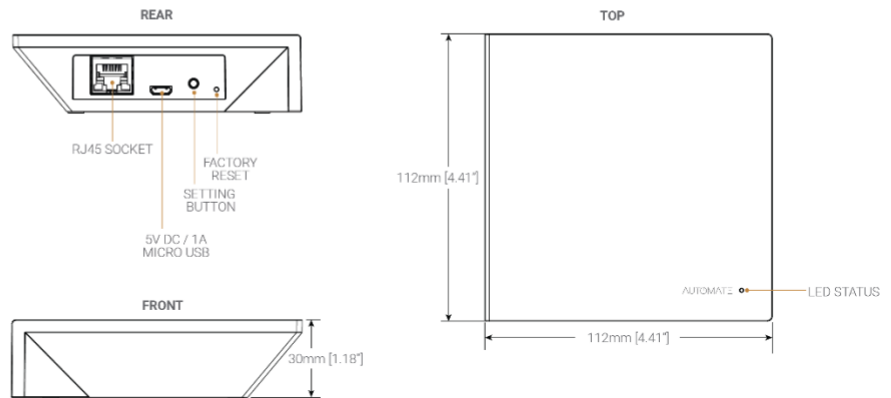
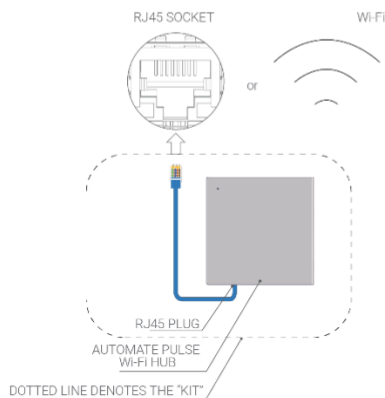

ADDITIONAL INFORMATION:

- The CAT 5 cable should be no longer than 100 meters (328ft).
- Router, switch or access point are required to connect the Hub via LAN connection;
- Wi-Fi repeater is required depending on the cover of the Wi-Fi Router signal.
- The AUTOMATE PULSE HUB 2.0 works only with Wi-Fi in 2.4Ghz (not 5Ghz).

The standard connections of the Automate Pulse Hub 2.0 is Ethernet or Wi-fi, for a LAN connection, you can use a straight through wiring accordingly indicated below:

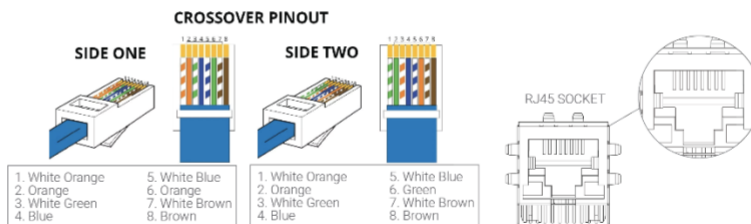



GETTING STARTED

Before you can use the Automate Pulse LINQ tool you first need to provision the Automate Pulse 2 hub(s) via a mobile device. Here is a quick guide of how to provision a hub. Please find linked complete provisioning instructions for you preferred platform.

- Downloaded the free Automate Pulse 2 app via the Apple App Store or Google Play store.
- Create an account, sign into the App.
 - Note: Initial Hub pairing **MUST** be performed via a Wi-Fi connection with internet access, before the ethernet / TCP port will be active. Do **NOT** attempt the hub pairing process with the hub connected via the ethernet port as the pairing will fail.

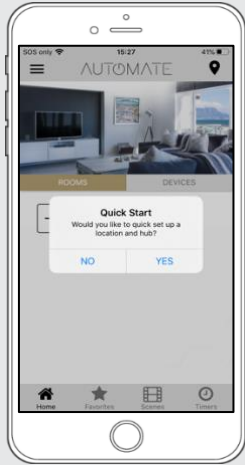
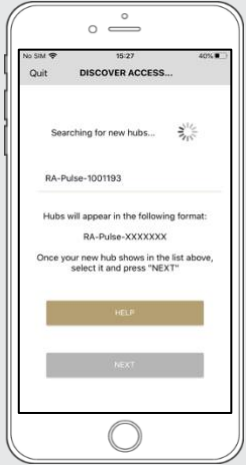
QUICK iOS APP SETUP: Complete iOS instructions found [HERE](#)

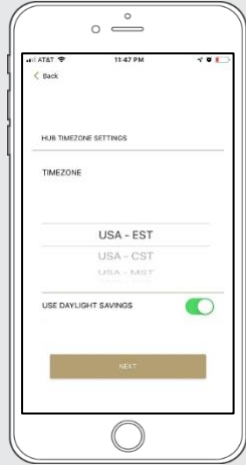
STEP 1 – QUICK START	STEP 2 – DISCOVER HUB	STEP 3 – SCAN HUB	STEP 4 – TIMEZONE
			
Follow the Quick Start instructions.	From the list select the hub to which you wish to pair and select "Next".	Scan the QR Code in the rear of the Hub to synchronize with the HomeKit function	Important select Time zone correctly for the HUB to Display & Timers to work correctly.

QUICK ANDROID APP SETUP: Complete Android instructions found [HERE](#)

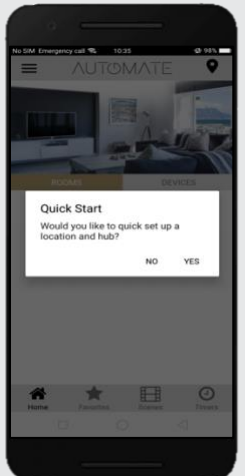
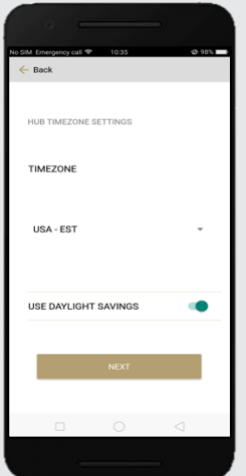
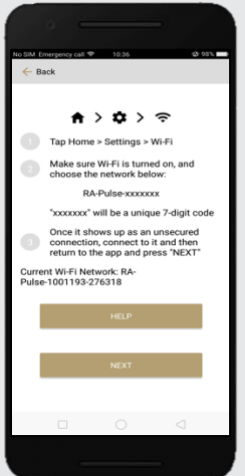
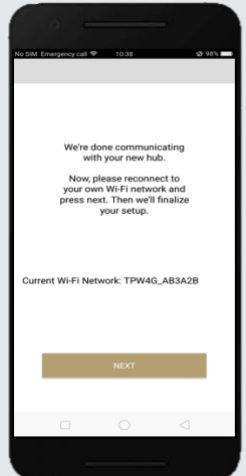
STEP 1 – QUICK START	STEP 2 – TIMEZONE	STEP 3 – WIFI SETTINGS	STEP 4 – COMPLETE
			
Follow the Quick Start instructions	Important select Time zone correctly for the HUB to Display & Timers to work correctly.	After connecting to the RA_Pulse_xxxx network, press "Next" to move to pair hub.	Press the "Next" button to complete the Hub configuration.

SETUP BEST PRACTICES:

- We recommend pairing and setting limits for motors via a remote, then pairing the motors to the hub via the Automate PULSE 2 mobile device app before connecting to the Pulse LINQ tool.
- The Hub must be within signal range of both the automated shades and the connected via Lan or Wi-Fi router.
- Connect the Computer to the same network / sub-net via Lan or Wi-Fi that the Automate Pulse 2 Hub is connected too.
- If you chose to use the Wi-Fi network, verify that it is visible and is a 2.4GHz connection.

PULSE LINQ SETUP:

Once you have completed the Automate Pulse 2 hub provisioning from a mobile device.

- Download & Install the latest Pulse LINQ version for either Windows [HERE](#) or Mac [HERE](#).

PULSE LINQ NAVIGATION:

Home - Shows the main control screen.

Control Utility - Connect to any hub(s) and select any number of motors to send commands.

System Test - Connect to any hub(s) and select any number of motors to perform a quick system test.

Help - A place to find where to get help.

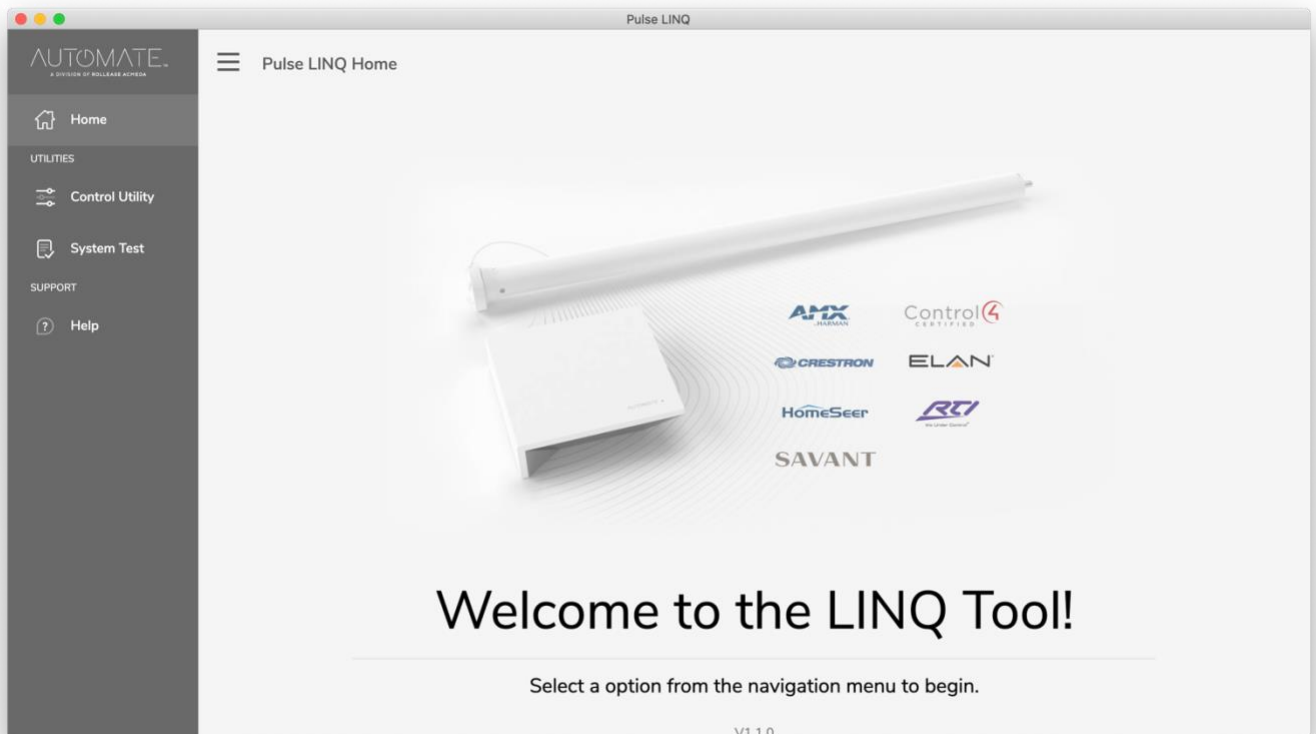

CONTROL UTILITY

The Control Utility is designed to allow you to send commands to motors, this tool is NOT designed to control or setup rooms, scenes & timers.

- To connect to the Hub(s) that are provisioned on the network,
 - If you know the IP address, then you can connect by entering the individual hub IP address.
 - You can “scan for hubs” on the network using the dropdown feature on the “Connect” button. This will search for all hubs on the network and automatically populate them and the connected motors in the utility.

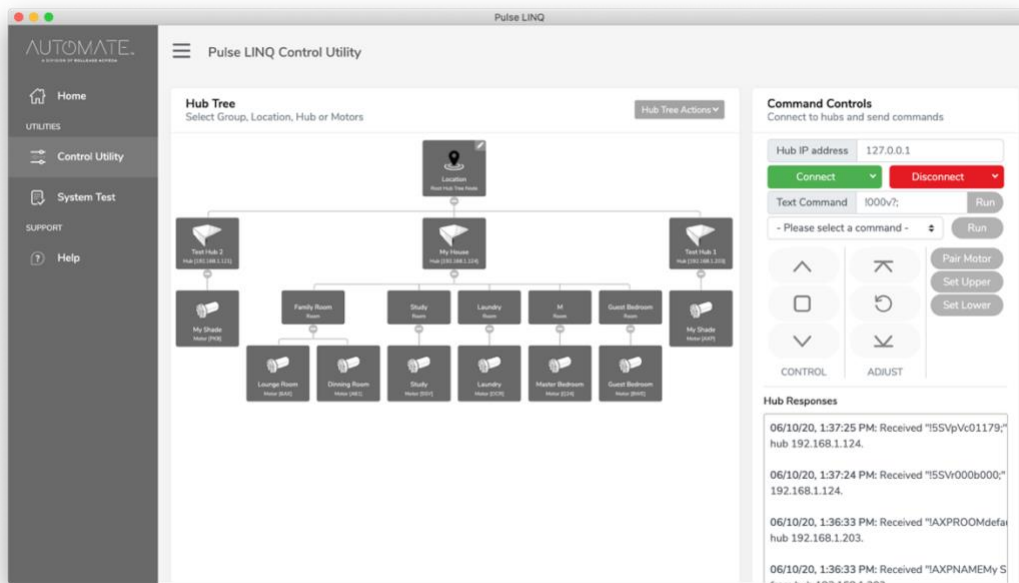
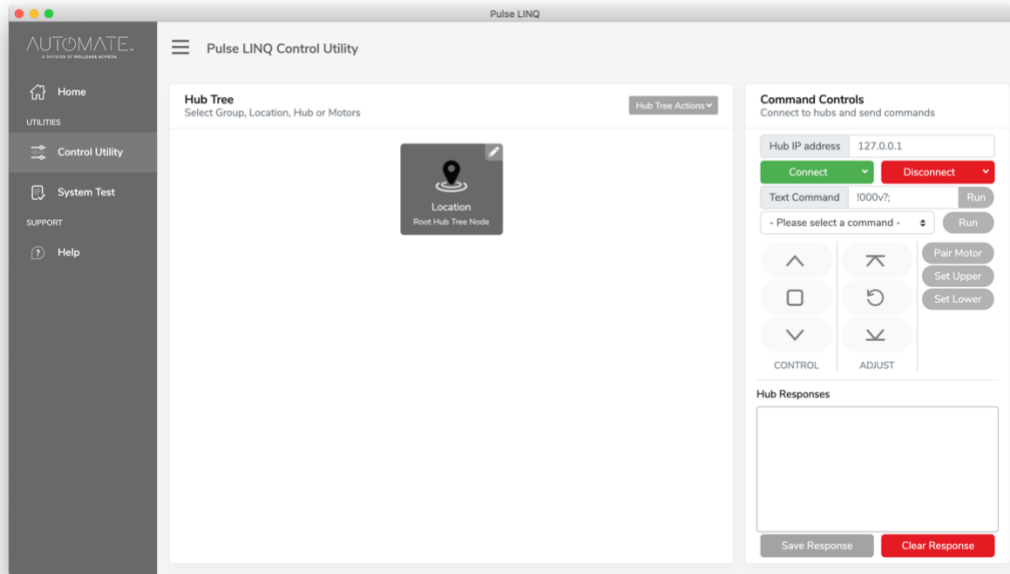

- Once connected to a Hub it will populate any rooms or motors that have been connected to the hub in the “Hub Tree”.
- To send a command to a hub or motor you must select the device you want to send the command to first then.
- On the right you will have the Command Controls from this you can;
 - either select a command from the drop-down list or type a text command.
 - Basic Motor controls.
 - See Hub Responses.

SYSTEM TEST

- From the system test tab, you can connect to hub(s) that are connected to the network via IP address or scanning the network.
- Once connected to a hub all motors will be populated in a list form below.

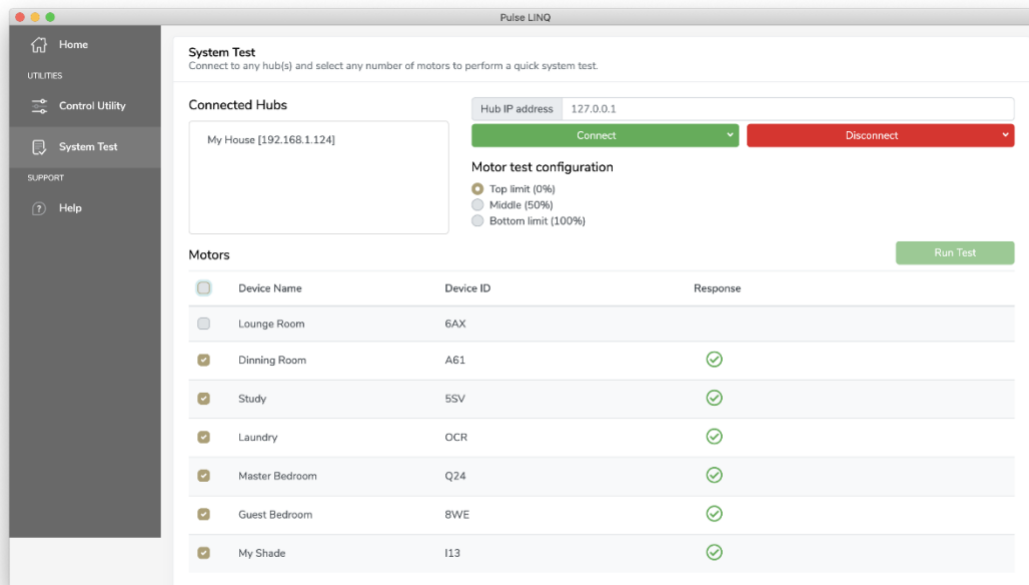
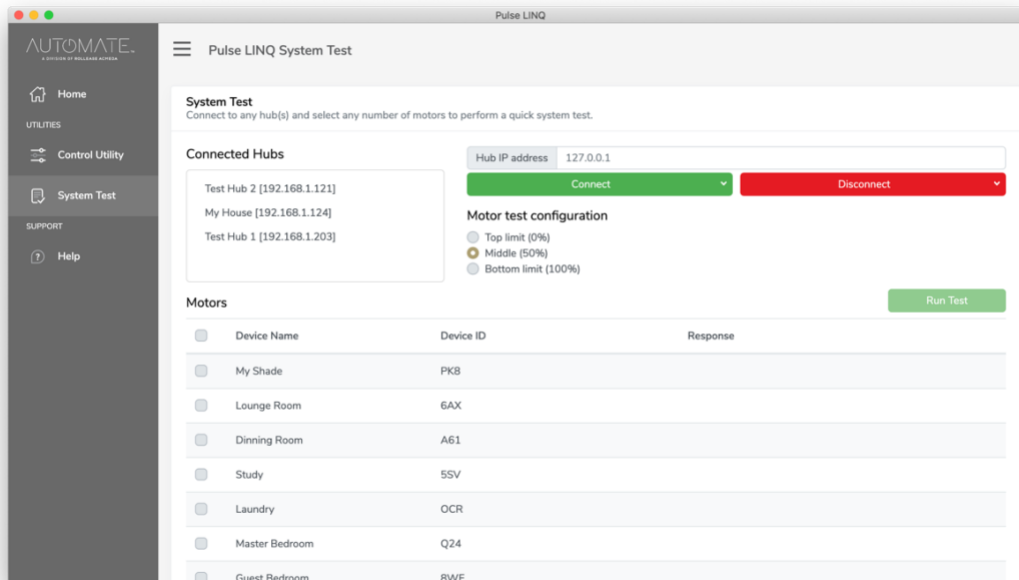

- To run a system test you need to select the motors you wish to perform the test on then select the Motor test configuration option then Run Test.
- Once a test has run you will get a response on whether the hub has received a response from the motor.
- If you get a warning this means the motor has not responded to the hub please check that the motor is within range, there is minimal interference and there is power to the motor.
- This page will also populate the device serial ID for each motor.

ASCII PROTOCOL

ASCII Protocol is for use in diagnosing communication issues, and for proactively integrating to the Pulse 2 hub via ASCII protocol over TCP/IP to any 3rd party system not already supported.

HUB CONFIGURATION

Downlink messages – Messages from a Controller / PC relayed to ARC motor via the Pulse 2 Hub.

Uplink messages – Messages from ARC motors relayed to Controller / PC via a Pulse 2 Hub.

Start Character	Address	Command	Data	End Character
!	3 Bytes ASCII Character 0-9 & A-Z, broadcast address 000 for query, range 001-ZZZ	1 Byte ASCII Character Non-numerical ASCII	Optional “?” for inquiry of motor status	;

PULSE HUB 2 COMMANDS

The address “000” is reserved for global commands.

Also note that room, scene & timer commands are not supported in ASCII commands.

Module: RF module

Destination:

- To motor, main controller send command to module to operate motor
- To module, main controller send command to module to operate motor
- From motor, motor returns information to module

Command	Command Description	Example	Destination	Bytes	Example description
&	Pairing	!000&;	To Motor (Bi-directional motors)	0	No data, module creates a random motor address for this to be paired motor Motor feedback: !XXXX; XXX is a 3 characters ASCII address
&	Pairing	!000&XXX;	To Motor	3	XXX : main controller sends a specified 3 ASCII characters (0 – 9 , A – Z) as the motor address for this to be paired motor Motor feedback : !XXXX; XXX is the specified 3 characters ASCII address
*	Reset module	!000*;	To Module	0	Reset module, delete all the module configuration/information
#	Unpair motor(Need motor feedback)	!123#;	To Motor	0	No data Motor feedback: !123A; Unpair motor success
\$	Delete motor(Do not need motor feedback)	!123\$;	To Module	0	Delete motor (Motor address:123)
A	Address edit feedback	!123A;	From Motor	0	Motor address edit success
b	Tilt control	!123b%%;	To Motor	2	%% = 00-99 (%) Tilt control percentage

					Motor feedback: [Motor without limit, motor returns E] [Motor limited; motor returns current type percentage when it stops]
c	Down control	!123c;	To Motor	0	No data Motor feedback [Motor without limit, no feedback] [Limited, motor returns current lift percentage when it stops]
c	JOG down control	!123cA;	To Motor	1	A : JOG Motor feedback [Motor without limit, no feedback] [Limited, motor returns current lift percentage when it stops]
m	Lift percentage control	!123m%%;	To Motor	2	%% = 00-99 (%) percentage value Motor feedback: [Motor without limit, no feedback, return E] [Limited, motor returns current lift percentage when it stops]
o	Open control	!123o;	To Motor	0	No data Motor feedback [Motor without limit, no feedback] [Limited, motor returns current lift percentage when it stops]
o	JOG open control	!123oA;	To Motor	1	A : JOG Motor feedback [Motor without limit, no feedback] [Limited, motor returns current lift percentage when it stops]
r	Inquiry the current motor position.	!123r?;	To Motor	1	? For inquiry information Motor feedback [Motor without limit, no feedback] [Limited, motor returns current lift percentage immediately]
r	Current position feedback	!123r%%b% %;	From Motor	2	%% = 00-99 (%) current lift position value
s	Stop control	!123s;	To Motor	0	No data Motor feedback [Motor without limit, no feedback] [Limited, motor returns current lift percentage immediately]
v	Read motor version	!123v?;	To Motor	1	? for inquiry information
v	Motor version feedback	!123vTVV;	From Motor	3	T = Type

					= A ,ac motor = B ,hub/gateway = C ,curtain motor = D ,dc motor = S ,socket = L ,lighting VV = version = 10 V1.0
E	Error	!123Exx;	From Motor	2	xx = bz // Inside the hub, the 433MHz module misses the message from the WIFI module when the first module is communicating with the paired motors. = df // The motors paired to the hub are more than the number limit of 30 motors. = np // Invalid motor address. The motor address is not in the paired motor list of the hub. = nc // The upper or low limits are not set for the paired motor. = mh //Master Hall sensor is in abnormal condition. = sh //Slave Hall sensor is in abnormal condition. = or // The motor is stalled by an obstacle during upper movement. = cr // The motor is stalled by an obstacle during down movement. = pl // Low voltage alarm of the motor power = ph // High voltage alarm of the motor power = nl // The hub cannot get the response from the target motor. = ec // Undefined errors.

PARAMETER ILLUSTRATION

Character(ASCII code)& illustration		Main controller send	Motor response	Illustration
E	Motor limit set	!123pEoH;	!123pEoH;	Set upper limit on current position
		!123pEcH;	!123pEcH;	Set down limit on current position
		!123pEoA;	!123pEoA;	Adjust upper limit
		!123pEcA;	!123pEcA;	Adjust down limit
		!123pEaC;	!123pEaC;	Delete all limits
R	Factory mode	!123pR*;	!123pR*;	Motor resume factory mode
V	Motor voltage	!123pVc?;	!123pVc01198;	Check the current voltage of motor and motor response: 11.98V.

TROUBLESHOOTING

The following scenarios are common issues that may cause connectivity problems between Pulse LINQ and Pulse 2. If you cannot achieve success connecting the Pulse LINQ to your network, please reference the below most common pairing roadblocks.

HAVING ISSUES DISCOVERING HUB(S).

When you have a problematic hub that refuses to establish a full connection. Either connect to the Hub via the IP address or Power cycle the hub.

CONNECTION WITH PULSE LINQ AND PULSE 2 IS NOT CONSISTENTLY WORKING.

There are many things that can interfere with the radio communication that the AUTOMATE PULSE HUB 2 uses. Try positioning the AUTOMATE PULSE HUB 2 in a different location and/or closer to the shade to improve performance. Due to varying levels of interference it may be necessary to purchase additional Wi-Fi bridges to extend the coverage throughout your location.

MOVING MULTIPLE MOTORS & NOT ALL MOTORS ARE RESPONDING.

Check that all motors are within signal range of the AUTOMATE PULSE HUB 2. Try moving the AUTOMATE PULSE HUB 2 closer to non-responding motors to confirm if it is an interference issue or motor issue. Also try to move a motor by itself and not within a group command, as this tool bypasses any of the group logic that is built into the hub and the AUTOMATE App. This tool is designed to send and receive raw data between the motor and the hub.

*Please note this product is only compatible with the Automate Pulse 2 Hub.

SUPPORT RESOURCES:

For further assistance, contact your retailer, visit our websites;

Australian Support website [HERE](#)

USA Support website [HERE](#)

Europe Support website [HERE](#)