

INPUT1

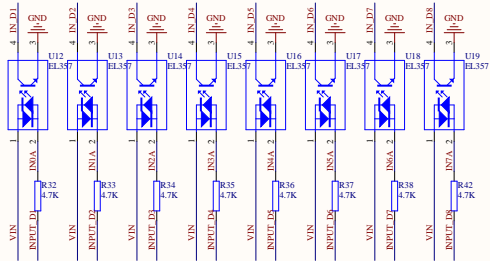

INPUT2

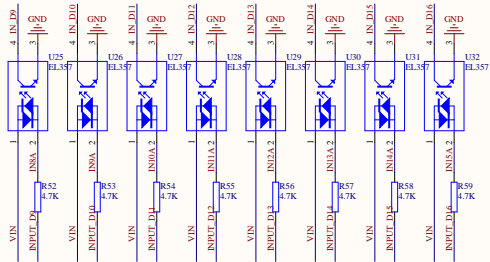

PWM

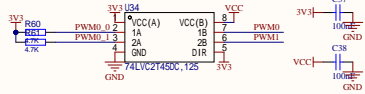

RS232

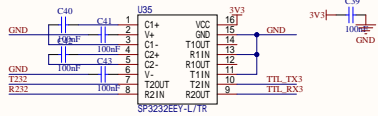

BEEP

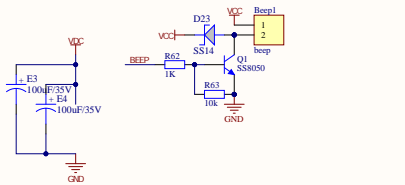

4G

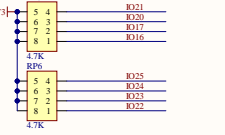
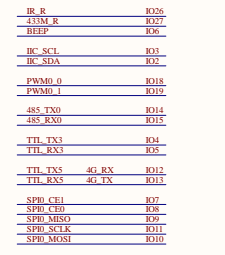
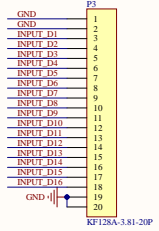
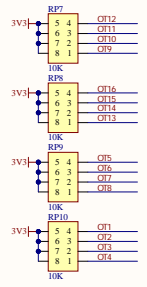
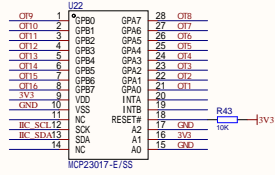
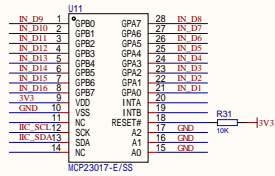
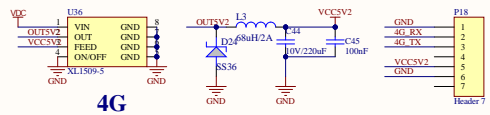

OUTPUT

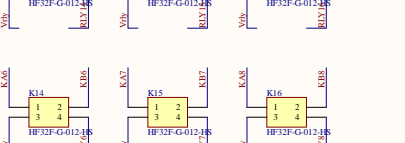
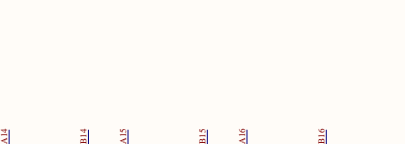
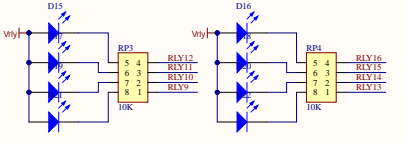
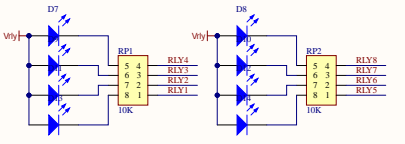
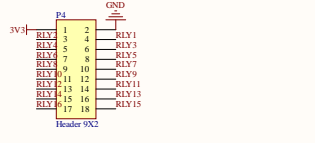
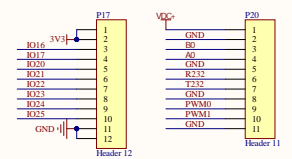
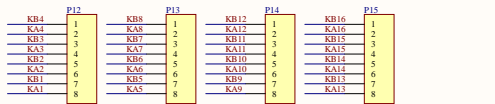
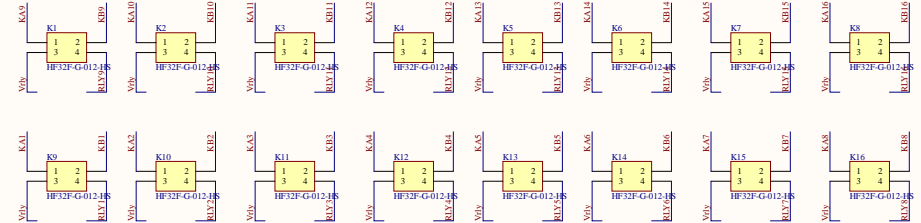
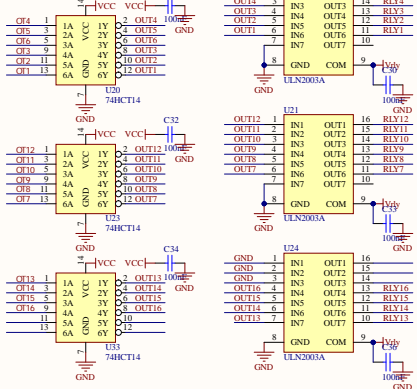

Title		
Size	Number	Revision
A2		
Date	6/16/2024	Sheet of
File	C:\Users\jmont_V1.2\SchDoc	Drawn By: