



E22-400T30DC User Manual

SX1262 433/470MHz 1W LoRa Module



Chengdu Ebyte Electronic Technology Co.,Ltd.

CONTENTS

1. OVERVIEW.....	3
1.1 INTRODUCTION.....	4
1.2 FEATURES.....	4
1.3 APPLICATION.....	5
2. SPECIFICATION AND PARAMETER.....	5
2.1 LIMIT PARAMETER.....	5
2.2 OPERATING PARAMETER.....	5
3 SIZE AND PIN DEFINITION.....	6
4. CONNECT TO MCU.....	8
5 FUNCTION DESCRIPTION.....	9
5.1 FIXED TRANSMISSION.....	9
5.2 BROADCASTING TRANSMISSION.....	9
5.3 BROADCASTING ADDRESS.....	9
5.4 MONITOR ADDRESS.....	10
5.5 RESET.....	10
5.6 AUX DESCRIPTION.....	10
5.6.1 Indication of UART output.....	10
5.6.2 Indication of wireless transmitting.....	11
5.6.3 Configuration procedure of module.....	11
5.6.4 Notes for AUX.....	11
6 OPERATING MODE.....	12
6.1 MODE SWITCHING.....	12
6.2 NORMAL MODE (MODE 0)	13
6.3 WOR MODE (MODE 1)	13
6.4 CONFIGURATION MODE (MODE 2)	13
6.5 DEEP SLEEP MODE (MODE 3)	14
7 REGISTER READ AND WRITE CONTROL.....	14
7.1 COMMAND FORMAT.....	14
7.2 REGISTER DESCRIPTION.....	15
7.3 FACTORY DEFAULT PARAMETER.....	17
8 REPEATER NETWORKING MODE.....	17

9 CONFIGURATION INSTRUCTIONS ON COMPUTER.....	18
10 HARDWARE DESIGN.....	19
11 FAQ.....	20
11.1 COMMUNICATION RANGE IS TOO SHORT.....	20
11.2 MODULE IS EASY TO DAMAGE.....	20
11.3 BER(BIT ERROR RATE) IS HIGH.....	21
12 PRODUCTION GUIDANCE.....	21
12.1 REFLOW SOLDERING TEMPERATURE.....	21
12.2 REFLOW SOLDERING CURVE.....	22
13 E22 SERIES.....	22
14 ANTENNA RECOMMENDATION.....	23
15 PACKAGE FOR BATCH ORDER.....	24
ABOUT US.....	24

Disclaimer

EBYTE reserves all rights to this document and the information contained herein. Products, names, logos and designs described herein may in whole or in part be subject to intellectual property rights. Reproduction, use, modification or disclosure to third parties of this document or any part thereof without the express permission of EBYTE is strictly prohibited.

The information contained herein is provided “as is” and EBYTE assumes no liability for the use of the information. No warranty, either express or implied, is given, including but not limited, with respect to the accuracy, correctness, reliability and fitness for a particular purpose of the information. This document may be revised by EBYTE at any time. For most recent documents, visit www.ebyte.com.

1. Overview

1.1 Introduction

E22-400T30DC is new lora module (UART) based on SEMTECH's SX1262 RF chip. It has multiple transmission modes working at 410.125 ~ 493.125MHz, LoRa spread spectrum technology, TTL level output, compatible with 3.3V and 5V IO port voltage.

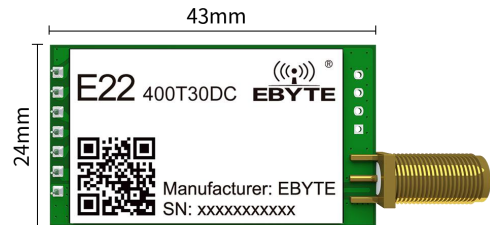

Compared with SX1278 , SX1262 solution has a longer transmission distance, faster speed, lower power consumption, and smaller size. It supports functions such as wake-up in the air, wireless configuration, carrier monitoring, automatic repeater, and communication key, and packet length setting, customized development services are available.

1.2 Features

- Based on SX1262 LoRa technology, it enables longer distance and better anti-interference ability.
- Automatic relay networking, multi-stage relay is suitable for ultra-long distance communication, multiple networks running in the same area are running simultaneously;
- Users to set their own communication keys and cannot be read, which greatly improves the confidentiality of user data;
- RSSI for evaluating signal quality, improving communication network, and ranging;
- With LBT for monitoring channel environmental noise before sending data, and for improving communication;
- Wireless parameter configuration, send command data packets wirelessly, remotely configure or read wireless module parameters;
- Wake-on-air, that is, ultra-low power consumption function, suitable for battery-powered applications;
- With fixed-point transmission, broadcast transmission, and channel monitoring;
- Global license-free ISM 433MHz and 470Mhz for meter reading ;
- In deep sleep mode, power consumption is 2uA ;
- With PA+LNA, communication distance tested is up to 6 km ;
- The parameters are saved after power-off. After power-on, the module will work according to the set parameters.
- High-efficiency watchdog design, once an exception occurs, the module will automatically restart and continue to work according to the previous parameter settings;
- Air data rate of 0.3kbps ~ 62.5kbps;
- 3.3V~5.5V power supply, power supply over 5.0 V can guarantee the best performance ;
- Industrial grade standard design, support -40 ~ 85 °C for working over a long time ;
- SMA-K interface for external antenna.

1.3 Application

- Home security alarm and remote keyless entry ;
- Smart home and industrial sensors ;
- Wireless alarm security system ;
- Building automation solutions ;
- Wireless industrial-grade remote control ;
- Health care products ;
- Advanced Meter Reading Architecture(AMI) ;
- Automotive industry applications.

2. Specification and parameter

2.1 Limit parameter

Main parameter	Performance		Remark
	Min.	Max.	
Power supply (V)	0	5.5	Voltage over 5.5V will cause permanent damage to module
Blocking power (dBm)	-	10	Chances of burn is slim when modules are used in short distance
Operating temperature (°C)	-40	85	/

2.2 Operating parameter

Main parameter		Performance			Remark
		Min.	Typ.	Max.	
Operating voltage (V)		3.3	5.0	5.5	≥5.0 V ensures output power
Communication level (V)			3.3		For 5V TTL, It is recommended to add level conversion
Operating temperature (°C)		-40	-	85	Industrial design
Operating frequency (MHz)		410.125	-	493.125	Support ISM band
Power consumption	TX current (mA)		610		Instant power consumption
	RX current (mA)		16		
	Sleep current (uA)		2		Software is shut down
Max Tx power (dBm)		29.5	30.0	30.5	
Receiving sensitivity (dBm)		-146	-147	-148	Air data rate is 2.4kbps
Air data rate (bps)		0.3k	2.4k	62.5k	Controlled via user's programming

Main parameter	Description	Remark
Distance for reference	10km	Test condition : clear and open area, antenna gain: 5dBi, antenna height: 2.5m, air data rate: 2.4kbps
TX length	240 Byte	Can be configured via command as 32/64/128/240 bytes per packet to transmit
Buffer	1000 Byte	
Modulation	LoRa	
Communication interface	UART	
Package	DIP	
Connector	1*7*2.54mm	
Size	24*43mm	
Antenna	SMA-K	50 ohm impedance

3 Size and pin definition

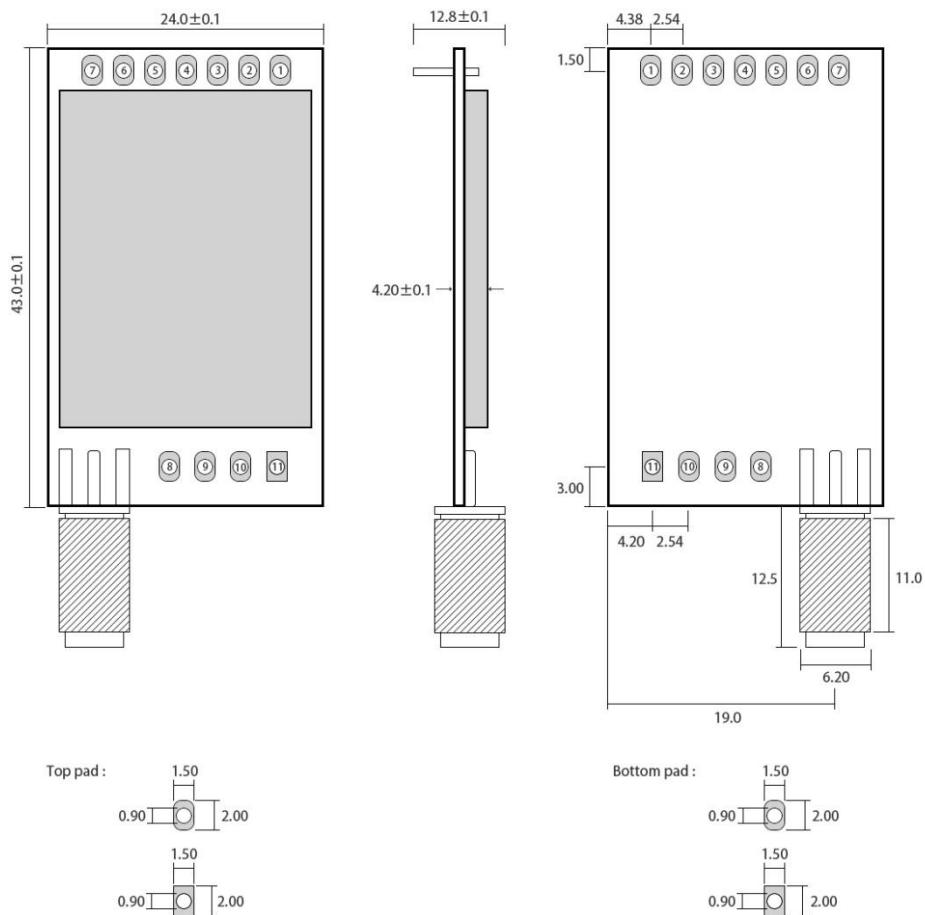

Pad quantity : 11
Unit: mm

No.	Name	Direction	Function
1	M0	Input (weak pull-up)	Work with M1 to decide 4 working modes of module (not suspended, if not used, could be grounded).
2	M1	Input (weak pull-up)	Work with M0 to decide 4 working modes of module (not suspended, if not used, could be grounded).
3	RXD	Input	TTL UART inputs, connects to external (MCU, PC) TXD output pin. Can be configured as open-drain or pull-up input. Ground
4	TXD	Output	TTL UART outputs, connects to external RXD (MCU, PC) input pin. Can be configured as open-drain or push-pull output
5	AUX	Output	To indicate module 's working status & wakes up the external MCU. During the procedure of self-check initialization, the pin outputs low level. Can be configured as push-pull output (can be suspended).
6	VCC	Input	Power supply : 3.3~ 5.5V DC
7	GND	Input	Ground
8	Fixed hole		Fixed hole
9	Fixed hole		Fixed hole
10	Fixed hole		Fixed hole
11	Fixed hole		Fixed hole

4. Connect to MCU

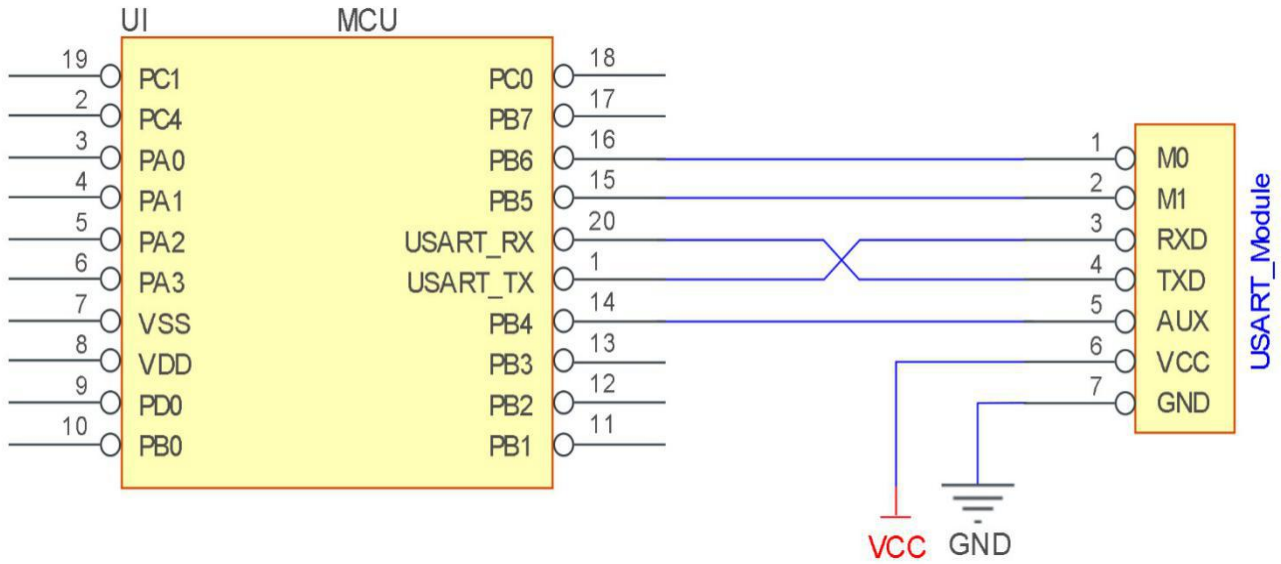

No.	Description (STM8L MCU)
1	The UART module is TTL level.
2	For some MCU works at 5VDC, it may need to add 4-10K pull-up resistor for the TXD & AUX pin.

5 Function description

5.1 Fixed transmission

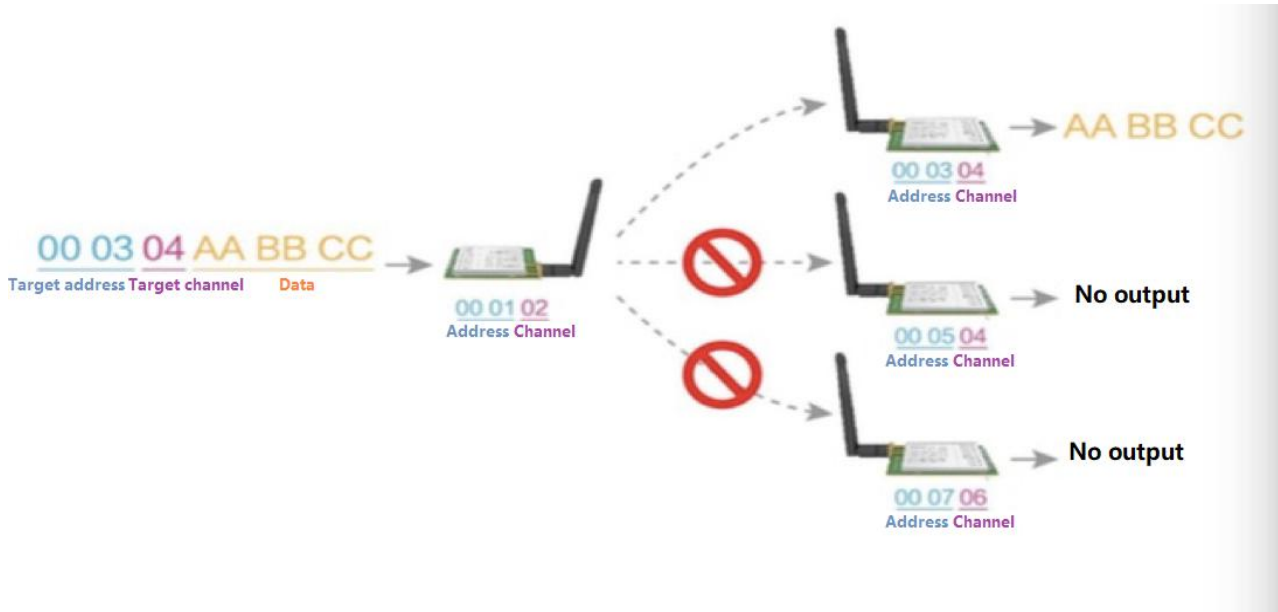

5.2 Broadcasting transmission



5.3 Broadcasting address

- For example: Set the address of module A as 0xFFFF or 0x0000, and the channel as 0x04;
- When module is the transmitter (transparent transmission), all modules under channel 0x04 will receive the data, the purpose of

broadcast is realized.

5.4 Monitor address

- For example: Set the address of module A as 0xFFFF or 0x0000, and the channel as 0x04;
- When module A is the receiver, it can receive the data sent from all modules under channel 0x04, the purpose of monitor is realized.

5.5 Reset

When the module is powered, AUX outputs low level immediately, conducts hardware self-check and sets the operating mode based on user's parameters. During the process, the AUX remains low level. After the process completed, the AUX outputs high level and starts to work as per the operating mode combined by M1 and M0. Therefore, users need to wait the AUX rising edge as the start of module's normal work.

5.6 AUX description

- AUX Pin can be used as indication for wireless send & receive buffer and self-check.
- It can indicate whether there are data that are not sent yet via wireless way, or whether all wireless data has been sent through UART, or whether the module is still in the process of self-check initialization.

5.6.1 Indication of UART output

- To wake up external MCU

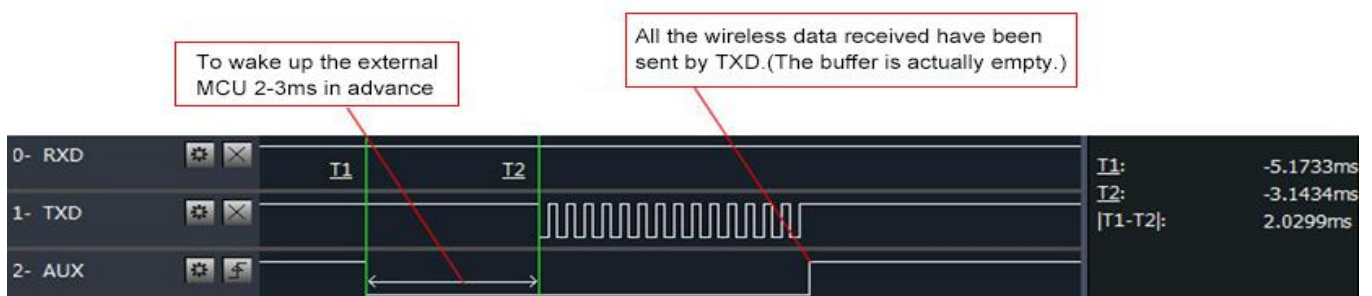

Timing Sequence Diagram of AUX when TXD pin transmits

5.6.2 Indication of wireless transmitting

Buffer (empty): the internal 1000 bytes data in the buffer are written to the RFIC (Auto sub-packaging). When AUX=1, the user can input data less than 1000 bytes continuously without overflow. Buffer (not empty): when AUX=0, the internal 1000 bytes data in the buffer have not been written to the RFIC completely. If the user starts to transmit data at this circumstance, it may cause overtime when the module is waiting for the user data, or transmitting wireless sub package. When AUX = 1, it does not mean that all the UART data of the module have been transmitted already, perhaps the last packet of data is still in transmission.

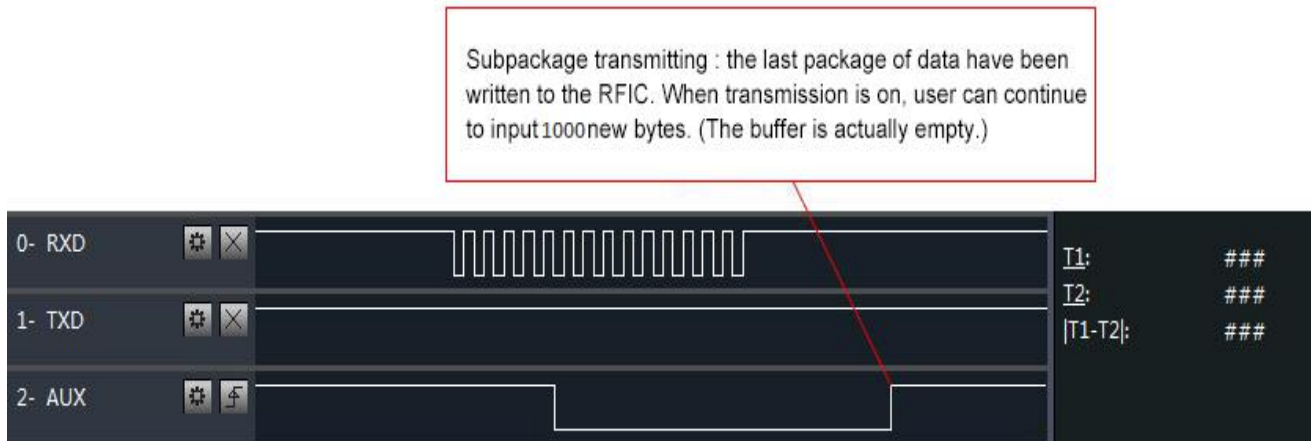

Timing Sequence Diagram of AUX when RXD pin receives

5.6.3 Configuration procedure of module

- Only happened when power-on resetting or exiting sleep mode



Timing Sequence Diagram of AUX when self-check

5.6.4 Notes for AUX

No.	Description
1	For function 1 & function 2 mentioned above, the priority should be given to the one with low level output, which means if it meets each of any low level output condition, AUX outputs low level, if none of the low level condition is met, AUX outputs high level.
2	When AUX outputs low level, it means the module is busy & cannot conduct operating mode checking. Within 1ms since AUX outputs high level, the mode switch will be completed.
3	After switching to new operating mode, it will not work in the new mode immediately until AUX rising edge lasts for 2ms . If AUX stays on the high level, the operating mode switch can be effected immediately.

4	When the user switches to other operating modes from mode 3 (sleep mode) or it's still in reset process, the module will reset user parameters, during which AUX outputs low level.
---	---

6 Operating mode

There are four operating modes, which are set by M1 and M0, the details are as follows:

Mode(0-3)	M1	M0	Description	Remark
0 Normal mode	0	0	UART and wireless channel are open, transparent transmission is on	Supports configuration over air via special command
1 WOR mode	0	1	Can be defined as WOR transmitter and WOR receiver	Supports wake up over air
2 Configuration mode	1	0	Users can access the register through the serial port to control the working state of the module	
3 Deep sleep mode	1	1	Sleep mode	

6.1 Mode switching

No.	Remark
1	<ul style="list-style-type: none"> ● Users can combine M1 and M0 with high and low levels to determine the operating mode. Two GPIOs of the MCU can be used to control mode switching; ● After changing M1 and M0: If the module is idle, after 1ms, it can start working according to the new mode; ● If the serial port data of the module has not been transmitted through the wireless, the new working mode can be switched after the transmission is completed; ● If the module receives the wireless data and transmits the data through the serial port, it needs to finish transmission before switching the new working mode; ● Therefore, mode switching can only be valid when AUX output is 1, otherwise it will delay switching.
2	<ul style="list-style-type: none"> ● For example, users continuously inputs a large amount of data and simultaneously performs mode switching. At this time, the switching mode operation is invalid; the module will process all the user data before performing the new mode detection; ● Therefore, the general recommendation is to detect the output state of the AUX pin and switch after 2ms when the output is high.
3	<ul style="list-style-type: none"> ● When the module is switched from other modes to sleep mode, if the data has not been processed yet; ● The module will process these data (including receiving and sending) before entering sleep mode. This feature can be used for fast sleep, which saves power; for example, the transmitter module works in mode 0, the user transmits the serial port data "12345", and then does not have to wait for the AUX pin to be idle (high level), and can directly switch to sleep mode. And the user's main MCU immediately sleeps, the module will automatically transmit the user data through the wireless, and automatically enters sleep within 1ms; ● This saves MCU's working time and reduces power consumption.

4	<ul style="list-style-type: none"> ● Similarly, any mode switching can use this feature. After the module processes the current mode event, it will automatically enter the new mode within 1ms; thus eliminating the need for the user to query AUX and achieve the purpose of fast switching; ● For example, switching from the transmit mode to the receive mode; the user MCU can also enter sleep before the mode switch, and use the external interrupt function to acquire the AUX change, thereby performing mode switching.
5	<ul style="list-style-type: none"> ● This operation mode is very flexible and efficient, and is designed according to the user's MCU's operation convenience, and can reduce the workload of the entire system as much as possible, improve system efficiency, and reduce power consumption.

6.2 Normal mode (Mode 0)

Type	M0 = 0, M1 = 0
Transmitting	Users can input data through the serial port and the module will start wireless transmission.
Receiving	The module wireless receiving function is turned on, and after receiving the wireless data, it will be output through the serial port TXD pin.

6.3 WOR mode (Mode 1)

Type	M0 = 1, M1 = 0
Transmitting	When defined as a transmitting party, a preamble is automatically added before transmitting.
Receiving	It can receive data normally, the receiving function is the same as mode 0.

6.4 Configuration mode (Mode 2)

Type	M0 = 0, M1 = 1
Transmitting	Wireless transmitting off
Receiving	Wireless receiving off
Configuration	Users can access the registers to configure the module's operation state.

6.5 Deep sleep mode (Mode 3)

Type	M0 = 1, M1 = 1
Transmitting	Unable to transmit wireless data
Receiving	Unable to receive wireless data
Note	When from the sleep mode to other modes, the module will reconfigure the parameters. During the configuration process, AUX will remain low; After configuration, it outputs high level, we suggest that user test rising edge AUX.

7 Register read and write control

7.1 Command format

In configuration mode (mode 2: M1 = 1, M0 = 0), the list of supported commands are as follows (**9600, 8N1 for configuration**) :

No.	Command format	Description
1	Set register	Command: C0+starting address+length+parameters Response: C1+starting address+length+parameters E.g 1: Channel is 0x09 command starting address length parameter Send: C0 05 01 09 Return: C1 05 01 09 E.g 2: Configure module address (0x1234), network address (0x00), serial port (9600 8N1) and air data rate (1.2K). Send: C0 00 04 12 34 00 61 Return: C1 00 04 12 34 00 61
2	Read register	Command: C1+starting address+parameters Response: C1+starting address+length+parameters E.g 1 : Read channel command starting address length parameter Send: C1 05 01 Return: C1 05 01 09 E.g 2: Read module address, network address, serial port and air data rate. Send: C1 00 04 Return: C1 00 04 12 34 00 61
3	Set temporary registers	Command: C2+starting address+parameters Response: C1+starting address+length+parameters E.g 1: Channel is 0x09 command starting address length parameter Send: C2 05 01 09 Return: C1 05 01 09 E.g 2: Configure module address (0x1234), network address (0x00), serial port (9600 8N1) and air data rate (1.2K).

		Send: C2 00 04 12 34 00 61 Return: C1 00 04 12 34 00 61															
5	Wireless configuration	Command: CF CF + normal command Respond : CF CF + normal respond E.g 1: Channel is 0x09 <table border="1"> <thead> <tr> <th>Command head</th> <th>command</th> <th>starting address</th> <th>length</th> <th>parameter</th> </tr> </thead> <tbody> <tr> <td>Send: CF CF</td> <td>C0</td> <td>05</td> <td>01</td> <td>09</td> </tr> <tr> <td>Return: CF CF</td> <td>C1</td> <td>05</td> <td>01</td> <td>09</td> </tr> </tbody> </table> E.g 2: Configure module address (0x1234), network address (0x00), serial port (9600 8N1) and air data rate (1.2K). Send: CF CF C2 00 04 12 34 00 61 Return: CF CF C1 00 04 12 34 00 61	Command head	command	starting address	length	parameter	Send: CF CF	C0	05	01	09	Return: CF CF	C1	05	01	09
Command head	command	starting address	length	parameter													
Send: CF CF	C0	05	01	09													
Return: CF CF	C1	05	01	09													
6	Wrong format	Wrong format respond: FF FF FF															

7.2 Register description

Address	Read or write	Name	Description	Remark
00H	Read/Wr ite	ADDH	ADDH (default 0)	<ul style="list-style-type: none"> The module address is high byte and low byte. Note: When the module address is FFFF, it can be used as the broadcast and monitor address, that is the module will not perform address filtering.
01H	Read/Wr ite	ADDL	ADDL (default 0)	
02H	Read/Wr ite	NETID	NETID (default 0)	<ul style="list-style-type: none"> Network address, used to distinguish the network. When communicating with each other, they should be set to the same.
03H	Read/Wr ite	REG0	7, 6, 5 UART: Serial port rate (bps) 000: 1200 001: 2400 010: 4800 011: 9600 (default) 100: 19200 101: 38400 110: 57600 111: 115200 ----- 4, 3 : Serial parity bit 00 : 8N1 (default) 01 : 8O1 10 : 8E1 11 : 8N1 (equal to 00) ----- 2, 1, 0, air data rate 000: 0.3k 001: 1.2k 010: 2.4k (default) 011: 4.8k 100: 9.6k 101: 19.2k 110: 38.4k 111: 62.5k	<ul style="list-style-type: none"> For the two modules that communicate with each other, the serial port baud rate can be different, and the verification method can also be different. When transmitting large packets continuously, users need to consider the data blocking caused by the same baud rate, and data may even be lost. It is generally recommended that both parties have the same baud rate. ----- <ul style="list-style-type: none"> Both parties must be the same The higher the rate, the shorter the distance

04H	Read/Wr ite	REG1	<p>7, 6 : Sub packet setting 00: 240 bytes (default) 01: 128 bytes 10: 64 bytes 11: 32 bytes</p> <p>-----</p> <p>5 : RSSI Ambient noise enable 1: Enable 0: Disable (default)</p> <p>-----</p> <p>4, 3, 2 Reserve</p> <p>-----</p> <p>1, 0 : Transmitting power 00 : 30dbm (default) 01 : 27dbm 10 : 24dbm 11 : 21dbm</p>	<ul style="list-style-type: none"> When the data is smaller than the sub packet length, the serial output of the receiving end is an uninterrupted continuous output. When the data is larger than the sub packet length, the receiving end serial port will output the sub packet. <p>-----</p> <ul style="list-style-type: none"> When enabled, the C0 C1 C2 C3 command can be sent in the transmitting mode or WOR transmitting mode to read the register. Register 0x00: Current ambient noise rssi Register 0X01: rssi when the data was received last time. (Current channel noise is: dBm = - (256 - RSSI)) <p>Command format: C0 C1 C2 C3 + starting address + read length Returns: C1 + address address + read length + read valid value E.g: send C0 C1 C2 C3 00 01 Return C1 00 01 rssi</p> <p>-----</p> <ul style="list-style-type: none"> Power and current are nonlinear, and power efficiency is highest at maximum power. The current does not decrease in proportion to the decrease in power.
05H	Read/Wr ite	REG2	<p>Channel control (CH) 0-83 represents a total of 84 channels</p>	<ul style="list-style-type: none"> Frequency= 410.125 + CH *1M
06H	Read/Wr ite	REG3	<p>7 Enable RSSI 1 : Enable 0 : Disable (default)</p> <p>-----</p> <p>6, Transmission mode 1 : Fixed point transmission mode 0 : Transparent transmission mode (default)</p> <p>-----</p> <p>5 Enable repeater 1 : Enable repeater function 0 : Disable repeater function(default)</p> <p>-----</p> <p>4 LBT enable (monitor before transmission) 1 : Enable 0 : Disable (default)</p> <p>-----</p> <p>3 WOR transceiver control 1 : WOR transmitter The module receiving and transmitting functions are turned on, and a wake-up code is added when transmitting data. Receiving is turned on. 0 : WOR receiver (default)</p>	<ul style="list-style-type: none"> When enabled, the module receives wireless data and it will follow an RSSI strength byte after output via the serial port TXD <p>-----</p> <ul style="list-style-type: none"> The module recognizes the first three bytes of the serial data as: address high + address low + channel and takes it as the wireless transmitting target. <p>-----</p> <ul style="list-style-type: none"> After the reply function is enabled, if the target address is not the module itself, the module will forward it once. In order to prevent data return-back, it is recommended to use it in conjunction with the fixed point mode. That is: the target address is different from the source address. <p>-----</p> <ul style="list-style-type: none"> When enabled, wireless data will be monitored before it is transmitted, which can avoid interference to a certain extent, but may cause data delay. <p>-----</p> <ul style="list-style-type: none"> Valid only for mode 1. After the WOR receiver receives the wireless data and outputs it through the serial port, it will wait for 1000ms before entering the WOR again. Users can input the serial port data and return it via the wireless during this period. Each serial byte will be refreshed for 1000ms. Users must transmit the first byte within 1000ms. <p>-----</p> <ul style="list-style-type: none"> Valid only for mode 1. Period T = (1 + WOR) * 500ms, maximum 4000ms,

			<p>The module is unable to transmit data and works in WOR monitoring mode. The monitoring period is as follows (WOR cycle), which can save a lot of power.</p> <p>-----</p> <p>2, 1, 0, WOR cycle</p> <p>000 : 500ms 001 : 1000ms 010 : 1500ms 011 : 2000ms 100 : 2500ms 101 : 3000ms 110 : 3500ms 111 : 4000ms</p>	<p>minimum 500ms</p> <ul style="list-style-type: none"> ● The longer the WOR monitoring interval period, the lower the average power consumption, but the greater the data delay ● Both the transmitter and the receiver must be the same (very important).
07H	Write	CRYPT_H	Key high byte (default 0)	<ul style="list-style-type: none"> ● Write only, read returns 0 ● Used for user encryption to avoid intercepting airborne wireless data by similar modules. ● The module will internally use these two bytes as a calculation factor to transform and encrypt the over-the-air wireless signal.
08H	Write	CRYPT_L	Key low byte (default 0)	
80H~86H	Read only	PID	Product information 7 bytes	<ul style="list-style-type: none"> ● Product information 7 bytes

7.3 Factory default parameter

Factory default parameters : C0 00 00 62 00 17							
Model No.	Frequency	Address	Channel	Air data rate	Baud rate	Parity format	Power
E22-400T30DC	433MHz	0x0000	0x17	2.4kbps	9600	8N1	30dBm

8 Repeater networking mode

No.	Description
1	After setting the repeater mode by configuration, switch to the normal mode and the repeater starts working.
2	In the repeater mode, ADDH, ADDL are no longer used as the module address, but is correspondingly paired with the NETID. If the data of one of the networks is received, it is forwarded to another network. The network ID of the repeater itself is invalid.
3	In repeater mode, the repeater module cannot transmit and receive data, and cannot perform low-power operation.
4	The user enters the other mode from mode 3 (sleep mode) or during the reset process, the module resets the user parameters during which the AUX outputs low level.

Repeater networking rules:

1. Forwarding rules, the repeater can forward data in both directions between two NETIDs.
2. In repeater mode, ADDH\ADDL is no longer used as the module address, and it is used as a NETID forwarding pairing flag.

Figure:

① Primary repeater

“Node 1” NETID is 08.

“Node 2” NETID is 33.

Primary repeater 1’s ADDH\ADDL are 08, 33.

So the signal sent by node 1 (08) can be forwarded to node 2 (33)

At the same time, node 1 and node 2 have the same address, so the data transmitted by node 1 can be received by node 2.

② Secondary repeater

Secondary repeater’s ADDH\ADDL are 33, 05.

Therefore, Repeater 2 can forward the data of Repeater 1 to the network NETID: 05.

Thus node 3 and node 4 can receive node 1 data. Node 4 outputs data normally, and node 3 has a different address than node 1, so no data is output.

③ Two-way repeater

As shown in the figure: the data sent by node 1, the nodes 2, 4 can receive the data sent by node 2, 4, and node 1 can also receive it.

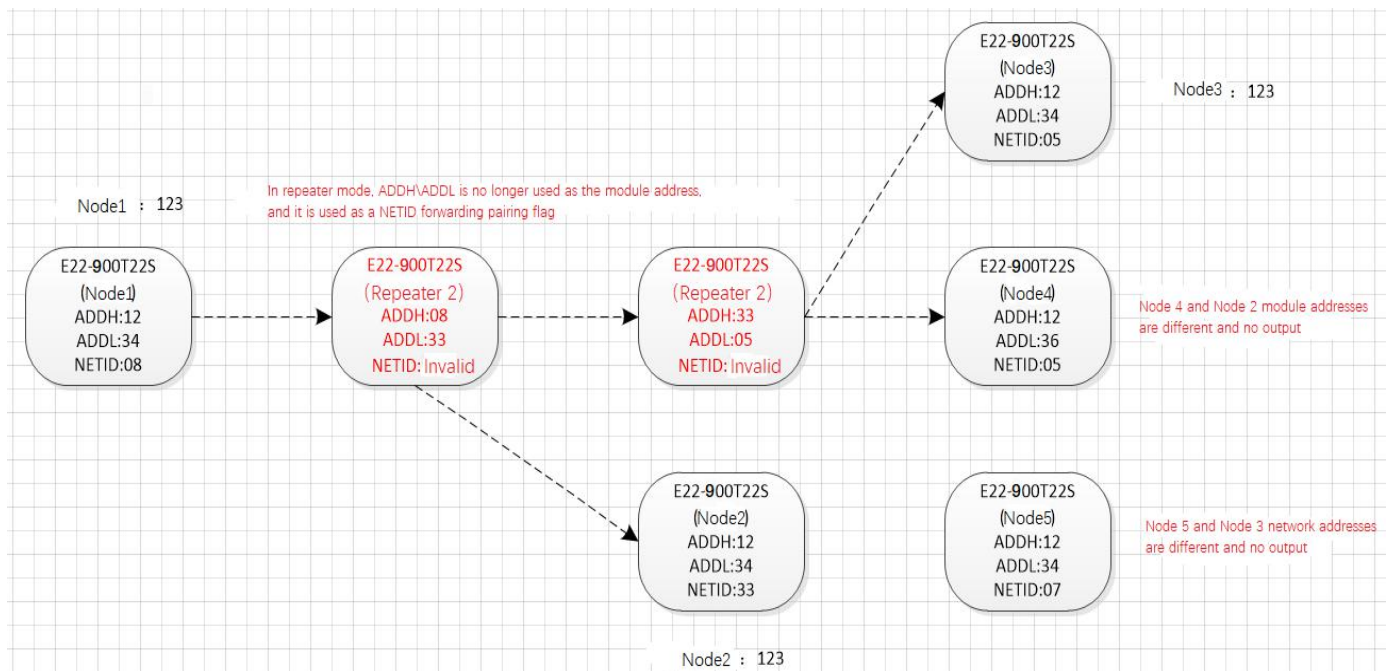

9 Configuration instructions on computer

- The following figure shows the E22-400T30DC configuration host computer display interface, the user can switch to the command mode through M0M1, and quickly configure and read the parameters on computer.



- In the configuration on computer, the module address, frequency channel, network ID, and key are all in decimal mode. The range of values of each parameter is:
 - Network address: 0-65535
 - Frequency channel: 0-83
 - Network ID: 0-255
 - Key: 0-65535
- When the user configures the repeater mode using the host computer, special attention must be paid. Since the parameters are in decimal mode in the host computer, the module address and network ID need to be converted into hexadecimal. For example, if the network ID input by the transmitting end A is 02, and the network ID input by the receiving end B is 10, when the repeater end R sets the module address, the hexadecimal value 0X020A is converted into the decimal value 522 as the repeater end R. Module address. That is, the module address value of the repeater terminal R is 522 at this time.

10 Hardware design

- It is recommended to use a DC stabilized power supply. The power supply ripple factor is as small as possible, and the module needs to be reliably grounded. ;
- Please pay attention to the correct connection of the positive and negative poles of the power supply. Reverse connection may cause permanent damage to the module ;
- Please check the power supply to ensure it is within the recommended voltage otherwise when it exceeds the maximum value the module will be permanently damaged ;
- Please check the stability of the power supply, the voltage can not be fluctuated frequently ;
- When designing the power supply circuit for the module, it is often recommended to reserve more than 30% of the margin, so the whole machine is beneficial for long-term stable operation. ;
- The module should be as far away as possible from the power supply, transformers, high-frequency wiring and other parts with large electromagnetic interference. ;

- High-frequency digital routing, high-frequency analog routing, and power routing must be avoided under the module. If it is necessary to pass through the module, assume that the module is soldered to the Top Layer, and the copper is spread on the Top Layer of the module contact part(well grounded), it must be close to the digital part of the module and routed in the Bottom Layer ;
- Assuming the module is soldered or placed over the Top Layer, it is wrong to randomly route over the Bottom Layer or other layers, which will affect the module's spurs and receiving sensitivity to varying degrees ;
- It is assumed that there are devices with large electromagnetic interference around the module that will greatly affect the performance. It is recommended to keep them away from the module according to the strength of the interference. If necessary, appropriate isolation and shielding can be done ;
- Assume that there are traces with large electromagnetic interference (high-frequency digital, high-frequency analog, power traces) around the module that will greatly affect the performance of the module. It is recommended to stay away from the module according to the strength of the interference.If necessary, appropriate isolation and shielding can be done.
- If the communication line uses a 5V level, a 1k-5.1k resistor must be connected in series (not recommended, there is still a risk of damage) ;
- Try to stay away from some physical layers such as TTL protocol at 2.4GHz , for example: USB3.0 ;

11 FAQ

11.1 Communication range is too short

- The communication distance will be affected when obstacle exists.
- Data lose rate will be affected by temperature, humidity and co-channel interference.
- The ground will absorb and reflect wireless radio wave, so the performance will be poor when testing near ground.
- Sea water has great ability in absorbing wireless radio wave, so performance will be poor when testing near the sea.
- The signal will be affected when the antenna is near metal object or put in a metal case.
- Power register was set incorrectly, air data rate is set as too high (the higher the air data rate, the shorter the distance).
- The power supply low voltage under room temperature is lower than 2.5V, the lower the voltage, the lower the transmitting power.
- Due to antenna quality or poor matching between antenna and module.

11.2 Module is easy to damage

- Please check the power supply source, ensure it is 2.0V~3.6V, voltage higher than 3.6V will damage the module.
- Please check the stability of power source, the voltage cannot fluctuate too much.
- Please make sure antistatic measure are taken when installing and using, high frequency devices have electrostatic susceptibility.
- Please ensure the humidity is within limited range, some parts are sensitive to humidity.
- Please avoid using modules under too high or too low temperature.

11.3 BER(Bit Error Rate) is high

- There are co-channel signal interference nearby, please be away from interference sources or modify frequency and channel to avoid interference;
- Poor power supply may cause messy code. Make sure that the power supply is reliable.
- The extension line and feeder quality are poor or too long, so the bit error rate is high;

12 Production guidance

12.1 Reflow soldering temperature

Profile Feature	Curve characteristics	Sn-Pb Assembly	Pb-Free Assembly
Solder Paste	Solder paste	Sn63/Pb37	Sn96.5/Ag3/Cu0.5
Preheat Temperature min (T _{min})	Min preheating temp.	100°C	150°C
Preheat temperature max (T _{max})	Mx preheating temp.	150°C	200°C
Preheat Time (T _{min} to T _{max})(t _s)	Preheating time	60-120 sec	60-120 sec
Average ramp-up rate(T _{max} to T _p)	Average ramp-up rate	3°C/second max	3°C/second max
Liquidous Temperature (TL)	Liquid phase temp.	183°C	217°C
Time (t _L) Maintained Above (TL)	Time below liquid phase line	60-90 sec	30-90 sec
Peak temperature (T _p)	Peak temp.	220-235°C	230-250°C
Average ramp-down rate (T _p to T _{max})	Average ramp-down rate	6°C/second max	6°C/second max
Time 25°C to peak temperature	Time to peak temperature for 25°C	max 6 minutes	max 8 minutes

12.2 Reflow soldering curve

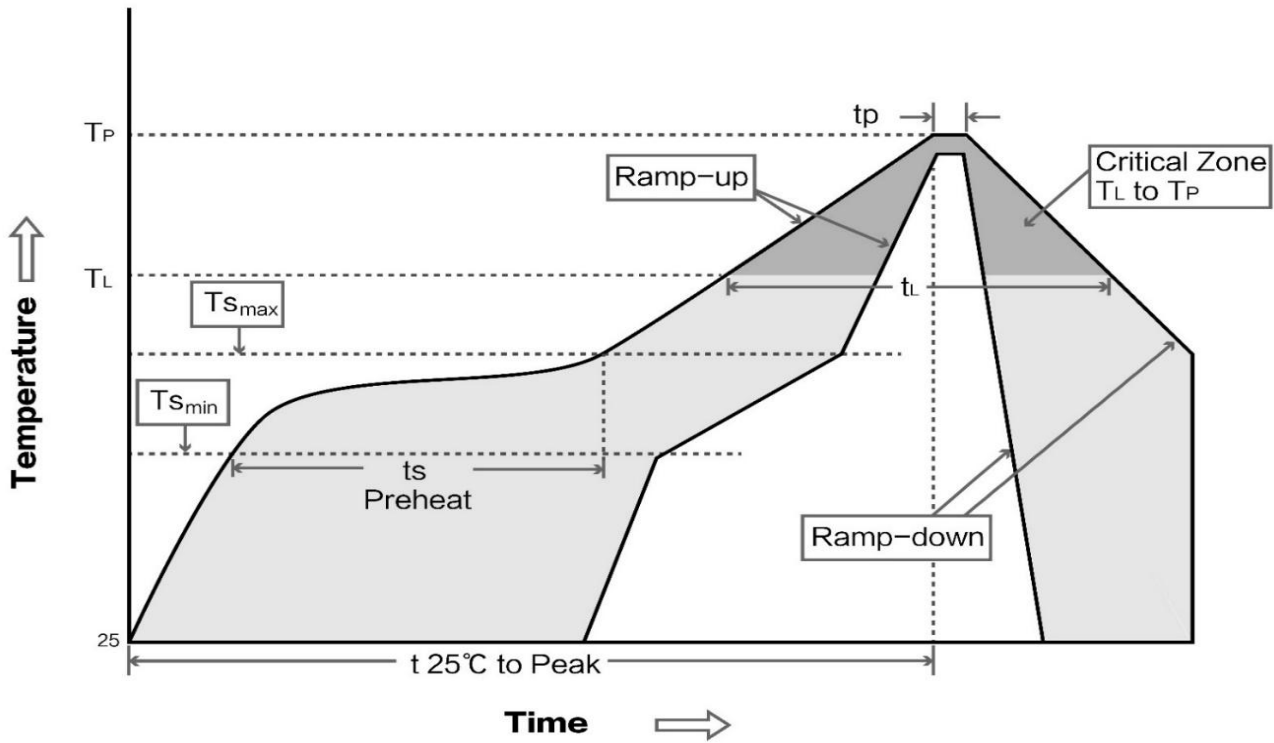

13 E22 series

Model No.	Core IC	Frequency Hz	Tx power dBm	Distance km	Package	Size mm	Interface
E22-900T22S	SX1262	868M 915M	22	7	SMD	16*26	UART
E22-230T22S	SX1262	230M	22	7	SMD	16*26	UART
E22-400T22S	SX1268	430M 470M	22	7	SMD	16*26	UART
E22-400M30S	SX1268	433M 470M	30	12	SMD	24*38.5	SPI
E22-900M30S	SX1262	868M 915M	30	12	SMD	24*38.5	SPI
E22-900M22S	SX1262	868M 915M	22	6.5	SMD	14*20	SPI
E22-400M22S	SX1268	433M 470M	22	6.5	SMD	14*20	SPI
E22-230T30S	SX1262	230M	30	10	SMD	40.5*25	UART
E22-400T30S	SX1268	430M 470M	30	10	SMD	40.5*25	UART
E22-900T30S	SX1262	868M 915M	30	10	SMD	40.5*25	UART

14 Antenna recommendation

The antenna is an important role in the communication process. A good antenna can largely improve the communication system. Therefore, we recommend some antennas for wireless modules with excellent performance and reasonable price.

Model No.	Type	Frequency Hz	Interface	Gain dBi	Height	Cable	Function feature
TX433-NP-4310	Flexible pcb antenna	433M	SMA-J	2	43.8*9.5mm	-	Embedded FPC antenna
TX433-JW-5	Rubber antenna	433M	SMA-J	2	50mm	-	Flexible & omnidirectional
TX433-JWG-7	Rubber antenna	433M	SMA-J	2.5	75mm	-	Flexible & omnidirectional
TX433-JK-20	Rubber antenna	433M	SMA-J	3	210mm	-	Flexible & omnidirectional
TX433-JK-11	Rubber antenna	433M	SMA-J	2.5	110mm	-	Flexible & omnidirectional
TX433-XP-200	Sucker antenna	433M	SMA-J	4	19cm	200cm	Sucker antenna, high gain
TX433-XPL-100	Sucker antenna	433M	SMA-J	3.5	18.5cm	100cm	Sucker antenna, high gain
TX433-XP-300	Sucker antenna	433M	SMA-J	6	96.5cm	300cm	Car sucker antenna, ultra high gain
TX433-JZG-6	Rubber antenna	433M	SMA-J	2.5	52mm	-	Short straight & omnidirectional
TX433-JZ-5	Rubber antenna	433M	SMA-J	2	52mm	-	Short straight & omnidirectional
TX490-JZ-5	Rubber antenna	470/490M	SMA-J	2.0	50mm	-	Short straight & omnidirectional
TX490-XPL-5	Sucker antenna	470/490M	SMA-J	3.5	120mm	100cm	Sucker antenna, high gain

15 Package for batch order

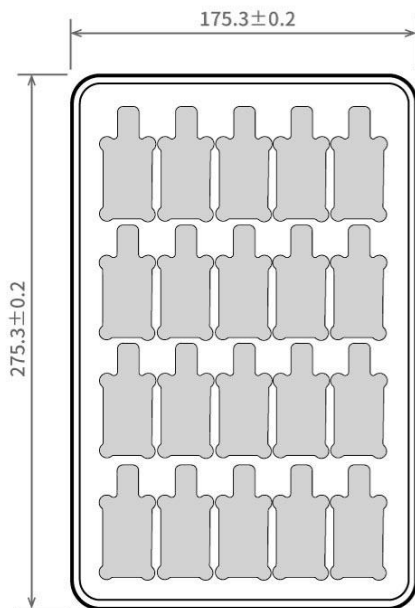

Unit: mm
Each Layer: 20 pcs
Each Package: 5 layers

Version	Date	Description	Issued by
1.00	2021-4-2	Initial version	Linson

About us

Technical support: support@cdebyte.com

Documents and RF Setting download link: www.ebyte.com

Thank you for using Ebyte products! Please contact us with any questions or suggestions: info@cdebyte.com

Web: www.ebyte.com

Address: Building B5, Mould Industrial Park, 199# Xiqu Ave, West High-tech Zone, Chengdu, 611731, Sichuan, China



Chengdu Ebyte Electronic Technology Co.,Ltd.