



ENGLISH

HomeConnect 620

KEYPAD ELECTRONIC SMART LOCK

Installation and User Guide

Required tools

Ruler
Phillips head screwdriver

Kwikset
1-866-863-6584
www.kwikset.com

| Parts List | | | |
|---------------------------|---|---|--|
| Mounting Plate | Adapter Ring | Exterior Assembly Traditional Contemporary | Interior Assembly Traditional Contemporary |
| Batteries | Keys | Latch A | For Latch / Strike Strike 03809 46780 <small>"B" is not included. If needed, please contact Kwikset to order a drive-in latch for your lock.</small> |
| Latch B | For Lock SmartKey Tool 69316 68272 68611 | | |

1 Prepare the door and check dimensions

If drilling a new door, use the supplied template and the complete door drilling instructions available at kwikset.com/doorprep

A Make sure your door is compatible. If you have a standard deadbolt mounted separately from the handle below it, your door is compatible.

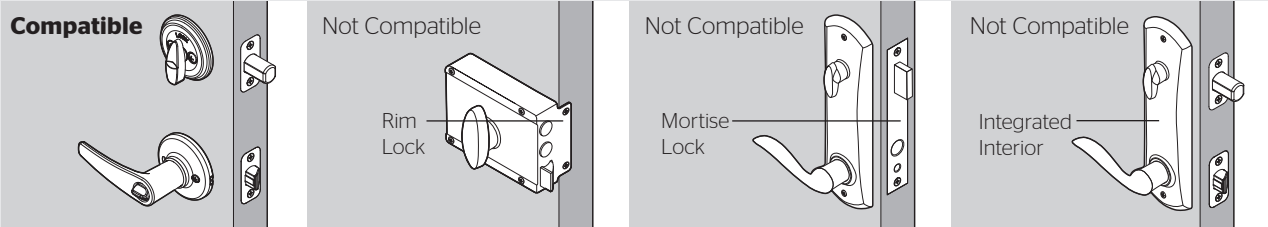

B Remove your existing deadbolt from your door.

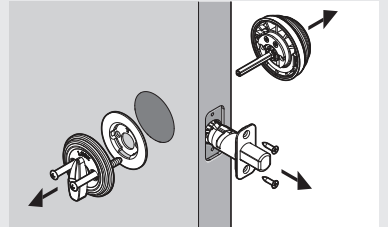

C Measure to confirm that the hole in the door is either 2-1/8" (54 mm) or 1-1/2" (38 mm).

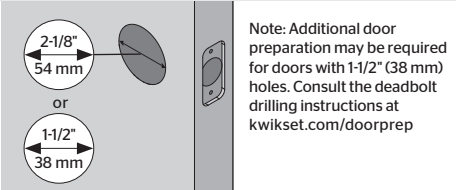

Note: Additional door preparation may be required for doors with 1-1/2" (38 mm) holes. Consult the deadbolt drilling instructions at kwikset.com/doorprep

D Measure to confirm that the backset is either 2-3/8" or 2-3/4" (60 or 70 mm).

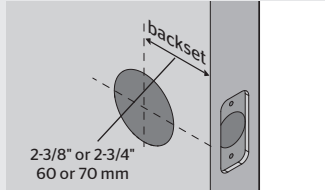

E Measure to confirm that the hole in the door edge is 1" (25 mm).

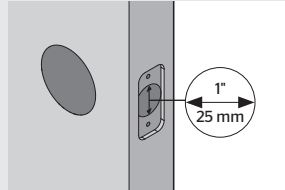

F Measure to confirm that the door is between 1-3/8" and 2" (35 mm and 51 mm) thick.

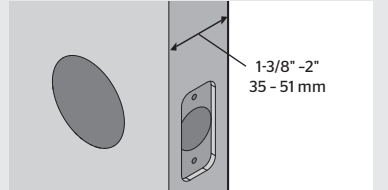

2 Install the latch and strike

For Latch / Strike Bag

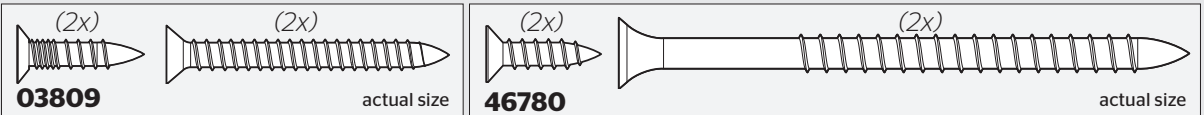

A Extend the latch bolt.

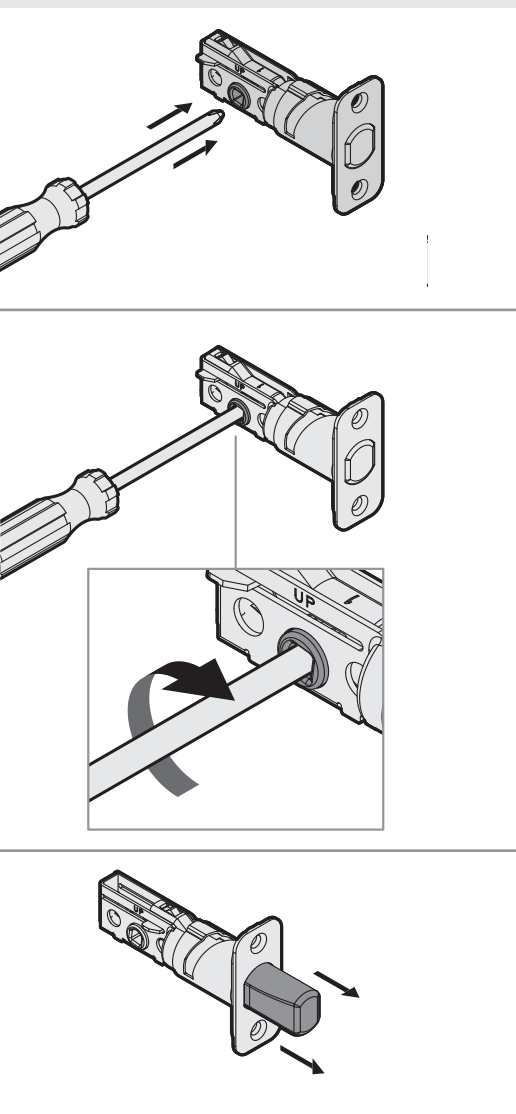

B Hold the latch in front of the door hole, with the latch face flush against the door edge.

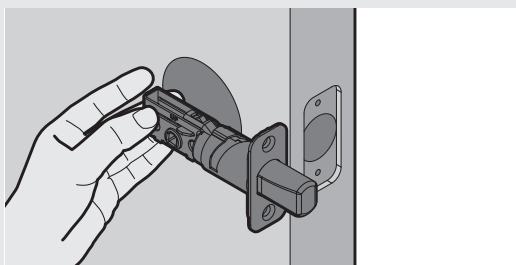

C Is the D-shaped hole centered in the door hole?

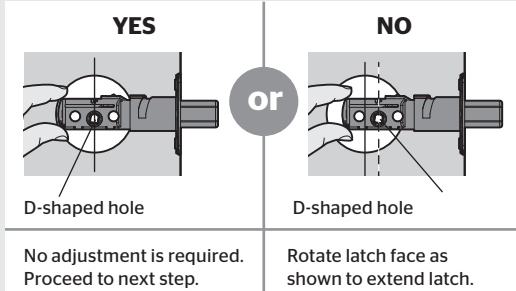

D Install the latch.

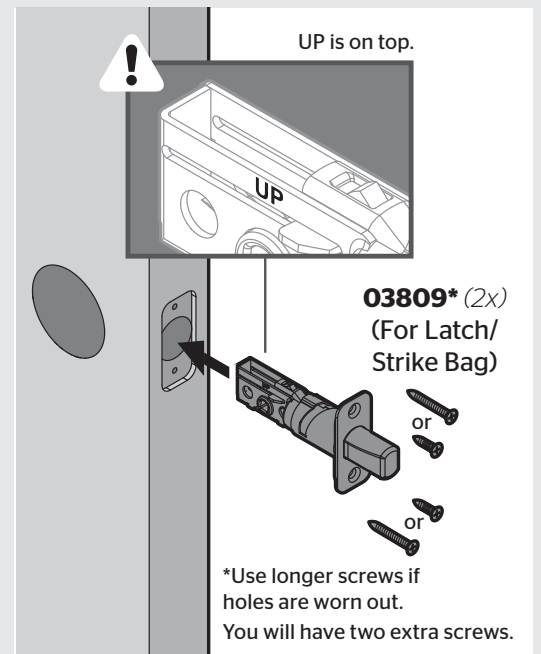

E Install the strike on the door frame.

⚠ Make sure the hole in the door frame is drilled a minimum of 1" (25 mm) deep.

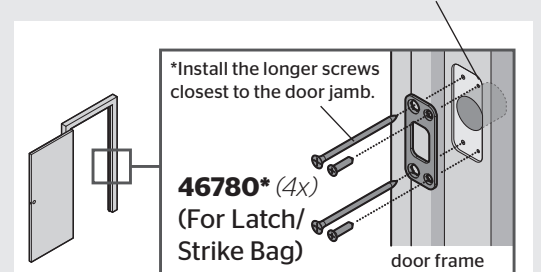

3 Install the exterior keypad

For Lock Bag

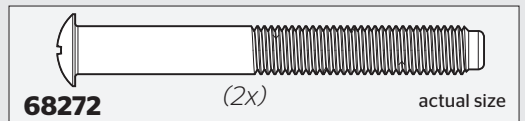

A What is the diameter of the hole in the door?

Diameter is 2-1/8" (54 mm)

Adaptor ring and frost guard 68780 are pre-assembled and no changes are needed. Proceed to next step.

Diameter is 1-1/2" (38 mm)

Remove pre-assembled adaptor ring and frost guard 68780. 1-1/2" (38 mm) frost guard is not included. If needed, please contact Kwikset to order.

adaptor ring
68780

B Remove the mounting plate from the interior assembly.

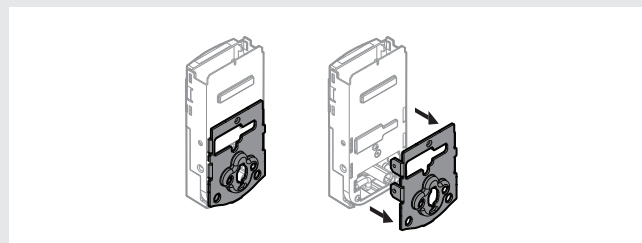

C Install the exterior keypad and mounting plate.

a

The cable goes underneath the latch.

b

Support the exterior assembly during mounting plate installation.

Route the cable through the center hole, then push it into the bottom hole.

c

Keep parallel to the edge of the door.

Tighten screws evenly. **DO NOT** over tighten screws.

68272 (2x)
torque blade

Make sure the torque blade is centered in the mounting plate hole.

d

Insert the key and test the latch. If the latch does not extend or retract smoothly, adjust the screws. Remove the key when finished, and make sure the latch bolt is fully extended.

4 Install the interior assembly

For Lock Bag



A Ensure the turnpiece shaft is pointing up, and remove the interior cover and battery pack from the interior assembly.

a

Remove the interior cover from the interior assembly.

b

Make sure turn piece shaft is rotated as shown.

Incorrect:

If turnpiece shaft is not oriented correctly, put the cover back on and rotate the turnpiece as shown in step C.

c

If the turnpiece shaft is pointing down, place the cover back onto the interior assembly and rotate the turnpiece until you hear it click. You may need to apply some force. Once the turnpiece shaft is correctly oriented, remove the cover again.

d

Do not install batteries until step 5.

B Install the interior assembly onto the mounting plate.

a

Ensure tight cable connection.

align

b

Lay the excess cable flat inside the bottom of the interior housing.

c

d

Note: the remaining three screws will be used in Step 9.

69316 (2x) (For Lock Bag)

bottom hole

Ensure you are using the correct screws. Using incorrect screws will damage the product.

5 Install the batteries and perform the door handing process

This step will teach your lock the orientation of your door and is crucial to lock operation.

A Install 4 AA batteries in the battery pack.

Ensure correct polarity. For best results, use new, non-rechargeable Alkaline batteries only.

B With the door open, install the battery pack to initiate auto-handing.

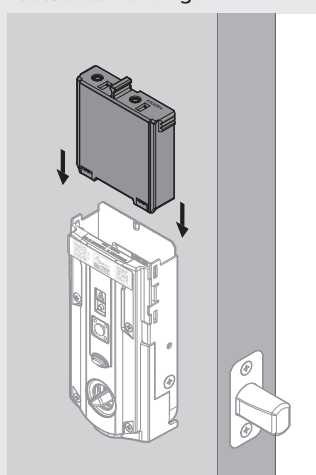

C The latch will retract and extend to learn the orientation of the door.

If the bolt does not move, make sure the batteries are correctly installed, and perform step 5B again.

Note: The latch bolt will only retract **half way**.

D The Status LED will indicate success or failure.

Green: Door handing was successful. Proceed to next step.

Red: Door handing was unsuccessful. Make sure the lock interior and batteries are correctly installed. Perform step 5B again.

If the door handing process is still unsuccessful after a second attempt, see the Manual Door Handing section on page 4.

NOTE: The lock will auto-hand again after the first time the door is locked or unlocked using the keypad or app. This is to confirm the door orientation.

Status LED

6 Add the lock to your smart home system

- A** Initiate the process to add the lock to your system at your smart home controller. Refer to your smart home system instructions for more information.
- B** If prompted by your smart home system to add the lock, press button "A" on the lock interior **one time**. The red LED will illuminate when the lock enters Add Mode.
- C** At this time, you may be prompted by your smart home system to enter the 5-digit PIN found on the label of the interior assembly. If not, proceed to step D.
- D** If successful, re-name the lock in your system (if applicable). If unsuccessful, follow your system's instructions to remove the lock from the controller and any other network, then press button "A" on the lock one time. Perform steps A-C again. If still unsuccessful, consult the Programming and Troubleshooting Guide on the Home Connect 620 page at kwikset.com/support.

SmartStart Enabled Products

SmartStart enabled products can be added into a Z-Wave network by scanning the Z-Wave QR Code present on the product with a controller providing SmartStart inclusion. No further action is required and the SmartStart product will be added automatically within 10 minutes of being switched on in the network vicinity.

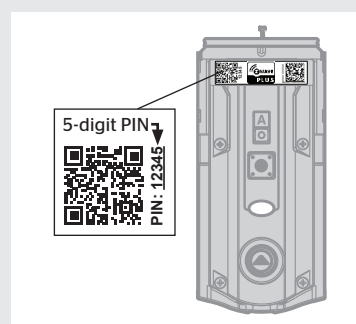
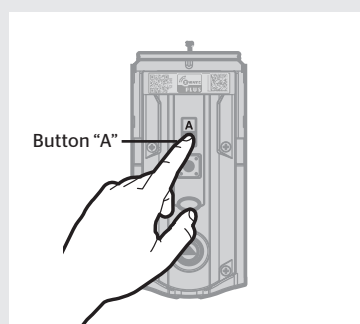

7 Add user codes (250 max)

It is recommended that you add and delete all user codes through your smart home control system. If your system does not allow this, codes may be added directly to the lock as shown here.

Programming Timeout

During programming, if no button is pressed for five seconds, the system will time out (indicated by three beeps and a red flashing Kwikset button), and you will need to restart the procedure.

- A** Make sure the door is open. Press the "Program" button once.
- B** Enter user code. A total of 250 user codes may be programmed.
- C** Press button once.

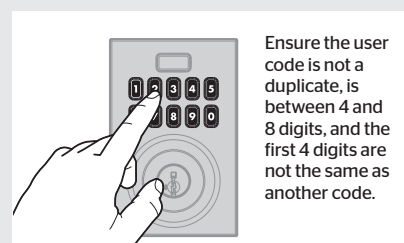
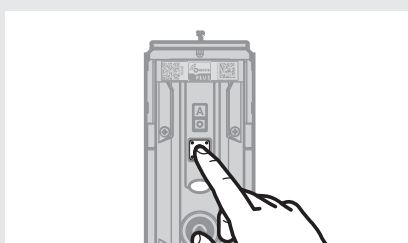

Ensure the user code is not a duplicate, is between 4 and 8 digits, and the first 4 digits are not the same as another code.



Mastercode

For enhanced security, a mastercode may be used when adding/deleting user codes and adjusting lock configuration settings. For more information about the mastercode, download the Programming and Troubleshooting Guide on the Home Connect 620 page at kwikset.com/support.

- D** What lights and sounds does the lock produce?

GREEN with ONE BEEP

Programming was successful.

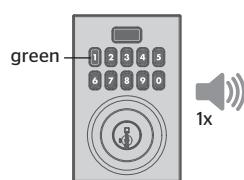

or

RED with THREE BEEPS

Programming was unsuccessful.

Ensure the user code is not a duplicate, is between 4 and 8 digits, and the first 4 digits are not the same as another code. Ensure the lock has room for an additional code. If all user code positions are filled, delete a code to make room for the new code.

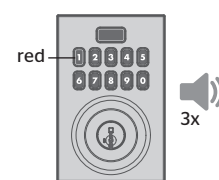

8 Test the lock and check door alignment

- A** With the door open, insert the key to extend the latch. Ensure that the latch extends smoothly.
- B** Turn the key 180° to retract the latch. Ensure that the latch retracts smoothly.
- C** Close the door. Insert and rotate the key to lock the door. Ensure that the door locks smoothly.
- D** Turn the key 180° to retract the latch. Ensure that the door unlocks smoothly.

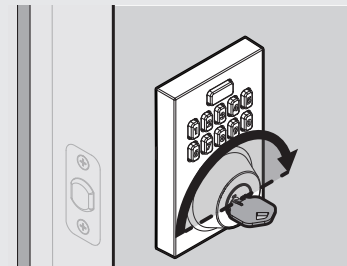
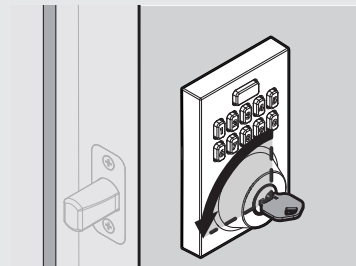
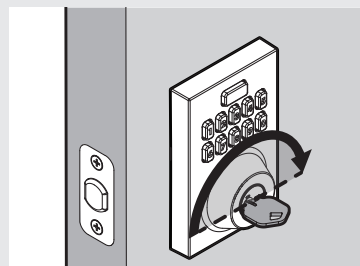
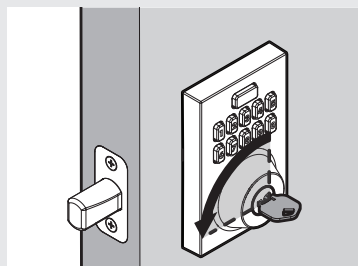

If your door does not lock and unlock smoothly, make sure you replaced your previous latch and strike with those supplied in the box. If you still experience locking errors, complete the troubleshooting steps at <http://bit.ly/HC620jam> or call Kwikset Support: 1-866-863-6584



9 Install the interior cover

Important Information about the interior cover

The window on the interior cover is unlocked by default for easier access to the battery pack and buttons.

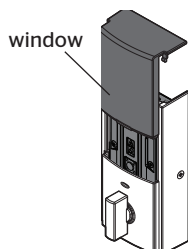

For additional security, you may choose to lock the window by installing the security screw.

Ensure you are using the correct screws. Using incorrect screws will damage the product.

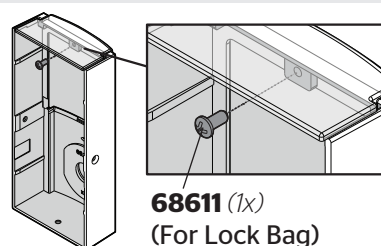

68611 (1x)
(For Lock Bag)

When the window is locked, you will need to remove the entire interior cover and screws to access the battery pack and buttons.

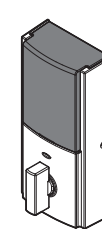

For Lock Bag



Cover Installation

- a** Install cover.

Note: You may need to rotate the turn piece to align with the turn piece shaft.

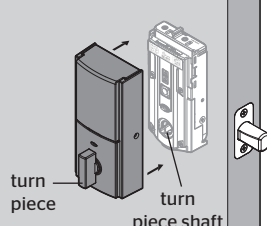

- b** Install screws.

69316 (3x)
(For Lock Bag)

Ensure you are using the correct screws. Using incorrect screws will damage the product.

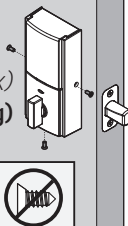

Battery Pack Access

If the window is unlocked, slide up the window to access the battery pack and buttons.



If the window is locked, remove the interior cover and screws to access the battery pack and buttons.

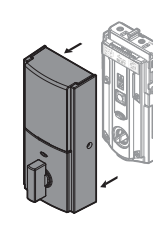

Home Connect 620 at a Glance

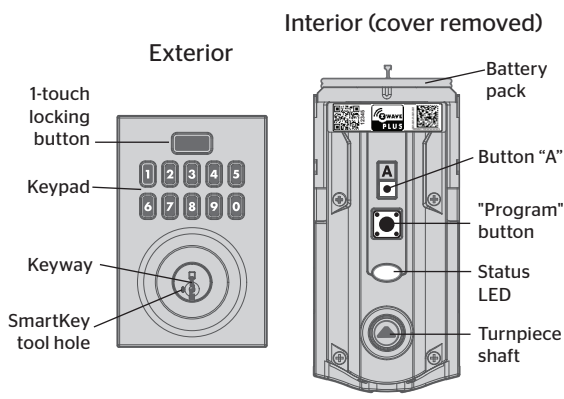

Note: When the cover is removed, the turnpiece shaft can be used to manually lock and unlock the door.

Troubleshooting

A complete Programming and Troubleshooting Guide is available on the Home Connect 620 page at www.kwikset.com/support.

System Alerts

| Alert | Reason | Solution |
|---|--|--|
| Keypad flashes red three times with three beeps*. | Incorrect code entered. | Re-enter code. |
| | No user code programmed. | Program at least one user code. |
| | Programming timeout after six seconds. | Attempt programming procedure again. |
| Keypad flashes red 15 times with 15 beeps* | Unsuccessful programming. | Attempt programming procedure again. |
| | Three incorrect codes entered within one minute. | Re-enter code after 60 second keypad lockout. |
| Keypad flashes red with fast beeping sound for three to four seconds. | Low battery. | Replace batteries. |
| Keypad flashes red with continuous beeping sound for two seconds. | Door jammed while attempting to lock. | Manually re-lock door. If needed, reposition strike. |
| Keypad flashes red one time for 5 seconds and beeps. | Failed handing. | Manually re-hand the lock. |

Deleting a single user code

Note: All codes may be deleted at once if the mastercode is enabled. For more information about the mastercode, consult the Programming and Troubleshooting Guide.

If no button is pressed for six seconds, the system will time out, and you will need to restart the procedure.

- Press "Program" button once.
- Press Kwikset button once.



- Enter user code to be deleted.
- Press Kwikset button once.



- Re-enter user code.
- Press Kwikset button once.



If unsuccessful: Make sure to enter the same valid code in steps 3 and 5.

⚠ **Test code:** While the door is open, test the user code to make sure it no longer unlocks the door.

Operating Your Lock

Locking

Press and release

Unlocking

Enter user code on the keypad.

Note: If you press an incorrect key, press to clear the code and enter your user code again.

Status LED

The Status LED blinks every 6 seconds to communicate whether the door is locked or unlocked. This feature is on by default.

Status LED Colors

| | |
|----------------|-------------|
| Blinking Green | Unlocked |
| Blinking Amber | Locked |
| Blinking Red | Low battery |

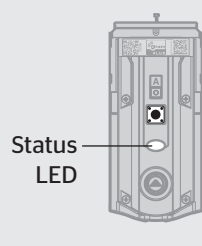

Turn Status LED On/Off

- Press "Program" button once.
- Press button "A" once.

- Press button "1" multiple times if needed to reach desired state.
- Press Kwikset button once.

Green Keypad Buttons: Feature is enabled.
Red Keypad Buttons: Feature is disabled.

Auto-Lock

Auto-lock automatically re-locks the door after unlocking. This feature is set to 30 seconds and is turned off by default.

Turn Auto-Lock On/Off

- Press "Program" button once.
- Press button "A" once.

- Press button "2" multiple times if needed to reach desired state.
- Press Kwikset button once.

Green Keypad Buttons: Feature is enabled.
Red Keypad Buttons: Feature is disabled.

Change Auto-Lock Time Delay

- Press "Program" button once.
- Press button "A" once.
- Press button "3" once.

- Press numeric button once that corresponds to desired time delay:
- Press Kwikset button once.

| | |
|---|--------------------|
| 1 | 30 sec. |
| 2 | 60 sec. (1 min.) |
| 3 | 180 sec. (3 min.) |
| 4 | 300 sec. (5 min.) |
| 5 | 600 sec. (10 min.) |

Mute/Unmute Audio

Audio is on by default.

- Press "Program" button once.
- Press button "A" once.

- Press button "4" multiple times if needed to reach desired state.
- Press Kwikset button once.

Green Keypad Buttons: Feature is enabled.
Red Keypad Buttons: Feature is disabled.

Manual Door Handing

If needed, the door handing process can be initiated manually. This is useful if the lock is being moved to a different door.

- Remove battery pack.
- Press and HOLD "Program" button while reinserting the battery pack. Release button shortly after battery pack is installed. The status LED will flash red and green.

- Press "Program" button once more.
- The latch bolt will extend and retract to learn the orientation of the door. The Status LED will indicate success or failure.

Success: LED flashes green
Failure: LED remains solid red for 5 seconds

If the Status LED indicates a failure, see the online Programming and Troubleshooting Guide or call Technical Support.

Factory Reset

A Factory Reset will delete all codes associated with the lock and the lock's network settings but will not remove the lock from the panel. Please run the Exclusion process to properly remove this lock from the network before performing a Factory Reset. Please use this procedure only when the network primary controller is missing or otherwise inoperable.

- Remove battery pack.
- Press and HOLD "Program" button while reinserting the battery pack. **Keep holding the button for 30 seconds until the lock beeps and the status LED flashes red.**

- Press "Program" button once more. LED will cycle flashing between red and green while the reset process is being performed.
- After a few seconds, the lock will initiate the door handing process, and the latch bolt will extend and retract to learn the orientation of the door.

NOTE: The lock will auto-hand again after the first time the door is locked or unlocked using the keypad or app. This is to confirm the door orientation.

Network Information

Removing the lock from the network

Follow your smart home system's instructions to remove the lock from the network. When prompted by the system, press button "A" on the lock interior once.



Z-Wave® System Notes

This product is a security enabled Z-Wave Plus product and must be used with a Security Enabled Z-Wave controller to be fully utilized. Z-Wave is a "Wireless mesh network," and results may vary based on building construction and communication path.

To assure interoperability, each Z-Wave product must pass a stringent conformance test to assure that it meets the Z-Wave standard for complete compliance with all other devices and controls. The Z-Wave identity mark assures consumers, integrators, dealers and manufacturers that their products will reliably perform with any other Z-Wave device. And, regardless of the vendor, always powered nodes may act as a repeater for Kwikset/Weiser/Baldwin products.

Z-Wave Configuration and Association Parameters are available on the Home Connect 620 page at www.kwikset.com.

SmartKey Re-Keying

Re-key the lock to work with your existing key. See the supplied SmartKey Re-key instructions for more information.

Note: If Auto-Lock is enabled, remove the battery pack before re-keying your lock.

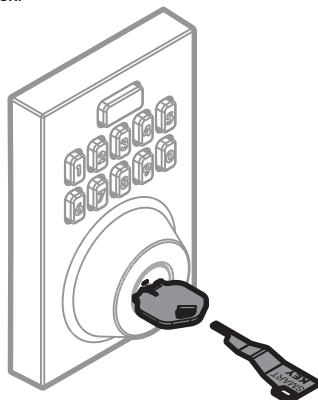

Important Safeguards

- Read all instructions in their entirety.
- Familiarize yourself with all warning and caution statements.
- Remind all family members of safety precautions.
- Protect your user codes and mastercode.
- Dispose of used batteries according to local laws and regulations.

⚠ **CAUTION:** Prevent unauthorized entry. Since anyone with access to the back panel can change the user codes, you must restrict access to the back panel and routinely check the user codes to ensure they have not been altered without your knowledge. The use of a mastercode can help protect your system's settings.

⚠ **WARNING:** This Manufacturer advises that no lock can provide complete security by itself. This lock may be defeated by forcible or technical means, or evaded by entry elsewhere on the property. No lock can substitute for caution, awareness of your environment, and common sense. Builder's hardware is available in multiple performance grades to suit the application. In order to enhance security and reduce risk, you should consult a qualified locksmith or other security professional.