



qubino®

WIRELESS SMART HOME

USER MANUAL **EN**

LUXY SMART SWITCH



Luxy Smart Switch is an innovative light source that gently illuminates in more than 16 million colours and easily fits into places of your light switch or socket. It can be used standalone, as an ambient light or as a smart home device. With an additional output it can simply replace your existing light switch or can be used for powering IR panels, fans, water heaters, etc.

1.	About Qubino.....	4
2.	Support.....	5
3.	Safety Information	6
4.	Introduction	7
5.	Functionalities.....	9
5.1	Control it	9
5.2	Measurements and reporting.....	10
5.3	Overload protection.....	10
5.4	Lock touch functions for enabling output ON/OFF	10
5.5	Turning off alarms.....	11
6.	Use Cases	12
6.1.	Usage examples for Luxy Smart Switch	12
6.2.	Usage examples when Luxy Smart Switch is connected to a wireless device/sensor .	13
6.3.	Usage examples when Luxy Smart Switch is connected to a wired device.....	15
7.	Advantages and Highlights.....	17
7.1.	Advantages.....	17
7.2.	Highlights	19
8.	Package Contents.....	21
9.	Installation	22
9.1.	Installation examples of the Luxy Smart Switch	25
10.	Technical Specification.....	29
11.	Electrical Diagram (230 Vac)	30
12.	Z-Wave	31
12.1.	Adding the device to a Z-Wave network (Inclusion).....	32
12.2.	Z-Wave Security	33
12.3.	Removing the device from a Z-Wave network (Exclusion).....	34
12.4.	Device factory reset	34
12.5.	Associations	35
12.6.	Notification Command Class.....	39

12.7. Configuration Parameters..... 40

12.8. Z-Wave Command Classes 44

13. Important Disclaimer 47

14. Warning..... 47

15. Regulations..... 47

1. About Qubino

Qubino is a family of innovative Z-Wave devices, many of them the smallest of their kind. Numerous breakthrough innovations, 100 % quality control, and responsive customer service make Qubino the number one choice for making your life more comfortable.

Qubino enables you to transform – inexpensively and invisibly – any traditional electric device into a smart, connected one that you can control with your smart phone. Qubino devices are simple to install and use, but also extremely versatile - they offer a wealth of additional features and parameters for you to play with.

We love helping people who enjoy creating new ideas for their home and then using their hard work and skill to turn those ideas into reality. We admire their passion and resourcefulness. We do our best to supply you with products that will enable you to create a unique and special home for yourself. We innovate so that you can be free to make the smartest home possible. With just a touch of magic.

"Simple is smart." We believe it is smart to make complex things simple. But only when this means simple for our customers, not for ourselves. We think a lot so that you will not have to when it comes to installing or using our devices.

For more information visit: www.qubino.com



To find your nearest Qubino dealer visit: <http://qubino.com/where-to-buy/>

2. Support

Did you know that Qubino offers Z-Wave devices with 100 % quality control guaranteed throughout the production process? Every single unit is tested and examined before being approved for sale – a truly unique pledge in the industry.

Why is this important?

Every device has a dedicated serial number and part number, which is assigned to the device only after it goes through a strict testing procedure.

Our support policy advises that every customer receives an answer within 24 hours during working days.

Go to our support website <https://support.qubino.com/support/home> and open a new support ticket. By telling us the product's unique serial number and part number, we will automatically review the production log file containing device parameters and information. This allows us to immediately identify and address issues, giving you the best customer support.

Based on customer and business partner feedback, we are proud to boast Qubino's support team as the best and fastest on the market. If you do not find the answers to your questions in this document, please contact us. We will try to help you as soon as possible.

3. Safety Information

For Qubino, safety is first, so we have prepared lots of safety tips and information that can be found throughout this manual.

To ensure your safety, please read this manual carefully before installing the device; follow the instructions exactly. The manufacturer (GOAP d.o.o. Nova Gorica) shall not be legally responsible for any equipment damage or personal injury caused by incorrect installation or operation other than that covered in this manual.

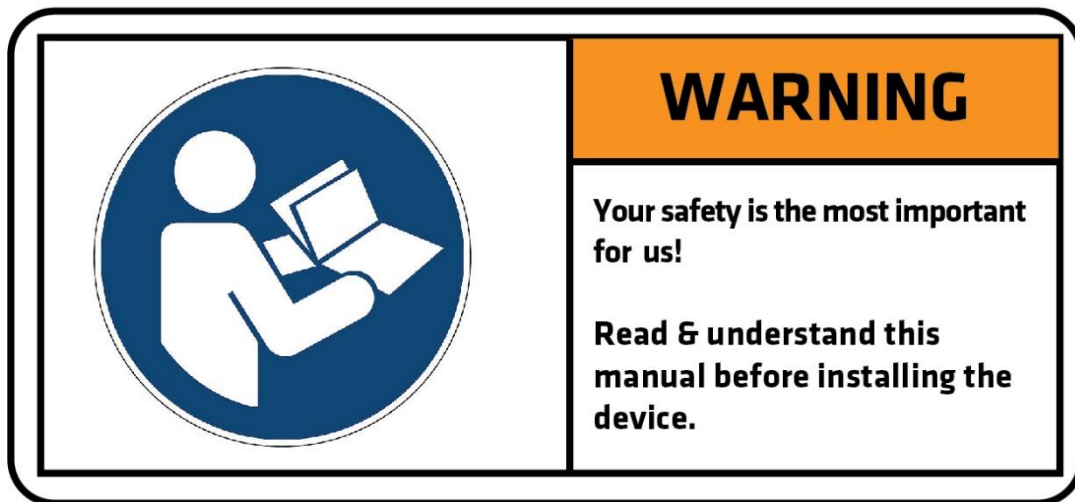

① Please check the Technical Specifications and Electrical Diagram chapters, as well as fuse requirements in the Installation chapter before installing the device.

Epilepsy warning!

This product can trigger epileptic seizures, especially with photosensitive people.

4. Introduction

The Luxy Smart Switch is an innovative light source that will gently illuminate your home in any of the 16 million colours that you can choose from, to fit your personal preference and give a personal touch to any room.

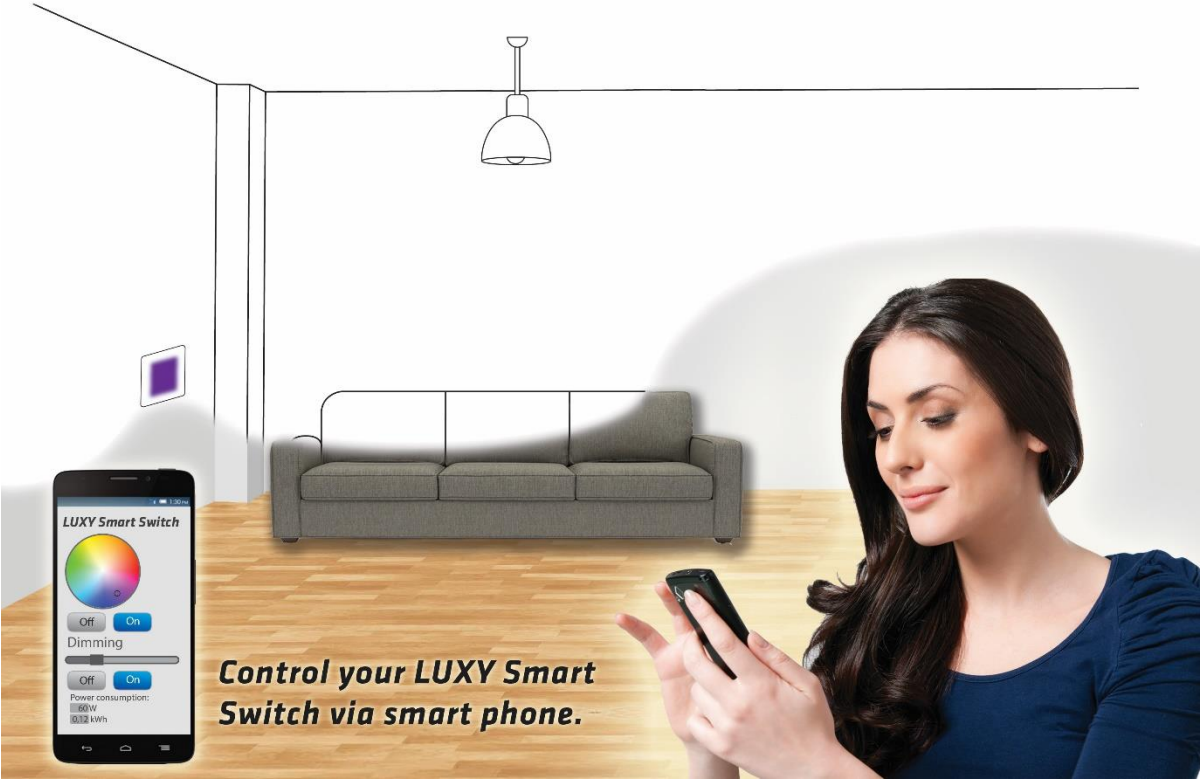

It is designed in a way that it fits in the flush mounting boxes at the height of the light switch or where you usually have electrical sockets. This means, Luxy Smart Switch can be quickly & easily installed anywhere in the house where you already have electricity (**neutral wire is mandatory for proper operation**) or where you can easily pull additional wires.

You can control Luxy Smart Switch manually, wirelessly or set it to work automatically.

If you use it as a standalone device, you can control it through 5 integrated touch-sensitive points on the surface. With a touch you can turn on/off the Luxy light, turn on/off the additional output, set the colour, dim the brightness, and choose between 4 lighting effects. The lighting scenes are inspired by nature and will help you set the mood, by simulating the ocean, sunrise, rainbow, and nature's colour scenes.

If you are a more advanced user, you can integrate Luxy Smart Switch into the Z-Wave network and enjoy plenty of other functionalities it offers. When connected to the gateway, Luxy Switch becomes a smart home device, enabling you to control it remotely via smartphone or tablet and creating more complex scenes, e.g. setting the time schedule.

One of the Luxy Smart Switch features is an additional power output for connecting other loads as room light, ceiling fan, IR panel, etc. It can trigger or be triggered by other devices.

Luxy Smart Switch supported functions as a Z-Wave device:



✓	Choosing among 16 million colours
✓	Output for connecting e.g. a room light or other loads
✓	Automatically turn ON/OFF Luxy light and/or connected output
✓	Dimming the Luxy light
✓	Associations
✓	Z-Wave Repeater
✓	Smart Start
✓	5 integrated touch-sensitive points on the surface

5. Functionalities

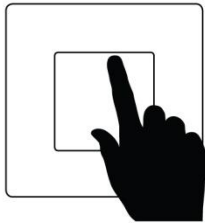

Nr. 1 (CENTER)	Turns ON/OFF the room light or any other load connected to Luxy Smart Switch output
Nr. 2 (UP)	Turns ON/OFF the Luxy light Dims the Luxy light
Nr. 3 (RIGHT)	Switches between 4 different lighting effects (ocean, sunrise, rainbow, and nature)
Nr. 4 (DOWN)	Turns ON/OFF the white light on the Luxy Dims the Luxy light
Nr. 5 (LEFT)	Starts the colour spectrum and stops at the colour you wish to have

5.1 Control it

With a touch on one of the 5 sides on the touch-sensitive surface (or touch screen)	Remotely via a smartphone	Set it to work automatically , according to the pre-programmed scenes, created on the Z-Wave gateway
		

5.2 Measurements and reporting

Measurements and reporting are only available for relay output.

Watt	Power – Active
kWh	Energy – Active power accumulated

Energy consumption in kWh is reported in 0.1 kWh resolution.

Active power in W is reported in 1 W resolution.

NOTE: For more options check parameter nr. 40.

5.3 Overload protection

Overload protection defined by user

The user has an option with parameter 70 to set an overload safety threshold. The threshold is set to 2300 W by default. If the power exceeds it for 5 seconds the Luxy Smart Switch relay will turn off, and a “Overload detected” notification will be sent. Controlled device can be turned back on by capacitive antenna/s or sending a control frame.

Overload safety protection

Overload safety protection is triggered if the load exceeds 10 A (2400 W) for more than 5 seconds. If the overload safety protection is triggered, the device will shut down the relay and start flashing red (1 sec ON, 0.5 sec OFF) and sends an overload notification message. Device is not responsive to touch commands or Z-wave commands. Controlled device can be turned back on with power cycle (mains cut off).

5.4 Lock touch functions for enabling output ON/OFF

This option enables/disables ONLY the touch functionality for closing/opening the relay output meant for switching ON/OFF the connected light or other connected load. While enabled, other touch functionalities are temporary unavailable. The option can be accessed:

Locally:

- You can choose any kind of light (also no light) except FULL white. Press and hold button 3 – right in between 6 to 9 seconds. Release the button.
- To revert the option, repeat the above procedure.

Remotely:

- Check the **Parameter no. 60 – Lock touch for relay only**. Set value to 1 (enable) or 0 (disable) the option.

NOTE: Your gateway needs to support advanced configuration and parameter input to use this feature.

5.5 Turning off alarms

When an alarm occurs (NOTIFICATION_REPORT is sent) Luxy Smart Switch starts blinking red, so you are notified.

As soon as the reason that caused the alarm is noted by the user, the alarm can be turned OFF:

Locally:

- If parameter 60 is set to its default value 0: Touch any out of the four integrated touch-sensitive points (excluding middle point) on the Luxy Smart Switch surface.
- If parameter 60 is set to the, non-default, value 1: Press and hold any out of the 4 integrated touch-sensitive points on the Luxy Smart Switch surface.

Remotely:

- Reset the alarm via gateway's user interface.

For more options, see **Parameter no. 3 – Turning off alarming**.

6. Use Cases

To get you an idea for your next smart home project, we have prepared a few real-life examples, where you can use Luxy Smart Switch. There are countless of options using Luxy as a standalone ambient light or in combination with a smart home system. In a smart home system Luxy can trigger or can be triggered by other Z-Wave devices.

6.1. Usage examples for Luxy Smart Switch

Example where Luxy Smart Switch is used as a light source for gentle and personalized illumination of your home in 16 million colours.

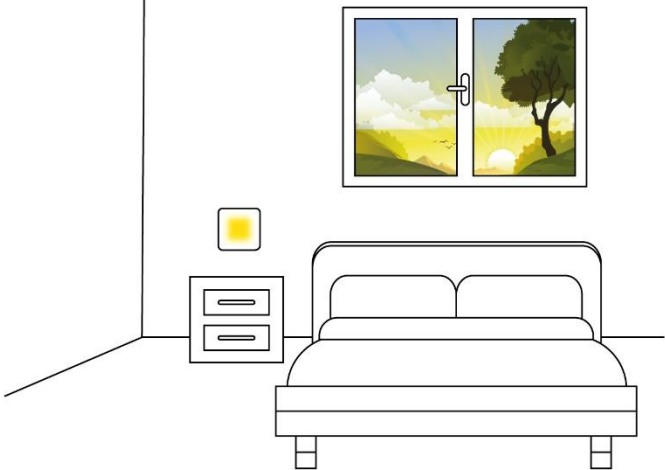
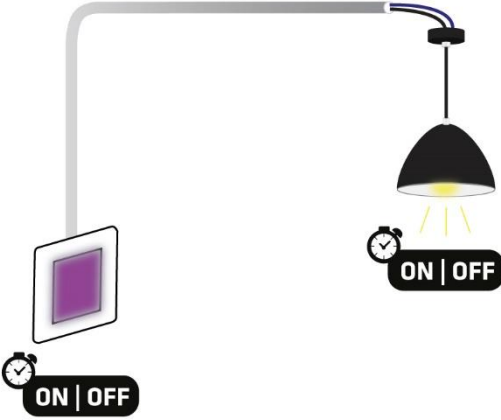
<p>As a visual alarm, for a gentle wake-up, with colours (example yellow) simulating the sunrise.</p>	
<p>Do you often forget to turn off a night light or main room light when you fall asleep?</p> <p>The Luxy Smart Switch can automatically turn ON or OFF after a set time (when you or your kids fall asleep). For example, the Luxy Smart Switch will automatically turn OFF if it has been ON for 30 minutes. This function is independent of other scenes and gateway (hub) commands.</p>	

6.2.Usage examples when Luxy Smart Switch is connected to a wireless device/sensor

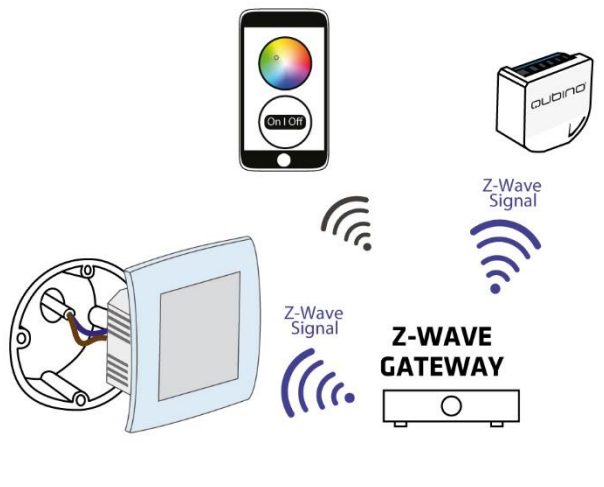
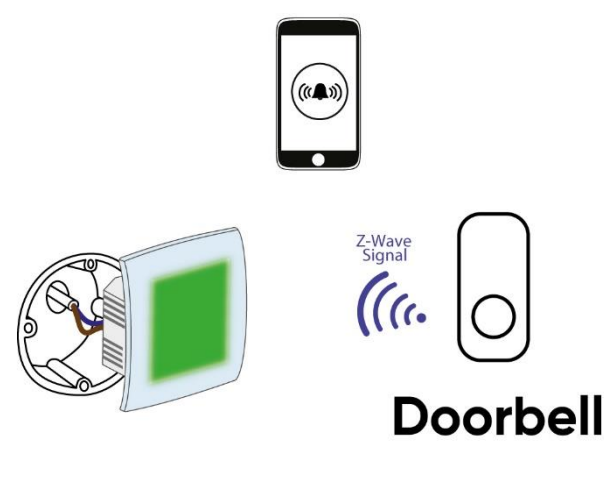
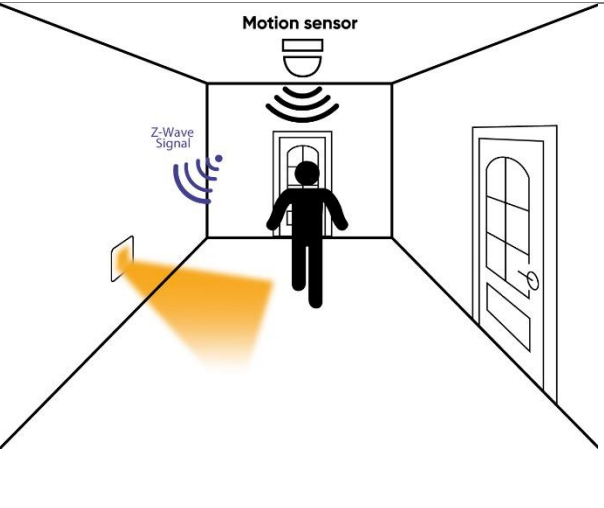
<p>Do you want to control other devices in your Z-Wave network with the Luxy Smart Switch?</p> <p>Connect the Luxy Smart Switch with other devices in your network and automatically trigger another Z-Wave device. And have other Z-Wave devices trigger your Qubino Luxy Smart Switch.</p>	 <p>The diagram illustrates a Luxy Smart Switch connected to a smartphone and a Z-Wave Gateway. The smartphone screen displays a color wheel and an 'On/Off' button. The Z-Wave Gateway is a small rectangular device. Blue Z-Wave signal waves connect the switch, smartphone, and gateway.</p>
<p>Connected to a wireless doorbell, Luxy can act as your visual doorbell. It illuminates in the colour you choose. This way you can completely personalize the way you want to be notified when getting visitors at the front door.</p>	 <p>The diagram shows a Luxy Smart Switch connected to a smartphone and a wireless doorbell. The smartphone screen displays a doorbell icon. The doorbell is a vertical rectangular device. Blue Z-Wave signal waves connect the switch, smartphone, and doorbell.</p> <p>Doorbell</p>
<p>Do not bother your eyes during nighttime with the too bright, main light in the corridor. Luxy can gently illuminate your corridor when the motion sensor detects movement. You can personalize the color and intensity of the Luxy light and set the period for how long it stays ON.</p>	 <p>The diagram depicts a hallway with a motion sensor on the ceiling and a Luxy Smart Switch on the wall. A person is walking in the hallway, and the Luxy light is illuminated in a warm orange glow. Blue Z-Wave signal waves connect the motion sensor and the Luxy light.</p> <p>Motion sensor</p>

Connected to a wireless motion sensor, Luxy can start blinking in red colour, so you are notified if there are any intruders around your house.

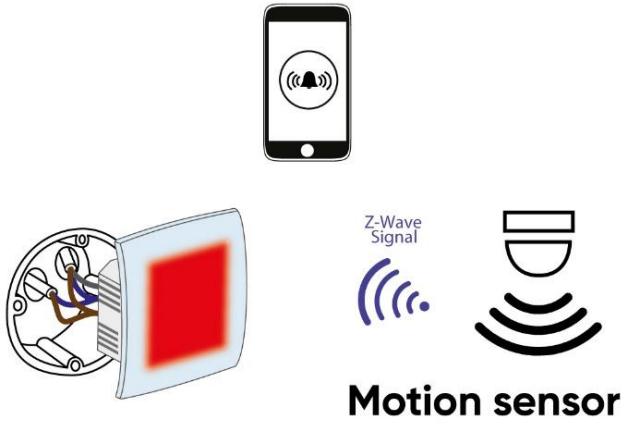

Connected to a wireless flood detector, Luxy can start blinking, when the water leakage is detected.

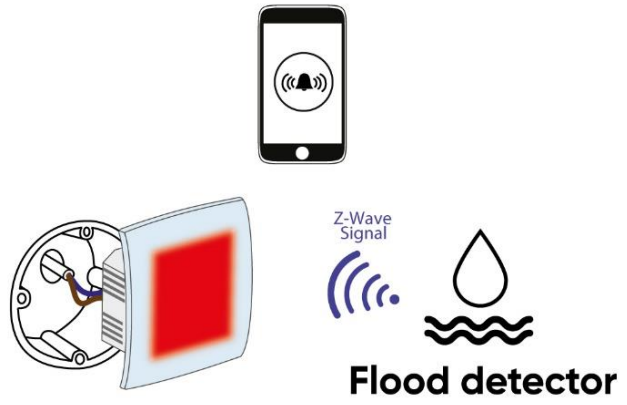

6.3. Usage examples when Luxy Smart Switch is connected to a wired device

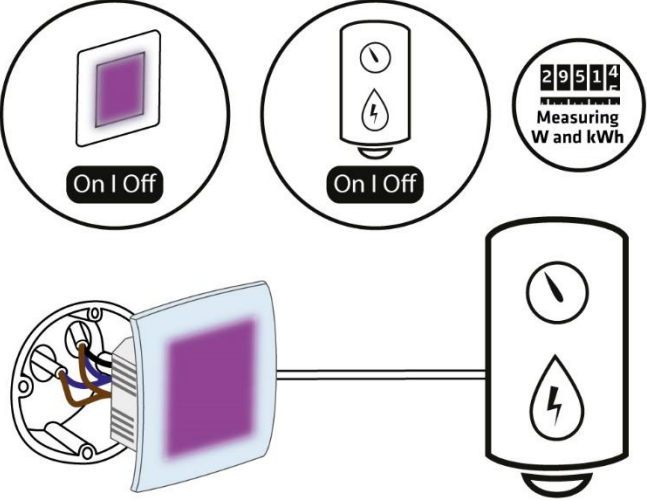
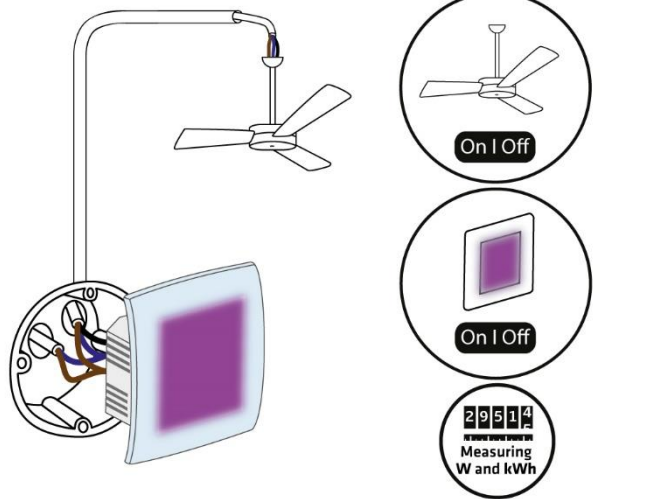
	<p>You can connect up to 10 A to its relay output.</p> <p>This means that even a water heater or...</p>
	<p>...ceiling fan, or...</p>

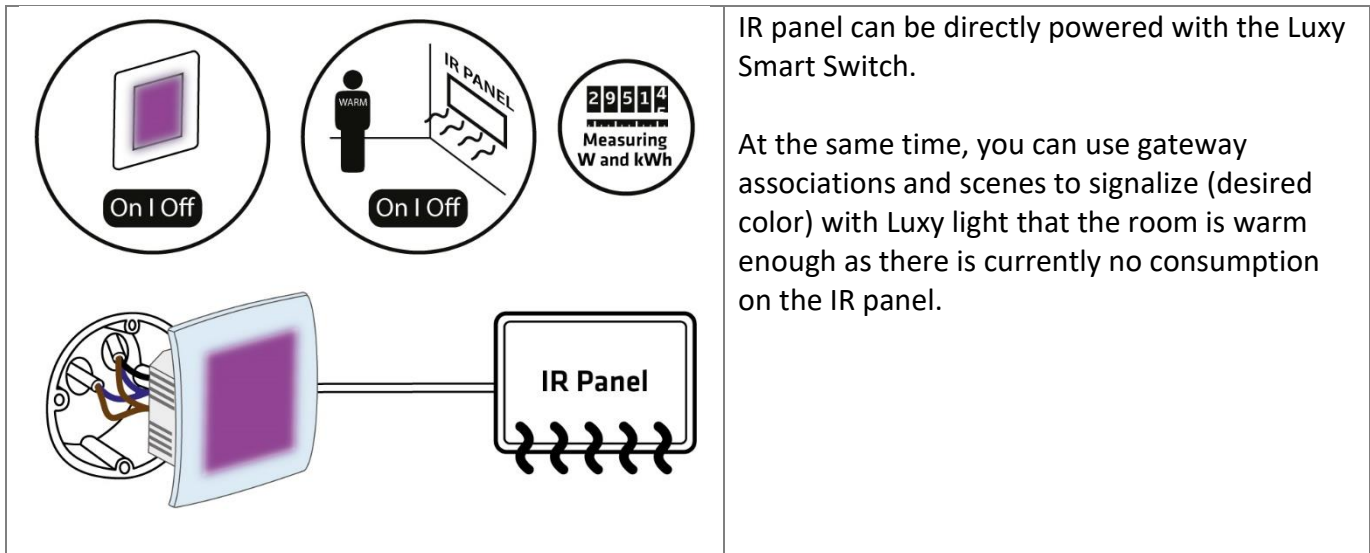

NOTE: Use cases demonstrate possible ways to use Luxy Smart Switch. Other, not mentioned use cases are still possible. Always bear in mind limitations of the Z-Wave gateways and the Z-Wave devices regarding associations, scenes, security types, etc.

7. Advantages and Highlights

7.1. Advantages

- Luxy Smart Switch offers you the possibility to connect a room light. It can be used as an independent light source, as an ambient light. At the same time, it can simply replace your existing light switch connected to the room light.
- Luxy Smart Switch is versatile, so you can connect other loads as well. Turn ON a ceiling fan, when wanting a cool breeze or switch ON your IR panel when feeling cold.
- Luxy Smart Switch can be **controlled**:
 - **Manually via 5 integrated touch-sensitive points on the surface**, designed in a way to not interfere with the light source.
 - Or **wirelessly** with just a simple **tap on your smartphone (via Z-Wave)**.
- Luxy Smart Switch can be **pre-programmed according to your needs**. For example, it can turn ON or OFF at any specific time. You can set two independent timers to turn ON/OFF the Luxy light itself or the load connected to it.

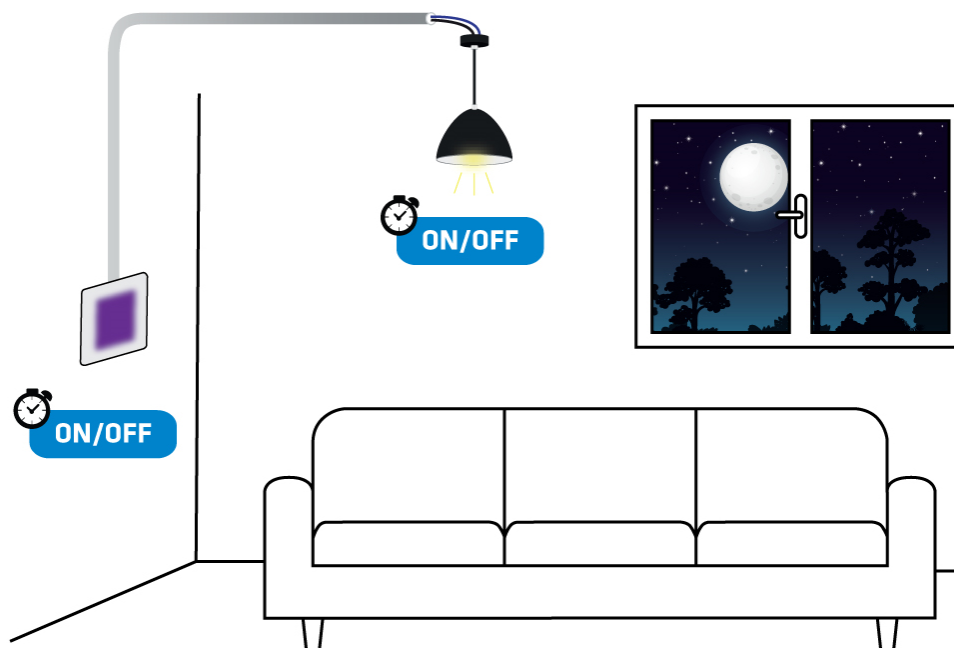

- Luxy Smart Switch comes with the **pre-programmed nature inspired lighting effects: Ocean, Nature, Sunrise, Rainbow** which will ensure you a relaxing lighting experience to help you start the day with more energy or to relax you after a tough day.



- As most walls are painted in bright colour, the **natural glass frame** makes it almost **invisible** on the wall, when turned OFF. When turned ON, it **disperses the coloured lighting effects beautifully**. The combination of RGB LEDs and a glass frame makes a wonderful effect when it shines.



- Qubino guarantees **100 % device quality**. Such high quality can be delivered because every Qubino device goes through rigorous quality control standards throughout the production process. Every device has a unique serial number and part number, which are assigned to the device only after it goes through a strict testing procedure.

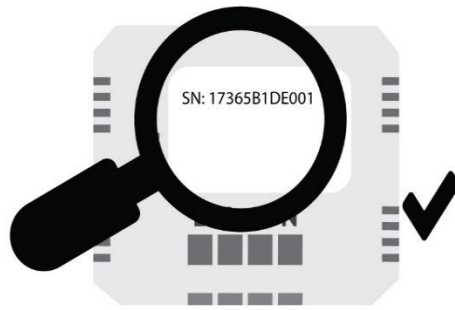

- Luxy Smart Switch is **engineered and manufactured in the EU** and contains only **the highest quality components**.

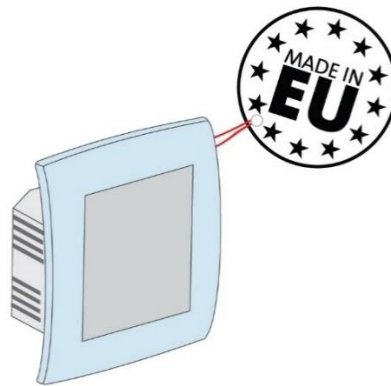

7.2. Highlights

- Features one of the easiest and quickest installations of devices of this kind
- Install it anywhere you like (hallway, stairway, bathroom, bedroom, living room, garage, terrace, etc.)
- Modern and minimalistic design
- The output can be used to directly power the main room light or other loads (water heater, IR panel, ceiling fan, etc.)
- Measures active power (W) and energy consumption (kWh) of the connected device
- You can choose between 16 million colours to fit your personal preference
- Energy efficient
- Saves and restores the last status after a power failure (set parameter 30 accordingly)
- Supports SmartStart mode for quick set up
- Supports additional parameters for expert users, which allows advanced configuration*
- Acts as a signal repeater which improves the range and stability of your Z-Wave network
- Can be triggered by other Z-Wave device

*Your gateway (hub) needs to support advanced configuration and parameter input if you wish to use this feature.

8. Package Contents

- Luxy Smart Switch device
- Glass Frame
- Mounting Frame with Claws
- Installation Manual
- S2 DSK label



9. Installation

Before installing the device, please read the following carefully and follow the instructions exactly:

① NOTES:

- Installation of this device requires a great degree of skill and may be performed only by a licensed and qualified electrician. Please keep in mind that even when the device is turned off, voltage may still be present in the device's terminals.
- Do not connect the device to loads outside recommended power range. Connect the device exactly as shown in the provided diagrams. Improper wiring may be dangerous and result in equipment damage.
- Capacitive antennas below the touch surface need proper calibration. This is done once the Luxy Smart Switch is mounted in its final position and powered up. Successful calibration is mandatory for proper operation of the product.

The installation process, tested and approved by professional electricians, consists of the following simple steps:

Step 1 – Turn OFF the fuse:

- To prevent electrical shock and/or equipment damage, disconnect electrical power at the main fuse or circuit breaker before installation and maintenance.
- Be aware that even if the circuit breaker is off, some voltage may remain in the wires — before proceeding with the installation, be sure no voltage is present in the wiring.
- Take extra precautions to avoid accidentally turning the device on during installation.

STEP 1

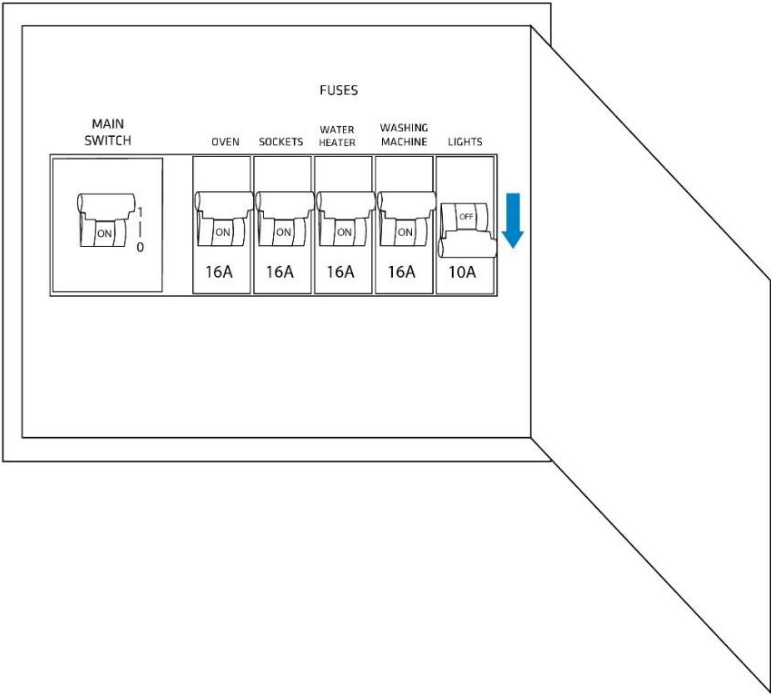

Step 2 – Installing the device:

Connect the load (if available) to the Luxy Smart Switch and then the mains power supply

STEP 2

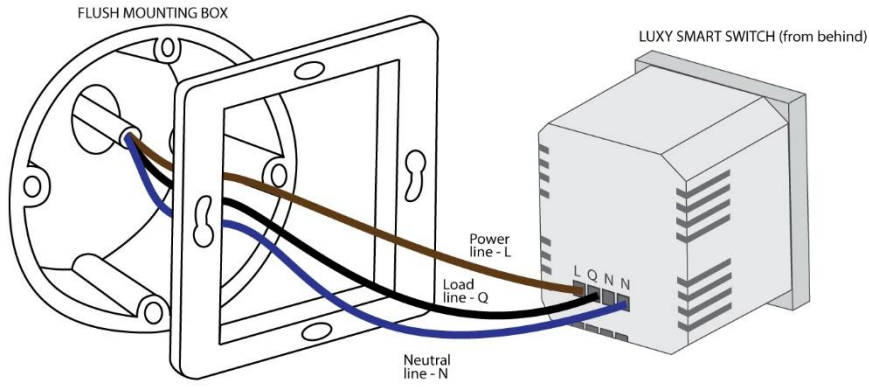

Insert the device into flush mounting box

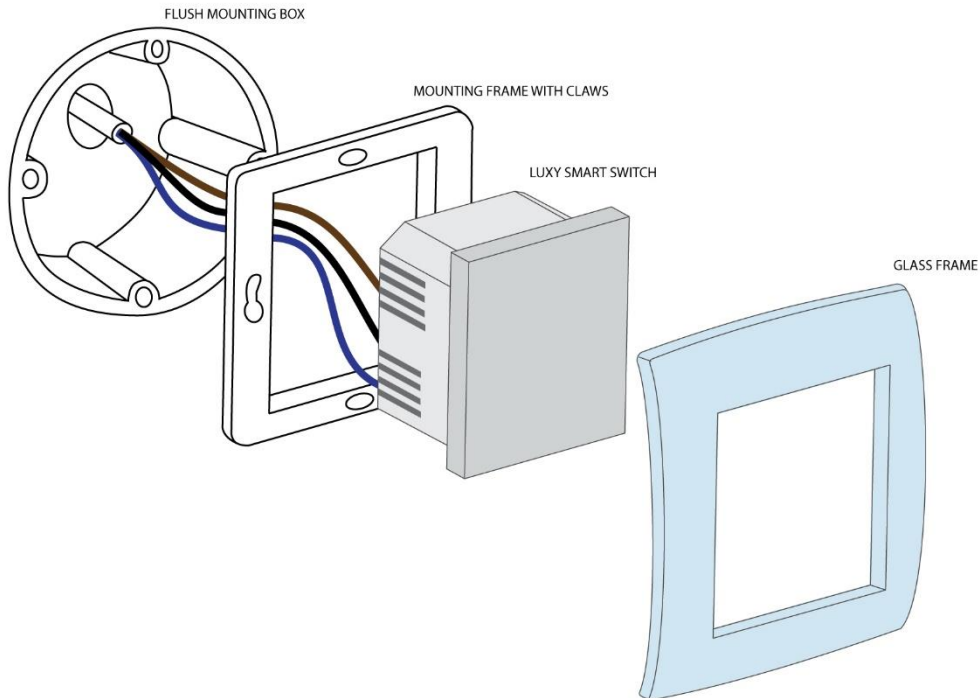

9.1. Installation examples of the Luxy Smart Switch

Connection of the Luxy Smart Switch with room light

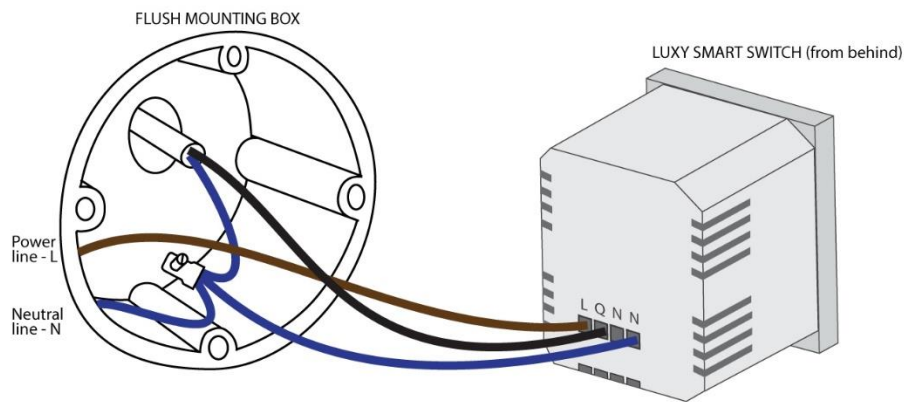
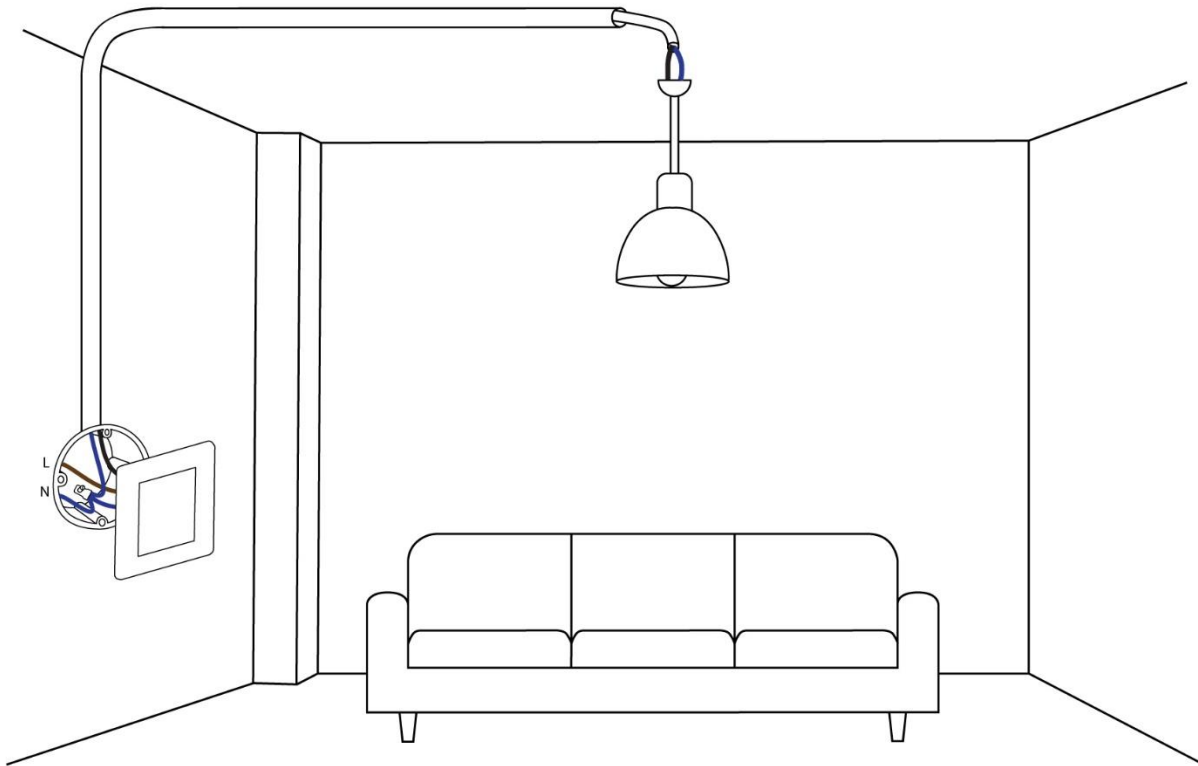

Connection of the Luxy Smart Switch with ceiling fan

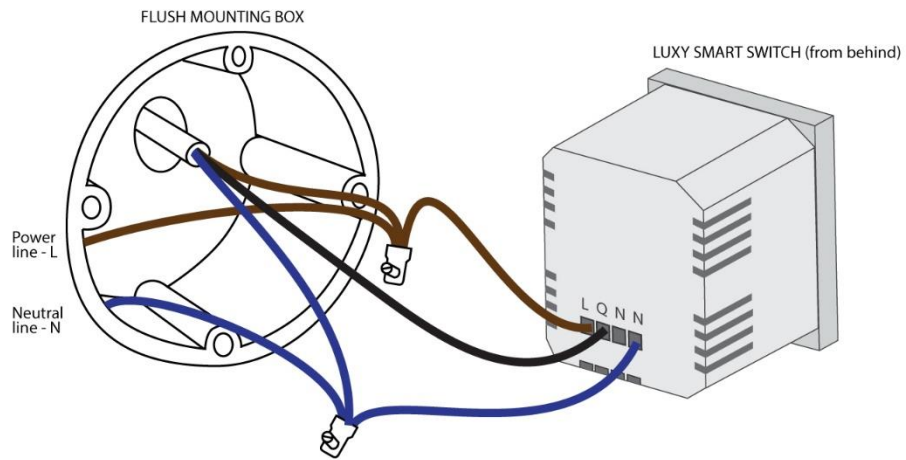
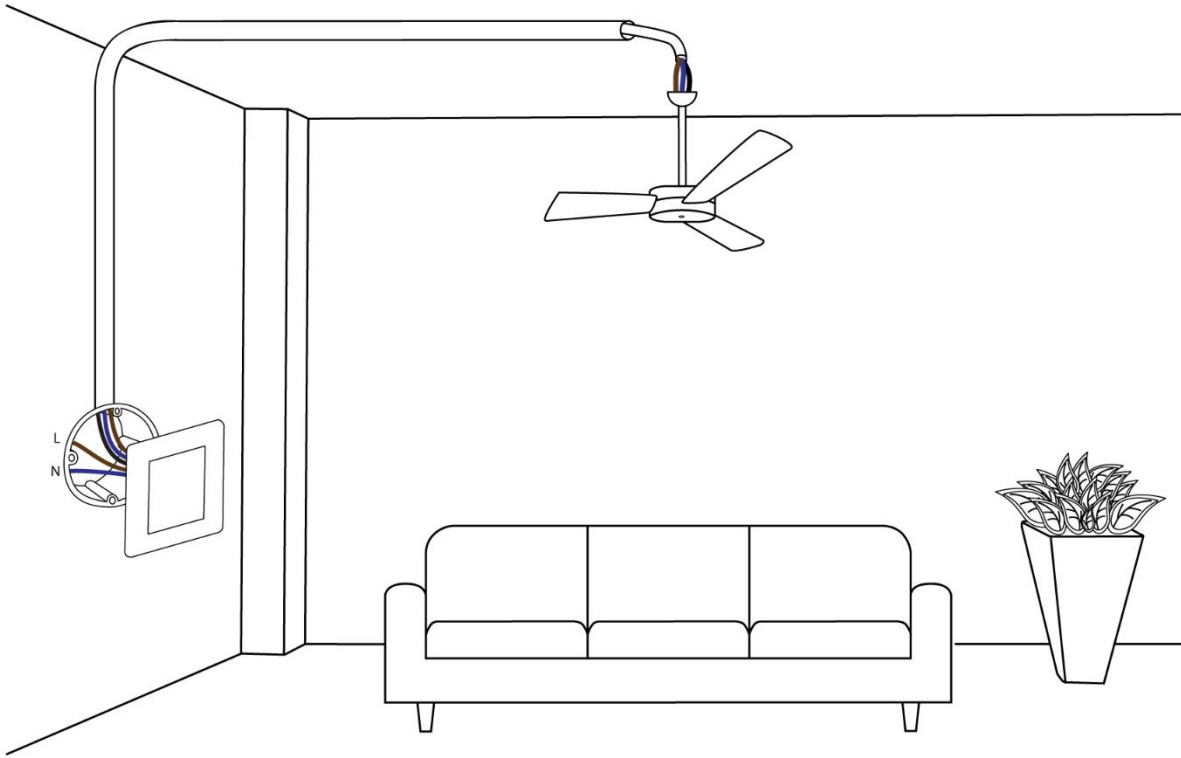

① **NOTE: Antenna positioning**

- Place the antenna as far as possible from metal elements as they may cause signal interference.
- Do not shorten the antenna.

The device’s antenna should be as upright as possible. This ensures the device’s operational range is maximized (up to 40 m (131 feet) line of sight).

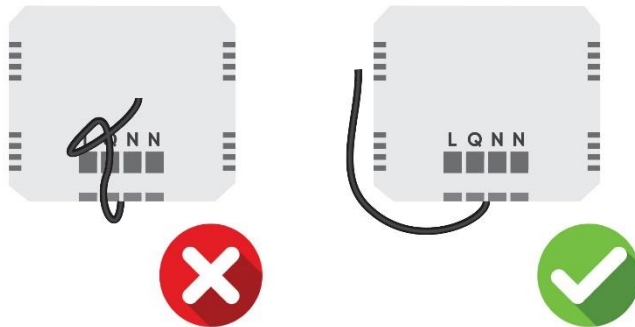

Step 3 – Turn ON the fuse:

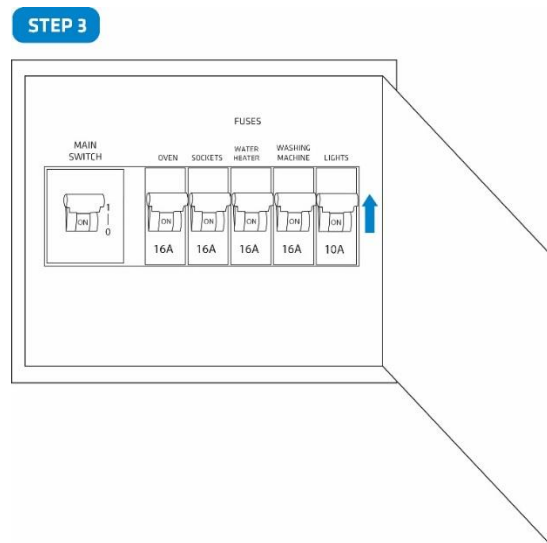

NOTE: On the 1st power up, the device starts in colour spectrum mode.

Step 4 – Include the device into the Z-Wave network

- For more details on how to include the device, please refer to the Z-Wave Inclusion chapter.



Step 5 – The Installation is now complete. It is time to make your life more comfortable with the help of the Qubino Luxy Smart Switch

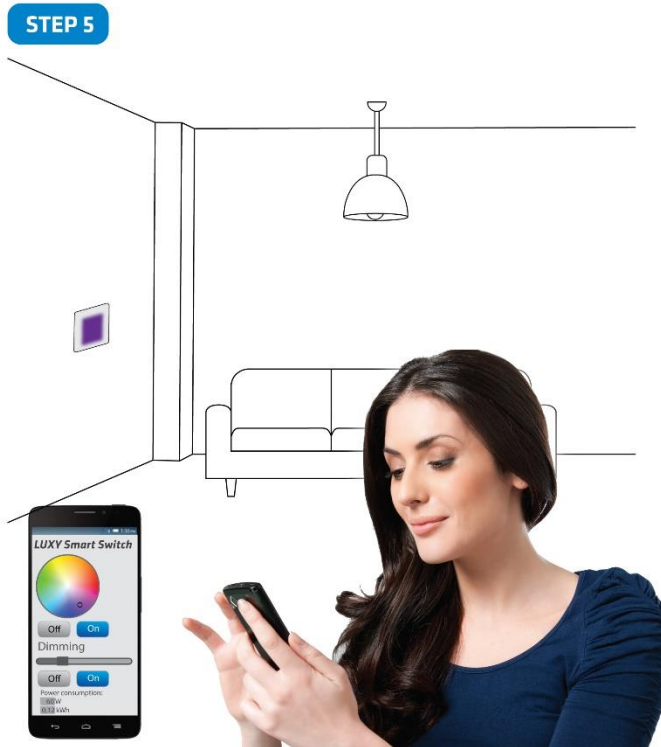

10. Technical Specification

Power supply	110 - 240 Vac \pm 10 % 50/60 Hz
Rated load current of relay output (resistive load)	1 x 10 A
Operation temperature	-10 ~ +40 °C
Z-Wave operation range	Up to 40 m indoors
Colours	16 million
Luminance	1090 cd/m ²
Standby/max. consumption	0,5 W / 1,5 W
Installation in boxes	$\varnothing \geq 60$ mm / at least 2M
Z-Wave Repeater	Yes
Dimensions (WxHxD) (with packaging)	93x90x45 mm / (149x136x53 mm)
Weight (with glass frame) (with packaging)	114 g / (230 g)

11. Electrical Diagram (230 Vac)

Wiring diagram - Load connection example 1

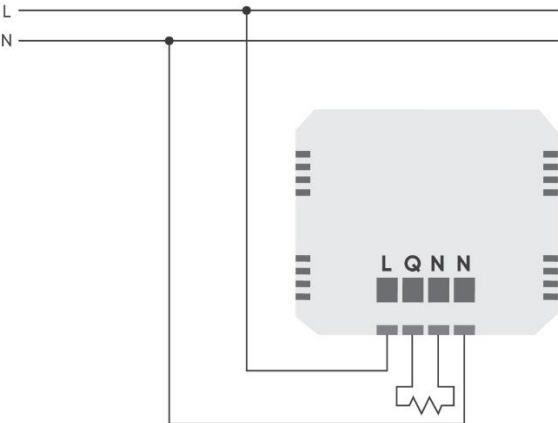

Wiring diagram - Load connection example 2

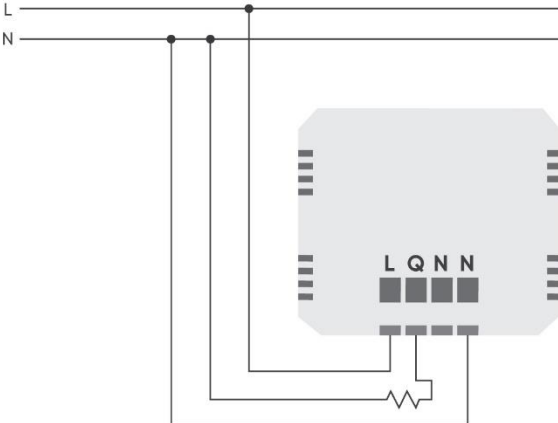

Wiring diagram – Without Load

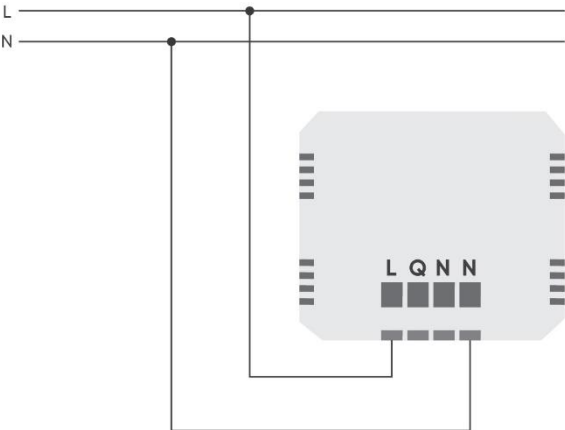

Legend

L	Live (line) wire
Q	Output terminal (connected to room light, IR panel, fan, etc.)
N	Neutral output (connected to load or left empty)
N	Neutral wire input

12. Z-Wave



The Z-Wave protocol is an interoperable, wireless, RF-based communications technology designed specifically for control, monitoring, and status reading applications in residential and light commercial environments. Mature, proven, and broadly deployed (with over 50 million products sold worldwide), Z-Wave is by far the world market leader in wireless control, bringing affordable, reliable, and easy-to-use 'smart' products to millions of people in every aspect of daily life.

Source: www.z-wavealliance.org

12.1. Adding the device to a Z-Wave network (Inclusion)

AUTOMATICALLY ADDING THE DEVICE TO A Z-WAVE NETWORK (SMARTSTART INCLUSION)

1. Scan QR code on device label and add S2 DSK to Provisioning List in gateway (hub).
2. Connect the device to the power supply.
3. Make sure the device is within direct range of your Z-Wave gateway (hub).
4. Inclusion will be initiated automatically within few seconds of connection to the power supply and the device will automatically enrol in your network (when the device is excluded and connected to the power supply it automatically enters the LEARN MODE state).

MANUALLY ADDING THE DEVICE TO A Z-WAVE NETWORK (MANUAL INCLUSION)

NOTE: check chapter 5.4



Nr. 1 (CENTER)	Turns ON/OFF the room light or other load connected to Luxy Smart Switch output
Nr. 2 (UP)	Turns ON/OFF the Luxy light Dims the Luxy light
Nr. 3 (RIGHT)	Switches between 4 different lighting effects (ocean, sunrise, rainbow, and nature)
Nr. 4 (DOWN)	Turns ON/OFF the white light on the Luxy Dims the Luxy light
Nr. 5 (LEFT)	Starts the colour spectrum and stops at the colour you wish to have

1. Enable add/remove mode on your Z-Wave gateway (hub).
2. Connect the device to the power supply.
3. Make sure the device is within direct range of your Z-Wave gateway (hub).
4. Press once on button 3 – right. One press on button 4 – down for enabling full white. When full white is enabled, press, and hold button 3 – right, between 4 and 6 seconds. After 6 seconds, the device starts flashing green (1 second ON, 0.5 second OFF). Once the device receives node ID (after 10 seconds), it stops flashing and turns full green. The procedure is always available.

12.2. Z-Wave Security

Luxy Smart Switch supports the latest Security 2 feature. Security S2 is handled by the Strong AES 128 Encryption protocol, which means that the S2 makes Z-Wave the most secure IoT (Internet of Things) security platform out there. To fully utilize the product and its SECURITY 2 feature, a Security Enabled Z-Wave gateway (hub) must be used.

Authenticated Control

- Out-Of-Band Device Specific Key for inclusion
- May be used by most implementations

Also supports: Security S2 Unauthenticated, Security S0 and Unsecure inclusion.

IMPORTANT: When adding the Luxy Smart Switch to a Z-Wave network with a controller supporting Security 2 (S2), the PIN code of the Z-Wave Device Specific Key (DSK) is required. The unique DSK code is printed on the product label and a copy is inserted in the packaging, which must not be lost. Do not remove the DSK from the product. As a backup measure, use the label in the packaging.

The first five digits of the key are highlighted or underlined to help the user identify the PIN code portion of the DSK text.

The DSK is additionally represented with a QR Code as shown here.



DSK label and QR code (example)

A joining node requesting to join the S2 Access Control Class or the S2 Authenticated Class will obfuscate its Public Key by setting the bytes 1..2 to zeros (0x00) before transferring its key via RF.

A joining node requesting to join only the S2 Unauthenticated Class will send the its full Public Key when transferring the key via RF as the including node has no access to the DSK.

The DSK may be used for out-of-band (OOB) authentication.

- The including gateway (hub) may use QR code scanning device to read the entire DSK off the joining device and match it with the obfuscated public key received via RF from the joining device.

SmartStart enabled products can be added into a Z-Wave network by scanning the Z-Wave QR Code present on the product with a controller providing SmartStart inclusion. No further action is required and the SmartStart product will be added automatically within 10 minutes of being switched on in the network vicinity.

12.3. Removing the device from a Z-Wave network (Exclusion)

NOTE: check chapter 5.4

1. Connect the device to the power supply.
2. Make sure the device is within direct range of your Z-Wave gateway (hub) or use a hand-held Z-Wave remote to perform exclusion.
3. Enable add/remove mode on your Z-Wave gateway (hub).
4. Press once on button 3 – right. One press on button 4 – down for enabling full white. When full white is enabled, press, and hold button 3 – right for 5 seconds. After 5 seconds, the device starts flashing red 1 second ON, 0.5 second OFF.

Once the device loses node ID (after 10 seconds), it stops flashing and turns full red. The procedure is always available.

NOTE1: LEARN MODE state allows the device to receive network information from the controller.

12.4. Device factory reset

NOTE: check chapter 5.4

1. Connect the device to the power supply.
2. Press once on button 3 – right. One press on button 4 – down for enabling full white. When full white is enabled, press, and hold button 5 – left for 10 seconds. After 10 seconds, the device starts flashing blue 1 second on, 0.5 second off.

After 10 seconds the device stops flashing and turns full blue.

The procedure is always available.

 By factory resetting the device, all custom parameters previously set on the device will return to their default values, and the node ID will be deleted. Use this reset procedure only when the main gateway (hub) is missing or otherwise inoperable.

12.5. Associations

Use associations for direct communication between the Luxy Switch and other devices within your Z-Wave network without the need of your primary gateway (hub).

Association Groups

Root endpoint:

Group ID	Name	Maximum allowed nodes	Description
1	Lifeline	1	<p>Supports following commands:</p> <ul style="list-style-type: none"> • COMMAND_CLASS_DEVICE_RESET_LOCALLY, DEVICE_RESET_LOCALLY_NOTIFICATION - triggered upon reset, • COMMAND_CLASS_SWITCH_MULTILEVEL_V4, SWITCH_MULTILEVEL_REPORT_V4 - triggered upon change of brightness, • COMMAND_CLASS_SWITCH_COLOR_V3, SWITCH_COLOR_REPORT_V3 - triggered upon change of color, • COMMAND_CLASS_NOTIFICATION_V8, NOTIFICATION_REPORT_V8 - triggered upon change of alarm detection state or upon current overload detection, • COMMAND_CLASS_SWITCH_BINARY, SWITCH_BINARY_REPORT - is triggered when a change of output state of relay occurs. • COMMAND_CLASS_METER, METER_REPORT - triggered upon energy consumption change according to configuration parameters 40 and 42. • CONFIGURATION_REPORT – triggered upon a local change of the working mode of the four capacitive buttons (see chapter 5.4) <p>Reserved for communication with the primary gateway/hub. Used to report unsolicited messages to the controller.</p>
2	LEDs on/off	5	<p>Supports the following command:</p> <ul style="list-style-type: none"> • COMMAND_CLASS_BASIC_V2, BASIC_SET_V2 - is triggered when a change of output state occurs; LEDs are on/off.

3	Change of brightness	5	Supports the following command: <ul style="list-style-type: none"> COMMAND_CLASS_SWITCH_MULTILEVEL_V4, SWITCH_MULTILEVEL_SET_V4 - is triggered when a change of output state occurs; brightness changes.
4	Change of color	5	Supports the following command: <ul style="list-style-type: none"> COMMAND_CLASS_SWITCH_COLOR_V3, SWITCH_COLOR_SET_V3 - is triggered when a change of output state occurs; colour changes.
5	Relay on/off	5	Supports the following command: <ul style="list-style-type: none"> COMMAND_CLASS_BASIC_V2, BASIC_SET_V2 - is triggered when a change of output state of relay occurs.

Endpoint 1 (LEDs):

Group ID	Name	Maximum allowed nodes	Description
1	Lifeline	0	Supports following commands: <ul style="list-style-type: none"> COMMAND_CLASS_NOTIFICATION_V8, NOTIFICATION_REPORT_V8- triggered upon change of alarm detection state COMMAND_CLASS_SWITCH_MULTILEVEL_V4, SWITCH_MULTILEVEL_REPORT_V4 - is triggered when a change of output state occurs, brightness changes COMMAND_CLASS_SWITCH_COLOR_V3, SWITCH_COLOR_REPORT_V3 - triggered upon change of brightness,
2	LEDs on/off	5	Supports the following command: <ul style="list-style-type: none"> COMMAND_CLASS_BASIC_V2, BASIC_SET_V2 - is triggered when a change of output state occurs; LEDs are on/off.
3	Change of brightness	5	Supports the following command: <ul style="list-style-type: none"> COMMAND_CLASS_SWITCH_MULTILEVEL_V4, SWITCH_MULTILEVEL_SET_V4 - is triggered when a change of output state occurs; brightness changes.

4	Change of color	5	Supports the following command: <ul style="list-style-type: none">• <code>COMMAND_CLASS_SWITCH_COLOR_V3, SWITCH_COLOR_SET_V3</code> - is triggered when a change of output state occurs; colour changes.
---	-----------------	---	------------------------------------------------------------------------------------------------------------------------------------------------------------------------------------------------------------------------

Endpoint 2 (Relay):

Group ID	Name	Maximum allowed nodes	Description
1	Lifeline	0	<p>Supports following commands:</p> <ul style="list-style-type: none"> • COMMAND_CLASS_NOTIFICATION_V8, NOTIFICATION_REPORT_V8 - triggered upon current overload detection, • COMMAND_CLASS_SWITCH_BINARY, SWITCH_BINARY_REPORT - is triggered when a change of output state of relay occurs. • COMMAND_CLASS_METER, METER_REPORT - triggered upon energy consumption change according to configuration parameters 40, 42
2	Relay on/off	5	<p>Supports the following command:</p> <ul style="list-style-type: none"> • COMMAND_CLASS_BASIC_V2, BASIC_SET_V2 - is triggered when a change of output state of relay occurs.

12.6. Notification Command Class

The Luxy Smart Switch supports the following notification types and events:

Notification Type	Notification Event
Siren (0x0E)	Siren active (0x01)
Power Management (0x08)	Over-load detected (0x08)

Siren

The device sends a NOTIFICATION_REPORT, with the listed type and event, when it receives a NOTIFICATION_REPORT.

The device can behave in one of two ways:

- When it receives a NOTIFICATION_REPORT(notificationType=0x08=POWER_MANAGEMENT) the device will start blinking with a yellow color.
- When the device receives any other NOTIFICATION_REPORT, it will start blinking with a red color.

The device will continue to do so, until the user puts it back into its default state, which can be done either with Z-Wave command or by physically touching the buttons of the device, so that a change of output state occurs. There is some control of this behaviour, described in the configuration parameters no. 3.

When the device receives notification report with State Idle (0x00), it will change state to Idle and stop signaling alarmed state (LEDs stop blinking).

Power Management

In case of exceeding the power value set in parameter 70 Overload safety switch (default 2300 W) for more than 5 seconds, the Luxy Smart Switch automatically turns off the output and the overload notification is sent (0x08 Over-load detected).

In case the parameter 70 is disabled the Luxy smart switch has a fixed overload safety value of 2400 W to prevent any damage to the module. In this case if the active power is greater than 2400 W for 5 seconds or more, the output is turned off automatically and the overload notification is sent (0x08 Over-load detected).

12.7. Configuration Parameters

Parameter no. 1 – Relay contact type

Defines the contact type when open/closed contact.

Values (size is 1-byte dec):

- Default value 0
- 0 - NO (normally open) output type
- 1 - NC (normally close) output type

Parameter no 3. – turning off alarming

Values (size is 1-byte dec):

- Default value 1
- 0 – only by z-wave command (basic set, switch multilevel set, switch multilevel start/stop level change, switch color set, switch color start/stop level change, notification report idle)
- 1 – capacitive input (up, down, left, right) or z-wave command (basic set, switch multilevel set, switch multilevel start/stop level change, , switch color set, switch color start/stop level change, notification report idle)

Parameter no. 10. – auto on timer

Defines the time after which the device is turned to last known state.

Values (size is 1-byte dec):

- Default value 0
- 0 – disabled
- 30 – 32535 = 30 – 32535 seconds after which the device turns on

Parameter no. 11. – auto off timer

Values (size is 2-byte dec):

Defines the time after which the device is turned to last known state.

- Default value 0
- 0 – disabled
- 30 – 32535 = 30 – 32535 seconds after which the device turns off

Parameter no. 12. – auto on timer relay

Defines the time after which the device's relay is turned to last known state.

Values (size is 2-byte dec):

- Default value 0
- 0 – disabled
- 30 – 32535 = 30 – 32535 seconds after which the device turns on

Parameter no. 13. – auto off timer relay

Defines the time after which the device's relay is turned to last known state.

Values (size is 2-byte dec):

- Default value 0
- 0 – disabled
- 30 – 32535 = 30 – 32535 seconds after which the device turns off

Parameter no. 30. – restore state on power failure

Values (size is 1-byte dec):

- Default value 1
- 1 – enabled (the device will restore state on power failure)
- 0 – disabled (the device will not restore state on power failure and will remain off)

Parameter no. 31. – restore relay state on power failure

Values (size is 1-byte dec):

- Default value 1
- 1 – enabled (the device will restore state on power failure)
- 0 – disabled (the device will not restore state on power failure and will remain off)

Parameter no. 40 – Watt Power Consumption Reporting Threshold for Load

Choose by how much power consumption needs to increase or decrease to be reported. Values correspond to percentages so if 10 is set (by default), the device will report any power consumption changes of 10 % or more compared to the last reading.

Values (size is 2-byte dec):

- Default value 10
- 0 - Power consumption reporting disabled
- 1 - 100 = 1 % - 100 % Power consumption reporting enabled. New value is reported only when Wattage in real time changes by more than the percentage value set in this parameter compared to the previous Wattage reading, starting at 1 % (the lowest value possible).

NOTE: Power consumption needs to increase or decrease by at least 1 Watt to be reported, REGARDLESS of percentage set in this parameter.

Parameter no. 42 – Watt Power Consumption Reporting Time Threshold for Load

Set value refers to the time interval with which power consumption in Watts is reported (0 – 32535 seconds). If 300 is entered (by default), energy consumption reports will be sent to the gateway (hub) every 300 seconds (or 5 minutes).

Values (size is 2-byte dec):

- Default value 0
- 0 - Power consumption reporting disabled
- 30 - 32535 = 30 - 32535 seconds. Power consumption reporting enabled. Report is sent according to time interval (value) set here.

Parameter no. 60 – Lock touch for relay only

This parameter enables ONLY the touch functionality for closing/opening the relay meant for switching ON/OFF the connected light or any other connected load. See chapter 5.4 for additional information.

Values (size is 1-byte dec):

- Default value 0
- 0 – disabled
- 1 – enabled (the user can switch ON/OFF the connected light or any other connected load by touching ANY button. Other functionalities (lighting mode, scenes, dimming and full white, inclusion/exclusion and reset) are unavailable until function disabled).

Parameter no. 70 - Overload safety switch

The function allows for turning off the controlled device in case of exceeding the defined power for more than 5 sec. Controlled device can be turned back on by capacitive antenna/s or sending a control frame.

Values (size is 2-byte dec):

- Default value 2300
- 0 = function not active
- 1 – 2300 = 1 W – 2300 W

ⓘ NOTE: This functionality is not an overload safety protection, please check chapter “Functionalities” for more details.

In case of overload the following message will be send towards the controller:

COMMAND_CLASS_NOTIFICATION_V5

The Alarm V1 type field set to 0x00

Notification Type 0x08 and 0x08 (Overload detected)

12.8. Z-Wave Command Classes

ROOT ENDPOINT (LED control):

Device Classes:

GENERIC_TYPE_SWITCH_MULTILEVEL (0x11)
 SPECIFIC_TYPE_COLOR_TUNABLE_MULTILEVEL (0x02)

Supported Z-Wave Command Classes:

COMMAND_CLASS_ZWAVEPLUS_INFO_V2
 COMMAND_CLASS_SUPERVISION_V1
 COMMAND_CLASS_TRANSPORT_SERVICE_V2
 COMMAND_CLASS_SECURITY_V1
 COMMAND_CLASS_SECURITY_2_V1

 COMMAND_CLASS_SWITCH_COLOR_V3 [S0]* [S2]*
 COMMAND_CLASS_ASSOCIATION_V2 [S0]* [S2]*
 COMMAND_CLASS_ASSOCIATION_GRP_INFO_V3 [S0]* [S2]*
 COMMAND_CLASS_MULTI_CHANNEL_ASSOCIATION_V3 [S0]* [S2]*
 COMMAND_CLASS_VERSION_V2 [S0]* [S2]*
 COMMAND_CLASS_MANUFACTURER_SPECIFIC_V2 [S0]* [S2]*
 COMMAND_CLASS_DEVICE_RESET_LOCALLY_V1 [S0]* [S2]*
 COMMAND_CLASS_POWERLEVEL_V1 [S0]* [S2]*
 COMMAND_CLASS_SWITCH_MULTILEVEL_V4 [S0]* [S2]*
 COMMAND_CLASS_SWITCH_BINARY_V1 [S0]* [S2]*
 COMMAND_CLASS_BASIC_V2 [S0]* [S2]*
 COMMAND_CLASS_METER_V4 [S0]* [S2]*
 COMMAND_CLASS_CONFIGURATION_V1 [S0]* [S2]*
 COMMAND_CLASS_NOTIFICATION_V8 [S0]* [S2]*
 COMMAND_CLASS_MULTI_CHANNEL_V4 [S0]* [S2]*

ENDPOINT 1 (LED control):

Device Classes:

GENERIC_TYPE_SWITCH_MULTILEVEL (0x11)
 SPECIFIC_TYPE_COLOR_TUNABLE_MULTILEVEL (0x02)

Supported Z-Wave Command Classes:

COMMAND_CLASS_ZWAVEPLUS_INFO_V2
 COMMAND_CLASS_SUPERVISION_V1
 COMMAND_CLASS_SECURITY_V1
 COMMAND_CLASS_SECURITY_2_V1

COMMAND_CLASS_SWITCH_COLOR_V3 [S0]* [S2]*
 COMMAND_CLASS_ASSOCIATION_V2 [S0]* [S2]*
 COMMAND_CLASS_ASSOCIATION_GRP_INFO_V3 [S0]* [S2]*
 COMMAND_CLASS_MULTI_CHANNEL_ASSOCIATION_V3 [S0]* [S2]*
 COMMAND_CLASS_SWITCH_MULTILEVEL_V4 [S0]* [S2]*
 COMMAND_CLASS_SWITCH_BINARY_V1 [S0]* [S2]*
 COMMAND_CLASS_BASIC_V2 [S0]* [S2]*
 COMMAND_CLASS_METER_V4 [S0]* [S2]*
 COMMAND_CLASS_NOTIFICATION_V8 [S0]* [S2]*

ENDPOINT 2 (built-in relay control)**Device Classes:**

GENERIC_TYPE_SWITCH_BINARY (0x10)
 SPECIFIC_TYPE_POWER_SWITCH_BINARY (0x01)

Supported Z-Wave Command Classes:

COMMAND_CLASS_ZWAVEPLUS_INFO_V2
 COMMAND_CLASS_SUPERVISION_V1
 COMMAND_CLASS_SECURITY_V1
 COMMAND_CLASS_SECURITY_2_V1

COMMAND_CLASS_ASSOCIATION_V2 [S0]* [S2]*
 COMMAND_CLASS_ASSOCIATION_GRP_INFO_V3 [S0]* [S2]*
 COMMAND_CLASS_MULTI_CHANNEL_ASSOCIATION_V3 [S0]* [S2]*
 COMMAND_CLASS_SWITCH_BINARY_V1 [S0]* [S2]*
 COMMAND_CLASS_BASIC_V2 [S0]* [S2]*
 COMMAND_CLASS_METER_V4 [S0]* [S2]*
 COMMAND_CLASS_NOTIFICATION_V8 [S0]* [S2]*

*[S0] Security Command Class

*[S2] Security S2 Command Class

① NOTE: This product can be included and operated in any Z-Wave network with other Z-Wave certified devices from any other manufacturers. All constantly powered nodes in the same network will act as repeaters regardless of the vendor to increase reliability of the network.

① NOTE: This device must be used in conjunction with a Security Enabled Z-Wave Controller to fully utilize all implemented functions.

① NOTE: This device is a security enabled Z-Wave Plus product that can use encrypted Z-Wave Plus messages to communicate to other security enabled Z-Wave Plus products.

① NOTE: DSK access via UI

Gateways, which implement the S2 and Smart Start security feature, display an input dialog box, with a full or partial DSK key. Most of them display a partial DSK (they do not show the PIN code) when the device is included with the S2-Authenticated security scheme. When included with the S2-Unauthenticated, some gateways show the complete DSK while others perform the complete inclusion process without prompting the user with the dialogue.

① NOTE: MAPPING OF COMMAND_CLASS_BASIC

The COMMAND_CLASS_BASIC is mapped into COMMAND_CLASS_SWITCH_MULTILEVEL, on the root endpoint and endpoint1. On endpoint2, COMMAND_CLASS_BASIC is mapped into COMMAND_CLASS_SWITCH_BINARY, for enabling relay control:

On the root endpoint and endpoint1, the 4 LEDs will be turned ON or OFF after receiving the BASIC_SET command:

- they will be turned on, when the device receives a BASIC_SET(Value=0x01-0x063) (1-99%)
- they will be turned on to the last non-zero value, when the device receives a BASIC_SET(Value=0xFF)
- they will turn off, when the device receives a BASIC_SET(Value=0x00)

On endpoint2, the relay will be turned ON or OFF, after receiving the BASIC_SET command:

- the relay will be turned on, when the device receives a BASIC_SET(Value=0x01-0x063) (1-99%)
- the relay will also turn on, when the device receives a BASIC_SET(Value=0xFF)
- the relay will turn off, when the device receives a BASIC_SET(Value=0x00)

① NOTE: Answering on a METER_GET_V1 command:

When the device receives a METER_GET_V1 command, it will answer with a METER_REPORT_V4, with the field values rateType=1 and scale=0 (kWh).

13. Important Disclaimer

Z-Wave wireless communication is not always 100% reliable. This device should not be used in situations in which life and/or valuables are solely dependent on its functioning. If the device is not recognized by your gateway (hub) or shows up incorrectly, you may need to change the device type manually and make sure your gateway (hub) supports multi-channel devices. Contact us for help before returning the device: <http://qubino.com/support/#email>

14. Warning

Do not dispose of electrical appliances as unsorted municipal waste, use separate collection facilities. Contact your local government for information regarding the collection systems available. If electrical appliances are disposed of in landfills or dumps, hazardous substances can leak into the groundwater and get into the food chain, damaging your health and well-being. When replacing old appliances with new ones, the retailer is legally obligated to take back your old appliance for disposal free of charge.

15. Regulations

Legal Notice

This user manual is subject to change and improvement without notice. GOAP d.o.o. Nova Gorica reserves all rights to revise and update all documentation without any obligation to notify any individual or entity.

WEEE

According to the WEEE (Waste electrical and electronic equipment) Directive, do not dispose of this product as household waste or commercial waste. Waste electrical and electronic equipment should be appropriately collected and recycled as required by practices established for your country. For information on recycling of this product, please contact your local authorities, your household waste disposal service or the shop where you purchased the product.



NOTE: User manual is valid for devices with SW version V1.1.

GOAP d.o.o. Nova Gorica

Ulica Klementa Juga 007, 5250 Solkan, Slovenia

E-mail: info@qubino.com

Tel: +386 5 335 95 00

Web: www.qubino.com

Date: 25.08.2020; V 1.1.7

[DON'T MISS OTHER INVENTIONS FROM QUBINO – CLICK HERE AND CHECK OUT QUBINO'S COMPLETE PORTFOLIO](#)